

RS261M**

Refrigerator user manual

English

imagine the possibilities



Thank you for purchasing this Samsung product.
To receive more complete service,
please register your product at
www.samsung.com/register



Free Standing Appliance

features of your side-by-side refrigerator

KEY FEATURES OF YOUR NEW REFRIGERATOR

Your Samsung Refrigerator comes equipped with various innovative storage and energy-efficient features.

- **Xtra Space™**
Vertical room next to the ice maker in the freezer provides space for pizza etc.
- **Door Alarm**
Beep sound reminds you the door is open.
- **Vegetable Crisper**
Optimized humidity control keeps vegetables & fruits fresh.
- **Compact Ice Maker**
- **Water Filtration System**
- **Digital Display and Temperature Control**



For easy future reference, write the model and serial number down. You will find your model number on the left bottom side of the refrigerator.

Model # _____

Serial # _____

safety Information











SAFETY INFORMATION

Before using your new Samsung Side-By-Side Refrigerator, please read this manual thoroughly to ensure that you know how to safely and efficiently operate the features and functions that your new appliance offers.

This appliance is not intended for use by people (including children) with reduced physical, sensory or mental capabilities, or lack of experience and knowledge, unless they have been given supervision or instruction concerning use of the appliance by a person responsible for their safety.

Because the following Instructions cover various models, the characteristics of your refrigerator may differ slightly from the refrigerator described in this manual. If you have any questions contact us at 1-800-SAMSUNG or find help and information online at www.samsung.com.

Important safety symbols and precautions:

 WARNING	Hazards or unsafe practices that may result in severe personal injury or death.
 CAUTION	Hazards or unsafe practices that may result in minor personal injury or property damage.
	Do NOT attempt.
	Do NOT disassemble.
	Do NOT touch.
	Follow directions carefully.
	Unplug the power plug from the wall socket.
	Make sure the refrigerator is grounded to prevent electric shock.
	Call the contact center for help.
	Note.

These warning signs are here to prevent injury to you and others.

Please follow them carefully.

After reading this section, keep it in a safe place for future reference.

SEVERE WARNING SIGNS FOR INSTALLATION

-  • Do not install the refrigerator in a damp place or place where it may come in contact with water.
 - Deteriorated insulation of electrical parts may cause an electric shock or fire.
- Do not place this refrigerator in direct sunlight or expose to the heat from stoves, room heaters or other appliance.
- Do not plug several appliances into the same multiple power board. The refrigerator should always be plugged into its own individual electrical board which has a voltage rating that matched the rating plate.
 - This provides the best performance and also prevents overloading house wiring circuits, which could cause a fire hazard from overheated wires.

safety Information

- If the wall socket is loose, do not insert the power plug.
 - There is a risk of electric shock or fire.
- Do not use a cord that shows cracks or abrasion damage along its length or at either end.
- Do not bend the power cord excessively or place heavy articles on it.
- Never unplug your refrigerator by pulling on the power cord. Always grip plug firmly and pull straight out from the outlet.
 - Damage to the cord may cause short-circuit, fire and/or electric shock.
- Do not use aerosols near the refrigerator.
 - Aerosols used near the refrigerator may cause an explosion or fire.

-
- ★ • This refrigerator must be properly installed and located in accordance with the manual before it is used.
 - Connect the power plug in proper position with the cord hanging down.
 - If you connect the power plug upside down, the wire can get cut off and cause a fire or electric shock.
 - When moving the refrigerator, be careful not to roll over or damage the power cord.
 - This constitutes a fire hazard.
 - Make sure that the power plug is not squashed or damaged by the back of the refrigerator.
 - Keep the packing materials out of reach of children.
 - There is a risk of death from suffocation if children put them on their head.
 - The appliance must be positioned so that the plug is accessible after installation.
 - You need to remove all the protective plastic film before you initially plug in to use the product.

-
- ⏚ • The Refrigerator must be safely grounded
 - Always make sure that you have grounded the Refrigerator before attempting to investigate or repair any part of the appliance. Power leakages can cause severe electric shock.
 - Never use gas pipes, telephone lines or other potential lightning attractors as an electrical ground.
 - Improper use of the grounding plug can result in a risk of electric shock.
 - If it is necessary to use an extension cord, use only a 3-wire extension cord that has a 3-blade grounding plug and a 3-slot receptacle that will accept the plug on the appliance. The marked rating of the extension cord should be AC115-120V, 10A, or more.
 - If a grounding adapter is used, make sure the receptacle box is fully grounded.
 - ✎ • If the power cord is damaged, have it replaced immediately by the manufacturer or its service agent.

CAUTION SIGNS FOR INSTALLATION

- ★ • Allow sufficient space to install the refrigerator on a flat surface.
 - If your refrigerator is not level, the internal cooling system may not work correctly.
- Keep ventilation opening in the appliance enclosure or mounting structure clear of obstruction.
- Allow the appliance to stand for 2 hours after installation.

SEVERE WARNING SIGNS FOR USING

- ☐ • Do not insert the power plug with wet hands.
- Do not store articles on the top of the appliance.
 - When you open or close the door, the articles may fall and cause personal injury and/or material damage.
- Do not put a container filled with water on the refrigerator.
 - If spilled, there is a risk of fire or electric shock.
- Children should be supervised to ensure that they do not play with the appliance.
- Do not let children hang on the door. A serious injury may occur.
- Do not let children enter inside of the refrigerator. There is a risk of children entrapment.

-  • **Do not insert your hands into the bottom area under the appliance.**
 - Any sharp edges may cause personal injury.
- **Do not let children step on drawer's cover.**
 - The drawer may break and cause them to slip.
- **Do not overfill the refrigerator with food.**
 - When you open the door, an item may fall out and cause personal injury or material damage.
- **Do not touch the inside walls of the freezer or products stored in the freezer with wet hands.**
 - This may cause frostbite.
- **Never put fingers or other objects into the water dispenser hole, ice chute and ice maker bucket.**
 - It may cause personal injury or material damage.
- **Do not spray inflammable gas near the refrigerator.**
 - There is a risk of explosion or fire.
- **Do not store volatile or flammable substances in the refrigerator.**
 - The storage of benzene, thinner, alcohol, ether, LP gas and other such products may cause explosions.
- **Do not store pharmaceuticals products, scientific materials or temperature sensitive products in the refrigerator.**
 - Products that require strict temperature controls must not be stored in the refrigerator.
- **Do not place or use an electrical appliance inside the refrigerator, unless it is of a type recommended by the manufacturer.**
- **Do not use mechanical devices or any other means to accelerate the defrosting process, other than those recommended by the manufacturer.**
- **Do not damage the refrigerant circuit.**

-
-  • **Do not disassemble or repair the refrigerator by yourself.**
 - You run risk of causing a fire, malfunction and/or personal injury.

-
-  • **Children should be supervised to ensure that they do not play with the appliance.**
 - **Bottles should be stored tightly together so that they do not fall out.**
 - **This product is intended only for the storage of food in a domestic environment.**
 - **If a gas leak is detected, avoid any naked flames or potential sources of ignition and air the room in which the appliance is standing for several minutes.**
 - **Use only the LED Lamps provided by manufacturer or service agents**

-
-  • **Pull the power plug out of the socket before changing the interior lamps of the refrigerator.**
 - Otherwise, there is a risk of electric shock.

-
-  • **If there are burning smells or smoke, pull out power plug immediately and contact your Samsung Electronics service center.**
 - **If you experience difficulty when changing the light, contact service agents.**
 - **If the products equipped with LED Lamp, do not disassemble Lamp Cover and LED Lamp by yourself.**
 - Please contact your service agents.
 - **If any dust or water is in refrigerator, pull out power plug and contact your Samsung Electronics service center.**
 - Otherwise there is a risk of fire.

CAUTION SIGNS FOR USING

-
-  • **Do not re-freeze frozen foods that have thawed completely.**
Do not place carbonated or fizzy drinks in the freezer compartment. Do not put bottles or glass containers in the freezer.
 - When the contents freeze, the glass may break and cause personal injury.

safety Information

- ★ • **Service warranty and Modification.**
 - Any changes or modifications performed by a 3rd party on this finished appliance is not covered under Samsung warranty service, nor can Samsung be responsible for safety issues that result from 3rd party modifications.
 - **Do not block air holes.**
 - If the air holes are blocked, especially with a plastic bag, the refrigerator can be over cooled. If this cooling period lasts too long, the water filter may break and cause water leakage.
 - **If the refrigerator is disconnected from the power supply, you should wait for at least five minutes before plugging it back.**
 - **If you have a long vacation planned or the refrigerator is not to be used for a long period of time, you must empty the refrigerator and pull out the power plug.**
 - Deterioration in the insulation may cause fire.
 - **Wipe excess moisture from the inside and leave the doors open.**
 - Otherwise, odor and mold may develop.
 - **To get best performance of product,**
 - Do not place foods too closely in front of the vents at the rear of the appliance as it can obstruct free air circulation in the refrigerator compartment.
 - Wrap the food up properly or place it in airtight containers before putting it into the refrigerator.
 - **Fill water tank, ice tray, water cubes only with potable water.**
-
- ✎ • **When the refrigerator gets wet by water, pull out the power plug and contact your Samsung Electronics service center.**



CAUTION SIGNS FOR CLEANING

- ☒ • **Do not directly spray water inside or outside the refrigerator.**
 - There is a risk of fire or electric shock.
- ★ • **Remove any foreign matter or dust from the power plug pins. Do not use a wet or damp cloth when cleaning the plug, remove any foreign material or dust from the power plug pins.**
 - Otherwise there is a risk of fire or electric shock.
- 🔌 • **Unplug the refrigerator before cleaning and making repairs.**



SEVERE WARNING SIGNS FOR DISPOSAL

- ★ • **Risk of child entrapment. Before you throw away your old refrigerator or freezer.**
 - Take off the doors.
 - Leave the shelves in place so that children may not easily climb inside.
- **Please dispose of the packaging material for this product in an environmentally friendly manner.**
- **Leave the shelves in place so that children may not easily climb inside. Ensure that none of the pipes on the back of the appliance are damaged prior to disposal.**
- **When disposing of this refrigerator, remove the door/door seals and door latch so that small children or animals cannot become trapped inside.**
Children should be supervised to ensure that they do not play with the appliance.
- **Cyclopentane is used as in the insulation. The gases in insulation material require a special disposal procedure. Please contact your local authorities in regard to the environmentally safe disposal of this product. Ensure that none of the pipes on the back of the refrigerator are damaged prior to disposal.**

contents

SETTING UP YOUR SIDE-BY-SIDE REFRIGERATOR

08

- 08 Getting ready to install the refrigerator
- 10 Setting up the refrigerator
- 15 Leveling the refrigerator
- 16 Making minor adjustment to the doors
- 17 Checking the water dispenser line
- 18 Installing the water line

OPERATING YOUR SIDE-BY-SIDE REFRIGERATOR

20

- 20 Checking the control panel
- 21 Using the control panel
- 23 Using the ice and cold water dispenser
- 24 Storing food

CLEANING AND MAINTAINING YOUR SIDE-BY-SIDE REFRIGERATOR

26

- 26 Removing the freezer/fridge accessories
- 27 Cleaning the refrigerator
- 28 Changing the water filter
- 29 Water filter chart

APPENDIX

30

- 30 Troubleshooting

setting up your side-by-side refrigerator

GETTING READY TO INSTALL THE REFRIGERATOR

Congratulations on the purchase of your Samsung Side-By-Side Refrigerator. We hope you will enjoy the many state-of-the-art features and efficiencies that this new appliance has to offer.

Selecting the best location for the refrigerator

- Select a location with easy access to the water supply.
- Select a location without direct exposure to sunlight.
- Select a location with level (or nearly level) flooring.
- Select a location with enough space for the refrigerator doors to open easily.
- Allow sufficient space to install the refrigerator on a flat surface.
 - If your refrigerator is not level, the internal cooling system may not work correctly.
 - Refer to drawing and dimensions below for overall space required for use.

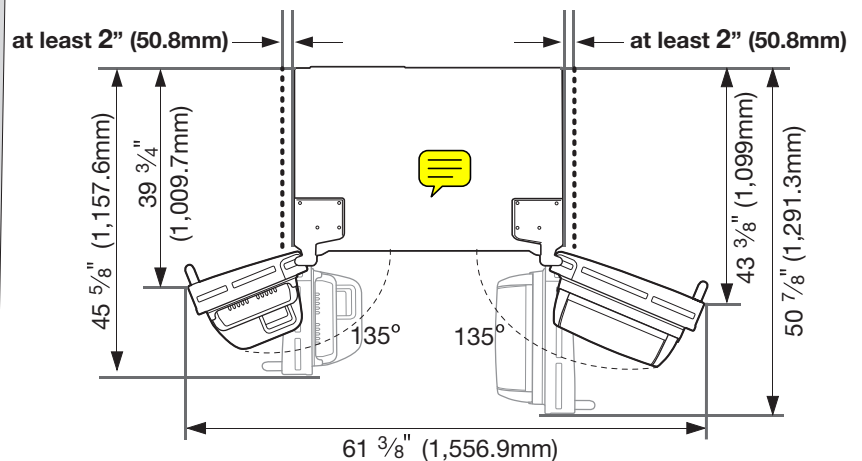
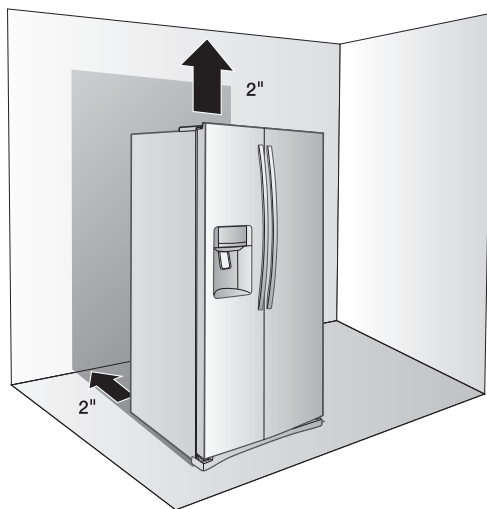

Do not install the refrigerator where the temperature can drop below 50°F (10°C).

When moving your refrigerator

To prevent floor damage, be sure the front leveling legs are in the up position (above the floor). Refer to 'Leveling the refrigerator' in the manual (page 15).

To protect the finish of the flooring, place a protection sheet, such as packing carton under the refrigerator.

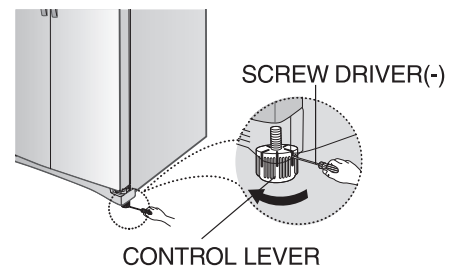

When installing, servicing or cleaning behind the refrigerator, be sure to pull the unit straight out and push back in straight after finishing.



First things first! Make sure that you can easily move your refrigerator to its final location by measuring doorways (both width and height), thresholds, ceilings, stairways, etc.
The following chart details the exact height and depth.

MODEL		RS261M** 	
Dimensions [inch(mm)]	Width	Only Cabinet	35 3/4 (908)
		With Leg Front	35 15/16 (915.5)
	Depth	Only Cabinet	23 5/8 (735)
		With Door	27 7/16 (861.2)
		With Handle	30 (920.4)
	Height	Only Cabinet	68 5/8 (1,742.4)
		With Hinge	69 5/16 (1,776)
		With Door	70 (1,776)



- Allow clearance to the right, left, back and top when installing. This will help reduce power consumption and keep your energy bills lower.
- Make sure you disconnect the water supply line BEFORE removing the freezer door. To avoid damage, refer to 'Separating the water line' in the manual (page 12).

setting up your side-by-side refrigerator

SETTING UP THE REFRIGERATOR

Now that you have your new Refrigerator installed in place, you are ready to set up and enjoy the features and functions of the appliance. By completing the following steps, your Refrigerator should be fully operational. If not, first check the power supply and electricity source or try the troubleshooting section at the back of this user's guide. If you have any further questions, contact your Samsung Electronics service center.

1. Place the Refrigerator in an appropriate location with reasonable clearance between the wall and the Refrigerator. Refer to installation instructions in this manual.
2. Once the Refrigerator is plugged in, make sure the interior light comes on when you open the doors.
3. Set the Temperature control to the coldest temperature and wait for an hour. The Freezer will get slightly chilled and the motor will run smoothly.
4. After powering the Refrigerator, it will take a few hours to reach the appropriate temperature. You can store food and drinks in the Refrigerator after the temperature is sufficiently cool.

 Check the accessory list below.



Hex wrench



Compression fitting



Compression nut



Clip



Screw

Installing the handles

1. Take the handles out from the right side door.



 The handles are included in the package.

2. Check if the word "UP" on the rear of the handle is facing right side up.

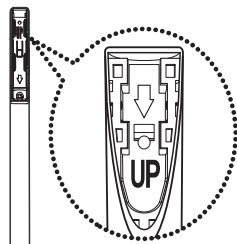

3. Match the upper and lower handle locking tabs on the doors to the handles.

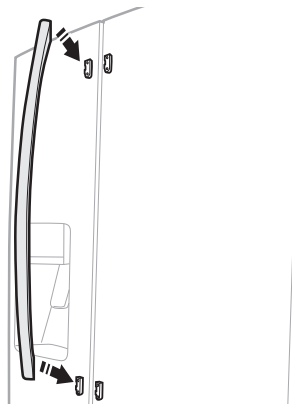

4. Fix the handles to the doors by sliding it down firmly until you hear a click sound.

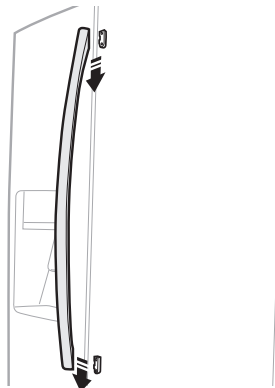

5. Check the installation of the handles by pulling on them. If the handles have been inserted correctly, they should not move. Ensure the 2 handles are horizontally aligned.

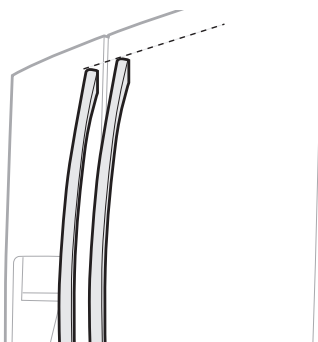

 If the handles are not aligned, repeat step 2 and 3. To align the doors, refer to 'Leveling the refrigerator' in the manual (page 15).

setting up your side-by-side refrigerator

SETTING UP THE REFRIGERATOR(CONT'D)

If your entrance won't allow the refrigerator to pass easily through it, you can remove the doors.

Removing the Front Leg Cover

First, open both the freezer and refrigerator doors, and then take off the front leg cover by turning the three screws counter-clockwise.

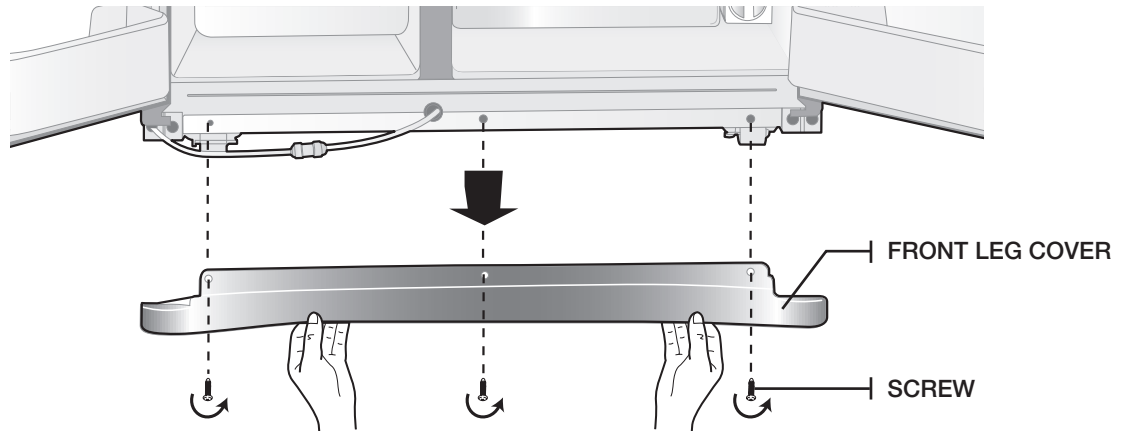

Separating the water supply line from the refrigerator

1. Remove the water tube by pressing the coupler **2** and pulling the water tube **1** away.

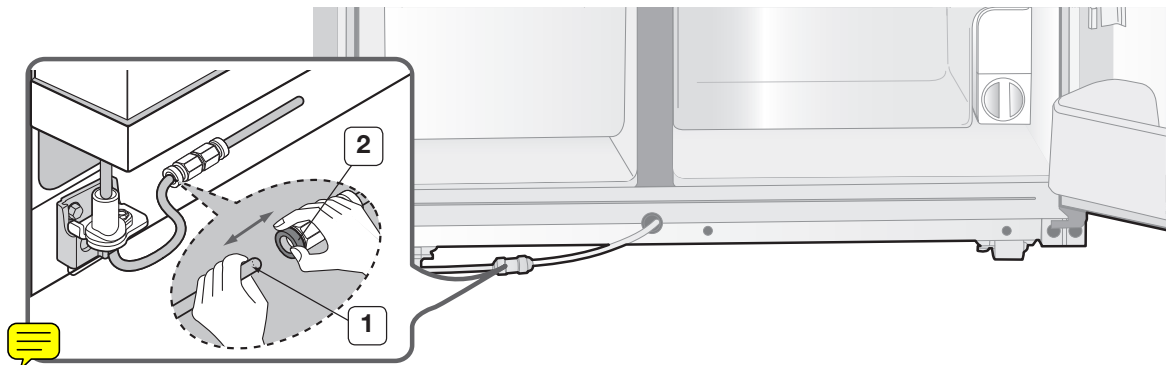

 Do not cut the water line. Gently separate it from the coupler.

Reattaching the water supply line

1. While pressing the front face of coupler **2**, insert the water line **1** in the coupler. Carefully place front cover and push to snap it into position.

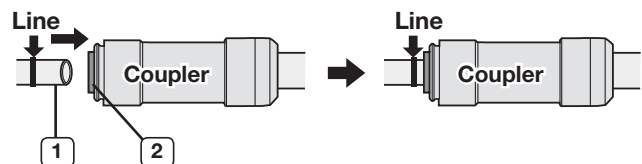

 The water line must be fully inserted to the marked line to prevent water leakage from the dispenser.

Removing the freezer door

A few things to mention first.

- Make sure that you lift the door straight up so the hinges are not bent or broken.
- Be careful not to pinch the water tubing and wire harness on the door.
- Place doors on a protected surface to prevent scratching or damage.

1. With the Freezer door closed, remove the upper hinge cover (1) using a screwdriver, and then disconnect the wires (2).

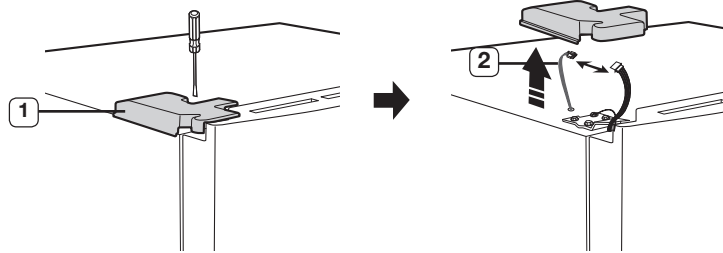

2. Remove hinge bolts (3) and a ground screw (4) counter-clockwise, and take off the upper hinge (5) in the direction of the arrow. Be careful when removing the door to ensure that it does not fall on you.

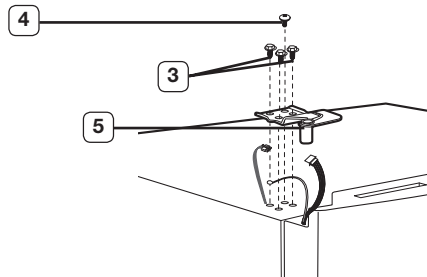

3. Remove the door from the lower hinge (6) by carefully lifting the door (7).

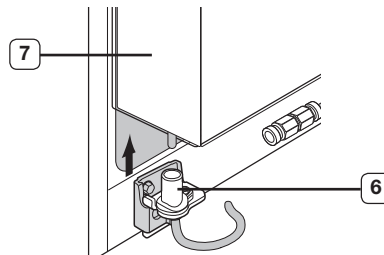

4. Remove the lower hinge (8) from the lower hinge bracket (9) by lifting the lower hinge in the direction of the arrow.

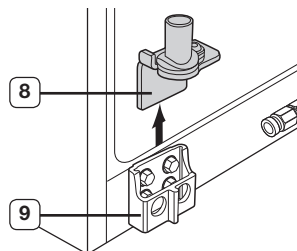

Reattaching the freezer doors

  To reattach the freezer doors, replace parts in reverse order.

setting up your side-by-side refrigerator

SETTING UP THE REFRIGERATOR(CONT'D)

Removing the fridge door

1. With the door closed, remove the upper hinge cover **1** using a screwdriver

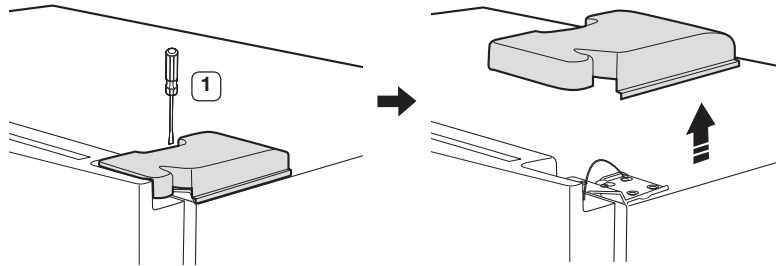

2. Remove hinge bolts **2** and ground screw **3** counter-clockwise, and take off the upper hinge **4** in the direction of the arrow. Be careful when removing the door to ensure that it does not fall on you.

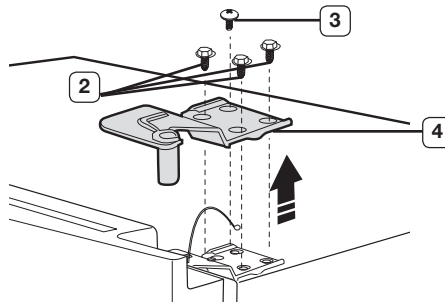

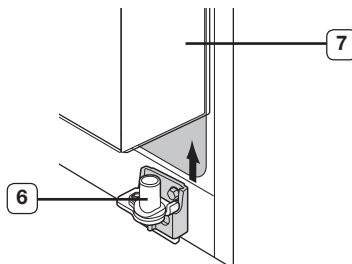

3. Remove the door from the lower hinge **6** by lifting the door **7**.

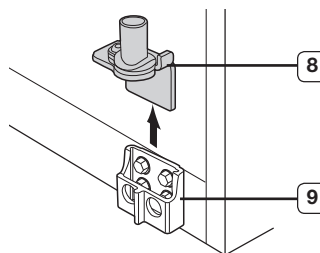

4. Remove the lower hinge **8** from the lower hinge bracket **9** by lifting the lower hinge in the direction of the arrow.



Reattaching the fridge door

  Reattach the fridge doors, replace parts in reverse order.

LEVELING THE REFRIGERATOR

Now that the doors are back on the refrigerator, you want to make sure the refrigerator is level so that you can make final adjustments. If the refrigerator is not level, it will not be possible to get the doors perfectly even.

 The front of the refrigerator is also adjustable.

Before leveling the refrigerator, remove the front leg cover

Open both the freezer and fridge doors, and then take off the front leg cover by turning the three screws counter-clockwise.

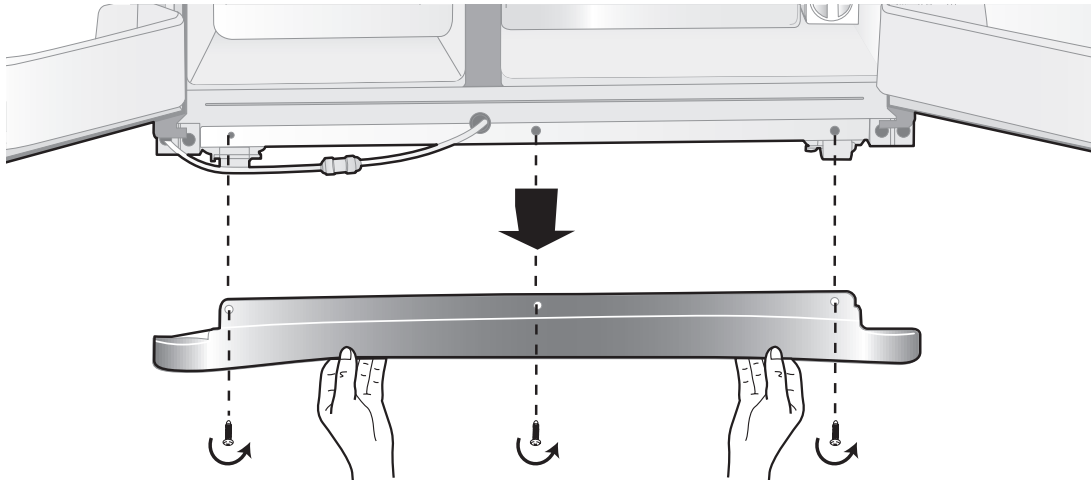



When the Freezer part is lower than the Fridge part.

Insert a flat-blade screwdriver into a slot on the Freezer Leg, then turn it clockwise.

When the Fridge part is lower than the Freezer part.

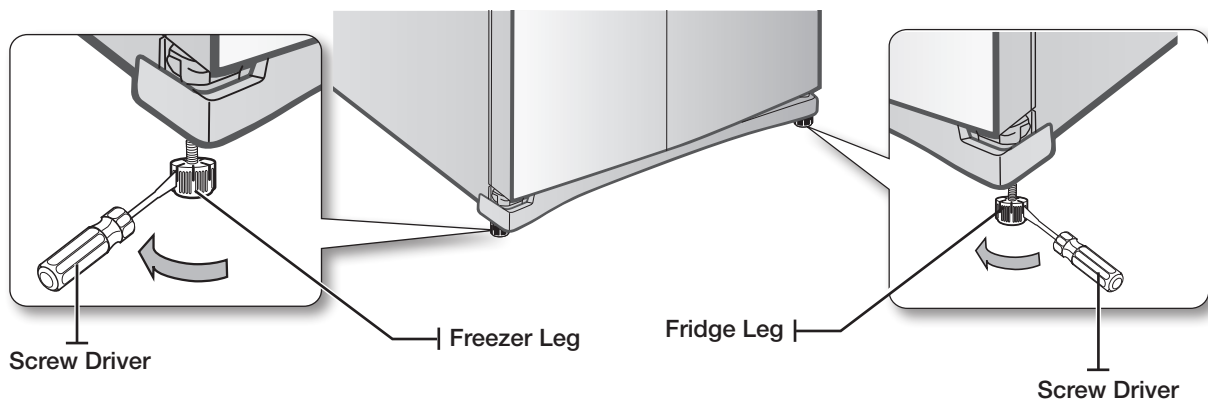
Insert a flat-blade screwdriver into a slot on the Fridge Leg, then turn it clockwise.



 Refer to the next section for the best way to make very minor adjustments to the doors.

setting up your side-by-side refrigerator

MAKING MINOR ADJUSTMENTS TO THE DOORS

Remember, a level refrigerator is necessary for getting the doors perfectly even. If you need help, review the previous section on levelling the refrigerator.

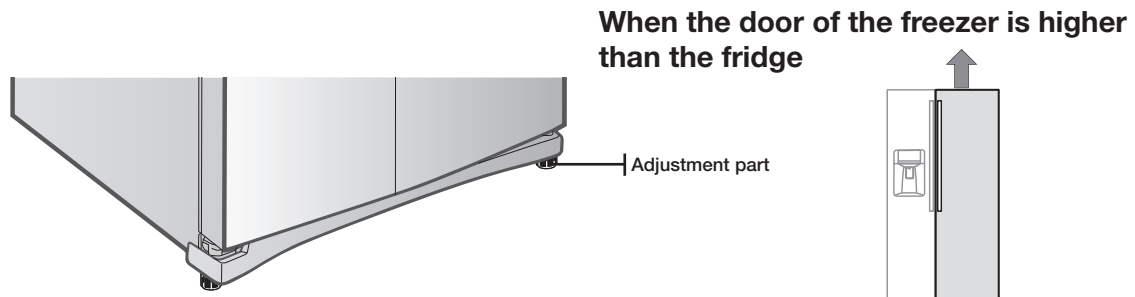

In the case of the process to correct the imbalance is the same. Open the doors and adjust them, one at a time, as follows:

1. Unscrew the nut **1** from the lower hinge until it reaches the upper end of the bolt **2**.

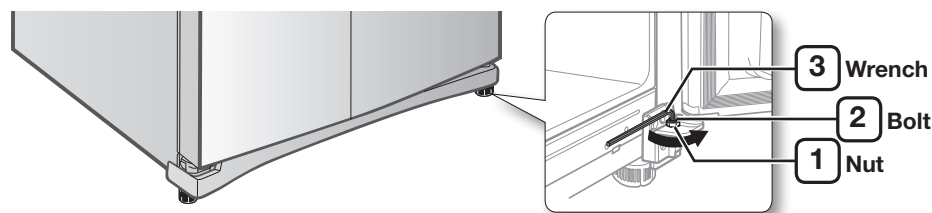

- When you release the nut **1**, make sure that you use the hex wrench provided **3** to loosen the bolt **2** in a counter-clockwise direction. You should then be able to unscrew the nut **1** with your fingers.

2. Adjust the height difference between the doors by turning the bolt **2** clockwise or counter clockwise .

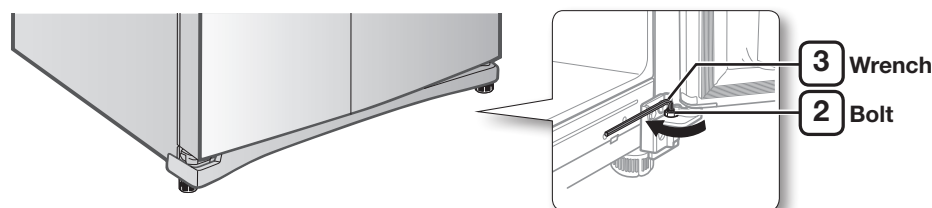

- When you turn clockwise , the door will move up.

3. After adjusting the doors, turn the nut **1** clockwise until it reaches the lower end of the bolt, then tighten the bolt again with the wrench **3** to fix the nut in place **1**.

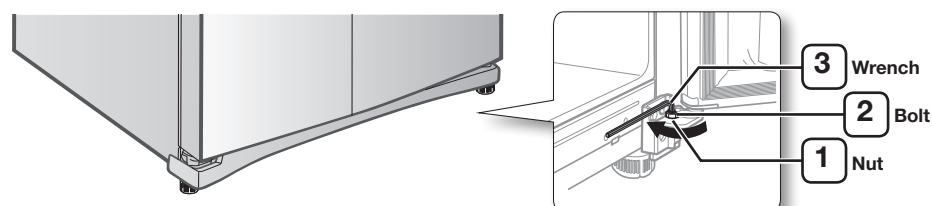

- If you do not secure the nut firmly, the bolt may release.

CHECKING THE WATER DISPENSER LINE

A water dispenser is one of the helpful features on your new Samsung Refrigerator. To help promote better health, the Samsung water filter removes unwanted particles from your water. However, it does not sterilize or destroy microorganisms. You may need to purchase a water purifying system to do that.

In order for the ice maker to operate properly, a water pressure of 20~125 psi (pound per square inch) is required. Under normal conditions, a 170 cc (5.75 oz.) paper cup can be filled in 10 seconds.

If the Refrigerator is installed in an area with low water pressure (below 20psi), you can install a booster pump to compensate for the low pressure.

Make sure the water storage tank inside the Refrigerator is properly filled. To do this, press the water dispenser lever until the water runs from the water outlet.

 Water line installation kits are available at extra cost from your dealer. We recommend using a water supply kit that contains copper tubing.

Connecting to the water supply line

1. First, shut off the main water supply line and turn the ice-maker off.
2. Locate the nearest cold, drinking water line.
3. After connecting the water supply to the water filter, turn your main water supply back on and flush 3 gallons (Flush approximately 6 minutes) into a bucket to clear and prime the water filter.

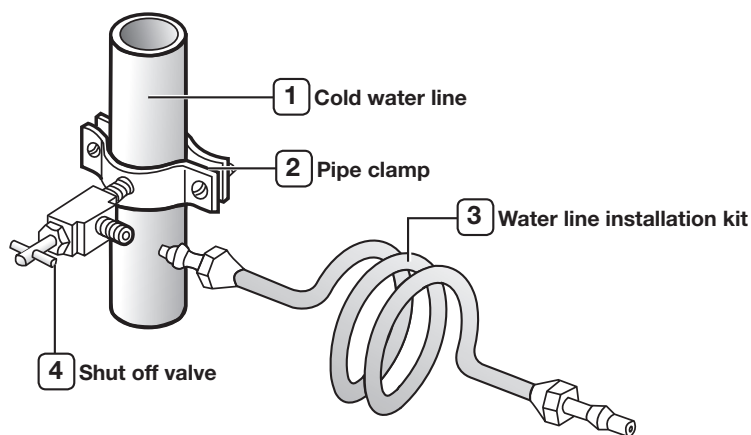

setting up your side-by-side refrigerator

INSTALLING THE WATER LINE

Connecting the water line to the Refrigerator.

There are several items that you need to purchase to complete this connection. You may find these items sold as a kit at your local hardware store.

- 1/4" compression nut
- plastic tubing
- copper tubing
- ferrule

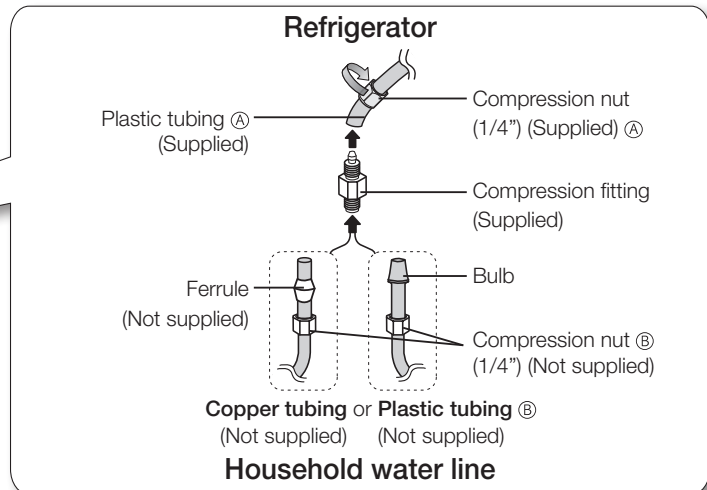
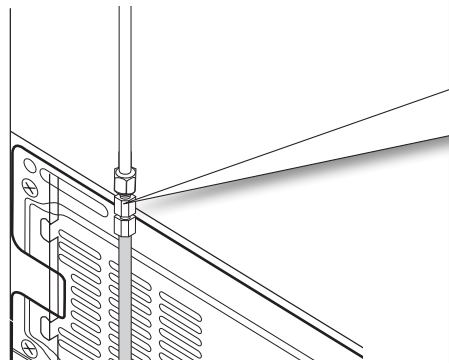

1. Slip the compression nut (A) through the supplied plastic tubing (A).
2. Tighten the compression nut (A) onto the 1/4" compression fitting.
 - If you are using copper tubing, slip the compression nut (B) (not included) and ferrule (not included) on copper tubing (not included) as shown.
 - If you are using plastic tubing (B), insert the molded end(Bulb) of the plastic tubing (B) into the compression fitting.

CAUTION  Do not use without the molded end(Bulb) of the plastic tubing (B).

3. Tighten the compression nut (B) onto the compression fitting. Do not over-tighten the compression nut (B).
4. Turn water on and check for any leakage.

 Only connect the water line to a drinkable water source.
If you have to repair or disassemble the water line, cut off 1/4" of the plastic tubing to make sure you get a snug, leak-free connection.

Removing residual matter inside the water supply line after installing filter

1. Turn ON the main water supply.
2. Press the **Water** button and push the dispenser pad.
3. Flush 3 gallons of water through the filter before use.
(Flush approximately 6 minutes.)
This will clean the water supply system and remove air from the lines.
4. Additional flushing may be required in some households.
5. Open the refrigerator door and make sure there are no water leaks coming from the water filter.

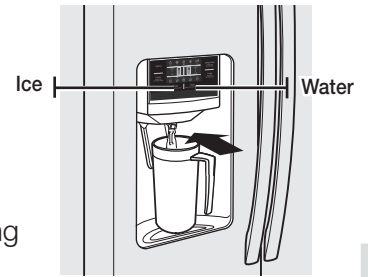

-  A newly installed water filter cartridge may cause water to briefly spurt from the water dispenser. This is due to air getting into the line. It should pose no problem to operation.

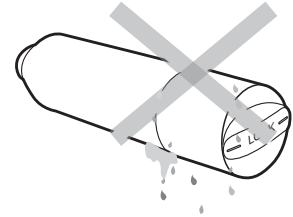

Check the amount of water supplied to the ice tray

1. Lift up and pull out the Ice maker bucket in the freezer.



2. When you press the Test button for 3 seconds, the ice cube container is filled with water from the water supply tap. Check to make sure the amount of water is correct (see the illustration). If the water level is too low, the ice cubes will be small. This is not a problem with the ice maker but of the water pressure in the pipe. When this problem occurs, contact the dealer service center to check the amount of water supplied.

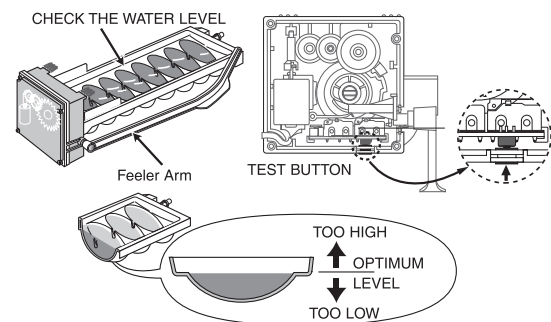

3. In case ice does not come out, pull out the ice bucket and press test button located on the bottom of ice maker.

operating your side-by-side refrigerator

CHECKING THE CONTROL PANEL

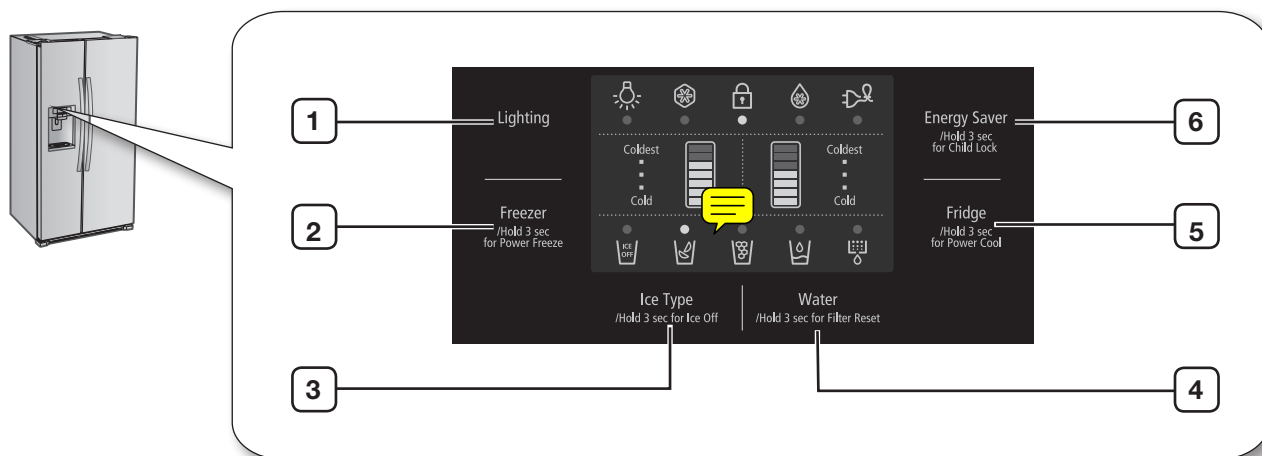

1 Lighting	Press the Lighting button to turn on the dispenser LED lamp.
2 Freezer (Hold 3 sec for Power Freeze)	Press the Freezer button to set the freezer temperature between cold and coldest. Press and hold the Freezer button for 3 seconds to activate Power Freeze function which speeds up the freezing process in the freezer.
3 Ice Type (Hold 3 sec for Ice Off)	Press the Ice Type button to get ice from the dispenser. Press the Ice Type button to select cubed or crushed ice. Press and hold the Ice Type button for 3 seconds to turn the ice making function off.
4 Water (Hold 3 sec for Filter Reset)	Press the Water button to get water from the dispenser. Press and hold the Water button for 3 seconds after changing the filter to reset the filter schedule.
5 Fridge (Hold 3 sec for Power Cool)	Press the Fridge button to set the Fridge temperature between cold and coldest. Press and hold the Fridge button for 3 seconds to activate Power Cool function which speeds up the cooling process in the refrigerator.
6 Energy Saver (Hold 3 sec for Child Lock)	For better energy efficiency, press the Energy Saver button. If condensation occurs on the doors, turn the Energy Saver Button function off. If you press and hold the Energy Saver button for 3 seconds, all buttons will be locked and the dispenser pad will not work.

 To deactivate the secondary functions (such as Power Freeze, Ice Off, Power Cool and Child Lock), press and hold the corresponding button again for 3 seconds.

USING THE CONTROL PANEL

Freezer/Fridge (Temperature adjustment)

Press the **Freezer** or **Fridge** button until the desired temperature is set.
For lower temperature, press the **Freezer** or **Fridge** button until more LED lights (coldest).
For higher temperature, press the **Freezer** or **Fridge** button until less LED lights (cold).
Each time you press the **Freezer** or **Fridge** button, temperature indicator will change in below order.

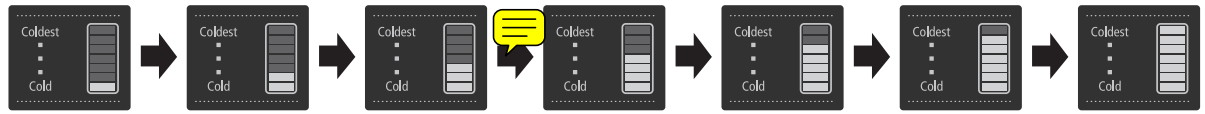

Lighting

This icon will light up when you activate the Lighting function. In this case, the dispenser light (under the display) will be on constantly. If you would like the dispenser light to come on only when using the dispenser, turn the Lighting function off by pressing the **Lighting** button.

Power Freeze

This icon will light up when you activate the Power Freeze function. Power Freeze function generates cool air for 72 hours continuously and it makes the inside of the refrigerator cool faster. This function is useful when you make ice more quickly. When you have enough, just press and hold the **Freeze** (Hold 3 sec for Power Freeze) button again for 3 seconds to cancel the Power Freeze function.

 When you use this function the energy consumption of the refrigerator may increase. Remember to turn it off when you do not need it and return the freezer to your original temperature setting.

Child Lock

This icon will light up when you activate the Lock function. In this case, you will not be able to use the control panel. If you press and hold the **Energy Saver** (Hold 3 sec for Child Lock) button again for 3 seconds, you will be able to use the control panel again.

Power Cool

This icon will light up when you activate the Power Cool function. Power Cool function is great for a quick fridge cool down. If you activate the Power Cool function, inside temperature of the Fridge will decrease for about two and a half hours.

Energy Saver

In some places, water drop may be generated on the door part. In this case, it is recommended to turn off the Energy saver function.

operating your side-by-side refrigerator

USING THE CONTROL PANEL(CONT'D)

Filter Indicator

When the filter indicator light changes to red, it is time to change the filter. Typically this happens about every 6 months.

The filter Indicator will be Blue when you initially insert the water filter.

The filter Indicator will be purple when you have used your water filter for 5 months.

The filter Indicator will be Red when you have used your water filter for 6 months.

Water

This icon will light up when you activate the Water function.

Cubed Ice , Crushed Ice

Enjoy cubed or crushed ice by selecting your preference from the digital control panel. The ice type light indicates the type of ice that is currently chosen.

Ice Off

This icon will light up when you activate the Ice Off function. In this case, the ice will not be produced.

Canceling cooling off mode (Freezer/Fridge Temperature Indicator moving)

 Cooling off function is for store display, and it makes the refrigerator not to generate cool air.



In case of Cooling off Mode, refrigerator may seem like working but it does not make cool air. To cancel this mode, press the **Lighting** button and the **Freezer** button at the same time for 3 seconds until “Ding-dong” sounds.

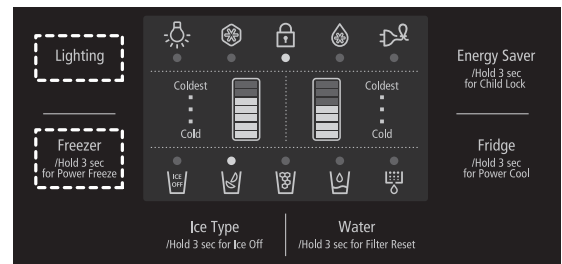

USING THE ICE AND COLD WATER DISPENSER

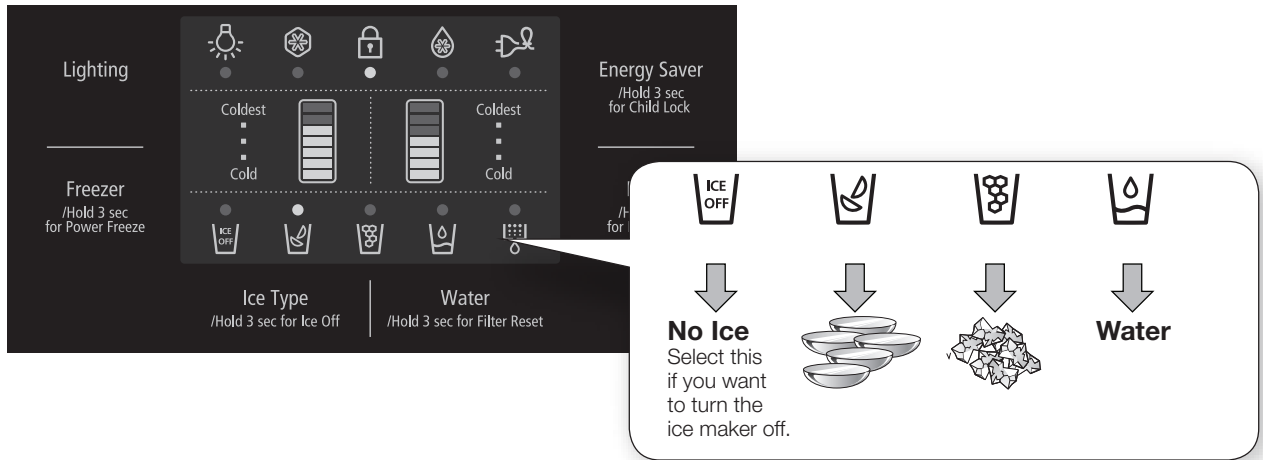

Using the water dispenser

Press the **Water** button on the control panel. Place your cup on the water outlet and push against the dispenser pad until hearing the “click” sounds. Make sure the glass is in line with the dispenser to prevent the water from splashing out.

To get colder water

- The dispensed water is cool, not icy cold
- When you want colder water with ice, dispense ice to your glass first before filling it with water to prevent water from splashing out.

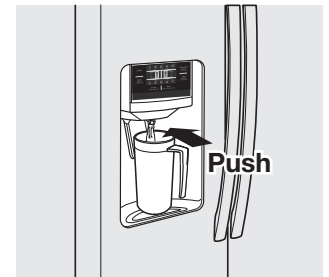

Using the ice dispenser

Press the **Ice Type** button to select the type of ice you want. Place your cup under the ice outlet and push gently against the dispenser pad. Make sure the glass is in line with the dispenser to prevent the ice from bouncing out. When cubed ice is selected after using the crushed ice, a small amount of residual crushed ice might be produced.

operating your side-by-side refrigerator

STORING FOOD

The Samsung Side-By-Side Refrigerator has been designed to provide you with maximum space saving features and functions. Here are some of the customized compartments we have created to keep your food fresher, longer. Remember, in order to prevent odor penetration to the ice, stored food should be wrapped securely and as airtight as possible.

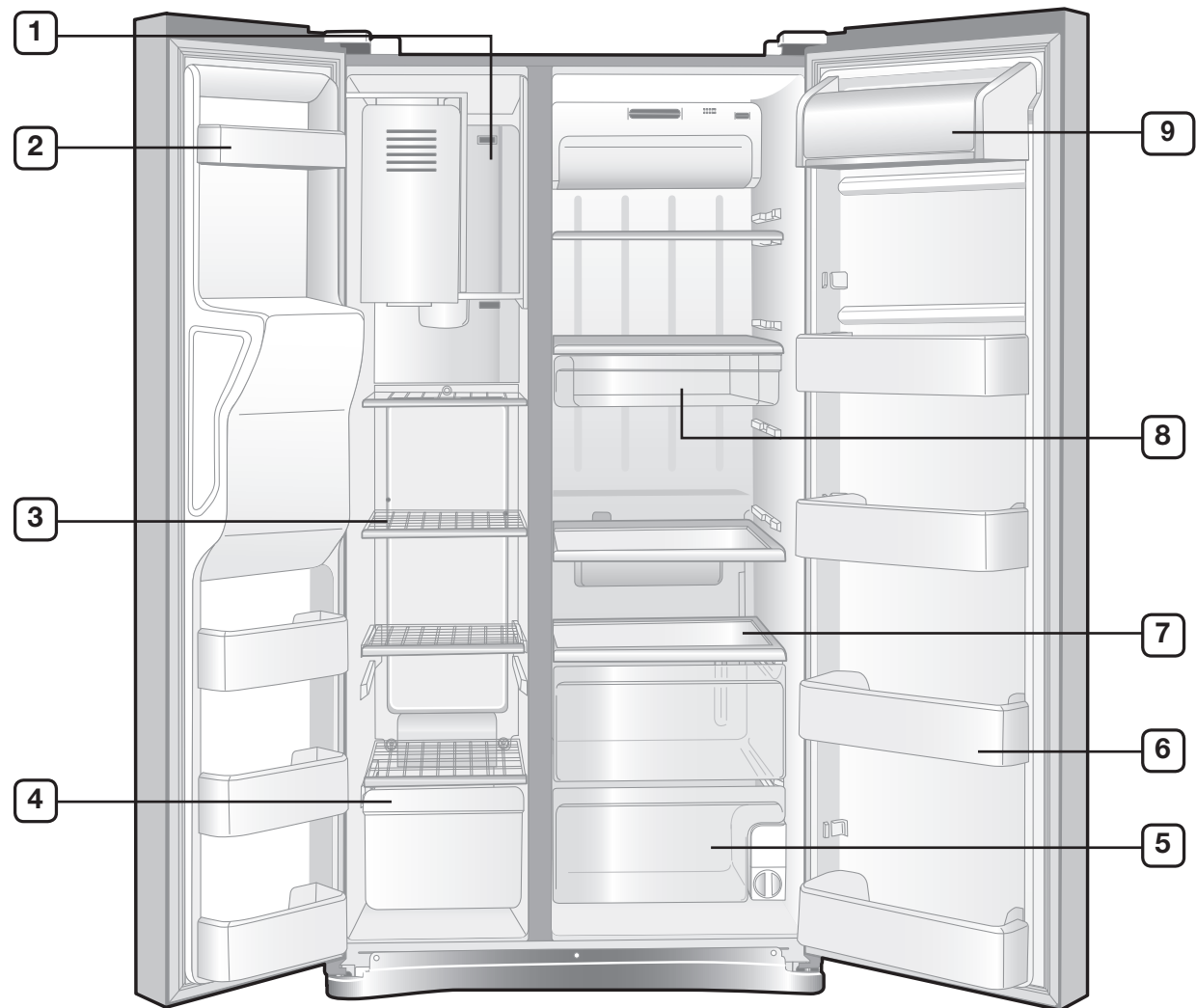

Because these following operating instructions cover various models, your refrigerator may differ from those described in this manual.

Storing Food in the Freezer

1 Xtra Space	<ul style="list-style-type: none"> • Can be used for frozen foods such as pizza, pasta, burritos, and fajitas. • In order to prevent odor penetration to the ice, stored food should be wrapped securely.
2 Door Bins	Can be used for small packages of frozen food.
3 Wire Shelf	Can be used to store frozen food.
4 Freezer Drawer	Best used for storing meat or other frozen items. For safe keeping, stored food should be wrapped securely using foil or other suitable wrapping materials or containers.

Storing Food in the Fridge

5 Fruit & Vegetable Drawer	Used to preserve the freshness of your stored vegetables and fruits.
6 Door Bin	Designed to handle large, bulky items such as gallons of milk or other large bottles and containers.
7 Glass Shelf	Designed to be crack-resistant. They can be used to store food and drinks. Circular marks on the glass surface are a normal phenomenon and can usually be wiped clean with a damp cloth.
8 Snack Bin	Can be used to store deli items separately.
9 Dairy Bin	Can be used to store smaller dairy items like butter or margarine, yogurt or cream-cheese bricks.

 Bottles should be stored tightly together so that they do not tip and fall out when the refrigerator door is opened.



- If you plan to go away for a significant time, empty the refrigerator and turn it off. Wipe the excess moisture from the inside of the appliance and leave the doors open. This helps keep odor and mold from developing.
- If the refrigerator is not to be used for a long period of time, pull out the power plug.
 - Deterioration in the power cord insulation may cause fire.

cleaning and maintaining your side-by-side refrigerator

REMOVING THE FREEZER/FRIDGE ACCESSORIES

1. Door Bin/Dairy Bin

Firmly grab the door bin with both hands and lift it up gently to remove the door bin.

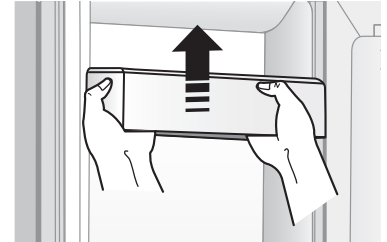

2. Shelves

Pull the shelf out as far as it goes. Then lift it up and remove it. (Wire Shelf/Glass Shelf)

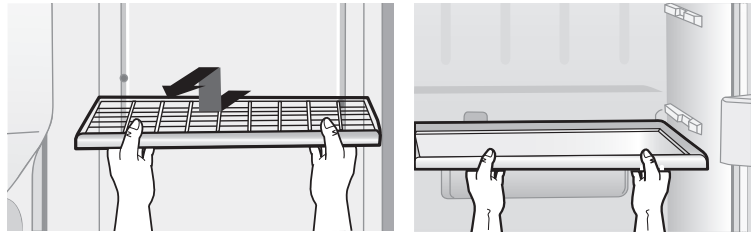

3. Drawer

Pull the drawers out fully then slightly lift it up to remove the drawers. (Drawer/Fruit & Vegetable Drawer)



4. Snack Bin

Remove the drawer by holding the handle, pulling the drawer out, and then lifting up the back side of the drawer bottom smoothly with the other hand.

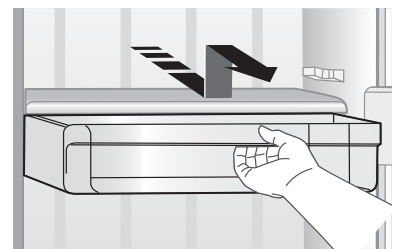

CLEANING THE REFRIGERATOR

Caring for your Samsung Side-By-Side Refrigerator prolongs the life of your appliance and helps keep it odor and germ-free.

Cleaning the Interior

Clean the inside walls and accessories with a mild detergent and then wipe dry with a soft cloth. You can remove the drawers and shelves for a more thorough cleaning. Just make sure to dry them before putting them back into place.

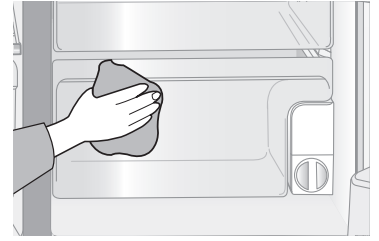

Cleaning the Exterior

Wipe the digital panel and display panel with a clean, soft cloth. Spray water onto the cleaning cloth instead of spraying directly on the surface of the refrigerator. This helps ensure an even distribution of moisture to the surface. The doors, handles and cabinet surfaces should be cleaned with a mild detergent and then wiped dry with a soft cloth. To keep your appliance looking its best, the exterior should be polished once or twice a year.

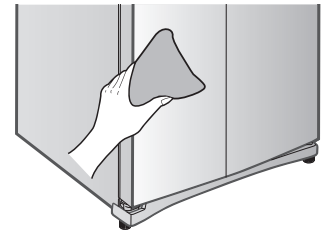

 Do not use Benzene, Thinner or Clorox™ for cleaning. They may damage the surface of the appliance and can create a risk of fire.

WARNING

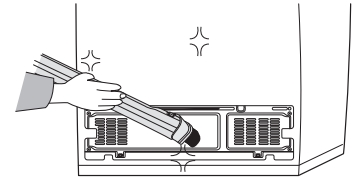

Cleaning the rubber door seals

If the rubber door seals are dirty, the doors may not close properly, and the refrigerator will not operate efficiently. Keep the door seals free of grit or grime by cleaning the doors with a mild detergent and damp cloth. Wipe dry with a clean, soft cloth.

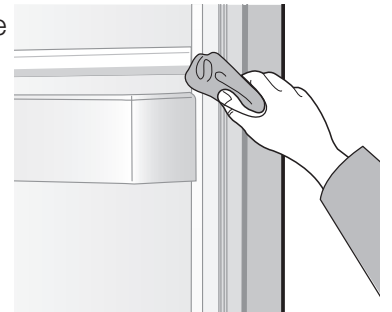

 Do not spray the refrigerator with water while it is plugged in, as it may cause an electric shock. Do not clean the refrigerator with benzene, thinner or car detergent as there is a risk of fire.

CAUTION

Changing the LED type lighting

 Do not disassemble or replace the LED type lighting. To change the LED type lighting, contact a Samsung service center.

CAUTION

cleaning and maintaining your side-by-side refrigerator

CHANGING THE WATER FILTER

 If the water filter indicator turns into red, filtering ability may decrease. Then you need to change the water filter. Water filter is located on the bottom right side of the refrigerator.

1. Turn the water filter 90° counter-clockwise.

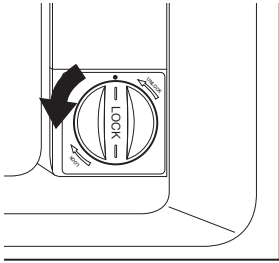

2. Pull the water filter from the filter housing.

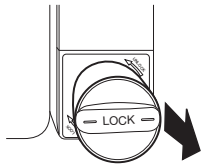

3. Insert new water filter inside the filter housing.

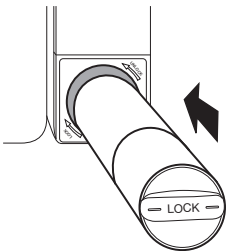

4. Turn the new water filter 90° clockwise.

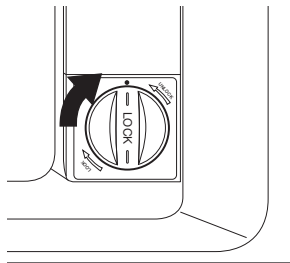

5. After changing the water filter, press **Water** button on the display part for 3 seconds and check if it turns into blue.

TROUBLESHOOTING

PROBLEM	SOLUTION
<p>The refrigerator does not work at all or it does not chill sufficiently.</p>	<ul style="list-style-type: none"> • Check that the power plug is properly connected. • Is the temperature control on the display panel set to the correct temperature? Try setting it to a lower temperature. • Is the refrigerator in direct sunlight or located too near a heat source? • Is the back of the refrigerator too close to the wall and therefore keeping air from circulating? • Check if the cooling off function is on. If the Freezer/Fridge temperature indicator is moving, refer to page 22 to cancel the cooling off function.
<p>The food in the fridge is frozen.</p>	<ul style="list-style-type: none"> • Is the temperature control on the display panel set to the correct temperature? Try setting it to a warmer temperature. • Is the temperature in the room very low? • Did you store the food with high water content in the coldest part of the fridge?
<p>You hear unusual noises or sounds.</p>	<ul style="list-style-type: none"> • Check that the refrigerator is level and stable. • Is the back of the refrigerator too close to the wall and therefore keeping air from circulating? • Was anything dropped behind or under the refrigerator? • A “ticking” sound is heard from inside the refrigerator. This is normal and occurs because various accessories are contracting or expanding in relation to the temperature of the refrigerator interior.
<p>The front corners of the appliance are hot and condensation is occurring.</p>	<ul style="list-style-type: none"> • Some heat is normal as anti-condensates’ are installed in the front corners of the refrigerator to prevent condensation. • Is the refrigerator door ajar? Condensation can occur when you leave the door open for a long time.
<p>Ice is not dispensing.</p>	<ul style="list-style-type: none"> • Did you wait for 12 hours after installation of the water supply line before making ice? • Is the water line connected and the shut-off valve open? • Did you manually stop the ice making function? Make sure Ice Type is set to Cubed or Crushed. • Is there any ice blocked within the ice maker bucket? • Is the freezer temperature too warm? Try setting the freezer temperature lower.
<p>You can hear water bubbling in the refrigerator.</p>	<ul style="list-style-type: none"> • This is normal. The bubbling comes from the refrigerant coolant liquid circulating through the refrigerator.
<p>There is a bad smell in the refrigerator.</p>	<ul style="list-style-type: none"> • Has a food item spoiled? • Make sure that strong smelling food (for example, fish) is wrapped so that it is airtight. • Clean out your freezer periodically and throw away any spoiled or suspect food.
<p>Frost forms on the walls of the freezer.</p>	<ul style="list-style-type: none"> • Is the air vent blocked? Remove any obstructions so air can circulate freely. • Allow sufficient space between the foods stored for efficient air circulation. • Is the freezer door closed properly?
<p>Water dispenser is not functioning.</p>	<ul style="list-style-type: none"> • Is the water line connected and the shut-off valve open? • Has the water supply line tubing been crushed or kinked? Make sure the tubing is free and clear of any obstruction. • Is the water tank frozen because the refrigerator temperature is too low? Try selecting a warmer setting on the main display panel.

memo

Ambient Room Temperature Limits

This refrigerator is designed to operate in ambient temperatures specified by its temperature class marked on the rating plate.

Class	Symbol	Ambient Temperature range (°C)
Extended Temperate	SN	+10 to +32
Temperate	N	+16 to +32
Subtropical	ST	+16 to +38
Tropical	T	+16 to +43

 Internal temperatures may be affected by such factors as the location of the refrigerator, ambient temperature and the frequency with which you open the door. Adjust the temperature as required to compensate for these factors.



Correct Disposal of This Product (Waste Electrical & Electronic Equipment) (Applicable in the European Union and other European countries with separate collection systems)

This marking shown on the product or its literature, indicates that it should not be disposed with other household wastes at the end of its working life.

To prevent possible harm to the environment or human health from uncontrolled waste disposal, please separate this from other types of wastes and recycle it responsibly to promote the sustainable reuse of material resources.

Household users should contact either the retailer where they purchased this product, or their local government office, for details of where and how they can take this item for environmentally safe recycling.

Business users should contact their supplier and check the terms and conditions of the purchase contract. This product should not be mixed with other commercial wastes for disposal.

Contact SAMSUNG WORLD WIDE

If you have any questions or comments relating to Samsung products, please contact the SAMSUNG customer care center.

COUNT RY	CUSTOMER CARE CENTER	WEB SITE
AUSTRALIA	1300 362 603	www.samsung.com/au
CHILE	800-726-7864(SAMSUNG)	www.samsung.com/cl
CZECH REPUBLIC	844 000 844	www.samsung.com/cz
FRANCE	3260 SAMSUNG(7267864) Oor 08 25 08 65 65(€0.15/min)	www.samsung.com/fr
GERMANY	01805-121213(€0.14/min)	www.samsung.de
HONGKONG	3698-4698	www.samsung.com/hk
HUNGARY	06-80-SAMSUNG(7267864)	www.samsung.com/hu
INDONESIA	0800 112 8888	www.samsung.com/id
ITALIA	800-SAMSUNG(7267864)	www.samsung.com/it
MALAYSIA	1800-88-9999	www.samsung.com/my
MEXICO	01-800-SAMSUNG(7267864)	www.samsung.com/mx
NETHERLANDS	0900 20 200 88(€0.10/min)	www.samsung.com/nl
PHILIPPINES	1800-10-SAMSUNG(7267864)	www.samsung.com/ph
POLAND	0 801 801 881	www.samsung.com/pl
RUSSIA	8-800-200-0400	www.samsung.ru
SINGAPORE	1800-SAMSUNG(7267864)	www.samsung.com/sg
SLOVAKIA	0800-SAMSUNG(7267864)	www.samsung.com/sk
SOUTH AFRICA	0860 7267864(SAMSUNG)	www.samsung.com/za
SPAIN	902 10 11 30	www.samsung.com/es
TAIWAN	0800-329-999	www.samsung.com/tw
THAILAND	1800-29-3232, 02-689-3232	www.samsung.com/th
TRINIDAD & TOBAGO	1-800-7267-864	www.samsung.com/latin
U.A.E	800SAMSUNG(7267864), 8000-4726	www.samsung.com/mea
U.K	0870 SAMSUNG(7267864)	www.samsung.com/uk
REPUBLIC OF IRELAND	0818 717 100	www.samsung.com/uk
U.S.A	1-800-SAMSUNG(7267864)	www.samsung.com
VENEZUELA	0-800-100-5303	www.samsung.com/latin
VIETNAM	1 800 588 889	www.samsung.com/vn

 In an effort to promote recycling this user manual is printed on recycled paper.