

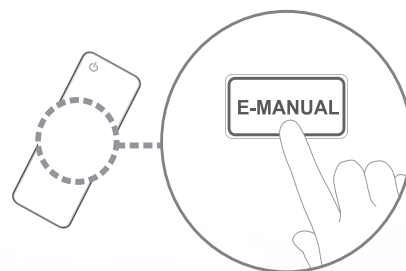

E-MANUAL



imagine the possibilities

Thank you for purchasing this Samsung product. To receive more complete service, please register your product at www.samsung.com/register

Model _____ Serial No. _____

Contents

Channel Setting

- Using the Channel menu 1
- Memorizing channels 14
- Other Features 18

Basic Features

- Changing the Preset Picture Mode 20
- Adjusting Picture Settings 21
- Changing the Picture Options 27
- Changing the Preset Sound Modes 36
- Sound Settings 37
- Adjusting Sound Settings 39

Preference Features

- Connecting to the Network 45
- Setting the Wired Network 61
- Setting the Wireless Network 67
- Managing the Network Connected Devices 79
- Setting the Setup 81
- Setting the Time 82
- Using the Sleep Timer 84
- Setting the On/Off Timer 85
- Blocking Programs 90
- Economical Solutions 102
- Other Features 104
- Support Menu 113

Advanced Features

- Using the 3D function 127
- Using the Explore 3D 138
- Using the AllShare Play 139
- Connecting a USB Device 140
- Connecting to the PC through network 146
- Screen Display 149
- Videos 150
- Photos 155
- Music 157
- AllShare Play - Additional Functions 160
- Using the DLNA Functions 165

Other Information

- Troubleshooting 171
- Anti-theft Kensington Lock 187
- License 189

❑ Using the Channel menu

Press the **CONTENT** button, and then select the desired menu item. Choose from **Channel List** and **Schedule Manager**.

■ Channel List

👉 **MENU** → **Support** → **Contents Home** → **Channel List** → **ENTER** 🔄





The **Channel List** contains the channels your TV displays (added channels) when you press the **CH LIST** button. On the **Channel List**, you can view channel information, **Added Ch.**, **Favorites 1-5** and manage channels.



- **Added Ch.:** Shows all added channels.
- **Favorites 1-5:** Shows all favorite channels, arranged in up to five groups. Each group has a separate screen.
 - ☞ The TV displays **Favorites 1-5** only if you have added favorites using **Edit Favorites**.
 - ☞ If you want to view the list of favorite channels quickly, press the **CH LIST** button, and then press the ► (**CH Mode**) to display **Favorites 1-5**. If you have favorites in more than one favorite group, press the ► (**CH Mode**) to view the other groups. Press the ◀ (**CH Mode**) to return to the **Added Ch.**



Using the function buttons with the **Channel List**.



-  (**Tools**): Displays the option menu.
-  (**CH Mode / Channel**): Moves to the **Favorites** list (if you have added favorites using **Edit Favorites**) / Moves to other channels when you select the **Program View** in  (**Tools**) menu.
-  (**Watch / Information**): Press to watch the channel you selected. / Displays details of the selected program.
-  (**Page**): Scrolls the **Channel List** to the next or previous page.



How to use Schedule Viewing in Channel List (digital channels only)

You can use **Schedule Viewing** in **Channel List** to schedule a digital channel program for viewing. The TV will turn on and display the digital channel program when the program begins.





To schedule a digital program, follow these steps:

1. Press the **CH LIST** button, then select a desired digital channel.
 2. Press **TOOLS** button, and then select the **Program View**. The program list for that channel appears.
 3. Press the ▲/▼ buttons to select the desired program, and then press the **ENTER**  (**Information**) button.
 4. Select **Schedule Viewing**, and then press the **ENTER**  button.
-  If you want to cancel **Schedule Viewing**, follow Steps 1 through 3, and then select **Cancel Schedule**.

Using Option Menu

Manage channels using the **Channel List** menu options (**Program View, Edit Favorites, Channel Name Edit, Delete, Information, Change Antenna, Edit Mode**).

1. Use the arrow buttons to select a channel, and then press the **TOOLS** button.
2. Select an option, and then press **ENTER**  to activate the option or change its settings.
 - **Program View** (digital channels only): Displays the program when digital channel is selected.

- **Edit Favorites** : Set channels you watch frequently as favorites. Add or delete the selected channel in **Favorites 1-5**.
 1. Select **Edit Favorites**, and then press the **ENTER**  button. The **Edit Favorites** screen appears.
 2. The **Edit Favorites** screen has five groups, **Favorites 1, Favorites 2**, etc. You can add a favorite channel to any one of the groups. Select a group using the **▲/▼** buttons, and then press **ENTER** .
 3. Select **OK**, and then press **ENTER**  twice.
-  If you want to edit or delete the channel as being **Favorites**, change its settings in **Edit Favorites** screen.





- **Channel Name Edit** (analog channels only): Assign a name of up to five characters to a channel. For example, Food, Golf, etc. This makes it easier to find and select the channel.
- **Delete**: Delete a channel from the channel list. When you use the channel button to change channels, your TV only displays the channels on the channel list.
- **Information**: Displays details of the selected program.
 - ✎ Press the **Watch** to switch the channel directly.
- **Change Antenna**: Switches to **Air** or **Cable**.
- **Edit Mode**: You can select desired channels and edit it. For detailed information about using **Edit Mode**, refer to “Using Option Menu in Edit Mode”.

Using Option Menu in Edit Mode

Press the ◀ / ▶ button to select the channel mode (**Added Ch.** / **All Channels** / **Favorites 1-5**).

- **Added Ch.:** Shows all added channels.
- **All Channels:** Shows all currently available channels.
- **Favorites 1-5:** Shows all favorite channels. The TV displays **Favorites 1-5** only if you have added favorites using **Edit Favorites**.

Set each channel using the menu options (**Edit Favorites, Add / Delete, Information, Deselect, Select All**). The option menu items that appear may differ depending on the channel status and type.

1. Press the **TOOLS** button in **Channel List** screen, then select the **Edit Mode**. A check box appears to the left of the channel.
2. Press the ▲/▼ buttons to select the desired channel, and then press **ENTER**  button. The (✓) mark indicates the channel you've selected.
 -  You can select more than one channel.
 -  Press **ENTER**  button again to deselect the channel.
3. Press the **TOOLS** button, then select a function and change its settings.
 - **Edit Favorites**: Set the selected channels you watch frequently as favorites.
 -  The **Edit Favorites** screen has five groups (**Favorites 1**, **Favorites 2**, etc.). You can add a favorite channel to any one of the groups. Press the ▲/▼ buttons to select a group.

- **Add / Delete:** Delete or add a channel to display the channels you want.
 - ✎ The **Add** menu is only available in **All Channels**.
 - ✎ The **Add** menu only appears for deleted channels.
 - ✎ A gray-colored channel indicates the channel has been deleted.
- **Information:** Displays details of the selected program.
 - ✎ Press the **Watch** to switch the channel directly.
- **Deselect:** Deselect the selected channels.
- **Select All:** Select all the channels in the channel list.

■ Schedule Manager

 **MENU** → **Support** → **Contents Home** → **Schedule Manager** →
ENTER 

Select the schedule menu item to access the **Schedule Viewing** function.
Schedule Viewing lets you display the channel you want at the time of your choice.

Using Option Menu

You can set the TV to display a desired channel automatically on a day and at a time of your choice. Set each channel using the menu options (**Cancel Schedule**, **Edit Schedule**, **Manually Schedule**)

 You must set the current time first using the **Time** → **Clock** function in the **System** menu to use this function.

To use **Schedule Viewing**, follow these steps:

1. Press the **TOOLS** button on the **Schedule Manager** screen. Press the **Manually Schedule** to add a scheduled viewing.

 You can press the **A** (**Manually Schedule**) directly on the **Schedule Manager** screen.

2. Press the ◀/▶/▲/▼ buttons to set **Antenna, Channel, Repeat, Date, and Start Time**.

- **Antenna**: Select the desired broadcasting signal.
- **Channel**: Select the desired channel.

- **Repeat:** Select **Once, Manual, Sat~Sun, Mon~Fri** or **Everyday**. If you select **Manual**, you can set the day you want.

 A check (✓) mark indicates a day you selected.

- **Date:** You can set a desired date.

 Date is available only when you select **Once** in **Repeat**.

- **Start Time:** You can set the start time you want.

 If you want to edit or cancel a scheduled viewing, select the scheduled viewing on the **Booking List**. Press the **TOOLS** button and select **Edit Schedule** or **Cancel Schedule**.





❑ Memorizing channels

 MENU  → Channel → ENTER 

Your TV memorizes channels and adds the memorized channels to the **Channel List** with the **Auto Program** function. Before your TV can memorize channels, you must specify the signal source, either **Air** or **Cable**. If you select cable, when you start **Auto Program**, you must also specify the cable system type, **STD**, **HRC**, or **IRC**. If you don't know your cable system type, contact your local cable company for the information. Most cable companies use **STD**.

■ Antenna (Air / Cable) **TOOLS**









To begin the memorizing procedure, follow these steps:



1. Push **MENU**  → **Channel** → **ENTER** .
 2. Select **Antenna**, and then press **ENTER** .
 3. Select the source of your TV signal, **Air** or **Cable**. Go to the next section, **Auto Program**.
-  Selecting **Air** or **Cable** also changes the actual signal input from **Air** to **Cable** or **Cable** to **Air**.

■ Auto Program



Scans for channels automatically and stores them in the TV's memory.

To start **Auto Program**, follow these steps:

1. Push **MENU**  → **Channel** → **ENTER** .
2. Select **Auto Program**, and then press **ENTER** .
3. Select **Start**, and then press **ENTER** .
4. Select **Air** or **Cable** or both by highlighting and then pressing **ENTER** .
-  If you selected **Air** or **Cable** or both on the **Antenna** screen, your choice will already be selected.
5. Select **Next**, and then press **ENTER** .
6. If you selected **Cable**, the cable system screen appears. Select **Digital Cable System**, and then press **ENTER** .
-  If you selected **Air** only, **Auto Program** starts.

7. Select **STD, HRC**, or **IRC**, and then press **ENTER** .
 8. Repeat for **Analog Cable System**.
 9. Select **Next**, and then press **ENTER** . **Auto Program** starts.
-  After all the available channels are stored, **Auto Program** removes scrambled channels. When done, the **Auto Program** menu then reappears. This process can take up to 30 minutes.

How to Stop Auto Programming

1. Press the **ENTER**  button to select **Stop**.
2. A message will ask **Stop Auto Program?** Select **Yes** by pressing the **▲** or **▼** button.
3. Press the **ENTER**  button.



❏ Other Features

 MENU  → Channel → ENTER 

■ Clear Scrambled Channel

This function filters out scrambled channels after **Auto Program** is completed. This process may take up to 20~30 minutes.

How to Stop the Clear Scrambled Channels Function

1. Press the **ENTER**  button to select **Stop**.
2. Press the **▲** button to select **Yes**.
3. Press the **ENTER**  button.

 This function is only available in **Cable** mode.

■ Fine Tune

(analog channels only)

If the reception is clear, you do not have to fine tune the channel, as this is done automatically during the search and store operation. If the signal is weak or distorted, fine tune the channel manually.

- Select **Fine Tune** in the **Channel** menu.
- 📖 Fine tuned channels that have been saved are marked with an asterisk “*” on the right-hand side of the channel number in the channel banner.
- 📖 To reset the fine-tuning, select **Reset**.

❑ Changing the Preset Picture Mode

■ Picture Mode **TOOLS**

 **MENU**  → **Picture** → **Picture Mode** → **ENTER** 

Picture modes apply preset adjustments to the picture. Select a mode using the ▲/▼ buttons, and then press **ENTER** .



 When connecting a PC, you can only select **Entertain** and **Standard**.

- **Dynamic**: Suitable for a bright room.
- **Standard**: Suitable for a normal environment.
- **Natural**: Suitable for an eye comfortable display.
- **Movie**: Suitable for watching movies in a dark room.
- **Entertain**: Suitable for watching movies and games.

 It is only available when connecting a PC.

❑ Adjusting Picture Settings

■ Backlight / Contrast / Brightness / Sharpness / Color / Tint (G/R)

 MENU  → Picture → Backlight → ENTER 

Your television has several options for adjusting picture quality. Select an option using the ▲/▼/◀/▶ buttons, and then press ENTER .

 NOTE

- When you make changes to **Backlight, Contrast, Brightness, Sharpness, Color** or **Tint (G/R)**, the OSD will be adjusted accordingly.
- When connecting a PC, you can only make changes to **Backlight, Contrast, Brightness**, and **Sharpness**.
- You can adjust and store settings for each external device connected to the TV.
- Lowering picture brightness reduces power consumption.

■ Screen Adjustment

 MENU  → **Picture** → **Screen Adjustment** → **ENTER** 

Screen Adjustment provides various picture size and aspect ratio options. Select an option using the ▲/▼/◀/▶ buttons, and then press **ENTER** .

- **Picture Size:** If you have a cable box or satellite receiver, it may have its own set of screen sizes as well. However, we highly recommend you use your TV's 16:9 mode most of the time.

16:9: Sets the picture to 16:9 wide screen mode.

Zoom1: Magnifies the picture moderately. Cuts off the top and sides.

Zoom2: Magnifies the picture more than **Zoom1**.

Wide Fit: Enlarges the aspect ratio of the picture so it fits the entire screen.

4:3: Sets the picture to **4:3** mode. For analog TV programs.

 Do not set your TV to **4:3** format for a long time. The borders displayed on the left and right, or top and bottom of the screen may cause image retention (screen burn) which is not covered by the warranty.

Screen Fit: When your TV inputs HDMI (720p / 1080i / 1080p) or Component (1080i / 1080p) signals, displays the full image without any cut-off.

Smart View 1: Reduces original screen by 50%.



Smart View 2: Reduces original screen by 25%.



 NOTE

- **Smart View 1** is enabled only in HDMI mode.
- **Smart View 2** is enabled only in DTV and HDMI modes.



- **Position**: Adjusts the picture position. **Position** is only available if **Picture size** is set to **Zoom1**, **Zoom2**, **Wide Fit**, or **Screen fit**.



 To use the **Position** function after selecting **Zoom1**, **Zoom2** or **Wide Fit**, follow these steps:





1. Select the **Position**, and then press the **ENTER**  button.
2. Select the **Position** button, and then press **ENTER** .
3. Press the **▲** or **▼** button to move the picture up or down.
4. Press the **ENTER**  button.

 If you want to reset the pictures to its original position, select **Reset** in the **Position** screen, and then press **ENTER** . The picture will be reset to its default position.

 To use the **Position** function after selecting **Screen Fit** when connected to an HDMI (1080i/1080p) or Component (1080i/1080p) source, follow these steps:

1. Select the **Position**, and then press the **ENTER**  button.
2. Select the **Position** button, and then press **ENTER** .
3. Press the **▲**, **▼**, **◀** or **▶** button to move the picture.
4. Press the **ENTER**  button.

 If you want to reset the pictures to its original position, select **Reset** in the **Position** screen, and then press **ENTER** . The picture will be reset to its default position.

-  The picture size can vary depending on the input resolution when you play content using **Videos** in **AllShare Play**.
-  HD (High Definition): 16:9 - 1080i/1080p (1920x1080), 720p (1280x720)
-  You can adjust and store settings for each external device you have connected to an input on the TV.
-  Picture Sizes available by Input Source:

Input Source	Picture Size
DTV (1080i, 1080p)	16:9, Wide Fit, 4:3, Screen Fit, Smart View 2
DTV (720p)	16:9, Wide Fit, 4:3, Smart View 2
DTV (480i, 480p)	16:9, Zoom1, Zoom2, 4:3, Smart View 2
ATV, AV	16:9, Zoom1, Zoom2, 4:3
Component (1080i, 1080p)	16:9, Wide Fit, 4:3, Screen Fit
Component (720p)	16:9, Wide Fit, 4:3
Component (480i, 480p)	16:9, Zoom1, Zoom2, 4:3
HDMI (720p, 1080i, 1080p)	16:9, Wide Fit, 4:3, Screen Fit, Smart View 1, Smart View 2

❑ Changing the Picture Options

■ Advanced Settings

 MENU  → **Picture** → **Advanced Settings** → ENTER 

Advanced Settings are available in the **Standard** and **Movie** modes.

To use, select an option using the ▲/▼/◀/▶ buttons, and then press **ENTER** .

 When connecting a PC, you can only make changes to **White Balance** and **Gamma**.

- **Dynamic Contrast (Off / Low / Medium / High):**
Adjusts the screen contrast.
- **Black Tone (Off / Dark / Darker / Darkest):**
Select the black level to adjust the screen depth.
- **Flesh Tone:** Emphasizes pink “Flesh Tone.”
- **RGB Only Mode (Off / Red / Green / Blue):**
Displays the **Red**, **Green** and **Blue** color for making fine adjustments to hue and saturation.
- **Color Space (Auto / Native):** Adjusts the range of colors (the color gamut) available to create images.

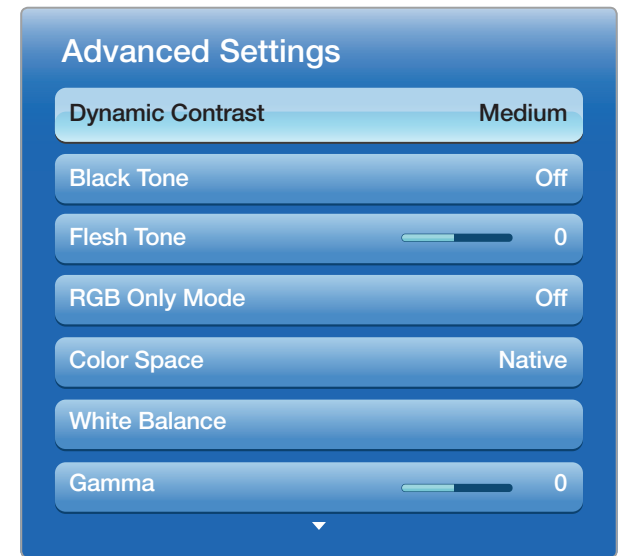

- **White Balance:** Adjusts the color temperature for a more natural picture.
R-Offset / G-Offset / B-Offset: Adjusts each color's (red, green, blue) darkness.
R-Gain / G-Gain / B-Gain: Adjusts each color's (red, green, blue) brightness.
Reset: Resets the White Balance to its default settings.
- **Gamma:** Adjusts the primary color intensity.
- **Motion Lighting (Off / On):** Reduces power consumption by reducing screen brightness when the picture on the screen is motionless.
 - ☞ This function is not supported in **3D** mode.
 - ☞ When you change the **Backlight**, **Contrast**, or **Brightness**, the TV sets **Motion Lighting** to **Off**.
 - ☞ Only available in **Standard** mode.

Picture Options

 **MENU**  → **Picture** → **Picture Options** → **ENTER** 

Select an option using the **▲/▼/◀/▶** buttons, and then press **ENTER** .

 When connecting a PC, you can only make changes to **Color Tone**.

- **Color Tone (Cool / Standard / Warm1 / Warm2)**

 **Warm1** or **Warm2** will be deactivated when the picture mode is **Dynamic**.

 You can adjust and store settings for each external device connected to an input on the TV.



* It may differ depending on the model.

- **Digital Noise Filter (Off / Low / Medium / High / Auto / Auto Visualization):** If the broadcast signal received by your TV is weak, you can activate the **Digital Noise Filter** feature to reduce any static and ghosting that may appear on the screen.

 When the signal is weak, try each option until the TV displays best picture.

Auto Visualization: When changing analog channels, displays signal strength.

 Only available for analog channels.

 When the **INFO** button is pressed, the signal strength bar is displayed.

 When the bar is green, you are receiving the best possible signal.

- **MPEG Noise Filter (Off / Low / Medium / High / Auto):** Reduces MPEG noise to provide improved picture quality.

- **HDMI Black Level (Low / Normal)**: Lets you select the black level on the screen to adjust the screen depth.
 - ☞ Available only in HDMI mode (RGB signals).
- **Film Mode (Off / Auto1 / Auto2)**: Sets the TV so that it senses and then processes film signals from all sources automatically and adjusts the picture for optimum quality.
 - ☞ Available in ATV, AV, Component (480i / 1080i) and HDMI (1080i).
 - ☞ If the screen does not seem natural, change its option to **Off / Auto1 / Auto2** in **Film Mode**.

- **Auto Motion Plus**
(Off / Clear / Standard / Smooth / Custom / Demo) **for FH6030 series** : Enhances motion in fast moving scenes.

 The info screen on your TV displays the resolution and frequency of the incoming video signal (60Hz). This frequency is not the frequency of the picture the TV is displaying when you have **Auto Motion Plus** on.

 If noise occurs on the screen, please set **Auto Motion Plus** to **Off**.
If **Auto Motion Plus** is set to **Custom**, you can set **Blur Reduction**, **Judder Reduction**, **Reset** manually.

Blur Reduction: Adjusts the blur reduction level of video from all sources.

Judder Reduction: Adjusts the judder reduction level of video sources playing movies.

Reset: Restores settings to default values.

- **LED Motion Plus (Off / On)**: Removes drag from fast scenes with a lot of movement to provide a clear picture.
 - ☞ It will be deactivated when the picture mode is set to **Natural**.
 - ☞ The screen may become slightly darker when you play **LED Motion Plus**.





■ **Reset Picture (Yes / No)**

Resets your current picture mode to its default settings.



❑ Changing the Preset Sound Modes

 MENU  → **Sound** → **Sound Mode** → ENTER 

■ **Sound Mode**

Use the ▲/▼ buttons to select an option, and then press ENTER .

- **Standard**: Selects the normal sound mode.
- **Music**: Emphasizes music over voices.
- **Movie**: Provides the best sound for movies.
- **Clear Voice**: Emphasizes voices over other sounds.
- **Amplify**: Increase the intensity of high-frequency sounds to allow a better listening experience for the hearing impaired.

 If **Speaker Select** is set to **External Speaker**, **Sound Mode** is disabled.

❏ Sound Settings

👉 MENU ☰ → **Sound** → **Sound Effect** → ENTER ↵

■ Sound Effect

(standard sound mode only)

Use the ▲/▼ buttons to select an option, and then press **ENTER** ↵.

- **SRS TruSurround HD (Off / On)** **TOOLS** 🎧

This function provides a virtual 5.1 channel surround sound experience through a pair of speakers or headphones using HRTF (Head Related Transfer Function) technology.

- **SRS TruDialog (Off / On)**

This function allows you to increase the intensity of a voice over background music or sound effects so that dialog can be heard more clearly.

- **Equalizer**

Use **Equalizer** to customize sound setting for each speaker.

Balance L / R: Adjusts the balance between the right and left speaker.

100Hz / 300Hz / 1kHz / 3kHz / 10kHz (Bandwidth Adjustment): Adjusts the volume level of specific bandwidth frequencies.

Reset: Resets the equalizer to its default settings.

 If **Speaker Select** is set to **External Speaker**, **Sound Effect** is disabled.

❑ Adjusting Sound Settings

■ Broadcast Audio Options

 **MENU**  → **Sound** → **Broadcast Audio Options** → **ENTER** 

- **Preferred Language**

(digital channels only)

Use the ▲/▼ buttons to select a language, and then press **ENTER** .

Digital-TV broadcasts can simultaneously transmit many audio tracks (for example, simultaneous translations of the program into foreign languages).

 You can only select a language from among the ones being broadcasted.

- **Multi-Track Sound (MTS)** **TOOLS** 

(analog channels only)

Select an option using the ▲/▼ buttons, and then press **ENTER** .

Mono: Choose for channels that are broadcasting in mono or if you are having difficulty receiving a stereo signal.

Stereo: Choose for channels that are broadcasting in stereo.

SAP: Choose to listen to the Separate Audio Program, which is usually a foreign-language translation.

 Depending on the program being broadcast, you can listen to **Mono**, **Stereo** or **SAP**.

 When you press the **TOOLS** button in digital channel, you can select a language from among the ones being broadcasted.

■ SPDIF Output

The SPDIF (Sony Philips Digital InterFace) outputs an uncompressed digital audio signal when you connect the digital audio jack on the back of the TV to a digital audio in jack on a receiver or home theater.

- **Audio Format:** You can select the Digital Audio output (SPDIF) format. The available Digital Audio output (SPDIF) format may differ depending on the input source.
 - 📖 By connecting the TV to a receiver or home theater with **Dolby Digital** and 5.1ch speakers and selecting **Dolby Digital**, you can maximize your interactive 3D sound experience.
- **Audio Delay:** Lets you correct timing mismatches between the audio track and the video when you are watching the TV and listening to digital audio output from the TV through an external device such as an AV receiver. When you select **Audio Delay**, a slider appears. Use the ◀/▶ buttons to adjust the slider. Press **ENTER**  when done (0ms ~ 250ms).

■ Speaker Settings

- **Speaker Select (External Speaker / TV Speaker)**

If you are listening to the sound track of a broadcast or movie through an external receiver, you may hear a sound echo caused by the difference in decoding speed between the TV's speakers and the speakers attached to your audio receiver. If this occurs, set the TV to **External Speaker**.

- ☞ When you set **Speaker Select** to **External Speaker**, the TV's speakers are turned off. You will hear sound through the external speakers only. When you set **Speaker Select** to **TV Speaker**, both the TV's speakers and the external speakers are on. You will hear sound through both.
- ☞ When **Speaker Select** is set to **External Speaker**, the **VOLUME** and **MUTE** buttons will not operate and the sound settings will be limited.
- ☞ If there is no video signal, both the TV's speakers and the external speakers will be mute.



- **Auto Volume (Off / Normal / Night)**

Normal equalizes the volume level on each channel, so that when you change channels, the volume level is the same.

Night equalizes and decrease the volume level on each channel, so each channel is quieter. **Night** is useful at night, when you may want to keep the volume low.

 To use the volume control on the source device connected to the TV, set **Auto Volume** to **Off** on the TV. Otherwise, a change to the volume control of the source device may not be applied.

■ Reset Sound (Yes / No)

Reset all sound settings to the factory defaults. Select **Reset Sound**, press **ENTER** , select **Yes** on the pop-up, and then press **ENTER**  again.



❑ Connecting to the Network

■ Wired Network Connection

There are three ways to attach your TV to your LAN using cable:

- You can attach your TV to your LAN by connecting the LAN port on the back of your TV to an external modem using a LAN cable. See the diagram below.

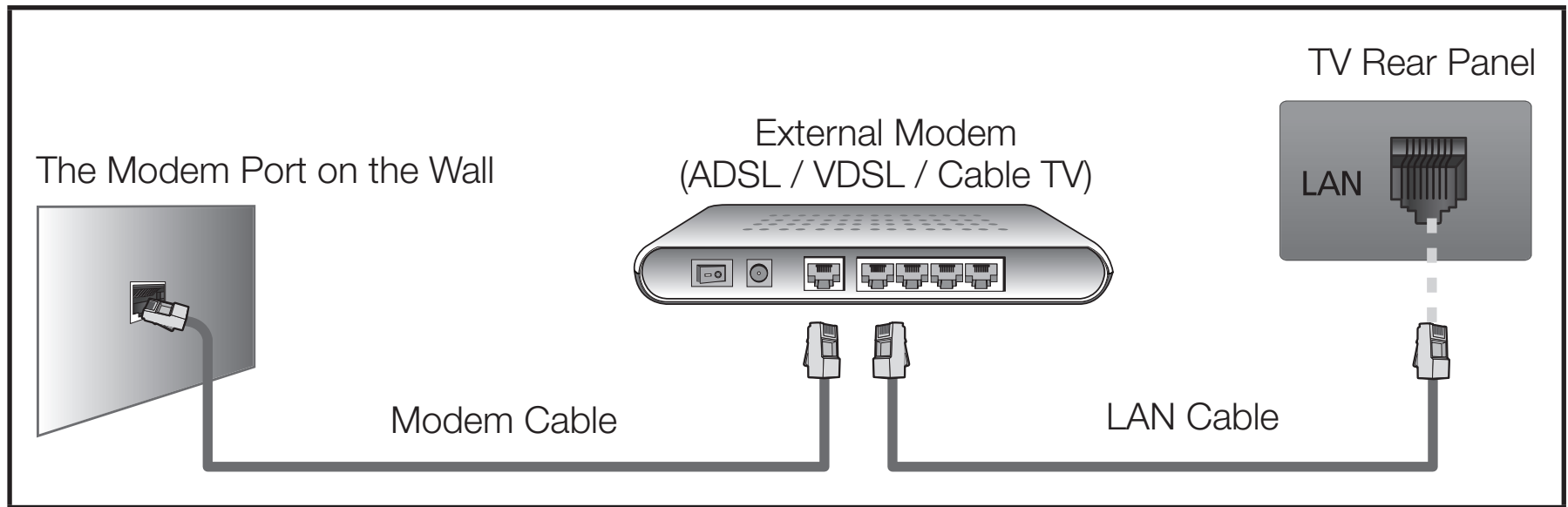

- You can attach your TV to your LAN by connecting the LAN port on the back of your TV to a IP Sharer (router) which is connected to an external modem. Use LAN cable for the connection. See the diagram below.

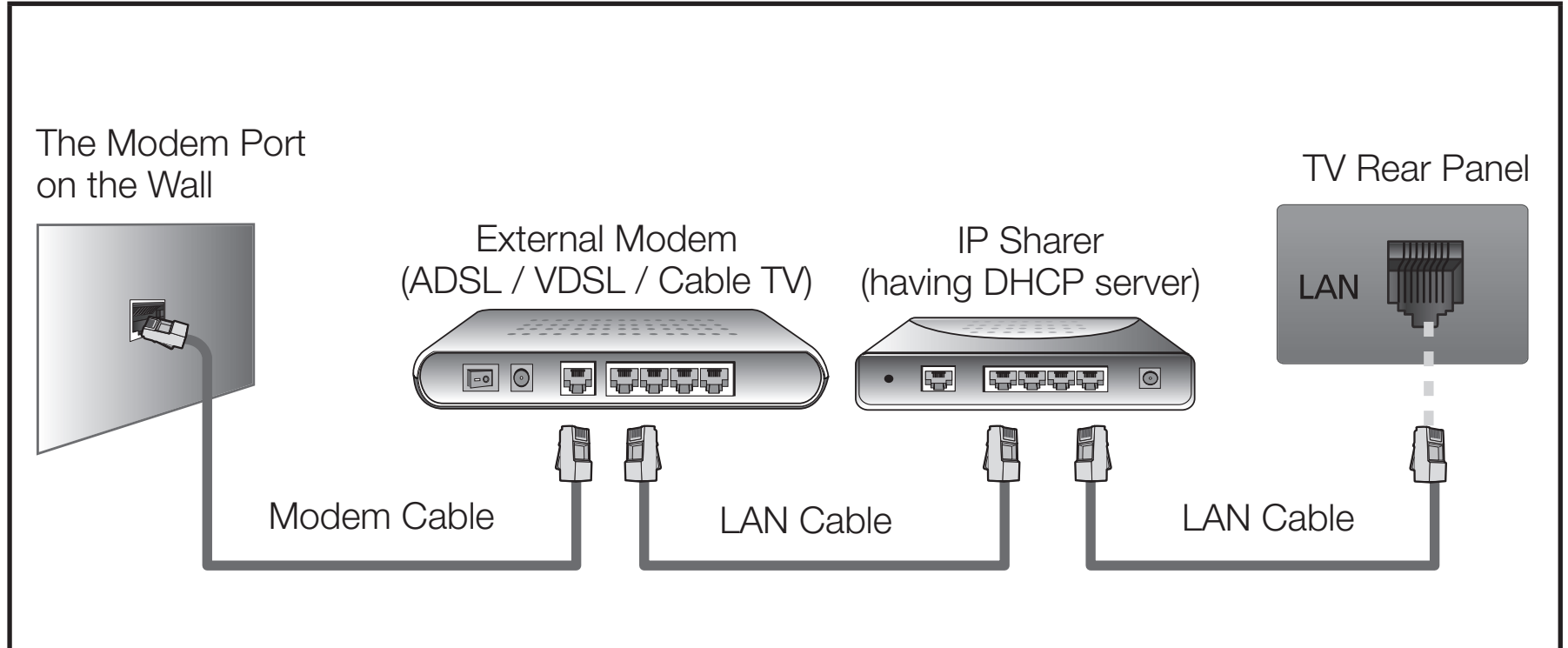

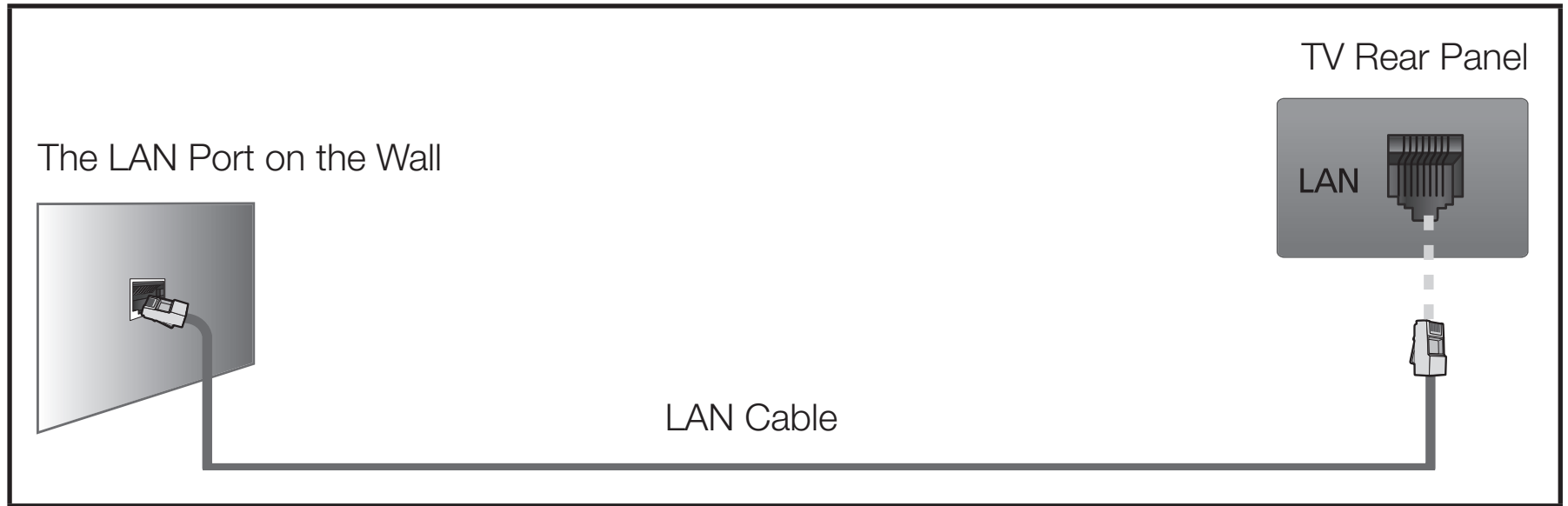

- Depending on how your network is configured, you may be able to attach your TV to your LAN by connecting the LAN port on the back of your TV directly to a network wall outlet using a LAN cable. See the diagram below. Note that the wall outlet is attached to a modem or router elsewhere in your house.



- If your network requires a Dynamic IP address, you should use an ADSL modem or router that supports the Dynamic Host Configuration Protocol (DHCP). Modems and routers that support DHCP automatically provide the IP address, subnet mask, gateway, and DNS values your TV needs to access the Internet so you do not have to enter them manually. Most home networks use a Dynamic IP address.

Some networks require a Static IP address. If your network requires a Static IP address, you must enter the IP address, subnet mask, gateway, and DNS values manually on your TV's Cable Setup Screen when you set up the network connection. To get the IP address, subnet mask, gateway, and DNS values, contact your Internet Service Provider (ISP). If you have a Windows computer, you can also get these values through your computer.

-  You can use ADSL modems that support DHCP if your network requires a Static IP address. ADSL modems that support DHCP also let you use Static IP addresses.
-  It is not supported when the network speed is below or equal to 10Mbps.
-  Use Cat 6 (*STP Type) cable for the connection. (*Shielded Twist Pair)

■ Wireless Network Connection

To connect your TV to your wireless network, you need a wireless router or modem and a Samsung Wireless LAN Adapter (WIS09ABGNX, WIS12ABGNX), which you connect to your TV's back or side panel USB port. See the illustration below.

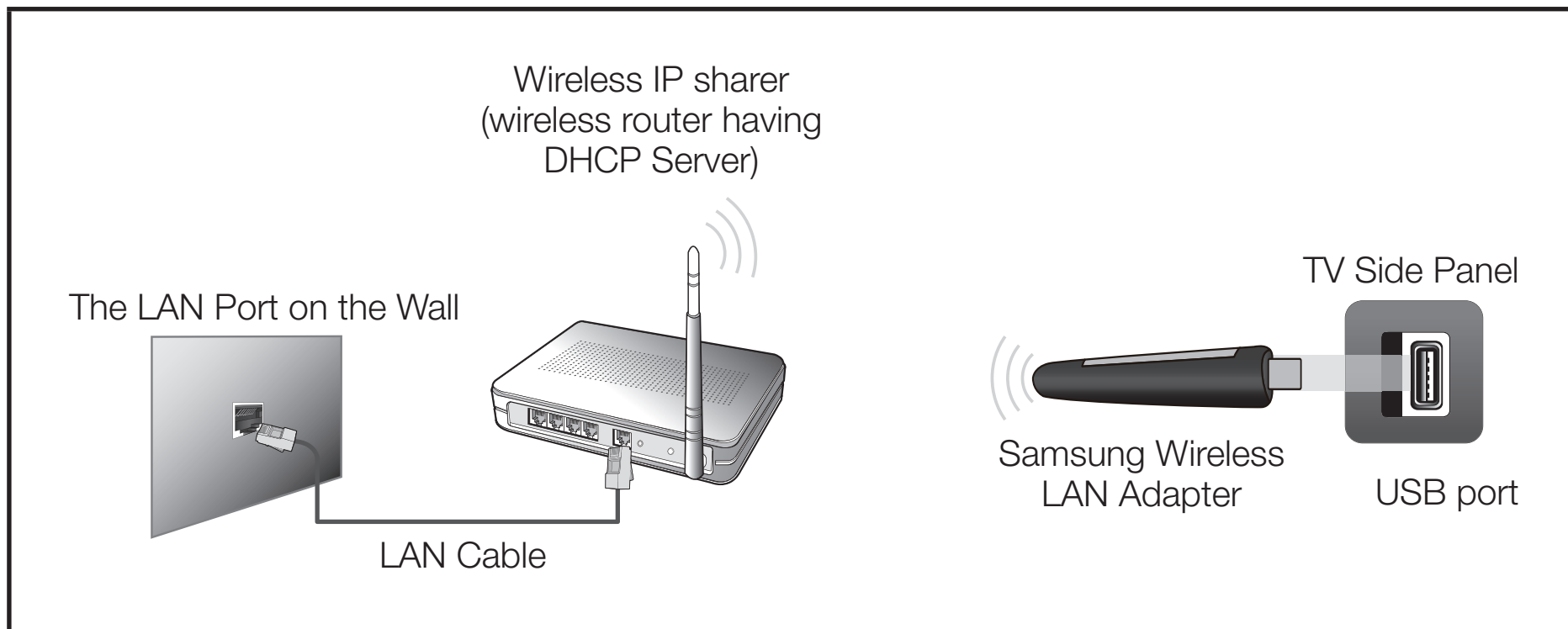

Samsung's Wireless LAN adapter is sold separately and is offered by selected retailers, Ecommerce sites, and Samsungparts.com. Samsung's Wireless LAN adapter supports the IEEE 802.11a/b/g and n communication protocols. Samsung recommends using IEEE 802.11n. When you play video over a network connection, the video may not be played smoothly.

 NOTE

- You must use the “Samsung Wireless LAN Adapter” (WIS09ABGNX, WIS12ABGNX) to use a wireless network.
- Samsung Wireless LAN Adapter and The USB extension Cable are sold separately and are offered by selected retailers, Ecommerce sites and Samsungparts.com.
- To use a wireless network, your TV must be connected to a wireless IP sharer (either a router or a modem). If the wireless IP sharer supports DHCP, your TV can use a DHCP or static IP address to connect to the wireless network.

- Select a channel for the wireless IP sharer that is not currently being used. If the channel set for the wireless IP sharer is currently being used by another device nearby, this will result in interference and communication failure.
- Your TV supports the following wireless security systems only:
 - Authentication Mode: WEP, WPAPSK, WPA2PSK
 - Encryption Type: WEP, AES
- If you select the HIGH PURE THROUGHPUT (Greenfield) 802.11n mode and the Encryption type is set to WEP or TKIP for your wireless router, Samsung TVs will not support a connection in compliance with new Wi-Fi certification specifications.
- If your wireless router supports WPS (Wi-Fi Protected Setup), you can connect to the network via PBC (Push Button Configuration) or PIN (Personal Identification Number). WPS will automatically configure the SSID and WPA key in either mode.

- If your router, modem, or device is not certified, it may not connect to the TV via the “Samsung Wireless LAN Adapter”.
- Ensure the TV is turned off before you connect the Samsung Wireless LAN Adapter.
- Connection Methods: You can setup the wireless network connection like below.
 - Auto Setup (Using the Auto Network Search function)
 - Manual Setup
 - **WPS (PBC)**
- The TV may not recognize the Samsung Wireless LAN Adapter if it is connected to the TV using a USB hub or USB extension cable other than the cable supplied.

Notice

The picture may appear corrupted or have static for some channels when the TV is connected to the Samsung Wireless LAN Adapter. In such a case, establish a connection using one of the following methods or connect the Samsung Wireless LAN Adapter using a USB cable in a place that is not affected by radio interference.

Method 1

Connect using the USB right angle adapter. To connect the Samsung Wireless LAN Adapter using the USB right angle adapter, follow these steps:

1. Connect the USB right angle adapter to the Samsung Wireless LAN Adapter.
2. Connect the other end of the right angle adapter to the USB port.

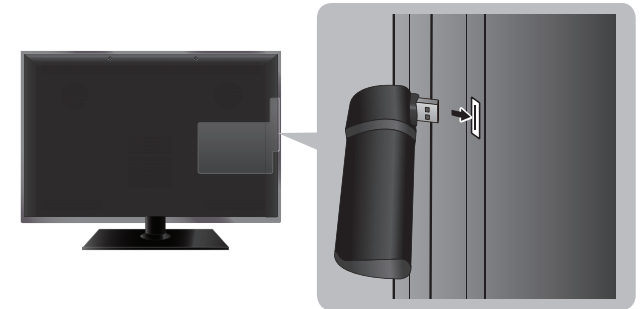

* The position of port may differ depending on the model.

Method 2

Connect via an extension cable

To connect the Samsung Wireless LAN Adapter using the extension cable, follow these steps:

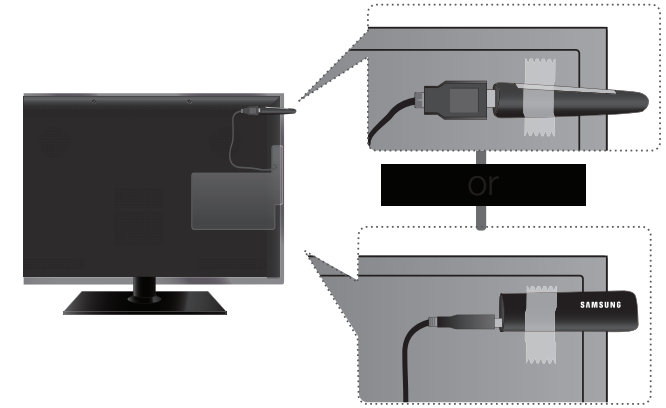

* The position of port may differ depending on the model.

1. Connect the extension cable to the USB port.
 2. Connect the extension cable and Samsung Wireless LAN Adapter.
 3. Attach the Samsung Wireless LAN Adapter to the back of the TV near the top, using double-sided adhesive tape.
-  The Samsung Wireless LAN Adapter should be installed in an interference-free area in order to avoid interference between the adapter and tuner.

■ Network Settings

 **MENU**  → **Network** → **Network Settings** → **ENTER** 

Set the network connection to use AllShare™ and perform software upgrade.

 For detailed settings for wired network, refer to the “Setting the Wired Network”, and for detailed settings for wireless network, refer to the “Setting the Wireless Network” in this manual.

 If you set the network, you can share the contents and update the functions through the **AllShare Play**. It only supports **AllShare Play** and software upgrade. Other Internet functions are not supported.

■ Network Status

 MENU  → Network → Network Status → ENTER 

You can check the current network and Internet status.



The check list for wired network connection failure

When wired network connection failed, try to apply the following information to each issue.

Issues	Solutions and Explanations
No network cable found.	<ul style="list-style-type: none">• Check that your network cable is plugged in.• If it is connected, make sure that the router is turned on; if it is on, try turning it off and on again.
IP auto setting failed.	<p>Try the following to set your IP address automatically or set your IP address manually by selecting IP Settings.</p> <ul style="list-style-type: none">• Ensure DHCP server is enabled on router and unplug and re-plug-in the router.• Contact your Internet Service Provider for more information.

Issues	Solutions and Explanations
Unable to connect to the network.	<ul style="list-style-type: none">• Check if your IP address is set correctly in IP Settings.• Contact your Internet Service Provider for more information.
Connected to your local network, but cannot connect to the Internet.	<ul style="list-style-type: none">• Check your Internet LAN cable is connected correctly to LAN port of router.• Check the DNS settings in IP Settings.• If the problem persists, contact your Internet Service Provider to access the Internet.
Network setup complete, but cannot connect to the Internet.	<ul style="list-style-type: none">• Confirm that your router is connected to the Internet.• If the problem persists, contact your Internet Service Provider to access the Internet.

The check list for wireless network connection failure

When wireless network connection failed, try to apply the following information to each issue.

Issues	Solutions and Explanations
Wireless network connection failed.	<ul style="list-style-type: none">• No wireless router selected. Go to Network Settings to select your router.
Unable to connect to wireless router.	<ul style="list-style-type: none">• Check that the router is turned on, and if it is on, try turning it off and on again.• Check if you need to enter a security key to use the router.
IP auto setting failed.	<ul style="list-style-type: none">• Try the following to set your IP address automatically or set your IP address manually by selecting IP Settings.• Ensure DHCP server is enabled on router and unplug and re-plug-in the router.• Check if you need to enter a security key to use the router.• Contact your Internet Service Provider for more information.

Issues	Solutions and Explanations
Unable to connect to the network.	<ul style="list-style-type: none">• Check if your IP address is set correctly in IP Settings.• Check if you need to enter a security key to use the router.• Contact your Internet Service Provider for more information.
Connected to your local network, but cannot connect to the Internet.	<ul style="list-style-type: none">• Check your Internet LAN cable is connected correctly to LAN port of router.• Check the DNS settings in IP Settings.• If the problem persists, contact your Internet Service Provider to access the Internet.
Network setup complete, but cannot connect to the Internet.	<ul style="list-style-type: none">• Confirm that your router is connected to the Internet.• If the problem persists, contact your Internet Service Provider to access the Internet.

❑ Setting the Wired Network



■ Wired Network Setup (Auto)

Use the Automatic Network Setup when connecting your TV to a network that supports DHCP. To set up your TV's cable network connection automatically, follow these steps:

📝 When connecting LAN cable, the screen pop-up appears directly to set wired network.



How to set up automatically

1. Go to the **Network Settings** screen. (**MENU**  → **Network** → **Network Settings** → **ENTER** )
2. Select **Start**, and then press **ENTER** .

3. The network connection screen appears and verifies the network connection. When the connection has been verified, the "**The Internet is connected and ready to upgrade your TV software...**" message appears.

 If the connection process fails, check the LAN port connection.

 If the automatic process cannot find the network connection values or if you want to set the connection manually, go to the next section, Manual Network Setup.

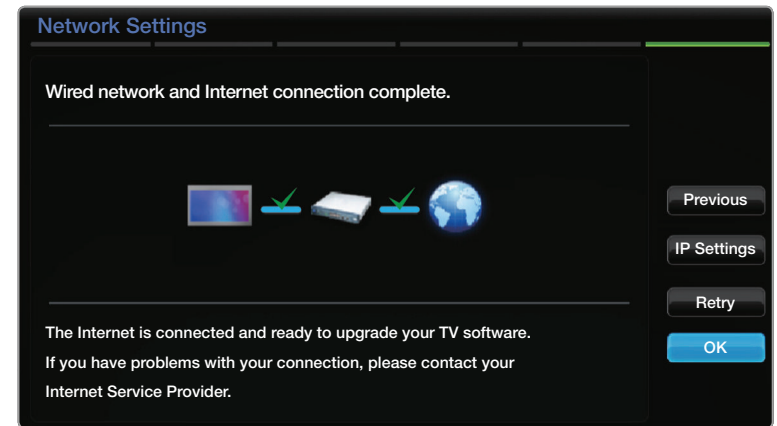

■ **Wired Network Setup (Manual)**

Use the Manual Network Setup when connecting your TV to a network that requires a Static IP address.





Getting the Network Connection Values

To view the Network connection values on most Windows computers, follow these steps:



1. Right click the Network icon on the bottom right of the screen.
2. In the pop-up menu that appears, click Status.
3. On the dialog that appears, click the Support tab.
4. On the Support Tab, click the Details button. The Network connection values are displayed.

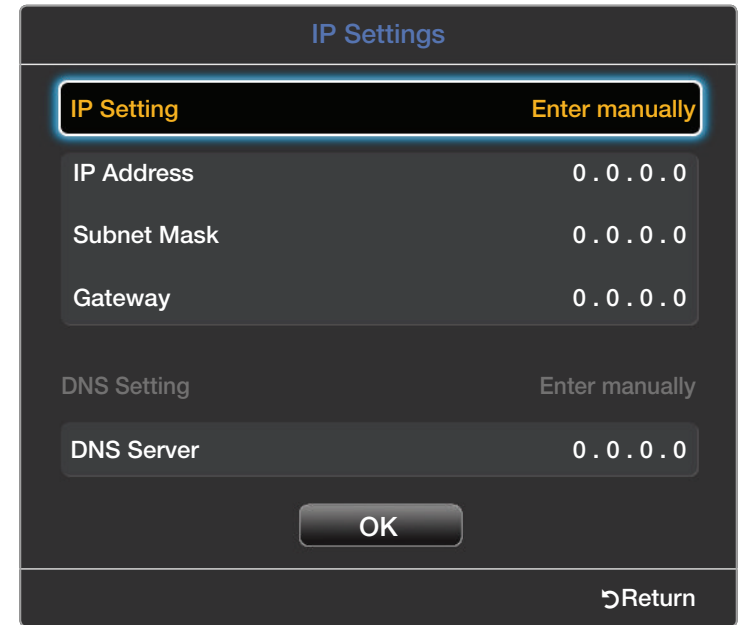

How to set up manually

To set up your TV's cable network connection manually, follow these steps:

1. Go to the **Network Settings** screen.
(**MENU**  → **Network** → **Network Settings** → **ENTER** )
2. Select **Start**, and then press **ENTER** .
The network connection screen appears and the verification process starts.
3. Press **ENTER** . The verification process stops. Select **IP Settings** on network connection screen. The **IP Settings** screen appears.
4. In the top entry field, press **ENTER** , and then set **IP Setting** to **Enter manually**.



5. Press the ▼ button to go to the IP Address entry field, and then press **ENTER** .
6. Enter the first portion of the IP Address (for example, 105) into the first entry field using the number keys. Press the ► button to go to the next field.
7. Enter the next portion of the IP Address. Press the ► button to go to the next field.
8. Repeat the entry process for each field in the IP Address.
 -  If you make a mistake when entering a number, re-enter the number to correct it. You can also press the ▲/▼ buttons to change the number one unit at a time.

9. When done entering **IP Address**, press **ENTER** .
10. Press the ▼ button to go to the Subnet Mask fields, and then press **ENTER** .
11. Repeat the same entry process for **Subnet Mask, Gateway**, and **DNS Server**.
12. When done, select **OK** at the bottom of the page, and then press **ENTER** . The network connection screen appears and the verification process starts. When the connection has been verified, the "**The Internet is connected and ready to upgrade your TV software...**" message appears.



❑ Setting the Wireless Network

■ Wireless Network Setup (Auto)





Most wireless networks have an optional security system that requires devices that access the network to transmit an encrypted security code called an Access or Security Key. The Security Key is based on a Pass Phrase, typically a word or a series of letters and numbers of a specified length you were asked to enter when you set up wireless security for your wireless network. If you use this method of setting up the network connection, and have a Security Key for your wireless network, you will have to enter the Pass Phrase during the automatic or manual setup process.

📝 When connecting Samsung Wireless LAN Adapter, the screen pop-up appears directly to set wireless network.



How to set up automatically

1. Go to the **Network Settings** screen.
(MENU  → **Network** → **Network Settings** → ENTER )
2. Select **Start**, and then press **ENTER** .
3. The Network function searches for available wireless networks. When done, it displays a list of the available networks.



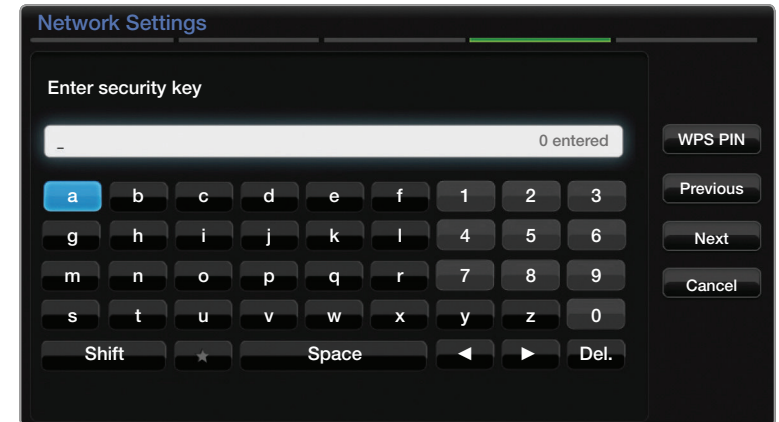

4. In the list of networks, press the ▲ or ▼ button to select a network, and then press the **ENTER**  button.
 -  If the wireless router is set to Hidden (Invisible), you have to select **Add Network** and enter the correct network **Name (SSID)** and Security key to establish the connection.
5. If the Enter security key screen appears, go to step 6. If you select an wireless router that does not have wireless security, go to step 8.
6. Enter the security key (Security key or PIN).
 -  When you enter the security key (Security or PIN), use ▲/▼/◀/▶ buttons to select number/characters. Press **ENTER**  to enter the characters.



-  You can also enter numbers by pressing the number buttons.
-  You should be able to find the Pass Phrase on one of the set up screens you used to set up your router or modem.

7. When done, use the ► button to move the cursor to **Next**, and then press **ENTER** .
8. The network connection screen appears and the verification process starts. When the connection has been verified, the “**The Internet is connected and ready to upgrade your TV software...**” message appears.

 If the network does not accept the Security key (Security or PIN), select **Retry** or select **IP Settings** to enter the settings manually.

 If you want to set up the connection manually, select **IP Settings**. Then, go to the next section, “How to set up manually”.

■ **Wireless Network Setup (Manual)**

Use Manual Network Setup when connecting your TV to a network that requires a Static IP address or if the automatic connection process has failed.





Getting the Network Connection Values





To view the Network connection values on most Windows computers, follow these steps:

1. Right click the Network icon on the bottom right of the screen.
2. In the pop-up menu that appears, click Status.
3. On the dialog that appears, click the Support tab.
4. On the Support Tab, click the Details button. The Network connection values are displayed.

How to set up manually

To set up your TV's cable network connection manually, follow these steps:

1. Go to the **Network Settings** screen. (**MENU**  → **Network** → **Network Settings** → **ENTER** )
2. Select **Start**, and then press **ENTER** .
3. The Network function searches for available wireless networks. When done, it displays a list of the available networks.
4. In the list of networks, press the ▲ or ▼ button to select a network, and then press the **ENTER**  button twice.
 -  If the wireless router is set to Hidden (Invisible), you have to select **Add Network** and enter the correct network **Name (SSID)** and Security key to establish the connection.

5. If the Enter security key screen appears, go to step 6. If you selected an AP or wireless router that does not have wireless security, go to step 8.
6. Enter the security key (Security key or PIN).
 -  When you enter the security key (Security key or PIN), use ▲/▼/◀/▶ buttons to select number/characters. Press **ENTER**  to enter the characters.
 -  You can also enter numbers by pressing the number buttons.
 -  You should be able to find the Pass Phrase on one of the set up screens you used to set up your router or modem.
7. When done, use the ▶ button to move the cursor to **Next**, and then press the **ENTER**  button.

8. The network connection screen appears and the verification process starts. Press **ENTER**  to cancel. Select **IP Settings** on network connection screen. The **IP Settings** screen appears.

9. In the top entry field, press **ENTER** , and then set **IP Setting** to **Enter manually**.

10. Press the **▼** button to go to the **IP Address** entry field, and then press **ENTER** .

11. Enter the first portion of the **IP Address** (for example, 105) into the first entry field using the number keys. Press the **▶** button to go to the next field.

12. Enter the next portion of the **IP Address**. Press the **▶** button to go to the next field.

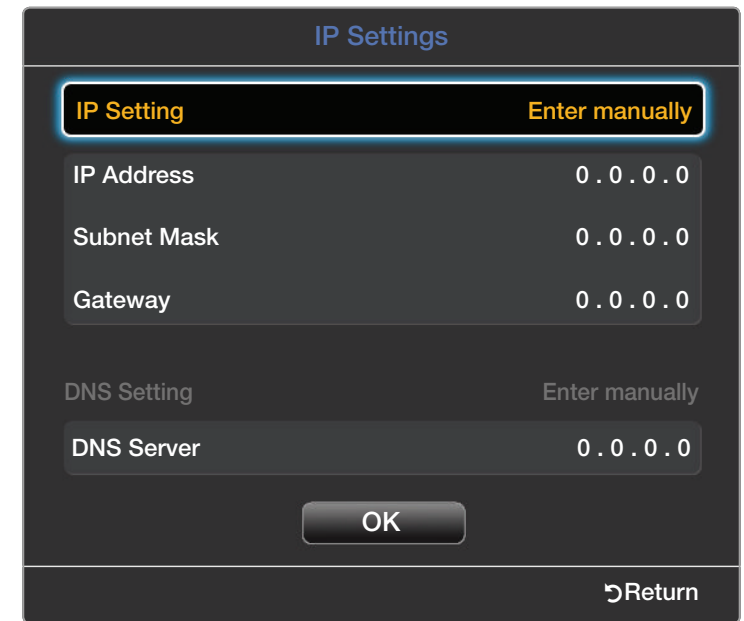

13. Repeat the entry process for each field in the **IP Address**.

 If you make a mistake when entering a number, re-enter the number to correct it. You can also press the ▲/▼ buttons to change the number one unit at a time.

14. When done entering the **IP Address**, press **ENTER** .

15. Press the ▼ button to go to the **Subnet Mask** fields, and then press **ENTER** .



16. Repeat the same entry process for **Subnet Mask, Gateway**, and **DNS Server**.

17. When done, select **OK** at the bottom of the page, and then press **ENTER** . The network connection screen appears and the verification process starts. When the connection has been verified, the “**The Internet is connected and ready to upgrade your TV software...**” message appears.

■ Wireless Network Setup (WPS(PBC))

How to set up using WPS(PBC)

If your router has a PBC (WPS) button, follow these steps:

1. Go to the **Network Settings** screen. (**MENU**  → **Network** → **Network Settings** → **ENTER** )
2. Select **Start**, and then press **ENTER** .
3. The Network function searches for available wireless networks. When done, it displays a list of the available networks.

4. Select the **WPS(PBC)**.
5. Press the WPS(PBC) button on your router within 2 minutes. Your TV automatically acquires all the network setting values it needs and connects to your network.
6. The network connection screen appears, and network set up is done.

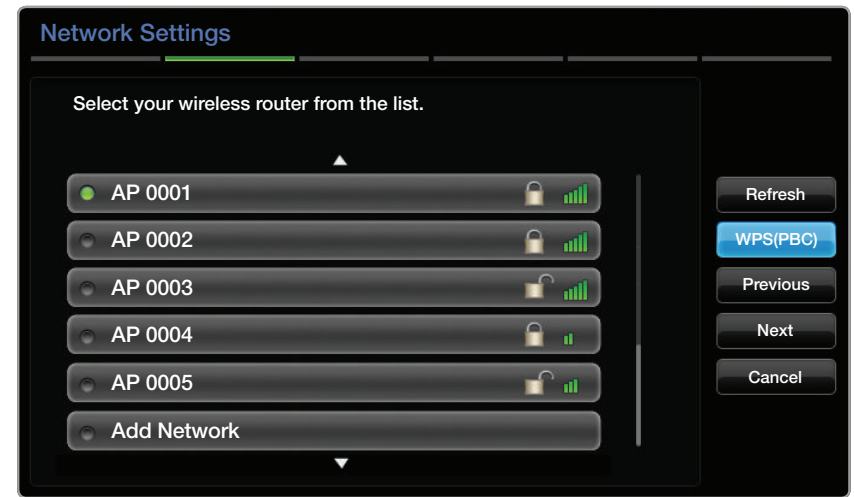

If Your TV Fails to Connect to the Internet

Your TV may not be able to connect to the Internet because your ISP has permanently registered the MAC address (a unique identifying number) of your PC or modem, which it then authenticates each time you connect to the Internet as a way of preventing unauthorized access. As your TV has a different MAC address, your ISP can not authenticate its MAC address, and your TV can not connect.

To resolve this problem, ask your ISP about the procedures required to connect devices other than a PC (such as your TV) to the Internet.

If your Internet service provider requires an ID or password to connect to the Internet, your TV may not be able to connect to the Internet. If this is the case, you must enter your ID or password when connecting to the Internet.

The internet connection may fail because of a firewall problem. If this is the case, contact your Internet service provider.

If you cannot connect to the Internet even after you have followed the procedures of your Internet service provider, please contact Samsung Electronics at 1-800-SAMSUNG.



❑ Managing the Network Connected Devices

■ AllShare Settings

 **MENU**  → **Network** → **AllShare Settings** → **ENTER** 

Set whether to allow a network connected device like a smartphone or tablet to share content or control TV using an application downloaded on your mobile device. For details on set up options, refer to the "Using the DLNA Functions".

■ Device Name

 **MENU**  → **Network** → **Device Name** → **ENTER** 

Change the TV's name by keying in a name manually.

 A keyboard appears on the screen and you can key in a name for your TV manually using your remote control. For example, if you want to change the name to Samsung TV, press each character using the ▲/▼/◀/▶ buttons, and then select **Done**.

❑ Setting the Setup

■ Setup

 **MENU**  → **System** → **Setup** → **ENTER** 

Configure the channels and the time when setting up the TV for the first time or when resetting the unit.

 For the detailed information about setting **Setup**, refer to “Setup (Initial Setup)” in User Manual.

❑ Setting the Time

■ Time

 MENU  → System → Time → ENTER 

 The current time will appear every time you press the **INFO** button.

- **Clock:** Set the clock to use the various timer features of the TV.

 If you disconnect the power cord, you have to set the clock again.

Clock Mode: Set the current time manually or automatically.

- **Auto:** The TV sets the current time automatically using the time from a digital channel.



 You must have cable or an antenna connected to the TV to set the time automatically.

- **Manual:** Set the current time manually.



Depending on the broadcast station and signal, the auto time set up may not be correct. In this case, set the time manually.

Clock Set: Set the **Date** and **Time**.

Select **Clock Set**. Select **Date** or **Time**, and then press **ENTER** . Use the number buttons or the ▲/▼ buttons to enter numbers. Use the ◀/▶ buttons to move from one entry field to the next. Press **ENTER**  when done.



Available only when **Clock Mode** is set to **Manual**.

Time Zone: Select your time zone.

 This function is only available when the **Clock Mode** is set to **Auto**.



DST (Off / On): Switches the DST (Daylight Saving Time) function on or off.

 This function is only available when the **Clock Mode** is set to **Auto**.

Using the Sleep Timer

 **MENU**  → **System** → **Time** → **Sleep Timer** → **ENTER** 

- **Sleep Timer** : Automatically shuts off the TV after a preset period of time. (30, 60, 90, 120, 150 and 180 minutes).

 Use the **▲/▼** buttons to select a period of time, and then press **ENTER** . To cancel the **Sleep Timer**, select **Off**.

❑ Setting the On/Off Timer

 MENU  → System → Time → On Timer <or> Off Timer → ENTER 

Set **On Timer** so that your TV turns on automatically at a time and on a day of your choosing.

- **On Timer:** You can set up three separate **On Timer** configurations. (**On Timer 1, On Timer 2, On Timer 3**)

 You must set the clock before you can use **On Timer**.

Setup: Select **Off, Once, Everyday, Mon~Fri, Mon~Sat, Sat~Sun** or **Manual**.

If you select **Manual**, you can choose the days you want **On Timer** to turn on your TV.

 The ✓ mark indicates days you've selected.

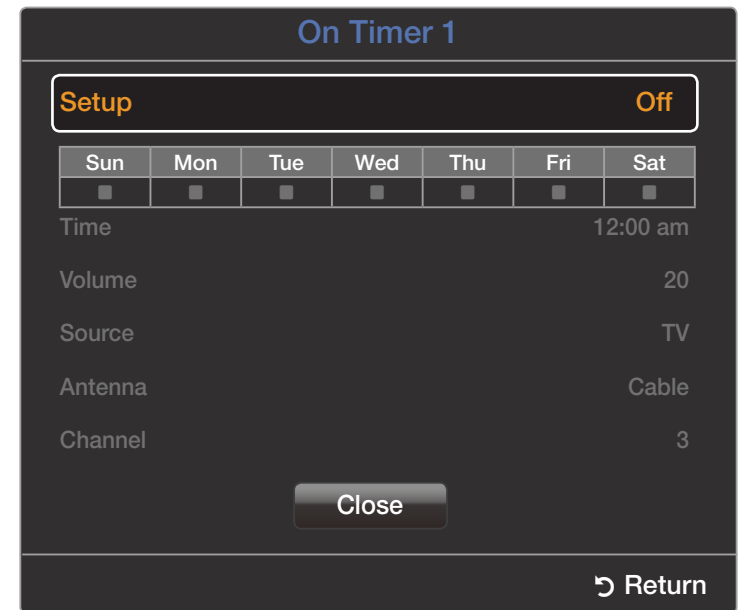

Time: Set the hour, minute, am/pm. Use the number buttons or the ▲/▼ buttons to enter numbers. Use the ◀/▶ buttons to change entry fields.

Volume: Set the desired volume level. Use the ◀/▶ buttons to change the volume level.

Source: To select the source of the content that will play when the TV turns on. You can:

- Select **TV** and have the TV display a specific air or cable channel.
- Select **USB** and have the TV play back photo or audio files from a USB device.
- Select a source on your TV (**HDMI1/DVI, HDMI2, AV, Component**) that you have connected a set-top box to, and have the TV display a channel from the set-top box.







 The USB device must be connected to your TV before you can select **USB**.

- ✎ If you select a source other than **TV** or **USB**, you must:
 - Have a cable or satellite set-top box attached to that source
 - Set the set-top box to the channel you want to watch when the TV goes on
 - Leave the set-top box turned on.
- ✎ When you select a source other than **TV** or **USB**, the **Antenna** and **Channel** options will disappear.

Antenna (when the **Source** is set to **TV**): Select **Air** or **Cable**.

Channel (when the **Source** is set to **TV**): Select the desired channel.

Music / Photo (when the **Source** is set to **USB**): Select a folder in the USB device containing the music or photo files you want to play when the TV turns on automatically.

-  If there is no music file on the USB device or you don't select a folder containing a music file, the Timer function does not operate correctly.
-  If there is only one photo file in the USB, the Slide Show will not play.
-  A folder with a name that is too long cannot be selected.
-  Each USB device you use is assigned its own folder. When using more than one of the same type of USB device, make sure the folders assigned to each USB device have different names.
-  It is recommended that you use a USB memory stick and a multi card reader when using **On Timer**.
-  The **On Timer** function may not work with USB devices with a built-in battery, MP3 players, or PMPs made by some manufacturers because these devices take a long time to be recognized.

- **Off Timer:** You can set up three separate **Off Timer** configurations. (**Off Timer 1, Off Timer 2, Off Timer 3**)

 You must set the clock before you can use **Off Timer**.

Setup: Select **Off, Once, Everyday, Mon~Fri, Mon~Sat, Sat~Sun** or **Manual**.

If you select **Manual**, you can choose the days you want **Off Timer** to turn off your TV.

 The ✓ mark indicates days you've selected.

Time: Set the hour, minute, and am/pm. Use the number buttons or the ▲/▼ buttons to enter numbers. Use the ◀/▶ buttons to change entry fields.

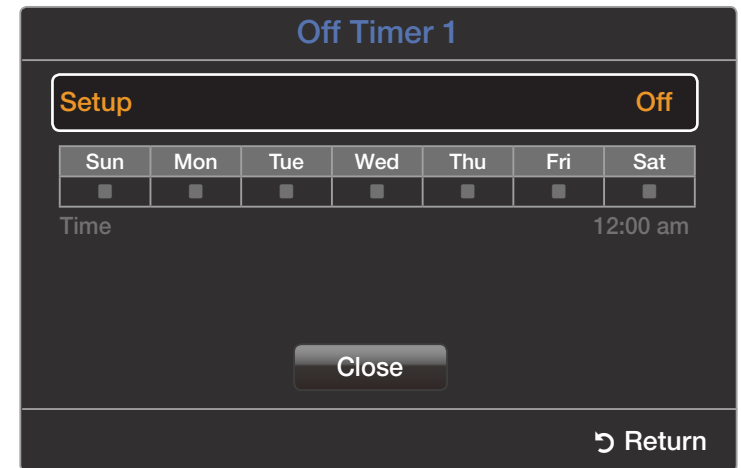

❑ Blocking Programs

 MENU  → System → Security → ENTER 

■ Security

When you access the Security functions for the first time, the PIN input screen appears. Enter a 4 digit PIN you will remember. The PIN screen closes and the Security Menu appears. Every time you access the Security functions, the PIN screen appears and you must enter that PIN.

- **Program Rating Lock (Off / On):** When **On**, lets you block TV programs based on their ratings.

 The default PIN number for a new TV set is “0-0-0-0”.

TV Rating: Lets you block TV programs based on their ratings. This function allows you to control which TV programs your children can watch. **TV Rating** displays a grid with locks. The following categories are on the left side:



- **TV-Y:** Young children / **TV-Y7:** Children 7 and over / **TV-G:** General audience / **TV-PG:** Parental guidance / **TV-14:** Viewers 14 and over / **TV-MA:** Mature audience

The following categories are on top:

- **ALL / FV:** Fantasy violence / **V:** Violence / **S:** Sexual situation / **L:** Adult Language / **D:** Sexually Suggestive Dialog

To block certain content, you select a lock, and press **ENTER**  (That is, you “click it”). For example, click the lock at the intersection of V and TV-MA, and you block all programs that are rated violent and for mature adults. The locks are also assigned to related groups. For example, if you click **TV-Y** under **ALL**, then **TV-Y7** will also automatically be blocked.

Similarly, if you click **TV-G** under **ALL**, then all the categories in the young adult group will be blocked (**TV-G**, **TV-PG**, **TV-14** and **TV-MA**). The sub-ratings (**D**, **L**, **S**, **V**) work similarly. So, if you block the L sub-rating in **TV-PG**, then the L sub-ratings in **TV-14** and **TV-MA** will automatically be blocked.

-  To unblock a category, click the lock. To unblock all the categories in a row, click the lock under **ALL**.
-  To watch a blocked program, you must enter the Security code when requested.

Movie Rating (MPAA): You can block movies based on their MPAA rating. The Motion Picture Association of America (MPAA) has implemented a rating system that provides parents or guardians with advanced information on which films are appropriate for children.

Movie Rating displays a column with locks and the following ratings categories:

- **G:** General audience (no restrictions). / **PG:** Parental guidance suggested. / **PG-13:** Parents strongly cautioned. / **R:** Restricted. Children under 17 should be accompanied by an adult. / **NC-17:** No children under age 17. / **X:** Adults only. / **NR:** Not rated.

To block certain content, you select a lock, and press **ENTER**  (That is, you “click it”). For example, click the **X** lock and you block all X-rated movies. The rating categories are also grouped so that clicking one category blocks all the categories a parent would block along with it. For example, if you block the **PG-13** category, then **R**, **NC-17** and **X** will automatically be blocked also.

 To unblock a category, click the lock.

Canadian English Rating: You can block TV programs based on their Canadian English rating.

Canadian English Rating displays a column with locks and the following ratings categories:

- **C:** Programming intended for children under age 8. / **C8+:** Programming generally considered acceptable for children 8 years and over to watch on their own. / **G:** General programming, suitable for all audiences. / **PG:** Parental Guidance. / **14+:** Programming contains themes or content which may not be suitable for viewers under the age of 14. / **18+:** Adult programming.

To block certain content, you select a lock, and press **ENTER**  (That is, you “click it”). For example, click the 18+ lock and you block all TV programs rated 18+. The rating categories are also grouped so that clicking one category blocks all the categories a parent would block along with it. For example, if you block the **G** category, then **PG**, **14+** and **18+** will automatically be blocked.

 To unblock a category, click the lock.

Canadian French Rating: You can block TV programs based on their French Canadian rating.

Canadian French Rating displays a column with locks and the following ratings categories:

- **G:** General / **8 ans+:** Programming generally considered acceptable for children 8 years and over to watch on their own. / **13 ans+:** Programming may not be suitable for children under the age of 13. / **16 ans+:** Programming is not suitable for children under the age of 16. / **18 ans+:** Programming restricted to adults.

To block certain content, you select a lock, and press **ENTER**  (That is, you “click it”). For example, click the 18 ans+ lock and you block all TV programs rated 18 ans+. The rating categories are also grouped so that clicking one category blocks all the categories a parent would block along with it. For example, if you block the **8 ans+** category, then **13 ans+**, **16 ans+** and **18 ans+** will automatically be blocked also.

 To unblock a category, click the lock.

Downloadable U.S. Rating: Parental restriction information you can use while watching DTV channels.

 NOTE

- If information is not downloaded from the broadcasting station, **Downloadable U.S. Rating** menu is deactivated.
- Parental restriction information is automatically downloaded while you watch DTV channels. It may take several seconds.
- The **Downloadable U.S. Rating** menu is available for use after information is downloaded from the broadcasting station. However, depending on the information from the broadcasting station, it may not be available for use.

- Parental restriction levels differ depending on the broadcasting station. The default menu name and **Downloadable U.S. Rating** change depending on the downloaded information.
- Even if you set the on-screen display to another language, the **Downloadable U.S. Rating** menu will appear in English only.
- Blocking one rating level will automatically block other categories that deal with more sensitive material.
- The rating titles (For example: Humor Level..etc) and TV ratings (For example: DH, MH, H..etc) may differ depending on the broadcasting station.

- **Change PIN:** The **Change PIN** screen will appear. Choose any 4 digits for your PIN and enter it in **Enter New PIN**. Re-enter the same 4 digits in **Confirm New PIN**. When the Confirm screen appears, press the **Close** button. The TV has memorized your new PIN.

How to watch a restricted program or movie

If the TV is tuned to a restricted program or movie, the **Program Rating Lock** will block it. The screen will go blank and the following message will appear:

This channel is blocked by Program Rating Lock. Please enter the PIN to unblock. Enter the PIN to unblock the program or movie.

- ☞ If you forget the PIN code, press the remote control buttons in the following sequence in Standby mode, which resets the PIN to “0-0-0-0” :
MUTE → 8 → 2 → 4 → **POWER** (on)

Economical Solutions

 MENU  → System → Eco Solution → ENTER 

■ Eco Solution

- **Energy Saving (Off / Low / Medium / High / Picture Off)**: Lets you adjust the brightness of the TV in order to reduce power consumption. If you select **Picture Off**, the screen is turned off, but the sound remains on. Press any button to turn on the screen again.
 - **Eco Sensor (Off / On)** : To enhance your power savings, the picture settings will automatically adapt to the light in the room.
-  If you adjust **Backlight** in the Picture menu, **Eco Sensor** is set to **Off**.

Min. Backlight: When **Eco Sensor** is **On**, lets you manually adjust the minimum screen brightness.

 If **Eco Sensor** is **On**, the display brightness may change (become slightly darker in most cases) depending on the surrounding light intensity. You can control the screen's minimum brightness with the **Min. Backlight** function.

- **No Signal Power Off (Off / 15 min. / 30 min. / 60 min.):** Sets how quickly the TV switches to standby mode if it is receiving no signal.

 Disabled when an attached PC is in power saving mode.

- **Auto Power Off (Off / On):** The TV will automatically turn off if you don't press a button on the remote control or touch a button on TV's front panel within 4 hours.

 If the **Auto Power Off** option is set to **Off**, the TV will stay on even if no operations are performed on the TV.

❏ Other Features

■ Menu Language

👉 MENU ☰ → System → Menu Language → ENTER ↵

Set the menu language.

1. Select **Menu Language**, and then press the **ENTER** ↵ button.
2. Choose a language, and then press the **ENTER** ↵ button.
 - 👉 Choose **English, Español, or Français.**

■ Caption

(On-Screen Text Messages)

- **Caption (Off / On):** You can switch the caption function on or off. If captions are not available, they will not be displayed on the screen.

 The Caption feature does not work with devices connected to the TV through the Component or HDMI input jacks.

- **Caption Mode:** You can select the desired caption mode.

 The availability of captions depends on the program being broadcasted.

Default / CC1 ~CC4 / Text1 ~Text4: (analog channels only) The Analog Caption function operates in either analog TV channel mode or when a signal is supplied from an external device to the TV. (Depending on the broadcasting signal, the Analog Caption function may or may not work with digital channels.)

Default / Service1 ~Service6 / CC1 ~CC4 / Text1 ~Text4: (digital channels only) The Digital Captions function works with digital channels.

 **Service1 ~6** may not be available in digital caption mode depending on the broadcast.

- **Digital Caption Options:** (digital channels only)

Size: Options include Default, Small, Standard and Large. The default is Standard.

Font Style: Options include Default and Styles 0 to 7. The default is Style 0.

Font Color: You can change the color of the letters. Options include Default, White, Black, Red, Green, Blue, Yellow, Magenta and Cyan. The default is White.

Background Color: You can change the background color of the caption. Options include Default, White, Black, Red, Green, Blue, Yellow, Magenta and Cyan. The default is Black.

Font Opacity: This adjusts the opacity of text. Options include Default, Transparent, Translucent, Solid and Flashing.

Background Opacity: This adjusts the opacity of the caption background. Options include Default, Transparent, Translucent, Solid and Flashing.

Return to Default: This option sets Size, Font Style, Font Color, Background Color, Font Opacity, and Background Opacity to their defaults.

 NOTE

- **Digital Caption Options** are available only when you can select **Default** and **Service1 ~ Service6** in **Caption Mode**.
- The availability of captions depends on the program being broadcast.
- The **Default** setting follows the standards set by the broadcaster.
- You cannot set the Foreground and Background to the same color.
- You cannot set both the **Font Opacity** and the **Background Opacity** to Transparent.

■ Auto Protection Time

- **Auto Protection Time (Off / 2 hours / 4 hours / 8 hours / 10 hours):** If the screen remains idle with a still image for a certain period of time defined by the user, the screen saver is activated to prevent the formation of ghost images on the screen.



■ General

- **Game Mode (Off / On):** When you have connected a game console such as PlayStation™ or Xbox™ to the TV, you can enjoy a more realistic gaming experience if you set **Game Mode** on.

NOTE

- Precautions and limitations for **Game Mode**:
 - Before disconnecting a game console and connecting another external device, set **Game Mode** to **Off**.
 - If you display the TV menu in **Game Mode**, the screen shakes slightly.

- **Game Mode** is not available when you've set the input source to **TV**.
- Set **Game Mode** to **On** only after connecting a game console. If you turn Game Mode on before you have attached the game console, you may notice reduced picture quality.
- If **Game Mode** is **On**:
 - **Picture Mode** is set to **Standard** and **Sound Mode** is set to **Movie**.

- **Panel Lock (Off / On)**: Lock or unlock all the keys on the panel.
- **Boot Logo (Off / On)**: Display the Samsung logo when the TV is turned on.

■ DivX® Video On Demand

Shows the registration code authorized for the TV. If you connect to the DivX web site and register with 10-digit registration code, you can download the VOD activation file. Once you play it using Media Play, the registration is completed.

 For more information about DivX® VOD, visit “<http://vod.divx.com>”.

❏ Support Menu

■ e-Manual

 **MENU**  → **Support** → **e-Manual** → **ENTER** 

You can read the introduction and instructions about the TV features stored in your TV.

 For the detailed information about e-Manual Screen, refer to “How to view the e-Manual” in the User Manual.

■ Self Diagnosis

- **Picture Test (Yes / No):** Use to check for picture problems. Picture test displays a high definition picture that you can examine for flaws or faults.
Yes: Select Yes if the test picture does not appear or there is noise or distortion in the test picture. There may be a problem with the TV. Contact Samsung's Call Center for assistance.
No: Select No if the test picture displays properly. There may be a problem with your external equipment. Please check your connections. If the problem persists, refer to the external device's user manual.

- **Sound Test (Yes / No):** Use to check for sound problems. Sound test plays a built-in melody that tests both speakers.

 If you hear no sound from the TV's speakers, before performing the sound test, make sure **Speaker Select** is set to **TV Speaker** in the **Sound** menu, and then try the speakers again.

 You will hear the melody during the test even if you have set **Speaker Select** to **External Speaker** or have muted the sound by pressing the **MUTE** button.

Yes: Select Yes if you can hear sound from only one speaker or from neither speaker during the sound test. There may be a problem with the TV. Contact Samsung's Call Center for assistance.

No: Select No if you can hear sound from the speakers. There may be a problem with your external equipment. Please check your connections. If the problem persists, refer to the external device's user manual.

- **Signal Information:** (digital channels only) The reception quality of over-the-air HD channels is either perfect or the channels are unavailable. Signal Information displays HD channel signal strength so you can adjust your antenna to increase signal strength and receive HD channels.
- **Reset:** Reset all settings to the factory defaults except network settings.
 - ✎ The PIN input screen appears before the setup screen.
 - ✎ Enter your 4-digit PIN. Change the PIN using the **Change PIN** option.
- **Troubleshooting:** Displays a troubleshooting guide organized into four symptom categories: Poor or Distorted Picture, Distorted Sound or No Sound, RF or PC Issues, and Other Issues. If your TV seems to be having a problem, access the trouble shooting guide for a solution.
 - ✎ If none of these troubleshooting tips apply, contact the Samsung customer service center.

■ Software Update

The **Software Update** menu lets you upgrade your TV's software to the latest version.

- **Current Version:** This is the software version already installed in the TV.



Upgrading to the Latest Version

You can upgrade in four ways:

- By USB
- Online
- Alternative Software
- Standby Mode Upgrade

The four methods are explained in the following pages.

 Be careful not to turn off the power until the upgrade is complete. The TV will turn off and on automatically after completing the firmware upgrade. When you upgrade software, all video and audio settings you have made will return to their default settings. We advise you to write down your settings so that you can easily reset them after the upgrade.

By USB

To upgrade by USB, follow these steps:

1. Visit www.samsung.com.
2. Download the latest USB software upgrade exe archive to your computer.
3. Copy the folder to a USB flash drive.
4. Turn on the TV, and then insert the USB flash drive into the USB port of the TV.
5. In the TV's menu, go to **MENU** → **Support** → **Software Update**.
6. Select **By USB**.

 Please be careful not to remove the USB drive until the upgrade is complete.

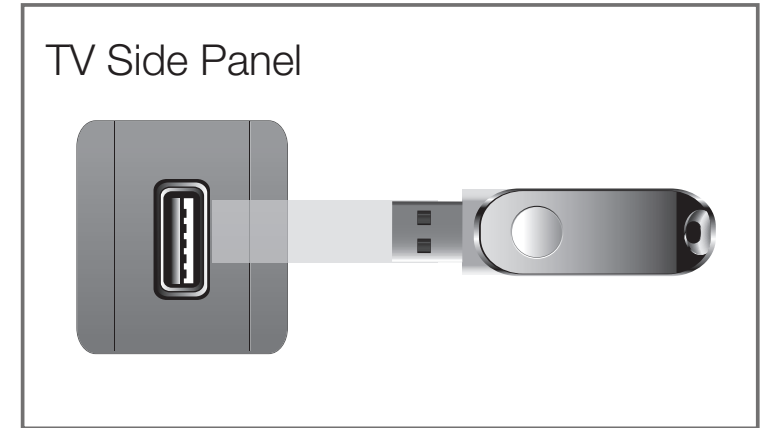

* The placement of the USB port may differ depending on the model.

Online

The **Online** function lets you download the upgrade software directly from the Internet into your TV and then upgrade the software in one operation. To use **Online**, you must have configured your TV to connect to your network and the TV must be connected to the Internet. See the Network Connection instructions.

To upgrade by online, follow these steps:

1. Select **Online**, and then press the **ENTER**  button. The Connecting to Server message appears.
2. If there is a download available, the Download pop-up appears with a progress bar and the download starts.

3. When the download is complete, the Upgrade Query window appears with three choices: **Update Now**, **Update Later**, or **Don't Update**.
4. If you select **Update Now**, the TV upgrades the software, turns off, and then turns on automatically.
5. If you do not make a selection in one minute or select **Update Later**, the TV stores the new upgrade software. You can upgrade the software later using the Alternative Software function.
6. If you select **Don't Update**, the TV cancels the upgrade.

Alternative Software

The **Alternative Software** option lets you upgrade using a file the TV downloaded earlier, but you decided not to install immediately, or a file downloaded by the TV in **Standby Mode Upgrade** (See **Standby Mode Upgrade** on the next page).

1. If upgrade software has been downloaded, you will see the software version number to the right of **Alternative Software**.
2. Select **Alternative Software**, and then press the **ENTER**  button.
3. The TV displays a message asking if you want to upgrade. Select **Yes**. The TV begins the upgrade.
4. When the update is complete, the TV turns off automatically, and then turns on.

Standby Mode Upgrade

You can set the **Standby Mode Upgrade** function so that the TV downloads new upgrade software when it is in Standby mode. In Standby mode, the TV is off, but its Internet connection is active. This allows the TV to download upgrade software automatically, when you are not using it. Because the TV is turned on internally, the screen may glow slightly. This phenomenon may continue for more than 1 hour until the software download is complete.

To set **Standby Mode Upgrade**, follow these steps:

1. Select **Standby Mode Upgrade**, and then press the **ENTER**  button.
2. Select **On** or **Off**.
 - **Off**: If you select **Off**, the TV will notify you with a pop up message when new upgrade software is available.

- **On**: If you select **On**, the TV will automatically download new upgrade software when it is in Standby mode with the power off. If it downloads new upgrade software, the TV will ask you if you want to install it when you turn the TV on.



To use the **Standby Mode Upgrade** function, your TV must be connected to the Internet.

■ Contact Samsung

View this information when your TV does not work properly or when you want to upgrade the software. You can find information regarding our call centers and how to download products and software.



■ Contents Home

You can enjoy useful and various contents.



❑ Using the 3D function

 MENU  → Picture → 3D → ENTER 

■ 3D

This exciting new feature enables you to view 3D content.

 “Full HD 3D Glasses™” Logo indicates compatibility between display products and 3D Glasses which are compliant with the “Full HD 3D Glasses™” format, and does not indicate picture quality of display products.

IMPORTANT HEALTH AND SAFETY INFORMATION FOR 3D PICTURES.





Read and understand the following safety information before using the TV's **3D** function.



WARNING

- Some viewers may experience discomfort while viewing 3D TV such as dizziness, nausea and headaches. If you experience any such symptom, stop viewing 3D TV, remove 3D Active Glasses and rest.
- Watching 3D images for an extended period of time may cause eye strain. If you feel eye strain, stop viewing 3D TV, remove your 3D Active Glasses and rest.

- A responsible adult should frequently check on children who are using the 3D function. If there are any reports of tired eyes, headaches, dizziness, or nausea, have the child stop viewing 3D TV and rest.
- Do not use the 3D Active Glasses for other purposes (such as general eyeglasses, sunglasses, protective goggles, etc.)
- Do not use the 3D function or 3D Active Glasses while walking or moving around. Using the 3D function or 3D Active Glasses while moving around may result in injuries due to running into objects, tripping, and/or falling.

- **3D Mode:** Select the 3D input format.
 - ☞ If you want to feel the 3D effect fully, please wear the 3D Active Glasses first, and then select 3D Mode from the list below that provides the best 3D viewing experience.
 - ☞ When watching 3D images, turn on 3D Active Glasses.

3D Mode		Operation
	Off	Turns the 3D function off.
	2D → 3D	Changes a 2D image to 3D.
	Side by Side	Displays two images next to each other.
	Top & Bottom	Displays one image above another.

-  Some file format may not be supported the “2D → 3D”.
-  When you watch 3D images under flickering lighting such as a fluorescent lamp (50Hz ~ 60Hz) or a 3 wavelength lamp, you may notice some screen flickering. If this occurs, dim or turn off the light.

- **3D Perspective (-5 ~ +5)**: Adjust overall 3D perspective of on-screen image.
- **Depth (1~10)**: Adjust overall depth.
- **L/R Change (L/R Image / R/L Image)**: Swap the left and right pictures.
- **3D → 2D (Off / On)**: Displays the image for the left eye only.

 This function is deactivated when 3D Mode set to “” or “”.

- **3D Optimize (-1 ~ +1)**: Automatically adjusts the picture overall to provide an optimal 3D effect.

Support resolution (16:9 only)

- HDMI

Source	Resolution	Frequency (Hz)
	1280 x 720p	59.94 / 60 Hz
	1920 x 1080i	59.94 / 60 Hz
	1920 x 1080p	23.98 / 24 / 29.97 / 30 / 59.94 / 60 Hz
Frame Packing	1280 x 720p	59.94 / 60 Hz
	1920 x 1080i	59.94 / 60 Hz
	1920 x 1080p	23.98 / 24 / 29.97 / 30 Hz

- Components & DTV

Source	Resolution	Frequency (Hz)
Components	1280 x 720p	59.94 / 60 Hz
	1920 x 1080i	59.94 / 60 Hz
	1920 x 1080p	23.98 / 24 / 29.97 / 30 / 59.94 / 60 Hz
DTV	1280 x 720p	59.94 / 60 Hz
	1920 x 1080i	59.94 / 60 Hz



- Videos / Photos (In **AllShare Play**)

Refer to “Supported Subtitle and AllShare Play file formats” in the Other Information section.





How to watch the 3D image

- Method 1

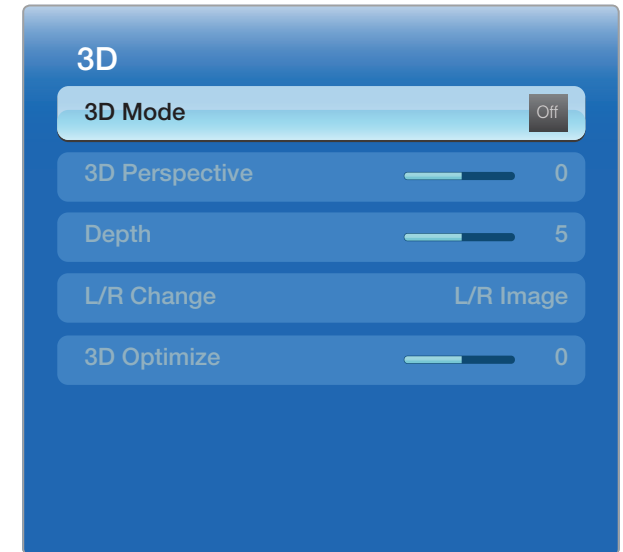
- ☞ Some 3D modes may not be available depending on the format of the image source.
- ☞ To watch in 3D, wear 3D Active Glasses and press the power button on the glasses.

1. Press the **MENU** button, use the ▲ or ▼ button to select **Picture**, and then press the **ENTER**  button.
2. Use the ▲ or ▼ button to select **3D**, and then press the **ENTER**  button.



3. Use the ▲ or ▼ button to select **3D Mode**, and then press the **ENTER**  button.
 4. Using the ◀ or ▶ buttons, select the **3D Mode** of the image you want to view.
- Method 2
 1. Press the  button, and then you can view the **3D** image.
 2. If you want to change 3D options (such as **3D Perspective**), press the **MENU** button, and then select **Picture**.
 3. Go to Step 3 in the “Method 1”, and follow the directions from that point on.
 -  To exit the **3D** mode, press the  button again.

Before using 3D function...

NOTE

- **3D Mode** is set to **Off** automatically when you access **AllShare Play** or **e-Manual** functions.
- **3D Mode** is set to memorized configuration value automatically, when changing the input source.
- Some **Picture** functions are disabled in **3D** mode.
- 3D Active Glasses from Samsung's previous product (IR type) or other manufacturers not be supported.
- When the TV is initially powered on, may take some time until the 3D display is optimized.

- The 3D Active Glasses may not work properly if there is any other 3D product or electronic devices turned on near the glasses or TV. If there is a problem, keep other electronic devices as far away as possible from the 3D Active Glasses.
- Be sure to stay within the viewing angle and optimum TV viewing distance when watching 3D pictures. Otherwise, you may not be able to enjoy proper 3D effects.
- The ideal viewing distance should be three times or more the height of the screen. We recommend sitting with viewer's eyes on a level with the screen.
- If you can not play 3D videos in some of the BD players, take out the disk from player and put it again, or restart the BD player.

❑ Using the Explore 3D

 MENU  → [Support](#) → [Contents Home](#) → ENTER 



Press the **CONTENT** button to select [Explore 3D](#). You can enjoy the diverse 3D contents through [Explore 3D](#).

 First, configure your network. For detailed procedures on using the Network Setup, refer to the “[Network Settings](#)” instructions.

 [Explore 3D](#) may not be available in all regions.

❑ Using the AllShare Play

Enjoy photos, music and movie files saved on a USB Mass Storage Class (MSC) device and your PC.

1. Press the **CONTENT** button to select **AllShare Play**.
2. Press ▲/▼ button to select desired menu (**Videos**, **Photos**, **Music**), then press the **ENTER**  button.
3. Press ▲/▼ button to select desired device, then press the **ENTER**  button again.



* The **Contents Home** main screen. Use the ◀/▶ buttons to change from one main category to another.

❑ Connecting a USB Device

1. Turn on your TV.
2. Connect a USB device containing photo, music and movie files to the USB port on the side of the TV.
3. When USB is connected to the TV, popup window appears. You can select the **Videos, Photos** or **Music** directly.

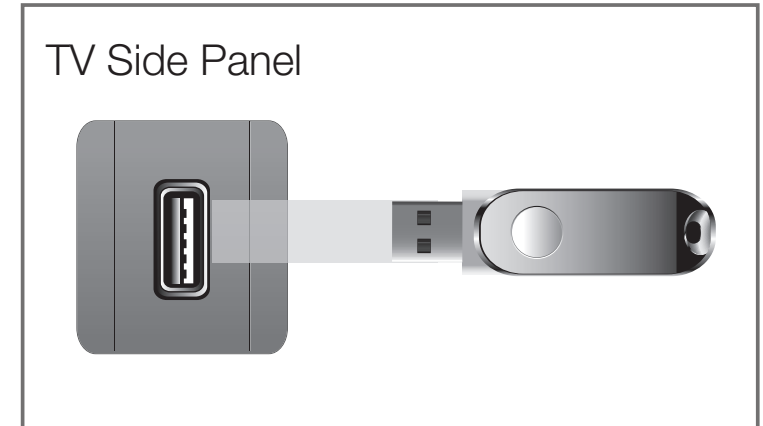

* The placement of the USB port may differ depending on the model.

 It might not work properly with unlicensed multimedia files.

 Need-to-Know List before using **AllShare Play**.



- MTP (Media Transfer Protocol) is not supported.
- The file system supports NTFS (Read Only), FAT16 and FAT32.
- Certain types of USB Digital camera and audio devices may not be compatible with this TV.
- **AllShare Play** only supports USB Mass Storage Class (MSC) devices. MSC is a Mass Storage Class Bulk-Only Transport device. Examples of MSC are Thumb drives, Flash Card Readers (USB HUB are not supported). Devices should be connected directly to the TV's USB port.
- Before connecting your device to the TV, please back up your files to prevent them from damage or loss of data. SAMSUNG is not responsible for any data file damage or data loss.

- The HDD (Hard Disk Drive) connected to USB is not supported.
- Do not disconnect the USB device while it is loading.
- The higher the resolution of the image, the longer it takes to display on the screen.
- The maximum supported JPEG resolution is 15360 x 8640 pixels.
- If a file is corrupted or the TV does not support the file type, the “Not Supported File Format” message appears.
- The TV cannot play MP3 files with DRM that have been downloaded from a for-pay site. Digital Rights Management (DRM) is a technology that supports the creation, distribution, and management of digital content in an integrated and comprehensive way, including protecting the rights and interests of content providers, preventing illegal copying of contents, and managing billings and settlements.
- A USB device that requires high power (more than 500mA or 5V) may not be supported.
- If the TV has no input during the time set in **Auto Protection Time**, the Screensaver will run.

- The power-saving mode of some external hard disk drives may be released automatically when you connect them to the TV.
- If you use a USB extension cable, the TV may not recognize the USB device or may not be able to read the files on the device.
- If a USB device connected to the TV is not recognized, the list of files on the device is corrupted, or a file in the list is not played, connect the USB device to a PC, format the device, and check the connection.
- If a file you deleted from the PC is still found when you run **AllShare Play**, use the “Empty the Recycle Bin” function on the PC to permanently delete the file.
- **AllShare Play** only supports sequential jpeg format.
- The scene search and thumbnail functions are not supported in the **Videos**.
- If the number of files and folders saved on a USB storage device is approximately over 4000, the files and folders may not appear and some folders may not be opened.

Disconnecting a USB Device







- Method 1: Using the **SOURCE** button.
 1. Press the **SOURCE** button.
 2. Select a desired USB device, and then press the **TOOLS** button. The **Tools** menu appears.
 3. Select **Safely Remove USB**, and then wait until the selected USB device is disconnected. You can remove a USB device from the TV.

- Method 2: Using the **AllShare Play** home screen.
 1. Go to **AllShare Play** home screen.
 2. Select any category, and then press the **ENTER**  button.
 3. Select a desired USB device, and then press the **TOOLS** button. The **Tools** menu appears.
 4. Select **Safely Remove USB**, and then wait until the selected USB device is disconnected. You can remove a USB device from the TV.
-  To remove a USB device from the TV, we recommend use **Safely Remove USB** function.

❑ Connecting to the PC through network

You can play pictures, music, and videos saved in your PC through a network connection using **AllShare Play** over your TV.

- 📖 Web storage and out of home network connectivity are not available.
- 📖 To use **AllShare Play** to play files saved in your PC on your TV, you must download “AllShare PC Software” and the AllShare PC Software users manual from “www.samsung.com”.
- 📖 For more information on how to configure your TV and connect it to your network, see ‘Network Connection’.
- 📖 We recommend you locate both your TV and PC in the same network subnet. IP addresses have four parts separated by periods (111.222.333.444). If your TV and PC are in the same subnet, the first 3 parts of the TV IP address and the PC IP address (111.222.333) will be the same and only the last part (the host address) will be different.

-  You need a router and/or modem to connect your PC to the Internet. For information about connecting your PC to your network, see the instructions for the router or modem.
-  The following **AllShare Play** functions that are not supported when you are playing media from a PC connected through a network:
 - The **Background Music On** and **Background Music Setting** functions.
 - The  (REW) or  (FF) button while a movie is playing.
-  The DivX DRM, Multi-audio, embedded caption is not supported.
-  Set your PC firewall program so that AllShare PC Software is a permitted program.

- ✎ Depending on the Internet server, when you use **AllShare Play** through a network connection:
 - The sorting method may vary.
 - The ◀◀ (REW), ▶▶ (FF) or || (Pause) buttons may not work depending on the content information.
- ✎ If you experience any file stuttering issues while playing a video over a wireless network, we recommend using a wired network.

❑ Screen Display

Move to the desired file using the ◀/▶/▲/▼ buttons and then press the **ENTER** ◀ or ▶ (Play) button. The file is played. The screen may differ depending on the way to enter the screen.

* The displayed image may differ depending on the model.

Information:

You can ascertain the selected device name, contents mode, folder/file name, page.

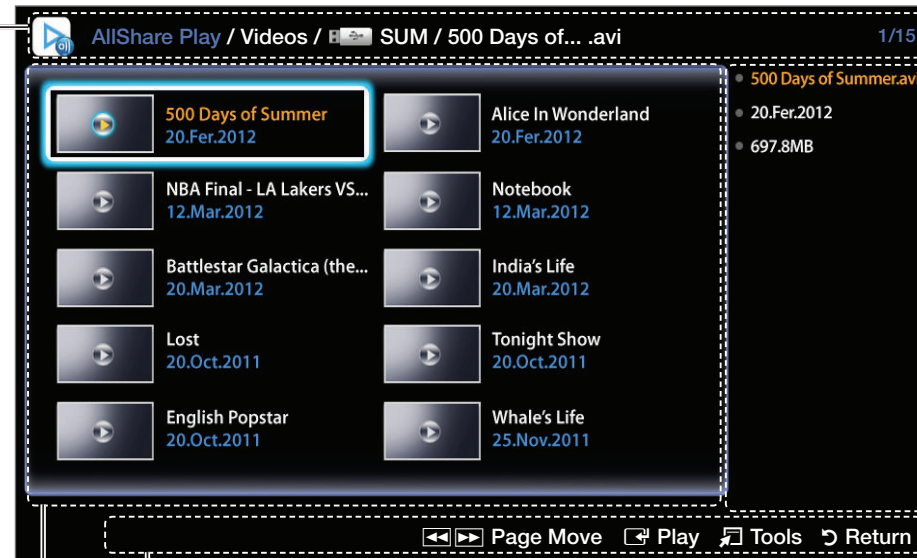

Information:

You can ascertain the name, size and created date of the selected file.

File List Section:





You can confirm the files and groups that are sorted by category.

Operation Buttons:

- ◀ **Play**: Play the selected file.
- ▶ **Tools**: Displays the option menu.
- ◀ **Return**: Move to the previous step.
- ◀▶/B C **Page Move**: Move to up or down page.

■ Videos

Playing Video

1. Press the ◀/▶/▲/▼ button to select the desired video in the file list.
 2. Press the **ENTER**  button or  (Play) button.
 - The selected file name is displayed on the top with its playing time.
 - If video time information is unknown, play time and progress bar are not displayed.
 - During video playback, you can search using ◀ and ▶ button.
 - You can use () (REW) and () (FF) buttons during playback.
-  In this mode, you can enjoy movie clips contained on a Game, but you cannot play the Game itself.

- Supported Subtitle Formats

- External

Name	File extension
MPEG-4 timed text	.ttx
SAMI	.smi
SubRip	.srt
SubViewer	.sub
Micro DVD	.sub or .txt
SubStation Alpha	.ssa
Advanced SubStation Alpha	.ass
Powerdivx	.psb

- Internal

Name	Container	Format
Xsub	AVI	Picture Format
SubStation Alpha	MKV	Text Format
Advanced SubStation Alpha	MKV	Text Format
SubRip	MKV	Text Format
MPEG-4 Timed text	MP4	Text Format

- Supported Video Formats

File Extension	Container	Video Codec	Resolution	Frame rate (fps)	Bit rate (Mbps)	Audio Codec
*.avi *.mkv *.asf *.wmv *.mp4 *.3gp *.vro *.mpg *.mpeg *.ts *.tp *.trp *.mov *.flv *.vob *.svi *.divx	AVI MKV ASF MP4 3GP VRO VOB PS TS	DivX 3.11/4.x/5.x/6.x	1920 x 1080	6~30	30	AC3 LPCM ADPCM (IMA, MS) AAC HE-AAC WMA DD+ MPEG(MP3) DTS Core G.711(A-Law, μ-Law)
		MPEG4 SP/ASP				
		H.264 BP/MP/HP	640 x 480	6~30	8	
		Motion JPEG				
		Window Media Video v9	1920 x 1080	6~30	30	
		MPEG2				
		MPEG1				

Other Restrictions

NOTE









- Video content will not play, or not play correctly, if there is an error in the content or the container.
- Sound or video may not work if the contents have a standard bit rate/frame rate above the compatible Frame/sec listed in the table above.
- If the Index Table is in error, the Seek (Jump) function is not supported.
- When you play a video through your network, it may not play, depending on the network status. When you play video over a network connection, the video may not be played smoothly.
- Some USB/digital camera devices may not be compatible with the TV.
- The menu can be displayed late if the video is over 10Mbps(bit rate).

Video decoder	Audio decoder
<ul style="list-style-type: none">● Supports up to H.264, Level 4.1● H.264 FMO / ASO / RS, VC1 SP / MP / AP L4 and AVCHD are not supported.● GMC is not supported.	<ul style="list-style-type: none">● WMA 10 Pro supports up to 5.1 channel.● WMA lossless audio is not supported.



■ Photos

Viewing a Photo (or Slide Show)







1. Press the ◀/▶/▲/▼ button to select the desired photo in the file list.
 2. Press the **ENTER**  button.
 -  When you press the  (Play) button in the file list, slide show will be started immediately.
 -  During the slide show, all files in the file list will be displayed in order.
 -  During the slide show, you can adjust the slide show speed using  (REW) or  (FF) button.
 -  You can move to other file using ◀ or ▶ button.
-  Music files can be automatically played during the slide show if the **Background Music On** is set.

- Supported Photo Formats



File Extension	Type	Resolution
*.jpg	JPEG	15360x8640
*.bmp	BMP	1920x1080
*.mpo	MPO	15360x8640

■ Music

Playing Music

1. Press the ◀/▶/▲/▼ button to select the desired Music in the file list.
 2. Press the **ENTER**  button or  (Play) button.
 - You can use  (REW) and  (FF) buttons during playback.
-  Only displays the files with supported music file extension. Other file extensions are not displayed, even if they are saved on the same USB device.
-  If the sound is abnormal when playing music files, adjust the **Equalizer** in the **Sound** menu. (An over-modulated music file may cause a sound problem.)

Using the playback menu





- Press the ◀/▶ button to select the desired menu.
 - **Play / Pause:** You can start or stop a music. Alternatively, the  or  button on the remote.
 - **Repeat Mode (Off / One Song / All):** You can play music files repeatedly.
 - **Shuffle Mode (On / Off):** You can play the music randomly.
 - **Sound Mode (Standard / Music / Movie / Clear Voice / Amplify):** You can adjust the sound setting.

- Supported Music Formats

File Extension	Type	Codec	Remark
*.mp3	MPEG	MPEG1 Audio Layer 3	
*.m4a *.mpa *.aac *.3ga	MPEG4	AAC	
*.flac	FLAC	FLAC	Seek is not supported. Supports up to 2ch.
*.wma	WMA	WMA	WMA 10 Pro supports up to 5.1 channel.

❑ AllShare Play - Additional Functions

Playing the selected Videos/Music/Photos files

1. Press the **TOOLS** button at each main screen and select **Selection Play**.
2. Select the desired files.
 -  The check box appears to the left of the selected files.
3. Press the **▶** button to select **Play**, then press the **ENTER**  button.
 -  You can select or deselect all files pressing the **Select All / Deselect All**. 

Setting the Encoding language in Music

Set the encoding language if the text is not supported.

1. Press the **TOOLS** button at Music main screen and select **Encoding**.
2. Select the desired encoding language.

Videos/Music/Photos Play Option menu

During playing a file, press the **TOOLS** button.

Category	Operation	Videos	Photos	Music
Go to Videos List / Go to Photos List	You can move to the file list screen.	✓	✓	
Play from the Beginning	You can restart a video file from the beginning.	✓		
Title Search	You can move the other file directly.	✓		
Time Search	You can search the video using ◀ and ▶ button at one minute interval or entering the number directly.  It may not be supported depending on the input source.	✓		
Repeat Mode	You can play movie files repeatedly.	✓		

Category	Operation	Videos	Photos	Music
Picture Size	You can adjust the picture size to your preference.	✓		
Picture Mode	You can adjust the picture setting.	✓	✓	
Sound Mode	You can adjust the sound setting.	✓	✓	
Audio Language	You can change the audio language if the video has more than one language.	✓		
Subtitle	You can set subtitles on/off.	✓		
Subtitle Settings	You can play the video with subtitles. This function only works if the subtitles are the same file name as the video.	✓		
Start Slide Show / Stop Slide Show	You can start or stop a slide show.		✓	

Category	Operation	Videos	Photos	Music
Slide Show Speed	You can select the slide show speed during the slide show.		✓	
Slide Show Effect	You can change the slide show effect during the slide show.		✓	
Background Music On / Background Music Off	You can turn background music on and off when watching a slide show.		✓	
Background Music Setting	You can select background music when watching a slide show.		✓	
Zoom	You can zoom into images in full screen mode.		✓	

Category	Operation	Videos	Photos	Music
Rotate	You can rotate images in full screen mode.		✓	
Edit Playlist	You can edit the play list when playing the desired music.			✓
Selection Play	Select and play multiple files.			✓
Information	You can see detailed information about the played file.	✓	✓	✓







❑ Using the DLNA Functions

You can play media contents including videos, photos and music saved on your mobile phones or the other devices (such as your PC) by controlling them on the TV via the network.

 Web storage and out of home network connectivity are not available.

 For more information, visit “www.samsung.com” or contact the Samsung call center. Mobile devices may need additional software installation. For details, refer to each device’s user’s guide.



 If your Samsung TV connects to a non-Samsung DLNA server, a compatibility issue may occur during video playback. 

- 
- By connecting your Samsung TV to a network via AllShare™, you can use Samsung's original functions as follows:
- Playback of various video formats (DivX, MP4, 3GPP, AVI, ASF, MKV, etc.)
 - Video thumbnail feature
 - Bookmark function (to resume video playback)
 - Auto-chaptering (scene navigation)
 - Digital content management
 - Compatibility with various subtitle formats (SRT, SMI, SUB, TXT, TTXT)
 - And many others
- 
- To use the original DLNA functions of Samsung fully, it is recommended that you use the AllShare™ software provided with your TV.

Playing the media contents saved on the devices



1. Connect the mobile phone or other devices which support **AllShare Play** function, and then play the media contents of each device. The popup screen appears on the bottom of your TV.
2. Select the **Allow** to accept the connected devices. The media contents of the devices can be playing on your TV.
 -  You can find the allowed devices on the **AllShare Settings**.

Using the **AllShare Play** function, play the media contents of the devices connected to DLNA function.

1. Press the **CONTENT** button to select **AllShare Play**.
2. Press **▲/▼** button to select desired menu (**Videos, Photos, Music**), then press the **ENTER**  button.
3. When the DLNA device is selected, press the **ENTER**  button again.
4. Press the **◀/▶/▲/▼** button to select the desired file.
5. Press the **ENTER**  button.



NOTE

- Contents may not be played on your TV depending on their resolution and format.
- The **ENTER**  and  buttons may not work depending on the type of media content.
- Using the mobile device, you can control the media playing. For details, refer to each mobile's user's guide.



Using the AllShare Settings function

 **MENU**  → **Network** → **AllShare Settings** → **ENTER** 

Shows a list of mobile phones or connected devices which have been set up with this TV for using the **AllShare Settings** function.

 The **AllShare Settings** function is available in all devices which support DLNA DMC.

- **Allow / Deny**: Allows/Blocks the devices.
- **Delete**: Deletes the devices from the list.

 This function only deletes the name of the devices from the list. If the deleted device is turned on or tries to connect to the TV, it may appear on the list again.

❑ Troubleshooting

If the TV seems to have a problem, first review this list of problems and solutions. If none of these troubleshooting tips apply, visit [samsung.com](https://www.samsung.com), then click on Support, or call Samsung customer service at 1-800-SAMSUNG.

Issues	Solutions and Explanations
Poor picture	<p>First, perform the Picture Test and to see if your TV is properly displaying the test image.</p> <ul style="list-style-type: none">• Go to MENU - Support - Self Diagnosis - Picture Test <p>If the test image is properly displayed, the poor picture may be caused by the source or signal.</p>

Issues	Solutions and Explanations
<p>The TV image does not look as good as it did in the store.</p>	<p>Store displays are typically tuned to digital, HD (high definition) channels.</p> <ul style="list-style-type: none">• If you have an analog cable/satellite box, upgrade to a digital set top box. Use HDMI or Component cables to deliver HD (high definition) picture quality.• Cable/Satellite subscribers: Try HD channels from the channel line up.• Air/Cable Antenna connection: Try HD channels after performing an Auto program.☑ Many HD channels are up scaled from SD (Standard Definition) contents. Look for a channel that is broadcasting true HD content.• Adjust the Cable/Set top box video output resolution to 1080i or 720p.

Issues	Solutions and Explanations
The picture is distorted: macroblock error, small block, dots, pixelization.	<ul style="list-style-type: none">• The compression of video contents may cause picture distortion, especially in fast moving pictures such as sports and action movies.• A weak signal can cause picture distortion. This is not a TV problem.• Mobile phones used close to the TV (within 3.3 ft) may cause noise in the picture on analog and digital channels.
Color is wrong or missing.	<ul style="list-style-type: none">• If you're using a Component connection, make sure the component cables are connected to the correct jacks. Incorrect or loose connections may cause color problems or a blank screen.

Issues	Solutions and Explanations
There is poor color or brightness.	<ul style="list-style-type: none">• Adjust the Picture options in the TV menu. (go to Picture Mode / Color / Brightness / Sharpness)• Adjust the Energy Saving option in the TV menu (go to MENU - System - Eco Solution - Energy Saving)• Try resetting the picture to view the default picture setting. (go to MENU - Picture - Reset Picture)
There is a dotted line on the edge of the screen.	<ul style="list-style-type: none">• If the picture size is set to Screen Fit, change it to 16:9.• Change the cable/satellite box resolution.
The picture is black and white.	<ul style="list-style-type: none">• If you are using an AV composite input, connect the video cable (yellow) to the Green jack of Component input 1 on the TV.

Issues	Solutions and Explanations
When changing channels, the picture freezes or is distorted or delayed.	<ul style="list-style-type: none">• If the TV is connected to a cable box, please try to reset the box. (Reconnect the AC cord and wait until the cable box reboots. It may take up to 20 minutes.)• Set output resolution of the cable box to 1080i or 720p.
Sound Problem	<p>First, perform the Sound Test to determine if your TV audio is operating properly.</p> <ul style="list-style-type: none">• Go to MENU - Support - Self Diagnosis - Sound Test <p>If the audio is ok, the sound problem may be caused by the source or signal.</p>
There is no sound or the sound is too low at maximum volume.	<ul style="list-style-type: none">• Please check the volume of the device (Cable/Sat Box, DVD, Blu-ray, etc.) connected to your TV.

Issues	Solutions and Explanations
<p>The picture is good but there is no sound.</p>	<ul style="list-style-type: none">• Set the Speaker Select option to TV speaker in the Sound menu.• If you are using an external device, check the device's audio output option (Ex. You may need to change your cable box's audio option to HDMI if you have the box connected to your TV using an HDMI cable.).• If you are using a DVI to HDMI cable, a separate audio cable is required.• Reboot the connected device by reconnecting the device's power cable.

Issues	Solutions and Explanations
The speakers are making an inappropriate noise.	<ul style="list-style-type: none">• Check the cable connections. Make sure a video cable is not connected to an audio input.• For Antenna or Cable connections, check the signal information. A weak signal may cause sound distortion.• Perform the Sound Test as explained above.
No Picture, No Video	
The TV will not turn on.	<ul style="list-style-type: none">• Make sure the AC power cord is securely plugged into the wall outlet and the TV.• Make sure the wall outlet is working.• Try pressing the POWER button on the TV to make sure the problem is not the remote control. If the TV turns on, refer to 'Remote control does not work' below.

Issues	Solutions and Explanations
The TV turns off automatically.	<ul style="list-style-type: none">• Ensure the Sleep Timer is set to Off in the System menu.• If your PC is connected to the TV, check your PC power settings.• Make sure the AC power cord is plugged in securely to the wall outlet and the TV.• When you are watching TV programs from an antenna, the TV will turn off after 10 - 15 minutes if there is no signal.
You can not play 3D videos in some of the BD players.	<ul style="list-style-type: none">• Take out the disk from player and put it again, or restart the BD player.

Issues	Solutions and Explanations
There is no picture/video.	<ul style="list-style-type: none">• Check the cable connections. (Remove and reconnect all cables connected to the TV and external devices).• Set your external device's (Cable/Sat Box, DVD, Blu-ray etc) video outputs to match the connections to the TV input. For example, if an external device's output is HDMI, it should be connected to an HDMI input on the TV.• Make sure your connected devices are powered on.• Be sure to select the TV's correct source by pressing the SOURCE button on the remote control.• Reboot the connected device by reconnecting the device's power cable.

Issues	Solutions and Explanations
Antenna(Air / Cable) Connection	
The TV is not receiving all channels.	<ul style="list-style-type: none"> • Make sure the coaxial cable is connected securely. • Run Auto Program to add available channels to the channel list. Go to MENU - Channel - Auto Program then select Auto and make sure to select the correct Cable TV signal type. There are 3 options, STD, HRC and IRC. Most cable systems use STD. • Verify the antenna is positioned correctly.
No Caption on digital channels.	<ul style="list-style-type: none"> • Check the Caption Setup menu. Try changing Caption Mode Service 1 to CC1. • Some channels may not have caption data.
The picture is distorted: macroblock, error, small block, dots, pixelization.	<ul style="list-style-type: none"> • Compression of video contents may cause picture distortion, especially on fast moving pictures such as sports and action movies. • A weak signal can cause picture distortion. This is not a TV problem.

Issues	Solutions and Explanations
Network Connection	
The wireless network connection failed.	<ul style="list-style-type: none">• Samsung Wireless LAN adapter is required to use a wireless network.• Make sure the TV is connected to a wireless IP sharer (router).
Software Upgrade over the network fails.	<ul style="list-style-type: none">• If you have latest SW version, SW upgrade will not proceed.



Issues	Solutions and Explanations
Others	
Purple/green rolling horizontal bars and buzzing noise from the TV speakers with Component cable connection.	<ul style="list-style-type: none">• Remove the left and right audio connections from the set-top-box. If the buzzing stops, this indicates that the set-top-box has a grounding issue. Replace the Component video cables with an HDMI connection.
The picture will not display in full screen.	<ul style="list-style-type: none">• HD channels will have black bars on either side of the screen when displaying up scaled SD (4:3) contents.• Black bars will appear on the top and bottom of the screen when you watch movies that have aspect ratios different from your TV.• Adjust the picture size option on your external device or change the TV to full screen.

Issues	Solutions and Explanations
The remote control does not work.	<ul style="list-style-type: none">• Replace the remote control batteries. Make sure you insert them with the plus and minus ends in the correct direction.• Clean the transmission window located on the top of the remote control.• Try pointing the remote control directly at the TV from 5~6 feet away.
The cable/set top box remote control does not turn the TV on or off, or adjust the volume.	<ul style="list-style-type: none">• Program the Cable/Set top box remote control to operate the TV. Refer to the Cable/Set top box user manual for the SAMSUNG TV code.
A “ Mode Not Supported ” message appears.	<ul style="list-style-type: none">• Check the supported resolution of the TV and adjust the external device’s output resolution accordingly. Refer to resolution settings in this manual.

Issues	Solutions and Explanations
<p>Caption on the TV menu is greyed out.</p>	<ul style="list-style-type: none">• You cannot select Caption in the TV menu when watching content from a device connected via HDMI or Component.• Caption must be activated on the external device.
<p>There is a plastic smell from the TV.</p>	<ul style="list-style-type: none">• This smell is normal and will dissipate over time.
<p>TV Signal Information is unavailable in the Self Diagnosis Test menu.</p>	<ul style="list-style-type: none">• This function is only available for digital channels the TV receives from an Antenna / RF/Coax connection.
<p>TV is tilted to the right or left side.</p>	<ul style="list-style-type: none">• Remove the stand base from the TV and reassemble it.



Issues	Solutions and Explanations
The Channel menu is grey out (unavailable).	<ul style="list-style-type: none"> The Channel menu is only available when you select the TV source.
Your settings are lost after 30 minutes or every time the TV is turned off.	<ul style="list-style-type: none"> If TV is in the Store Demo mode, it will reset audio and picture settings every 30 minutes. Please change from Store Demo mode to Home Use mode using the Setup procedure. Press the SOURCE button to select TV mode, go to MENU → System → Setup → ENTER .
You have intermittent loss of audio or video.	<ul style="list-style-type: none"> Check the cable connections and reconnect them. Loss of audio or video can be caused by using overly rigid or thick cables. Make sure the cables are flexible enough for long term use. If mounting the TV to the wall, we recommend using cables with 90 degree connectors.

Issues	Solutions and Explanations
You see small particles when you look closely at the edge of the frame of the TV.	<ul style="list-style-type: none">• This is part of the product's design and is not a defect.
POP (TV's internal banner ad) appears on the screen.	<ul style="list-style-type: none">• Select Home Use under Setup mode. For details, refer to Setup (Initial Setup).
The message " This file may not be playable properly. " appears.	<ul style="list-style-type: none">• This may appear because of high bit rate of content. Content generally will play but could experience some playability issue.

❑ Anti-theft Kensington Lock

A Kensington Lock is a device you can use to physically fix your TV in place when using it in a public place. You wrap the Kensington Lock's cable around a large, immobile object and then attach the lock to the Kensington slot on the back of the TV.

The appearance and locking method may differ from the illustration below depending on the manufacturer. Refer to the manual provided with the Kensington Lock for additional information on proper use. The Kensington Lock is not supplied by Samsung.

- ❑ Please find a “” icon on the rear of the TV. The Kensington slot is beside the “” icon.
- ❑ The position and color may differ depending on the model.

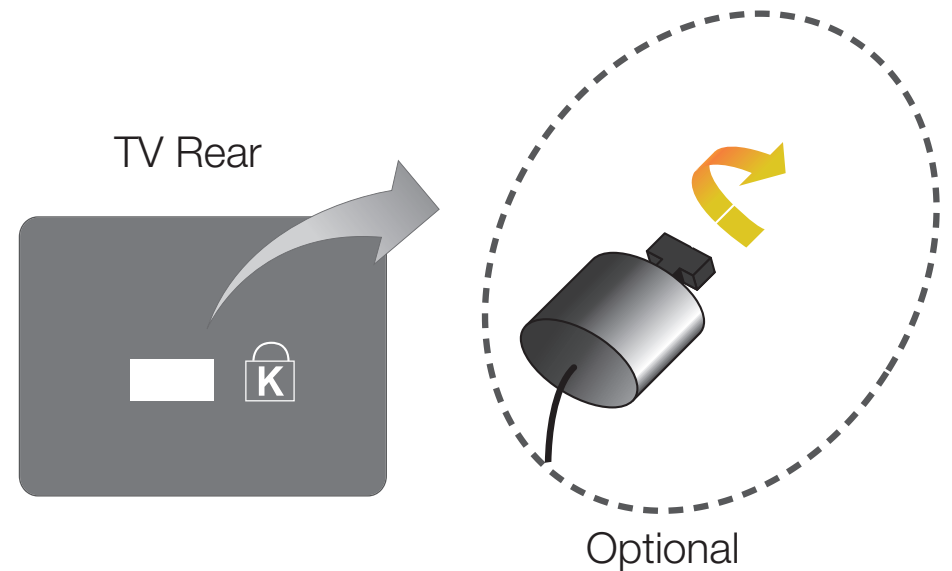

To lock the product, follow these steps:

1. Wrap the Kensington lock cable around a large, stationary object such as desk or chair.
2. Slide the end of the cable with the lock attached through the looped end of the Kensington lock cable.
3. Insert the locking device into the Kensington slot on the product.
4. Lock the lock.



NOTE

- These are general instructions. For exact instructions, see the User manual supplied with the locking device.
- The locking device has to be purchased separately.
- The location of the Kensington slot may be different depending on the TV model.

□ License



TheaterSound HD, SRS and the  symbol are trademarks of SRS Labs, Inc. TheaterSound HD technology is incorporated under license from SRS Labs, Inc.

SRS TheaterSound HD™ provides the most immersive surround sound experience from the TVs built-in speakers, while maintaining steady volume and delivering rich bass and clear dialog.



Manufactured under license from Dolby Laboratories. Dolby and the double-D symbol are trademarks of Dolby Laboratories.



Manufactured under license under U.S. Patent Nos: 5,956,674; 5,974,380; 6,487,535 & other U.S. and worldwide patents issued & pending. DTS, the Symbol, & DTS and the Symbol together are registered trademarks & DTS 2.0+Digital Out is a trademark of DTS, Inc. Product includes software. © DTS, Inc. All Rights Reserved.



The terms HDMI and HDMI High-Definition Multimedia Interface, and the HDMI Logo are trademarks or registered trademarks of HDMI Licensing LLC in the United States and other countries.



DivX Certified® to play DivX® video up to HD 1080p, including premium content.

ABOUT DIVX VIDEO: DivX® is a digital video format created by DivX, LLC, a subsidiary of Rovi Corporation. This is an official DivX Certified® device that plays DivX video. Visit divx.com for more information and software tools to convert your files into DivX videos.

ABOUT DIVX VIDEO-ON-DEMAND: This DivX Certified® device must be registered in order to play purchased DivX Video-on-Demand (VOD) movies. To obtain your registration code, locate the DivX VOD section in your device setup menu. Go to vod.divx.com for more information on how to complete your registration. Covered by one or more of the following U.S. patents : 7,295,673; 7,460,668; 7,515,710; 7,519,274 DivX®, DivX Certified® and associated logos are trademarks of Rovi Corporation or its subsidiaries and are used under license.

Open Source License Notice

In the case of using open source software, Open Source Licenses are available on the product menu. Open Source License Notice is written only English.