



Important Warranty Information Regarding Television Format Viewing

See the warranty card for more information on warranty terms.

Wide screen format LED Displays (16:9), the aspect ratio of the screen width to height are primarily designed to view wide screen format full-motion video. The images displayed on them should primarily be in the wide screen 16:9 ratio format, or expanded to fill the screen if your model offers this feature and the images are constantly moving. Displaying stationary graphics and images on screen, such as the dark sidebars on non-expanded standard format television video and programming, should be limited to no more than 5% of the total television viewing per week. Additionally, viewing other stationary images and text such as stock market reports, video game displays, station logos, web sites or computer graphics and patterns, should be limited as described above for all televisions. Displaying stationary images that exceed the above guidelines can cause uneven aging of LED Displays that leave subtle, but permanent burned-in ghost images in the LED picture. To avoid this, vary the programming and images, and primarily display full screen moving images, not stationary patterns or dark bars. On LED models that offer picture sizing features, use these controls to view different formats as a full screen picture. Be careful in the selection and duration of television formats you use for viewing. Uneven LED aging as a result of format selection and use, as well as burned-in images, are not covered by your Samsung limited warranty.

SAMSUNG ELECTRONICS NORTH AMERICAN LIMITED WARRANTY STATEMENT
Subject to the requirements, conditions, exclusions and limitations of the original Limited Warranty supplied with Samsung products, and the requirements, conditions, exclusions and limitations contained herein, SAMSUNG will additionally provide Warranty Repair Service in the United States on SAMSUNG products purchased in Canada, and in Canada on SAMSUNG products purchased in the United States, for the warranty period originally specified, and to the Original Purchaser only.

The above described warranty repairs must be performed by a SAMSUNG Authorized Service Center. Along with this Statement, the Original Limited Warranty Statement and a dated Bill of Sale as Proof of Purchase must be presented to the Service Center. Transportation to and from the Service Center is the responsibility of the purchaser. Conditions covered are limited only to manufacturing defects in material or workmanship, and only those encountered in normal use of the product. Excluded, but not limited to, are any originally specified provisions for, in-home or on-site services, minimum or maximum repair times, exchanges or replacements, accessories, options, upgrades, or consumables.

For the location of a SAMSUNG Authorized Service Center, please call toll-free:

— In the United States: 1-800-SAMSUNG (1-800-729-7864)
— In Canada: 1-800-SAMSUNG



BN68-04499-02

Getting Started

Accessories

- Remote Control (AA59-00600A) & Batteries (AAA x 2)
- Warranty Card / Safety Guide
- Owner's Instructions
- Power Cord
- Cable manager

Input Cables (Sold Separately)

- RS232 (AA38-0031A)
- Audio
- HDMI
- HDMI-DM
- Component
- Composite (AV)
- Coaxial (FF)

Check the cable before plug-in

	Cable	Ports
HDMI		
USB		
Optical		

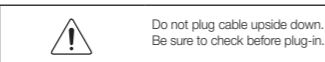

TV Controller (Panel Key)

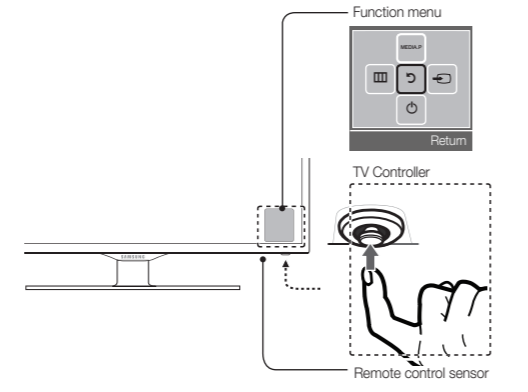

Power on	Turns the TV on by pressing the controller in standby mode.
Adjusting the volume	Adjusts the volume by moving the controller from side to side when the power is on.
Selecting a channel	Selects a channel by moving the controller up and down when the power is on.
Using the function menu	Presses the controller when the power is on, then the function menu screen appears. If you press it again, the function menu screen disappears.
Selecting the Media Play	Selects the MEDIA P by moving the controller in the function menu screen. The Media Play main screen appears.
Selecting the MENU (M)	Selects the MENU (M) by moving the controller in the function menu screen. The OSD (On-Screen Display) of your TV's feature appears.
Selecting the Source (S)	Selects the Source List (S) by moving the controller in the function menu screen. The Source List screen appears.
Power Off (O)	Selects the Power Off (O) by turn the TV off by moving the controller in the function menu screen.

Exits the menu when pressing the controller more than 1 second.

When selecting the controller by moving the controller to the up/down/left/right directions, be sure not to press the controller. If you press it first, you cannot operate it to move the up/down/left/right directions.

Plug & Play (Initial Setup)

When you turn the TV on for the first time, a sequence of on-screen prompts will assist in configuring basic settings. Press the **POWER** button. **Plug & Play** is available only when the Input source is set to TV.

Connecting the power cord and antenna. (refer to 'Connections')

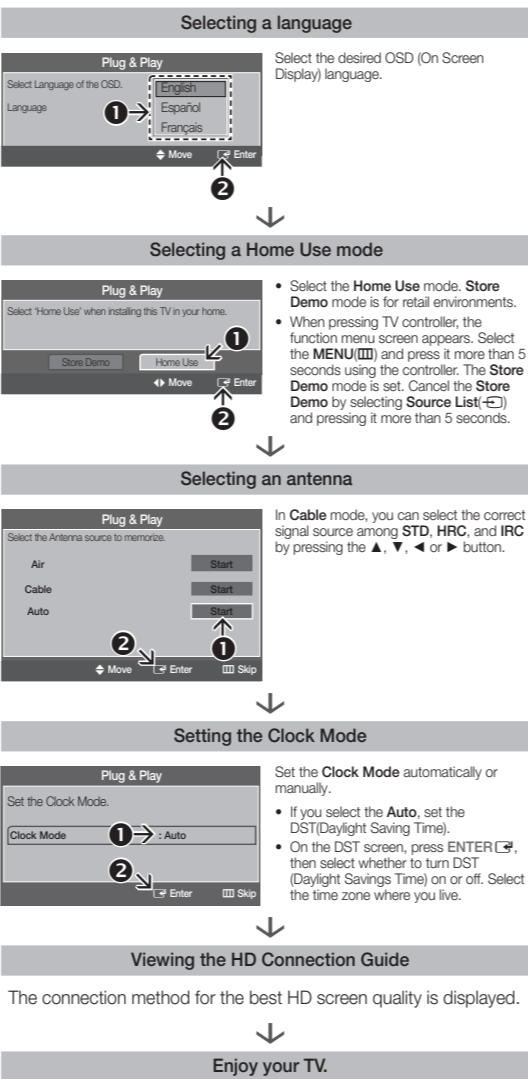

Viewing the HD Connection Guide
The connection method for the best HD screen quality is displayed.
Enjoy your TV.
Press the **ENTER** button.

Connections

- For better picture and audio quality, connect to a digital device using an HDMI cable.
- The picture may not display normally if all or the audio may not work if an external device that uses an older version of HDMI mode is connected to the TV. If such a problem occurs, ask the manufacturer of the external device about the HDMI version and . For of date, request an upgrade.
- Be sure to purchase a certified HDMI cable. Otherwise, the picture may not display or a connector error may occur.
- PCID-Sub** and **PC/DVI AUDIO IN** input are not supported.
- For **HDMI/DVI** cable connection, you must use the **HDMI IN 1 (DVI)** jack.
- Connecting through the **HDMI** cable may not be supported depending on the PC.
- If an **HDMI to DVI** cable is connected to the **HDMI IN 1 (DVI)** port, the audio does not work.
- EX-LINK** Connector for service only.

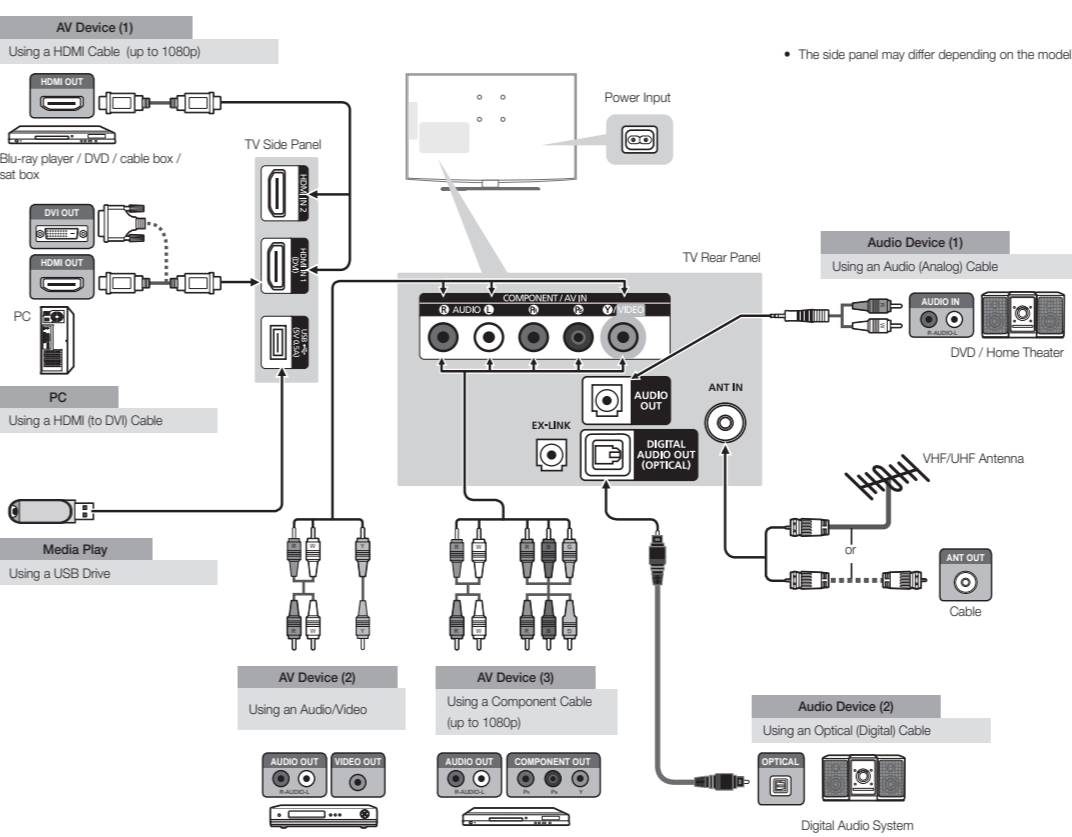

Changing the Input Source

Source List

Use to select TV or an external input source such as a DVD player / Blu-ray player / cable box / STB satellite receiver.

- Press the **SOURCE** button.
 - Select a desired external input source.
- TV / AV / Component / HDMI1/DVI / HDMI2**
 - You can only choose external devices that are connected to the TV. In the **Source List**, connected inputs will be highlighted.

How to use Edit Name

Edit Name lets you associate a device name to an input source. To access **Edit Name**, press the **TOOLS** button in **Source List**. The following selections appear under **Edit Name**:

- VCR / DVD / Cable STB / Satellite STB / PVR STB / AV Receiver / Game / Camcorder / PC / DVI PC / DVI / TV / IPTV / Blu-ray / HD DVD / DMA:** Name the device connected to the input jacks to make your input source selection easier.
- When connecting a PC to the **HDMI IN 1 (DVI)** port with **HDMI** cable, you should set the TV to **PC** mode under **Edit Name**.
- When connecting a PC to the **HDMI IN 1 (DVI)** port with **HDMI to DVI** cable, you should set the TV to **DVI PC** mode under **Edit Name**.
- When connecting an AV devices to the **HDMI IN 1 (DVI)** port with **HDMI to DVI** cable, you should set the TV to **DVI mode** under **Edit Name**.

Information

You can see detailed information about the connected external device.

Remote Control

This remote control has Braille points on the Power, Channel, and Volume buttons and can be used by visually impaired persons.

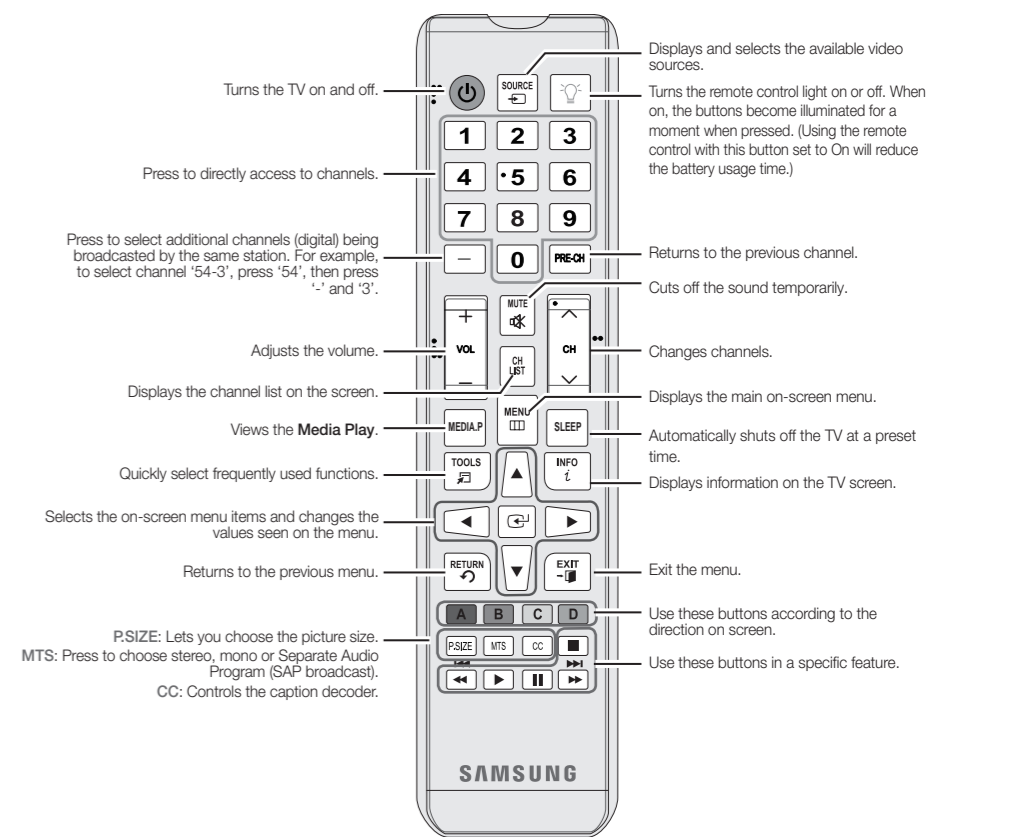

Display Modes (HDMI/DVI Input)

Optimal resolution
4000 series: 1366 x 768@60Hz / 5000 series: 1920 x 1080@60Hz

Mode	Resolution	Horizontal Frequency (Hz)	Vertical Frequency (Hz)	Pixel Clock Frequency (MHz)	Sync Polarity (H/V)	1366 x 768	1920 x 1080
BTM	650 x 350	31.469	70.266	25.175	+/+	✓	✓
	720 x 400	31.469	70.267	25.222	-/+	✓	✓
	640 x 480	35.000	60.000	30.240	-/+	✓	✓
	1152 x 454	49.728	74.551	57.284	-/+	✓	✓
	1152 x 454	48.988	75.362	56.388	-/+	✓	✓
	864 x 480	31.469	59.940	25.175	-/+	✓	✓
	864 x 480	37.861	72.839	31.820	-/+	✓	✓
	864 x 480	37.861	72.839	31.820	-/+	✓	✓
	800 x 600	37.879	60.317	40.000	+/+	✓	✓
	800 x 600	48.077	72.188	50.000	+/+	✓	✓
	800 x 600	48.079	72.000	49.900	+/+	✓	✓
	1024 x 768	48.363	60.004	60.000	-/+	✓	✓
	1024 x 768	56.476	70.266	70.266	-/+	✓	✓
	1024 x 768	60.000	75.000	75.000	-/+	✓	✓
	1152 x 864	67.500	75.000	108.000	+/+	✓	✓
	1280 x 720	45.000	60.000	72.000	+/+	✓	✓
	1280 x 800	60.702	59.870	60.000	-/+	✓	✓
	1280 x 1024	60.981	60.020	108.000	+/+	✓	✓
	1280 x 1024	75.079	75.000	108.000	+/+	✓	✓
	1368 x 768	47.712	59.790	60.000	+/+	✓	✓
	1440 x 900	58.000	59.867	108.000	+/+	✓	✓
	1600 x 900	60.000	60.000	108.000	+/+	✓	✓
	1680 x 1080	68.000	59.954	144.000	+/+	✓	✓
	1920 x 1080	67.500	60.000	144.000	+/+	✓	✓

Installing batteries (Battery size: AAA)

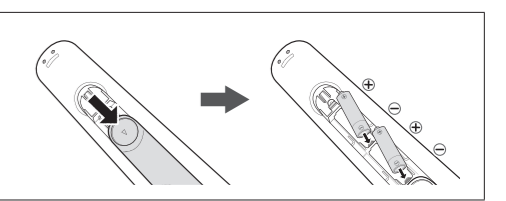

NOTE

- Use the remote control within 23 feet from TV.
- Bright light may affect the performance of the remote control. Avoid use when nearby fluorescent lights or neon signs.
- The Color and shape may vary depending on the model.

Channel Menu

Seeing Channels

Channel List

Add, delete or set Favorite channels and use the program guide for digital broadcasts. Select a channel in the **All Channels, Added Channels, Favorite or Programmed** screen by pressing the **▲ / ▼** buttons, and pressing the **ENTER** button. Then you can watch the selected channel.

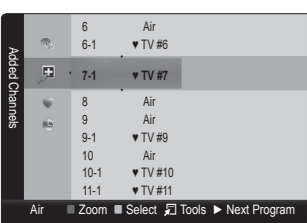

- All Channels:** Shows all currently available channels.
- Added Channels:** Shows all added channels.
- Favorite:** Shows all favorite channels.
- Programmed:** Shows all currently reserved programs.

Using the remote control buttons with the **Channel List**

- Green (Zoom):** Enlarges or shrinks a channel number.
- Yellow (Select):** Selects multiple channel lists. Select desired channels and press the Yellow button to set all the selected channels at the same time. The **✓** mark appears to the left of the selected channels.
- Tools:** Displays the Channel List option menu. (The Options menu may differ depending on the situation.)

Channel Status Display icons

Icons	Operations
	A channel selected.
	A channel set as a Favorite.
	A reserved program.
	A program currently being broadcast.

Memorizing channels

Antenna (Air / Cable) TOOLS P

Before your television can begin memorizing the available channels, you must specify the type of signal source that is connected to the TV (i.e. an Air or a Cable system).

Auto Program

- When selecting the Cable TV system: Selects the cable system. **STD, HRC** and **IRC** identify various types of cable TV systems. Contact your local cable company to identify the type of cable system that exists in your particular area. At this point, the signal source has been selected.
- After all the available channels are stored, it starts to remove scrambled channels. The **Auto program** menu then reappears.
- Press the **ENTER** button to stop the channel store during **Auto Program**.

How to Stop Auto Programming

- Press the **ENTER** button.
- A message will ask **Stop Auto Program?** Select **Yes** by pressing the **◀** or **▶** button.
- Press the **ENTER** button.

Other Features

Clear Scrambled Channel

This function filters out scrambled channels after **Auto Program** is completed. This process may take up to 20-30 minutes.

- Press the **ENTER** button to stop the **Clear Scrambled Channel**.

This function is only available in **Cable** mode.

Channel List

Channel List Option Menu TOOLS P

- Set each channel using the **Channel List** menu options. Option menu items may differ depending on the channel status.
- Add / Delete:** Delete or add a channel to display the channels you want.
 - All deleted channels will be shown on the **All Channels** menu.
 - A gray-colored channel indicates the channel has been deleted.
 - The **Add** menu only appears for deleted channels.
- Delete a channel from the **Added Channels** or **Favorite** menu in the same manner.
- Add to Favorite / Delete from Favorite TOOLS P:** Set channels you watch frequently as Favorites.
- Timer Viewing:** You can set a desired channel to be displayed automatically at the set time, even when you are watching another channel. Set the current time first to use this function.
 - Only memorized channels can be reserved.
 - Reserved programs will be displayed in the **Programmed** menu.
 - When a digital channel is selected, press the **▶ (Next Program)** button to view the digital program. If you select the **ENTER** (Schedule) button on the next program, you can set **Timer Viewing** directly.

- Channel Name Edit** (analog channels only): Assign your own channel name.
- Select All:** Select all the channels in the channel list.
- Deselect All:** Deselect all the selected channels.
 - You can only select **Deselect All** when one or more channels are selected.
- Auto Program:** Scans for a channel automatically and stores in the TV
- Programmed** (in Channel List)
 - You can view, modify or delete a show you have reserved to watch.
 - Change Info:** Change a show you have reserved to watch.
 - Cancel Schedules:** Cancel a show you have reserved to watch.
 - Information:** Display a show you have reserved to watch. (You can also change the reservation information.)
 - Select All / Deselect All:** You can select or deselect all channels in the channel list.

Channel Mode

Change the channel mode directly between **Added Channels** and **Favorite Channels**.

- The **Favorite Channels** is enabled only when you set **Add to Favorite**.

Fine Tune

(analog channels only)

If the reception is clear, you do not have to fine tune the channel, as this is done automatically during the search and store operation. If the signal is weak or distorted, fine tune the channel manually.

- Fine tuned channels that have been saved are marked with an asterisk "*" on the right-hand side of the channel number in the channel banner.
- To reset the fine-tuning, select **Reset**.

Picture Menu

Mode TOOLS P

Select your preferred picture type.

- When connecting a PC, you can only select **Entertain** and **Standard**.
- Dynamic:** Suitable for a bright room.
- Standard:** Suitable for a normal environment.
- Movie:** Suitable for watching movies in a dark room.
- Entertain:** Suitable for watching movies and games.
 - Only available when connecting a PC.

Backlight / Contrast / Brightness / Sharpness / Color / Tint (G/R)

Your television has several setting options for picture quality control.

- When connecting a PC, you can only make changes to **Backlight, Contrast, Brightness and Sharpness**

Advanced Settings

- (available in **Standard / Movie** mode)
- Compared to previous models, new Samsung TVs have a more precise picture.
- When connecting a PC, you can only make changes to **Gamma** and **White Balance**.
- Color Space (Auto / Native):** Adjusts the range of colors available to create the image.
- White Balance:** Adjusts the color temperature for a more natural picture.
- R-Offset / G-Offset / B-Offset:** Adjusts each color's (red, green, blue) darkness.
- R-Gain / G-Gain / B-Gain:** Adjusts each color's (red, green, blue) brightness.
- Reset:** Resets the **White Balance** to it's default settings.
- Gamma:** Adjusts the primary color intensity.
- Dynamic Contrast (Off / Low / Medium / High):** Adjusts the screen contrast.
- Black Tone (Off / Dark / Darker / Darkest):** Select the black level to adjust the screen depth.
- Flesh Tone:** Emphasize pink "flesh tone".
- Motion Lighting (Off / On):** Reduce power consumption by brightness control adapted motion.
 - Available in **Standard** mode only.

Picture Options

When connecting a PC, you can only make changes to the **Color Tone, Size and HDMI Black Level**.

- Color Tone (Cool / Standard / Warm1 / Warm2)**
- Warm1 or Warm2** will be deactivated when the picture mode is **Dynamic**.

- Size:** Your cable box/satellite receiver may have its own set of screen sizes as well. However, we highly recommend you use 16:9 mode most of the time.
- 16:9:** Sets the picture to 16:9 wide mode.
- Zoom1:** Use for moderate magnification.
- Zoom2:** Use for a stronger magnification.
- Wide Fit:** Enlarges the aspect ratio of the picture to fit the entire screen.
- 4:3:** Sets the picture to basic (4:3) mode.
- Do not watch in 4:3 format for a long time. Traces of borders displayed on the left, right and center of the screen may cause image retention (screen burn) which are not covered by the warranty.

Screen Fit (DTV): Displays the full image without any cut-off when **HDMI (720p / 1080i / 1080p)** or **Component (1080i / 1080p)** signals are input.

- HD High Definition:** 16:9 - 1080i/1080p (1920x1080), 720p (1280x720)
- Settings can be adjusted and stored for each external device you have connected to an input on the TV.

Picture Sizes available by Input Source:

Input Source	Picture Size
ATV, AV, Component (480i, 480p)	16:9, Zoom1, Zoom2, 4:3
DTV(1080i, 1080p), Component (1080i, 1080p), HDMI (720p, 1080i, 1080p)	16:9, Wide Fit, 4:3, Screen Fit

- Digital Noise Filter (Off / Low / Medium / High / Auto):** If the broadcast signal received by your TV is weak, you can activate the **Digital Noise Filter** feature to reduce any static and ghosting that may appear on the screen.
 - When the signal is weak, try other options until the best picture is displayed.

- HDMI Black Level (Normal / Low):** Selects the black level on the screen to adjust the screen depth.
 - Available only in **HDMI** mode (RGB signals).
- Film Mode (Off / Auto):** Sets the TV to automatically sense and process film signals from all sources and adjusts the picture for optimum quality.
 - Available in **ATV, DTV(Interlace), AV, COMPONENT (480i / 1080i)** and **HDMI (480i / 1080i)**.

- LED Motion Plus (Off / On):** Removes drag from fast scenes with a lot of movement to provide a clear picture.

Picture Reset

- Resets your current picture mode to its default settings.
- Reset Picture Mode:** Returns all picture values in the currently selected mode to the default settings.

Sound Menu

Mode TOOLS P

- Standard:** Selects the normal sound mode.
- Music:** Emphasizes music over voices.
- Movie:** Provides the best sound for movies.
- Clear Voice:** Emphasizes voices over other sounds.
- Amplify:** Increase the intensity of high-frequency sounds to allow a better listening experience for the hearing impaired.

Equalizer

(standard sound mode only)

- Balance L/R:** Adjusts the balance between the right and left speaker.
- 100Hz / 300Hz / 1KHz / 3KHz / 10KHz:** (Bandwidth Adjustment): Adjusts the level of specific bandwidth frequencies.
- Reset:** Resets the equalizer to its default settings.

SRS TruSurround HD

(standard sound mode only)

SRS TruSurround HD is a patented SRS technology that solves the problem of playing 5.1 multichannel content over two speakers. TruSurround delivers a compelling, virtual surround sound experience through any two-speaker playback system, including internal

Eco Solution

■ **Energy Saving (Off / Low / Medium / High / Picture Off) :**

This adjust the brightness of the TV in order to reduce power consumption. If you select **Picture Off**, the screen is turned off, but the sound remains on. Press any button except volume button to turn on the screen.

■ **Eco Sensor (Off / On)** *for LED 5000 series* : To enhance your power savings; the picture settings will automatically adapt to the light in the room.

☞ If you adjust the **Backlight**, the **Eco Sensor** will be set to **Off**.

Min. Backlight: When **Eco Sensor is On**, the minimum screen brightness can be adjusted manually.

☞ If **Eco Sensor is On**, the display brightness may change (become slightly darker in most cases) depending on the surrounding light intensity.

■ **No Signal Power Off (Off / 15 min. / 30 min. / 60 min.)**: Sets how quickly the TV switches to standby mode, if no picture is being received.

☞ Disabled when the PC is in power saving mode.

■ **Auto Power Off (Off / On)**: The TV will be automatically turned off when no user operation is received for 4 hours.

Support Menu

Self Diagnosis

■ **Picture Test:** Use to check for picture problems. If the problem continues to occur, check the color pattern.

■ **Sound Test:** Use the built-in melody sound to check for sound problems.

■ **Signal Strength:** (digital channels only) An HD channel's reception quality is either perfect or the channels are unavailable. Adjust your antenna to increase signal strength.

■ **Reset:** Reset all settings to the factory defaults.

☞ The PIN input screen appears before the setup screen.

☞ Enter your 4-digit PIN. Change the PIN using the **Change PIN** option.

Software Upgrade

Software Upgrade can be performed by downloading the latest firmware from samsung.com to a USB memory device.

HD Connection Guide

Refer to this information when connecting external devices to the TV.

Contact Samsung

View this information when your TV does not work properly or when you want to upgrade the software. You can find information regarding our call centers and how to download products and software.

Media Play

Enjoy photos, music and/or movie files saved on a USB Mass Storage Class (MSC) device.

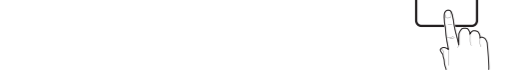

Connecting a USB Device

1. Turn on your TV.

2. Connect a USB device containing photo, music and/or movie files to the **USB** jack on the side of the TV.

When USB is connected to the TV, you can select **Media Play (USB)** in **Application** menu.

Using the Media Play Menu



1. Press the MENU button. Press the **▲** or **▼** button to select **Application**, then press the ENTER **↵** button.

2. Press the **▲** or **▼** button to select **Media Play (USB)**, then press the ENTER **↵** button.

3. Press the **◀** or **▶** button to select an icon (**Videos, Music, Photos, Settings**), then press the ENTER **↵** button.

☞ It might not work properly with unlicensed multimedia files.

☞ **Need-to-Know List** before using **Media Play (USB)**

• The file system supports FAT16, FAT32 and NTFS.

• Certain types of USB Digital camera and audio devices may not be compatible with this TV.

• **Media Play** only supports USB Mass Storage Class (MSC) devices. MSC is a Mass Storage Class Bulk-Only Transport device. Examples of MSC are Thumb drives and Flash Card Readers. Devices should be connected directly to the TV's USB port. USB HDD is not supported.

• Before connecting your device to the TV, please back up your files to prevent them from damage or loss of data. SAMSUNG is not responsible for any data file corruption or data loss.

• A USB device that requires high power (more than 0.5A) may not be supported.

• Do not disconnect the USB device while it is loading.

• The higher the resolution of the image, the longer it takes to display on the screen.

• The maximum supported JPEG resolution is 15360 x 8640 pixels.

• If a file is corrupted or the TV does not support the file type, the "Not Supported File Format" message appears.

• The TV cannot play MP3 files with DRM that have been downloaded from a for-pay site. Digital Rights Management (DRM) is a technology that supports the creation, distribution, and management of digital content in an integrated and comprehensive way, including protecting the rights and interests of content providers, preventing illegal copying of contents, and managing billings and settlements.

• PTP device is not supported.

• If an over-power warning message is displayed while you are connecting or using a USB device, the device may not be recognized or may malfunction.

• If the TV has no input during the time set in **Auto Protection Time**, the Screensaver will run.

• The power-saving mode of some external hard disk drives may be released automatically when you connect them to the TV.

• If you use a USB extension cable, the TV may not recognize the USB device or may not be able to read the files on the device.

• If a USB device connected to the TV is not recognized, the list of files on the device is completed, or a file is not displayed, connect the USB device to a PC, format the device, and check the connection.

• If a file you deleted from the PC is still found when you run **Media Play**, use the "Empty the Recycle Bin" function on the PC to permanently delete the file.

• **Photos** only supports sequential jpeg format.

• The scene search and thumbnail functions are not supported in the **Videos**.

• If the number of files and folders saved on a USB storage device is approximately over 4000, the files and folders may not appear and some folders may not be opened.

• The maximum displayed number of files, including sub folders, in one folder of USB storage device is 2000.

• The media may not be playing smoothly when using the device lower than USB 2.0.

Videos



1. Press the **◀** or **▶** button to select **Videos**, then press the ENTER **↵** button in the **Media Play** menu.

2. Press the **◀/▶/▲/▼** button to select the desired video in the file list.

3. Press the ENTER **↵** button or **▶** (Play) button.

- The selected file is displayed on the top with its playing time.

- If video time information is unknown, playing time and the progress bar are not displayed.

- During video playback, you can search using the **◀** and **▶** button.

☞ In this mode, you can play movie clips contained in a game, but you cannot play the game itself.

• Supported Subtitle Formats

- External

Name	File extension
MPEG-4 timed text	.txt
SAMI	.sml
SubRip	.srt
SubViewer	.sub
Micro DVD	.sub or .txt
SubStation Alpha	.ssa
Advanced SubStation Alpha	.ass

- Internal

Name	Container	Format
Xsib	AVI	Picture Format
SubStation Alpha	MKV	Text Format
Advanced SubStation Alpha	MKV	Text Format
SubRip	MKV	Text Format
MPEG-4 Timed text	MP4	Text Format

• Supported Video Formats

File Extension	Container	Video Codec	Resolution	Frame rate(fps)	Bit rate(kbps)	Audio Codec
*.mp4	MP4	DxV3.11/4xS/16.0	1920x1080	6~30	30Mbps	MP3 / AAC / PCM /
		H264	1920x1080	6~30	30Mbps	AAC /
		JVC	1920x1080	6~30	30Mbps	AAC
		MPEG2	640x480	6~30	10Mbps	
		DxV3.11/4xS/16.0	1920x1080	6~30	30Mbps	MP3 / AC3 / LPCM /
*.avi	AVI	MPEG4 SP / ASP	1920x1080	6~30	30Mbps	OTIS Core
*.mkv	MKV	H264	1920x1080	6~30	30Mbps	AAC / PCM / AAC /
		H264	1920x1080	6~30	30Mbps	LPCM / AAC /
		MPEG2	1920x1080	6~30	30Mbps	MP3 / AC3 / LPCM / AAC
*.avi	ASF	MPEG4 SP / ASP	1920x1080	6~30	30Mbps	MP3 / AC3 / LPCM / AAC
*.wmv	ASF	MPEG4 SP / ASP	1920x1080	6~30	30Mbps	MP3 / AC3 / LPCM / AAC
*.ts		MPEG2	1920x1080	6~30	30Mbps	AC3 / MP3 / Core
*.tp	TS	H.264 BP / MP / HP	1920x1080	6~30	30Mbps	HE-AAC
*.m2ts						HE-AAC
*.dat		MPEG1	1920x1080	24/25/30	30Mbps	MPEG /
*.msg	PS	H.264 BP / MP / HP	1920x1080	24/25/30	30Mbps	LPCM / AAC
*.m2p						MPEG / AAC
*.3gp	3GPP	MPEG4 SP / ASP	1920x1080	6~30	30Mbps	MP3
		H.264	1920x1080	6~30	30Mbps	MP3
*.avi	format	H.264	1920x1080	6~30	30Mbps	MP3
*.avi	format	Sorenson H.263	1920x1080	6~30	30Mbps	MP3

Other Restrictions

• Video content will not play, or not play correctly, if there is an error in the content or the container.

• Sound or video may not work if the contents have a standard bit rate/frame rate above the compatible Frame/sec listed in the table above.

• If the Index Table is in error, the Seek (Jump) function is not supported.

• The menu may take longer to appear if the video's bit rate exceeds 10Mbps.

• Video content can not be played, if there are many contents in one file.

Video Decoder
Supports up to H.264, Level 4.1
H.264 FMO / ASO / RS, VC1 SP / MP / AP L4 and AVCHD are not supported.
MPEG4 SP, ASP :
- Below 1280 x 720: 60 frame max
- Above 1280 x 720: 30 frame max
H.263 is not supported.
GMC is not supported.
Audio Decoder
Supports up to WMA7, 8, 9 STD, 9 PRO, 10 PRO
WMA 9 PRO and WMA 10 PRO support 5.1 channel. (LBR mode of WMA Pro is not supported)
WMA Lossless is not supported.

Music

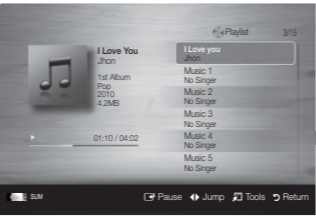

1. Press the **◀** or **▶** button to select **Music**, then press the ENTER **↵** button in the **Media Play** menu.

2. Press the **◀/▶/▲/▼** button to select the desired Music in the file list.

3. Press the ENTER **↵** button or **▶** (Play) button.

☞ During music playback, you can search using the **◀** and **▶** button.

☞ **◀◀** (REW) and **▶▶** (FF) buttons do not function during play.

☞ Only displays the files with MP3 and PCM file extension. Other file extensions are not displayed, even if they are saved on the same USB device.

☞ If the sound is abnormal when playing MP3 files, adjust the **Equalizer in the Sound menu**. (An over-modulated MP3 file may cause a sound problem.)

Photos



1. Press the **◀** or **▶** button to select **Photos**, then press the ENTER **↵** button in the **Media Play** menu.

2. Press the **◀/▶/▲/▼** button to select the desired photo in the file list.

3. Press the ENTER **↵** button or **▶** (Play) button.

☞ NOTE

• While a photo list is displayed, press the **▶** (Play) / ENTER **↵** button on the remote control to start the slide show.

• All files in the file list section will be displayed in the slide show.

• During the slide show, files are displayed in order.

• During the slide show, you can adjust the slide show speed using **◀◀** (REW) or **▶▶** (FF) button.

• You can move to other file using **◀** or **▶** button.

• Supported Photo Formats

Image	Photo	Resolution
JPEG	Basic-Info	15360 x 8704
	Progressive	1024 x 768

Other Restrictions

• CMYK, YCCK Color space JPEG are not supported.

Playing Multiple Files

■ **Playing selected video/music/photo files**

1. Press the Yellow button in the file list to select the desired file.

2. Repeat the above operation to select multiple files.

☞ **NOTE**

• The **✓** mark appears to the left of the selected files.

• To cancel a selection, press the Yellow button again.

• To deselect all selected files, press the **TOOLS** button and select **Deselect All**.

3. Press the **TOOLS** button, and then select **Play Selected Contents**.

■ **Playing the video/music/photo file group**

1. While a file list is displayed, move to any file in desired group.

2. Press the **TOOLS** button, and then select **Play Folder**.

Media Play - Additional Functions

■ **Videos/Music/Photos Play Options menus**
When playing a file, press the **TOOLS** button.

Category	Operation	Videos	Music	Photos
Title	You can move the other file directly.	✓		
Repeat Mode	You can play movie and music files repeatedly.	✓	✓	
Picture Size	You can adjust the picture size to your preference.	✓		
Picture Mode	You can adjust the picture setting.	✓	✓	✓
Sound Mode	You can adjust the sound setting.	✓	✓	✓
Subtitle Setting	You can play the video with Subtitles. This function only works if the subtitles are the same file name as the video.	✓		
Audio Format	You can select the digital audio output format.	✓		
Audio Language	You can change the audio language if the video has more than one language.	✓		
Stop Slide Show F	You can start or stop a Slide Show.			✓
Slide Show Speed	You can select the slide show speed during the slide show.			✓
Background Music	You can set and select background music when watching a Slide Show.		✓	
Zoom	You can zoom into images in full screen mode.			✓
Rotate	You can rotate images in full screen mode.			✓
Information	You can see detailed information about the played file.	✓	✓	✓

Settings

Using the Setup Menu

■ **DiX® Video On Demand** : Shows the registration code authorized for the TV. If you connect to the DiX web site and register with 10-digit registration code, you can download the VOD activation file. Once you play it using Media Play, the registration is completed.

☞ For more information on DiX® VOD, visit "http://vod.dixv.com".

■ **Information:** Select to view information on the connected device.

Other Information

Installing the Wall Mount Kit

The wall mount kit (sold separately) allows you to mount the TV on the wall.

For detailed information on installing the wall mount, see the instructions provided with the wall mount items. Contact a technician for assistance when installing the wall mount bracket. Samsung Electronics is not responsible for any damage to the product or injury to yourself or others if you elect to install the wall mount on your own.

Wall Mount Kit Specifications (VESA)

☞ The wall mount kit is not supplied, but sold separately.

Install your wall mount on a solid wall perpendicular to the floor. When attaching to other building materials, please contact your nearest dealer. If you install the TV on a ceiling or slanted wall, it may fall and result in severe personal injury.

☞ **NOTE**

• Standard dimensions for wall mount kits are shown in the table below.

• When purchasing our wall mount kit, a detailed installation manual and all parts necessary for assembly are provided.

• Do not use screws that do not comply with the VESA standard screw specifications.

• Do not use screws that are longer than the standard dimension or do not comply with the VESA standard screw specifications. Screws that are too long may cause damage to the inside of the TV set.

• For wall mounts that do not comply with the VESA standard screw specifications, the length of the screws may differ depending on the wall mount specifications.

• Do not fasten the screws too firmly. This may damage the product or cause the product to fall, leading to personal injury. Samsung is not liable for these kinds of accidents.

• Samsung is not liable for product damage or personal injury when a non-VESA or non-specified wall mount is used or the consumer fails to follow the product installation instructions.

• Do not mount the TV at more than a 15 degree tilt.

• Always have two people mount the TV on a wall.

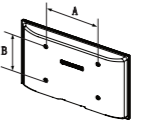
Product Family	TV size in inches	VESA screw hole specs (A * B) in millimeters	Standard Screw	Quantity
LED-TV	19~22	75 X 75	M4	4
	26	100 X 100	M6	
	32~40	200 X 200	M8	
	46~60	400 X 400	M8	
				Do not install your Wall Mount Kit while your TV is turned on. It may result in personal injury due to electric shock.

Securing the TV to the Wall

⚠ **Caution:** Pulling, pushing, or climbing onto the TV may cause the TV to fall. In particular, ensure that your children do not hang over or destabilize the TV, doing so may cause the TV to tip over, resulting in serious injuries or death. Follow all safety precautions provided on the included Safety Flyer. For added stability, install the anti-fall device for safety purposes, as follows.

To prevent the TV from falling

☞ Since the necessary cables, screws, and string are not supplied, please purchase these additionally.

1. Drive the screws into the clamps and firmly fasten them onto the wall. Make sure the screws are firmly fixed into the wall.

2. Remove the screws from the back center of the TV, put the screws into the clamps, and then fasten the screws onto the TV again.

3. Connect the clamps fixed onto the TV and the clamps fixed onto the wall with a strong cable and then tie the string tightly.

☞ Verify all connections are properly secured. Periodically check the connections for any sign of fatigue or failure. If you have any doubt about the security of your connections, contact a professional installer.

☞ Install the TV close to the wall so that it does not fall.

☞ It is safe to connect the string so that the clamps fixed on the wall are equal to or lower than the clamps fixed on the TV. Untie the string before moving the TV.

Kensington Lock

The Kensington Lock is not supplied by Samsung. It is a device used to physically fix the system when using it in a public place. Refer to the manual provided with the Kensington Lock for additional information on proper use.

☞ Please find a "🔒" icon on the rear of the TV. The Kensington slot is beside the "🔒" icon.

☞ The position and color may differ depending on the model.

Assembling the Cable manager

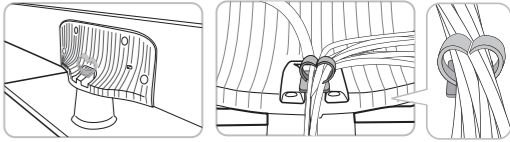

- 9 -

Troubleshooting