

SAMSUNG

E-MANUAL

Thank you for purchasing this Samsung product.
To receive more complete service, please register your
product at

www.samsung.com/register

Model _____ Serial No. _____

To directly go to the page that provides instructions
on how to use the manual for visually impaired users,
select the Learn the Menu Screen link below.

[“Learn Menu Screen” Link](#)

Contents

Quick Guides

Connecting the Samsung Smart Remote to the TV

Using Smart Hub

Using Voice Interaction

- 3 Running Voice Interaction
- 5 Read Before Using Voice Interaction

Updating the TV's Software

- 6 Updating the TV's software to the latest version
- 7 Updating the TV automatically

Getting Support

- 7 Getting support through Remote Management
- 8 Finding the contact information for service
- 8 Requesting service

Connections

Connection Guide

Connecting an Antenna

Connecting to the Internet

- 10 Connecting to your Internet network

Troubleshooting Internet Connectivity Issues

- 12 Troubleshooting wired Internet connectivity issues
- 13 Troubleshooting wireless Internet connectivity issues

Connecting Video Devices

- 14 Connecting with an HDMI cable
- 15 Connecting with a component cable (Only for models with COMPONENT IN / AV IN)
- 16 Connecting with a composite cable (Only for models with COMPONENT IN / AV IN)

Audio Input and Output Connections

- 17 Connecting with an HDMI (ARC) cable
- 17 Connecting with a digital audio (optical) cable
- 17 Connecting through a wireless network
- 18 Connecting Bluetooth Devices

Connecting a Computer

- 18 Connecting through the HDMI port — Screen sharing (HDMI)

Connecting a Mobile Device

- 19 Viewing the screen of a mobile device on your TV (Screen Sharing)
- 19 Sharing content through the Smart View app
- 20 Managing a Mobile Device

Switching between external devices connected to the TV

- 20 Changing the input signal
- 21 Editing the name and icon of an external device
- 22 Using additional functions

Connection Notes

- 22 Connection notes for HDMI
- 23 Connection notes for audio devices
- 24 Connection notes for computers
- 24 Connection notes for mobile devices

Remote Control and Peripherals

About the Samsung Smart Remote

About the Samsung Smart Remote (THE FRAME)

Connecting to the Samsung Smart Remote

Controlling External Devices with the Samsung Smart Remote - Using the Universal Remote

Using Anynet+ (HDMI-CEC)

- 30 Connecting an external device through Anynet+ and using their menus

Controlling the TV with a Keyboard

- 31 Connecting a USB keyboard
- 31 Connecting a Bluetooth keyboard
- 31 Using the keyboard

Entering Text using the On-Screen QWERTY Keyboard

- 33 Using additional functions
- 33 Entering Text using the remote control's microphone and the on-screen QWERTY keyboard

Smart Features

Smart Hub

- 34 Displaying the Home Screen
- 37 Launching Smart Hub automatically
- 37 Launching the last used app automatically
- 37 Testing Smart Hub connections
- 37 Resetting Smart Hub

Using a Samsung account

- 37 Creating and managing your Samsung account
- 38 Signing in to a Samsung account

Using the APPS Service

- 41 Installing and running an app
- 42 Managing purchased or installed apps
- 43 Rating apps

Using the e-Manual

- 44 Launching the e-Manual
- 44 Using the buttons in the e-Manual

Using the Internet

Playing pictures/video/music

- 46 Playing media content

Using the Music Service

Using the Sports Service

Using the TV PLUS Service

Using Voice Interaction

- 50 Running Voice Interaction
- 51 Read Before Using Voice Interaction

TV Viewing

Viewing Broadcast Information at a Glance

- 53 Using the guide

Recording Programs

- 55 Recording programs
- 56 Managing the schedule recording list
- 57 Viewing recorded programs

Setting Up a Schedule Viewing

- 57 Setting up a schedule viewing for a channel
- 58 Editing a schedule viewing

Using Timeshift

- 59 Buttons and functions available while recording a program or Timeshift

Using the Channel List

Editing channels

- 61 Re-registering and deleting a channel
- 61 Editing registered channels
- 62 Using Program Rating Lock

Creating a Personal Favorites List

- 62 Registering channels as favorites
- 63 Viewing and selecting channels on Favorites lists only

Editing a Favorites List

- 63 Adding channels to favorites list
- 63 Removing channels from a favorites list
- 63 Rearranging a favorites list
- 63 Renaming a favorites list

TV-Viewing Support Functions

- 64 Changing the broadcast signal
- 64 Scanning for available channels
- 64 Configuring advanced broadcasting audio settings

Picture and Sound

Adjusting the Picture Quality

- 65 Choosing a picture mode
- 65 Configuring advanced picture settings

Setting the Viewing Environment for External Devices

- 67 Playing games on an optimized screen
- 67 Viewing UHD videos
- 67 Using HDMI black level
- 68 Registering the TV as a DivX-certified device (watching for pay DivX movies)

Picture Support Functions

- 68 Changing the picture size

Adjusting the Sound Quality

- 69 Choosing a sound mode
- 69 Configuring advanced sound settings

Using the Sound Support Functions

- 70 Selecting speakers
- 70 Listening to the TV through Bluetooth devices
- 71 Listening to the TV through a Multiroom speaker

System and Support

Setting the Time and Using the Timer

- 72 Setting the current time
- 73 Using the timers

Using the Screen Burn Protection and Energy Saving Functions

- 74 Preventing screen burn
- 74 Reducing the energy consumption of the TV

Updating the TV's Software

- 75 Updating the TV's software to the latest version
- 75 Updating the TV automatically

Protecting the TV from Hacking and Malicious Code

- 76 Scanning the TV and connected storage for malicious code

Using Other Functions

- 76 Running the accessibility functions
- 77 Enabling voice guides for the visually impaired
- 77 Enabling audio for the video description function
- 77 White text on black background (high contrast)
- 77 Enlarging the font (for the visually impaired)
- 78 Learning about the remote control (for the visually impaired)
- 78 Learning about the TV menu
- 78 Showing captions
- 79 Listening to the TV through Bluetooth devices (for the hearing impaired)
- 79 Configuring advanced system settings
- 81 Checking digital channel signal info and strength
- 81 Restoring the TV to the factory settings

Troubleshooting

Getting Support

- 82 Getting support through Remote Management
- 83 Finding the contact information for service
- 83 Requesting service

Diagnosing TV operational issues

There Is a Problem with the Picture

- 84 Testing the picture

I Can't Hear the Sound Clearly

- 86 Testing the sound

There Is a Problem with the Broadcast

My Computer Won't Connect

The TV Won't Connect to the Internet

The Schedule Recording/Timeshift Function Isn't Working

Anynet+ (HDMI-CEC) Isn't Working

I Have Trouble Launching/Using Apps

My File Won't Play

I Want to Reset the TV

Other Issues

Precautions and Notes

Before Using the Recording and Timeshift Functions

- 93 Before using the recording and schedule recording functions
- 94 Before using the timeshift function

Read Before Using APPS

Read Before Using the Internet

Read Before Playing Photo, Video, or Music Files

- 97 Limitations on use of photo, video, and music files
- 98 Supported external subtitles
- 98 Supported internal subtitles
- 99 Supported image formats and resolutions
- 99 Supported music formats and codecs
- 100 Supported video codecs

Read After Installing the TV

- 102 Picture sizes and input signals
- 103 Installing an anti-theft lock
- 103 Read before setting up a wireless Internet connection

Supported Resolutions for UHD Input Signals

- 104 If HDMI UHD Color is set to Off
- 104 If HDMI UHD Color is set to On

Read Before Connecting a Computer (Supported Resolutions)

- 105 IBM
- 105 MAC
- 106 VESA DMT
- 106 CEA-861

Supported Resolutions for Video Signals

- 107 CEA-861

Read Before Using Bluetooth Devices

- 108 Restrictions on using Bluetooth

Blocking programs based on their TV Rating

- 110 Blocking movies base on their Movie Rating (MPAA)
- 110 Blocking programs based on their Canadian English Rating
- 111 Blocking programs based on their Canadian French Rating
- 111 Blocking Programs based on their Downloadable U.S. Rating

Buttons and Functions

- 112 Buttons and functions available while playing multimedia content

License

Accessibility Guidance

Learn Menu Screen

Using the Remote control

- 116 Orientation of the Samsung Smart Remote
- 116 Description of the Samsung Smart Remote

Using the accessibility menu

- 118 Accessibility short cut menu
- 119 Step by Step instructions to.
- 121 Setting accessibility settings using Voice Interaction

Using the TV with Voice Guide on

- 122 Watching TV

Using the guide

Setting Up a Schedule Viewing

Using the Channel List

- 129 Creating a Personal Favorites List

Recording

- 131 Using the instant and schedule recording options from the guide screen:
- 132 Using the Instant and Schedule Recording options from program info window
- 132 Recording a program you are currently watching directly from live TV
- 133 Changing the recording time
- 133 Viewing recorded programs
- 134 Deleting a recorded program

Using Smart Hub

- 134 Smart Hub
- 136 Displaying the Home Screen in Smart Hub

Using the e-Manual

- 137 Launching the e-Manual

Using Voice Interaction



- 138 Running Voice Interaction

Quick Guides



You can learn quickly how to run and use the frequently used functions.

Connecting the Samsung Smart Remote to the TV

Connect the Samsung Smart Remote to your TV to operate the TV.

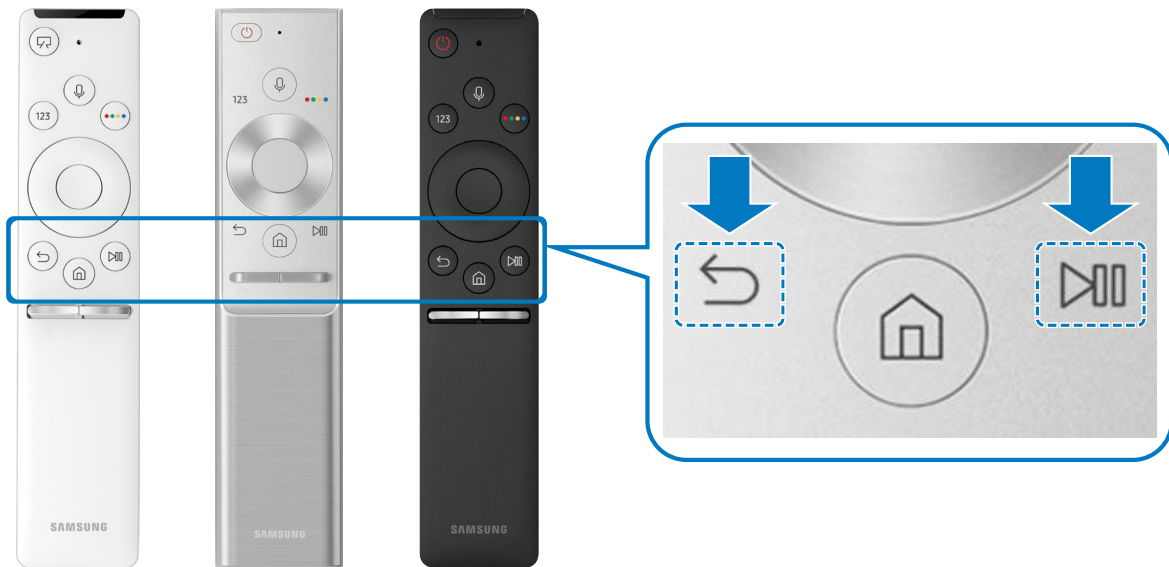
When you turn on the TV for the first time, the Samsung Smart Remote pairs to the TV automatically. If the Samsung Smart Remote does not pair to the TV automatically, point it at the remote control sensor of the TV, and then press and hold the  and  buttons simultaneously for 3 seconds or more.





-  The images, buttons, and functions of the Samsung Smart Remote may differ by model.
-  For more information, refer to "[About the Samsung Smart Remote.](#)"
-  Availability depends on the specific model.

Using Smart Hub

Connect to Smart Hub for apps, games, movies, and more.

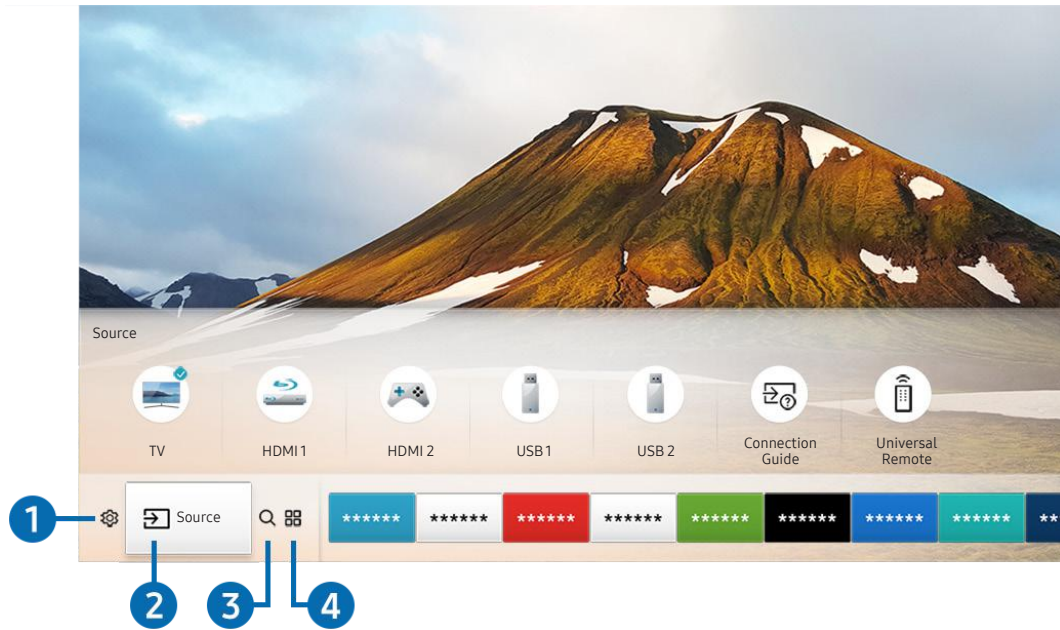
Enjoy the multiple functions provided by **Smart Hub** simultaneously on a single screen.



 The image on your TV may differ from the image above depending on your model and geographical area.

When you press the  button on your remote control, you can use the following functions and features.

1 Settings

When the focus is moved to the  icon, a list of quick settings icons appears above the top of the menu. You can quickly set frequently used functions by clicking the icons.

2 Source

You can select an external device connected to the TV.

 For more information, refer to "[Switching between external devices connected to the TV.](#)"

3 Search

You can search data for channels, programs, movie titles, and apps from Smart Hub.

 For more information, refer to "[Smart Hub.](#)"

4 APPS

You can enjoy a wide range of content including news, sports, weather, and games by installing the corresponding apps on your TV.

- To use this feature, the TV must be connected to the Internet.
- For more information, refer to "[Using the APPS Service.](#)"

Art

You can use the Art Mode function to edit image content such as artworks or pictures when you are not watching TV or when the TV is turned off, and then display the content in full screen mode.



- This function is supported only in THE FRAME model.
- For more information, refer to the provided user manual.

Using Voice Interaction

Speak into the microphone on your Samsung Smart Remote to control your TV.

- Availability depends on the specific model.

Running Voice Interaction

Press and hold the  button on your Samsung Smart Remote, say a command, and then release the  button. The TV recognizes the voice command.

- When you press the  button once, the Help Guide is displayed. Use the Voice Interaction function as instructed in the Guide.
- During voice analysis, the system cannot receive voice commands.





- If you say an accessibility-related command such as "Caption" or "Voice Guide," the command is applied directly and you will see a notification that the function is operating.
- When playing back media content, you can execute commands such as "Play," "Pause," "Stop," "Rewind," and "Fast Forward."

 The function does not operate for all apps.

- You can set the timer with the command "Sleep reservation in 30 minutes."
- To change the source, say "HDMI," "TV," or "USB."
- To change the picture mode, say "Movie Picture Mode" or "Set Picture Mode to Standard."
- To search, say "Search ****" or "Search **** in YouTube."
- To view Help, say "Help," "What can I say" or "User guide."

 The supported language may differ by geographical region.

 When you press the  button once, the Help Guide is displayed. Use the Voice Interaction function as instructed in the Guide.

Read Before Using Voice Interaction

Precautions for voice interaction

- To use Voice Interaction, you must have a Samsung account. For more information, refer to "[Using a Samsung account](#)."
- The supported voice interaction languages and features may differ by geographical region.
- If the language set differs from the language of your country, some features are not available.
- The function is available only when the TV is connected to the Internet.
- Voice interaction is available only on TVs that support it and come with remote controls that have a microphone.
- Symbols including "-" and special characters are not supported. Consequently, if a word or sentence contains numeric values or symbols, the function may not operate properly.
- Searched results may not provide complete results.
- You may be required to pay for some apps. Consequently, you may encounter a service application or contract.
- To change the current channel by saying channel names as voice commands, you must finish [Set Up Your Service Provider](#). (🏠) > ⚙️ [Settings](#) > [General](#) > [Start Setup](#))
- To use the voice text input function and Smart search function, you must consent to provisions allowing third parties to collect and use your voice data.
- To use the interactive voice interaction function, you must:
 - Agree to Smart Hub's Terms of Use
 - Agree to a guidance regarding the collection and use of personal information for the Smart Hub service.
 - Consent to the collection and use of personal information for the voice interaction-based service.

Requirements for using voice interaction

- The voice interaction rate differs with the volume/tone, pronunciation, and ambient sound environment (TV sound and ambient noise).
- The optimal volume for voice commands is between 75 dB and 80 dB.

Updating the TV's Software

View your TV's software version and update it if necessary.

 >  [Settings](#) > [Support](#) > [Software Update](#) [Try Now](#)

Updating the TV's software to the latest version

 **DO NOT turn off the TV's power until the update is complete. The TV will turn off and on automatically after completing the software update. Video and audio settings will be reset to their defaults after a software update.**

Updating through the Internet

 >  [Settings](#) > [Support](#) > [Software Update](#) > [Update Now](#)

 Updating from the Internet requires an active Internet connection.

Updating through a USB device

 >  [Settings](#) > [Support](#) > [Software Update](#) > [Update Now](#)

After downloading the update file from the Samsung website and storing it on a USB device, connect the USB device to the TV to update.

 To update using a USB flash drive, download the update package from Samsung.com to your computer. Then, save the update package in the USB device's top-level folder. Otherwise, the TV will not be able to locate the update package.

Updating the TV automatically

 >  [Settings](#) > [Support](#) > [Software Update](#) > [Auto Update](#)

If the TV is connected to the Internet, you can have the TV's software update itself automatically while you are watching the TV. When the background update is completed, it is applied the next time the TV is turned on.

If you agree to the Smart Hub terms and conditions, [Auto Update](#) is set to **On** automatically. If you want this function disabled, use the Select button to turn it off.

 This function may take a longer time if another network function is running concurrently.

 This function requires an Internet connection.

Getting Support

Get help directly from Samsung if you have a problem with your TV.

Getting support through Remote Management

 >  [Settings](#) > [Support](#) > [Remote Management](#)

After consenting to our service agreement, you can use [Remote Management](#) to access Remote Support and have a Samsung service technician diagnose your TV, correct problems, and update your TV's software, remotely, via the web. You can also turn [Remote Management](#) on and off.

 This function requires an Internet connection.

What is Remote Support?

Samsung Remote Support service offers you one-on-one support with a Samsung Technician who can remotely:

- Diagnose your TV
- Adjust the TV settings for you
- Perform a factory reset on your TV
- Install recommended firmware updates

How does Remote Support Work?

You can easily have a Samsung Tech service your TV remotely:



1. Call the Samsung Contact Center and ask for remote support.
2. Open the menu on your TV and go to the [Support](#) section.
3. Select [Remote Management](#), then read and agree to the service agreements. When the PIN screen appears, provide the PIN number to the agent.
4. The agent will then access your TV.

Finding the contact information for service

 >  [Settings](#) > [Support](#) > [About This TV](#)

You can view the address of the Samsung website, the call center phone number, your TV's model number, your TV's software version, Open Source License and other information you may need to get service support from a Samsung call agent or the Samsung website.

 You can also view information by scanning the QR code of your TV.

 You can also start this function by pressing and holding the  button for 5 or more seconds.

Requesting service

 >  [Settings](#) > [Support](#) > [Request Support](#)

You can request service when you encounter a problem with the TV. Select the item matching the problem that you encountered, and then select [Request Now](#) or [Schedule Appointment](#) > [Send](#). Your service request will be registered. The Samsung Contact Center will contact you to set up or confirm your service appointment.

 You must agree to the terms and conditions for the service request.

 This function is not available in specific geographical areas.

 This function requires an Internet connection.

Connections

You can watch live broadcasts by connecting an antenna and antenna cable to your TV and can get access to the Internet by using a LAN cable or wireless router. Using various connectors, you can also connect external devices.

Connection Guide

You can view detailed information about external devices that can be connected to the TV.

 >  [Source](#) > [Connection Guide](#)

It shows you how to connect various external devices such as set-top boxes, game consoles, and PCs using pictures. If you select the connection method and an external device, the connection details appear.

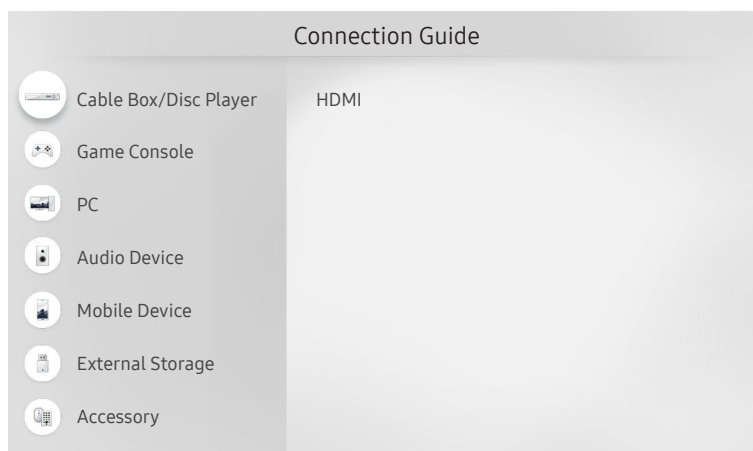

 The image on your TV may differ from the image above depending on your model and geographical area.

Connecting an Antenna

You can connect an antenna cable to your TV.

 An antenna connection is not necessary if you connect a cable or satellite box.

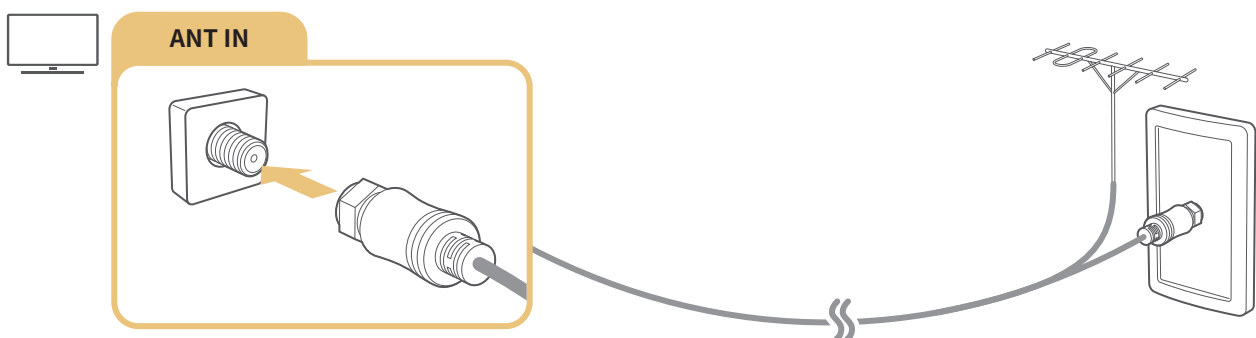

Connecting to the Internet

You can get access to the Internet through your TV.

Connecting to your Internet network

 >  **Settings** > **General** > **Network** > **Open Network Settings**

Connect to an available network.

Establishing a wired Internet connection

 >  **Settings** > **General** > **Network** > **Open Network Settings** > **Wired**

If you connect a LAN cable, the TV automatically accesses the Internet.

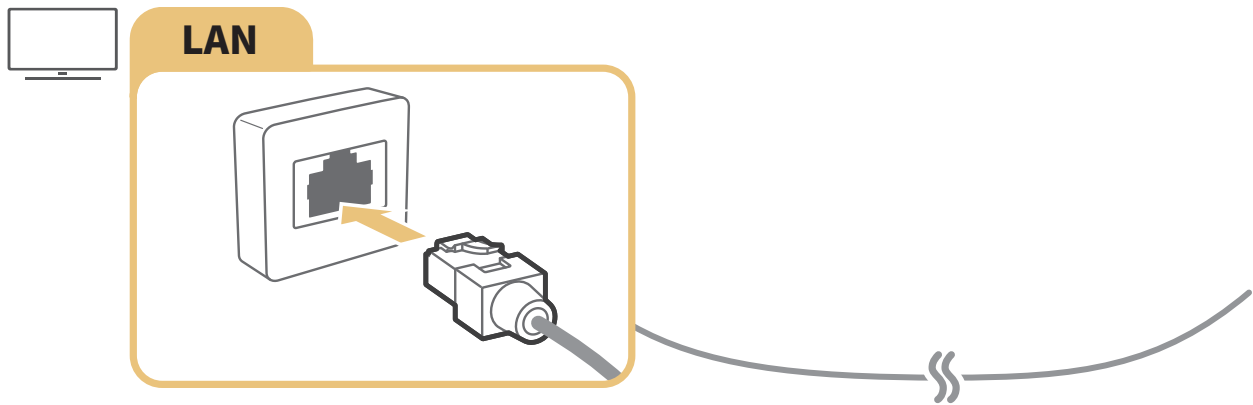

 Use a CAT 7 (*STP type) cable for the connection.
* Shielded Twist Pair



 The TV will not be able to connect to the Internet if your network speed is below 10 Mbps.

Establishing a wireless Internet connection

 >  **Settings** > **General** > **Network** > **Open Network Settings** > **Wireless**

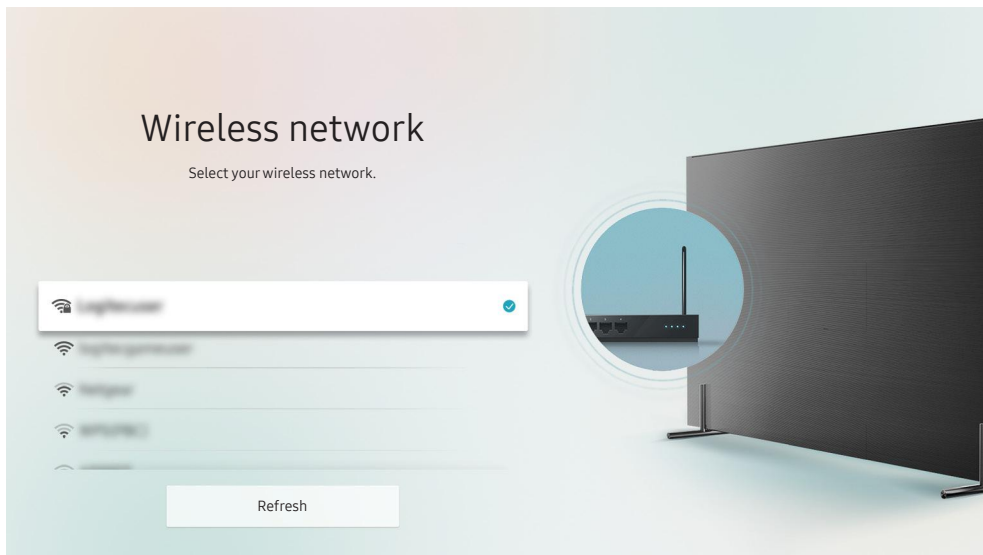
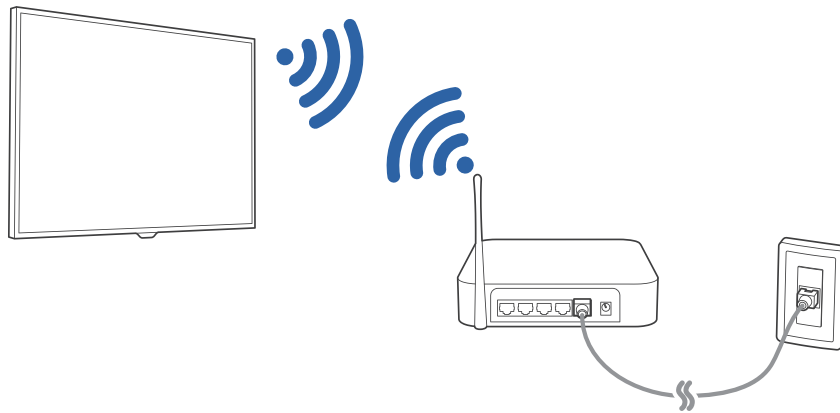
Make sure that you have the wireless router's SSID (name) and password settings before attempting to connect, and then follow the directions on the screen.



-  The image on your TV may differ from the image above depending on your model and geographical area.
-  If no wireless router is found, select **Add Network** at the bottom of the list and enter the network name (SSID).
-  If your wireless router has a WPS or PBC button, select **Use WPS** at the bottom of the list, and then push the WPS or PBC button on your router within 2 minutes. The TV will connect automatically.

Checking the Internet connection status

 >  **Settings** > **General** > **Network** > **Network Status**

View the current network and Internet status.

Resetting Your Network

 >  [Settings](#) > [General](#) > [Network](#) > [Reset Network](#)

Restore the network settings to the factory default.

Changing the name of the TV on a network

 >  [Settings](#) > [General](#) > [System Manager](#) > [Device Name](#)

You can change the name of the TV on the network. Select [User Input](#) at the bottom of the list and change the name.

Setting up network IP settings according to IPv6

 >  [Settings](#) > [General](#) > [Network](#) > [Expert Settings](#) > [IPv6](#)

 This function is not available on certain models in specific geographical areas.

Checking an Internet connection set up over IPv6

 >  [Settings](#) > [General](#) > [Network](#) > [Expert Settings](#) > [IPv6 Status](#)

 This function is not available on certain models in specific geographical areas.

Troubleshooting Internet Connectivity Issues

If your TV won't connect to the Internet, try the solutions below.

Troubleshooting wired Internet connectivity issues [Try Now](#)

After reading the following content, troubleshoot the wired Internet connection issue. If the problem persists, contact your Internet Service Provider.

No network cable found

Make sure that the LAN cable is plugged in on both ends. If it is plugged in, make sure that the router is turned on. If the router is on, try turning it off and then on.

IP auto setting failed

1. Configure the settings in [IP Settings](#).
2. Make sure that the DHCP server is enabled on the router, and then reset the router.

Unable to connect to the network

1. Check all [IP Settings](#).
2. After checking the DHCP server status (must be active) on the router, remove the LAN cable, and then connect it again.

Connected to a local network, but not to the Internet

1. Make sure that the Internet LAN cable is connected to the router's external LAN port.
2. Check the DNS values in [IP Settings](#).

Network setup is complete, but unable to connect to the Internet

If the problem persists, contact your Internet Service Provider.

Troubleshooting wireless Internet connectivity issues

After reading the following content, troubleshoot the wireless Internet connection issue. If the problem persists, contact your Internet Service Provider.

Wireless network connection failed

If a selected wireless router is not found, go to [Open Network Settings](#), and then select the correct router.

Unable to connect to a wireless router

1. Check if the router is turned on. If it is, turn it off and then on.
2. Enter the correct password if required.

IP auto setting failed

1. Configure the settings in [IP Settings](#).
2. Make sure that the DHCP server is enabled on the router. Then, unplug the router and plug it back in.
3. Enter the correct password if required.

Unable to connect to the network

1. Check all [IP Settings](#).
2. Enter the correct password if required.

Connected to a local network, but not to the Internet

1. Make sure that the Internet LAN cable is connected to the router's external LAN port.
2. Check the DNS values in [IP Settings](#).

Network setup is complete, but unable to connect to the Internet

If the problem persists, contact your Internet Service Provider.

Connecting Video Devices

Make the correct video connections between your TV and your external devices.

Connecting with an HDMI cable

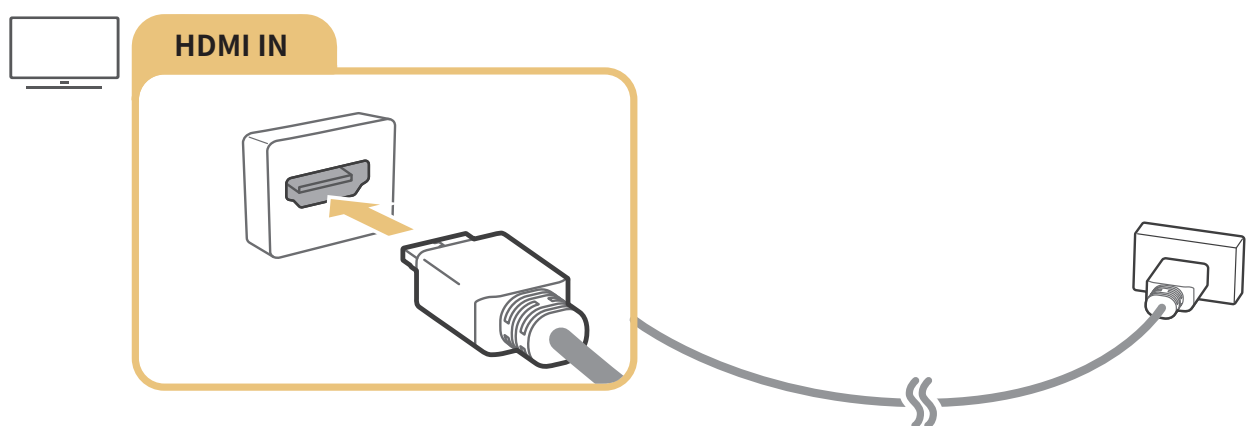

Connecting with a component cable (Only for models with COMPONENT IN / AV IN)

A Component connection lets you enjoy video resolutions up to 1080p. To watch video from most DVD and Blu-ray players, use the Component connection.

Review the illustration below, and then connect Component IN and AV IN on the TV to Component OUT on the external device by using the provided component and AV adaptors. Make sure to connect the same color connectors together. (blue to blue, yellow to yellow, etc.)

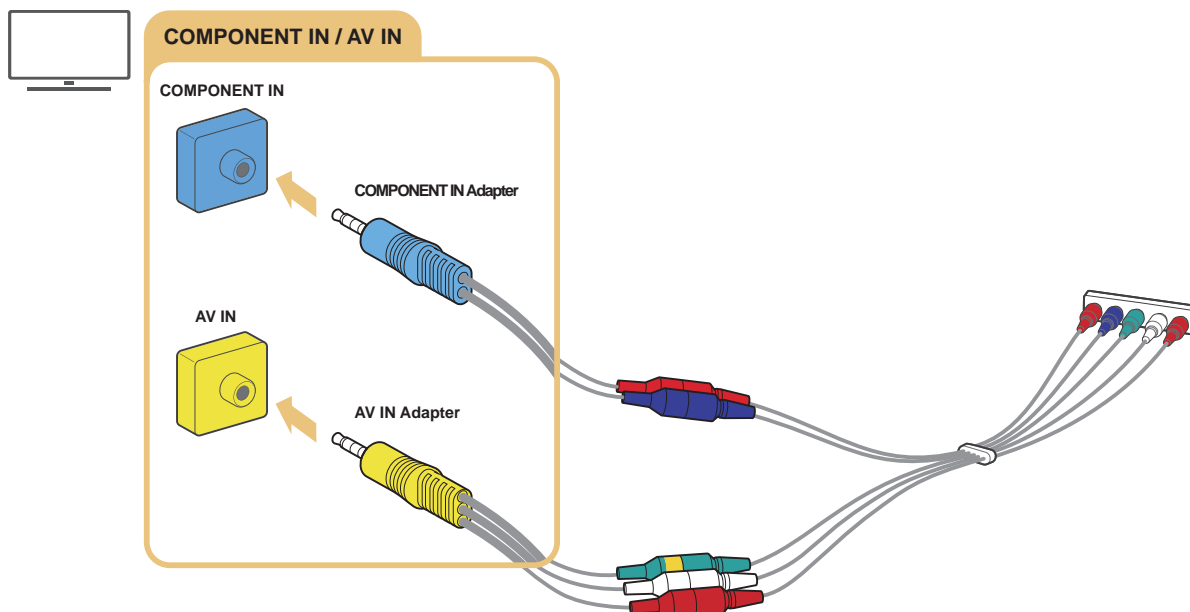

 To use component equipment, connect both the component adaptor (blue) and the AV adaptor (yellow).

Connecting with a composite cable (Only for models with COMPONENT IN / AV IN)

Through the Composite connection, you can enjoy the resolution up to 480i.

Review the illustration below, and then connect AV IN on the TV to AV OUT on the external device using the provided AV adapter and composite cable. When connecting the cables, be sure to match the colors of the cables to the colors of the ports.

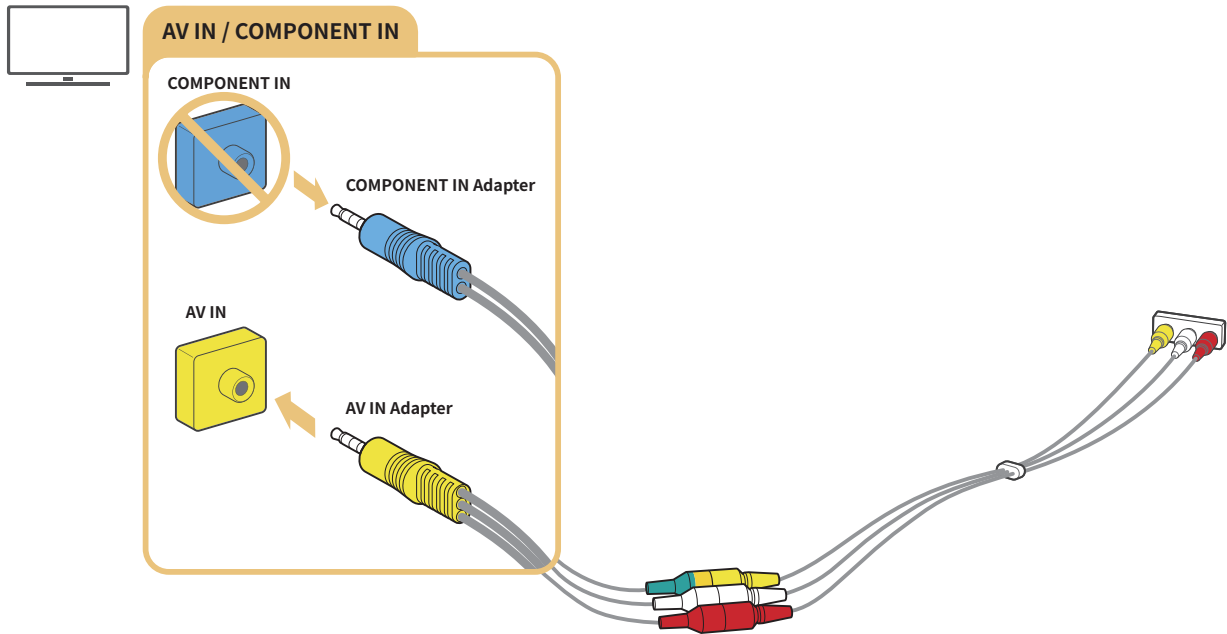

 Connect AV (composite) equipment to AV In only. Do not connect to Component In.

Audio Input and Output Connections

Make the correct audio connections between your TV and your external devices.

 For more information about how to select external speakers, refer to "[Selecting speakers.](#)"

Connecting with an HDMI (ARC) cable

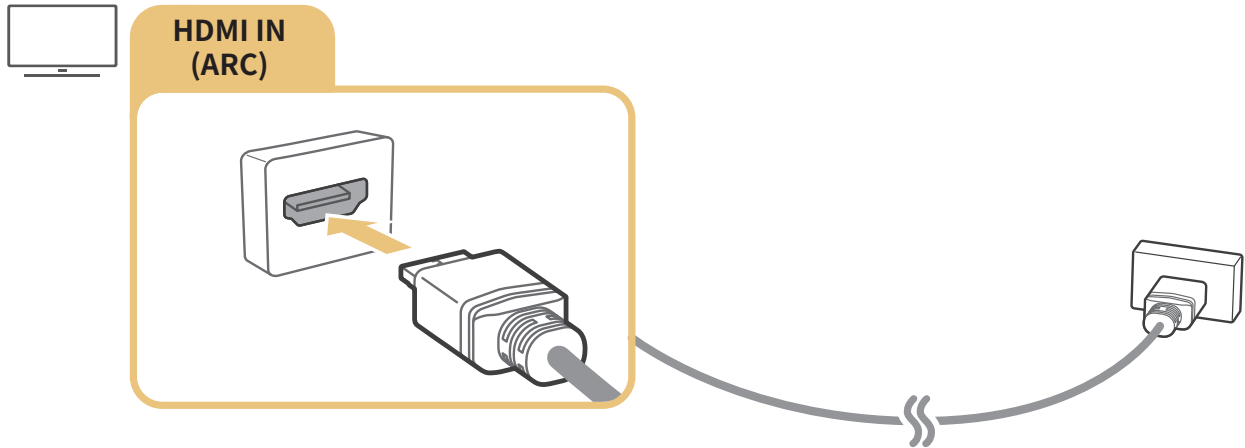

Connecting with a digital audio (optical) cable

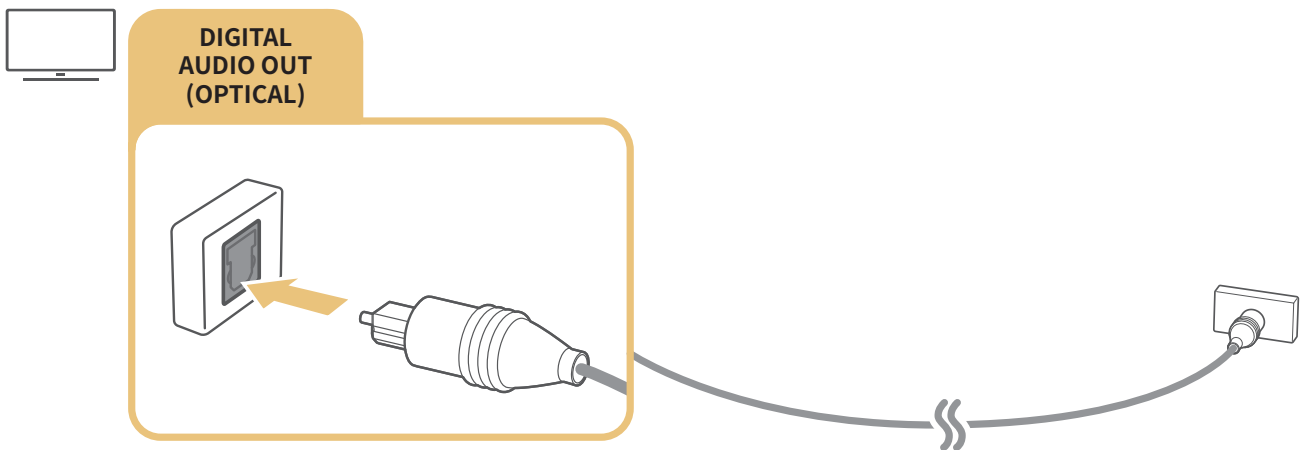

Connecting through a wireless network

You can connect the TV to a Samsung wireless audio device through your wireless network. The two devices must be connected to the same network. For more information about the connection and its use, refer to the user manual of the audio device.

Connecting Bluetooth Devices

For more information about how to connect and use external speakers, refer to the [Connection Guide](#) (🏠 > 📄) [Source](#) > [Connection Guide](#)) and to the speakers' user manuals.

 This function is not available on certain models in specific geographical areas.

Connecting a Computer

Use the TV as a computer monitor or connect the TV to a computer via your network and access the computer's content.

Connecting through the HDMI port — Screen sharing (HDMI)

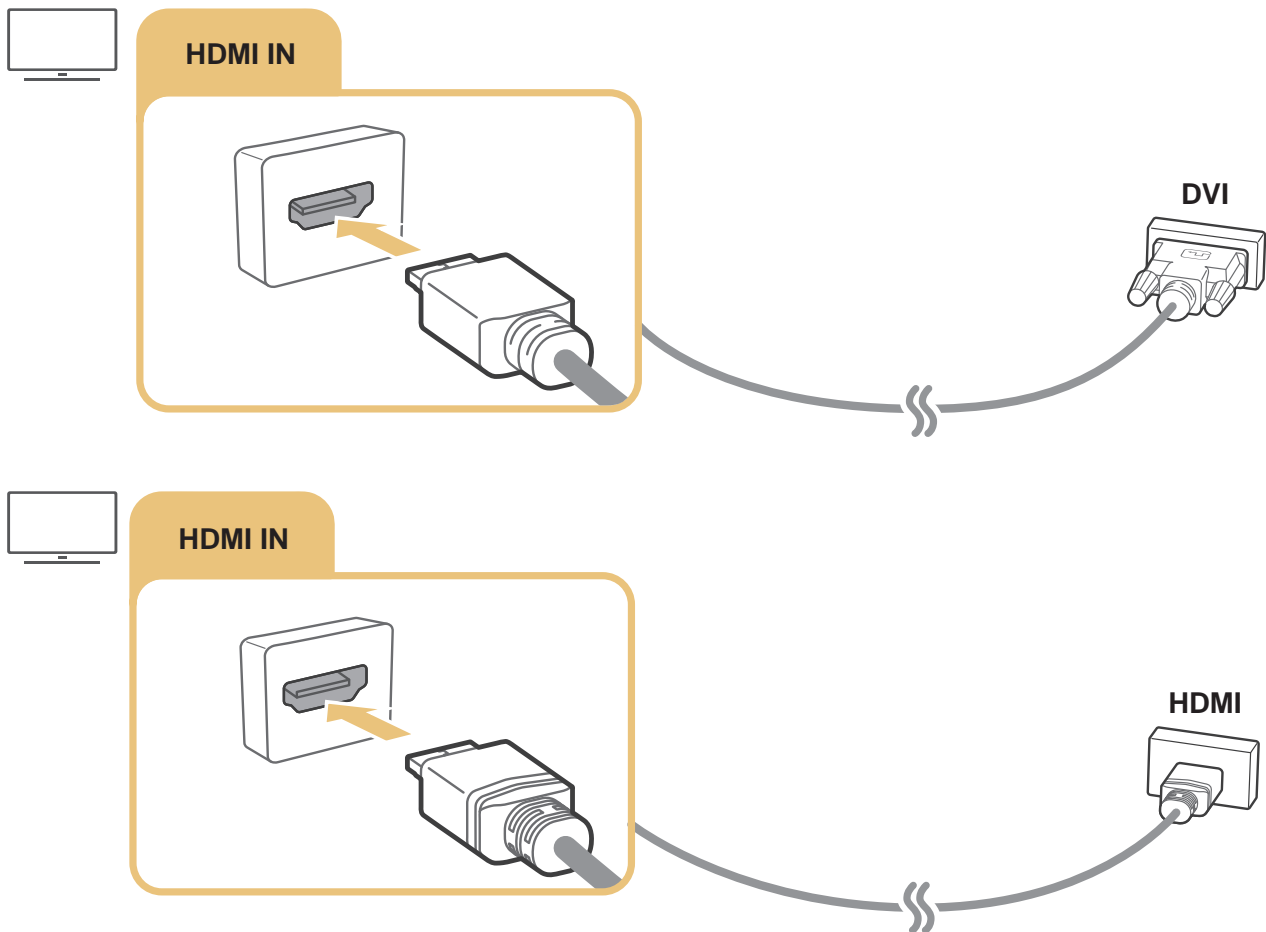

 When your PC is connected, select PC for the [Device Icon](#). For more information about the port settings, refer to "[Editing the name and icon of an external device.](#)"



Connecting a Mobile Device

View a mobile device's screen and multi-media content by connecting the mobile device to your TV or network.

After you connect a mobile device that supports screen mirroring to your TV, you can use screen mirroring to view the screen of the mobile device on your TV wirelessly and play the video, audio, or photo files currently playing on the mobile device on your TV. If your mobile device does not support mirroring, download and install the Smart View (Screen Mirroring) app.

Viewing the screen of a mobile device on your TV (Screen Sharing)

When you run the Smart View on a mobile device, you can view the screen of the mobile device on the TV.

1. Run the Smart View (Screen Mirroring) on your mobile device. The device searches for TVs that can be connected.
2. Select the desired TV from the searched result. The TV and the mobile device are connected.
 - If there is no TV found, try again after turning both off and on.
 - If you have multiple TVs, assign a different name to each TV in  >  [Settings](#) > [General](#) > [System Manager](#) > [Device Name](#) to make selection easy.

Sharing content through the Smart View app

When you install and then run the Samsung Smart View App on your mobile device, you can play the mobile device's multimedia content on your TV. You can download the app from Google Play Store, Samsung Apps, or the App Store.

The mobile device and your Smart TV must be connected to each other on the same network.

 This function is not available on certain models in specific geographical areas.

Managing a Mobile Device

 >  [Settings](#) > [General](#) > [External Device Manager](#) > [Device Connect Manager](#)

- [Access Notification](#)

Set whether to display a notification when a mobile device attempts to connect to the TV for the first time.

- [Device List](#)

View and manage a list of mobile devices that have requested permission to connect to the TV.

Switching between external devices connected to the TV

You can switch between TV programs and the content of external devices.

Changing the input signal

 >  [Source](#)

When you select a connected external device on the [Source](#) screen, the output of the selected device is displayed on the TV's screen.

 To control a device (Blu-ray player, game console, etc.) that supports universal remote control with the TV's remote, connect the device to an HDMI port on the TV, and then turn on the device. Lets you switch to the output of the device automatically or lets you configure universal remote control for the device automatically. To configure the device for universal remote control automatically, point the TV's remote control at the device. Note that this function may not be supported depending on the device and geographical area.

 When a USB device is connected to the USB port, a pop-up message appears that lets you switch easily to the media content listed on the device.

Editing the name and icon of an external device

 >  Source

You can change the port name for a connected external device or add it to Home Screen.

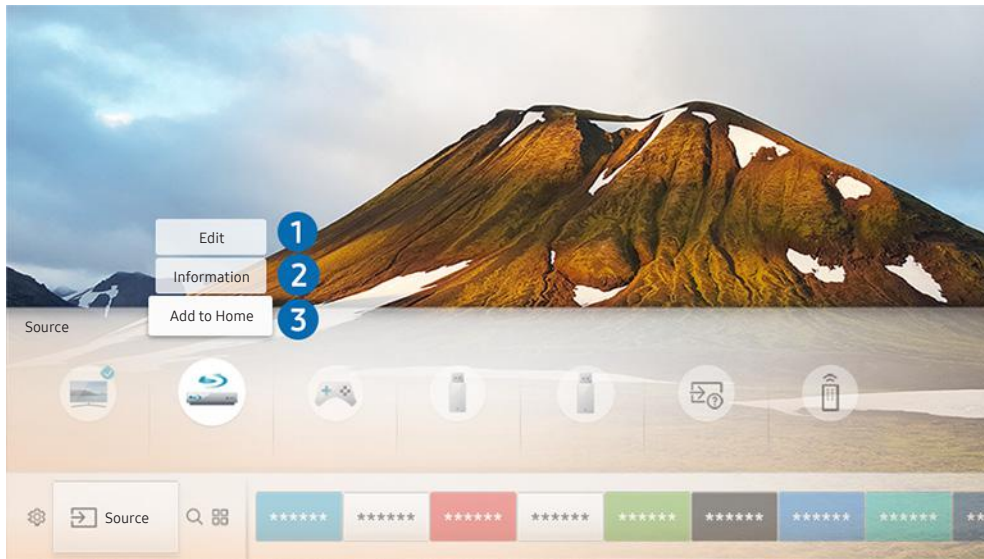

 The image on your TV may differ from the image above depending on your model and geographical area.

1. Move the focus to a connected external device.
2. Press the Up directional button. The following 2 functions become available. (Note that available functions may differ with the port type.)

1 Edit

You can change the port name of an external device for easy identification.

2 Information

You can view detailed information about an external device.

3 Add to Home

You can add the port of an external device to the Home Screen for quick switching.

Using additional functions

You can use the following features on the **Source** screen.

- **Connection Guide:** The guide to device connections
- **Universal Remote:** The function that lets you register external devices to your Samsung Smart Remote and control them using the Remote.

 This function is not available on certain models in specific geographical areas.

 For more information, refer to "[Controlling External Devices with the Samsung Smart Remote - Using the Universal Remote.](#)"

Connection Notes

When connecting an external device, note the following.

 The number of connectors and their names and locations may differ with the model.



 Refer to the external device's operating manual when connecting it to the TV. The number of external device connectors and their names and locations may differ with the manufacturer.

Connection notes for HDMI

- The following types of HDMI cables are recommended:
 - High-Speed HDMI Cable
 - High-Speed HDMI Cable with Ethernet
- Use an HDMI cable with a thickness of 0.66 inches (17 mm) or less.
- Using a non-certified HDMI cable may result in a blank screen or a connection error.
- Some HDMI cables and devices may not be compatible with the TV due to different HDMI specifications.
- This TV does not support HDMI Ethernet Channel. Ethernet is a Local Area Network (LAN) built with coaxial cables standardized by the IEEE.
- Use a cable shorter than 10 feet (3 m) to get the best UHD viewing quality.





- Many computer graphics adaptors do not have HDMI ports, but have DVI ports instead. If your PC does not support HDMI video out, connect your PC with an HDMI-DVI cable.

 For more information, refer to "[Connecting a Computer](#)."

- For One Connect or One Connect Mini supported models, when the TV is connected to other equipment such as a DVD/BD player or a set-top-box via HDMI, network standby mode will be automatically activated. In this network standby mode, the TV continues to detect and connect HDMI Devices. This function can be deactivated by pressing the following buttons on the remote control:
 - On the Samsung Smart Remote: **VOL** > (up directional button) > (left directional button) > (up directional button) > (down directional button) > **VOL** > 
 - On the standard remote control:  > (up directional button) > (left directional button) > (up directional button) > (down directional button) >  > **RETURN**.

 If the function is deactivated and TV is turned off, the function is automatically activated again when the TV is next switched on.

Connection notes for audio devices

- For better audio quality, it is a good idea to use an AV receiver.
- Connecting a device using an optical cable does not automatically change the audio output to the device's speakers. To change the audio output to the device, do one of the following:
 - Use the **Quick Settings** screen to change to the connected device:
Use the Select button to select **Audio Out/Optical** on the **Sound Output** menu. ( >  **Settings** > up directional button > **Sound Output**).
 - Use the **Settings** screen to change to the connected device:
Select **Audio Out/Optical** on the **Sound Output** menu. ( >  **Settings** > **Sound** > **Sound Output**).
- An unusual noise coming from a connected audio device while you are using it may indicate a problem with the audio device itself. If this occurs, ask for assistance from the audio device's manufacturer.
- Digital audio is only available with 5.1-channel broadcasts.

Connection notes for computers

- For the resolutions supported by the TV, refer to "[Read Before Connecting a Computer \(Supported Resolutions\)](#)."
- As long as file sharing is activated, unauthorized access may occur. When you do not need to access data, disable file sharing.
- Your PC and Smart TV must be connected to each other on the same network.
- When sharing content with other network-based devices such as those in an IP (Internet Protocol) storage system, sharing may not be supported due to the network's configuration, quality, or functionality, for example, if the network has an NAS (Network-Attached Storage) device.

Connection notes for mobile devices

- To use the Smart View function, the mobile device must support a mirroring function such as AllShare Cast or Smart View. To check whether your mobile device supports the mirroring function, please visit the mobile device manufacturer's website.
- To use Wi-Fi Direct, the mobile device must support the Wi-Fi Direct function. Please check if your mobile device supports Wi-Fi Direct.
- The mobile device and your Smart TV must be connected to each other on the same network.
- The video or audio may stop intermittently, depending on network conditions.
- When sharing content with other network-based devices such as those in an IP (Internet Protocol) storage system, sharing may not be supported due to the network's configuration, quality, or functionality, for example, if the network has an NAS (Network-Attached Storage) device.







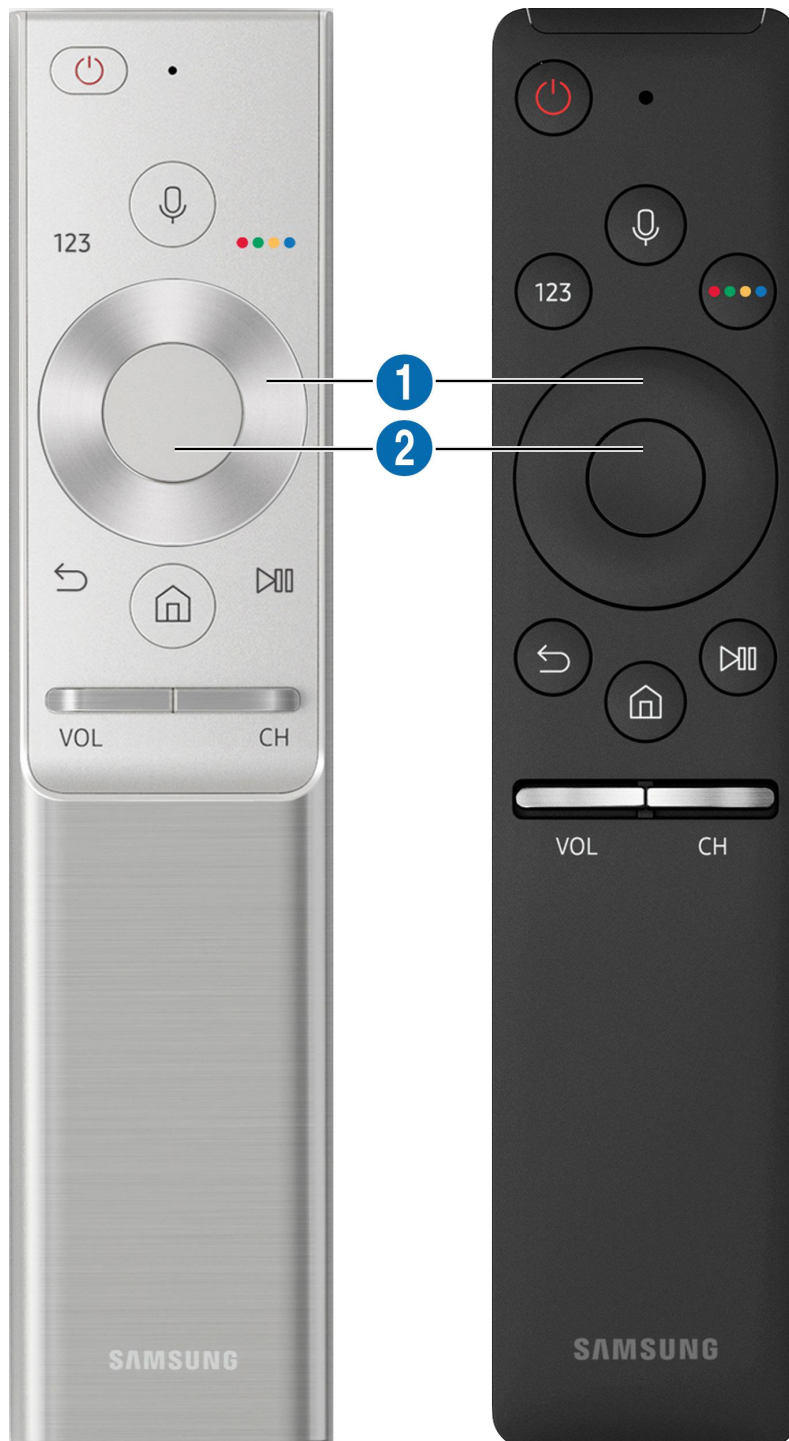

Remote Control and Peripherals





You can control TV operations with your Samsung Smart Remote. Pair external devices such as a keyboard for ease of use.

About the Samsung Smart Remote

Learn about the buttons on the Samsung Smart Remote.













Button	Description
 (Voice recognition)	Runs Voice Interaction. Press the button, say a voice command, and then release the button to run Voice Interaction. When pressed once, the guide to Voice Interaction appears.
 (Virtual numeric pad)	<p>Press to bring up the virtual numeric pad on the screen. Use the numeric keypad to enter numeric values.</p> <p>Select numbers and then select Done to enter a numeric value. Use to change the channel, enter a PIN, enter a ZIP code, etc.</p> <p>If the Color Button appears with a number strip on the screen, select the Color Button and then select a specific color by using the directional pad (up/down/left/right). Use this to access additional options that are specific to the feature in use.</p>
 4 Color button	<p>Use these colored buttons to access additional options that are specific to the feature in use.</p> <p> These buttons are not available in the U.S.A. and Canada.</p>
 Directional pad (up/down/left/right)	Moves the focus.
 Select	Selects or runs a focused item. When pressed while you are watching content, detailed program information appears.
 (Return)	Press to return to the previous menu. When pressed for 1 second or more, the running function is terminated. When pressed while you are watching a program, the previous channel appears.
 (Smart Hub)	Press to return to the Home Screen.
 (Play/pause)	When pressed, the playback controls appear. Using these controls, you can control the media content that is playing.
VOL (Volume)	Move the button up or down to adjust the volume. To mute the sound, press the button. When pressed for 1 second or more, the Accessibility Shortcuts appears.
CH (Channel)	<p>Move the button up or down to change the channel. To see the Guide screen, press the button.</p> <p>Press and hold the button up or down to quickly change the channel.</p>





-  Use the Samsung Smart Remote less than 20 feet from the TV. The usable distance may vary with the wireless environmental conditions.
-  The images, buttons, and functions of the Samsung Smart Remote may differ with the model.
-  This function may not be supported depending on the model or geographical region.
-  To use the Samsung Smart Remote to control a compatible external device that does not support HDMI-CEC (Anynet+), you must configure universal remote control for the device. For more information, refer to "[Controlling External Devices with the Samsung Smart Remote - Using the Universal Remote.](#)"
-  To use the Samsung Smart Remote to control a compatible external device that does support HDMI-CEC (Anynet+), connect the device to an HDMI port on the TV using an HDMI cable. For more information, refer to "[Using Anynet+ \(HDMI-CEC\).](#)"

About the Samsung Smart Remote (THE FRAME)

Learn about the buttons on the Samsung Smart Remote.





Button	Description
 (Power)	When watching TV, press to switch to Art mode. In Art mode, press to switch to watching TV. Press and hold to turn off the TV completely.
 (Voice recognition)	Runs Voice Interaction. Press the button, say a voice command, and then release the button to run Voice Interaction. When pressed once, the guide to Voice Interaction appears.
 123 (Virtual numeric pad)	Press to bring up the virtual numeric pad on the screen. Use the numeric keypad to enter numeric values. Select numbers and then select Done to enter a numeric value. Use to change the channel, enter a PIN, enter a ZIP code, etc. If the Color Button appears with a number strip on the screen, select the Color Button and then select a specific color by using the directional pad (up/down/left/right). Use this to access additional options that are specific to the feature in use.
 4 Color button	Use these colored buttons to access additional options that are specific to the feature in use.  These buttons are not available in the U.S.A. and Canada.
 1 Directional pad (up/down/left/right)	Moves the focus.
 2 Select	Selects or runs a focused item. When pressed while you are watching content, detailed program information appears.
 (Return)	Press to return to the previous menu. When pressed for 1 second or more, the running function is terminated. When pressed while you are watching a program, the previous channel appears.
 (Smart Hub)	Press to return to the Home Screen. Press in Art mode to switch to TV mode.
 (Play/pause)	When pressed, the playback controls appear. Using these controls, you can control the media content that is playing.
VOL (Volume)	Move the button up or down to adjust the volume. To mute the sound, press the button. When pressed for 1 second or more, the Accessibility Shortcuts appears.
CH (Channel)	Move the button up or down to change the channel. To see the Guide screen, press the button. Press and hold the button up or down to quickly change the channel.

-  Use the Samsung Smart Remote less than 20 feet from the TV. The usable distance may vary with the wireless environmental conditions.
-  The images, buttons, and functions of the Samsung Smart Remote may differ with the model.
-  This function may not be supported depending on the model or geographical region.
-  To use the Samsung Smart Remote to control a compatible external device that does not support HDMI-CEC (Anynet+), you must configure universal remote control for the device. For more information, refer to "[Controlling External Devices with the Samsung Smart Remote - Using the Universal Remote.](#)"
-  To use the Samsung Smart Remote to control a compatible external device that does support HDMI-CEC (Anynet+), connect the device to an HDMI port on the TV using an HDMI cable. For more information, refer to "[Using Anynet+ \(HDMI-CEC\).](#)"

Connecting to the Samsung Smart Remote

Pair the TV with the Samsung Smart Remote.

When you turn on the TV for the first time, the Samsung Smart Remote pairs to the TV automatically. If the Samsung Smart Remote does not pair to the TV automatically, point it at the remote control sensor of the TV, and then press and hold the  and  buttons simultaneously for 3 seconds or more.

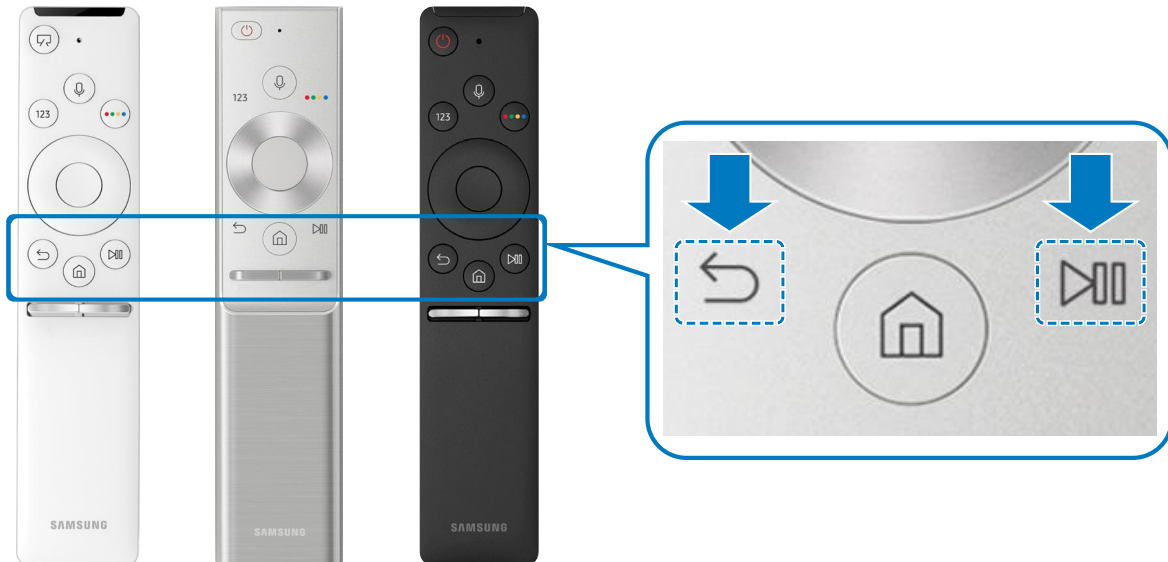





 Availability depends on the specific model.

Controlling External Devices with the Samsung Smart Remote - Using the Universal Remote

Control the TV and connected external devices with the Samsung Smart Remote.

 >  [Source](#) > [Universal Remote](#)

You can control external devices connected to the TV using the remote control. To control external devices, register them by following the instructions on the screen.

-  Availability depends on the specific model.
-  You can also use the [Anynet+ \(HDMI-CEC\)](#) function to operate external Samsung devices with your TV's remote control without any additional setup. For more information, refer to "[Using Anynet+ \(HDMI-CEC\)](#)."
-  Certain external devices connected to the TV may not support the universal remote feature.
-  Do not place any obstacles in front of an external device. It may cause signals from the remote control to be transmitted improperly.
-  The TV memorizes both the external device and its connection port (HDMI 1, HDMI 2, etc.).

Using Anynet+ (HDMI-CEC)

Control an external device connected via Anynet+ (HDMI-CEC) with the remote control.

You can use the TV's remote control to control external devices that are connected to the TV by an HDMI cable and that support Anynet+ (HDMI-CEC). Note that you can only set up and operate Anynet+ (HDMI-CEC) with the remote control.









Connecting an external device through Anynet+ and using their menus

 >  **Settings** > **General** > **External Device Manager** > **Anynet+ (HDMI-CEC)**

1. Set **Anynet+ (HDMI-CEC)** to **On**.
2. Connect an HDMI-CEC-compliant device to the TV.
3. Turn on the connected external device. The device is automatically connected to the TV. After connection is finished, you can access the menu of the connected device on your TV screen using your TV remote and control the device.

 The connecting process can take up to 2 minutes to complete.

Read before connecting an Anynet+ (HDMI-CEC) device

-  You can configure the TV's Universal Remote to control third-party cable boxes, Blu-ray players, and home theaters that do not support HDMI-CEC. For more information, refer to "[Controlling External Devices with the Samsung Smart Remote - Using the Universal Remote.](#)"
-  Anynet+ cannot be used to control external devices that do not support HDMI-CEC.
-  Anynet+ (HDMI-CEC)-enabled devices must be connected to the TV with an HDMI cable. Note that some HDMI cables may not support Anynet+ (HDMI-CEC).
-  The TV remote control may not work under certain circumstances. If this occurs, set up the device as an Anynet+ (HDMI-CEC)-enabled device again.
-  Anynet+ (HDMI-CEC) works only with external devices that support HDMI-CEC and only when those devices are either in standby mode or turned on.
-  Anynet+ (HDMI-CEC) can control up to 12 compliant external devices (up to 3 of the same type) except for home theaters. Anynet+ (HDMI-CEC) can control only one home theater system.
-  To listen to 5.1-channel audio from an external device, connect the device to the TV via an HDMI cable and connect a 5.1 home theater system directly to the external device's digital audio output connector.
-  If an external device has been set up for both Anynet+ and a universal remote control, the device can be controlled only with the universal remote control.

Controlling the TV with a Keyboard



Connecting a keyboard makes it easier to control the TV.

Connecting a USB keyboard





Plug the keyboard cable into the USB port.

Connecting a Bluetooth keyboard

 >  **Settings** > **General** > **External Device Manager** > **Keyboard Manager** > **Add Bluetooth Keyboard**

-  This function is not available on certain models in specific geographical areas.
-  If your device was not detected, position the keyboard close to the TV, and then select **Refresh**. The TV scans for available devices again.

Using the keyboard

Keyboard	Remote control functions
Directional keys	Moves the focus
Windows key	Displays the TV settings
Enter key	Selects or runs a focused item
ESC key	Returns to the previous screen
F1 / F2 / F3 / F4 key	Color buttons —  /  /  / 
F5 key	Launches the Home Screen
F6 key	Displays the source screen
F7 key	Launches the Channel List
F8 key	Mutes the sound
F9 / F10 key	Adjusts the volume
F11 / F12 key	Changes the channel

Setting up the keyboard

In  >  Settings > General > External Device Manager > Keyboard Manager, you can set the following functions.

- Keyboard Language
- Keyboard Type

Entering Text using the On-Screen QWERTY Keyboard

Use the QWERTY keyboard to enter text on your TV.

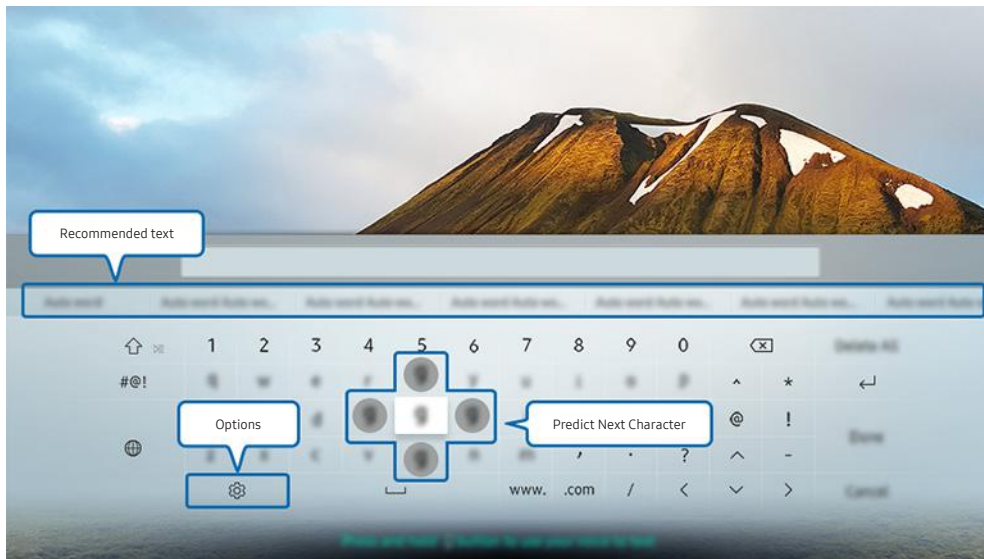

 The image on your TV may differ from the image above depending on your model and geographical area.

Using additional functions

Select  on the QWERTY keyboard screen. The following options are available:

 The options available may differ depending on the function running currently.

- [Recommended text](#)
- [Reset Recommended Text Memory](#)
- [Predict Next Character \(when using direction buttons\)](#)
- [Language](#)

Entering Text using the remote control's microphone and the on-screen QWERTY keyboard

When the QWERTY keyboard is on the screen, press and hold the button  on the Samsung Smart Remote, speak into the microphone on the Samsung Smart Remote, and then release the button. What you say appears on the screen as text.

 This function is not available on certain models in specific geographical areas.











Smart Features

You can enjoy various apps with Smart Hub.

Smart Hub

View descriptions of Smart Hub's basic functions.

After pressing the  button on your remote control, you can surf the web and download apps with Smart Hub.

-  Some of the **Smart Hub** services are paid services.
-  To use **Smart Hub**, the TV must be connected to the Internet.
-  Some **Smart Hub** features may not be available depending on the service provider, language, or region.
-  **Smart Hub** service outages can be caused by disruptions in your Internet service.
-  You can view the entire text of the **Terms & Policy** document by navigating to  >  **Settings** > **Support** > **Terms & Policy**. If you want to stop using **Smart Hub**, you can cancel the agreement. [Try Now](#)
-  To cancel the Smart Hub service agreement though it is a required one, select **Reset** ( >  **Settings** > **General** > **Support** > **Self Diagnosis** > **Reset**) and then press the right directional button at the **Smart Hub Terms & Conditions, Privacy Policy** step.

Displaying the Home Screen

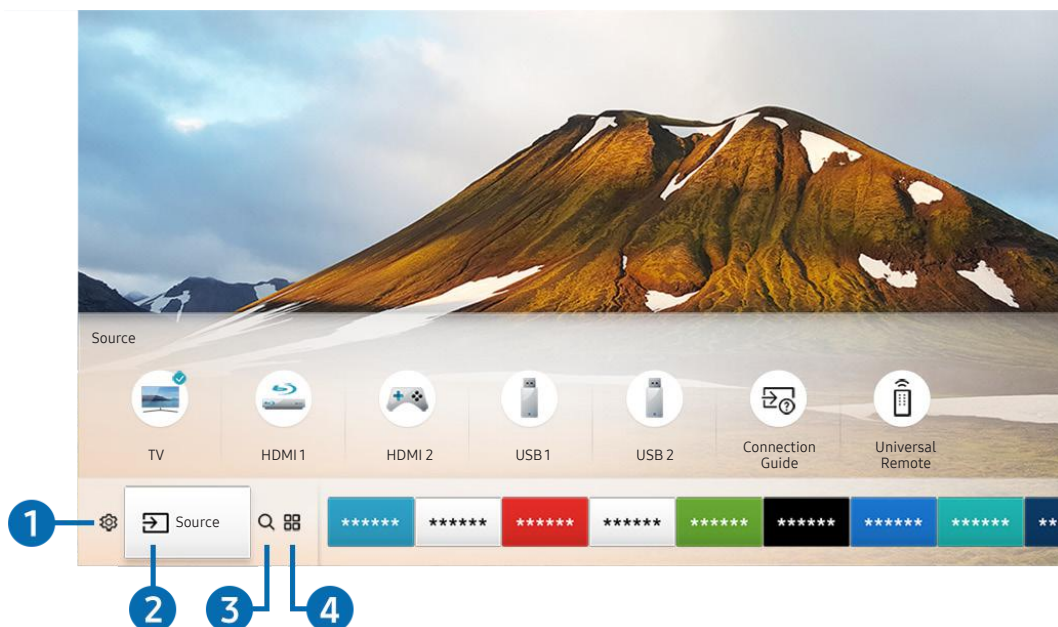

Press the  button.



-  The image on your TV may differ from the image above depending on your model and geographical area.

On the Home Screen, you can easily run the apps you have used previously or frequently. The apps can also be moved or deleted from the screen.

1 Settings

When the focus is moved to the  icon, a list of quick settings icons appears above the top of the menu. You can quickly set frequently used functions by clicking the icons. Pressing  **Settings** displays all setting menus available.

- **Picture Mode**
You can select the picture mode that provides the best viewing experience.
- **Sound Mode**
You can select a sound mode to optimize your listening experience.
- **Sound Output**
You can select which speakers the TV uses for audio output.
- **Caption**
You can watch TV broadcasts with captions.
 This function is not available on certain models in specific geographical areas.
- **Sleep Timer**
You can automatically shut off the TV after a pre-set period of time.
- **Network**
You can view the current network and Internet status.

2 Source

You can select an external device connected to the TV.

-  For more information about connecting external devices, refer to "[Switching between external devices connected to the TV.](#)"

3 🔍 Search

You can search the apps or games in Smart Hub services.

4 📺 APPS

You can enjoy a wide range of content including news, sports, weather, and games by installing the corresponding apps on your TV.

 To use this feature, the TV must be connected to the Internet.

 For more information, refer to "[Using the APPS Service.](#)"

🖼️ Art

You can use the Art Mode function to edit image content such as artworks or pictures when you are not watching TV or when the TV is turned off, and then display the content in full screen mode.

 This function is supported only in THE FRAME model.

 For more information, refer to the provided user manual.

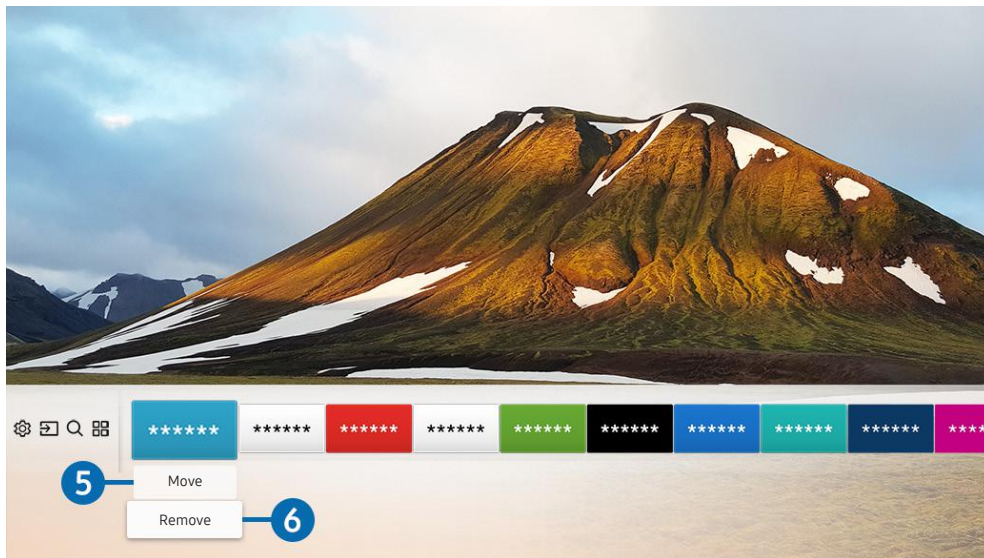

5 📍 Moving an item on the Home Screen

Move the focus to the app you want to move, press the down directional button on the remote control, and then select **Move**. Move the app to the desired position by pressing the left or right directional button, and then press the Select button. The selected app is moved on the Home screen.

6 🗑️ Removing an item on the Home Screen

Move the focus to the app you want to delete, press the down directional button on the remote control, and then select **Remove**. The selected app is deleted.

Launching Smart Hub automatically

 >  [Settings](#) > [General](#) > [Smart Features](#) > [Autorun Smart Hub](#)

When you set [Autorun Smart Hub](#) to **On**, the TV displays the Home Screen automatically when you turn the TV on.

Launching the last used app automatically

 >  [Settings](#) > [General](#) > [Smart Features](#) > [Autorun Last App](#)

If [Autorun Last App](#) is set to **On**, the last used app is automatically run when you turn on the TV.

Testing Smart Hub connections

 >  [Settings](#) > [Support](#) > [Self Diagnosis](#) > [Start Smart Hub Connection Test](#)

Resetting Smart Hub

 >  [Settings](#) > [Support](#) > [Self Diagnosis](#) > [Reset Smart Hub](#)

Using a Samsung account

Create and manage your own Samsung account.



 >  [Settings](#) > [General](#) > [System Manager](#) > [Samsung Account](#)

Creating and managing your Samsung account



 You can view the entire text of the Terms & Policy in  >  [Settings](#) > [General](#) > [System Manager](#) > [Samsung Account](#) > [My Account](#) > [Samsung Account Privacy Policy](#) after logging in to your Samsung account.

 You can also create a Samsung account at <http://account.samsung.com>. Once you have an account, you can use the same ID on both the TV and the Samsung website.



Creating a new account

 >  [Settings](#) > [General](#) > [System Manager](#) > [Samsung Account](#) > [\(Add Account\)](#) > [Create Account](#)



To create a new Samsung account, follow the instructions on the screen.

-  For more information about the terms, select [View Details](#).
-  To protect personal information, select [Profile image selection and password entry \(High security\)](#) in the field below the password entry bar.
-  If you want the TV to log you into your account automatically whenever you turn on the TV, click [Sign me in automatically](#).

Creating a Samsung account using a Facebook account

 >  [Settings](#) > [General](#) > [System Manager](#) > [Samsung Account](#) > [\(Add Account\)](#) > [Create with Facebook](#)

Creating a Samsung account using a PayPal account

 >  [Settings](#) > [General](#) > [System Manager](#) > [Samsung Account](#) > [\(Add Account\)](#) > [Create with PayPal](#)

Signing in to a Samsung account



 >  [Settings](#) > [General](#) > [System Manager](#) > [Samsung Account](#) > [Sign In](#)

Changing and adding information to a Samsung account

 >  [Settings](#) > [General](#) > [System Manager](#) > [Samsung Account](#) > [My Account](#) > [Edit profile](#)

-  To change the account information, you must be logged in to your Samsung account.

Managing payment information saved on the TV

 >  [Settings](#) > [General](#) > [System Manager](#) > [Samsung Account](#) > [My Account](#) > [Payment Info](#)



-  To manage the payment information, you must be logged in to your Samsung account.

Configure the sync internet settings

 >  [Settings](#) > [General](#) > [System Manager](#) > [Samsung Account](#) > [My Account](#) > [Sync Internet](#)



 To configure the sync internet settings, you must be logged in to your Samsung account.

Deleting a Samsung account from the TV

 >  [Settings](#) > [General](#) > [System Manager](#) > [Samsung Account](#) > [My Account](#) > [Remove Account](#)

 To remove account information, you must be logged in to your Samsung account.

Signing out of your Samsung account

To sign out of your Samsung account, move the focus to your account at  >  [Settings](#) > [General](#) > [System Manager](#) > [Samsung Account](#), and then press the Select button. When the pop-up message appears, select **Yes**.

Viewing the user agreement and privacy policy

 >  [Settings](#) > [General](#) > [System Manager](#) > [Samsung Account](#) > [My Account](#) > [Samsung Account Privacy Policy](#)



 To view the user agreement and privacy policy, you must be logged in to your Samsung account.

Using the APPS Service

Download and run various apps from Smart Hub.

> APPS

You can enjoy a wide range of content including news, sports, weather, and games by installing the corresponding apps on your TV.

-  To use this feature, the TV must be connected to the Internet.
-  When Smart Hub is launched for the first time, the default apps are automatically installed. The default apps may differ with the geographical area.

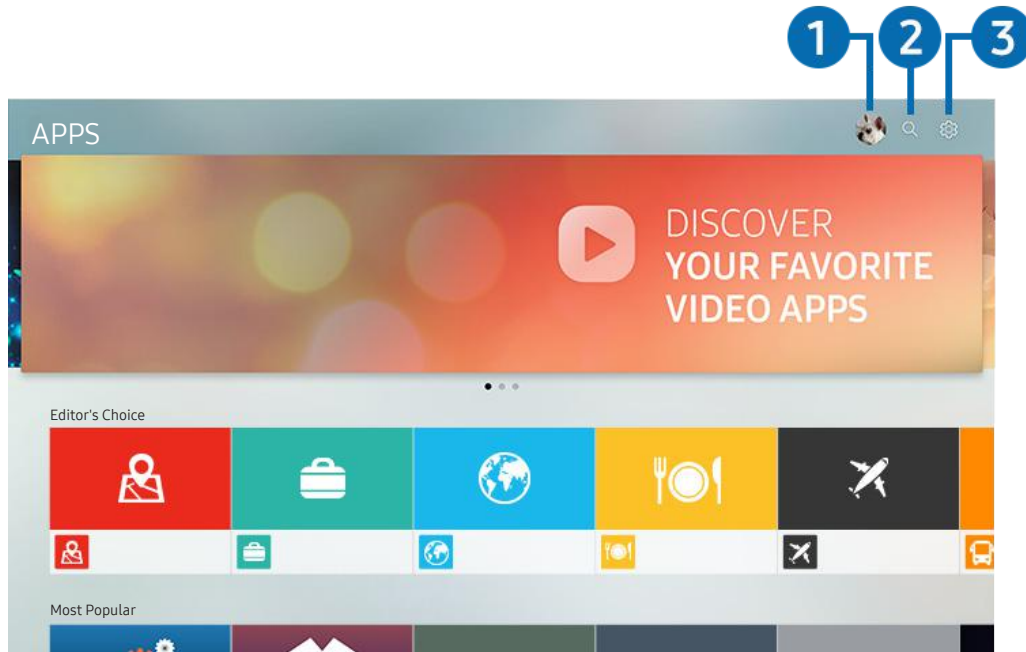

-  The image on your TV may differ from the image above depending on your model and geographical area.

Sign In

Selecting **Sign In** displays the **Samsung Account** screen on which you can create a Samsung account or log in to the system.

2 🔍 App Search

You can search for available apps.

3 ⚙️ Settings

You can manage the installed apps.

Installing and running an app

Installing an app

1. Move to the app you want to install, and then press the Select button. The detailed information screen appears.
2. Select **Install**. When the installation is complete, you can run the app immediately.

 You can view installed apps on the [Settings](#) screen.

 When the TV's internal memory is insufficient, you can install an app on a USB device.





 You can run an app installed on a USB device only when the USB device is connected to the TV. If the USB device is disconnected while an app is running, the app is terminated.

 You cannot run an app installed on a USB device on a PC or another TV.

Launching an app

You can run the app desired from [Downloaded App](#).

The icons below appear within the selected app's icon and indicate the following:

-  : The app is installed on a USB device.
-  : The app has a password.
-  : The app is installed.
-  : The app needs to be updated.
-  : The app supports Smart View.

Managing purchased or installed apps

Select  **Settings** on **APPS**. You can manage installed apps.

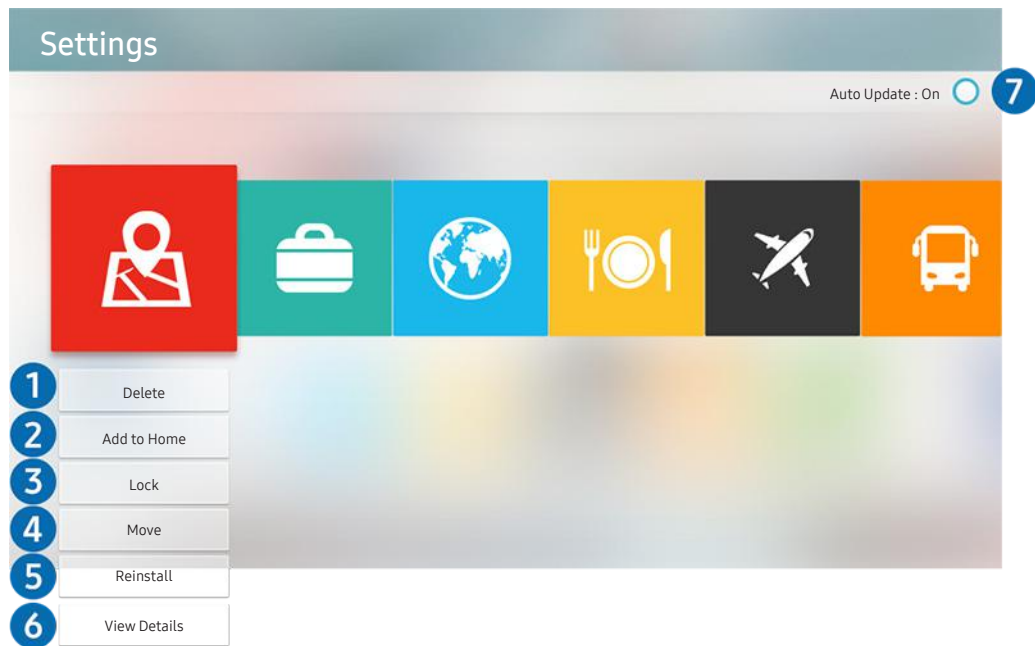

 The image on your TV may differ from the image above depending on your model and geographical area.

1 Removing an app

1. Select an app to delete.
2. Select **Delete**. The selected app is deleted.



 Ensure that the related app data is also removed when you remove an app.

2 Adding apps to the Home Screen

1. Select an app to add.
2. Select **Add to Home**.
3. After the Home screen appears, move the selected app to the desired location.
4. Press the Select button. The selected app is added to the Home Screen.

3 Locking and unlocking apps

1. Select an app to lock or unlock.
2. Select **Lock/Unlock**. The selected app is locked or unlocked.

 To lock or unlock an app, enter the PIN. The default PIN is "0000." You can set the PIN in  >  **Settings** > **General** > **System Manager** > **Change PIN**.

4 Moving apps

1. Select an app to move.
2. Select **Move**.
3. Move the app to the desired location.
4. Press the Select button.

 This function is not available on certain models in specific geographical areas.

5 Reinstalling an app

1. Select the app to install again.
2. Select **Reinstall**. Reinstallation starts.

6 Checking the app information details

1. Select the app to check.
2. Select **View Details**.
3. The app information screen appears.

7 Automatically updating apps

Installed apps can be automatically updated. If you do not want apps automatically updated, set **Auto Update** to **Off**.

 Automatic update is enabled only when the TV is connected to the Internet.

Rating apps

You can rate an app on the detailed information screen using the left or right directional button on the remote.

Using the e-Manual

Control and read the manual embedded in your TV.

Launching the e-Manual





 >  **Settings** > **Support** > **Open e-Manual**

You can view the embedded e-Manual that contains information about your TV's key features.

 Alternatively, you can download a copy of the e-Manual from Samsung's website.

 Words in blue (e.g., **Picture Mode**) indicate a menu item.

Using the buttons in the e-Manual



-  (**Search**)
- **A-Z** (**Index**)
-  (**Recently Viewed Topics**)
-  (**Try Now**): Allows you to access the corresponding menu item and try out the feature right away.
-  (**Link**): Allows you to access the corresponding reference page.

 Some menu screens cannot be accessed from the e-Manual.

Using the Internet

Surf the Internet on your TV.

 > **Internet**

 When you select  > **Internet**, you can see recently viewed web sites or featured recommendations. When you select a desired web site, you can get immediate access to it.

 You can use the **Internet** more easily after connecting a keyboard and mouse.

 You can scroll web pages with the Directional pad.

 The web pages may differ from those on a PC.

 For more information about the **Internet**, refer to "Read Before Using the Internet."

Playing pictures/video/music

Play media content stored on your TV, USB devices, smartphones, cameras, PCs, etc.



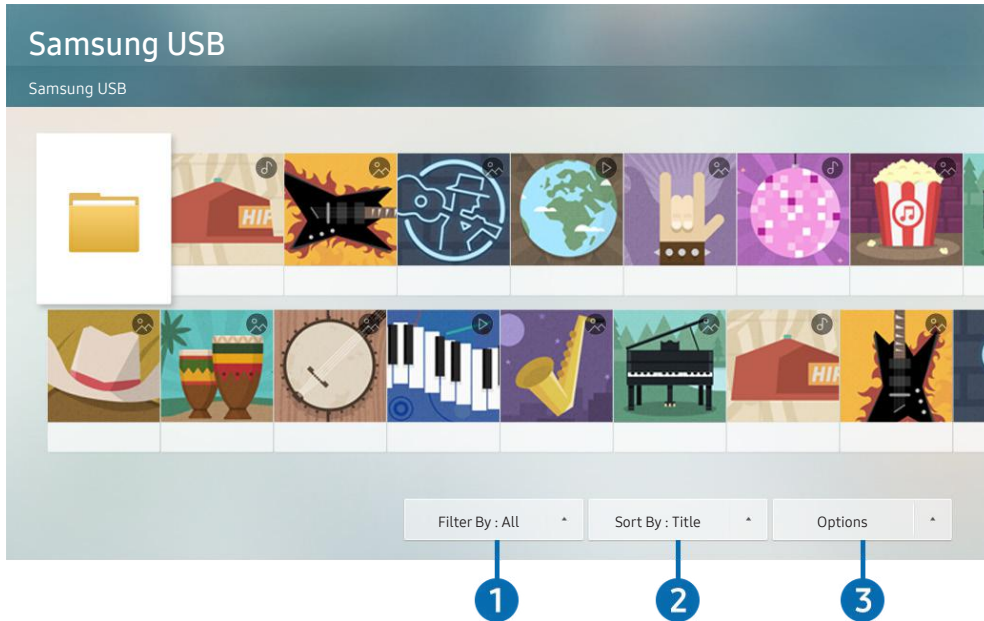

Home > Source > Connected Device



 The image on your TV may differ from the image above depending on your model and geographical area.

You can play media content saved on storage devices, such as USB devices, mobile devices, and cameras, on the TV.

Try Now

-  You cannot play media content if the content or the storage device is not supported by the TV. For more information, refer to "[Read Before Playing Photo, Video, or Music Files.](#)"
-  To connect the TV to a computer, refer to "[Connecting a Computer.](#)"
-  Backup important files before connecting a USB device. Samsung is not responsible for damaged or lost files.
-  To connect the TV to a mobile device, refer to "[Connecting a Mobile Device.](#)"

You can use the following functions on the media content list screen of a storage device.

1 Filter By

Filters the media content by type of media. (music, photo, video, recorded contents, etc.)

2 Sort By

Sorts the content list by title, date, or channel.

3 Options

Deletes or plays the selected media content in the media content list. When you select **Refresh**, the content list is reloaded.

 You can delete only the recorded content. To delete content, change the **Filter By** option to **Recorded**.

Playing media content

Playing multimedia content on PC or mobile device

1. Select a device with media content in  >  **Source**. The media content list in the device appears.

2. Select a media content item from the list. The content is played.

 For more information about buttons, refer to "Buttons and functions available while playing multimedia content."

 The content may not be played depending on the encoding method or file format. Furthermore, several functions may be restricted.

 Content on devices connected to the TV via your network may not play smoothly due to the network communication problems. If this occurs, use a USB device.

 For more information about connection to PC, refer to "Connecting a Computer."

 For more information about connection to mobile device, refer to "Connecting a Mobile Device."

Playing multimedia content on USB device

1. Connect a USB device to the USB port. A pop-up message appears that lets you move easily to the multimedia content list on the device.

2. Select a content item to play from the list. The content is played back.

Using the Music Service

This service is a music service app that recommends songs.

 > Music

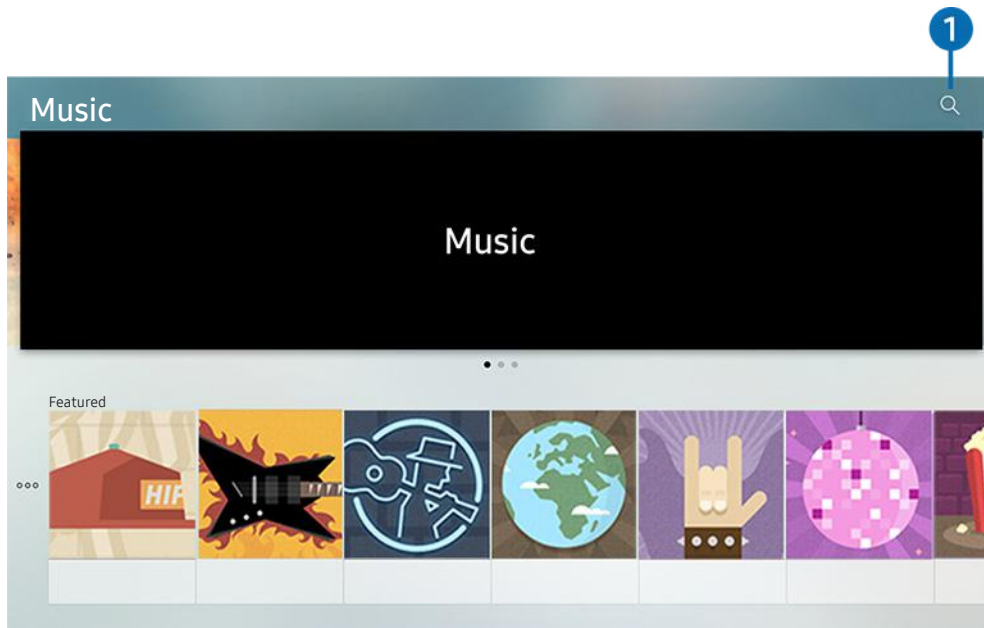

 The image on your TV may differ from the image above depending on your model and geographical area.

This service is a music service app that works with other music apps to recommend songs. You can search for and hear songs that you want. If you select a song, an associated app is run to play the song.

 This function may not be supported depending on the geographical region.

Search

You can search for music that you want.

Using the Sports Service

This service displays information about your favorite sports teams.

 > Sports

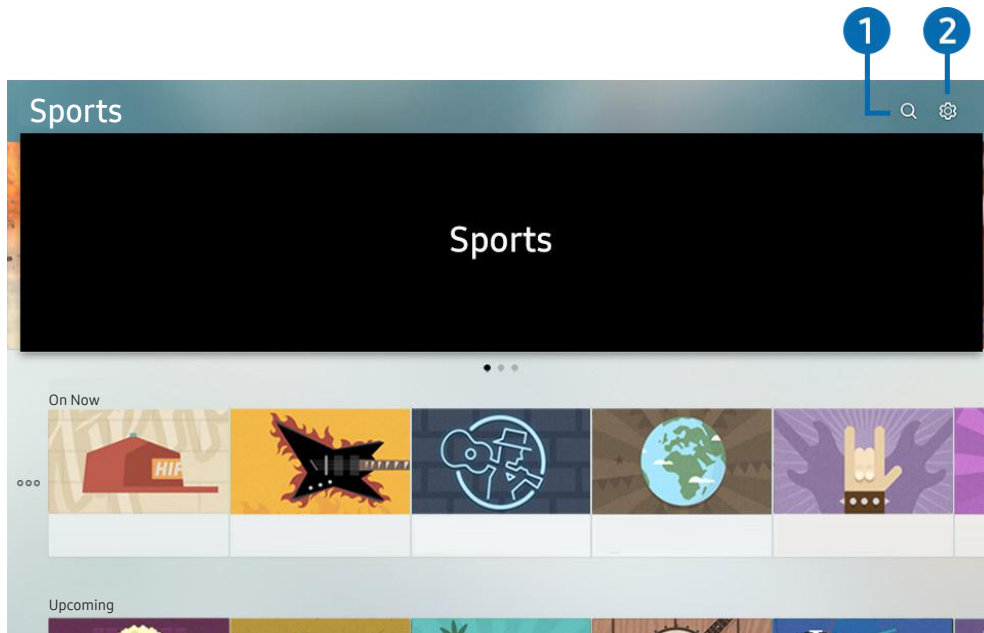

 The image on your TV may differ from the image above depending on your model and geographical area.

This service displays the match or game schedules of your favorite sports teams and the results.

 This function may not be supported depending on the geographical region.

1 Search

You can search your favorite sports teams.

2 Settings

You can set your favorite sports teams and events. You can also activate the notification service that shows the match schedules and results of the selected teams.

Using the TV PLUS Service



View movies, dramas, and TV shows.

> TV PLUS

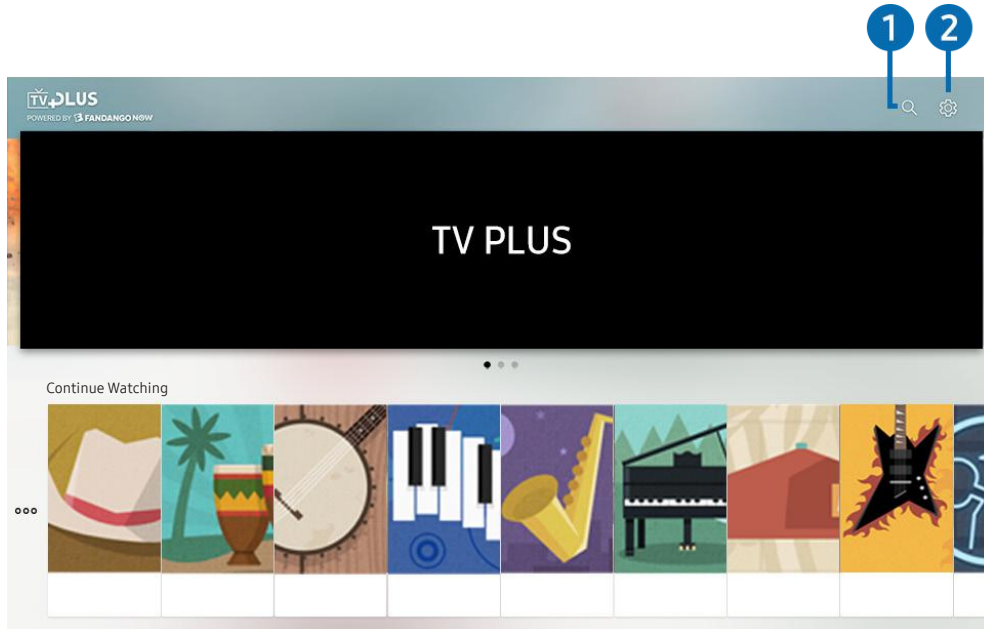
You can use the **TV PLUS** app to view movies, dramas, and TV shows.



1 2

-  The image on your TV may differ from the image above depending on your model and geographical area.
-  To use this feature, the TV must be connected to the Internet.

1 Search

You can search for movies, dramas, and TV shows you want to view.

2 Settings

You can check your account, payments, and purchases.



- **Account and Payment**
You can check your Samsung account and your payments for paid content.
- **Link UltraViolet™**
To purchase content with the **TV PLUS** app, you must have an UltraViolet™ account. If you already have an account, enter your account information to continue to use the service. If not, follow the instructions on the screen to create an account.
- **Transaction History**
You can check the content that you purchased with the **TV PLUS** app.



Using Voice Interaction

Speak into the microphone on your Samsung Smart Remote to control your TV.

 Availability depends on the specific model.

Running Voice Interaction

Press and hold the  button on your Samsung Smart Remote, say a command, and then release the  button. The TV recognizes the voice command.

 When you press the  button once, the Help Guide is displayed. Use the Voice Interaction function as instructed in the Guide.

 During voice analysis, the system cannot receive voice commands.



- If you say an accessibility-related command such as caption or voice guide, the command is applied directly and you will show an notification that the function is operating.
- When playing back media content, you can execute commands such as "Play," "Pause," "Stop," "Rewind," and "Fast Forward."

 The function does not operate for all apps.

- You can set the timer with the command "Sleep reservation in 30 minutes."
- To change the source, say "HDMI," "TV," or "USB."
- To change the picture mode, say "Movie Picture Mode" or "Set Picture Mode to Standard."
- To search, say "Search ****" or "Search **** in YouTube."
- To view Help, say "Help," "What can I say" or "User guide."

 The supported language may differ by geographical region.

 When you press the  button once, the Help Guide is displayed. Use the Voice Interaction function as instructed in the Guide.

Read Before Using Voice Interaction

Precautions for voice interaction

- To use Voice Interaction, you must have a Samsung account. For more information, refer to "[Using a Samsung account](#)."
- The supported voice interaction languages and features may differ by geographical region.
- If the language set differs from the language of your country, some features are not available.
- The function is available only when the TV is connected to the Internet.
- Voice interaction is available only on TVs that support it and come with remote controls that have a microphone.
- Symbols including "-" and special characters are not supported. Consequently, if a word or sentence contains numeric values or symbols, the function may not operate properly.

- Searched results may not provide complete results.
- You may be required to pay for some apps. Consequently, you may encounter a service application or contract.
- To change the current channel by saying channel names as voice commands, you must finish [Set Up Your Service Provider](#). (🏠) > ⚙️ [Settings](#) > [General](#) > [Start Setup](#))
- To use the voice text input function and Smart search function, you must consent to provisions allowing third parties to collect and use your voice data.
- To use the interactive voice interaction function, you must
 - Agree to Smart Hub's Terms of Use
 - Agree to a guidance regarding the collection and use of personal information for the Smart Hub service.
 - Consent to the collection and use of personal information for the voice interaction-based service.

Requirements for using voice interaction

- The voice interaction rate differs with the volume/tone, pronunciation, and ambient sound environment (TV sound and ambient noise).
- The optimal volume for voice commands is between 75 dB and 80 dB.

TV Viewing

You can use convenient features while watching TV. Additionally, you can edit the channel list or create favorite channel lists.

Viewing Broadcast Information at a Glance

See an overview of each channel's program lineup.

Using the guide

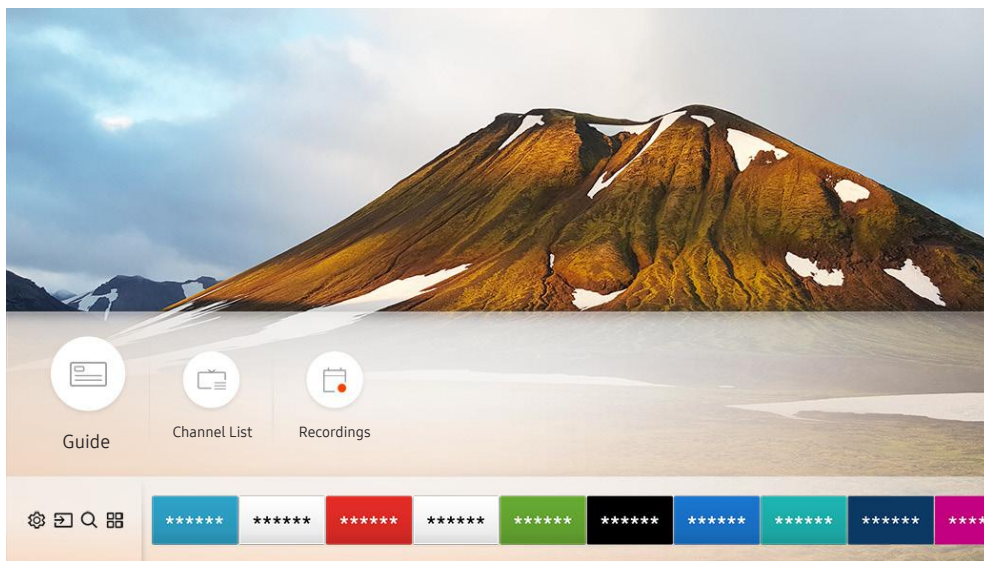

 > [Live TV](#) > [Guide](#) Try Now



 The image on your TV may differ from the image above depending on your model and geographical area.

In the [Guide](#), you can see the daily program schedules for each broadcaster, see program information, choose a program to watch, and set up a schedule viewing or recording.

In the [Guide](#), you can see only the TV programs scheduled after the current time.

-  The [Guide](#) also appears when you press the **CH** button while watching TV.
-  To see information about analog channels and use the analog channel functions of the [Guide](#), you must finish the service provider settings in initial setup.
-  To view the [Guide](#), you must first set the TV's clock ([Home](#) > [Settings](#) > [General](#) > [System Manager](#) > [Time](#) > [Clock](#)).

To start Scheduled viewing, Scheduled recording, and other function for a program listed in the Guide, first move the cursor to it and then operate the remote control as follows:

- For a program currently being broadcast: Press and hold the Select button.
- For a program scheduled to be broadcast: Press the Select button.
- To move to the [Channel Filter](#) or [Schedule Manager](#) screen: Press the  button.

- **Record:** You can make a recording of a current program.

 This function is not available in the U.S.A. and Canada.

- **Timeshift:** The current broadcasting program you are viewing is automatically saved on a USB device so that you can play, pause, rewind, fast forward, slow rewind, slow forward, and even perform slow motion on the program like a DVD title.

- **Schedule Viewing:** You can schedule viewing of a broadcast scheduled program.

 For more information about watching or [Schedule Viewing](#), refer to "[Setting Up a Schedule Viewing.](#)"

- **Schedule Recording:** You can schedule recording of a broadcast scheduled program.

 This function is not available in the U.S.A. and Canada.

 For more information about recording or [Schedule Recording](#), refer to "[Recording Programs.](#)"







- **Edit Recording Time:** You can change the start and end times of scheduled program recordings.

 This function is not available in the U.S.A. and Canada.

- **Stop:** You can stop the recording or Timeshift function that is currently running.
- **Cancel Scheduled Viewing / Cancel Scheduled Recording:** You can cancel scheduled viewings or recordings.
- **View Details:** You can see detailed information about the selected program. The information may differ with the broadcast signal. If information is not provided with the program, nothing appears.
- **Channel Filter:** You can select a channel filter from a filter list to see a list of channels filtered accordingly.
- **Schedule Manager:** You can see the [Recording & Schedule Manager](#) screen.

Recording Programs

Record a current or upcoming program using a USB device instead of a video recorder.

-  This function is not available in the U.S.A. and Canada.
-  Read all precautions before using the recording feature. Refer to "[Before Using the Recording and Timeshift Functions](#)" for more information.
-  You can record only the programs that have been received through an antenna.
-  The  appears next to the programs and channels scheduled for recording.
-  If you go to  > [Live TV](#) while no USB device is connected, the [Schedule Manager](#) screen appears in place of the [Recordings](#) screen.

Recording programs

Using the instant and schedule recording options from the guide screen

- **Instant Recording**
Select a live program from the [Guide](#), press and hold the Select button, and then select [Record](#) from the pop-up menu to start recording immediately.
- **Schedule Recording**
Select a program scheduled to be broadcast, press the Select button, and then select [Schedule Recording](#) to set up a schedule recording of the scheduled program.

Using the instant and schedule recording options while watching a program

- **Instant Recording**
If you select [Record](#) after pressing the  button while watching a broadcast, recording starts.
- **Schedule Recording**
Press the Select button while watching a program to display the program info window. Use the left or right directional button to select a scheduled program. Press the Select button, and then select [Schedule Recording](#) to set up a schedule recording of the scheduled program.

Scheduling a video recording after entering the date and time

 > [Live TV](#) > [Recordings](#) > [Schedules](#) > [Add Recording](#)

To schedule a recording, set the values for [Antenna](#), [Channel](#), [Repeat](#), [Date](#), [Start Time](#), and [End Time](#) of the broadcast program to record, and then select [Save](#).

 Check the current time in  >  [Settings](#) > [General](#) > [System Manager](#) > [Time](#) > [Clock](#).

Managing the schedule recording list

 > [Live TV](#) > [Recordings](#) > [Schedules](#)

You can change scheduled recording information or cancel scheduled recordings.

 You can schedule up to 30 recordings or viewings at once using [Schedule Recording](#) and [Schedule Viewing](#).

Setting the Schedule Recording Time

 > [Live TV](#) > [Recordings](#) > [Schedules](#) > [Edit](#)

You can set the start and end times for a schedule recording. You can set the start time up to 10 minutes before the program starts and the end time up to 10 minutes after the program ends.

Canceling a schedule recording

 > [Live TV](#) > [Recordings](#) > [Schedules](#) > [Delete](#)

Checking scheduled recordings

 > [Live TV](#) > [Recordings](#) > [Schedules](#) > [View Details](#)

Viewing recorded programs



 > [Live TV](#) > [Recordings](#) > [Recordings](#)

Select a file containing a recording from the list. The file is played back.

 Buttons that appear may differ depending on the file being played. For more information about control buttons, refer to "[Buttons and functions available while recording a program or Timeshift.](#)"

Setting Up a Schedule Viewing

Configure the TV to show a specific channel or program at a specific time and date.

 The  appears next to programs that have been configured for a schedule viewing.

 To set up a schedule viewing, you must first set the TV's clock ( >  [Settings](#) > [General](#) > [System Manager](#) > [Time](#) > [Clock](#)).

Setting up a schedule viewing for a channel

Using the schedule viewing options from the guide screen

On the [Guide](#) screen, select a program you would like to view, press and hold the Select button, and then select [Schedule Viewing](#) in the pop-up menu that appears.

Using the schedule viewing options in the program info window

Press the Select button while watching TV. The Program Info window appears. Select a program that will be broadcast using the left or right directional buttons. Press and hold the Select button, and then select [Schedule Viewing](#) to schedule viewing of that program.

Using schedule viewing to view programs at a specified time on a specified date

(U.S.A and Canada)  > [Live TV](#) > [Schedule Manager](#) > [Add Viewing](#)

(Other countries)  > [Live TV](#) > [Recordings](#) > [Schedules](#) > [Add Viewing](#)

To schedule a viewing, set the values for [Antenna](#), [Channel](#), [Repeat](#), [Date](#) and [Start Time](#) of the broadcast program to view, and then select [Save](#).

 Check the current time in  >  [Settings](#) > [General](#) > [System Manager](#) > [Time](#) > [Clock](#).

Editing a schedule viewing

(U.S.A and Canada)  > [Live TV](#) > [Schedule Manager](#)

(Other countries)  > [Live TV](#) > [Recordings](#) > [Schedules](#)

 You can set up a maximum total of 30 [Schedule Viewing](#) and [Schedule Recording](#) entries.

Setting the Schedule Viewing Time

(U.S.A and Canada)  > [Live TV](#) > [Schedule Manager](#) > [Edit](#)

(Other countries)  > [Live TV](#) > [Recordings](#) > [Schedules](#) > [Edit](#)

You can set the start time of a schedule viewing. The start time can be set up to 10 minutes before the program starts.

Canceling a schedule viewing

(U.S.A and Canada)  > [Live TV](#) > [Schedule Manager](#) > [Delete](#)

(Other countries)  > [Live TV](#) > [Recordings](#) > [Schedules](#) > [Delete](#)

Checking scheduled viewings

(U.S.A and Canada)  > [Live TV](#) > [Schedule Manager](#) > [View Details](#)

(Other countries)  > [Live TV](#) > [Recordings](#) > [Schedules](#) > [View Details](#)

Using Timeshift

Play, pause, or rewind live TV.

You can pause and rewind live TV by using [Timeshift](#). Activating this function disables the [Broadcasting](#) function. 





To activate the [Timeshift](#) function while watching TV, press the  button and then select [Timeshift](#), or press the  button.



 This function is not available in the U.S.A. and Canada.

 When the [Timeshift](#) function is running, some functions are not available in  >  [Settings](#) > [Broadcasting](#).

 To use Timeshift, you must connect a USB device for recording.

-  Read all precautions before using the Timeshift function. For more information, refer to "[Before Using the Recording and Timeshift Functions.](#)"
-  For more information about control buttons, refer to "[Buttons and functions available while recording a program or Timeshift.](#)"

Buttons and functions available while recording a program or Timeshift

-  This function is not available in the U.S.A. and Canada.
-  The available buttons and functions may differ with the functions.

If you press the down directional button, the following buttons appear.

- **Edit Recording Time**

You can set for what period of time the program will be recorded.

 This function is only available when a program is being recorded.

- **Record**

You switch from the Timeshift function to the recording function. When switching to the recording function, you can include the content recorded by the Timeshift function in the new recording.

 This function is only available when the Timeshift function is running.

- **Go to Live TV**

Select to return to the current scenes of the program when the recording or Timeshift function is playing its past scenes.

- **Stop Recording / Stop Timeshift**



Ends the recording or Timeshift function.

- **Info**

Displays the program info window for the program on which the recording or Timeshift function is working.

- **Pause / Play**

You can use the following functions when the video is paused. (Note that with the video paused, the TV does not play audio.)

- **Slow Rewind** or **Slow Forward**: Allows you to play the video slowly (1/8, 1/4, 1/2) backward or forward by selecting the  or  button. To increase the rewind or forward speed in slow mode up to 3 times, select the button repeatedly. To return to normal speed, select the  button.

 When the **Slow Rewind** function is activated, you can view the difference between the current recording time and the current rewind time.

- **Jump Backward / Jump Forward**: Allows you to move backward or forward by 10 seconds in the video by selecting the left or right directional button in the playback control bar.

 When the Jump Backward function is activated, you can view the difference between the current recording time and the current rewind time.

- **Rewind / Fast Forward**

 This function is not available while you are watching a program that is currently being broadcast.



Using the Channel List

Change the channel or check programs on other digital channels.

> [Live TV](#) > [Channel List](#)

Using the [Channel List](#), you can change the channel or check programs on other digital channels while watching TV.

The [Channel List](#) screen contains the following icons:

-  : A favorite channel
-  : A locked channel.

If you press the right directional button when viewing the [Channel List](#) screen, you can use the following functions:

- **All Channels**

Displays the channels that the TV found during the Auto Program channel search.

- **Favorites**

Displays favorites lists 1 to 5.

- **Air** or **Cable**



Allows you to select **Air** or **Cable** as the DTV mode. **Air** is suitable for homes equipped with separate, over-the-air antennas. **Cable** is suitable for homes that subscribe to a local cable-service. You do not need to use this function if your TV is connected to a cable or satellite box.

Editing channels

Edit the channels stored on your TV.

 > [Live TV](#) > [Channel List](#) > [All Channels](#) > [Edit Channels](#)

The [Edit Channels](#) screen contains the following icons:

-  : A favorite channel
-  : A locked channel.

Re-registering and deleting a channel

Removing registered channels

To remove a channel, select it, and then select [Delete](#).

Adding back removed channels

You can add back removed channels from the [Edit Channel](#) list only. Removed channels are displayed in gray in the [All Channels](#) list. To display the [Edit Channel](#) list, select [Live TV](#) > [Channel List](#) > [All Channels](#) > [Edit Channels](#). Then, to add back a removed channel, select it, and then select [Restore](#).

Editing registered channels

You can access the following options by selecting [All Channels](#) > [Edit Channels](#):

Changing a channel name

After selecting a channel to change in [Edit Channels](#), select [Rename Channel](#) to change the channel name.



 This function is only available for selected channels.



 This function is available for analog channels only.

Using Program Rating Lock

 >  [Settings](#) > [Broadcasting](#) > [Program Rating Lock Settings](#) Try Now

This function is useful for controlling what children watch on TV. [Program Rating Lock Settings](#) does not, however, block programs originating from external sources, such as Blu-ray players, DVD players, or USB files.

Every time you access [Program Rating Lock Settings](#), you must enter the security PIN. You must also enter this PIN to watch a blocked program. The default PIN is 0000. To change the PIN, go to  >  [Settings](#) > [General](#) > [System Manager](#) > [Change PIN](#).

-  [Program Rating Lock Settings](#) may not be supported depending on your input signal.
-  For more information about how to set your password, refer to "[Setting up a password](#)."
-  For more information about the rating system of different countries, refer to "[Blocking programs based on their TV Rating](#)."

Watching blocked / restricted programs

To watch a blocked program, enter the PIN when requested.

When initially showing a restricted program or movie, the screen is blank because the [Program Rating Lock Settings](#) blocks it. Enter the PIN to unblock the program when a message appears requesting the code.

Creating a Personal Favorites List

Designate frequently watched channels as favorite channels.

Favorite channels are highlighted in the [Edit Channels](#) and [All Channels](#) screens with the  symbol.

Registering channels as favorites

 > [Live TV](#) > [Channel List](#)

1. Press the right directional button on your remote control.
2. Select [Favorites](#).
3. Select one of the five favorites lists.
4. Move to [Edit Favorites](#).
5. Select a channel to add to the favorites list.
6. Select . The selected channel is registered in the favorites list.

Viewing and selecting channels on Favorites lists only

 > [Live TV](#) > [Channel List](#)

1. Press the right directional button on your remote control.
2. Select [Favorites](#).
3. Select the desired list among the five favorites lists on the screen. The channels in the selected favorites list appear.

 Only favorites lists that contain registered channels will display channels.

Editing a Favorites List

Edit a favorites channel list.

 > [Live TV](#) > [Channel List](#)

After pressing the right directional button on your remote control, select [Favorites](#) > [Favorites 1 - Favorites 5](#) > [Edit Favorites](#). The [Edit Favorites](#) screen appears.

Adding channels to favorites list

Select channels to add and select the  icon. The selected channels are added to favorites list.

Removing channels from a favorites list

Select channels in a favorites list, and then select the  button.

Rearranging a favorites list

Select one or more channels, and then select [Change order](#). The [Change order](#) highlight appears. Press the up/down directional buttons to indicate the new location for the channels. Press the Select button to set the channels into their new location.

Renaming a favorites list

Select the favorites list you want to rename, and then select [Rename Favorites](#). Enter a new name using the on-screen keyboard that appears, and then select [Done](#).

TV-Viewing Support Functions

Use the functions that are available while watching TV.

Changing the broadcast signal

 > [Live TV](#) > [Channel List](#)

After pressing the right directional button on your remote control, select [Antenna](#) to choose [Air](#) or [Cable](#).

 You do not need to use this function if your TV is connected to a cable or satellite box.

Scanning for available channels

 >  [Settings](#) > [Broadcasting](#) > [Auto Program](#)

 Do not use this function if your TV is connected to a cable or satellite box.

 If the TV has saved channels, [Auto Program](#) deletes the existing list, and then saves the newly scanned channels.

Configuring advanced broadcasting audio settings

 >  [Settings](#) > [Broadcasting](#) > [Audio Options](#)

[Audio Options](#) functions differently for analog and digital channels.

 This function is not available on certain models in specific geographical areas.

Selecting a Language

 >  [Settings](#) > [Broadcasting](#) > [Audio Options](#) > [Preferred Language](#)

This is the language you will hear while watching TV if the language is included in the broadcast signal.

Listening to Multi-Track Sound

 >  [Settings](#) > [Broadcasting](#) > [Audio Options](#) > [Multi-Track Sound](#)

Picture and Sound

You can change the settings for the picture and the sound according to your preference.

Adjusting the Picture Quality

Change the Picture Mode and adjust Expert Settings.

Choosing a picture mode

 >  [Settings](#) > [Picture](#) > [Picture Mode](#) 

You can select the [Picture Mode](#) that provides the best viewing experience.

- [Dynamic](#)
Makes the picture brighter and clearer in bright viewing environments.
- [Standard](#)
Is the default mode suitable for general viewing environments.
- [Natural](#)
Reduces eye strain for a comfortable viewing experience.
- [Movie](#)
Is suitable for watching TV or movies in a dark room.

Configuring advanced picture settings

 >  [Settings](#) > [Picture](#) > [Expert Settings](#) 

Configure the screen settings to your taste by using the following functions:

- [Backlight](#)
- [Brightness](#)
- [Contrast](#)
- [Sharpness](#)
- [Color](#)

- [Tint \(G/R\)](#)
- [Apply Picture Settings](#)
- [Digital Clean View](#)
- [Auto Motion Plus Settings](#)

 When [LED Clear Motion](#) is set to **On**, the screen appears darker than when it is **Off**.

- [Local Dimming](#)

 This function is not available on certain models in specific geographical areas.

- [Contrast Enhancer](#)

- [HDR+ Mode](#)

Automatically provide an optimal HDR effect based on the video source.

The HDR (High Dynamic Range) technology implements video images that are very similar to the images seen through human eyes by finely adjusting the contrast of the source.

 This function is only available on certain models in specific geographical areas.

- [Film Mode](#)

 This function is only available when the input signal is TV, AV, Component (480i, 1080i), or HDMI (1080i).

- [Color Tone](#)

 [Cool](#) and [Standard](#) are only available when [Picture Mode](#) is set to **Dynamic**.

 [Color Tone](#) is only available when the TV is connected to a computer via an HDMI-to-DVI cable.

- [White Balance](#)

- [Gamma](#)

- [RGB Only Mode](#)

- [Color Space Settings](#)

- [Reset Picture](#)





Setting the Viewing Environment for External Devices

You can optimize the TV for viewing specific video formats.

Playing games on an optimized screen

 >  **Settings** > **General** > **External Device Manager** > **Game Mode**



You can enable game mode to optimize the TV's settings for playing video games with a gaming console, such as a PlayStation™ or Xbox™.

-  The game mode is not available for normal TV viewing.
-  The screen may shake somewhat.
-  When **Game Mode** is enabled, **Picture Mode** and **Sound Mode** are switched to **Game** automatically.
-  To use a different external device on the same port, remove the game console connection, turn off Game Mode, and then connect the external device to the port.

Viewing UHD videos

 >  **Settings** > **General** > **External Device Manager** > **HDMI UHD Color**

If an external UHD player is connected to the TV, use the HDMI UHD Color function to convert the TV's HDMI connector to a mode optimized for the UHD 50P/60P signals.

-  When you set the HDMI connection to **On**, the TV screen flickers.
-  The HDMI connection with **HDMI UHD Color** set to **Off** supports up to UHD 50P/60P 4:2:0 input signals, while the HDMI connection with **HDMI UHD Color** set to **On** supports up to UHD 50P/60P 4:4:4 and 4:2:2 input signals. For more information, refer to "[Supported Resolutions for UHD Input Signals](#)."
-  When you connect the TV to an external device that supports only the UHD 24 or 30 Hz frequency or any FHD frequency, the **HDMI UHD Color** function may not be available. In this case, set **HDMI UHD Color** to **Off**.

Using HDMI black level



 >  **Settings** > **General** > **External Device Manager** > **HDMI Black Level**

Use HDMI Black Level to adjust the black level to compensate for low black levels, low contrast, or dull colors generated by external devices connected to the TV via an HDMI cable.

-  This function is only available when the input signal, connected to the TV via an HDMI connector, is set to RGB444.

Registering the TV as a DivX-certified device (watching for pay DivX movies)

 >  **Settings** > **General** > **External Device Manager** > **DivX® Video On Demand**

-  Digital Rights Management (DRM) is a technical security mechanism that protects the content provider's copyright.
-  You can watch recorded movies or free DivX movies without registration.
-  Visit the DivX website (<http://www.divx.com>) and log in to your user account before registering the TV as a DivX-certified device. If you do not have an account, create one.

Picture Support Functions

Configure the picture settings for your TV.

Changing the picture size

 >  **Settings** > **Picture** > **Picture Size Settings** > **Picture Size** 

You can change the size of the picture displayed on the TV screen.



- **16:9 Standard**
- **Custom**
- **4:3**

 **Do not watch your TV in 4:3 mode for extended periods of time. This can cause the black bars, which appear at the top, bottom, left, and right sides of the screen in 4:3 mode, to "burn in" and appear as temporary or permanent after images on the screen. If the TV is used for commercial or non-normal consumer use, then damage to the screen caused by screen "burn in" is not covered by your Warranty.**

 Supported picture sizes differ with the input signal. For more information about supported picture sizes, refer to "[Picture sizes and input signals](#)."



Fitting the picture to the screen

 >  **Settings** > **Picture** > **Picture Size Settings** > **Fit to Screen**

-  The availability of this function depends on the **Picture Size**.
-  The availability of this function depends on broadcasting signals.

Adjusting the picture size and/or position

 >  **Settings** > **Picture** > **Picture Size Settings** > **Zoom and Position**

-  This function is available only if **Picture Size** is set to **Custom**.
-  To change the picture position on analog channels, first enlarge the picture and then change the position.

Adjusting the Sound Quality

Change the Sound Mode and adjust Expert Settings.

Choosing a sound mode

 >  [Settings](#) > [Sound](#) > [Sound Mode](#) Try Now

You can select a favorite sound mode suitable for the content type or the listening environment.

- [Standard](#)
- [Optimized](#)
- [Amplify](#)

Configuring advanced sound settings

 >  [Settings](#) > [Sound](#) > [Expert Settings](#) Try Now

You can personalize the sound quality by adjusting the following settings.

- [Balance](#)
- [Equalizer](#)
- [HDMI Input Audio Format](#)
- [Digital Output Audio Format](#)



If you use a receiver that does not support Dolby Digital Plus, you will hear no sound if you select [Dolby Digital+](#).



The [Dolby Digital+](#) option is only available via ARC(HDMI) for external devices that support the format.

- [Audio Delay](#)
- [Sound Feedback](#)
- [Reset Sound](#)

Using the Sound Support Functions

Configure the sound settings for your TV.

Selecting speakers

 >  **Settings** > **Sound** > **Sound Output** [Try Now](#)





You can select which speakers the TV uses for audio output.

-  External speakers may not be controlled with the Samsung Smart Remote. When an external speaker is enabled, some sound menus are not supported.

Listening to the TV through Bluetooth devices

 >  **Settings** > **Sound** > **Sound Output** >  **Speaker List**

You can connect Bluetooth audio devices to the TV. They must be paired using the TV's Bluetooth function. For more information on pairing, refer to the Bluetooth audio device's operating manual.

-  This function is not available on certain models in specific geographical areas.
-  If the TV fails to find a Bluetooth audio device, place the device closer to the TV, and then select [Refresh](#).
-  When you turn on a paired Bluetooth audio device, the TV detects it automatically, and then displays a pop-up window. Use this pop-up window to activate/deactivate the Bluetooth audio device.
-  The sound quality may be affected by the condition of the Bluetooth connection.
-  Before using a Bluetooth audio device, refer to "[Read Before Using Bluetooth Devices](#)."

Listening to the TV through a Multiroom speaker

For more information about connection and usage, refer to the user manual of the multiroom audio device.

 This function is not available on certain models in specific geographical areas.

Using the surround effect function and Multiroom speakers to create a surround sound configuration

 >  **Settings** > **Sound** > **Wi-Fi Speaker Surround Setup** 

If you've connected one or more multiroom speakers to the TV, you can create an optimal sound set up by configuring the surround effect settings. You can select any of the Multiroom speaker configurations, with or without a sound bar.

After you have configured the surround effect, you can hear the TV's audio through the Multiroom speaker(s).

 The Surround Setup function is only available when at least one Samsung Multiroom Link compatible speaker is connected to the TV.

 The Multiroom Link function is deactivated when you activate Smart View (Screen Mirroring).

 The audio from the secondary device(s) may lag behind the audio and video of the main device that is playing the source content.

System and Support

You can configure system and support settings such as time, screen burn protection, software update, etc.

Setting the Time and Using the Timer

Set the current time and use the timer function.

Setting the current time

 >  [Settings](#) > [General](#) > [System Manager](#) > [Time](#)

You can set the **Clock** manually or automatically. Once the **Clock** is set, you can view the current time on the TV anytime.

You must set the clock in the following cases:

- The power cable is disconnected and then connected.
- The **Clock Mode** is changed from **Manual** to **Auto**.
- The TV is not connected to the Internet.
- No broadcast signals are received.

Setting the clock automatically

 >  [Settings](#) > [General](#) > [System Manager](#) > [Time](#) > [Clock](#) > [Clock Mode](#) > [Auto](#)

 This function works only when the TV is connected to the Internet or is receiving digital broadcasts through an antenna connected.

 Depending on the broadcast signal, the displayed time may differ.

 The accuracy of the time information received may differ with the channel and signal.

Adjusting the clock for DST and time zone

 >  [Settings](#) > [General](#) > [System Manager](#) > [Time](#) > [Clock](#)

Sets the right time by setting Daylight Savings Time (DST) and your local time zone.

 This function is only available when the [Clock Mode](#) is set to [Auto](#).

- [Time Zone](#)
Selects your time zone.
- [DST](#)
Switches the Daylight Saving Time (DST) function on or off.

 This function is only available when the [Clock Mode](#) is set to [Auto](#).

Changing the current time

 >  [Settings](#) > [General](#) > [System Manager](#) > [Time](#) > [Clock](#) > [Time Offset](#)

 [Time Offset](#) adjusts the time through a network connection. This function is only available if [Clock Mode](#) is set to [Auto](#) and the TV is connected to the Internet through a local area network.

 [Time Offset](#) adjusts the time if the TV fails to receive time information through normal digital broadcast signals.

Setting the clock manually

 >  [Settings](#) > [General](#) > [System Manager](#) > [Time](#) > [Clock](#) > [Clock Mode](#) > [Manual](#)

When [Clock Mode](#) is set to [Manual](#), you can directly enter the current time. Select the date and time by using the directional buttons on the remote control.

Using the timers

Using the sleep timer

 >  [Settings](#) > [General](#) > [System Manager](#) > [Time](#) > [Sleep Timer](#)

You can use this function to automatically shut off the TV after a pre-set period of time. You can set the sleep timer to up to 180 minutes to automatically turn off the TV.

Turning off the TV using the off timer

 >  [Settings](#) > [General](#) > [System Manager](#) > [Time](#) > [Off Timer](#)

You can set Off Timer to shut off the TV automatically at a specific time. Off Timer is only available if the Clock has been set.

Using the Screen Burn Protection and Energy Saving Functions

Protect the screen from screen burn-in and reduce the TV's energy consumption.

Preventing screen burn

 >  [Settings](#) > [General](#) > [System Manager](#) > [Auto Protection Time](#)

Still images can leave burned-in after-images if left on the screen for a long period of time. If a still image continues for two hours, the screen burn protection function can be activated automatically to protect the screen from burned-in after-images.

Reducing the energy consumption of the TV



 >  [Settings](#) > [General](#) > [Eco Solution](#) [Try Now](#)

You can adjust the brightness level of the TV, reduce overall power consumption, and prevent overheating.

- [Ambient Light Detection](#)

Automatically adjusts the brightness level of the TV, according to the ambient light level, to reduce power consumption. If the [Ambient Light Detection](#) has adjusted the screen brightness to a too bright or dark level, you can select [Minimum Backlight](#) to manually adjust the minimum screen brightness.

- [Minimum Backlight](#)

When the [Ambient Light Detection](#) is turned on, you can manually adjust the minimum brightness of the TV screen to consider the brightness level of the surroundings. This function acts only when the value is less than the setting in  >  [Settings](#) > [Picture](#) > [Expert Settings](#) > [Backlight](#).

- [Power Saving Mode](#)

Allows you to select a brightness setting from the list to reduce the TV's power consumption.

- [Motion Lighting](#)

Adjusts the brightness in response to on-screen movements to reduce power consumption.

- [Auto Power Off](#)

Automatically turns off the TV to reduce unnecessary power consumption if there is no operation for 4 hours.

Updating the TV's Software

View your TV's software version and update it if necessary.

 >  [Settings](#) > [Support](#) > [Software Update](#) [Try Now](#)

Updating the TV's software to the latest version

 **DO NOT turn off the TV's power until the update is complete. The TV will turn off and on automatically after completing the software update. Video and audio settings will be reset to their defaults after a software update.**

Updating through the Internet

 >  [Settings](#) > [Support](#) > [Software Update](#) > [Update Now](#)

 Updating from the Internet requires an active Internet connection.

Updating through a USB device

 >  [Settings](#) > [Support](#) > [Software Update](#) > [Update Now](#)

After downloading the update file from the Samsung website and storing it on a USB device, connect the USB device to the TV to update.

 To update using a USB flash drive, download the update package from Samsung.com to your computer. Then, save the update package in the USB device's top-level folder. Otherwise, the TV will not be able to locate the update package.

Updating the TV automatically

 >  [Settings](#) > [Support](#) > [Software Update](#) > [Auto Update](#)

If the TV is connected to the Internet, you can have the TV update its software automatically while you are watching the TV. When the background update is completed, it is applied the next time the TV is turned on.

If you agree to the Smart Hub terms and conditions, [Auto Update](#) is set to **On** automatically. If you want this function disabled, use the Select button to turn it off.

 This function may take a longer time if another network function is running concurrently.

 This function requires an Internet connection.

Protecting the TV from Hacking and Malicious Code

Protect your TV from hacking attempts and malicious code.

 >  [Settings](#) > [General](#) > [System Manager](#) > [Smart Security](#)

You can use [Smart Security](#) to protect the TV from hacking and malicious code when it is connected to the Internet.

Scanning the TV and connected storage for malicious code

 >  [Settings](#) > [General](#) > [System Manager](#) > [Smart Security](#) > [Scan](#)

If malicious code is found, the results of the scan will appear on the screen. This result window displays all malicious code found. You can quarantine (isolate) the code. Quarantining prevents it from executing.

1. Select all the malicious code to quarantine.
2. Select [Isolate](#). The selected malicious code is relocated to the [Isolated List](#).

 The [Isolated List](#) displays all quarantined malicious codes.

Using Other Functions

[View other functions.](#)

Running the accessibility functions

 >  [Settings](#) > [General](#) > [Accessibility](#) [Try Now](#)

The [Accessibility Shortcuts](#) provide easy access to the accessibility functions. To display the [Accessibility Shortcuts](#), press and hold the Volume button for 1 second or more. You can easily turn on or turn off the functions such as [Voice Guide](#), [Video Description](#), [High Contrast](#), [Enlarge](#), [Learn TV Remote](#), [Learn Menu Screen](#), [Caption](#), [Multi-output Audio](#), etc.

 Even if the [Voice Guide](#) is set to [Off](#) or muted, the voice guide for [Accessibility Shortcuts](#) is enabled.

Enabling voice guides for the visually impaired

 >  [Settings](#) > [General](#) > [Accessibility](#) > [Voice Guide Settings](#)

You can activate voice guides that describe the menu options aloud to aid the visually impaired. To activate this function, set [Voice Guide](#) to **On**. With [Voice Guide](#) on, the TV provides voice guides for channel change, volume adjust, information on current and upcoming programs, schedule viewing, other TV functions, various content in the Web Browser, and in [Search](#).

 The [Voice Guide](#) is provided in the language that is specified on the [Language](#) screen. However, some languages are not supported by [Voice Guide](#) even though they are listed in the [Language](#) screen. [English](#) is always supported.

Changing the volume, speed, and pitch of the Voice Guide

You can configure the volume, speed, pitch, and level of the [Voice Guide](#).

Enabling audio for the video description function

 >  [Settings](#) > [General](#) > [Accessibility](#) > [Video Description](#)

You can activate an audio guide that provides an audio description of video scenes for the visually impaired. This function is only available with broadcasts that provide this service.

White text on black background (high contrast)

 >  [Settings](#) > [General](#) > [Accessibility](#) > [High Contrast](#)

You can change major service screens to white text on a black background or change the transparent TV menus to opaque so that text can be more easily read. To activate this function, set [High Contrast](#) to **On**.



Enlarging the font (for the visually impaired)

 >  [Settings](#) > [General](#) > [Accessibility](#) > [Enlarge](#)

You can enlarge the size of the font on the screen. To activate, set [Enlarge](#) to **On**.

Learning about the remote control (for the visually impaired)

 >  [Settings](#) > [General](#) > [Accessibility](#) > [Learn TV Remote](#)

This function helps individuals with a visual impairment to learn the positions of the buttons on the remote control. When this function is activated, you can press a button on the remote control and the TV will tell you its name. To return to the previous screen, press the  button twice. To exit, press and hold the  button.

 This function is only available in the U.S.A. and Canada.

 This function is only available when [Voice Guide](#) is enabled.

Learning about the TV menu

 >  [Settings](#) > [General](#) > [Accessibility](#) > [Learn Menu Screen](#)

Learn the menus on the TV screen. Once enabled, your TV will tell you the structure and features of the menus you select.

Showing captions

 >  [Settings](#) > [General](#) > [Accessibility](#) > [Caption Settings](#) > [Caption](#)

Set [Caption](#) to **On** to watch programs with the captions displayed.

 Captions are not displayed by programs that do not support captions.

 The TV cannot control or modify DVD or Blu-ray subtitles. To control DVD or Blu-ray subtitles, use the sub-title feature of the DVD or Blu-ray player and the player's remote control.

Selecting the caption language

 >  [Settings](#) > [General](#) > [Accessibility](#) > [Caption Settings](#) > [Caption Mode](#)

- [Default](#) / [CC1 ~ CC4](#) / [Text1 ~ Text4](#)

(Analog channels only) Operates in either analog TV channel mode or when a signal is supplied from an external device to the TV. (Depending on the broadcast signal, the analog caption function may or may not work with digital channels.)

- [Default](#) / [Service1 ~ Service6](#) / [CC1 ~ CC4](#) / [Text1 ~ Text4](#)

(Digital channels only) Works with digital channels. [Service1](#) – [Service6](#) may not be available in digital caption mode depending on the broadcast.

Setting the digital caption related options

 >  **Settings** > **General** > **Accessibility** > **Caption Settings** > **Digital Caption Options**

You can change the font color, background color, and size settings.

 The foreground and background colors and opacity settings cannot be the same.

Listening to the TV through Bluetooth devices (for the hearing impaired)

 >  **Settings** > **General** > **Accessibility** > **Multi-output Audio**

You can turn on both the TV speaker and Bluetooth devices at the same time. When this function is active, you can set the volume of the Bluetooth devices higher than the volume of the TV speaker.

 This function is not available on certain models in specific geographical areas.

 When you connect Bluetooth devices to the TV, **Multi-output Audio** is activated. For more information about connecting Bluetooth devices to the TV, refer to "[Listening to the TV through Bluetooth devices.](#)"

Configuring advanced system settings

 >  **Settings** > **General** > **System Manager** Try Now

Changing the menu language

 >  **Settings** > **General** > **System Manager** > **Language**

Setting up a password

 >  **Settings** > **General** > **System Manager** > **Change PIN**

The PIN input window appears. Enter a PIN. Enter it again to confirm it. The default PIN is 0000.

 If you forget your PIN, you can reset it with your remote control. With the TV turned on, press the following buttons on the remote control in the order shown to reset the PIN to 0000.

On the Samsung Smart Remote: **VOL** → Volume Up →  → Volume Down →  → Volume Up → .

On the standard remote control:  → **(+)** (Volume Up) → **RETURN** → **(-)** (Volume Down) → **RETURN** → **(+)** (Volume Up) → **RETURN**.

Enabling/Disabling the front indicators

 >  [Settings](#) > [General](#) > [System Manager](#) > [Light Effect](#)

 The color of the TV's indicator lights may differ by the model.

 This function is not available on certain models in specific geographical areas.

Checking Notifications

 >  [Settings](#) > [General](#) > [System Manager](#) > [View Notifications](#)

You can view the list of event messages generated by the TV. [View Notifications](#) appears on the screen when events such as an update release for an app or a Samsung account login/logout occurs.

 To delete all notifications, select [Delete All](#).

 To check the SMART TV's service notifications on the [Internet](#), select [Service Notice](#).

Using the TV as a display model (for retail stores)

 >  [Settings](#) > [General](#) > [System Manager](#) > [Usage Mode](#)

You can turn the TV into a display model for retail environments by setting [Usage Mode](#) to [Retail Mode](#).

 For all other uses, select [Home Mode](#).

 With [Retail Mode](#), some functions are disabled, and the TV automatically resets itself after a preset amount of time.

Checking digital channel signal info and strength

 >  [Settings](#) > [Support](#) > [Self Diagnosis](#) > [Signal Information](#)

 If your TV is attached to a separate, over-the-air antenna, you can use the signal strength information to adjust the antenna for increased signal strength and improved HD channel reception.

Restoring the TV to the factory settings

 >  [Settings](#) > [Support](#) > [Self Diagnosis](#) > [Reset](#)

You can restore all TV settings (excluding the Internet and network settings) to the factory defaults.

1. Select [Reset](#). The security PIN entry window appears.
2. Enter the security PIN, and then select [Yes](#). All settings are then reset. The TV turns off and on again automatically and displays the [Setup](#) screen.

 For more information on [Setup](#), refer to the user manual that came with the TV.

Troubleshooting

If you have a problem with your TV, you can access various solutions while watching TV. If your problem is not addressed in the Troubleshooting section, contact the Samsung Call Center.

Getting Support

Get help directly from Samsung if you have a problem with your TV.

Getting support through Remote Management

 >  [Settings](#) > [Support](#) > [Remote Management](#) [Try Now](#)

After consenting to our service agreement, you can use [Remote Management](#) to access Remote Support and have a Samsung service technician diagnose your TV, correct problems, and update your TV's software remotely, via the web. You can also turn [Remote Management](#) on and off.

 This function requires an Internet connection.

What is Remote Support?

Samsung Remote Support service offers you one-on-one support with a Samsung Technician who can remotely:

- Diagnose your TV
- Adjust the TV settings for you
- Perform a factory reset on your TV
- Install recommended **firmware updates**

How does Remote Support Work?

You can easily have a Samsung Tech service your TV remotely:



1. Call the Samsung Contact Center and ask for remote support.
2. Open the menu on your TV and go to the [Support](#) section.
3. Select [Remote Management](#), then read and agree to the service agreements. When the PIN screen appears, provide the PIN number to the agent.
4. The agent will then access your TV.

Finding the contact information for service

 >  [Settings](#) > [Support](#) > [About This TV](#) [Try Now](#)

You can view the address of the Samsung website, the call center phone number, your TV's model number, your TV's software version, information about Smart Hub, and other information you may need to get service support from a Samsung call agent or the Samsung website.

 You can also view information by scanning the QR code of your TV.

 You can also start this function by pressing and holding the  button for 5 or more seconds.

Requesting service

 >  [Settings](#) > [Support](#) > [Request Support](#) [Try Now](#)

You can request service when you encounter a problem with the TV. Select the item matching the problem that you encountered, and then select [Request Now](#) or [Schedule Appointment](#) > [Send](#). Your service request will be registered. The Samsung Contact Center will contact you to set up or confirm your service appointment.

 You must agree to the terms and conditions for the service request.

 This function is not available in specific geographical areas.

 This function requires an Internet connection.

Diagnosing TV operational issues

You can diagnose issues with your TV and Smart Hub and run reset functions.

 >  [Settings](#) > [Support](#) > [Self Diagnosis](#) [Try Now](#)

You can use the [Picture Test](#) to help diagnose video issues and the [Sound Test](#) to diagnose sound issues. You can also view signal strength information for over-the-air digital signals, test the Smart Hub Internet connection, and run the Smart Hub and TV factory reset functions.

















There Is a Problem with the Picture

When the TV has trouble with the picture, these steps may help resolve the problem.

Testing the picture

 >  [Settings](#) > [Support](#) > [Self Diagnosis](#) > [Start Picture Test](#)

Before you review the list of problems and solutions below, use [Start Picture Test](#) to determine if the problem is caused by the TV. [Start Picture Test](#) displays a high definition picture you can examine for flaws or faults.

The problem	Try this!
Flickering and Dimming	If your Samsung Television is flickering or dimming sporadically, you may need to disable some of the energy efficiency features. Disable Power Saving Mode ( >  Settings > General > Eco Solution > Power Saving Mode), Ambient Light Detection ( >  Settings > General > Eco Solution > Ambient Light Detection), or Motion Lighting ( >  Settings > General > Eco Solution > Motion Lighting).
Component Connections/ Screen Color	If the color on your Samsung television screen is not correct or the black and white colors are off, run Start Picture Test ( >  Settings > Support > Self Diagnosis > Start Picture Test). If the test results indicate that the problem is not caused by the TV, do the following: <ul style="list-style-type: none"> • Confirm that the video input connectors are connected to the correct external device video output connectors. • Check the other connections as well. If the TV is connected to an external device via a component cable, confirm that the Pb, Pr, and Y jacks are plugged into their proper connectors.
Screen Brightness	If the colors on your Samsung TV are correct but just a little too dark or bright, try adjusting the following settings first. <ul style="list-style-type: none"> • Select  >  Settings > Picture > Expert Settings and adjust the Backlight, Contrast, Brightness, Sharpness, Color, or Tint (G/R) settings.
Ghosting, Blurring, or Juddering	If you notice ghosting or blurring on the screen, use the Auto Motion Plus Settings function ( >  Settings > Picture > Expert Settings > Auto Motion Plus Settings) to resolve the issue.
Unwanted Powering Off	If your Samsung TV appears to turn off by itself, try disabling some of the TV's energy efficiency functions. See if Sleep Timer ( >  Settings > General > System Manager > Time > Sleep Timer) has been enabled. The Sleep Timer automatically turns the TV off after a specified period of time. If the Sleep Timer has not been enabled, see if Auto Power Off ( >  Settings > General > Eco Solution > Auto Power Off) has been enabled and disable it.
Problems Powering On	If you are having problems powering on your Samsung television, there are a number of things to check before calling the service department. Confirm that the TV's power cord is connected correctly at both ends and that the remote control is operating normally. Make sure that the antenna cable or cable TV cable is firmly connected. If you have a cable or satellite box, confirm that it is plugged in and turned on.

The problem	Try this!
Unable to find a Channel	If your TV is not connected to a cable or satellite box, run Auto Program (🏠 > ⚙️ Settings > Broadcasting > Auto Program).
The TV image does not look as good as it did in the store.	<p>Store displays are all tuned to digital, HD (high definition) channels.</p> <p>If you have an analog cable or satellite box, upgrade to a digital cable or satellite box. Use HDMI or Component cables to deliver HD (high definition) picture quality.</p> <p>Many HD channels are upscaled from SD (Standard Definition) content. Look for a channel that is broadcasting HD content.</p> <ul style="list-style-type: none"> • Cable/Satellite Subscribers: Try HD channels from the channel lineup. • Air/Cable Antenna Connection: Try HD channels after running the Auto Program function. <p>Adjust the cable or satellite box's video output resolution to 1080i or 720p.</p>
The picture is distorted.	<p>The compression of video content may cause picture distortions, especially in fast moving pictures from sports programs and action movies.</p> <p>If the signal reception is weak or poor, screen distortion may be visible but it is not a malfunction.</p> <p>Mobile phones used close to the TV (within 3.2 ft) may cause noise on analog and digital channels.</p>
The color is wrong or missing.	If you're using a Component connection, make sure that the Component cables are connected to the correct jacks. Incorrect or loose connections may cause color problems or a blank screen.
The color is poor or the picture is not bright enough.	<p>Go to Picture and then adjust the Picture Mode, Brightness, Sharpness, and Color settings.</p> <p>See if Power Saving Mode (🏠 > ⚙️ Settings > General > Eco Solution > Power Saving Mode) has been enabled.</p> <p>Try resetting the picture. (🏠 > ⚙️ Settings > Picture > Expert Settings > Reset Picture)</p>
There is a dotted line on the edge of the screen.	Change Picture Size Settings to 16:9 Standard .
The picture is black and white.	If you are using AV, analog equipment, disconnect the adapter from the Component (Blue) input jack on the TV and connect it to the AV In (Yellow) input jack.

 If the test picture does not appear or there is noise or distortion, the TV may have a problem. Contact Samsung's Call Center for assistance.

 If the test picture is displayed properly, there may be a problem with an external device. Please check the connections.

 If the problem persists, check the signal strength or refer to the external device's user manual.







I Can't Hear the Sound Clearly

When the TV has difficulties with sound, these steps may help resolve the problem.

Testing the sound











 >  [Settings](#) > [Support](#) > [Self Diagnosis](#) > [Start Sound Test](#)

If the TV plays the [Start Sound Test](#) melody without distortion, there may be a problem with an external device or the broadcast signal's strength.

The problem	Try this!
There is no sound or the sound is too low at maximum volume.	Check the volume control of the device (cable or satellite box, DVD, Blu-ray, etc.) connected to your TV.
The picture is good but there is no sound.	Set  >  Settings > Sound > Sound Output to TV Speaker . If you are using an external device, check the device's audio output option. (For example, you may need to change your cable box's audio option to HDMI if the box connected to your TV is using an HDMI cable.) To listen to computer sound, connect an external speaker to the computer's audio output connector. If your TV has a headphone jack, make sure there is nothing plugged into it. Reboot the connected device by disconnecting and then reconnecting the device's power cable.
No sound is heard.	Check whether the Digital Output Audio Format is set to Dolby Digital+ in  >  Settings > Sound > Expert Settings > Digital Output Audio Format . If you are using a receiver that does not support Dolby Digital Plus, you will hear no sound when you select Dolby Digital+ .
The speakers are making an odd sound.	Make sure that the audio cable is connected to the correct audio output connector on the external device. For antenna or cable connections, check the signal information. A low signal level may cause sound distortions. Run Start Sound Test ( >  Settings > Support > Self Diagnosis > Start Sound Test).

There Is a Problem with the Broadcast

When the TV has difficulties receiving broadcasts, these steps may help resolve the problem.

The problem	Try this!
"Weak or No Signal" displayed in TV mode/ cannot find channel.	Select  >  Source to confirm that the correct input source has been selected. If the TV is not connected to a cable or satellite box, run Auto Program to search for channels ( >  Settings > Broadcasting > Auto Program).
The TV is not receiving all channels.	Confirm that the coaxial cable is securely connected to the TV. Run Start Setup ( >  Settings > General > Start Setup) or Auto Program ( >  Settings > Broadcasting > Auto Program).
There are no captions with digital channels.	Go to Caption Settings ( >  Settings > General > Accessibility > Caption Settings) and change the Caption Mode . Some channels may not have caption data.
The picture is distorted.	The compression of the video content may cause picture distortions. This is especially true with fast moving pictures from sports programs and action movies. A weak signal can cause picture distortions. This is not a problem with the TV.
The picture quality is low.	Select high definition (HD) channels or programs.





My Computer Won't Connect

When the TV has difficulties connecting to a PC, these steps may help resolve the problem.

The problem	Try this!
The "Mode Not Supported" message appears.	Set your PC's output resolution so it matches a resolution supported by the TV.
The video is OK but there is no audio.	If you are using an HDMI connection, check the audio output setting on your PC. If you are using an HDMI-to-DVI cable, a separate audio cable is required. Note that the HDMI-to-DVI connection is only supported by the HDMI (DVI) port and does not transmit audio. To listen to the computer sound, connect external speakers to the audio output connection of the computer.

The TV Won't Connect to the Internet

When the TV has difficulties connecting to the Internet, these steps may help resolve the problem.

The problem	Try this!
The TV cannot connect to your network or apps (for Internet compatible models only).	<p>Make sure the TV has a network connection ( >  Settings > General > Network > Network Status).</p> <p>Contact your Internet service provider.</p>
The wireless network connection failed.	<p>Confirm your wireless modem/router is on and connected to the Internet.</p>
The wireless network signal is too weak.	<p>Position your wireless router, modem router, or access point in a central location. Avoid putting it in a corner.</p> <p>Use a wireless repeater to get an instant boost in your wireless signal strength. Place the repeater halfway between your wireless router and your TV.</p> <p>The most common wireless technology, 802.11g (wireless-G), operates at a frequency of 2.4 GHz. This frequency is widely used by many cordless phones, microwave ovens, baby monitors, garage doors, and other wireless devices. Reduce interference by not using or turning off wireless devices that use the 2.4 GHz frequency. Instead, use devices that communicate via the 5.0 GHz frequency.</p>
The software update over the Internet has failed.	<p>Check the network connection status ( >  Settings > General > Network > Network Status).</p> <p>If the TV is not connected to a network, connect it to a network.</p> <p>The upgrade stops if you already have the latest software version.</p>

The Schedule Recording/Timeshift Function Isn't Working

When Timeshift or Schedule recording aren't working, these steps may help resolve the problem.

 This function is not available in the U.S.A. and Canada.

The problem	Try this!
Schedule Recording cannot be used.	<p>Check if there is a USB device connected to the TV.</p> <p>Recording will automatically stop if the signal becomes too weak.</p> <p>Check the free space on the USB device. The function will not work if there isn't enough storage space on the USB device.</p>

Anynet+ (HDMI-CEC) Isn't Working

When Anynet+ (HDMI-CEC) isn't working, these steps may help resolve the problem.

The problem	Try this!
Anynet+ does not work.	<p>Confirm that the device is an Anynet+ device. The Anynet+ system supports Anynet+ devices only.</p> <p>Check if the power cord of the Anynet+ device is properly connected.</p> <p>Check the cable connections of the Anynet+ device.</p> <p>Go to Anynet+ (HDMI-CEC) (🏠) > ⚙️ Settings > General > External Device Manager > Anynet+ (HDMI-CEC) and see if Anynet+ (HDMI-CEC) has been set to On.</p> <p>Anynet+ may not function when some other functions are active, including Channel Search, Smart Hub, Initial Setup, etc.</p> <p>If you have disconnected and then reconnected the HDMI cable, scan for devices again or turn your TV off and on.</p>
I want to start Anynet+.	<p>Move the focus to the Anynet+ device at (🏠) > [Source] Source, and then press the up directional button.</p> <p>Check if the Anynet+ device is properly connected to the TV, and then select Anynet+ (HDMI-CEC) (🏠) > ⚙️ Settings > General > External Device Manager > Anynet+ (HDMI-CEC) menu to see if Anynet+ (HDMI-CEC) is set to On.</p>
I want to exit Anynet+.	<p>Set Anynet+ (HDMI-CEC) (🏠) > ⚙️ Settings > General > External Device Manager > Anynet+ (HDMI-CEC) to Off.</p>
The message "Connecting to Anynet+ device..." or "Disconnecting from Anynet+ device" appears on the screen.	<p>You cannot use the remote control when the TV is configuring Anynet+ or switching to a viewing mode. Use the remote control after the TV has completed the Anynet+ configuration or has switched to a viewing mode.</p>
The Anynet+ device won't play.	<p>You cannot use the play function when Start Setup is in progress.</p>
The connected device is not displayed.	<p>Check whether the device supports Anynet+.</p> <p>Check whether the HDMI cable is properly connected.</p> <p>Go to Anynet+ (HDMI-CEC) (🏠) > ⚙️ Settings > General > External Device Manager > Anynet+ (HDMI-CEC) and see if Anynet+ (HDMI-CEC) has been set to On.</p> <p>Scan for Anynet+ devices again.</p> <p>Anynet+ devices must be connected to the TV using an HDMI cable. Make sure the device is connected to your TV with an HDMI cable. Some HDMI cables may not support Anynet+.</p> <p>If the connection is terminated because there has been a power failure or the HDMI cable has been disconnected, please scan for the device again.</p>
The TV audio is not being played through the receiver.	<p>Connect an optical cable to the TV and the receiver.</p> <p>ARC enables the TV to output digital sound via the HDMI (ARC) port.</p> <p>However, ARC is only available when the TV is connected to an audio receiver that supports ARC.</p>

I Have Trouble Launching/Using Apps

When apps aren't working, these steps may help resolve the problem.

The problem	Try this!
I launched an app, but it's in English. How can I change the language?	Languages supported by the app may be different from the user interface language. The ability to change the language depends on the service provider.
My application is not working.	Check with the service provider. Refer to the Help section on the application service provider's website.





My File Won't Play

When files aren't playing, this may help resolve the problem.

The problem	Try this!
Some files can't be played.	This problem may occur with high-bitrate files. Most files can be played back, but you might experience problems with high-bitrate files.

I Want to Reset the TV





Initialize the settings to factory defaults.

Reset	Path	Description
Reset Settings	 >  Settings > Support > Self Diagnosis > Reset	Resets Picture , Sound , Broadcasting , and all other settings, except for the network settings, to the default settings.
Reset Smart Hub	 >  Settings > Support > Self Diagnosis > Reset Smart Hub	Resets all Smart Hub settings to their factory defaults and deletes all information related to Samsung accounts, linked service accounts, Smart Hub service agreements, and Smart Hub applications.

Other Issues

Use these procedures to resolve other issues that may occur.

The problem	Try this!
The TV is hot.	Watching TV for an extended period of time causes the panel to generate heat. The heat from the panel is dissipated through internal vents running along the top of the TV. The bottom, however, may feel hot to the touch after extended use. Children watching TV need constant adult supervision to prevent them from touching the TV. This heat, however, is not a defect and does not affect the TV's functionality.
The picture won't display in full screen.	<p>HD channels will have black bars on either side of the screen when displaying upscaled SD (4:3) content.</p> <p>Black bars will appear at the top and bottom of the screen when you watch movies that have aspect ratios different from your TV.</p> <p>Adjust the picture size options on your external device or set the TV to full screen.</p>
The "Mode Not Supported" message appears.	The output resolution of the attached device is not supported by the TV. Check the TV's supported resolutions and adjust the external device's output resolution accordingly.
The Captions item in the TV is grayed out.	When an external device is connected with an HDMI or Component cable, the Caption function is unavailable. Adjust the caption setting on the external device.
The TV smells of plastic.	This smell is normal and will dissipate over time.
Signal Information under Self Diagnosis isn't activated.	Verify that the current channel is a digital channel. Signal Information is only available for digital channels.
The TV is tilted to the side.	Remove the base stand from the TV and reassemble it.
The stand is wobbly or crooked.	Make sure the indicator arrows on the stand and stand holder are properly aligned.
The remote control and/or voice control does not work.	The TV ships with protective stickers covering some of the sensors. Make sure all of the stickers have been removed.
The Broadcasting function has been deactivated.	<p>Broadcasting is only available when the Source is set to TV.</p> <p>Broadcasting cannot be accessed while you watch TV using a cable or satellite box.</p> <p>Broadcasting cannot be accessed while a recording is in progress or the Timeshift function is running.</p>

The problem	Try this!
There is an intermittent loss of audio or video.	<p>Check the cable connections and reconnect them.</p> <p>Loss of audio or video can be caused by using overly rigid or thick cables. Make sure the cables are flexible enough for long term use. If you are mounting the TV to a wall, we recommend using cables with 90-degree connectors.</p>
There are small particles on the TV's bezel.	<p>This is part of the product's design and is not a defect.</p>
PIP is not available.	<p>PIP is available only when an external device is connected with an HDMI or Component cable. Note that the function is unavailable when the Smart Hub is active.</p> <p> This function is not available in the U.S.A. and Canada.</p>
The settings are lost after 5 minutes or every time the TV is turned off.	<p>If Usage Mode is set to Retail Mode, the TV's audio and video settings are automatically reset every 5 minutes.</p> <p>Change Usage Mode ( >  Settings > General > System Manager > Usage Mode) to Home Mode.</p>
A POP (TV's internal banner ad) appears on the screen.	<p>Change Usage Mode ( >  Settings > General > System Manager > Usage Mode) to Home Mode.</p>
The TV is making a popping noise.	<p>The expansion and contraction of the TV's outer casing may cause a popping noise. This does not indicate a product malfunction. The TV is safe to use.</p>
The TV is making a humming noise.	<p>Your TV utilizes high-speed switching circuits and high levels of electrical current. Depending on the TV's brightness level, the TV may seem slightly noisier than a conventional TV.</p> <p>Your TV has undergone strict quality control procedures that meet our demanding performance and reliability requirements.</p> <p>Some noise coming from the TV is considered normal and is not an acceptable cause for an exchange or refund.</p>



Precautions and Notes

You can get instructions and information that you must read after installation.

Before Using the Recording and Timeshift Functions

Read these instructions before using [Recording](#) and [Timeshift](#).

Before using the recording and schedule recording functions

-  Recording is not supported in the U.S.A. and Canada.
- To set up a Schedule Recording, you must first set the TV's clock. Set the [Clock](#) (🏠) > [Settings](#) > [General](#) > [System Manager](#) > [Time](#) > [Clock](#).
- You can set up a maximum total of 30 [Schedule Viewing](#) and [Schedule Recording](#) entries.
- Recordings are DRM-protected and therefore cannot be played back on a computer or on a different TV. In addition, these files cannot be played back on your TV if its video circuit has been replaced.
- A USB hard drive with a speed of 5,400 rpm or above is recommended. However, RAID-type USB hard drives are not supported.
- USB memory sticks are not supported.
- The total recording capacity may differ with the amount of available hard drive space and the recording quality level.
- [Schedule Recording](#) requires at least 100 MB of free space on the USB storage device. Recording will stop if the available storage space falls below 50 MB while recording is in progress.
- If the available storage space falls below 500 MB while both the Schedule Recording and Timeshift functions are in progress, only the recording will stop.
- The maximum recording time is 720 minutes.
- Videos are played according to the TV settings.
- If the input signal is changed while recording is in progress, the screen will go blank until the change is made. In this case, recording will resume, but  will not be available.

- When using the Record or Schedule Recording function, the actual recording may start a second or two later than the specified time.
- If the Schedule Recording function is operating while a recording is being made on an HDMI-CEC external device, the priority is given to the Schedule Recording.
- Connecting a recording device to the TV automatically deletes abnormally saved recorded files.
- If the **Off Timer** or **Auto Power Off** has been set, the TV will override these settings, continue to record, and turn off after the recording has ended.

Before using the timeshift function

 Timeshift is not supported in the U.S.A. and Canada.

- A USB hard drive with a speed of 5,400 rpm or above is recommended. However, RAID-type USB hard drives are not supported.
- USB memory sticks or flash drives are not supported.
- The total recording capacity may differ with the amount of available hard drive space and the recording quality level.
- If the available storage space falls below 500 MB while both the Schedule Recording and Timeshift functions are in progress, only the recording will stop.
- The maximum amount of time available for the Timeshift function is 90 minutes.
- The Timeshift function is not available for locked channels.
- Time-shifted videos are played according to the TV settings.
- The Timeshift function may be terminated automatically once it reaches its maximum capacity.
- The Timeshift function requires at least 1.5 GB of free space available on the USB storage device.



Read Before Using APPS

Read this information before using APPS.

- Due to the product characteristics featured on Samsung Smart Hub, as well as limitations in available content, certain features, applications, and services may not be available on all devices or in all territories. Visit <http://www.samsung.com> for more information on specific device information and content availability. Services and content availability are subject to change without prior notice.
- Samsung Electronics takes no legal responsibility whatsoever for any interruption of app services caused by the service provider for any reason.
- Application services may be provided in English only and available content may differ with the geographical area.
- For more information about applications, visit the applicable service provider's website.
- An unstable Internet connection may cause delays or interruptions. In addition, applications may terminate automatically depending on the network environment. If this occurs, check your Internet connection and try again.
- Application services and updates may become unavailable.
- Application content is subject to change by the service provider without prior notice.
- Specific services may differ with the version of the application installed on the TV.
- An application's functionality may change in future versions of the application. If this occurs, run the application's tutorial or visit the service provider's website.
- Depending on the service provider's policies, certain applications may not support multitasking.

Read Before Using the Internet

Read this information before using the [Internet](#).

- The [Internet](#) is not compatible with Java applications.
- You can download the supported types of files, such as videos, mp3 files, and images, but you cannot download files that are not supported by the TV. If you attempt to download an unsupported file, you will receive an error message instead.
- The [Internet](#) may not be able to access certain websites.
- The TV does not support playback of flash videos.
- E-commerce for online purchases is not supported.
- With websites that have scrollable windows, scrolling a window can result in corrupted characters.
- ActiveX is not supported.
- Only a limited number of fonts are supported. Certain symbols and characters may not be displayed properly.
- The response to remote commands and the resulting on-screen display may be delayed while a web page is loading.
- Loading a web page may be delayed or suspended completely with certain operating systems.
- The copy and paste operations are not supported.
- When composing an email or a simple message, certain functions such as the font size and color selection may not be available.
- There is a limit to the number of bookmarks and the size of the log file that can be saved.
- The number of windows that can be opened concurrently differs with the search conditions and the TV model.
- The web browsing speed will differ with the network environment.
- Embedded videos in a web page cannot be played at the same time while the PIP (picture-in-picture) function is operating.
- If the [Clock](#) ( >  [Settings](#) > [General](#) > [System Manager](#) > [Time](#) > [Clock](#)) has not been set, the browsing history will not be saved.
- The browsing history is saved from latest to oldest, with the oldest entries being overwritten first.

- Depending on the types of video/audio codecs supported, it might not be possible to play certain video and audio files while playing HTML5 Video/Audio.
- Video sources from PC-optimized streaming service providers may not play properly on our proprietary [Internet](#).

Read Before Playing Photo, Video, or Music Files

Read this information before playing media content.

Limitations on use of photo, video, and music files [Try Now](#)

- The TV supports MSC (Mass Storage Class) USB devices only. MSC is a class designation for mass storage devices. Types of MSC devices include external hard drives, flash card readers, and digital cameras. (USB hubs are not supported.) These kinds of devices must be connected directly to the USB port. The TV may not be able to recognize a USB device or read the files on the device if it is connected with a USB extension cable. Do not disconnect USB devices while they are transferring files.
- When connecting an external hard drive, use the USB (HDD) port. We recommend that you use an external hard drive with its own power adapter.
- Certain digital cameras and audio devices may not be compatible with the TV.
- If there are multiple USB devices connected to the TV, the TV might not be able to recognize some or all the devices. USB devices that use high-power input should be connect to the USB [5V, 1A] port.
- The TV supports the FAT, exFAT, and NTFS file systems.
- After sorting files in the Folder view mode, the TV can display up to 1,000 files per folder. If the USB device contains more than 8,000 files and folders, however, some files and folders might not be accessible.
- Certain files, depending on how they are encoded, may not play on the TV.
- Certain files are not supported on all models.
- UHD Video Pack contents is not supported with 2017 Samsung UHD TVs.

Supported external subtitles

Name	Format
MPEG-4 Timed text	.txt
SAMI	.smi
SubRip	.srt
SubViewer	.sub
Micro DVD	.sub or .txt
SubStation Alpha	.ssa
Advanced SubStation Alpha	.ass
Powerdivx	.psb
SMPTE-TT Text	.xml

Supported internal subtitles

Name	Container
Xsub	AVI
SubStation Alpha	MKV
Advanced SubStation Alpha	MKV
SubRip	MKV
VobSub	MKV
MPEG-4 Timed text	MP4
TTML in smooth streaming	MP4
SMPTE-TT TEXT	MP4
SMPTE-TT PNG	MP4

Supported image formats and resolutions

File extension	Format	Resolution
*.jpg *.jpeg	JPEG	15360 x 8640
*.png	PNG	4096 x 4096
*.bmp	BMP	4096 x 4096
*.mpo	MPO	15360 x 8640

 The MPO format is supported partly.

Supported music formats and codecs

File extension	Format	Codec	Note
*.mp3	MPEG	MPEG1 Audio Layer 3	
*.m4a *.mpa *.aac	MPEG4	AAC	
*.flac	FLAC	FLAC	Supports up to 2 channels
*.ogg	OGG	Vorbis	Supports up to 2 channels
*.wma	WMA	WMA	Supports WMA10 Pro up to 5.1 channels. WMA lossless audio is not supported. Supports up to the M2 profile.
*.wav	wav	wav	
*.mid *.midi	midi	midi	Supports type 0 and type 1. Seek is not supported. Supports USB device only.
*.ape	ape	ape	
*.aif *.aiff	AIFF	AIFF	
*.m4a	ALAC	ALAC	

Supported video codecs

File format	Container	Video codecs	Resolution	Frame rate (fps)	Bitrate (Mbps)	Audio codecs
*.avi *.mkv *.asf *.wmv *.mp4 *.mov *.3gp *.vro *.mpg *.mpeg *.ts *.tp *.trp *.mov *.flv *.vob *.svi *.m2ts *.mts *.divx	AVI	H.264 BP/MP/HP	4096 x 2160	4096 x 2160: 30	60	Dolby Digital LPCM ADPCM(IMA, MS) AAC HE-AAC WMA Dolby Digital Plus MPEG(MP3) DTS (Core, LBR, HD_MA, HD_HRA,) G.711(A-Law, μ-Law)
		HEVC (H.265 - Main, Main10)		60		
		Motion JPEG	3840 x 2160	30	80	
	MKV ASF MP4 3GP MOV FLV VRO VOB PS TS SVAF	MVC	1920 x 1080	60	20	
		DivX 3.11 / 4 / 5 / 6				
		MPEG4 SP/ASP				
		Window Media Video v9 (VC1)				
		MPEG2				
		MPEG1				
		Microsoft MPEG-4 v1, v2, v3				
		Window Media Video v7 (WMV1), v8 (WMV2)				
		H.263 Sorrenson				
		VP6				
*.webm	WebM	VP8	1920 x 1080	60	20	Vorbis
		VP9 (Supported up to profile 2)	4096 x 2160	4096 x 2160: 60	40	
*.rmvb	RMVB	RV8/9/10 (RV30/40)	1920 x 1080	60	20	RealAudio 6

Other restrictions

- Codecs may not function properly if there is a problem with the content.
- Video content does not play or does not play correctly if there is an error in the content or container.
- Sound or video may not work if they have standard bit rates/frame rates above the TV's compatibility ratings.
- If the Index Table is has an error, the Seek (Jump) function will not work.
- When playing video over a network connection, the video may not play smoothly because of data transmission speeds.
- Some USB/digital camera devices may not be compatible with the TV.
- HEVC codec is only available in MKV / MP4 / TS containers.
- The MVC codec is supported partly.

Video decoders

- H.264 FHD is supported up to Level 4.1. (TV does not support FMO / ASO / RS)
- H.264 UHD is supported up to Level 5.1.
- HEVC FHD is supported up to Level 4.1, and HEVC UHD is supported up to Level 5.1.
- VC1 AP L4 is not supported.
- GMC 2 or above is not supported.

Audio decoders

- Supports WMA 10 Pro up to 5.1 channels. Supports up to the M2 profile. WMA lossless audio is not supported.
- QCELP and AMR NB/WB are not supported.
- Vorbis is supported for up to 5.1 channels.
- Dolby Digital Plus is supported for up to 5.1 channels.
- The DTS LBR codec is only available for MKV / MP4 / TS containers.
- The supported sample rates are 8, 11.025, 12, 16, 22.05, 24, 32, 44.1, and 48 KHz, and differ with the codec.

Read After Installing the TV

Read this information after installing the TV.

Picture sizes and input signals

The **Picture Size** settings are applied to the current source. The applied **Picture Size Settings** will remain in effect whenever you select that source unless you change them.

Input signal	Picture size
Component	16:9 Standard, Custom, 4:3
Digital channel (720p)	16:9 Standard, Custom, 4:3
Digital channel (1080i, 1080p)	16:9 Standard, Custom, 4:3
Digital channel (3840 x 2160p @ 24/30 Hz)	16:9 Standard, Custom
Digital channel (3840 x 2160p @ 50/60 Hz)	16:9 Standard, Custom
Digital channel (4096 x 2160p)	16:9 Standard, Custom
HDMI (720p)	16:9 Standard, Custom, 4:3
HDMI (1080i, 1080p)	16:9 Standard, Custom, 4:3
HDMI (3840 x 2160p)	16:9 Standard, Custom
HDMI (4096 x 2160p)	16:9 Standard, Custom
USB (720p)	16:9 Standard, Custom, 4:3
USB (1080i/p @ 60 Hz)	16:9 Standard, Custom, 4:3
USB (3840 x 2160p @ 24/30 Hz)	16:9 Standard, Custom
USB (3840 x 2160p @ 60 Hz) USB (4096 x 2160p @ 24/30/60 Hz)	16:9 Standard, Custom

Installing an anti-theft lock

An anti-theft lock is a physical device that can be used to protect the TV against theft. Look for the lock slot on the back of the TV. The slot has a  icon next to it. To use the lock, wrap the lock cable around an object that is too heavy to carry and then thread it through the TV's lock slot. The lock is sold separately. The method of using an anti-theft lock may differ for each TV model. Refer to the lock's user manual for more information.

 This function is not available on certain models in specific geographical areas.

Read before setting up a wireless Internet connection

Precautions for wireless Internet

- This TV supports the IEEE 802.11 a /b /g /n /ac communication protocols. Samsung recommends using IEEE 802.11n. Video files stored on a device connected to the TV via a Home Network may not play back smoothly.
 IEEE 802.11 ac communication protocol is not available on certain models.
- To use wireless Internet, the TV must be connected to a wireless router or modem. If the wireless router supports DHCP, the TV can use a DHCP or static IP address to connect to the wireless network.
- Select a channel that is not currently in use for the wireless router. If the channel set for the wireless router is currently being used by another device, the result is usually interference and/or a communications failure.
- Most wireless networks have an optional security system. To enable a wireless network's security system, you need to create a password using characters and numbers. This password is then needed to connect to a security-enabled AP.

Wireless security protocols

The TV only supports the following wireless network security protocols. The TV cannot connect to non-certified wireless routers.

- Authentication Modes: WEP, WPAPSK, WPA2PSK
- Encryption Types: WEP, TKIP, AES

In compliance with the newest Wi-Fi certification specifications, Samsung TVs do not support WEP or TKIP security encryption in networks running in the 802.11n mode. If the wireless router supports WPS (Wi-Fi Protected Setup), you can connect the TV to your network using PBC (Push Button Configuration) or a PIN (Personal Identification Number). WPS automatically configures the SSID and WPA key settings.

Supported Resolutions for UHD Input Signals

Check the supported resolution for UHD input signals.

- Resolution: 3840 x 2160p, 4096 x 2160p



An HDMI connection with **HDMI UHD Color** set to **Off** supports up to UHD 50P/60P 4:2:0 input signals, while an HDMI connection with **HDMI UHD Color** set to **On** supports up to UHD 50P/60P 4:4:4 and 4:2:2 input signals.

If HDMI UHD Color is set to Off

Frame rate (fps)	Color Depth / Chroma Sampling	RGB 4:4:4	YCbCr 4:4:4	YCbCr 4:2:2	YCbCr 4:2:0
50 / 60	8 bit	-	-	-	0

If HDMI UHD Color is set to On

Frame rate (fps)	Color Depth / Chroma Sampling	RGB 4:4:4	YCbCr 4:4:4	YCbCr 4:2:2	YCbCr 4:2:0
50 / 60	8 bit	0	0	0	0
	10 bit	-	-	0	0
	12 bit	-	-	0	0

Read Before Connecting a Computer (Supported Resolutions)

Check the supported resolution for PC input signals.

When you connect your TV to a computer, set the computer's video card to one of the standard resolutions listed in the tables below or on the next page. The TV will automatically adjust to the resolution you choose. Note that the optimal and recommended resolution is 3840 x 2160 at 60 Hz. Choosing a resolution not included in the tables can result in a blank screen or just the power indicator turning on. Refer to the user manual of your graphics card for compatible resolutions.

 The native resolution is 3840 x 2160 at 60Hz with the **HDMI UHD Color** set to **On**. The native resolution is 3840 x 2160 at 30Hz with the **HDMI UHD Color** set to **Off**.

IBM

Resolution (Dots x lines)	Display format	Horizontal frequency (KHz)	Vertical frequency (Hz)	Clock frequency (MHz)	Polarity (horizontal / vertical)
720 x 400	70 Hz	31.469	70.087	28.322	- / +

MAC

Resolution (Dots x lines)	Display format	Horizontal frequency (KHz)	Vertical frequency (Hz)	Clock frequency (MHz)	Polarity (horizontal / vertical)
640 x 480	67 Hz	35.000	66.667	30.240	- / -
832 x 624	75 Hz	49.726	74.551	57.284	- / -
1152 x 870	75 Hz	68.681	75.062	100.000	- / -

VESA DMT

Resolution (Dots x lines)	Display format	Horizontal frequency (KHz)	Vertical frequency (Hz)	Clock frequency (MHz)	Polarity (horizontal / vertical)
640 x 480	60 Hz	31.469	59.940	25.175	- / -
640 x 480	72 Hz	37.861	72.809	31.500	- / -
640 x 480	75 Hz	37.500	75.000	31.500	- / -
800 x 600	60 Hz	37.879	60.317	40.000	+ / +
800 x 600	72 Hz	48.077	72.188	50.000	+ / +
800 x 600	75 Hz	46.875	75.000	49.500	+ / +
1024 x 768	60 Hz	48.363	60.004	65.000	- / -
1024 x 768	70 Hz	56.476	70.069	75.000	- / -
1024 x 768	75 Hz	60.023	75.029	78.750	+ / +
1152 x 864	75 Hz	67.500	75.000	108.000	+ / +
1280 x 720	60 Hz	45.000	60.000	74.250	+ / +
1280 x 800	60 Hz	49.702	59.810	83.500	- / +
1280 x 1024	60 Hz	63.981	60.020	108.000	+ / +
1280 x 1024	75 Hz	79.976	75.025	135.000	+ / +
1366 x 768	60 Hz	47.712	59.790	85.500	+ / +
1440 x 900	60 Hz	55.935	59.887	106.500	- / +
1600 x 900RB	60 Hz	60.000	60.000	108.000	+ / +
1680 x 1050	60 Hz	65.290	59.954	146.250	- / +
1920 x 1080	60 Hz	67.500	60.000	148.500	+ / +

CEA-861

Resolution (Dots x lines)	Display format	Horizontal frequency (KHz)	Vertical frequency (Hz)	Clock frequency (MHz)	Polarity (horizontal / vertical)
3840 x 2160	30 Hz	67.500	30.000	297.000	- / -
*3840 x 2160	60 Hz	135.000	60.000	594.000	- / -

 *: This resolution is only supported by HDMI 2.0 mode.

Supported Resolutions for Video Signals

Check the supported resolution for video signals.

CEA-861

Resolution (Dots x lines)	Display format	Horizontal frequency (KHz)	Vertical frequency (Hz)	Clock frequency (MHz)	Polarity (horizontal / vertical)
720 (1440) x 576i	50 Hz	15.625	50.000	27.000	- / -
720 (1440) x 480i	60 Hz	15.734	59.940	27.000	- / -
720 x 576	50 Hz	31.250	50.000	27.000	- / -
720 x 480	60 Hz	31.469	59.940	27.000	- / -
1280 x 720	50 Hz	37.500	50.000	74.250	+ / +
1280 x 720	60 Hz	45.000	60.000	74.250	+ / +
1920 x 1080i	50 Hz	28.125	50.000	74.250	+ / +
1920 x 1080i	60 Hz	33.750	60.000	74.250	+ / +
1920 x 1080	24 Hz	27.000	24.000	74.250	+ / +
1920 x 1080	25 Hz	28.125	25.000	74.250	+ / +
1920 x 1080	30 Hz	33.750	30.000	74.250	+ / +
1920 x 1080	50 Hz	56.250	50.000	148.500	+ / +
1920 x 1080	60 Hz	67.500	60.000	148.500	+ / +
3840 x 2160	24 Hz	54.000	24.000	297.000	+ / +
3840 x 2160	25 Hz	56.250	25.000	297.000	+ / +
3840 x 2160	30 Hz	67.500	30.000	297.000	+ / +
*3840 x 2160	50 Hz	112.500	50.000	594.000	+ / +
*3840 x 2160	60 Hz	135.000	60.000	594.000	+ / +
4096 x 2160	24 Hz	54.000	24.000	297.000	+ / +
4096 x 2160	25 Hz	56.250	25.000	297.000	+ / +
4096 x 2160	30 Hz	67.500	30.000	297.000	+ / +
*4096 x 2160	50 Hz	112.500	50.000	594.000	+ / +
*4096 x 2160	60 Hz	135.000	60.000	594.000	+ / +

 *: This resolution is only supported by HDMI 2.0 mode.

Read Before Using Bluetooth Devices

Read this information before using a Bluetooth device.

 This function is not available on certain models in specific geographical areas.

Restrictions on using Bluetooth

- You can't use Bluetooth devices and the [Surround](#) feature simultaneously.
- Compatibility issues may occur, depending on the Bluetooth device. (A Mobile exclusive headphone may not be available, depending on the environment.)
- Lip-sync errors may occur.
- The TV and Bluetooth device may disconnect, depending on the distance between them.
- A Bluetooth device may hum or malfunction:
 - When a part of your body is in contact with the receiving/transmitting system of the Bluetooth device or the TV.
 - When the device is subject to electrical variation from obstructions caused by a wall, corner, or office partitioning.
 - When the device is exposed to electrical interference from same frequency-band devices including medical equipment, microwave ovens, and wireless LANs.
- If the problem persists, try connecting the device using the digital optical port or the HDMI (ARC) port.

Blocking programs based on their TV Rating

Read this information before viewing a blocking program.

To block content, select a rating category to lock. All programs at that level and higher are blocked and require the PIN to watch. To unblock a category, select the lock icon. To unblock all the categories in a row, select the lock under **ALL**.

Categories on the left:

- **TV-Y**: Young children
- **TV-Y7**: Children 7 and over
- **TV-G**: General audience
- **TV-PG**: Parental guidance
- **TV-14**: Viewers 14 and over
- **TV-MA**: Mature audience

Categories on the top:

- **ALL**: Lock all TV ratings.
- **FV**: Fantasy violence
- **V**: Violence
- **S**: Sexual situations
- **L**: Adult Language
- **D**: Sexually Suggestive Dialog

Blocking movies base on their Movie Rating (MPAA)

This rating system applies to all materials with supplied ratings in the U.S.A.

From the MPAA:

“The Motion Picture Association of America (MPAA) has implemented a rating system that provides parents or guardians with advanced information on which films are appropriate for children.”

Select a lock beside one of the rating categories to block that category and all higher categories. To unblock a category, select the lock icon.

- **G**: General audience (no restrictions).
- **PG**: Parental guidance suggested.
- **PG-13**: Parents strongly cautioned.
- **R**: Restricted. Children under 17 should be accompanied by an adult.
- **NC-17**: No children under age 17.
- **X**: Adults only.
- **NR**: Not rated.

Blocking programs based on their Canadian English Rating

This rating system applies to all rated material viewed on English-Canadian TV channels.

Select a lock beside one of the rating categories to block that category and all higher categories. To unblock a category, select the lock icon.

- **C**: Programming intended for children under age 8
- **C8+**: Programming generally considered acceptable for children 8 years and over to watch on their own
- **G**: General programming, suitable for all audiences
- **PG**: Parental Guidance
- **14+**: Programming containing themes or content that may not be suitable for viewers under the age of 14
- **18+**: Adult programming

Blocking programs based on their Canadian French Rating

This rating system applies to all rated material viewed on French-Canadian TV channels.

Select a lock beside one of the rating categories to block that category and all higher categories. To unblock a category, select the lock icon.

- **G**: General
- **8 ans+**: Programming acceptable for children 8 years and over to watch on their own
- **13 ans+**: Programming that may not be suitable for children under the age of 13
- **16 ans+**: Programming not suitable for children under the age of 16
- **18 ans+**: Programming restricted to adults

Blocking Programs based on their Downloadable U.S. Rating

This rating system only applies to material originating from US DTV channels.

Parental restriction information is automatically downloaded while you watch DTV channels. This download may take several seconds. If the information is unavailable from the broadcasting station, the [Downloadable U.S. Rating](#) menu is deactivated.

Parental restriction levels differ with the broadcasting station. The default menu name and the [Downloadable U.S. Rating](#) name changes depending on the downloaded information.

Even when the on-screen display is set to another language, the [Downloadable U.S. Rating](#) menu appears only in English.

Select a lock beside one of the rating categories to block that category and all higher categories. To unblock a category, select the lock icon.

Buttons and Functions

Review available media playback, control, and record buttons and descriptions of how they are used.

 The available buttons and functions may differ with the content you are viewing or playing.





Buttons and functions available while playing multimedia content

Press the Select button while playing any video, photo, or recorded content. The following buttons appear.

 The provided buttons or functions may differ with the media content type.

- **Pause / Play or Start**



Pauses or plays the multimedia content. You can use the following functions when the video is paused.

- **Slow Rewind** or **Slow Forward**: Allows you to play the video slowly (1/8, 1/4, 1/2) backward or forward by selecting the  or  button. To increase the rewind or forward speed in slow mode up to 3 times, select the button repeatedly. To return to normal speed, select the  button or press the  button.

- **Previous / Next**

Displays the previous or the next multimedia content file.

- **Rewind / Fast Forward**

Rewinds or fast forwards the multimedia content. To increase the rewind or fast forward speed up to 3 times faster than normal, select the button repeatedly. To return to normal speed, select the  button or press the  button.

- **360 Mode**

Provides a 360-degree view for videos and photos.

 This function is not supported by some file formats.

- **Repeat**

Plays the current multimedia content repeatedly or all multimedia content files in the same folder repeatedly.

- **Shuffle**

Plays music files in random order.

- **Picture Off**



Plays multimedia content with the screen off.

- **Rotate left / Rotate right**

Rotates a photo left or right.

- **Zoom**
Zooms a photo in by up to a factor of 4.
- **Screen Fit**
Fits a photo to the screen.
- **Background Music**
During a slideshow, plays or pauses the background music.
- **Options**

 The available options may differ with the model and content.

Function	Description
Slideshow Speed	Sets the slideshow speed.
Slideshow Effect	Applies transition effects to the slide show.
Background Music	Plays background music while the TV displays photos.  The music files must be saved in the same USB device as the photo files.  To pause the background music, select Background Music on the playback screen.
Information	Displays detailed information about the current multimedia content.
Subtitles	Controls video subtitles. Subtitles: Turns the subtitles on or off. Language: Sets the caption language. Sync: Adjusts the synchronization when the video and the subtitles are not synchronized. Reset Sync: Resets the subtitle synchronization adjustment to 0. Size: Changes the font size of the subtitles. Encoding: Displays a list of encoding languages. Allows you to change the encoding language when subtitles are displayed incorrectly. Edge Type: Adjusts the position of text and subtitle edges. Edge Color: Changes the color of subtitle edges.
Rotate	Rotates the video.
Audio Language	This function is only available if the video supports multi-track sound.

License

Check the license information and trademarks applied in your TV.



This DivX Certified® device can play DivX® HD video files (including .avi, .divx).
Download free software at www.divx.com to create, play and stream digital videos.
To play purchased DivX movies, first register your device at vod.divx.com. Find your registration code in the DivX VOD section of your device setup menu.
This DivX Certified® device can play DivX® HD video (including .avi, .divx).
DivX®, DivX Certified® and associated logos are trademarks of DivX, LLC and are used under license.
Covered by one or more of the following U.S. patents: 7,295,673; 7,460,668; 7,515,710; 8,656,183; 8,731,369; RE45,052.



For DTS patents, see <http://patents.dts.com>. Manufactured under license from DTS, Inc. DTS, the Symbol, DTS in combination with the Symbol, DTS Premium Sound|5.1, DTS Digital Surround, DTS Express, and DTS Neo2:5 are registered trademarks or trademarks of DTS, Inc. in the United States and/or other countries.
© DTS, Inc. All Rights Reserved.



Manufactured under license from Dolby Laboratories. Dolby, Dolby Audio, Pro Logic, and the double-D symbol are trademarks of Dolby Laboratories.



The terms HDMI and HDMI High-Definition Multimedia Interface, and the HDMI Logo are trademarks or registered trademarks of HDMI Licensing LLC in the United States and other countries.

Open Source License Notice

Open Source used in this product can be found on the following webpage. (<http://opensource.samsung.com>) Open Source License Notice is written only English.



 This license may not be supported depending on your country or model.



THIS PRODUCT IS SOLD WITH A LIMITED LICENCE AND IS AUTHORISED TO BE USED ONLY IN CONNECTION WITH HEVC CONTENT THAT MEETS EACH OF THE THREE FOLLOWING QUALIFICATIONS: (1) HEVC CONTENT ONLY FOR PERSONAL USE; (2) HEVC CONTENT THAT IS NOT OFFERED FOR SALE; AND (3) HEVC CONTENT THAT IS CREATED BY THE OWNER OF THE PRODUCT. THIS PRODUCT MAY NOT BE USED IN CONNECTION WITH HEVC ENCODED CONTENT CREATED BY A THIRD PARTY, WHICH THE USER HAS ORDERED OR PURCHASED FROM A THIRD PARTY, UNLESS THE USER IS SEPARATELY GRANTED RIGHTS TO USE THE PRODUCT WITH SUCH CONTENT BY A LICENSED SELLER OF THE CONTENT. YOUR USE OF THIS PRODUCT IN CONNECTION WITH HEVC ENCODED CONTENT IS DEEMED ACCEPTANCE OF THE LIMITED AUTHORITY TO USE AS NOTED ABOVE.

Accessibility Guidance

Provides a menu and a remote control guide that aid the visually impaired.

Learn Menu Screen

Learn the menus on the TV screen. Once enabled, your TV will tell you the structure and features of the menus you select.

Using the Remote control





Guide for Samsung Smart Remote and standard remote control.

Orientation of the Samsung Smart Remote

Hold the remote control with the buttons facing towards you. The remote is slightly thinner towards the top and thicker towards the bottom. There are two thin horizontal silver rocker buttons next to each other which stand out more than other buttons or small pips, and these are located slightly below the middle of the remote.

Description of the Samsung Smart Remote



From top to bottom and left to right you will find:

- Pip at the top left is the  button.
- Top middle is a small LED.
- Below the LED is a round button which is the  button.
- Underneath the voice recognition button are two small pips, the one on the left is the number pad button and the one on the right is the  button.
- Underneath these two buttons is the directional pad which consists of a large outer circle with a round button in the middle.
- Underneath the directional pad are again two pips, left and right hand side, with a round button in the middle. The one on the left is the return button and the one on the right the  button. The round button in the middle is the  button.

- Below the  button are two thin horizontal silver rocker buttons, these are the only buttons that protrude from the remote. The one on the left is the volume button and the one on the right is the channel button. Push up from beneath or down from above to use these as rocker buttons to change channel or volume.
 - Press on top of the volume button to mute the sound.
 - Press and hold on top of the volume button to open the accessibility menu.
 - Press on top of the channel button to open the program guide.
 - Press and hold the channel button to open the [Channel List](#).

 This function is only available on certain models in specific geographical areas.

The color buttons

Pressing the  button displays on the screen a button for recording the program or starting the Timeshift function (when the program is paused) together with 4 color buttons: red, green, yellow, and blue. You can press the  button while watching live TV.

The play/pause button

Pressing the  button displays a window containing the [Rewind](#), [Play](#), [Fast Forward](#), [Stop Timeshift](#), [Record](#), [Go to Live TV](#), and [Info](#) buttons. With this window on the screen, pressing the up arrow button on the remote control displays the timeshift time and recording time on the control bar.

Using the accessibility menu

View descriptions of accessibility menu functions.

Your TV should be set up and tuned. To use Voice Interaction you will need the TV connected to the internet. You can do this yourself if you are confident enough through the settings menu.

This quick start guide assumes that the TV is set up and tuned and connected to the internet for the Voice Interaction section. If it is not yet connected, then the Voice Interaction section will not be relevant.

Accessibility short cut menu

The accessibility short cut menu allows you to change a number of settings that might help you use the TV including turning voice guide on and off. **Voice Guide** is text-to-speech that speaks the menu items on screen making the TV usable by people who cannot see or read the information on screen.

The menu contains a number of items including:

- **Voice Guide**. This works on every screen on the TV and when turned on speaks to identify items displayed on screen. For example, it tells you the selected volume, the current channel and program information. It also reads out the program information in the Electronic Program Guide (EPG).
- **High Contrast** mode allows you to display all menus with an opaque black background and a white font, providing maximum contrast.
- **Enlarge** enables the important elements on the screen such as the name of programs to be larger.
- **Learn TV Remote** opens a menu screen containing a picture of the remote control. On this screen, pressing the power button (top left button) will turn off the TV, but when any other button is pressed the TV will say the button name and briefly tell what that button does. This teaching mode helps you to learn the location and operation of the buttons on the Samsung Smart Remote without affecting normal TV operation. Press the return button twice to return to the previous screen.
- **Learn Menu Screen**. Learn the menus on the TV screen. Once enabled, your TV will tell you the structure and features of the menus you select.

Opening the accessibility short cut menu:

On the Samsung Smart Remote there are two thin horizontal silver rocker buttons next to each other located slightly below the middle of the remote. The one on the left is the volume rocker button. You press and hold the volume rocker button to open the [Accessibility Shortcuts](#) menu.

This menu will speak regardless of the [Voice Guide](#) settings. It contains several options including turning [Voice Guide](#) on and off, turning [Video Description](#) on and off, changing menu [High Contrast](#), [Enlarge](#), and [Learn TV Remote](#).

Using the accessibility menu

To use the accessibility short cut menu, you will need to locate the arrow keys and select button. See the description of the remote control to learn where these are.

Use the up and down arrow buttons to move between the menu items. Press Select to open a menu item. Generally, this will open a sub-menu with options on. Again, use the up and down arrows to move between options and press Select to choose an option. To close this menu, use the right arrow button to get to the [Close](#) button and select this, or press the [Return](#) or [Exit](#) button.

Step by Step instructions to.

Turn Voice Guide on

1. Press and hold the [VOL](#) button on the remote. The [Accessibility Shortcuts](#) menu appears.
2. Press the up or down arrow on the remote to move to and highlight the [Voice Guide](#) option.
3. Press the Select button on the remote to turn [Voice Guide](#) on or off.
4. Close the menu either by pressing  on the remote or by pressing the right arrow to highlight [Close](#) and then pressing the Select button.

Turn Video Description on

1. Press and hold the **VOL** button on the remote. The **Accessibility Shortcuts** menu appears.
2. Press the up or down arrow on the remote to move to and highlight the **Video Description** option.
3. Press the Select button on the remote to turn **Video Description** on or off.
4. Close the menu either by pressing  on the remote or by pressing the right arrow to highlight **Close** and then pressing the Select button.

Learn the remote

1. Press and hold the **VOL** button on the remote. The **Accessibility Shortcuts** menu appears.
2. Press the up or down arrow on the remote to move to and highlight the **Learn TV Remote** option.
3. Press the Select button on the remote. You are now in the e-Manual and specifically on the Learn TV Remote page.
4. When you have finished and want to exit the e-Manual, press the  button twice to go to the previous page.

Accessing the main accessibility menu to change Voice Guide settings



You can also go to an accessibility menu from the main TV menu. This provides more options, for example, to change the speed of Voice Guide.

The TV will not verbalize this menu unless Voice Guide is already turned on.

1. Press the  button.
2. Press the left arrow key until you reach **Settings**.
3. Press Select and a menu will open.
4. Press the down arrow to reach **General**, and then press Select to open this menu.
5. Use the arrow buttons to go to the **Accessibility** option, and then press Select to open this menu.
6. The menu will appear with **Voice Guide Settings** being the first option. Highlight **Voice Guide Settings**, and then press Select.
7. A menu appears with the options to change speed, and pitch and tone.
8. Select the options using the arrow buttons, and then press Select.

Setting accessibility settings using Voice Interaction

There are many commands you can say to control the TV. These can be used together with [Voice Guide](#) to have voice input and voice output. You will need to use the Samsung Smart Remote for this and the TV must be connected to the Internet.

To speak a command, press and hold the  button (the round button near the top of the Samsung Smart Remote, directly below the LED power indicator and above the directional navigation pad). The TV will give a “speak now” prompt. Say the command, and then release the  button. The TV will confirm the command.

For example you can:

Turn Voice Guide on:

Press the  button on the Samsung Smart Remote and say “Voice Guide on”. When you turn off [Voice Guide](#), there is no audible confirmation that it is turned off.

Turn Audio Description on:

Press the  button on the Samsung Smart Remote, and then say “Audio Description on”.

Turn High Contrast on.

Press the  button on the Samsung Smart Remote, and then say “High Contrast on”.

Using the TV with Voice Guide on

You can turn on Voice Guide that describe the menu options aloud to aid the visually impaired.

To use your TV with Voice Guide enabled, your TV must be set up and connected to the Internet.

Watching TV

Turning the TV on

Press the  button to turn the TV on. Voice guide will speak the channel name, program title and the start and end times for this program.

Changing channel

You can change the channel in a number of ways. Every time you change channels, the new channel details will be announced.

- Channel up/down rocker button
- Open the channel list, use the up and down arrow buttons to move between channels, and then press Select.
- Use the number buttons directly on the standard remote control.
- Use the  button on the Samsung Smart Remote to display the virtual numeric pad on the screen.

Using on-screen number entry via the Samsung Smart Remote:

The virtual numeric pad entry is used to enter numbers e.g. to enter a channel number or to enter a PIN.

Press the  button on the Samsung Smart Remote and the virtual numeric pad with 2 rows appears on screen. Voice Guide speaks “virtual numeric pad, 6” which indicates that the number strip is on screen and the focus is on the number 6. This strip has the following buttons:

- On the bottom row: From the far left: **1 – 9, 0**, move the virtual numeric pad to the top
- The top row: is one button, **Done**.

Use the left and right arrow buttons to move along the row, and then press Select to choose a number or button. When you have finished selecting all the numbers you need (for example, 123), press the up arrow to move to the **Done** button, and then press Select to finish.

When entering a channel number, you can enter the number, and then select the **Done** button on the top row or you can enter the channel number and wait. After a short while, the channel will change and the virtual numeric pad will disappear from the screen.

Changing volume

Use the volume rocker button on the left to change the volume. Every time you change the volume, the new volume level will be announced.

Using program information

When watching live TV, press the Select button to bring up program information at the top of the screen. Voice Guide will speak the program details and say if it has **Audio Description** and **Subtitles** available. Press the left and right arrow buttons to see what is on later on the same channel. Press the up and down arrow buttons to move to the other channels and see what is on at the moment on these channels.

Press and hold Select to bring up more detailed program information.

Voice Guide will speak the program details including the synopsis. Beneath the synopsis there are buttons that allow you to carry out functions such as recording, schedule viewing, timeshift (where you can pause live TV). This synopsis cannot currently be interrupted, so you will need to listen it in its entirety. Use the left and right arrow buttons to move between the buttons, and then press Select when you have reached the one you want. You can also press  to go back or go directly to live TV.

Using the guide

See an overview of each channel's program lineup.

 > [Live TV](#) > [Guide](#)

You can see the daily program schedules for each broadcaster and program information in the [Guide](#). You can also use the [Guide](#) to select programs to watch and to schedule programs to record.

 In the [Guide](#), you can see only the TV programs scheduled after the current time.

You can also open the [Guide](#) using Voice Interaction. Press and hold the  button on your Samsung Smart Remote, and then say the command “[guide](#)”.



 The information in the [Guide](#) is for digital channels only. Analog channels are not supported.

 To view the [Guide](#), you must first set the TV's clock ( >  [Settings](#) > [General](#) > [System Manager](#) > [Time](#) > [Clock](#)).

The clock should have been set to automatic when the TV was installed. If you need to set the clock again, follow the instructions below.

1. Press the  button to open [Smart Hub](#).
2. Press the left arrow until you reach [Settings](#).
3. Press Select to open the main menu.
4. Use the up and down arrows to move through this menu until you reach [General](#), and then press Select.
5. Again, use the up and down arrows to move through this menu until you reach [System Manager](#), and then press Select.
6. Again, use the up and down arrow buttons to reach [Time](#), and then press Select.
7. Move to [Clock](#), and then press Select. Move to the [Clock Mode](#) item, and then press Select.
8. Move to the [Auto](#) setting, and then press Select. Alternatively you can select [Manual](#), and then use the menu to set the time.

When you open the [Guide](#), a table grid of channels and programs is displayed. The top row shows [Channel Filter](#) being displayed then the day and times. Each row has a channel name on the left and programs on that channel on the right.

In the [Guide](#), use the up and down arrow buttons to move between channels and the left and right buttons to move between programs within a channel. You can also use the  button to enter a channel number and go to that channel directly. You can use the  button to go to the current time.

If you are using the standard remote control, you will be able to move backwards and forwards 24 hours through the program guide by using the  and  buttons.

When you move the focus to a program, you will hear the program title, start/end time, and synopsis. You will also hear if the [Audio Description](#) and [Caption](#) are available for the program. When you move the focus to a different channel, you will hear the channel name and number, and then the program details. If you move to a different day, you will hear the day announced for the first program you reach on that day. The day is not repeated, so if you are not sure what the day is, you can move forwards and backwards 24 hours and then the day will be announced.

To view a program on now

Move to a program that is currently broadcasting, and then press Select to go to live TV on the channel and program you selected in the guide.

Other options in the guide

After moving to a desired program, press and hold the Select button on the remote control. A pop-up window listing the following functions appears.

Use the up and down arrow buttons to move within this menu, and then press Select to choose an item. Press  to close the menu and go back to the [Guide](#).

- **Scheduled viewing**

After selecting [Schedule Viewing](#), you can schedule viewing for a broadcast scheduled program.

- **Scheduled recording**

After selecting **Schedule Recording**, you can schedule recording for a broadcast scheduled program.

 This function is not available in the U.S.A. and Canada.

 For more information on **Schedule Recording**, refer to "Recording Programs."

- **Detailed information**

After selecting **View Details**, you can see the detailed information on the selected program. The information may differ with the broadcast signal. If the information is not provided with the program, nothing appears.

Press Select on the **View Details** option. This will open the Details page for that program which will display a synopsis. To close this page, press the Select button.

- **Displaying Record & Schedule Manager**

After selecting **Schedule Manager**, you can see the **Recording & Schedule Manager** screen.

When you have scheduled a program to record or view, an icon will be shown next to the program title in the **Guide** denoting if the program is scheduled to view or record (these icons are different visually). Voice Guide will not speak this information. To find out if a program is scheduled to record or view, press and hold the Select button. The option in the menu will be Cancel schedule instead of schedule viewing or schedule recording. Press  to go back to the **Guide** without changing the setting.

Displaying your favorite channels:

If you have set up favorite channels, you will be able to filter the **Guide**, so that only those channels are shown. This makes it easier to find channels you want.

To display your favorites list, move to the current time (press the  button) and then press the left arrow to move to the list of channels. Use the up arrow to move up the list until you reach the **Channel Filter** button. Press Select to bring up a list of options. Use the up and down arrows to move between the categories in the list. Highlight the option you want, for example, **Favorites 1**, and then press Select. The **Guide** will then show the information for only those channels.

 When you have set a filter in the **Guide**, it will remain when you close and re-open the **Guide**. If you find that you don't have the channels you think you should, it is a good idea to check the category, and then select "**All**" which will display all tuned channels.

Setting Up a Schedule Viewing

Configure the TV to show a specific channel or program at a specific time and date.

The  icon appears next to programs that have been configured for a schedule viewing.

Setting up a schedule viewing for a channel

- **The Guide Screen**

On the **Guide** screen, select a program you would like to view, and then press and hold the Select button. Select **Schedule Viewing** on the pop-up menu that appears.

- **The Program Info Screen**

Press the Select button while watching the TV. The Program Info window appears. Select a broadcast scheduled program by using the left or right directional buttons, and then press and hold the Select button. You can schedule watching the program by selecting **Schedule Viewing**.

Cancelling a schedule viewing

 > **Live TV** > **Schedule Manager** or **Recordings** > **Scheduled Remove**

You can cancel a scheduled viewing via the **Guide** or **Smart Hub**.

From the program guide, move to the program, and then press and hold Select. Move to the **Cancel Schedule** option, and then press Select. You will return to the program guide with the scheduled viewing removed.

To use **Smart Hub**, press the  button to open **Smart Hub**, press the up arrow to move to the top row and the right arrow to move to **Schedule Manager**. Press Select to open **Schedule Manager**. Press the up arrow to reach the top menu which has two buttons **Recordings** and **Schedules**. Press the left or right arrows to highlight **Schedules**, and then press Select. Use the down arrow to move to the list of programs scheduled to view. Move to the program you want, and then press the right arrow to move to a list of options. Use the up and down arrows to move between these options until you reach the **Delete** button. Press the Select button to remove the scheduled viewing.

Using the Channel List

See how to list the channels available on your TV.

> [Live TV](#) > [Channel List](#)

Using [Channel List](#), you can change the channel or check programs on other digital channels while watching TV.

Press the  button on the remote to open [Smart Hub](#), press the left or right arrows to move to [Live TV](#), press the up arrow to move to the top row, press the right arrow to move to [Channel List](#), and then press the Select button. This shows a list of the channels and the program currently on. The focus will be on the channel you are currently watching, showing channel name, channel number, and program title.

Use the up and down arrows to move within the channel list (or use the channel rocker button to go up and down a page at a time). You can also use the  button to enter a channel number and go to that channel directly.

Pressing the right arrow takes you to the [Category List](#). Use the up and down arrows to move within this list. Press Select to choose an option. You will open a second list. Use the up and down arrows to move between the items in the list. Press Select to choose one.

- [All Channels](#)

Displays the channels that have been automatically searched.

- [Favorites](#)

Displays Favorites Lists 1 to 5. Use the up and down arrows to move between the lists of favorites. Highlight the one you want, and then press Select. The channel list will now show only the channels in this list.

- [Category](#)

Sorts the list so that it includes channels of a selected genre only. However, [Category](#) can only be used with channels that contain genre information. Use the up and down arrows to move within the list of genres (or TV, radio, data). Highlight the genre you want, and then press Select. The channel list will now show only the channels in this genre.

- **Sort**

Sorts the list by **Channel Number** or by **Name**.



This option is only available on digital channels and may not always be available.

- **Air or Cable**

Allows you to choose between **Air**, and **Cable**.



This option is only available on certain models in specific geographical areas.

Creating a Personal Favorites List

Designate frequently watched channels as favorite channels.

Favorite channels are highlighted in the **Edit Channel** and **All** screens with the symbol .



There is currently no feedback with Voice Guide for this.

Registering channels as favorites



> **Live TV** > **Channel List**

1. Press the right directional button on your remote control.
2. Select **Favorites**.
3. Select a desired favorites list.
4. Move to **Edit Favorites**.
5. Select a channel to add to the favorites list
6. Press Select. The selected channel is added to the favorites list.

To add channels to a favorites list - Detail

1. Open the [Channel List](#).
2. Press the right arrow to move to the [Category List](#).
3. Use the up and down arrow buttons to move to [Favorites](#), and then press Select. You will see Favorites Lists 1 to 5. The five lists let you set up different lists of favorites.
4. Use the up and down arrow buttons to move to the list you want, and then press Select.
5. Use the up and down arrow buttons to move between channels. When you reach a channel you want as a favorite, press Select. This will select the channel and put a check in the checkbox.
6. When you have selected all the channels you want, press the right arrow button.
7. On the next screen, highlight [Add to Favorites](#), and then press Select. The selected channels are added to the Favorites List.

Deleting channels from a favorites list – Detail

1. Open the [Channel List](#).
2. Press the right arrow to move to the [Category List](#).
3. Use the up and down arrow buttons to move to [Favorites](#), and then press Select. You will see Favorites Lists 1 to 5.
4. Use the up and down arrow buttons to move to the list you want, and then press Select.
5. Use the up arrow buttons to move to [Edit Favorites](#), and then press Select.
6. Use the right arrow button to move to [Favorites](#), move to the channel to remove, and then press Select. Repeat for other channels to remove.
7. Press the left arrow button to move to the [Add to Favorites](#) / [Remove from Favorites](#) buttons.
8. Highlight [Remove from Favorites](#), and then press Select to remove the selected channels from the Favorites List.
9. Press the right arrow button.
10. On the next screen, highlight the [Exit](#) button, and then press Select.

Viewing and selecting channels on favorites lists only

> [Live TV](#) > [Channel List](#)

1. Open the channel list by pressing the **Channel List** button
2. Press the right directional button on your remote control. Use the up and down arrow buttons to move within the list.
3. Highlight **Favorites**, and then press Select.
4. Use the up and down arrow buttons to move within the list. Select the desired list among five favorites lists on the screen. The channels in the selected favorites list appear.

 A list of channels appears only if the favorite list you selected contains channels.

Recording

Recording a program to an external hard drive connected via USB.



When you have set a program to record an  icon appears next to the program title in the guide or channel list or when viewing further information.

 This function is not available in the U.S.A. and Canada.



 This function is only available on certain models in specific geographical areas.

 Read all precautions before using the recording feature. For more information, refer to "[Before Using the Recording and Timeshift Functions.](#)"

Using the instant and schedule recording options from the guide screen:

To record a program that is on now, open the program guide, move to the program and then press and hold the Select button. You will get a pop-up menu. Use the up and down arrow buttons to move to **Record**. Press select to record the program. You will be returned to the program guide. The  icon is shown next to the program title. To find out if the program is set to record or to stop the recording press and hold the Select button. The menu is displayed and there is now a **Stop** option instead of a **Record** option. Press select on **Stop** to stop the recording or press the  button to go back to the program guide without stopping the recording.

To record a program that is on later, move to the program in the guide, and then press Select. You will get a pop-up menu. Use the up and down arrows to move within this menu. Move to the **Schedule Recording** option, and then press Select. You will hear a message saying the program has been set to record and then you will be returned to the program guide.

The  icon is placed visually next to the program title to show it is set to record. To find out if a program is set to record or to cancel a scheduled recording, press select on the program. If it is already set to record, then the option on the menu will be **Cancel Scheduled Recording**. You can press select to cancel the scheduled recording or just press the  button to go back to the program guide without cancelling the recording.

Using the Instant and Schedule Recording options from program info window

To display a menu for recording a program or starting the Timeshift function, press the  button while watching the program. You can select the following functions on the menu:



- **Record**: Immediately starts to record the program you are watching.
- **Timeshift**: Starts the Timeshift function.
- **Stop**: Stops the recording or the Timeshift function that is running.
- **Info**: Displays the details about the program you are watching.

Recording a program you are currently watching directly from live TV

If you want to record a program you are currently watching you can also just press the record button on the standard remote control. This will tell you that the program is recording and how long it will record for (the default is until the end of the program).

Changing the recording time

When recording a live program you can specify how long you want to record for.

Press the  button on the remote, press the left or right arrows to move to [Edit Recording Time](#), and then press the Select button. A slider scale appears and you will hear the recording time currently set. Use the left and right arrows to change the time, and then press the Select button. You will hear a menu that gives information about the recording time. To return to the program you are watching, press the  button on the remote, or press the left or right arrows to move to [Go to Live TV](#) and then press the Select button.

Viewing recorded programs

 > [Live TV](#) > [Schedule Manager](#) or [Recordings](#) > [Record](#)

Open [Smart Hub](#) by pressing the  button on the remote control. You will be on the [Live TV](#) option. Press the up arrow to move to the row above, and then move to the [Guide](#) option.

Press the right arrow to move to [Recordings](#), and then press Select. This will open the [Recording & Schedule Manager](#) screen showing [Recordings](#) and [Schedules](#). The focus is placed on the first [Recordings](#).

To play a program, use the up and down arrows to move between program titles. Press Select to play the program or press the right arrow button to move to a list of options. Use the up and down arrows to move between the options in this list. You can play, remove, or delete the program, or view the program details.

Select the [Play](#) option to play the program. The program will start. If you have watched part of this program before, you will get a pop-up menu on screen allowing you to [Play](#) (from start), [Resume](#) (from where you left off), or [Cancel](#). Use the left and right arrow buttons to move to the required option, and then press Select.

 This function is only available on certain models in specific geographical areas.

Deleting a recorded program

To delete a recorded program, go to the list of [Recordings](#) (see viewing recorded programs). Use the up and down arrow buttons to move to the recording you want to delete.

Press the right arrow button to move to a list of 3 options. Press the down arrow to move to the [Delete](#) option, and then press Select.











You will be asked if you want to remove the selected item. Press the left arrow to move to the [Delete](#) button, and then press Select to delete the program title. The program will be deleted and you will be returned to the list of [Recordings](#).

Using Smart Hub

Learn how to open Smart Hub to access apps, games, movies, and more.





Smart Hub

After pressing the  button on your remote control, you can surf the web and download apps with Smart Hub.

-  Some [Smart Hub](#) services are for pay services. To use a for pay service, you must have an account with the service provider or a Samsung account. For more information, refer to "[Using a Samsung account](#)."
-  To use this feature, the TV must be connected to the Internet.
-  Some [Smart Hub](#) features may not be available depending on the service provider, language, or region.
-  [Smart Hub](#) service outages can be caused by disruptions to your Internet service.
-  You can view the entire text of the [Terms & Policy](#) by navigating to  >  [Settings](#) > [Support](#) > [Terms & Policy](#).
-  To cancel the Smart Hub service agreement, select [Reset](#) ( >  [Settings](#) > [General](#) > [Support](#) > [Self Diagnosis](#) > [Reset](#)), and then press the right directional button at the [Smart Hub Terms & Conditions, Privacy Policy](#) step.
-  You must accept the Smart Hub service agreement to use Smart Hub. If you cancel the agreement, you will no longer be able to use Smart Hub.

Press the  button on your remote. This will bring up a display with 2 rows. The focus will be on [Live TV](#) on the bottom row. The options on the top row change depending on the item selected in the bottom row.

The bottom row contains buttons to the left of Live TV. These are:

-  **Search** – to search for data about channels, programs, movie titles, and apps in Smart Hub.
-  **Source** – to select an external device connected to the TV
-  **Settings** – a quick settings menu appears on the top row. You can quickly set frequently used functions.
-  **APPS** - You can enjoy a wide range of content including news, sports, weather, and games by installing the corresponding apps on your TV.
-  **Art** - You can use the Art Mode function to edit image content such as artworks or pictures when you are not watching TV or when the TV is turned off, and then display the content in full screen mode.

 This function is supported only in THE FRAME model.

 For more information, refer to the provided user manual.

The buttons to the right of the **Live TV** option provide quick access to apps such as **Netflix** and **Amazon**. Currently, many of these apps are not accessible with Voice Guide.

Use the left and right arrow buttons to move between options on a row and the up and down arrows to move between rows. Press Select to access an option.

When you open **Smart Hub**, you will be on **Live TV**. Press the up arrow to move to the top row. You will be on the Guide button. The items in this row are:

- **Guide** –select to open the program guide
- **Channel List** – select to open the channel list
- To the right of the Channel List button, you will find a list of recently viewed channels. Highlight one of the channels in the list, and then press Select to go quickly to that channel.

Displaying the Home Screen in Smart Hub

On the Home Screen, you can easily run apps you have used previously or frequently. The apps can also be moved on or deleted from the screen.

Smart Hub has 2 rows. When it opens, the focus is on Live TV on the bottom row. The options on the top row change depending on the item selected in the bottom row. Use the up and down arrows to move between the rows and the left/right arrow buttons to move within a row.

The bottom row contains buttons to the left of Live TV. These are **Settings**, **Source**, **Search**, and **APPS**:

-  **Settings**

When the focus is moved to the  icon, a list of quick settings icons appears above the top of the menu. You can quickly set frequently used functions by clicking the icons.

- **Picture Mode**

You can select the picture mode that provides the best viewing experience.

- **Sound Mode**

You can select a sound mode to optimize your listening experience.

- **Sound Output**

You can select which speakers the TV uses for audio output.

- **Caption**

You can watch TV broadcasts with captions.



This function is not available on certain models in specific geographical areas.

- **Sleep Timer**

You can automatically shut off the TV after a pre-set period of time.

- **Network**

You can view the current network and Internet status.

-  **Source**

You can select an external device connected to the TV.



For more information, refer to "[Switching between external devices connected to the TV.](#)"

-  **Search**

You can search the apps or games in Smart Hub services. The search option brings up an on-screen keyboard laid out as a qwerty keyboard with the focus on the number 1.

-  **APPS**

You can enjoy a wide range of content including news, sports, weather, and games by installing the corresponding apps on your TV.

 To use this feature, the TV must be connected to the Internet. For more information, refer to "[Using the APPS Service.](#)"

-  **Art**

You can use the Art Mode function to edit image content such as artworks or pictures when you are not watching TV or when the TV is turned off, and then display the content in full screen mode.

 This function is supported only in THE FRAME model.

 For more information, refer to the provided user manual.

Using the e-Manual

Open the user manual embedded in your TV.

Launching the e-Manual

Press the menu button on the standard remote control to open the menu. Alternatively, press the  button to open **Smart Hub**, press the left arrow until you reach settings, and then press Select.

Use the up and down arrows to move within this menu. Move to the **Support** option, select the **e-Manual** option, and then press Select to open it.

 >  **Settings** > **Support** > **Open e-Manual**

You can view the embedded e-Manual containing information about your TV's key features.

 Alternatively, you can download a copy of the e-Manual from Samsung's website.

 Words in blue (e.g., **Picture Mode**) indicate a menu item.

The e-Manual contains 2 rows of buttons. Use the up and down arrows to move between rows and the left and right arrows to move within a row. Press Select to open the section you want to read.

The e-Manual contains a section called "Learn TV Remote" in "Accessibility Guidance" (at the right corner of the screen). This is particularly useful for people who cannot easily see the buttons on the control or who are not clear what each button does. In this section, the buttons on the remote control will not affect the TV.

Using Voice Interaction

A Guide to using Voice Interaction to control your TV.

To use Voice Interaction, your TV must be connected to the Internet and you must use the microphone on your Samsung Smart Remote.

Voice Interaction lets you speak commands to control the TV, for example, to change the channel or display the program guide. This is not the same as Voice Guide which provides speech output from the TV that says what is displayed on screen. Voice Guide is useful for people who cannot see or read the menu items on screen.

To use Voice Interaction, you press the  button on the remote, say a command, such as "Guide", into the microphone on your Samsung Smart Remote.

 This function may not be supported depending on the model or geographical region.

Running Voice Interaction

Press and hold the  button on the Samsung Smart Remote. The TV will respond, saying "Speak now". Say the command you want, and then release the button. The TV will provide feedback about what it has understood, and then carry out the action.

 If the TV cannot identify the command, try again with more precise pronunciation.

 This function may not be supported depending on the model or geographical region.

Some useful commands are:

- **Voice Guide on/off** – turns the speech output on/off
- **Audio description on/off** – turns audio description on/off
- **Guide** – opens the program guide
- **Channel list** – opens the channel list
- **Volume up/down** – changes the volume up/down

You can also search for videos on YouTube. Press and hold the  button, and then say a phrase for example, "songs by [name]". This will bring up a list of video clips of songs by that artist.

 Voice Guide will voice a lot of information about the video. It is not yet possible to interrupt this and it will run over the first few seconds of the video.

If you say a command which is not recognized, the TV will often try a search. Press  to return to TV.