

RS 160

Digital Wireless Headphone System



Instruction Manual

Contents

The RS 160 digital RF headphone system	4
Delivery includes	5
Product overview	6
Overview of the HDR 160 headphones	6
Overview of the TR 160 transmitter	7
Overview of the indicators and acoustic signals	8
Overview of the connection stages	10
Putting the RS 160 into operation	11
Setting up the transmitter	11
Connecting the transmitter to a sound source	12
Powering the transmitter	13
Powering the headphones	15
Adjusting the headband of the headphones	17
Using the RS 160	18
Switching the transmitter on and off	18
Switching the headphones on and off	20
Adjusting the volume on the headphones	21
Muting the headphones	21
Adjusting the signal of the sound source	22
Associating the headphones to the transmitter	23
Listening with several headphones simultaneously	26
Cleaning the RS 160	27
If a problem occurs	28
Accessories and spare part	30
Specifications	31
Manufacturer declarations	32

Important safety information

- ▶ Read this instruction manual carefully and completely before using the product.
- ▶ Always include this instruction manual when passing the product on to third parties.
- ▶ Do not use an obviously defective product.

Preventing damage to health and accidents



- ▶ Protect your hearing from high volume levels. Permanent hearing damage may occur when headphones are used at high volume levels for long periods of time. Sennheiser headphones sound exceptionally good at low and medium volume levels.
- ▶ Keep the headphones at least 10 cm/3.94" from cardiac pacemakers or implanted defibrillators. The headphones contain magnets that generate a magnetic field which could cause interference with cardiac pacemakers and implanted defibrillators.
- ▶ Keep the product, accessories and packaging parts out of reach of children and pets to prevent accidents and choking hazards.
- ▶ Do not use the product in situations which require special attention (e.g. in traffic or when performing skilled jobs).

Preventing damage to the product and malfunctions

- ▶ Always keep the product dry and do not expose it to extreme temperatures to avoid corrosion or deformation. The normal operating temperature is from 0 to 40°C/32 to 104°F.
- ▶ Use only attachments/accessories/spare parts supplied or recommended by Sennheiser.
- ▶ Unplug the power supply unit from the AC wall outlet if you are not going to use the product for extended periods of time.
- ▶ Varnish or furniture polish may degrade the feet of the transmitter, which could stain your furniture. You should therefore place the transmitter on a non-slip pad to avoid potential staining of furniture.
- ▶ Do not place your headphones on a glass dummy head, chair armrest or similar objects for long periods as this can widen the headband and reduce the contact pressure of the headphones.
- ▶ Clean the product only with a soft, dry cloth.

Intended use/Liability

This wireless headphone system is suitable for use with portable devices, hi-fi systems, TV sets, and home cinema systems.

It is considered improper use when this product is used for any application not named in this instruction manual and the associated product guides.

Sennheiser does not accept liability for damage arising from abuse or misuse of this product and its attachments/accessories.

Replacement parts

When replacement parts are required, be sure the service technician uses replacement parts specified by Sennheiser or those having the same characteristics as the original part. Unauthorized substitutions may result in fire, electric shock, or other hazards.

















Safety instructions for standard/rechargeable batteries



WARNING

In extreme cases, the standard/rechargeable batteries may leak and may cause the following hazards if abused or misused:

- explosion
- fire
- heat
- smoke/gas

	Keep away from children.		Do not heat above 70°C/ 158°F), e.g. do not expose to sunlight or throw into a fire.
	Do not expose to moisture.		When not using rechargeable batteries for extended periods of time, charge them regularly (about every 3 months).
	Do not mutilate or dismantle.		When not using the product for an extended period of time, remove the standard/rechargeable batteries.
	Observe correct polarity.		Use only rechargeable batteries and chargers recommended by Sennheiser.
	Pack/store standard/charged rechargeable batteries so that the terminals cannot contact each other – danger of shorting out/ fire hazard.		Do not continue using defective standard/rechargeable batteries and dispose of them immediately.
	Switch battery-powered products off after use.		Immediately remove standard/rechargeable batteries from an obviously defective product.
	Charge rechargeable batteries at ambient temperatures between 10 and 40°C/50 and 104°F.		Dispose of standard/rechargeable batteries at special collection points or return them to your specialist dealer.
	Do not charge standard batteries.		Do not mix standard and rechargeable batteries in the battery compartments.

The RS 160 digital RF headphone system

The RS 160 is an RF stereo hi-fi headphone system with comprehensive technical features. Its transparent and balanced sound image with excellent bass response makes this system an ideal choice for hi-fi, home cinema and TV use.

Enjoy total freedom of sound, stylish design and maximum comfort.

Additional features of the RS 160 headphone system

- Transmits uncompressed audio over a robust 2.4 GHz digital link, enabling you to enjoy your music without the hassles of cables.
- Dynamic transducer systems with powerful neodymium magnets deliver clear and detailed audio reproduction.
- Kleer's uncompressed digital wireless transmission delivers CD-quality sound.
- No set-up required – just plug and play. Simply connect the transmitter to your personal audio/video player, put on the headphones and turn it on!
- TR 160 transmitter with multi-receiver capability, enabling up to 4 people to listen to the same sound source.

Kleer™ wireless transmission technology



The RS 160 headphone system features the digital wireless audio transmission technology from Kleer. The Kleer company has developed an RF-based wireless transmission standard (of the same name) that offers lossless audio transmission in CD-quality while consuming minimal power.

Delivery includes

- 1 HDR 160 headphones
- 1 TR 160 transmitter
- 1 Power supply unit with country adapters
- 1 Stereo audio cable with 3.5 mm jack plugs
- 1 DC cable (4.0 mm DC jack socket to 2 x 4.0 mm DC plug)
- 2 Low self-discharge NiMH rechargeable batteries, AAA size
- 1 Quick guide
- 1 Safety guide

Product overview

Overview of the HDR 160 headphones

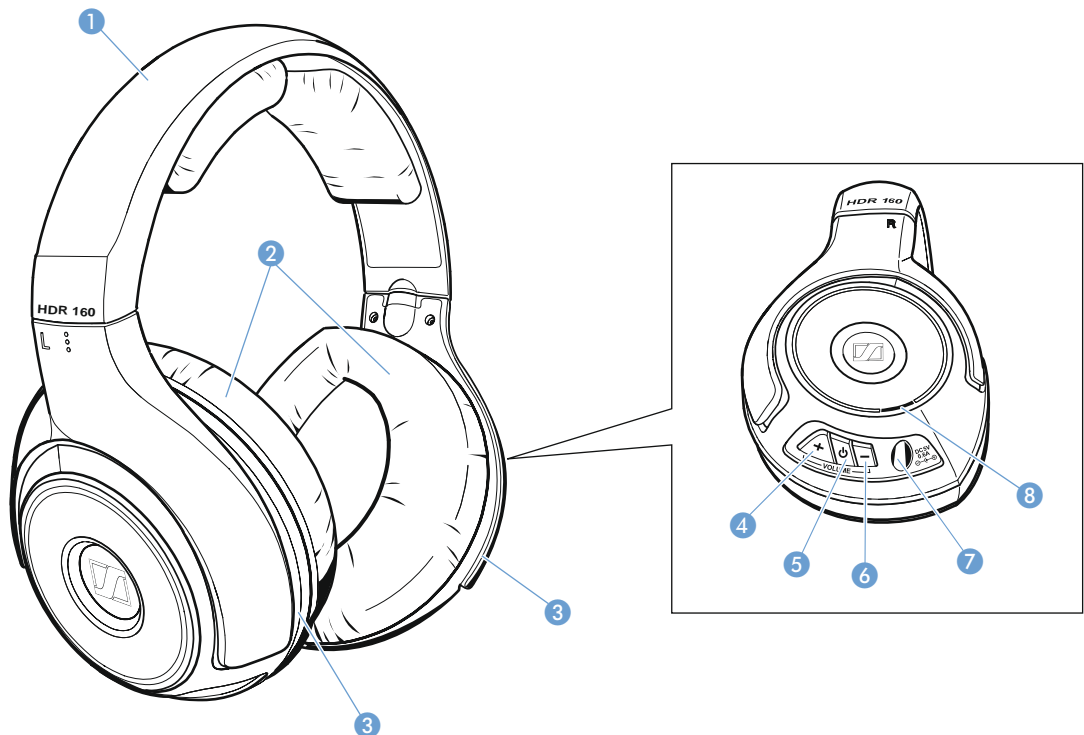



- ① Headband
- ② Ear pads
- ③ Battery compartments
- ④ VOLUME + button
- ⑤ Multi-function button 
- ⑥ VOLUME - button
- ⑦ Charging socket (DC 5V 0.6A)
- ⑧ Multi-function LED

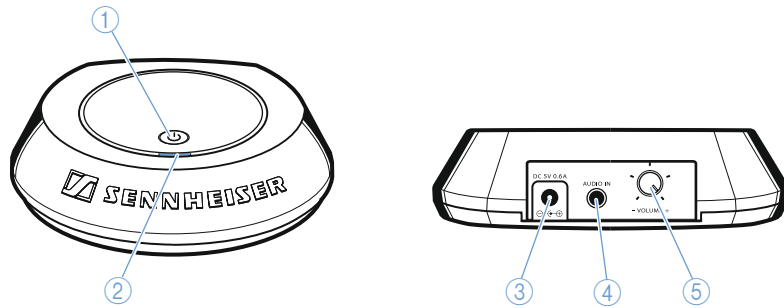

With the multi-function button  ⑤, you can switch the headphones on/to standby mode, set the headphones to multi-user operation, mute the headphones and associate the headphones.

Overview of the TR 160 transmitter





- ① Multi-function button 
- ② Multi-function LED
- ③ Socket for power supply unit (DC 5V 0.6A)
- ④ Audio input (AUDIO IN)
- ⑤ VOLUME control (- +)









With the multi-function button  ①, you can switch the transmitter on/to standby mode, set the transmitter to multi-user operation and associate the transmitter.

Overview of the indicators and acoustic signals





Meaning of the pictograms for the different LEDs

Status	Meaning
	The LED is lit.
	The LED flashes once per second.
	The LED flashes twice every 5 seconds.

Indicators on the headphones

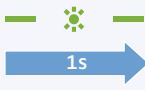
Indicator	Status	Meaning
Multi-function LED 		The rechargeable batteries are almost flat.
		The rechargeable batteries are being charged.
	off	The rechargeable batteries are fully charged.
		The headphones are in enrollment mode (searching for a transmitter to pair with).
		The headphones are in association mode (exchanging device information with the transmitter).
		The headphones receive an audio signal.

Indicators on the transmitter

Indicator	Status	Meaning
Multi-function LED ②		The signal of the sound source is too strong.
		The transmitter is in enrollment mode (searching for headphones to pair with).
		The transmitter is in association mode (exchanging device information with the headphones).
		The transmitter is in single-user operation.
		The transmitter is in multi-user operation.

Acoustic signal of the headphones

1 short beep	Meaning
	The minimum volume is reached.
	The maximum volume is reached.

Overview of the connection stages

Connection establishment

Enrollment mode

When you switch the headphones and the transmitter on, the headphones search for a suitable transmitter.

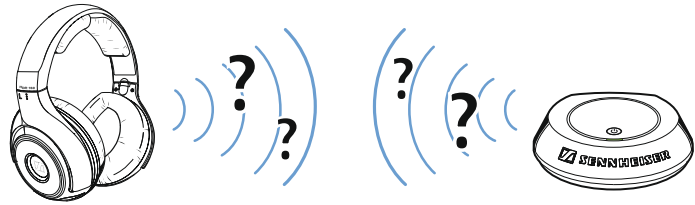

Pairing

The headphones and the transmitter have recognized each other and the headphones are paired with the transmitter.

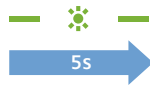

Single-user and multi-user operation

Single-user operation

You can listen to your sound source via one pair of headphones. By default, the transmitter is set to single-user operation (see page 23).



Multi-user operation

In order to be able to listen to your sound source with several headphones simultaneously, you have to set your transmitter to multi-user operation (see page 26).

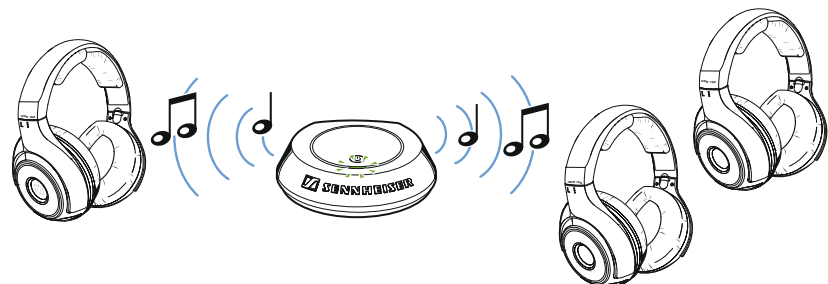

Putting the RS 160 into operation

Setting up the transmitter

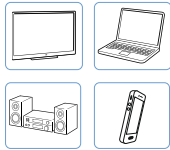

- ▶ Choose a suitable place near your sound source (e.g. TV, stereo or home cinema system).
- ▶ Do not place the transmitter close to metal objects such as shelf bars, reinforced concrete walls, etc. as this can decrease the transmitter's range.
- ▶ Make sure that there is direct line of sight between the transmitter and the headphones.



Connecting the transmitter to a sound source

You can connect the TR 160 transmitter to different sound sources, such as a TV, a smartphone or a stereo system.

- ▶ Switch your sound source off before connecting the transmitter.

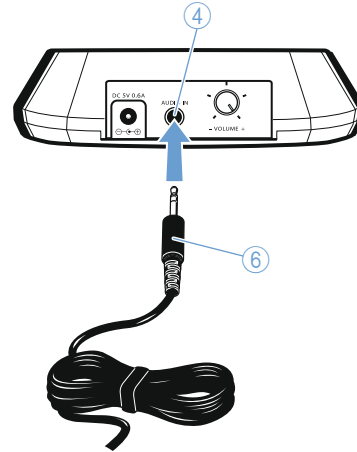

- ▶ Connect the audio cable ⑥ to the audio input ④ of the transmitter.
- ▶ Connect the audio cable ⑥ to the headphone socket of your sound source.

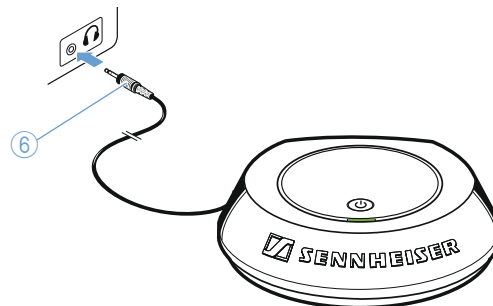

- ▶ Adjust the volume on your sound source to a medium level. This improves the quality of wireless sound transmission. If necessary, check the settings of your sound source.

Powering the transmitter

For powering the TR 160 transmitter, you can use:

- the supplied NT5-6AW power supply unit for stationary use
- rechargeable batteries (AA size, NiMH, 1.2 V, at least 1,300 mAh) for mobile use
- standard batteries (AA size, 1.5 V) for mobile use

Powering the transmitter via the power supply unit

- ▶ Select the suitable country adapter **8** for your wall socket.
- ▶ Slide the country adapter **8** onto the power supply unit **7** until it locks into place.

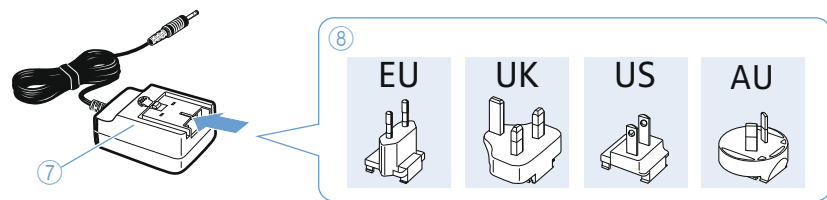

- ▶ Connect the connector **9** of the power supply unit to the socket **3**.

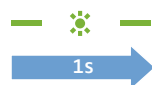
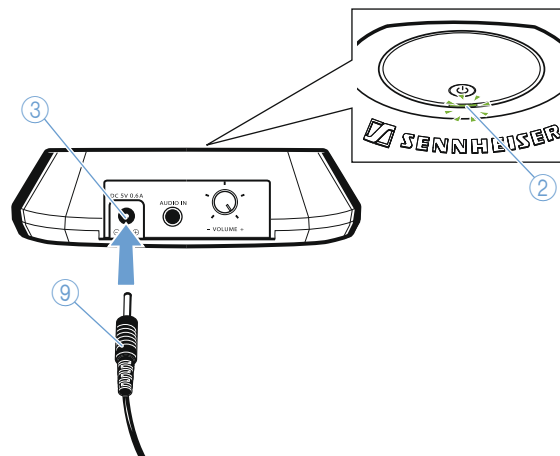

- ▶ Plug the power supply unit **7** into a wall socket. The transmitter switches on. The multi-function LED **2** flashes green after 9 seconds. The transmitter is in enrollment mode.

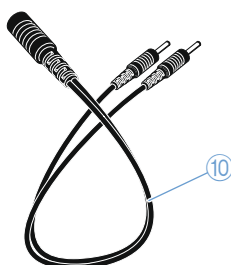

- ▶ You can also connect the charging cable **10** to the connector **9** of the power supply unit to conveniently charge your headphones (see "Charging rechargeable batteries in the headphones" on page 16).

Inserting rechargeable batteries/standard batteries into the transmitter and changing them

- ▶ Power the TR 160 transmitter either with rechargeable batteries (AA size, NiMH, 1.2 V at least 1,300 mAh) or standard batteries (AA size, 1.5 V).
- ▶ Open the battery compartment at the base of the transmitter as shown.
- ▶ Remove the depleted rechargeable batteries or batteries (where applies).
- ▶ Insert the rechargeable batteries or batteries. Observe correct polarity.

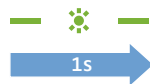
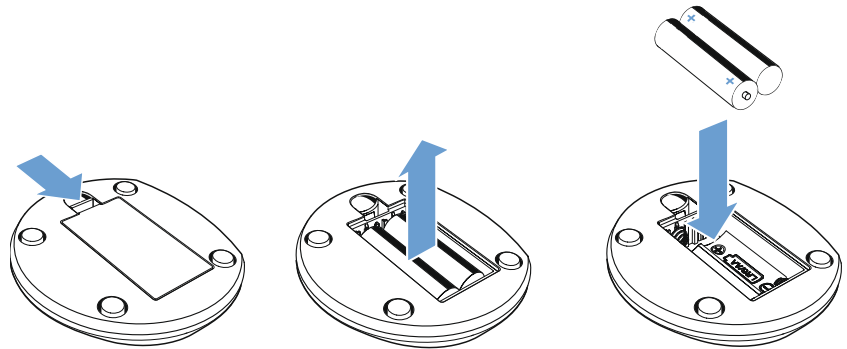

- ▶ Close the battery compartment.
The cover locks into place with an audible click and the transmitter switches on. The multi-function LED ② flashes green after 9 seconds. The transmitter is in enrollment mode.

Powering the headphones

For powering the headphones, you can use:

- standard batteries (AAA size, 1.5 V)
- rechargeable batteries (AAA size, NiMH, 1.2 V)

If you use rechargeable batteries, you can charge them in the headphones using the charging cable ⑩ (see next chapter).

Inserting rechargeable batteries/standard batteries into the headphones and changing the rechargeable batteries/standard batteries



- ▶ Remove the ear pads ② from both ear cups by turning the ear pads in the direction of the arrow until you overcome a slight resistance.
- ▶ Lift the ear pads ② off the ear cups.

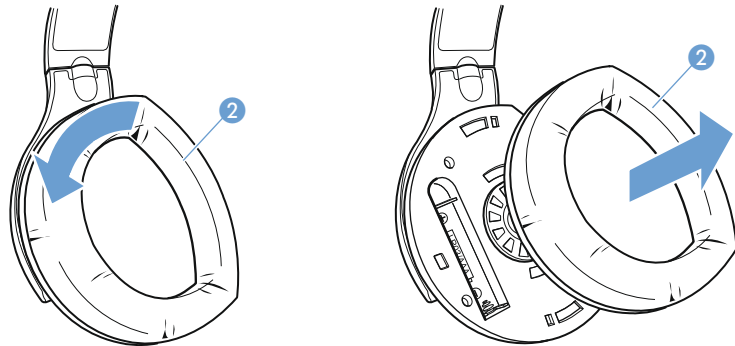

- ▶ Remove the depleted rechargeable batteries or batteries (where applies).
- ▶ Insert the rechargeable batteries or batteries. Observe correct polarity.

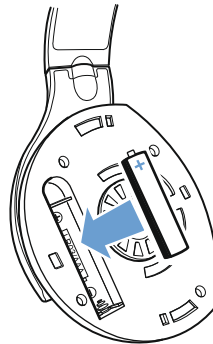

- ▶ Secure the ear pads ② to the ear cups.

Charging rechargeable batteries in the headphones

CAUTION Danger of damage to the headphones!

If standard batteries are inserted into the headphones, the batteries can leak during charging and damage the headphones.

- ▶ Only charge rechargeable batteries in your headphones.

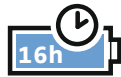

Charge the rechargeable batteries for at least 16 hours prior to first time use. Subsequent charging time is about half of the previous operating time. The operating time is up to 24 hours.

- ▶ Connect the charging cable ⑩ to the charging socket ⑦ on the headphones.
- ▶ Connect the charging cable ⑩ to the socket ③ on the transmitter.
- ▶ Connect the charging cable ⑩ to the connector ⑨ of the power supply unit.
- ▶ Plug the power supply unit ⑦ into a wall socket. The rechargeable batteries are being charged. The multi-function LED ⑧ on the headphones lights up orange.

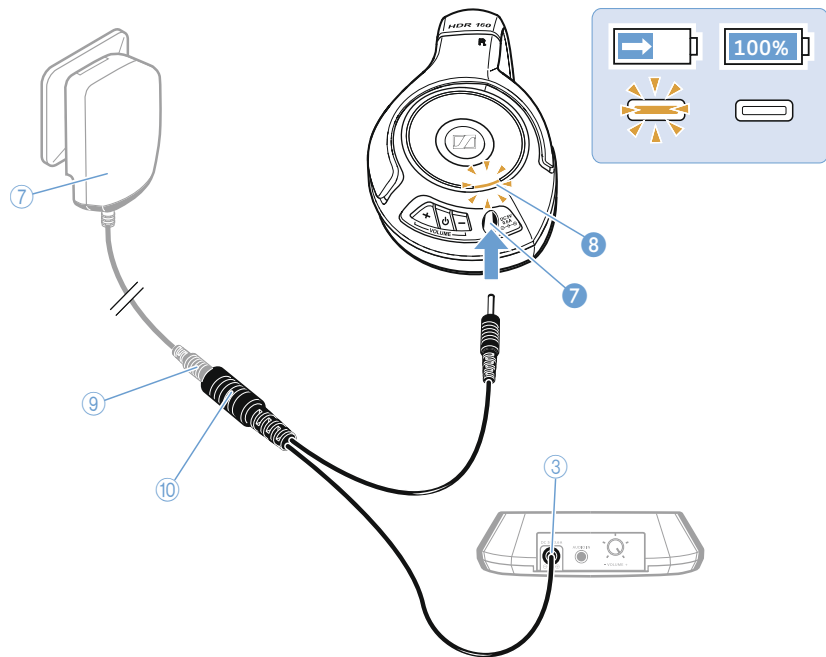

The transmitter automatically switches from battery operation to mains operation if you connect the power supply unit or the charging cable ⑩ to the transmitter.

Adjusting the headband of the headphones

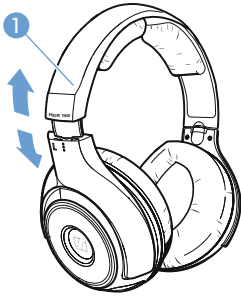

For good sound quality and best possible comfort, the headband has to be adjusted to properly fit your head. To do so, adjust the headband ① via its snap-in locking mechanism:

- ▶ Wear the headphones so that the headband ① runs over the top of your head.
- ▶ Adjust the length of the headband so that
 - your ears are completely inside the earpads,
 - you feel even, gentle pressure around your ears,
 - a snug fit of the headband ① on the head is ensured.

Using the RS 160

To switch the product on and to listen to your sound source, proceed as follows:

Sequence of steps	Page
1. Make sure that the rechargeable batteries are charged.	16
2. Switch your sound source on.	–
3. Switch your transmitter on.	18
4. Switch your headphones on.	20
5. Adjust the desired volume.	21

Switching the transmitter on and off

Switching the transmitter on

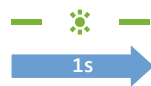



- ▶ Press the multi-function button ① for approx. 1 second. The transmitter switches on. The multi-function LED ② flashes green, indicating that the transmitter is in enrollment mode.

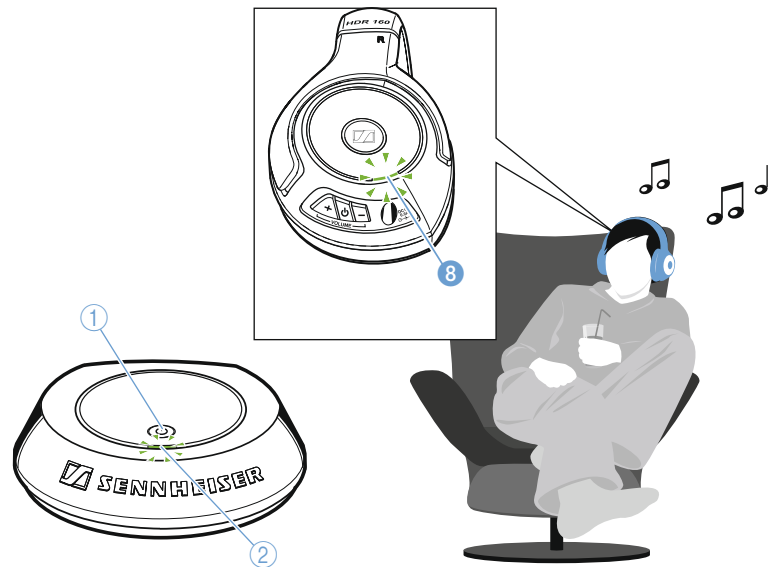

Once the transmitter has found suitable headphones, it pairs with the headphones and transmits an audio signal. The multi-function LED ⑧ of the headphones and the multi-function LED ② of the transmitter flash slowly.



Switching the transmitter off

- ▶ Press the multi-function button  ① for approx. 1 second.
The multi-function LED  goes off. The transmitter is in standby mode.

To disconnect the transmitter from the mains:

- ▶ Pull out the mains plug from the wall socket.



If the headphones are outside the transmission range or switched off for more than 5 minutes, the transmitter automatically switches to standby mode. The multi-function LED  goes off. In standby mode, the transmitter's power consumption is very low so that it can remain connected to the mains.

Switching the headphones on and off

WARNING Danger due to high volumes!



Listening at high volume levels for long periods can lead to permanent hearing defects.

- ▶ Before putting the headphones on, set the volume to a low level.
- ▶ Do not continuously expose yourself to high volumes.

Switching the headphones on



- ▶ Press the multi-function button  **5** for approx. 1 second. The headphones switch on. The multi-function LED **8** flashes green, indicating that the headphones are in enrollment mode.

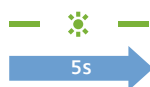

Once the headphones have found a suitable transmitter, the transmitter pairs with the headphones and transmits an audio signal. The multi-function LED **8** of the headphones and the multi-function LED **2** of the transmitter flash slowly.

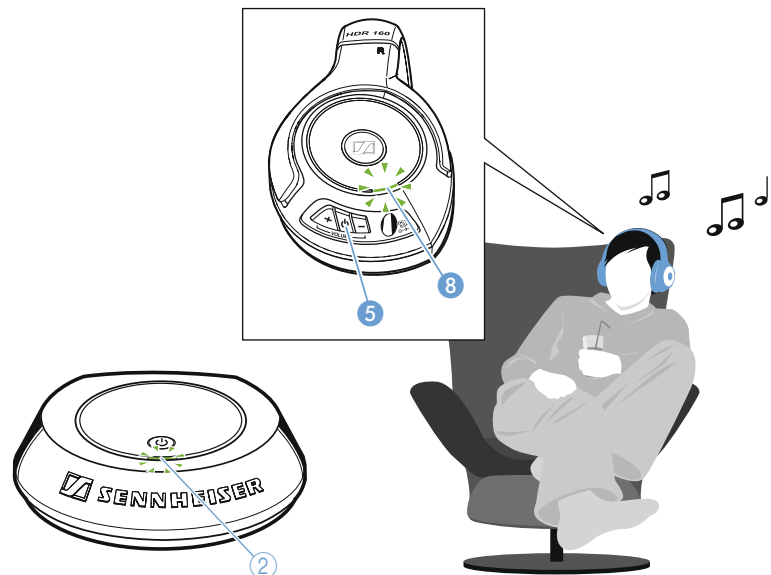

Switching the headphones off

- ▶ Press the multi-function button  **5** for approx. 1 second. The multi-function LED **8** goes off. The headphones are in standby mode.



If there is no signal from the transmitter for more than 5 minutes, the headphones automatically switch to standby mode.

Adjusting the volume on the headphones

- ▶ Press the **VOLUME –** button **6** or the **VOLUME +** button **4** repeatedly until the volume is adjusted to a comfortable and undistorted level.

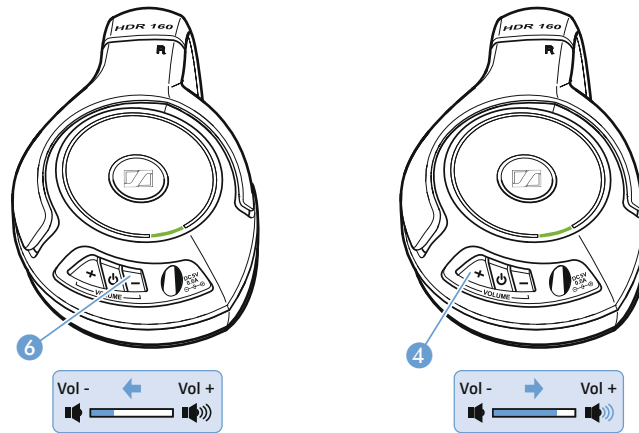

Muting the headphones

- ▶ Briefly press the multi-function button **5** to mute the headphones or to cancel the muting.

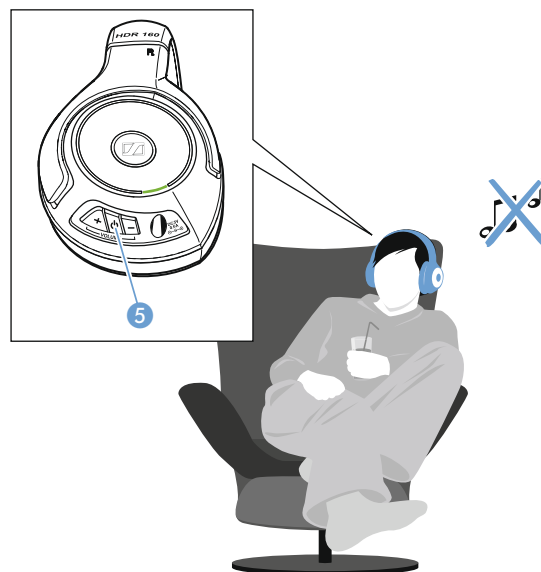

Adjusting the signal of the sound source

The transmitter automatically ensures that the headphones always receive an optimum signal. If necessary, use the **VOLUME** control ⑤ to adjust the volume of the audio signal.

However, the signal of the sound source can be so strong that it can no longer be automatically adjusted.

If the signal of the sound source is too strong, the multi-function LED ② of the transmitter flashes or lights up red.

- ▶ Either adjust the **VOLUME** control ⑤ on the transmitter so that the multi-function LED ② stops flashing or lighting up red.
- ▶ Or adjust the volume of your sound source so that the multi-function LED ② stops flashing or lighting up red.

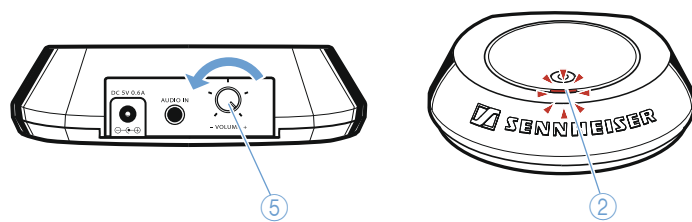

Associating the headphones to the transmitter



The RS 160 system features the digital wireless audio transmission technology from Klear. You can also associate other Klear compatible headphones (e.g. the Sennheiser MX W1) to the transmitter. For more information, refer to the chapter “Associating other Klear compatible headphones to the transmitter” on page 25 or to the instruction manual of the corresponding product.

The headphones and the transmitter are already associated upon delivery. You only have to associate the headphones to the transmitter

- if you want to use another pair of Klear compatible headphones or
- if the transmission between the headphones and the transmitter is disturbed by interferences in the vicinity.

If you want to use several headphones, refer to the chapter “Associating several headphones to the transmitter” on page 25.

Associating the HDR 160 headphones to the transmitter

When associating the headphones to the transmitter, the distance between the transmitter and the headphones should not exceed 1 m.

- ▶ Make sure that the transmitter and the headphones are in standby mode (see page 19 and 20).

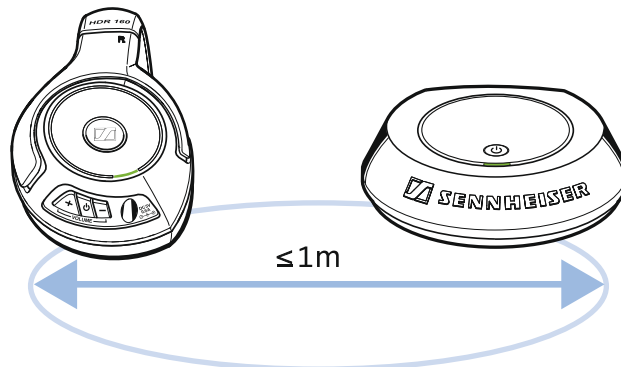

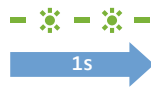

- ▶ Simultaneously press the multi-function button ① of the transmitter and the multi-function button ⑤ of the headphones for 7 seconds.
The multi-function LED ② of the transmitter flashes green.

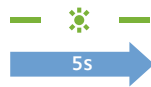
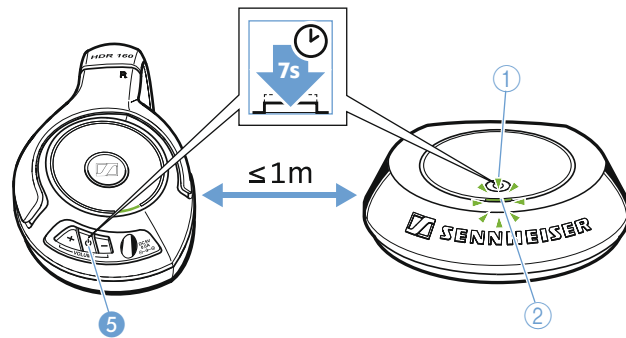

- After approx. 30 seconds, the headphones are paired with the transmitter and you can hear your sound source via the headphones. The multi-function LED ⑧ of the headphones and the multi-function LED ② of the transmitter flash green.

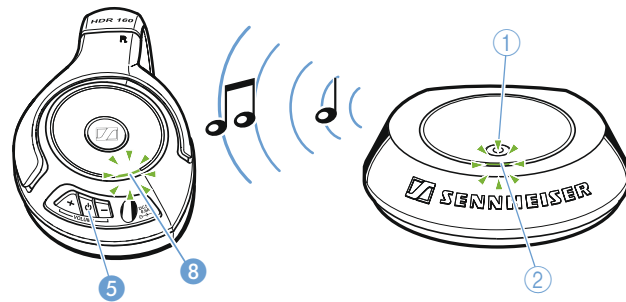

Associating other Klear compatible headphones to the transmitter

The following describes how to associate the Sennheiser MX W1 earphones to the TR 160 transmitter.

For information on how to associate other Klear compatible headphones to the transmitter, refer to the instruction manual of the corresponding product.

- ▶ Press the **operation/pairing** button on both MX W1 earphones for 7 seconds.
- ▶ Press the multi-function button **⏻ ①** of the transmitter for 7 seconds.

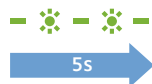
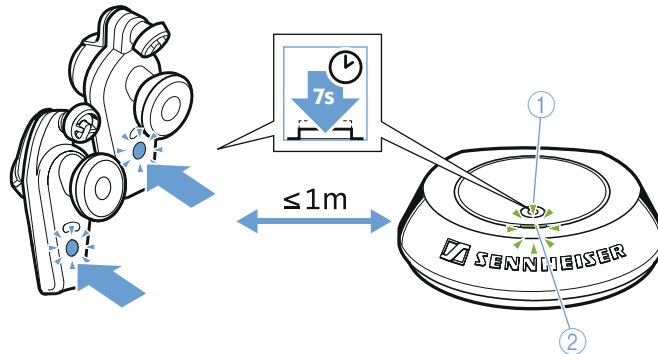

After approx. 30 seconds, the MX W1 earphones are paired with the transmitter and you can hear your sound source via the earphones. The multi-function LED **②** of the transmitter flashes green.

Associating several headphones to the transmitter

In order to be able to use several headphones simultaneously, you first have to associate your additional headphones to the transmitter.

Follow the steps in the previous chapter "Associating the headphones to the transmitter" on page 23.

You can then only use the last headphones paired to listen to your sound source (single-user operation).

To listen to your sound source with up to 4 headphones simultaneously:

- ▶ Set your transmitter to multi-user operation as described in the next chapter.

Listening with several headphones simultaneously

By default, the transmitter is set to single-user operation. In order to be able to listen to your sound source with several headphones simultaneously, you have to set your transmitter to multi-user operation.

- ▶ Make sure that all headphones are paired to the transmitter (see previous chapter).
- ▶ Switch all headphones on (see page 20).
- ▶ Then switch the transmitter on (see page 18).
- ▶ Briefly press the multi-function button  ① of the transmitter. The multi-function LED ② of the transmitter and the multi-function LEDs ③ of the headphones flash green. You can now listen to your sound source with several headphones simultaneously.

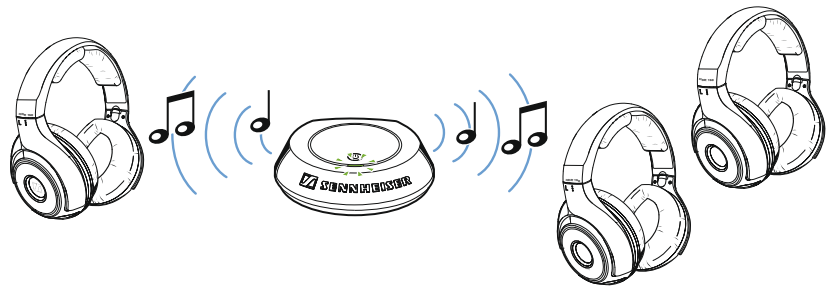

When pressing the transmitter's multi-function button  ① in multi-user operation, the transmitter switches to single-user operation. You can still listen to your sound source with the last headphones paired, the other headphones are disconnected from the transmitter.

Cleaning the RS 160

CAUTION Liquids can damage the electronics of the product!

Liquids entering the housing of the product can cause a short-circuit and damage the electronics.

- ▶ Keep all liquids far away from the product.
 - ▶ Do not use any cleansing agents or solvents.
-

- ▶ Before cleaning, switch the product off and disconnect the transmitter from the mains.
- ▶ Only use a dry and soft cloth to clean the product.

Replacing the ear pads

For reasons of hygiene, you should replace the earpads from time to time. Spare earpads are available from your Sennheiser dealer (see "Accessoires and spare parts" on page 30).

- ▶ Remove the ear pads ② from the ear cups by turning the ear pads in the direction of the arrow until you overcome a slight resistance.
- ▶ Lift the ear pads ② off the ear cups.

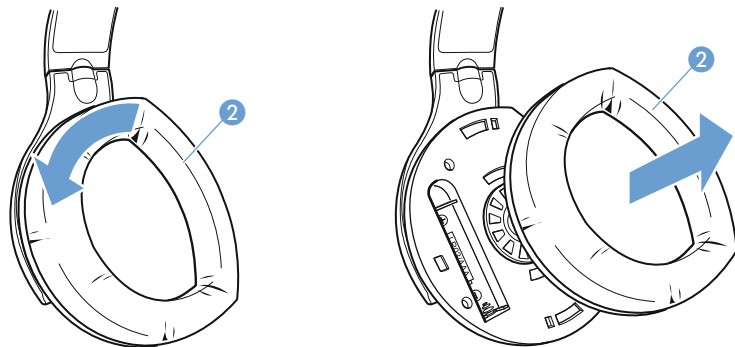

- ▶ Secure the new ear pads to the ear cups.

If a problem occurs ...

Sound problems

Problem	Possible cause	Possible solutions	Page	
No sound	Transmitter is/headphones are switched off	Switch the transmitter/headphones on	18/20	
	Headphones are muted	Cancel the muting	12	
	Jack plug is not properly connected	Check the plug connection	12	
	Sound source is switched off	Switch the sound source on	–	
	Audio cable is defective	Replace the cable	–	
	Transmission between transmitter and headphones is disturbed by interferences (including ESD) in the vicinity	Associate the headphones with the transmitter again		23
		Disconnect the transmitter from the mains and reconnect it again		13
		Remove the rechargeable batteries and reinsert them again		15
Headphones are not correctly associated with the transmitter (e.g. additional headphones)	Associate the headphones with the transmitter		23	
Occasional sound dropouts	Headphones are out of range	Reduce the distance between headphones and transmitter	12	
	Signal is shielded	Remove obstacles between transmitter and headphones	12	
	Interfering devices in the vicinity	Change your position	12	
Sound is too low	Volume of the sound source is adjusted too low	Increase the volume of the sound source	–	
	Signal of the sound source is too weak	Turn the VOLUME control ⑤ on the transmitter clockwise	21	
	Headphone volume is adjusted too low	Increase the volume by pressing the VOLUME + button ④	21	

Problem	Possible cause	Possible solutions	Page
Sound only on one ear	Audio cable is defective	Replace the audio cable	–
	Audio cable is not properly connected	Check the plug connection	12
Sound is distorted	Signal of the sound source is distorted	Reduce the volume of the sound source	–
		Reduce the volume by pressing the VOLUME – button 6 on the headphones	21
Multi-function LED 2 on the transmitter flashes or lights up red	Signal of the sound source is too strong	Turn the VOLUME control 5 on the transmitter counter-clockwise	22
		Reduce the volume of the sound source	22

Other problems

Problem	Possible cause	Possible solution	Page
The transmitter cannot be switched on	No mains connection	Check the connection of the power supply unit to the transmitter and to the mains	13
Headphones cannot be switched on	Rechargeable batteries are flat	Recharge the rechargeable batteries	16
	Rechargeable batteries are inserted the wrong way round	Remove the rechargeable batteries and reinsert them again. Observe correct polarity	15
Operating time decreases	Rechargeable batteries are exhausted	Replace the rechargeable batteries	14/15

If a problem occurs that is not listed in the above table or if the problem cannot be solved with the proposed solutions, please contact your local Sennheiser partner for assistance.

To find a Sennheiser partner in your country, search at www.sennheiser.com.

Accessories and spare part

Only use original Sennheiser accessories and spare parts, otherwise the product quality can be impaired or the product can be damaged.

Cat. No.	Accessory/spare part
504250	HDR 160 headphones
555691	Power supply unit with country adapters
534486	Stereo audio cable with two 3.5 mm jack plugs (1 m)
534479	DC cable (4.0 mm DC jack socket to 2 x 4.0 mm DC plug)
093778	Adapter (3.5 mm jack socket to ¼" (6.3 mm) jack plug)
514267	Adapter (3.5 mm jack socket to 2 RCA plugs)
534470	1 pair of ear pads (closed type)

Specifications

RS 160 system

Modulation	MSK digital
Carrier frequencies	2.4 – 2.48 GHz
Range	approx. 20 m in the open area
Ambient temperature	32 °F to 104 °F (0 °C to 40 °C)

TR 160 transmitter

Audio connection	3.5 mm stereo jack socket
Power consumption (standby mode)	< 0.3 W
Power supply	5 V $\overline{\text{DC}}$, 600 mA 2 AA size batteries, 1.5 V or 2 AA size NiMH rechargeable batteries, 1.2 V, at least 1,300 mAh
Transmission power	< 2.5 mW
Operating time with batteries	approx. 120 hours
Weight (w/o batteries)	approx. 56 g
Dimensions	8.7 cm x 9.7 cm x 2.7 cm

HDR 160 headphones

Transducer principle	circumaural, closed
Max. SPL	106 dB (SPL)
THD	< 0.5 % at 1 kHz, 100 dB SPL
Frequency response	18 Hz – 21,000 Hz
Charging time of rechargeable batteries	approx. 16 hours
Power supply	2 AAA size NiMH rechargeable batteries, 1.2 V, 820 mAh
Operating time	approx. 24 hours
Weight (w/o rechargeable batteries)	approx. 226 g

NT5-6AW power supply unit

Rated input	100 – 240 V \sim , 0.2 A, 50 – 60 Hz
Rated output	5 V $\overline{\text{DC}}$, 600 mA
Operating temperature range	32 °F to 104 °F (0 °C to 40 °C)

Manufacturer declarations

Warranty

Sennheiser GmbH & Co. KG gives a warranty of 24 months on this product. For the current warranty conditions, please visit our website at www.sennheiser.com or contact your Sennheiser partner.

FOR AUSTRALIA ONLY

Sennheiser goods come with guarantees that cannot be excluded under the Australian Consumer Law. You are entitled to a replacement or refund for a major failure and compensation for any other reasonably foreseeable loss or damage. You are also entitled to have the goods repaired or replaced if the goods fail to be of acceptable quality and the failure does not amount to a major failure.

This warranty is in addition to other rights or remedies under law. Nothing in this warranty excludes, limits or modifies any liability of Sennheiser which is imposed by law, or limits or modifies any remedy available to the consumer which is granted by law.

To make a claim under this warranty, contact Sennheiser Australia Pty Ltd, Unit 3, 31 Gibbes Street Chatswood NSW 2067, Australia; Phone: (02) 9910 6700, email: service@sennheiser.com.au

All expenses of claiming the warranty will be borne by the person making the claim.

The Sennheiser International Warranty is provided by Sennheiser Australia Pty Ltd (ABN 68 165 388 312), Unit 3, 31 Gibbes Street Chatswood NSW 2067, Australia.

In compliance with the following requirements

- WEEE Directive (2012/19/EU)



Please dispose of this product at the end of its operational lifetime by taking it to your local collection point or recycling center for such equipment.

- Battery Directive (2013/56/EU)



The supplied standard/rechargeable batteries can be recycled. Please dispose of them as special waste or return them to your specialist dealer. In order to protect the environment, only dispose of exhausted batteries.

CE Declaration of Conformity

- R&TTE Directive (1999/5/EC)
- EMC Directive (2014/30/EU)
- Low Voltage Directive (2014/35/EU)
- ErP Directive (2009/125/EC)
- RoHS Directive (2011/65/EU)
- Product Safety Directive (2001/95/EC)

Headphones for mobile players: EN 60065/A12, EN 60950/A12, EN 50332-2

The declaration is available at www.sennheiser.com.
 Before putting the product into operation, please observe the respective country-specific regulations!

Statements regarding FCC and Industry Canada

FCC Declaration of Conformity (DoC)	
 SENNHEISER Model No: TR 160, HDR 160	
We,	Sennheiser Electronic Corporation One Enterprise Drive • Old Lyme • CT 06371 • USA Tel: +1 (860) 434 9190 Fax: +1 (860) 434 1759
declare the above device comply with the requirements of Federal Communications Commission.	
This device complies with Part 15 of the FCC rules. Operation is subjected to the following two conditions:	
1) This device may not cause harmful interference, and 2) This device must accept any interference received, including interference that may cause undesired operation.	
Responsible Party: Greg Beebe	

This device complies with Part 15 of the FCC Rules and with RSS-210 of Industry Canada. Operation is subject to the following two conditions: (1) this device may not cause harmful interference, and (2) this device must accept any interference received, including interference that may cause undesired operation.

This equipment has been tested and found to comply with the limits for a Class B digital device, pursuant to Part 15 of the FCC Rules. These limits are designed to provide reasonable protection against harmful interference in a residential installation. This equipment generates, uses and can radiate radio frequency energy and, if not installed and used in accordance with the instructions, may cause harmful interference to radio communications. However, there is no guarantee that interference will not occur in a particular installation. If this equipment does cause harmful interference to radio or television reception, which can be determined by turning the equipment off and on, the user is encouraged to try to correct the interference by one or more of the following measures:

- Reorient or relocate the receiving antenna.
- Increase the separation between the equipment and receiver.
- Connect the equipment into an outlet on a circuit different from that to which the receiver is connected.
- Consult the dealer or an experienced radio/TV technician for help.

Changes or modifications made to this equipment not expressly approved by Sennheiser electronic Corp. may void the FCC authorization to operate this equipment.

CAN ICES-3 (B)







RF Radiation Exposure Information

Since the radiated output power of this device is far below the FCC / IC radio frequency exposure limits, it is not subjected to routine RF exposure evaluation as per Section 2.1093 of the FCC rules and RSS-102 of Industry Canada.

This device meets FCC/ IC RF exposure guidelines for an uncontrolled environment. Use of other accessories not verified by the manufacturer may not ensure compliance with FCC / IC RF exposure guidelines.

This transmitter must not be co-located or operated in conjunction with any other antenna or transmitter.

In compliance with:

USA	FCC ID: DMOTR160 FCC ID: DMOHDR160	
Canada	IC: 2099A-TR160 IC: 2099A-HDR160 CAN ICES-3 (B)/NMB-3(B)	
Europe		
Australia/ New Zealand		
Singapore	Complies with IDA Standards DB100582	
Japan	  201 WW 09215278 201 WW 09215279	

Trademarks

The Kleer logo is a trademark of Kleer Corporation.

Sennheiser is a registered trademark of Sennheiser electronic GmbH & Co. KG.

Other product and company names mentioned in this instruction manual may be the trademarks or registered trademarks of their respective holders.



Sennheiser electronic GmbH & Co. KG

Am Labor 1, 30900 Wedemark, Germany
www.sennheiser.com

Publ. 06/16, A04