



# evolution wireless G4 100 series

Instruction Manual

Sennheiser electronic GmbH & Co. KG

**SENNHEISER**

Am Labor 1, 30900 Wedemark, Germany, [www.sennheiser.com](http://www.sennheiser.com)  
ew 100 G4 - v2.0



## **Overview 6**

### **ew 100 G4 series products 7**

EM 100 G4 rack receiver 8

SKM 100 G4 handheld transmitter 9

SK 100 G4 bodypack transmitter 10

### **Accessories 11**

Microphones and cables 12

Microphone modules 12

Headset and Lavalier microphones 12

Line/instrument cables 13

Rechargeable battery and charger 14

BA 2015 rechargeable battery 14

L 2015 charger 14

LA 2 charging adapter 15

Accessories for rack mounting 16

GA 3 rack mount kit 16

AM 2 antenna front mounting kit 16

Antennas and accessories 17

Omni-directional antennas 17

Directional antennas 17

Antenna splitter 17

Antenna amplifiers 17

Antenna cables 17

Additional accessories 18

Color labeling set 18

Microphone clamp 18

### **The frequency bank system 19**

### **Installing and starting up ew 100 G4 series devices 20**

#### **Installing the EM 100 G4 21**

Connectors on the rear of the device 22

Product overview for the rear side of the **EM 100 G4 22**

Connecting/disconnecting the EM 100 G4 to/from the power supply system 23

Creating a data network 24

Setting up a multi-channel system with more than 12 receivers 25

Outputting audio signals 26

Connecting antennas 27

Installing the EM 100 G4 in a rack 28

Mounting a single receiver in a rack 29

Mounting two receivers side by side in a rack 30

#### **Installing the SKM 100 G4 31**

Inserting and removing the batteries/rechargeable batteries 32

Battery status 33

Replacing the microphone module 34

Changing the colored ring 35

#### **Installing the SK 100 G4 36**

Inserting and removing the batteries/rechargeable bat-



series 37

Battery status 38

Connecting a microphone to the SK 100 G4 39

Connecting an instrument or line source to the SK 100 G4 40

Attaching the bodypack transmitter to clothing 41

## **Installing the ASA 214 42**

Connectors on the rear of the device 43

Product overview for the rear side of the ASA 214 43

Connecting/disconnecting the ASA 214 to/from the power supply system 44

Connecting receivers to the ASA 214 45

Connecting antennas 47

Connecting remote antennas 47

Connecting rod antennas 47

Information on antenna amplifiers and cable lengths 48

Configuring multi-channel systems 50

Option 1: Two antennas supply a 4-channel system 50

Option 2: Two 4-channel systems are interconnected 51

Option 3: Two antennas supply a 8-channel system 51

Installing the ASA 214 in a rack 52

Mounting a single antenna splitter in a rack 53

Mounting two antenna splitters side by side in a rack 55

## **Using ew 100 G4 series devices 56**

### **Using the EM 100 G4 58**

Operating elements on the front of the device 59

Product overview for the front of the **EM 100 G4 59**

Switching the EM 100 G4 on and off 60

Muting the audio output 61

Lock-off function 62

Displays on the EM 100 G4 display panel 63

Buttons for navigating through the menu 63

Home screen 65

**Receiver Parameters** standard display 65

**Soundcheck** standard display 66

RF Min 66

RF Max 67

AF Max 67

**Guitar Tuner** standard display 67

Setting options in the menu 68

Menu structure 69

Squelch menu item 70

Easy Setup menu item 72

Scan New List 72

Current List 73

Reset 73

Performing multi-channel frequency setup 73

Setting up a multi-channel system with more than 12 receivers 75



- Frequency Preset menu item 76
- Name menu item 77
- AF Out menu item 78
- Equalizer menu item 79
- Auto Lock menu item 80
- Advanced menu item 81
- Advanced -> Tune menu item 82
  - Only adjusting the frequency 82
  - Setting the channel and frequency 82
- Advanced -> Guitar Tuner menu item 83
- Advanced -> Pilot Tone menu item 83
- Advanced -> LCD Contrast menu item 84
- Advanced -> Reset menu item 84
- Advanced -> Software Revision menu item 84

## **Using the SKM 100 G4 85**

- Operating elements of the SKM 100 G4 handheld transmitter 86
- Switching the SKM 100 G4 handheld transmitter on and off 87
- Muting the handheld transmitter (AF mute) 88
  - SKM 100 G4 88
  - SKM 100 G4-S 88
- Deactivating the RF signal (RF mute) 89
- Lock-off function 90
- Displays on the SKM 100 G4 handheld transmitter display panel 91
  - Select a standard display 92
- Buttons for navigating the SKM 100 G4 menu 93
  - Navigating through the menu 93
  - Making changes in a menu item 93
- Setting options in the menu 94
- Sensitivity menu item 95
- Frequency Preset menu item 96
- Name menu item 96
- Auto Lock menu item 97
- Advanced menu item 98
- Advanced > Tune menu item 99
  - Only adjusting the frequency 99
  - Setting the channel and frequency 99
- Advanced > Mute Mode menu item (SKM 100 G4-S only) 100
- Advanced > Pilot Tone menu item 100
- Advanced > LCD Contrast menu item 100
- Advanced > Reset menu item 101
- Advanced > Software Revision menu item 101

## **Using the SK 100 G4 102**

- Operating elements of the SK 100 G4 bodypack transmitter 103
- Switching the SK 100 G4 bodypack transmitter on and off 104
- Muting the bodypack transmitter (AF mute) 105



- Deactivating the RF signal (RF mute) 106
  - Deactivating the RF signal with the **MUTE** switch 106
  - Deactivating the RF signal with the **ON/OFF** button 108
- Lock-off function 109
- Displays on the SK 100 G4 bodypack transmitter display panel 110
  - Select a standard display 111
- Buttons for navigating the SK 100 G4 menu 112
  - Navigating through the menu 112
  - Making changes in a menu item 112
- Setting options in the menu 113
- Sensitivity menu item 114
- Frequency Preset menu item 114
- Name menu item 115
- Auto Lock menu item 115
- Advanced menu item 116
- Advanced > Tune menu item 117
  - Only adjusting the frequency 117
  - Setting the channel and frequency 117
- Advanced > Mute Mode menu item 118
- Advanced > Cable Emulation menu item 118
- Advanced > Pilot Tone menu item 119
- Advanced > LCD Contrast menu item 119
- Advanced > Reset menu item 119
- Advanced > Software Revision menu item 119
- Establishing a radio link 120**
  - Setting notes 120
- Synchronizing devices 121**
- Using the ASA 214 123**
  - Operating elements on the front of the device 124
  - Switching the ASA 214 on and off 125
- Overview 126**
- Product variants 127**
  - EM 100 G4 product variants 127
    - Made in Germany 127
    - Assembled in the USA 127
  - SKM 100 G4 product variants 128
    - Made in Germany 128
    - Assembled in the USA 128
  - SK 100 G4 product variants 129
    - Made in Germany 129
    - Assembled in the USA 129
- Frequency tables 130**
- Specifications 131**
  - EM 100 G4 132
    - RF characteristics 132
    - AF characteristics 133
    - Overall device 133
  - SKM 100 G4 134
    - RF characteristics 134



- AF characteristics 134
- Overall device 135
- SK 100 G4 136
  - RF characteristics 136
  - AF characteristics 136
  - Overall device 137
- ASA 214 138
  - Specifications 138
  - Block diagram 139
- Pin assignment 140**
  - 3.5 mm stereo jack plug 140
  - 3.5 mm mic jack plug 140
  - 3.5 mm line jack plug 140
  - 6.3 mm stereo jack plug, balanced (audio in/loop out) 140
  - 6.3 mm mono jack plug, unbalanced 141
  - 6.3 mm stereo jack plug for headphone jack 141
  - XLR-3 plug, balanced 141
  - Hollow jack plug for power supply 141
- Cleaning and maintenance 142**
  - Cleaning the sound inlet basket of the microphone module 142



## PRODUCT INFORMATION

### Overview

---

You can find information about the individual products in the ew 100 G4 series under “ew 100 G4 series products”.

---

For information about the available accessories, see “Accessories”.

---

You can find information about the ew 100 G4 series frequency bank system under “The frequency bank system”.

---





## ew 100 G4 series products

---

 You can also find more information here:

- A variety of **frequency variants** are available from the individual products. You can find more information under “Product variants”.
  - You can find **technical specifications** about the individual products under “Specifications”.
  - You can find information about **installing** the products under “Installing and starting up ew 100 G4 series devices”.
  - You can find information about **operating** the products under “Using ew 100 G4 series devices”.
-





## EM 100 G4 rack receiver



---

**i** You can find more detailed information about the EM 100 G4 in the following sections:

- **Installation and Startup:** “Installing the EM 100 G4”
  - **Operation:** “Using the EM 100 G4”
  - **Technical Data:** “EM 100 G4”
-



## SKM 100 G4 handheld transmitter



### SKM 100 G4 variant:



### SKM 100 G4-S variant:



The SKM 100 G4 handheld transmitter is also available in the SKM 100 G4-S variant with an integrated mute switch.



You can find more detailed information about the SKM 100 G4 in the following sections:

- **Installation and Startup:** “Installing the SKM 100 G4”
  - **Operation:** “Using the SKM 100 G4”
  - **Technical Data:** “SKM 100 G4”
-



## SK 100 G4 bodypack transmitter



---

**i** You can find more detailed information about the SK 100 G4 in the following sections:

- **Installation and Startup:** “Installing the SK 100 G4”
  - **Operation:** “Using the SK 100 G4”
  - **Technical Data:** “SK 100 G4”
-



## Accessories

A variety of accessories are available for the ew 100 G4 series.



## Microphones and cables

### Microphone modules

We recommend using the following microphone modules with the SKM 100 G4 and SKM 100 G4-S handheld transmitters.

| Module              | Features   | Article no. |
|---------------------|--|-------------|
| <b>MMD 835-1 BK</b> | Dynamic, cardioid, black                                 | 502575      |
| <b>MMD 845-1 BK</b> | Dynamic, super-cardioid, black                           | 502576      |
| <b>MME 865-1 BK</b> | Capacitor, super-cardioid, black                         | 502581      |
| <b>MMD 935-1 BK</b> | Dynamic, cardioid, black                                 | 502577      |
| <b>MMD 945-1 BK</b> | Dynamic, super-cardioid, black                           | 502579      |
| <b>MMK 965-1 BK</b> | Capacitor, switchable<br>Cardioid/super-cardioid, black  | 502582      |
| <b>MMK 965-1 NI</b> | Capacitor, switchable<br>Cardioid/super-cardioid, nickel | 502584      |
| <b>MMD 42-1</b>     | Dynamic, omni-directional, black                         | 506772      |

**i** You can find more information about the individual microphone modules on their respective product pages at [www.sennheiser.com](http://www.sennheiser.com).

### Headset and Lavalier microphones

We recommend using the following Lavalier microphones and headset microphones with the SK 100 G4 bodypack transmitter.

| Microphone             | Features                                     | Article no. |
|------------------------|--|-------------|
| <b>ME 2-II</b>         | Lavalier microphone, omni-directional, black | 507437      |
| <b>ME 3-II</b>         | Headset microphone, cardioid, black          | 506295      |
| <b>ME 4-N</b>          | Lavalier microphone, cardioid, black         | 005020      |
| <b>MKE 1-ew</b>        | Lavalier microphone, omni-directional, black | 502876      |
| <b>MKE 1-ew-3</b>      | Lavalier microphone, omni-directional, beige | 502879      |
| <b>MKE 2-ew Gold</b>   | Lavalier microphone, omni-directional, black | 009831      |
| <b>MKE 2 ew-3 Gold</b> | Lavalier microphone, omni-directional, beige | 009832      |
| <b>MKE 40-ew</b>       | Lavalier microphone, cardioid, black         | 500527      |



| Microphone             | Features                                      | Article no. |
|------------------------|---|-------------|
| <b>SL Headmic 1 BE</b> | Headband microphone, omni-directional, beige  | 506272      |
| <b>SL Headmic 1 BK</b> | Headband microphone, omni-directional, black  | 506271      |
| <b>SL Headmic 1 SB</b> | Headband microphone, omni-directional, silver | 506904      |

**i** You can find more information about the individual microphones on their respective product pages at [www.sennheiser.com](http://www.sennheiser.com).

### Line/instrument cables

The following cables are available to connect instruments and line sources to the SK 100 G4 bodypack transmitter:

- **Sennheiser CL 2**  
Line cable with XLR-3F plug on lockable 3.5 mm jack plug, article no. 004840



- **Sennheiser Ci 1-N**  
Guitar cable with 6.3 mm jack plug on lockable 3.5 mm jack plug, article no. 005021





## Rechargeable battery and charger

### BA 2015 rechargeable battery

The BA 2015 rechargeable battery is designed for use with evolution wireless G4 series handheld transmitters, bodypack transmitters and bodypack receivers.

Article no. 009950



### L 2015 charger

The BA 2015 rechargeable battery can be charged in the L 2015 charger on its own or inside of the bodypack transmitter/bodypack receiver.

Article no. 009828





### LA 2 charging adapter

Charging adapter for L 2015 charger for charging SKM G4 handheld transmitters with installed BA 2015 rechargeable battery.

Article no. 503162







## Accessories for rack mounting

### GA 3 rack mount kit

19" rack adapter for mounting the EM 100 G4, EM 300-500 G4 or SR IEM G4 in a 19" rack.

Article no. 503167



### AM 2 antenna front mounting kit

Antenna front mounting kit for installing antenna connections on the front of the rack when using the EM 100 G4, EM 300-500 G4 or SR IEM G4 together with the GA 3 rack mounting kit.

Article no. 009912





## Antennas and accessories

The following antenna components are available as accessory parts.

### Omni-directional antennas

- **A 1031-U**, passive omni-directional antenna, article no. 004645

### Directional antennas

- **A 2003 UHF**, passive directional antenna, article no. 003658
- **AD 1800**, passive directional antenna, 1.8 GHz range, article no. 504916

### Antenna splitter

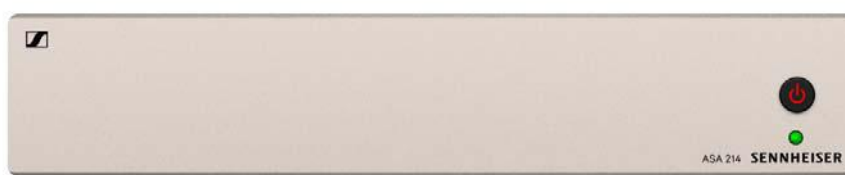

- **ASA 214**, active antenna splitter 2×1:4
  - **ASA 214-UHF** variant, 470 – 870 MHz, article no. 508241
  - **ASA 214-1G8** variant, 1785 – 1800 MHz, article no. 508242
  - See “Installing the ASA 214” and “Using the ASA 214”

### Antenna amplifiers

- **AB 3700**, broadband antenna amplifier, article no. 502196
- **AB 3**, antenna amplifier, up to 42 MHz bandwidth
  - **AB 3-A** variant, frequency range A, article no. 502567
  - **AB 3-A1** variant, frequency range A1, article no. 507367
  - **AB 3-B** variant, frequency range B, article no. 502568
  - **AB 3-C** variant, frequency range C, article no. 502569
  - **AB 3-D** variant, frequency range D, article no. 502570
  - **AB 3-E** variant, frequency range E, article no. 502571
  - **AB 3-G** variant, frequency range G, article no. 502572
  - **AB 3-GB** variant, frequency range GB, article no. 504680
  - **AB 3-K** variant, frequency range K, article no. 505550
  - **AB 3-1G8** variant, frequency range 1G8, article no. 504915

### Antenna cables

- **GZL 1019**, BNC/BNC coaxial cable, antenna cable with 50 Ω characteristic (wave) impedance
  - **GZL 1019-A1** variant, 1 m (3 ft), article no. 002324
  - **GZL 1019-A5** variant, 5 m (16 ft), article no. 002325
  - **GZL 1019-A10** variant, 10 m (32 ft), article no. 002326



## Additional accessories

### Color labeling set

- **KEN 2**, color labeling set for SKM handheld transmitters, article no. 530195



### Microphone clamp

- **MZQ 1**, microphone clamp for SKM handheld transmitters, article no. 076670





## The frequency bank system

There are different frequency ranges in the UHF band available for transmission.

The following frequency ranges are available for the **ew 100 G4** series:

- **A1 range:** 470 – 516 MHz
- **A range:** 516 – 558 MHz
- **AS range:** 520 – 558 MHz
- **G range:** 566 – 608 MHz
- **GB range:** 606 – 648 MHz
- **B range:** 626 – 668 MHz
- **C range:** 734 – 776 MHz
- **D range:** 780 – 822 MHz
- **TH range:** 794 – 806 MHz
- **JB range:** 806 – 810 MHz
- **E range:** 823 – 865 MHz
- **K+ range:** 925 – 937.5 MHz
- **1G8 range:** 1785 – 1800 MHz

Every frequency range has **21 frequency banks** with up to 12 channels:

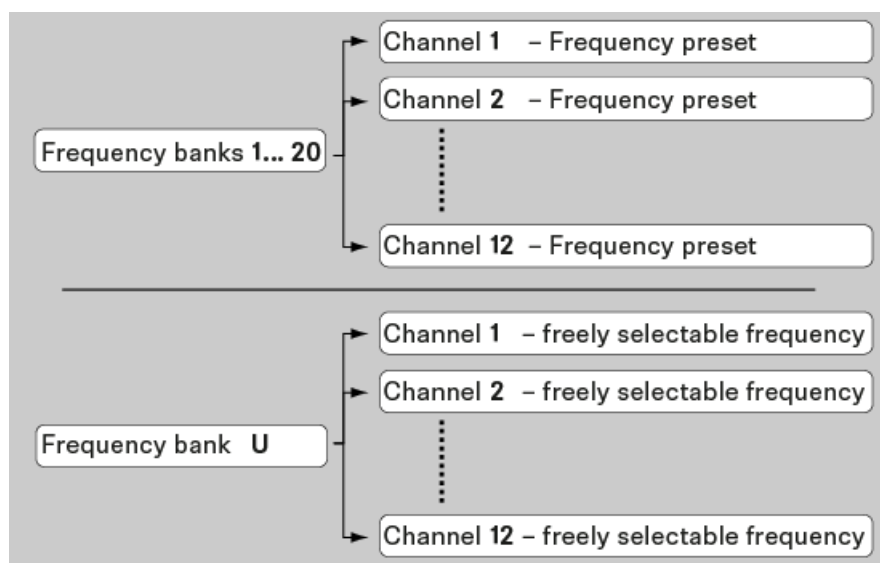

---

**i** You can find information about the frequency presets in the frequency tables of the respective frequency ranges under “Frequency tables”.

---



## INSTALLATION

### Installing and starting up ew 100 G4 series devices

You can find information about installing and connecting ew 100 G4 series devices in the following sections.



- **EM 100 G4** rack receiver >> “Installing the EM 100 G4”



- **SKM 100 G4(-S)** handheld transmitter >> “Installing the SKM 100 G4”



- **SK 100 G4** bodypack transmitter >> “Installing the SK 100 G4”

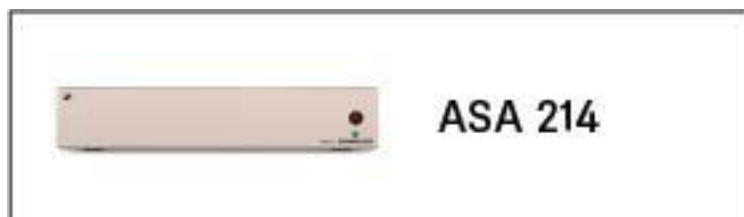

- **ASA 214** antenna splitter >> “Installing the ASA 214”



You can find information about **operating** the products under “Using ew 100 G4 series devices”.



## Installing the EM 100 G4

These sections contain detailed information about installing and starting up the EM 100 G4.

You can find information about operating the EM 100 G4 under “Using the EM 100 G4”.



## Connectors on the rear of the device

### Product overview for the rear side of the EM 100 G4

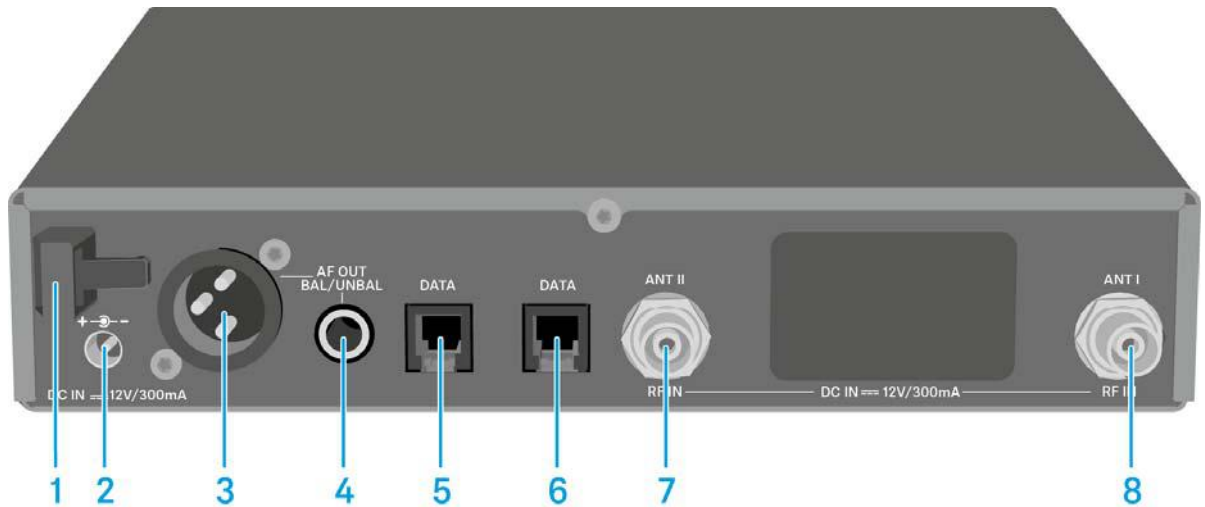

- 1** Strain relief for the cable of the power supply unit
  - See “Connecting/disconnecting the EM 100 G4 to/from the power supply system”
- 2** Connecting cables for the power supply unit (**DC IN**)
  - See “Connecting/disconnecting the EM 100 G4 to/from the power supply system”
- 3** XLR-3 socket for audio output, balanced (**AF OUT BAL**)
  - See “Outputting audio signals”
- 4** 6.3 mm jack socket for audio output, unbalanced (**AF OUT UNBAL**)
  - See “Outputting audio signals”
- 5** RJ-10 interface (**DATA**)
  - See “Creating a data network”
- 6** RJ-10 interface (**DATA**)
  - See “Creating a data network”
- 7** BNC socket, antenna input II (**ANT II**) with remote power supply unit
  - See “Connecting antennas”
- 8** BNC socket, antenna input I (**ANT I**) with remote power supply unit
  - See “Connecting antennas”



## Connecting/disconnecting the EM 100 G4 to/from the power supply system

Only use the supplied power supply unit. It is designed for your receiver and ensures safe operation.

To connect the EM 100 G4 to the power supply system:

- ▷ Insert the plug of the power supply unit into the **DC IN** socket of the receiver.
- ▷ Pass the cable of the power supply unit through the cable grip.
- ▷ Slide the supplied country adapter onto the power supply unit.
- ▷ Plug the power supply unit into the wall socket.

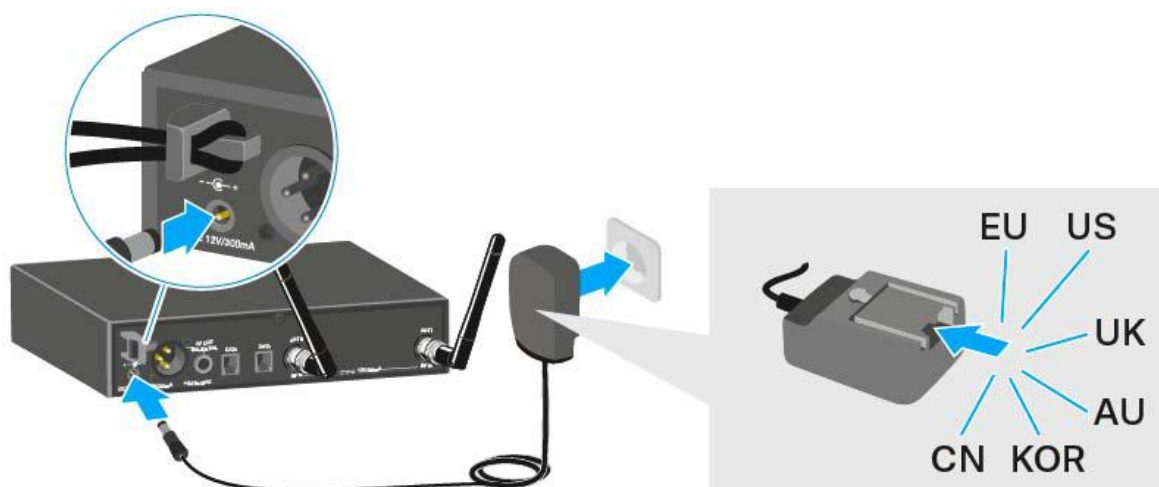

To completely disconnect the EM 100 G4 from the power supply system:

- ▷ Unplug the power supply unit from the wall socket.
- ▷ Unplug the power supply unit from the **DC IN** socket of the receiver.





## Creating a data network

You can cascade multiple EM 100 G4s to a multi-channel system using the two **DATA** RJ-10 interfaces (up to 12 receivers). You can perform a frequency setup for the entire multi-channel system via this data network using the **Easy Setup** function.

The setup only works when all of the receivers have the same frequency range.

- ▷ Connect the receivers to create a multi-channel system using the supplied RJ-10 cables as shown in the diagram.  
Both RJ-10 sockets are interchangeable. There is no set order for cabling.

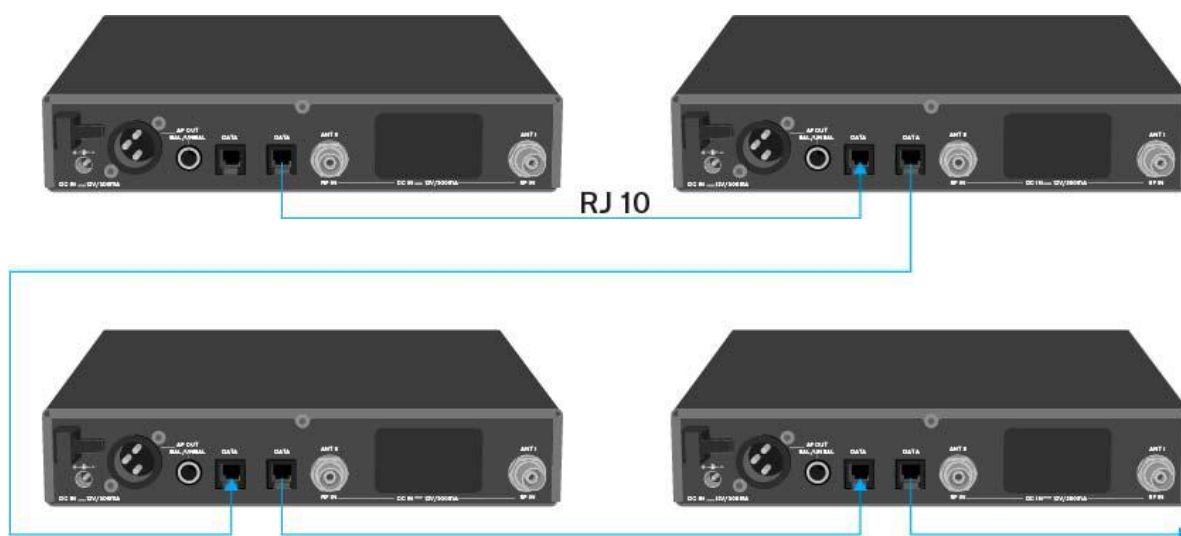

**i** You can find more information about the **Easy Setup** function under “Easy Setup menu item”.



### Setting up a multi-channel system with more than 12 receivers

You can use the **Easy Setup** function to automatically set up a maximum of **12** receivers.

If you assign the frequencies manually, however, you can use up to **20** receivers in a multi-channel system (not possible in the TH, JB, K+ and 1G8 frequency ranges).

- ▷ To do so, set a frequency manually in each receiver (see “Advanced -> Tune menu item”).
- ▷ Use the frequencies from the following table.

| Channel | Frequency Ranges |         |         |         |         |         |         |         |         |
|---------|------------------|---------|---------|---------|---------|---------|---------|---------|---------|
|         | A1               | A       | AS      | G       | GB      | B       | C       | D       | E       |
| 1       | 470.100          | 518.200 | 530.100 | 566.200 | 606.500 | 626.200 | 742.200 | 790.200 | 830.200 |
| 2       | 470.500          | 518.700 | 530.800 | 566.600 | 606.875 | 626.600 | 742.600 | 790.600 | 830.600 |
| 3       | 471.050          | 519.650 | 531.650 | 567.200 | 607.325 | 627.200 | 743.150 | 791.200 | 831.200 |
| 4       | 471.750          | 520.450 | 532.050 | 568.000 | 607.850 | 628.400 | 743.850 | 792.000 | 832.000 |
| 5       | 472.200          | 520.900 | 533.050 | 569.200 | 608.250 | 629.800 | 744.300 | 793.200 | 833.200 |
| 6       | 472.800          | 521.600 | 533.550 | 571.600 | 608.725 | 631.400 | 744.900 | 795.600 | 834.800 |
| 7       | 473.650          | 522.000 | 534.850 | 573.800 | 609.275 | 632.200 | 750.200 | 797.800 | 838.600 |
| 8       | 474.750          | 522.900 | 535.750 | 572.900 | 609.900 | 634.200 | 750.700 | 796.900 | 839.900 |
| 9       | 475.250          | 524.750 | 536.850 | 568.475 | 610.400 | 637.600 | 751.550 | 792.475 | 842.600 |
| 10      | 506.150          | 526.350 | 537.400 | 570.125 | 611.150 | 632.650 | 752.550 | 794.125 | 843.100 |
| 11      | 506.950          | 526.900 | 538.200 | 570.575 | 612.200 | 633.550 | 753.950 | 794.575 | 844.800 |
| 12      | 511.000          | 527.750 | 539.250 | 572.475 | 612.775 | 635.300 | 754.750 | 796.475 | 845.500 |
| 13      | 508.500          | 528.400 | 542.400 | 558.200 | 614.700 | 639.450 | 759.000 | 801.950 | 846.750 |
| 14      | 512.300          | 529.400 | 545.250 | 558.750 | 615.300 | 640.150 | 761.450 | 803.900 | 848.250 |
| 15      | 514.350          | 531.500 | 547.000 | 580.650 | 615.975 | 644.150 | 762.100 | 806.600 | 848.900 |
| 16      | 515.550          | 534.350 | 549.500 | 583.100 | 616.400 | 645.850 | 763.400 | 807.700 | 851.550 |
| 17      | 482.100          | 537.700 | 552.900 | 585.800 | 617.975 | 647.300 | 765.000 | 810.350 | 857.000 |
| 18      | 482.750          | 541.950 | 554.350 | 587.750 | 620.425 | 647.800 | 765.900 | 817.900 | 858.050 |
| 19      | 484.100          | 547.350 | 555.000 | 591.800 | 622.600 | 653.550 | 770.550 | 819.500 | 862.750 |
| 20      | 485.000          | 550.300 | 555.950 | 594.300 | 623.600 | 656.600 | 775.050 |         | 864.300 |



## Outputting audio signals

The EM 100 G4 has a balanced XLR-3M output socket and an unbalanced 6.3 mm jack output socket.

- Always use only one of the two **AF OUT** output sockets for each channel.

To connect an XLR cable:

- Plug the XLR cable into the **AF OUT BAL** socket of the EM 100 G4.

To connect a jack cable:

- Plug the jack cable into the **AF OUT UNBAL** socket of the EM 100 G4.

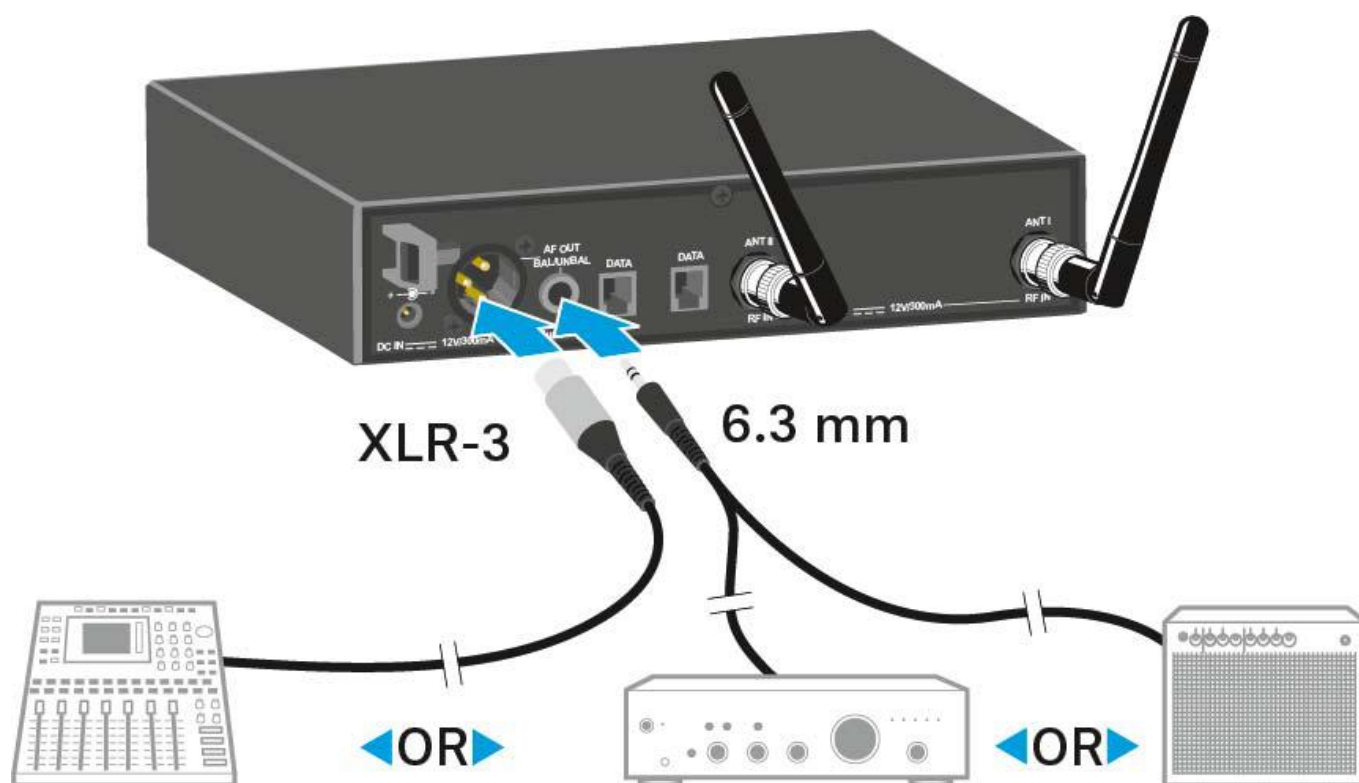



## Connecting antennas

To connect the supplied rod antennas:

- ▷ Connect the first rod antenna to the **ANT I** socket on the rear side of the EM 100 G4.
- ▷ Connect the second rod antenna to the **ANT II** socket on the rear side of the EM 100 G4.
- ▷ Gently angle the rod antennas to the left and right as shown in the figure.



**i** If you are using more than one receiver, we recommend using remote antennas and the ASA 214 antenna splitter. You can find more information here:

- “Installing the ASA 214”
- “Using the ASA 214”



## Installing the EM 100 G4 in a rack

---

### CAUTION

#### **Rack mounting poses risks**

When installing the device in a closed or multi-rack assembly, please consider that, during operation, the ambient temperature, the mechanical loading and the electrical potentials will be different from those of devices which are not mounted into a rack.

- ▷ Make sure that the ambient temperature within the rack does not exceed the permissible temperature limit specified in the specifications. See “EM 100 G4”.
  - ▷ Ensure sufficient ventilation; if necessary, provide additional ventilation.
  - ▷ Make sure that the mechanical loading of the rack is even.
  - ▷ When connecting to the power supply system, observe the information indicated on the type plate. Avoid circuit overloading. If necessary, provide overcurrent protection.
  - ▷ When rack mounting, please note that intrinsically harmless leakage currents of the individual power supply units may accumulate, thereby exceeding the allowable limit value. As a remedy, ground the rack via an additional ground connection.
-



### Mounting a single receiver in a rack

To mount the receiver in a rack, you will need the GA 3 rack mounting kit (optional accessory).

To fasten the mounting angle of the GA 3 rack mounting kit:

- ▷ Unscrew and remove the two recessed head screws (M4x8) on each side of the receiver.
- ▷ Secure both of the the mounting angles to the sides of the receiver using the previously removed recessed head screws.

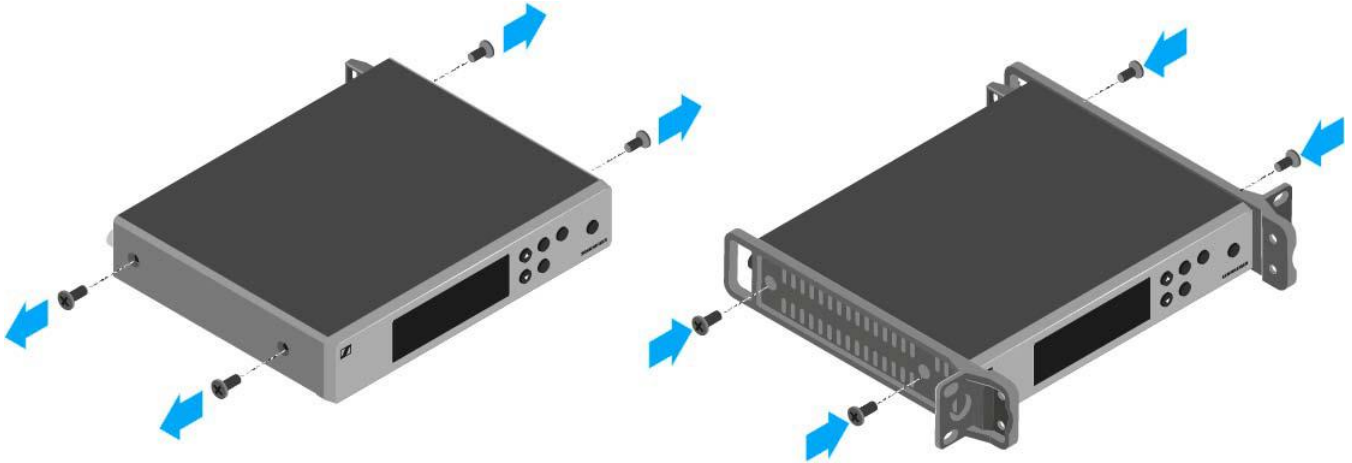

- ▷ Secure the blanking plate to one of the mounting angles using two recessed head screws (M6x10).
- ▷ Attach the AM 2 antenna front mounting set (optional accessory) and mount the rod antennas on the blanking plate (right diagram).

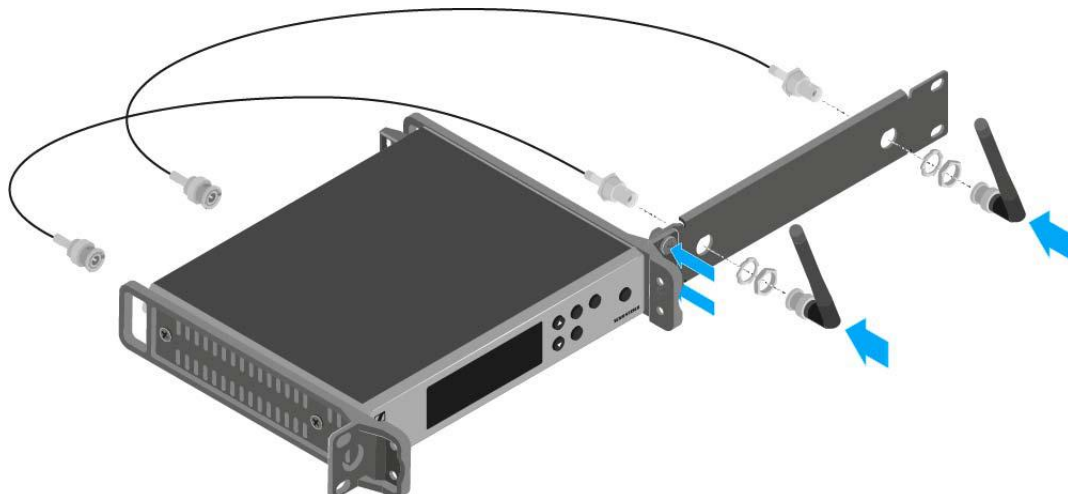

- ▷ Slide the receiver with the mounted blanking plate into the 19" rack.
- ▷ Secure the mounting angle and the blanking plate to the 19" rack.
- ▷ Align the mounted antennas in a V-shape.



### Mounting two receivers side by side in a rack

**i** When you mount two receivers side by side, it is only possible to front mount antennas when you use the ASA 214 antenna splitter in combination with the AM 2 front mounting kit and an additional GA 3 rack mounting kit,

To mount the receiver using the GA 3 rack mounting kit (optional accessory):

- ▷ Place both receivers upside down and side by side on an even surface.
- ▷ Secure the jointing plate to the transmitters using the six recessed head screws (M3x6).
- ▷ Secure the mounting angle.

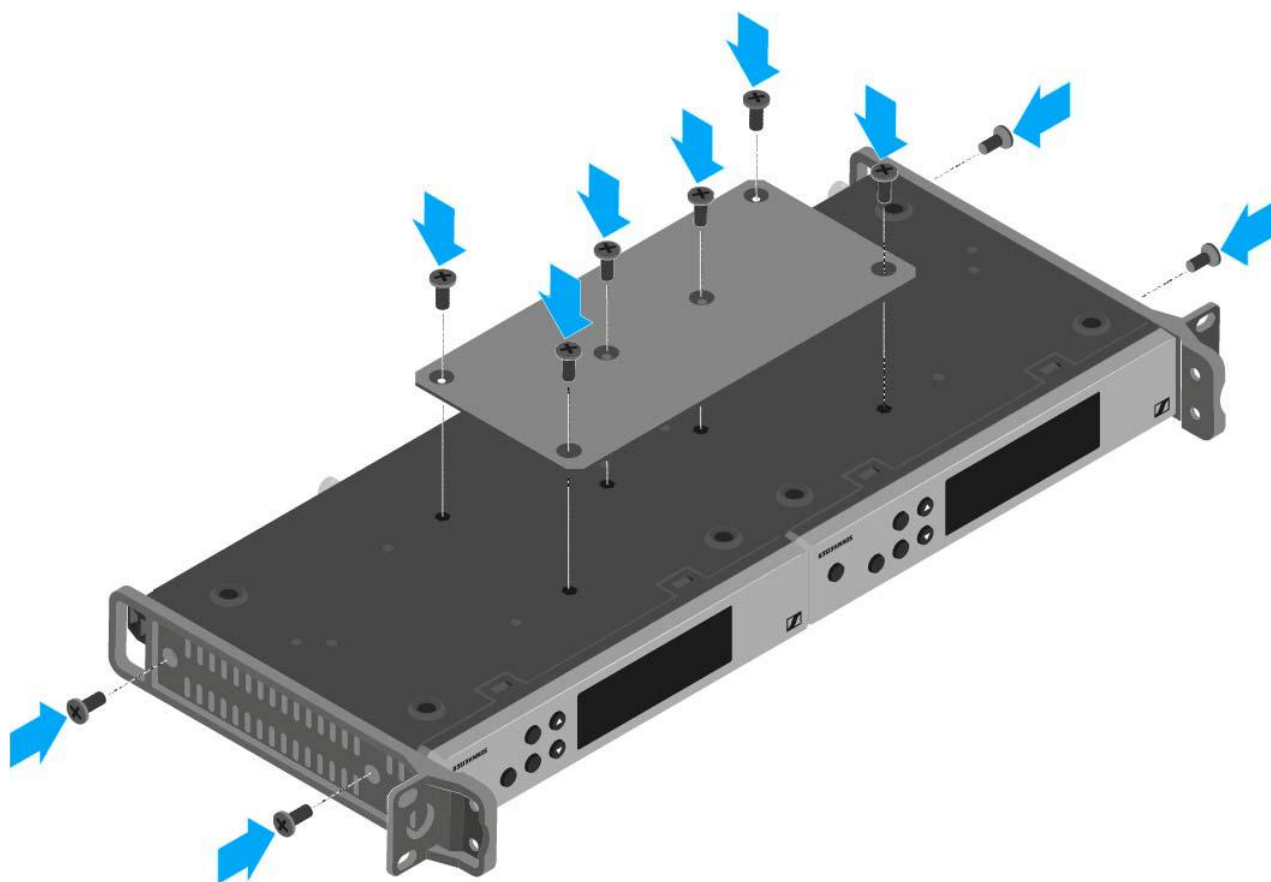



## Installing the SKM 100 G4

These sections contain detailed information about installing and starting up the SKM 100 G4.

You can find information about operating the SKM 100 G4 under “Using the SKM 100 G4”.





## Inserting and removing the batteries/rechargeable batteries

You can operate the wireless microphone either with batteries (AA, 1.5 V) or with the rechargeable Sennheiser BA 2015 battery.

- ▷ Screw the rear part of the wireless microphone in the direction of the arrow (counter-clockwise) off of the handle of the wireless microphone.

**i** When you remove the wireless microphone during operation, mute is automatically activated. **MUTE** appears in the display panel. When you screw the microphone back together, mute is deactivated.

- ▷ Pull the rear part of the wireless microphone all the way out.
- ▷ Open the cover of the battery compartment.
- ▷ Place the batteries or the BA 2015 rechargeable battery in the battery compartment as shown on the cover. Please observe correct polarity when inserting the batteries/accupack.

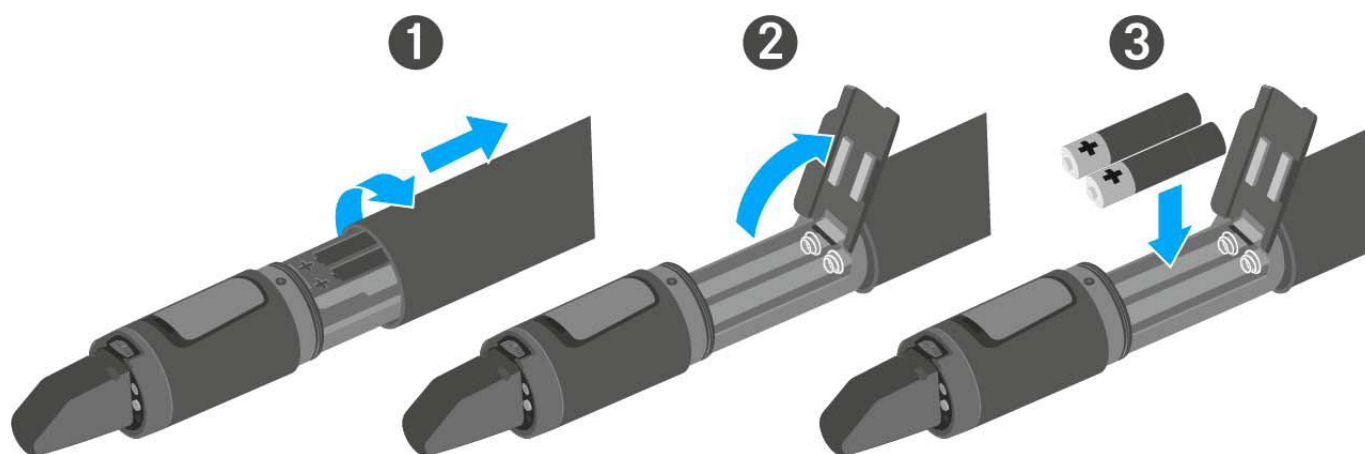









- ▷ Close the cover.
- ▷ Push the battery compartment into the handle of the wireless microphone.
- ▷ Screw the rear part of the wireless microphone back onto the handle.



### Battery status

Charge status of the batteries:

|   |  |  |
|---|--|--|
|              | 100 %  | > 8 h  |
|              | 70 %   | 4 - 6 h  |
|              | 30 %   | 2 - 3 h  |
| LOW BATT<br> |    |  |

Charge status is critical (LOW BATT):

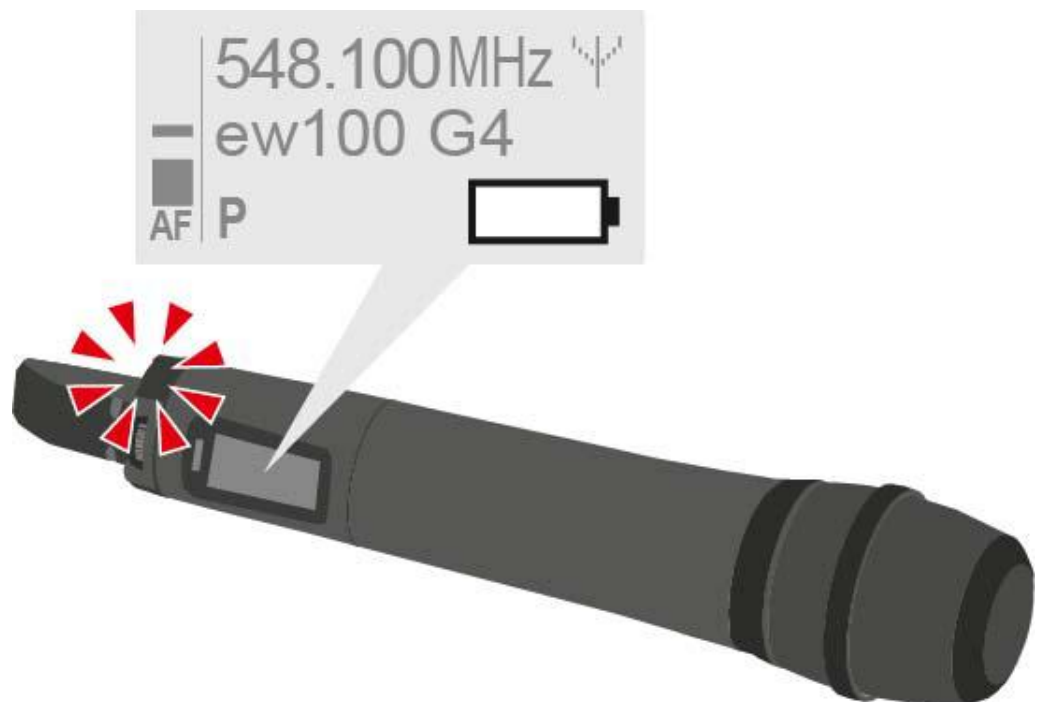



## Replacing the microphone module

You can find a list of the recommended microphone modules for the handheld transmitter under “Microphones and cables”.

To change the microphone module:

- ▷ Unscrew the microphone module.
- ▷ Screw the desired microphone module on.



---

**i** Do not touch the wireless microphone contacts or the microphone module contacts. If you touch the contacts, they may become dirty or bent.

When you unscrew the microphone module during operation, mute is automatically activated. **MUTE** appears in the display panel. When you screw the microphone module back on, mute is deactivated.

---



## Changing the colored ring

To change the colored ring:

- ▷ Pull the colored ring off as shown in the diagram.

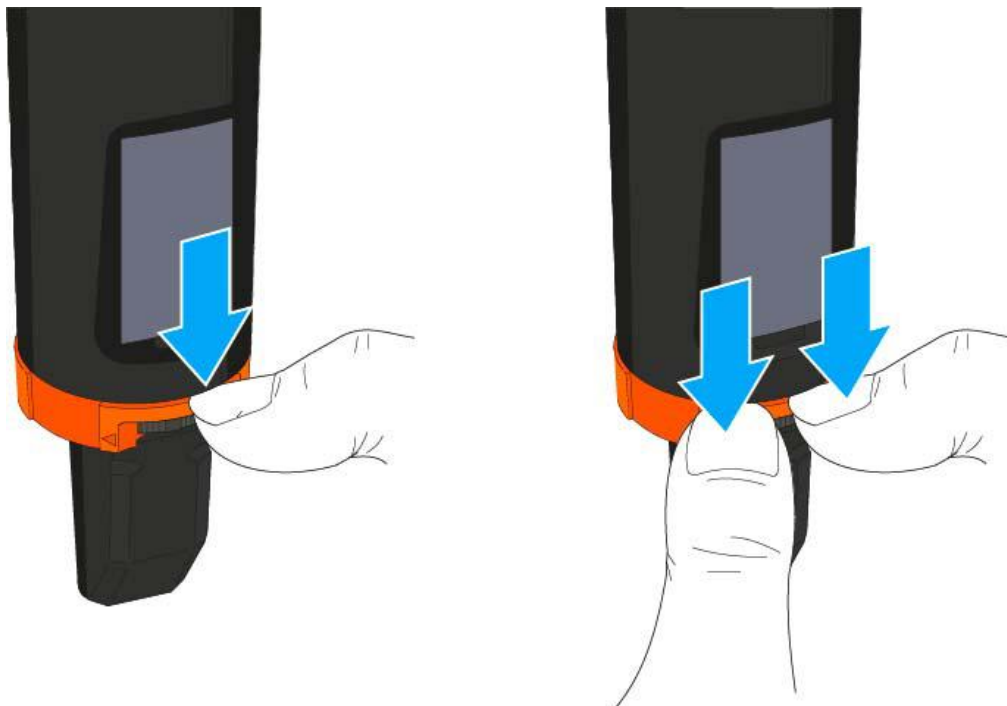

- ▷ Attached a colored ring in the color you want as shown in the diagram.

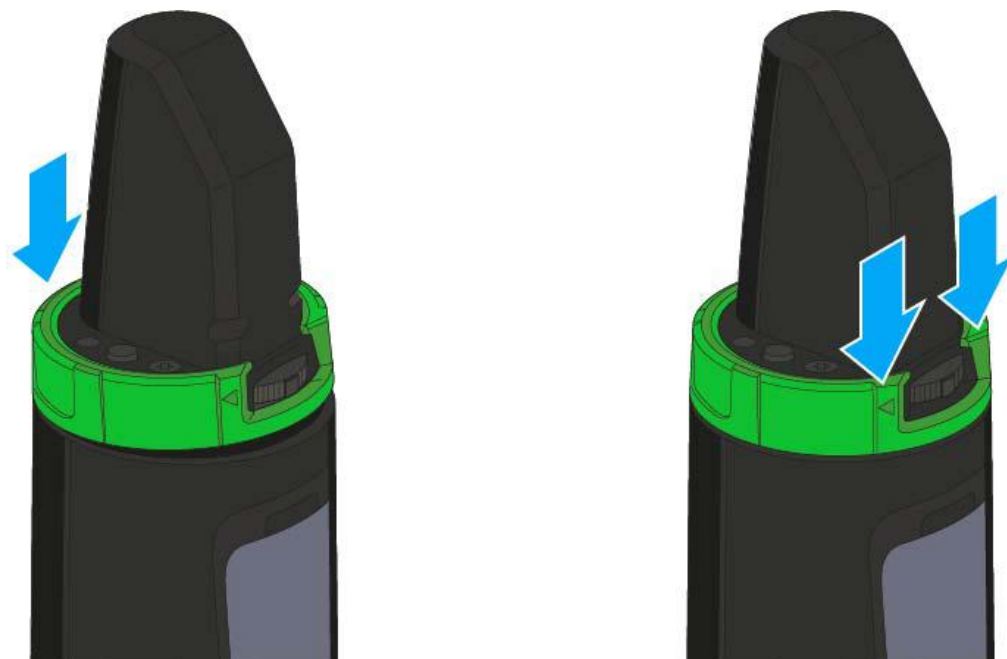



## Installing the SK 100 G4

These sections contain detailed information about installing and starting up the SK 100 G4.

You can find information about operating the SK 100 G4 under “Using the SK 100 G4”.



## Inserting and removing the batteries/rechargeable batteries

You can operate the bodypack transmitter either with batteries (AA, 1.5 V) or with the rechargeable Sennheiser BA 2015 battery.

- ▷ Press the two catches and open the battery compartment cover.
- ▷ Insert the batteries or the rechargeable battery as shown below. Please observe correct polarity when inserting the batteries.









- ▷ Close the battery compartment.  
The cover locks into place with an audible click.



### Battery status

Charge status of the batteries:

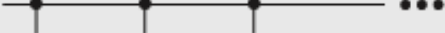
|   |  |  |
|---|--|--|
|              | 100 %  | > 8 h  |
|              | 70 %   | 4 - 6 h  |
|              | 30 %   | 2 - 3 h  |
| LOW BATT<br> |    |  |

Charge status is critical (LOW BATT):

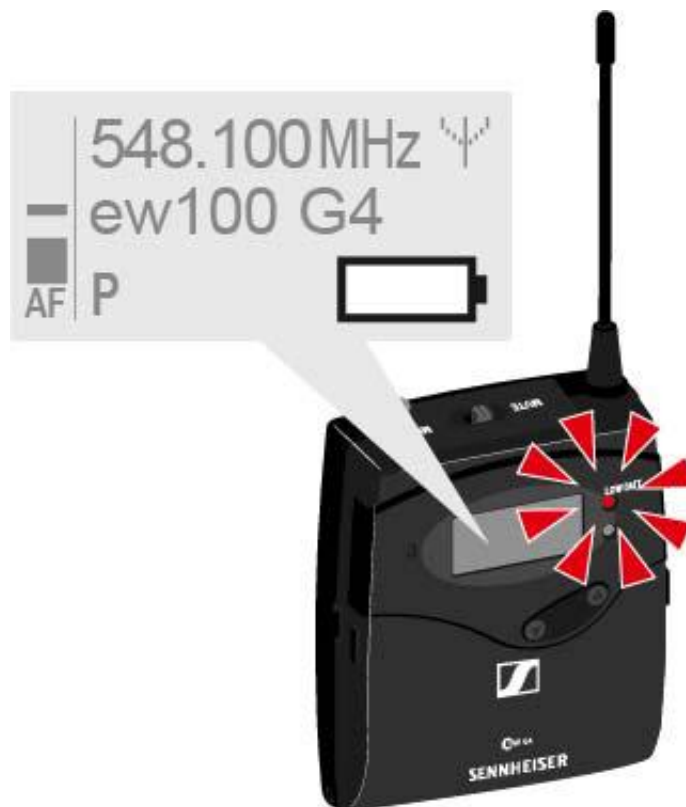



## Connecting a microphone to the SK 100 G4

You can find a list of recommended Lavalier and headset microphones for the bodypack transmitter under “Microphones and cables”.

To connect a microphone to the bodypack transmitter:

- ▷ Insert the cable's 3.5 mm jack plug into the MIC/LINE socket on the bodypack transmitter as shown in the diagram.
- ▷ Screw the plug's coupling ring onto the audio socket thread of the bodypack transmitter.







## Connecting an instrument or line source to the SK 100 G4

You can connect instruments or audio sources with a line level to the bodypack transmitter.

To do this, you will need the **Ci 1-N** (6.3 mm jack plug on a lockable 3.5 mm jack plug) or **CL 2** (XLR-3F plug on lockable 3.5 mm jack plug) Sennheiser cables.

To connect an instrument or line source to bodypack transmitter:

- ▷ Insert the cable's 3.5 mm jack plug into the MIC/LINE socket on the bodypack transmitter as shown in the diagram.
- ▷ Screw the plug's coupling ring onto the audio socket thread of the bodypack transmitter.





## Attaching the bodypack transmitter to clothing

You can use the belt clip to attach the bodypack transmitter to your waistband or on a guitar strap.

The belt clip is detachable so that you can also attach the bodypack transmitter with the antenna pointing downwards. To do so, withdraw the belt clip from its fixing points and attach it the other way round.

The belt clip is secured so that it cannot slide out of its fixing points accidentally.



To detach the belt clip:

- ▷ Lift the belt clip as shown in the diagram.
- ▷ Press one side of the clip downward on the fixing hole and pull it out of the transmitter housing.
- ▷ Do the same thing on the other side.

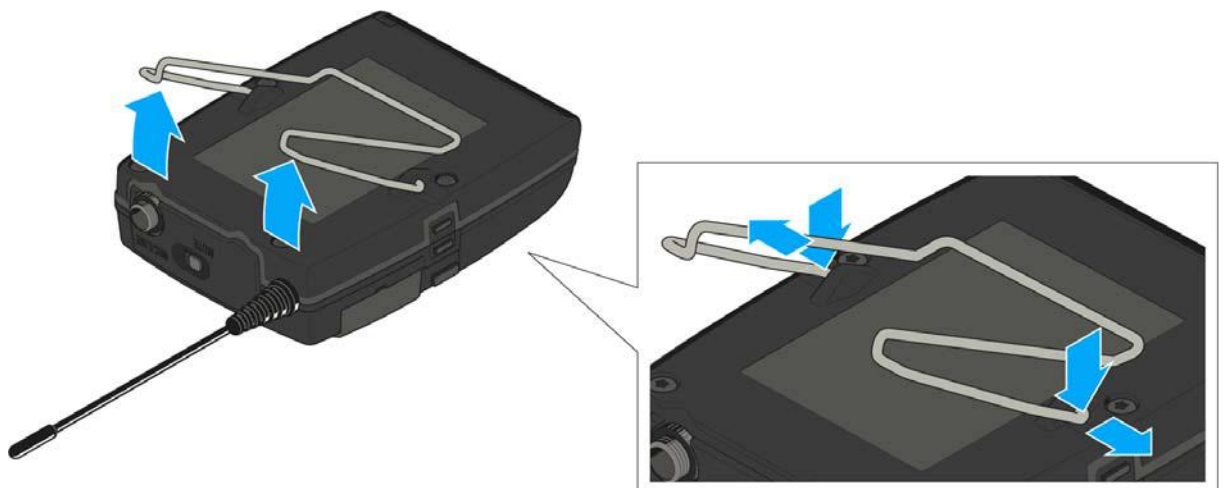



## Installing the ASA 214

These sections contain detailed information about installing and starting up the ASA 214.

You can find information about operating the ASA 214 under “Using the ASA 214”.



## Connectors on the rear of the device

### Product overview for the rear side of the ASA 214

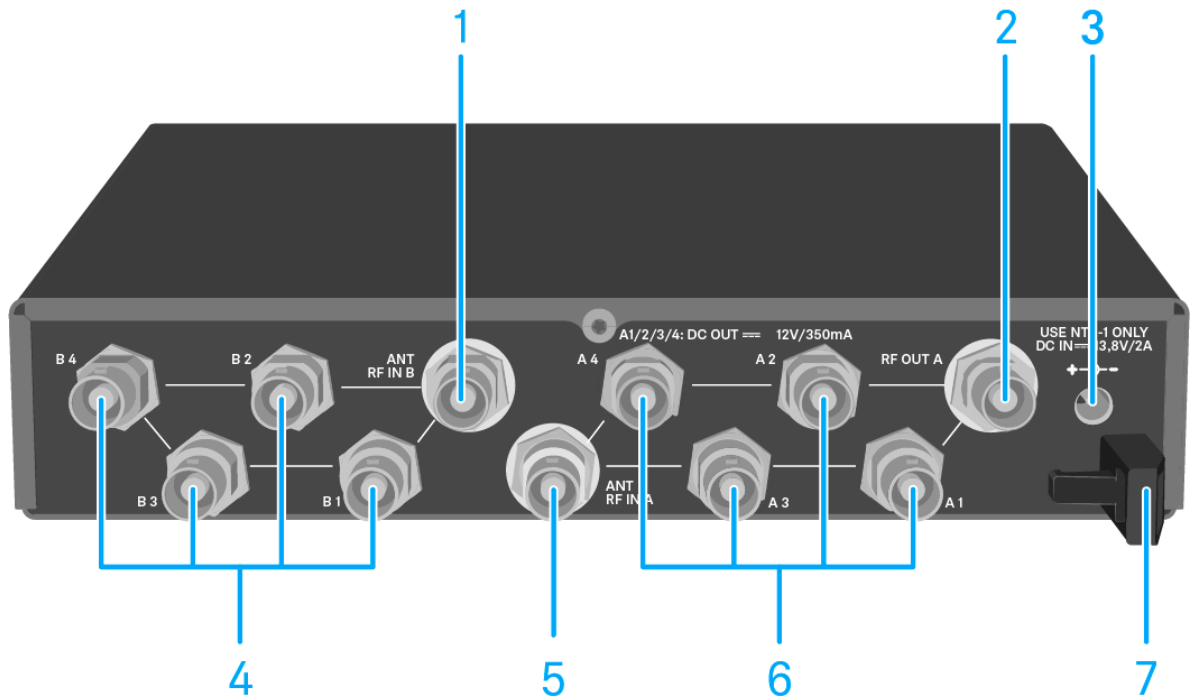

#### 1 ANT RF IN B BNC socket

- Antenna input of diversity branch B
- See “Connecting antennas”

#### 2 RF OUT A BNC socket

- RF output only for connecting an additional ASA 214 to build an 8-channel diversity system
- See “Configuring multi-channel systems”

#### 3 DC IN socket

- To connect the NT 1-1 power supply unit
- See “Connecting/disconnecting the ASA 214 to/from the power supply system”

#### 4 4 BNC sockets B1 to B4

- RF outputs of diversity branch B for connection to the receiver
- See “Connecting receivers to the ASA 214”

#### 5 ANT RF IN A BNC socket

- Antenna input of diversity branch A
- See “Connecting antennas”

#### 6 4 BNC sockets A1 to A4

- RF outputs of diversity branch A for connection to the receiver
- Every one of these RF outputs can also provide voltage to a receiver.
- See “Connecting receivers to the ASA 214”

#### 7 Strain relief for the cable of the power supply unit

- See “Connecting/disconnecting the ASA 214 to/from the power supply system”



## Connecting/disconnecting the ASA 214 to/from the power supply system

To supply power to the ASA 214, the connected receivers and any antenna amplifiers used, you will need the NT 1-1 power supply unit.

Only use the supplied NT 1-1 power supply unit. It is designed for your antenna splitter and ensures safe operation.

To connect the ASA 214 antenna splitter to the power supply system:

- Plug the hollow jack plug of the power supply unit into the **DC IN** socket of the antenna splitter.
- Pass the cable of the power supply unit through the cable grip.
- Slide the supplied country adapter onto the power supply unit.
- Plug the power supply unit into the wall socket.

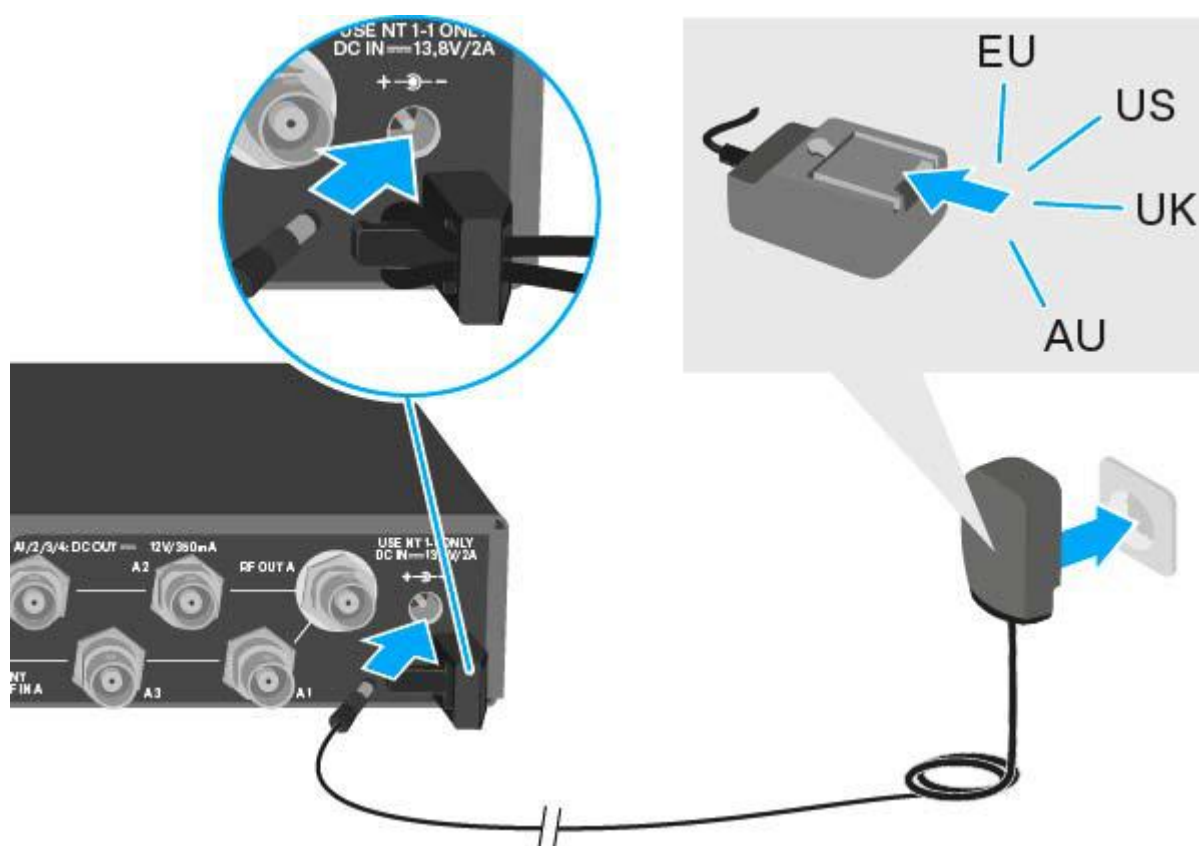

To completely disconnect the ASA 214 antenna splitter from the power supply system:

- Unplug the power supply unit from the wall socket.
- Unplug the hollow jack plug of the power supply unit from the **DC IN** socket of the antenna splitter.



## Connecting receivers to the ASA 214

You can connect and operate up to four stationary receivers to the ASA 214.

Sennheiser receivers of the ew G4 and ew G3 series can also be supplied with power from the ASA 214.

The following receivers are compatible:

### **evolution wireless G4:**

- EM 100 G4
- EM 300-500 G4

### **evolution wireless G3:**

- EM 100 G3
- EM 300 G3
- EM 500 G3

### **2000 series:**

- EM 2000 (with its own power supply)
- EM 2050 (with its own power supply)



To connect the receivers to the ASA 214 antenna splitter:

- ▷ Connect one of the receiver's antenna inputs to one of the BNC sockets **A1** to **A4** using one of the supplied BNC cables.  
The compatible receivers listed above do not require their own power supply. They are powered via the BNC sockets **A1** to **A4**.
- ▷ Connect the receiver's other antenna input to one of the BNC sockets **B1** to **B4** using one of the supplied BNC cables.

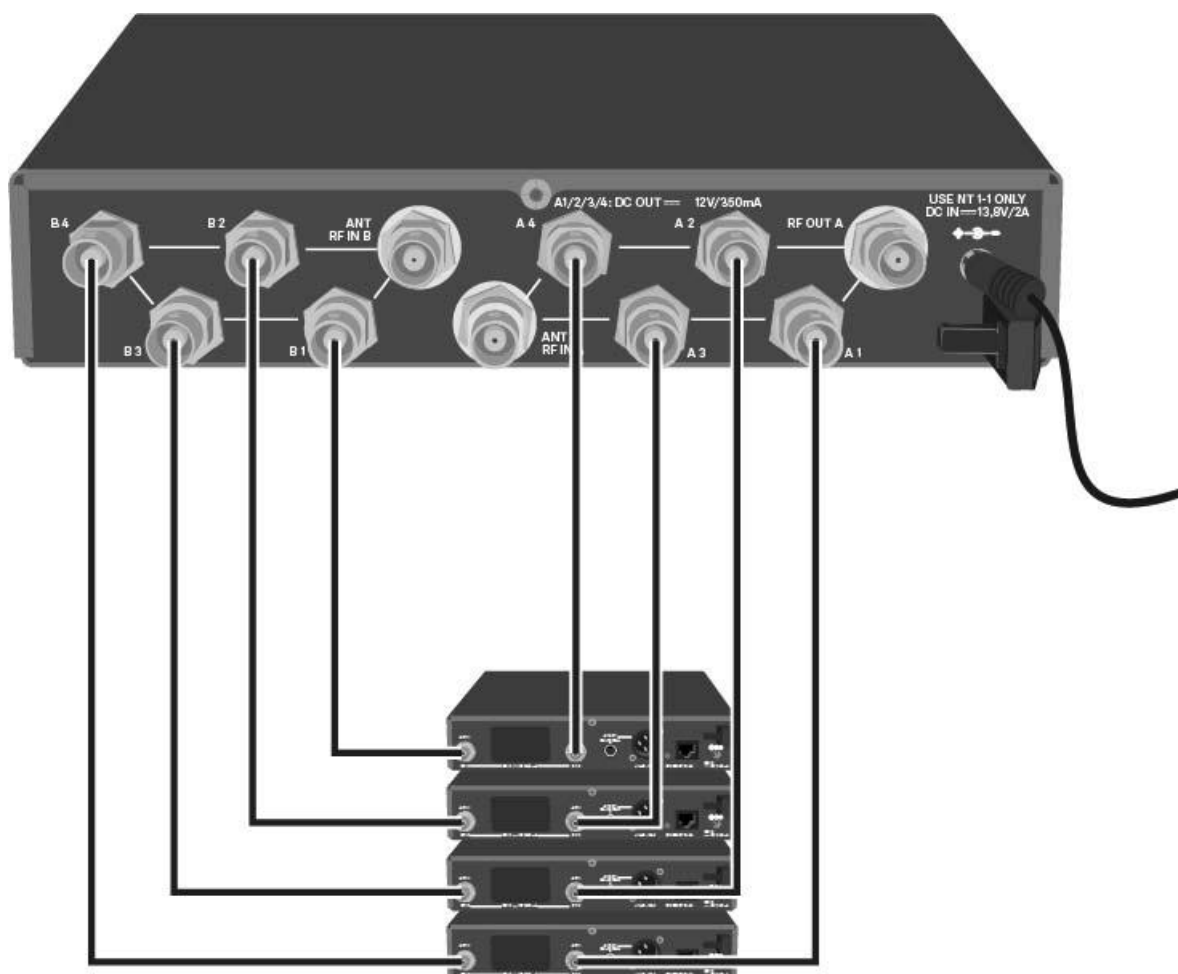



## Connecting antennas

**i** For more information about antennas and antenna accessories, see “Antennas and accessories”.

**i** In order to ensure optimal reception even in the case of poor reception conditions, we recommend using remote antennas.

### Connecting remote antennas

- ▷ Mount two antennas or a combination of an antenna and an antenna amplifier to the BNC sockets **ANT RF IN A** and **ANT RF IN B**.

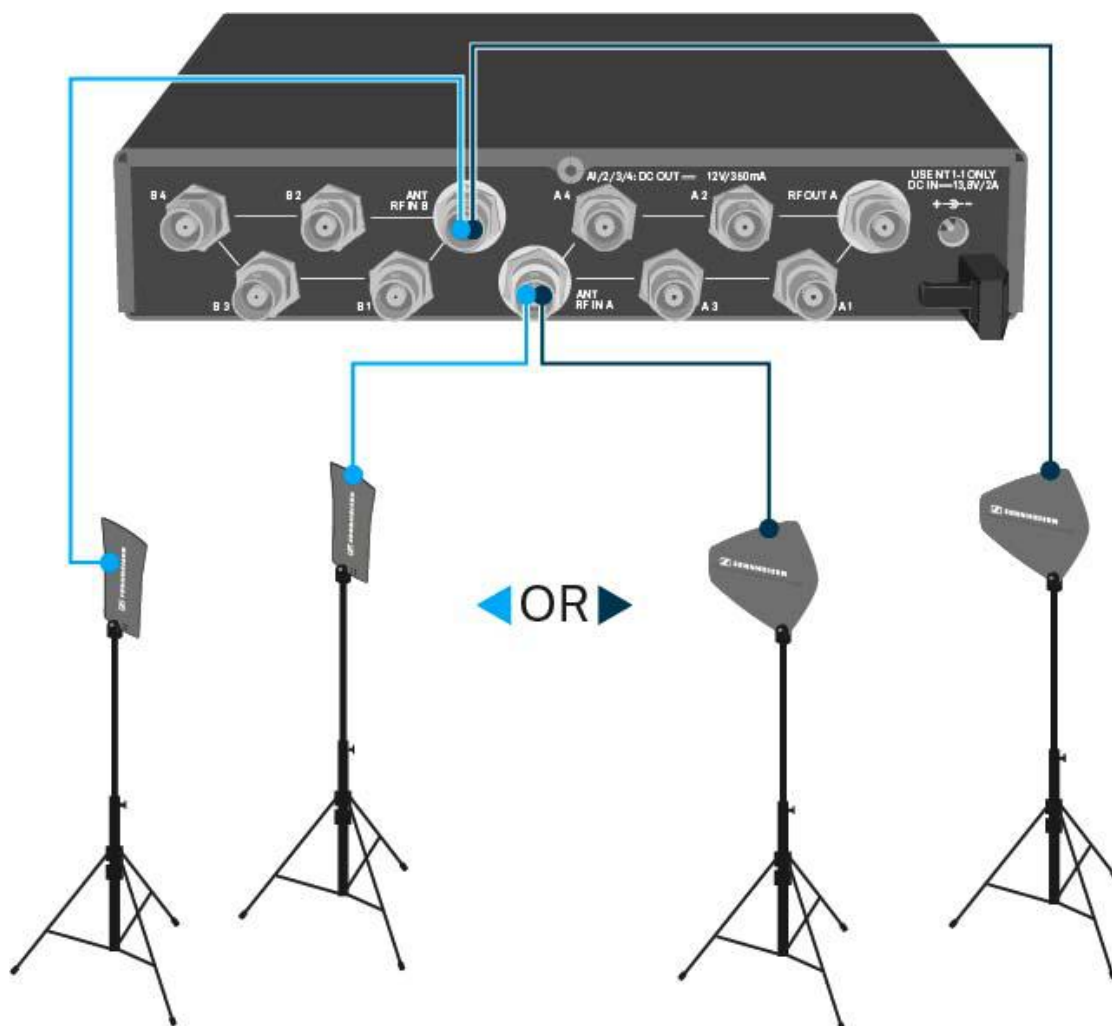

### Connecting rod antennas

- ▷ Mount the antennas to the BNC sockets **ANT RF IN A** and **ANT RF IN B**.
- ▷ Align the antennas in a V-shape in order to ensure the best possible reception.





## Information on antenna amplifiers and cable lengths

The following table shows which cable lengths require the use of the AB 3 or AB 4 antenna amplifier as well as the maximum recommended cable lengths.

| Device                   | Frequency range around | Number of AB 3 or AB 4 | Max. cable length |          |
|--------------------------|------------------------|------------------------|-------------------|----------|
|                          |                        |                        | RG 58             | GZL 5000 |
| ASA 214<br>(AB 3 & AB 4) | 500 MHz                | 0                      | 8 m               | 16 m     |
|                          |                        | 1                      | 36 m              | 72 m     |
|                          |                        | 2                      | 64 m              | 128 m    |
|                          | 700 MHz                | 0                      | 7 m               | 14 m     |
|                          |                        | 1                      | 30 m              | 60 m     |
|                          |                        | 2                      | 53 m              | 106 m    |
|                          | 900 MHz                | 0                      | 6 m               | 12 m     |
|                          |                        | 1                      | 26 m              | 52 m     |
|                          |                        | 2                      | 46 m              | 92 m     |
| ASA 214 - 1G8<br>(AB 3)  | 1800 MHz               | 0                      | 4 m               | 8 m      |
|                          |                        | 1                      | 16 m              | 36 m     |
|                          |                        | 2                      | 28 m              | 64 m     |

Use the **AB 3** for the following frequency ranges:

- **A1 range:** 470 – 516 MHz
- **A range:** 516 – 558 MHz
- **G range:** 566 – 608 MHz
- **GB range:** 606 – 648 MHz
- **B range:** 626 – 668 MHz
- **C range:** 734 – 776 MHz
- **D range:** 780 – 822 MHz
- **TH range:** 794 – 806 MHz
- **JB range:** 806 – 810 MHz
- **E range:** 823 – 865 MHz
- **K+ range:** 925 – 937.5 MHz
- **1G8 range:** 1785 – 1800 MHz

Use the **AB 4** for the following frequency ranges:



- **Aw+ range:** 470 – 558 MHz
- **Gw range:** 558 – 626 MHz
- **GBw range:** 606 – 678 MHz
- **Bw range:** 526 – 698 MHz
- **Cw range:** 718 – 790 MHz
- **Dw range:** 790 – 865 MHz



## Configuring multi-channel systems

The following options for connecting multi-channel systems are possible:

### Option 1: Two antennas supply a 4-channel system

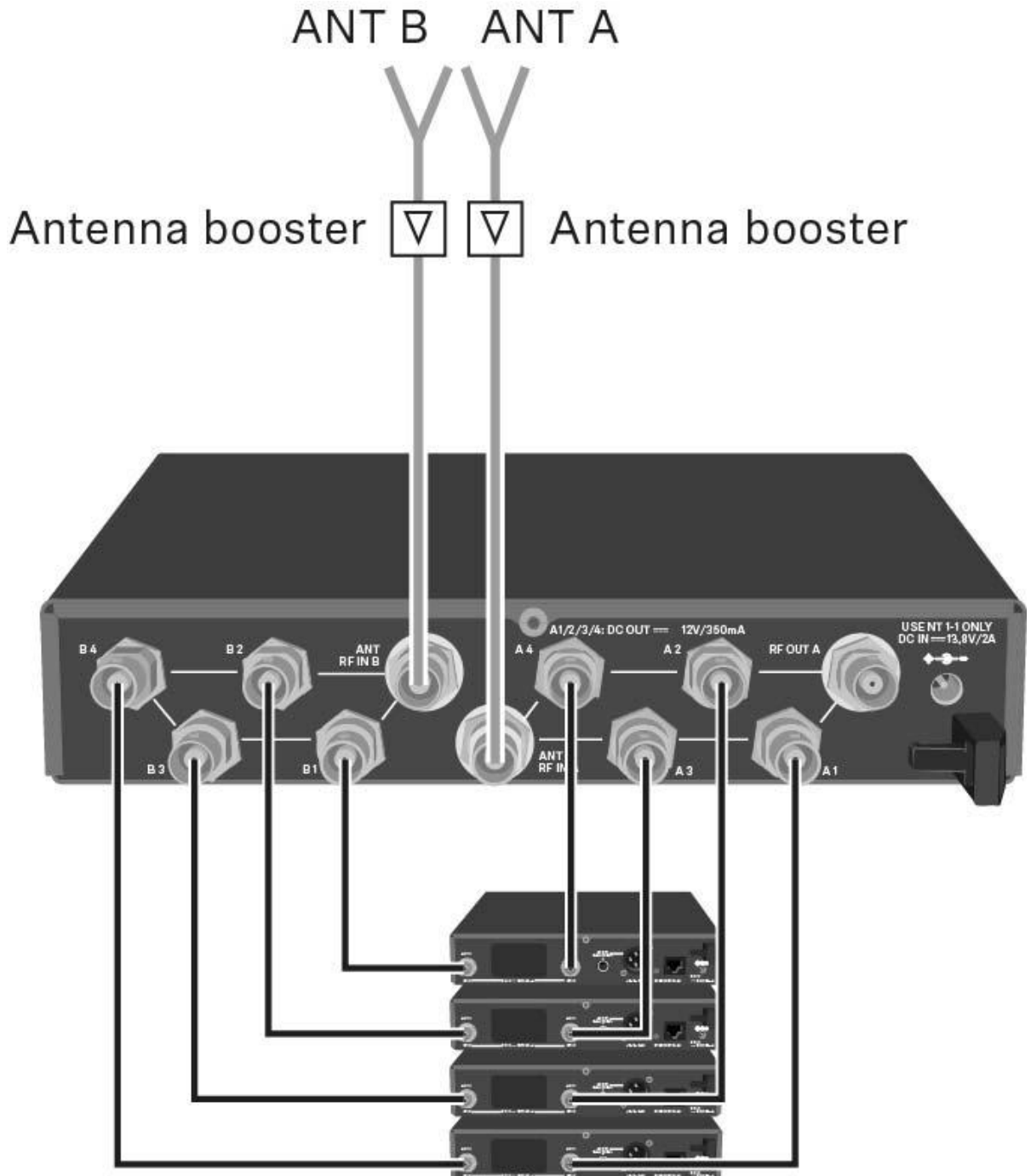



Option 2: Two 4-channel systems are interconnected

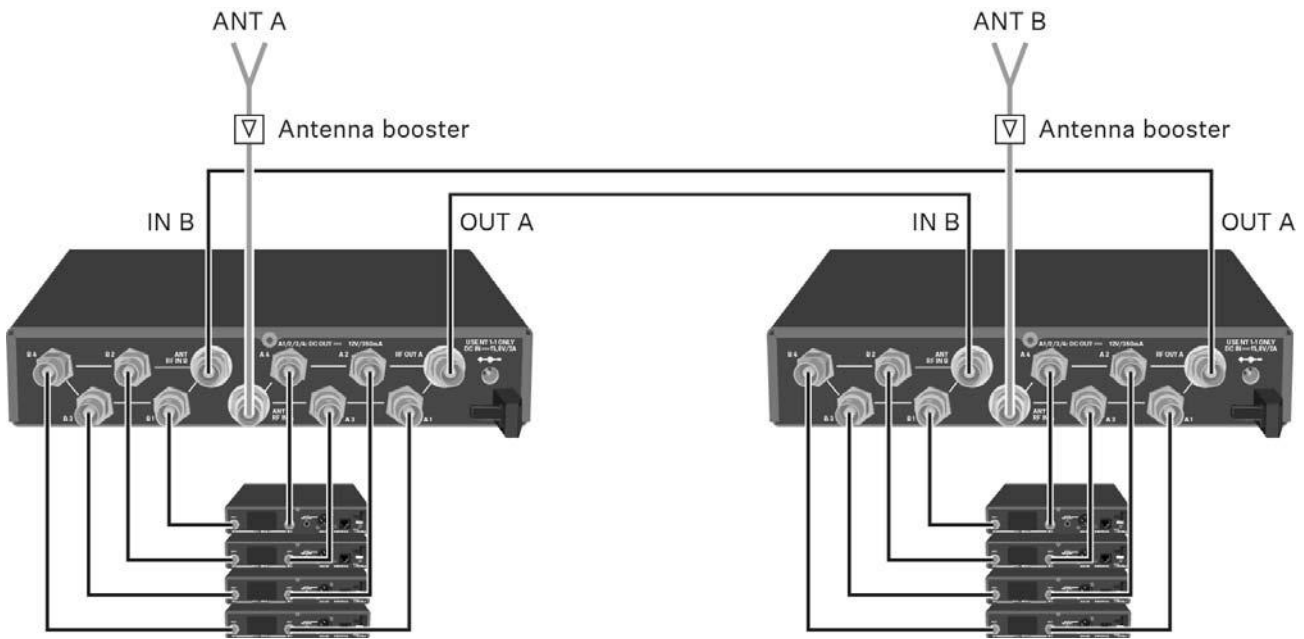

Option 3: Two antennas supply a 8-channel system

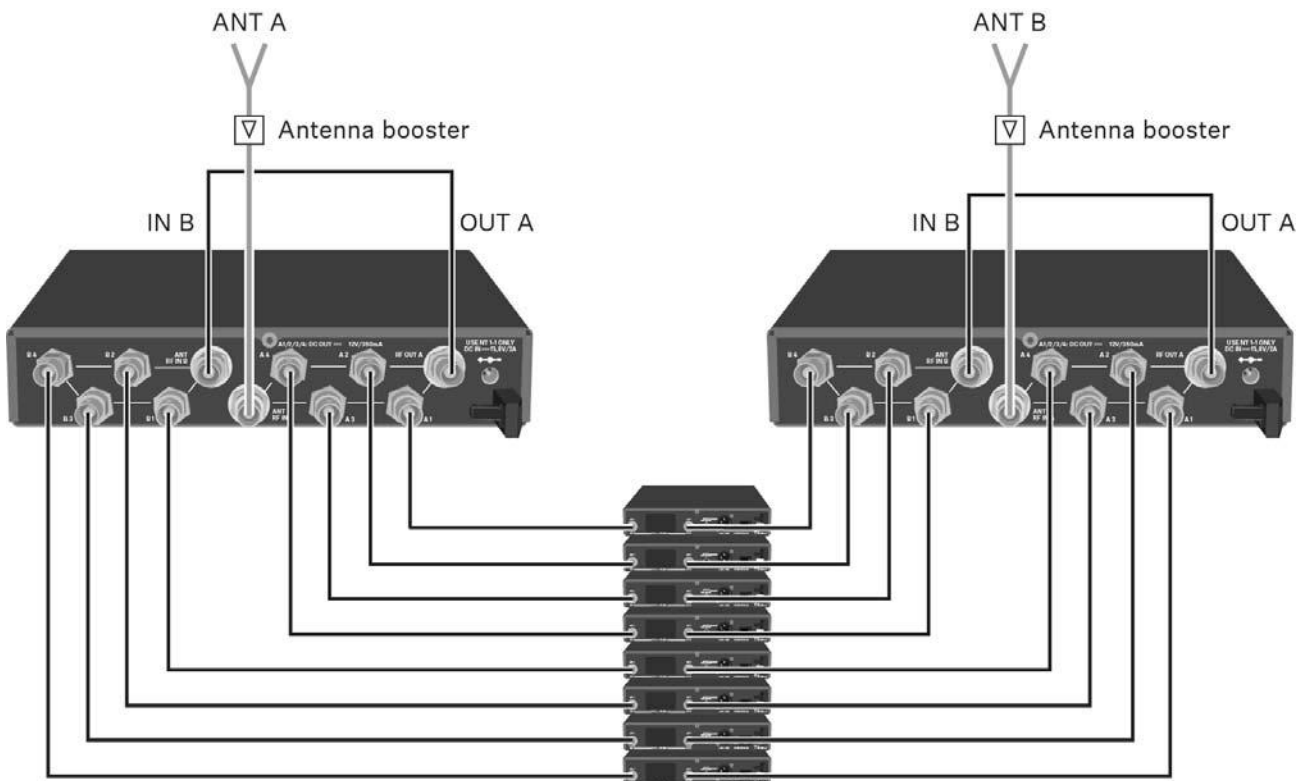



## Installing the ASA 214 in a rack

---

### CAUTION

#### **Rack mounting poses risks**

When installing the device in a closed or multi-rack assembly, please consider that, during operation, the ambient temperature, the mechanical loading and the electrical potentials will be different from those of devices which are not mounted into a rack.

- ▷ Make sure that the ambient temperature within the rack does not exceed the permissible temperature limit specified in the specifications. See “Specifications”.
  - ▷ Ensure sufficient ventilation; if necessary, provide additional ventilation.
  - ▷ Make sure that the mechanical loading of the rack is even.
  - ▷ When connecting to the power supply system, observe the information indicated on the type plate. Avoid circuit overloading. If necessary, provide overcurrent protection.
  - ▷ When rack mounting, please note that intrinsically harmless leakage currents of the individual power supply units may accumulate, thereby exceeding the allowable limit value. As a remedy, ground the rack via an additional ground connection.
-



### Mounting a single antenna splitter in a rack

To mount the antenna splitter in a rack, you will need the GA 3 rack mounting kit (optional accessory).

To fasten the mounting angle of the GA 3 rack mounting kit:

- ▷ Unscrew and remove the two recessed head screws (M4x8) on each side of the antenna splitter.
- ▷ Secure the mounting angles to the sides of the antenna splitter using the previously removed recessed head screws.

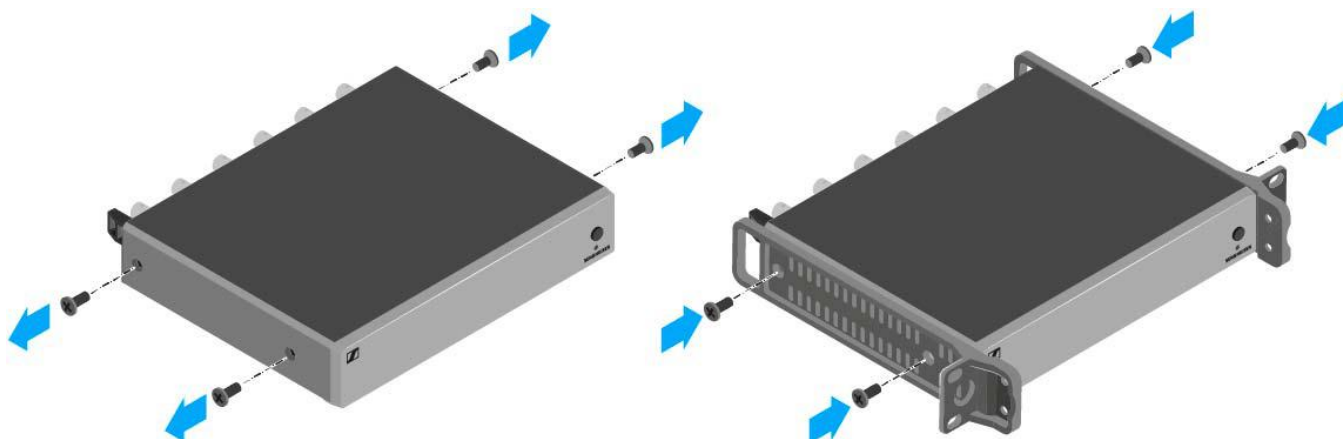

- ▷ Secure the blanking plate to one of the mounting angles using two recessed head screws (M6x10).

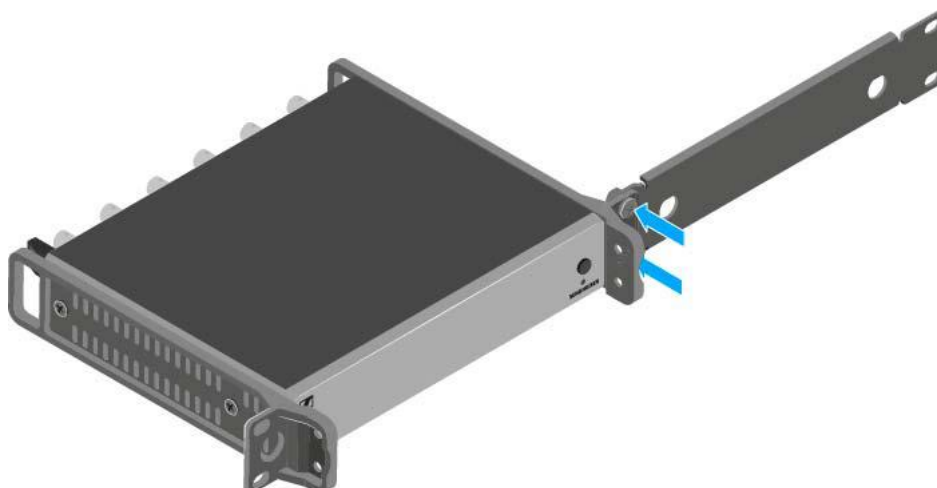



- ▷ Attach the antennas. You have the following options:
  - Connect the supplied rod antennas on the rear side of the antenna splitter. In this case, cover the antenna holes with the two covers (left diagram).
  - Attach the AM 2 antenna front mounting set (optional accessory) and mount the rod antennas on the blanking plate (right diagram).

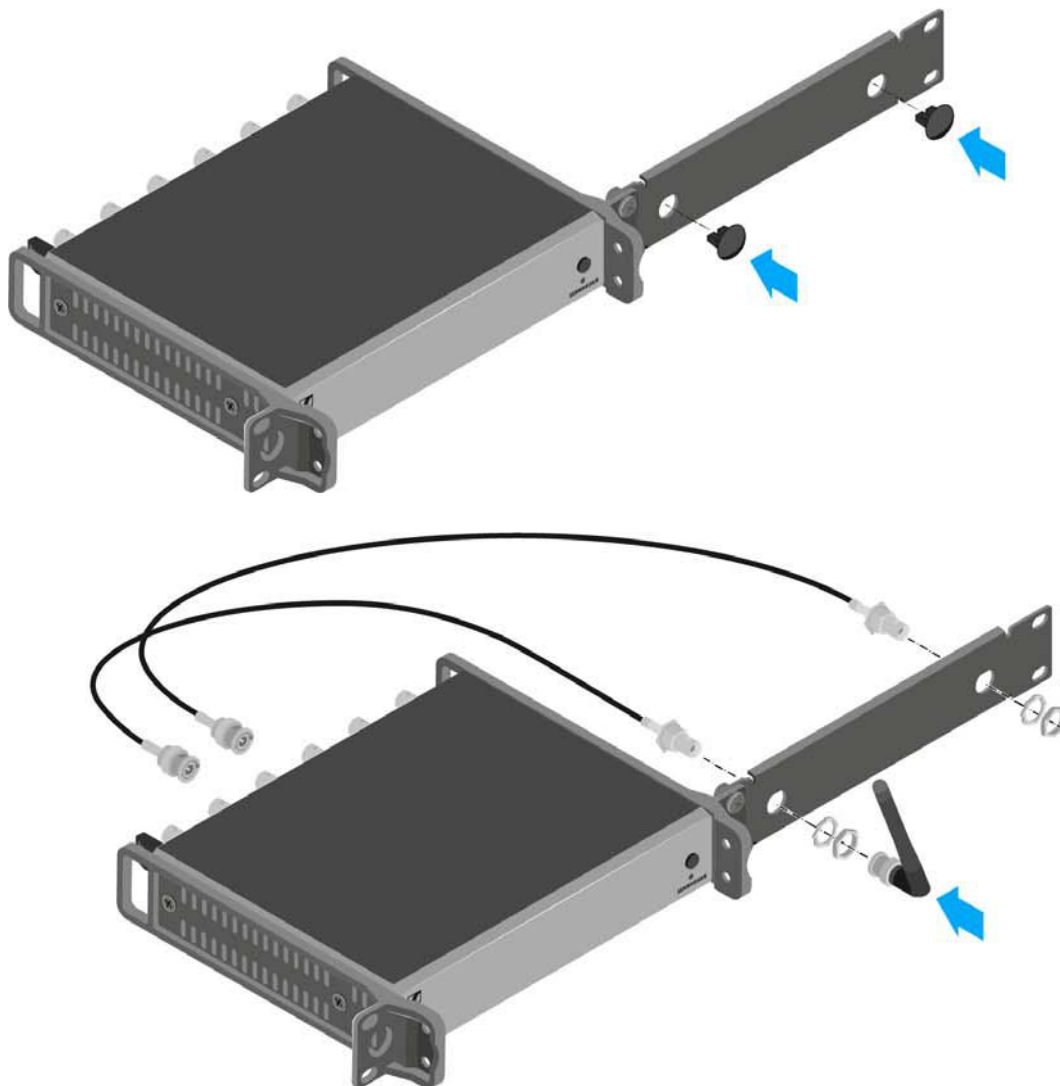

- ▷ Slide the antenna splitter with the mounted blanking plate into the 19" rack.
- ▷ Secure the mounting angle and the blanking plate to the 19" rack.
- ▷ Align the mounted antennas in a V-shape.



### Mounting two antenna splitters side by side in a rack

To mount the antenna splitters using the GA 3 rack mounting kit (optional accessory):

- ▷ Place both antenna splitters upside down and side by side on an even surface.
- ▷ Secure the jointing plate to the transmitters using the six recessed head screws (M3x6).
- ▷ Secure the mounting angle.

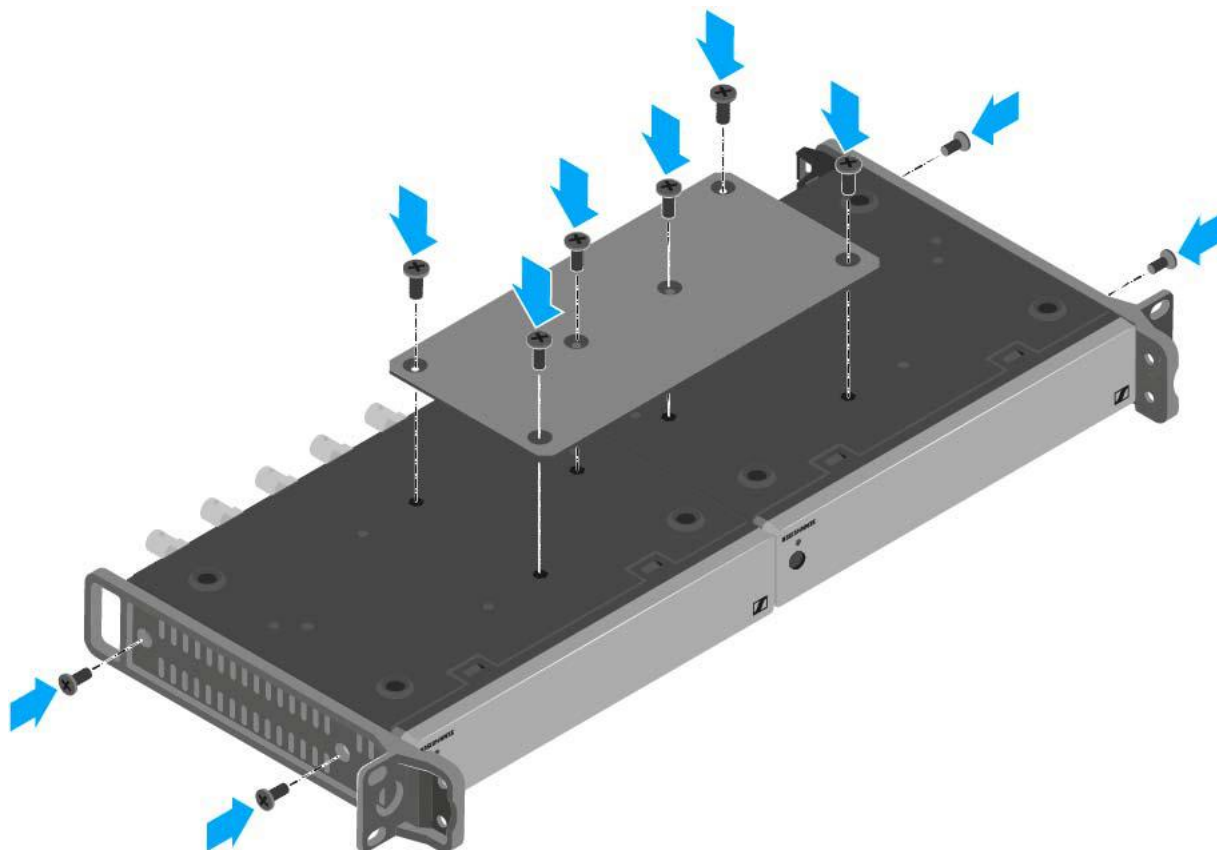





## OPERATION

### Using ew 100 G4 series devices

You can find information about using ew 100 G4 series devices in the following sections.

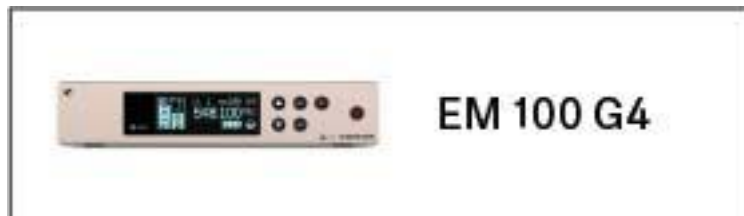

- **EM 100 G4** rack receiver >> “Using the EM 100 G4”



- **SKM 100 G4(-S)** handheld transmitter >> “Using the SKM 100 G4”



- **SK 100 G4** bodypack transmitter >> “Using the SK 100 G4”

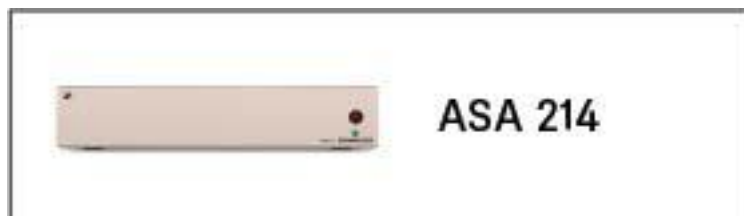

- **ASA 214** antenna splitter >> “Using the ASA 214”



You can find information about **installation and start up** of the products under “Installing and starting up ew 100 G4 series devices”.



In the sections below, you can find important **information about specific use cases**.



- Establishing a **radio link** between the transmitter and receiver >> “Establishing a radio link”

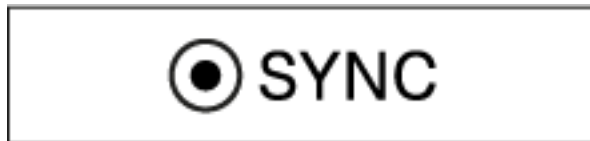

- **Synchronizing** the receiver **settings** to the transmitter >> “Synchronizing devices”



- Using the **menu** of the **receiver** >> “Displays on the EM 100 G4 display panel”

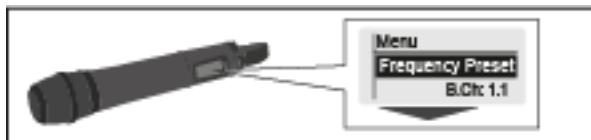

- Using the **menu** of the **handheld transmitter** >> “Displays on the SKM 100 G4 handheld transmitter display panel”

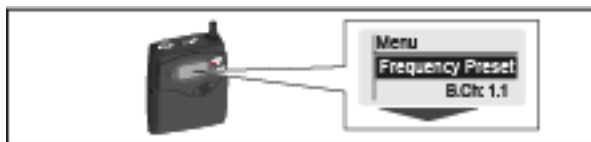

- Using the **menu** of the **bodypack transmitter** >> “Displays on the SK 100 G4 bodypack transmitter display panel”



## Using the EM 100 G4

These sections contain detailed information about using the EM 100 G4.

You can find information on installation and startup of the EM 100 G4 under “Installing the EM 100 G4”.



## Operating elements on the front of the device

### Product overview for the front of the EM 100 G4

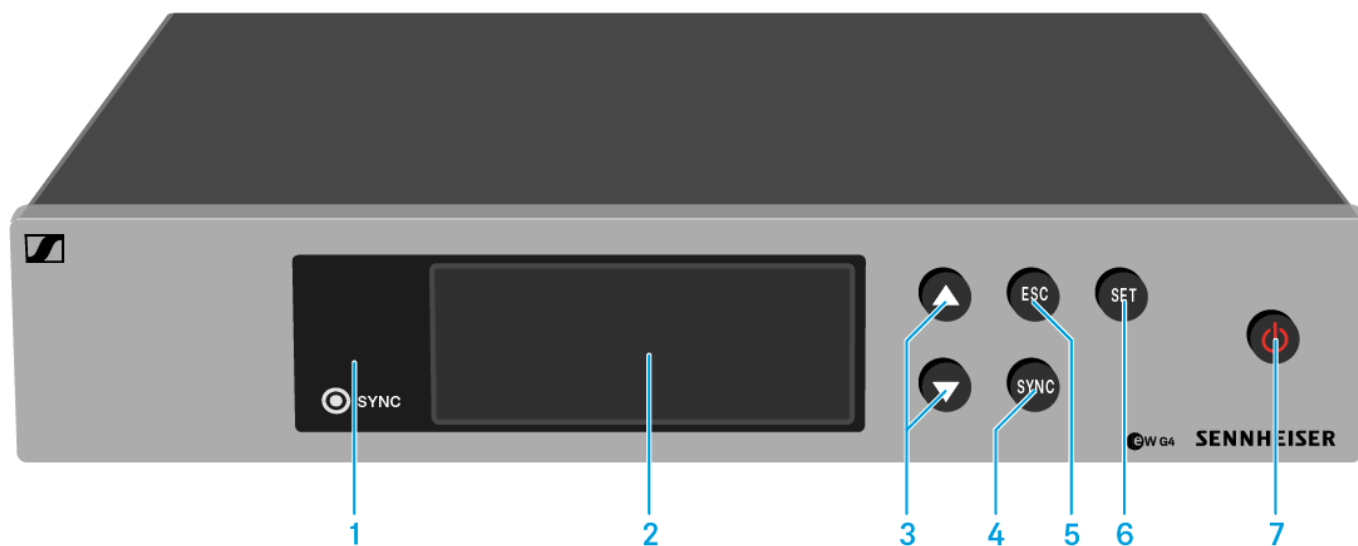

- 1** Infrared interface with a blue LED
  - See “Synchronizing devices”
- 2** Display panel
  - See “Displays on the EM 100 G4 display panel”
- 3** **UP/DOWN** buttons
  - See “Buttons for navigating through the menu”
- 4** **SYNC** button
  - See “Synchronizing devices”
- 5** **ESC** button
  - See “Buttons for navigating through the menu”
- 6** **SET** button
  - See “Buttons for navigating through the menu”
- 7** **STANDBY** button
  - See “Switching the EM 100 G4 on and off”



## Switching the EM 100 G4 on and off

To switch the receiver on:

- ▷ Short-press the **STANDBY** button.  
The receiver switches on and the **Receiver Parameters** standard display appears.

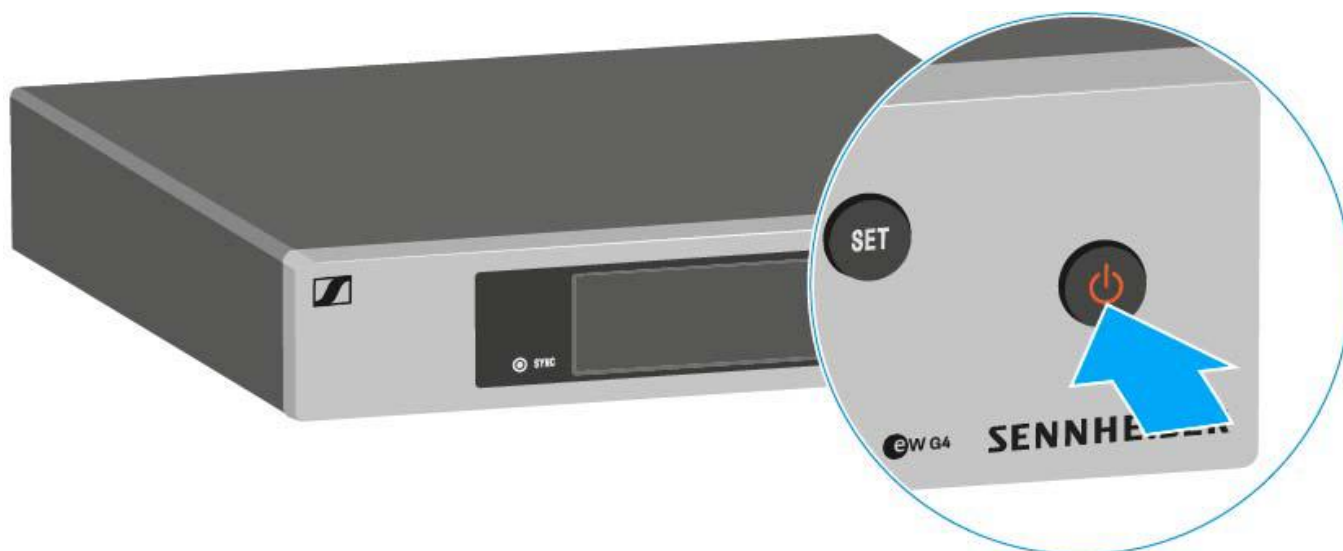

To switch the receiver to **standby mode**:

- ▷ If necessary, deactivate the lock-off function (see “Lock-off function”).
- ▷ Press and hold the **STANDBY** button until **OFF** appears on the display panel.  
The display panel switches off.

To **completely switch** the receiver **off**:

- ▷ Disconnect the receiver from the power supply system by unplugging the power supply unit from the wall socket.



## Muting the audio output

To **mute** the audio signal of the receiver:

- ▷ Short-press the **STANDBY** button in one of the standard displays. The **RX Mute On?** display appears.
- ▷ Press the **SET** button. The audio signal is muted.

To **cancel the muting**:

- ▷ Short-press the **STANDBY** button. The **RX Mute Off?** display appears.
- ▷ Press the **SET** button. The audio output is no longer muted.

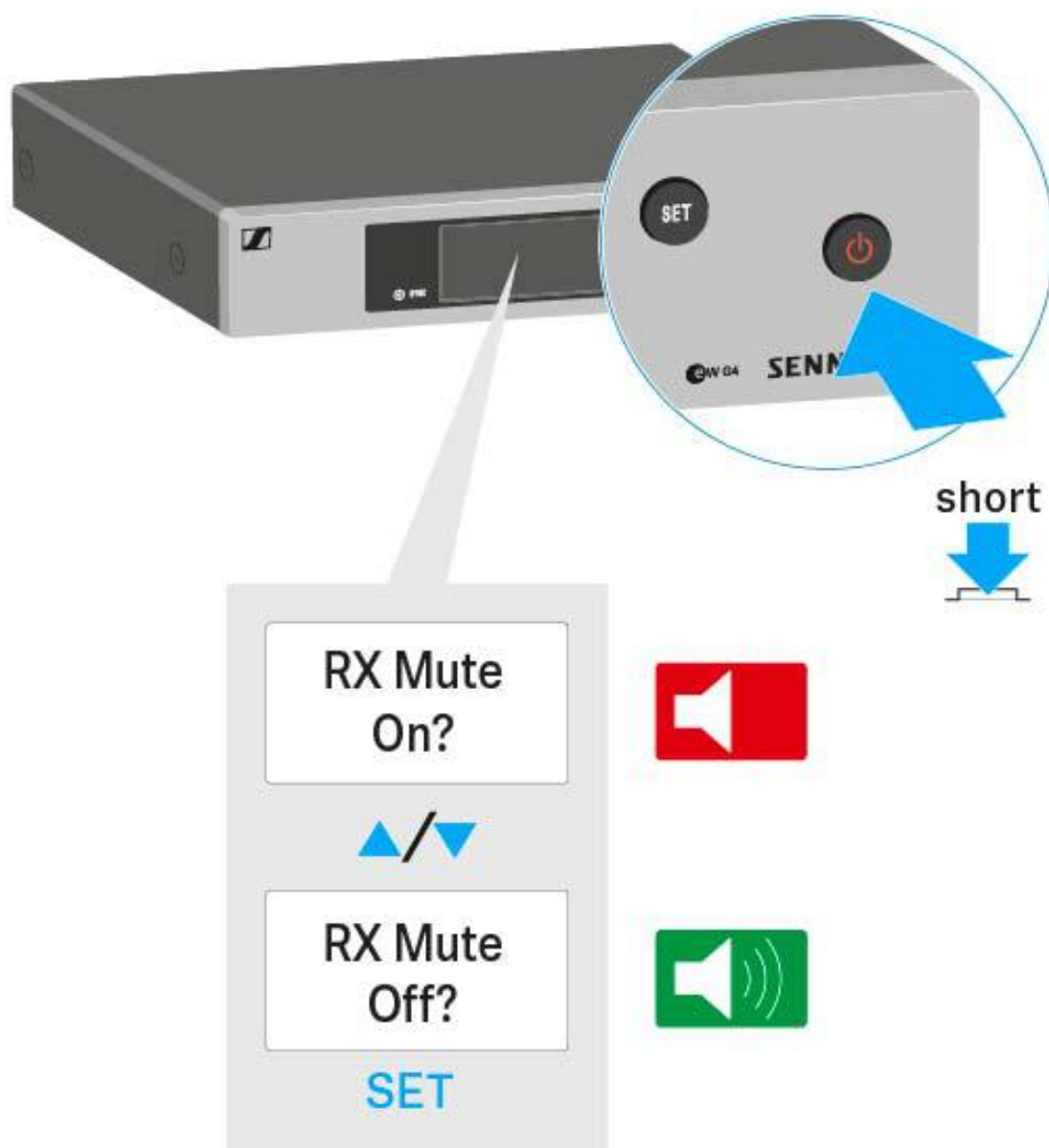



## Lock-off function

You can set the automatic lock-off function in the **Auto lock** menu (see “Auto Lock menu item”).

When you have switched on the lock-off function, you will have to turn the receiver off and on again in order to operate it.

To temporarily deactivate the lock-off function:

- ▷ Press the **SET** button.  
Locked appears in the display panel.
- ▷ Press the **UP** or **DOWN** button.  
Unlock? appears in the display panel.
- ▷ Press the **SET** button.  
Lock-off function is now temporarily deactivated.

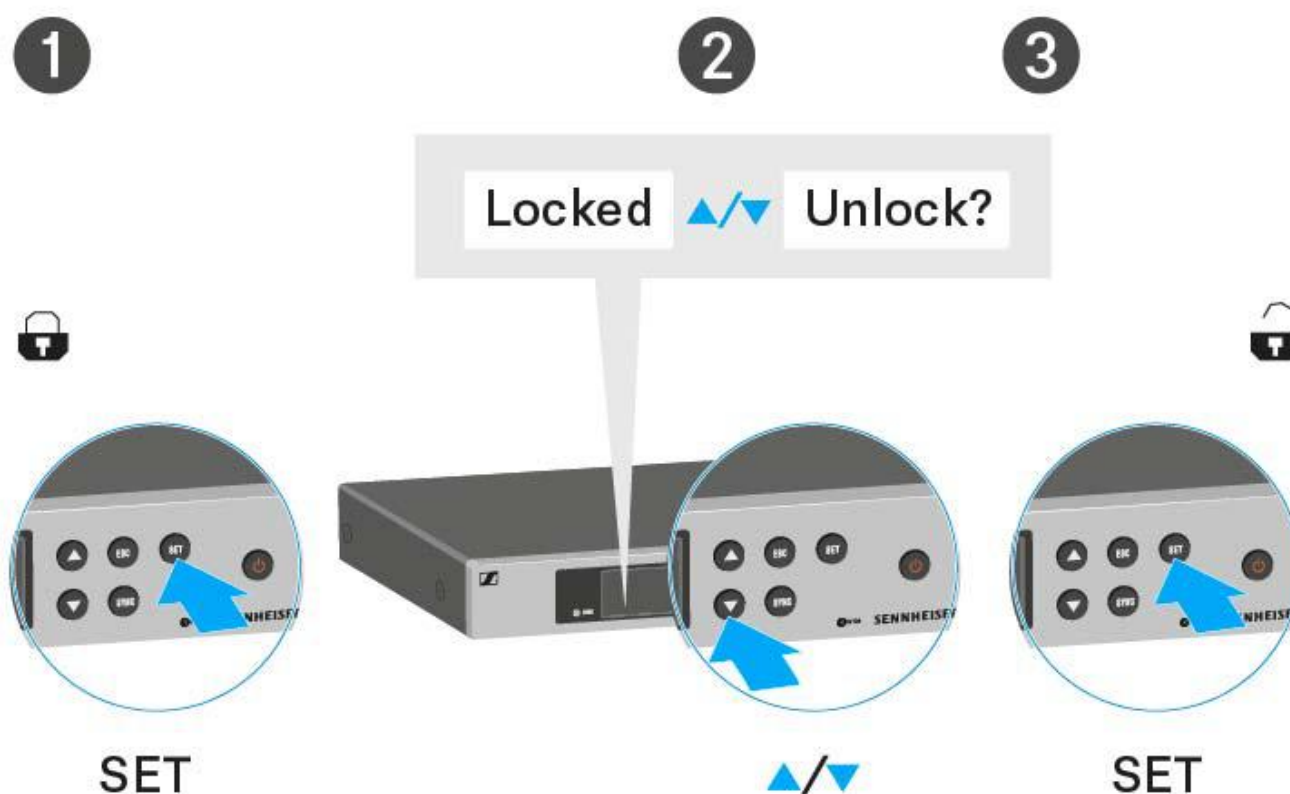

### When you are in the operating menu

>> Lock-off function is deactivated long enough for you to work in the operating menu.

### When one of the standard displays is shown

>> Lock-off function is automatically activated after 10 seconds.

The Lock-off function icon flashes while the lock-off function is being activated again.



## Displays on the EM 100 G4 display panel

---

**Status information** such as reception quality, battery status, audio level, etc. is displayed on the **home screen** of the display panel.

- See “Home screen”.
- 

The display panel also displays the **operating menu** which you can use to configure all of the **settings**.

- See “Setting options in the menu”.
- 

## Buttons for navigating through the menu

To navigate through the EM 100 G4 operating menu, you need the following buttons.

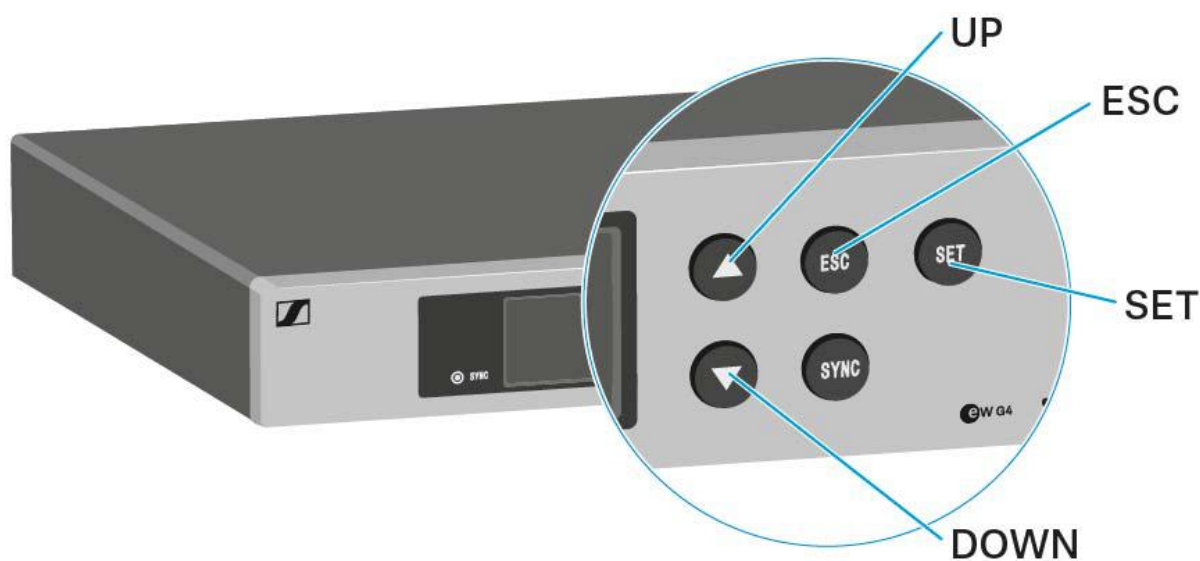

Short-press the **ESC** button

- Cancels the entry and returns to the previous display

Long-press the **ESC** button

- Cancels the entry and returns to the home screen
-





Press the **SET** button

- Changes from the current standard display to the operating menu
  - Calls up a menu item
  - Changes to a submenu
  - Stores the settings and returns to the operating menu
- 

**UP**

**DOWN**



Press the **UP** or **DOWN** button

- Selects a standard display (see “Home screen”)
  - Changes to the previous or next menu item
  - Changes the setting of a menu item
-



## Home screen

After you switch on the receiver, the display panel initially displays the Sennheiser logo. After a short time, the home screen is then displayed.

The home screen has three different standard displays.

- ▷ On the home screen, press the **UP** and **DOWN** buttons to switch between the standard displays.

### Receiver Parameters **standard display**

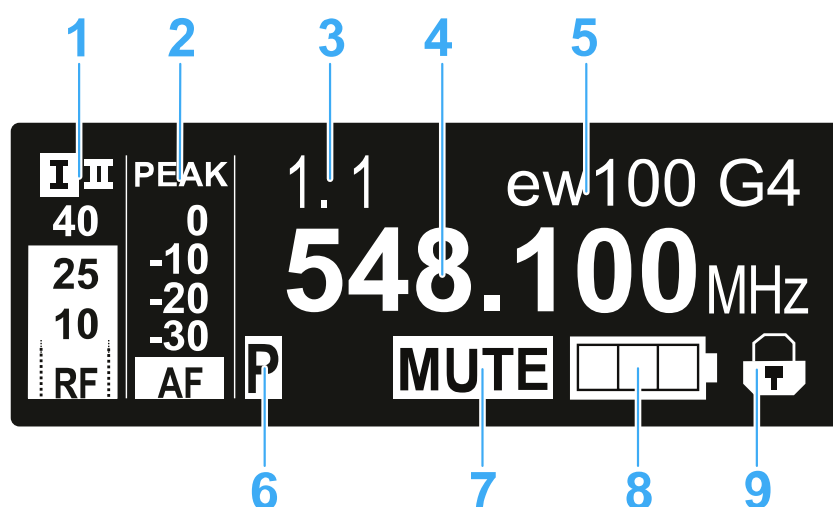

- 1 RF** RF level (radio frequency)
  - RF signal level display
  - including the display of the squelch threshold (see “Squelch menu item”)
- 2 AF** audio level (audio frequency)
  - Displays the audio level of the received transmitter  
When the display shows full deflection, the audio input level is excessively high. When the transmitter is overloaded frequently or for extended periods of time, the **PEAK** display is shown inverted.
  - See “AF Out menu item”
- 3** Frequency bank and channel
  - Current frequency bank and channel number
  - See “Frequency Preset menu item”
- 4** Frequency
  - Current receiving frequency
  - See “Frequency Preset menu item”
- 5** Name
  - Freely selectable name of the receiver
  - See “Name menu item”
- 6 P** pilot tone



- Activated pilot tone evaluation
- See “Advanced -> Pilot Tone menu item”

#### 7 MUTE muting function

- Receiver or transmitter is muted
- See “Muting the audio output”

#### 8 Battery status of the transmitter

- SKM 100 G4: see “Inserting and removing the batteries/rechargeable batteries”
- SK 100 G4: see “Inserting and removing the batteries/rechargeable batteries”

#### 9 Lock-off function

- Lock-off function is activated on the receiver
- See “Lock-off function”

### Soundcheck standard display

The Soundcheck standard display shows the transmission quality between the transmitter and the receiver.

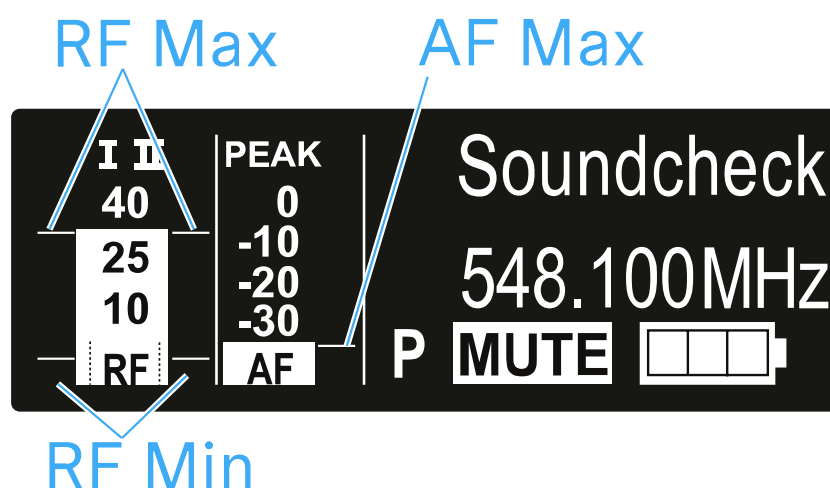

By doing a soundcheck, you can ensure adequate transmission quality in the entire area in which you want to use the transmitter. You can do the soundcheck without the help of another person.

- ▷ With the transmitter, walk up and down the area in which you want to use the transmitter.

The receiver records the following parameters:

#### RF Min

- Minimum RF signal level
- must be well above the squelch threshold level for one of the two antennas

#### Ways to optimize

- ▷ Check that the antennas and the antenna cables are correctly connected.
- ▷ Improve the position of the antennas.
- ▷ If necessary, use an antenna booster.



### RF Max

- Maximum RF signal level
- both antennas should reach 40 dB $\mu$ V

#### Ways to optimize

- ▷ Check that the antennas and the antenna cables are correctly connected.
- ▷ Improve the position of the antennas.
- ▷ If necessary, use an antenna booster.

### AF Max

Maximum audio level

#### Ways to optimize

On your transmitter, adjust the audio level as high as possible without the display for the audio level showing full deflection (**AF Max** is at a level with the **PEAK** display).

See “AF Out menu item”.

### Guitar Tuner **standard display**

The **Guitar Tuner** standard display shows the guitar tuner (only for the SK 100 G4).

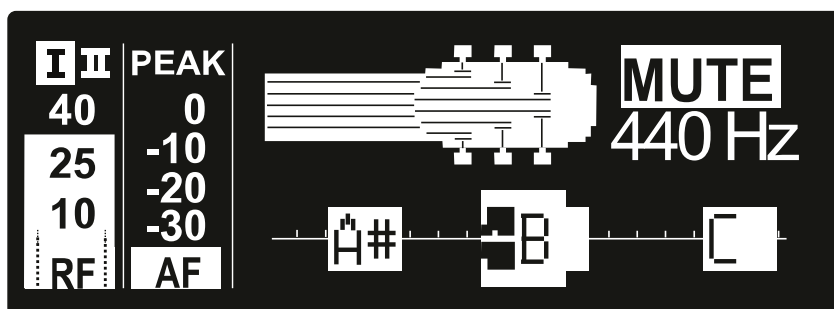

The **Guitar Tuner** standard display is deactivated upon delivery. To show this standard display, you have to activate it (see “Advanced -> Guitar Tuner menu item”).



## Setting options in the menu

In the EM 100 G4 menu, you can configure the following settings.

---

### Adjusting the squelch threshold

- ▷ See “Squelch menu item”

---

### Scanning for unused frequency presets, releases and selects frequency presets

- ▷ See “Easy Setup menu item”

---

### Setting the frequency bank and the channel

- ▷ See “Frequency Preset menu item”

---

### Entering a freely selectable name

- ▷ See “Name menu item”

---

### Adjusting the audio output level

- ▷ See “AF Out menu item”

---

### Adjusting the frequency response of the output signal

- ▷ See “Equalizer menu item”

---

### Activate/deactivate the automatic lock-off function

- ▷ See “Auto Lock menu item”

---

### Configuring enhanced settings in the **Advanced Menu**:

- Adjusting the receiving frequencies for the U frequency bank
  - Adjusting the guitar tuner options
  - Activating/deactivating the pilot tone evaluation
  - Adjusting the contrast of the display panel
  - Resetting the receiver
  - Displaying the current software revision
  - ▷ See “Advanced menu item”
-



## Menu structure

The figure shows the complete EM 100 G4 menu structure in an overview.

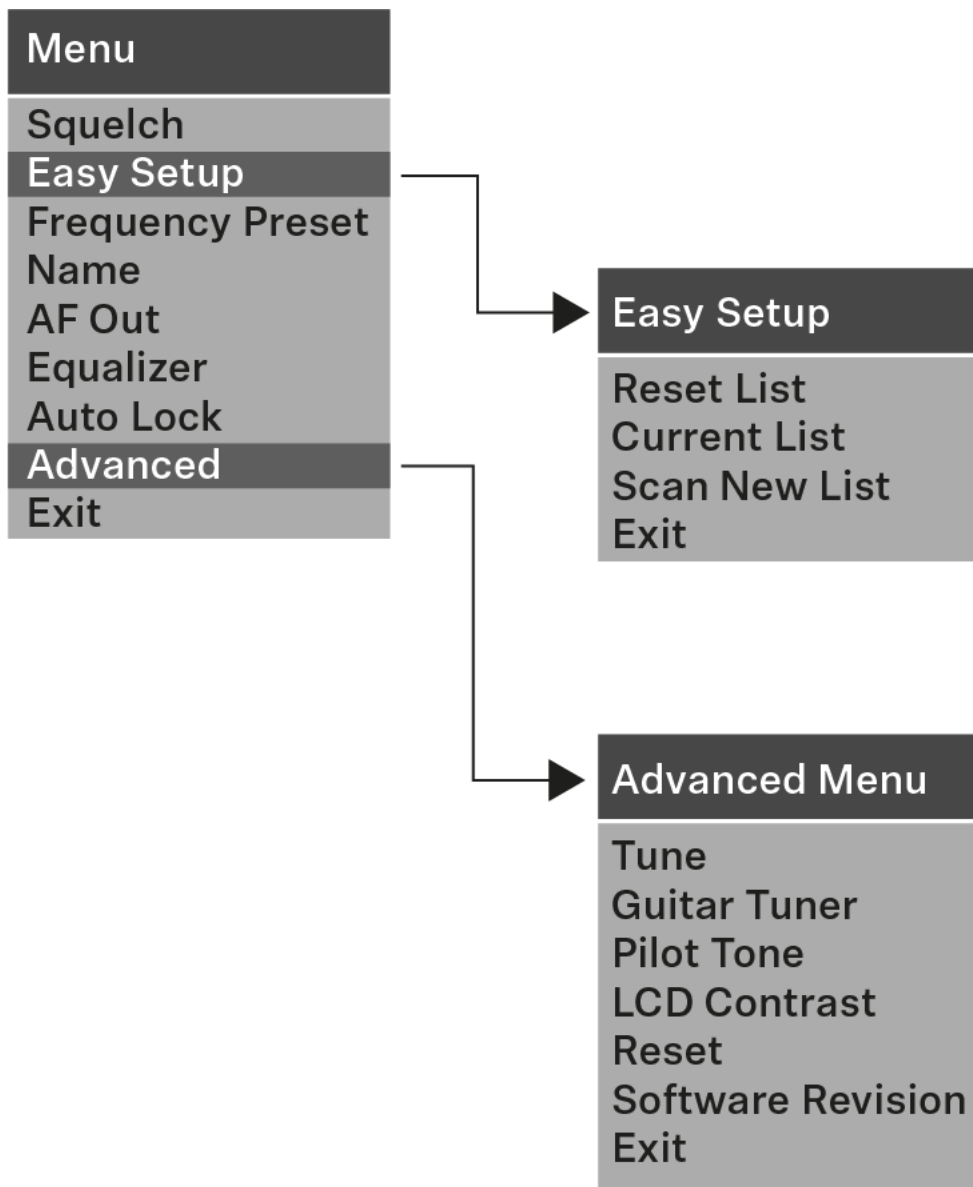



## Squelch menu item

You can adjust the squelch threshold in the **Squelch** menu item.

### Setting range:

- **Low** >> 5 dB $\mu$ V
- **Middle** >> 15 dB $\mu$ V
- **High** >> 25 dB $\mu$ V

The squelch threshold is displayed on the home screen in the RF signal level area.

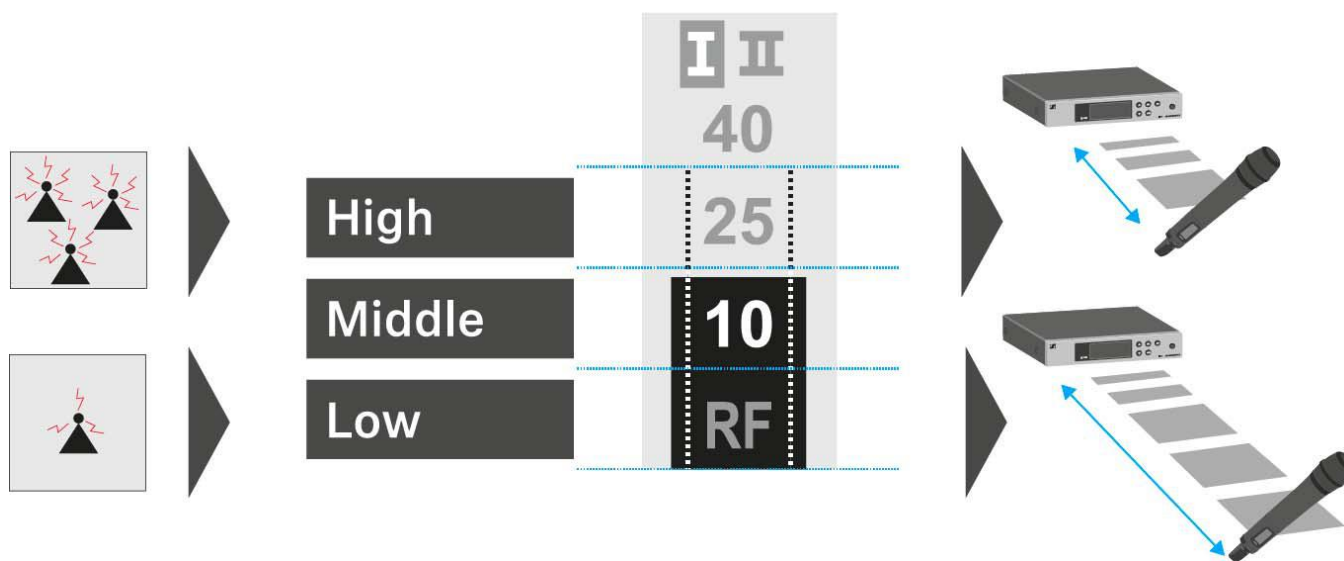

---

### CAUTION

#### Risk of hearing and material damage

If you set the squelch threshold to a very low value, a very loud hissing noise can occur in the receiver. This hissing noise can be loud enough to cause hearing damage or overload your system's loudspeakers.

- ▷ Before adjusting the squelch threshold, set the volume of the audio output to the minimum.
  - ▷ Never change the squelch threshold during a live transmission.
-



To open the **Squelch** menu item:

- ▷ On the home screen, press the **SET** button to open the operating menu.
- ▷ Press the **UP** or **DOWN** button until the **Squelch** menu item appears in the selection frame.
- ▷ Press the **SET** button to open the menu item.
- ▷ Adjust the settings as desired.

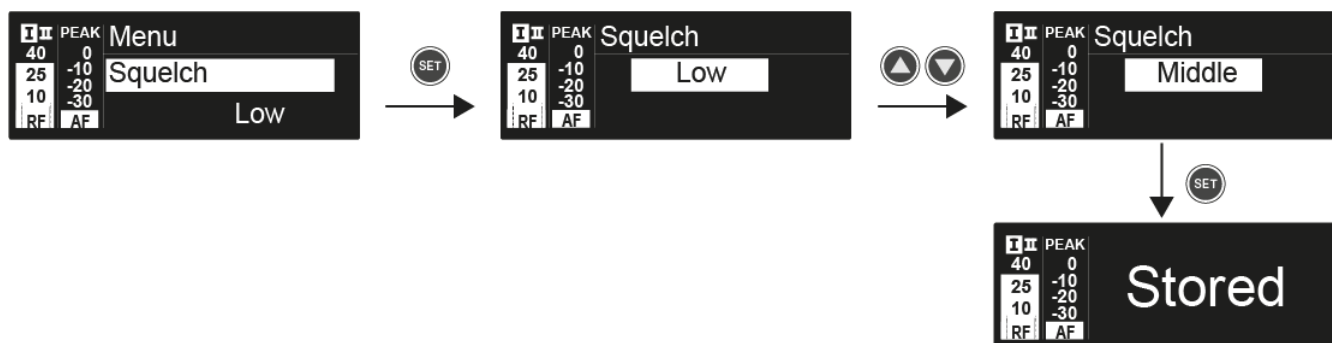

- ▷ Press the **SET** button to save the changes you made to the settings.  
or
- ▷ Press the **ESC** button to cancel the entry without saving the setting.





## Easy Setup menu item

You can scan for unused frequencies using the **Easy Setup** menu item.

When you have connected multiple EM 100 G4 devices to a network via the RJ-10 interfaces (see “Creating a data network”), you can perform the frequency setup for all of the connected receivers. You can find more information about connecting multiple devices under “Performing multi-channel frequency setup”



Switch off all transmitters before you perform the scan. If transmitters are still switched on, they are detected as unavailable frequencies and the frequencies that are actually available cannot then be used.

The squelch threshold setting influences the result. Set the squelch threshold to **Low** for as many frequencies as possible, and to **High** for as many safe frequencies as possible (see “Squelch menu item”).

To open the **Easy Setup** menu item:

- On the home screen, press the **SET** button to open the operating menu.
- Press the **UP** or **DOWN** button until the **Easy Setup** menu item appears in the selection frame.
- Press the **SET** button to open the menu item.

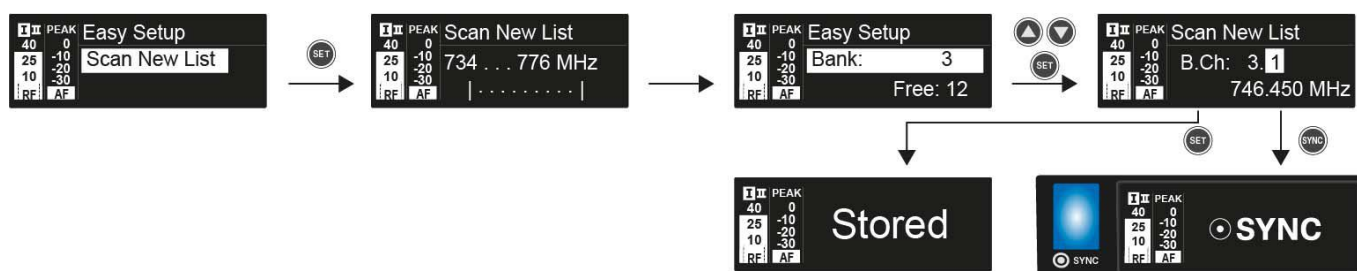

### Scan New List

- Select **Scan New List** to scan for unused frequencies.
- Press the **SET** button to start the scan.  
The frequency range of the receiver is scanned. As a result, the number of unused frequencies is displayed for every frequency bank.
- Press the **UP** or **DOWN** buttons to select a frequency bank.
- Press the **SET** button to confirm your selection.
- Press the **UP** or **DOWN** buttons to select an unused frequency from the selected bank.



- ▷ Press the **SET** button to save your selection and synchronize the selected frequency with the transmitter at a later point (see “Synchronizing devices”).

or

- ▷ Press the **SYNC** button to synchronize the selected frequency with the transmitter immediately.

### Current List

- ▷ Select **Current List** to show the list of unused frequencies from the last scan.

### Reset

- ▷ Select **Reset List** to delete the list of unused frequencies.

### Performing multi-channel frequency setup

To perform the automatic frequency setup for multiple receivers (max. 12) simultaneously:

- ▷ Connect all of the receivers to one network.  
See “Creating a data network”.
- ▷ Open the **Easy Setup** menu item on one of the receivers.  
This receiver is the master. You can choose any receiver to be the master.
- ▷ Perform the frequency scan on the master receiver as described above.  
After the scan, the display panels of the other receivers will display the message **Assign New Frequency?**.  
Receivers with non-compatible frequency ranges will display the message **Unassignable Frequency!**.
- ▷ Select an unused frequency for the first receiver on the master receiver.
- ▷ Press the **SET** button on the receiver that you would like to assign this frequency to.
- ▷ Use this procedure to assign a frequency to each connected receiver, one after another.
- ▷ For the last step, assign a frequency to the master receiver.  
This completes the multi-channel frequency setup.

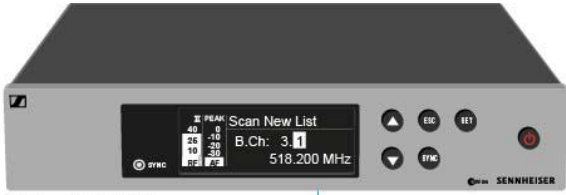

516 - 558 MHz

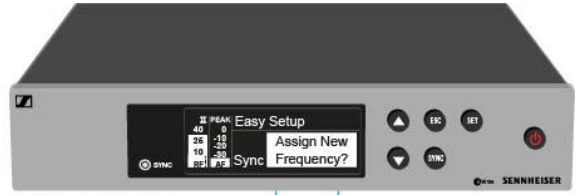

516 - 558 MHz



516 - 558 MHz



823 - 865 MHz

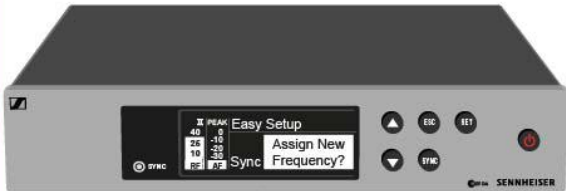

516 - 558 MHz

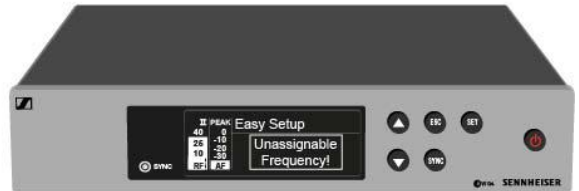

734 - 776 MHz



### Setting up a multi-channel system with more than 12 receivers

You can use the **Easy Setup** function to automatically set up a maximum of **12** receivers.

If you assign the frequencies manually, however, you can use up to **20** receivers in a multi-channel system (not possible in the JB, K+ and 1G8 frequency ranges).

- ▷ To do so, set a frequency manually in each receiver (see “Advanced -> Tune menu item”).
- ▷ Use the frequencies from the following table.

| Channel | Frequency Ranges |         |         |         |         |         |         |         |         |
|---------|------------------|---------|---------|---------|---------|---------|---------|---------|---------|
|         | A1               | A       | AS      | G       | GB      | B       | C       | D       | E       |
| 1       | 470.100          | 518.200 | 530.100 | 566.200 | 606.500 | 626.200 | 742.200 | 790.200 | 830.200 |
| 2       | 470.500          | 518.700 | 530.800 | 566.600 | 606.875 | 626.600 | 742.600 | 790.600 | 830.600 |
| 3       | 471.050          | 519.650 | 531.650 | 567.200 | 607.325 | 627.200 | 743.150 | 791.200 | 831.200 |
| 4       | 471.750          | 520.450 | 532.050 | 568.000 | 607.850 | 628.400 | 743.850 | 792.000 | 832.000 |
| 5       | 472.200          | 520.900 | 533.050 | 569.200 | 608.250 | 629.800 | 744.300 | 793.200 | 833.200 |
| 6       | 472.800          | 521.600 | 533.550 | 571.600 | 608.725 | 631.400 | 744.900 | 795.600 | 834.800 |
| 7       | 473.650          | 522.000 | 534.850 | 573.800 | 609.275 | 632.200 | 750.200 | 797.800 | 838.600 |
| 8       | 474.750          | 522.900 | 535.750 | 572.900 | 609.900 | 634.200 | 750.700 | 796.900 | 839.900 |
| 9       | 475.250          | 524.750 | 536.850 | 568.475 | 610.400 | 637.600 | 751.550 | 792.475 | 842.600 |
| 10      | 506.150          | 526.350 | 537.400 | 570.125 | 611.150 | 632.650 | 752.550 | 794.125 | 843.100 |
| 11      | 506.950          | 526.900 | 538.200 | 570.575 | 612.200 | 633.550 | 753.950 | 794.575 | 844.800 |
| 12      | 511.000          | 527.750 | 539.250 | 572.475 | 612.775 | 635.300 | 754.750 | 796.475 | 845.500 |
| 13      | 508.500          | 528.400 | 542.400 | 558.200 | 614.700 | 639.450 | 759.000 | 801.950 | 846.750 |
| 14      | 512.300          | 529.400 | 545.250 | 558.750 | 615.300 | 640.150 | 761.450 | 803.900 | 848.250 |
| 15      | 514.350          | 531.500 | 547.000 | 580.650 | 615.975 | 644.150 | 762.100 | 806.600 | 848.900 |
| 16      | 515.550          | 534.350 | 549.500 | 583.100 | 616.400 | 645.850 | 763.400 | 807.700 | 851.550 |
| 17      | 482.100          | 537.700 | 552.900 | 585.800 | 617.975 | 647.300 | 765.000 | 810.350 | 857.000 |
| 18      | 482.750          | 541.950 | 554.350 | 587.750 | 620.425 | 647.800 | 765.900 | 817.900 | 858.050 |
| 19      | 484.100          | 547.350 | 555.000 | 591.800 | 622.600 | 653.550 | 770.550 | 819.500 | 862.750 |
| 20      | 485.000          | 550.300 | 555.950 | 594.300 | 623.600 | 656.600 | 775.050 |         | 864.300 |



## Frequency Preset menu item

In the **Frequency Preset** menu item, you can adjust the receiving frequency of the receiver by adjusting the frequency bank and the channel.

To open the **Frequency Preset** menu item:

- ▷ On the home screen, press the **SET** button to open the operating menu.
- ▷ Press the **UP** or **DOWN** button until the **Frequency Preset** menu item appears in the selection frame.
- ▷ Press the **SET** button to open the menu item.
- ▷ Adjust the settings as desired.

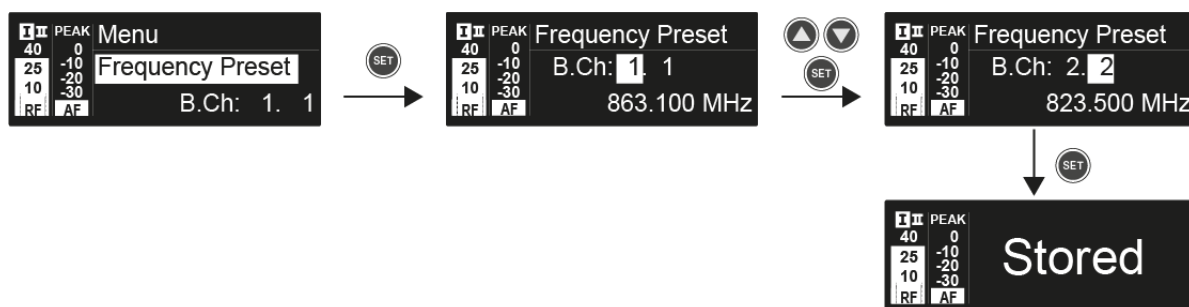

- ▷ Press the **SET** button to save the changes you made to the settings.  
or
- ▷ Press the **ESC** button to cancel the entry without saving the setting.

**i** You can set the frequencies of the frequency bank **U** here: “Advanced -> Tune menu item”



## Name menu item

In the **Name** menu item you can enter a name for the radio link.

To open the **Name** menu item:

- ▷ On the home screen, press the **SET** button to open the operating menu.
- ▷ Press the **UP** or **DOWN** button until the **Name** menu item appears in the selection frame.
- ▷ Press the **SET** button to open the menu item.
- ▷ Adjust the settings as desired.

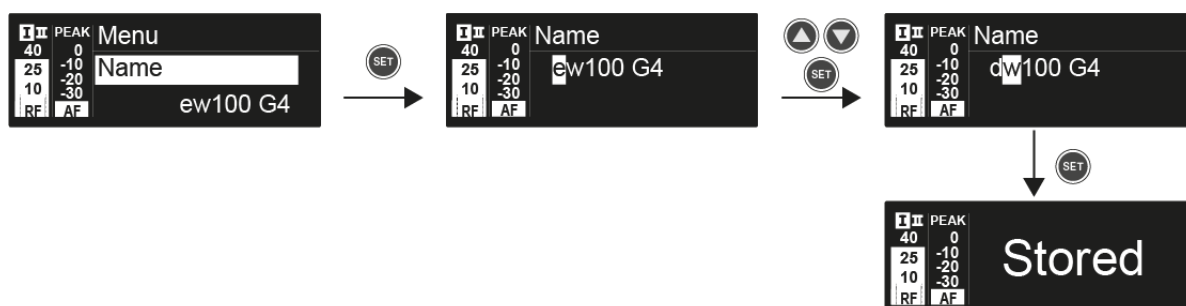

- ▷ Press the **SET** button to save the changes you made to the settings.  
or
- ▷ Press the **ESC** button to cancel the entry without saving the setting.



## AF Out menu item

In the **AF Out** menu item, you can set the audio level that is output via the receiver audio outputs.

### Setting range:

- -24 dB to +18 dB in 3 dB steps

To open the **AF Out** menu item:

- ▷ On the home screen, press the **SET** button to open the operating menu.
- ▷ Press the **UP** or **DOWN** button until the **AF Out** menu item appears in the selection frame.
- ▷ Press the **SET** button to open the menu item.
- ▷ Adjust the settings as desired.

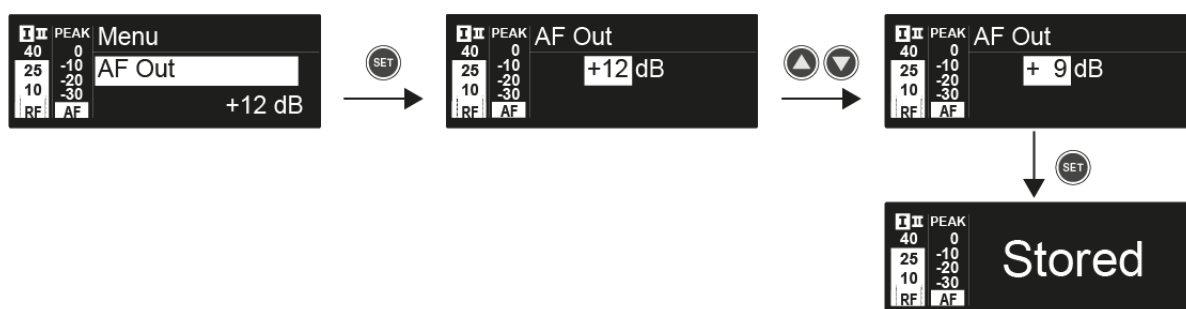

- ▷ Press the **SET** button to save the changes you made to the settings.  
or
- ▷ Press the **ESC** button to cancel the entry without saving the setting.



## Equalizer menu item

In the **Equalizer** menu item, you can change the frequency response of the output signal. You can reduce the bass range and boost the treble range.

To open the **Equalizer** menu item:

- ▷ On the home screen, press the **SET** button to open the operating menu.
- ▷ Press the **UP** or **DOWN** button until the **Equalizer** menu item appears in the selection frame.
- ▷ Press the **SET** button to open the menu item.
- ▷ Adjust the settings as desired.

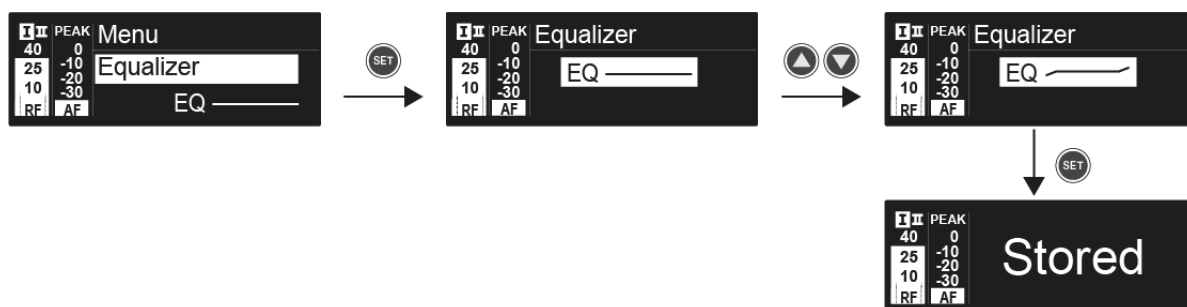

- ▷ Press the **UP** or **DOWN** buttons to configure the desired settings.
- ▷ Press the **SET** button to save the changes you made to the settings.  
or
- ▷ Press the **ESC** button to cancel the entry without saving the setting.





## Auto Lock menu item

In the **Auto Lock** menu item you can activate or deactivate the auto lock-off function.

**i** You can find information about temporarily deactivating the lock-off function during operation under “Lock-off function”.

To open the **Auto Lock** menu item:

- ▷ On the home screen, press the **SET** button to open the operating menu.
- ▷ Press the **UP** or **DOWN** button until the **Auto Lock** menu item appears in the selection frame.
- ▷ Press the **SET** button to open the menu item.
- ▷ Adjust the settings as desired.

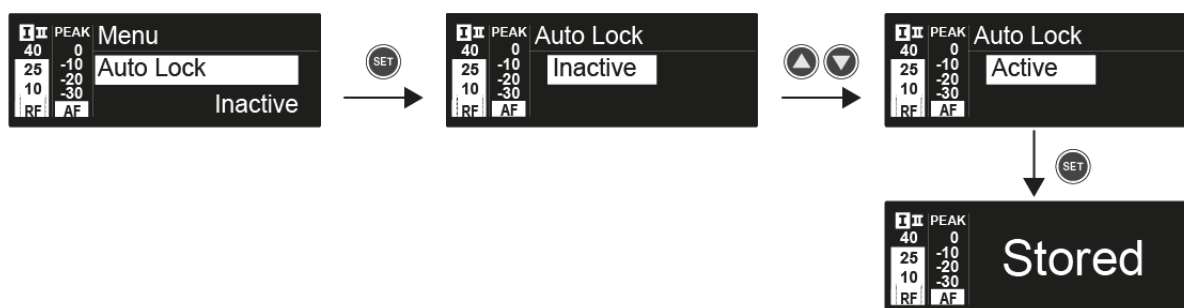

- ▷ Press the **SET** button to save the changes you made to the settings.  
or
- ▷ Press the **ESC** button to cancel the entry without saving the setting.



## Advanced menu item

In the **Advanced** submenu you can configure enhanced settings.

To open the **Advanced** submenu:

- ▷ On the home screen, press the **SET** button to open the operating menu.
- ▷ Press the **UP** or **DOWN** button until the **Advanced** menu item appears in the selection frame.
- ▷ Press the **SET** button to open the menu item.

The following sub-items are available:

---

### Adjusting the receiving frequencies for the U frequency bank

- ▷ See “Advanced -> Tune menu item”
- 

### Adjusting the guitar tuner options

- ▷ See “Advanced -> Guitar Tuner menu item”
- 

### Activating/deactivating the pilot tone evaluation

- ▷ See “Advanced -> Pilot Tone menu item”
- 

### Adjusting the contrast of the display panel

- ▷ See “Advanced -> LCD Contrast menu item”
- 

### Resetting the receiver

- ▷ See “Advanced -> Reset menu item”
- 

### Displaying the current software revision

- ▷ See “Advanced -> Software Revision menu item”
-



## Advanced -> Tune menu item

In the **Tune** menu item of the **Advanced** submenu, you can configure the receiving frequencies for the **U** frequency bank.

You can save a total of 12 frequencies in the **U** frequency bank.

### Only adjusting the frequency

- ▷ Open the **Tune** menu item in the **Advanced** menu.
- ▷ Adjust the settings.

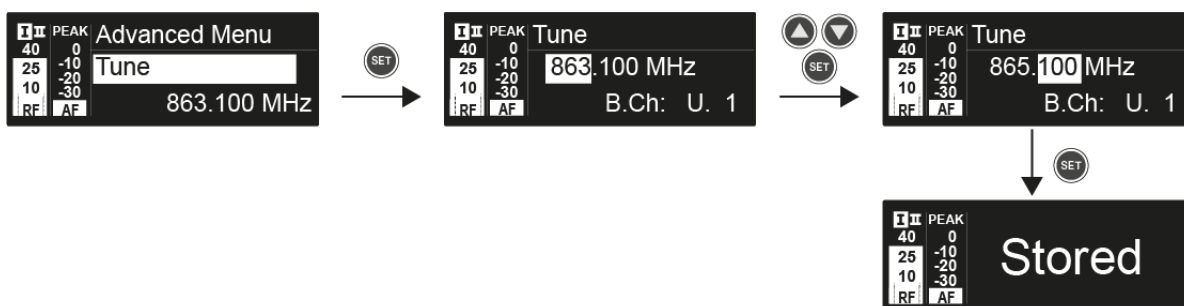

- ▷ Press the **SET** button to save the changes you made to the settings.  
or
- ▷ Press the **ESC** button to cancel the entry without saving the setting.

### Setting the channel and frequency

- ▷ Select the **Tune** menu item and call it up by holding down the **SET** button until the channel selection appears.
- ▷ Adjust the settings.

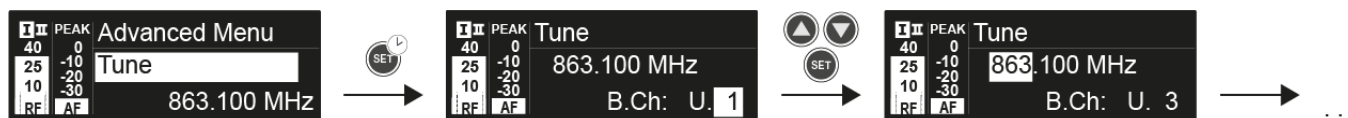

- ▷ Press the **SET** button to save the changes you made to the settings.  
or
- ▷ Press the **ESC** button to cancel the entry without saving the settings.



## Advanced -> Guitar Tuner menu item

In the **Guitar Tuner** menu item of the **Advanced** submenu, you can adjust the options of the guitar tuner.

The guitar tuner is opened in the **Guitar Tuner** standard display on the home screen. See “**Guitar Tuner** standard display”.

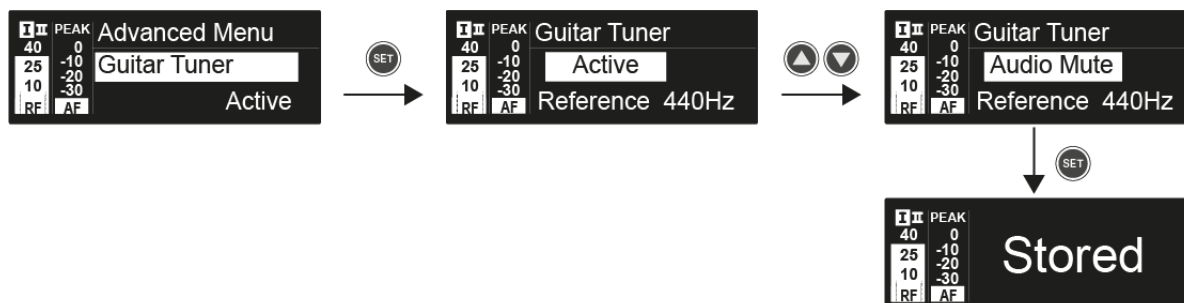

- **Inactive:** The guitar tuner is deactivated.
- **Active:** The guitar tuner is activated.
- **Audio mute:** The guitar tuner is activated. Once the **Guitar Tuner** standard display is open on the home screen, the audio signal is muted.

## Advanced -> Pilot Tone menu item

In the **Pilot Tone** menu item of the **Advanced** submenu, you can activate and deactivate the pilot tone evaluation.

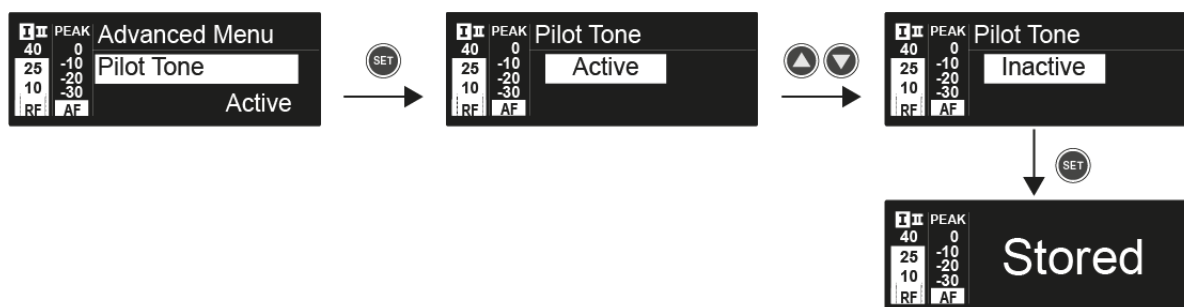

The pilot tone has an inaudible frequency that is sent from the transmitter and evaluated by the receiver. It supports the receiver's squelch function.

**i** For the best possible operational reliability, we recommend leaving the pilot tone activated.



## Advanced -> LCD Contrast menu item

In the **LCD Contrast** menu item of the **Advanced** submenu, you can adjust the display contrast of the display panel.

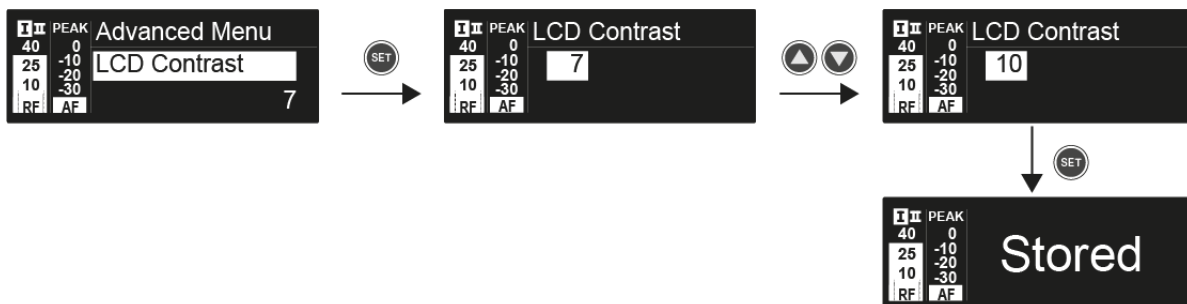

## Advanced -> Reset menu item

In the **Reset** menu item of the **Advanced** submenu, you can reset all of the settings of the receiver to the factory settings.

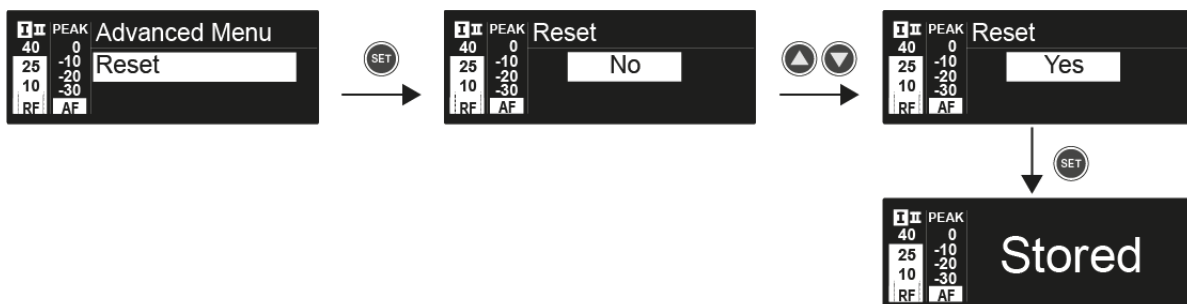

## Advanced -> Software Revision menu item

In the **Software Revision** menu item of the **Advanced** submenu, you can display the current software version of the receiver.



## Using the SKM 100 G4

These sections contain detailed information about using the SKM 100 G4 and SKM 100 G4-S.

You can find information on installation and startup of the SKM 100 G4 and SKM 100 G4-S under “Installing the SKM 100 G4”.



## Operating elements of the SKM 100 G4 handheld transmitter

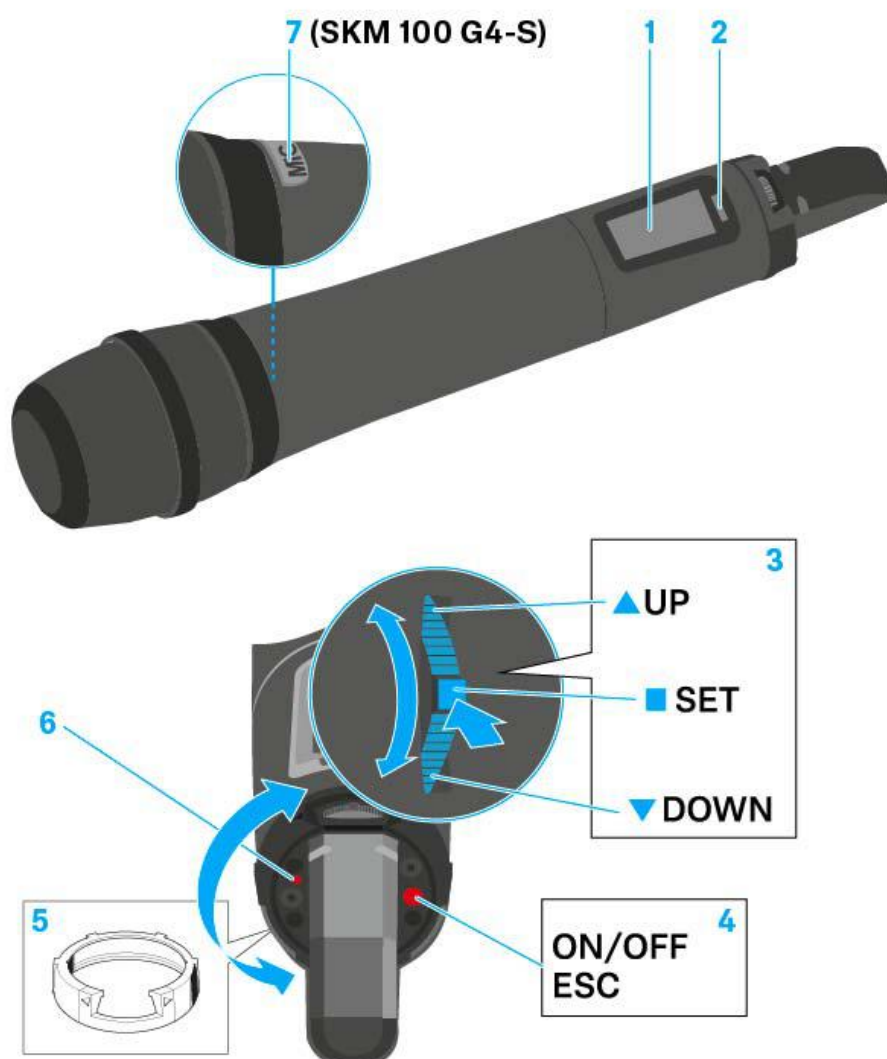

- 1** Display panel
  - See “Displays on the SKM 100 G4 handheld transmitter display panel”
- 2** Infra-red interface
  - See “Synchronizing devices”
- 3** **DOWN**, **UP** and **SET** multi-function switch
  - See “Buttons for navigating the SKM 100 G4 menu”
- 4** **ON/OFF** button with **ESC** function in the operating menu
  - Switch the transmitter on or off  
See “Switching the SKM 100 G4 handheld transmitter on and off”
  - Escape function in the menu  
See “Buttons for navigating the SKM 100 G4 menu”
- 5** Colored ring
  - Available in different colors (see “Additional accessories” and “Changing the colored ring”)
  - Can be turned to protect the multi-function switch



- 6** Operation and battery indicator, red LED
- illuminated = ON  
See “Switching the SKM 100 G4 handheld transmitter on and off”
  - flashing = LOW BATTERY  
See “Inserting and removing the batteries/rechargeable batteries”
- 7** **MIC** button (only SKM 100 G4-S)
- See “Muting the handheld transmitter (AF mute)”
  - See “Advanced > Mute Mode menu item (SKM 100 G4-S only)”

## Switching the SKM 100 G4 handheld transmitter on and off

To switch on the SKM 100 G4:

- ▷ Hold down the **ON/OFF** button until the Sennheiser logo appears on the display.

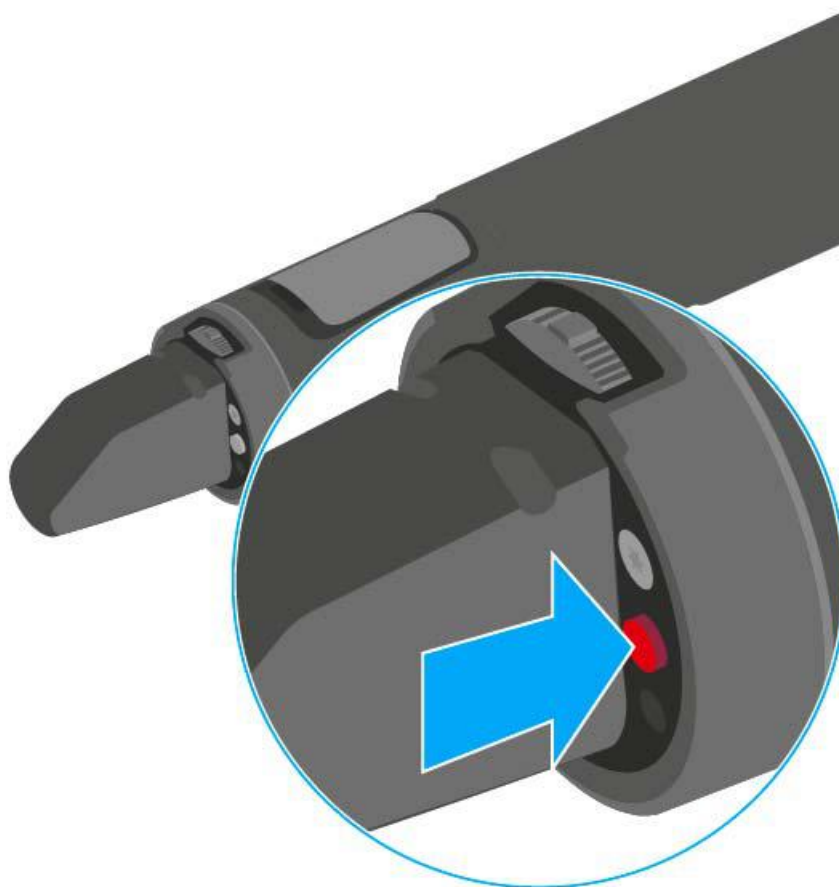

To switch off the SKM 100 G4:

- ▷ Hold down the **ON/OFF** button until the display goes off.





## Muting the handheld transmitter (AF mute)

### SKM 100 G4

The audio signal of the transmitter cannot be muted.

However, when you deactivate the RF signal no AF signal is output. See “Deactivating the RF signal (RF mute)”.

### SKM 100 G4-S

You can mute the audio signal by pressing the **MIC** button.

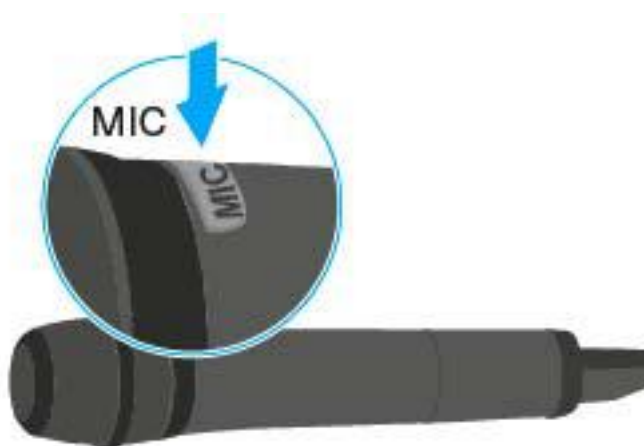

- The **MIC** button lights up red: the audio signal is activated
- The **MIC** button is not lit: the audio signal is muted



## Deactivating the RF signal (RF mute)

You can temporarily deactivate the RF signal when the microphone is switched on. When the RF signal is deactivated, no audio signal is output.

Use this function to save battery or when you want to prepare a microphone for use during live broadcast without interfering with the current transmission path.

To **deactivate** the RF signal:

- ▷ Short-press the **ON/OFF** button.  
RF Mute On? appears.
- ▷ Press the **SET** button.

The transmission frequency is displayed, however the wireless microphone is not transmitting an RF signal. The transmission icon is not lit (see “Displays on the SKM 100 G4 handheld transmitter display panel”).

To **activate** the RF signal:

- ▷ Short-press the **ON/OFF** button.  
RF Mute Off? appears.
- ▷ Press the **SET** button.

The transmission icon appears again (see “Displays on the SKM 100 G4 handheld transmitter display panel”).

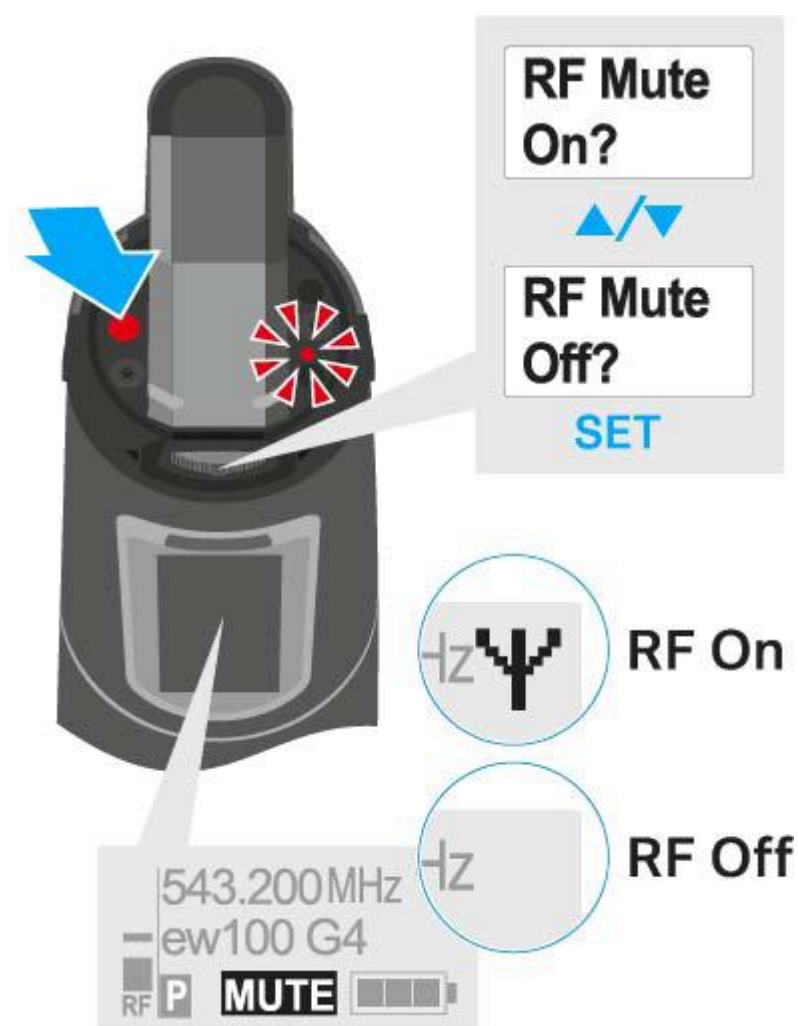



## Lock-off function

You can set the automatic lock-off function in the **Auto lock** menu (see “Buttons for navigating the SKM 100 G4 menu”).

When you have switched on the lock-off function, you will have to turn the transmitter off and on again in order to operate it.

To temporarily deactivate the lock-off function:

- ▷ Press the **SET** button.  
**Locked** appears in the display panel.
- ▷ Press the **UP** or **DOWN** button.  
**Unlock?** appears in the display panel.
- ▷ Press the **SET** button.  
Lock-off function is now temporarily deactivated.

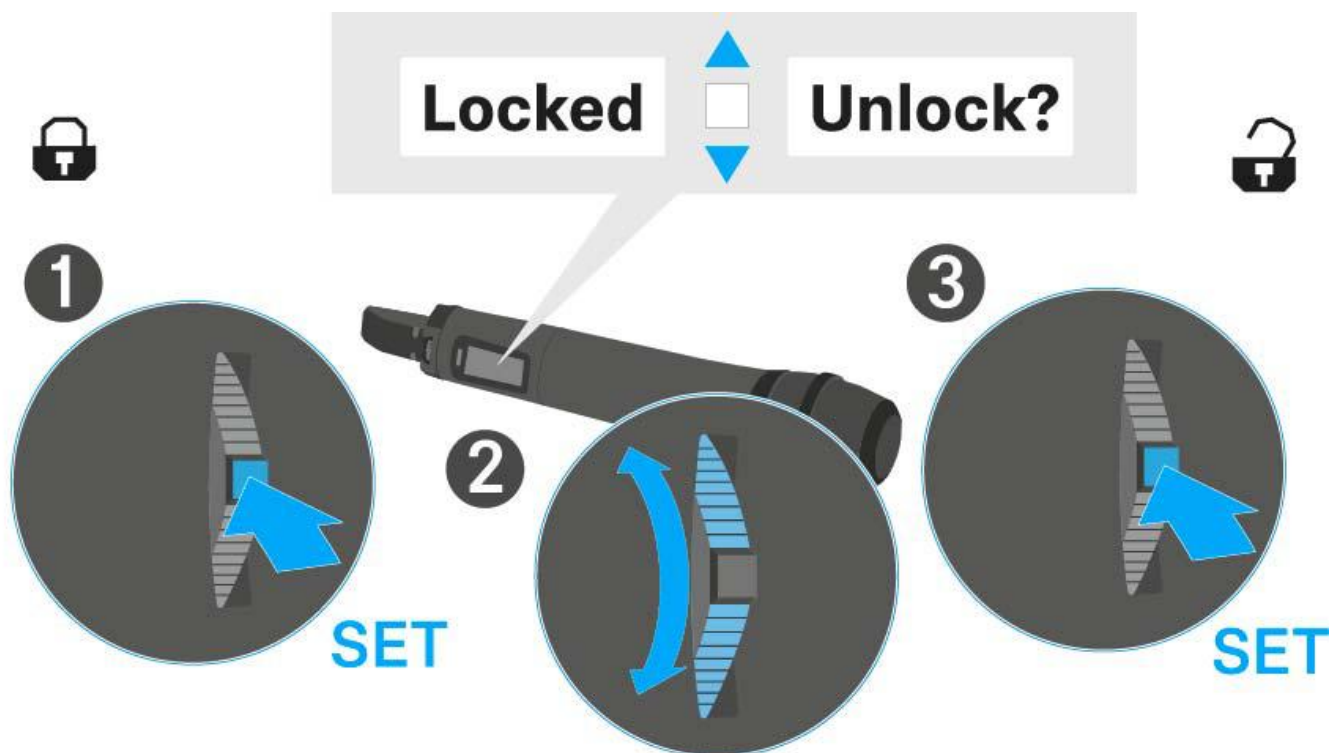



## Displays on the SKM 100 G4 handheld transmitter display panel

You can view the following information on the transmitter display.

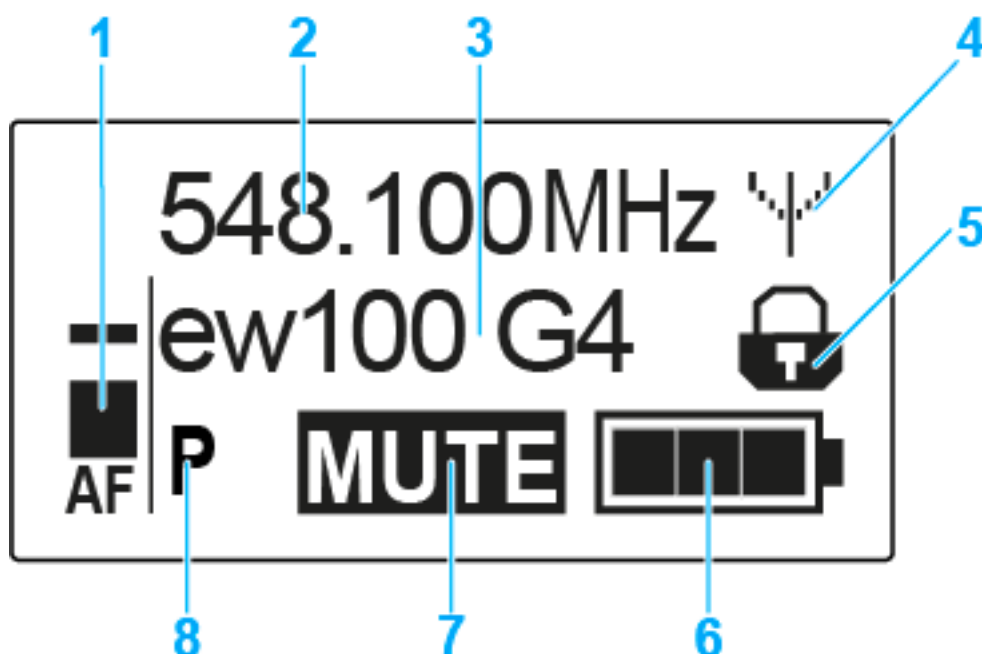

- 1 AF audio level**
  - Displays the audio level with peak hold function
  - See “Sensitivity menu item”
- 2 Frequency**
  - Configured transmission frequency
  - See “Frequency Preset menu item”
- 3 Name**
  - Freely selectable name of the receiver
  - See “Name menu item”
- 4 Transmission icon**
  - RF signal is being transmitted
  - See “Deactivating the RF signal (RF mute)”
- 5 Lock-off function**
  - Lock-off function is activated
  - See “Auto Lock menu item”
- 6 Battery status**
  - See “Battery status”
- 7 MUTE muting function**
  - The audio signal is muted
  - See “Muting the handheld transmitter (AF mute)”
  - See “Deactivating the RF signal (RF mute)”
- 8 P pilot tone**
  - Pilot tone transmission is activated
  - See “Advanced > Pilot Tone menu item”



---

>> “Buttons for navigating the SKM 100 G4 menu”

>> “Setting options in the menu”

---

### Select a standard display

▷ Move the **multi-function switch** to select a standard display:

#### Frequency/Name standard display



#### Channel/Frequency standard display

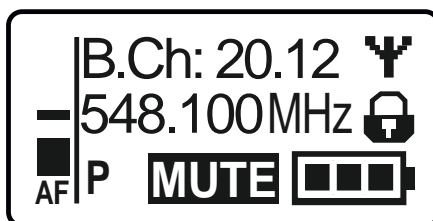

#### Name/Channel standard display

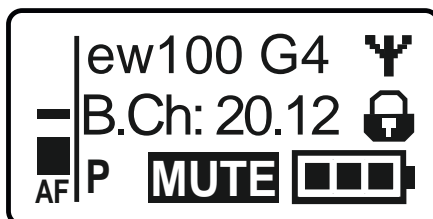



## Buttons for navigating the SKM 100 G4 menu

### Navigating through the menu

To open the menu:

- ▷ Press the **SET** button.  
The operating menu is shown on the transmitter display panel.

To open a menu item:

- ▷ Press the **UP** or **DOWN** buttons to navigate through the individual menu items.
- ▷ Press the **SET** button to open the selected menu item.

 “Operating elements of the SKM 100 G4 handheld transmitter”

### Making changes in a menu item

After you open a menu item, you can make changes as follows:

- ▷ Press the **UP** or **DOWN** buttons to set the displayed value.
- ▷ Press the **SET** button to save the setting.
- ▷ Press the **ESC (ON/OFF)** button to leave the menu item without saving the setting.

 “Operating elements of the SKM 100 G4 handheld transmitter”

---

>> “Displays on the SKM 100 G4 handheld transmitter display panel”

>> “Setting options in the menu”

---



## Setting options in the menu

In the SKM 100 G4 menu, you can configure the following settings.

---

### Adjusting the input sensitivity

- ▷ See “Sensitivity menu item”

---

### Setting the frequency bank and the channel

- ▷ See “Frequency Preset menu item”

---

### Entering a freely selectable name

- ▷ See “Name menu item”

---

### Activating/deactivating the automatic lock-off function

- ▷ See “Auto Lock menu item”

---

### Configuring enhanced settings in the **Advanced Menu**:

- Adjusting the transmission frequencies for the U frequency bank
  - Defining the MIC button setting (SKM 100 G4-S only)
  - Activating/deactivating the pilot tone evaluation
  - Adjusting the contrast of the display panel
  - Resetting the transmitter
  - Displaying the current software revision
  - ▷ See “Advanced menu item”
-



## Sensitivity menu item

- Adjusting the input sensitivity – **AF** audio level

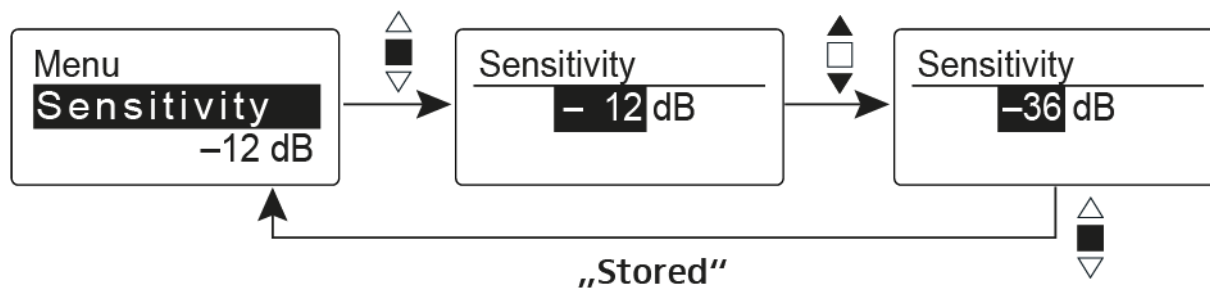

**Setting range:** 0 dB to -48 dB in 6 dB steps.

The **AF** audio level is also displayed when the wireless microphone is muted, e.g. to check the sensitivity before a live broadcast.

### Recommended presets:

- Loud music/vocals: -48 to -18 dB
- Moderation: -18 to -12 dB
- Interviews: -12 to 0 dB





## Frequency Preset menu item

- Manually selecting a frequency bank and channel

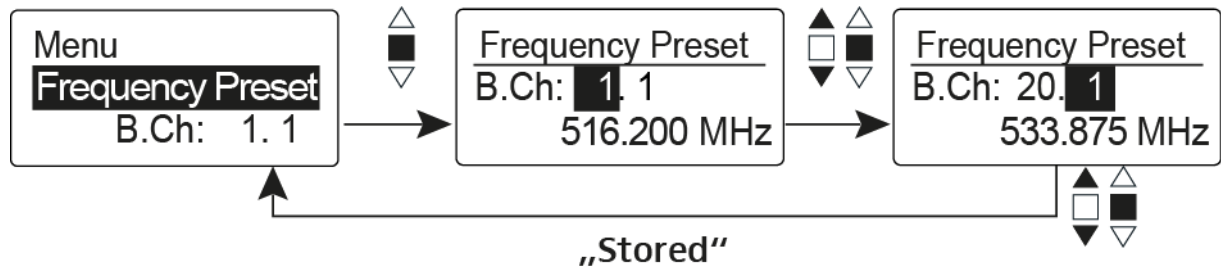

**i** While you work in the Frequency Preset menu, the RF signal is deactivated.

### Please note when creating multi-channel systems:

Only the factory-preset frequencies within one frequency bank are intermodulation-free. The wireless microphone and receiver must be set to the same frequency. Be sure to note the information on frequency selection under “Establishing a radio link”.

## Name menu item

- Entering names

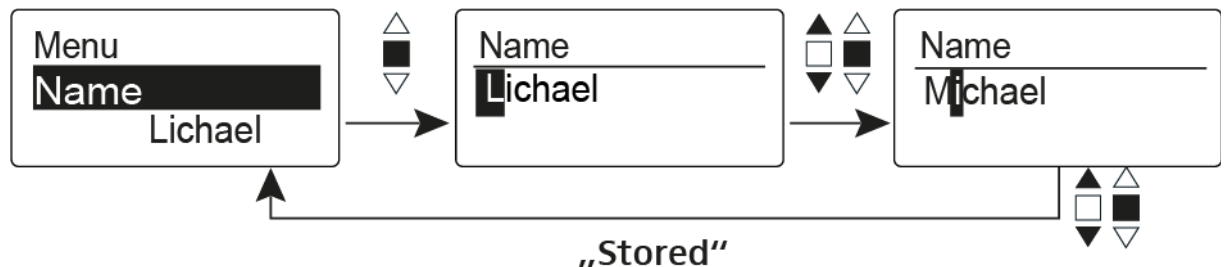

In the **Name** menu item you can enter any name you want for the wireless microphone (e.g. the names of the musicians).

The name can be shown in the [Frequency/Name](#) and [Name/Channel](#) standard displays.

The names are a maximum of 8 characters:

- All letters except umlauts.
- Numbers from 0 to 9
- Special characters and spaces

Enter the names as follows:

- ▷ Move the multi-function switch to select a character.
- ▷ Press the multi-function switch to jump to the next space or to save the name you have entered once it is complete.



## Auto Lock menu item

- Switching the automatic lock-off function on and off

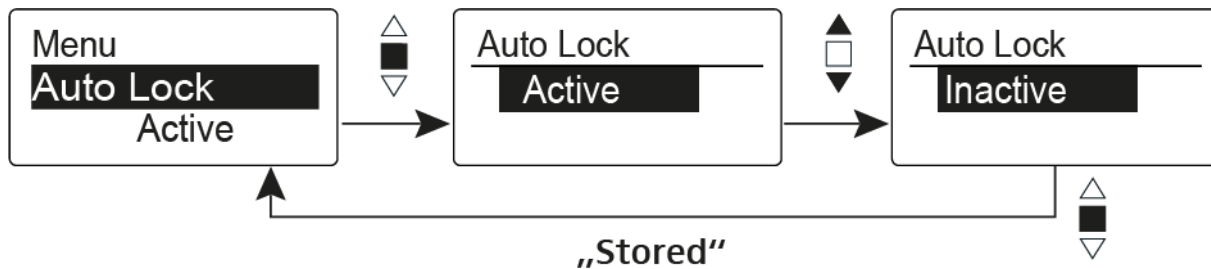

This lock prevents the wireless microphone from being unintentionally switched off and also prevents any unintentional changes to the transmitter's configuration. In the current standard display, the lock icon shows whether the lock-off function is currently switched on.

You can find information about using the lock-off function under "Lock-off function".



## Advanced menu item

In the **Advanced** submenu you can configure enhanced settings.

The following sub-items are available:

---

### Adjusting the transmission frequencies for the U frequency bank

- ▷ See “Advanced > Tune menu item”

---

### Defining the MIC button setting (SKM 100 G4-S only)

- ▷ See “Advanced > Mute Mode menu item (SKM 100 G4-S only)”

---

### Activating/deactivating the pilot tone evaluation

- ▷ See “Advanced > Pilot Tone menu item”

---

### Adjusting the contrast of the display panel

- ▷ See “Advanced > LCD Contrast menu item”

---

### Resetting the transmitter

- ▷ See “Advanced > Reset menu item”

---

### Displaying the current software revision

- ▷ See “Advanced > Software Revision menu item”
-



## Advanced > Tune menu item

- Configuring the transmission frequency and frequency bank U

When you have configured the wireless microphone to a system bank and you call up the **Tune** menu item, channel 1 of the frequency bank **U** is automatically set. The message **U.1** briefly appears in the display. In the factory settings, the channels of the frequency bank **U** are not assigned to any transmission frequency.

While you work in the **Tune** menu, the RF signal is deactivated.

You can configure a transmission frequency for the current channel or select a channel in the frequency bank **U** and configure a transmission frequency for this channel in the **Tune** menu. Be sure to note the information on frequency selection, see “Setting notes”.

### Only adjusting the frequency

To configure the transmission frequency for the current channel:

- ▷ Open the **Tune** menu item in the **Advanced** menu.

The frequency selection appears.

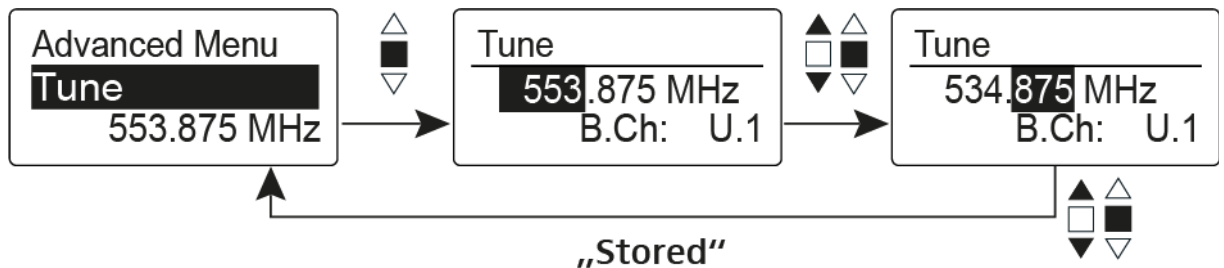

- ▷ Configure the desired frequency.
- ▷ Press the multi-function switch.  
Your settings will be saved. You are now back in the operating menu.

### Setting the channel and frequency

To select a **channel** and assign it a frequency:

- ▷ Move the multi-function switch until the **Tune** menu item appears.
- ▷ Hold down the multi-function switch until the frequency bank selection appears.

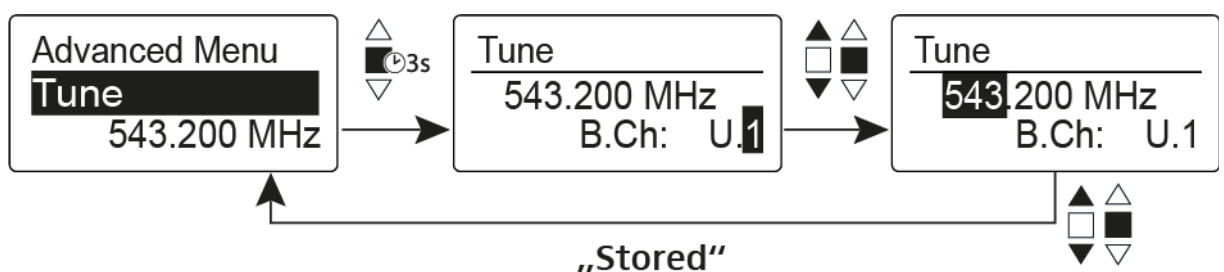

- ▷ Set the desired channel.
- ▷ Press the multi-function switch.  
The frequency selection appears.
- ▷ Configure the frequency.



## Advanced > Mute Mode menu item (SKM 100 G4-S only)

- Configuring the function of the **MIC** button

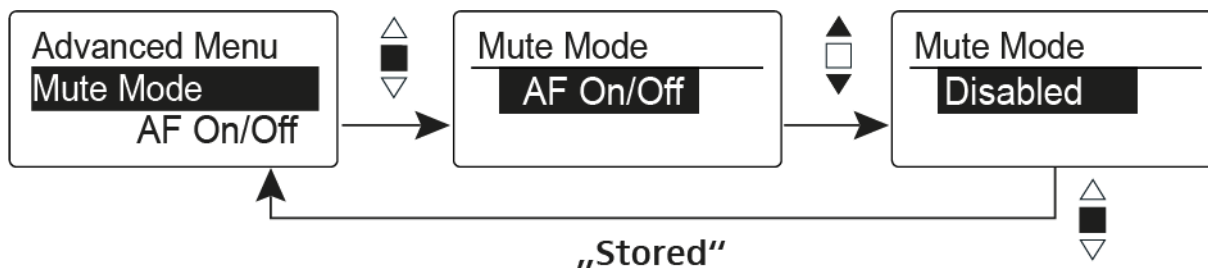

### AF On/Off mode

- When you press the **MIC** button, no audio signal is transmitted.

### Disabled mode

- No function

You can find information about the **MIC** button under “Muting the handheld transmitter (AF mute)”.

## Advanced > Pilot Tone menu item

- Activating/deactivating pilot tone transmission

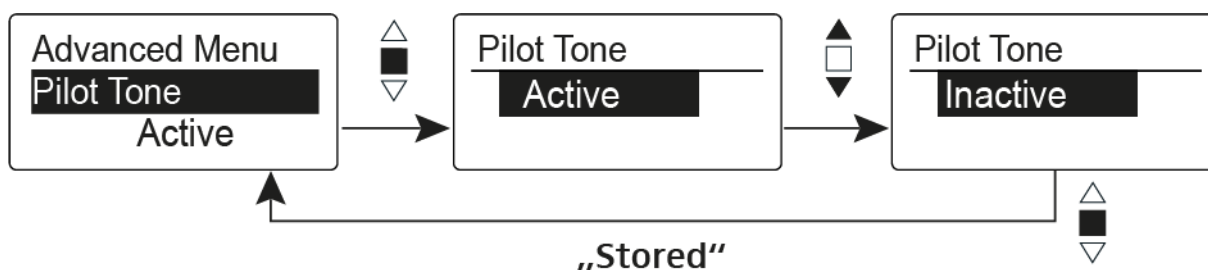

The pilot tone has an inaudible frequency that is sent from the transmitter and evaluated by the receiver. It supports the receiver’s squelch function.

## Advanced > LCD Contrast menu item

- Adjusting the contrast of the display panel

You can configure the contrast of the display in 16 steps.



## Advanced > Reset menu item

- Resetting the wireless microphone

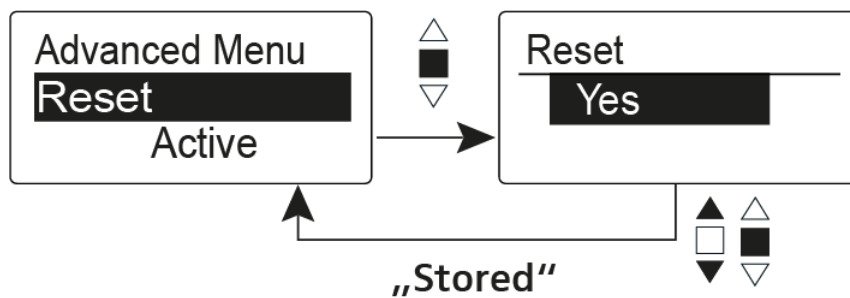

When you reset the wireless microphone, only the selected settings of the pilot tone and the **U** frequency bank are retained.

## Advanced > Software Revision menu item

- Show software revision

You can display the current software revision.



## Using the SK 100 G4

These sections contain detailed information about using the SK 100 G4.

You can find information on installation and startup of the SK 100 G4 under “Installing the SK 100 G4”.



## Operating elements of the SK 100 G4 bodypack transmitter



- 1** Display panel
  - See “Displays on the SK 100 G4 bodypack transmitter display panel”
- 2** Operation and battery indicator, red LED
  - illuminated = ON  
See “Switching the SK 100 G4 bodypack transmitter on and off”
  - flashing = LOW BATTERY  
See “Inserting and removing the batteries/rechargeable batteries”
- 3** Audio overload indicator, yellow LED
  - illuminated = AF PEAK (overload)  
See “Sensitivity menu item”
- 4** UP button
  - See “Buttons for navigating the SK 100 G4 menu”
- 5** SET button
  - See “Buttons for navigating the SK 100 G4 menu”
- 6** DOWN button
  - See “Buttons for navigating the SK 100 G4 menu”





## 7 **ON/OFF** button with ESC function in the operating menu

- Switch the transmitter on or off  
See “Switching the SK 100 G4 bodypack transmitter on and off”
- Escape function in the menu  
See “Buttons for navigating the SK 100 G4 menu”

## 8 Infra-red interface

- See “Synchronizing devices”

## 9 **MUTE** switch

- Deactivate and activate audio signal  
See “Muting the bodypack transmitter (AF mute)”
- Deactivate and activate RF signal  
See “Deactivating the RF signal (RF mute)”

## Switching the SK 100 G4 bodypack transmitter on and off

- ▷ Press the two catches and open the battery compartment cover.

To switch on the SK 100 G4:

- ▷ Hold down the **ON/OFF** button until the Sennheiser logo appears on the display.



To switch off the SK 100 G4:

- ▷ Hold down the **ON/OFF** button until the display goes off.



## Muting the bodypack transmitter (AF mute)

You can deactivate the audio signal with the **MUTE** switch.

To do this, the **MUTE** switch function must be configured to **AF On/Off**. You can find more information about this subject under “Advanced > Mute Mode menu item”.



- ▷ Slide the **MUTE** switch to the **MUTE** position.  
The audio signal is muted. The message **MUTE** is shown on the display.



## Deactivating the RF signal (RF mute)

You can deactivate the RF signal in two ways:

### Deactivating the RF signal with the **MUTE** switch

You can deactivate the RF signal with the **MUTE** switch.

To do this, the **MUTE** switch function must be configured to **RF On/Off**. You can find more information about this subject under “Advanced > Mute Mode menu item”.





- ▶ Slide the **MUTE** switch to the **MUTE** position.  
The RF signal is deactivated. The message **MUTE** is shown in the display and the transmission icon no longer appears.





### Deactivating the RF signal with the **ON/OFF** button

You can deactivate the RF signal with the **ON/OFF** button.

To deactivate the RF signal:

- ▷ Short-press the **ON/OFF** button.

**RF Mute On?** appears.

- ▷ Press the **SET** button.

The RF signal is deactivated. The message MUTE is shown in the display and the transmission icon no longer appears.



To activate the RF signal:

- ▷ Short-press the **ON/OFF** button.

**RF Mute Off?** appears.

- ▷ Press the **SET** button.

The transmission icon appears again.



## Lock-off function

You can set the automatic lock-off function in the **Auto lock** menu (see “Buttons for navigating the SK 100 G4 menu”).

When you have switched on the lock-off function, you will have to turn the transmitter off and on again in order to operate it.

To temporarily deactivate the lock-off function:

- ▷ Press the **SET** button.  
**Locked** appears in the display panel.
- ▷ Press the **UP** or **DOWN** button.  
**Unlock?** appears in the display panel.
- ▷ Press the **SET** button.  
Lock-off function is now temporarily deactivated.

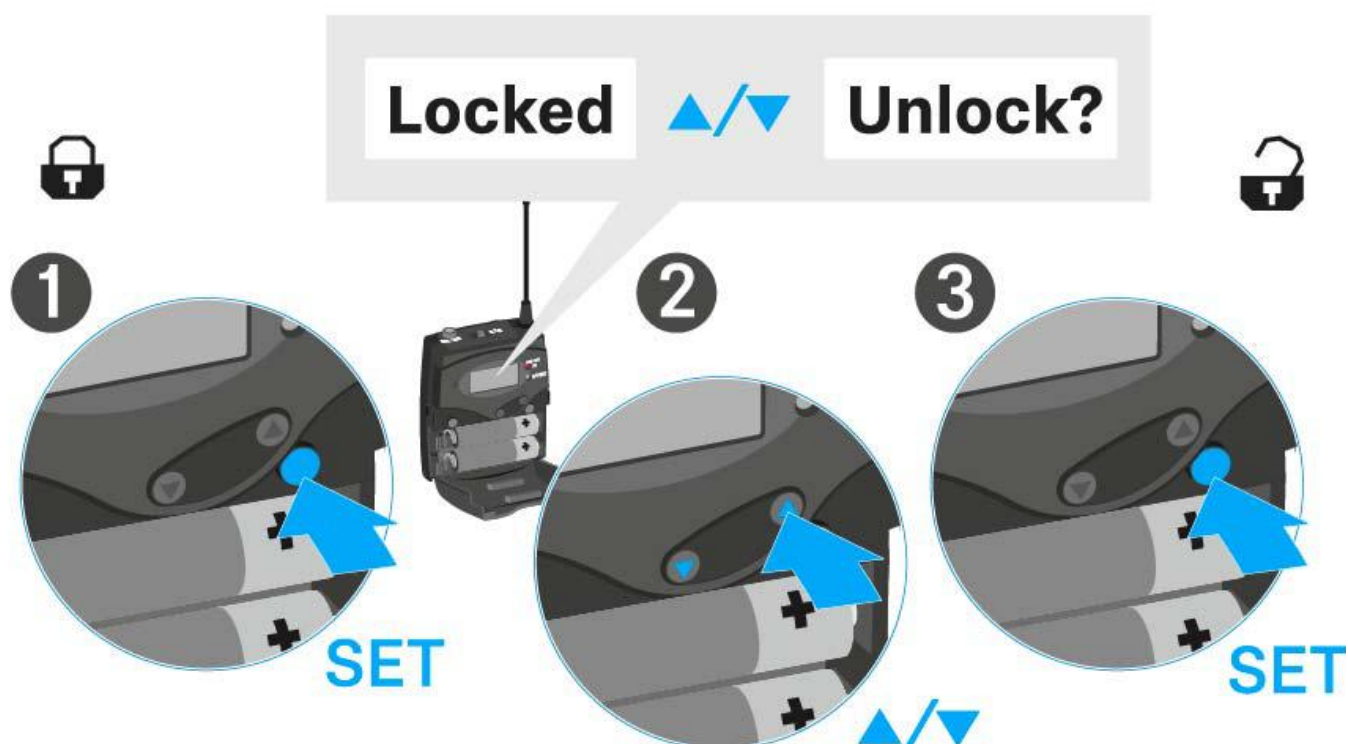



## Displays on the SK 100 G4 bodypack transmitter display panel

You can view the following information on the transmitter display.

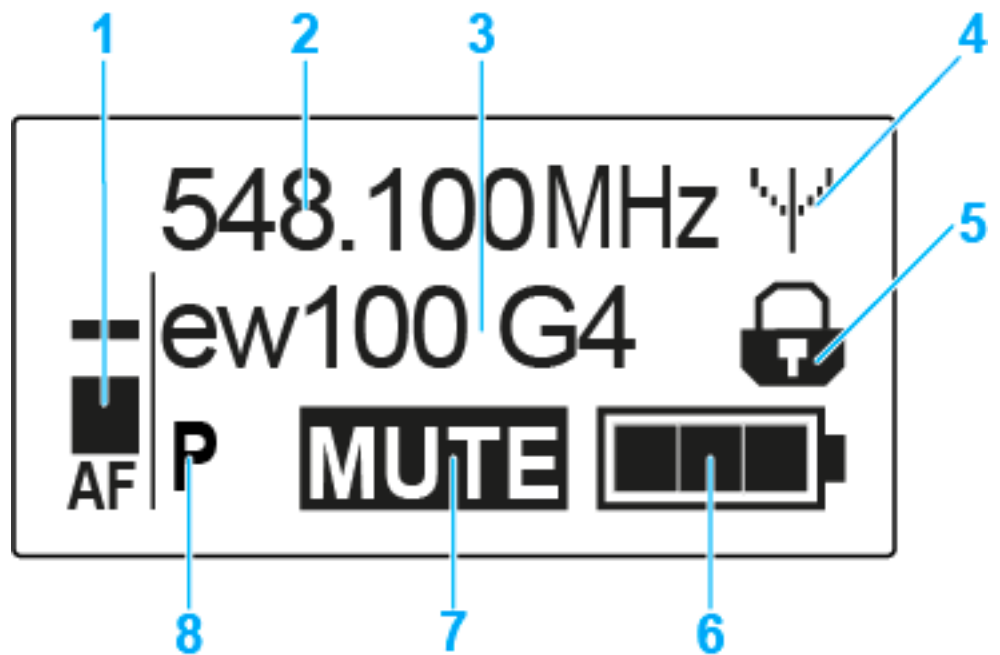

- 1 AF** audio level
  - Displays the audio level with peak hold function
  - See “Sensitivity menu item”
- 2** Frequency
  - Configured transmission frequency
  - See “Frequency Preset menu item”
- 3** Name
  - Freely selectable name of the receiver
  - See “Name menu item”
- 4** Transmission icon
  - RF signal is being transmitted
  - See “Deactivating the RF signal (RF mute)”
- 5** Lock-off function
  - Lock-off function is activated
  - See “Auto Lock menu item”
- 6** Battery status
  - See “Battery status”
- 7 MUTE** muting function
  - The audio signal is muted
  - See “Muting the bodypack transmitter (AF mute)”
  - See “Deactivating the RF signal (RF mute)”
- 8 P** pilot tone
  - Pilot tone transmission is activated
  - See “Advanced > Pilot Tone menu item”



---

>> “Buttons for navigating the SK 100 G4 menu”

>> “Setting options in the menu”

---

### Select a standard display

▷ Press the **UP** or **DOWN** buttons to select a standard display.

#### Frequency/Name standard display



#### Channel/Frequency standard display



#### Name/Channel standard display

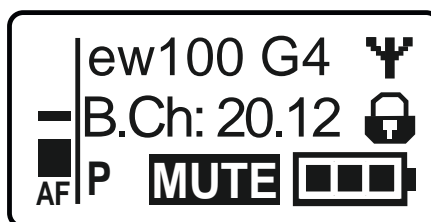





## Buttons for navigating the SK 100 G4 menu

### Navigating through the menu

To open the menu:

- ▷ Press the **SET** button.  
The operating menu is shown on the transmitter display panel.

To open a menu item:

- ▷ Press the **UP** or **DOWN** buttons to navigate through the individual menu items.
- ▷ Press the **SET** button to open the selected menu item.

 “Operating elements of the SK 100 G4 bodypack transmitter”

### Making changes in a menu item

After you open a menu item, you can make changes as follows:

- ▷ Press the **UP** or **DOWN** buttons to set the displayed value.
- ▷ Press the **SET** button to save the setting.
- ▷ Press the **ESC (ON/OFF)** button to leave the menu item without saving the setting.

 “Operating elements of the SK 100 G4 bodypack transmitter”

---

>> “Displays on the SK 100 G4 bodypack transmitter display panel”

>> “Setting options in the menu”

---



## Setting options in the menu

In the SK 100 G4 menu, you can configure the following settings.

---

### Adjusting the input sensitivity

- ▷ See “Sensitivity menu item”

---

### Setting the frequency bank and the channel

- ▷ See “Frequency Preset menu item”

---

### Entering a freely selectable name

- ▷ See “Name menu item”

---

### Activating/deactivating the automatic lock-off function

- ▷ See “Auto Lock menu item”

---

### Configuring enhanced settings in the **Advanced Menu**:

- Adjusting the transmission frequencies for the U frequency bank
  - Configuring the MUTE switch
  - Configuring the guitar cable emulation
  - Activating/deactivating the pilot tone evaluation
  - Adjusting the contrast of the display panel
  - Resetting the transmitter
  - Displaying the current software revision
  - ▷ See “Advanced menu item”
-



## Sensitivity menu item

- Adjusting the input sensitivity – **AF** audio level

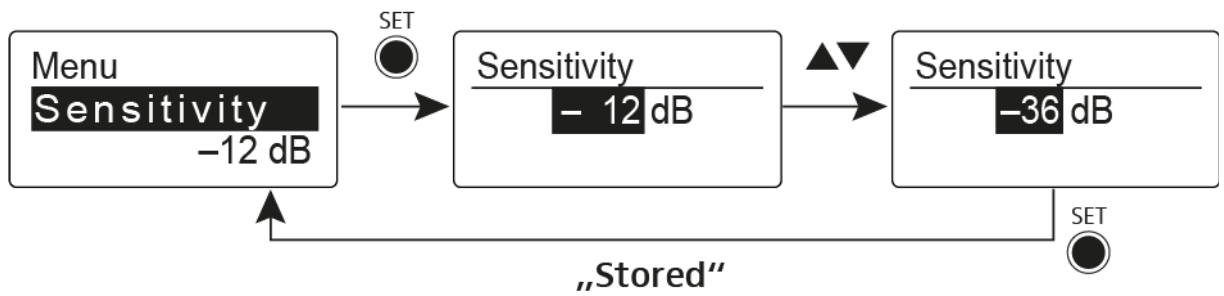

**Setting range:** 0 dB to -60 dB in 6 dB steps.

The **AF** audio level is also displayed when the bodypack transmitter is muted, e.g. to check the sensitivity before a live broadcast.

### Recommended presets:

- Loud music/vocals: -30 to -21 dB
- Moderation: -21 to 0 dB
- Electric guitar with single-coil pickups: -30 to -24 dB
- Electric guitar with Humbucker pickups: -45 to -30 dB
- Electric guitars with active electronics: -45 to -30 dB

## Frequency Preset menu item

- Manually selecting a frequency bank and channel

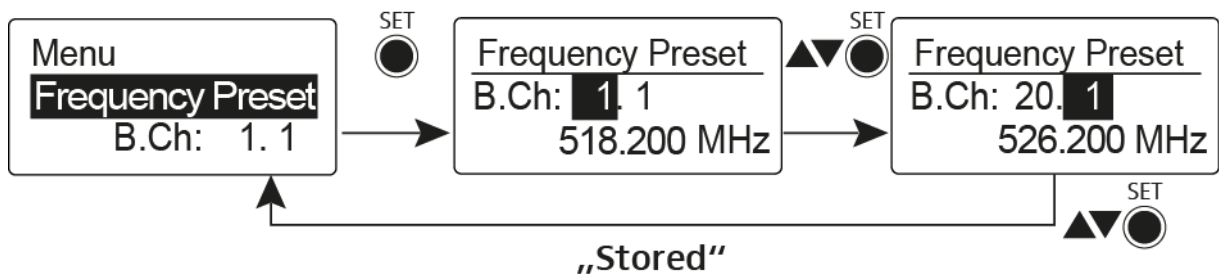

While you work in the Frequency Preset menu, the RF signal is deactivated.

### Please note when creating multi-channel systems:

Only the factory-preset frequencies within one frequency bank are intermodulation-free. The bodypack transmitter and receiver must be set to the same frequency. Be sure to note the information on frequency selection under “Establishing a radio link”.



## Name menu item

- Entering names

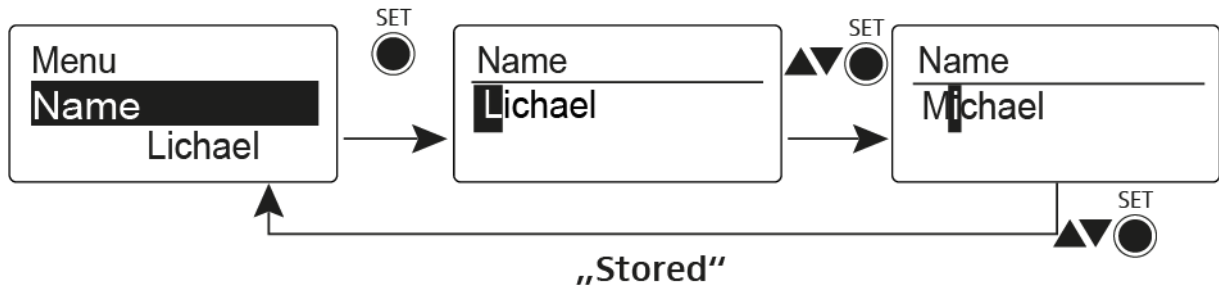

In the **Name** menu item you can enter any name you want for the bodypack transmitters (e.g. the names of the musicians).

The name can be shown in the [Frequency/Name](#) and [Name/Channel](#) standard displays.

The names are a maximum of 8 characters:

- All letters except umlauts.
- Numbers from 0 to 9
- Special characters and spaces

Enter the names as follows:

- ▷ Press the **UP** or **DOWN** buttons to select a character.
- ▷ Press the **SET** button to switch to the next space or to save the name you have entered once it is complete.

## Auto Lock menu item

- Switching the automatic lock-off function on and off

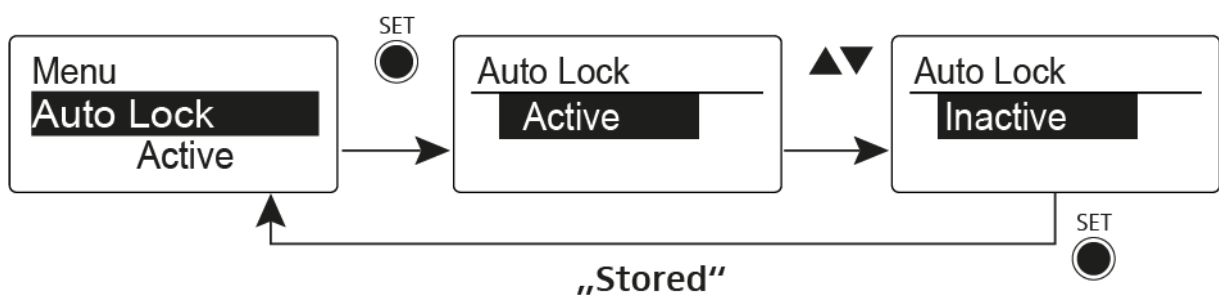

This lock prevents the wireless microphone from being unintentionally switched off and also prevents any unintentional changes to the transmitter's configuration. In the current standard display, the lock icon shows whether the lock-off function is currently switched on.

You can find information about using the lock-off function under "Lock-off function".



## Advanced menu item

In the **Advanced** submenu you can configure enhanced settings.

The following sub-items are available:

---

### Adjusting the transmission frequencies for the U frequency bank

- ▷ See “Advanced > Tune menu item”

---

### Configuring the MUTE switch

- ▷ See “Advanced > Mute Mode menu item”

---

### Configuring the guitar cable emulation

- ▷ See “Advanced > Cable Emulation menu item”

---

### Activating/deactivating the pilot tone evaluation

- ▷ See “Advanced > Pilot Tone menu item”

---

### Adjusting the contrast of the display panel

- ▷ See “Advanced > LCD Contrast menu item”

---

### Resetting the transmitter

- ▷ See “Advanced > Reset menu item”

---

### Displaying the current software revision

- ▷ See “Advanced > Software Revision menu item”
-



## Advanced > Tune menu item

- Configuring the transmission frequency and frequency bank U

When you have configured the bodypack transmitter to a system bank and you call up the **Tune** menu item, channel 1 of the frequency bank **U** is automatically set. The message **U.1** briefly appears in the display. In the factory settings, the channels of the frequency bank **U** are not assigned to any transmission frequency.

While you work in the **Tune** menu, the RF signal is deactivated.

You can configure a transmission frequency for the current channel or select a channel in the frequency bank **U** and configure a transmission frequency for this channel in the **Tune** menu. Be sure to note the information on frequency selection, see “Setting notes”.

### Only adjusting the frequency

To configure the transmission frequency for the current channel:

- ▷ Open the **Tune** menu item in the **Advanced** menu.  
The frequency selection appears.

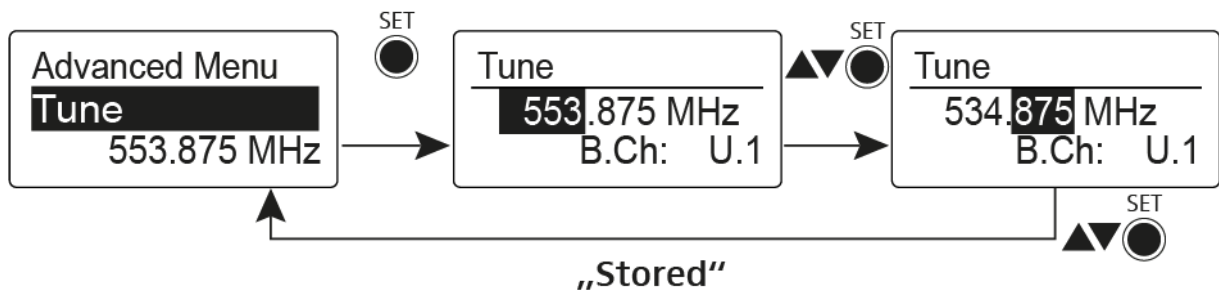

- ▷ Configure the desired frequency.
- ▷ Press the **SET** button.  
Your settings will be saved. You are now back in the operating menu.

### Setting the channel and frequency

To select a **channel** and assign it a frequency:

- ▷ Open the **Tune** menu item in the **Advanced** menu by pressing and holding the **SET** button until the frequency bank selection appears.

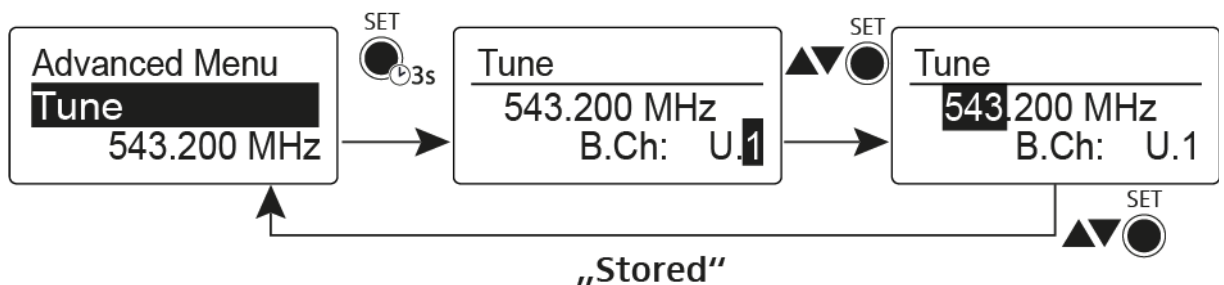

- ▷ Set the desired channel.
- ▷ Press the **SET** button.  
The frequency selection appears.
- ▷ Configure the frequency.



## Advanced > Mute Mode menu item

- Configuring the **MUTE** switch

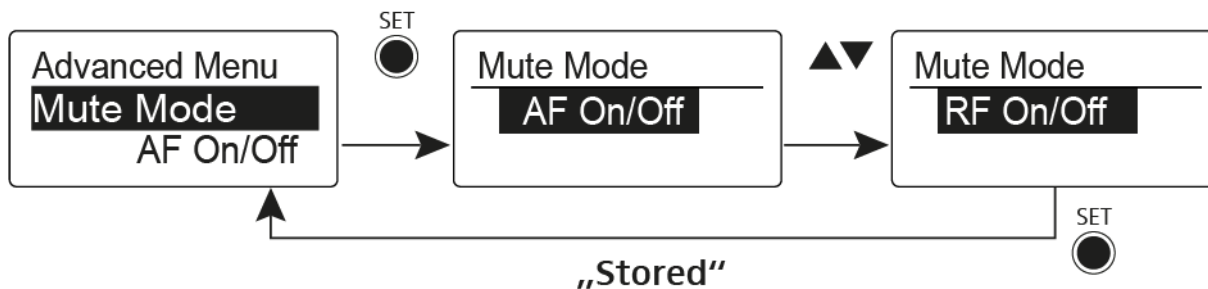

### AF On/Off mode

- If set to position MUTE, the audio signal is muted.

### RF On/Off mode

- If set to position MUTE, the RF signal is deactivated.

### Disabled mode

- No function

You can find information about operating the mute switch under “Muting the bodypack transmitter (AF mute)” and “Deactivating the RF signal (RF mute)”.

## Advanced > Cable Emulation menu item

- Emulating a guitar cable

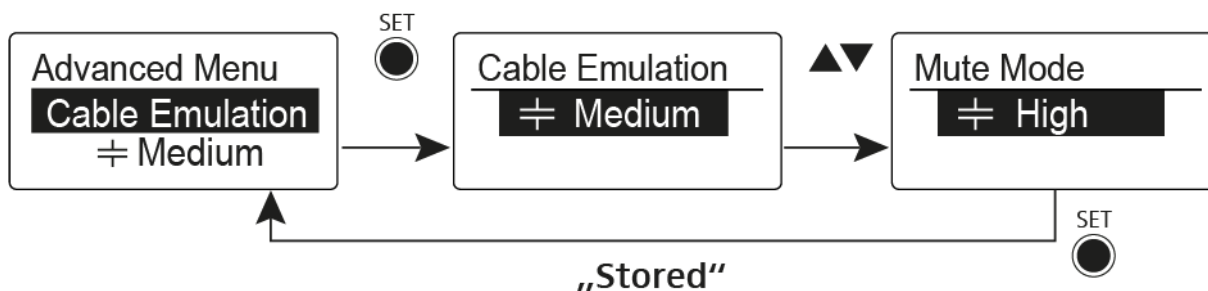

Using this menu item you can emulate the capacitances of your guitar cables and influence the sound of your guitar.



## Advanced > Pilot Tone menu item

- Activating/deactivating pilot tone transmission

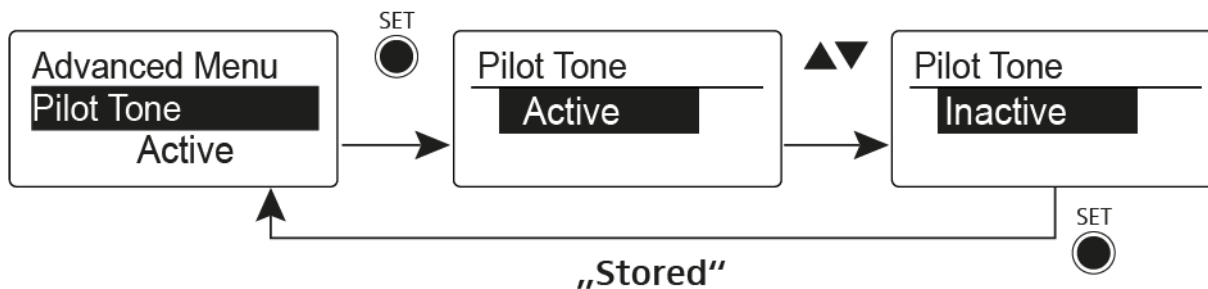

The pilot tone has an inaudible frequency that is sent from the transmitter and evaluated by the receiver. It supports the receiver's squelch function.

## Advanced > LCD Contrast menu item

- Adjusting the contrast of the display panel

You can configure the contrast of the display in 16 steps.

## Advanced > Reset menu item

- Resetting the bodypack transmitter

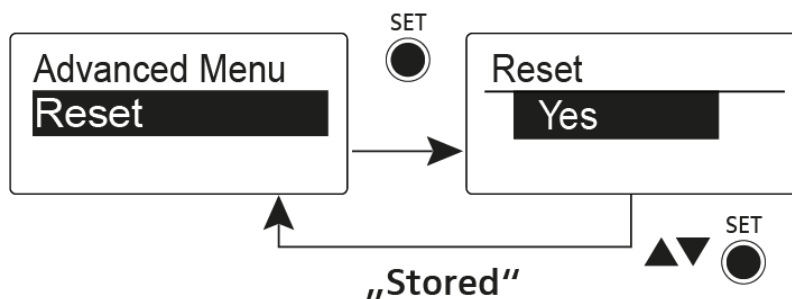

When you reset the bodypack transmitter, only the selected settings of the pilot tone and the **U** frequency bank are retained.

## Advanced > Software Revision menu item

- Show software revision

You can display the current software revision.





## Establishing a radio link

To establish a radio link between the transmitter and receiver, the same frequency must be set in both devices.

You can do this in a number of different ways:

1. Use the **Easy Setup** function to perform an **automatic frequency set-up** (see “Easy Setup menu item”).
2. Set a frequency in the receiver **manually** (see “Frequency Preset menu item”) and **synchronize** it with the transmitter (see “Synchronizing devices”).
3. Set the frequency on the receiver and the transmitter **manually** (EM 100 G4: “Frequency Preset menu item”, SKM 100 G4: “Frequency Preset menu item”, SK 100 G4: “Frequency Preset menu item”)

### Setting notes

Please note the following when synchronizing a transmitter with a receiver:

- ▷ Only use transmitters and receivers from the same frequency range (see the type plate on the transmitter and receiver).
- ▷ Make sure that your chosen frequencies are listed in the frequency table for the particular frequency range (see “Frequency tables”).
- ▷ Ensure that the desired frequencies are permitted in your country and apply for an operating license if necessary.



**Please note the information at the following address:**

General conditions and restrictions for the use of frequencies

---



## Synchronizing devices

You can synchronize ew 100 G4 series transmitters and receivers via the receiver's infrared interface.

The following **Parameters** are transferred to the transmitters:

- 
- **Frequency Preset** >> currently configured frequency (see "Frequency Preset menu item")
- 
- **Name** >> individually configured name (see "Name menu item")
- 
- **Pilot Tone** >> current setting of the pilot tone on the receiver (see "Advanced -> Pilot Tone menu item")
- 

To synchronize the devices:

- ▷ Switch the transmitter and the receiver on.
- ▷ Press the **SYNC** button on the receiver.  
**Sync** appears in the receiver's display and the blue LED turns blue.



- ▷ Hold the infra-red interface of the transmitter (see "Operating elements



of the SKM 100 G4 handheld transmitter” and “Operating elements of the SK 100 G4 bodypack transmitter”) in front of the infra-red interface of the receiver (see “Operating elements on the front of the device”).



The parameters are transferred to the transmitter. The blue LED blinks during transmission.

When the transfer is complete, a tick appears in the receiver’s display as a confirmation. Then the receiver will return to the current standard display.

To cancel synchronization:

- ▷ Press the **ESC** button on the receiver.  
An **X** appears in the display.

This icon also appears when:

- no transmitter is found or the transmitter is not compatible.
- no transmitter is found and the synchronization process automatically ends after 30 seconds.



## Using the ASA 214

These sections contain detailed information about operating the ASA 214.

You can find information on installation and startup of the ASA 214 under “Installing the ASA 214”.



## Operating elements on the front of the device

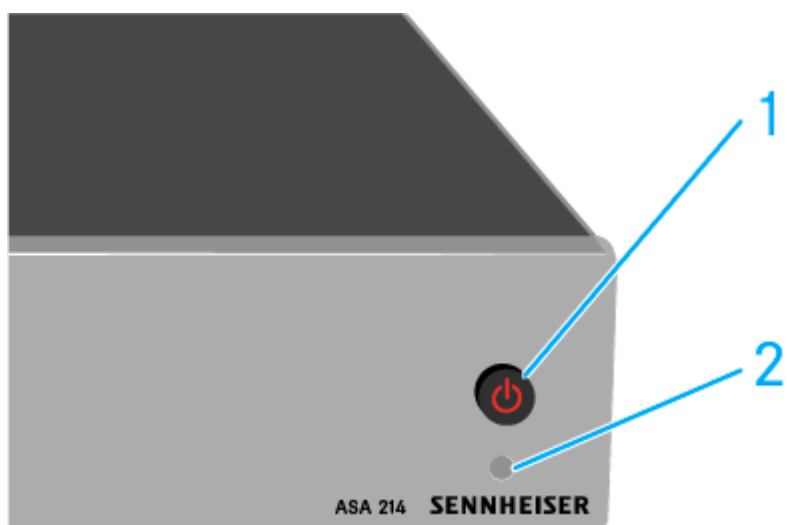

- 1** STANDBY button
  - See “Switching the ASA 214 on and off”
- 2** LED: Operation indicator



## Switching the ASA 214 on and off

To switch on the antenna splitter:

- ▷ Short-press the **STANDBY** button.  
The antenna splitter switches on and the power LED turns green.  
The RF signals of the connected antennas are distributed to all connected receivers.



To switch the antenna splitter to **standby mode**:

- ▷ Press the **STANDBY** button for approx. 2 seconds.  
The LED turns off. The connected antenna amplifiers are switched off.  
Connected receivers are switched off if they draw their supply voltage from the BNC sockets A1 to A4 (see “Connecting receivers to the ASA 214”).

To **fully switch off** the antenna splitter:

- ▷ Disconnect the antenna splitter from the power supply system by unplugging the power supply unit from the wall socket.  
The LED turns off.



# SPECIFICATIONS

## Overview

In the sections below, you can find information about the different variants of the products in the **ew 100 G4** series as well as technical data for the individual products.

- Product variants and frequency variants >> “Product variants”
- Frequency tables with overviews of all banks and channels >> “Frequency tables”
- Product-specific technical data >> “Specifications”
- Information about plug assignments >> “Pin assignment”

You can also find information about safely cleaning and maintaining **evolution wireless G4** series products.

- “Cleaning and maintenance”



## Product variants

### EM 100 G4 product variants

#### Made in Germany

|               |                 |                 |
|---------------|-----------------|-----------------|
| EM 100 G4-A1  | 470 – 516 MHz   | Art. no. 507603 |
| EM 100 G4-A   | 516 – 558 MHz   | Art. no. 507604 |
| EM 100 G4-GB  | 606 – 648 MHz   | Art. no. 507605 |
| EM 100 G4-G   | 566 – 608 MHz   | Art. no. 507606 |
| EM 100 G4-B   | 626 – 668 MHz   | Art. no. 507607 |
| EM 100 G4-C   | 734 – 776 MHz   | Art. no. 507608 |
| EM 100 G4-E   | 823 – 865 MHz   | Art. no. 507609 |
| EM 100 G4-1G8 | 1785 – 1800 MHz | Art. no. 507610 |
| EM 100 G4-K+  | 925 – 937.5 MHz | Art. no. 507611 |

#### Assembled in the USA

|              |               |                 |
|--------------|---------------|-----------------|
| EM 100 G4-A1 | 470 – 516 MHz | Art. no. 507945 |
| EM 100 G4-A  | 516 – 558 MHz | Art. no. 507946 |
| EM 100 G4-AS | 520 – 558 MHz | Art. no. 507947 |
| EM 100 G4-G  | 566 – 608 MHz | Art. no. 507948 |
| EM 100 G4-B  | 626 – 668 MHz | Art. no. 507949 |
| EM 100 G4-C  | 734 – 776 MHz | Art. no. 507950 |
| EM 100 G4-D  | 780 – 822 MHz | Art. no. 507951 |
| EM 100 G4-JB | 806 – 810 MHz | Art. no. 507952 |





## SKM 100 G4 product variants

### Made in Germany

#### SKM 100 G4-S

|                  |                 |                 |
|------------------|-----------------|-----------------|
| SKM 100 G4-S-A1  | 470 – 516 MHz   | Art. no. 507594 |
| SKM 100 G4-S-A   | 516 – 558 MHz   | Art. no. 507595 |
| SKM 100 G4-S-GB  | 606 – 648 MHz   | Art. no. 507596 |
| SKM 100 G4-S-G   | 566 – 608 MHz   | Art. no. 507597 |
| SKM 100 G4-S-B   | 626 – 668 MHz   | Art. no. 507598 |
| SKM 100 G4-S-C   | 734 – 776 MHz   | Art. no. 507599 |
| SKM 100 G4-S-E   | 823 – 865 MHz   | Art. no. 507600 |
| SKM 100 G4-S-1G8 | 1785 – 1800 MHz | Art. no. 507601 |
| SKM 100 G4-S-K+  | 925 – 937.5 MHz | Art. no. 507602 |

#### SKM 100 G4

|                |                 |                 |
|----------------|-----------------|-----------------|
| SKM 100 G4-A1  | 470 – 516 MHz   | Art. no. 507660 |
| SKM 100 G4-A   | 516 – 558 MHz   | Art. no. 507661 |
| SKM 100 G4-GB  | 606 – 648 MHz   | Art. no. 507662 |
| SKM 100 G4-G   | 566 – 608 MHz   | Art. no. 507663 |
| SKM 100 G4-B   | 626 – 668 MHz   | Art. no. 507664 |
| SKM 100 G4-C   | 734 – 776 MHz   | Art. no. 507665 |
| SKM 100 G4-E   | 823 – 865 MHz   | Art. no. 507666 |
| SKM 100 G4-1G8 | 1785 – 1800 MHz | Art. no. 507667 |
| SKM 100 G4-K+  | 925 – 937.5 MHz | Art. no. 507668 |

### Assembled in the USA

#### SKM 100 G4-S

|                 |               |                 |
|-----------------|---------------|-----------------|
| SKM 100 G4-S-A1 | 470 – 516 MHz | Art. no. 507937 |
| SKM 100 G4-S-A  | 516 – 558 MHz | Art. no. 507938 |
| SKM 100 G4-S-AS | 520 – 558 MHz | Art. no. 507939 |
| SKM 100 G4-S-G  | 566 – 608 MHz | Art. no. 507940 |
| SKM 100 G4-S-B  | 626 – 668 MHz | Art. no. 507941 |
| SKM 100 G4-S-C  | 734 – 776 MHz | Art. no. 507942 |
| SKM 100 G4-S-D  | 780 – 822 MHz | Art. no. 507943 |
| SKM 100 G4-S-JB | 806 – 810 MHz | Art. no. 507945 |

**SKM 100 G4-S**

|               |               |                 |
|---------------|---------------|-----------------|
| SKM 100 G4-A1 | 470 – 516 MHz | Art. no. 508001 |
| SKM 100 G4-A  | 516 – 558 MHz | Art. no. 508002 |
| SKM 100 G4-AS | 520 – 558 MHz | Art. no. 508003 |
| SKM 100 G4-G  | 566 – 608 MHz | Art. no. 508004 |
| SKM 100 G4-B  | 626 – 668 MHz | Art. no. 508005 |
| SKM 100 G4-C  | 734 – 776 MHz | Art. no. 508006 |
| SKM 100 G4-D  | 780 – 822 MHz | Art. no. 508007 |
| SKM 100 G4-JB | 806 – 810 MHz | Art. no. 508008 |

**SK 100 G4 product variants****Made in Germany**

|               |                 |                 |
|---------------|-----------------|-----------------|
| SK 100 G4-A1  | 470 – 516 MHz   | Art. no. 507585 |
| SK 100 G4-A   | 516 – 558 MHz   | Art. no. 507586 |
| SK 100 G4-GB  | 606 – 648 MHz   | Art. no. 507587 |
| SK 100 G4-G   | 566 – 608 MHz   | Art. no. 507588 |
| SK 100 G4-B   | 626 – 668 MHz   | Art. no. 507589 |
| SK 100 G4-C   | 734 – 776 MHz   | Art. no. 507590 |
| SK 100 G4-E   | 823 – 865 MHz   | Art. no. 507591 |
| SK 100 G4-1G8 | 1785 – 1800 MHz | Art. no. 507592 |
| SK 100 G4-K+  | 925 – 937.5 MHz | Art. no. 507593 |

**Assembled in the USA**

|              |               |                 |
|--------------|---------------|-----------------|
| SK 100 G4-A1 | 470 – 516 MHz | Art. no. 507929 |
| SK 100 G4-A  | 516 – 558 MHz | Art. no. 507930 |
| SK 100 G4-AS | 520 – 558 MHz | Art. no. 507931 |
| SK 100 G4-G  | 566 – 608 MHz | Art. no. 507932 |
| SK 100 G4-B  | 626 – 668 MHz | Art. no. 507933 |
| SK 100 G4-C  | 734 – 776 MHz | Art. no. 507934 |
| SK 100 G4-D  | 780 – 822 MHz | Art. no. 507935 |
| SK 100 G4-JB | 806 – 810 MHz | Art. no. 507936 |



## Frequency tables

You can find frequency tables for all available frequency ranges in the download section of the Sennheiser website under [www.sennheiser.com/download](http://www.sennheiser.com/download).

Download area of the Sennheiser website

Enter **ew G4** into the search bar to show the frequency tables.



## Specifications

You can find product-specific technical data in the sections below.



## EM 100 G4

### RF characteristics

|   |  |
|---|--|
| <b>Modulation</b>                             | Wideband FM  |
| <b>Receiving frequency ranges</b>             | A1: 470 – 516 MHz<br>A: 516 – 558 MHz<br>AS: 520 – 558 MHz<br>G: 566 – 608 MHz<br>GB: 606 – 648 MHz<br>B: 626 – 668 MHz<br>C: 734 – 776 MHz<br>D: 780 – 822 MHz<br>TH: 794 – 806 MHz<br>E: 823 – 865 MHz<br>JB: 806 – 810 MHz<br>K+: 925 – 937.5 MHz<br>1G8: 1785 – 1800 MHz |
| <b>Receiving frequencies</b>                  | Max 1680 receiving frequencies, adjustable in 25 kHz steps<br><br>20 frequency banks, each with up to 12 factory-preset channels, no intermodulation<br><br>1 frequency bank with up to 12 programmable channels   |
| <b>Switching bandwidth</b>                    | up to 42 MHz   |
| <b>Nominal/peak deviation</b>                 | $\pm 24$ kHz / $\pm 48$ kHz  |
| <b>Receiver principle</b>                     | True diversity   |
| <b>Sensitivity (with HDX, peak deviation)</b> | $< 2.5 \mu\text{V}$ for 52 dBA <sub>eff S/N</sub>  |
| <b>Adjacent channel selection</b>             | Typically $\geq 65$ dB   |
| <b>Intermodulation attenuation</b>            | Typically $\geq 65$ dB   |
| <b>Blocking</b>                               | $\geq 70$ dB   |
| <b>Squelch</b>                                | Off<br>Low: 5 dB $\mu\text{V}$<br>Middle: 15 dB $\mu\text{V}$<br>High: 25 dB $\mu\text{V}$   |
| <b>Pilot tone squelch</b>                     | Can be switched off  |
| <b>Antenna inputs</b>                         | 2 BNC sockets  |



### AF characteristics

|  |  |
|--|--|
| <b>Compander system</b>  | Sennheiser HDX   |
| <b>EQ presets (switchable, act on line and monitor outputs):</b> |  |
| <b>Preset 1: Flat</b>  |  |
| <b>Preset 2: Low Cut</b>   | -3 dB at 180 Hz  |
| <b>Preset 3: Low Cut / High Boost</b>                            | -3 dB at 180 Hz<br>+6 dB at 10 kHz   |
| <b>Preset 4: High Boost</b>                                      | +6 dB at 10 kHz  |
| <b>Signal-to-noise ratio (1 mV, peak deviation)</b>              | ≥ 110 dBA  |
| <b>Total harmonic distortion (THD)</b>                           | ≤ 0.9 %  |
| <b>AF output voltage (at peak deviation, 1 kHz AF)</b>           | 6.3 mm jack socket (unbalanced): +12 dBu<br>BNC socket (balanced): +18 dBu |
| <b>AF OUT setting range</b>                                      | 48 dB in 3 dB steps  |

### Overall device

|                          |                                    |
|--------------------------|------------------------------------|
| <b>Temperature range</b> | -10 °C to +55 °C (14 °F to 131 °F) |
| <b>Power supply</b>      | 12 V DC                            |
| <b>Power consumption</b> | 300 mA                             |
| <b>Dimensions</b>        | Approx. 190 x 212 x 43 mm          |
| <b>Weight</b>            | approx. 980 g                      |



## SKM 100 G4

### RF characteristics

|                                   |   |
|-----------------------------------|---|
| <b>Modulation</b>                 | Wideband FM   |
| <b>Receiving frequency ranges</b> | A1: 470 – 516 MHz<br>A: 516 – 558 MHz<br>AS: 520 – 558 MHz<br>G: 566 – 608 MHz<br>GB: 606 – 648 MHz<br>B: 626 – 668 MHz<br>C: 734 – 776 MHz<br>D: 780 – 822 MHz<br>E: 823 – 865 MHz<br>JB: 806 – 810 MHz<br>K+: 925 – 937.5 MHz<br>1G8: 1785 – 1800 MHz |
| <b>Transmission frequencies</b>   | Max 1680 receiving frequencies,<br>adjustable in 25 kHz steps<br><br>20 frequency banks, each with up<br>to 12 factory-preset channels<br><br>1 frequency bank with up to 12<br>programmable channels   |
| <b>Switching bandwidth</b>        | up to 42 MHz  |
| <b>Nominal/peak deviation</b>     | $\pm 24$ kHz / $\pm 48$ kHz   |
| <b>Frequency stability</b>        | $\leq \pm 15$ ppm   |
| <b>RF output power at 50 ?</b>    | Max. 30 mW  |
| <b>Pilot tone squelch</b>         | Can be switched off   |

### AF characteristics

|   |                     |
|---|---------------------|
| <b>Compander system</b>                                 | Sennheiser HDX      |
| <b>AF frequency response</b>                            | 80 – 18,000 Hz      |
| <b>Signal-to-noise ratio<br/>(1 mV, peak deviation)</b> | $\geq 110$ dBA      |
| <b>Total harmonic distortion (THD)</b>                  | $\leq 0.9$ %        |
| Input voltage   | $3 V_{\text{eff}}$  |
| Input impedance   | 40 k $\Omega$       |
| Input capacitance                                       | Switchable          |
| <b>Setting range for input sensitivity</b>              | 48 dB in 6 dB steps |



### Overall device

|   |  |
|---|--|
| <b>Temperature range</b>                                    | -10 °C to +55 °C (14 °F to 131 °F)           |
| <b>Power supply</b>   | 2 AA batteries, 1,5 V or<br>BA 2015 accupack |
| <b>Nominal voltage</b>                                      | 3 V battery /<br>2.4 V rechargeable battery  |
| <b>Power consumption</b>                                    |  |
| <b>at nominal voltage<br/>with transmitter switched off</b> | typically 180 mA<br>≤ 25 µA                  |
| <b>Operating time</b>                                       | Typically 8 h                                |
| <b>Dimensions</b>   | Approx. Ø 50 x 265 mm                        |
| <b>Weight (with batteries)</b>                              | Approx. 450 g                                |





## SK 100 G4

### RF characteristics

|                                   |   |
|-----------------------------------|---|
| <b>Modulation</b>                 | Wideband FM   |
| <b>Receiving frequency ranges</b> | A1: 470 – 516 MHz<br>A: 516 – 558 MHz<br>AS: 520 – 558 MHz<br>G: 566 – 608 MHz<br>GB: 606 – 648 MHz<br>B: 626 – 668 MHz<br>C: 734 – 776 MHz<br>D: 780 – 822 MHz<br>E: 823 – 865 MHz<br>JB: 806 – 810 MHz<br>K+: 925 – 937.5 MHz<br>1G8: 1785 – 1800 MHz |
| <b>Transmission frequencies</b>   | Max. 1680 receiving frequencies,<br>adjustable in 25 kHz steps<br><br>20 frequency banks, each with up<br>to 12 factory-preset channels<br><br>1 frequency bank with up to 12<br>programmable channels  |
| <b>Switching bandwidth</b>        | up to 42 MHz  |
| <b>Nominal/peak deviation</b>     | $\pm 24$ kHz / $\pm 48$ kHz   |
| <b>Frequency stability</b>        | $\leq \pm 15$ ppm   |
| <b>RF output power at 50 ?</b>    | Max. 30 mW  |
| <b>Pilot tone squelch</b>         | Can be switched off   |

### AF characteristics

|   |  |
|---|--|
| <b>Compander system</b>                                 | Sennheiser HDX                                     |
| <b>AF frequency response</b>                            | Microphone: 80 – 18,000 Hz<br>Line: 25 – 18,000 Hz |
| <b>Signal-to-noise ratio<br/>(1 mV, peak deviation)</b> | $\geq 110$ dBA                                     |
| <b>Total harmonic distortion (THD)</b>                  | $\leq 0.9$ %                                       |
| <b>Max. input voltage<br/>Microphone/line</b>           | $3 V_{\text{eff}}$                                 |
| <b>Input impedance<br/>Microphone/line</b>              | 40 k $\Omega$ , unbalanced/1 M $\Omega$            |
| <b>Input capacitance</b>                                | Switchable   |
| <b>Setting range for input sensitivity</b>              | 60 dB in 3 dB steps                                |



### Overall device

|   |  |
|---|--|
| <b>Temperature range</b>                                    | -10 °C to +55 °C (14 °F to 131 °F)           |
| <b>Power supply</b>   | 2 AA batteries, 1,5 V or<br>BA 2015 accupack |
| <b>Nominal voltage</b>                                      | 3 V battery<br>2.4 V rechargeable battery    |
| <b>Power consumption</b>                                    |  |
| <b>at nominal voltage<br/>with transmitter switched off</b> | typically 180 mA<br>≤ 25 µA                  |
| <b>Operating time</b>                                       | Typically 8 h                                |
| <b>Dimensions</b>   | approx. 82 x 64 x 24 mm                      |
| <b>Weight (with batteries)</b>                              | Approx. 160 g                                |



## ASA 214

### Specifications

|  |  |
|--|--|
| <b>ASA 214 antenna splitter</b>                                      | 2 × 1:4 or 1 × 1:8, active   |
| <b>Connection cable</b>  | 8 pieces, 50 cm, BNC   |
| <b>Frequency range</b>   |  |
| ASA 214-UHF:   | 470 – 870 MHz at –3 dB   |
| ASA 214-1G8:   | 1785 – 1805 MHz at –3 dB   |
| <b>Amplification</b>   |  |
| In A – Out A   | 0 ± 1 dB   |
| In A – Out A1 ... A4   | 0 ± 1 dB   |
| In B – Out B1 ... B4   | 0 ± 1 dB   |
| <b>IIP3</b>  | 20 dBm min.<br>23 dBm, typical   |
| <b>Impedance</b>   | 50 Ω   |
| <b>Reflection loss</b>   | 10 dB (all RF outputs)   |
| <b>Operating voltage</b>   | 13.8 V DC (with power supply unit NT 1-1)                                  |
| <b>Power consumption</b>   | ASA 1: 245 mA<br>ASA 1-1G8: 350 mA   |
| <b>Total power consumption</b>                                       | max. 2.0 A with 4 receivers and 2 × 2 antenna amplifiers per antenna input |
| <b>Antenna amplifier power supply at ANT RF IN A and ANT RF IN B</b> | 12 V, 130 mA   |
| <b>Receiver power supply at A1 to A4</b>                             | 12 V (protected against reverse supply), 350 mA                            |
| <b>Relative air humidity</b>   | 5 to 95%   |
| <b>Temperature range</b>   |  |
| Operation:   | -10 °C to +55 °C (14 °F to 131 °F)   |
| Storage:   | -20 °C to +70 °C (-4 °F to 158 °F)   |
| <b>Dimensions</b>  | approx. 212 x 168 x 43 mm  |
| <b>Weight</b>  | approx. 1090 g   |



Block diagram

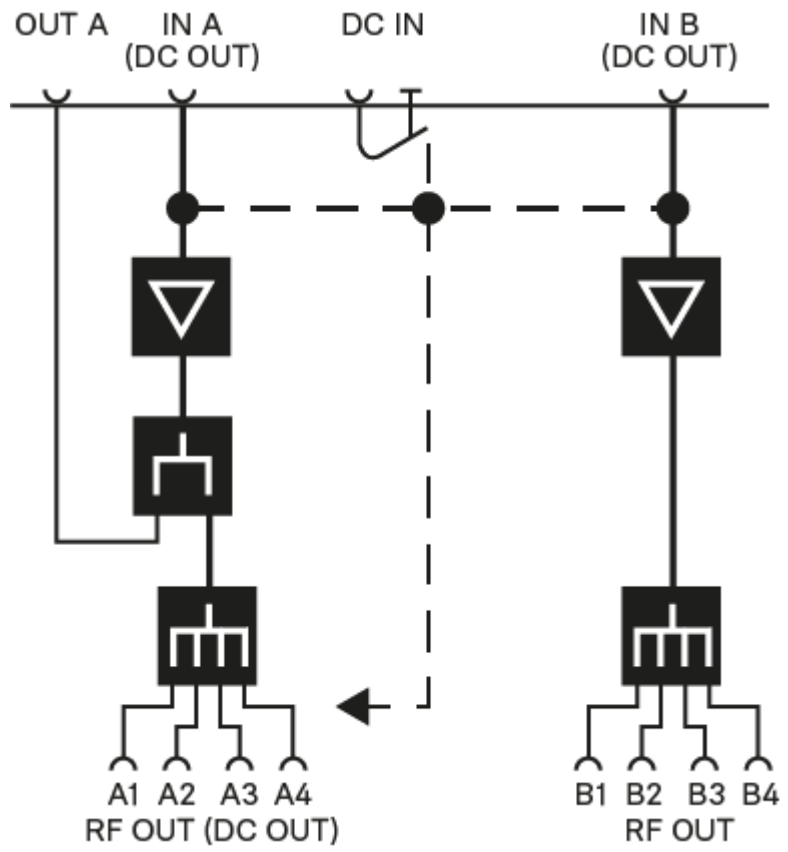



## Pin assignment

### 3.5 mm stereo jack plug

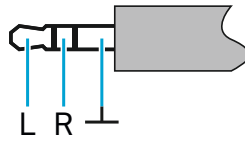

- Plug for headphone and earphone cables, e.g. IE 4.
- Connect to:
  - EK IEM G4
  - EK 500 G4

### 3.5 mm mic jack plug

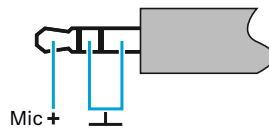

- Plug for lavalier and headset microphone, e.g. ME 2.
- Connect to:
  - SK 100 G4
  - SK 300 G4
  - SK 500 G4

### 3.5 mm line jack plug

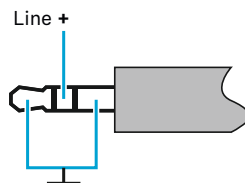

- Plug for line and instrument cables, e.g. Ci 1-N
- Connect to:
  - SK 100 G4
  - SK 300 G4
  - SK 500 G4

### 6.3 mm stereo jack plug, balanced (audio in/loop out)

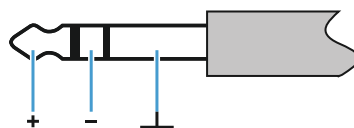

- Connect to:
  - SR IEM G4 Audio In
  - SR IEM G4 Loop Out



### 6.3 mm mono jack plug, unbalanced

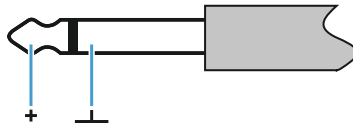

- Connect to:
  - EM 100 G4 Audio Out
  - EM 300-500 G4 Audio Out

### 6.3 mm stereo jack plug for headphone jack

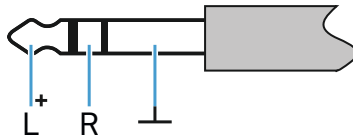

- Connect to:
  - EM 100 G4 headphone input
  - EM 300-500 G4 headphone input
  - SR IEM G4 headphone input

### XLR-3 plug, balanced

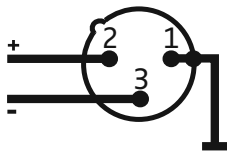

### Hollow jack plug for power supply





## Cleaning and maintenance

Note the following information when cleaning and maintaining evolution wireless G4 series products.

---

### CAUTION

#### Liquids can damage the products' electronics.

Liquids entering the product housing can cause a short-circuit and damage the electronics.

- ▷ Keep all liquids away from the products.
  - ▷ Do not use any solvents or cleansing agents.
- 
- ▷ Disconnect the products from the power supply system and remove rechargeable batteries and batteries before you begin cleaning.
  - ▷ Clean all products only with a soft, dry cloth.
  - ▷ Note the special cleaning instructions below for the following products.

#### Cleaning the sound inlet basket of the microphone module

- ▷ Unscrew the top sound inlet basket from the microphone module by turning it counterclockwise.
- ▷ Remove the foam insert.

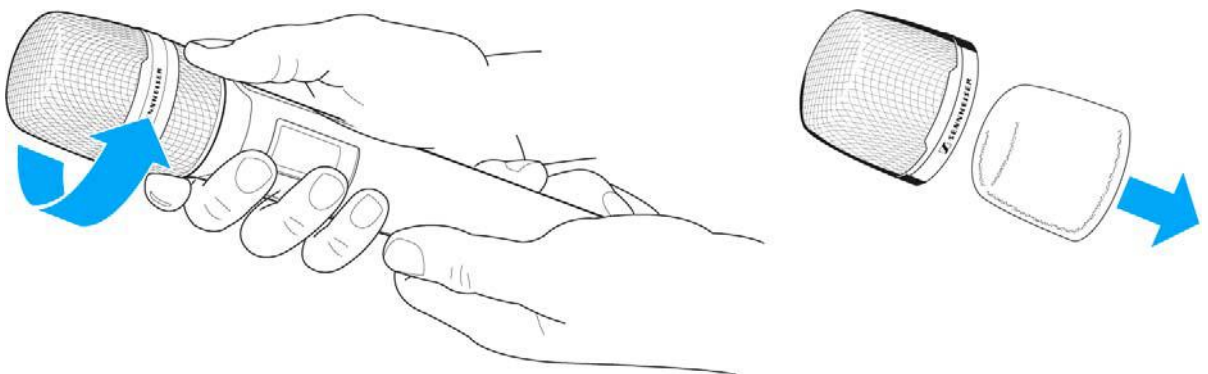

You can clean the sound inlet basket in two ways:

- ▷ Use a slightly damp cloth to clean the top sound inlet basket from the inside and outside.
- ▷ Use a brush and rinse with clean water.
- ▷ If necessary, clean the foam insert with a mild detergent or replace the foam insert.
- ▷ Dry the top sound inlet basket and foam insert.
- ▷ Reinsert the foam insert.



- ▷ Screw the sound inlet basket back onto the microphone module.

From time to time, you should also clean the microphone module contacts:

- ▷ Wipe the contacts of the microphone module with a soft, dry cloth.