

300 IEM Series



Instruction manual

Tastensymbole / Button icons / Icônes de touches /
 Simboli dei tasti / Símbolos de las teclas / Toetssymbolen /
 Símbolos dos botões / СИМВОЛЫ КНОПОК / 按键图标

SR 300 IEM G3

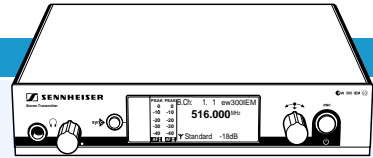

Taste **STANDBY** / **STANDBY** button / Touche **STANDBY** /
 Tasto **STANDBY** / Tecla **STANDBY** / Toets **STANDBY** /
 Botão **STANDBY** / Кнопка **STANDBY** / 待机键 **STANDBY**



STANDBY drücken / Press the **STANDBY** button / Appuyer sur la touche **STANDBY** /
 Premere **STANDBY** / Pulsar **STANDBY** / **STANDBY** indrukken /
 Premir **STANDBY** / Нажать **STANDBY** / 按 **STANDBY** 键



Jog-Dial / Jog dial / Molette de sélection /
 Jog dial / Rueda de clic táctil / Jog-dial /
 Botão rotativo / Колесико / 设置旋钮



Jog-Dial drücken / Press the **jog dial** / Appuyer sur la molette de sélection /
 Premere il **jog dial** / Pulsar la rueda de clic táctil / **Jog-dial** indrukken /
 Premir botão rotativo / Нажать Колесико / 按设置旋钮



Jog-Dial drehen / Turn the **jog dial** / Tournez sur la molette de sélection /
 Ruotare il **jog dial** / Girar la rueda de clic táctil / **Jog-dial** draaien /
 Rodar botão rotativo / Повернуть Колесико / 旋转设置旋钮

EK 300 IEM G3



Taste **ESC** / **ESC** button / Touche **ESC** /
 Tasto **ESC** / Botón **ESC** / Toets **ESC** /
 Botão **ESC** / Кнопка **ESC** / 设置键 **ESC**



ESC drücken / Press the **ESC** button / Appuyer sur la touche **ESC** /
 Premere **ESC** / Pulsar **ESC** / **ESC** indrukken /
 Premir **ESC** / Нажать **ESC** / 按 **ESC** 键



Taste **SET** / **SET** button / Touche **SET** /
 Tasto **SET** / Botón **SET** / Toets **SET** /
 Botão **SET** / Кнопка **SET** / 设置键 **SET**



SET drücken / Press the **SET** button / Appuyer sur la touche **SET** /
 Premere **SET** / Pulsar **SET** / **SET** indrukken /
 Premir **SET** / Нажать **SET** / 按 **SET** 键



Taste **UP/DOWN** / **UP/DOWN** button / Touche **UP/DOWN** /
 Tasto **UP/DOWN** / Tecla **UP/DOWN** / Toets **UP/DOWN** /
 Botão **UP/DOWN** / Кнопка **UP/DOWN** / 上下键 **UP/DOWN**



UP/DOWN drücken / Press the **UP/DOWN** button / Appuyer sur la touche **UP/DOWN** / Tasto **UP/DOWN** /
 Pulsar tecla **UP/DOWN** / De toets **UP/DOWN** indrukken / Premir o botão **UP/DOWN** / Нажать кнопки **UP/DOWN** /
 按 **UP/DOWN** 键



Contents

Important safety instructions	2
The evolution wireless series ew 300 IEM G3	3
The frequency bank system	4
Product overviews	5
Overview of the SR 300 IEM G3 transmitter	5
Overview of the displays of the SR 300 IEM G3 transmitter	6
Overview of the EK 300 IEM G3 diversity receiver	7
Overview of the displays of the EK 300 IEM G3 diversity receiver	8
Putting the devices into operation	9
Putting the SR 300 IEM G3 transmitter into operation	9
Putting the EK 300 IEM G3 diversity receiver into operation	14
Using the devices	16
Switching the devices on/off	16
Monitoring the audio signal via headphones	17
Deactivating the lock mode temporarily	18
Selecting a standard display on the diversity receiver	18
Adjusting the audio channels on the transmitter	19
Activating/deactivating the RF signal on the transmitter	19
Synchronizing transmitters and EK 300 IEM G3 receivers via the infra-red interface	19
Using the operating menus	23
The buttons of the SR 300 IEM G3 transmitter	23
The buttons of the EK 300 IEM G3 diversity receiver	23
Overview of the operating menus	24
Synchronizing the transmitter with the diversity receiver	27
Cleaning the devices	28
If a problem occurs	29
Specifications	31
System	31
SR 300 IEM G3 transmitter	31
NT 2-3 mains unit	32
EK 300 IEM G3 diversity receiver	32
Connector assignment	33
Manufacturer Declarations	34



For more detailed information on the individual sections of this instruction manual, visit the corresponding product page on our website at www.sennheiser.com.

Important safety instructions

System

- Read this instruction manual.
- Keep this instruction manual. Always include this instruction manual when passing the products on to third parties.
- Heed all warnings and follow all instructions in this instruction manual.
- Only clean the products when they are not connected to the mains. Use a cloth for cleaning.
- Only use attachments/accessories specified by Sennheiser.
- Refer all servicing to qualified service personnel. Servicing is required if the products have been damaged in any way, liquid has been spilled, objects have fallen inside, the products have been exposed to rain or moisture, do not operate properly or have been dropped.
- **WARNING:** To reduce the risk of fire or electric shock, do not use the products near water and do not expose them to rain or moisture.

SR 300 IEM G3 transmitter

- Only use the supplied mains unit.
- Unplug the mains unit from the wall socket
 - to completely disconnect the product from the mains,
 - during lightning storms or
 - when unused for long periods of time.
- Only operate the mains unit from the type of power source specified in the chapter “Specifications” (see page 31).
- Ensure that the mains unit is
 - in a safe operating condition and easily accessible,
 - properly plugged into the wall socket,
 - only operated within the permissible temperature range,
 - not covered or exposed to direct sunlight for longer periods of time in order to prevent heat accumulation (see “Specifications” on page 31).
- Do not block any ventilation openings. Install the products in accordance with the instructions given in this instruction manual.
- Do not install the products near any heat sources such as radiators, stoves, or other devices (including amplifiers) that produce heat.
- Do not overload wall outlets and extension cables as this may result in fire and electric shock.

- **Danger due to high volumes**
This product is also intended for professional use. Commercial use is subject to the safety-at-work regulations. Sennheiser, as the manufacturer, is therefore obliged to expressly point out possible health risks arising from use.
This product is capable of producing sound pressure exceeding 85 dB(A). 85 dB(A) is the sound pressure corresponding to the maximum permissible volume which is by law (in some countries) allowed to affect your hearing for the duration of a working day. It is used as a basis according to the specifications of industrial medicine. Higher volumes or longer durations can damage your hearing. At higher volumes, the duration must be shortened in order to prevent hearing damage. The following are sure signs that you have been subjected to excessive noise for too long a time:
 - You can hear ringing or whistling sounds in your ears.
 - You have the impression (even for a short time only) that you can no longer hear high notes.

EK 300 IEM G3 diversity receiver

Do not place the product near any heat sources such as radiators, heat registers, stoves, or other devices (including amplifiers) that produce heat.

Intended use of the system

Intended use of the ew G3 series products includes:

- having read this instruction manual especially the chapter “Important safety instructions”,
- using the products within the operating conditions and limitations described in this instruction manual.

“Improper use” means using the products other than as described in these instructions, or under operating conditions which differ from those described herein.

The evolution wireless series ew 300 IEM G3

The evolution wireless monitoring system ew 300 IEM G3 is a high-quality state-of-the-art RF transmission system with a high level of operational reliability and ease of use. Transmitter and diversity receiver are designed for monitoring applications and permit wireless transmission with studio-quality sound.

Features of the evolution wireless ew 300 IEM G3 series:

SR 300 IEM G3 transmitter	EK 300 IEM G3 receiver
<ul style="list-style-type: none"> • Optimized PLL synthesizer and microprocessor technology • HDX noise reduction system • Switching bandwidth of 42 MHz 	<ul style="list-style-type: none"> • Stereo/Focus selection • Adaptive diversity technology* • Scan function (Easy Setup) for scanning the frequency banks for unused channels • Adjustable and switchable limiter
<ul style="list-style-type: none"> • Stereo/mono selection • Easy setup of a multi-channel system using the Easy Setup Sync function • Safe configuration of a multi-channel system using the WSM 	

* The receiver uses the ground connection of the earphones cable as its second antenna to provide improved reception.

The frequency bank system

Transmitter and receiver are available in 7 UHF frequency ranges with 1,680 frequencies per frequency range:

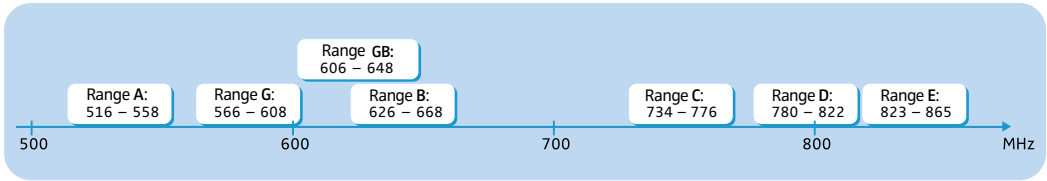

Each frequency range (A–E, G, GB) offers 26 frequency banks with up to 16 channels each:

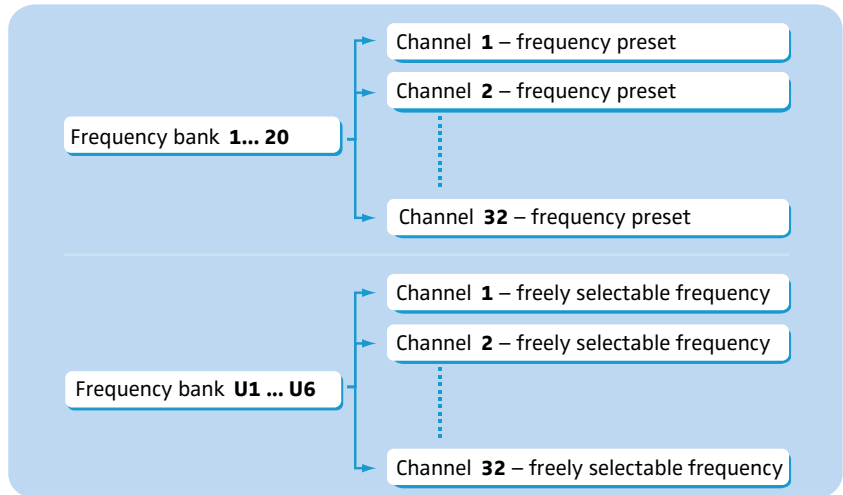

Each of the channels in the frequency banks “1” to “20” has been factory-preset to a fixed frequency (frequency preset). The factory-preset frequencies within one frequency bank are intermodulation-free. These frequencies cannot be changed.

For an overview of the frequency presets, please refer to the supplied frequency information sheet. Updated versions of the frequency information sheet can be downloaded from the corresponding product page on our website at www.sennheiser.com.

The frequency banks “U1” to “U6” allow you to freely select and store frequencies. It might be that these frequencies are **not** intermodulation-free (see page 28).

Product overviews

Overview of the SR 300 IEM G3 transmitter

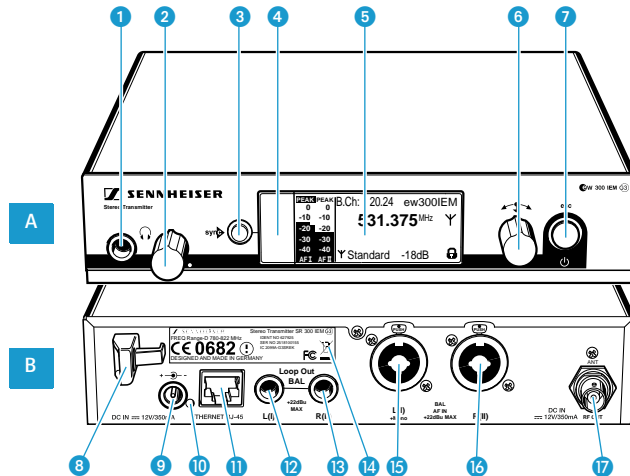

A Operating elements – front panel

- 1 Headphone output, 1/4" (6.3 mm) jack socket (🎧)
- 2 Headphone volume control
- 3 **syn** button, backlit
- 4 Infra-red interface
- 5 Display panel, backlit in orange
- 6 Jog dial
- 7 **STANDBY** button
operation indication (red backlighting),
ESC function (cancel)

B Operating elements – rear panel

- 8 Cable grip for power supply DC cable
- 9 DC socket (**DC IN**) for connection of
NT 2-3 mains unit
- 10 LED (yellow) for network activity
indication
- 11 LAN socket (**ETHERNET RJ 45**)
- 12 Audio output left (**LOOP OUT BAL L(I)**),
1/4" (6.3 mm) jack socket
- 13 Audio output right (**LOOP OUT BAL R(II)**),
1/4" (6.3 mm) jack socket
- 14 Type plate
- 15 Audio input left (**BAL AF IN L(I)+Mono**),
1/4" (6.3 mm) jack/XLR-3 combo socket
- 16 Audio input right (**BAL AF IN R(II)**),
1/4" (6.3 mm) jack/XLR-3 combo socket
- 17 Antenna output (**RF OUT**)
with remote power supply input (**DC IN**),
BNC socket



In **mono** mode, the signal from the **left** audio input **BAL AF IN L(I)+Mono** 15 (1/4" (6.3 mm) jack/XLR-3 combo socket) is transmitted.

Overview of the displays of the SR 300 IEM G3 transmitter

After switch-on, the transmitter displays the standard display.

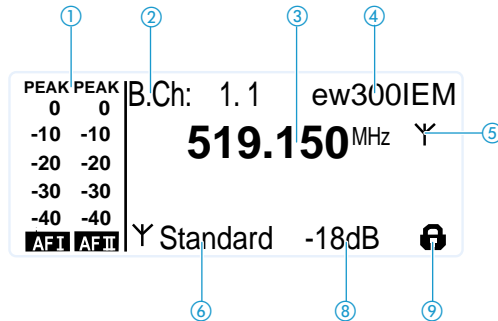

Display	Meaning
① Audio level (AF = Audio Frequency)	<p>PEAK PEAK 0 0</p> <p>-10 -10 -</p> <p>-20 -20</p> <p>-30 -30</p> <p>-40 -40</p> <p>AF I AF II</p> <p>Modulation of the left (AF I) and right (AF II) audio channel with peak hold function</p> <p>When the displays show full deflection, the audio input level is excessively high.</p> <p>When the transmitter is overmodulated frequently or for extended periods of time, the "PEAK" display is shown inverted. In addition, the display backlighting changes from orange to red and "AF PEAK" flashes in alternation with the standard display.</p>
② Frequency bank and channel	Current frequency bank and channel number
③ Frequency	Current transmission frequency
④ Name	Freely selectable name of the transmitter
⑤ Transmission icon	RF signal is being transmitted
⑥ Transmission power	Current transmission power
⑧ Input sensitivity	Current input sensitivity for the audio signal available at the audio input sockets BAL AF IN L (I)+Mono 15 and BAL AF IN R (II) 16
⑨ Lock mode icon	Lock mode is activated (see page 18)

Overview of the EK 300 IEM G3 diversity receiver

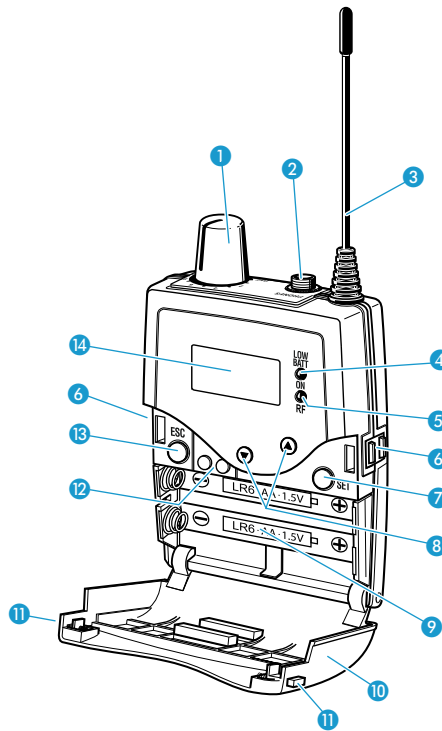







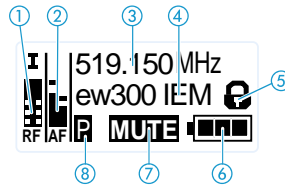

- | | |
|--|------------------------------------|
| ① On/off/volume control | ⑥ Charging contacts |
| ② 3.5 mm stereo jack socket (PHONES), lockable
(the ground contact is used by antenna II) | ⑦ SET button |
| ③ Antenna I | ⑧ UP/DOWN button ▲/▼ |
| ④ Operation and battery status indicator, red LED
lit = ON
flashing = LOW BATT | ⑨ Battery compartment |
| ⑤ RF signal indication, green LED
lit = RF | ⑩ Battery compartment cover |
| | ⑪ Battery compartment catches |
| | ⑫ Infra-red interface |
| | ⑬ ESC button |
| | ⑭ Display panel, backlit in orange |

Overview of the displays of the EK 300 IEM G3 diversity receiver

After switch-on, the diversity receiver displays the standard display “Frequency/Name”. For further illustrations and examples of the different standard displays, refer to page 18. The standard display displays the operating states of the diversity receiver. The display backlighting is automatically reduced after approx. 20 seconds.

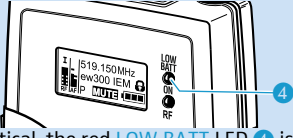

Display	Meaning
① RF level “RF” (Radio Frequency)	 <p>Diversity display:</p> <ul style="list-style-type: none"> I Antenna input I is active II Antenna input II is active <p>RF signal level: Field strength of the received signal</p> <p>Squelch threshold level</p>
② Audio level “AF” (Audio Frequency)	 <p>Peak hold function</p> <p>Modulation of the transmitter (channel-separated when the transmitter is set to stereo mode)</p> <p>When the display shows full deflection, the audio input level is excessively high.</p>
③ Frequency	Current receiving frequency
④ Name	Freely selectable name of the receiver
⑤ Lock mode icon	Lock mode is activated (see page 18)
⑥ Battery status	<p>Charge status:</p> <ul style="list-style-type: none">  approx. 100%  approx. 70%  approx. 30%  charge status is critical, the red LOW BATT LED ④ is flashing: 
⑦ Muting function “MUTE”	<p>“Mute” is only displayed on the “Frequency/Name” standard display (see page 18)</p> <ul style="list-style-type: none"> when the transmitter’s RF signal is deactivated or when the transmitter is set to mono mode and therefore does not transmit a pilot tone but the receiver’s pilot tone evaluation is activated.
or audio channels	<p>The audio channels are only displayed on the “Frequency/Limiter” and “Frequency/High Boost” standard displays (see page 18)</p> <ul style="list-style-type: none">  Stereo  Focus
⑧ Pilot tone “P”	Activated pilot tone evaluation

Putting the devices into operation

Putting the SR 300 IEM G3 transmitter into operation



When using more than one transmitter, we recommend connecting remote antennas and, if necessary, using Sennheiser antenna accessories. For more information, visit the ew G3 product page at www.sennheiser.com.

Setting up the transmitter on a flat surface

Place the transmitter on a flat, horizontal surface. Please note that the device feet can leave stains on delicate surfaces.



The rack mount "ears" are designed to help protect the operating elements from damage or deformation, e.g. if the transmitter is dropped. Therefore, fasten the rack mount "ears", even if you do not want to rack mount your transmitter.

Mounting the rack mount "ears"

To fasten the rack mount "ears" 21:

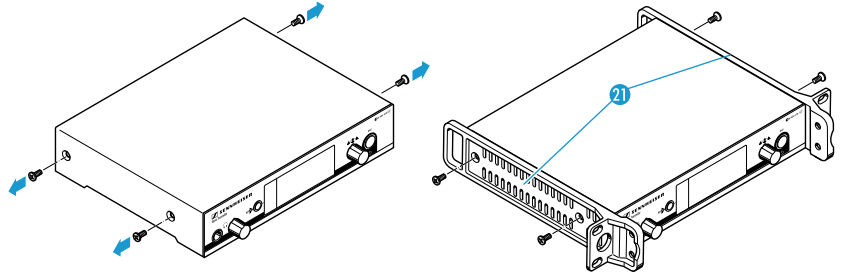

- ▶ Unscrew and remove the two recessed head screws (M4x8) on each side of the transmitter.
- ▶ Secure the rack mount "ears" 21 to the sides of the transmitter using the previously removed recessed head screws.

Fitting the device feet



Do not fit the device feet when mounting the transmitter into a 19" rack.

- ▶ Clean the base of the transmitter where you want to fix the device feet.
- ▶ Fit the device feet to the four corners of the transmitter.

Connecting the rod antenna

The supplied rod antenna 18 is suitable for use in good reception conditions.

- ▶ Connect the rod antenna 18 to the BNC socket 17.

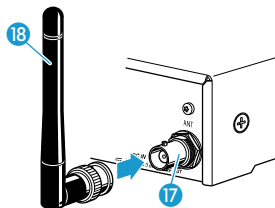

Mounting the transmitter into a 19" rack



Do not fit the device feet when mounting the transmitter into a 19" rack.

CAUTION!



Risks when rack mounting the transmitter!

When installing the device in a closed or multi-rack assembly, please consider that, during operation, the ambient temperature, the mechanical loading and the electrical potentials will be different from those of devices which are not mounted into a rack.

- ▶ Make sure that the ambient temperature within the rack does not exceed the permissible temperature limit specified in the SR 300 IEM G3 specifications. If necessary, provide additional ventilation.
- ▶ Make sure that the mechanical loading of the rack is even.
- ▶ When connecting to the power supply, observe the information indicated on the type plate. Avoid circuit overloading. If necessary, provide overcurrent protection.
- ▶ When rack mounting, please note that intrinsically harmless leakage currents of the individual mains units may accumulate, thereby exceeding the allowable limit value. As a remedy, ground the rack via an additional ground connection.

Rack mounting one transmitter

- ▶ Secure the rack mount "ears" 21 of the supplied GA 3 rack adapter to the transmitter as described on page 9.
- ▶ Secure the blanking plate 22 to one of the rack mount "ears" using two recessed head screws (M 6x10) (see diagram).

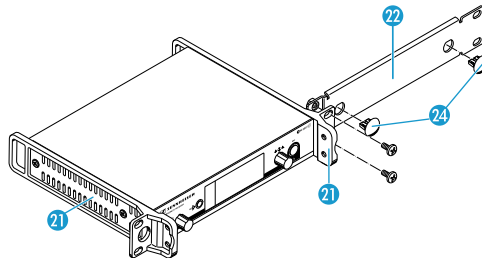

- ▶ Connect the antenna. You have the following options:
 - You can connect the supplied rod antenna 18 to the rear of the transmitter (see page 9). In this case, insert the two blanking plugs 24 into the holes of the blanking plate.
 - You can use the AM 2 antenna front mount kit (optional accessory) and mount the rod antenna to the blanking plate 22.
 - You can use a remote antenna, if necessary in conjunction with the AC 3 antenna combiner.
- ▶ Slide the transmitter with the mounted blanking plate 22 into the 19" rack.
- ▶ Secure the rack mount "ear" 21 and the blanking plate 22 to the 19" rack.

Rack mounting two transmitters

To mount two transmitters into a rack using the GA 3 rack adapter:

- ▶ Place the two transmitters side by side upside-down onto a flat surface:

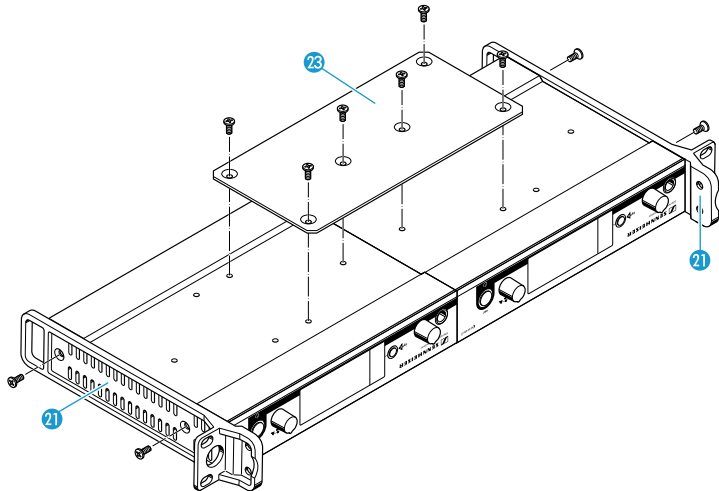

- ▶ Secure the jointing plate 23 to the transmitters using six recessed head screws (M 3x6).
- ▶ Secure the rack mount "ears" 21 to the transmitters as described on page 9.

To mount the antennas:

- ▶ Use remote antennas, if necessary in conjunction with the AC 3 antenna combiner. For more information, visit the ew G3 product pages at www.sennheiser.com.

To mount the transmitters into the rack:

- ▶ Slide the transmitters into the 19" rack.
- ▶ Secure the rack mount "ears" to the 19" rack.

Connecting the mains unit

Only use the supplied mains unit. It is designed for the transmitter and ensures safe operation.

- ▶ Insert the yellow connector of the NT 2-3 mains unit into the yellow socket 9 of the transmitter.
- ▶ Pass the cable of the mains unit through the cable grip 8.
- ▶ Slide the supplied country adapter 20 onto the mains unit 19.
- ▶ Plug the mains unit 19 into a wall socket.

The **STANDBY** button is backlit in red.

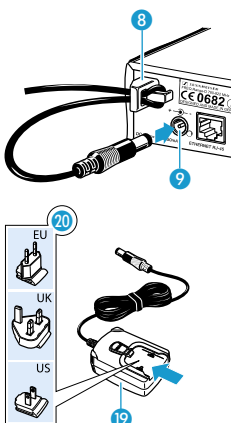

The AC 3 antenna combiner incorporates DC distribution to enable simultaneous powering of up to four transmitters via its BNC sockets. These transmitters do not require their individual power supply (see also page 12).

Connecting devices to the input sockets

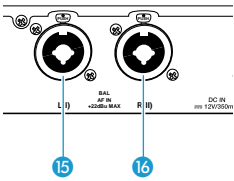

- ▶ Use a suitable cable to connect the output of an external device (e.g. a mixing console or an additional SR 300 IEM G3) to the input socket **BAL AF IN L(I)+Mono 15** and/or **BAL AF IN R(II) 16** (see also page 13).
- ▶ Adjust the output level of your external device.
- ▶ Via the operating menu, adjust the transmitter's input sensitivity. The input sensitivity is adjusted via the "Sensitivity" menu item and is common for both inputs (see page 24).



The input amplifier of the SR 300 IEM G3 is designed for line level input.

Connecting devices to the output sockets

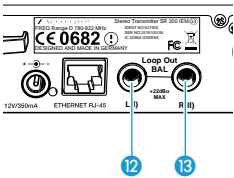

- ▶ Use a suitable cable to connect the input of an external device (e.g. a mixing console or an additional SR 300 IEM G3) to the output socket **LOOP OUT BAL L(I) 12** and/or **LOOP OUT BAL R(II) 13** (see also page 13).



The signal received from the AF input sockets **BAL AF IN L(I)+Mono 15** and **BAL AF IN R(II) 16** is actively buffered and then routed to the output sockets **LOOP OUT BAL L(I) 12** and **LOOP OUT BAL R(II) 13**. The AF output sockets will therefore work only when the transmitter is switched on and powered.

Connecting a remote antenna to the BNC socket and positioning the antenna

Use a remote antenna when the transmitter position is not the best antenna position for optimum transmission. You can choose between two antennas:

- A 2003 UHF passive directional antenna
- A 1031 passive omni-directional antenna
- ▶ Use a low-attenuation 50-Ω cable to connect the antenna to the transmitter.
- ▶ If possible, use a short antenna cable and as little connections as possible, since long cables and many connectors lead to an attenuation of the antenna signal.
- ▶ Position the antenna in the same room in which the transmission takes place.
- ▶ Observe a minimum distance of 1 m between the antenna and metal objects (including reinforced concrete walls).

Connecting the AC 3 antenna combiner to the BNC socket

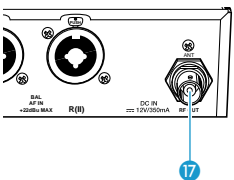

To make multi-channel systems, you should use the AC 3 antenna combiner (optional accessory). The AC 3 allows you to operate up to four transmitters with a single antenna without virtually any intermodulation. In addition, the AC 3 incorporates DC distribution to enable simultaneous powering of up to four transmitters via its BNC sockets.

- ▶ Connect the AC 3 antenna combiner to the BNC socket **17**.

Daisy chaining audio signals

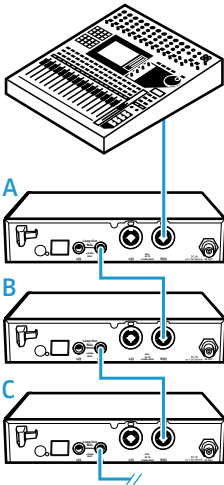

You can transmit the same audio signal (e.g. the sum of all audio signals) to several diversity receivers of a multi-channel system. To do so, you have to daisy chain this audio signal from one transmitter to the next via the output sockets **LOOP OUT BAL L(I)** 12 or **LOOP OUT BAL R(II)** 13. The audio signal is then transmitted by all transmitters on one of the two audio channels (L(I) or R(II)). The second audio channel allows you to transmit an individual audio signal (e.g. the instrument of a musician). Using the balance setting on the receiver, you can then adjust the relative levels of the sum of all audio signals and the individual audio signal. For this, the transmitter has to be set to stereo mode and the receiver to Focus mode.

To daisy chain an audio signal from one transmitter to the next:

- ▶ Route a signal from the mixing console to the input socket (in this example: **BAL AF IN R(II)** 16) of transmitter A.
- ▶ Connect the output socket **LOOP OUT BAL R(II)** 13 of transmitter A to the input socket **BAL AF IN R(II)** 16 of transmitter B.
- ▶ Connect the output socket **LOOP OUT BAL R(II)** 13 of transmitter B to the input socket **BAL AF IN R(II)** 16 of transmitter C.
- ▶ Repeat for the other transmitters.



The AF output sockets **LOOP OUT BAL L(I)** 12 and/or **LOOP OUT BAL R(II)** 13 will work only when the transmitter is switched on and powered (see page 12).

Connecting transmitters in a network

You can connect several transmitters in a network. The transmitters are remote controlled via a PC running the “**Wireless Systems Manager**” (WSM) software. This software will assist in the quick and safe configuration of multi-channel systems.



The “**Wireless Systems Manager**” (WSM) software can be downloaded from the corresponding product page on our website at www.sennheiser.com.

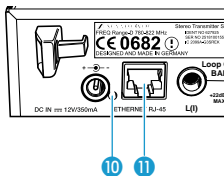

- ▶ Connect a standard network cable (at least Cat 5) to the LAN socket 11 of the transmitter.
- ▶ Connect your transmitter to an Ethernet switch.
- ▶ Connect the other transmitters to the Ethernet switch.
- ▶ Connect a PC to the Ethernet switch.

When a transmitter is properly connected to the Ethernet switch or the PC, the yellow LED 10 at the rear of the transmitter lights up.

For further information on network operation using the WSM software, refer to page 27.

Putting the EK 300 IEM G3 diversity receiver into operation

Inserting the batteries/accupack

For powering the diversity receiver, you can either use two 1.5 V AA size batteries or the rechargeable Sennheiser BA 2015 accupack (accessory, see www.sennheiser.com).

- ▶ Open the battery compartment by pushing the two catches **11** in the direction of the arrows and open the cover **10**.

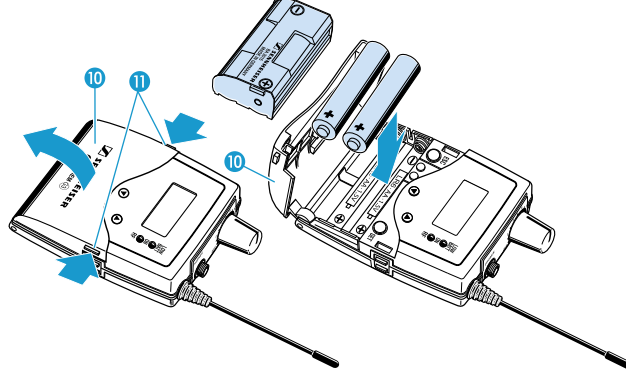

- ▶ Insert the two batteries or the accupack as shown above. Observe correct polarity when inserting the batteries/accupack.
- ▶ Close the battery compartment by pressing on the center of the cover **10**. The battery compartment cover **10** locks into place with an audible click.

Charging the accupack

To charge the BA 2015 accupack (accessory, see www.sennheiser.com) installed in the diversity receiver:

- ▶ Insert the diversity receiver into the L 2015 charger (accessory, see www.sennheiser.com).



The L 2015 charger can only charge the combination BA 2015 accupack/diversity receiver. Standard batteries (primary cells) or individual rechargeable battery cells cannot be charged.

Attaching the diversity receiver to clothing

You can use the belt clip **15** to attach the diversity receiver to clothing (e.g. belt, waistband).

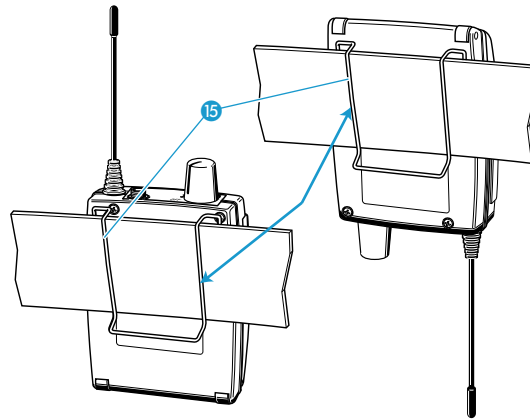

The belt clip is detachable so that you can also attach the diversity receiver with the antenna pointing downwards. To do so, withdraw the belt clip from its fixing points and attach it the other way round. The belt clip is secured so that it cannot slide out of its fixing points accidentally.

To detach the belt clip:

- ▶ Lift one side of the belt clip as shown.

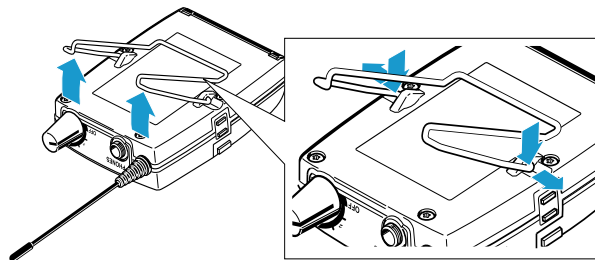

- ▶ Press down the belt clip at one fixing point and pull it out of the receiver housing.
- ▶ Repeat for the other side.

Using the devices

To establish a transmission link, proceed as follows:

1. Switch the transmitter on.
2. Switch the diversity receiver on.
The transmission link is established.



It is vital to observe the notes on frequency selection on page 27.

- ▶ If you cannot establish a transmission link between transmitter and receiver, read the chapter “Synchronizing the transmitter with the diversity receiver” on page 27.

Switching the devices on/off

Switching the SR 300 IEM G3 transmitter on/off

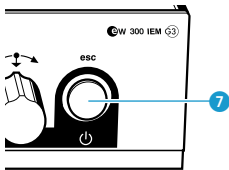

To switch the transmitter **on** (online operation):



- ▶ Press the **STANDBY** button **7**.
The transmitter switches on and the standard display appears.
The transmission icon **5** is displayed, the transmitter transmits an RF signal.

To switch the transmitter **on** and to **deactivate the RF signal on switch-on** (offline operation):



- ▶ Press the **STANDBY** button **7** until “RF Mute Off?” appears on the display panel.



- ▶ Turn the jog dial.
“RF Mute On?” appears on the display panel.



- ▶ Press the jog dial.
The transmission frequency is displayed but the transmitter does not transmit an RF signal. The transmission icon **5** is not displayed. When the display has been activated via the “Warnings” menu item on the transmitter, “RF Mute” (backlit in red) appears alternately with the standard display.



Use this function to prepare a transmitter for use during live operation without causing interference to existing transmission links.

To **activate** the RF signal:



- ▶ Briefly press the **STANDBY** button **7**.
“RF Mute On?” appears on the display panel.



- ▶ Turn the jog dial.
“RF Mute Off?” appears on the display panel.



- ▶ Press the jog dial.
The RF signal is activated and the transmission icon **5** is displayed again.

To switch the transmitter to **standby mode**:

- ▶ If necessary, deactivate the lock mode (see page 18).



- ▶ Keep the **STANDBY** button **7** pressed until “OFF” appears on the display panel.
The transmitter switches to standby mode.



When in the operating menu, pressing the **STANDBY** button **7** will cancel your entry (ESC function) and return you to the standard display.

The **STANDBY** button **7** is backlit in red both during operation and in standby mode.

To completely switch the transmitter **off**:

- ▶ Disconnect the transmitter from the mains by unplugging the mains unit from the wall socket. The backlighting of the **STANDBY** button **7** goes off.

Switching the EK 300 IEM G3 diversity receiver on/off

To switch the diversity receiver **on**:

- ▶ Turn the volume control **1** clockwise until it clicks. The red **ON** LED **4** lights up. The “**Frequency/Name**” standard display appears on the display panel.

To switch the diversity receiver **off**:

- ▶ Turn the volume control **1** counterclockwise until it clicks. The red **ON** LED **4** goes off and the diversity receiver switches off.

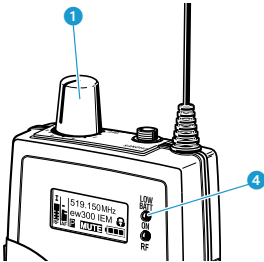

Monitoring the audio signal via headphones

CAUTION!



Danger of hearing damage!

Listening at high volume levels for long periods can lead to permanent hearing defects.

- ▶ Set the volume control to the minimum position before putting the headphones on.
- ▶ Do **not** continuously expose yourself to high volumes.

To monitor the audio signal via the headphone output of the diversity receiver:

- ▶ Connect earphones with a 3.5 mm stereo jack plug to the headphone output **2**.
- ▶ When switching the receiver on, slowly and carefully turn the volume control **1** clockwise.
- ▶ Via the receiver’s operating menu (see page 24), adjust:
 - stereo or Focus operation (“**Mode**” menu item)
 - the balance (“**Balance**” menu item)
 - the treble boost (“**High Boost**” menu item)
 - the limiter (“**Advanced**” menu/ “**Limiter**” menu item)

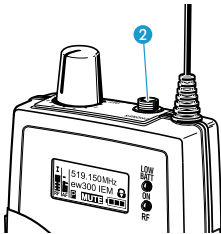

The ground connection of the earphones cable serves as the second antenna for adaptive diversity operation.





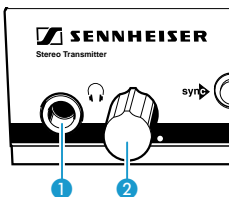

To monitor the audio signal via the headphone output of the transmitter:

- ▶ Set the headphone volume control **2** to the minimum position.
- ▶ Connect headphones with a 1/4" (6.3 mm) stereo jack plug to the headphone output **1**.
- ▶ Gradually increase the volume and monitor the audio signal with the lowest possible volume.



Deactivating the lock mode temporarily

You can activate or deactivate the automatic lock mode via the “Auto Lock” menu item. If the lock mode is activated, you have to temporarily deactivate it in order to be able to operate the devices:

SR 300 IEM G3 transmitter	EK 300 IEM G3 receiver
 ▶ Press the jog dial.	 ▶ Press the SET button.
“Locked” appears on the display panel.	
 ▶ Turn the jog dial.	 ▶ Press the UP/DOWN button ▲/▼.
“Unlock?” appears on the display panel.	
 ▶ Press the jog dial.	 ▶ Press the SET button.

The lock mode is temporarily deactivated:

- When you are in the operating menu, the lock mode remains deactivated until you exit the operating menu.
- When a standard display is shown, the lock mode is automatically activated after 10 seconds.

The lock mode icon ⑨ of the transmitter or the lock mode icon ⑤ of the diversity receiver flashes prior to the lock mode being activated again.

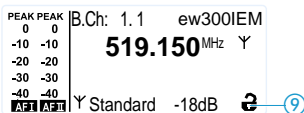

Selecting a standard display on the diversity receiver

 ▶ Press the ESC button to select a standard display. In stereo mode, you can alternatively press the UP/DOWN button ▲/▼.

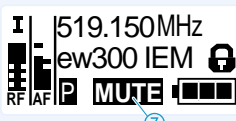
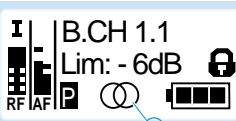
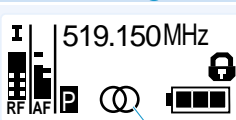
Contents of the display	Selectable standard display
	“Frequency/Name” with “Mute” display ⑦
	“Frequency/Limiter” with display of the audio channels (Stereo/Focus) ⑦
	“Frequency/High Boost” with display of the audio channels (Stereo/Focus) ⑦

For more detailed information, refer to the chapter “Overview of the displays of the EK 300 IEM G3 diversity receiver” on page 8.

Adjusting the audio channels on the transmitter

Via the “Mode” menu item, you can adjust the audio channels.



- ▶ Select “Stereo” if you want to transmit two separate audio signals on channel I and channel II (e.g. channel I = audio signal of the presenter/musician, channel II = sum of all audio signals). Make sure that the receiver’s pilot tone evaluation (“Pilot Tone” menu item) is activated.
This allows the presenter/musician to adjust the balance between the left and right stereo signal on his receiver.
- ▶ Select “Mono” if you only want to transmit a mono audio signal. In this case, the signal from the left audio input **BAL AF IN L 15** is transmitted.





During mono operation, you have to deactivate the pilot tone evaluation on the diversity receiver (“Pilot Tone” menu item) in order to ensure that your receiver outputs the same signal on channel I and II.

Activating/deactivating the RF signal on the transmitter

To **deactivate** the RF signal:

-  ▶ When the standard display is shown on the display panel, press the **STANDBY** button.
“RF Mute On?” appears on the display panel.
-  ▶ Press the jog dial.
The RF signal is deactivated. The transmission icon ⑤ is not displayed. In addition, the display backlighting changes from orange to red and “RF Mute” flashes in alternation with the standard display.

To **activate** the RF signal:

-  ▶ Press the **STANDBY** button.
“RF Mute Off?” appears on the display panel.
-  ▶ Press the jog dial.
The RF signal is activated and the display backlighting changes from red to orange.



You can also deactivate the RF signal on switch-on. For more information, refer to the chapter “Switching the devices on/off” on page 16”.



Synchronizing transmitters and EK 300 IEM G3 receivers via the infra-red interface

Synchronization allows you to quickly and easily transfer transmitter and receiver settings from one device to the other, especially if you want to configure a multi-channel system. There are two transfer directions:

1. **Easy Setup Sync**: Transfer from the receiver to one or several transmitters

Once you have performed a frequency preset scan with a receiver, you can use the **Easy Setup Sync** function to transfer unused frequency presets from the receiver to the transmitters via the infra-red interface. In order to configure a multi-channel system, you use the diversity receiver to transfer the first unused channel from the selected frequency bank to the first transmitter and the next unused channel to the second transmitter and so on, thus ensuring that all transmitters of a multi-channel system operate on suitable frequencies.

2. **Sync**: Transfer from a transmitter to a receiver

Once you have selected and set the desired receiver settings on the transmitter (either manually or using the **Easy Setup Sync** function), you transfer these settings to a receiver. This configures the receiver and establishes a transmission link between transmitter and receiver.

Via the "**Sync Settings**" submenu, you can adjust the receiver parameters listed below and activate or deactivate their transfer to an EK 300 IEM G3 receiver.

Setting	Transferred receiver parameter
"Balance"	Current balance setting ("–15" / "+15")
"Squelch"	Current squelch setting ("Off", "5 dB" ... "25 dB")
"Mode"	Current audio mode setting ("Stereo" / "Focus")
"High Boost"	Current treble boost setting ("flat" / "High boost")
"Auto Lock"	Current lock mode setting ("active" / "inactive")
"Limiter"	Current limiter setting ("–18 dB", "–12 dB", "–6 dB", "Off")

When carrying out the **Sync** function, the transmitter's current frequency bank and channel setting as well as the receiver parameters adjusted via the "**Sync Settings**" submenu are transferred to the EK 300 IEM G3 receiver via the infra-red interface.

Carrying out an Easy Setup Sync or a Sync function

The following assumes that you are using the **Easy Setup Sync** function for setting up a multi-channel system. You can also use the **Easy Setup Sync** function for establishing a transmission link between one transmitter and one EK 300 IEM G3 receiver.

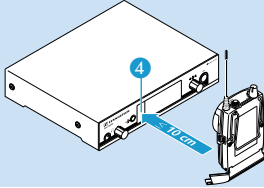
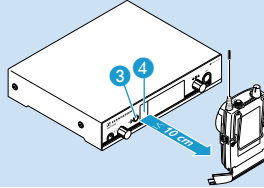

Easy Setup Sync	Sync
<ul style="list-style-type: none"> ▶ Switch all transmitters and one diversity receiver on. 	<ul style="list-style-type: none"> ▶ Switch your transmitter and your diversity receiver on.
<ul style="list-style-type: none"> ▶ On all transmitters, call up the "Easy Setup" menu item. The text "Easy Setup Sync" and the sync icon appear on the display panels of the transmitters. The RF signal of the transmitters is automatically deactivated. 	<ul style="list-style-type: none"> ▶ Press the sync button ③ on the transmitter. The sync icon appears on the display panel of the transmitter.
<ul style="list-style-type: none"> ▶ Use your diversity receiver to perform a frequency preset scan (Scan New List). ▶ Select a channel within a frequency bank with a sufficient number of unused channels (Current List). 	–

Easy Setup Sync	Sync
	
<p>▶ Place the infra-red interface of the receiver in front of the infra-red interface 4 of the first transmitter.</p> <p>The first unused frequency preset is transferred from the receiver to the transmitter.</p> <p>As soon as the transfer is completed, the display panel of the transmitter displays the numbers of the transferred frequency bank and channel.</p> <p>Please note that the transmitter does not store the frequency bank and channel setting. The RF signal remains deactivated.</p>	<p>▶ Place the infra-red interface of the receiver in front of the infra-red interface 4 of your transmitter.</p> <p>The current frequency bank and channel setting as well as the parameters adjusted via the "Sync Settings" menu item are transferred from the transmitter to the receiver.</p> <p>When the transfer is completed, "✓" appears on the display panel of the transmitter. The transmitter then switches back to the standard display.</p> <p>The transferred parameters are automatically adjusted and stored by the receiver. The transmission link between transmitter and receiver is now established.</p>
<p>▶ Place the infra-red interface of the diversity receiver in front of the infra-red interfaces of the remaining transmitters, one after the other.</p> <p>In each case, the next unused frequency preset is transferred from the receiver to the transmitter.</p>	<p>–</p>
<p>Either:</p> <p>▶ Store the frequency bank and channel setting by pressing the jog dial on your transmitters.</p> <p>The RF signal is activated. You can carry out the Sync function (see right-hand column) at a later time to establish a transmission link between transmitters and receivers.</p>	<p>–</p>
<p>Or:</p> <p>▶ Immediately synchronize your receivers with your transmitters by carrying out the Sync function (see right-hand column). The sync icon in the left lower corner of the transmitter display indicates that the Sync function can be carried out. The transmission link between transmitters and receivers is established.</p>	<p>–</p>



Easy Setup Sync	Sync
-	<p>To cancel the transfer:</p> <ul style="list-style-type: none">▶ Press the STANDBY button on the transmitter. <p>"X" appears on the display panel of the transmitter. "X" also appears if no suitable receiver was found.</p>

Using the operating menus

The buttons of the SR 300 IEM G3 transmitter

Button	Function of the button
Press the STANDBY button 	<ul style="list-style-type: none"> • Switches the transmitter on and off • Cancels the entry and returns to the standard display (ESC function) • Activates/deactivates the RF signal (special function, see page 19)
Press the jog dial 	<ul style="list-style-type: none"> • Changes from the standard display to the operating menu • Calls up a menu item • Enters a submenu • Stores the settings and returns to the operating menu
Turn the jog dial 	<ul style="list-style-type: none"> • Changes to the next/previous menu item • Changes the setting of a menu item

The buttons of the EK 300 IEM G3 diversity receiver

Button	Function of the button
Press the ESC button 	<ul style="list-style-type: none"> • Selects a standard display (see page 18) • Cancels the entry and returns to the current standard display (ESC function)
Press the SET button 	<ul style="list-style-type: none"> • Changes from the standard display to the operating menu • Calls up a menu item • Enters a submenu • Stores the settings and returns to the operating menu
Press the UP/DOWN button ▲/▼ 	<ul style="list-style-type: none"> • In Focus mode: Adjusts the balance • In stereo mode: Selects a standard display (see page 18) • Changes to the next/previous menu item • Changes the setting of a menu item

Overview of the operating menus



For more detailed information on the operating menus, refer to the instruction manuals of the transmitter and the diversity receiver which can be downloaded from www.sennheiser.com.

SR 300 IEM G3 transmitter

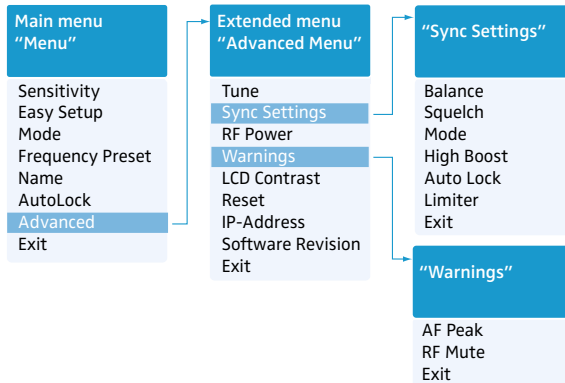

EK 300 IEM G3 receiver

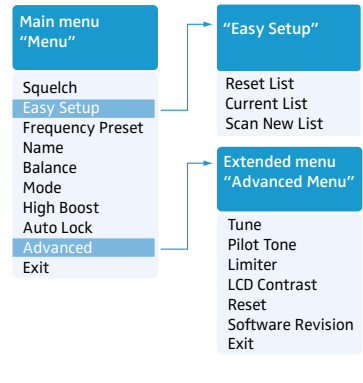

Operating menu of the SR 300 IEM G3 transmitter

When the standard display is shown on the display panel, you can get into the main menu by pressing the jog dial. The extended menu “Advanced Menu” and the other menus can be accessed via the corresponding menu items.

Display	Function of the menu item
---------	---------------------------

Main menu “Menu”

Sensitivity	Adjusts the input sensitivity (0 to -42 dB, adjustable in steps of 3 dB)
Mode	Selects mono or stereo operation (see page 19)
Easy Setup	Deactivates the RF signal and activates Easy Setup Sync (see page 27)
Frequency Preset	Sets the frequency bank and the channel
Name	Enters a freely selectable name
AutoLock	Activates/deactivates the automatic lock mode
Advanced	Calls up the extended menu “Advanced Menu”
Exit	Exits the operating menu and returns to the standard display

Extended menu “Advanced Menu”

Tune	Sets the transmission frequencies for the frequency banks “U1” to “U6” Sets the channel and the transmission frequency for the frequency banks “U1” to “U6”: ▶ Select this menu item and call it up by pressing the jog dial 6 until the channel selection appears.
Sync Settings	Adjusts the receiver parameters and activates/deactivates their transfer to the EK 300 IEM G3 receiver. For an overview of the parameters, refer to page 20.
RF Power	Adjusts the transmission power (“Low” or “Standard”)
Warnings	Calls up “Warnings”
LCD Contrast	Adjusts the contrast of the display panel in 16 steps

Display	Function of the menu item
Reset	Resets the settings made in the operating menu When resetting the settings made in the operating menu, only the selected settings for the pilot tone and for the frequency banks "U1" to "U6" remain unchanged. For an overview of the factory-preset default settings, refer to the supplied frequency information sheet.
IP-Address	Adjusts the IP address of the transmitter
Software Revision	Displays the current software revision
Exit	Exits the extended menu "Advanced Menu" and returns to the main menu

"Warnings"

Activates/deactivates the warning messages (color change and warning messages)

AF Peak	Audio overmodulation
RF Mute	RF signal is deactivated
Exit	Exits the submenu "Warnings" and returns to the extended menu "Advanced Menu"

Operating menu of the EK 300 IEM G3 diversity receiver

Display	Function of the menu item
Main menu "Menu"	
Squelch	Adjusts the squelch threshold, adjustment range: 5 to 25 dB μ V, adjustable in 2-dB steps, can be switched off <div style="border: 1px solid black; padding: 5px;"> <p>CAUTION! Danger of hearing damage and material damage!</p> <p> If you switch the squelch off or adjust the squelch threshold to a very low value, loud hissing noise can occur in the receiver. The hissing noise can be loud enough to cause hearing damage or overload the loudspeakers of your system!</p> <ul style="list-style-type: none"> ▶ Always make sure that the squelch is switched on (see above). ▶ Before adjusting the squelch threshold, set the volume of the headphone output to the minimum. ▶ Never change the squelch threshold during a live transmission. </div> <p>Special function (for servicing purposes only): With the squelch threshold set to "5 dB", you switch the squelch off by keeping the DOWN button ▼ pressed for 3 seconds. If you then press the UP button ▲, you switch the squelch on again.</p>
Easy Setup	Scans for unused frequency presets, releases and selects frequency presets
Frequency Preset	Sets the frequency bank and the channel
Name	Enters a freely selectable name
Balance	Adjusts the balance
Mode	Selects stereo or Focus mode
High Boost	Activates/deactivates the treble boost
Auto Lock	Activates/deactivates the automatic lock mode
Advanced	Calls up the extended menu "Advanced Menu"
Exit	Exits the operating menu and returns to the current standard display

"Easy Setup"

Reset List	Releases all locked frequency presets
Current List	Selects an unused frequency preset

Display	Function of the menu item
Scan New List	Scans for unused receiving frequencies (frequency preset scan)
Exit	Exits "Easy Setup" and returns to the main menu
Extended menu "Advanced Menu"	
Tune	<p>Sets the receiving frequencies for the frequency banks "U1" to "U6"</p> <p>Sets the channel and the receiving frequency for the frequency banks "U1" to "U6":</p> <p>▶ Select this menu item and call it up by pressing the SET button 7 until the channel selection appears.</p>
Pilot Tone	Activates/deactivates the pilot tone evaluation
Limiter	Adjusts the limiter
Volume Boost	Adjusts the volume boost
LCD Contrast	Adjusts the contrast of the display panel
Engineer Mode	Adjusts the menu item and loading profiles
Reset	<p>Resets the settings made in the operating menu</p> <p>Resets the settings made in the operating menu, only the selected settings for the pilot tone and for the frequency banks "U1" to "U6" remain unchanged. For an overview of the factory-preset default settings, refer to the supplied frequency information sheet.</p>
Software Revision	Displays the current software revision
Exit	Exits the extended menu "Advanced Menu" and returns to the main menu

Synchronizing the transmitter with the diversity receiver

When synchronizing the transmitter with the receiver, please observe the following:



- ▶ Only use a transmitter and a receiver from the same frequency range (see the type plate on the transmitter and the receiver).
- ▶ Make sure that the desired frequencies are listed in the enclosed frequency information sheet. You can also contact your Sennheiser partner who will be pleased to calculate intermodulation-free frequencies for you.
- ▶ Make sure that the desired frequencies are approved and legal in your country and, if necessary, apply for an operating license.
- ▶ The frequency information sheet can also be downloaded from the corresponding product page on our website at www.sennheiser.com.

Synchronizing the transmitter with the receiver – individual operation

Upon delivery, transmitter and receiver are synchronized with each other. If, however, you cannot establish a transmission link between transmitter and receiver, you have to synchronize the channels of the devices:

- ▶ First carry out the [Easy Setup Sync](#) function (see table on page 20, left-hand column). The transmitter is set to a suitable frequency.
- ▶ Then carry out the [Sync](#) function (see table on page 20, right-hand column). This establishes a transmission link between transmitter and receiver.

Alternatively, you can set the channel on the transmitter manually:

- ▶ Make sure that you set the transmitter to the same frequency bank and the same channel as the receiver.

Synchronizing transmitters with receivers – multi-channel operation

Network operation using the WSM

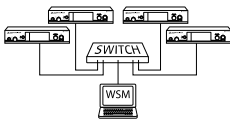

In multi-channel operation, the transmitters are remote controlled via a PC running the “[Wireless Systems Manager](#)” (WSM) software.



Advantages of controlling the transmitters via the “[Wireless Systems Manager](#)” (WSM) software:

- Detailed overview of all transmission and receiving channels
- Remote control of all transmitters in the network
- Combination of transmitters of different frequency ranges (see page 4)

Operation without network

- ▶ Connect your transmitters and your PC in a network (see page 13).
- ▶ Switch your transmitters and your PC on (see page 16).
- ▶ Launch the “[Wireless Systems Manager](#)” (WSM) software.
- ▶ To set up your multi-channel system, proceed as described in the instruction manual of the “[Wireless Systems Manager](#)” (WSM) software.
- ▶ First carry out the [Easy Setup Sync](#) function and then carry out the [Sync](#) function for each transmitter/receiver pair (see table on page 20). This establishes a transmission link between each transmitter/receiver pair.

Using freely selectable frequencies

You can also freely select the frequencies and store these frequencies in the frequency banks "U1" to "U6".

If you want to use the frequency banks "U1" to "U6":

- ▶ Make sure to use transmitters and receivers from the same frequency range (see page 4 and the type plates of the devices).



To ensure that the desired frequencies are intermodulation-free:

- ▶ Contact your Sennheiser partner (see www.sennheiser.com).
-
- ▶ Set each transmitter to the same frequency bank ("U1" to "U6").
 - ▶ On one of the transmitters, select a channel within this frequency bank (see page 24).
 - ▶ Assign this channel one of the calculated transmission frequencies (see page 24).
Either:
 - ▶ Then carry out the **Sync** function for each transmitter/receiver pair (see table on page 20, right-hand column).
This establishes a transmission link between each transmitter/receiver pair.
 - Or:
 - ▶ Manually set the receiver to the same frequency bank, channel and frequency that you set on the transmitter (see page 24).

Cleaning the devices

CAUTION!

Liquids can damage the electronics of the devices!

Liquids entering the housing of the devices can cause a short-circuit and damage the electronics.

- ▶ Keep all liquids away from the devices.
 - ▶ Do not use any solvents or cleansing agents
-

SR 300 IEM G3 transmitter

- ▶ Before cleaning, disconnect the device from the mains.
- ▶ Use a cloth to clean the device from time to time. Do not use any solvents or cleansing agents.

EK 300 IEM G3 diversity receiver

- ▶ Use a cloth to clean the device from time to time. Do not use any solvents or cleansing agents.

If a problem occurs ...

SR 300 IEM G3 transmitter

Problem	Possible cause	Possible solution
Transmitter cannot be operated, "Locked" appears on the display panel	Lock mode is activated	Deactivate the lock mode (see page 18 and page 24).
No operation indication	No mains connection	Check the connections of the mains unit.
No RF signal at the receiver	Transmitter and receiver are not on the same channel	Synchronize the transmitter with the receiver (see page 19).
	If "RF Mute" additionally appears on the transmitter display: RF signal is deactivated	Activate the RF signal of the transmitter (see page 19).
Very weak RF signal at the receiver	Transmission range is exceeded	Reduce the distance between receiver and transmitter.
		Reposition the antennas.
		Increase the transmission power (see page 24).
		Reduce the squelch threshold (see table on page 20).
RF signal available, no audio signal at the receiver	No input signal at the transmitter	Check the audio level on the transmitter display (see page 6).
	Very low input signal	Check the audio level on the transmitter display (see page 6), increase the level of the input signal or adjust the input sensitivity (see page 24).
Audio signal has a high level of background noise	Transmitter sensitivity is adjusted too low	Adjust the transmitter sensitivity correctly (see page 24).
Audio signal is distorted	If "AF PEAK" additionally appears on the transmitter display: transmitter sensitivity is adjusted too high	Adjust the transmitter sensitivity correctly (see page 24).
	Receiver's audio output level is adjusted too high	Reduce the receiver's audio output level.

EK 300 IEM G3 diversity receiver

Problem	Possible cause	Possible solution
Receiver cannot be operated, "Locked" appears on the display panel	Lock mode is activated	Deactivate the lock mode (see page 18).
No operation indication	Batteries are flat or accupack is flat	Replace the batteries or recharge the accupack (see page 14).
No RF signal	Transmitter and receiver are not on the same channel	Set the transmitter and receiver to the same channel. Synchronize the transmitter with the receiver (see page 19).
	Transmission range is exceeded	Check the squelch threshold setting. Reduce the distance between transmitter and receiving antennas.
	RF signal is deactivated ("RF Mute")	Activate the RF signal (see page 19).
RF signal available, no audio signal, "MUTE" appears on the display panel	Transmitter is muted	Cancel the muting (see page 16).
	Receiver's squelch threshold is adjusted too high	Reduce the squelch threshold setting on the receiver.
	Transmitter is set to mono operation and therefore doesn't transmit a pilot tone	Deactivate the pilot tone evaluation.
	Transmitter is set to stereo operation and therefore transmits a pilot tone	Activate the pilot tone evaluation.
Audio signal has a high level of background noise	Transmitter sensitivity is adjusted too low	Adjust the transmitter sensitivity correctly.
Audio signal is distorted	Transmitter sensitivity is adjusted too high	Adjust the transmitter sensitivity correctly.
No access to a certain channel	During scanning, an RF signal has been detected on this channel and the channel has been locked	Set the transmitter operating on this channel to a different channel and redo the frequency preset scan.
	During scanning, a transmitter of your system operating on this channel has not been switched off	Switch the transmitter off and redo the frequency preset scan.

If a problem occurs that is not listed in the above table or if the problem cannot be solved with the proposed solutions, please contact your local Sennheiser partner for assistance.

To find a Sennheiser partner in your country, search at www.sennheiser.com under "Service & Support".

Specifications

System

Modulation	wideband FM stereo (MPX pilot tone)
Frequency ranges	516–558, 566–608, 606–648, 626–668, 734–776, 780–822, 823–865 MHz (A to E, G, GB, see page 4)
Transmission/receiving frequencies	1680 frequencies, tuneable in steps of 25 kHz 20 frequency banks, each with up to 16 factory-preset channels 6 frequency banks with up to 16 user programmable channels
Switching bandwidth	42 MHz
Frequency stability	±10 ppm (–10°C to +55°C)
Compander system	Sennheiser HDX
Nominal/peak deviation	±24 kHz/±48 kHz
MPX pilot tone (frequency/deviation)	19 kHz/±5 kHz
AF frequency response	25 Hz to 15 kHz
THD (at 1 kHz and nominal deviation)	< 0.9%
Signal-to-noise ratio at nominal load and peak deviation	> 90 dB
Temperature range	–10°C to +55°C

SR 300 IEM G3 transmitter

Antenna output	BNC socket, 50 Ω with remote power supply input 12 V DC
RF output power at 50 Ω	typ. 10/30 mW (Low/Standard), switchable
AF input BAL AF IN L(I)+Mono/BAL AF IN R(II)	2 x XLR-3/¼" (6.3 mm) jack combo socket, electronically balanced
Max. input level	+22 dBu (line)
AF output LOOP OUT BAL L(I)/LOOP OUT BAL R(II)	¼" (6.3 mm) stereo jack socket, balanced
Headphone output	¼" (6.3 mm) stereo jack socket
Power supply	12 V ===
Current consumption	max. 350 mA
Dimensions	approx. 202 mm x 212 mm x 43 mm
Weight	approx. 980 g

In compliance with

Europe



EMC	EN 301489-1/-9
Radio	EN 300422-1/-2
Safety	EN 60065

If a problem occurs ...

Approved by

Canada

Industry Canada RSS 123
IC: 2099A-G3SREK
limited to 698 MHz

USA

FCC-Part 74 FCC-ID: DMOG3SREK
limited to 698 MHz

NT 2-3 mains unit

Input voltage

100 to 240 V~, 50/60 Hz

Current consumption

max. 120 mA

Output voltage

12 V ===

Secondary output current

400 mA

Temperature range

-10°C to +40°C

In compliance with

Europe

 EMC EN 55022, EN 55024,
EN 55014-1/-2
Safety EN 60065

USA

 47 CFR 15 subpart B

Canada

ICES 003

The mains unit is certified in accordance with the legal safety requirements of Europe, the United States, Canada, Russia and Japan.

EK 300 IEM G3 diversity receiver

Receiver principle

adaptive diversity

Sensitivity (with HDX, peak deviation)

< 4 µV, typ. 1.6 µV for 52 dBA_{rms S/N}

Adjacent channel rejection

typ. ≥ 65 dB

Intermodulation attenuation

typ. ≥ 70 dB

Blocking

≥ 80 dB

Squelch

Off, 5 to 25 dBµV, adjustable in steps of 2 dB

Pilot tone squelch

evaluation can be switched off

S/N ratio (1 mV, peak deviation)

approx. 90 dB

Max. output power

2 x 100 mW at 32 Ω

High Boost

+8 dB at 10 kHz

Limiter

-18 dB to -6 dB, adjustable in steps of 6 dB, can be switched off

Power supply

2 AA size batteries, 1.5 V or BA 2015 accupack

Nominal voltage

2.4 V ===

Power consumption:

- at nominal voltage
- with switched-off receiver

approx. 140 mA

≤ 25 µA

Operating time

approx. 4 to 6 hrs (depending on volume level)

Dimensions

approx. 82 x 64 x 24 mm

Weight (incl. batteries)

approx. 200 g

In compliance with

Europe

CE EMC EN 301489-1/-9
 Radio EN 300422-1/-2
 Safety EN 60065

USA



FC 47 CFR 15 subpart B

Approved by

Canada

Industry Canada RSS 123
 IC 2099A-G3SREK300
 limited to 698 MHz

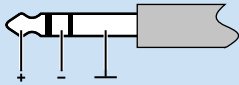
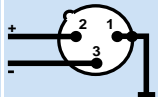
Connector assignment

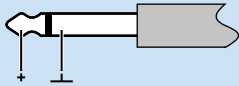
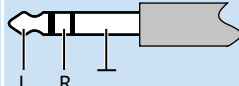
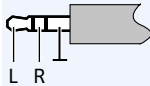
SR 300 IEM G3 transmitter		
<p>¼" (6.3 mm) stereo jack plug, balanced (BAL AF IN/LOOP OUT)</p> 	<p>XLR-3F connector, balanced (BAL AF IN)</p> 	<p>DC connector for power supply</p> 
<p>¼" (6.3 mm) mono jack plug, unbalanced (BAL AF IN/LOOP OUT)</p> 	<p>¼" (6.3 mm) stereo jack plug for headphone output</p> 	<p>EK 300 IEM G3 receiver</p> <p>3.5 mm jack plug</p> 

Manufacturer Declarations

Warranty

Sennheiser electronic GmbH & Co. KG gives a warranty of 24 months on this product.

For the current warranty conditions, please visit our web site at www.sennheiser.com or contact your Sennheiser partner.

FOR AUSTRALIA ONLY

Sennheiser goods come with guarantees that cannot be excluded under the Australian Consumer Law. You are entitled to a replacement or refund for a major failure and compensation for any other reasonably foreseeable loss or damage. You are also entitled to have the goods repaired or replaced if the goods fail to be of acceptable quality and the failure does not amount to a major failure.

This warranty is in addition to other rights or remedies under law. Nothing in this warranty excludes, limits or modifies any liability of Sennheiser which is imposed by law, or limits or modifies any remedy available to the consumer which is granted by law.

To make a claim under this warranty, contact

Sennheiser Australia Pty Ltd, Unit 3, 31 Gibbes Street Chatswood NSW 2067, AUSTRALIA.

Phone: (02) 9910 6700, email: service@sennheiser.com.au.

All expenses of claiming the warranty will be borne by the person making the claim.

The Sennheiser International Warranty is provided by Sennheiser Australia Pty Ltd (ABN 68 165 388 312), Unit 3, 31 Gibbes Street Chatswood NSW 2067 Australia.

In compliance with the following requirements

- WEEE Directive (2012/19/EC)



Please dispose of the products at the end of their operational lifetime by taking them to your local collection point or recycling center for such equipment.

- Battery Directive (2006/66/EC)



The supplied batteries or rechargeable batteries can be recycled. Please dispose of them as special waste or return them to your specialist dealer. In order to protect the environment, only dispose of exhausted batteries.

CE Declaration of Conformity

- **CE 0682** 
- R&TTE Directive (1999/5/EC)
- RoHS Directive (2011/65/EU)
- EMC Directive (2004/108/EC)
- Low Voltage Directive (2014/35/EC)

The declarations are available at www.sennheiser.com.

Before putting the devices into operation, please observe the respective country-specific regulations.

Statements regarding FCC and Industry Canada

These devices comply with Part 15 of the FCC Rules and with RSS-123 of Industry Canada. Operation is subject to the following two conditions: (1) these devices may not cause harmful interference, and (2) these devices must accept any interference received, including interference that may cause undesired operation.

This equipment has been tested and found to comply with the limits for a Class B digital device, pursuant to Part 15 of the FCC Rules. These limits are designed to provide reasonable protection against harmful interference in a residential installation. This equipment generates, uses and can radiate radio frequency energy and, if not installed and used in accordance with the instructions, may cause harmful interference to radio communications. However, there is no guarantee that interference will not occur in a particular installation. If this equipment does cause harmful interference to radio or television reception, which can be determined by turning the equipment off and on, the user is encouraged to try to correct the interference by one or more of the following measures:

- Reorient or relocate the receiving antenna.
- Increase the separation between the equipment and receiver.
- Connect the equipment into an outlet on a circuit different from that to which the receiver is connected.
- Consult the dealer or an experienced radio/TV technician for help.

These class B digital devices comply with the Canadian ICES-003.

Changes or modifications made to this equipment not expressly approved by Sennheiser electronic Corp. may void the FCC authorization to operate this equipment.

Before putting the devices into operation, please observe the respective country-specific regulations!



Sennheiser electronic GmbH & Co. KG

Am Labor 1, 30900 Wedemark, Germany
www.sennheiser.com

Publ. 09/14, 549140/A03