

Wireless Noise Canceling Stereo Headset
WI-1000X



Use this manual if you encounter any problems, or have any questions.

Getting started

[What you can do with the BLUETOOTH function](#)

[About voice guidance](#)

Supplied accessories

[Checking the package contents](#)

[Replacing the earbuds](#)

[Storing the cables](#)

Parts and controls

[Location and function of parts](#)

[About the indicator](#)

Power/Charging

[Charging the headset](#)

[Available operating time](#)

- [Checking the remaining battery charge](#)
- [System requirements for battery charge using USB](#)
- [Turning on the headset](#)
- [Turning off the headset](#)

Making connections

[How to make a wireless connection to BLUETOOTH devices](#)

One-touch connection (NFC) compatible Android devices

- [One-touch connection \(NFC\) with a smartphone \(Android 4.1 or later\)](#)
- [Disconnecting the smartphone by one touch \(NFC\)](#)
- [Switching the device by one touch \(NFC\)](#)

Android devices not compatible with one-touch connection (NFC)

- [Pairing and connecting with an Android smartphone](#)
- [Connecting to a paired Android smartphone](#)

iPhone (iOS devices)

- [Pairing and connecting with an iPhone](#)
- [Connecting to a paired iPhone](#)

Computers

- [Pairing and connecting with a computer \(Windows 10\)](#)
- [Pairing and connecting with a computer \(Windows 8/Windows 8.1\)](#)
- [Pairing and connecting with a computer \(Windows 7\)](#)
- [Connecting to a paired computer \(Windows 10\)](#)
- [Connecting to a paired computer \(Windows 8/Windows 8.1\)](#)
- [Connecting to a paired computer \(Windows 7\)](#)

Other BLUETOOTH devices

- [Pairing and connecting with other BLUETOOTH devices](#)
- [Connecting to a paired BLUETOOTH device](#)

Multi point connection

- [Connecting the headset to both a music player and a smartphone or mobile phone](#)
- [Connecting the headset to 2 Android smartphones](#)
- [Connecting the headset to an Android smartphone and an iPhone](#)

[Disconnecting BLUETOOTH connection \(after use\)](#)

[Using the supplied dedicated headphone cable](#)

Listening to music

Listening to music via a BLUETOOTH connection

- └ [Listening to music from a device via BLUETOOTH connection](#)

 - └ [Controlling the audio device \(BLUETOOTH connection\)](#)

 - └ [Disconnecting BLUETOOTH connection \(after use\)](#)
-

Noise canceling function

- └ [What is noise canceling?](#)

 - └ [Using the noise canceling function](#)

 - └ [About the Automatic AI noise canceling function](#)

 - └ [Optimizing the noise canceling function to suit the usage environment \(NC optimizer\)](#)
-

Listening to ambient sound

- └ [Listening to ambient sound during music playback \(Ambient Sound Mode\)](#)
-

Sound quality mode

- └ [About the sound quality mode](#)
-

Supported codecs

[About the DSEE HX function](#)

Making phone calls

[Receiving a call](#)

[Making a call](#)

[Functions for a phone call](#)

[Disconnecting BLUETOOTH connection \(after use\)](#)

Using the voice assist function

[Using the voice assist function \(Google Assistant\)](#)

[Using the voice assist function \(Google App\)](#)

[Using the voice assist function \(Siri\)](#)

Using the apps

[What you can do with "Sony | Headphones Connect" app](#)

[Installing "Sony | Headphones Connect" app](#)

Important information

[Precautions](#)

[Trademarks](#)

[Customer support websites](#)

Troubleshooting

[What can I do to solve a problem?](#)

Power/Charging

- [The headset is not turned on.](#)
- [Charging cannot be done.](#)
- [Charging time is too long.](#)
- [The headset cannot be recognized by a computer.](#)
- [The remaining battery charge of the headset is not displayed on the screen of an iPhone or iPod touch.](#)

Sound

- [No sound](#)
- [Low sound level](#)
- [Low sound quality](#)
- [Sound skips frequently during playback.](#)
- [The noise canceling effect is not sufficient.](#)

BLUETOOTH

- [Pairing cannot be done.](#)
- [Unable to connect the headset to a BLUETOOTH device with one-touch connection \(NFC\).](#)
- [Unable to make a BLUETOOTH connection](#)
- [Distorted sound](#)
- [The BLUETOOTH wireless communication range is short, or the sound skips.](#)
- [The headset does not operate properly.](#)
- [No voice from callers](#)
- [Low voice from callers](#)

Resetting or initializing the headset

- [Resetting the headset](#)

Wireless Noise Canceling Stereo Headset
WI-1000X

What you can do with the BLUETOOTH function

The headset uses BLUETOOTH® wireless technology, allowing you to listen to music or make phone calls wirelessly.

Listening to music

You can receive audio signals from a smartphone or music player to enjoy music wirelessly.



Talking on the phone

You can make and receive a call with your hands free, while leaving your smartphone or mobile phone in your bag or pocket.

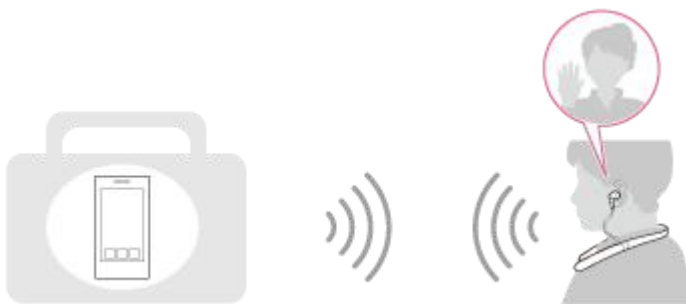

Wireless Noise Canceling Stereo Headset
WI-1000X

About voice guidance

You hear voice guidance in the following situations via the headset.

- When powering on: "Power on"
- When powering off: "Power off"
- When entering pairing mode: "BLUETOOTH pairing"
- When establishing a BLUETOOTH connection: "BLUETOOTH connected"
- When disconnecting a BLUETOOTH connection: "BLUETOOTH disconnected"
- When checking the remaining battery charge: "Battery level high" / "Battery level medium" / "Battery level low"
- When automatically turning off due to the low battery condition: "Please recharge headset"
- When turning on the noise canceling function: "Noise canceling"
- When turning on the Ambient Sound Mode: "Ambient sound"
- When turning off the noise canceling function and the Ambient Sound Mode : "Off"
- When starting the NC Optimizer: "Optimizer start"
- When the NC Optimizer is finished: "Optimizer finished"

When the software version of your headset is 2.0.0 or later

- When Google Assistant is not available on the smartphone connected to the headset even if you press the Google Assistant button on the headset: "Google Assistant is not connected"

Wireless Noise Canceling Stereo Headset
WI-1000X

Checking the package contents

After opening the package, check that all items in the list are included in the package. If items are missing, contact your dealer.

Numbers in () indicate the item amount.

Wireless Noise Canceling Stereo Headset (1)
Micro-USB cable (approx. 50 cm (19 3/4 in.)) (1)

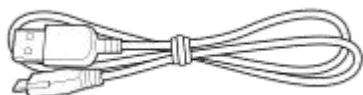

Dedicated headphone cable (approx. 1.0 m (39 3/8 in.)) (1)

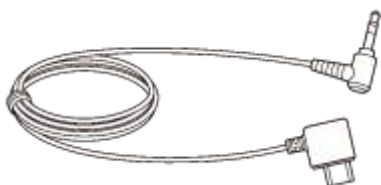

Carrying pouch (1)

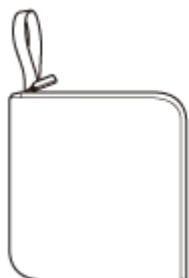

Hybrid silicone rubber earbuds (SS/S/M/L 2 each)

- Size M earbuds come attached to the headset. According to the headset's color, one of the following size M earbuds is attached.

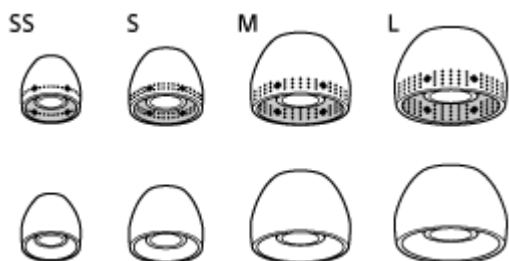

Triple-comfort earbuds (S/M/L 2 each)



Plug adaptor for in-flight use (1)

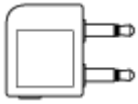

Reference Guide (1)

Operating Instructions (1)

Other documents (1 set) (*)

* May not be supplied in some countries or regions.

4-697-051-11(4) Copyright 2017 Sony Corporation

Replacing the earbuds

The headset comes with the M size hybrid silicone rubber earbuds.

If the headset tends to come off or you feel a lack of low frequency sound, change the earbuds to another size to fit your right and left ears comfortably and snugly.

Hybrid silicone rubber earbuds

- Size M earbuds come attached to the headset. According to the headset's color, one of the following size M earbuds is attached.

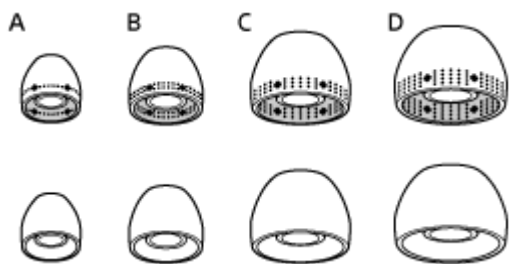

A: SS size (one line or red)

B: S size (two lines or orange)

C: M size (three lines or green)

D: L size (four lines or light blue)

Triple-comfort earbuds



A: S size (orange)

B: M size (green)

C: L size (light blue)

1 Remove the earbuds.

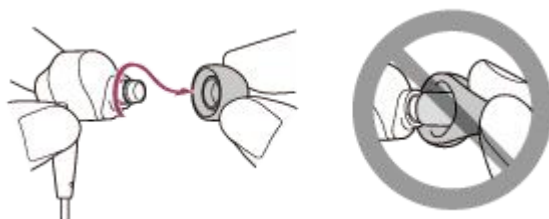

- Do not pinch the end of the earbud when removing it.

2 Attach the earbuds.

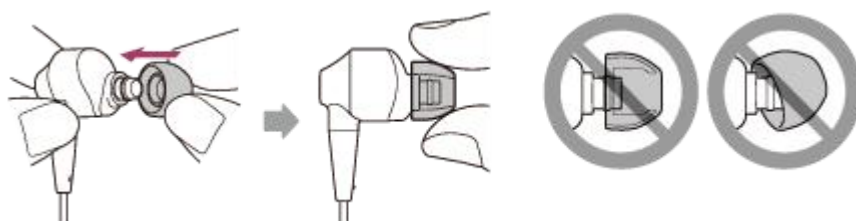

- Do not attach the earbuds loose or skewed.

4-697-051-11(4) Copyright 2017 Sony Corporation

Wireless Noise Canceling Stereo Headset
WI-1000X

Storing the cables

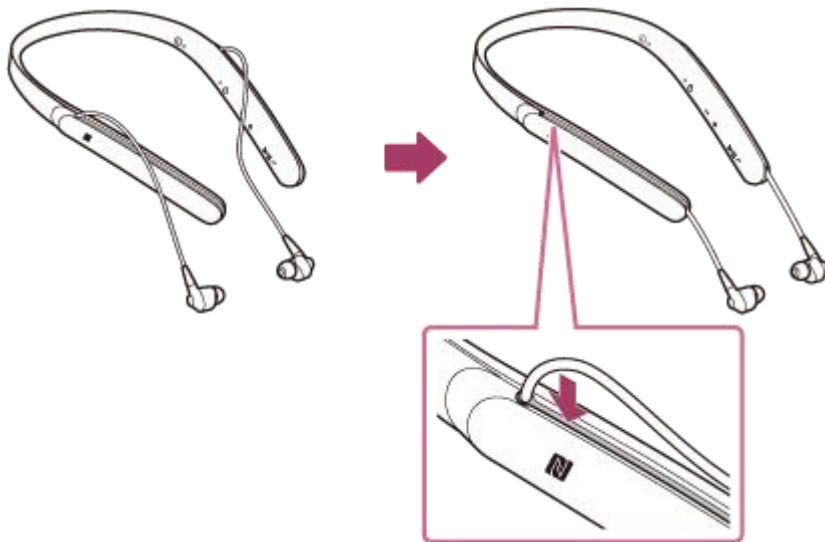

You can store the cable in the groove of the headset body when you do not use the headset.

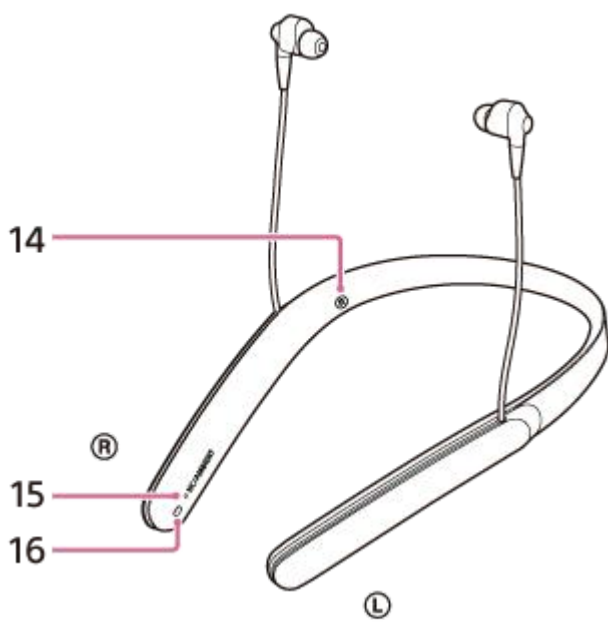
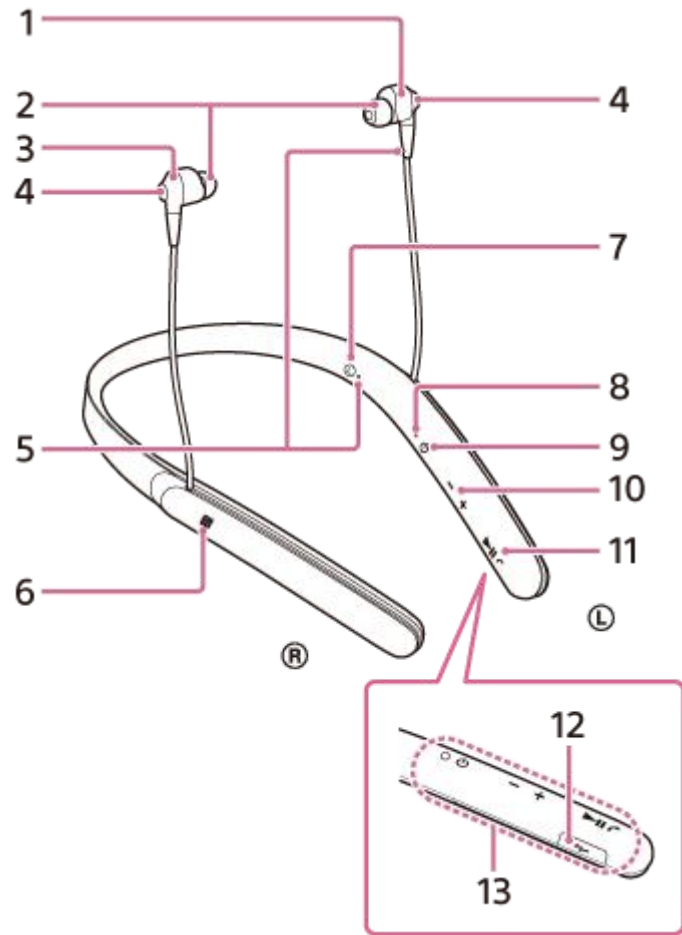

Location and function of parts



- 1. Ⓞ left unit
- 2. Earbuds
- 3. Ⓢ right unit

4. Microphone
Picks up the sound of your voice (when talking on the phone) and noise (when using the noise canceling function).
Use both microphones of the left and right units when talking on the phone.
5. Tactile dot
The left unit has a tactile dot.
6. N-mark
7. L mark
8. Indicator (blue/red)
Lights up in red during charging.
Lights up in red or blue to indicate the power or communication status of the headset.
9.  (power) button
10. +/- buttons
11.  button
Controls various call and playback functions.
12. Micro-USB port
Connect a computer to this port with the supplied micro-USB cable to charge the headset.
You can connect a playback device to this port with the supplied dedicated headphone cable.
13. Built-in antenna
A BLUETOOTH antenna is built into the headset.
14. R mark
15. Indicator (green/yellow)
Green: shows the noise canceling status.
Yellow: shows the Ambient Sound Mode status.
16. NC/AMBIENT (noise canceling/Ambient Sound Mode) button

Related Topic

- [About the indicator](#)
- [Checking the remaining battery charge](#)

Wireless Noise Canceling Stereo Headset
WI-1000X

About the indicator

You can check various statuses of the headset by the indicators.

●: Turns on in blue/●: Turns on in red/●: Turns on in green/●: Turns on in yellow/-: Turns off

Indicator (blue/red) next to the button

Turning on

● - ● (flashes two times)

Turning off

 (lights for about two seconds)

BLUETOOTH status indication

- Pairing mode

● ● ● ● ● ● ● ● ● ●

- Not connected

● - - ● - - ● - - ● (about one-second intervals)

- Connection process completed

● ● ● ● ● ● ● ● (flashes quickly for about five seconds)

- Connected

● - - - (about five-second interval) - - - ●

- Incoming call

● ● ● ● ● ● ● ●

Remaining battery charge indication

- High

● - - - ● - - - ●

- Medium

● - - ●

- Low (needs to charge)

●

For details, refer to [“Checking the remaining battery charge.”](#)

Charging

- While charging



Other

- Initialization completed



For details, refer to [“Initializing the headset to restore factory settings.”](#)

Indicator next to the NC/AMBIENT button

Noise canceling function (green)

- Noise canceling on



- Noise canceling off



For details, refer to [“What is noise canceling?.”](#)

Ambient Sound Mode (yellow)

- On



- Focus on Voice



Use the “Sony | Headphones Connect” app to switch to Focus on Voice.

For details, refer to [“Listening to ambient sound during music playback \(Ambient Sound Mode\).”](#)

Hint

- When the remaining battery charge becomes low, the indicator turns from blue to red, except for pairing mode.

Charging the headset

The headset contains a lithium ion rechargeable battery. Charge the headset using the supplied micro-USB cable.

1 Open the micro-USB port cover.

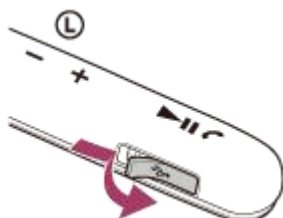

2 Connect the supplied micro-USB cable to the headset, and then connect the other end to a booted computer.

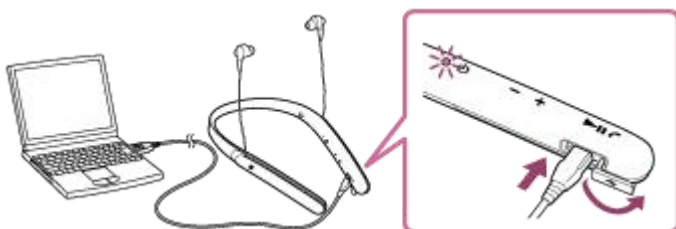

- The indicator (red) of the headset lights up.
- Charging is completed in about 3.5 hours (*) and the indicator (red) goes off automatically.

* Time required for charging the empty battery to its full capacity. The time may be different depending on the conditions of use.

After charging is complete, disconnect the micro-USB cable, then close the micro-USB port cover securely to prevent water or dusts being mixed into the headset.

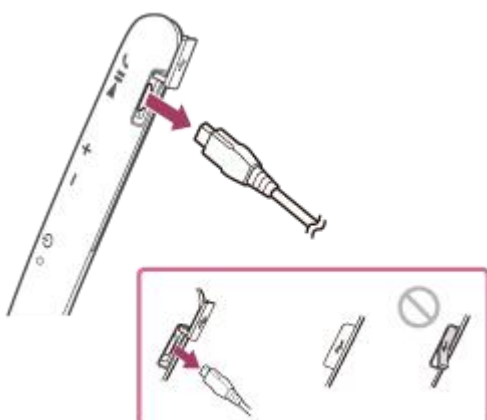

Hint

- If charging starts while the headset is turned on, the headset will turn off automatically.

Note

- If the headset is not used for a long time, the battery may be quickly depleted, however, after a few recharges, the battery life will improve.
- If you store the headset for a long time, charge the battery to its full capacity once every 6 months to avoid over discharge.
- If the headset is not used for a long time, it may take longer to charge the battery.
- If the computer enters into hibernation mode while connected to the headset, charging will not be completed properly. Check the setting of the computer before charging. The indicator (red) will go off automatically if the computer enters into hibernation mode. Charge the headset again in this case.
- The headset cannot be operated (turning on, BLUETOOTH pairing and connection, music playback, etc.) while charging or if kept connected to the computer after charging is complete.
- The noise canceling function cannot be used while charging or if kept connected to the computer after charging is complete.
- If the headset detects a problem while charging due to following causes, the indicator (red) may turn off, although charging is not complete. In this case, charge again within the charging temperature range. If the problem persists, consult your nearest Sony dealer.
 - Ambient temperature exceeds the charging temperature range of 5 °C – 35 °C(41 °F - 95 °F).
 - There is a problem with the battery.
- If the headset is not used for a long time, the indicator (red) may not light up when you connect the micro-USB cable to charge the headset. In this case, do not disconnect the micro-USB cable from the headset: wait a few minutes until the indicator (red) lights up.
- If the life of the built-in rechargeable battery drops significantly, the battery should be replaced. Consult your nearest Sony dealer for replacement of the rechargeable battery.
- Avoid exposure to temperature extremes, direct sunlight, moisture, sand, dust or mechanical shock. Never leave the headset in a car parked in the sun.
- Use the supplied micro-USB cable only, and connect directly to a computer. Charging will not be completed properly by an indirect connection, such as via a USB hub.

Available operating time

The available operating times of the headset on a fully-charged battery are as follows:

BLUETOOTH connection

Music Playback time

Codec	DSEE HX	Noise canceling function/Ambient Sound Mode	Available operating time
Qualcomm aptX™ audio/aptX HD/LDAC™	AUTO/OFF	Noise canceling function: ON	Max. 9 hours
		Ambient Sound Mode: ON	Max. 9 hours
		OFF	Max. 11 hours
SBC/AAC	AUTO	Noise canceling function: ON	Max. 8 hours
		Ambient Sound Mode: ON	Max. 8 hours
		OFF	Max. 10 hours
	OFF	Noise canceling function: ON	Max. 10 hours
		Ambient Sound Mode: ON	Max. 10 hours
		OFF	Max. 13 hours

- About 70 minutes of music playback is possible after 15 minutes charging.

Communication time

Noise canceling function/Ambient Sound Mode	Available operating time
Noise canceling function: ON	Max. 10 hours
Ambient Sound Mode: ON	Max. 10 hours
OFF	Max. 12 hours

Standby time

Noise canceling function/Ambient Sound Mode	Available operating time
Noise canceling function: ON	Max. 17 hours
Ambient Sound Mode: ON	Max. 17 hours
OFF	Max. 100 hours

Wired connection (Power on)

Noise canceling function/Ambient Sound Mode	Available operating time
Noise canceling function: ON	Max. 14 hours
Ambient Sound Mode: ON	Max. 14 hours
OFF	Max. 19 hours

Hint

- By using the “Sony | Headphones Connect” app, you can check which codec is used for a connection or switch the DSEE HX function.

Note

- Usage hours may be different depending on the settings and conditions of use.

Related Topic

- [Supported codecs](#)
- [About the DSEE HX function](#)
- [What you can do with "Sony | Headphones Connect" app](#)



Checking the remaining battery charge

You can check the remaining battery charge of the rechargeable battery.

When you turn on the headset or press the  button while the headset is on, the indicator (blue) flashes two times, then the indicator (red) flashes.

You also hear voice guidance of the remaining battery charge.

3 times  - -  - -  : High "Battery level high"

2 times  - -  : Medium "Battery level medium"

1 time  : Low (needs to charge) "Battery level low"

When the battery is almost empty

The indicator turns red. When the battery becomes empty, the headset sounds a warning beep, you hear voice guidance "Please recharge headset", and the head set turns off automatically.

When you are using an iPhone or iPod touch

When the headset is connected to an iPhone or iPod touch (iOS 5.0 or later) that supports HFP (Hands-free Profile), it will show an icon that indicates the remaining battery charge of the headset on the screen.

Compatible devices

iPhone or iPod touch (iOS 5.0 or later) supporting Hands-free Profile (HFP)

iOS 10.2 or later

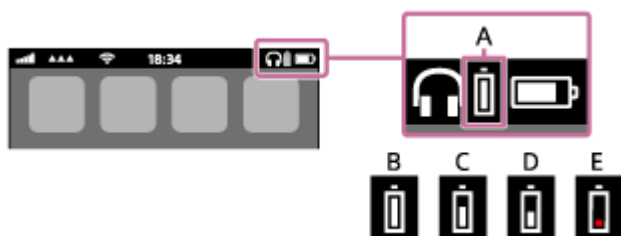

iOS 7.0 or later

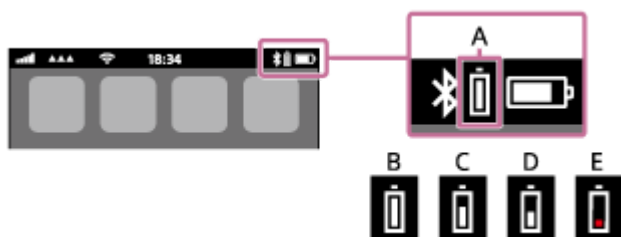

iOS 5.X / 6.X

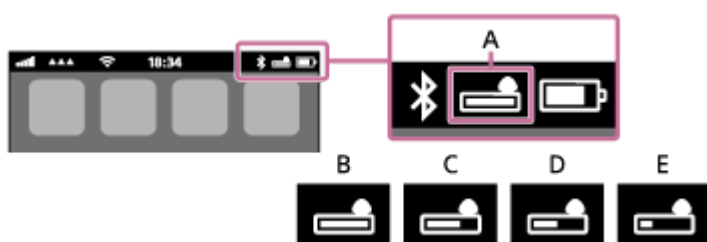

A: Remaining battery charge of the headset

B: 100% to 70%

C: 70% to 50%

D: 50% to 20%

E: 20% or lower (needs to charge)

Hint

- You can also check the remaining battery charge with the "Sony | Headphones Connect" app. Android smartphones and iPhone/iPod touch support this app.

Note

- If you connect the headset to an iPhone or iPod touch with "Media audio" (A2DP) only in a multi point connection, the remaining battery charge will not be displayed correctly.

Related Topic

- [What you can do with "Sony | Headphones Connect" app](#)

4-697-051-11(4) Copyright 2017 Sony Corporation

Wireless Noise Canceling Stereo Headset
WI-1000X

System requirements for battery charge using USB

The headset contains a lithium ion rechargeable battery, which should be charged before using the headset for the first time.

Personal Computer with pre-installed with any of the following operating systems and USB port:

- When using Windows®
Windows® 10 Home / Windows® 10 Pro
Windows® 8.1 / Windows® 8.1 Pro
Windows® 8 / Windows® 8 Pro
Windows® 7 Home Basic / Home Premium / Professional / Ultimate
- When using Mac
Mac OS X (version 10.9 or later)

Note

- Sony does not guarantee proper operation in all system environments.
- When using Windows 8.1 update using Windows Update.

Wireless Noise Canceling Stereo Headset
WI-1000X

Turning on the headset

- 1 Press and hold the  button for about 2 seconds until the indicator (blue) flashes.

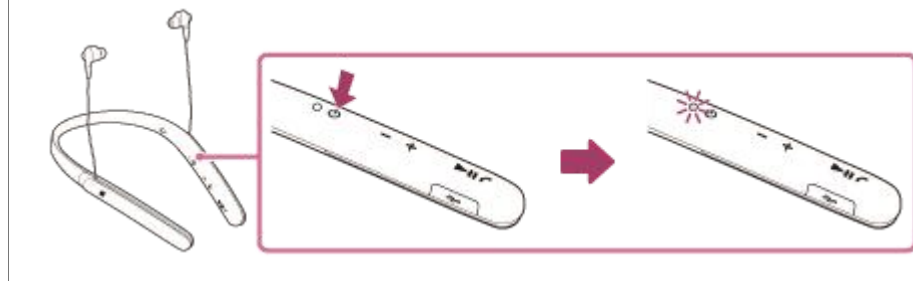

Related Topic

- [Turning off the headset](#)

Wireless Noise Canceling Stereo Headset
WI-1000X

Turning off the headset

- 1 Press and hold the  button for about 2 seconds until the indicator (blue) turns off.

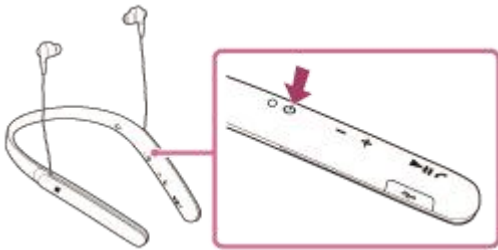

Related Topic

- [Turning on the headset](#)

Wireless Noise Canceling Stereo Headset
WI-1000X

How to make a wireless connection to BLUETOOTH devices

You can enjoy music and hands-free calling with the headset wirelessly by using your device's BLUETOOTH function.

Device registration (pairing)

When using the BLUETOOTH function for the first time, you must previously register both devices to allow connection. The operation to register a device is called device registration (pairing).

If the device to be connected does not support the one-touch connection (NFC), operate the headset and the device to perform device registration (pairing).

If the device supports one-touch connection (NFC), you can just touch to perform device registration (pairing) and establish a BLUETOOTH connection.

Connecting the headset to a registered (paired) device

When the device is registered, it is not necessary to register it again. Connect to it with an appropriate method.

One-touch connection (NFC) with a smartphone (Android 4.1 or later)

By touching the headset with a smartphone, the headset turns on automatically and then pairs and makes a BLUETOOTH connection.

Compatible smartphones

NFC-compatible smartphones installed with Android™ 4.1 or later

NFC

NFC (Near Field Communication) is a technology enabling short-range wireless communication between various devices, such as smartphones and IC tags. Thanks to the NFC function, data communication - for example, BLUETOOTH pairing - can be achieved easily by simply touching NFC-compatible devices together (i.e., at the N-Mark symbol or location designated on each device).

1 Unlock the screen of the smartphone if it is locked.

2 Select [Setting] — [More].

3 Set the NFC function to on.



* The above procedure is an example. For details, refer to the operating instructions supplied with your Android smartphone.

4 Touch the headset with the smartphone.

- Touch the smartphone on the N-Mark of the headset. Keep touching the headset with the smartphone until the smartphone reacts.
- Refer to the operating instructions of the smartphone for the designated location to be touched on the smartphone.

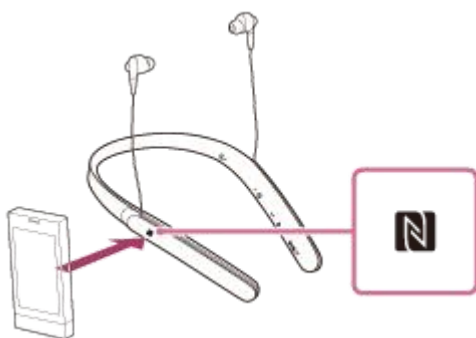

Follow the on-screen instructions to complete the pairing and connection.

When the headset is connected with the smartphone, the blue indicator starts flashing slowly. You hear voice guidance "BLUETOOTH connected".

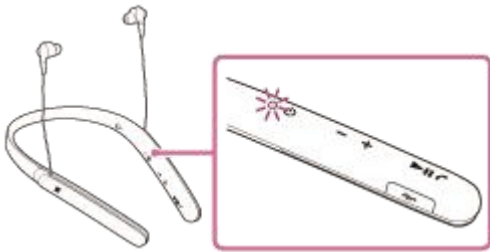

- To disconnect, touch the smartphone again.
- To connect a paired smartphone, perform step 4.
- Unlock the screen of the smartphone if it is locked.

Hint

- If you cannot connect the headset, try the following.
 - Unlock the screen of the smartphone if it is locked, and move the smartphone slowly over the N-Mark.
 - If the smartphone is in a case, remove the case.
- If you touch an NFC-compatible smartphone with the headset, the smartphone terminates BLUETOOTH connection with any current device, and connects to the headset (One-touch connection switching).

Related Topic

- [How to make a wireless connection to BLUETOOTH devices](#)
- [Disconnecting the smartphone by one touch \(NFC\)](#)
- [Switching the device by one touch \(NFC\)](#)
- [Listening to music from a device via BLUETOOTH connection](#)

Disconnecting the smartphone by one touch (NFC)

You can disconnect the headset from the connected smartphone by touching the headset with it.

1 Unlock the screen of the smartphone if it is locked.

2 Touch the headset with the smartphone.

Touch the smartphone on the N-Mark of the headset. You hear voice guidance "BLUETOOTH disconnected".

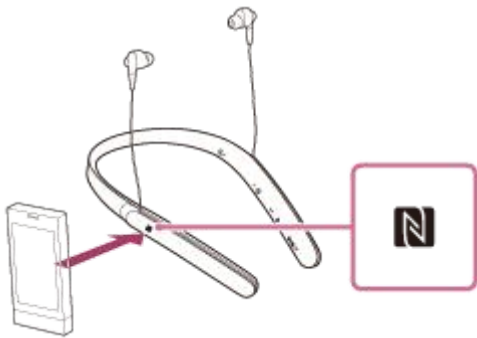

Note

- After the headset is disconnected from the smartphone, if no operation is performed for about 5 minutes, the headset turns off automatically. To turn off the headset before that, press and hold the  button for about 2 seconds. You hear voice guidance "Power off", the indicator (blue) goes off, then the headset turns off.

Switching the device by one touch (NFC)

- When the headset is connected with a BLUETOOTH device, if you touch an NFC-compatible smartphone on the headset, the headset is connected with the smartphone that touched on the headset most recently (One-touch connection switching). However, if you are talking on a BLUETOOTH mobile phone connected to the headset, you cannot switch the BLUETOOTH connection by one touch.
- When the headset is connected with an NFC-compatible smartphone, if you touch the smartphone on another NFC-compatible BLUETOOTH headset or BLUETOOTH speaker, the smartphone disconnects from the headset, and connects to the BLUETOOTH device it touched.

Note

- Unlock the screen of the smartphone if it is locked.

Wireless Noise Canceling Stereo Headset
WI-1000X

Pairing and connecting with an Android smartphone

Pairing is the process required to create a link between BLUETOOTH devices to allow wireless connection. You must pair a device with the headset to be able to make a BLUETOOTH connection for the first time. Before you start pairing operation, make sure that:

- The smartphone is placed within 1 m(3 feet) of the headset.
- The headset is charged sufficiently.
- The operating instructions of the smartphone is on hand.

1 Enter pairing mode on this headset.

Turn on the headset, when you pair the headset with a device for the first time after you bought it, or after you initialized the headset (the headset has no pairing information). The headset enters pairing mode automatically. When you pair a 2nd or subsequent device (the headset has pairing information for other devices), press and hold the  button for about 7 seconds.

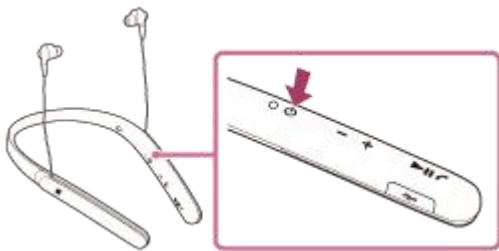

Make sure that the indicator flashes blue and red alternately after you release the button. You hear voice guidance "BLUETOOTH pairing".

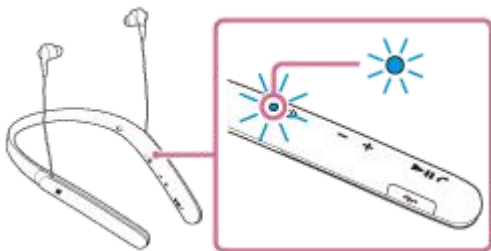

2 Unlock the screen of the Android smartphone if it is locked.

3 Search for this headset on the smartphone.

1. Select [Setting] - [Bluetooth].



2. Touch [] next to [Bluetooth] to turn on the BLUETOOTH function.



4. Touch [WI-1000X].



If passkey (*) input is required on the display of the smartphone, input "0000."

The headset and the smartphone are paired with each other and connected. You hear voice guidance "BLUETOOTH connected".

If they are not connected, see ["Connecting to a paired Android smartphone."](#)

If [WI-1000X] does not appear on the display, try again from step 3.

* A Passkey may be called a "Passcode," a "PIN code," or a "Password."

Hint

- The above procedure is an example. For details, refer to the operating instructions supplied with your Android smartphone.
- To delete all pairing information, see ["Initializing the headset to restore factory settings."](#)

Note

- If pairing is not established within about 5 minutes, pairing mode will be canceled and the headset will turn off. In this case, start over from step 1.
- Once BLUETOOTH devices are paired, there is no need to pair them again, except in the following cases:
 - Pairing information has been deleted after repair, etc.
 - The headset is already paired with 8 devices and another device is to be paired.
The headset can be paired with up to 8 devices. If a new device is paired after 8 devices are already paired, the paired device with the oldest connection time is replaced by the new one.
 - When the pairing information for the headset has been deleted from the BLUETOOTH device.
 - When the headset is initialized, all pairing information is deleted.
In this case, delete the pairing information of the headset from the BLUETOOTH device, and then pair them again.
- The headset can be paired with multiple devices, but can only play music from one paired device at a time.

Related Topic

- [How to make a wireless connection to BLUETOOTH devices](#)
- [Connecting to a paired Android smartphone](#)
- [Listening to music from a device via BLUETOOTH connection](#)

- [Initializing the headset to restore factory settings](#)

4-697-051-11(4) Copyright 2017 Sony Corporation

Connecting to a paired Android smartphone

1 Unlock the screen of the Android smartphone if it is locked.

2 Turn on the headset.

Press and hold the  button for about 2 seconds.

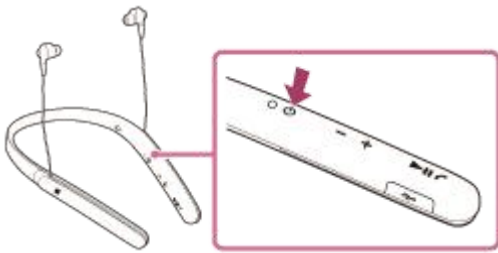

Make sure that the indicator (blue) flashes after you release the button. You hear voice guidance “Power on”.

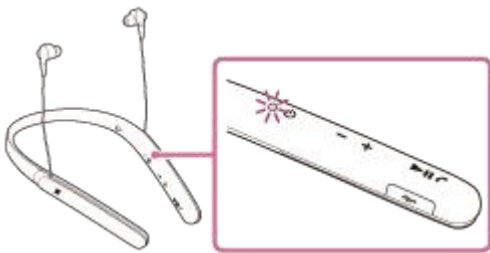

After the headset turns on, if it has automatically connected to the last connected device, you hear voice guidance “BLUETOOTH connected”.

Check the connection status on the Android smartphone. If not connected, proceed to step 3.

3 Display the devices paired with the smartphone.

1. Select [Setting] - [Bluetooth].



2. Touch [] next to [Bluetooth] to turn on the BLUETOOTH function.



4 Touch [WI-1000X].

You hear voice guidance “BLUETOOTH connected”.



Hint

- The above procedure is an example. For details, refer to the operating instructions supplied with your smartphone.
- If the smartphone was connected with the headset the last time, an HFP/HSP connection is made when you turn on the headset. While the headset is on, you can make an A2DP connection (music playback) by pressing the ►|| button.

Note

- If the last-connected BLUETOOTH device is put near the headset, the headset may connect automatically to the device by simply turning on the headset. In this case, deactivate the BLUETOOTH function on the BLUETOOTH device or turn off the power.
- If you cannot connect your smartphone to the headset, deactivate pairing on your smartphone and perform pairing again. For details, refer to the operating instructions supplied with your smartphone.

Related Topic

- [How to make a wireless connection to BLUETOOTH devices](#)
- [Pairing and connecting with an Android smartphone](#)
- [Listening to music from a device via BLUETOOTH connection](#)

Wireless Noise Canceling Stereo Headset
WI-1000X

Pairing and connecting with an iPhone

Pairing is the process required to create a link between BLUETOOTH devices to allow wireless connection. You must pair a device with the headset to be able to make a BLUETOOTH connection for the first time. Before you start pairing operation, make sure that:

- The iPhone is placed within 1 m(3 feet) of the headset.
- The headset is charged sufficiently.
- The operating instructions of the iPhone is on hand.

1 Enter pairing mode on this headset.

Turn on the headset, when you pair the headset with a device for the first time after you bought it, or after you initialized the headset (the headset has no pairing information). The headset enters pairing mode automatically. When you pair a 2nd or subsequent device (the headset has pairing information for other devices), press and hold the  button for about 7 seconds.

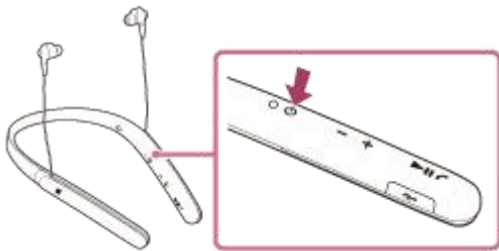

Make sure that the indicator flashes blue and red alternately after you release the button. You hear voice guidance "BLUETOOTH pairing".

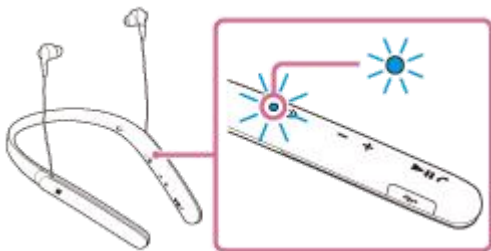

2 Unlock the screen of the iPhone if it is locked.

3 Select the BLUETOOTH setting on the iPhone.

1. Select [Settings].
2. Touch [Bluetooth].



3. Touch [] to change it to [] (turn on the BLUETOOTH function).

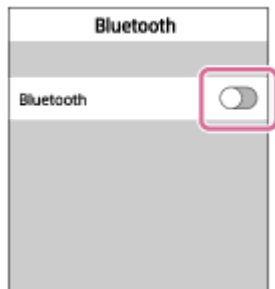

- 4 Touch [WI-1000X].



If passkey (*) input is required on the display of the iPhone, input "0000."

The headset and the iPhone are paired with each other and connected. You hear voice guidance "BLUETOOTH connected".

If they are not connected, see "[Connecting to a paired iPhone.](#)"

If [WI-1000X] does not appear on the display, try again from step 3.

* A Passkey may be called a "Passcode," a "PIN code," or a "Password."

Hint

- The above procedure is an example. For details, refer to the operating instructions supplied with your iPhone.
- To delete all pairing information, see "[Initializing the headset to restore factory settings.](#)"

Note

- If pairing is not established within about 5 minutes, pairing mode will be canceled and the headset will turn off. In this case, start over from step 1.
- Once BLUETOOTH devices are paired, there is no need to pair them again, except in the following cases:
 - Pairing information has been deleted after repair, etc.
 - The headset is already paired with 8 devices and another device is to be paired.
The headset can be paired with up to 8 devices. If a new device is paired after 8 devices are already paired, the paired device with the oldest connection time is replaced by the new one.
 - When the pairing information for the headset has been deleted from the BLUETOOTH device.
 - When the headset is initialized, all pairing information is deleted.
In this case, delete the pairing information of the headset from the BLUETOOTH device, and then pair them again.
- If the pairing information was deleted by initializing the headset, etc., delete from your iPhone the pairing information for the headset, and then pair them again.
- The headset can be paired with multiple devices, but can only play music from one paired device at a time.

Related Topic

- [How to make a wireless connection to BLUETOOTH devices](#)
- [Connecting to a paired iPhone](#)

- Listening to music from a device via BLUETOOTH connection
- Initializing the headset to restore factory settings

4-697-051-11(4) Copyright 2017 Sony Corporation

Connecting to a paired iPhone

1 Unlock the screen of the iPhone if it is locked.

2 Turn on the headset.

Press and hold the  button for about 2 seconds.

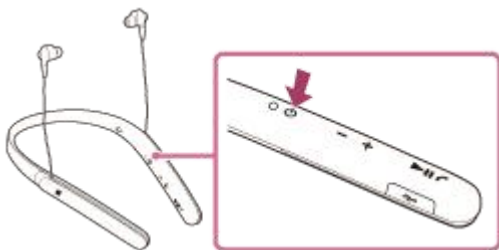

Make sure that the indicator (blue) flashes after you release the button. You hear voice guidance “Power on”.

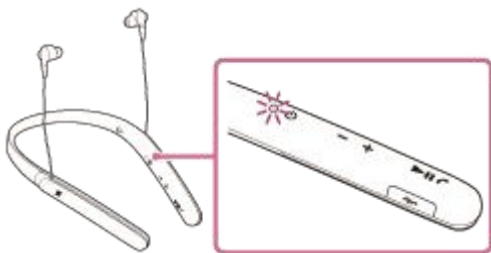

After the headset turns on, if it has automatically connected to the last connected device, you hear voice guidance “BLUETOOTH connected”.

Check the connection status on the iPhone. If not connected, proceed to step 3.

3 Display the devices paired with the iPhone.

1. Select [Settings].
2. Touch [Bluetooth].



3. Touch [] to change it to [] (turn on the BLUETOOTH function).

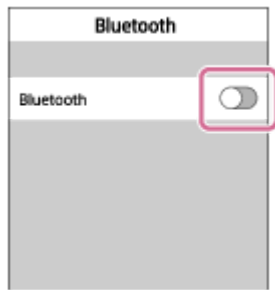

4 Touch [WI-1000X].

You hear voice guidance “BLUETOOTH connected”.



Hint

- The above procedure is an example. For details, refer to the operating instructions supplied with your iPhone.
- If the iPhone was connected with the headset the last time, an HFP/HSP connection is made when you turn on the headset. While the headset is on, you can make an A2DP connection (music playback) by pressing the ►|| button.

Note

- If the last-connected BLUETOOTH device is put near the headset, the headset may connect automatically to the device by simply turning on the headset. In this case, deactivate the BLUETOOTH function on the BLUETOOTH device or turn off the power.
- If you cannot connect your iPhone to the headset, deactivate pairing on your iPhone and perform pairing again. For details, refer to the operating instructions supplied with your iPhone.

Related Topic

- [How to make a wireless connection to BLUETOOTH devices](#)
- [Pairing and connecting with an iPhone](#)
- [Listening to music from a device via BLUETOOTH connection](#)

Pairing and connecting with a computer (Windows 10)

Pairing is the process required to create a link between BLUETOOTH devices to allow wireless connection. You must pair a device with the headset to be able to make a BLUETOOTH connection for the first time.

Before you start pairing operation, make sure that:

- Your computer has a BLUETOOTH function that supports music playback connections (A2DP).
- The computer is placed within 1 m(3 feet) of the headset.
- The headset is charged sufficiently.
- The operating instructions of the computer is on hand.
- Depending on the computer, the built-in BLUETOOTH adaptor should be turned on. For whether or not a BLUETOOTH adaptor is incorporate, and for how to turn it on, refer to the operating instructions supplied with the computer.

1 Enter pairing mode on this headset.

Turn on the headset, when you pair the headset with a device for the first time after you bought it, or after you initialized the headset (the headset has no pairing information). The headset enters pairing mode automatically. When you pair a 2nd or subsequent device (the headset has pairing information for other devices), press and hold the  button for about 7 seconds.

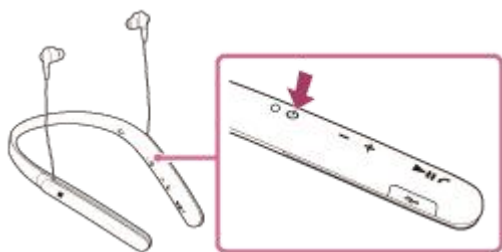

Make sure that the indicator flashes blue and red alternately after you release the button. You hear voice guidance “BLUETOOTH pairing”.

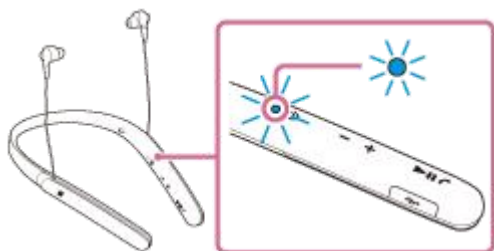

2 Resume the computer from sleep mode.

3 Register the headset using the computer.

1. Click the [Start] button, then [Settings].
2. Click [Devices].

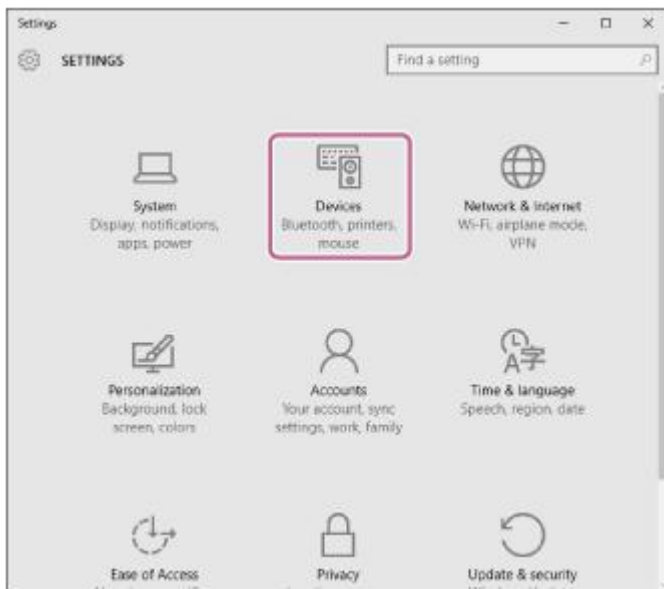

3. Click the [Bluetooth] tab, then click the [Bluetooth] button to turn on the BLUETOOTH function.

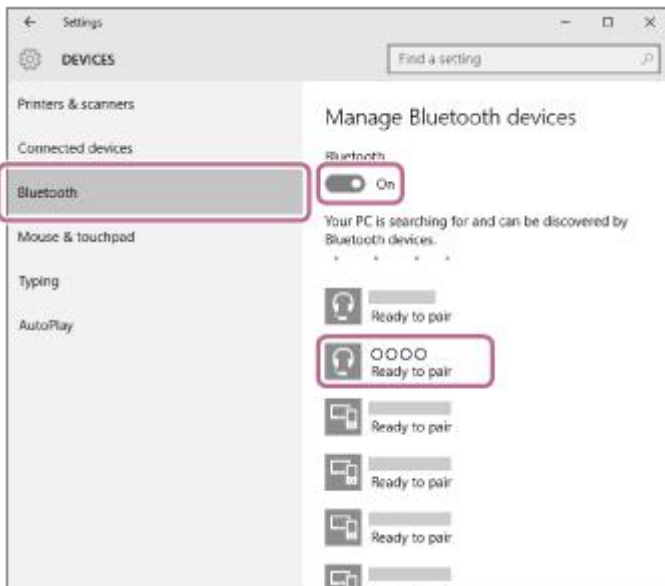

4. Select [WI-1000X], then click [Pair].

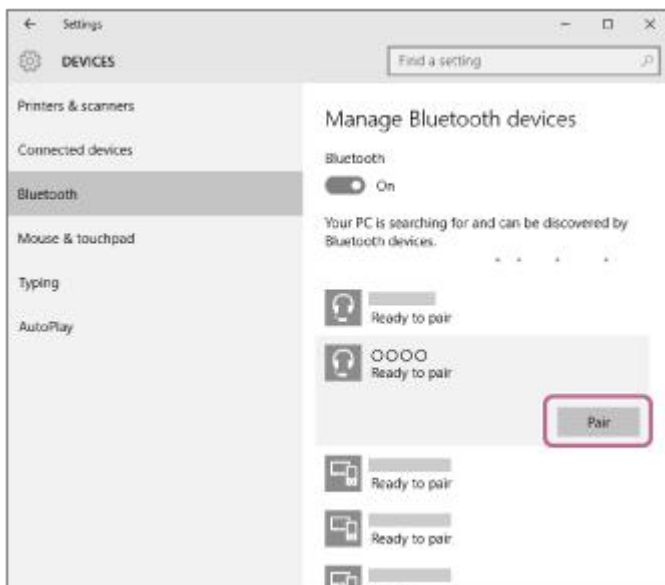

If passkey (*) input is required on the display of the computer, input "0000."

The headset and the computer are paired with each other and connected.

You hear voice guidance “BLUETOOTH connected”.

If they are not connected, refer to “[Connecting to a paired computer \(Windows 10\)](#).”

If [WI-1000X] does not appear on the display, try again from step 3.

* A Passkey may be called a “Passcode,” a “PIN code,” or a “Password.”

Hint

- The above procedure is an example. For details, refer to the operating instructions supplied with your computer.
- To delete all pairing information, refer to “[Initializing the headset to restore factory settings](#).”

Note

- If pairing is not established within about 5 minutes, pairing mode will be canceled and the headset will turn off. In this case, start over from step 1.
- Once BLUETOOTH devices are paired, there is no need to pair them again, except in the following cases:
 - Pairing information has been deleted after repair, etc.
 - The headset is already paired with 8 devices and another device is to be paired.
The headset can be paired with up to 8 devices. If a new device is paired after 8 devices are already paired, the paired device with the oldest connection time is replaced by the new one.
 - When the pairing information for the headset has been deleted from the BLUETOOTH device.
 - When the headset is initialized, all pairing information is deleted.
In this case, delete the pairing information of the headset from the BLUETOOTH device, and then pair them again.
- The headset can be paired with multiple devices, but can only play music from one paired device at a time.

Related Topic

- [How to make a wireless connection to BLUETOOTH devices](#)
- [Connecting to a paired computer \(Windows 10\)](#)
- [Listening to music from a device via BLUETOOTH connection](#)
- [Disconnecting BLUETOOTH connection \(after use\)](#)
- [Initializing the headset to restore factory settings](#)

Pairing and connecting with a computer (Windows 8/Windows 8.1)

Pairing is the process required to create a link between BLUETOOTH devices to allow wireless connection. You must pair a device with the headset to be able to make a BLUETOOTH connection for the first time.

Before you start pairing operation, make sure that:

- Your computer has a BLUETOOTH function that supports music playback connections (A2DP).
- The computer is placed within 1 m(3 feet) of the headset.
- The headset is charged sufficiently.
- The operating instructions of the computer is on hand.
- Depending on the computer, the built-in BLUETOOTH adaptor should be turned on. For whether or not a BLUETOOTH adaptor is incorporate, and for how to turn it on, refer to the operating instructions supplied with the computer.

1 Enter pairing mode on this headset.

Turn on the headset, when you pair the headset with a device for the first time after you bought it, or after you initialized the headset (the headset has no pairing information). The headset enters pairing mode automatically. When you pair a 2nd or subsequent device (the headset has pairing information for other devices), press and hold the  button for about 7 seconds.

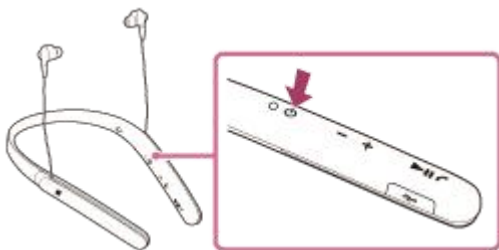

Make sure that the indicator flashes blue and red alternately after you release the button. You hear voice guidance "BLUETOOTH pairing".

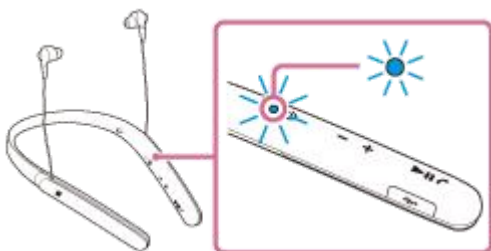

2 Resume the computer from sleep mode.

3 Register the headset using the computer.

1. Move the mouse pointer to the top-right corner of the screen (when using a touch panel, swipe from the right edge of the screen), then select [Settings] from the Charm Bar.



2. Select [Change PC settings] of the [Settings] charm.



3. Select [Devices] of [PC settings].

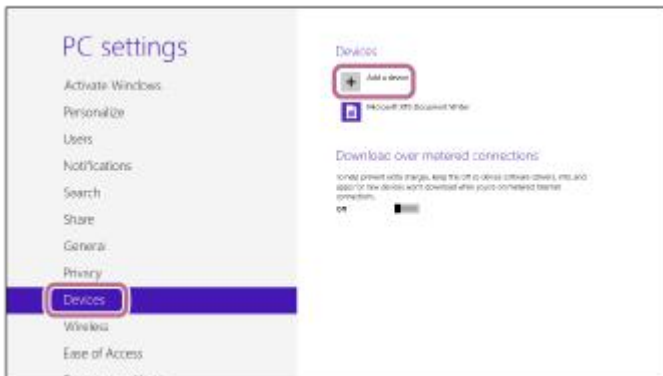

4. Select [Add a device].
5. Select [WI-1000X].

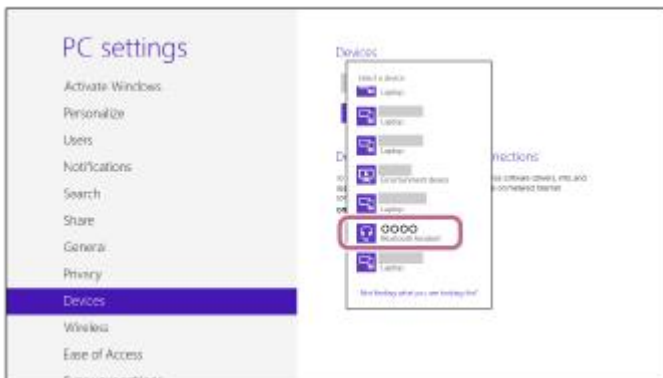

If passkey (*) input is required on the display of the computer, input "0000."
 The headset and the computer are paired with each other and connected. You hear voice guidance "BLUETOOTH connected".
 If they are not connected, see "[Connecting to a paired computer \(Windows 8/Windows 8.1\).](#)"
 If [WI-1000X] does not appear on the display, try again from step 3.

* A Passkey may be called a "Passcode," a "PIN code," or a "Password."

Hint

- The above procedure is an example. For details, refer to the operating instructions supplied with your computer.
- To delete all pairing information, see [“Initializing the headset to restore factory settings.”](#)

Note

- If pairing is not established within about 5 minutes, pairing mode will be canceled and the headset will turn off. In this case, start over from step 1.
- Once BLUETOOTH devices are paired, there is no need to pair them again, except in the following cases:
 - Pairing information has been deleted after repair, etc.
 - The headset is already paired with 8 devices and another device is to be paired.
The headset can be paired with up to 8 devices. If a new device is paired after 8 devices are already paired, the paired device with the oldest connection time is replaced by the new one.
 - When the pairing information for the headset has been deleted from the BLUETOOTH device.
 - When the headset is initialized, all pairing information is deleted.
In this case, delete the pairing information of the headset from the BLUETOOTH device, and then pair them again.
- The headset can be paired with multiple devices, but can only play music from one paired device at a time.

Related Topic

- [How to make a wireless connection to BLUETOOTH devices](#)
- [Connecting to a paired computer \(Windows 8/Windows 8.1\)](#)
- [Listening to music from a device via BLUETOOTH connection](#)
- [Disconnecting BLUETOOTH connection \(after use\)](#)
- [Initializing the headset to restore factory settings](#)

Pairing and connecting with a computer (Windows 7)

Pairing is the process required to create a link between BLUETOOTH devices to allow wireless connection. You must pair a device with the headset to be able to make a BLUETOOTH connection for the first time.

Before you start pairing operation, make sure that:

- Your computer has a BLUETOOTH function that supports music playback connections (A2DP).
- The computer is placed within 1 m(3 feet) of the headset.
- The headset is charged sufficiently.
- The operating instructions of the computer is on hand.
- Depending on the computer, the built-in BLUETOOTH adaptor should be turned on. For whether or not a BLUETOOTH adaptor is incorporate, and for how to turn it on, refer to the operating instructions supplied with the computer.

1 Enter pairing mode on this headset.

Turn on the headset, when you pair the headset with a device for the first time after you bought it, or after you initialized the headset (the headset has no pairing information). The headset enters pairing mode automatically. When you pair a 2nd or subsequent device (the headset has pairing information for other devices), press and hold the  button for about 7 seconds.

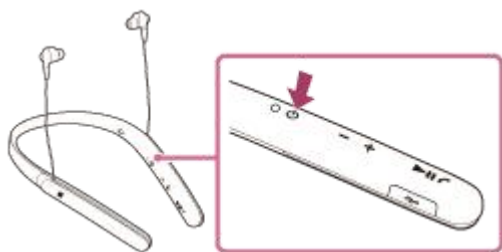

Make sure that the indicator flashes blue and red alternately after you release the button. You hear voice guidance "BLUETOOTH pairing".

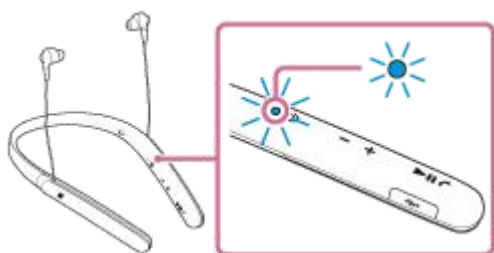

2 Resume the computer from sleep mode.

3 Search for the headset using the computer.

1. Click the [Start] button, then [Devices and Printers].
2. Click [Add a device].



3. Select [WI-1000X], then click [Next].

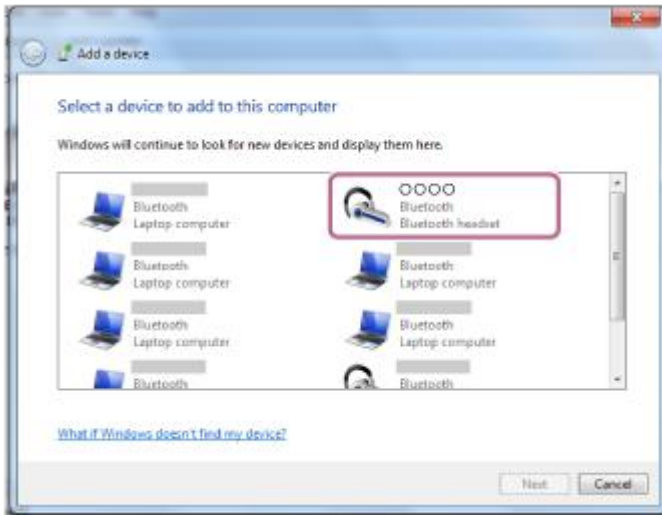

If passkey (*) input is required on the display of the computer, input "0000."

The headset and the computer are paired with each other and connected. You hear voice guidance "BLUETOOTH connected".

If they are not connected, see "[Connecting to a paired computer \(Windows 7\).](#)"

If [WI-1000X] does not appear on the display, try again from step 3.

* A Passkey may be called a "Passcode," a "PIN code," or a "Password."

Hint

- The above procedure is an example. For details, refer to the operating instructions supplied with your computer.
- To delete all pairing information, see "[Initializing the headset to restore factory settings.](#)"

Note

- If pairing is not established within about 5 minutes, pairing mode will be canceled and the headset will turn off. In this case, start over from step 1.
- Once BLUETOOTH devices are paired, there is no need to pair them again, except in the following cases:
 - Pairing information has been deleted after repair, etc.
 - The headset is already paired with 8 devices and another device is to be paired.
The headset can be paired with up to 8 devices. If a new device is paired after 8 devices are already paired, the paired device with the oldest connection time is replaced by the new one.
 - When the pairing information for the headset has been deleted from the BLUETOOTH device.
 - When the headset is initialized, all pairing information is deleted.
In this case, delete the pairing information of the headset from the BLUETOOTH device, and then pair them again.
- The headset can be paired with multiple devices, but can only play music from one paired device at a time.

Related Topic

- [How to make a wireless connection to BLUETOOTH devices](#)
- [Connecting to a paired computer \(Windows 7\)](#)
- [Listening to music from a device via BLUETOOTH connection](#)
- [Disconnecting BLUETOOTH connection \(after use\)](#)
- [Initializing the headset to restore factory settings](#)

4-697-051-11(4) Copyright 2017 Sony Corporation

Connecting to a paired computer (Windows 10)

Before starting the operation, make sure the following:

- Depending on the computer, the built-in BLUETOOTH adaptor should be turned on. For whether or not a BLUETOOTH adaptor is incorporate, and for how to turn it on, refer to the operating instructions supplied with the computer.

1 Resume the computer from sleep mode.

2 Turn on the headset.

Press and hold the  button for about 2 seconds.

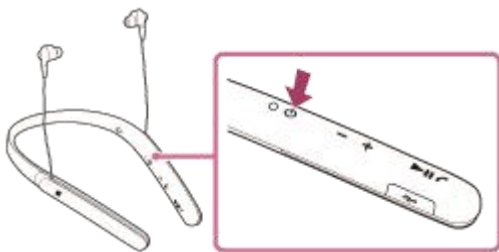

Make sure that the indicator (blue) flashes after you release the button. You hear voice guidance “Power on”.

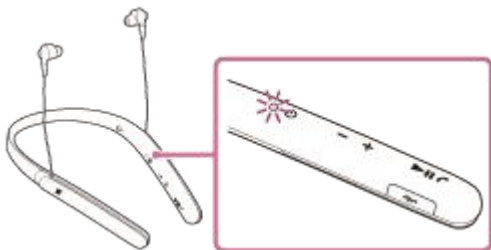

After the headset turns on, if it has automatically connected to the last connected device, you hear voice guidance “BLUETOOTH connected”.

Use the computer to check whether the connection is established, and if it is not established, proceed to step 3.

If the computer has connected to the last BLUETOOTH device connected, disconnect it, then proceed to the next step.

3 Select the headset using the computer.

1. Right-click the volume icon on the windows toolbar, then click [Playback devices].

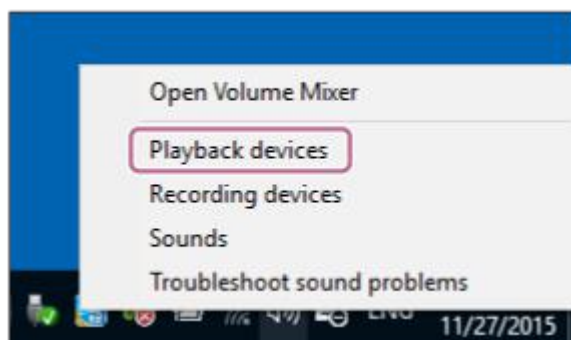

2. Right-click [WI-1000X].
If [WI-1000X] is not displayed, right-click on the [Sound] screen, then select [Show Disabled Devices].



3. Click [Connect].

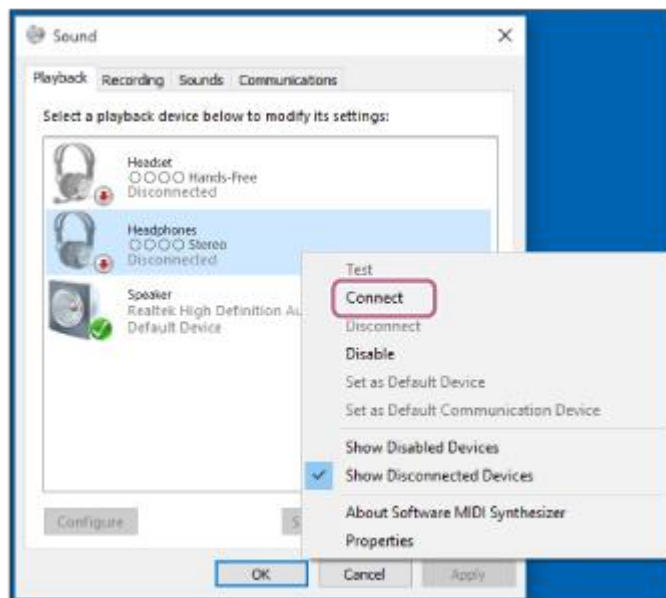

The connection is established.



Hint

- The above procedure is an example. For details, refer to the operating instructions supplied with your computer.
- If the computer was connected with the headset the last time, an HFP/HSP connection is made when you turn on the headset. While the headset is on, you can make an A2DP connection (music playback) by pressing the ►|| button.

Note

- If the sound quality for music playback is low, make sure that the function that supports music playback connections (A2DP) is available on your computer. For details, refer to the operating instructions supplied with your computer.
- If the last-connected BLUETOOTH device is put near the headset, the headset may connect automatically to the device by simply turning on the headset. In this case, deactivate the BLUETOOTH function on the BLUETOOTH device or turn off the power.
- If you cannot connect your computer to the headset, deactivate pairing on your computer and perform pairing again. For details, refer to the operating instructions supplied with your computer.

Related Topic

- [How to make a wireless connection to BLUETOOTH devices](#)
- [Pairing and connecting with a computer \(Windows 10\)](#)
- [Listening to music from a device via BLUETOOTH connection](#)
- [Disconnecting BLUETOOTH connection \(after use\)](#)

Connecting to a paired computer (Windows 8/Windows 8.1)

Before starting the operation, make sure the following:

- Depending on the computer, the built-in BLUETOOTH adaptor should be turned on. For whether or not a BLUETOOTH adaptor is incorporate, and for how to turn it on, refer to the operating instructions supplied with the computer.

1 Resume the computer from sleep mode.

2 Turn on the headset.

Press and hold the  button for about 2 seconds.

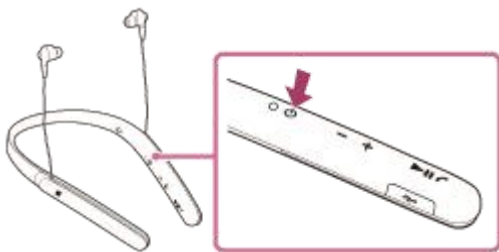

Make sure that the indicator (blue) flashes after you release the button. You hear voice guidance “Power on”.

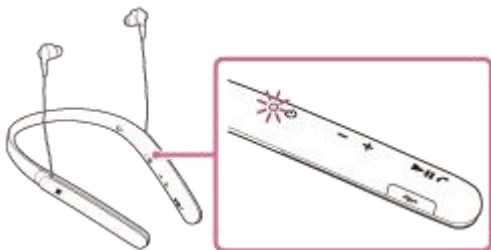

After the headset turns on, if it has automatically connected to the last connected device, you hear voice guidance “BLUETOOTH connected”.

Use the computer to check whether the connection is established, and if it is not established, proceed to step 3.

If the computer has connected to the last BLUETOOTH device connected, disconnect it, then proceed to the next step.

3 Select the headset using the computer.

1. Select [Desktop] on the Start screen.
2. Move the mouse pointer to the top-right corner of the screen (when using a touch panel, swipe from the right edge of the screen), then select [Settings] from the Charm Bar.



3. Select [Control Panel] in the [Settings] charm.
4. Select [Hardware and Sound], then [Devices and Printers].

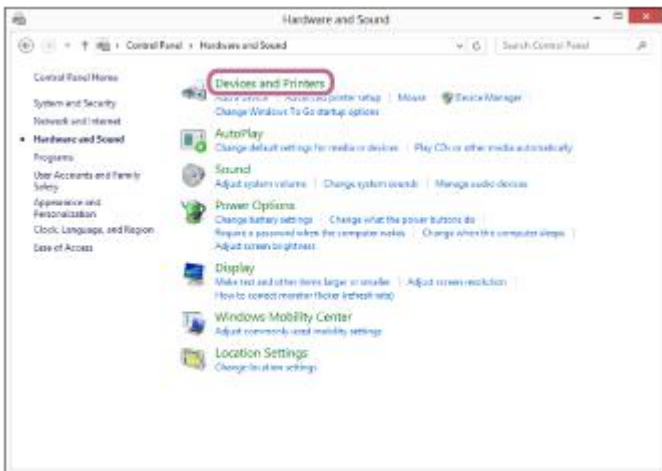
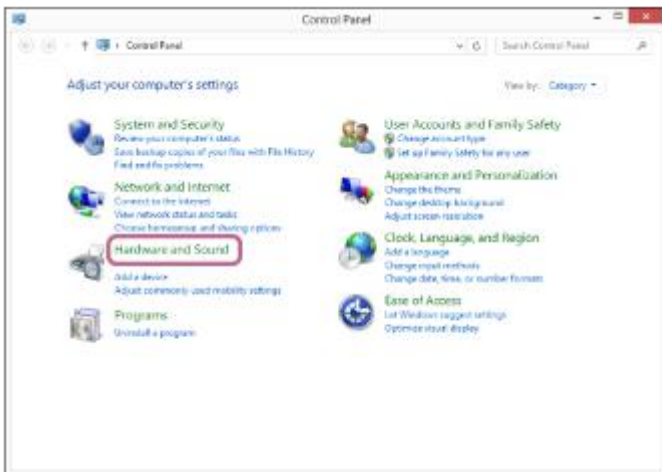

5. Right-click [WI-1000X] in the [Devices and Printers] screen.

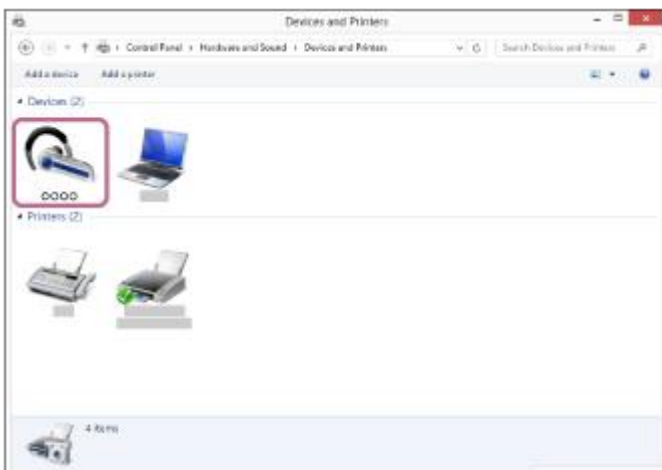

6. Select [Advanced Operation] — [Connect to audio sink device].

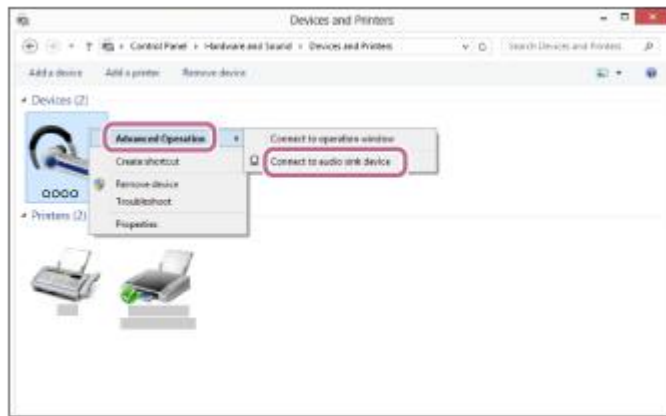

Hint

- The above procedure is an example. For details, refer to the operating instructions supplied with your computer.
- If the computer was connected with the headset the last time, an HFP/HSP connection is made when you turn on the headset. While the headset is on, you can make an A2DP connection (music playback) by pressing the ►|| button.

Note

- If the sound quality for music playback is low, make sure that the function that supports music playback connections (A2DP) is available on your computer. For details, refer to the operating instructions supplied with your computer.
- If the last-connected BLUETOOTH device is put near the headset, the headset may connect automatically to the device by simply turning on the headset. In this case, deactivate the BLUETOOTH function on the BLUETOOTH device or turn off the power.
- If you cannot connect your computer to the headset, deactivate pairing on your computer and perform pairing again. For details, refer to the operating instructions supplied with your computer.

Related Topic

- [How to make a wireless connection to BLUETOOTH devices](#)
- [Pairing and connecting with a computer \(Windows 8/Windows 8.1\)](#)
- [Listening to music from a device via BLUETOOTH connection](#)
- [Disconnecting BLUETOOTH connection \(after use\)](#)

Connecting to a paired computer (Windows 7)

Before starting the operation, make sure the following:

- Depending on the computer, the built-in BLUETOOTH adaptor should be turned on. For whether or not a BLUETOOTH adaptor is incorporate, and for how to turn it on, refer to the operating instructions supplied with the computer.

1 Resume the computer from sleep mode.

2 Turn on the headset.

Press and hold the  button for about 2 seconds.

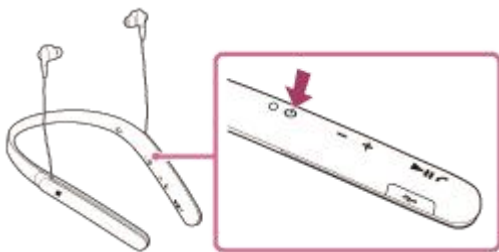

Make sure that the indicator (blue) flashes after you release the button. You hear voice guidance “Power on”.

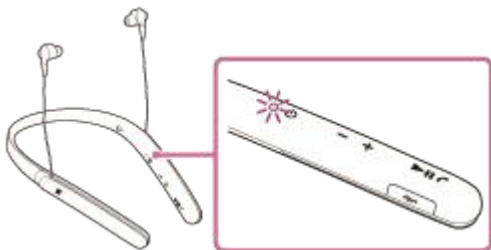

After the headset turns on, if it has automatically connected to the last connected device, you hear voice guidance “BLUETOOTH connected”.

Use the computer to check whether the connection is established, and if it is not established, proceed to step 3.

If the computer has connected to the last BLUETOOTH device connected, disconnect it, then proceed to the next step.

3 Select the headset using the computer.

1. Click the [Start] button, then [Devices and Printers].
2. Double-click [WI-1000X] of the device.



3. Click [Listen to Music].

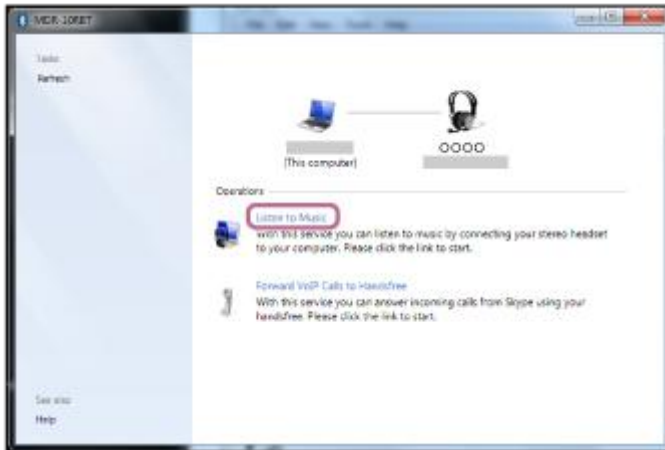

Hint

- The above procedure is an example. For details, refer to the operating instructions supplied with your computer.
- If the computer was connected with the headset the last time, an HFP/HSP connection is made when you turn on the headset. While the headset is on, you can make an A2DP connection (music playback) by pressing the ►|| button.

Note

- If the sound quality for music playback is low, make sure that the function that supports music playback connections (A2DP) is available on your computer. For details, refer to the operating instructions supplied with your computer.
- If the last-connected BLUETOOTH device is put near the headset, the headset may connect automatically to the device by simply turning on the headset. In this case, deactivate the BLUETOOTH function on the BLUETOOTH device or turn off the power.
- If you cannot connect your computer to the headset, deactivate pairing on your computer and perform pairing again. For details, refer to the operating instructions supplied with your computer.

Related Topic

- [How to make a wireless connection to BLUETOOTH devices](#)
- [Pairing and connecting with a computer \(Windows 7\)](#)
- [Listening to music from a device via BLUETOOTH connection](#)
- [Disconnecting BLUETOOTH connection \(after use\)](#)

Pairing and connecting with other BLUETOOTH devices

Pairing is the process required to create a link between BLUETOOTH devices to allow wireless connection. You must pair a device with the headset to be able to make a BLUETOOTH connection for the first time. Before you start pairing operation, make sure that:

- The BLUETOOTH device is placed within 1 m(3 feet) of the headset.
- The headset is charged sufficiently.
- The operating instructions of the BLUETOOTH device is on hand.

1 Enter pairing mode on this headset.

Turn on the headset, when you pair the headset with a device for the first time after you bought it, or after you initialized the headset (the headset has no pairing information). The headset enters pairing mode automatically. When you pair a 2nd or subsequent device (the headset has pairing information for other devices), press and hold the  button for about 7 seconds.

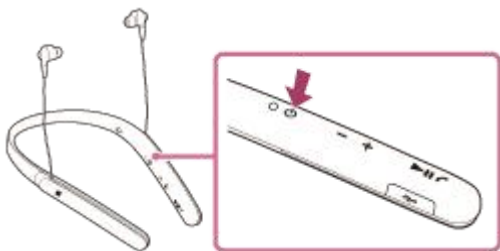

Make sure that the indicator flashes blue and red alternately after you release the button. You hear voice guidance "BLUETOOTH pairing".

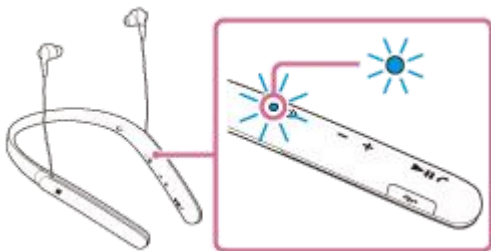

2 Perform the pairing procedure on the BLUETOOTH device to search for this headset.

[WI-1000X] will be displayed on the list of detected devices on the screen of the BLUETOOTH device. If not displayed, repeat from step 1.

3 Select [WI-1000X].

If passkey (*) input is required on the display of the BLUETOOTH device, input "0000."

* A Passkey may be called a "Passcode," a "PIN code," or a "Password."

4 Make the BLUETOOTH connection from the BLUETOOTH device.

Depending on the BLUETOOTH device, the headset may be connected with the device automatically as soon as they are paired.

When connected, you hear voice guidance "BLUETOOTH connected".

Hint

- The above procedure is an example. For details, refer to the operating instructions supplied with your BLUETOOTH device.
- To delete all pairing information, see [“Initializing the headset to restore factory settings.”](#)

Note

- If pairing is not established within about 5 minutes, pairing mode will be canceled and the headset will turn off. In this case, start over from step 1.
- When pairing with a BLUETOOTH device that cannot display a list of detected devices or that has no display, you may pair the device by setting both the headset and the BLUETOOTH device to pairing mode. At this time, if passkey is set other than “0000” on the BLUETOOTH device, pairing cannot be done with the headset.
- Once BLUETOOTH devices are paired, there is no need to pair them again, except in the following cases:
 - Pairing information has been deleted after repair, etc.
 - The headset is already paired with 8 devices and another device is to be paired.
The headset can be paired with up to 8 devices. If a new device is paired after 8 devices are already paired, the paired device with the oldest connection time is replaced by the new one.
 - When the pairing information for the headset has been deleted from the BLUETOOTH device.
 - When the headset is initialized, all pairing information is deleted.
In this case, delete the pairing information of the headset from the BLUETOOTH device, and then pair them again.
- The headset can be paired with multiple devices, but can only play music from one paired device at a time.

Related Topic

- [How to make a wireless connection to BLUETOOTH devices](#)
- [Connecting to a paired BLUETOOTH device](#)
- [Listening to music from a device via BLUETOOTH connection](#)
- [Initializing the headset to restore factory settings](#)

Wireless Noise Canceling Stereo Headset
WI-1000X

Connecting to a paired BLUETOOTH device

1 Turn on the headset.

Press and hold the  button for about 2 seconds.

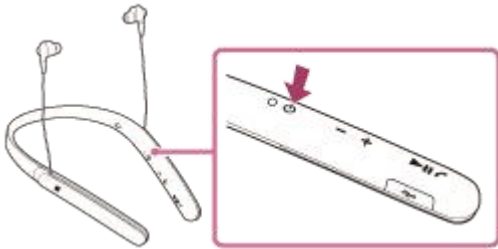

Make sure that the indicator (blue) flashes after you release the button. You hear voice guidance “Power on”.

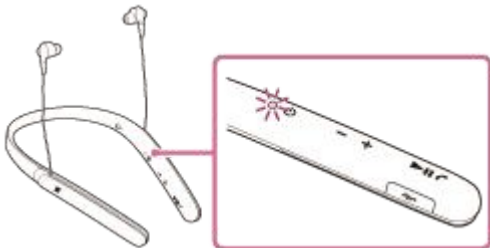

After the headset turns on, if it has automatically connected to the last connected device, you hear voice guidance “BLUETOOTH connected”.

Check the connection status on the BLUETOOTH device. If not connected, proceed to step 2.

2 Make the BLUETOOTH connection from the BLUETOOTH device.

For details, refer to the operating instructions supplied with your BLUETOOTH device.

When connected, you hear voice guidance “BLUETOOTH connected”.

Hint

- The above procedure is an example. For details, refer to the operating instructions supplied with your BLUETOOTH device.
- If the BLUETOOTH device was connected with the headset the last time, an HFP/HSP connection is made when you turn on the headset. While the headset is on, you can make an A2DP connection (music playback) by pressing the  button.

Note

- If the last-connected BLUETOOTH device is put near the headset, the headset may connect automatically to the device by simply turning on the headset. In this case, deactivate the BLUETOOTH function on the BLUETOOTH device or turn off the power.
- If you cannot connect your BLUETOOTH device to the headset, deactivate pairing on your BLUETOOTH device and perform pairing again. For details, refer to the operating instructions supplied with your BLUETOOTH device.

- How to make a wireless connection to BLUETOOTH devices
- Pairing and connecting with other BLUETOOTH devices
- Listening to music from a device via BLUETOOTH connection

4-697-051-11(4) Copyright 2017 Sony Corporation

Connecting the headset to both a music player and a smartphone or mobile phone

When you connect the headset to 2 BLUETOOTH devices, you can use them differently. For example, one for listening to music (with the A2DP BLUETOOTH connection) and the other for making phone calls (with the HFP or HSP BLUETOOTH connection).

To use a BLUETOOTH music player for listening to music and a BLUETOOTH smartphone for making phone calls, the headset needs to be connected with each device with a BLUETOOTH connection.

- 1 Pair the headset with a music player and smartphone or mobile phone, respectively.**
- 2 Make a BLUETOOTH connection between the headset and the BLUETOOTH music player.
Operate the music player to make the BLUETOOTH connection with the headset.**
- 3 Make a BLUETOOTH connection between the headset and the BLUETOOTH smartphone or mobile phone.
Operate the smartphone or mobile phone to make the BLUETOOTH connection with the headset.**

Note

- If the smartphone or mobile phone was connected with the headset the last time, an HFP or HSP connection is made automatically when you turn on the headset. At the same time, an A2DP connection may also be made automatically. If this happens, disconnect the headset from the smartphone or mobile phone once using the phone, then connect the devices again by repeating the process from step 2.
- When using Google Assistant, the headset cannot make a multi point connection.

Wireless Noise Canceling Stereo Headset
WI-1000X

Connecting the headset to 2 Android smartphones

When you connect the headset to a smartphone, usually the music playback function and the phone call function are both connected automatically.

To make a multi point connection with 2 smartphones separately, one for listening to music and the other for making phone calls, change the settings of the smartphones so that only one of the functions is connected for each smartphone.

- 1 Pair the headset with both smartphones, respectively.
- 2 Use one of the smartphones to establish a BLUETOOTH connection with the headset.
- 3 On the smartphone connected to the headset, uncheck either [Phone audio] (HFP) or [Media audio] (A2DP).

Example: To connect "Media audio" (A2DP) only

Touch [Settings] - [Bluetooth] - the setting icon next to [WI-1000X].



On the [Paired Bluetooth device] screen, uncheck [Phone audio].



- 4 Terminate the BLUETOOTH connection of the smartphone.
- 5 Use the other smartphone to establish a BLUETOOTH connection to the headset.
- 6 In the same way, uncheck the function that you did not uncheck in step 3.
- 7 Use the first smartphone to establish a BLUETOOTH connection again.

Both smartphones are connected to the headset with only one function enabled.

Hint

- The above procedure is an example. For details, refer to the operating instructions supplied with your Android smartphones.

Note

- When using Google Assistant, the headset cannot make a multi point connection.

4-697-051-11(4) Copyright 2017 Sony Corporation

Connecting the headset to an Android smartphone and an iPhone

When you connect the headset to a smartphone, usually the music playback function and the phone call function are both connected automatically. To make a multi point connection using an Android smartphone and an iPhone separately for listening to music and making phone calls, change the settings on the Android smartphone so that only one of the functions is connected. Connect the Android smartphone first, and then connect the iPhone.
You cannot set the iPhone to connect one function only.

- 1 **Pair the headset with both Android smartphone and iPhone, respectively.**
- 2 **Use the Android smartphone to establish a BLUETOOTH connection with the headset.**
- 3 **On the Android smartphone connected to the headset, uncheck either [Phone audio] (HFP) or [Media audio] (A2DP).**

Example: To connect “Media audio” (A2DP) only

Touch [Settings] - [Bluetooth] - the setting icon next to [WI-1000X].



On the [Paired Bluetooth device] screen, uncheck [Phone audio].



- 4 **Use the iPhone to establish a BLUETOOTH connection to the headset.**

The iPhone is connected to the headset with both functions, but you can only use the function that you unchecked in step 3.

Hint

- The above procedure is an example. For details, refer to the operating instructions supplied with your Android smartphone.

Note

- If you connect an Android smartphone with [Phone audio] (HFP), the remaining battery charge of the headset will not be displayed correctly on an iPhone.
- When using Google Assistant, the headset cannot make a multi point connection.

4-697-051-11(4) Copyright 2017 Sony Corporation

Disconnecting BLUETOOTH connection (after use)

- 1 If using a device that supports one-touch connection (NFC), touch the device to the headset again. (Unlock the screen of the device if it is locked.) If using a device that does not support one-touch connection (NFC), operate from the BLUETOOTH device.**

When disconnected, you hear voice guidance "BLUETOOTH disconnected".

- 2 Turn off the headset.**

You hear voice guidance "Power off".

Hint

- When you finish playing music, the BLUETOOTH connection may terminate automatically, depending on the BLUETOOTH device.

Related Topic

- [Disconnecting the smartphone by one touch \(NFC\)](#)
- [Turning off the headset](#)

Wireless Noise Canceling Stereo Headset
WI-1000X

Using the supplied dedicated headphone cable

You can use the headset as noise canceling headphones by connecting a device via the supplied dedicated headphone cable and turn the headset on. The headset supports high resolution audio playback when connecting via the supplied dedicated headphone cable and turned on.

When turning on the headset, the indicator (green) next to the NC/AMBIENT button lights up or flashes.

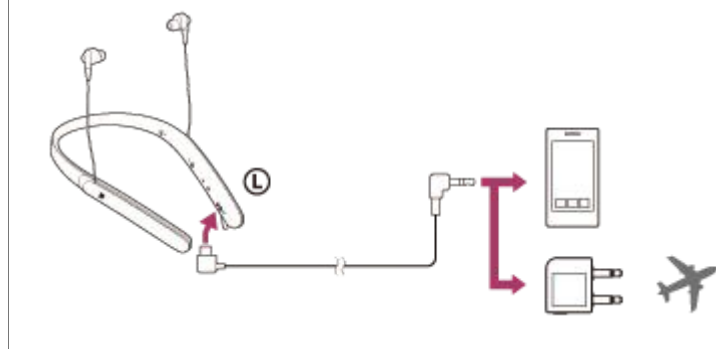

1 Connect a playback device to the micro-USB port with the supplied dedicated headphone cable.



Hint

- You can enjoy music by connecting the supplied dedicated headphone cable to the headset even when the headset is turned off. In this case the noise canceling function is not available.
- To enjoy high resolution audio music or use the noise canceling function/Ambient Sound Mode, turn the headset on.
- Use the supplied plug adaptor for in-flight use when you enjoy the in-flight entertainment.
- When the noise canceling function is turned on, the headset turns off automatically if you disconnect the dedicated headphone cable.
- When an incoming call arrives, a ring tone will be heard via the headphones. Answer the call using your smartphone or mobile phone, and talk using the microphone of the phone. You can hear the voice of the caller from the headphones.
- If you disconnect the dedicated headphone cable from the smartphone or mobile phone, you can talk using the microphone and speaker of the phone.

Note

- Use the supplied dedicated headphone cable only.
- Make sure you insert the plug firmly.
- Close the cover of the micro-USB port to prevent water or dusts being mixed into the headset, when you are not using the supplied dedicated headphone cable.
- The BLUETOOTH function cannot be used.
- The  button, +/- buttons and  button cannot be used. For volume, playback, pausing, etc., control with the connected device.
- The NC/AMBIENT button cannot be used when the headset is powered off.
- Depending on the in-flight entertainment, the plug adaptor for in-flight use may not be used.

Wireless Noise Canceling Stereo Headset
WI-1000X

Listening to music from a device via BLUETOOTH connection

You can enjoy listening to music and basic remote control operation of a BLUETOOTH device via a BLUETOOTH connection. The BLUETOOTH device is required to support the following BLUETOOTH profiles.

- A2DP (Advanced Audio Distribution Profile):
enables you to enjoy high-quality audio content wirelessly.
- AVRCP (Audio Video Remote Control Profile):
enables you to adjust volume, etc.

The operation may vary depending on the BLUETOOTH device. Refer to the operating instructions supplied with your BLUETOOTH device.

1 Connect the headset to a BLUETOOTH device.

2 Wear the headset.

Put the headset with **L** indication to the left and **R** indication to the right. The **L** unit of the headset has a tactile dot.

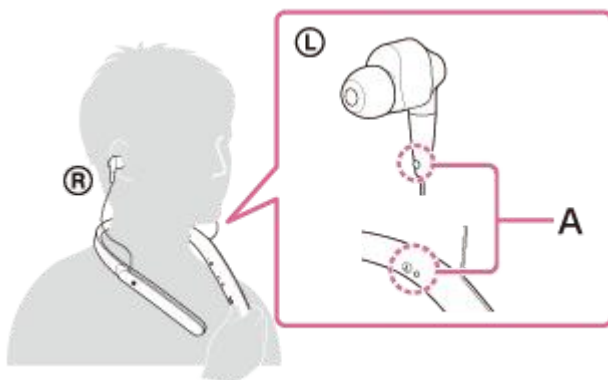

A: Tactile dot

Adjust the headset position to fit your ears.



3 Play back music or video on the BLUETOOTH device.

Adjust the volume on the BLUETOOTH device.

4 Adjust the volume by pressing the +/- buttons of the headset.

When the volume reaches the maximum or minimum, an alarm sounds.

Hint

- The headset supports SCMS-T content protection. You can enjoy music, etc., from a device such as a mobile phone or portable TV that supports SCMS-T content protection.
- Depending on the BLUETOOTH device, it may be necessary to adjust the volume or set the audio output setting on the BLUETOOTH device.
- Volume during a call and volume during music playback can be adjusted independently. Changing the call volume does not change the volume of music playback, and vice versa.

Note

- If the communication condition is poor, the BLUETOOTH device may react incorrectly to the operation on the headset.

Related Topic

- [How to make a wireless connection to BLUETOOTH devices](#)
- [Controlling the audio device \(BLUETOOTH connection\)](#)
- [Using the noise canceling function](#)
- [About the Automatic AI noise canceling function](#)

Controlling the audio device (BLUETOOTH connection)

If the BLUETOOTH device supports AVRCP, you can control it by the headset. The functions available may vary depending on the BLUETOOTH device. Refer to the operating instructions supplied with your BLUETOOTH device.

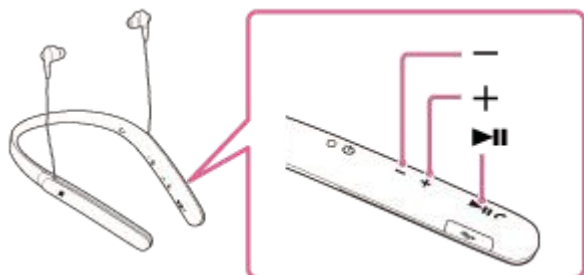

Each button has the following function:

▶||

- Press once during pause to start playback.
- Press once during playback to pause.
- Press twice to skip to the beginning of the next track (●●).
- Press three times to skip to the beginning of the previous (or current) track (●●●).
- Press once and release, and then press and hold to fast-forward (● [bar]).
- Press twice and release, and then press and hold to fast-reverse (●● [bar]).

+/-

- Press to adjust the volume.

Note

- If the communication condition is poor, the BLUETOOTH device may react incorrectly to the operation on the headset.
- The available functions may vary depending on the BLUETOOTH device. When you operate as illustrated above, it may operate differently or may not work at all.

Disconnecting BLUETOOTH connection (after use)

- 1** If using a device that supports one-touch connection (NFC), touch the device to the headset again. (Unlock the screen of the device if it is locked.) If using a device that does not support one-touch connection (NFC), operate from the BLUETOOTH device.

When disconnected, you hear voice guidance "BLUETOOTH disconnected".

- 2** Turn off the headset.

You hear voice guidance "Power off".

Hint

- When you finish playing music, the BLUETOOTH connection may terminate automatically, depending on the BLUETOOTH device.

Related Topic

- [Disconnecting the smartphone by one touch \(NFC\)](#)
- [Turning off the headset](#)

Wireless Noise Canceling Stereo Headset
WI-1000X

What is noise canceling?

The noise canceling circuit actually senses outside noise with built-in microphones and sends an equal-but-opposite canceling signal to the headset.

Note

- The noise canceling effect may not be pronounced in a very quiet environment, or some noise may be heard.
- Depending on how you wear the headset, the noise canceling effect may vary or a beeping sound (howling) may occur. In these cases, take off the headset and put it on again.
- The noise canceling function works for noise in the low frequency band primarily. Although noise is reduced, it is not canceled completely.
- When you use the headset in a train or a car, noise may occur depending on street conditions.
- Mobile phones may cause interference and noise. Should this occur, locate the headset further away from the mobile phone.
- Do not cover the microphones of the headset with your hands. The noise canceling function or the Ambient Sound Mode may not work properly, or a beeping sound (howling) may occur. In these cases, take your hands off of the microphones of the headset.

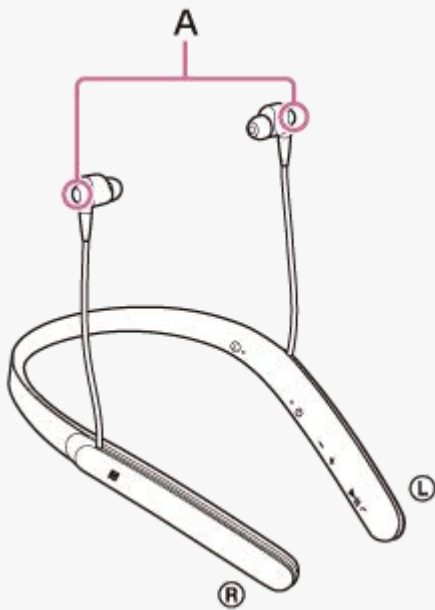

A: Microphones

Related Topic

- [Using the noise canceling function](#)
- [About the Automatic AI noise canceling function](#)

Using the noise canceling function

If you use the noise canceling function, you can enjoy music without being disturbed by ambient noise.

1 Turn on the headset.

You hear voice guidance “Power on”.

The noise canceling function is turned on automatically when you turn on the headset.

The indicator (green) next to the NC/AMBIENT button lights up.

To turn off the noise canceling function

Press the NC/AMBIENT button repeatedly.

Each time you press the button, the function is switched as follows. You hear voice guidance which informs the switching of the function.

The Ambient Sound Mode: ON (the indicator (yellow) next to the NC/AMBIENT button lights up)



The noise canceling function/The Ambient Sound Mode: OFF (the indicator (green) next to the NC/AMBIENT button flashes)



The noise canceling function: ON (the indicator (green) next to the NC/AMBIENT button lights up)

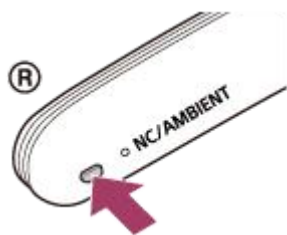

Hint

- If you use the noise canceling function with a BLUETOOTH connection, the noise canceling function is on even if you connect the supplied dedicated headphone cable.
- When you are using the supplied dedicated headphone cable, turn off the headset. You can use the headset as ordinary wired headphones.
- To enjoy high resolution audio music, turn the headset on.
- You can also turn on/off the noise canceling function with the “Sony | Headphones Connect” app.

Note

- If the NC/AMBIENT button is set as the Google Assistant button, the noise canceling function cannot be switched by pressing the NC/AMBIENT button.
- When the headset is connected with the dedicated headphone cable and the noise canceling function is turned on, the indicator next to the  button turns off.

- If the earbuds are not the supplied ones, the effect of the noise canceling function will be insufficient.
- If the earbuds are not attached to your ears securely, the effect of the noise canceling function will be insufficient. Adjust the headset position to fit your ears.

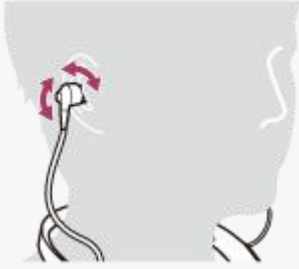

Related Topic

- [About voice guidance](#)
- [Turning on the headset](#)
- [What is noise canceling?](#)
- [About the Automatic AI noise canceling function](#)
- [Listening to ambient sound during music playback \(Ambient Sound Mode\)](#)
- [What you can do with "Sony | Headphones Connect" app](#)

Wireless Noise Canceling Stereo Headset
WI-1000X

About the Automatic AI noise canceling function

The Automatic AI (Artificial Intelligence) Noise Canceling function constantly analyzes environmental ambient sound components and automatically selects the most effective noise canceling mode.

Noise canceling mode types

NC Mode A

Noise mainly in an airplane is effectively reduced.

NC Mode B

Noise mainly in a bus or a train is effectively reduced.

NC Mode C

Noise mainly found in an office environment (PC, copier, air ventilation, etc.) is effectively reduced.

Related Topic

- [What is noise canceling?](#)
- [Using the noise canceling function](#)

Wireless Noise Canceling Stereo Headset
WI-1000X

Optimizing the noise canceling function to suit the usage environment (NC optimizer)

Turn on the NC Optimizer function, when an air pressure is changed in an airplane. This function optimizes the noise canceling function by detecting the pressure changes.

- 1 Wear the headset when the headset is turned on.

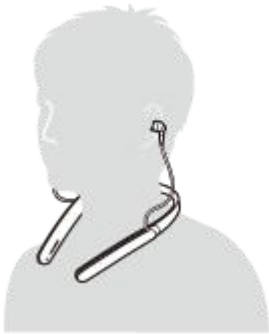

- 2 Press and hold the NC/AMBIENT button until you hear voice guidance “Optimizer start” (for about two seconds).

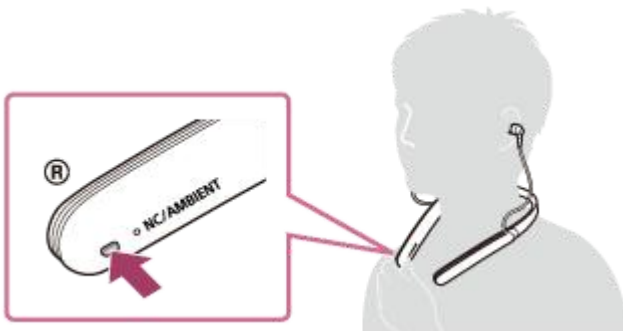

While optimizing, you will hear test sounds.

When the optimizing process is finished, you will hear voice guidance “Optimizer finished”.

Hint

- If you are on an airplane, we recommend that you turn on the NC Optimizer function at the stable flight condition.
- The condition set with the NC Optimizer function is kept until you use this function again. We recommend that you turn on the NC Optimizer function again after getting off the airplane and so on.

Note

- When performing the NC Optimizer, wear the headset in the actual use condition. Do not touch the headset while performing the optimizer.
- If the headset receives another operation while performing the NC Optimizer, the optimizing is canceled.

Wireless Noise Canceling Stereo Headset
WI-1000X

Listening to ambient sound during music playback (Ambient Sound Mode)

You can hear ambient sound through the microphones embedded in the left/right units of the headset while enjoying music.

To activate the Ambient Sound Mode

Press the NC/AMBIENT button repeatedly while the noise canceling function is on.

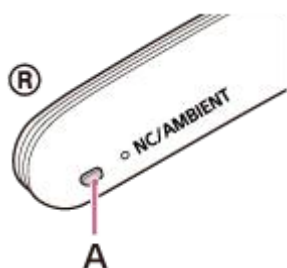

A: NC/AMBIENT button

To change the setting of the Ambient Sound Mode

You can change the setting of the Ambient Sound Mode by connecting the smartphone (installed with the “Sony | Headphones Connect” app) and the headset via the BLUETOOTH function.

To deactivate the Ambient Sound Mode

Press the NC/AMBIENT button repeatedly until the noise canceling function is turned on or off. Each time you press the button, the function is switched as follows. You hear voice guidance which informs the switching of the function.

The Ambient Sound Mode: ON (the indicator (yellow) next to the NC/AMBIENT button lights up)



The noise canceling function/The Ambient Sound Mode: OFF (the indicator (green) next to the NC/AMBIENT button flashes)



The noise canceling function: ON (the indicator (green) next to the NC/AMBIENT button lights up)

Hint

- Depending on the ambient condition and type/volume of the audio played back, ambient sound may not be heard even if you use the Ambient Sound Mode. Do not use the headset in places where it would be dangerous if you are unable to hear ambient sound, such as a road with car traffic.
- If the headset is not worn properly, the Ambient Sound Mode may not work correctly. Wear the headset properly.
- The setting of the Ambient Sound Mode changed with the “Sony | Headphones Connect” app is recorded in the headset. You can enjoy music with the recorded setting of the Ambient Sound Mode even when you connect the headset to other devices which do not have the “Sony | Headphones Connect” app installed.

Related Topic

- [About voice guidance](#)
- [Using the noise canceling function](#)
- [What you can do with "Sony | Headphones Connect" app](#)

4-697-051-11(4) Copyright 2017 Sony Corporation

Wireless Noise Canceling Stereo Headset
WI-1000X

About the sound quality mode

The sound quality mode has the following two modes. You can switch or check the sound quality mode with the “Sony | Headphones Connect” app.

Priority on sound quality: prioritizes the sound quality (default).

Priority on stable connection: prioritizes the stable connection.

- When using an AAC, aptX, aptX HD or LDAC compatible device, use with the “Priority on sound quality” mode.
- If the connection is unstable, such as when producing only intermittent sound, select the “Priority on stable connection” mode.

Note

- The playback time may become shorter, depending on the sound quality and the conditions under which you are using the headset.
- Depending on the ambient conditions in the area where you are using the headset, intermittent sound may still occur, even if the “Priority on stable connection” mode is selected.

Related Topic

- [What you can do with "Sony | Headphones Connect" app](#)

Supported codecs

A codec is an audio coding algorithm used when transmitting sound via a BLUETOOTH connection.

The headset supports the following 5 codecs for music playback via an A2DP connection: SBC, AAC, aptX, aptX HD and LDAC.

- SBC

This is an abbreviation for Subband Codec.

This is the standard audio coding technology used by BLUETOOTH devices.

All BLUETOOTH devices support SBC.

- AAC

This is an abbreviation for Advanced Audio Coding.

AAC is mainly used by Apple products such as iPhones, and it provides higher sound quality than that of SBC.

- aptX

This is an audio coding technology.

aptX is used by some Android smartphones, and it provides higher sound quality than that of SBC.

- aptX HD

This is an audio coding technology.

aptX HD is used by some Android smartphones, and it provides higher sound quality than that of aptX.

- LDAC

LDAC is an audio coding technology developed by Sony that enables the transmission of High-Resolution (Hi-Res) Audio content, even over a BLUETOOTH connection.

Unlike other BLUETOOTH compatible coding technologies such as SBC, it operates without any down-conversion of the Hi-Res Audio content (*), and allows approximately three times more data (**) than those other technologies to be transmitted over a BLUETOOTH wireless network with unprecedented sound quality, by means of efficient coding and optimized packetization.

* excluding DSD format contents

** in comparison with SBC when the bitrate of 990 kbps (96/48 kHz) or 909 kbps (88.2/44.1 kHz) is selected

With the headset set to the “Priority on sound quality” mode, when music in one of the above codecs is transmitted from a connected device, the headset switches to that codec automatically and plays back the music in the same codec. However, depending on the device to be connected with the headset, you may need to set the device beforehand to listen to music in a different codec on the headset, even if the device supports a codec of higher sound quality than SBC. Refer to the operating instructions supplied with the device regarding setting the codec.

Related Topic

- [About the sound quality mode](#)

Wireless Noise Canceling Stereo Headset
WI-1000X

About the DSEE HX function

The DSEE HX function upscales the compressed sound source data such as CD or MP3 to quality almost that of High-Resolution Audio quality and reproduces the clear high-range sound that is often lost.

The DSEE HX function is available when you set as follows by using the "Sony | Headphones Connect" app.

DSEE HX	Connection	Codec	Sound Position Control Surround (VPT) Equalizer
AUTO	BLUETOOTH connection	SBC or AAC	All OFF

Related Topic

- [What you can do with "Sony | Headphones Connect" app](#)

Receiving a call

You can enjoy a hands-free call with a smartphone or mobile phone that supports the BLUETOOTH profile HFP (Hands-free Profile) or HSP (Headset Profile), via a BLUETOOTH connection.

- If your smartphone or mobile phone supports both HFP and HSP, set it to HFP.
- Operations may vary depending on the smartphone or mobile phone. Refer to the operating instructions supplied with your smartphone or mobile phone.
- This headset supports normal incoming calls only. Calling apps for smartphones and computers are not supported.

Ring tone

When an incoming call arrives, a ring tone will be heard from the headset, and the indicator (blue) flashes quickly. Also, the right unit of the headset vibrates (Vibration function for receiving a call).

You will hear either of following ring tones, depending on your smartphone or mobile phone.

- Ring tone set on the headset
- Ring tone set on the smartphone or mobile phone
- Ring tone set on the smartphone or mobile phone only for a BLUETOOTH connection

1 Connect the headset to a smartphone or mobile phone beforehand.

2 When you hear a ring tone, press button on the headset and receive the call.

When an incoming call arrives even while you are listening to music, playback pauses and a ring tone will be heard from the headset.

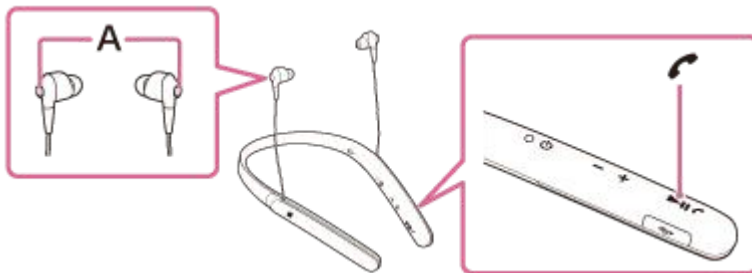

A: Microphone

Use the microphone of the L left or R right unit (which suppresses noise when using the noise canceling function) for talking on the phone.

If no ring tone is heard via the headset

- The headset may not be connected with the smartphone or mobile phone with HFP or HSP. Check the connection status on the smartphone or mobile phone.
- If playback does not pause automatically, operate the headset to pause playback.

3 Press the + or - button to adjust the volume.

When the volume reaches the maximum or minimum, an alarm sounds.

4 To end the call, press the button on the headset again.

If you received a call during music playback, music playback resumes automatically.

Hint

- Use the "Sony | Headphones Connect" app to switch on and off the vibration function for receiving a call. The default setting is "on."
- Some smartphones or mobile phones by default receive calls with the phone instead of the headset. With an HFP or HSP connection, switch the call device to the headset by holding the  button down for about 2 seconds or by using your smartphone or mobile phone.
- Volume for a call can be adjusted during a telephone conversation only.
- Volume during a call and volume during music playback can be adjusted independently. Changing the call volume does not change the volume of music playback, and vice versa.

Note

- Depending on the smartphone or mobile phone, playback may not resume automatically even if you finish the call.
- Use a smartphone or mobile phone at least 50 cm(19 3/4 in.) away from the headset. Noise may result if the headset and the smartphone or mobile phone are too close.

Related Topic

- [How to make a wireless connection to BLUETOOTH devices](#)
- [Making a call](#)
- [Functions for a phone call](#)
- [What you can do with "Sony | Headphones Connect" app](#)

Making a call

You can enjoy a hands-free call with a smartphone or mobile phone that supports the BLUETOOTH profile HFP (Hands-free Profile) or HSP (Headset Profile), via a BLUETOOTH connection.

- If your smartphone or mobile phone supports both HFP and HSP, set it to HFP.
- Operations may vary depending on the smartphone or mobile phone. Refer to the operating instructions supplied with your smartphone or mobile phone.
- This headset supports normal incoming calls only. Calling apps for smartphones and computers are not supported.

1 Connect the headset to a smartphone or mobile phone beforehand.

2 Operate your smartphone or mobile phone to make a call.

When you make a call, the dial tone is heard from the headset.

If you make a call while you are listening to music, playback pauses.

If no dial tone is heard via the headset, switch the call device to the headset using your smartphone or mobile phone or by holding the  button down for about 2 seconds.

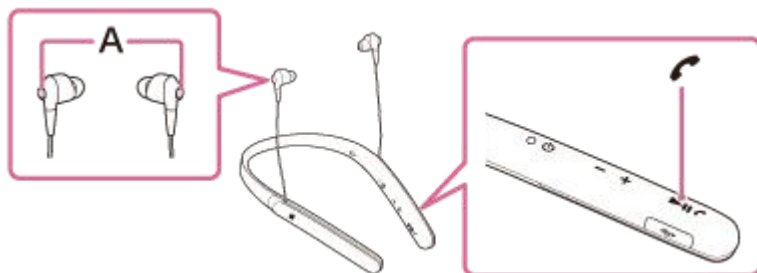

A: Microphone

Use the microphone of the **L** left or **R** right unit (which suppresses noise when using the noise canceling function) for talking on the phone.

3 Press the + or - button to adjust the volume.

When the volume reaches the maximum or minimum, an alarm sounds.

4 To end the call, press the button on the headset again.

If you made a call during music playback, music playback resumes automatically after ending the call.

Hint

- Volume for a call can be adjusted during a telephone conversation only.
- Volume during a call and volume during music playback can be adjusted independently. Changing the call volume does not change the volume of music playback, and vice versa.

Note

- Use a smartphone or mobile phone at least 50 cm (19 3/4 in.) away from the headset. Noise may result if the headset and the smartphone or mobile phone are too close.

Related Topic

- [How to make a wireless connection to BLUETOOTH devices](#)
- [Receiving a call](#)
- [Functions for a phone call](#)

4-697-051-11(4) Copyright 2017 Sony Corporation

Functions for a phone call



The available functions may vary depending on the profile supported by your smartphone or mobile phone. Even if the profile is the same, functions may vary depending on the smartphone or mobile phone. Refer to the operating instructions supplied with your smartphone or mobile phone.

Supported profile: HFP (Hands-free Profile)



During standby/music playback

- Press the  button for about 2 seconds to start the voice dial function of the smartphone/mobile phone (*), activate Siri of the iPhone.



Outgoing call

- Press the  button once to cancel an outgoing call.
- Press and hold the  button for about 2 seconds to change the call device between the headset and the smartphone or mobile phone.

Incoming call

- Press the  button once to answer a call.
- Press and hold the  button for about 2 seconds to reject a call.

During call

- Press the  button once to finish a call.
- Press and hold the  button for about 2 seconds to change the call device between the headset and the smartphone or mobile phone.

Supported profile: HSP (Headset Profile)

Outgoing call

- Press the  button once to cancel an outgoing call. (*)

Incoming call

- Press the  button once to answer a call.

During call

- Press the  button once to finish a call. (*)

* Some devices may not support this function.

Related Topic

- [Receiving a call](#)
- [Making a call](#)

Disconnecting BLUETOOTH connection (after use)

- 1 If using a device that supports one-touch connection (NFC), touch the device to the headset again. (Unlock the screen of the device if it is locked.) If using a device that does not support one-touch connection (NFC), operate from the BLUETOOTH device.**

When disconnected, you hear voice guidance "BLUETOOTH disconnected".

- 2 Turn off the headset.**

You hear voice guidance "Power off".

Hint

- When you finish playing music, the BLUETOOTH connection may terminate automatically, depending on the BLUETOOTH device.

Related Topic

- [Disconnecting the smartphone by one touch \(NFC\)](#)
- [Turning off the headset](#)

Wireless Noise Canceling Stereo Headset
WI-1000X

Using the voice assist function (Google Assistant)

Google Assistant is available when the software version of your headset is 2.0.0 or later, and the version of the "Sony | Headphones Connect" app installed on the smartphone is 3.1.0 or later.

By using the Google Assistant feature that comes with the smartphone, you can speak to the headset's microphone to operate the smartphone or perform the search.

Compatible smartphones

- Smartphones installed with Android 5.0 or later (The latest version of Google App is required.)
- iPhone/iPod touch (Installation of Google Assistant application is required.)

1 If your smartphone is an iPhone/iPod touch, turn Google Assistant on.

2 Turn the "Sony | Headphones Connect" app on, and set the NC/AMBIENT button as the Google Assistant button.

When using Google Assistant for the first time, follow the on-screen instructions to complete initial settings for Google Assistant.

For details of the "Sony | Headphones Connect" app, refer to the following URL.

http://rd1.sony.net/help/mdr/hpc/h_zz/

3 Press the NC/AMBIENT button to use Google Assistant.

- Press and hold to input a voice command.
- Press once to read out the notification.
- Press twice to cancel the voice command.

For details of Google Assistant, refer to the following website:

<https://assistant.google.com>

Hint

- Check or update the software version of the headset with the "Sony | Headphones Connect" app.
- When Google Assistant is not available for reasons such as not being connected to the network, a voice guidance "Google Assistant is not connected" is heard.

Note

- If the NC/AMBIENT button is set as the Google Assistant button in step 2, the noise canceling function cannot be switched by pressing the NC/AMBIENT button.
- Google Assistant may not be used in some countries, regions, or languages.

Related Topic

- [About voice guidance](#)
- [What you can do with "Sony | Headphones Connect" app](#)

Using the voice assist function (Google App)

By using the Google App feature that comes with the Android smartphone, you can speak to the headset's microphone to operate the Android smartphone.

1 Turn the Google App on.

On the Android smartphone, select [Settings] — [Apps]. A gear icon appears in the top-right corner of the display. Select the gear icon, then [Default Apps] — [Assist & Voice input] — [Assist App], and then set [Assist App] to the Google App.

The operation above is an example. For details, refer to the operating instructions of the Android smartphone.

Note: The latest version of the app may be required.

For details on the Google App, refer to the operating instructions or support website of the Android smartphone.

The Google App may not be activated from the headset depending on specifications of the Android smartphone.

2 Connect the headset to the Android smartphone via BLUETOOTH connection.

3 When the Android smartphone is in standby or playing music, press and hold the button to activate the Google App.

The Google App is activated and you will hear the start-up sound.

4 Make a request to the Google App through the headset's microphone.

For details on the Google App, such as apps which work with the Google App, refer to the operating instructions of the Android smartphone.

After activating the Google App, when a certain time has passed without requests, a beep will sound and the Google App will be deactivated

Note

- If the NC/AMBIENT button is set as the Google Assistant button, the voice assist function (Google App) is not available.
- The Google App cannot be activated when you say "OK Google" through the headset's microphone even when the Android smartphone's [OK Google] setting is on.

Using the voice assist function (Siri)

By using the Siri feature that comes with iPhone, you can speak to the headset's microphone to operate the iPhone.

1 Turn Siri on.

On iPhone, select [Settings] — [Siri] to turn Siri on.

The operation above is an example. For details, refer to the operating instructions of the iPhone.

Note: For details on Siri, refer to the operating instructions or support website of the iPhone.

2 Connect the headset to the iPhone via BLUETOOTH connection.

3 When the iPhone is in standby or playing music, press and hold the button to activate Siri.

Siri is activated and you will hear the start-up sound.

4 Make a request to Siri through the headset's microphone.

For details on Siri, such as apps which work with Siri, refer to the operating instructions of the iPhone.

5 To continue to request, press the button before Siri is deactivated.

* After activating Siri, when a certain time has passed without requests, a beep will sound and Siri will be deactivated.

Note

- Siri cannot be activated when you say "Hey Siri" through the headset's microphone even when the iPhone's [Allow "Hey Siri"] setting is on.

Wireless Noise Canceling Stereo Headset
WI-1000X

What you can do with "Sony | Headphones Connect" app

When you connect the smartphone (installed with the "Sony | Headphones Connect" app) and the headset via the BLUETOOTH function, you can do the following.

- Display the remaining battery of the headset
- Display the BLUETOOTH connection codec
- Turn noise canceling on/off
- Use auto adjustment of the noise canceling function by behavior recognition
- Set the Ambient Sound mode
- Set the NC Optimizer function
- Control the auditory localization
- Select the sound effect mode (VPT)
- Select the Equalizer setting
- Switch the sound quality mode by setting the BLUETOOTH connection mode
- Set the DSEE HX (completion for high-range sound) function
- Set the vibration function for receiving a call
- Check the headset's status of connection/settings
- Check the software version of the headset
- Update the software of the headset
- Change the function of the NC/AMBIENT button

For details of the "Sony | Headphones Connect" app, refer to the following URL.

http://rd1.sony.net/help/mdr/hpc/h_zz/

Hint

- The operation of the "Sony | Headphones Connect" app depends on audio devices. The app specifications and screen design may be changed without prior notice.

Related Topic

- [Installing "Sony | Headphones Connect" app](#)
- [Checking the remaining battery charge](#)
- [Using the noise canceling function](#)
- [Optimizing the noise canceling function to suit the usage environment \(NC optimizer\)](#)
- [Listening to ambient sound during music playback \(Ambient Sound Mode\)](#)
- [About the sound quality mode](#)
- [Supported codecs](#)
- [About the DSEE HX function](#)

Wireless Noise Canceling Stereo Headset
WI-1000X

Installing "Sony | Headphones Connect" app

- 1 Download the "Sony | Headphones Connect" app from Google Play store or App Store, and install the app to your smartphone.

For details of the "Sony | Headphones Connect" app, refer to the following URL.

http://rd1.sony.net/help/mdr/hpc/h_zz/



Sony Headphones Connect 

- 2 After installing the app, launch the "Sony | Headphones Connect" app.

Related Topic

- [What you can do with "Sony | Headphones Connect" app](#)

Precautions

On BLUETOOTH communications

- BLUETOOTH wireless technology operates within a range of about 10 m (30 feet). Maximum communication range may vary depending on obstacles (human body, metal, wall, etc.) or electromagnetic environment.
- Microwaves emitting from a BLUETOOTH device may affect the operation of electronic medical devices. Turn off this headset and other BLUETOOTH devices in the following locations, as it may cause an accident:
 - where inflammable gas is present, in a hospital, or a petrol station
 - near automatic doors or a fire alarm.
- When you use the headset on an airplane, follow the instructions of cabin attendants or ask the airline you fly with about conditions for using the headset. If you do not use the supplied headphone cable, radio waves may affect instruments, causing risk of accident due to malfunction. Be sure that you use the supplied headphone cable on an airplane.
- Due to the characteristic of the wireless technology, the sound played on this headset is delayed from the sound and music played on the sending device. Therefore, the image and sound may be misaligned when viewing a movie or playing a game.
- This headset supports security capabilities that comply with the BLUETOOTH standard to provide a secure connection when the BLUETOOTH wireless technology is used, but security may not be enough depending on the setting. Be careful when communicating using BLUETOOTH wireless technology.
- We do not take any responsibility for the leakage of information during BLUETOOTH communications.
- Connection with all BLUETOOTH devices cannot be guaranteed.
 - A device featuring BLUETOOTH function is required to conform to the BLUETOOTH standard specified by Bluetooth SIG, Inc. and be authenticated.
 - Even if the connected device conforms to the above mentioned BLUETOOTH standard, some devices may not be connected or work correctly, depending on the features or specifications of the device.
 - While talking on the phone hands free, noise may occur, depending on the device or communication environment.
- Depending on the device to be connected, it may require some time to start communications.

Note on static electricity

- Static electricity accumulated in the body may cause mild tingling in your ears. To minimize the effect, wear clothes made from natural materials.

Others

- When you use the headset as wired headphones, use the supplied dedicated headphone cable only. Make sure that the headphone cable is firmly inserted.
- Do not place this headset in a place exposed to humidity, dust, soot or steam, or subject to direct sunlight. Do not leave the headset in a car for a long time. It may cause a malfunction.
- Using the BLUETOOTH device may not function on mobile phones, depending on radio wave conditions and location where the device is being used.
- Listening with this headset at high volume may affect your hearing.
- For traffic safety, do not use this headset while driving or cycling.
- Do not put weight or pressure on this headset as it may cause the headset to deform during long storage.
- Do not use the headset in places where it would be dangerous if you are unable to hear ambient sound, such as at railroad crossings, train station platforms, pedestrian crossings, and construction sites.
- Do not subject the headset to excessive shock.
- Clean the headset with a soft dry cloth.
- Do not expose the headset to water. The headset is not waterproof. Remember to follow the precautions below.

- Be careful not to drop the headset into a sink or other container filled with water.
 - Do not use the headset in humid locations or bad weather, such as in the rain or snow.
 - Do not get the headset wet. If you touch the headset with wet hands, or put the headset in a damp article of clothing, the headset may get wet and this may cause a malfunction of the headset.
-
- If you experience discomfort after using the BLUETOOTH device, stop using the BLUETOOTH device immediately. Should any problem persist, consult your nearest Sony dealer.
 - Install the earbuds firmly. If an earbud accidentally detaches and is left in your ear, it may cause injury.
 - Since children may swallow small parts such as an earbud, keep the headset out of reach of children.
 - If you have any questions or problems concerning this headset that are not covered in this manual, please consult your nearest Sony dealer.

4-697-051-11(4) Copyright 2017 Sony Corporation

Trademarks

- The Bluetooth® word mark and logos are registered trademarks owned by the Bluetooth SIG, Inc. and any use of such marks by Sony Corporation is under license.
- The N-Mark is a trademark or registered trademark of NFC Forum, Inc. in the United States and in other countries.
- Qualcomm is a trademark of Qualcomm Incorporated, registered in the United States and other countries, used with permission. aptX is a trademark of Qualcomm Technologies International, Ltd., registered in the United States and other countries, used with permission.
- Android, Google Play, Google and the Google Assistant are trademarks of Google LLC.
- Windows is a registered trademark or trademark of Microsoft Corporation in the United States and/or other countries.
- Mac, OS X, iPhone, iPod touch and Siri are trademarks of Apple Inc., registered in the U.S. and other countries. App Store is a service mark of Apple Inc., registered in the U.S. and other countries.
- The LDAC name and logo is a trademark of Sony Corporation.
- IOS is a trademark or registered trademark of Cisco in the U.S. and other countries and is used under license.

Other trademarks and trade names are those of their respective owners.

Wireless Noise Canceling Stereo Headset
WI-1000X

Customer support websites

Please access the following support website to get the support information about your headset:

For customers in the U.S.A:

<http://esupport.sony.com/>

For customers in Canada:

<http://esupport.sony.com/CA/>

For customers in Latin America:

<http://esupport.sony.com/LA/>

For customers in European countries:

www.sony.eu/support

For customers in China:

<https://service.sony.com.cn/>

For customers in other countries/regions:

<http://www.sony-asia.com/>

Wireless Noise Canceling Stereo Headset
WI-1000X

What can I do to solve a problem?

If the headset does not function as expected, try the following steps to resolve the issue.

- Find the symptoms of the issue in this Help Guide, and try any corrective actions listed.
- Connect the headset to a computer to charge the battery.
You may be able to resolve some issues by charging the battery.
- Reset the headset.
- Initialize the headset.
This operation resets volume settings, etc., and deletes all pairing information.
- Look up information on the issue on the customer support website.

If the operations above do not work, consult your nearest Sony dealer.

Related Topic

- [Charging the headset](#)
- [Customer support websites](#)
- [Resetting the headset](#)
- [Initializing the headset to restore factory settings](#)

Wireless Noise Canceling Stereo Headset
WI-1000X

The headset is not turned on.

- Charge the battery of the headset.
 - The headset cannot be turned on while charging the battery. Remove the micro-USB cable from the headset, and then turn on the headset again.
-

Related Topic

- [Charging the headset](#)
- [Checking the remaining battery charge](#)

Wireless Noise Canceling Stereo Headset
WI-1000X

Charging cannot be done.

- Check that you are using the micro-USB cable supplied.
 - Check that the micro-USB cable is connected to the headset and the computer firmly.
 - Check that the computer is turned on.
 - Check that the computer is not in standby, sleep or hibernation mode.
 - When using Windows 8.1, update using Windows Update.
-

Related Topic

- [Charging the headset](#)

Wireless Noise Canceling Stereo Headset
WI-1000X

Charging time is too long.

- Check that the headset and the computer are directly connected, not via a USB hub.
-

Related Topic

- [Charging the headset](#)

4-697-051-11(4) Copyright 2017 Sony Corporation

Wireless Noise Canceling Stereo Headset
WI-1000X

The headset cannot be recognized by a computer.

- The micro-USB cable is not connected properly to the USB port of the computer. Connect the micro-USB cable again.
- Check that the headset and the computer are directly connected, not via a USB hub.
- A problem may have occurred with the connected USB port of the computer. Connect to another USB port if it is available.
- Try the USB connection procedure again in cases other than those stated above.
- Check that you are using the micro-USB cable supplied.

Wireless Noise Canceling Stereo Headset
WI-1000X

The remaining battery charge of the headset is not displayed on the screen of an iPhone or iPod touch.

-
- The remaining battery charge is shown only on the screen of an iPhone or iPod touch (iOS 5.0 or later) that supports HFP (Hands-free Profile).
 - Make sure that the iPhone or iPod touch is connected with HFP (Hands-free Profile). Otherwise, the remaining battery charge will not be displayed correctly.
-

Related Topic

- [Checking the remaining battery charge](#)

Wireless Noise Canceling Stereo Headset
WI-1000X

No sound

- Check that both the headset and the connected device (i.e., smartphone) are turned on.
 - An A2DP BLUETOOTH connection is not made between the headset and the BLUETOOTH device. Use the BLUETOOTH device and make an A2DP BLUETOOTH connection.
 - Turn up the volume of the headset and the connected device (i.e., smartphone).
 - Check that the connected device is playing back.
 - If you are connecting a computer to the headset, make sure the audio output setting of the computer is set for a BLUETOOTH device.
 - Pair the headset and the BLUETOOTH device again.
 - Check that the dedicated headphone cable is connected firmly.
-

Related Topic

- [How to make a wireless connection to BLUETOOTH devices](#)
- [Listening to music from a device via BLUETOOTH connection](#)

Wireless Noise Canceling Stereo Headset
WI-1000X

Low sound level

- Turn up the volume of the headset and the connected device.

4-697-051-11(4) Copyright 2017 Sony Corporation

Low sound quality

- Turn down the volume of the connected device.
- Keep the headset away from a microwave oven, Wi-Fi device, etc.
- Bring the headset and the BLUETOOTH device closer together. Remove any obstacles between the headset and the BLUETOOTH device.
- Keep the headset away from a TV.
- Switch the BLUETOOTH connection to A2DP by operating the BLUETOOTH device when HFP or HSP is set.
- If you connect a device with a built-in radio or tuner to the headset, broadcasts may not be received, or sensitivity may be reduced. Locate the headset farther away from the device and check that you can listen to the broadcasts satisfactorily.
- If you have previously connected the headset to this BLUETOOTH device, only an HFP/HSP BLUETOOTH connection may be made when the headset is turned on. If this happens, use the BLUETOOTH device and make an A2DP BLUETOOTH connection.
- When you listen to music from a computer on the headset, sound quality may be poor for the first few seconds after a connection is made. This is caused by the computer transmitting music at sound quality for communications at first, and it is not a malfunction. If the sound quality does not improve after a few seconds, press the ►|| button on the headset once during playback. Or, operate the computer to make an A2DP connection. Refer to the operating instructions supplied with your computer for computer operation.

Sound skips frequently during playback.

- Set the headset to the “Priority on stable connection” mode. For details, refer to “[About the sound quality mode.](#)”
- Remove any obstacles between the antenna of the BLUETOOTH device to be connected and the built-in antenna of the headset. The antenna of the headset is built into the part shown in the dotted line below.

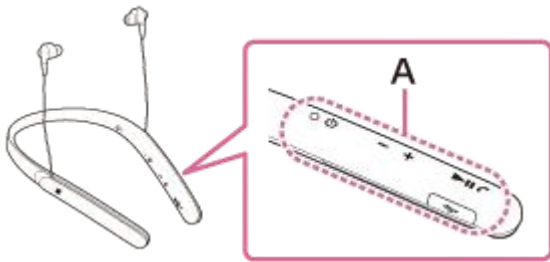

A: Location of the built-in antenna

- BLUETOOTH communications may be disabled, or noise or audio dropout may occur under the following conditions.
 - There is a human body between the headset and the BLUETOOTH device. This situation may be improved by placing the BLUETOOTH device facing the antenna of the headset.
 - There is an obstacle, such as metal or wall, between the headset and the BLUETOOTH device.
 - A device using 2.4 GHz frequency, such as a Wi-Fi device, cordless telephone, or microwave oven, is in use near this headset.
- The situation may be improved by changing the wireless playback quality settings or fixing the wireless playback mode to SBC on the transmitting device. For details, refer to the operating instructions supplied with the transmitting device.
- Because BLUETOOTH devices and Wi-Fi (IEEE802.11b/g/n) use the same frequency (2.4 GHz), microwave interference may occur resulting in noise or audio dropout or communications being disabled if this headset is used near a Wi-Fi device. In such a case, perform the following.
 - Use this headset at least 10 m (30 feet) away from the Wi-Fi device.
 - If this headset is used within 10 m (30 feet) of a Wi-Fi device, turn off the Wi-Fi device.
 - Install this headset and the BLUETOOTH device as near to each other as possible.
- In case that you enjoy music with your smartphone, the situation may be improved by shutting down unnecessary apps or restarting your smartphone.

Wireless Noise Canceling Stereo Headset
WI-1000X

The noise canceling effect is not sufficient.

- Make sure that the noise canceling function is turned on (the indicator (green) next to NC/AMBIENT button lights up).
 - Adjust the earpad position to fit your ears.
 - The noise canceling function is effective in low frequency ranges such as airplanes, trains, offices, near air-conditioning, and is not as effective for higher frequencies, such as human voices.
-
-

Related Topic

- [What is noise canceling?](#)
- [Using the noise canceling function](#)
- [About the Automatic AI noise canceling function](#)

Pairing cannot be done.

- Bring the headset and the BLUETOOTH device within 1 m(3 feet) from each other.
 - When you turn on the headset for the first time after purchasing, initializing, or repairing it, the headset enters pairing mode automatically. Pair the headset with a BLUETOOTH device. When you want to pair a 2nd or subsequent device, press and hold the  button of the headset for more than 7 seconds to enter pairing mode.
 - When you pair the headset with devices again after initializing or repairing the headset, information for pairing with the headset remaining on the iPhone or other device may prevent you from pairing them successfully. In this case, delete the pairing information of the headset from the device, and then pair them again.
-

Related Topic

- [About the indicator](#)
- [How to make a wireless connection to BLUETOOTH devices](#)
- [Initializing the headset to restore factory settings](#)

Unable to connect the headset to a BLUETOOTH device with one-touch connection (NFC)

- Keep the smartphone close to the headset until the smartphone reacts. If you fail to connect, move the smartphone slowly on the N-Mark of the headset.
 - Check that the NFC function of the smartphone is set to on.
 - If the smartphone is in a case, remove it.
 - NFC reception sensitivity varies depending on the device. If you repeatedly fail to connect the headset with a smartphone by one touch, connect it to the headset by on-screen operation on the smartphone.
 - You cannot make a one-touch connection (NFC) while charging the battery because the headset cannot be turned on. Finish charging first, and then make the one-touch connection (NFC).
 - You cannot make a one-touch connection (NFC) when the dedicated headphone cable is connected to the micro-USB port. Remove the dedicated headphone cable from the headset.
-

Related Topic

- [One-touch connection \(NFC\) with a smartphone \(Android 4.1 or later\)](#)

Unable to make a BLUETOOTH connection

- Check that the headset is turned on.
 - Check that the BLUETOOTH device is turned on and the BLUETOOTH function is on.
 - If the headset automatically connects to the last connected BLUETOOTH device, you may fail to connect the headset to other devices via the BLUETOOTH function.
In that case, operate the last connected BLUETOOTH device and disconnect the BLUETOOTH connection.
 - The BLUETOOTH device is in sleep mode. Cancel the sleep mode.
 - The BLUETOOTH connection is terminated. Make the BLUETOOTH connection again.
 - In case that the pairing information for the headset has been deleted on the connected device, pair the headset with the device again.
-

Related Topic

- [About the indicator](#)
- [How to make a wireless connection to BLUETOOTH devices](#)

Wireless Noise Canceling Stereo Headset
WI-1000X

Distorted sound

- Keep the headset away from a microwave oven, Wi-Fi device, etc.

4-697-051-11(4) Copyright 2017 Sony Corporation

The BLUETOOTH wireless communication range is short, or the sound skips.

- Set the headset to the “Priority on stable connection” mode. For details, refer to “[About the sound quality mode.](#)”
- Remove any obstacles between the antenna of the BLUETOOTH device to be connected and the built-in antenna of the headset. The antenna of the headset is built into the part shown in the dotted line below.

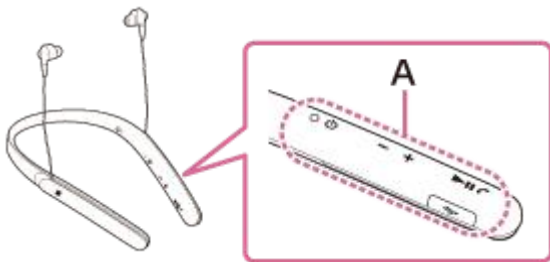

A: Location of the built-in antenna

- BLUETOOTH communications may be disabled, or noise or audio dropout may occur under the following conditions.
 - There is a human body between the headset and the BLUETOOTH device. This situation may be improved by placing the BLUETOOTH device facing the antenna of the headset.
 - There is an obstacle, such as metal or wall, between the headset and the BLUETOOTH device.
 - A device using 2.4 GHz frequency, such as a Wi-Fi device, cordless telephone, or microwave oven, is in use near this headset.
- The situation may be improved by changing the wireless playback quality settings or fixing the wireless playback mode to SBC on the transmitting device. For details, refer to the operating instructions supplied with the transmitting device.
- Because BLUETOOTH devices and Wi-Fi (IEEE802.11b/g/n) use the same frequency (2.4 GHz), microwave interference may occur resulting in noise or audio dropout or communications being disabled if this headset is used near a Wi-Fi device. In such a case, perform the following.
 - Use this headset at least 10 m (30 feet) away from the Wi-Fi device.
 - If this headset is used within 10 m (30 feet) of a Wi-Fi device, turn off the Wi-Fi device.
 - Install this headset and the BLUETOOTH device as near to each other as possible.
- In case that you enjoy music with your smartphone, the situation may be improved by shutting down unnecessary apps or restarting your smartphone.

Wireless Noise Canceling Stereo Headset
WI-1000X

The headset does not operate properly.

- Reset the headset. Pairing information is not deleted by this operation.
 - If you cannot use the headset even after resetting it, initialize the headset.
-

Related Topic

- [Resetting the headset](#)
- [Initializing the headset to restore factory settings](#)

Wireless Noise Canceling Stereo Headset
WI-1000X

No voice from callers

- Check that both the headset and the connected device (i.e., smartphone) are turned on.
 - Turn up the volume of the headset and the connected device (i.e., smartphone).
 - Check that output of the BLUETOOTH device is set for the headset.
 - Select an HFP or HSP BLUETOOTH connection by operating the BLUETOOTH device.
 - If you are listening to music using the headset, stop playback, press the  button on the headset and talk.
-

Related Topic

- [How to make a wireless connection to BLUETOOTH devices](#)
- [Receiving a call](#)
- [Making a call](#)

Wireless Noise Canceling Stereo Headset
WI-1000X

Low voice from callers

- Turn up the volume of the headset and the connected device.

4-697-051-11(4) Copyright 2017 Sony Corporation

Wireless Noise Canceling Stereo Headset
WI-1000X

Resetting the headset

If the headset cannot be turned on, or if it cannot be operated even when it is turned on, connect the headset to a booted computer using the supplied micro-USB cable, then press the  button and NC/AMBIENT button simultaneously. The headset will be reset. Pairing information is not deleted.

To charge the headset after resetting, disconnect and reconnect the micro-USB cable.

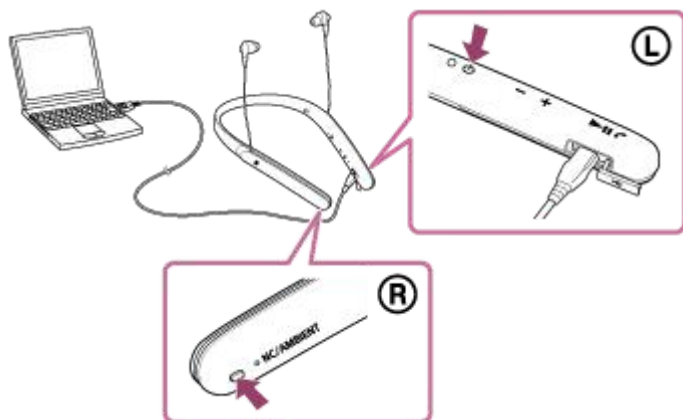



If the headset does not operate correctly even after resetting, initialize the headset to restore factory settings.





Related Topic

- [Initializing the headset to restore factory settings](#)

Wireless Noise Canceling Stereo Headset
WI-1000X

Initializing the headset to restore factory settings

Disconnect the micro-USB cable, turn off the headset, then press and hold the  button and  button simultaneously for more than 7 seconds.

The indicator (blue) flashes 4 times (   ), and the settings such as the volume adjustment are reset to the factory settings. All pairing information is deleted. In this case, delete the pairing information for the headset on the device which has been connected, then pair the headset with the device again.

If the headset does not operate correctly even after initializing, consult your nearest Sony dealer.