

# STIHL 015

Occasional User Saw



# STIHL®

**Warning:**  
Always follow safety precautions in  
owner's manual – improper use  
can cause serious injury.

## Important Safety Precautions

1. Do not operate a chain saw when you are fatigued.
2. Use safety footwear, snug-fitting clothing, and eye, hearing and head protection devices.
3. Use caution when handling fuel. Move the chain saw at least 10 feet (3 m) from the fueling point before starting the engine.
4. Do not allow other persons to be near the chain saw when starting or cutting with the chain saw. Keep bystanders and animals out of the work area.
5. Do not start cutting until you have a clear work area, secure footing, and a planned retreat path from the falling tree.
6. Hold the chain saw firmly with both hands, the right hand on the rear handle and the left hand on the front handle, when the engine is running. Use a firm grip with thumbs and fingers encircling the chain saw handles.
7. Keep all parts of your body away from the saw chain when the engine is running.
8. Before you start the engine, make sure the saw chain is not contacting anything.
9. Carry the chain saw with the engine stopped, the guide bar and saw chain to the rear, and the muffler away from your body.
10. Do not operate a chain saw that is damaged, improperly adjusted, or is not completely and securely assembled. Be sure that the saw chain stops moving when the throttle trigger is released.
11. Shut off the engine before setting it down.
12. Use extreme caution when cutting small size brush and saplings because slender material may catch the saw chain and be whipped toward you or pull you off balance.
13. When cutting a limb that is under tension be alert for spring back so that you will not be struck when the tension in the wood fibers is released.

continued on the back inside cover →

# Stihl 015, 015 L, 015 L electronic, 015 AV, 015 AV electronic

## **Congratulations!**

You are the owner of a precision-manufactured STIHL chain saw designed to give you long and dependable service. To receive maximum performance and satisfaction from your STIHL chain saw, it is important that you read and understand the maintenance and safety precautions before using your saw. Contact your STIHL Dealer or the STIHL Distributor for your area if you do not understand any of the instructions or warnings in this Manual.

This Manual contains warnings regarding your saw, operating and safety instructions for all STIHL 015 series power saws.

## **Warning!**

Because a chain saw is a high-speed wood-cutting tool, some special safety precautions must be observed as with any other power saw to reduce the risk of personal accidents. Careless or improper use may cause serious or even fatal injury.

It is important that you fully understand the contents of this Manual and that you allow only persons who understand this Manual to operate your chain saw.

Pay special attention to the cutting techniques and safety precautions outlined on pages 4 to 19.

STIHL's philosophy is to continually improve all of its products. As a result, engineering changes and improvements are made from time-to-time. Written notices relating to such changes are sent to STIHL Dealers and are available to you. If the operating characteristics or the appearance of your saw differs from those described in this Manual, please contact your local STIHL Dealer for updated information and assistance.

## **Operating Instructions Sharpening and Maintenance of Saw Chains**

### **Contents**

Parts of the Chain Saw	2
Safety Precautions	4
Fuel	20
Chain Oil	20
Mounting the Bar and Chain	21
Chain Brake	22
Starting	23
Cutting Attachment	26
Air Filter	28
Carburetor	28
Starter Assembly	29
Replacing the Chain Sprocket	31
Maintenance Chart	33
Specifications	34
Sharpening and Maintenance of Oilomatic Picco Chain	35

**STIHL**<sup>®</sup>

Andreas Stihl  
Postfach 1760

D-7050 Waiblingen

## Parts of the Chain Saw

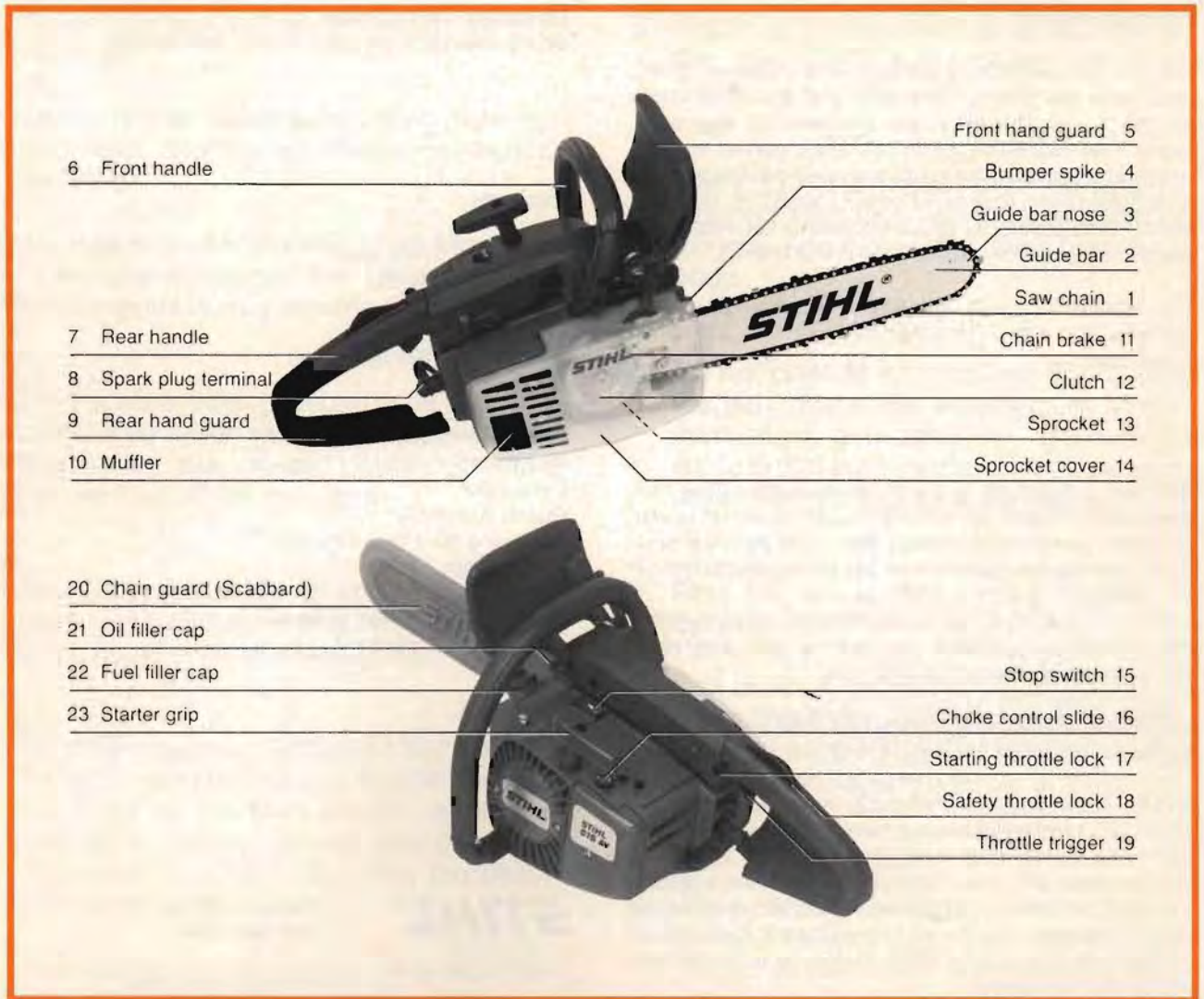

## Definitions

1. **Saw Chain.** A loop consisting of cutters, tie straps and drive links.
2. **Guide Bar.** Supports and guides the saw chain.
3. **Guide Bar Nose.** The exposed part of the guide bar.
4. **Bumper Spike.** Toothed stop for holding saw steady against wood.
5. **Front Hand Guard.** Provides protection against projecting branches and helps prevent the left hand from touching the chain if it slips off the handle bar.
6. **Front Handle.** Handle bar for the left hand at front of saw.
7. **Rear Handle.** The support handle for the right hand, located at or toward the rear of the saw.
8. **Spark Plug Terminal.** Connects the spark plug with the ignition wire.
9. **Rear Hand Guard.** Gives added protection to operator's right hand.
10. **Muffler.** Attenuates exhaust noises and diverts exhaust gases in required direction.
11. **Chain Brake.** An optional device to stop the rotation of the chain if activated by the operator's hand in a kick-back-situation.
12. **Clutch.** Couples engine to chain sprocket when engine is accelerated beyond idle speed.
13. **Sprocket.** The toothed wheel that drives the saw chain.
14. **Sprocket Cover.** Covers the clutch and the sprocket.
15. **Stop Switch.** Switches the engine's ignition system off and stops the running of the engine.
16. **Choke Control Slide.** Eases engine starting by enriching mixture.
17. **Starting Throttle Lock.** Keeps the throttle partially open during starting.
18. **Safety Throttle Lock.** Must be depressed before activating the throttle trigger.
19. **Throttle Trigger.** Controls the speed of the engine.
20. **Chain guard (Scabbard).**
21. **Oil Filler Cap.** For closing the oil tank.
22. **Fuel Filler Cap.** For closing the fuel tank.
23. **Starter Grip.** The grip of the pull starter, which is the device to start the engine.
24. **Chain Catching Bolt.** Catches a broken chain and guides it inside the sprocket cover (not illustrated).

## Safety Precautions



The use of any chain saw may be hazardous. The saw chain has large, sharp cutters. If the cutters contact your flesh, they will cut you, even if the chain is not moving. At full throttle, the chain speed can reach 45 mph (20 m/s). It is important that you read, fully understand and observe the following safety precautions and warnings. Read the owner's manual **and** the safety instructions periodically. Pay special attention to the section on reactive forces, pages 10 to 13. Reactive forces, including kickback, can be dangerous. Careless or improper use of any chain saw may cause serious or fatal injury.

All safety precautions that are generally observed when working with an axe or a hand saw also apply to the operation of chain saws. However, because a chain saw is a highspeed, fast cutting power tool, special safety precautions must be observed to reduce the risk of personal accidents.

Have your STIHL dealer show you how to operate your chain saw. Observe all applicable local safety regulations, standards and ordinances.

### **Warning!**

Minors should never be allowed to use a chain saw. Bystanders, especially children and animals should not be allowed in the area where a chain saw is in use (ill. 1).

4



Never let the saw run unattended. Store it in a locked place away from children and empty the fuel tank before storing for longer than a few days.

Do not lend your chain saw without the Owner's Manual. Be sure that anyone using your saw understands the information contained in this Manual.

These safety precautions and warnings apply to the use of all STIHL chain saws. Different models may have different parts and controls. See the appropriate section of your Owner's Manual for a description of the controls and function of the parts of your model saw.

Safe use of a chain saw involves

1. the operator
2. the saw
3. the use of the saw.

### **THE OPERATOR**

#### **Physical Condition**

You must be in good physical condition and mental health and not under the influence of any substance (drugs, alcohol, etc.) which might impair vision, dexterity or judgment. Do not operate a chain saw when you are fatigued (ill. 2).

Be alert – If you get tired while operating your chain saw, take a break, tiredness may result in loss of control.

Working with any chain saw can be strenuous. If you have any condition that might be aggravated by strenuous work, check with your doctor before operating a chain saw.

### Proper Clothing

Clothing must be sturdy and snug-fitting, but allow complete freedom of movement. Avoid loose-fitting jackets, scarfs, neckties, jewelry, flared or cuffed pants, or anything that could become entangled with the saw or brush. Wear overalls or jeans with a reinforced cutting resistant insert (ill. 3).

Protect your hands with gloves when handling saw and saw chain. Heavy-duty, nonslip gloves improve your grip and protect your hands.

Good footing is most important in chain saw work. Wear sturdy boots with nonslip soles. Steel-toed safety boots are recommended.

Proper eye protection is a must. Non-fogging, vented goggles or a face screen is recommended. Their use reduces the risk of eye injury.

Wear an approved safety hard hat to protect your head. Wear sound barriers (ear plugs or ear muffers) to protect your hearing.



### THE SAW

Parts of the chain saw; illustrations and definitions of the parts see pages 2 and 3!

#### Warning!

Never modify a chain saw in any way. Only attachments supplied by STIHL or expressly approved by STIHL for use with the specific STIHL saw models are authorized. Although certain unauthorized attachments are useable with the STIHL powerhead, their use may, in fact, be extremely dangerous.

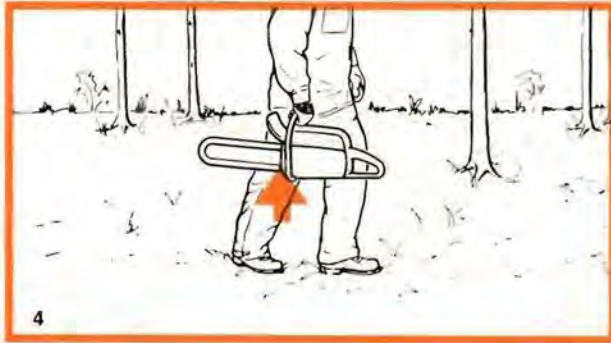

## THE USE OF THE SAW

### Transporting the chain saw

#### Warning!

Always stop the engine before putting a chain saw down or carrying it. Carrying a chain saw with the engine running is extremely dangerous. Accidental acceleration of the engine can cause the chain to rotate. Avoid touching the hot muffler.

**By hand:** When carrying your saw by hand, the engine must be stopped and the saw must be in the proper position. Grip the front handle and place the muffler at the side away from the body (ill. 4).

The chain guard (scabbard) should be over the chain and the guide bar which should point backwards. When carrying your saw the bar should be behind you (ill. 5).

**By vehicle:** When transporting in a vehicle, keep chain and bar covered with the chain guard. Properly secure your saw to prevent turnover, fuel spillage and damage to the saw.

6



### Preparation for the use of the saw

Take off the chain guard and inspect for safety in operation. For assembly please follow the procedure described on pages 21 and 22.

STIHL-Oilomatic chain, guide bar and sprocket must match each other.

If the guide bar or chain is replaced, it must be with a bar or chain of the same type. Replacement with another type of guide bar or chain will seriously increase the chances of operator injury due to the contact of the moving chain with the operator during rotational kickback.

#### Warning!

Proper tension of the chain is extremely important. In order to avoid false setting the tensioning procedure must be followed as described on pages 21 and 22. Make always sure the hexagonal nut for the sprocket cover is tightened securely after tensioning the chain. Check chain tension once more after having tightened the nut and thereafter at regular intervals (whenever the saw is cut off). If the chain becomes loose while cutting, shut off the engine and then tighten. Never try to tighten the chain while the engine is running!





### Fueling

Your STIHL chain saw uses an oil-gasoline mixture for fuel (see page 20).

#### Warning!

Gasoline is an extremely flammable fuel. Use extreme caution when handling gasoline or fuel mix. Do not smoke or bring any fire or flame near the fuel (ill. 6).

### Fueling Instructions

Fuel your chain saw in well-ventilated areas, outdoors only.

Always shut off the engine and allow it to cool before refueling. Relieve fuel tank pressure by loosening fuel cap slowly.

Select bare ground for fueling and move at least 25 feet (7.5 m) from fueling spot before starting the engine.

Wipe off any spilled fuel before starting your saw and check for leakage.

Check for fuel leakage while refueling and during operation. If fuel or oil leakage is found, do not start or run the engine until leak is fixed and spilled fuel has been wiped away.



### Starting

#### Warning!

Your chain saw is a one-person saw. Do not allow other persons to be near the chain saw. Start and operate your saw without assistance.

For safe and specific starting instructions, see the appropriate section of this manual on pages 23 to 25.

Do not drop start. This method is very dangerous because you may lose control of the saw (see figure 7).

Place the chain saw on firm ground or other solid surface in an open area. Maintain a good balance and secure footing. Be absolutely sure that guide bar and chain are clear of you and all other obstructions and objects, including the ground; because when the engine starts at starting- throttle, engine speed will be fast enough for the clutch to engage sprocket and turn the chain, which may cause kickback to occur.

Engage the chain brake when starting a Quickstop model (see page 23).

Never attempt to start the saw when the guide bar is in a cut or kerf.

When you pull the starter grip, don't wrap the rewind starter around your hands. Do not allow the grip to snap back, but guide the starter rope slowly back to permit the rope to rewind properly. Failure to follow this procedure may result in injury to hand or fingers and may damage the starter mechanism.

### Working Conditions

Operate your chain saw only outdoors in a ventilated area. Operate the saw under good visibility and daylight conditions only.

**Warning!** Take extreme care in wet and freezing weather (rain, snow, ice). Put off the work when the weather is windy, stormy or rainfall is heavy. Clear the area where you are working.

**Warning!** Avoid stumbling on obstacles such as stumps, roots or rocks and watch out for holes or ditches. Be extremely cautious when working on slopes or uneven ground. There is increased danger of slipping on freshly debarked logs.

### Cutting Instructions

**Grip:** Always hold the saw firmly with both hands when the engine is running. Place your left hand on front handle bar and your right hand on rear handle and throttle trigger. Left-handers should follow this instruction too.

Wrap your fingers tightly around the handles, keeping the handles cradled between your thumb and forefinger (ill. 8). With your hands in this position, you can best oppose and absorb the push, pull and kickback forces of your saw without having it slip out of your grip (see section of reactive forces). Make sure your chain saw handles and grip are in good condition and free of moisture, pitch, oil or grease.

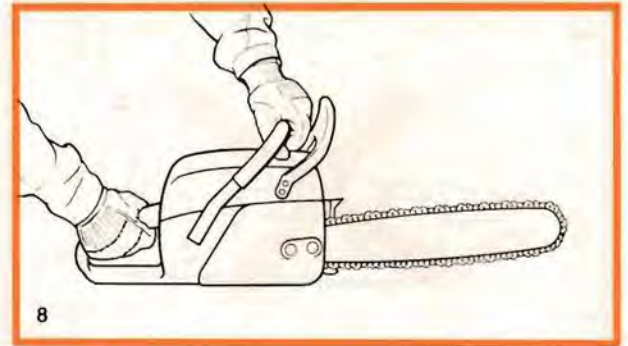

**Warning!** Never use the saw with one hand. You cannot control reactive forces (see pages 10 to 13) and may lose control of the saw.

### Important adjustments

**Warning!** At correct idle speed, chain should not turn. For directions to adjust idle speed, see the appropriate section of this Owner's Manual.

Do not use a saw with incorrect idle speed adjustment. Adjust the idle speed your-self according to the appropriate section of this manual.

Have your STIHL Dealer check your saw and make proper adjustments or repairs.

After adjusting a chain start the saw, let the engine run for a while, then switch engine off and recheck chain tension. Proper chain tension is very important at all times.

**Warning!** Never touch a rotating chain with your hand or any part of your body.

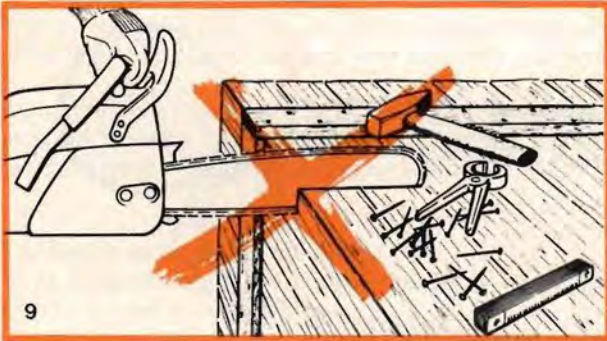

### Warning!

Do not cut any material other than wood or wooden objects.

Use your chain saw for cutting only. It is not designed for prying or shoveling away limbs, roots or other objects.

When sawing, make sure that the saw chain does not touch any foreign materials such as rocks, nails and the like (ill. 9). Such objects may be flung off, damage the saw chain or cause the saw to kick back.



In order to keep control of your saw, always maintain a firm foothold. Never work on a ladder, in a tree or on any other insecure support. Never use the saw overhead (ill. 10).

Position the chain saw in such a way that your body is clear of the cutting attachment whenever the engine is running. Stand to the left of cut while bucking (see ill. 11).



Don't put pressure on the saw when reaching the end of a cut. The pressure may cause the bar and rotating chain to pop out of the cut or kerf, go out of control and strike the operator or some other object. If the rotating chain strikes some other object a reactive force (see pages 10 to 13) may cause the chain to strike the operator.

## Reactive forces during the cut, including kickback

### Warning!

Reactive forces, that may occur during any cut are kickback, pushback and pull-in. Reactive forces can be dangerous! In any chain saw, the powerful force used to cut wood can be reversed (and work against the operator). If the rotating chain is suddenly stopped by contact with any solid object like a log or branch or is pinched, the reactive forces instantly occur. These reactive forces may result in loss of control which may, in turn, cause serious or fatal injury. An understanding of the causes of these reactive forces may help you avoid loss of control.

The most common reactive forces are

- kickback,
- pushback,
- pull-in.

### Kickback:

Kickback occurs when the upper quadrant of the bar nose contacts a solid object in the wood or is pinched (ill. 12). The reaction of the cutting force of the chain causes a rotational force of the chain saw in the direction opposite to the chain movement, flinging the bar in a uncontrolled arc mainly in the plane of the bar. Under some circumstances the bar moves towards the operator who may suffer severe or fatal injury. It may also occur during limbing. It also occurs when the nose of the guide bar is pinched unexpectedly, unintentionally contacts solid material in the wood (ill. 13) or is incorrectly used to begin a plunge or boring cut.

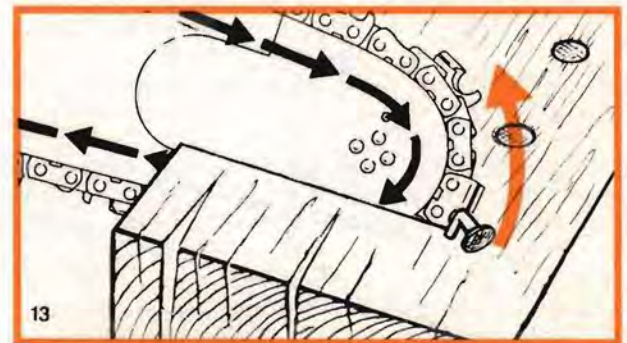
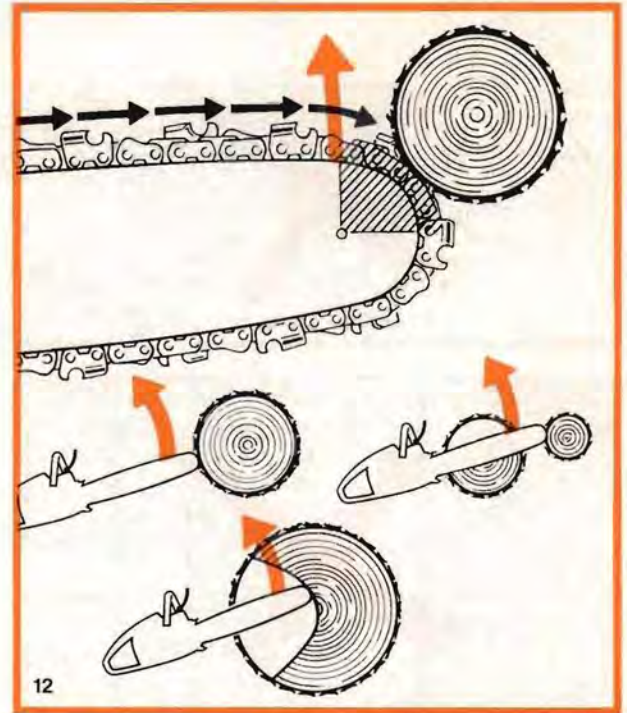

The greater the force of the kickback reaction, the more difficult it becomes for the operator to control the saw.

Many factors influence the occurrence and force of the kickback reaction. The type of bar and saw chain you use is a factor in the force of the kickback reaction.

**The radius of the guide bar nose.**

Kickback tendency increases as the radius or size of the guide bar nose increases.

**The speed of contact at which the cutter contacts the object.**

Kickback forces increase with the rate of impact.

**The contact angle between the nose of the bar and the foreign object** (see ill. 12).

Kickback is most pronounced in the upper quadrant of the bar nose.

**The saw chain.**

Some **STIHL chain types** are designed to reduce kickback forces.

**The depth gauges:**

Improper lowering of the depth gauges also increases the chance of a kickback.

**The sharpening condition:**

An improperly sharpened chain increases the risk of a kickback.

**To avoid kickback**

The best protection from personal injury that may result from kickback is to avoid kickback situations:

1. Hold the chain saw firmly with both hands and maintain a secure grip.
2. Be aware of the location of the guide bar nose at all times.
3. Never bring the nose of the guide bar in contact with any object. Do not cut limbs with the nose of the guide bar. Be especially careful with small, tough limbs, small size brush and saplings which may easily catch the chain.
4. Don't overreach.
5. Don't cut above shoulder height.
6. Begin cutting and continue at full throttle.
7. Cut only one log at a time.
8. Use extreme caution when re-entering a previous cut.
9. Do not attempt plunge cuts (see page 16) if you are not experienced with these cutting techniques.
10. Be alert for shifting of the log or other forces that may cause the cut to close and pinch the chain.
11. Maintain saw chain properly. Cut with a correctly sharpened, properly tensioned chain at all times.
12. Stand to the side of the cutting path of the chain saw.



#### Devices for reducing the risk of kickback

STIHL has developed a chain stopping system designed to reduce the risk of injury in a kickback situation. The device is called a Quickstop. The Quickstop is available as an option on many STIHL saws. This device does not prevent kickback, but will stop the chain in some kickback situations if the operator's left hand is in position to activate the Quickstop lever by contacting the front hand guard.

When a kickback occurs, the chain saw rotates in the plane of the bar. The left hand, when properly gripping the front handle behind the front handguard should engage the Quickstop lever. This activates the Quickstop and stops the chain (see ill. 14).

STIHL has developed guide bars with a small radius nose. These guide bars are designed to reduce the kickback tendency and are available as an option.

12 STIHL has developed chains with cutters whose configuration are designed to reduce kickback forces. These chains are available as an option.

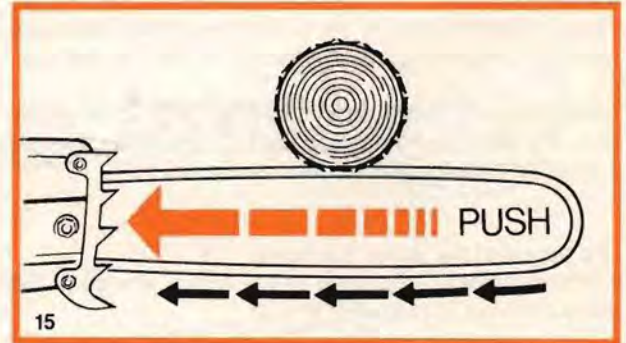

However, even if your saw has a "Quickstop" a narrow nose bar or a guard-link or a pro-guard chain, it does not guarantee that you will not be injured by a "kickback" and therefore, you should observe all of the precautions to prevent kickback discussed previously.

#### Warning!

Chain saw kickback may cause serious or fatal injury. To reduce the risk of kickback injuries STIHL recommends that you equip your saw with a narrow nose bar, low profile chain or other chain designed to reduce kickback forces, and a STIHL Quickstop.

#### Pushback:

Pushback occurs when the chain on the top of the bar is suddenly stopped when it is pinched, caught or encounters a foreign object in the wood. The reaction of the chain drives the saw straight back toward the operator causing loss of saw control. Pushback frequently occurs when the top of the bar is used for cutting (see ill. 15).

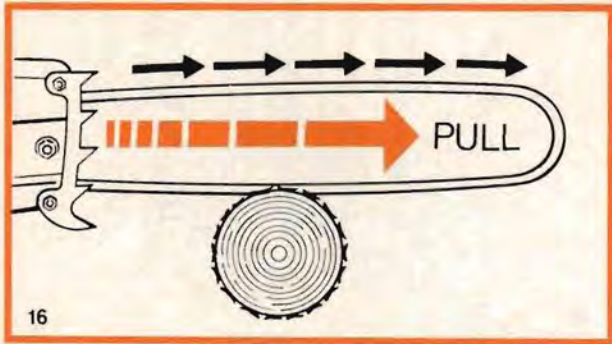

#### To avoid pushback

1. Be alert to forces or situations that may cause material to pinch the top of the chain.
2. Do not cut more than one log at a time.
3. Do not twist the saw when withdrawing the bar from a plunge cut or under buck cut (figures 26 to 28 and 34, pages 16, 17 and 19), because the chain can pinch.

#### Pull-in:

Pull-in occurs when the chain on the bottom of the bar is suddenly stopped. The chain on the bottom of the bar stops when it is pinched, caught or encounters a foreign object in the wood (see ill. 16). The reaction of the chain pulls the saw forward, causing the operator to lose control.

Pull-in frequently occurs when the bumper spike of the saw is not held securely against the tree or limb and when the chain is not rotating at full speed before it contacts the wood.

#### Warning!

Use extreme caution when cutting small size brush and saplings which may easily catch the chain and pull you off balance.

#### To avoid pull-in

1. Always start a cut with the chain rotating at full speed and the bumper spike in contact with the wood.
2. Pull-in may also be prevented by using wedges to open the kerf or cut.

#### Cutting Techniques

##### Felling

Felling is cutting down a tree.

Before felling a tree, consider carefully all conditions which may affect the direction of fall, including:

- The intended direction of the fall.
- The natural lean of the tree.
- Any unusually heavy limb structure.
- Surrounding trees and obstacles.
- The wind direction and speed.

#### Warning!

Always observe the general conditions of the tree. Look for decay and rot in the trunk. If it is rotted inside, it could snap and fall toward the operator while being cut.

Also look for broken or dead branches which could vibrate loose and fall on the operator. When felling on a slope, the operator should stand on the up-hill side if possible.

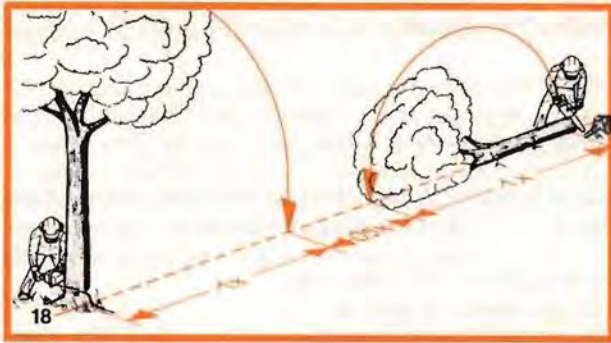

When felling in the vicinity of roads, railways and power lines, etc., take extra precautions (see ill. 17). Inform the police, utility company or railway authority before beginning to cut.

When felling, maintain a distance of at least 2½ tree lengths from the nearest person (see ill. 18).

**14 Note:** The noise of your engine may drown any warning call.



**Felling Instructions:**

First clear the tree base and work area from interfering limbs and brush and clean its lower portion with an axe (ill. 19).

Then, establish a path of escape and remove all obstacles. This path should be opposite to the planned direction of the fall of the tree and at a 45° angle (ill. 20). An alternate path must also be selected. Place all tools and equipment a safe distance away from the tree, but not on the escape path.





21

If the tree has large buttress roots, cut into the largest buttresses vertically first (horizontally next) and remove (ill. 21).

Then, determine the placement of the felling notch (ill. 22). The felling notch when properly placed determines the direction in which the tree will fall. It is made perpendicular to the line of fall and should be as close to the ground as possible. Cut the felling notch to a depth of about one-fifth to one-fourth of the trunk diameter (ill. 23). It should be in no case higher than it is deep. Make the felling notch very carefully.



22

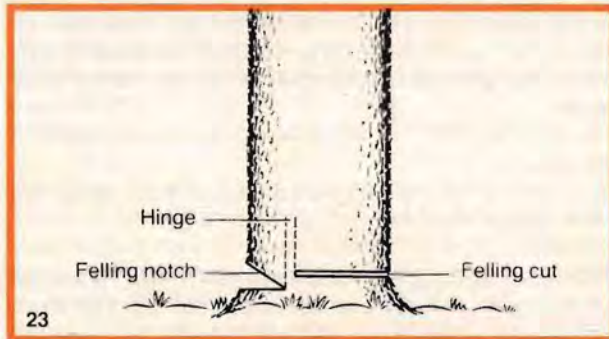

23

Begin the felling cut slightly higher than the felling notch and on the opposite side of the tree (ill. 23). Then cut horizontally through towards the felling notch. Apply the chain saw with its spikes directly behind the uncut portion of wood and cut toward the notch (ill. 24). Leave approximately  $\frac{1}{10}$  of the tree diameter uncut. This is the hinge (ill. 24). Do not cut through the hinge because you could lose control of the direction of the fall. Drive wedges into the felling cut where necessary to control the direction of the fall. Wedges should be of wood, light alloy or plastic – never of steel, which can cause kick-back and damage to the chain.

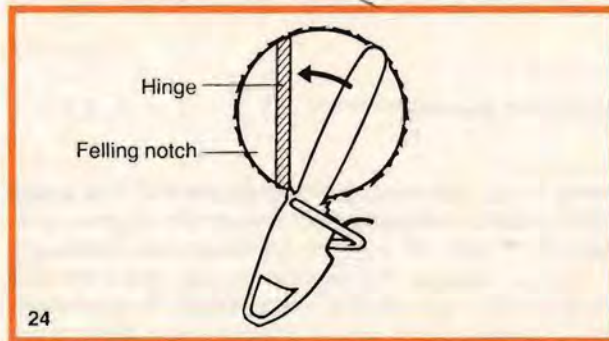

24

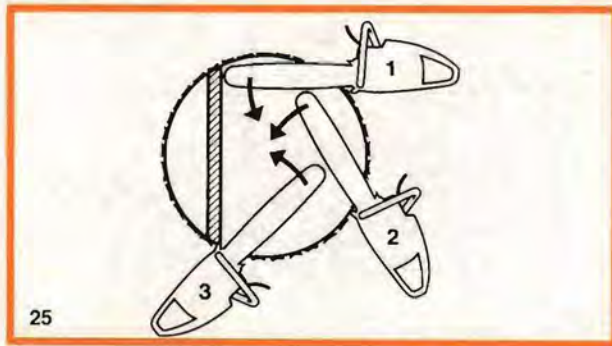

Always keep to the side of the falling tree. When the tree starts to fall, cut off the engine, withdraw the bar and walk away on the pre-planned escape path. Watch out for falling limbs.

**Warning!**

Be extremely careful with partially fallen trees which are poorly supported.

When the tree hangs or for some other reason does not fall completely, set the saw aside and pull the tree down with a cable winch, block and tackle or tractor. If you try to cut it down with your saw, you may be injured.

**Sectioning Method**

**Warning!**

Felling a tree that has a diameter greater than the length of the guide bar requires use of either the sectioning or plunge-cut method. These methods are extremely dangerous because they involve the use of the nose of the guide bar and can result in kickback. Only properly trained professionals should attempt these techniques.

16

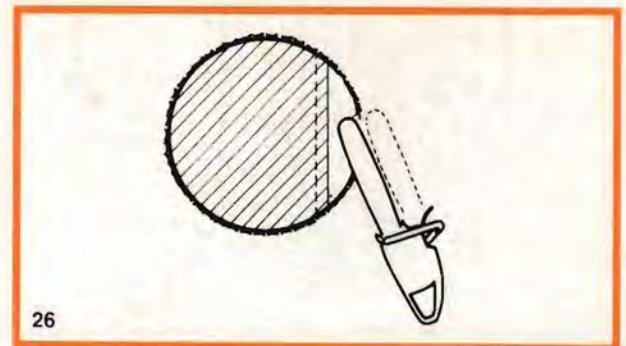

For the sectioning method (ill. 25) make the first cut with the guide bar fanning in toward the hinge. Then, using the bumper spika as a pivot, reposition the saw for the next cut. Avoid repositioning the saw more than necessary. When repositioning for the next cut, keep the guide bar fully engaged in the kerf to keep the felling cut straight. If the saw begins to pinch, insert a wedge to open the cut. On the last cut, do not cut the hinge.

**Plunge-Cut Method**

Timber having a diameter more than twice the length of the guide bar requires the use of the plunge-cut method before making the felling cut.

First, cut a large, wide notch. Make a plunge cut in the center of the notch.

The plunge cut is made with the guide bar nose. Begin the plunge cut by applying the lower portion of the guide bar nose to the tree at an angle (ill. 26). Cut until the depth of the kerf is about the same as the width of the guide bar

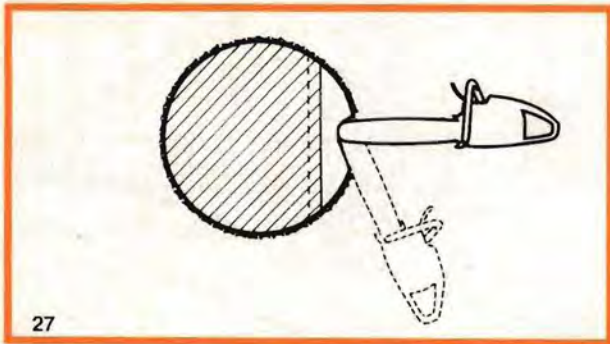

27

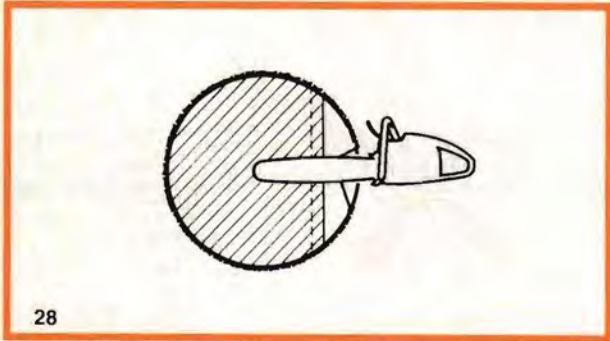

28

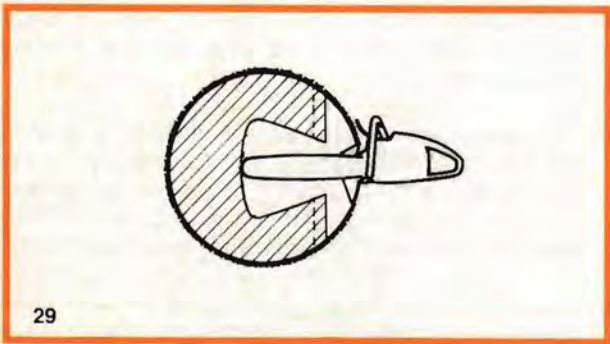

29

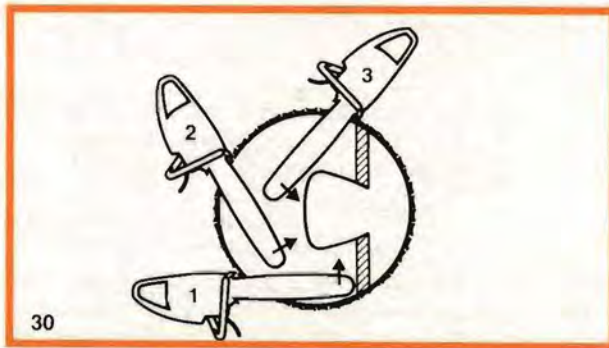

30

(ill. 27). Next, align the saw in the direction in which the recess is to be cut.

With the saw at full throttle, insert the guide bar in the trunk (ill. 28).

Enlarge the plunge cut as shown in illustration (ill. 29).

**Warning!**

There is an extreme danger of kickback at this point. Extra caution must be taken to maintain control of the saw. To make the felling cut, follow the sectioning method described previously (ill. 30).

If you are inexperienced with a chain saw plunge-cutting should not be attempted. Seek the help of a professional.

**Limbing**

Limbing is removing the branches from a fallen tree.

**Warning!**

There is an extreme danger of kickback during the limbing operation. Do not work with the nose of the bar. Be extremely cautious and avoid contacting the log or other limbs with the nose of the guide bar.

Do not stand on a log while limbing it – you may slip or the log may roll.



31 Start limbing by leaving the lower limbs to support the log off the ground (ill. 31). Always cut from the top of the limb. Do not underbuck freely hanging limbs. A pinch may result or the limb may fall, causing loss of control. If a pinch occurs, stop the engine and remove the saw, by lifting the limb.

**Warning!**

Be extremely cautious when cutting limbs under tension. The limb could spring back toward the operator and cause loss of control of the saw or injury to the operator.

**Bucking**

Bucking is cutting a log into sections.

**Warnings!**

1. When bucking, do not stand on the log. Make sure the log will not roll down-hill. If on a slope, stand on the up-hill side of the log (see ill. 32). Watch out for rolling logs.
2. Cut only one log at a time.
3. Shattered wood should be cut very carefully. Sharp slivers of wood may be caught and flung in the direction of the operator of the saw.



4. When cutting small logs, use a sawhorse (ill. 33). Never permit another person to hold the log. Never hold the log with your leg or foot.
5. Logs under strain require special attention to prevent the saw from pinching. The first cut is made on the compression side to relieve the stress on the log (see ill. 34, 35). The bucking cut is then made as shown. If the saw pinches, stop the engine and remove it from the log.
6. Only properly trained professionals should work in an area where the logs, limbs and roots are tangled (i.e. a

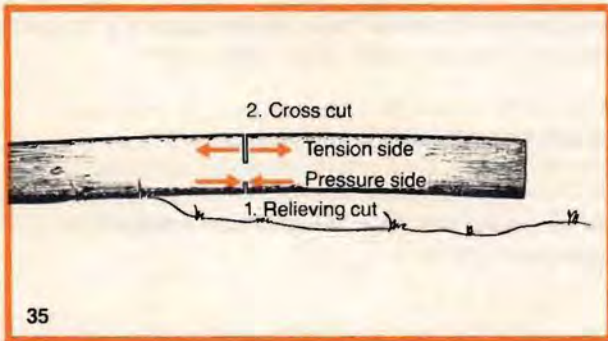
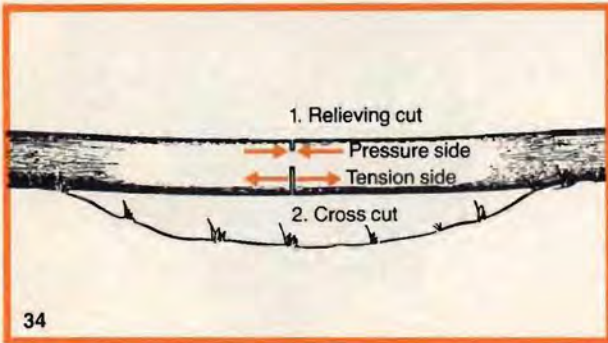

blowdown area, ill. 36). Working in blowdown areas is extremely hazardous.

7. Drag the logs into a clear area before cutting. Pull out exposed and cleared logs first.

### Maintenance and Repair

Never operate a chain saw that is damaged, improperly adjusted or not completely or securely assembled. Follow the maintenance and repair instructions in the appropriate section of your Owner's Manual.

#### Warning!

Always stop the engine and make sure that the chain is stopped before doing any maintenance or repair work or cleaning the saw. Do not attempt any maintenance or repair work not described in your Owner's Manual. Have such work performed at your STIHL service shop only.

### MAINTAINING AND STORING THE SAW

Keep the chain, bar and sprocket clean and lubricated; replace worn sprockets or chains.

Keep the chain sharp. You can spot a dull chain when easy-to-cut wood becomes hard to cut and burn marks appear on the wood.

Keep the chain at proper tension. Tighten all nuts, bolts and screws except the carburetor adjustment screws after each use.

Keep spark plugs and wire connections tight and clean.

Store saws in a high or locked place, away from children.

## Fuel

Fuel tank cap open



The two-stroke engine is powered by a mixture of regular gasoline and engine oil.

Never use high octane gasoline as it contains benzol which will permanently damage the carburetor diaphragms.

Only use STIHL two-cycle engine oil or other branded two-cycle engine oils for mixing. The mix ratio is 1:40 (1 part oil to 40 parts regular gasoline) with STIHL two-cycle engine oil or 1:25 for other branded engine oils.

During the running-in period use a fuel-oil mixture of ratio 1:25 for the first five tank fillings.

**Important: Always shake mixture in fuel can vigorously before fueling.**

## Chain Oil

Oil filler cap open



The service life of the chain and bar depends on good lubrication and the quality of the lubricating oil.

**Never use waste oil for this purpose!**

Always use the chain lubricating oil approved by STIHL and appointed dealers.

If special chain lubricating oil is not available, one of the high-duty, single-grade engine oils listed below may be used in an emergency, depending on the outside temperature.

Outside temperature +10°C ... +40°C: SAE 30

Outside temperature +10°C ... -10°C: SAE 20

Outside temperature -10°C ... -30°C: SAE 20 W or  
SAE 10 W or

Always top up with chain oil when you refuel. Carefully clean the area around the filler caps before opening and make sure that no dirt falls into the tank while you are refueling.

## Mounting the Bar and Chain

Removing the chain sprocket cover



The guide bar and Oilomatic chain are supplied separately.

To mount them, first unscrew the collar nut (1) and take off the chain sprocket cover (2). On Quickstop models the chain brake must be released before the sprocket cover is removed, i. e. pull hand guard (3) towards handlebar. Take off and **discard** cardboard spacer washer.

Now move nut (4) of chain tensioner back as far as the stop by turning the tensioning screw (5) counterclockwise.

Locate slot of guide bar over the stud bolt (6) so that the peg of the tensioning nut (4) engages in the lower fixing hole (7).

Starting at the chain sprocket, place the Oilomatic chain on the guide bar so that the cutting edges on the top of the bar are facing the bar nose (8). Push chain sprocket tight (2) onto stud bolt (6), screw on collar nut (1) finger tight.

Top: Backing off the tensioning nut  
Center: Locating the guide bar  
Bottom: Fitting the Oilomatic chain –  
cutting edges face the bar nose

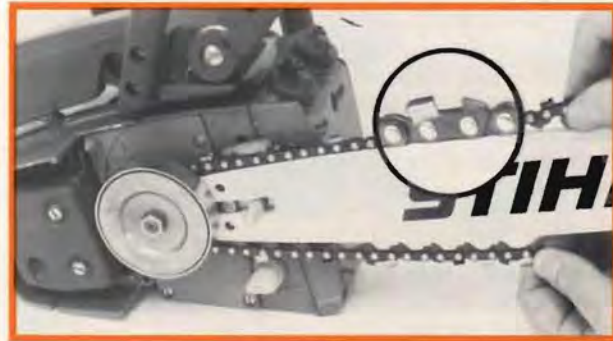
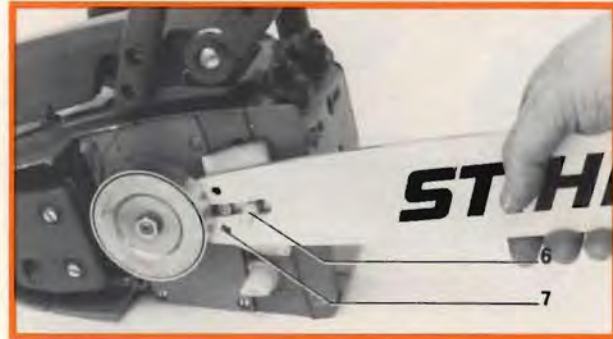
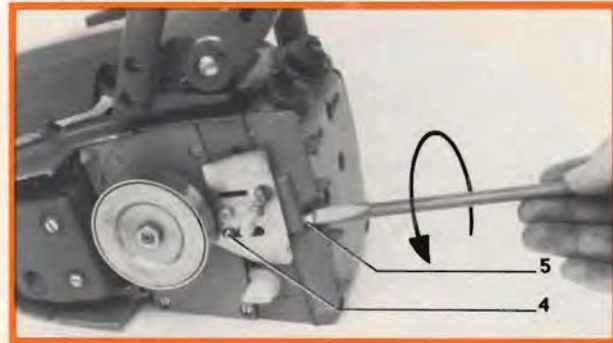

Top: Tensioning the Oilomatic chain  
Bottom: Checking chain tension



Now tension the Oilomatic chain by turning the tensioning screw (5) clockwise, making sure that the drive link tangs are lined up with the bottom groove of the bar. Hold the bar nose (8) up and turn tensioning screw (5) until the Oilomatic chain is properly seated on the underside of the bar. While still holding the bar nose up, tighten the collar nut (1) securely.

The Oilomatic chain is correctly tensioned when it fits snugly on the underside of the bar but can still be pulled easily around the bar.

22

## Chain Brake (Quickstop model only)

Chain brake engaged



The chain brake is actuated by means of the front hand guard.

### Engaging the chain brake

When the hand guard is moved towards the nose of the guide bar the actuating lever automatically unlatches the brake lever and the spring-assisted brake band is clamped round the clutch drum at the same instant. This causes the saw chain to be brought to a standstill and locked in position.

### Releasing the chain brake

The locked saw chain must be released before cutting can be continued. To do this, pull the hand guard back against the handlebar – this disengages the brake band from the clutch drum.

**Important:** Apart from starting and emergencies, the chain brake may be engaged only when the saw is idling. The chain brake is subject to normal wear. It is therefore necessary to have it regularly serviced and maintained by trained personnel (STIHL servicing dealer) to insure that it is always in good working order.



## Starting

Chain brake engaged



Start your saw without assistance of a second person. Keep other people clear of the general work area of the saw.

Place the chain saw on firm ground or other solid surface in an open area. Have a good balance and secure footing. Be absolutely sure that guide bar and chain are clear of you and all other obstructions and objects, including the ground. When engine starts (at starting-throttle position), engine speed will be fast enough for the clutch to engage sprocket and turn the chain, which may cause kickback to occur.

### Starting procedure

1. Engage the chain brake on **Quickstop models** by pushing the hand guard (1) towards the bar nose.
2. Move stop switch (2) away from "Stop".
3. If the engine is **cold**, move choke lever (3) to "Choke".

If the engine is **warm**, move choke lever (3) away from "Choke". This also applies if the engine has been running but is still cold.

Top: Stop switch away from "Stop"  
Center: Choke lever in "Choke" position (cold start)  
Bottom: Choke lever away from "Choke" (warm start)



Starting throttle position on 015, 015 L, 015 LE



4. Set throttle trigger to starting throttle position: Depress at first safety throttle lock (4), then throttle trigger (5) and starting throttle lock (6). Next release throttle trigger (5) and then starting throttle lock (6).

**Important!** Take care that the starting throttle lock is different positioned.

5. Hold the front handle bar with your left hand, for type AV also put your right foot through rear handle.
6. Pull starter grip (9) slowly with your right hand until you feel the starter engage. Then make a short, quick pull. Do not allow the grip to snap back, but guide the starter rope slowly back to permit the rope to rewind properly.

Crank until the engine fires. Then open choke (choke lever away from "Choke") if the saw is cold and pull again. Failure to follow this procedure may result in injury to hand or fingers and may damage the starting mechanism.

Top: Starting throttle position on 015 AV, 015 AVE  
Center: Correct handling of the chain saw  
Bottom: Starting



Top: Idle position  
Center: Chain brake released  
Bottom: Stop switch in "Stop" position

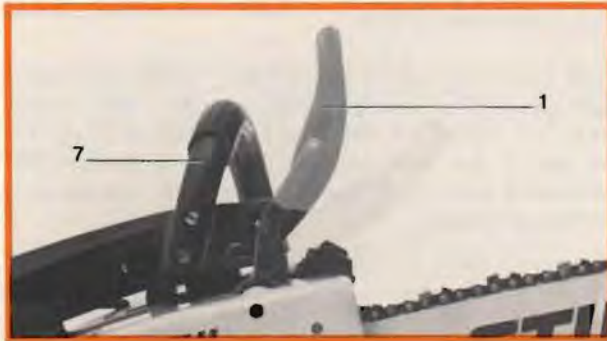

7. As soon as engine is running, depress throttle trigger (5) momentarily to release starting throttle lock (6) and allow the engine to run on idle speed.
8. On Quickstop machines, disengage the chain brake before starting cutting work: Push the hand guard (1) toward the handle bar (7).
9. The engine is stopped by moving the stop switch (2) to the "Stop" position.

#### Hints for starting a chain saw:

When starting a cold engine only keep the choke closed until the engine begins to fire. Then open choke fully – choke lever away from "Choke" – even if the engine stops and you have to repeat the starting procedure. If the choke is left closed, the combustion chamber will flood and stall the engine.

If you opened the choke after the engine fired and the engine still does not run after several attempts, it is already flooded. In such a case, remove and dry off the spark plug. Clear the combustion chamber by cranking the engine over several times on the starter with the spark plug removed. The stop switch should be off (move to "Stop") and the throttle in starting throttle position during this process:

At very low outside temperatures do not open the choke fully immediately after starting. First allow engine to warm up for a brief period with very little throttle (release). Then release throttle trigger and open the choke.

A new engine or one which has been run until the fuel tank is dry will not start first time after refueling because the carburetor's diaphragm pump has to be primed with fuel by cranking the engine over several times on the starter.

## Cutting Attachment

Guide bar with oil inlet and locating holes

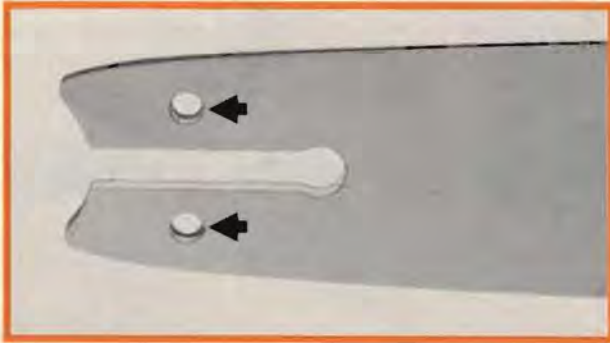

The cutting attachment of a chain saw consists of the guide bar, saw chain and chain sprocket.

### Guide bar

The nose and underside of the guide bar are subjected to particular high stress and strain. To avoid one-sided wear, turn the guide bar over every time you sharpen or replace the chain. Regular cleaning of the oil inlet holes and the guide bar groove is also very important.

The guide bar can be examined for signs of wear at the same time. A minimum groove depth of 5 mm (0.2 in) must be maintained in order to avoid the drive link tangs scraping the bottom of the groove (the cutters and tie straps would not be able to run on the guide bar rails).

This depth should be measured at the spot where the bar is stressed most, i.e. the bar nose on Duromatic bars and the area with which most cutting is done on Rollomatic bars.

The guide bar must be replaced if the minimum depth cannot be maintained.

To lubricate the Rollomatic guide bar, place chain saw on its side so that the bar nose is firmly supported. Clean the grease hole and pump in grease while slowly pulling saw chain around bar (sprocket rotates) so that bearing is uniformly filled. When grease emerges at the hole on the other side of the bar or around the nose sprocket, repeat the procedure on the other side.

### Chain lubrication

Never operate the chain saw without proper chain lubrication. Check operation of chain lubrication and level in oil tank before starting work.

Hold chain saw with mounted cutting attachment over a light background. Take care, the Oilomatic chain must not touch the ground, i.e. keep it at least 20 cm (8 in) clear of the ground. Run the engine with half-throttle position. If an increasing patch of oil can be seen, chain lubrication is operating correctly.

Checking chain lubrication



### Breaking in the saw chain

Every new chain has to be broken in for about 2 to 3 minutes. Ample chain lubrication is essential during this period. After breaking in, check chain and adjust if necessary.

### Correct chain tension

The chain must always be slackened off after finishing cutting work. A chain properly tension when it is warm would, when the temperature drops, be subjected to such great contraction stresses that the chain would break and also damage the crankshaft and bearings.

The chain must, therefore, always be tensioned – with the engine off – before you start cutting. Chain tension is correct in the cold condition when the chain fits snugly on the underside of the bar and can still be moved along the bar by hand. Extreme care must be taken as the cutting edges are very sharp.

Worn chain sprocket



When the chain saw is operated at extremely low outside temperatures a correctly cold-tensioned chain will begin to sag noticeably as it warms up to normal operating temperature. The chain must then be retensioned. However, the chain must be **immediately** slackened off again after shutting down the saw. This is necessary to avoid contraction stress which would occur as the chain cools down to ambient temperature.

A new chain must be retensioned more frequently than a used one until it has stretched fully.

### Chain sprocket

The stress and strain on the chain sprocket are particularly high. If the wear marks on the teeth are very pronounced (about 0.5 mm/0.02 in), the sprocket should be replaced. A worn sprocket reduces the service life of the saw chain. The chain sprocket should be replaced with every second chain. It is best to use two chains alternately with one sprocket.

## Air Filter

Disassembly of air filter



The air filter is designed to retain the dirt in the air, which is sucked into the engine, in order to reduce the wear of the moving parts.

A dirty air filter will cause a loss in the power of the engine, it will increase the fuel consumption and make starting more difficult.

**Therefore clean air filter daily!**

Close choke shutter before removing the air filter in order to prevent dirt from entering the carburetor, which is positioned behind the air filter. Loosen the cylinder head screw with the combination wrench and remove the cover and the air filter which is a felt "plate".

To clean the air filter tap filter lightly onto the palm of your hand dirty side down or clean it with a soft brush and then wash it in straight gasoline.

If air filter is badly clogged it must be replaced by a new one because even a careful cleaning will show only temporary results.

## Carburetor

H = High speed adjustment screw

L = Low speed adjustment screw

LA = Idle speed regulating screw



The carburetor of your chain saw has been carefully adjusted at the factory for maximum performance under average atmospheric conditions. When working at high altitudes or near sea level the carburetor, however, may need readjusting. Check carburetor adjustment with warm engine and a clean air filter.

**Normal adjustment of carburetor: (Turn adjustment screws in carefully until they are seated).**

**High speed adjustment screw (H):**  $\frac{1}{2}$  of a turn open

**Low speed adjustment screw (L):**  $\frac{3}{4}$  of a turn open

**Engine stops when idling:**

With engine running turn idle speed regulating screw (LA) clockwise (the chain should not turn at idle speed).

**Chain turns when engine idles:**

Turn idle speed regulating screw counter-clockwise.

## Starter Assembly

### Replacing a broken rope

Carefully pull off the spark plug socket and choke control after closing the choke by shifting the choke control lever to "Choke" in direction of arrow. Unscrew spark plug and cylinder head of air cleaner cover and take off cover with air cleaner element.

For Types 015, 015 L and 015 L electronic, remove the 4 cylinder head screw at the hood and remove the hood together with the starter assembly. Slide shortcircuit switch toward "Stop" in direction of arrow.

For Types 015 AV and 015 AV electronic, remove 3 cylinder head screws from the hood, 1 cylinder head screw from the handle tube and 1 from the gripp shell. Take off hood with starter assembly. Force the lock washer from the starter axle and clear rope rotor from the starter axle first by about 10 mm (0.4 in). Insert screwdriver bit of the combination wrench through the rope guide bore of the hood, use it to push the rewind spring back and hold it in this position. Now completely pull the rope rotor off the starter axle.

Remove the remaining rope from the rotor, thread in a new 3.5 mm (0.14 in) dia., 960 mm (37.8 in) long rope and anchor it to the rotor with a simple knot. Pass the other end of the rope through the guide bore from inside, thread it through the starter grip from below and fasten it with a figure-eight knot.

Apply a few drops of non-resinous oil to the bearing bushing of the rope rotor. Attach the rotor to the starter axle, turning it back and forth until the inner eye of the rewind spring snaps into the recess of the rotor. Use the lock washer for locking.

Top: Fastening screws of 015 I  
Center: Fastening screws of 015 AV  
Bottom: Prying loose the lock washer



Top: Rewind spring hooked to nose  
Center: Winding up the starter rope  
Bottom: Tensioning the rewind spring

### Replacing a broken rewind spring

First, remove the rope rotor as described before. The spare spring is supplied ready for installation and secured with a wire loop. Apply a few drops of nonresinous oil to the spring before installing it. When installing, pass the outer eye of the spring over the die-cast nose in the socket of the hood and force the wire loop outward. If the rewind spring should flip out when trying to insert it into the socket, re-install it in clockwise direction from outside to inside. Then reinstall the rope rotor.

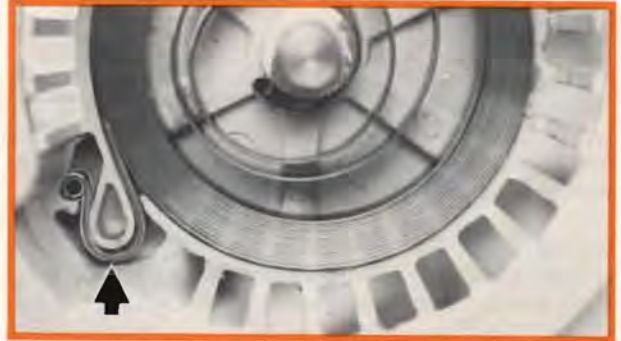

### Tensioning the rewind spring

Wind up the starter rope by turning the rotor in counter-clockwise direction. Form a loop with the free portion of the rope through the recess at the perimeter of the rotor and turn it clockwise three to four times. If the rope is twisted, pull it out through the guide bore and untwist it. Release the rope rotor cautiously and slowly slacken the starter rope until it is wound up by the spring completely.



Then tension of the rewind spring is correct if the starter grip rests firmly in the guide bore. If it does not, tension the spring by another turn.

With the rope fully extended the rotor must rotate for at least another half turn until maximum spring deflection is reached.



**30** Too much load on the spring will break it prematurely.



## Replacing the Chain Sprocket

### On machines without chain brake

Remove chain sprocket cover and cutting attachment. Carefully pry off spark plug terminal, loosen spark plug with combination wrench and remove it from the cylinder. Then pull out starter rope until you can wind the rope end approx. 3 times around the handle bar.

This prevents the starter rope from breaking when tightening the clutch.

To lock the crankshaft screw locking screw into the cylinder by hand until it butts.

**Attention: The clutch has a left hand thread! Therefore unscrew it by turning it clockwise.**

Loosen clutch with the combination wrench (SW 13) and remove it. The clutch shoes are held in place by a retainer washer behind the clutch. When properly installed the projecting rim of the retainer washer must point towards the clutch carrier. Now remove retainer, chain sprocket and needle cage from crankshaft.

Before reassembling the parts, wash needle cage in clean gasoline and lubricate it with some ball bearing grease.

Then put needle cage, chain sprocket and clutch retainer (make sure to install correctly) back into place on crankshaft. Screw clutch onto crankshaft by hand. Unwind starter rope from handle frame and hold it with your left hand. Now tighten clutch with the combination wrench until piston bottoms on the crankshaft locking screw, at the same time let starter rope glide back slowly.

Now tighten clutch securely and reinstall the other parts by reversing the disassembly sequence.

Top: Starter rope wrapped round handlebar  
Center: Removing clutch  
Bottom: Disassembly of clutch and sprocket

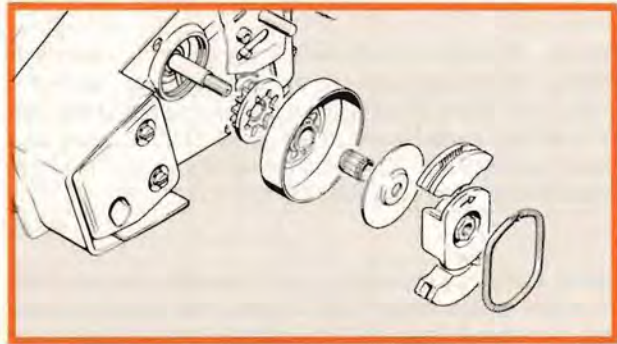

### Machines with chain brake

First remove chain sprocket cover and cutting attachment. Take out spark plug. Pull out starter rope about 30 cm (12 in) and wrap it round the handlebar; this is necessary to prevent the rope breaking away when the clutch is tightened.

Screw locking screw into spark plug hole by hand. Use combination wrench to unscrew hexagon nut and then take off front guide washer. Now insert claws of clutch wrench between clutch shoes and unscrew the clutch.

**Caution: The hexagon nut and clutch spider have left-hand threads – unscrew clockwise.**

After unscrewing the clutch, remove rear guide washer, sprocket and needle bearing from the crankshaft in that order.

Clean stub of crankshaft, wash out needle cage in clean gasoline and lubricate with antifriction bearing grease.

Reverse the above sequence to fit the new chain sprocket. Position rear guide washer so that its raised edge faces the crankcase. When fitting the clutch, make sure that the side on which the thread is drilled out about 2 mm (0.08 in) also faces the crankcase. The raised inner diameter of the front guide washer must fit against the clutch.

Before tightening the clutch, turn crankshaft counterclockwise until piston crown butts against the locking screw. Release starter rope from handlebar at the same time.

Top: Starter rope wrapped round handlebar  
Center: Unscrewing hexagon nut  
Bottom: Removing clutch

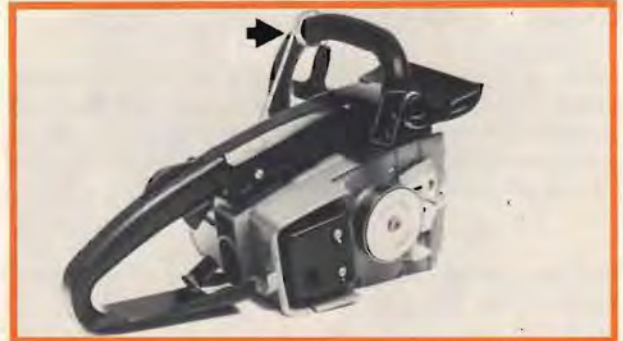

# Maintenance Chart

		before starting work	after finishing work or daily	after each refueling stop	weekly	monthly	if faulty	if damaged	as required	see page:
Complete machine	Visual inspection (condition, leaks)	x		x						
	clean		x							
Throttle trigger, safety throttle lock, stop switch	Check operation	x		x						
Chain brake	Check operation	x		x						22
	Clean				x					
Filter in fuel tank	Clean wire filter									
	Replace felt						x			
Fuel tank	Clean					x				
Chain oil tank	Clean					x				
Chain lubrication	Check	x								26, 27
Saw chain	Inspect, also check sharpness	x		x						
	Check chain tension	x		x						27
	Sharpen								x	35
Guide bar	Inspect (wear, damage)	x								27
	Clean and turn over				x		x			
	Lubricate sprocket nose				x					27
	Deburr				x					
	Replace							x	x	
Chain sprocket	Check				x					
Air filter	Clean	x					x			28
	Replace							x		28
Cooling inlets	Clean		x							
Cylinder fins	Clean					x				
Carburetor	Check idle adjustment – chain must not turn	x		x						28
	Readjust idle								x	28
Spark plug	Readjust electrode gap						x			
All accessible screws and nuts (not adjusting screws)	Retighten								x	
	Inspect				x					
Rubber vibration buffers	To be replaced only by STIHL Dealer							x		
	Inspect									
Spark arrestor screen	Clean or replace									
	Check	x								
Chain catching bolt	Check	x								
	Replace							x		

## Specifications

### Engine

STIHL single-cylinder, two-stroke cycle engine

Piston displacement: 32 cm<sup>3</sup> (1.95 cu.in)  
Cylinder bore: 38 mm (1.5 in)  
Piston stroke: 28 mm (1.1 in)

### Ignition system 015, 015 L, 015 AV

System: Contact-controlled magneto  
Timing: 2.0...2.2 mm  
(0.079...0.087 in) before T.D.C.  
Breaker point gap: 0.35...0.4 mm  
(0.014...0.016 in)

### Ignition system 015 LE, 015 AVE

System: Transistor-controlled  
(contactless) magneto  
Timing: 2.2 mm (0.087 in) before T.D.C.  
Spark plug (suppressed): Bosch WSR 6 F or  
Champion RCJ 6 Y  
electrode gap 0.5 mm (0.02 in)

### Fuel system

Carburetor: All-position diaphragm type  
with integrated fuel pump  
Air filter: Large-area felt element  
Fuel tank capacity: 0.33 l (0.7 pt)  
Fuel mixture: Mixing ratio 1:40 for STIHL  
two-stroke engine oil;  
1:25 for other good-grade  
two-stroke engine oils

### Guide bar and saw chain

Guide bar: Without tungsten carbide on  
chain deflecting surface.  
With tungsten carbide on  
chain deflecting surface  
Cutting length: 25 (10 in) and 30 cm (12 in)  
without carbide  
30 (12 in) and 35 cm (14 in)  
with carbide  
Chain type:  $\frac{3}{8}$ " (9.32 mm) Oilomatic-  
Picco  
Sprocket: 6 teeth  
Chain lubrication: All-automatic, with constant  
oil delivery  
Oil tank capacity: 0.18 l (0.38 pt)

### Weight

with 30 cm (12 in) bar and chain assembly:

Type 015: 4.7 kg (10.4 lb)  
Type 015 L: 5.0 kg (11.0 lb)  
Type 015 AV: 5.2 kg (11.5 lb)

# Sharpening and Maintenance of Oilomatic Picco Chain

## Foreword

Like any other cutting tool, the saw chain is subject to normal wear. A properly sharpened chain will eat into the wood and require very little effort on the part of the operator. For this reason you should never attempt to cut with a dull or damaged chain.

A carefully sharpened saw chain offers many benefits, i. e. a higher cutting capacity, clean and smooth cuts – this means less operator effort, a lower fuel consumption and minimum wear.

There are a few crucial angles which must be maintained in order to obtain good results when sharpening a chain. They are explained below.

## Filing angle

The filing angle on the Oilomatic-Picco chain is  $35^\circ$ ; the chain is initially sharpened to this angle before leaving the factory. However, if you use the chain primarily for cutting hardwood or frozen timber, it is best to sharpen it at an angle of  $30^\circ$ .

Always make sure that the filing angle is exactly the same on all cutters. Irregular angles will cause the chain to run roughly and unevenly as well as increase the rate of wear and result in chain breakage.

## Side plate angle

The upright cutting edge just below the top plate is known as the side plate cutting edge. The side plate angle is the angle between the side plate cutting edge and the horizontal line formed by the cutter toe and heel. The specified side

Top: Filing angle  
Bottom: Side plate angle

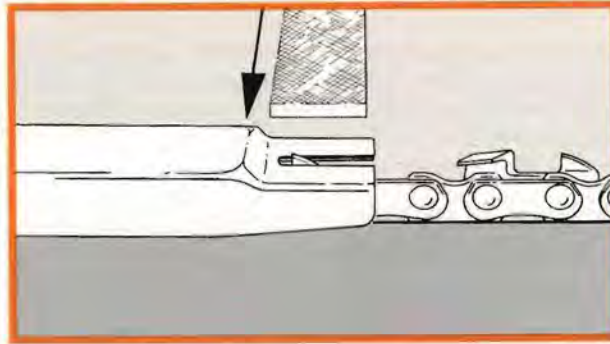
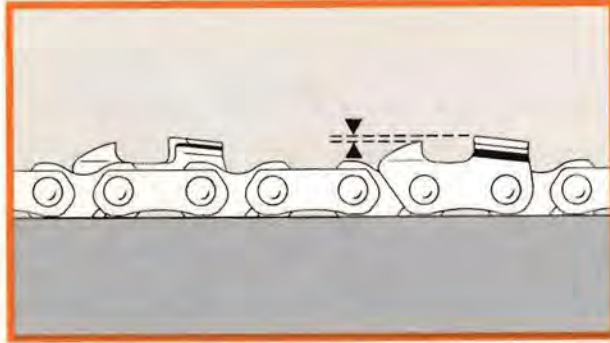

plate angle is  $85^\circ$  for the Oilomatic-Picco chain and is obtained automatically if the file holder 5605 750 4310 is used with the prescribed file and the file is held correctly during sharpening.

### Top plate cutting angle

The top plate cutting angle is  $60^\circ$ . It is also obtained automatically when the chain is sharpened carefully with file holder 5605 750 4310 or another STIHL sharpening tool.

### Sharpening

Only special 3.5 mm dia. saw chain files (part No. 0811 411 8068) may be used for sharpening. The shape and cut of machinists' files makes them unsuitable for saw chain. The file holder 5605 750 4310 or a STIHL filing tool will insure that the file is positioned correctly on the cutter.

All cutters must be filed to the same length. As the top plate slopes downward to the rear (clearance angle) the cutter heights will be uneven if the cutter lengths are different. If the cutters are not all the same height the chain will run roughly and eventually break.

As it is very important to achieve uniform cutter lengths it is best to measure them with a slide caliper. Find and sharpen the shortest cutter first and then use it as a master for all the others, i. e. all cutters must be filed back to the same length as the master cutter. Sharpen all the cutters on one side of the chain first and then repeat the procedure on the other side.

The file must be held level with the top plate so that it is at  $90^\circ$  to the perpendicular faces of the chain links. **The cutters must always be filed from the inside to the outside.**

**36** File evenly and steadily and note that the file only sharpens on the forward stroke.

Top: Top plate cutting angle  
Center: File position  
Bottom: Sharpening with the file holder

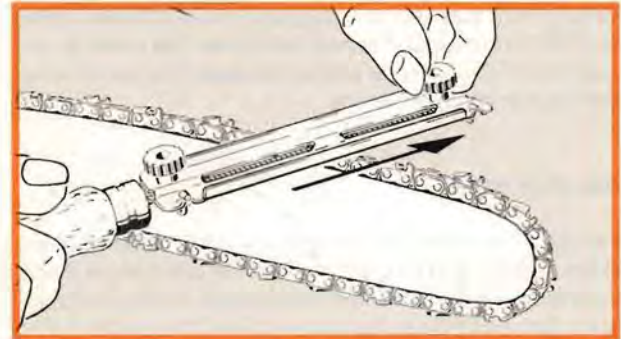
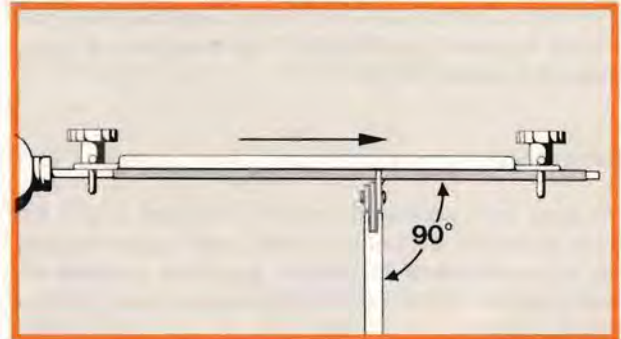
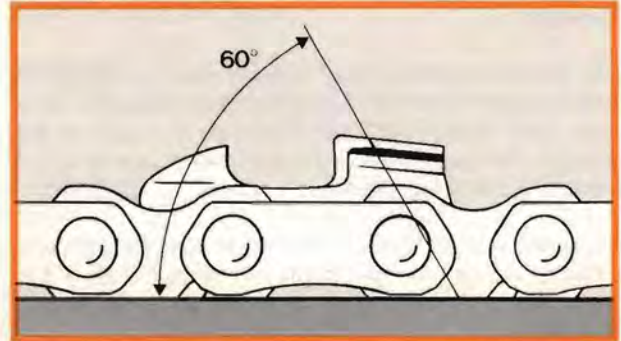

The file must be lifted off the cutter on the backstroke. Make sure you do not touch the tie straps and drive links with the file. Burrs on the cutting edge can be rubbed smooth with a piece of hardwood.

Rotate the file at frequent intervals in order to prevent it becoming worn on one side.

**Important:** Sharpen your chain frequently and take away as little material as possible. Two or three strokes of the file are usually sufficient to keep the chain sharp.

A STIHL electric sharpener greatly simplifies chain sharpening.

### Depth gauges

The depth gauge determines the height at which the cutter enters the wood and thus the thickness of the chip removed. The cutting capacity and life of a saw chain are therefore influenced by the distance between the depth gauge and the cutting edge, i.e. the depth gauge setting. This setting is 0.65 mm on Oilomatic-Picco chain and is checked with the STIHL filing gauge 1110 893 4000.

The best cutting results are obtained with the depth gauges set to this value. However, the depth gauge setting may be increased by 0.2 mm for cutting softwood in mild weather conditions.

As the cutter is sharpened the depth gauge setting is reduced. This means that the height of the depth gauge must be checked and lowered if necessary. If the depth

Top: Depth gauge setting  
Bottom: Filing down depth gauge

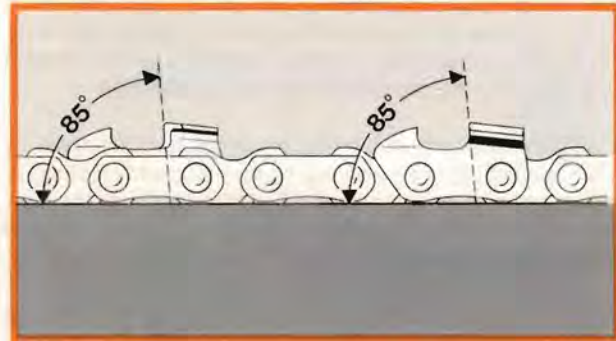
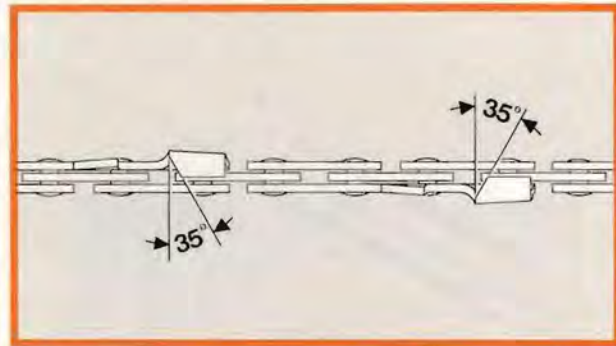

gauge projects from the filing gauge, it must be filed down level with a flat or triangular file.

### General chain maintenance

Chain maintenance begins as soon as the chain is fitted on the bar and sprocket. The essential points are **correct chain tension and ample lubrication**. See also "Cutting Attachment".

Clean the chain thoroughly in gasoline after sharpening in order to remove filings or grinding dust.

STIHL file holder

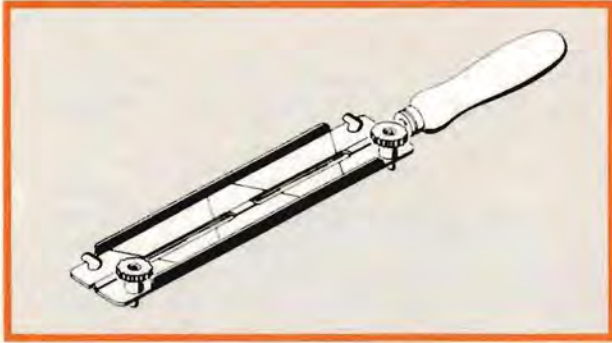

Then lubricate the chain by immersing it in an oil bath. If the chain has not been in use for an extended period, clean it with a brush and immerse it in an oil-paraffin bath.

Carefully examine the chain for cracks in the links or damaged rivets while you are sharpening and cleaning it. Any damaged or worn parts must be replaced. The new parts must then be reworked to match the shape and size of the original parts.

Chain breaking and riveting is best carried out with the STIHL rivet spinner.

#### Tools for chain maintenance

The **filing grid** has reference marks for the filing angle and is attached to the guide bar by means of a magnet.

**File holders**, which also have reference marks for the filing angle, simplify chain sharpening.

If you use the **STIHL "Feilgenau"**, the **STIHL HOS** and **USG electric sharpeners** or the **STIHL rivet spinner**, always follow the separate operating instructions supplied with the tool.

STIHL filing gauge

- 1 = Sighting edge for side plate angle
- 2 = Slots for filing angles
- 3 = Cut-out for depth gauge setting
- 4 = Groove cleaner and scale for groove depth

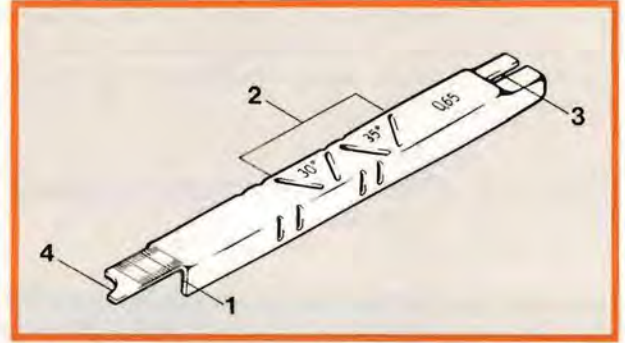

The **filing gauge** is a universal tool for checking the filing and side plate angles as well as the depth gauge setting and cutter length. It can also be used for cleaning the groove and oil inlet hole on the guide bar and measuring the groove depth.



## Attachment for 015 Powerhead

A hedge trimmer attachment and brushcutter attachment are available for mounting to the 015 powerhead. The great advantage is that only one engine is required to power any of the attachments. This makes the powerhead economical even if the individual attachments are only used occasionally.

The attachments are easily mounted in a few minutes. Each attachment has its own corrugated spring clutch for positive transmission of power.

Almost any type of hedge can be efficiently cut using the combination of the lightweight **STIHL HS 151 hedge trimmer attachment** and the 015 powerhead. The 24 in. (60 cm) cutter bar provides high cutting performance and can even tackle 1/2" thick branches.

The lightweight STIHL FS 151 brushcutter attachment combined with the 015 powerhead can be used for practically all clearing, trimming and thinning jobs. Other applications include moving of grass and brush, especially around shrubs, on slopes, along fences and walls – areas that cannot be reached with a normal lawn mower.

Top: HS 151 hedge trimmer attachment  
Bottom: FS 151 brushcutter attachment



For ordering spare parts fill in below the model name of your power tool, the machine number as well as the part number of your chain and guide bar.

This makes ordering of a new chain and bar easier as both parts are wearing parts. The part number for the chain sprocket which from time to time must be replaced as well is already filled in; also the part numbers for the standard chain and guide bar are already filled in.

When purchasing these parts it is sufficient to just mention the model and the respective part number.

The machine number is found at the crankcase, the part number for the chain is marked on the chain box and the one of the guide bar can be found on the guide bar packaging.

<b>Model</b>	.....
<b>Machine number</b>	.....
<b>Chain part number</b>	.... . . . .
<b>Guide bar number</b>	.... . . . .
<b>Sprocket part number</b>	1116 640 2001
<b>Standard chain 30 cm (12 in)</b>	3876 000 0044
<b>Standard bar 30 cm (12 in)</b>	3005 000 6305

**Guaranty for repairs can only be give if the repair work is done by an authorized STIHL-Service Shop using original STIHL spare parts.**

Continuation of  
Important Safety Precautions

14. Keep the handles dry, clean and free of oil or fuel mixture.
15. Operate the chain saw only in well ventilated areas.
16. Do not operate a chain saw in a tree unless specifically trained to do so.
17. **All** chain saw service, other than the items listed in the Owner's Manual maintenance instructions, should be performed by competent chain saw service personnel. (E.g., if improper tools are used to remove the flywheel, or if an improper tool is used to hold the flywheel in order to remove the clutch, structural damage to the flywheel could occur which could subsequently cause the flywheel to burst).
18. Avoid kickback. Kickback is the upward motion of the guide bar which occurs when the saw chain at the nose of the guide bar contacts an object. Kickback can lead to dangerous loss of control of the chain saw.

**To avoid kickback:**

- Hold the chain saw firmly with both hands.
  - Don't over reach.
  - Don't let the nose of the guide bar contact a log, branch, ground or any other obstruction.
  - Cut at high engine speeds.
  - Don't cut above shoulder height.
  - Follow manufacturer's sharpening and maintenance instructions for the saw chain.
  - Use devices such as low kickback chain, which may help to reduce the hazards associated with kickback.
19. When transporting your chain saw, use the appropriate guide bar scabbard.

englisch/english