

STIHL 034

Instruction Manual
Owner's Manual

Assembling
Safety Precautions
Operating Instructions
Maintenance



Warning!

Read and follow all safety precautions in Owner's Manual – improper use can cause serious or fatal injury.

To reduce risk of kickback injury use STIHL reduced kickback bar and STIHL RM 2 (0.325") or RM 2 (3/8") chain depending on sprocket pitch or other available low kickback components.

© Andreas Stihl 1992.

Important Safety Precautions for Chain Saw Users

A. Kickback Safety Precautions

Warning!

Kickback may occur when the nose or tip of the guide bar touches an object, or when the wood closes in and pinches the saw chain in the cut. Tip contact in some cases may cause a lightning fast reverse reaction, kicking the guide bar up and back towards the operator. Pinching the saw chain along the top of the guide bar may push the guide bar rapidly back towards the operator. Either of these reactions may cause you to lose control of the saw which could result in serious personal injury.

Section 5.12 of ANSI B 175.1-1991 sets certain performance and design criteria related to chainsaw kickback. STIHL has developed a color code system using green and yellow to help you select a powerhead, bar and chain combination that complies with the kickback requirements of the ANSI Standard. See the sections entitled "Safety Precautions" and "Specifications" of this manual.

Do not rely exclusively upon the safety devices built into your saw. As a chainsaw user, you should

take several steps to keep your cutting jobs free from accident or injury.

1. With a basic understanding of kickback, you can reduce or eliminate the element of surprise. Sudden surprise contributes to accidents.
2. Keep a good firm grip on the saw with both hands, the right hand on the rear handle, and the left hand on the front handle, when the engine is running. Use a firm grip with thumbs and fingers encircling the chainsaw handles. A firm grip will help you reduce kickback and maintain control of the saw. Don't let go.
3. Make sure that area in which you are cutting is free from obstructions. Do not let the nose of the guide bar contact a log, branch, or any other obstruction which could be hit while you are operating the saw.
4. Cut at high engine speeds.
5. Do not overreach or cut above shoulder height.

6. Follow manufacturer's sharpening and maintenance instructions for the saw chain.

7. Only use replacement bars and chains specified by the manufacturer or the equivalent.

B. Other Safety Precautions

- Do *not* operate a chainsaw with one hand! Serious injury to the operator, helpers, bystanders, or any combination of these persons may result from one-handed operation. A chainsaw is intended for two-handed use.
1. Do not operate a chainsaw when you are fatigued.
 2. Use safety footwear; snug-fitting clothing; protective gloves; and eye, hearing, and head protection devices.
 3. Use caution when handling fuel. Move the chainsaw at least 10 feet (3 m) from the fueling point before starting the engine.

continued on the back inside cover →

Contents

Main Parts of the Saw	2	Carburetor	42
Definitions	3	Replacing the Chain Sprocket	43
Safety Precautions	4	Oil Quantity Control	44
- The Operator	4	Starter Assembly	45
- The Saw	5	Maintaining and Sharpening	47
- The Use of the Saw	5	Saw Chain	50
- Maintenance, Repair and Storing	23	Maintenance Chart	51
Mounting the Bar and Chain	24	Specifications	52
Tensioning the Saw Chain	26	Ordering Spare Parts	52
Fuel Mix	27	Storing the Machine	52
Fueling	28		
Chain Lubricant	29		
Fill Chain Lubricant	29		
Chain Brake	30		
Checking Spark Plug	31		
Master Control	32		
Starting	33		
Electrically Heated Handles	36		
Winter Operation	37		
Checking Chain Lubrication	38		
Taking Care of Guide Bar	38		
During Break-in Period	39		
During Operation	39		
Air Filter	40		

Printed on chlorine-free paper

Printing inks contain vegetable oils,
paper is recyclable

© 1997 Andreas Stihl, Waiblingen
0458 128 3021. M3. E7. Rei. Printed in Germany

X

This Manual contains operating and safety instructions for all STIHL 034 series power saws. Pay special attention to the safety precautions outlined on pages 4 to 23. Allow only persons who understand this Manual to operate your chain saw.

To receive maximum performance and satisfaction from your STIHL chain saw, it is important that you read and understand the maintenance and safety precautions before using your saw. Contact your STIHL dealer or the STIHL distributor for your area if you do not understand any of the instructions in this Manual.



Warning!

Because a chain saw is a high-speed wood-cutting tool, some special safety precautions must be observed as with any other power saw to reduce the risk of personal injury. Careless or improper use may cause serious or even fatal injury.

STIHL's philosophy is to continually improve all of its products. As a result, engineering changes and improvements are made from time-to-time.

If the operating characteristics or the appearance of your saw differs from those described in this Manual, please contact your STIHL dealer for informations and assistance.

STIHL®

Main Parts of the Saw

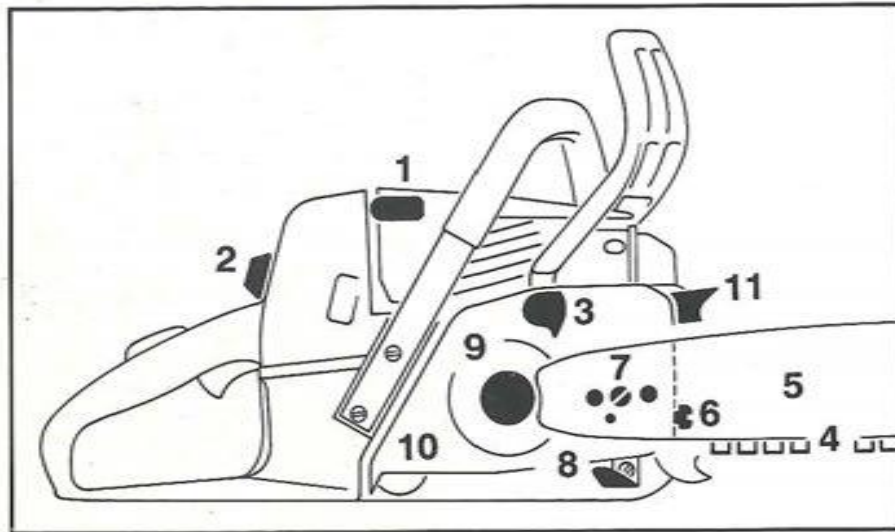

- 1 = Spark plug boot
- 2 = Twist lock
- 3 = Chain brake
- 4 = Oilomatic saw chain
- 5 = Guide bar
- 6 = Front chain tensioner
- 7 = Side chain tensioner
- 8 = Chain catcher
- 9 = Chain sprocket
- 10 = Chain sprocket cover
- 11 = Bumper spike

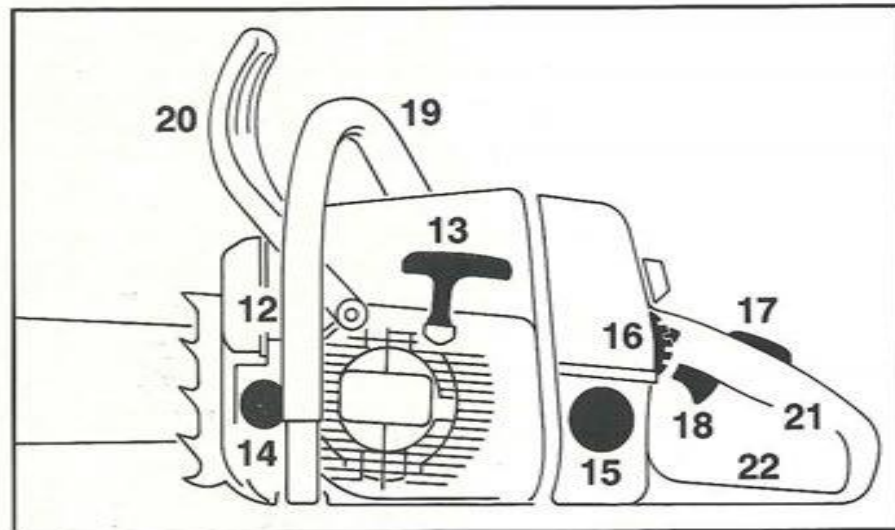

- 12 = Muffler
- 13 = Starter grip
- 14 = Oil filler cap
- 15 = Fuel filler cap
- 16 = Master control lever
- 17 = Throttle trigger interlock
- 18 = Throttle trigger
- 19 = Front handle
- 20 = Front hand guard
- 21 = Rear handle
- 22 = Rear hand guard

 **WARNING!**

The engine exhaust from this product contains chemicals known to the State of California to cause cancer, birth defects or other reproductive harm.

englisch/english U.S.A.

Continuation of Important Safety Precautions

4. Do not allow other persons to be near the chainsaw when starting or cutting with the chainsaw. Keep bystanders and animals out of the work area.
5. Do not start cutting until you have a clear work area, secure footing, and a planned retreat path from the falling tree.
6. Keep all parts of your body away from the saw chain when the engine is running.
7. Before you start the engine, make sure that the saw chain is not contacting anything.
8. Carry the chainsaw with the engine stopped, the guide bar and saw chain to the rear, and the muffler away from your body.
9. Do not operate a chainsaw that is damaged, improperly adjusted, or not completely and securely assembled. Be sure that the saw chain stops moving when the throttle trigger is released.
10. Shut off the engine before setting the chainsaw down.
11. Use extreme caution when cutting small size brush and saplings because slender material may catch the saw chain and be whipped toward you or pull you off balance.
12. When cutting a limb that is under tension be alert for springback so that you will not be struck when the tension in the wood fibers is released.
13. Keep the handles dry, clean, and free of oil or fuel mixture.
14. Operate the chainsaw only in well-ventilated areas.
15. Do not operate a chainsaw in a tree unless you have been specifically trained to do so.
16. All chainsaw service, other than the items listed in the Owner's Manual maintenance instructions, should be performed by competent chainsaw service personnel.
(For example, if improper tools are used to remove the flywheel or if an improper tool is used to hold the flywheel in order to remove the clutch, structural damage to the flywheel could occur and could be subsequently cause the flywheel to burst).
17. When transporting your chainsaw, use the appropriate chain guard (scabbard).
18. Reduced kickback bars and low kickback chains are designed to reduce the risk of kickback injury. Ask your STIHL dealer about these devices.

Note:

When using a chainsaw for logging purposes, refer to the Code of Federal Regulations, Parts 1910 and 1928.

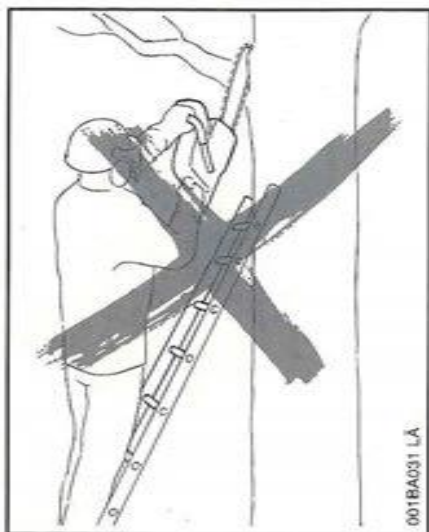

Such objects may be flung off, damage the saw chain or cause the saw to kickback.

In order to keep control of your saw, always maintain a firm foothold. Never work on a ladder, in a tree or on any other insecure support. Never use the saw above shoulder height.

Position the chainsaw in such a way that your body is clear of the cutting attachment whenever the engine is running. Stand to the left of cut while bucking.

Don't put pressure on the saw when reaching the end of a cut. The pressure may cause the bar and rotating chain to pop out of the cut or kerf, go out of

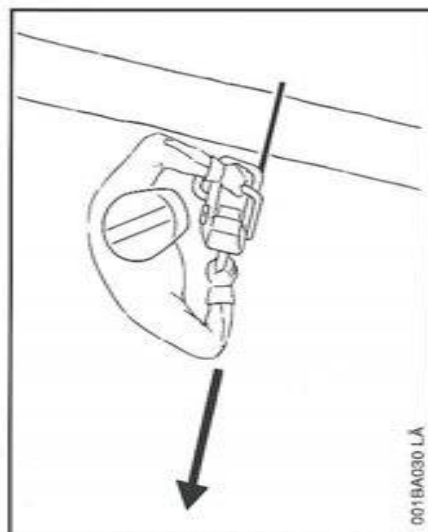

control and strike the operator or some other object. If the rotating chain strikes some other object, a reactive force may cause the moving chain to strike the operator.

Reactive forces including kickback

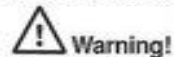

Warning!

Reactive forces may occur any time the chain is rotating.

Reactive forces can be dangerous! In any chainsaw, the powerful force used to cut wood can be reversed (and work against the operator).

If the rotating chain is suddenly stopped by contact with any solid object like a log



or branch or is pinched, the reactive forces may occur instantly. These reactive forces may result in loss of control which may, in turn, cause serious or fatal injury. An understanding of the causes of these reactive forces may help you avoid loss of control.

The most common reactive forces are

- kickback,
- pushback,
- pull-in.

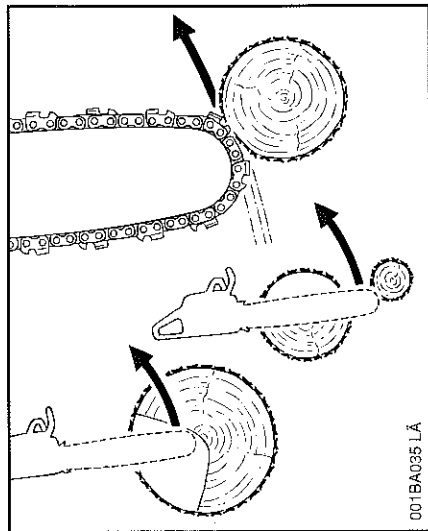

Kickback:

Kickback occurs when the upper quadrant of the bar nose contacts a solid object or is pinched.

The reaction of the cutting force of the chain causes a rotational force on the chainsaw in the direction opposite to the chain movement.

This may fling the bar up and back in an uncontrolled arc mainly in the plane of the bar. Under some cutting circumstances the bar moves towards the operator, who may suffer severe or fatal injury. Kickback may occur when the nose of the guide bar is pinched unexpectedly, unintentionally contacts solid material in the wood or is incorrectly used to begin a plunge or boring cut.

It may also occur during limbing. The greater the force of the kickback reaction, the more difficult it becomes for the operator to control the saw. Many factors influence the occurrence and force of the kickback reaction. These include chain speed, the speed at which the bar and chain contact the object, the angle of contact, the condition of the chain and other factors.

The type of bar and saw chain you use is an important factor in the occurrence and force of the kickback reaction. Some STIHL bar and chain types are designed to reduce kickback forces. STIHL recommends the use of reduced kickback bars and low kickback chains.

ANSI B 175.1-1991 chainsaw kickback standard

Section 5.12 of ANSI standard B 175.1-1991, sets certain performance and design criteria related to chainsaw kickback.

To comply with section 5.12 of ANSI B 175.1-1991:

- a) saws with a displacement of less than 3.8 cubic inches
 - must, in their original condition, meet a 45° computer derived kickback angle when equipped with certain cutting attachments.
 - and must be equipped with at least two devices to reduce the risk of kickback injury, such as a chain brake, low kickback chain, reduced kickback bar, etc.

- b) saws with a displacement of 3.8 cubic inches and above
 - must be equipped with at least one device designed to reduce the risk of kickback injury such as a chain brake, low kickback chain, reduced kickback bar, etc.

These kickback requirements do not apply to chainsaws fitted with bow guides. Bow-equipped saws are only for use by thoroughly instructed and experienced operators. Use of bow guides may result in serious or fatal injury. See section entitled "Bow Guides" of this manual.

The computer derived angles for saws below 3.8 cubic inch displacement are measured by applying a computer program to test results from a kickback test machine.



Warning!

The computer derived angles of § 5.12 of ANSI B 175.1-1991 may bear no relationship to actual kickback bar rotation angles that may occur in real life cutting situations. Compliance with § 5.12 of ANSI B 175.1-1991 does not automatically mean that in a real life kickback the bar and chain will rotate at most 45°.

**Warning!**

In order for powerheads below 3.8 cubic inch displacement to comply with the computed kickback angle requirements of § 5.12 of ANSI B 175.1-1991 use only the following cutting attachments:

- bar and chain combinations listed as complying in the "Specifications" section of the Owner's Manual or
- other replacement bar and chain combinations marked in accordance with the standard for use on the powerhead or
- replacement chain designated "low kickback saw chain"¹⁾.

**Warning!**

There are potential powerhead and bar combinations with which low kickback saw chains can be used which have not been specifically certified to comply with the 45° computer derived kickback angle of § 5.12 of ANSI B 175.1-1991. Some low kickback chains have not been tested with all powerhead and bar combinations.

¹⁾ "Low kickback saw chain" is a chain which has met the kickback performance requirements of § 5.12.2.4 of ANSI B 175.1-1991 (Safety Requirements for Gasoline-Powered Chain-Saws) when tested on a selected representative sample of chainsaws below 3.8 cubic inch displacement specified in ANSI B 175.1-1991.

STIHL offers a variety of bars and chains. STIHL reduced kickback bars and low kickback chains are designed to reduce the risk of kickback injury. Other chains are designed to obtain higher cutting efficiency or sharpening ease but may result in higher kickback tendency.

STIHL has developed a color code system to help you identify the STIHL reduced kickback bars and low kickback chains. Cutting attachments with green warning decals or green labels on the packaging are designed to reduce the risk of kickback injury. The matching of green decaled powerheads under 3.8 cubic inch displacement with green labeled bars and green labeled chains gives compliance with the computed kickback angle requirements of ANSI B 175.1-1991 when the products are in their original condition. Products with yellow decals or labels are for users with extraordinary cutting needs and experience and specialized training for dealing with kickback.

STIHL recommends the use of its green labeled reduced kickback bars, green labeled low kickback chains and a STIHL Quickstop chain brake for both experienced and inexperienced chainsaw users.

Please ask your STIHL dealer to properly match your powerhead with the appropriate bar/chain combinations to reduce the risk of kickback injury. Green labeled bars and chains are recommended for all powerheads. See your "STIHL Bar and Chain Information" leaflet for details.

**Warning!**

Use of other, non-listed bar/chain combinations may increase kickback forces and increase the risk of kickback injury. New bar/chain combinations may be developed after publication of this literature, which will, in combination with certain powerheads, comply with § 5.12 of ANSI B 175.1-1991. Check with your STIHL dealer for such combinations.

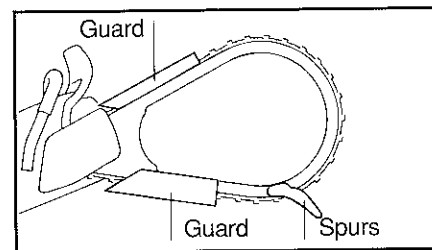

Bow Guides

Warning!

Any chainsaw equipped with a bow guide is potentially very dangerous. Improper use can result in kickback, pushback or pull-in, and very serious injury or death. Only thoroughly instructed and experienced operators should use a chainsaw equipped with a bow guide.

A bow guide (or bow bar) is a specially designed substitution for a regular guide bar. Like a regular guide bar, it supports and guides the saw chain. Unlike a regular guide bar, it consists of a narrow rail structure with a large open space in the middle.

Warning!

The risk of kickback is increased with a bow guide because of the increased kickback contact area. STIHL recommends the use of the STIHL Quickstop chain brake. Low kickback chain **will not** significantly reduce the risk of kickback injury when used on a bow guide. Only STIHL bow guides are approved for

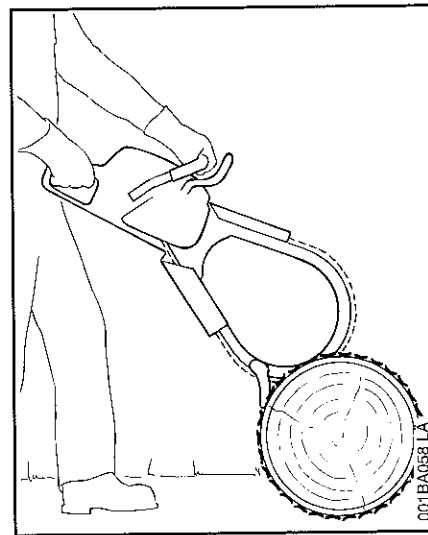

use with STIHL powerheads. The use of other bow guides with a STIHL powerhead can be hazardous to the operator due to the absence of safety guards and spurs and necessary unauthorized modifications needed to mount the bow guide to the STIHL powerhead.

Do not use a STIHL bow guide on any powerhead except a STIHL powerhead. Unauthorized combinations are dangerous.

Warning!

Never attempt to operate a chainsaw equipped with a bow guide unless the spurs and both guards are in place. Under no circumstances should any of

the spurs or guards be removed. Keep the nuts which hold these items in place tightened at all times.

The guards at the top and bottom of the bow guide are required to reduce the possibility of injury caused by contact with the chain. These guards are slotted to allow positioning as close to the powerhead as possible. After the bow guide is mounted on the chainsaw, slide the guards as close to the powerhead as possible.

The spurs should always be placed firmly against the wood before starting a cut and should be kept against the wood until the cut is completed. Failure to keep the spurs firmly against the wood during the entire cut could cause the saw to react violently and could result in serious injury or death to the operator.

Warning!

Be sure to keep the chain properly tensioned. A chain which "sags" or is too loose could jump off the bow and result in serious injury to the operator. Felling with a bow bar is dangerous, because it is more difficult to follow safe felling techniques. Cut only one log at a time. A chain catcher which has been removed to allow mounting of a bow guide must be reattached when remounting the regular guide bar.



Devices for reducing the risk of kickback injury

STIHL recommends the use of the STIHL Quickstop chain brake on your power-head with green labeled reduced kickback bars and low kickback chains.

Caution! If the chain brake does not function correctly, stop using the saw immediately.

Risk of injury! Take the saw to your local STIHL Service Centre! Do not use the saw until the fault has been rectified (see the section "Chain Brake")

Quickstop chain brake

STIHL has developed a chain stopping system designed to reduce the risk of injury in certain kickback situations. It is called a Quickstop chain brake. The Quickstop is available as standard equipment on your STIHL chain saw and is available for installation on most older STIHL saws. Ask your dealer to retrofit your older model saw with a chain brake. When a kickback occurs, the guide bar may rotate around the front handle. If the cutting position is such that the operator's left hand is gripping the front handle behind the hand guard, and if the left hand rotates around the front handle and contacts the front hand guard, which is the Quickstop activating lever, this contact will activate the Quickstop. The chain brake on most new model STIHL chain saws can also be activated by inertia. See the chapter entitled "Chain Brake" of your Owner's Manual.

Warning!

Never operate your chain saw without a front hand guard. In a kickback situation this guard helps protect your left hand or other parts of your body. In addition, removal of the hand guard on a saw equipped with a chain brake will deactivate the chain brake.

Warning!

No Quickstop or other chain brake device prevents kickback. These devices are designed to reduce the risk of kickback injury, if activated, in certain kickback situations. In order for the Quickstop to reduce the risk of kickback injury, it must be properly maintained and in good working order. See the chapter entitled "Chain Brake" and "Maintenance, Repair and Storing" of your Owner's Manual. In addition, there must be enough distance between the bar and the operator to ensure that the Quickstop has sufficient time to activate and stop the chain before potential contact with the operator.

Warning!

An improperly maintained chain brake may increase the time needed to stop the chain after activation, or may not activate at all.

Reduced kickback bar

STIHL green labeled reduced kickback bars are designed to reduce the risk of kickback injury when used with STIHL green labeled low kickback chains.



Warning!

When used with other, more aggressive chains, these bars may be less effective in reducing kickback, and may result in higher kickback forces.

Low kickback chain

Some types of saw chain have specially designed components to reduce the force of nose contact kickback. STIHL has developed low kickback chain for your powerhead.



Warning!

A dull or improperly sharpened chain may reduce or negate the effects of the design features intended to reduce kickback energy. Improper lowering or sharpening of the depth gauges or shaping of the cutters may increase the chance and the potential energy of a kickback. Always cut with a properly sharpened chain.



Warning!

Reduced kickback bars and low kickback chains do not prevent kickback, but they are designed to reduce the risk of kickback injury. They are available from your STIHL dealer.



Warning!

Even if your saw is equipped with a Quickstop, a reduced kickback bar and/or low kickback chain, this does not eliminate the risk of injury by kickback. Therefore, always observe all safety precautions to avoid kickback situations.

To avoid kickback

The best protection from personal injury that may result from kickback is to avoid kickback situations:

1. Hold the chainsaw firmly with both hands and maintain a secure grip.
2. Be aware of the location of the guide bar nose at all times.
3. Never let the nose of the guide bar contact any object. Do not cut limbs with the nose of the guide bar. Be especially careful when cutting small, tough limbs, small size brush and saplings which may easily catch the chain.
4. Don't overreach.
5. Don't cut above shoulder height.
6. Begin cutting and continue at full throttle.
7. Cut only one log at a time.
8. Use extreme caution when reentering a previous cut.
9. Do not attempt to plunge cut if you are not experienced with these cutting techniques.
10. Be alert for shifting of the log or other forces that may cause the cut to close and pinch the chain.
11. Maintain saw chain properly. Cut with a correctly sharpened, properly tensioned chain at all times.
12. Stand to the side of the cutting path of the chainsaw.

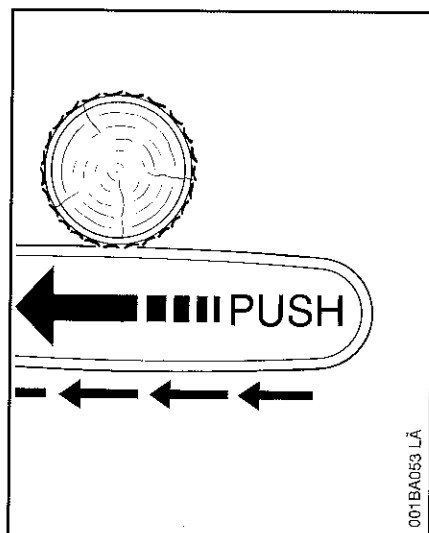

001BA053 LÄ

Pushback:

Pushback occurs when the chain on the top of the bar is suddenly stopped when it is pinched, caught or encounters a foreign object in the wood. The reaction of the chain drives the saw straight back toward the operator and may cause loss of saw control. Pushback frequently occurs when the top of the bar is used for cutting.

To avoid pushback

1. Be alert to forces or situations that may cause material to pinch the top of the chain.

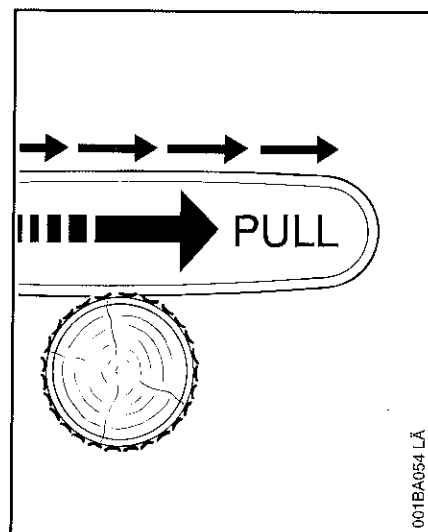

001BA054 LÄ

2. Do not cut more than one log at a time.
3. Do not twist the saw when withdrawing the bar from a plunge cut or underbuck cut because the chain can pinch.

Pull-in:

Pull-in occurs when the chain on the bottom of the bar is suddenly stopped. The chain on the bottom of the bar stops when it is pinched, caught or encounters a foreign object in the wood. The reaction of the chain pulls the saw forward and may cause the operator to lose control.

Pull-in frequently occurs when the bumper spike of the saw is not held securely against the tree or limb and when the chain is not rotating at full speed before it contacts the wood.



Warning!

Use extreme caution when cutting small size brush and saplings which may easily catch the chain and pull you off balance.

To avoid pull-in

1. Always start a cut with the chain rotating at full speed and the bumper spike in contact with the wood.
2. Pull-in may also be prevented by using wedges to open the kerf or cut.

Cutting Techniques

Felling

Felling is cutting down a tree.

Before felling a tree, consider carefully all conditions which may affect the direction of fall, including:

The intended direction of the fall.

The natural lean of the tree.

Any unusually heavy limb structure.

Surrounding trees and obstacles.

The wind direction and speed.



Warning!

Always observe the general condition of the tree. Inexperienced users should never attempt to cut trees which are decayed or rotted inside or which are leaning or otherwise under tension. There is an increased risk that such trees could snap or split while being cut and cause serious or fatal injury to the operator or bystanders.

Also look for broken or dead branches which could vibrate loose and fall on the operator. When felling on a slope, the operator should stand on the uphill side if possible.

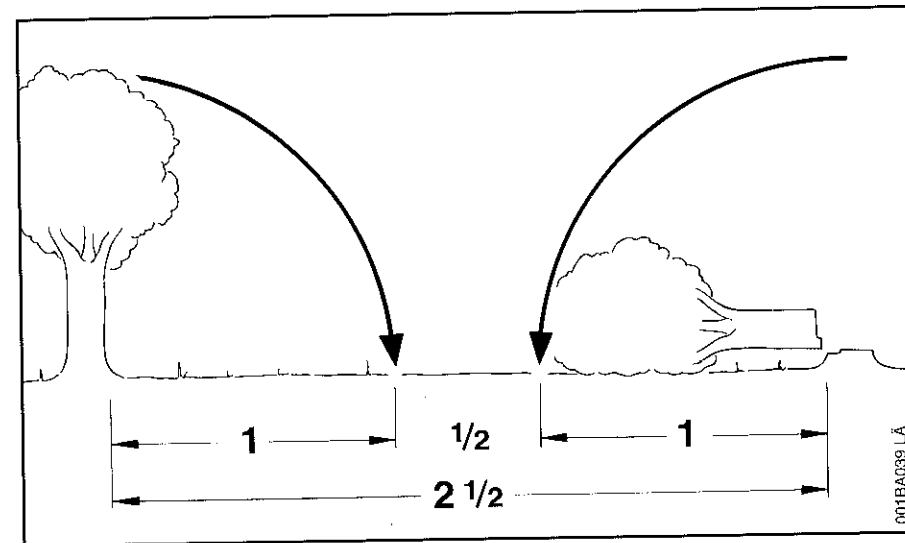

When felling in the vicinity of roads, railways and power lines, etc., take extra precautions. Inform the police, utility company or railway authority before beginning to cut.

When felling, maintain a distance of at least $2\frac{1}{2}$ tree lengths from the nearest person.

Note:

The noise of your engine may drown any warning call.

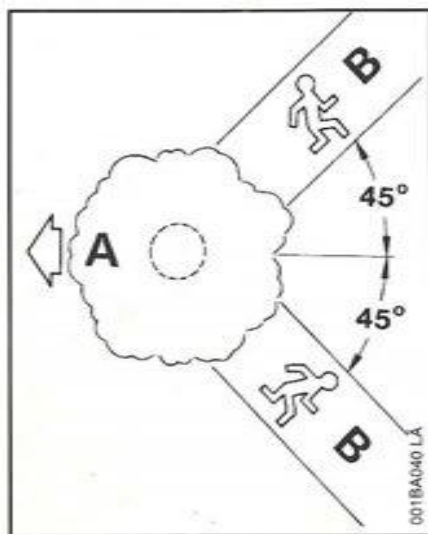

Felling Instructions:

First clear the tree base and work area from interfering limbs and brush and clean its lower portion with an axe.

Then, establish a path of escape (B) and remove all obstacles. This path should be generally opposite to the planned direction of the fall of the tree (A) and at about a 45° angle. An alternate path (B) must also be selected. Place all tools and equipment a safe distance away from the tree, but not on the escape path.

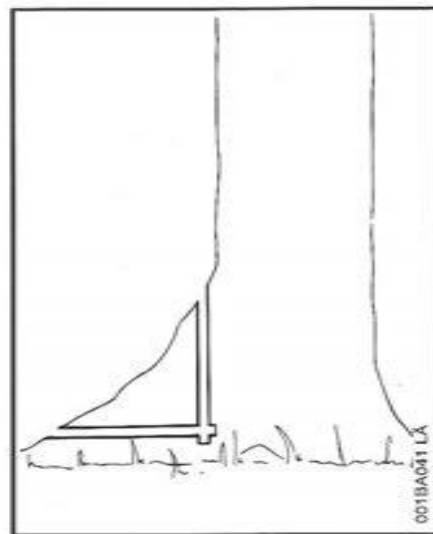

If the tree has large buttress roots, cut into the largest buttress vertically first (horizontally next) and remove the resulting piece.

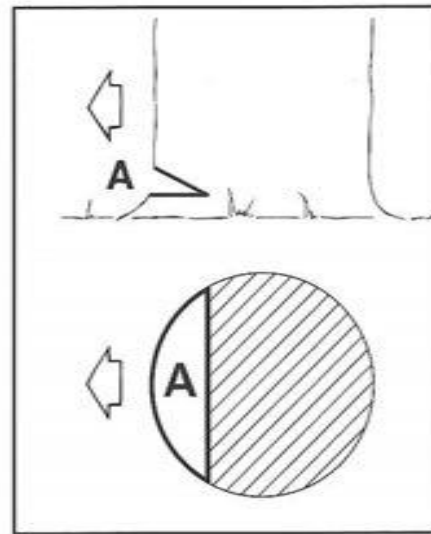

Conventional cut

A = felling notch - determines the direction of the fall

For a conventional cut:

- Properly place felling notch perpendicular to the line of fall, close to the ground
- Cut down at app. 45-degree angle to a depth of about 1/5 to 1/4 of the trunk diameter
- Make second cut horizontal
- Remove resulting 45-degree piece

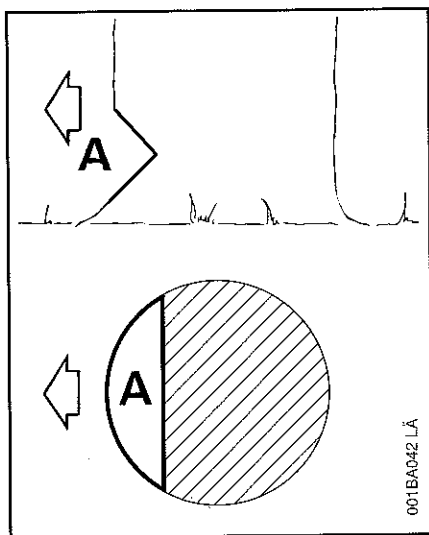

Open-face technique

A = felling notch - determines the direction of the fall

For an open-face cut:

- Properly place felling notch perpendicular to the line of fall, close to the ground
- Cut down at app. 50-degree angle to a depth of app. 1/5 to 1/4 of the trunk diameter
- Make second cut from below at app. 40 degree angle
- Remove resulting 90-degree piece

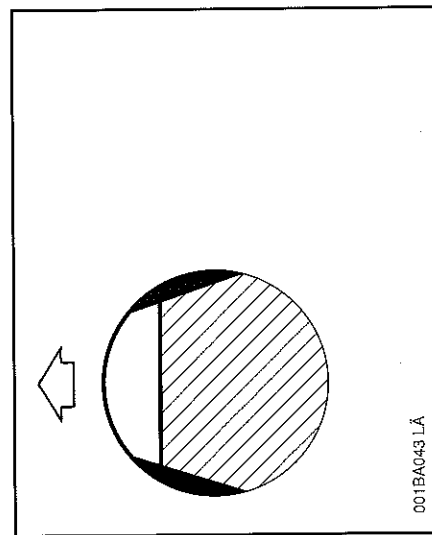

Making sapwood cuts

- For medium sized or larger trees make cuts at both sides of the trunk, at same height as subsequent felling cut.
- Cut to no more than width of guide bar

This is especially important in soft wood in summer- it helps prevent sapwood splintering when the tree falls.

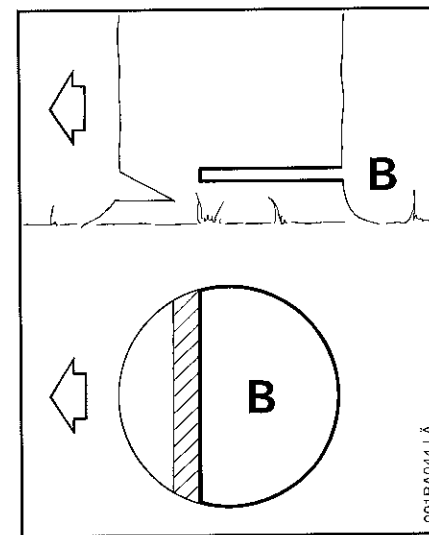

B = Felling cut

Conventional and open-face technique:

- Begin 1 to 2 inches higher than center of felling notch
- Cut horizontally towards the felling notch
- Leave approx. 1/10 of diameter uncut. This is the hinge
- Do not cut through the hinge – you could lose control of the direction of the fall

Drive wedges into the felling cut where necessary to control the fall.

Warning!

If the tip of the bar contacts a wedge, it may cause kickback. Wedges should be of wood or plastic – never steel, which can damage the chain.

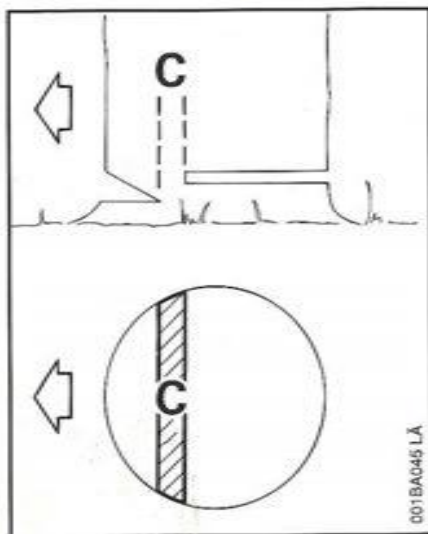

001BA045 LA

C = Hinge

- Helps control the falling tree
- Do not cut through the hinge - you could lose control of the direction of the fall

⚠ Warning!

In order to reduce the risk of personal injury, never stand directly behind the tree when it is about to fall, since part of the trunk may split and come back towards the operator (barber-chairing), or the tree may jump backwards off the stump. Always keep to the side of the falling tree. When the tree starts to fall, withdraw the bar, shut off the engine and walk away on the preplanned escape path. Watch out for falling limbs.

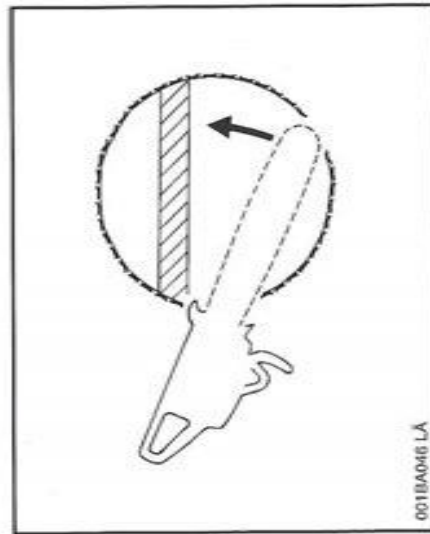

001BA046 LA

⚠ Warning!

Be extremely careful with partially fallen trees which are poorly supported. When the tree hangs or for some other reason does not fall completely, set the saw aside and pull the tree down with a cable winch, block and tackle or tractor. If you try to cut it down with your saw, you may be injured.

Felling cut for small diameter trees: simple fan cut

Engage the bumper spikes of the chainsaw directly behind the hinge and pivot the saw around this point only as far as the hinge. The spiked bumper rolls against the trunk.

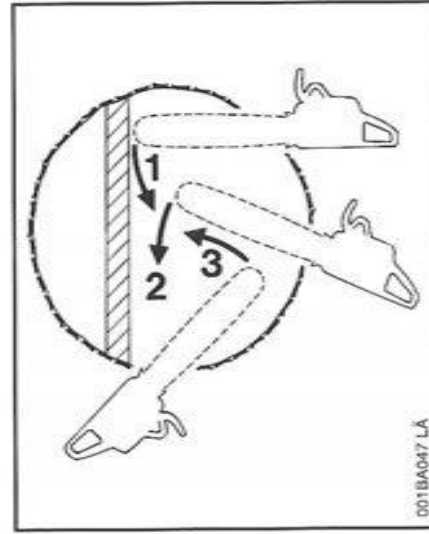

001BA047 LA

Felling cut for large diameter trees: sectioning method

⚠ Warning!

Felling a tree that has a diameter greater than the length of the guide bar requires use of either the sectioning felling cut or plunge-cut method. These methods are extremely dangerous because they involve the use of the nose of the guide bar and can result in kickback. Only properly trained professionals should attempt these techniques.

For the sectioning method make the first part of the felling cut with the guide bar fanning in toward the hinge. Then, using the bumper spike as a pivot, reposition the saw for the next cut.

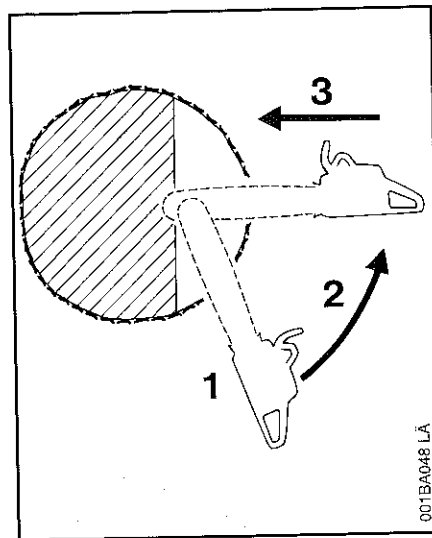

Avoid repositioning the saw more than necessary. When repositioning for the next cut, keep the guide bar fully engaged in the kerf to keep the felling cut straight. If the saw begins to pinch, insert a wedge to open the cut. On the last cut, do not cut the hinge.

Plunge-cut method

Timber having a diameter more than twice the length of the guide bar requires the use of the plunge-cut method before making the felling cut.

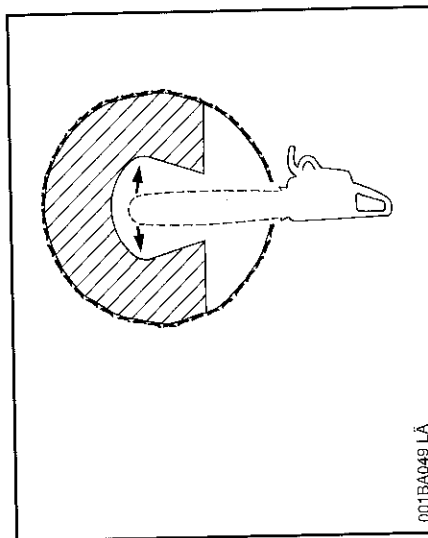

First, cut a large, wide felling notch. Make a plunge cut in the center of the notch.

The plunge cut is made with the guide bar nose. Begin the plunge cut by applying the lower portion of the guide bar nose to the tree at an angle. Cut until the depth of the kerf is about the same as the width of the guide bar. Next, align the saw in the direction in which the recess is to be cut.

With the saw at full throttle, insert the guide bar in the trunk.

Enlarge the plunge cut as shown in illustration.

Warning!

There is an extreme danger of kickback at this point. Extra caution must be taken to maintain control of the saw. To make the felling cut, follow the sectioning method described previously. If you are inexperienced with a chainsaw, plunge-cutting should not be attempted. Seek the help of a professional.

Limbing

Limbing is removing the branches from a fallen tree.

Warning!

There is an extreme danger of kickback during the limbing operation. Do not work with the nose of the bar. Be extremely cautious and avoid contacting the log or other limbs with the nose of the guide bar.

Do not stand on a log while limbing it – you may slip or the log may roll.

Start limbing by leaving the lower limbs to support the log off the ground. When underbucking freely hanging limbs, a pinch may result or the limb may fall, causing loss of control. If a pinch occurs, stop the engine and remove the saw, by lifting the limb.



Warning!

Be extremely cautious when cutting limbs or logs under tension (spring poles). The limbs or logs could spring back toward the operator and cause loss of control of the saw and severe or fatal injury to the operator.

Bucking

Bucking is cutting a log into sections.

Warnings!

1. When bucking, do not stand on the log. Make sure the log will not roll downhill. If on a slope, stand on the uphill side of the log. Watch out for rolling logs.



2. Cut only one log at a time.
3. Shattered wood should be cut very carefully. Sharp slivers of wood may be caught and flung in the direction of the operator of the saw.
4. When cutting small logs, place log through "V" - shaped supports on top of a sawhorse. Never permit another person to hold the log. Never hold the log with your leg or foot.

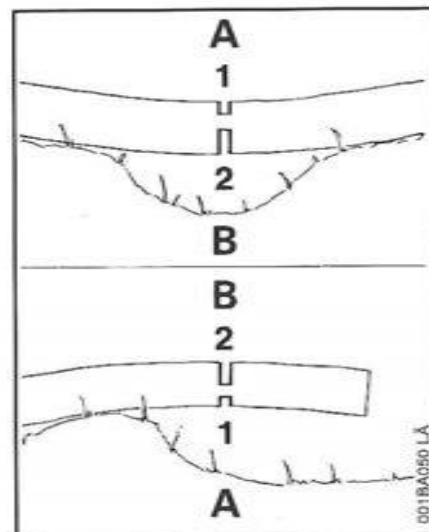

5. Logs under strain: Risk of pinching! Always start relieving cut (1) at compression side (A). Then make bucking cut (2) at tension side (B). If the saw pinches, stop the engine and remove it from the log.
6. Only properly trained professionals should work in an area where the logs, limbs and roots are tangled. Working in blowdown areas is extremely hazardous.
7. Drag the logs into a clear area before cutting. Pull out exposed and cleared logs first.

MAINTENANCE, REPAIR AND STORING

Never operate a chainsaw that is damaged, improperly adjusted or not completely or securely assembled. Follow the maintenance and repair instructions in the appropriate section of your Owner's Manual, especially those in the chapters "Mounting the bar and chain" "Maintaining and Sharpening" and "Chain Brake".

Use only STIHL replacement parts for maintenance and repair. Use of parts manufactured by others may cause serious or fatal injury.

Warning!

Always stop the engine and ensure that the chain is stopped before making any adjustments, maintenance or repair work, changing the saw chain or cleaning the saw. Do not attempt any maintenance or repair work not described in your Owner's Manual. Have such work performed at your STIHL service shop only.

Warning!

Never test the ignition system with ignition wire terminal removed from spark plug or with unseated spark plug, since uncontained sparking may cause a fire.

Warning!

To reduce the risk of fire and burn injury, use only spark plugs authorized by STIHL. Always press spark plug boot snugly onto spark plug terminal of the

proper size. (Note: If terminal has detachable SAE adapter nut, it must be attached.) A loose connection between spark plug terminal and ignition wire connector in the boot may create arcing that could ignite combustible fumes and cause a fire. Keep spark plug clean, and make sure ignition lead is in good condition.

Warning!

Do not operate your chainsaw if the muffler is damaged, missing or modified. An improperly maintained muffler will increase the risk of fire and hearing loss. Never touch a hot muffler or burn will result. If your muffler was equipped with a spark-arresting screen to reduce the risk of fire (e. g. in the USA, Canada and Australia), never operate your saw if the screen is missing or damaged. Remember that the risk of forest fires is greater in hot or dry weather.

Keep the chain, bar and sprocket clean; replace worn sprockets or chains. Keep the chain sharp. You can spot a dull chain when easy-to-cut wood becomes hard to cut and burn marks appear on the wood.

Keep the chain at proper tension. Tighten all nuts, bolts and screws except the carburetor adjustment screws after each use.

Warning!

In order for the chain brake on your STIHL chainsaw to properly perform its function of reducing the risk of kickback and other injuries, it must be properly

maintained. Like an automobile brake, a chainsaw chain brake incurs wear each time it is engaged.

The amount of wear will vary depending upon usage, conditions under which the saw is used and other factors. Excessive wear will reduce the effectiveness of the chain brake and can render it inoperable. For the proper and effective operation of the chain brake the brake band and clutch drum must be kept free of dirt, grease and other foreign matter which may reduce friction of the band on the drum.

For these reasons, each STIHL chainsaw should be returned to trained personnel such as your STIHL servicing dealer for periodic inspection and servicing of the brake system according to the following schedule:

Heavy usage - every three months,
Moderate usage - twice a year,
Occasional usage - annually.

The chainsaw should also be returned immediately for maintenance whenever the brake system cannot be thoroughly cleaned or there is a change in its operating characteristics.

Additionally, the daily maintenance schedule for your chainsaw set forth in your STIHL Owner's Manual should be strictly followed.

Store chainsaw in a dry place and away from children. Before storing for longer than a few days, always empty the fuel tank.

Mounting the Bar and Chain

Chain brake released

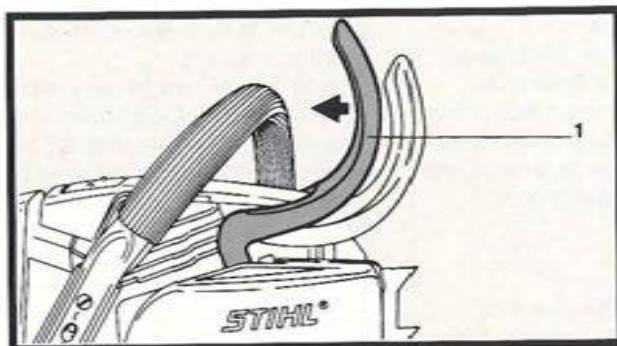

There are two types of chain tensioner. Depending on the model you have, tensioning is performed either through the side of the sprocket cover or from the front of the machine.

Release the chain brake by pulling the front hand guard (1) back toward the handlebar.

Unscrew the hexagon nuts (2) and take off the chain sprocket cover (3).

Use the screwdriver end of the combination wrench to turn the adjusting screw (4) (lateral chain tensioner) or the tensioning screw (5) (front chain tensioner) counterclockwise as far as the stop. This backs off the tensioner slide or tensioning nut (6).

The cutting edges of the chain are very sharp. You should always wear gloves to protect your hands from injury when fitting the chain, mounting the guide bar, tensioning the chain and checking chain tension.

Top: Removing chain sprocket cover
Center: Backing off tensioner slide on lateral chain tensioner
Bottom: Backing off tensioning nut on front chain tensioner

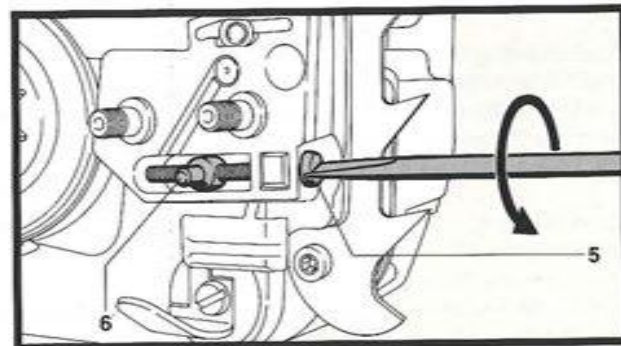
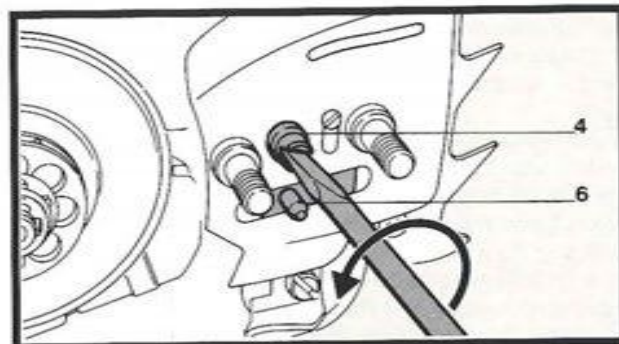

- Top: Fitting saw chain on guide bar
- Center: Fitting the chain on the sprocket – cutting edges point toward bar nose
- Bottom: Peg of tensioner slide/tensioning nut in loading hole – guide bar flat against saw body

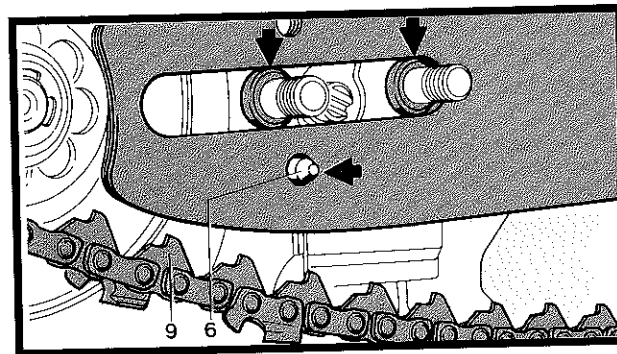
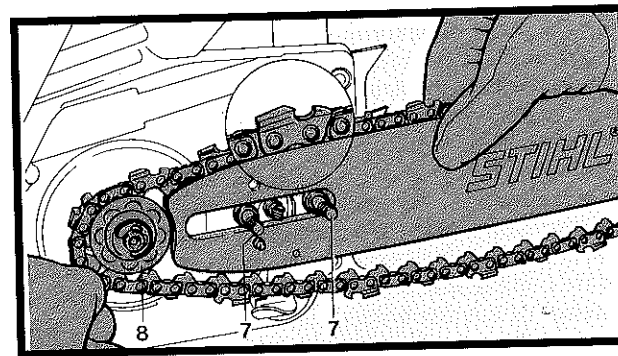
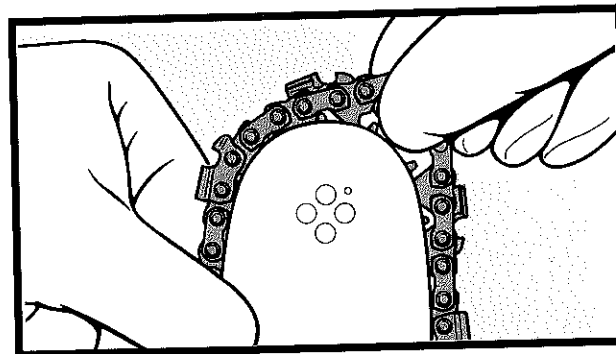

Pretensioning the chain (lateral chain tensioner)

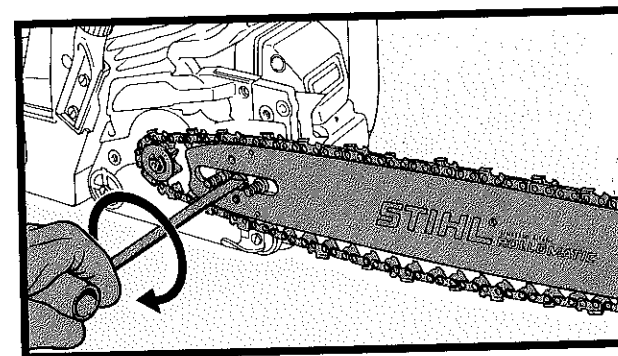

Hold the guide bar vertically with the nose upward and fit the Oilomatic chain on it, starting at the bar nose.

With the chain in position, locate the slot of the guide bar over the studs (7) and place the Oliomatic chain over the sprocket (8) at the same time. Be sure that the cutting edges on the top of the bar point toward the bar nose. The peg of the tensioner slide/tensioning nut (6) must engage the lower guide bar locating hole.

Now tension the chain by turning the adjusting screw (4) or tensioning screw (5) clockwise until there is very little chain sag on the underside of the bar. Make sure that the drive link tangs (9) are properly located in the guide bar groove.

Fit the sprocket cover (3) on the studs (7) and screw on the hexagon nuts (2) finger-tight.

Tensioning the Saw Chain

Top: Tensioning the chain (lateral chain tensioner)
Bottom: Holding bar nose up and tightening the hexagon nuts

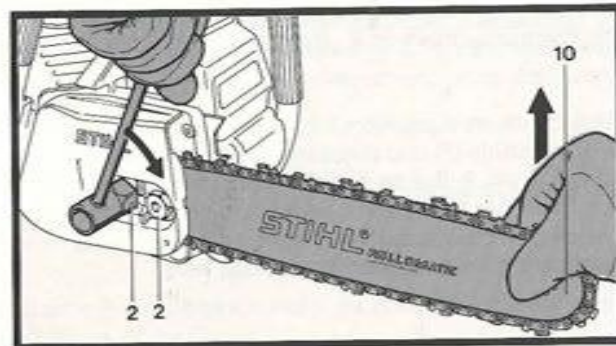
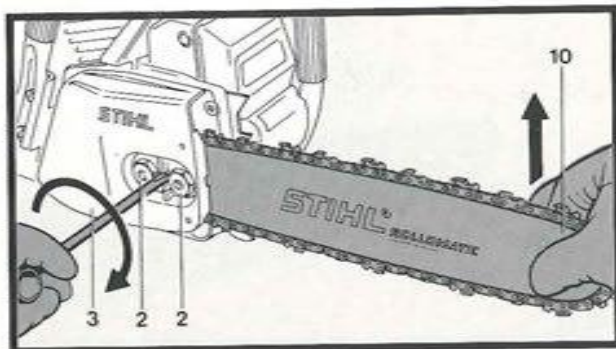

The chain must be tensioned after initial assembly and retensioned during cutting work.
To retension the chain, first slacken off the hexagon nuts (2). Insert screwdriver end of combination wrench through hole in chain sprocket cover.

Hold the bar nose (10) up and turn the adjusting screw (lateral chain tensioner) or tensioning screw (front chain tensioner) clockwise with the screwdriver until the chain lies against the underside of the bar. While still holding the bar nose up, **firmly** tighten down the hexagon nuts (2).

Checking chain tension



The Oilomatic chain is correctly tensioned when it fits snugly against the underside of the bar but can still be pulled easily along the bar by hand (with chain brake disengaged). Important: Wear protective gloves when performing this work.

Proper chain tension and lubrication are critically important for the cutting performance and service life of your whole cutting attachment. Always check chain lubrication before starting work.

Chain tension should be checked frequently during cutting work and corrected as necessary. For further details see Chapter "Bar, Chain and Sprocket".

Fuel mix

Your two-stroke engine requires a mixture of brand-name gasoline and quality two-stroke engine oil with the **classification TC**.

Use regular branded unleaded gasoline with a minimum octane number of 90 ROZ (U.S.A./Canada: pump octane min. 89!). If the octane number of the regular grade gasoline in your area is lower use premium unleaded fuel.

Fuel with a lower octane number may result in preignition (causing "pinging") which is accompanied by an increase in engine temperature. This, in turn, increases the risk of the piston seizure and damage to the engine.

The chemical composition of the fuel is also important. Some fuel additives not only detrimentally affect elastomers (carburetor diaphragms, oil seals, fuel lines etc.), but magnesium castings as well. This could cause running problems or even damage the engine. For this reason it is essential that you use only name branded fuels!

Use only STIHL two-stroke engine oil or equivalent branded two-stroke air-cooled engine oils with the classification TC for mixing.

We recommend STIHL 50:1 two-stroke engine oil since it is specially formulated for use in STIHL engines. The mix ratio with STIHL oil is 50:1 (50 parts gasoline to 1 part oil), or 25:1 (25 parts gasoline to 1 part oil) with other branded two-stroke-air-cooled engine oils.

Do not use BIA or TCW (two-stroke water cooled) mix oils!

Take care when handling gasoline. Avoid direct contact with the skin and avoid inhaling fuel vapour.

The canister should be kept tightly closed in order to avoid any moisture getting into the mixture.

The fuel tank and the canister in which fuel mix is stored should be cleaned from time to time.

Fuel mix ages:

Only mix sufficient fuel for a few days work, not to exceed 30 days of storage. Store in approved safety fuel-canisters only. When mixing, pour oil into the canister first, and then add gasoline.

Gasoline Liters	STIHL engine oil 50:1		Other branded TC oils 25:1	
	Liters	(cc)	Liters	(cc)
1	0.02	(20)	0.04	(40)
5	0.10	(100)	0.2	(200)
10	0.20	(200)	0.4	(400)
15	0.30	(300)	0.6	(600)
20	0.40	(400)	0.8	(800)
25	0.50	(500)	1.0	(1000)

Gasoline US gal.	STIHL engine oil 50:1		Other branded TC oils 25:1	
	US fl.oz	US fl.oz	US fl.oz	US fl.oz
1	2.6		5.1	
2 1/2	6.4		12.8	
5	12.8		25.6	

Fueling

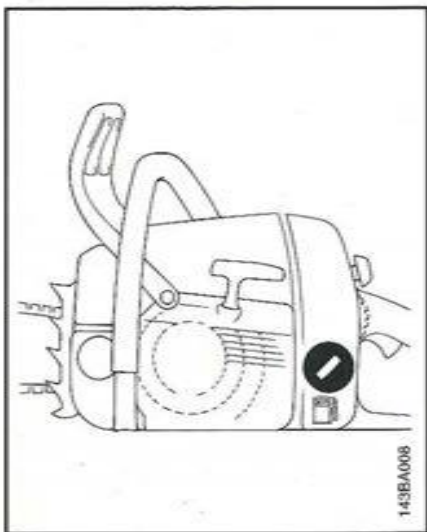

Before fueling, clean the filler cap and the area around it to ensure that no dirt falls into the tank. Always thoroughly shake the mixture in the canister before fueling your machine.

Warning!

In order to reduce the risk of burns or other personal injury from escaping gas vapor and fumes, remove the fuel filler cap carefully so as to allow any pressure build-up in the tank to release slowly.

Warning!

After fueling, tighten fuel cap **as securely as possible** by hand. Use a suitable tool (e.g. screwdriver end of combination wrench) to tighten slotted fuel caps.

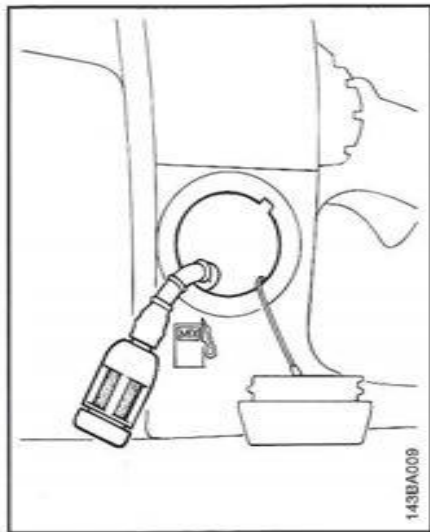

Change the fuel pick up body every year.

Before storing your machine for a long period, drain and clean the fuel tank and run engine until carburetor is dry.

Chain lubricant

Only ecologically acceptable, high-quality chain oil - preferably STIHL chain lubricant with non-fling additive or the rapidly biodegradable STIHL Bioplus - should be used for automatic, durable lubrication of the saw chain and guide bar.

The quality of the lubricant has a decisive effect on the service life of the saw chain and guide bar. Only special-purpose chain oil should therefore be used!

One of the following HD single-range oils may be used in exceptional cases if a special-purpose chain lubricant is not available.

At outside temperatures of
+ 10 °C. . . + 40 °C
(+ 50 °F. . . + 104 °F) SAE 30
+ 10 °C. . . - 10 °C
(+ 50 °F. . . + 14 °F) SAE 20
- 10 °C. . . - 30 °C
(+ 14 °F. . . - 22 °F) SAE 20W/10W

Waste oil must not be used! Waste oil does not have the required lubricating properties and is unsuitable for chain lubrication.

Waste oil is environmentally harmful and can cause skin cancer as a result of prolonged and repeated contact!

Fill chain lubricant

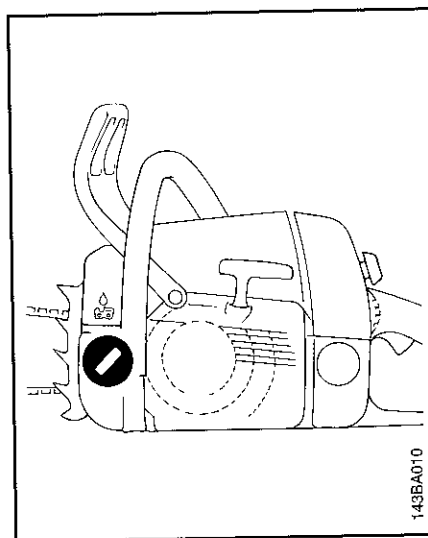
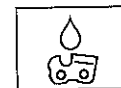

- Thoroughly clean the filler cap and surrounding area so that dirt cannot fall into the tank.
- Fill with chain lubricant - whenever the chainsaw is refuelled.

A small amount of lubricant remains in the oil tank when the fuel tank is empty.

If the amount of lubricant in the oil tank does not decrease, this may be due to a fault in the lubricant supply: check lubrication of the chain, clean the oil ducts and contact the STIHL service centre if necessary.

Definitions

1. **Spark Plug Boot**
Connects the spark plug with the ignition wire.
2. **Twist Lock**
Lock for carburetor box cover.
3. **Chain Brake**
A device to stop the rotation of the chain if activated in a kickback situation by the operator's hand or by inertia.
4. **Oilomatic Saw Chain**
A loop consisting of cutters, tie straps and drive links.
5. **Guide Bar**
Supports and guides the saw chain.
6. **Front Chain Tensioner**
Permits precise adjustment of chain tension.
7. **Side Chain Tensioner**
Permits precise adjustment of chain tension.
8. **Chain Catcher**
Helps to reduce the risk of operator contact by a chain when it breaks or comes off the bar.
9. **Chain Sprocket**
The toothed wheel that drives the saw chain.
10. **Chain Sprocket Cover**
Covers the clutch and the sprocket.
11. **Bumper Spike**
Toothed stop for holding saw steady against wood.
12. **Muffler**
Reduces engine exhaust noise and directs the exhaust gases.
13. **Starter Grip**
The grip of the starter, for starting the engine.
14. **Oil Filler cap**
For closing the oil tank.
15. **Fuel Filler Cap**
For closing the fuel tank.
16. **Master Control Lever**
Lever for choke control, starting throttle, run and stop switch position.
17. **Throttle Trigger Interlock**
Must be depressed before the throttle trigger can be activated.
18. **Throttle Trigger**
Controls the speed of the engine.
19. **Front Handle**
Handle bar for the left hand at front of saw.
20. **Front Hand Guard**
Provides protection against projecting branches and helps prevent the left hand from touching the chain if it slips off the handle bar.
21. **Rear Handle**
The support handle for the right hand, located at or toward the rear of the saw.
22. **Rear Hand Guard**
Gives added protection to operator's right hand.

Guide Bar Nose
The exposed end of the guide bar. (not illustrated, see chapter „Tensioning the Saw Chain“.

Clutch
Couples engine to chain sprocket when engine is accelerated beyond idle speed. (not illustrated).

Anti-Vibration System
The anti-vibration system includes a number of buffers designed to reduce the transmission of vibrations created by the engine and cutting attachment to the operator's hands. (not illustrated).

Chain Brake

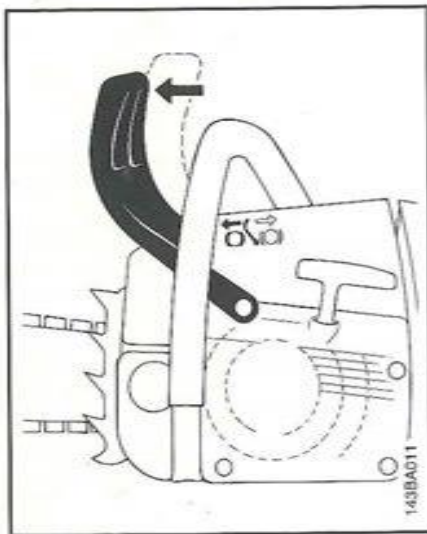

Locking chain with chain brake

- in an emergency
 - when starting
 - at idling speed.
- The chain is stopped and locked when the hand guard is pushed toward the bar nose by the left hand - or when brake is activated by inertia in certain kickback situations.

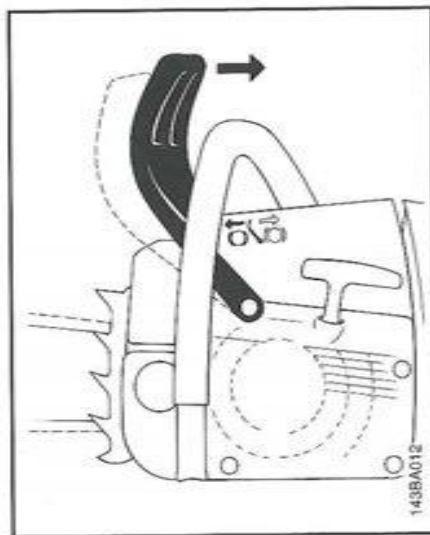

Releasing the chain brake

- Pull the hand guard back toward the front handle.

Note: Always disengage chain brake before accelerating engine and before starting cutting work. The only exception to this rule is when you check operation of the chain brake. High revs with the chain brake engaged (chain locked) will quickly damage the powerhead and chain drive (clutch, chain brake).

The chain brake is activated by the inertia of the front hand guard

if the kickback force of the saw is high enough:

The hand guard is accelerated toward the bar nose - even if your left hand is not behind the hand guard, e.g. during felling cut.

The chain brake will operate only if the hand guard has not been modified in any way.

Check operation of chain brake

Before starting work: Run engine at idle speed, engage the chain brake (push hand guard toward bar nose). Accelerate up to full throttle for no more than 3 seconds - the chain must not rotate. The hand guard must be free of dirt and move freely.

Chain brake maintenance

The chain brake is subject to normal wear and tear. It must therefore be checked and serviced regularly by trained personnel (e.g. STIHL dealer) at the following intervals:

Full-time professional users:	every 3 months
Semi-professional (farm and construction industry):	every 6 months
Hobby and occasional users:	every 12 months

Checking Spark Plug

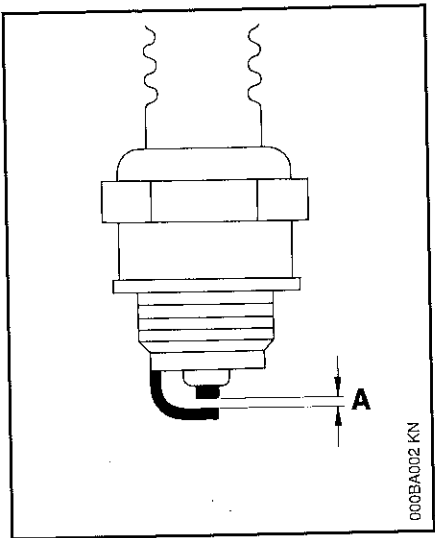

Wrong fuel mix (too much engine oil in the gasoline), a dirty air filter and unfavorable running conditions (mostly at part throttle etc.) affect the condition of the spark plug. These factors cause deposits to form on the insulator nose which may result in trouble in operation.

If engine is down on power, difficult to start or runs poorly at idling speed, first check the spark plug.

- Remove spark plug - see "If engine doesn't start:"
- Clean dirty spark plug.
- Check electrode gap - it should be 0.5mm/0.02" (A) - readjust if necessary.

- Use only resistor type spark plugs of the approved range.

Rectify faults which have caused fouling of spark plug:
Incorrect carburetor setting, too much oil in fuel mix, dirty air filter, unfavorable running conditions, e.g. operating at part load.

- **Fit a new spark plug after approx. 100 operating hours -**

or earlier if the electrodes are badly eroded.

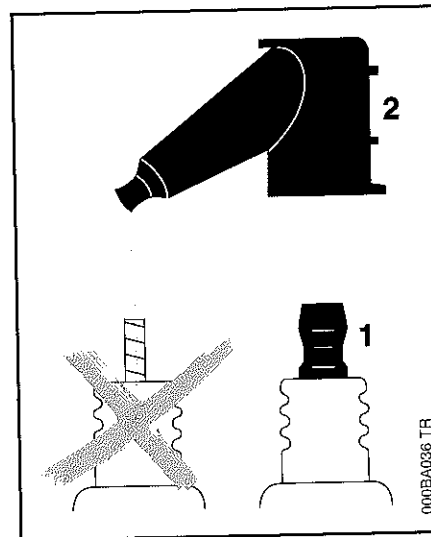

Warning!

To reduce the risk of fire and burn injury, use only spark plugs authorized by STIHL. Always press spark plug boot (2) snugly onto spark plug terminal (1) of the proper size. (Note: If terminal has detachable SAE adapter nut, it must be attached.) A loose connection between spark plug terminal and ignition wire connector in the boot may create arcing that could ignite combustible fumes and cause a fire.

Master Control

Master Control in position ③

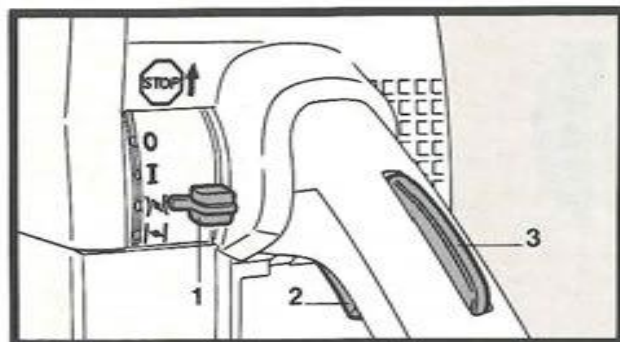

The Master Control lever (1) controls the various engine functions. Depending on its position, it acts either on the carburetor's choke shutter, the throttle trigger (2) or the stop contact (for stopping the engine).

Note the following points when operating the Master Control lever:

1. When the Master Control lever is moved to "STOP" ① (this position can only be selected from ②), the stop contact engages the contact spring – this cuts out the ignition system.
2. Press down the safety throttle lock (3) before you move the Master Control lever (1) from "Run" ② to ③ or ④. Do not squeeze the throttle trigger at the same time.
3. When the Master Control lever (1) is moved to "Warm START" ③, the choke shutter is opened and the throttle trigger (2) set to the starting-throttle position.

Positions of Master Control lever:

- ① = Stop
- ② = Run
- ③ = Warm start
- ④ = Cold start

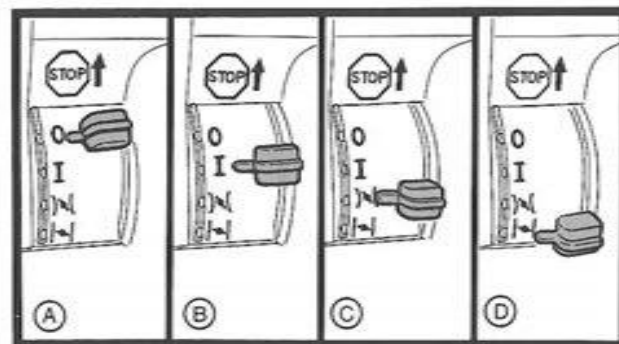

4. When in the "Warm Start" position ③, the Master Control lever (1) is locked by the throttle trigger (2) and must not be forced into the "Run" position ②. It returns automatically to "Run" ② when the throttle trigger (2) is squeezed.
5. When the Master Control lever (1) is moved to "Cold Start" ④, the choke shutter is closed and the throttle trigger (2) set to the starting-throttle position.
6. It is possible to move the Master Control lever (1) from ③ to ④ or vice versa without touching any other controls.

Starting

Before starting your saw, make sure you have a firm foothold and check that the saw chain is not touching the ground or any other obstacles. Bystanders must be kept well clear of the general work area of the saw.

See "Master Control" for full description of its functions.

1. Preparations

- 1.1 Engage the chain brake by pushing the hand guard (1) towards the bar nose.

Note: You will hear a definite click when the brake engages.

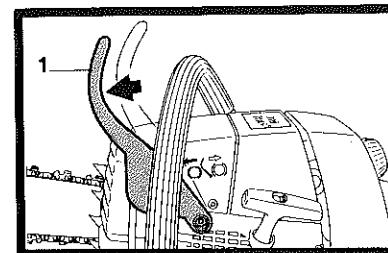
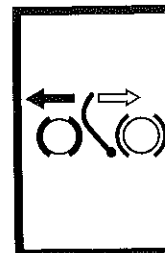

- 1.2 Adjust controls

If the engine is cold: Press down safety throttle lock (2) and move Master Control lever (3) to "Cold Start".

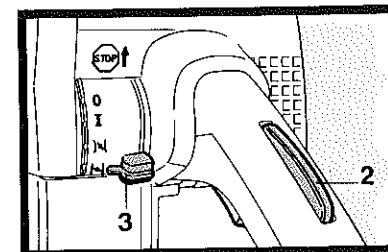

If engine is warm: Press down safety throttle lock (2) and move Master Control lever (3) to "Warm Start".
Note: Also select this position if engine has been running but is still cold.

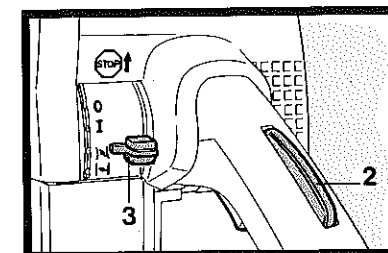
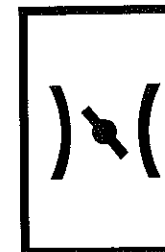

2. Starting procedure

2.1 You can hold the saw in one of two ways for starting:

– **Saw between legs**

Hold the rear handle tightly between your legs, just above the knees. Grip the front handle (5) securely with your left hand.

– **Saw on ground**

Hold the saw firmly on the ground with your left hand on the front handle (5). Put your right foot into the rear handle (6) and press down.

2.2 Pull the starter grip (7) slowly with your right hand until you feel the starter engage, then give the grip a brisk strong pull (the engine will kick back if you pull too slowly).

The starter rope must not be pulled out more than 70 cm (about 28 in) as it might otherwise break.

Do not let the starter grip (7) snap back. Guide it slowly into the housing so that the starter rope can rewinding properly.

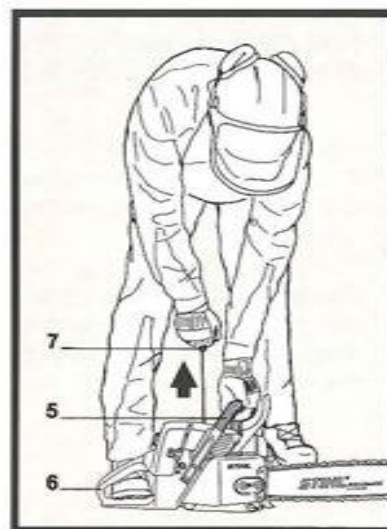
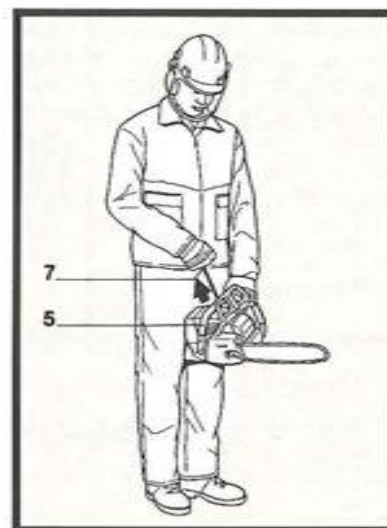

2.3 **Important:** If starting in “Cold Start” position, move Master Control lever (1) to “Warm Start” as soon as engine begins to fire and then continue cranking until engine runs.

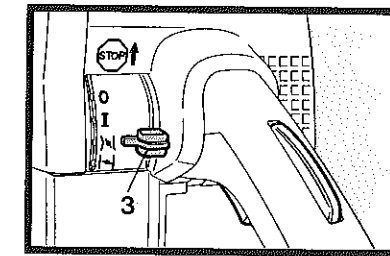
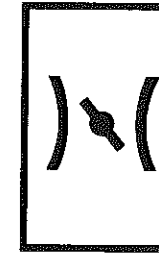

3. Engine running

3.1 Immediately blip the throttle trigger (8) so that Master Control lever moves to “Run” position and engine settles down to idle speed.

Warning! The clutch can be damaged if the engine is not immediately returned to idle speed.

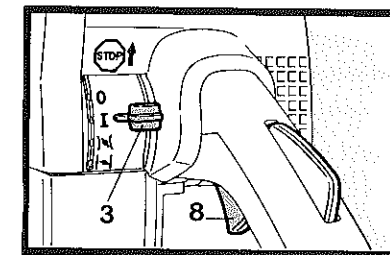
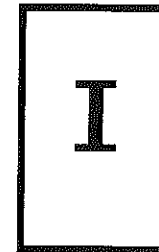

3.2 Disengage the chain brake before starting work, i.e. pull the hand guard (1) back towards the front handle.

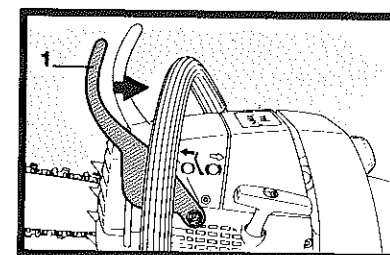
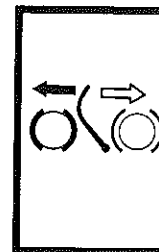

4. Stopping engine

The engine is stopped by moving the Master Control lever (3) to “Stop”.

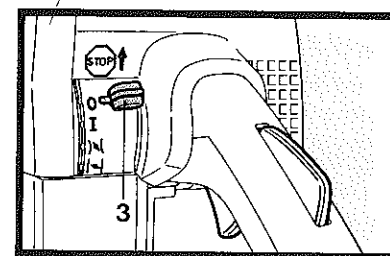
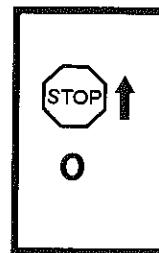

Other points to observe when starting:

The choke valve is operated by the Master Control lever (see "Master Control").

When starting a cold engine only keep the Master Control lever in the "CHOKE" position until the engine fires. Then move Master Control lever immediately to "START", even if the engine stops and you have to continue cranking. If you leave the Master Control lever on "CHOKE", the combustion chamber will flood and stall the engine.

If you have moved the Master Control lever to "START" and the engine still does not run after several attempts, it is already flooded. In such a case, remove and dry off the spark plug. With the spark plug still removed, set the Master Control lever to "STOP" and crank the engine over several times with the starter to clear the combustion chamber. When you now try to start, move the Master Control lever to "START" – even if the engine is cold.

At very low outside temperatures you should still move the Master Control to "START" and disengage the throttle trigger from the starting throttle position by briefly accelerating the engine – but then warm up the engine at part throttle for a short period.

A new engine or one which has been run until the fuel tank is dry will not start first time after fueling because fuel will only begin to reach the carburetor after the engine has been cranked over several times.

Electrically Heated Handles (Option)



Heating switched on

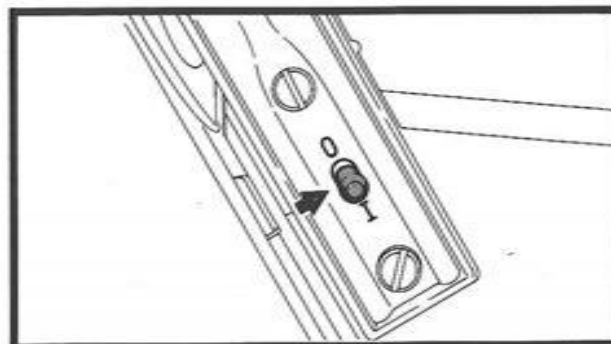

The handle heating systems enables you to keep a warm, comfortable grip on the front and rear handles at extremely low outside temperatures.

The heating system is controlled by means of a switch on the handlebar. The symbols above and below the switch indicate the two switch positions: "O" for heating off – "I" for heating on, i.e. the switch must be moved to "I" to switch the heating on.

The heating system is designed to heat the front and rear handles to an adequate level. There is no risk of overheating during long periods of continuous operation. The whole heating system is maintenance-free.

Safety Precautions



The use of any chainsaw may be hazardous. The saw chain has many sharp cutters. If the cutters contact your flesh, they will cut you, even if the chain is not moving. At full throttle, the chain speed can reach 45 mph (20 m/s). It is important that you read, fully understand and observe the following safety precautions and warnings. Read the owner's manual **and** the safety instructions periodically.

Pay special attention to the section on reactive forces.



Warning!

Reactive forces, including kickback, can be dangerous. Careless or improper use of any chainsaw may cause serious or fatal injury.

All safety precautions that are generally observed when working with an axe or a hand saw also apply to the operation of chainsaws. However, because a chainsaw is a high-speed, fast-cutting power tool, special safety precautions must be observed to reduce the risk of personal injury.

Have your STIHL dealer show you how to operate your chainsaw. Observe all applicable local safety regulations, standards and ordinances.



Warning!

Minors should never be allowed to use a chainsaw. Bystanders, especially

children, and animals should not be allowed in the area where a chainsaw is in use. Never let the saw run unattended. Store it in a locked place away from children and empty the fuel tank before storing for longer than a few days.



Do not lend or rent your chainsaw without the owner's manual. Be sure that anyone using your saw reads and under-

stands the information contained in this manual.

These safety precautions and warnings apply to the use of all STIHL chainsaws. Different models may have different parts and controls. See the appropriate section of your owner's manual for a description of the controls and function of the parts of your model saw.

Safe use of a chainsaw involves

1. the operator
2. the saw
3. the use of the saw.

THE OPERATOR

Physical Condition

You must be in good physical condition and mental health and not under the influence of any substance (drugs, alcohol) which might impair vision, dexterity or judgment.

Do not operate a chainsaw when you are fatigued. Be alert – If you get tired while operating your chainsaw, take a break. Tiredness may result in loss of control. Working with any chainsaw can be strenuous. If you have any condition that might be aggravated by strenuous work, check with your doctor before operating a chainsaw.



Warning!

Prolonged use of chainsaws (or other machines) exposing the operator to vibrations may produce whitefinger disease (Raynaud's phenomenon) or carpal tunnel syndrome. These conditions reduce the hand's ability to feel and regulate temperature, produce numbness and burning sensations and may cause nerve and circulation damage and tissue necrosis.

Many STIHL models are available with an anti-vibration (AV) system designed to reduce the transmission of vibrations created by the engine and cutting attachment to the operator's hands. An anti-vibration system is recommended for those using chainsaws on a regular or sustained basis.

Heated handles help to reduce the risk of whitefinger disease and are recommended for cold weather use. Most STIHL powerheads are available with heated handles.

Winter Operation



Below +10 °C/50 °F: Carburetor preheating

If outside temperatures are below +10 °C (50 °F), change the flow of intake air to the carburetor to “winter operation” to avoid the carburetor icing up. To do this, remove the carburetor box cover and open the shutter in the shroud (to right of spark plug). Refit carburetor box cover. This causes hot air from around the cylinder to be drawn in along with cold outside air.

Important: The shutter must be closed at temperatures above +20 °C (70 °F) to avoid engine running problems.

Below -10 °C/+14 °F: Intake air preheating kit (optional extra)

The intake air preheating kit is recommended in extreme wintery operating conditions (temperatures below -10 °C/+14 °F and in powder or drifting snow). Once it is fitted, the kit causes heated air to be drawn in from around the cylinder instead of cold outside air. This prevents air filter and carburetor icing. Furthermore, the cover plate blanks off the lower slots in the air filter housing to help prevent snow being sucked into the machine.

Detail assembly instructions are supplied with each intake air preheating kit.

Important: The shutter in the shroud (see “Carburetor preheating”) must be fully open when the intake air preheating kit is fitted.

Note: If the saw is very cold (frost or ice on machine), start the engine and keep it at a high idle speed until it reaches normal operating temperature and idles smoothly.

Top: Carburetor preheating shutter
Bottom: Carburetor box cover and cover plate for intake air preheating

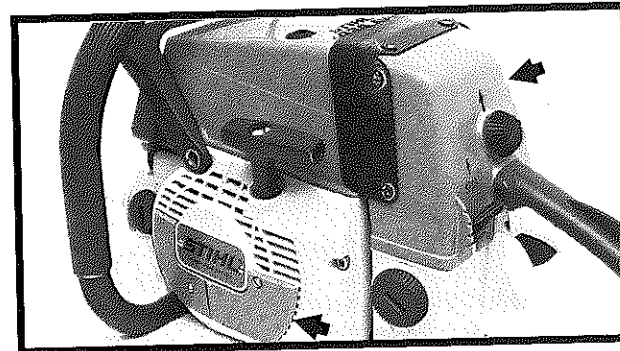
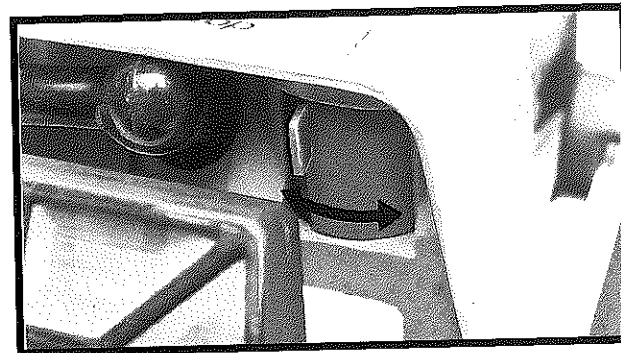

Owing to the modified air flow when the kit is fitted, the air filter may tend to load up with dust at a faster rate. If this is the case, clean the air filter more frequently.

Below -28 °C/-20 °F: A special shroud (Part No. 1125 080 1603) is available as a special accessory.

In the event of engine running problems, first check that conditions specified for use of the intake air preheating kit still apply (see assembly instructions for intake air preheating kit).

Checking Chain Lubrication

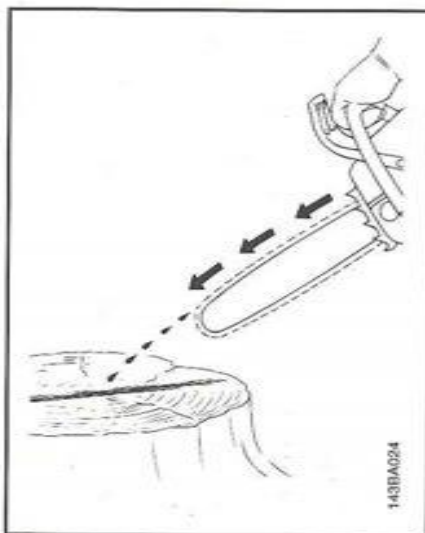

The saw chain must always throw off a small amount of oil.

- Never operate your saw without chain lubrication. If the chain is run dry the whole cutting attachment will be irretrievably damaged within a very short time. Always check chain lubrication and oil level in tank before starting work.
- Every new chain has to be broken in for about 2 to 3 minutes.

After breaking in chain, check chain tension and adjust if necessary - see section "Checking chain tension".

Taking Care of Guide Bar

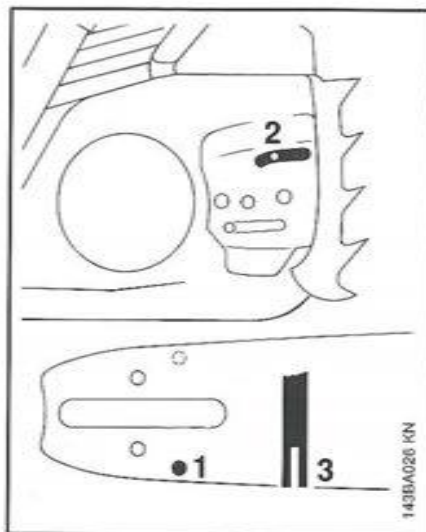

- **Turn the bar over** - every time you sharpen the chain - and every time you replace the chain - this avoids one-sided wear, especially at nose and underside of the bar.

Regularity clean

- 1 = oil inlet hole
- 2 = oilway
- 3 = bar groove.

- **Measure groove depth** - with scale on filing gauge* - at area of nose of Duromatic bars - or in area used most for cutting on Rollomatic bars -

Chain type	Chain pitch	Minimum groove depth
Rapid	0.325", 3/8"	6.0 mm (0.24")

If groove depth is less than specified:
Replace the guide bar.

*Special accessory

The drive link tangs will otherwise scrape along the bottom of the groove - the cutters and tie straps will not ride on the rails.

During Break-in Period

A factory new machine should not be run at high revs (full throttle off load) for the first three tank fillings. This avoids unnecessary high loads during the break-in period.

As all moving parts have to bed in during the break-in period, the frictional resistances in the engine are greater during this period. The engine develops its maximum power after about 5 to 15 tank fillings.

Do not make the mixture leaner to achieve an apparent increase in power - this could damage the engine - see chapter - "Adjusting Carburetor".

Always disengage chain brake before accelerating engine and before starting cutting work. High revs with the chain brake engaged (chain locked) will quickly damage the powerhead and chain drive (clutch, chain brake).

During Operation

Begin cutting with the saw at full throttle and **keep it at all full throttle** all the way through the cut. Always cut with a properly sharpened chain and apply only **moderate feed pressure**.

The sound and running behavior of the saw must remain constant. Engine speed may only drop a little in the cut - **the chain must not jerk or stop**. Pay attention to the sound of the engine.

If engine noise drops suddenly or begins to pulsate, or the chain stops, reduce feed pressure **immediately** to avoid overheating and possible damage to the engine housing and chain brake.

Check chain tension frequently.

A new chain has to be retensioned more often than one that has been in use for some time.

Cold chain:

Tension is correct when chain fits snugly against the underside of the bar and can still be pulled along the bar by hand.

Retension if necessary - see chapter "Tensioning the Saw Chain".

Chain at operating temperature:

The chain stretches and begins to sag. The drive links on the underside of the bar must not come out of the bar groove - the chain may otherwise jump off the bar.

Retension the chain - see chapter "Tensioning the Saw Chain".

Always slacken off the chain again after finishing work.

The chain contracts as it cools down. If it is not slackened off, it may damage the crankshaft and bearings.

After a long period of full-throttle operation

Allow engine to run for a short while at idling speed so that engine heat can be dissipated by the flow of cooling air. This helps protect engine-mounted components (ignition, carburetor) from thermal overload.

After Finishing Work

Slacken off the chain

if you have retensioned it at operating temperature during cutting work. The chain contracts as it cools down. If it is not slackened off, it could damage the crankshaft and bearings.

Air Filter

Component parts of filter system in correct sequence

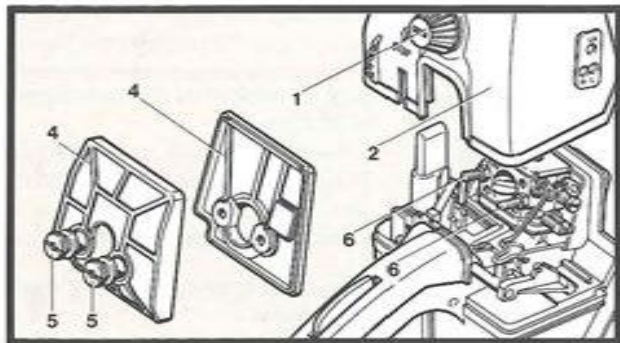

The intake air must be cleaned of dust and dirt in order to protect the moving parts of the engine from abnormal wear. Two filters (034 WB one filter only) are installed in front of the carburetor for this purpose.

The air filter must be cleaned whenever there is a noticeable loss of engine power.

Clean both filters daily after finishing work or more often if the air is exceptionally dusty in the work area.

To **remove** the air filters, first press in the twist lock (1) on the carburetor box cover (2) firmly and turn it about $\frac{1}{4}$ turn to the left (counterclockwise) so that the integrally molded rib is vertical. Then lift the carburetor box cover (2) off **upwards**.

The **prefilter (3; not 034 WB)** is fitted inside the carburetor box cover. To remove, press down the retaining lug and pull out in the direction of the arrow.

Prefilter in carburetor box cover

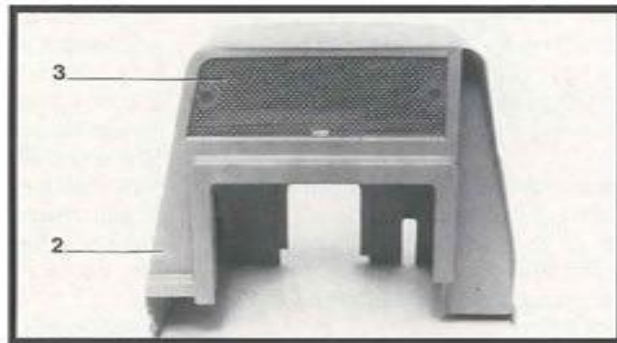

Before removing the **fine mesh filter (4)**, clean away any loose dirt from around it and close the choke shutter (move Master Control to "CHOKE") to ensure that no dirt gets into the carburetor. Use screwdriver end of combination wrench to release and unscrew the two slotted nuts (5) and then lift the complete fine mesh filter (4) off the studs (6).

Clean the complete air filter (prefilter and fine filter) by either blowing it out with compressed air or washing it thoroughly in fresh, non-inflammable cleaning solution. Carefully shake dry. Encrusted dirt should be softened by soaking the filter in cleaning solution. If the filter fabric is damaged, replace the filter **immediately**.

It is best to carry a spare filter at all times and clean the dirty one after finishing work.

Reassemble by reversing the above sequence. Pay special attention to the following points: The prefilter (3) must be pushed into its guide as far as the stop so that the locating lug snaps into place. After refitting the carburetor box cover (2), press in the twist lock (1) firmly and turn it about $\frac{1}{4}$ turn to the right (clockwise) so that the integrally molded rib is horizontal.

Carburetor

- 1 = High speed adjusting screw
- 2 = Low speed adjusting screw
- 3 = Idle speed adjusting screw

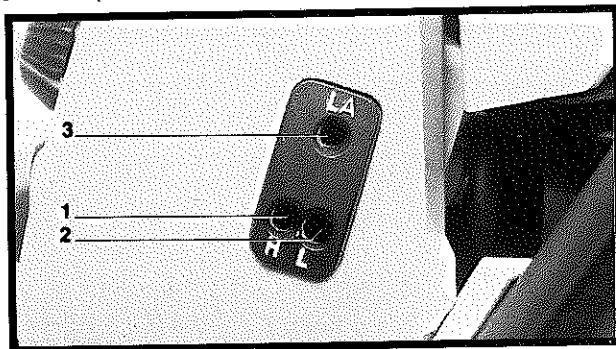

When the engine is tested at the factory the carburetor is set to obtain a slightly richer mixture to ensure that the cylinder bore and the bearings receive additional lubrication during the break-in period. This setting should be left as it is for the first three tank fillings. The high speed adjusting screw may then be turned no more than ¼ turn clockwise (leaner mixture). Caution: The engine's maximum permissible rpm must not be exceeded!

If you use your chain saw at high altitudes (mountains) or at sea level it may be necessary to change the carburetor setting slightly. Carry out the correction at the two adjusting screws (L and H) as follows: Turn clockwise (leaner) for high altitude operation or counterclockwise (richer) for operation at sea level.

Note that even slight alterations on the adjusting screws have a noticeable effect on the engine's running behavior. Only carry out carburetor adjustments after cleaning the air filter and warming up the engine.

Caution: Adjustment of the high speed adjusting screw not only affects the power output but also the maximum off-load engine speed. If the setting is too lean (screw turned too far clockwise), the maximum permissible

Regulating idle speed adjusting screw

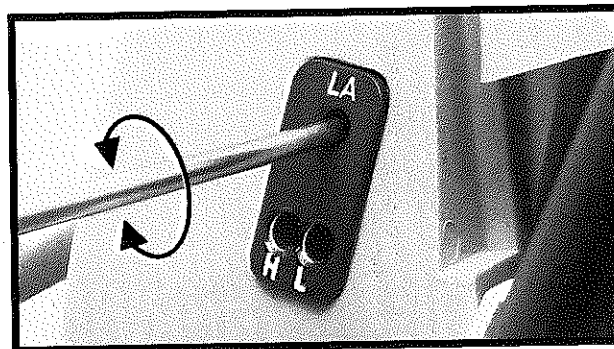

engine speed will be exceeded. This can cause engine damage, brought about by lack of lubrication and overheating in particular. Corrections to the setting of the high speed adjusting screw may be carried out only if an accurate tachometer is available to check the maximum engine speed of 13000 r.p.m. (with bar and correctly tensioned chain).

Basic setting

If it is necessary to readjust the carburetor again from the beginning, first carry out the basic setting to obtain a starting point for fine adjustment. To do this, carefully screw the two adjusting screws down onto their seats (clockwise). Then make the following adjustment:

High speed adjusting screw H:
back off 1 complete turn

Low speed adjusting screw L:
back off 1 complete turn

If you have no means of checking the maximum engine speed, do not set the high speed adjusting screw any leaner by turning it beyond the basic setting.

Notes for adjusting idle speed

Engine stops while idling

Turn idle speed adjusting screw (LA) clockwise until chain begins to run. Then back off one quarter of a turn.

Chain runs when engine is idling

Turn idle speed adjusting screw (LA) counterclockwise until chain stops running and then turn it about another quarter turn in the same direction.

Erratic idling behavior; poor acceleration

Idle setting too lean; turn low speed adjusting screw (L) counterclockwise until engine runs and accelerates smoothly.

Exhaust smokes at idle speed

Idle speed setting too rich; turn low speed adjusting screw (L) clockwise until engine speed drops. Then turn screw back one quarter turn and check that engine still accelerates smoothly when you open the throttle.

A correction at the low speed adjusting screw usually necessitates a change in the setting of the idle speed adjusting screw (LA).

Apart from minor readjustments, you should leave all carburetor setting and repair work to your STIHL dealer. STIHL dealers have trained staff and all the necessary servicing tools and equipment.

Replacing the Chain Sprocket

Chain brake disengaged

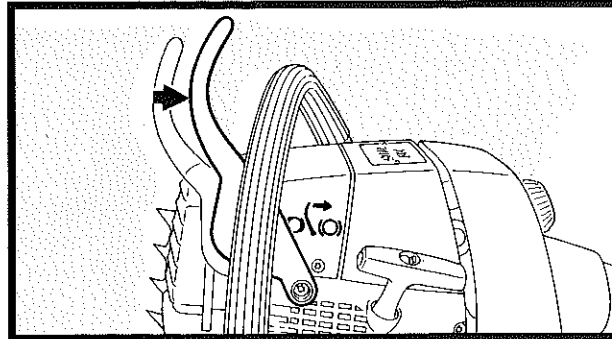

Rim sprocket

Remove chain sprocket cover, Oilomatic saw chain and guide bar.

Disengage chain brake by pulling the hand guard towards the handlebar. Insert a pointed knife or similar tool behind the E-clip (1) to ease it clear of the warts on the thrust washer (2) and then use a small screwdriver to prise the E-clip off the crankshaft.

Take off the thrust washer and rim sprocket (3).

Examine the teeth on the clutch drum (4) for signs of wear. If wear marks are severe, fit a new clutch drum.

To do this, pull the clutch drum (4) and needle cage off the crankshaft. Clean the stub of the crankshaft, wash the needle cage in clean gasoline and lubricate it with STIHL grease (tube 0781 120 1111). Only original STIHL clutch drums may be installed.

Assemble in the reverse sequence. When fitting the new rim sprocket (3) note that the side with the cavities must face outwards. Finish off by refitting the washer (2) and E-clip (1) on the crankshaft.

Top: Removing E-clip
Center: Rim sprocket removed
Bottom: Severe wear marks on teeth of clutch drum

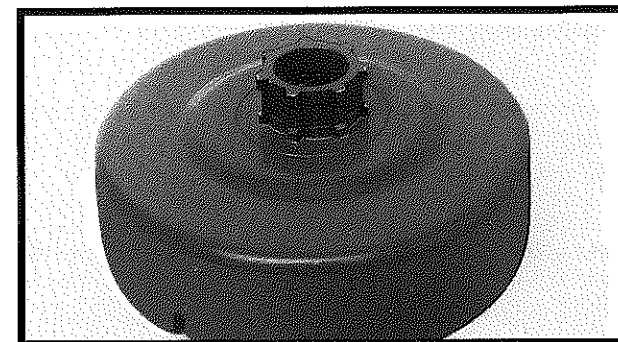
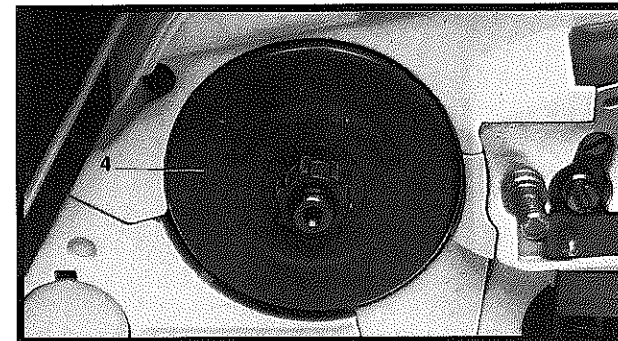
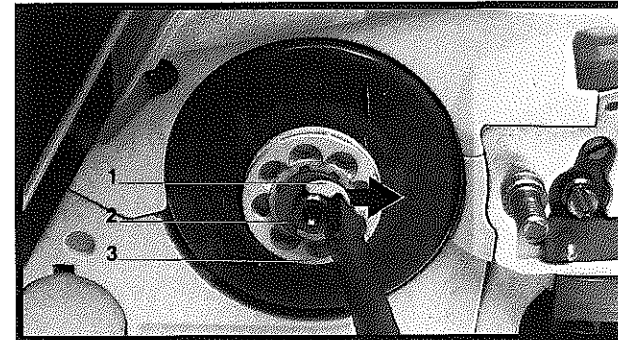

Check for fuel leakage while refueling and during operation. If fuel or oil leakage is found, do not start or run the engine until leak is fixed and spilled fuel has been wiped away. Take care not to get fuel on your clothing. If this happens, change your clothing immediately.

 **Warning!**

Unit vibrations can cause an improperly tightened fuel cap to loosen or come off and spill quantities of fuel. In order to reduce risk of fuel spillage and fire, tighten fuel cap by hand with as much force as possible.

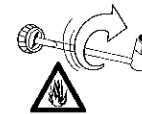

The screw driver end of the STIHL combination wrench or other similar tool can be used as an aid in tightening slotted fuel caps.

Starting

The chain brake must be blocked when starting the saw

 **Warning!**

Your chainsaw is a one-person saw. Do not allow other persons to be near the running chainsaw. Start and operate your saw without assistance. For specific starting instructions, see the appropriate section of the Owner's Manual. Proper starting methods reduce the risk of injury. Do not drop start. This method is very dangerous because you may lose control of the saw.

There are two recommended methods for starting your chainsaw.

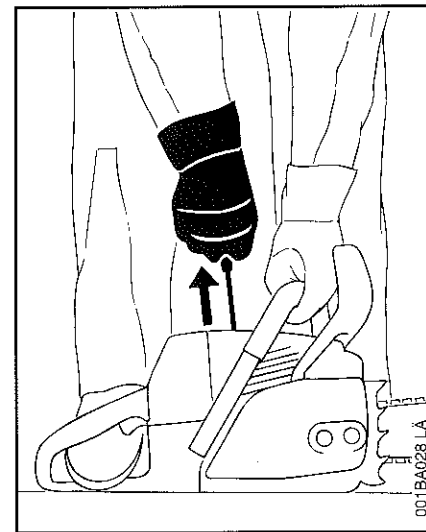

With the **first method**, the chainsaw is started on the ground. Make sure the chain brake is engaged (see "Chain Brake" chapter in your Owner's Manual) and place the chainsaw on firm ground or other solid surface in an open area. Maintain good balance and secure footing.

Grip the front handlebar of the saw firmly with your left hand and press down. For saws with a rear handle level with the ground, put the toe of your right foot into the rear handle and press down. With your right hand pull out the starter grip slowly until you feel a definite resistance and then give it a brisk, strong pull.

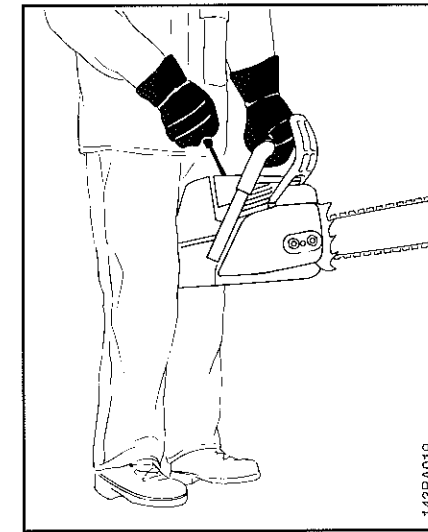

The **second recommended method** for starting your chainsaw allows you to start the saw without placing it on the ground. Make sure the chain brake is engaged, grip the front handle of the chainsaw firmly with your left hand. Keep the arm on the front handle in a locked (straight) position. Hold the rear handle of the saw tightly between your legs just above the knees. Maintain good balance and secure footing. Pull the starting grip slowly until you feel a definite resistance and then give it a brisk, strong pull.

Starter Assembly

Remove the mounting screws

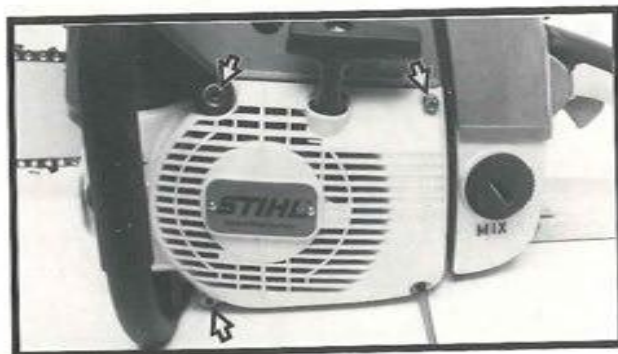

Replacing a broken starter rope

First remove the four screws which retain the fan housing. Then lift the base of the fan housing clear of the crankcase so that you can pull it downwards and remove it from the machine.

Use a screwdriver or a suitable pair of pliers to carefully remove the spring clip (1) from the starter post. Now take off the rope rotor (2) together with the washer (3) and pawl (4).

Remove any remaining rope from the rope rotor. Thread a new 3.5 mm (0.14 in) diameter and 960 mm (37.8 in) long starter rope (5) into the rope rotor and secure it with a simple overhand knot. Thread the other end of the rope through the rope guide in the fan housing from inside, pass it upwards through the underside of the starter grip and secure it with a figure 8 or looped overhand knot (see illustration of knots). Do not wind the rope onto the rotor at this stage.

Clean and lubricate the rope rotor's bushing with a non-resinous oil. Slide the rotor onto the starter post and turn it back and forth until the slotted area engages the anchor loop of the rewind spring (7).

Top: Special knots
Bottom: Component parts of starter assembly

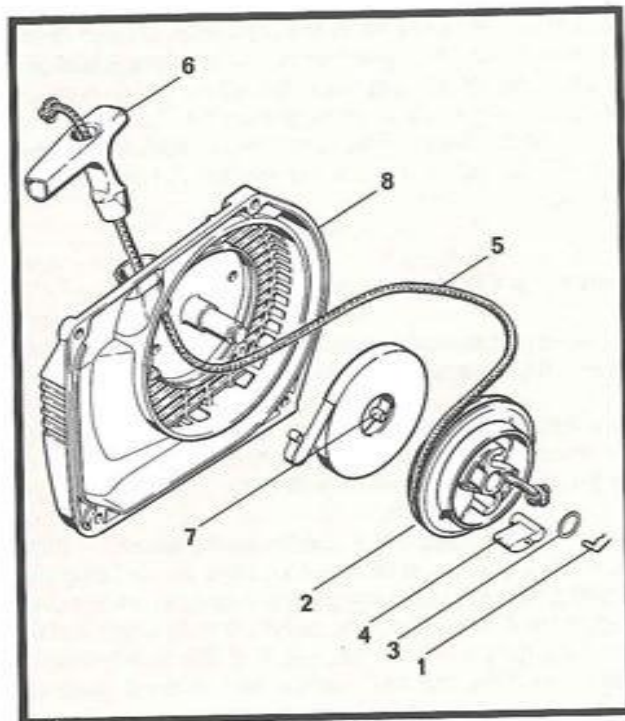
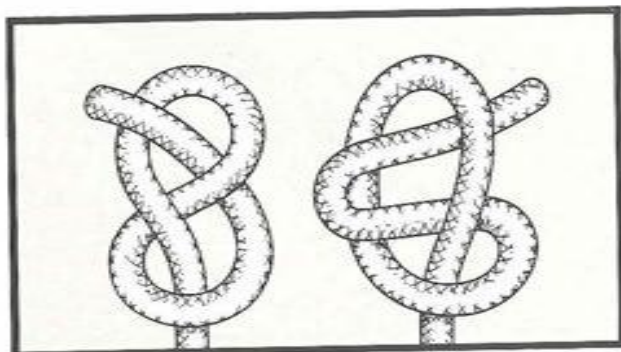

Warning!

Take extreme care in wet and freezing weather (rain, snow, ice). Put off the work when the weather is windy, stormy or rainfall is heavy. Clear the area where you are working.

Warning!

Avoid stumbling on obstacles such as stumps, roots or rocks and watch out for holes or ditches. Be extremely cautious when working on slopes or uneven ground. There is increased danger of slipping on freshly debarked logs.



Warning!
To reduce the risk of serious or fatal injury to the operator or bystanders,

never use the saw with one hand. You cannot control reactive forces and you may lose control of the saw, which can result in theskating or bouncing of the bar and chain along the limb or log.

Even for those compact saws designed for use in confined spaces, one-handed operation is dangerous because the operator may lose control.

Cutting Instructions

Grip: Always hold the saw firmly with both hands when the engine is running. Place your left hand on front handle bar and your right hand on rear handle and throttle trigger. Left-handers should follow these instructions too.

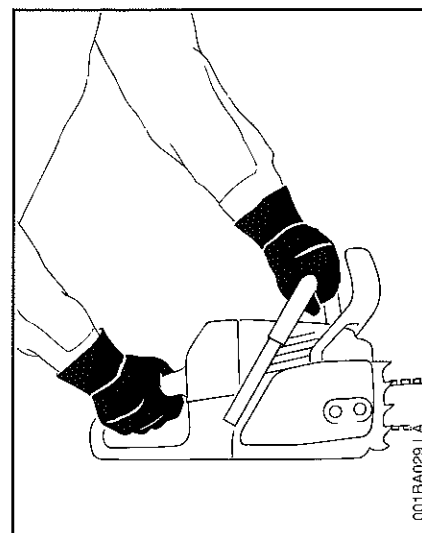

Wrap your fingers tightly around the handles, keeping the handles cradled between your thumb and forefinger. With your hands in this position, you can best oppose and absorb the push, pull and kickback forces of your saw without losing control (see section on reactive forces). Make sure your chainsaw handles and grip are in good condition and free of moisture, pitch, oil or grease.

Warning!

Do not operate your chainsaw with the starting throttle lock engaged. Cutting with the starting throttle lock engaged does not permit the operator proper control of the saw or chain speed.

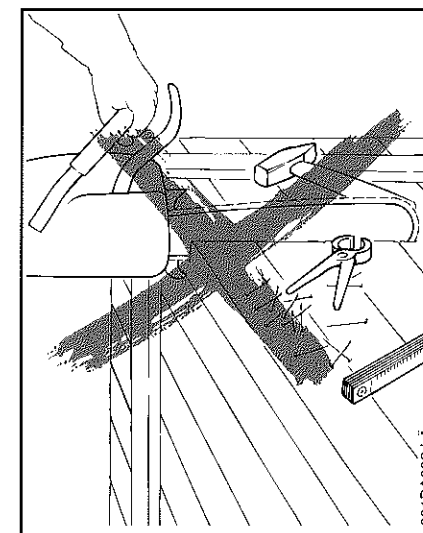

Warning!

Never touch a chain with your hand or any part of your body when the engine is running, even when the chain is not rotating. The chain continues to rotate for a short period after the throttle trigger is released.

Warning!

Do not cut any material other than wood or wooden objects. Use your chainsaw for cutting only. It is not designed for prying or shoveling away limbs, roots or other objects. When sawing, make sure that the saw chain does not touch any foreign materials such as rocks, fences, nails and the like.



Warning!

Be sure that the guide bar and chain are clear of you and all other obstructions and objects, including the ground. When the engine is started, the engine speed with the starting throttle lock engaged will be fast enough for the clutch to engage the sprocket and, if the chain-brake is not activated, turn the chain. If the upper quadrant of the tip of the bar touches any object, it may cause kick-back to occur (see section on reactive forces). To reduce this risk, always engage the chain brake before starting. Never attempt to start the chainsaw when the guide bar is in a cut or kerf.



Warning!

When you pull the starter grip, do not wrap the starting rope around your hands. Do not allow the grip to snap back, but guide the starter rope slowly back to permit the rope to rewind properly. Failure to follow this procedure may result in injury to hand or fingers and may damage the starter mechanism.

Important adjustments



Warning!

To reduce the risk of personal injury from loss of control or contact with the running chain, do not use a saw with incorrect idle adjustment. At correct idle speed, the chain should not rotate. For directions to adjust idle speed, see the appropriate section of your Owner's Manual. If you cannot set the correct idle speed, have your STIHL dealer check your saw and make proper adjustments or repairs.

After adjusting a chain, start the saw, let the engine run for a while, then switch engine off and recheck chain tension. Proper chain tension is very important at all times.

Working Conditions

Operate the chainsaw under good visibility and daylight conditions only, even if your chainsaw is equipped with a catalytic converter.



Warning!



Your chainsaw produces poisonous exhaust fumes as soon as the combustible engine is running.

These gases (e.g. carbon monoxide) may be colorless and odorless.

To reduce the risk of serious or fatal injury from breathing toxic fumes, never run the chainsaw indoors or in poorly ventilated locations. Ensure proper venti-

lation when working in trenches or other confined areas.

The muffler and other parts of the engine (e.g. fins of the cylinder, spark plug) become hot during operation and remain hot for a while after stopping the engine. To reduce risk of burns do not touch the muffler and other parts while they are hot. Operate the saw under good visibility and daylight conditions only. Don't work alone. Keep within calling distance of others in case help is needed.

Your chainsaw is equipped with a chain catcher. It is designed to reduce the risk of personal injury in the event of a thrown or broken chain. From time to time the catcher may be damaged or removed. To reduce the risk of personal injury, do not operate a chainsaw with a damaged or missing catcher. Inspect buffers periodically. Replace damaged, broken or excessively worn buffers immediately, since they may result in loss of control of the saw. A "sponginess" in the feel of the saw, increased vibration or increased "bottoming" during normal operation may indicate damage, breakage or excessive wear. Buffers should always be replaced in sets. If you have any questions as to whether the buffers should be replaced, consult your STIHL servicing dealer.

Anti-vibration systems and heated handles do not guarantee that you will not sustain whitefinger disease or carpal tunnel syndrome. Therefore, continual and regular users should monitor closely the condition of their hands and fingers. If any of the above symptoms appear, seek medical advice immediately.

Proper Clothing



Clothing must be sturdy and snug-fitting, but allow complete freedom of movement. Avoid loosefitting jackets, scarfs, neckties, jewelry, flared or cuffed pants, unconfined long hair or anything that could become entangled with the saw or brush. Wear overalls or jeans with a reinforced cut retardant insert or cut retardant chaps.



Protect your hands with gloves when handling saw and saw chain. Heavyduty, nonslip gloves improve your grip and protect your hands.



Good footing is most important in chainsaw work. Wear sturdy boots with nonslip soles. Steel-toed safety boots are recommended.

To reduce the risk of injury to your eyes never operate a chainsaw unless wearing goggles or properly fitted safety glasses with adequate top and side protection complying with your national standard.



Wear an approved safety hard hat to protect your head. Chainsaw noise may damage your hearing. Always wear sound barriers (ear plugs or ear muffers) to protect your hearing. Continual and regular users should have their hearing checked regularly.

THE SAW

Parts of the chainsaw; for illustrations and definitions of the parts see the chapter on "Main Parts of Saw".



Warning!

Never modify a chainsaw in any way. Only attachments and parts supplied by STIHL or expressly approved by STIHL for use with the specific STIHL saw models are authorized. Although certain unauthorized attachments are useable with the STIHL powerhead, their use may, in fact, be extremely dangerous.

THE USE OF THE SAW

Transporting the chainsaw



Warning!

Always stop the engine before putting a chainsaw down or carrying it. Carrying a chainsaw with the engine running is extremely dangerous.

Accidental acceleration of the engine can cause the chain to rotate. During operation, the powerhead muffler and the material around it reach extremely high temperatures. Avoid touching the hot muffler, you could receive serious burns.

By hand: When carrying your saw by hand, the engine must be stopped and the saw must be in the proper position.

Installing the spring clip

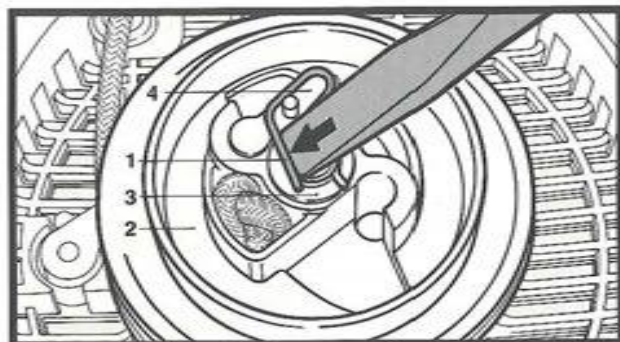

Now insert the pawl (4) in the rope rotor (2) and fit the washer (3) on the starter post. Use a screwdriver or a suitable pair of pliers to press the spring clip (1) onto the starter post, making sure that the spring clip engages on the pawl's guide pin and points in the clockwise direction. Finish off by tensioning the rewind spring (see below).

Replacing a broken rewind spring

First remove the rope rotor (2). Take the spring housing and rewind spring (7) out of the fan housing (8).

The replacement spring and spring housing are supplied as an assembly. Lubricate the spring with a few drops of non-resinous oil before installing it.

Drop the rewind spring (7) and housing assembly (bottom plate area must face up) into the fan housing (8), making sure the outer spring loop engages over the cast lug on the fan housing. If the spring should pop out of its housing during installation, refit it in the counterclockwise direction, starting outside and working inwards. Reassemble the rope rotor (2) as above.

Tensioning the rewind spring

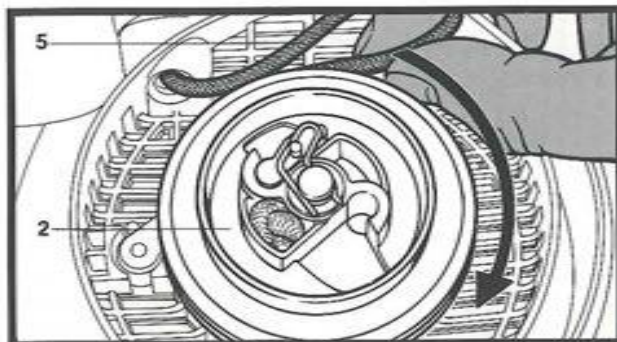

Tensioning the rewind spring

With the starter rope (5) fully extended, make a loop in the rope between the rotor (2) and fan housing and use it to turn the rope rotor (2) six full revolutions clockwise. Hold the rope rotor steady in this position. Pull out and straighten the twisted rope (5). Now release the rope rotor gradually and allow spring force to wind the starter rope fully onto the rope rotor.

The rewind spring is correctly tensioned if the starter grip is held firmly in place against the starter housing and does not droop to one side. If this is not the case and more tension is required, add one more turn on the rope rotor. When the starter rope is fully extended it must be possible to rotate the rope rotor at least another half turn before maximum spring tension is reached. If this is not the case, hold the rope rotor firmly and take off one turn of the rope.

The rewind spring will break prematurely if it is over-tensioned.

Finish off by refitting the fan housing.

Spur chain sprocket fitted in position



Spur chain sprocket

Remove chain sprocket cover, Oilomatic saw chain and guide bar.

Disengage chain brake by pulling the hand guard towards the handlebar.

Insert a pointed knife or similar tool behind the E-clip (1) to ease it clear of the warts on the thrust washer (5) and then use a small screwdriver to prise the E-clip off the crankshaft. Take the thrust washer, sprocket and needle cage off the crankshaft.

Clean the stub of the crankshaft, wash the needle cage in clean gasoline and lubricate it with STIHL grease (tube 0781 120 1111).

Assemble in the reverse sequence. After fitting the clutch drum, rotate it about one half turn in either direction to engage the oil pump drive spring. Finish off by refitting the washer (5) and E-clip (1) on the crankshaft.

Oil Quantity Control

- A= Adjusting screw in minimum position
- B= Adjusting screw in "E" (Ematic) position
- C= Adjusting screw in maximal position

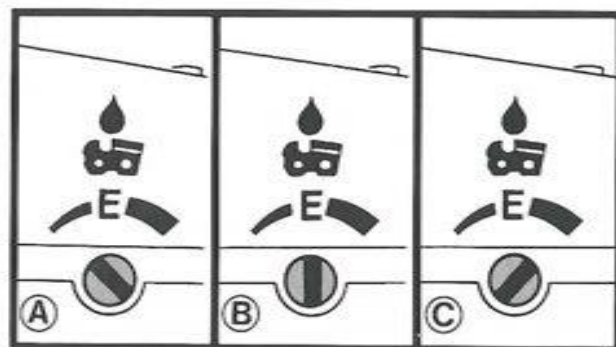

Different quantities of oil are required for different bar lengths, types of wood and cutting techniques to ensure adequate lubrication of the bar and chain. The feed rate of the oil pump can be varied to suit requirements by means of the adjusting screw on the underside of the machine.

The oil feed rate is increased by turning the adjusting screw clockwise or decreased by turning it counter-clockwise.

If you use a STIHL *Ematic* guide bar in normal operating conditions you should leave the adjusting screw in the "E" position. This is the oil pump's most economic setting.

If you fit a shorter guide bar for felling small trees or limbing, you can reduce the oil feed rate to a little less than the "E" position. In case of longer guide bars, large stem diameters and very dry wood it may be necessary to increase the oil feed rate by turning the adjusting screw slightly beyond the "E" position.

Insufficient lubrication can cause an abnormally high rate of wear. For this reason you should make sure the chain is always wetted with a film of lubricant.

Maintaining and Sharpening Saw Chain

Correctly sharpened chain

A properly sharpened chain slices through wood effortlessly and requires very little feed pressure.

Do not work with a dull or damaged chain as it will increase the physical effort required, produce unsatisfactory results and a higher rate of wear.

Clean and check your chain

for cracks in the links and damaged rivets -
replace any damaged or worn parts of the chain and match the new parts to the shape and size of the original parts.

Important: It is absolutely imperative to comply with the angles and dimensions specified below. If the **saw chain is incorrectly sharpened** - and in particular if the depth gauge is set too low - there is a risk of increased kickback of the chainsaw, with resulting **danger of injury**.

Select the appropriate sharpening tools for the chain pitch.

See "Technical Data" for the permitted chain pitches.

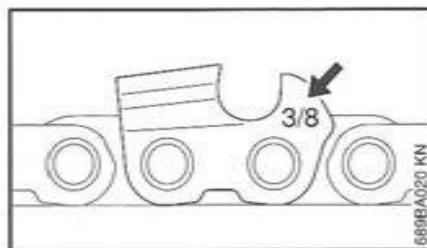

The chain pitch (e.g. 3/8) is marked on the depth gauge side of each cutter.

Use only special saw chain files

Other files have the wrong shape and cut.

Select file diameter according to chain pitch.

Chain pitch Inch (mm)	File-dia. mm (Inch)	Part No.
1/4 (6,35)	4,0 (5/32)	0814 243 3383
3/8 P (9,32)	4,0 (5/32)	0814 243 3383
0.325 (8,25)	4,8 (3/16)	0811 412 8088
3/8 (9,32)	5,2 (13/64)	0814 243 3384
0.404 (10,26)	5,5 (7/32)	0811 412 8108

You must observe certain angles when sharpening the chain cutters

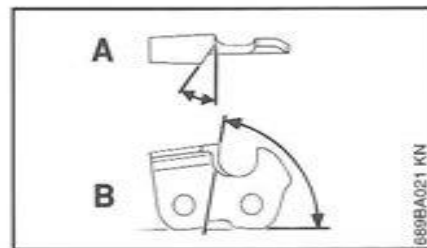

A = Filing angle
B = Side plate angle

Chain type	Angle (°)	
	A	B
Rapid-Micro (RM)	30	85
Rapid-Super (RS)	30	60
Picco-Micro (PM/PMN)	30	85

Cutter shapes:
Micro = Semi-chisel
Super = Full chisel

Specified angles A and B are obtained automatically if recommended files or sharpening tools and correct settings are used.

Furthermore, the angles must be the same on all cutters.
If angles are uneven:
Chain will run roughly, not in a straight line, wear quickly and finally break.

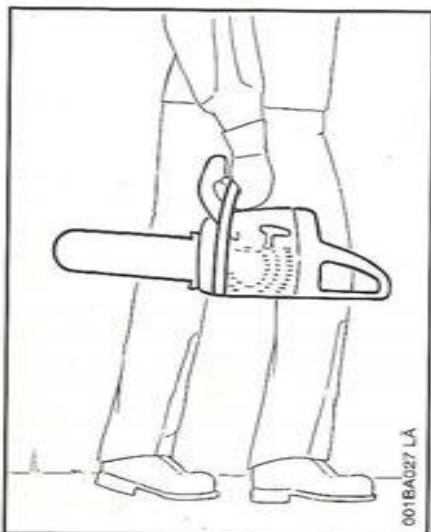

Grip the front handle and place the muffer away from the body.

The chain guard (scabbard) should be over the chain and the guide bar, which should point backwards. When carrying your saw, the bar should be behind you.

By vehicle: When transporting in a vehicle, keep chain and bar covered with the chain guard. Properly secure your saw to prevent turnover, fuel spillage and damage to the saw.

Preparation for the use of the saw

Take off the chain guard and inspect for safety in operation. For assembly, follow the procedure described in the chapter "Mounting the Bar and Chain" of your Owner's Manual.

STIHL Oilomatic chain, guide bar and sprocket must match each other in gauge and pitch. Before replacing any bar and chain, see the sections on "Specifications", kickback and the ANSI B 175.1-1991 chain-saw kickback standard in this manual.

Warning!

Proper tension of the chain is extremely important. In order to avoid improper setting, the tensioning procedure must be followed as described in your manual. Always make sure the hexagonal nut(s) for the sprocket cover is (are) tightened securely after tensioning the chain. Never start the saw with the sprocket cover loose. Check chain tension once more after having tightened the nut(s) and thereafter at regular intervals (whenever the saw is shut off). If the chain becomes loose while cutting, shut off the engine and then tighten. Never try to tighten the chain while the engine is running!

Fueling

Your STIHL chainsaw uses an oil-gasoline mixture for fuel (see chapter "Fuel" of your Owner's Manual).

Warning!

Gasoline is an extremely flammable fuel. If spilled or ignited by a spark or other ignition source, it can cause fire and serious burn injury or property damage. Use extreme caution when handling gasoline or fuel mix.



Do not smoke or bring any fire or flame near the fuel.

Fueling Instructions

Fuel your chainsaw in well-ventilated areas, outdoors only.

Always shut off the engine and allow it to cool before refueling. Gasoline vapor pressure may build up inside the gas-tank of a two cycle engine depending on the fuel used, the weather conditions, and the venting system of the tank. In order to reduce the risk of burns or other personal injury from escaping gas vapor and fumes, remove the gas cap on the STIHL product carefully so as to allow any pressure build-up in the tank to release slowly. Never remove fuel filler cap while engine is running.

Select bare ground for fueling and move at least 10 feet (3 m) from fueling spot before starting the engine. Wipe off any spilled fuel before starting your saw, and check for leakage.

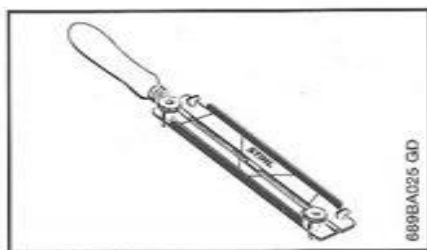

As these requirements can be met only after sufficient and constant practice:

Use a file holder.*

A file holder must be used for manual sharpening of Super chain. The correct filing angle is marked on the file holder.

Chain pitch		File holder
Inch	(mm)	Part No.
1/4	(6,35)	5605 750 4327
3/8 P	(9,32)	5605 750 4327
0.325	(8,25)	5605 750 4328
3/8	(9,32)	5605 750 4329
0.404	(10,26)	5605 750 4330

* Special accessory

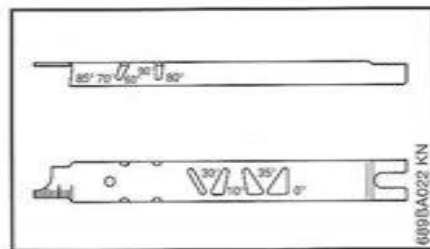

For checking angles

STIHL filing gauge*

A universal tool for checking the filing and side plate angles, depth gauge setting and cutter length. Also cleans the guide bar groove and oil inlet hole.

Chain pitch		Filing gauge
Inch	(mm)	Part-No.
1/4	(6,35)	1110 893 4000
3/8-PM	(9,32)	1110 893 4000
3/8-PMN	(9,32)	0000 893 4000
0.325	(8,25)	1110 893 4000
3/8	(9,32)	1110 893 4000
0.404	(10,26)	1106 893 4000

* Special accessory

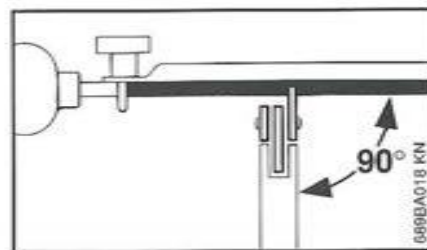

File correctly

- If you use a file holder or the FG 1: Leave the chain on the bar.
- Clamp the bar in a vise if necessary.
- Lock the chain - push hand guard forward
- To rotate the chain - pull hand guard against front handle
- Sharpen chain frequently, take away as little metal as possible - two or three strokes of the file are usually enough
- Always file from the inside to the outside of the cutter.
- The file only sharpens on the forward stroke - lift the file off the cutter on the back-stroke.
- Hold the file **horizontally** for all chain types (at right angle to side of guide bar) and file according to the angles marked on the filing tool.

- Avoid touching the tie straps and drive links with the file.
- Rotate the file at regular intervals while filing - this avoids one-sided wear.
- Use a piece of hardwood to remove burrs from cutting edge.
- Check angles with the filing gauge.

All cutters must be the same length

If the cutters are not the same length, they will have different heights. This makes the chain run roughly and can cause it to break.

Find the shortest cutter and then file all other cutters back to the same length. This can be very time consuming - it is best to have it done in the workshop on an electric grinder.

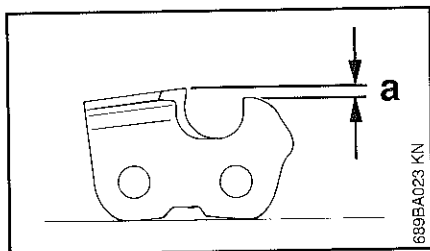

Depth gauge setting

The depth gauge determines the height at which the cutter enters the wood and thus the thickness of the chip removed.

Distance between depth gauge and cutting edge = a:

Chain pitch	Depth gauge distance "a" mm	Filing gauge* Part No.
1/4	0,65	1110 893 4000
3/8-PM	0,65	1110 893 4000
3/8-PMN	0,45	0000 893 4000
0.325	0,65	1110 893 4000
3/8	0,65	1110 893 4000
0.404	0,80	1106 893 4000

This setting may be increased by 0.2 mm (0.008") for cutting softwood in mild weather season - no frost.

* Special accessory

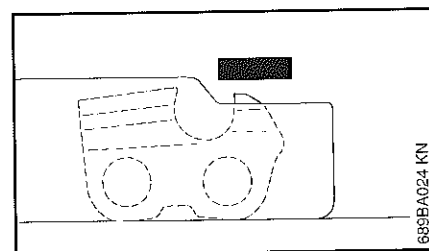

Lowering depth gauges

The depth gauge setting is reduced when the chain is sharpened. Use filing gauge to check the setting every time you sharpen the chain and, if necessary, lower the depth gauge with a flat or triangular file so that it is level with the filing gauge.

Round off depth gauges parallel to the stamped marking.

For lowering depth gauges

Triangular file*
Part No. 0811 421 8971
Flat file*
Part No. 0814 252 3356

After sharpening

Clean the chain thoroughly, remove filings or grinding dust - lubricate the chain by immersing it in an oil bath.

Before long out-of-service period

Clean the chain with a brush and immerse it in an oil bath.

Maintenance Chart

		before	after	after	weekly	monthly	if faulty	if damaged	as required	see page:
		starting work	finishing work or daily	each refueling stop						
Please note that the following maintenance intervals apply for normal operating conditions only. If your daily working time is longer than normal or cutting conditions are difficult (very dusty work area tropical wood etc.) shorten the specified intervals accordingly.			x		x					
			x							
Complete machine	Visual inspection (condition leaks)		x		x					
	Clean		x							
Throttle trigger, trigger interlock, Master Control	Check operation		x		x					
Chain brake	Check operation	x		x						30
	Check by STIHL dealer								x	
Filter in fuel tank	Check					x				28
	Clean, Replace filter element									
	Replace pick-up body						x	x		
Fuel tank	Clean					x				28
Chain oil tank	Clean					x				
Chain lubrication	Check	x								38
Saw chain	Inspect, also check sharpness	x		x						
	Check chain tension	x		x						26
	Sharpen								x	47
Guide bar	Check (wear, damage)	x								38
	Clean and turn over				x		x			
	Deburr				x					
	Replace							x	x	
Chain sprocket	Check			x					43, 44	
Air filter	Clean						x		x	40
	Replace							x		
Cooling inlets	Clean		x							
Cylinder fins	Clean					x				
Carburetor	Check idle adjustment – chain must not turn	x		x						41
	Readjust idle								x	
Spark plug	Readjust electrode gap						x			
All accessible screws and nuts (not adjusting screws)	Tighten								x	
Rubber vibration buffers	Inspect				x					
	Have replaced by STIHL dealer							x		
Spark arrestor screen in muffler	Inspect						x			
	Clean or replace							x	x	
Chain catcher	Check	x								
	Replace							x		

Specifications

Engine	034:	034 S:
STIHL single-cylinder two-stroke engine		
Displacement:	56.5 cm ³ (3.45 cu. in)	61.5 cm ³ (3.75 cu. in)
Bore:	46 mm (1.81 in)	48 mm (1.89 in)
Stroke:	34 mm (1.34 in)	34 mm (1.34 in)
Max. engine speed with bar and chain:	13,000 r.p.m.	13,000 r.p.m.

Ignition System

Principle:	Electronic magneto ignition
Ignition timing:	1.9–2.5 mm (0.075–0.098 in) before TDC at 8,000 r.p.m.
Spark plug (suppressed):	Bosch WSR 6 F or NGK BPMR 7 A Heat value 200 Electrode gap 0.5 mm (0.02 in) Spark plug thread M 14×1.25; 9.5 mm (0.37 in) long

Fuel/Oil System

Carburetor:	All position diaphragm carburetor with integral fuel pump
Air filter:	Wire mesh prefilter and bisectio- nal fine wire mesh main filter
Fuel tank capacity:	0.625 L (1.32 US pt)
Fuel mixture:	See chapter "Fuel"
Chain lubrication:	Fully automatic oil pump
Oil tank capacity:	0.36 L (0.76 US pt)

Weight

without bar and chain	
034 AVEQZ:	5.3 kg (11.7 lb)
034 AVSEQZ:	5.4 kg (12.0 lb)

Cutting Attachment

Recommended cutting attachments for compliance with § 5.12 of ANSI Standard B 175.1–1991

STIHL reduced kickback bar (with green label):
for 0.325" pitch and 3/8" pitch:
Rollomatic with sprocket nose
40, 45 or 50 cm (16, 18 or 20 in)

STIHL low kickback chain* (with green label):
8.25 mm (0.325") Rapid-Micro 2 (26 RM 2)
9.32 mm (3/8") Rapid-Micro 2 (33 RM 2, 36 RM 2)

Chain sprocket:
8-tooth for 0.325" pitch or 7-tooth for 3/8" pitch

Since new bar/chain combinations may be developed after publication of this Manual, ask your STIHL dealer for the latest STIHL recommendations.

Other bars and chains available for this powerhead are:

STIHL yellow-labeled bar:
for 0.325" pitch and 3/8" pitch:
Rollomatic "S" with sprocket nose
40, 45, 50 or 55 cm (16, 18, 20 or 24 in)
Duromatic with stellite tipped nose
40, 45, 50 or 55 cm (16, 18, 20 or 24 in)

STIHL yellow-labeled chain:
for 0.325" pitch:
Rapid-Micro (26 RM) Rapid-Super (26 RS)

for 3/8" Pitch:
Rapid-Micro (33/36 RM), Rapid-Super (33/36 RS,
33 RSL), Rapid-Duro (33 RD)

In Order to comply with the kickback performance requirements of § 5.12 of ANSI Standard B 175.1–1991, do not use replacement saw chain unless it has been designated as meeting the ANSI § 5.12 requirements on this specific powerhead, or has been designated as "low kickback" saw chain* in accordance with the ANSI B 175.1–1991 standard.

* See definition of "low kickback chain" on page 12 of this Manual.

