

TCL

LED TV

OPERATION MANUAL

For use with models: S6/S6000/S6500 series

COLOUR YOUR WORLD

Figures and illustrations in this User's Guide are provided for reference only and may differ from actual product appearance. Product design and specifications may be changed without notice.

Table of Contents

Chapter 1 - Introduction

Precautions	3
Warning	3
Product	3
Power and Plug	3
Power Cord and Signal Cable	3
Use Environment	3
Cleaning.....	3
Hanging the TV Set on the Wall.....	3
Buttons on the TV	4
Installing the TV Stand.....	4
Sockets	5
Remote Control Functions	6

Chapter 2 - Getting Started

Switching On	7
Switching Off	7
Network Connection	8
Network Settings	9
Initial Setup	10

Chapter 3 - Basic Operation

Accessing Channels	11
Watching Connected Devices	11
Adjusting Volume	11
Using TV Settings	11
Selecting Menu Language	11
Instant Power On	11
Automatic Channel Search	11

Chapter 4 - Homepage Operation

Using Homepage-Home	12
Using Homepage-Videos	13
Using Homepage-TV	13
Using Homepage-Apps	14

Chapter 5 - Using More of Your TV

Setting up Your Favourite Channels	15
Energy Saving	15
SPDIF Type	15
Audio Description	15
Diagnostics on Digital TV Channels	15
Using Subtitles	15
Customising the Input Settings	16
Software Update	16
Changing to Shop or Home Mode	16
Reset Shop	16
T-Link	17
Time Shift	17
Using EPG (Electronic Programme Guide)	17
PVR (Personal Video Recorder).....	18
Netflix Settings	18
Password in Parental Control	18
E-Manual	18
Share & See	19
WiFi Display	19
T-CAST	19
Network Waking up	20
HbbTV	20
Freeview On Demand	20

Chapter 6 - Other information

Problems and Solutions	21
Troubleshooting.....	22
Legal statement	23
Licence	23

Precautions

Read all of the instructions before operating the set. Keep these instructions well for future use.

Warning

Never place a television set in an unstable location. A television set may fall, causing serious personal injury or death. Many injuries, particularly to children, can be avoided by taking simple precautions such as:

- Using cabinets or stands recommended by the manufacturer of the television set.
- Only using furniture that can safely support the television set.
- Ensuring the television set is not overhanging the edge of the supporting furniture.
- Not placing the television set on tall furniture (for example, cupboards or bookcases) without anchoring both the furniture and the television set to a suitable support.
- Not placing the television set on cloth or other materials that may be located between the television set and supporting furniture.
- Educating children about the dangers of climbing on furniture to reach the television set or its controls.

If your existing television set is being retained and relocated, the same considerations as above should be applied.

Product

- Do not block or cover the ventilation openings on the back cover.
- Do not push objects of any kind into this unit through the cabinet slots as they could touch the current carrying parts or short-circuit parts, resulting in fire, electric shock, or damage to the unit.
- Do not attempt to open the cabinet as this may cause damage. There are no parts inside you can service by yourself. Refer all servicing to qualified personnel.
- Do not touch the screen surface with fingers as this may scratch or mar the TV screen.
- Do not impact the TV screen with hard pressure as this may damage the TV screen severely.
- This appliance is not intended for use by young children or infirm persons without supervision. Young children should be supervised to ensure that they do not play with the appliance.

Power and Plug

- Unplug the set under the following conditions:
 - If the set will not be used for a long period of time.
 - If the power cord or the power outlet/plug is damaged.
 - Follow the instructions to install and adjust the product. Adjust those controls that are covered in these operating instructions as improper adjustment of other controls may result in damage. If this happens, unplug the set and refer to the service personnel.
 - If the set is subject to impact or has been dropped

and the cabinet has been damaged.

- Where the mains plug or an appliance coupler is used as disconnect device, the disconnect device shall remain readily operable.

Power Cord and Signal Cable

- Do not allow anything to rest on or roll over the power cord and the signal cable.
- Protect the power cord and the signal cable from being trampled.
- Do not overload the power cord or the power outlet.
- Do not expose the power cord and the signal cable to moisture.

Use Environment

- Do not place the set on an unstable cart, stand, or table.
- Place the set on a place that allows good ventilation.
- Do not use the set near damp, and cold areas.
- Do not expose the set to excessive heat such as direct sunlight, fire, or the like and no naked flame sources, such as lighted candles, should be placed on the apparatus.
- Do not expose the set to dripping or splashing and no objects filled with liquids, such as vases, shall be placed on the apparatus.
- Do not use the set in dusty environments.
- Operating Temperature: 5°C to 35°C (41°F to 95°F)
Operating Humidity: 20% to 80%, non-condensing
Storage Temperature: -15°C to 45°C (5°F to 113°F)
Storage Humidity: 10% to 90%, non-condensing

Cleaning

- Dust the set by wiping the screen and the cabinet with a soft, clean cloth or some special liquid cleaner.
- Do not apply excessive force to the screen when cleaning.
- Do not use water or other chemical cleaner to clean the screen as this may damage the surface of the TV screen.

Hanging the TV Set on the Wall

Warning: This operation requires two people.

To ensure a safe installation, observe the following safety notes:

- Check that the wall can support the weight of the TV set and wall mount assembly.
- Follow the mounting instructions provided with the wall mount.
- The TV set must be installed on a vertical wall.
- Make sure to use only screws suitable for the material of the wall.
- Make sure that the TV set cables are placed so that there is no danger of tripping over them.

All other safety instructions about our TV sets are also applicable here. Wall mount bracket not included.

(Note: Certain TV model is not designed to be mounted to the wall.)

Buttons on the TV

If the batteries in your remote control are run down, you can use the buttons on your TV set. They have the following functions:

For models with below buttons on the set:

- ◀ or < 🔊/▶
- ▶ or > 🔊/▶
- ⏻ or ≡⏻ Features (Short press)
⏻ (Long press)

For models with below buttons on the set:

- | | TV mode | In menus |
|---|-----------------------|-----------------------|
| ▲ | P▲ | ▲ |
| ▼ | P▼ | ▼ |
| > | ▶ | ▶ |
| < | ◀ | ◀ |
| ⏻ | Features (Long press) | Features (Long press) |
| ⏻ | OK (Short press) | OK (Short press) |

For models with only one button on the set:

- ⏻ Power on/Standby

Note:

Figures and illustrations are provided for reference only and may vary depending on the model.

Installing the Table Stand

Note:

Some TV's may be supplied without the table stand attached. This will give you the choice to either mount your TV to the supplied table stand; or to a wall using an appropriate wall mount bracket (wall mount bracket sold separately).

For certain models, the table stand may need to be secured to the table or hard surface using a screw (s) inserted in the specified hole in the table stand. Keep the screws and plastic parts away from grease and organic solvents to avoid damage, especially during the assembly process.

Figures are provided for reference only for certain models when installing the table stand.

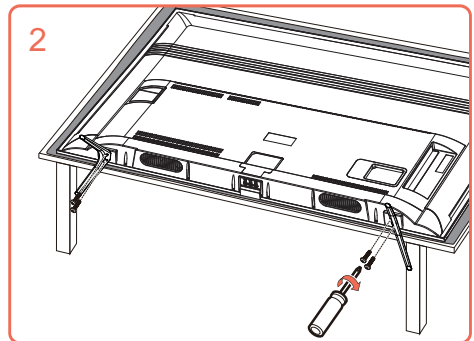
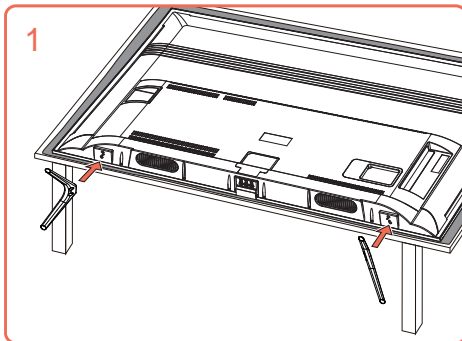

Sockets

Note: The location and names of the sockets on the TV may vary according to TV model, and not all sockets available on all models.

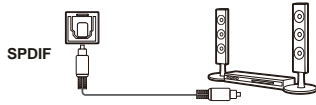

SPDIF socket (output)

The SPDIF socket can be used to connect a compatible digital audio receiver.

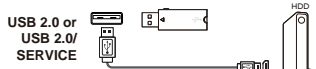

USB2.0 socket (input)

These USB sockets can be used to connect an USB device.

Note: the number of USB sockets on the TV may vary according to TV model.

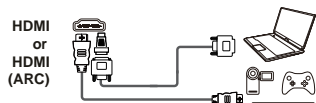

HDMI or HDMI2(ARC) or HDMI3 socket (input)

The HDMI (High-Definition Multimedia Interface) socket can be used to connect a PC with a compatible video card installed, certain DVD players or a high-definition compatible digital satellite decoder. This socket provides an uncompressed digital connection that carries both video and audio data by way of an integrated mini-plug cable.

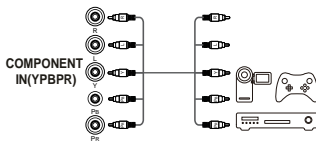

YPBPR component sockets (input)

These YPBPR sockets can be used to connect a device that has component video sockets, such as a DVD player. The component sockets can recognize if the device you're connecting to is Y PB PR compatible. The component sockets provide excellent picture quality because the video is separated into three separate parts.

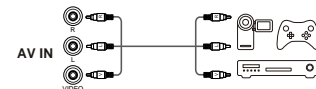

AV RCA audio + video sockets (input)

The AV IN sockets can be used to connect a range of equipment, including video recorders, camcorders, decoders, satellite receivers, DVD players, or games consoles. The VIDEO IN socket provides composite video connection.

Note: AV IN shares video (Y/VIDEO) and audio sockets with YPBPR.

AV IN adapter socket

The AV IN adapter socket can be used to connect the attached AV adapter cable with VIDEO and AUDIO L & R IN sockets.

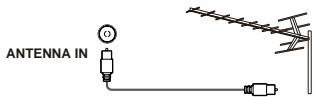

ANTENNA IN socket (input)

This socket can be used to connect the outside aerial or cable network.



LAN

RJ45 plug for connecting to external modem or network access equipment.



Headphone socket (output)

This socket can be used to connect headphones or stereo earphones.

Note: When the Headphone socket is connected, the speakers will be muted.

Warning: excessive sound pressure from earphones and headphones can cause hearing loss.

Remote Control Functions

Most of your television's functions are available via the menus that appear on the screen. The remote control supplied with your set can be used to navigate through the menus and to configure all the general settings.

Note: Figures and illustrations in this operation manual are provided for reference only and may differ from actual product appearance. The remote control type may be changed without notice.

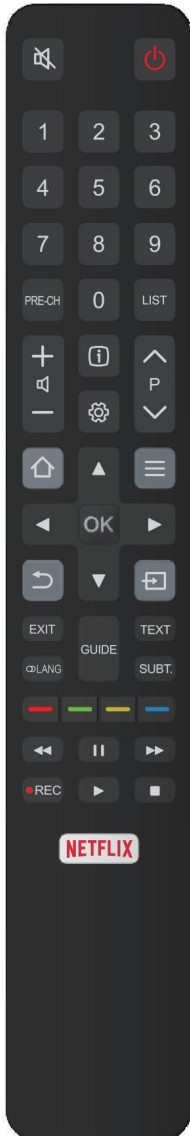

- To switch the sound off and back on.
- Standby / quit standby.
- Numeric buttons** To enter channel numbers or a digit.
- PRE-CH** To return to the previous channel in TV mode.
- LIST** To display the channel list.
- To control the volume.
- To display programme information, if available.
- To display the Settings menu.
- P** To change channels.
- To access or exit the Smart TV homepage.
- To display the Option menu.
- ▲/▼/◀/▶** Navigation direction buttons.
- OK** To confirm an entry or selection.
- To return to the previous menu or quit an App.
- To select input source.
- EXIT** To exit the Settings menu.
- LANG** To select a sound type available for selected analogue TV programme; to select an audio language available for selected digital TV programme.
- GUIDE** To toggle the Electronic Programme Guide on or off (only available for digital channels).
- TEXT** To toggle Teletext on or off. (Note: Teletext is no longer supported in New Zealand).
- SUBT.** To select a subtitle language available for selected digital TV programme.
- Colour buttons** Access Freeview On Demand and application shortcuts.
 - To start fast reverse.
 - To pause playback.
 - To start fast forward.
 - REC** To record programs under DTV source.
 - To start playback.
 - To stop playback.
- NETFLIX** To access the NETFLIX application. (Not available for some models.)

Installing Batteries

1. Push to open the back cover as illustrated.
2. Insert two AAA batteries according to the polarities marked on the battery case.
3. Replace the back cover as illustrated.

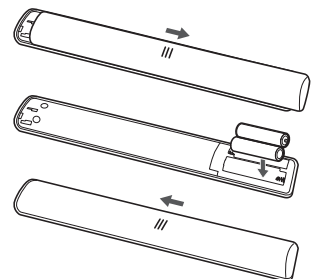

Switching On

Follow the instructions on this page on how to switch on your TV set and the remote control before going on to following pages describing how to use the channel set-up procedure.

1. Insert two AAA batteries in the remote control.

Precautions on using batteries:

- Only use the battery types specified.
- Make sure you use the correct polarity.
- Do not mix new and used batteries.
- Do not use rechargeable batteries.
- Do not expose batteries to excessive heat such as sunshine, fire or the like, throw them in a fire, recharge them or try to open them, as this could cause them to leak or explode.
- Remove the batteries from the remote control if you are not using it for a long period of time.
- Attention should be drawn to the environmental aspects of battery disposal.

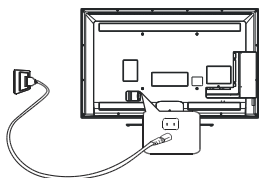

2. Connect the power cable FIRST to the television, THEN to a mains socket. (**Note:** If the power cable is connected to the television, please only connect the power cable to the mains socket.)

Your TV set should only be connected to an AC supply. It must not be connected to a DC supply. If the plug is detached from the cable, do not, under any circumstances, connect it to a mains socket, as there is a risk of electric shock.

Note: The figures are for representation only, the location of power socket of the television might differ depend on the model.

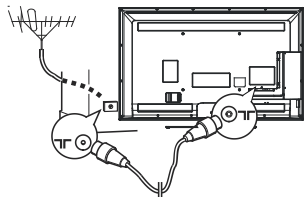

3. Connect an outside aerial to the ANTENNA IN socket at the back of the TV set.

The aerial socket (75 OHM - UHF cable) can be used for connecting an external aerial or other equipment fitted.

Note: If you want to receive the signal from your cable or cable box, please connect a coaxial cable to the ANTENNA IN socket at the back of the TV set.

4. When powered on, the TV will be turned on directly or be in standby mode.

If the power indicator lights up, the TV set is in standby mode. Press the  button on the remote control or on the TV set to turn on the TV.

Switching Off

- To put the TV set into standby mode, press the  button on the remote control. The TV set remains powered up, but with low energy consumption.
- To switch off the TV set, unplug the mains socket from the mains outlet.

Network Connection



Your TV will require an internet connection to operate all functions. Data usage charges may apply. Please refer to your Internet Service Provider (ISP) for additional information.

To access the internet, you must subscribe high speed broadband internet service from your internet service provider.

Your TV can be connected to your home network in two ways:

- Wired, using the RJ45 (LAN) connector on the back panel.
- Wireless, using the internal wireless or external wireless USB adapter and your home wireless network.

Note: The following instructions are just the usual ways to connect your TV to the wired or wireless network. The connection method may be different depending on your actual network configuration. If you have any questions about your home network, please refer to your ISP (Internet Service Provider).

Connecting to a Wired Network

To connect to a wired network:

1. Ensure you have:
 - An Ethernet cable long enough to reach your TV
 - A router or modem with an available Ethernet port
 - A high-speed internet connection
 - An **Ethernet (LAN) port** on the back of the TV
2. Connect your Ethernet cable to the router and to the **Ethernet port** on the back of the TV.
3. Use the **Network Settings** to configure the TV.

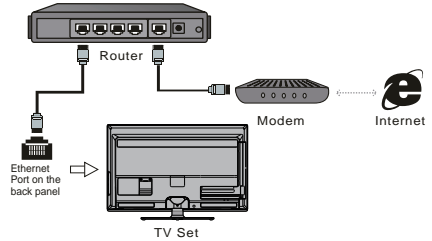

Connecting to a Wireless Network

To connect to a wireless network

1. Ensure you have:
 - A router broadcasting a high-speed wireless signal
 - A high-speed internet connection
2. Use the **Network Settings** to configure the TV.

Note: Some models may have no internal wireless module, you can use wireless network by inserting external wireless adapter into USB socket of the TV. Some external wireless adapters can't be compatible with the TV.

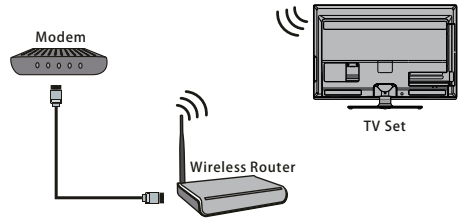

Built-in wireless connection

Network Settings

You can set up your TV so that it can access the Internet through your local area network (LAN) using a wired or wireless connection.

Connecting to a Wired Network

1. Press  on the remote control, select **Network > Internet connection** and press **OK/▶** to enter.
2. Press **▲/▼** to select **On** and press **OK** to confirm.
3. Press **▲/▼** to select **Interface**, then select **Ethernet** and press **OK** to confirm.
4. Press **▲/▼** to select **IP settings** and press **OK/▶** to enter. You can set **Address type** to **Auto** or **Manual**.
 - Select **Auto** if you want the TV to acquire and enter the needed IP address automatically.
 - Select **Manual** if you want to enter your IP address manually, then:
 - Press **▼** to go to the first entry field.
 - Enter the **IP Address**, **Subnet Mask**, **Default Gateway**, **Primary DNS** and **Secondary DNS** values. Use the numeric buttons to enter numbers and the **▲/▼/◀/▶** buttons to move from one entry field to another.
 - Once **IP setting** is completed, press **▲/▼/◀/▶** to select **OK** and press **OK** to confirm. The set will try to connect to the network and inform you about the result. Press **⏪** to return to the **Network** menu.

Connecting to a Wireless Network

Your TV is equipped to be connected to your home network wirelessly. To do that you need a wireless router or modem.

1. Press  on the remote control, select **Network > Internet connection** and press **OK/▶** to enter.
2. Press **▲/▼** to select **On** and press **OK** to confirm.
3. Press **▲/▼** to select **Interface**, then select **Wireless** and press **OK** to confirm.
4. Press **▲/▼** to select **Wireless settings** and press **OK/▶** to enter. You can set the wireless network connection in 3 ways:
 - **a) Scan**
 - Press **▲/▼** to select **Scan** and press **OK/▶** to enter. The TV will search all access points within range. Access points found by the TV will be displayed.
 - Press **▲/▼** to select an available access point, then press **OK/▶** to connect.
 - Press **⏪** to return to the **Wireless settings** menu.

Note: If you select a protected access point, you will have to enter the corresponding password. Press **OK** on the remote control to display the virtual keyboard to enable you to enter the password.

- **b) Manual**
 - Press **▲/▼** to select **Manual** and press **OK/▶** to enter. You will be prompted to enter the correct SSID of an available wireless router to set up the connection. Press **⏪** to return to the **Wireless settings** menu.
 - **c) Auto**

If your AP (Access Point) supports WPS (Wi-Fi Protected Setup), you can connect to the network via PIN (Personal Identification Number) or PBC (Push Button Configuration). WPS will automatically configure the SSID and WPA key in either mode.

Press **▲/▼** to select **Auto** and press **OK/▶** to enter.

 - **PIN:** Select **PIN** and press **OK/▶** to enter. Choose a random PIN code. Make sure this code is installed on the AP. (For the procedures, refer to your router manual.) Select **OK** and press **OK** to set up the connection.
 - **PBC:** If your router has a PBC push button, select **PBC** and press **OK/▶** to enter. Press the PBC push button on your router within 2 minutes before you select **OK** and press **OK** again. Your TV will automatically acquire all the network setting values it needs and connect to your network.
 - Press **⏪** to return to the **Wireless settings** menu.
 - Press **⏪** to return to the **Network** menu.
5. Press **EXIT** or  to close the menu.

Initial Setup

Initial setup involves selecting all the settings required to be able to search for and store all the analogue and digital channels you can receive.

Make sure that the television is switched on and follow all the steps in turn specified hereafter.

Note: If the channel search retrieved only the analogue channels it could be caused by poor broadcasting and therefore is not covered by manufacturer warranty. Manufacturers cannot be held responsible for lack of or poor broadcasting in some areas.

The first time you switch the set on, the **Initial Setup** wizard opens, which guides you through the initial setup process.

Step 1: Environment Setup

1. Press **▲/▼** to select your language, then press **OK/▶** to enter the next step.
2. Press **▲/▼** to select your country, then press **OK/▶** to enter the next step.
3. Press **▲/▼** to select your location, then press **OK/▶** to enter the next step.

Step 2: Network Setup

1. Press **▲/▼** to select your network connection type (**Wired** or **Wireless**), then press **OK/▶** to enter the next step.
2. Follow the guides on the screen and press the corresponding buttons on the remote control to proceed.

Note: You can also skip this step and step 3 by selecting "I do not have a network connection", and connect to the Internet later. For details please refer to section **Network Connection**.

Step 3: Software Update

1. If the set has connected to the network successfully, it will search for upgrade files automatically.
2. Follow the guides on the screen and press the corresponding buttons on the remote control to proceed.

Step 4: Channel Installation

1. Press **▲/▼** to select **Continue** to install channels.
2. Follow the guides on the screen and press the corresponding buttons on the remote control to proceed.

Note: To prevent the channel installation process from being interrupted, wait for the message indicating that the installation is complete. You can also skip this step by selecting "I don't want to install channels". In this case, to search and store your channels you may do an automatic channel search by following the instructions in the next section **Performing an automatic channel search**.

Step 5: Clock Setup

If the set was not connected to the network, you can use the numeric buttons to enter the date and time, then select the **OK** button and press **OK** to confirm.

When the initial setup is completed, the **Congratulations** message appears. Press **OK** to confirm.

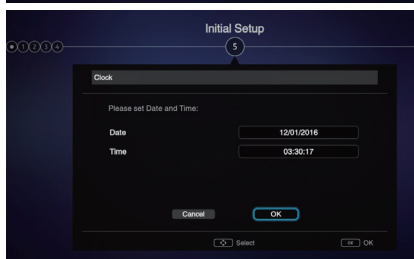
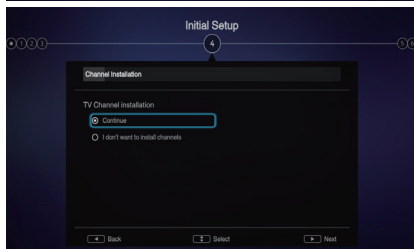
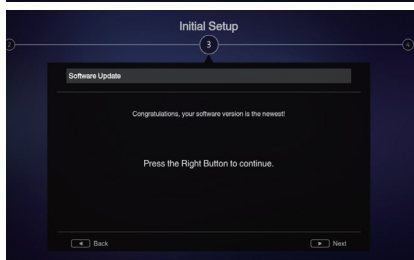
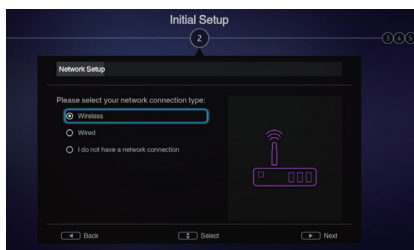
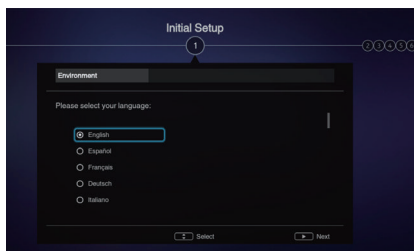

Accessing Channels

Using the numeric buttons: press the corresponding numeric buttons on the remote control to access the channels.

Using the P+/- buttons: press the P+/- buttons on the remote control or the corresponding buttons on the TV set to scroll through the channels.

Using the LIST button: press the LIST button on the remote control to display the channel list and press ▲/▼/◀/▶ and OK to select channels.

Watching Connected Devices

Repeatedly press SOURCE on the remote control or OK on the TV set to toggle between TV and other input sources. Press P+/- to cycle through all TV channels and other input sources.

Note: Not all models have OK button on the set.

Adjusting Volume

Volume control: press the V+/- buttons on the remote control or the corresponding buttons on the TV set to increase or decrease the volume.

Sound mute: press the  button to temporarily mute the sound. Press this button again or the V+ button to restore the sound.

Using TV Settings

1. Press  on the remote control to display the Settings menu.





2. Press ▲/▼ to select the desired item, then press OK/▶ to enter the corresponding submenu.
3. In submenus, press ▲/▼ to select menu options, then press OK/▶ to enter the option list, the adjustment interface, or the corresponding submenu.
4. Press ⏪ to return to the previous menu.
5. Press EXIT or  to close the menu.

Note:

You can also press ≡ on the remote control, select Settings (if available) and press OK to enter the Settings menu. Some options may not be available for certain signal sources.



Selecting Menu Language

You can choose your preferred menu language following the instructions below.

1. Press  on the remote control, select **System > Menu language > Language** and press OK/▶ to enter.
2. Press ▲/▼ to select your desired language to display the menus and press OK to confirm.
3. Press EXIT or  to close the menu.



Instant Power On

This function enables you to turn on your TV quickly.

1. Press  on the remote control, select **System > Instant power on** and press OK/▶ to enter.
2. Press ▲/▼ to select **On** and press OK to confirm.
3. Press EXIT or  to close the menu.







Automatic Channel Search

This section describes how to search and store channels automatically. This may be done in any of the cases below:

- you have selected "I don't want to install channels" in the initial setup;
 - you see "No program info now, please search channels first!" in TV mode;
 - you want to update your channels.
1. In TV mode, press  on the remote control and select **Channel > Channel scan**. Press OK/▶ to enter.
 2. The TV installs and arranges channels according to your country. Press ▲/▼ to select **Country**, and press OK/▶ to enter. Enter the default password 1234 or your own password in case you have changed the password in the **System > Lock** menu. Press ▲/▼ to select your country and press OK/▶ to confirm.
 3. Press ▲/▼ to select **Automatic search**, then press OK/▶ to enter.
 4. Press ▲/▼ to select **Channel type (Digital & Analogue, Digital or Analogue)**, then press OK to start the automatic search for all digital and/or analogue channels. The search may take a few minutes. During the process, you can press OK to abort halfway.
 5. The channel search may take a few minutes. During the process, you can press OK to stop the search halfway.
 6. After the automatic search, channels are arranged in a preset order. If you wish to skip channels, modify the preset order, rename or delete channels, press  on the remote control, select **Channel > Organiser** and press OK/▶ to enter.

Note: This manual is for common use. Figures and illustrations in this User Manual are provided for reference only and may differ from actual product appearance. And for some models, certain options are not available.

You can select all the features from homepage.

1. Press  to display homepage.
2. Press /// to select icons from the screen list.
3. Press **OK** to enter each option.
4. To exit the menu, press .

Homepage contains 4 parts: **Home**, **Videos**, **TV**, and **Apps**. Use / to switch among them.







Shortcut: Press  to move the cursor to the very top of the screen under any homepage, the **Settings** option will appear. You can access accordingly settings options directly here. For details, please refer to **Using System Settings** in the **General Operation** chapter.

WARNING:

- Configure the network settings before using Smart TV.
- Slow responses and/or interruptions may occur, depending on your network conditions.
- If you experience a problem using an application, please contact the content provider.
- According to circumstances of the contents provider, an application's updates or the application itself may be discontinued.
- Depending on your country's regulations, some applications may have limited service or not be supported.

Using Homepage - Home

This section explores the most commonly used menu of your TV.

Press  on the remote control to display the homepage. Press /// to enter the Home page and select icons from the screen list. Press **OK** to enter each option. To exit the menu, press .

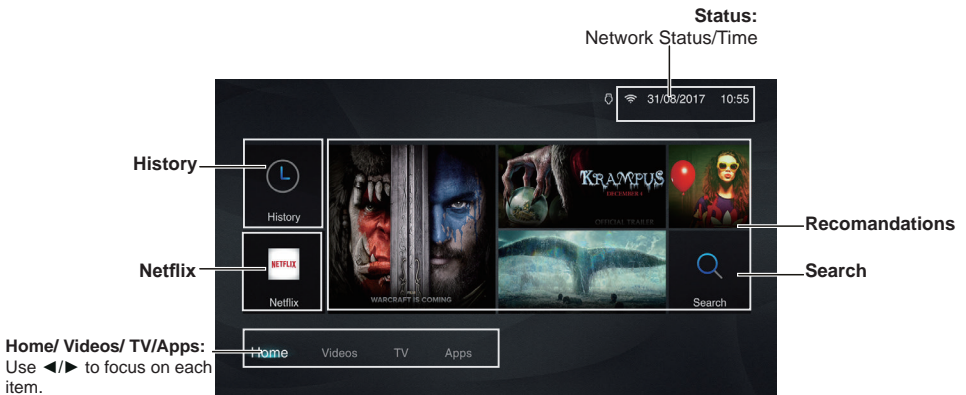

History: This page shows your recently watched programmes. To delete the history, press  to display the submenu, choose **Delete One/ Delete All** and operate according to screen display.

Search: You can search for your desired programmes using the virtual keyboard.

Netflix: With a Netflix unlimited membership, you can instantly watch TV episodes & movies streamed over the Internet watch TV episodes & movies streamed over the Internet from Netflix right to your TV.

Note: Netflix is available in certain countries. Unlimited membership required. More information at WWW.netflix.com.

Using Homepage - Videos

Note: The information displayed will be updated periodically.

Press **Home** on the remote control to display the homepage. Press **Up/Down/Left/Right** to enter the **Videos** page and select icons from the screen list. Press **OK** to enter each content. To exit the menu, press **Back**.

This interface enables you to search for videos by genre, such as movie, sport, music, popular, news, education, and game, etc. For details, refer to your local platform.

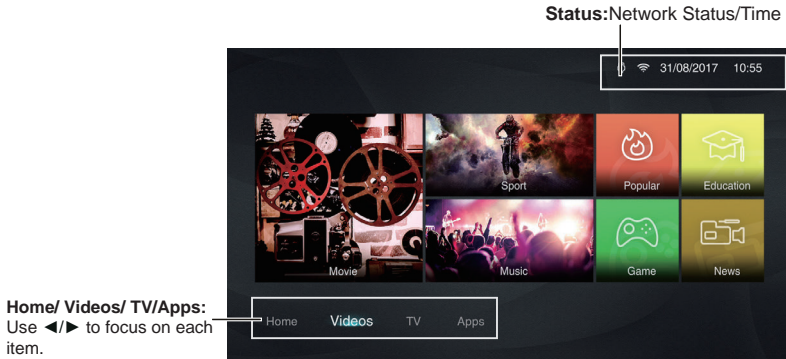

Using Homepage- TV

Note: Some options may not be available for certain signal sources.

This section explores the input sources of your TV.

Press **Home** on the remote control to display homepage. Press **Up/Down/Left/Right** to enter TV page and select input source you want from the screen list, then press **OK** to confirm. To exit TV page, press **Home**.

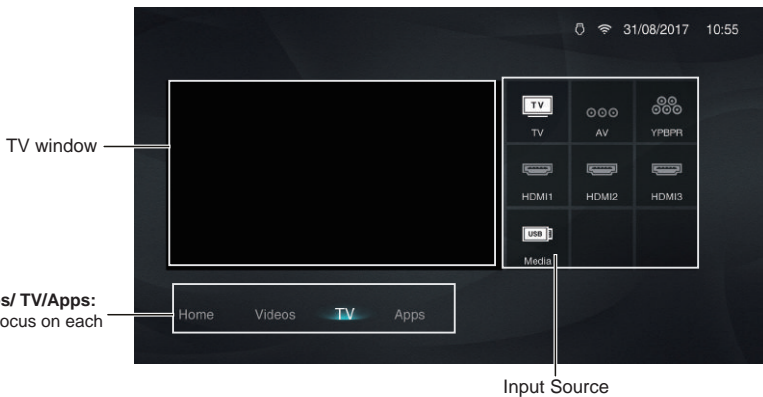

TV window

Displays the current selected TV broadcast programme.

Input Source

Select the input source from devices connected to TV through different ports, including **TV**, **AV**, **YPBPR**, **HDMI1**, **HDMI2**, **HDMI3**, and **Media**. Press **Up/Down/Left/Right** to select your desired source, and then press **OK** to confirm.

Note: The available source might differ depending on the model.

Using Homepage- Apps

Note: The pre-installed apps or items can not be deleted. And the apps (regardless of order) listed in the below figure may differ from actual product. For some models, certain apps are not available.

Press **Home** on the remote control to display the homepage. Press **Up/Down/Left/Right** to enter the **Apps** page and select icons from the screen list. Press **OK** to enter each option. Press **Home** or **Back** repeatedly to return to the homepage.

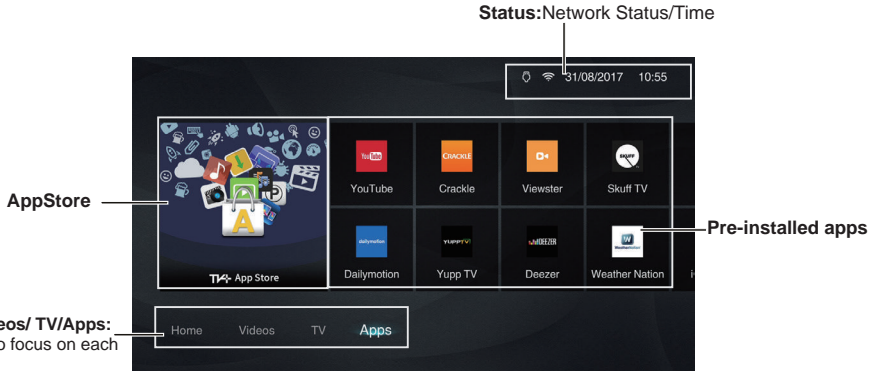

Home/ Videos/ TV/Apps: Use **Left/Right** to focus on each item.

AppStore: Many useful and entertaining apps are available for downloading. After entering the AppStore, you will see the recommendations. Press **Up/Down/Left/Right** to select, press **OK** to enter.

Pre-installed apps: These are recommended Apps. Highlight an app and press **OK** to open it.

Note: The pre-installed apps or items can not be deleted.



Note: You may need a webcam to use certain apps. The webcam is an optional accessory, and is available by separate purchase. Only use the specified webcam. Some external devices like webcam, smartphone, joystick and external wireless adapter may not be supported.

Setting up Your Favourite Channels

You can create a list of your favourite TV channels.

1. Press **LIST**.
2. Press the red button to enter **Select list**, press **▲/▼** to select a list and press **OK** to enter.
3. Press **▲/▼/◀/▶** to scroll through the channel list and press the green button to add the selected channel to your favourite list.
4. Repeat this procedure to set up other favourite channels.
5. Press the red button to enter **Select channel list**, select **Favorites** and press **OK** to enter.
6. Press **▲/▼/◀/▶** to select a channel, press **OK** to watch it or press the green button to remove it from your favourite list.
7. Press **LIST** or **EXIT** to exit.

Energy Saving

1. Press  on the remote control, select **Picture > ECO settings > Energy saving** and press **OK/▶** to enter.
2. Press **◀/▶** to select a desired power saving mode and press **OK** to confirm.
3. Press **EXIT** or  to close the menu.

*Note: This option is only available when **Picture preset** is set to **Personal**.*

SPDIF Type

Connect the TV to an audio device through the **SPDIF** output. To select a proper sound type for your SPDIF output, press  on the remote control, select **Sound > SPDIF type** and press **OK/▶** to enter. Press **▲/▼** to select an option and press **OK** to confirm.

- If you select **Auto**, the SPDIF output format is
 - Dolby Digital when the programme's sound format is Dolby Digital or Dolby Digital Plus or HE-AAC.
 - PCM when the programme's sound format is MPEG.
- If you select **PCM**, the SPDIF output format is PCM, regardless of the programme's sound format.
- If you select **Off**, this turns off the audio output from the audio device connected to the SPDIF output.



*Note: The options you may choose depend on the programme you are watching. If the sound is ahead of the picture, you can select **SPDIF delay** from the **Sound** menu, press **OK/▶** then press **◀/▶** to adjust the delay time to synchronize the sound with the picture.*

Audio Description



Audio description refers to an additional narration track for blind and visually impaired viewers of visual media, including television programmes and movies.

The description narrator talks through the presentation describing what is happening on the screen during the natural pauses in the audio (and during dialogue if deemed necessary).

You can use this feature if the current broadcast contains audio description.

1. Press  on the remote control, select **Sound > Advanced settings > Audio description** and press **OK/▶** to enter.
2. Select **Speaker** or **Headphone**, press **OK/▶** to enter, press **◀/▶** to select **Audio description** and press **OK** to confirm.
3. To adjust the volume for audio description in case this function is turned on, press **▲/▼** to select **AD volume**, press **OK/▶** then press **◀/▶** to set the volume. Press **↵** to return.
4. Press **EXIT** or  to close the menu.

Diagnostics on Digital TV Channels



1. Press  on the remote control and select **Channel > Channel diagnostics**.
2. Press **OK/▶** to display some signal information on the current digital channel, such as signal strength, frequency, etc.
3. Press **OK** to confirm.
4. Press **EXIT** or  to close the menu.

Using Subtitles

You can enable subtitles for each TV channel.

Subtitles are broadcast via DVB-T digital broadcasts. With digital broadcasts, you have the additional option of selecting a preferred subtitle language.

Turning On/Off Subtitles

1. Press  on the remote control, select **Channel > Subtitle** and press **OK/▶** to enter.
2. Select the **Subtitle** option, press **OK/▶** to enter, press **▲/▼** to select **On** or **Off** and press **OK** to confirm.
3. Press **EXIT** or  to close the menu.

Enabling Subtitle Languages on Digital TV Channels

1. Press  on the remote control, select **Channel > Subtitle > Digital subtitle language** and press **OK/▶** to enter.
2. Press **▲/▼** to select a subtitle language as your preferred language and press **OK** to confirm.

3. Press ▲/▼ to select **Digital subtitle language 2nd** and press **OK/▶** to enter.
4. Press ▲/▼ to select a secondary subtitle language and press **OK** to confirm.
5. Press **EXIT** or ⌂ to close the menu.

Shortcut operation: Press **SUBT.** on the remote control to directly select a subtitle language available for the selected digital TV programme.

Selecting a Subtitle Type on Digital TV Channels

6. Press ⌂ on the remote control, select **Channel > Subtitle > Subtitle type** and press **OK/▶** to enter.
7. Press ▲/▼ to select a subtitle type and press **OK** to confirm. You can select **Hearing Impaired** to display the hearing impaired subtitles with your selected language.
8. Press **EXIT** or ⌂ to close the menu.

Note: before selecting subtitle languages and a subtitle type, turn on subtitles.

Customising the Input Settings

You can name your connected sources according to the type of device instead of the type of socket.

1. Press ⌂ on the remote control, select **System > Input settings** and press **OK/▶** to enter.
2. Press ▲/▼ to select a connector your equipment is connected to and press **OK/▶** to enter.
3. Press ▲/▼ to select the type of device connected to this connector and press **OK** to confirm.
4. Press **EXIT** or ⌂ to close the menu.

After configuring, the selected source name will be displayed after the name of the related connector in the source list when pressing **SOURCE** on the remote control or **OK** on the TV set.

*Note: Not all models have **OK** button on the set.*

Software Update

Note: Do not switch off or unplug the TV until the upgrade is completed.

Press ⌂ on the remote control, select **Support > Software update** and press **OK/▶** to enter. You have the following options to update the software.

- **By USB:** Enables you to install a new version software from a USB stick. Insert the USB stick in which a new version software is stored into a USB socket of the set. Select **By USB** and press **OK/▶** to enter. Follow the on-screen instructions to complete the process.
- **By network:** Enables you to download and install the latest version software from the Internet. Make sure to set up a wired or wireless network connection first then select **By network** and press **OK/▶** to enter. Follow the on-screen instructions to complete the process.

Note: Keep successful network connection during upgrade.

- **By channel:** Enables you to install the latest version software if available from the broadcast. Select **By channel** and press **OK/▶** to enter. Follow the on-screen instructions to complete the process.

Changing to Shop or Home Mode

1. Press ⌂ on the remote control, select **System > Location** and press **OK/▶** to enter.
2. Press ▲/▼ to select **Home, Shop or Shop with demo** and press **OK** to confirm.
3. Press **EXIT** or ⌂ to close the menu.

*Note: If **Shop** or **Shop with demo** mode was selected, it is not MEPS compliant. In **Home** mode, TV will be put into standby mode automatically if there is no operation in 4 hours. This feature can be deactivated in the **System > Timer > Auto standby** menu.*

Reset shop

Allows you to reset the TV to factory default settings.

1. Press ⌂ on the remote control, select **System > Reset shop** and press **OK/▶** to enter.
2. Use the numeric buttons to enter the password.
3. Press ◀/▶ to select **OK** and press **OK** to confirm.

4. The **Initial setup** menu appears. Follow the instructions in the section **Initial setup**.

T-Link

Use this function to search for CEC devices connected to the HDMI sockets in your TV and enable one-touch play and one-touch standby between CEC devices.

Enabling or Disabling T-Link

1. Press \equiv on the remote control, press $\blacktriangle/\blacktriangledown$ to select **T-Link** and press **OK/▶** to enter.
2. Press $\blacktriangle/\blacktriangledown$ to select **T-Link** and press **OK/▶** to enter.
3. Press $\blacktriangleleft/\blacktriangleright$ to select **On** or **Off** and press **OK** to confirm.
4. Press **EXIT** to close the menu.

Using Auto Power On

Enables the TV to automatically power on when you power on a CEC device (e.g. DVD) with the device's remote. Select **On** to enable this function.

Using Auto Standby

Enables all CEC devices to automatically go to the standby mode when you turn off the TV with the TV remote. Select **On** to enable this function.

Note: The CEC functions depend on the devices connected and it is possible that some devices may not interoperate correctly when connected to this TV. The user manual or the manufacturer of the problematic devices should be consulted for further information.

Time Shift

Note: This Option is only available when Time Shift is set to **On**: Press \equiv on the remote control, press $\blacktriangle/\blacktriangledown$ to select **Settings> Channel> Time Shift**, press **OK/▶** to enter and use $\blacktriangle/\blacktriangledown$ to set Time Shift to **On** or **Off**.

Allows you to pause, fast forward and rewind live TV, so you don't have to miss any part of your favourite programs. Before you use the function, connect a USB drive to the TV first. For the first time, you should complete the disk setup for the USB drive.

1. Press \equiv on the remote control and select **Time Shift**, then press **OK** to confirm.
2. Follow the directions on the screen to do the disk setup if you use time shift for the first time.
3. After the disk setup is done, time shift will start, and the time shift menu displays on the screen.
4. For later use, press \equiv and select **Time Shift**. press **OK** to display the time shift menu and operate according to the on-screen prompt.

5. Pressing **Stop** button stops the time shift and exits.
 - When the time shift menu disappears and only the timing of the time shift remains on the screen, you can press $\blacktriangleleft/\blacktriangleright/\blacktriangleright/\parallel$ to call out the time shift menu.

Notes:

- Before you plug the USB drive to TV, make sure you have backed up the data on the drive to avoid unforeseen malfunction and data loss.
- We recommend that you use a USB drive with at least 1GB free space and a disk speed faster than 5.0MB/sec.
- The bigger the USB drive free space for time shift, the bigger the recording length.

Quick Access of Time Shift:

Insert a USB disk, press **PAUSE(II)** on the remote control, it will access Time Shift automatically.

Using EPG (Electronic Programme Guide)

EPG is an on-screen guide that displays scheduled digital TV programmes. You can navigate, select, view and record programmes.

1. Press **GUIDE** on the remote control, the **Program Guide** menu will appear, which allows you to get information about the current or next programme playing on each channel. Navigate through the different programmes using the $\blacktriangle/\blacktriangledown/\blacktriangleleft/\blacktriangleright$ buttons on the remote control.
2. Use the related buttons shown at the bottom of the screen to view **EPG**.
 - **Prev day:** Press \blacktriangleleft to display EPG of the previous day.
 - **Next day:** Press \blacktriangleright to display EPG of the next day.
 - **Filter:** Programme guide filter for digital TV programmes.
 - Press \equiv to display the type list of the programme.
 - Navigate through the different types and available subtypes using the $\blacktriangle/\blacktriangledown/\blacktriangleleft/\blacktriangleright$ buttons on the remote control.
 - Select one or more types, which you want to highlight from the **Type** list, press **OK** to select or deselect. A checkmark will appear to the left of the type when selected. When you select a type, all its subtypes (if available) will be selected accordingly.
 - Also, you can select some desired subtypes (if available) without selecting any type first.
 - Press \equiv to exit the type list.
 - After filtering, all your desired digital TV programmes will be highlighted.

- **Schedule list:** Press the yellow button to bring up the **Schedule list** menu.
 - Press the red button to add a schedule.
 - Press the green button to delete a selected schedule.
 - Press **OK** to edit a selected schedule.
 - **Add schedule:** Press the red button to add a schedule into your schedule list.
 - **Channel number:** use **◀/▶** to select the desired channel.
 - **Start date:** use the numeric buttons to set the start date.
 - **Start time:** use the numeric buttons to set the start time.
 - **End time:** use the numeric buttons to set the end time.
 - **Schedule type:** use **◀/▶** to select the available schedule type.
 - Select **Reminder** to be reminded that you can switch to the scheduled programme when the time you have set comes.
 - Select **Record** (if available) if you want to start your scheduled recording when the time you have set comes. When time is out and you do not execute any operation, scheduled recording will start automatically.
 - **Repeat type:** use **◀/▶** to select different repeat mode for the schedule.
 - Press **▲/▼** to select **Add schedule**, and press **OK** to confirm.
3. Press **GUIDE** or **EXIT** to exit EPG.

PVR (Personal Video Recorder)

Allows you to record your favourite TV programs. Before you use the function, connect a USB drive to the TV first.

Note: *The feature is available only in selected products and, due to specific TV network limitations and country technical requirements, might not be available in product or place of installation. Feature might also be blocked by TV network due to copyright protection (HD content, recording protection). Please use **≡** on the remote control to check if the feature is available in your product.*

1. Press **≡** on the remote control and select **PVR**.
2. Press **OK/▶** to enter and select **Record**. It starts to record automatically.
3. Press **BLUE** button on the remote control to access **Settings** and use **▲/▼/◀/▶** to adjust the recording duration.
4. Press **■** to stop recording manually, the recorded file will be saved. In normal operation, the recording will stop automatically when the recording duration expires.

5. In recording, the PVR mini pane will also show on the screen to indicate the recording progress.
6. To watch the recorded program, exit PVR mode first, Press **≡** and select **PVR > PVR list**, or press **⏪** and go to **TV > Media > PVR**, then select the related record file. Press **OK** to play. (It is the same if you record a digital radio program).

Notes:

- *This feature is available only for digital non encrypted channels.*
- *Before you connect the USB drive to the TV, make sure you have backed up the data in the drive to avoid the loss of your important data due to unforeseen malfunction.*
- *The bigger the USB drive free memory for the PVR function, the bigger the recording length.*
- *If you want to change channel or signal source during recording, store the recording data before changing the channel or source.*
- *The TV cannot play files normally if the parameters of the file exceed the limitations of the system, the file format is not supported, the file is damaged, or the file cannot be decoded.*
- *Do not disconnect the USB drive when the system is reading a file or transmitting data, otherwise the system or the drive may be damaged.*

Netflix Settings

Netflix provides on-demand movies and TV shows delivered via the Internet. Netflix is available in certain countries. Unlimited membership is required. More information can be found at www.netflix.com <<http://www.netflix.com/>> .

Password in Parental Control

- The default password is 1234. You can change it to a new one.
- The super password is 0423. If you forget your code, enter the super password to override any existing codes.

E-Manual

E-Manual is an electronic user manual for the product. You can find instructions for the features of this TV set.

1. Press **⚙** on the remote control, select **Support > E-Manual** and press **OK** to enter.
2. Press **◀/▶** to select the contents and press **OK** to enter, then press **◀/▶** to view the instruction pages. Press **↶** to return to the contents.
3. Press **EXIT** to exit.

Share&See

Note: Share&See is DLNA-compatible.

Connecting to your PC

Make sure to set up a wired or wireless connection from your TV to a router first. Then connect your PC to your router either through a network cable or wirelessly. Also make sure to select **Network > Internet connection** and select **On**, and that your computer firewall won't block the connection.

Enabling Share&See function

Press  on the remote control, select **Smart TV > Share&See** and press **OK/▶** to enter. Press **▲/▼** to select **On** and press **OK** to confirm. Follow the steps in turn specified hereafter, then you can enjoy recorded videos, images and music saved on your PC.

Adding media from your PC for sharing

Install a DLNA media server on your PC. The simple and familiar server you may install is Microsoft Windows Media Player 11 and above. Follow the instructions below to allow your TV to access the designated files on your PC.

1. Open the Microsoft Windows Media Player 11.
2. Select **Library > Media sharing**.
3. Check the checkbox **Share my media to**.
4. Select the icon of the TV set connected to your PC.
5. Select **Allow** to allow the TV set to access your PC, and select **OK** to enable the access.
*Note: Use the **Settings** button to customize your desired settings.*
6. Select **Library > Add to Library**.
7. Select your personal folders or folders of other users that you can access for sharing.
8. Select **Add** and press **OK** to enable the addition.

Share&See application

Select **Media** from the homepage and press **OK** to enter. Then you can view pictures, listen to music or watch videos, which are stored on your PC.

Supported file formats:

Picture JPEG, PNG, BMP
Music MP3, WMA, LPCM
Video FLV, TS, MP4

Notes:

- If **Share&See** is switched on, the TV will display the list of available DLNA servers which are available in local network.
- Content from third-party DLNA servers may not play correctly on your TV due to compatibility problems.

- When sharing media files from a PC, certain features may be unavailable and, due to the file and encoding formats used, playback issues may occur.
- Because of network related conditions, playback of media files may not be error-free. When this happens, play them from a USB drive.

WiFi Display

*(*not available for some models)*

WiFi display allows you to share screen and sound of your device such as a smartphone or a tablet to your TV, wirelessly (i.e. without cables). This makes it possible to view on your TV, at the same time, what your smartphone or tablet is showing. For example, you can launch a video on your smartphone and display it simultaneously on your TV, or use your tablet as game controller with content displayed on the big screen of your TV.

Whenever you want to use WiFi display, you must first activate this function in your TV. To do it follow the steps below:

1. Press  on the remote control, select **Smart TV > WiFi display** and press **OK** to enter. You will see details for this function.
2. Find the WiFi display function on your device. Different devices may have different names for this function.
3. Tap the name of the TV on your device. If connected successfully, you can mirror exactly what you see on your device to your TV screen.

Note:

- To use the function, both the smart TV and your smartphone or tablet should be connected to the same wireless network.
- It is not guaranteed that the use of the WiFi display function will be smooth or error-free since not all devices are compatible with the WiFi display function.

T-CAST

T-Cast lets you enjoy plenty of videos, rich of applications, and share great contents on large screen. It also allows you to turn a smart device into a sophisticated remote control, providing more features than your normal TV remote control. You can then control your TV through your smart device.

Follow the on-screen instructions to scan the QR code on the TV screen and download T-Cast.

Note: Make sure the smart device and your TV are in the same home LAN (local area

network) or network segment to use TV remote function.

Network Waking up

This function allows you to turn on your TV from standby mode via a network. To use this function, please make sure:

1. Your TV is connected to an effective home network;
2. The desired controller, such as a smartphone, is connected to the same network as your TV;
3. An App which supports networked waking up function, has been installed into the controller;
4. **Networked standby** is set to **On** in the **Smart TV** menu.

When the TV is in networked standby mode, you can use the App to wake up the TV remotely.

HbbTV

HbbTV (Hybrid broadcast broadband TV) is a service offered by certain broadcasters and available only on some digital TV channels. HbbTV delivers interactive television over broadband Internet. These interactive features are added to and enrich the normal digital programmes, and include services such as digital teletext, electronic programme guide, games, voting, specific information related to the current programme, interactive advertising, information magazines, catch-up TV, etc.

To use HbbTV please ensure your TV is connected to Internet and HbbTV is switched on.

Notes:

- *HbbTV services are broadcast- or country-dependent and may be unavailable in your area.*
- *You cannot download files to your TV with HbbTV function.*
- *Application provider or broadcasting related conditions may cause an HbbTV application to be unavailable momentarily.*
- *To access HbbTV applications you must connect your TV to the Internet via a broadband link. HbbTV applications may not work correctly in case of network related issues.*

HbbTV access

1. Press  on the remote control, select **Smart TV > HbbTV Setting** and press **OK/▶** to enter.
2. Press **▲/▼** to select **On** and press **OK** to confirm.
3. When you tune to a TV digital channel that offers HbbTV, this will be signalled to you by an on-screen indication (generally a red button, but other colour buttons may also be used). Press

the indicated colour button to open the interactive pages.

4. Use **▲/▼/◀/▶** and the colour buttons to navigate through the HbbTV pages and press **OK** to confirm.

HbbTV deactivation

HbbTV is required to access Freeview On Demand so we recommend that HbbTV is activated. If you wish to to activate / deactivate HbbTV:

1. Press  on the remote control, select **Smart TV > HbbTV** and press **OK/▶** to enter.
2. Press **▲/▼** to select **Off** and press **OK** to confirm.

Freeview On Demand

Freeview On Demand is a free content aggregation and streaming service provided by Freeview New Zealand. Using Freeview On Demand, you can watch the best free TV and movies on your TV, any time.

To access Freeview On Demand

Connect your TV to a UHF aerial* and broadband**. Make sure HbbTV is activated on your TV and you have completed a channel scan to tune in Freeview Live TV channels.

To use Freeview On Demand

When watching Live TV, a Freeview pop up will be displayed at the bottom of the screen each time you change channel.

Use the **arrow** keys and the **OK** button on your remote to interact with the pop up to access Freeview On Demand.

Alternatively, you can use the red button on your TV remote to load the Freeview On Demand application.

*UHF coverage is required. Check your coverage at www.freeviewnz.tv/check

**Data usage applies.

For more information about Freeview On Demand, please see www.freeviewnz.tv

Problems & Solutions

Note: Problems & solutions 1 to 2 are for the TV models which have network functions, so users of non-connected TV models can disregard them.

1. Fail to link to the network.

- Check if your TV is connected with the network;
- Reboot your TV;
- Consult your internet service provider, to confirm if access of your router is supported. Refer to the operation manual of your router.
- Make sure if your TV is connected with the router. If the router is well connected and powered on, try to change a new router and network line, and use your PC to have a test. Should your problem persist, try to consult Client Service Centre.

2. The video could not be played smoothly.

- Videos from your USB flash drive --- It may result from data transmission, or its code flow is far beyond the supported formats of this TV set.
- Videos downloaded from internet, or online videos.
 - a. It may be caused by the lower bandwidth of your network. A high network speed is required to handle online videos.
 - b. Peak internet usage times may affect the bandwidth.
 - c. Check if any other computers on the same network are also operating, as they may be using up bandwidth. Especially if they are downloading or displaying on-line videos.
 - d. The video may not be smooth itself, it is not the problem of your TV or network.

3. When two mobile hard disks are connected with the TV at the same time, they will not be recognized some times.

- All mobile hard disks consume a lot of power, which may result in power supply problems. We recommend inserting only one hard disk, or a low power consumption mobile hard disk.

4. The video from a mobile hard disk (USB) is playing with no sound.

- The audio format of the video in your mobile hard disk is not supported by the TV player.

5. Some videos fail to play.

- The formats of the videos may not be supported by the TV, especially videos shot by certain kinds of cameras, generally with their private protocol of formats, which are not compatible with your TV.

6. Video stops playing midway.

- Mistakes may occur when videos are copied or compressed, so they may automatically stop playing during playback.

7. What should I pay attention to, when I do SW updating

- No power cuts when SW updating;
- Avoid any operations with your remote control when SW updating;
- Be patient because the SW updating process may take a little bit longer time.

8. There are no distinct changes of TV interface after SW updating.

- Under certain conditions, SW updating may not only update or add new functions but also improve the performance of the TV set, without distinct changes of interface. Also, there may be no changes to the user interface at all.

9. External device cannot be recognized

- Some external devices (e.g. webcam, smart phone, tablet, game handle, and external wireless adapter) may not be compatible with the TV and cannot be supported for certain functions (nScreen, wireless display, gesture control, face recognition, if any). Please try a similar device. If it does not work, contact your local dealer.

Troubleshooting

Note: Most problems you encounter with your TV can be corrected by consulting the following troubleshooting list.

No picture, no sound

1. Check if the fuse or circuit breaker is working.
2. Plug another electrical device into the outlet to make sure it is working or turned on.
3. Power plug is in a bad contact with the outlet.
4. Check the signal source.

No color

1. Change the color system.
2. Adjust the saturation.
3. Try another channel. Black-white programme may be received.

Remote control does not work

1. Change the batteries.
2. Batteries are not installed correctly.

No picture, normal sound

1. Adjust the brightness and contrast.
2. Broadcasting failure may happen.

Normal picture, no sound

1. Press button ► to increase volume.
2. Volume is set to mute, press the Mute button to restore sound.
3. Change the sound system.
4. Broadcasting failure may happen.

Unorderly ripples on the picture

It is usually caused by local interference, such as cars, daylight lamps and hair driers. Adjust the antenna to minimize the interference.

Blank screen in VGA mode

Perhaps the TV can not recognize the resolution set by the PC. Suggest to change to the best resolution or other standard resolutions of the Windows system.

Snowy dots and interference

If the antenna is located in the fringe area of a television signal where the signal is weak, the picture may be marred by dots. When the signal is extremely weak, it may be necessary to install a special antenna to improve the reception.

1. Adjust the position and orientation of the indoor/outdoor antenna.
2. Check the connection of antenna.
3. Fine tune the channel.
4. Try another channel. Broadcasting failure may happen.

Ignition

Black spots or horizontal streaks appear, or the picture flutters or drifts. This is usually caused by interference from car ignition system, neon lamps, electric drills, or other electrical appliance.

Ghost

Ghosts are caused by the television signal following two paths. One is the direct path, the other is reflected from tall buildings, hills, or other objects. Changing the direction or position of the antenna may improve the reception.

Radio frequency interference

This interference produces moving ripples or diagonal streaks, and in some case, loss of contrast in the picture. Find out and remove the radio interference source.

** To bring you better visual experience, please remove all labels, if any, from TV front panel and screen before use.*

** Figures and illustrations in this User Manual are provided for reference only and may differ from actual product appearance. Product design and specifications may be changed without notice.*

Legal statement

[Legal Statement] of TCL - manufacturer of this TV set

Due to the various capabilities of products featuring the SmartTV - Services, as well as limitations in the available content, certain features, applications, and services may not be available on all devices or in all territories. Some features on SmartTV may also require additional peripheral devices or membership fees that are sold separately. Please visit our website for more information on specific device information and content availability. The services and availability of content through SmartTV are subject to change from time to time without prior notice.

All content and services accessible through this device belong to third parties and are protected by copyright, patent, trademark and/or other intellectual property laws. Such content and services are provided solely for your personal noncommercial use. You may not use any content or services in a manner that has not been authorized by the content owner or service provider. Without limiting the foregoing, unless expressly authorized by the applicable content owner or service provider, you may not modify, copy, republish, upload, post, transmit, translate, sell, create derivative works, exploit, or distribute in any manner or medium any content or services displayed through this device.

You expressly acknowledge and agree that use of the device is at your sole risk and that the entire risk as to satisfactory quality, performance and accuracy is with you. The device and all third party content and services are provided "as is" without warranty of any kind, either express or implied. TCL expressly disclaims all warranties and conditions with respect to the device and any content and services, either express or, implied, including but not limited to, warranties of merchantability, of satisfactory quality, fitness for a particular purpose, of accuracy, of quiet enjoyment, and non-infringement of third party rights. TCL does not guarantee the accuracy, validity, timeliness, legality, or completeness of any content or service made available through this device and does not warrant that the device, content or services will meet your requirements, or that operation of the device or services will be uninterrupted or error-free. Under no circumstances, including negligence, shall TCL be liable, whether in contract or tort, for any direct, indirect, incidental, special or consequential damages, attorney fees, expenses, or any other damages arising out of, or in connection with, any information contained in, or as a result of the use of the device, or any content or service accessed by you or any third party, even if advised of the possibility of such damages.

Third party services may be changed, suspended, removed, terminated or interrupted, or access may be disabled at any time, without notice, and TCL makes no representation or warranty that any content or service will remain available for any period of time. Content and services are transmitted by third parties by means of networks and transmission facilities over which TCL has no control. Without limiting the generality of this disclaimer, TCL expressly disclaims any responsibility or liability for any change, interruption, disabling, removal of or suspension of any content or service made available through this device. TCL may impose limits on the use of or access to certain services or content, in any case and without notice or liability. TCL is neither responsible nor liable for customer service related to the content and services. Any question or request for service relating to the content or services should be made directly to the respective content and service providers.

Licence



The terms HDMI and HDMI High-Definition Multimedia Interface, and the HDMI logo are trademarks or registered trademarks of HDMI Licensing Administrator, Inc. in the United States and other countries.



Manufactured under license from Dolby Laboratories. Dolby, Dolby Audio, and the double-D symbol are trademarks of Dolby Laboratories.



H.265-HIGH EFFICIENCY VIDEO CODING

HEVC, or H.265 is the successor to H.264 and strives to deliver video with equivalent quality with bitrate savings of up to 50 percent. HEVC is critical for streaming high-quality video even in congested network environments, and will be a driving factor in the delivery of 4K content to new Ultra HD displays.



www.tclelectronics.co.nz



Like us on Facebook

TCL Electronics New Zealand PTY LIMITED.

NZBN 9429043411917

Address: 25 Aerovista Place, Wiri 2104, Auckland

Telephone: 0800 449 750

service.nz@tcl.com

www.tclelectronics.co.nz