



User Guide

300Mbps Wi-Fi Range Extender
TL-WA850RE

Contents

About This Guide	1
Chapter 1. Get to Know About Your Extender	2
1. 1. Product Overview.....	3
1. 2. Appearance	3
1. 2. 1.LED Explanation.....	4
1. 2. 2.Port and Button Description.....	4
Chapter 2. Set Up Internet Connection	5
2. 1. Quick Setup	6
2. 1. 1.Method 1: Via the WPS Button.....	6
2. 1. 2.Method 2: Via a Web Browser	7
2. 1. 3.Method 3: Via the TP-Link Tether App.....	9
2. 2. Position Your Extender.....	11
Chapter 3. Customize Your Network.....	12
3. 1. Check Internet Status.....	13
3. 2. Configure Wireless Network	14
3. 3. Change LAN Settings.....	15
3. 4. Specify DHCP Server Settings	16
3. 5. Adjust Wi-Fi Coverage	17
3. 6. Set Access Control	17
Chapter 4. More Features of Your Extender.....	20
4. 1. Use Your Extender as a Wireless Adapter.....	21
4. 2. Transform Your Existing Wired Network to a Wireless One	21
4. 2. 1.To Set Up the Extender as an Access Point	21
4. 2. 2.To Connect Your Wireless Devices to the Extender via WPS.....	22
Chapter 5. Manage Your Extender	24
5. 1. Set Up System Time	25
5. 2. Control LEDs	25
5. 3. Power Schedule	26
5. 4. Upgrade the Firmware	27
5. 5. Backup and Restore Configuration Settings.....	27
5. 6. Change Admin Account.....	28
5. 7. System Log.....	29
FAQ	30

About This Guide

This guide is a complement to Quick Installation Guide. The Quick Installation Guide provides instructions for quick internet setup, while this guide contains details of each function and demonstrates how to configure them.

When using this guide, please notice that features of the extender may vary slightly depending on the model and software version you have, and on your location, language, and internet service provider. All screenshots, images, parameters and descriptions documented in this guide are used for demonstration only.

Conventions

In this guide the following conventions are used:

Convention	Description
<u>Underlined</u>	Underlined words or phrases are hyperlinks and You can click to redirect to a website or a specific section.
Teal	Contents to be emphasized and texts on the web page are in teal, including the menus, items, buttons, and so on.
>	The menu structures to show the path to load the corresponding page. For example, Advanced > Wireless > MAC Filtering means the MAC Filtering function page is under the Wireless menu that is located in the Advanced tab.
Note:	Ignoring this type of note might result in a malfunction or damage to the device.
Tips:	Indicates important information that helps you make better use of your device.
symbols on the web page	<ul style="list-style-type: none">✎ click to edit the corresponding entry.🗑️ click to delete the corresponding entry.

More Info

The latest software, management app and utility are available from the [Download Center](#) at www.tp-link.com/support.

The Quick Installation Guide can be found where you find this guide or inside the package of the range extender.

Specifications can be found on the product page at <http://www.tp-link.com>.

A Technical Support Forum is provided for you to discuss our products at <http://forum.tp-link.com>.

Our Technical Support contact information can be found at Contact Technical Support page at www.tp-link.com/support.

Chapter 1

Get to Know About Your Extender

This chapter introduces what the extender can do and its appearance.

It contains the following sections:

- [Product Overview](#)
- [Appearance](#)

1.1. Product Overview

Bring Dead Zones Back to Life

Tired of Wi-Fi “dead zones”? The TP-Link extender is connected to your router wirelessly, strengthening its signal and expanding its coverage into areas that could not otherwise be reached. The device also reduces signal interference to ensure reliable Wi-Fi coverage throughout your home or office.

Easy Installation & Quick Position

The extender works with any standard wireless router. Instantly connect the extender to a router by pressing the router’s WPS button (if available) followed by the extender’s WPS button. Alternatively, follow the Quick Setup instructions on the extender’s web management page.

Once the extender is connected to a router, you can relocate it to your preferred location with no further configuration required. The intelligent signal light can help to find the best location.

Easy Management with the Tether APP

Tether provides a simple, intuitive way to access and manage your extender with your smart devices.

1.2. Appearance





■ **Note:** The provided plug may differ from the picture due to different regional power specifications.

1.2.1. LED Explanation

You can check the extender's working status by following the LED Explanation table.

Name	Status	Indication
RE	On/Off	The extender is connected or not connected to your router's wireless network.
	Blinking	WPS connection is in process.
Wireless	On	The extender's wireless function is enabled.
Power	On/Off	The extender is on or off.
	Blinking	The system is starting up or firmware is being upgraded.
 (Signal Strength)	On	Indicates the Wi-Fi connection between the extender and the router. More lit LEDs indicate a better signal strength.
Ethernet	On/Off	The Ethernet port is connected or not connected to a powered-on device.

1.2.2. Port and Button Description

Ports or Buttons	Description
 (WPS Button)	Press the WPS button on your host router, and immediately press the  button on the extender for 1 second. The RE LED of the extender should change from blinking to solid on, indicating successful WPS connection.
RESET Button	With the extender powered on, use a pin to press the RESET button for 1 second. The extender will reboot.
Ethernet Port	Connect your Ethernet-only device to the Ethernet port of the extender to join the network.

Chapter 2

Set Up Internet Connection

This chapter informs you how to boost your host wireless coverage. Please follow the step-by-step instructions to set up the internet connection.

It contains the following sections:

- [Quick Setup](#)
- [Position Your Extender](#)

2.1. Quick Setup



Power on

Plug the extender into an electrical outlet **next to your host router**, and then wait until the Power LED changes to solid on.

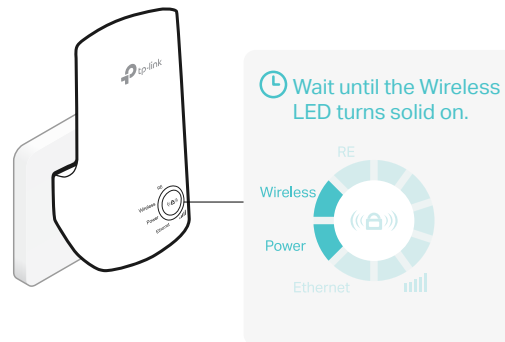
■ **Note:** For safety, we suggest that you plug the extender in upright directions as shown below.



Connect to the host network

There are three ways to connect to the host network: via the WPS button, via a web browser, or via the Tether app. Using the WPS button is an easier way to extend your host network. We recommend you to use this way if your router has a WPS button. The button might look like one of these:  |  |  .

2.1.1. Method 1: Via the WPS Button

1. Press the WPS button on your host router, and then press the  button on the extender within 2 minutes.

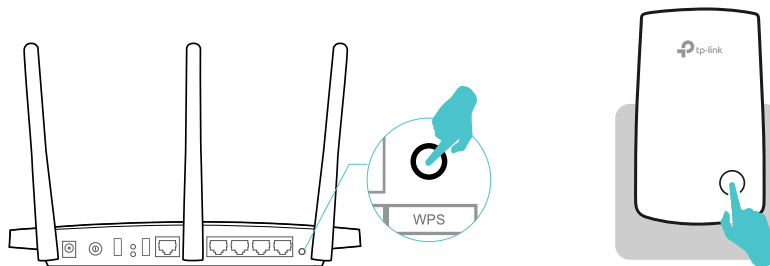

■ **Note:**

For more information about using WPS button on your host router, please refer to the router's user guide.

2. Wait until the RE LED changes from blinking to solid on, which indicates that the WPS connection is successful.
3. **Enjoy!** Connect to the extended network and enjoy internet. The extended network shares the same network name and password as your router.

■ **Note:**

- If the WPS method fails, or if you want to customize the extended network name, refer to [Method 2: Via a Web Browser](#) or [Method 3: Via the TP-Link Tether App](#).
- Since the performance of the extended network will be affected by the distance between the extender and host router, we recommend that you relocate your extender by referring to [Position Your Extender](#).

2.1.2. Method 2: Via a Web Browser

1. Connect your computer to the extender via your Ethernet cable, or connect wirelessly as follows:

- For Windows Users

- 1) Unplug the Ethernet cable from your computer (if any).
- 2) Click the Wi-Fi icon on the task bar and connect to the extender's network: [TP-Link_Extender](#).

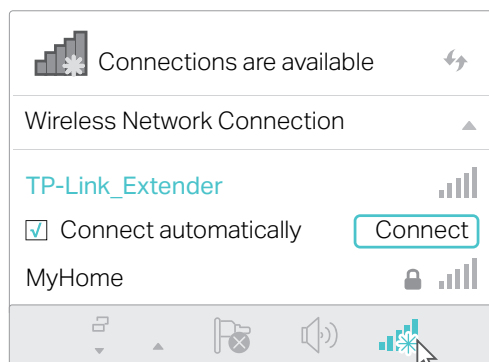

- For Mac OS X Users

- 1) Unplug the Ethernet cable from your computer (if any).
- 2) Click the Wi-Fi icon in the top right corner of the screen, and connect to the extender's network: [TP-Link_Extender](#).

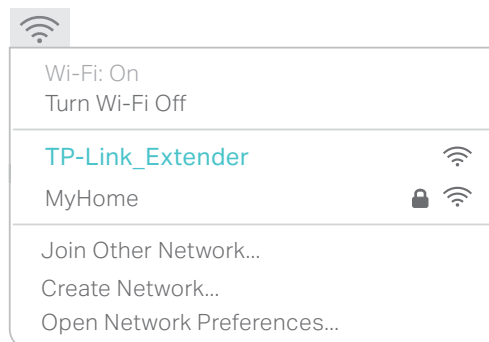

2. Follow the instructions of Quick Setup Wizard to connect the extender to your host router.

- 1) Launch a web browser, enter <http://tplinkrepeater.net> or <http://192.168.0.254> in the address field, create a password for future logins, and click **Start**.

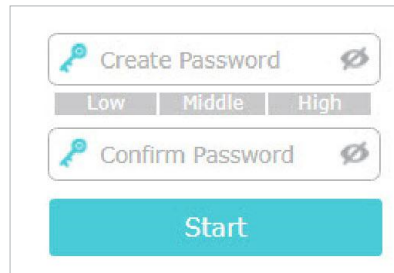

■ **Note:**

If the login window does not appear, please refer to [FAQ](#).

- 2) Select your host router's 2.4GHz SSID (network name), enter its password (NOT the password you just created for logins), and click **Next**.

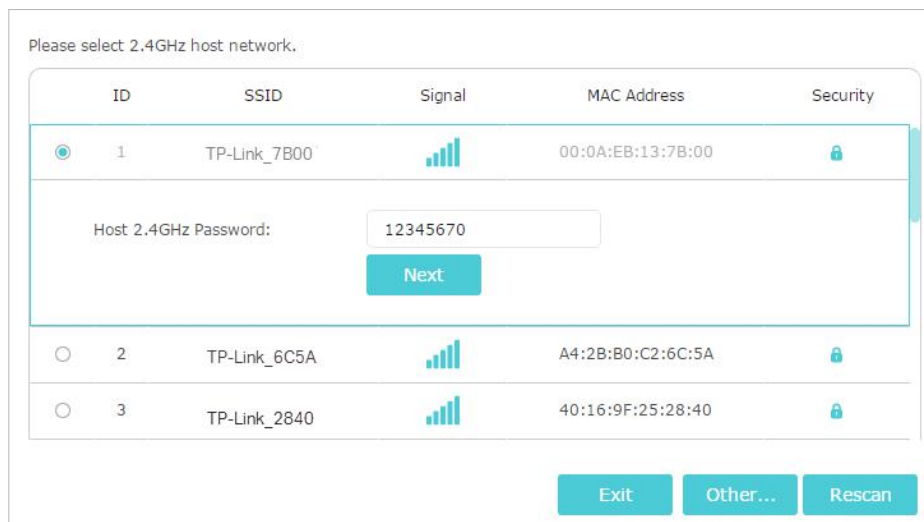

ID	SSID	Signal	MAC Address	Security
<input checked="" type="radio"/> 1	TP-Link_7B00		00:0A:EB:13:7B:00	
<input type="radio"/> 2	TP-Link_6C5A		A4:2B:B0:C2:6C:5A	
<input type="radio"/> 3	TP-Link_2840		40:16:9F:25:28:40	

- 3) Either keep the default SSID (network name) or customize it for the extended network, and then click **Next**.

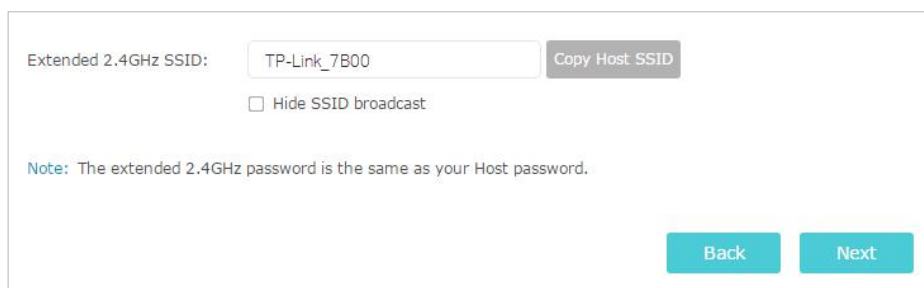

- 4) Verify your wireless settings and click **Save**.

Router	Range Extender
2.4GHz Wireless	2.4GHz Wireless
SSID: TP-Link_7B00	SSID: TP-Link_7B00
Password: 12345670	Hide SSID: Off
	Password: 12345670

- 5) **Enjoy!** Connect to the extended network and enjoy internet. The extended network shares the same wireless password as that of your host network, but may have different network name if you have customized the SSID during the configuration.

Congratulations!

Now, connect to your new extended network and enjoy the Internet.

2.4GHz Wireless

SSID: TP-Link_7B00

Password: 12345670

I am connected to the extended network.

■ **Note:**

Since the performance of the extended network will be affected by the distance between extender and host router, we highly recommend you to relocate your extender referring to [Position Your Extender](#).

2.1.3. Method 3: Via the TP-Link Tether App

1. Launch the Apple App Store or Google Play Store and search **TP-Link Tether** or simply scan the QR code to download and install the app.



2. Go to Wi-Fi Settings and connect your device to the extender's wireless network: [TP-Link_Extender](#).

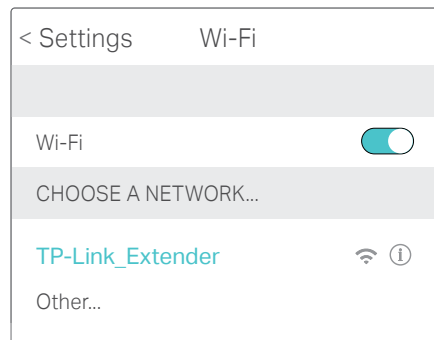

3. Launch Tether and select your extender from the Local Device list.

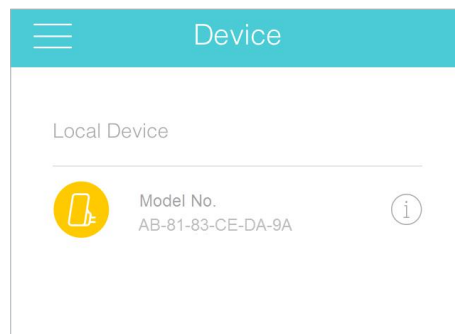

4. Create a password for future logins.

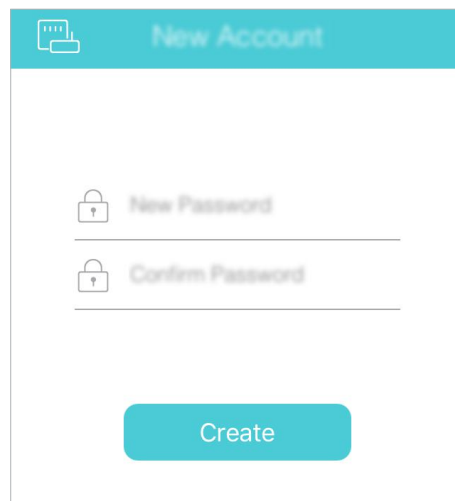

5. Follow the on-screen instructions to complete the configuration.

Tips:

You can manage your extender via Tether, such as controlling LEDs, sharing the password of your network and blocking devices.

Note:

Since the performance of the extended network will be affected by the distance between the extender and host router, we recommend that you relocate your extender by referring to [Position Your Extender](#).

2.2. Position Your Extender

Please follow the instructions below to achieve optimal performance of the extender.

1. Plug the extender into an electrical outlet between your host router and the Wi-Fi “dead” zone. The location you choose must be within the range of your existing host network.
2. Wait until the  LEDs are lit. Make sure the extender is in a location with 3 or more LEDs lit. If not, relocate it closer to the router to achieve better signal quality.

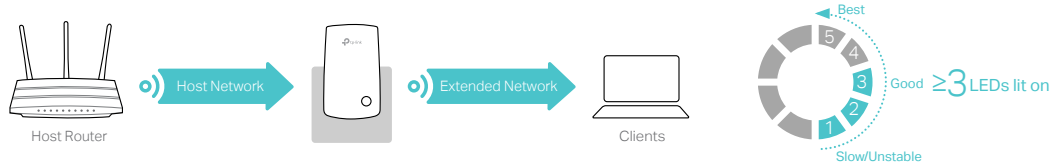

Tips:

To minimize signal interference, please choose a location which is far away from Bluetooth devices and other household electronic devices, such as cordless phones, microwave ovens and baby monitors.

Chapter 3

Customize Your Network

This chapter guides you on how to configure network settings that are available for this extender.

It contains the following sections:

- [Check Internet Status](#)
- [Configure Wireless Network](#)
- [Change LAN Settings](#)
- [Specify DHCP Server Settings](#)
- [Adjust Wi-Fi Coverage](#)
- [Set Access Control](#)

3.1. Check Internet Status

You can view the internet status of your extender to check whether you have successfully set up the extended network(s).

1. Visit <http://tplinkrepeater.net>, and log in with the password you set for the extender.
2. Go to **Settings** > **Status** to view the internet status of your extender.
 - The extender is functioning normally.



- The extender is not connected to the host network. Please go to **Settings** > **Wireless** > **Connect to Network** to check whether the host network passwords are correct. If the problem still exists, relocate the extender closer to the router to achieve better signal quality.



- The extender is connected to the host network, but is not transmitting data. Please check your router's internet connection.



- The extender is connected to the router abnormally. Please go to **Settings** > **Network** and try setting your extender to obtain an IP address automatically.

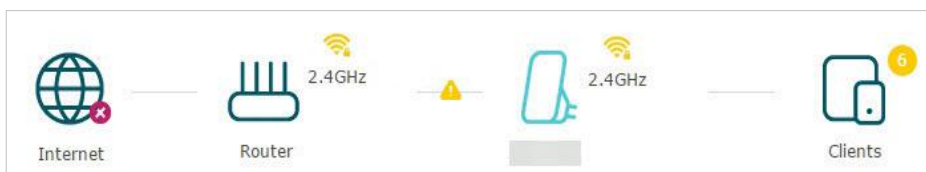

Click the Internet/Router/Range Extender/Clients icon to view corresponding information.

3.2. Configure Wireless Network

If you want to extend another host network after Quick Setup, you can refer to this section. Moreover, you can change the wireless settings for your extended network.

Visit <http://tplinkrepeater.net>, and log in with the password you set for the extender.

➤ **To extend another host network:**

1. Go to [Settings](#) > [Wireless](#) > [Connect to Network](#).

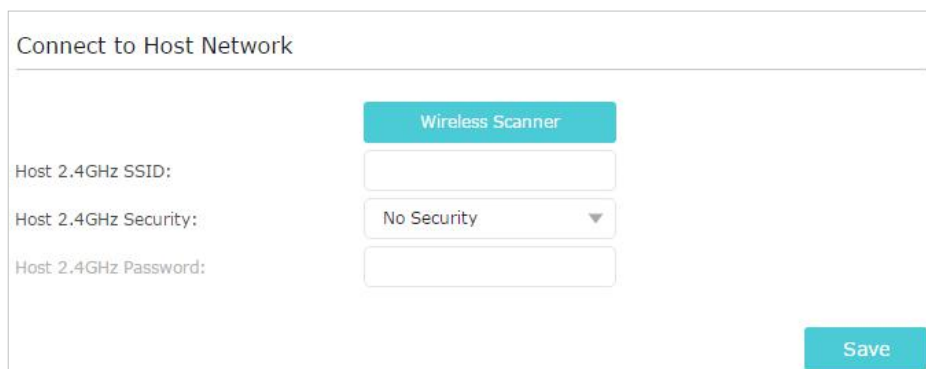

Connect to Host Network

Wireless Scanner

Host 2.4GHz SSID:

Host 2.4GHz Security: No Security ▼

Host 2.4GHz Password:

Save

2. Click [Wireless Scanner](#) to find all available networks.

3. Select the host network you want to extend.

■ **Note:**

If the network you want to extend is on but not listed, please try the following steps.

1. Move the extender closer to your router, and click [Rescan](#) in the top-right corner of the list.
 2. You can manually enter the parameters of the network you want to extend, and click [Save](#).
4. Once a host network is selected, the SSID and security type will be automatically filled in. If the selected network is encrypted, enter the password in the [Password](#) field.
 5. Click [Save](#).

➤ **To change the wireless network name (SSID):**

1. Go to [Settings](#) > [Wireless](#) > [Extended Network](#).

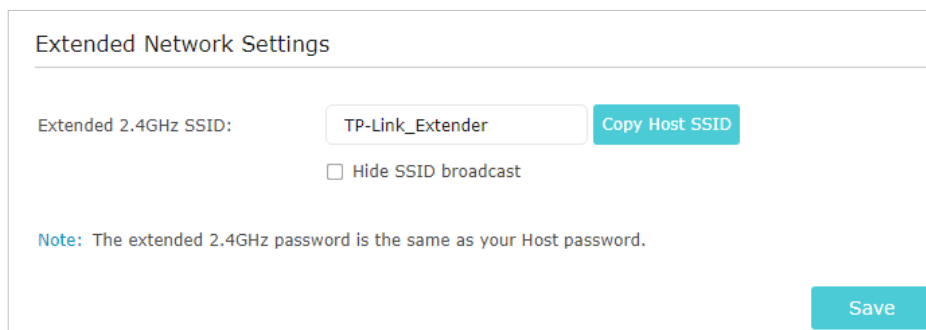

Extended Network Settings

Extended 2.4GHz SSID: TP-Link_Extender Copy Host SSID

Hide SSID broadcast

Note: The extended 2.4GHz password is the same as your Host password.

Save

2. Create a new SSID in [Extended 2.4GHz SSID](#) or click [Copy Host SSID](#). The value is case-sensitive.

3. Click [Save](#).

▀ **Note:**

If you have changed the wireless settings via a wireless device, you will be disconnected after the settings are applied. Please write down the new SSID for future use.

➤ **To hide the SSID of the extended network:**

1. Go to [Settings](#) > [Wireless](#) > [Extended Network](#).

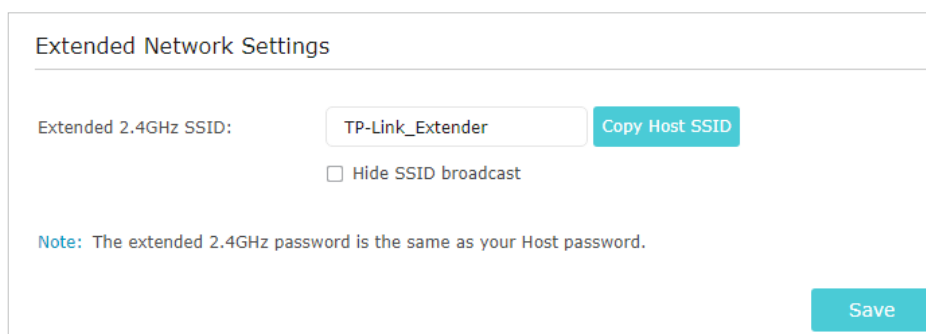

Extended Network Settings

Extended 2.4GHz SSID: [Copy Host SSID](#)

Hide SSID broadcast

Note: The extended 2.4GHz password is the same as your Host password.

[Save](#)

2. Select [Hide SSID broadcast](#), and the corresponding SSID will not be displayed when wireless devices scan for local wireless networks. Devices must join the network manually in order to connect.

3. Click [Save](#).

3.3. Change LAN Settings

The extender is preset with a default LAN IP 192.168.0.254, with which you can log in to the web management page. The LAN IP address, together with the Subnet Mask, also defines the subnet that the connected devices are on. If the IP address conflicts with another device on your local network or your network requires a specific IP subnet, you can change it.

1. Visit <http://tplinkrepeater.net>, and log in with the password you set for the extender.

2. Go to [Settings](#) > [Network](#).

3. Select [Use the following IP address](#).

4. Enter a new IP address as needed and leave the [Subnet Mask](#) as the default settings and enter the gateway that is in the same subnet as the IP address. The gateway is usually the LAN IP address of your extender.

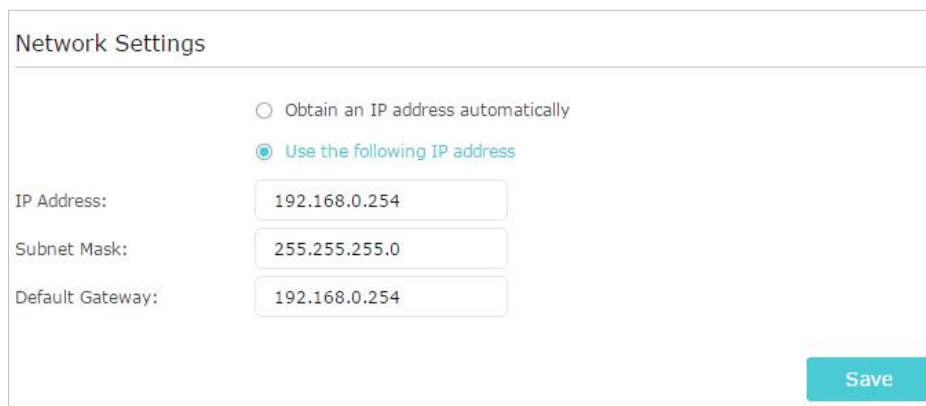

Network Settings

Obtain an IP address automatically
 Use the following IP address

IP Address:
 Subnet Mask:
 Default Gateway:

5. Click [Save](#).

3. 4. Specify DHCP Server Settings

By default, the DHCP (Dynamic Host Configuration Protocol) Server is enabled and the extender acts as a DHCP server; it dynamically assigns TCP/IP parameters to client devices from the IP Address Pool. You can change the settings of the DHCP Server if necessary.

1. Visit <http://tplinkepeater.net>, and log in with the password you set for the extender.
2. Go to [Settings](#) > [Network](#).

➤ **To specify the IP address that the extender assigns:**

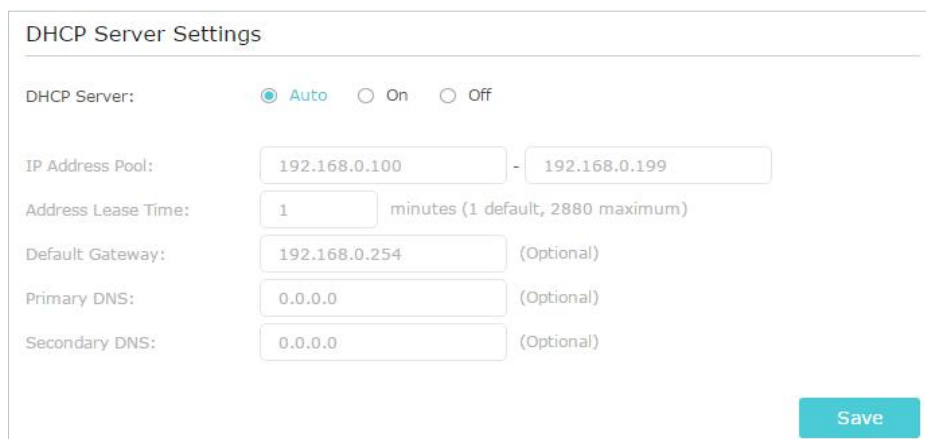

DHCP Server Settings

DHCP Server: Auto On Off

IP Address Pool: -

Address Lease Time: minutes (1 default, 2880 maximum)

Default Gateway: (Optional)

Primary DNS: (Optional)

Secondary DNS: (Optional)

1. Select [Auto](#) (recommended) or [On](#) to enable the DHCP Server.
2. Enter the starting and ending IP addresses in the [IP Address Pool](#).
3. Enter other parameters if the ISP requires them. The [Default Gateway](#) is automatically filled in and is the same as the LAN IP address of the extender.
4. Click [Save](#).

➤ **To view the DHCP Client List:**

You can view the information of the DHCP clients connected to the extender in the DHCP Client List.

DHCP Client List				
Client Number: 1				Refresh
ID	Client Name	MAC Address	Assigned IP Address	Lease Time
1		FC-AA-14-C4-3D-0C	192.168.0.100	00:00:58

3.5. Adjust Wi-Fi Coverage

You can set the extender's Wi-Fi coverage depending on how large you want your Wi-Fi area to be.

1. Visit <http://tplinkrepeater.net>, and log in with the password you set for the extender.
2. Go to [Settings](#) > [Advanced Settings](#) > [Wi-Fi Coverage](#).
3. Select [Min](#), [Mid](#) or [Max](#) to adjust your Wi-Fi coverage of the extender.

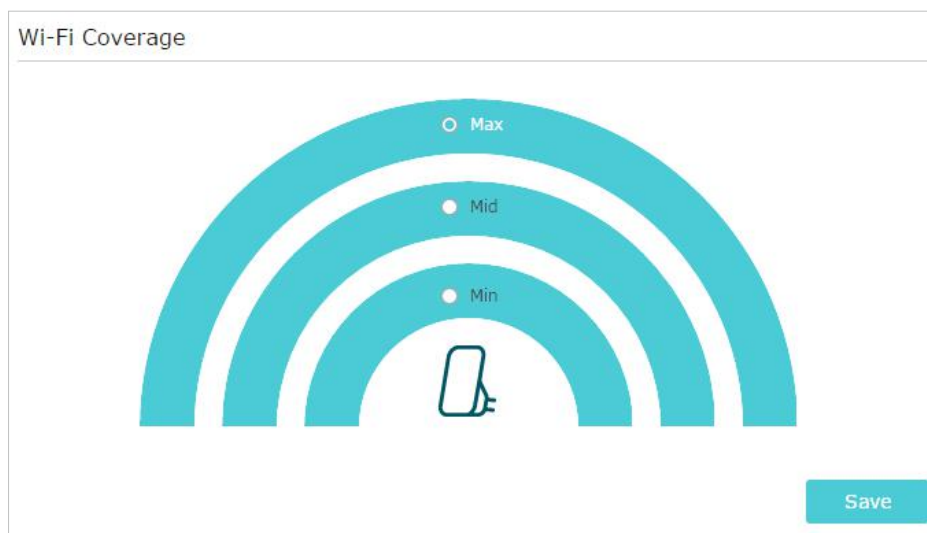

4. Click [Save](#).

3.6. Set Access Control

Access Control allows you to permit or block specific devices from accessing internet for a specific period.

1. Visit <http://tplinkrepeater.net>, and log in with the password you set for the extender.
2. Go to [Settings](#) > [Advanced Settings](#) > [Access Control](#).
3. Enable [Access Control](#).

Access Control

Access Control:

➤ **To block specific device(s):**

■ **Note:**

Devices connected to the extender via an Ethernet cable cannot be blocked.

1. Select **Blacklist** and click **Save**.

Access Mode

Default Access Mode: **Blacklist** Whitelist

Save

2. Select the device to be blocked in the **Online Devices** table by ticking the corresponding checkbox.
3. Click **Block** and the selected device(s) will be added to the **Devices in Blacklist** table.

Online Devices

Refresh Block

<input type="checkbox"/>	ID	Device Name	IP Address	MAC Address	Connection Type	Modify
<input type="checkbox"/>	1		192.168.0.102		Wireless	<input checked="" type="checkbox"/>

4. Click in the **Devices in Blacklist** table to set the **Effective Time** for a certain entry as needed.

Device Name:

MAC Address:

Effective Time: Cannot access at any time
 Cannot access based on the time schedule

Time: : - :

Day(s): Monday Tuesday
 Wednesday Thursday
 Friday Saturday
 Sunday

Cancel **OK**

5. Click **OK**.

➤ **To permit specific device(s):**

1. Select **Whitelist** and click **Save**.



The screenshot shows a dialog box titled "Access Mode". It contains a section labeled "Default Access Mode:" with two radio button options: "Blacklist" and "Whitelist". The "Whitelist" option is selected. A teal "Save" button is located in the bottom right corner of the dialog.

2. Click **Add** in the **Devices in Whitelist** table. Enter the **Device Name** and **MAC Address**. And you can set the **Effective Time** for a certain entry as needed.

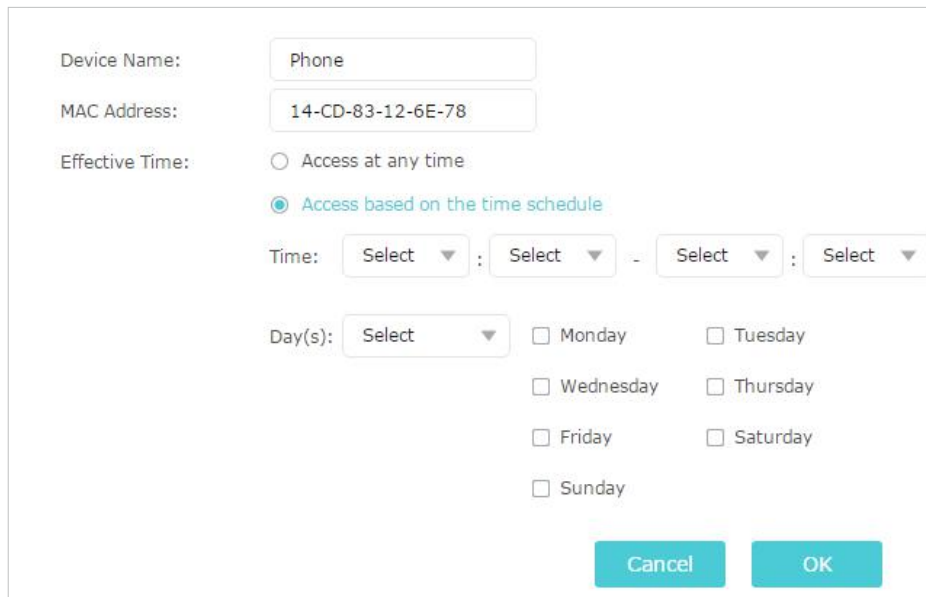

The screenshot shows a dialog box for configuring a device. It has the following fields and options:

- Device Name:** A text input field containing "Phone".
- MAC Address:** A text input field containing "14-CD-83-12-6E-78".
- Effective Time:** Two radio button options: "Access at any time" and "Access based on the time schedule". The "Access based on the time schedule" option is selected.
- Time:** Four dropdown menus for selecting hours, minutes, and AM/PM, separated by colons and a hyphen.
- Day(s):** A dropdown menu for selecting days, followed by checkboxes for Monday, Tuesday, Wednesday, Thursday, Friday, Saturday, and Sunday.
- Buttons for "Cancel" and "OK" are at the bottom right.

3. Click **OK**.

Chapter 4

More Features of Your Extender

This chapter explains how to use the extender as a wireless adapter and as an access point.

It contains the following sections:

- [Use Your Extender as a Wireless Adapter](#)
- [Transform Your Existing Wired Network to a Wireless One](#)

4. 1. Use Your Extender as a Wireless Adapter

The extender can be used as a wireless adapter to connect any wired-only device, such as a Blu-ray player, game console, DVR, or smart TV, to your wireless network.

After configuration, you can connect an Ethernet-enabled device to the extender via an Ethernet cable.

■ **Note:**

Extenders that have no Ethernet port do not support this feature.

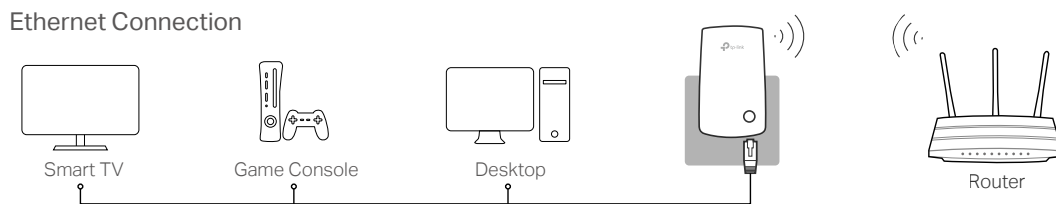

4. 2. Transform Your Existing Wired Network to a Wireless One

The extender can work as an access point, transforming your existing wired network to a wireless one.

4. 2. 1. To Set Up the Extender as an Access Point

1. Visit <http://tplinkrepeater.net>, and log in with the password you set for the extender.
2. Click **Mode** in the top right corner of the page. Select **Access Point** and click **Save**. The extender will reboot and switch to Access Point mode.

Switch Mode

Access Point
Transforms your existing wired network to a wireless network.

Range Extender
Extends your existing wireless coverage by repeating the wireless signal.

Cancel **Save**

3. After rebooting, connect the extender to your modem or wired router via an Ethernet cable.

4. Visit <http://tplinkrepeater.net>, and log in with the password you set for the extender.
5. Go to **Quick Setup** to configure your extender.
 - 1) Configure your wireless settings and click **Next**.

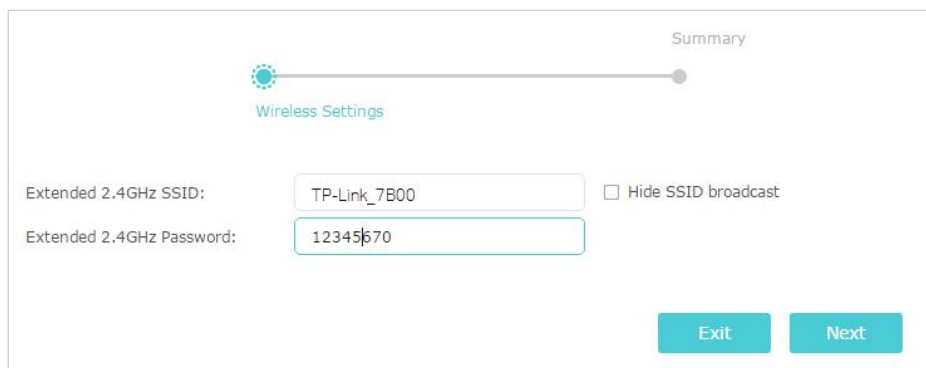

Summary

Wireless Settings

Extended 2.4GHz SSID: TP-Link_7B00 Hide SSID broadcast

Extended 2.4GHz Password: 12345670

Exit Next

- 2) Confirm the information and click **Finish**. Now, you can enjoy Wi-Fi.

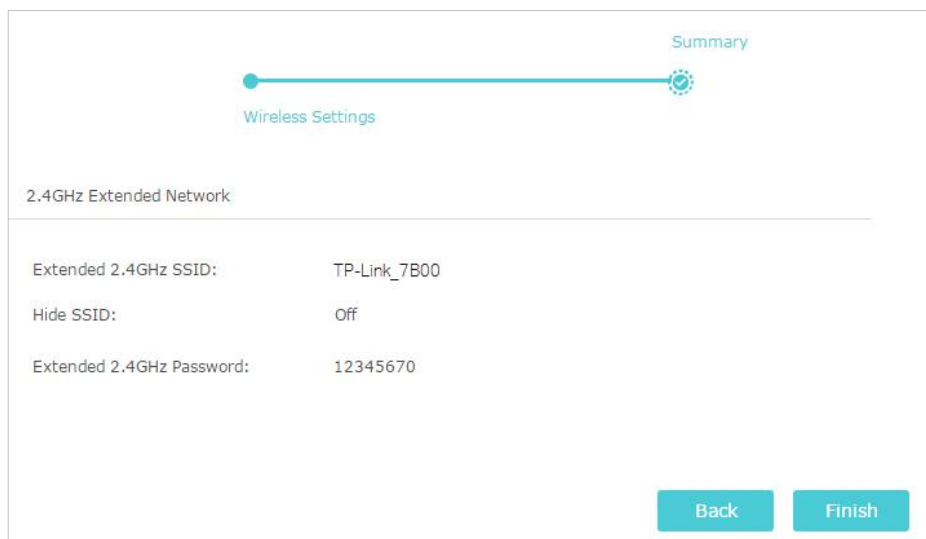

Summary

Wireless Settings

2.4GHz Extended Network

Extended 2.4GHz SSID: TP-Link_7B00

Hide SSID: Off

Extended 2.4GHz Password: 12345670

Back Finish

4. 2. 2. To Connect Your Wireless Devices to the Extender via WPS

Wi-Fi Protected Setup (WPS) provides an easier way to set up a secure Wi-Fi connection. Wireless devices that support WPS, including Android phones, tablets and most USB network cards, can be connected to your extender through this method (not supported by iOS devices).

1. Visit <http://tplinkrepeater.net>, and log in with the password you set for the extender.
2. Go to **Settings > Wireless > WPS**.
3. Enable **WPS**.

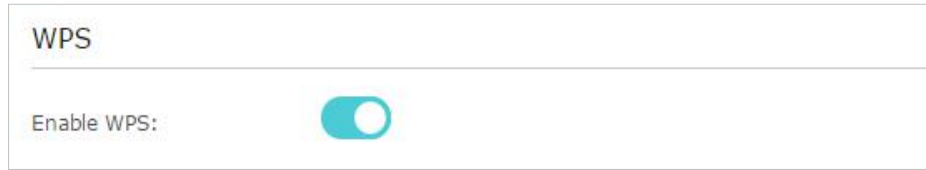

WPS

Enable WPS:

4. Connect via WPS:

- AP's PIN: Enable [AP's PIN](#) and enter the PIN on your device. You can click [Generate](#) to get a new PIN or click [Default](#) to restore the PIN to its factory one.

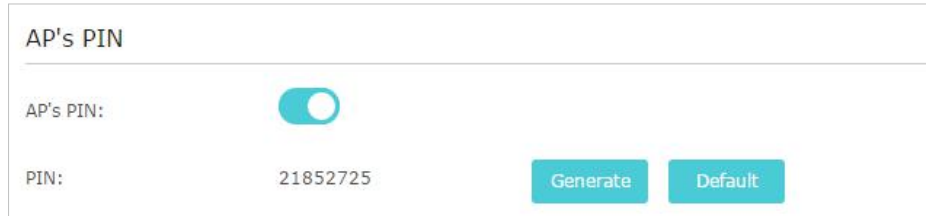

AP's PIN

AP's PIN:

PIN: 21852725 [Generate](#) [Default](#)

- Push Button (Recommended): Click [Connect](#) and push the WPS button on the client device.
- PIN code: Enter the client's PIN, and click [Connect](#).

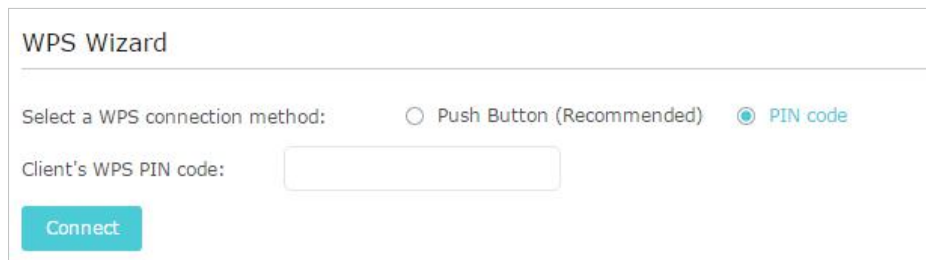

WPS Wizard

Select a WPS connection method: Push Button (Recommended) PIN code

Client's WPS PIN code:

[Connect](#)

Chapter 5

Manage Your Extender

This chapter presents how to manage and maintain your extender.

It includes the following sections:

- [Set Up System Time](#)
- [Control LEDs](#)
- [Power Schedule](#)
- [Upgrade the Firmware](#)
- [Backup and Restore Configuration Settings](#)
- [Change Admin Account](#)
- [System Log](#)

5.1. Set Up System Time

The System Time of the extender will be used for time-based functions such as the Power Schedule function. If you have enabled the Daylight Saving Time feature, the system time will be synchronized with the daylight saving time you configure.

1. Visit <http://tplinkrepeater.net>, and log in with the password you set for the extender.
2. Go to [Settings](#) > [System Tools](#) > [Time Settings](#).

➤ **To get system time:**

1. Select your local [Time Zone](#) from the drop-down list.

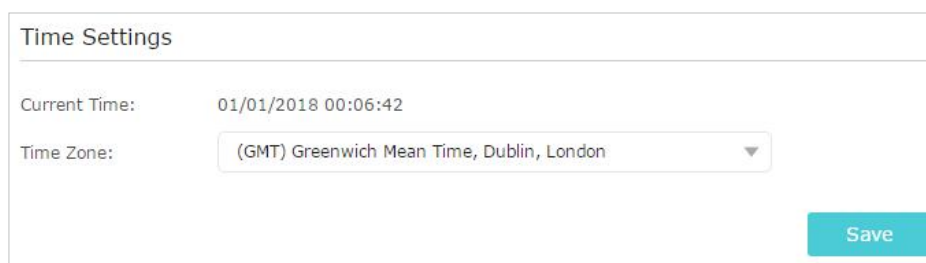

Time Settings

Current Time: 01/01/2018 00:06:42

Time Zone: (GMT) Greenwich Mean Time, Dublin, London

Save

2. Click [Save](#).

➤ **To set up Daylight Saving Time:**

1. Select [Enable Daylight Saving Time](#).

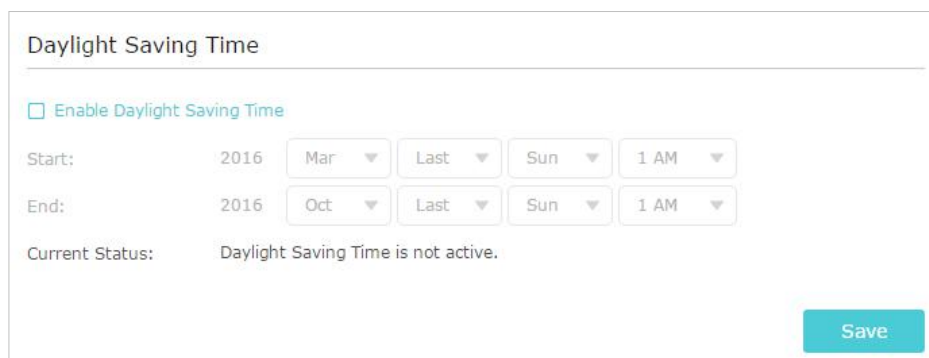

Daylight Saving Time

Enable Daylight Saving Time

Start: 2016 Mar Last Sun 1 AM

End: 2016 Oct Last Sun 1 AM

Current Status: Daylight Saving Time is not active.

Save

2. Select the [Start](#) and [End](#) date and time of the daylight saving time at your local time zone.
3. Click [Save](#).

5.2. Control LEDs

The LEDs of the extender indicate its activities and status. You can enable the Night Mode feature to specify a time period during which the LEDs are off.

1. Visit <http://tplinkrepeater.net>, and log in with the password you set for the extender.

2. Go to [Settings](#) > [System Tools](#) > [LED Control](#).

➤ **To specify a time period when LEDs are off:**

1. Select [Night Mode](#).
2. Specify a time period in the [LED Off Time](#) field, and the LEDs will be off during this period.
3. Click [Save](#).

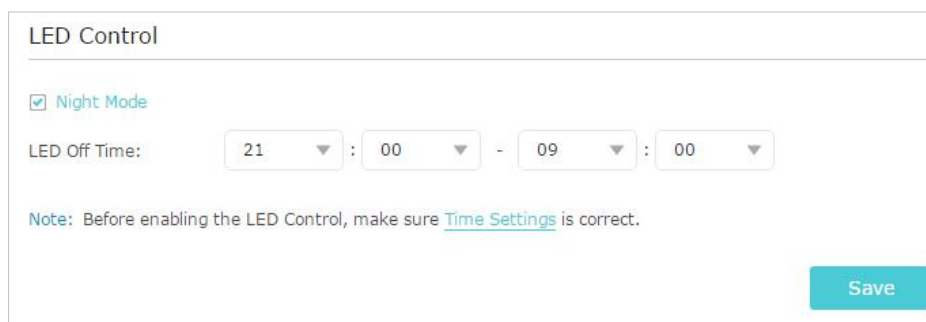

LED Control

[Night Mode](#)

LED Off Time: 21 : 00 - 09 : 00

Note: Before enabling the LED Control, make sure [Time Settings](#) is correct.

[Save](#)

5.3. Power Schedule

The Power Schedule feature allows you to specify a time period during which the extender is off.

1. Visit <http://tplinkrepeater.net>, and log in with the password you set for the extender.
2. Go to [Settings](#) > [Advanced Settings](#) > [Power Schedule](#).

➤ **To specify a time period when the extender is off:**

1. Select [Enable Power Schedule](#).
2. Specify a time period in the [Power-Off Time](#) field and days in the [Day\(s\)](#) field, and the extender will be off during this period.

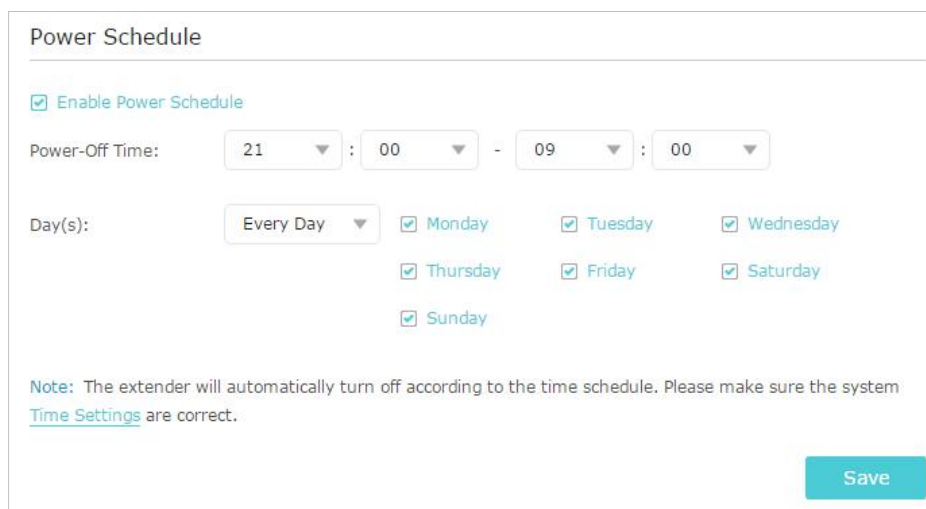

Power Schedule

[Enable Power Schedule](#)

Power-Off Time: 21 : 00 - 09 : 00

Day(s): [Every Day](#) [Monday](#) [Tuesday](#) [Wednesday](#)
 [Thursday](#) [Friday](#) [Saturday](#)
 [Sunday](#)

Note: The extender will automatically turn off according to the time schedule. Please make sure the system [Time Settings](#) are correct.

[Save](#)

3. Click [Save](#).

5.4. Upgrade the Firmware

TP-Link is committed to improving product features, giving you a better network experience. You can download the latest firmware file from the [Support](#) page of our website www.tp-link.com and upgrade the firmware to the latest version.

■ **Note:**

1. Make sure the latest firmware file is matched with the hardware version (as shown in the download section of the Support page).
2. Make sure that you have a stable connection between the extender and your computer. It is NOT recommended to upgrade the firmware wirelessly.
3. Backup your extender configuration.
4. Do NOT power off the extender during the firmware upgrade.

➤ **To upgrade the firmware:**

1. Download the latest firmware file for the extender from our website www.tp-link.com.
2. Visit <http://tplinkrepeater.net>, and log in with the password you set for the extender.
3. Go to [Settings](#) > [System Tools](#) > [Firmware Upgrade](#).
4. Click [Browse](#) to locate the downloaded new firmware file, and then click [Upgrade](#).

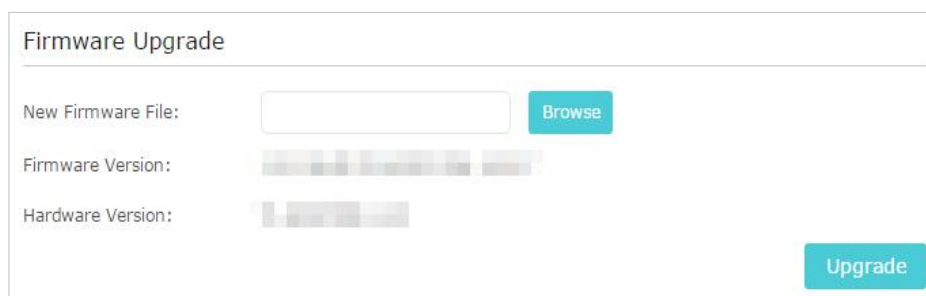

The screenshot shows a web interface titled "Firmware Upgrade". It contains three input fields: "New Firmware File:" with a text box and a "Browse" button; "Firmware Version:" with a text box; and "Hardware Version:" with a text box. A large "Upgrade" button is located at the bottom right of the form.

5. Wait a few minutes for the firmware upgrade to complete and the extender to reboot.

5.5. Backup and Restore Configuration Settings

The configuration settings are stored as a configuration file in the extender. You can backup the configuration file and restore the extender to the previous settings from the backup file when needed. Moreover, if necessary, you can erase the current settings and reset the extender to the default factory settings.

1. Visit <http://tplinkrepeater.net>, and log in with the password you set for the extender.
2. Go to [Settings](#) > [System Tools](#) > [Backup & Restore](#).

➤ **To backup configuration settings:**

Click [Backup](#) to save a copy of the current settings to your local computer. A '.bin' file of the current settings will be stored on your computer.

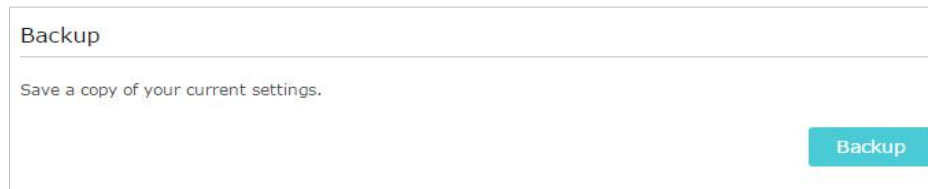

The screenshot shows a web interface titled "Backup". Below the title is a horizontal line, followed by the text "Save a copy of your current settings." In the bottom right corner, there is a teal button labeled "Backup".

➤ **To restore configuration settings:**

1. Click [Browse](#) to locate the backup configuration file stored on your computer, and click [Restore](#).

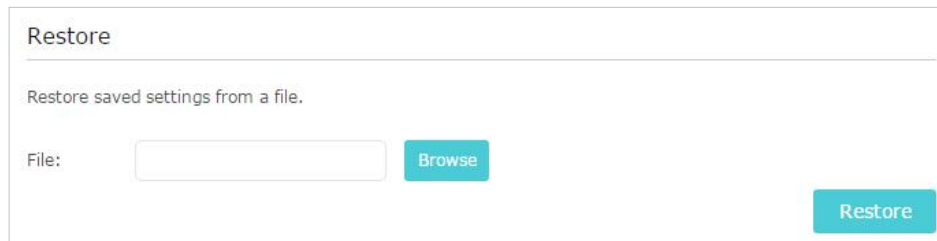

The screenshot shows a web interface titled "Restore". Below the title is a horizontal line, followed by the text "Restore saved settings from a file." Below this text, there is a label "File:" followed by an empty text input field and a teal button labeled "Browse". In the bottom right corner, there is a teal button labeled "Restore".

2. Wait a few minutes for the restore and reboot.

▀ **Note:** During the restore process, do not power off or reset the extender.

➤ **To reset the extender to factory default settings:**

1. Click [Factory Restore](#) to reset the extender.

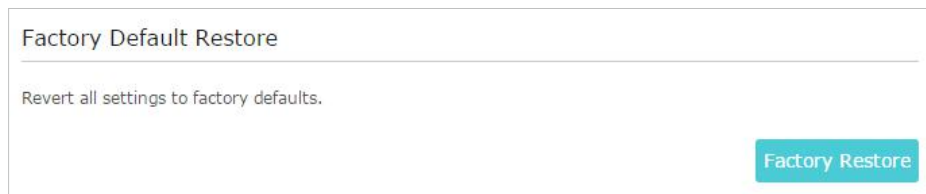

The screenshot shows a web interface titled "Factory Default Restore". Below the title is a horizontal line, followed by the text "Revert all settings to factory defaults." In the bottom right corner, there is a teal button labeled "Factory Restore".

2. Wait a few minutes for the reset and reboot.

▀ **Note:**

1. During the reset process, do not power off or reset the extender.
2. We strongly recommend you backup the current configuration settings before resetting the extender.

5.6. Change Admin Account

The account management feature allows you to change your login password of the web management page.

1. Visit <http://tplinkrepeater.net>, and log in with the password you set for the extender.
2. Go to [Settings > System Tools > Admin Account](#).

3. Enter the old password, then the new password twice (both case-sensitive) and click [Save](#).

Admin Account

Old Password:

New Password:

Low
Middle
High

Confirm Password:

4. Use the new password for future logins.

5.7. System Log

If the extender is not working normally, you can save the system log and send it to our technical support team.

1. Visit <http://tplinkrepeater.net>, and log in with the password you set for the extender.
 2. Go to [Settings](#) > [System Tools](#) > [System Log](#).
- **To save the system log locally:**
1. Choose the type and level of the system log as needed.
 2. Click [Save Log](#) to save the system logs to a local disk.

System Log

Log Filter: Type = Level =

ID	Time	Type	Level	Content
1	0 days 00:10:02	OTHERS	INFO	User cleared up all the logs.

FAQ

Q1. How to reset the extender to its factory default settings?

- With the extender powered on, use a pin to press the **RESET** button for 1 second. The extender will reboot.
- Log in to the extender's web management page. Go to **Settings > System Tools > Restore & Backup** and click **Factory Restore**.

Q2. What can I do if I forgot my login password?

Refer to FAQ > Q1 to reset the extender, and create a new password for future logins.

Note: The extender must be reconfigured after a reset to access internet. Please note down your new login password for future use.

Q3. What can I do if I forgot my wireless password?

The factory default wireless password is printed on the label of the extender.

If the password has been altered, please connect your computer to the extender using an Ethernet cable and follow the steps below:

1. Visit <http://tplinkrepeater.net>, and log in with the password you set for the extender.
2. Go to **Settings > Wireless > Wireless Settings** to retrieve or reset your wireless password.

Q4. What can I do if I cannot access the web management page?

This can happen for a variety of reasons. Please try the methods below to log in again.

- Make sure your computer is connected to the extended network.
- Make sure your computer is configured as **Obtain an IP address automatically** and **Obtain DNS server address automatically**.
- Use the IP address to access the extender. The default IP is **192.168.0.254**. If the extender is connected to the router, you should go to your router's DHCP client list to obtain the extender's current IP address.
- Reset the extender. Then connect your computer to its wireless network, enter <http://tplinkrepeater.net> or <http://192.168.0.254> in a web browser and press **Enter**.

Q5. I enabled wireless MAC filter, wireless access control, or access control list (ACL) on my router, what should I do to configure and use the extender?

When a device connects through the extender to your router, the MAC address of the device shown on the router is translated to another MAC address. If your router's MAC filter, wireless access control, or ACL is enabled, the devices connected to the extender cannot get an IP address from the extender and cannot access internet.

To solve this problem, please follow the steps below:

1. Log in to your router and disable the MAC filter, wireless access control or ACL.

■ **Note:** For more information about how to disable your router's MAC filter, wireless access control or ACL, please refer to your router's user guide.

2. Power on your extender, and run the [Quick Setup](#) to configure your extender.

3. Connect all of your devices to the extended network, and make sure the router's Link LED remains lit.

4. On your router, add all the Online Devices' MAC addresses to your router's MAC filter table.

5. Enable the router's MAC filter, wireless access control, or ACL to complete the configuration.

COPYRIGHT & TRADEMARKS

Specifications are subject to change without notice.  tp-link is a registered trademark of TP-Link Technologies Co., Ltd. Other brands and product names are trademarks or registered trademarks of their respective holders.

No part of the specifications may be reproduced in any form or by any means or used to make any derivative such as translation, transformation, or adaptation without permission from TP-Link Technologies Co., Ltd. Copyright © 2018 TP-Link Technologies Co., Ltd. All rights reserved.

FCC compliance information statement



Product Name: 300Mbps Wi-Fi Range Extender

Model Number: TL-WA850RE

Responsible Party:

TP-Link USA Corporation, d/b/a TP-Link North America, Inc.

Address: 145 South State College Blvd. Suite 400, Brea, CA 92821

Website: <http://www.tp-link.com/us/>

Tel: +1 626 333 0234

Fax: +1 909 527 6803

E-mail: sales.usa@tp-link.com

This equipment has been tested and found to comply with the limits for a Class B digital device, pursuant to part 15 of the FCC Rules. These limits are designed to provide reasonable protection against harmful interference in a residential installation. This equipment generates, uses and can radiate radio frequency energy and, if not installed and used in accordance with the instructions, may cause harmful interference to radio communications. However, there is no guarantee that interference will not occur in a particular installation. If this equipment does cause harmful interference to radio or television reception, which can be determined by turning the equipment off and on, the user is encouraged to try to correct the interference by one or more of the following measures:

- Reorient or relocate the receiving antenna.
- Increase the separation between the equipment and receiver.
- Connect the equipment into an outlet on a circuit different from that to which the receiver is connected.
- Consult the dealer or an experienced radio/ TV technician for help.

This device complies with part 15 of the FCC Rules. Operation is subject to the following two conditions:

1. This device may not cause harmful interference.
2. This device must accept any interference received, including interference that may cause undesired operation.

Any changes or modifications not expressly approved by the party responsible for compliance could void the user's authority to operate the equipment.

Note: The manufacturer is not responsible for any radio or TV interference caused by unauthorized modifications to this equipment. Such modifications could void the user's authority to operate the equipment.

FCC RF Radiation Exposure Statement:

This equipment complies with FCC RF radiation exposure limits set forth for an uncontrolled environment. This device and its antenna must not be co-located or operating in conjunction with any other antenna or transmitter.

"To comply with FCC RF exposure compliance requirements, this grant is applicable to only Mobile Configurations. The antennas used for this transmitter must be installed to provide a separation distance of at least 20 cm from all persons and must not be co-located or operating in conjunction with any other antenna or transmitter."

We, TP-Link USA Corporation, has determined that the equipment shown as above has been shown to comply with the applicable technical standards, FCC part 15. There is no unauthorized change is made in the equipment and the equipment is properly maintained and operated.

Issue Date: 2018-03-27

CE Mark Warning



This is a class B product. In a domestic environment, this product may cause radio interference, in which case the user may be required to take adequate measures.

OPERATING FREQUENCY (the maximum transmitted power)

2400 MHz -2483.5 MHz (20dBm)

EU Declaration of Conformity

TP-Link hereby declares that the device is in compliance with the essential requirements and other relevant provisions of directives 2014/53/EU, 2009/125/EC and 2011/65/EU.

The original EU declaration of conformity may be found at <http://www.tp-link.com/en/ce>

RF Exposure Information

This device meets the EU requirements (2014/53/EU Article 3.1a) on the limitation of exposure of the general public to electromagnetic fields by way of health protection.

The device complies with RF specifications when the device used at 20 cm from your body.

Canadian Compliance Statement

This device complies with Industry Canada license-exempt RSSs. Operation is subject to the following two conditions:

1. This device may not cause interference, and
2. This device must accept any interference, including interference that may cause undesired operation of the device.

Le présent appareil est conforme aux CNR d'Industrie Canada applicables aux appareils radio exempts de licence. L'exploitation est autorisée aux deux conditions suivantes :

1. l'appareil ne doit pas produire de brouillage;
2. l'utilisateur de l'appareil doit accepter tout brouillage radioélectrique subi, même si le brouillage est susceptible d'en compromettre le fonctionnement.

Radiation Exposure Statement:

This equipment complies with IC radiation exposure limits set forth for an uncontrolled environment. This equipment should be installed and operated with minimum distance 20cm between the radiator & your body.

Déclaration d'exposition aux radiations:

Cet équipement est conforme aux limites d'exposition aux rayonnements IC établies

pour un environnement non contrôlé. Cet équipement doit être installé et utilisé avec un minimum de 20 cm de distance entre la source de rayonnement et votre corps.

Industry Canada Statement

CAN ICES-3 (B)/NMB-3(B)

Korea Warning Statements

당해 무선설비는 운용중 전파혼신 가능성이 있음.

NCC Notice & BSMI Notice

注意！

依據 低功率電波輻射性電機管理辦法

第十二條 經型式認證合格之低功率射頻電機，非經許可，公司、商號或使用者均不得擅自變更頻率、加大功率或變更原設計之特性或功能。

第十四條 低功率射頻電機之使用不得影響飛航安全及干擾合法通行；經發現有干擾現象時，應立即停用，並改善至無干擾時方得繼續使用。前項合法通信，指依電信規定作業之無線電信。低功率射頻電機需忍受合法通信或工業、科學以及醫療用電波輻射性電機設備之干擾。

安全諮詢及注意事項

- 請使用原裝電源供應器或只能按照本產品注明的電源類型使用本產品。
- 清潔本產品之前請先拔掉電源線。請勿使用液體、噴霧清潔劑或濕布進行清潔。
- 注意防潮，請勿將水或其他液體潑灑到本產品上。
- 插槽與開口供通風使用，以確保本產品的操作可靠並防止過熱，請勿堵塞或覆蓋開口。
- 請勿將本產品置放於靠近熱源的地方。除非有正常的通風，否則不可放在密閉位置中。
- 請不要私自打開機殼，不要嘗試自行維修本產品，請由授權的專業人士進行此項工作。

限用物質含有情況標示聲明書

產品元件名稱	限用物質及其化學符號					
	鉛 Pb	鎘 Cd	汞 Hg	六價鉻 CrVI	多溴聯苯 PBB	多溴二苯醚 PBDE
PCB	○	○	○	○	○	○
外殼	○	○	○	○	○	○
電源供應板	-	○	○	○	○	○

備考1. "超出0.1 wt %" 及 "超出0.01 wt %" 系指限用物質之百分比含量超出百分比含量基準值。
備考2. "○"系指該項限用物質之百分比含量未超出百分比含量基準值。
備考3. " - " 系指該項限用物質為排除項目。



Продукт сертифіковано згідно с правилами системи УкрСЕПРО на відповідність вимогам нормативних документів та вимогам, що передбачені чинними законодавчими актами України.



Safety Information

- Keep the device away from water, fire, humidity or hot environments.
- Do not attempt to disassemble, repair, or modify the device.
- Do not use the device where wireless devices are not allowed.
- The socket-outlet shall be installed near the equipment and shall be easily accessible.

Please read and follow the above safety information when operating the device. We cannot guarantee that no accidents or damage will occur due to improper use of the device. Please use this product with care and operate at your own risk.

Explanations of the symbols on the product label

Symbol	Explanation
	Class II equipment
	AC voltage
	Indoor use only
	RECYCLING This product bears the selective sorting symbol for Waste electrical and electronic equipment (WEEE). This means that this product must be handled pursuant to European directive 2012/19/EU in order to be recycled or dismantled to minimize its impact on the environment. User has the choice to give his product to a competent recycling organization or to the retailer when he buys a new electrical or electronic equipment.
	Protection earth