

LawnMaster

Three-Program Electronic Sprinkler Timer

TORO

Model 53603

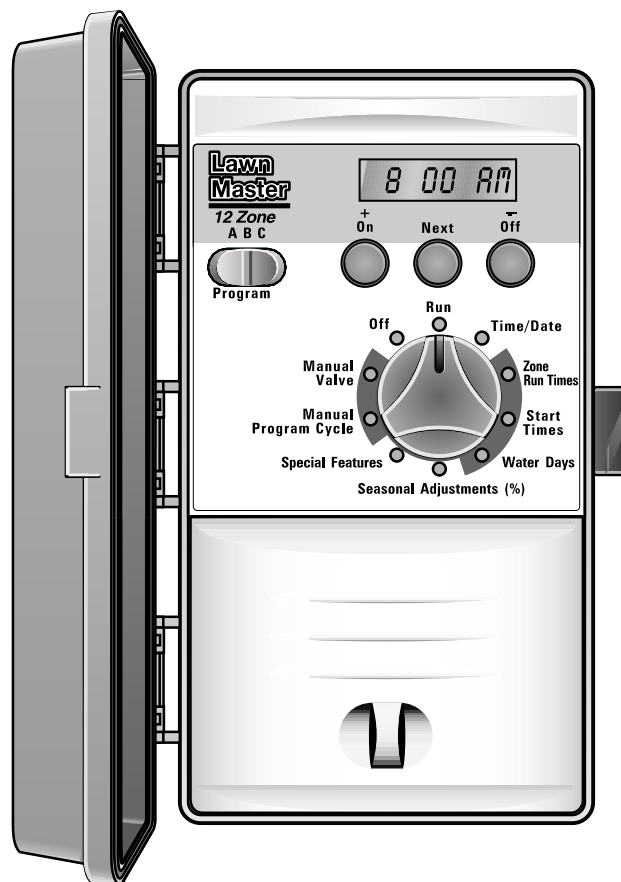

Owner's Manual

Español - P. 19
Français - P. 39

Table of Contents

I. Introduction	1
Sample Watering Plan	1
II. Installation	2-3
Mounting the Timer	2
Connecting Valves and Transformer	2
Connecting a Pump Start Relay	3
III. Dial Programming	4-9
Setting Time and Date	4
Setting Valve Run Time	5
Selecting Program Start Times	6
Canceling a Program Start Time	7
Selecting Days to Water	7-8
Run/Off Positions	9
IV. Manual Operation	10-11
Manual Program Cycle	10
Manual Valve	11
V. Other Dial Functions.	12-14
Seasonal Adjust	12
Program Review	13
Erase Program Information	13
Sensor Override	14
VI. Special Protection	15
VII. Troubleshooting	16
Warranty Information	17
FCC Information	18

I. Introduction: What is a Watering Cycle?

Each watering cycle opens and closes all the valves assigned to a program, in sequence, starting with the lowest valve number. For example, in the sample watering plan shown, program A has three start times which initiate three watering cycles. All four valves in the program water in sequence, three times each day, once at 7:00am, once at 5:00pm, and once at 11:00pm. This timer can be set to start three watering cycles per program. The three programs are all completely independent of each other, giving you the freedom to include any combination of valves in each program and the ability to select different watering days and start times for each program. After programming, write your watering plan in pencil on the back of the Quick Reference Card, located on the inside of the timer door. The REVIEW feature can be used to review your programmed watering plan. For the days you have selected in programs A, B and C, each programmed start time turns on every selected valve in sequence, from the lowest valve number to the highest valve number.

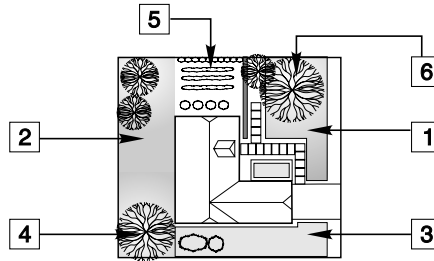

Sample Watering Plan

Program	Days	Water Start Times	Valves	Valve Run Time Duration
A	Su, Tu, Th, Fr	(#1) 7:00am	1, 2, 3, 5	10 minutes (1, 3, 5) 15 minutes (2)
		(#2) 5:00pm	Same as above	Same as above
		(#3) 11:00pm	Same as above	Same as above
B	Odd Days	(#1) 5:00am	5,6	10 minutes each (5,6)
C	Once every 10 days	(#1) 4:00am	4	1 Hour

Note: Each program (A, B and C) is simply a set of instructions that direct which valves to run for how long, on which days and at what time. If you need numerous start times or several schedules, you will need to use multiple programs. However, in some cases one program will be sufficient.

II. Installation

Selecting an Installation Site

Install the timer with the display at eye level. If you will be using a pump, the timer must be mounted at least 15 feet (4.5m) away from your pump start relay and pump. Do not plug the timer into any power circuit serving a refrigerator, a pump, an air conditioner, a garage door opener, a washer or dryer, or other high-powered equipment.

⚠ WARNING: This timer is designed for indoor installation only. Installing this timer outdoors will void the warranty and may result in an electric shock hazard.

Mounting the timer

1. Select an indoor location within 6 feet (1.8m) of an outlet to mount your timer. Do not use an outlet that is controlled by an On/Off switch. Mount with display at eye level.
2. Drive one #8 screw into wall leaving approximately 1/8" (3.2mm) exposed. Use a plastic anchor sleeve if wall is plaster board or masonry.
3. Mount the hanger kit to the top/back of the timer. Hang the timer on the mounting screw.
4. Drive two additional #8 screws through the holes at the bottom of the timer case into the wall to secure.

Note: To enable programming the timer prior to installation, connect a 9-volt Alkaline battery to the battery clip at this time. Refer to "Dial Programming" on page 4 for programming instructions.

⚠ Caution: Replace battery with the same or equivalent type. Dispose of used batteries as recommended by the battery manufacturer.

Connect the Valves & Transformer

⚠ WARNING: To avoid an electrical shock hazard, do not plug the transformer into the outlet until all wire connections to the timer have been completed. The timer operates on 24 V a.c. Do not attempt to connect the timer directly to the wall outlet. This will destroy the timer and may result in electrical shock or fire hazard.

Figure 1

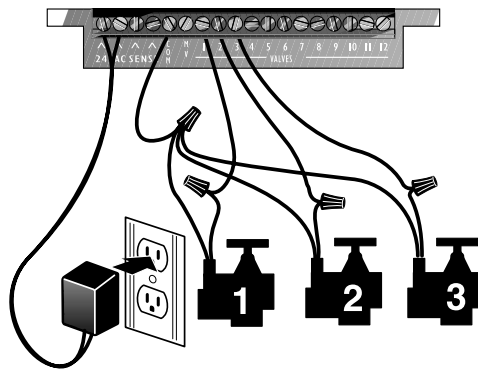

Note: Please use only single strand, color-coded irrigation wire for your installation.

1. Connect the wire from valve #1 to the terminal slot marked 1, connect the wire from valve #2 to the terminal slot #2 and so on until all valves are connected.
2. Connect the one common wire from the valves to the terminal marked "COM". (See **Figure 1**). Back the terminal screw out until head is 1/8" (3.2mm) above plastic partition. Expose approximately 1/2" (13mm) of bare copper from the end of the wire to reduce short circuiting of two adjacent wires. Slip wire through hole under screw and tighten screw until wire is secure.
3. Connect the transformer wires to the two screws marked 24 VAC.

⚠ Caution: Wire only one valve to each terminal screw. Wiring more than one valve per terminal may result in damage to the timer. Do not use valves that exceed 0.25 amps maximum output holding current. Also, if using more than one timer, do not share common wires. Run a separate common wire for each timer.

Connecting a Pump Start Relay

Note: When a pump is to be operated by the timer, a pump start relay must be used and should be set up by an electrician. The relay coil should be connected to the master valve output terminal marked MV and the common terminal COM at the timer. The relay contacts will be connected to the pump start terminals and must be rated for use with your particular pump. (See **Figure 2**). In addition, a high pressure relief mechanism is recommended. See your pump dealer for more information.

⚠ Caution: The timer must be mounted at least 15 feet (4.5m) away from both the pump start relay and the pump. Do not drive the pump directly from the timer. The relay coil must be rated for 24 V a.c. at 250 mA (maximum).

Note: When all connections have been completed, install the front access cover and plug the timer transformer into the wall outlet.

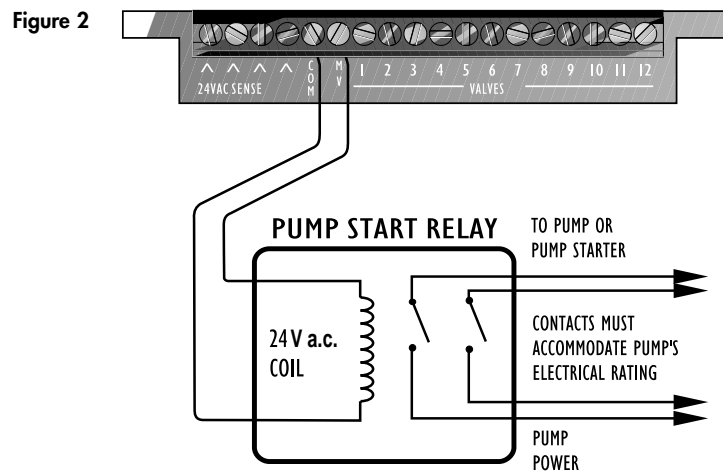

III. Dial Programming

Use the dial to set all elements of your program or to simply review and update existing information.

Setting Time and Date

1. Set the dial to the **Time/Date** position.
2. **Time:** The hour will flash. Use the **+** and **-** buttons to change the hour shown on the display. Press the **Next** button and the Minutes will flash. Press the **+** or **-** button to change the minutes shown on the display. Press the **Next** button and AM/PM will flash. Press either the **+** or **-** button to change AM/PM.
3. **Month:** Press the **Next** button to set the month. Use the **+** and **-** buttons to change the month.
4. **Date:** Press the **Next** button to set the date. Use the **+** and **-** buttons to change the date.
5. **Year:** Press the **Next** button to set the year. Use the **+** and **-** buttons to change the year.

Return dial to **Run** position.

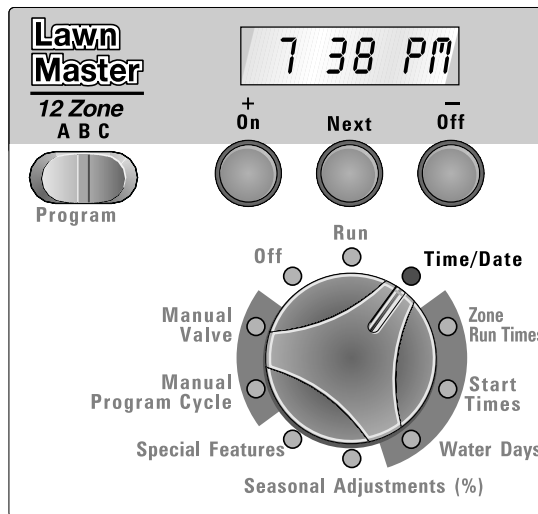

Setting Valve Run Times

Follow the steps below to program how long each valve will water.

1. Set the dial to the **Zone Run Time** position.
2. Select program **A**, **B**, or **C**.
3. The display will indicate the valve number and then the run time for that valve.
4. Use the **+** and **-** buttons to change the time shown on the display.
5. Press the **Next** button to advance to the next valve.
6. Repeat steps 4 and 5 for each valve.
7. You may set the water duration for each zone from one minute to 9 hours and 59 minutes.
8. Set the watering time to under 1 minute or over 9 hours and 59 minutes to set the valve in OFF mode.

Return dial to **Run** position.

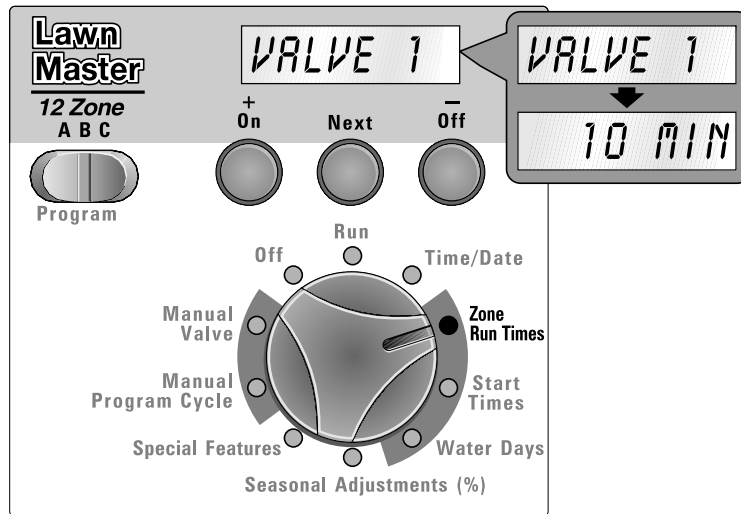

Master Valve/Pump Start

A master valve or pump start is sometimes used in systems. When the master valve is on, the timer provides constant output to that terminal when any valves are on. This feature allows a pump to draw water from a well or other source, or opens the master valve whenever watering occurs. The practice of using a pump is common in some areas and rare in others. (If you do not have a pump start or master valve installed, you will not need this feature.)

The Lawn Master allows you to operate a master valve or pump start in each program.

1. To select your master valve option ON, set the dial to **Zone Run Time**.
2. Press the **Next** button until Master is displayed (after the last valve).
3. Press the **+** button to turn the master valve ON.
4. Press the **-** button to turn the master valve OFF.



Selecting Program Start Times

This sets the time of the day you wish to water. Each program has three start times available.

1. Set the dial to the **Start Time** position. The display will flash "**START A1**, **START B1**, or **START C1**" depending on the position of the program select switch, and then show the start time programmed. If there is no start time entered, **OFF** will be displayed.
2. Select program **A**, **B**, or **C**.
3. Use the **+** and **-** buttons to change the start time.
4. Press the **Next** button to select the next start time.
5. Repeat steps 3 and 4 for subsequent start times, when watering is needed more than one time per day.
6. If a start time is not required, set the start time to between 11:59 p.m. and 12:00 a.m. to set a start time to **OFF**. Return dial to **Run** position.

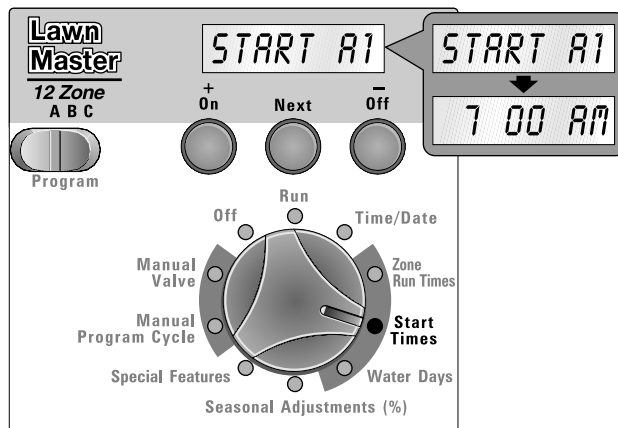

Canceling a Program Start Time

1. With the dial set to the **START TIME** position, use the **+** and **-** buttons to set the start time to **OFF**, (which is between 11:59 p.m. and 12:00 a.m.).
2. If a program has all three start times turned off, then that program is Off. (All other program details are retained). Because there are no start times, there will be no watering with that program. This is a convenient way to stop one program without turning the dial to the **OFF** position in case you need the other program(s) to water.

Selecting Days to Water

This sets the days of the week you wish to water.

1. Set the dial to **Water Days**.
2. Select program **A**, **B**, or **C**.

There are four different options: odd days, even days, skip days, or specific days of the week.

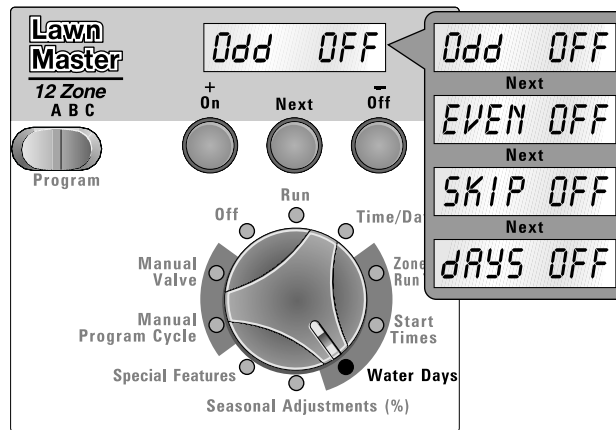

Selecting Odd or Even Days

This option will water only odd days or even days of the month.

3. Press the **+** button to select or the **-** button to cancel **Odd Days**.
4. Press the **Next** button to go to **Even Days**.
5. Press the **+** button to select or the **-** button to cancel **Even Days**.

Note: The 31st of any month and the 29th of February of a leap year, are always treated as Off days in Odd Days watering.

Selecting Skip Days

This option allows you to select an interval from 1 to 30 days between watering days.

6. Press the **Next** button to go to **Skip Days**.
7. Press the **+** or **-** button to select the number of days to skip before each watering day.

Selecting Specific Days of the Week

This option allows you to water on specific days of the week, e.g. MON, WED and FRI.

8. Press the **Next** button to advance to the day of the week option.
9. Press the **+** button to activate specific days **ON**, then use the **Next** button to sequence through the individual days. Press the **+** button to turn on a particular day of the week to water. Press the **-** button to turn watering off that day.
10. Press the **Next** button to advance to the next day of the week.
11. Repeat steps **9** and **10** until all desired days have been selected.

Return dial to **Run** position.

Run

Set the dial to the **Run** position to enable automatic watering of all programmed schedules.

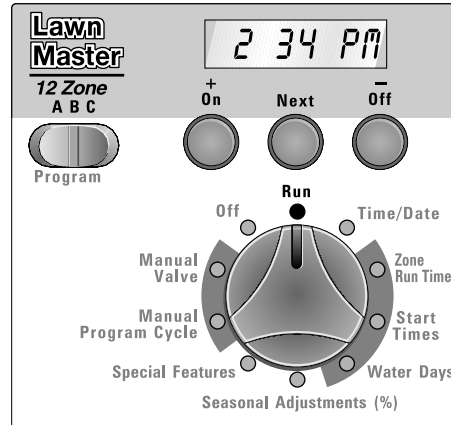

Off

Use this dial position to turn off watering, such as when it is raining or you don't want watering. As long as the dial is in the **Off** position, watering programs will not be activated automatically. This position is also used to terminate any running programs whether manual or automatic (allow 3 seconds to turn off). For immediate shut down, turn to **Off** and push the - button.

1. Set the dial to the **Off** position.
2. To return timer to normal Automatic operation, simply return dial to **Run** position.

⚠ Caution: In warm weather you may experience landscape damage if the dial is left unintentionally in the **Off** position for extended periods of time. Always return the dial to **Run** position if automatic operation is desired.

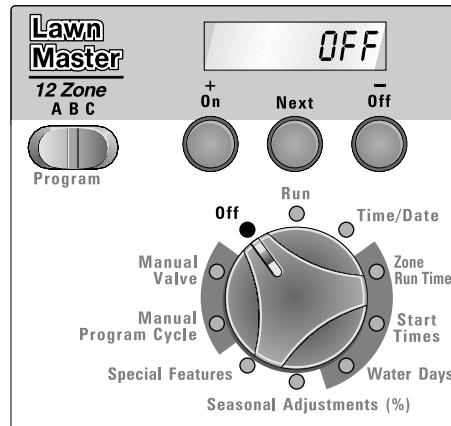

IV. Manual Operation

Manual Program Cycle

Use this feature to manually start your normal program cycle at any time. Each valve's run time will be operated for the program selected. For example, this can be used to start a program an extra time on a particularly hot day.

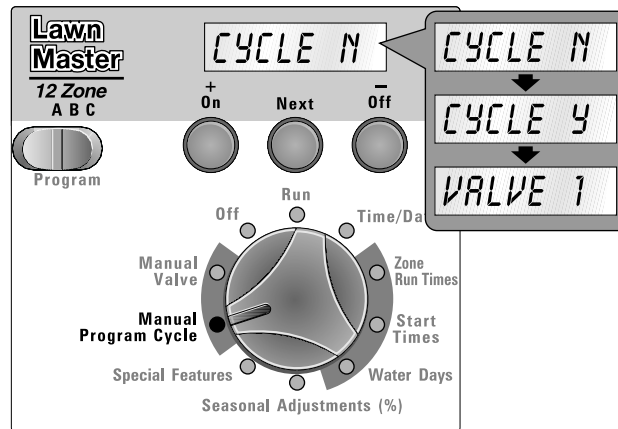

1. Set the dial to the **Manual Program Cycle** position.
2. Select program **A**, **B**, or **C**.
3. Press the **+** button to select **Manual Program Cycle** watering.
4. Press the **Next** button until the desired starting valve is displayed. That valve and all subsequent valves in the selected program will water in sequence.
5. Turn the dial to **Run** position. The timer will complete the manual watering cycle and then revert to automatic operation.
6. The display will periodically show the valve number and will count down the run time for each active valve.
7. If desired, you may turn the dial to the **Off** position for longer than three seconds to discontinue manual watering. Always return dial to the **Run** position to enable automatic watering.

Manual Valve

Use this feature to start one or more valves, watering sequentially, for a selected period of time.

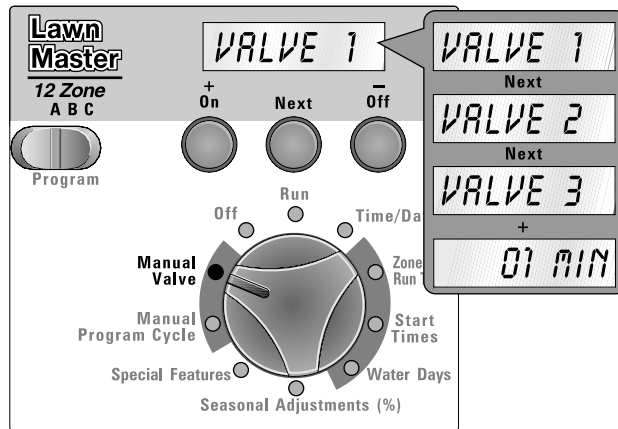

1. Set the dial to the **Manual Valve** position.
2. Valve 1 will show on the display. You may use **+** and **-** buttons to select the amount of time for valve 1 to water or you may skip to the next valve by pressing the **Next** button.
3. Select the valves to water and their watering duration by repeating Step 2 for the remaining valves.
4. If using a master valve or pump, press the **Next** button until **MASTER** is displayed (after last valve). Press the **+** button. This opens the master valve while the other valves are watering.
5. Set the dial to the **Run** position. Valves will water sequentially for the set time with the operating valve scrolling on the display periodically during its manual watering operation.
6. If desired, you may turn the dial to **Off** position for longer than three seconds to discontinue the manual valve operation. Always return dial to **Run** position to enable automatic watering.

V. Other Dial Functions

Seasonal Adjustment(%)

Use this dial position for simple seasonal adjustment of all your valve's watering durations. When weather conditions return to normal this adjustment can be returned to normal (100%). A setting of less than 100% results in less watering. A setting of more than 100% results in more watering. 00% turns the timer to OFF.

Example:

Program	Normal	Seasonal Adjustment
	(%Adj) Time (Valve 1)	(%Adj) Time (Valve 1)
A	100% 10 min.	50% 5 min.
B	100% 10 min.	170% 17 min.
C	100% 10 min.	200% 20 min.

1. Select **PROGRAM A, B, or C**.
2. Set the dial to **Seasonal Adjustments (%)**. This indicates all valves will water at a particular % of their programmed watering duration.
3. Use the **+** and **-** buttons to adjust the % value. The display will show selected % value.
4. After adjusting the % return the dial to **Run** position.

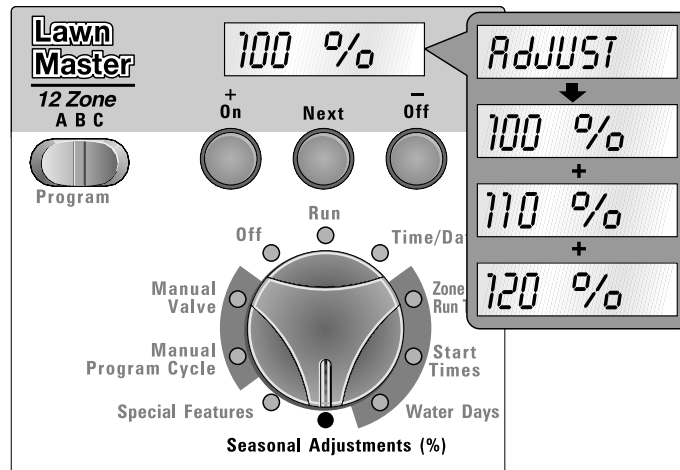

Special Features

This position has three functions. In this position, you may **Erase** all programmed information, **Review** all Programmed information, or activate a Rain **Sensor**.

Program Review

You can review the contents of programs **A**, **B**, and **C** by setting the dial to the **Special Features** position. The display will show "Review". Pressing the **+** button will begin the program review. The display will scroll through the contents of the selected program. The items displayed include the seasonal adjustment %, the start times selected, the valves selected, the valve run times, and the active watering days. By moving the program selector switch, each program can be reviewed in turn. You can press and hold the **+** button to speed up the review and the **-** button to slow down the review.

Erase Program Information

Use this to erase program information.

Note: When new from the factory, a default program has been installed in program **A** to water all valves for 10 minutes every day at 4:00 a.m.

1. Set the dial to **Special Features**.
2. Select Program **A**, **B**, or **C** using the program selection switch.
3. Press the **Next** button until **Erase** is displayed.
4. Press the **+** button and display will show **Confirm**.
5. Press the **+** button again, and the display will show **Done**.
6. The program is completely blank, allowing you to program Lawn Master using the instructions on the previous pages.

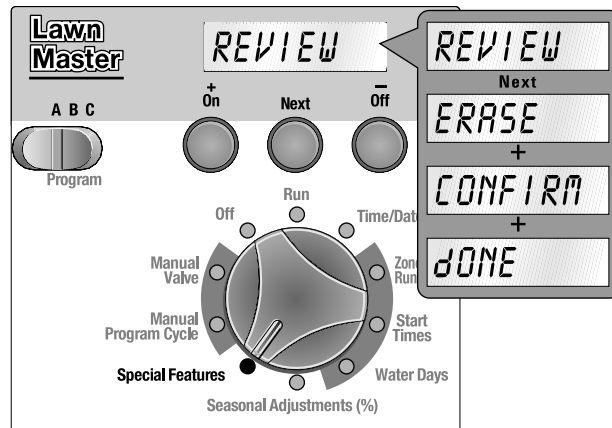

Sensor Override

Rain switches or moisture sensors are often used in automatic irrigation systems to prevent automatic watering during rainy or wet conditions. This timer provides convenient sensor hook-up terminals and a sensor override or bypass option. The override option (OFF) lets you bypass the sensor for testing. If you are not using a sensor, the sensor setting should be Sensor N for Off.

Setting Sensor Option

1. Set the dial to **Special Features** position.
2. Press the **Next** button twice. The display will show Sensor N.
3. Press the **+** button to activate the rain sensor. Once installed and activated, the rain sensor will override your programs and prevent watering during rainy days. The display will show Sensor Y if the sensor is to be enabled. A flashing "**SENSOR Y**" will appear on the display if the rain sensor was triggered and a watering cycle was cancelled. This display disappears at midnight, until the next time it is triggered.

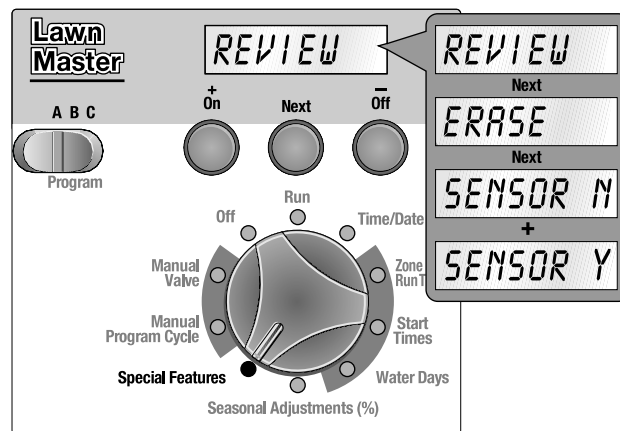

VI. Special Protection

Lawn Master has been designed to ensure operation of the timer in the event of unexpected electrical disturbances, power loss or valve failure.

Memory Protection

Your programs are stored in a unique electronic device called "Non-Volatile Memory." This protects your programs from being lost when electrical power is interrupted for up to 10 years, even without having a battery connected. However, if power is lost and there is no battery connected, you will have to reprogram the date and time once power resumes.

Circuit Protection

Lawn Master electronics are protected from electrical disturbances such as large transient voltages and static discharge.

Electronic Fuse

Lawn Master is protected with an electronic circuit breaker. If the timer's electronics detect a short circuit at one of the valves, that valve will be shut off automatically, and the display will show "**SHORT.**" However the timer will continue running the remaining valves as programmed so that you do not lose all of your watering. You only miss watering on the one valve that has the short. Once you have repaired the valve, set the dial to the **Run** position, and the timer will be ready to enable automatic execution of all selected programmed schedules once again.

VII. Troubleshooting

Problem	Correction
1. All valves do not turn on automatically	<ol style="list-style-type: none">1. Verify program. Use Special Features Review option.2. Check valve common wire for proper hook-up.3. Check for shorted valve, refer to Special Protection Section V, "Electronic Fuse".4. Check RAIN SENSOR status; refer to Sensor Override, set to Off.5. Check to see if Seasonal Adjustment (%) is set to 00%.6. Verify that transformer is plugged in.
2. Cannot Program	<ol style="list-style-type: none">1. Remove battery (check voltage). Disconnect power to timer for 1 min.2. Reconnect power and reprogram. Reconnect good 9 volt alkaline battery.
3. Timer Skips a Cycle	<ol style="list-style-type: none">1. Verify start times, valve run times and water days.
4. No Displays	<ol style="list-style-type: none">1. Remove battery (check voltage). Disconnect power to timer for 1 min.2. Reconnect power and reprogram. Reconnect good 9 volt alkaline battery.
5. Valve stays on	<ol style="list-style-type: none">1. Verify valve run times.2. Disconnect valve; check for manual bleed closure.3. Disconnect wire to valve. If still on, valve is bad.4. Check for manual mode; place timer in OFF Position.5. Check solenoids for obstructions or wiring shorts.6. Check valve for rocks or other obstructions, or torn or damaged diaphragm.7. Unplug transformer from wall outlet.
6. Valve will not turn on	<ol style="list-style-type: none">1. Verify start times, valve run times and water days.2. Make sure dial is not in OFF Position.3. Verify program, refer to Special Features Review Option.4. Make sure common wire and valve wire are connected.5. Check solenoid and valve bleed tube.6. Check for shorted valve, refer to Special Protection, Section V, "Electronic Fuse".7. Check RAIN SENSOR status; refer to Sensor Override, set to Off.
7. Timer Displays SHORT	<ol style="list-style-type: none">1. Note valve number flashing.2. Examine wiring connections for breaks or bad connections. Repair and reconnect.3. Examine solenoid for shorted connections. Repair and reconnect.4. Make sure solenoid rating does not exceed capacity of timer.5. To reset, turn dial to Run.
8. Timer Displays SENSOR	<p>This means that your rain switch sensor was triggered. If your sensor is enabled, make sure you have a sensor hooked up.</p>
9. Timer Displays SHORT with no valve	<ol style="list-style-type: none">1. You have experienced a power glitch.2. You have exceeded the 24 VA max. load of the timer.3. Clear this display by turning the dial.

The Toro Promise - Limited One-Year Warranty

The Toro Company and its affiliate, Toro Warranty Company, pursuant to an agreement between them, jointly warrants, to the owner, against defects in material and workmanship for a period of one year from the date of purchase.

Neither The Toro Company nor Toro Warranty Company is liable for failure of products not manufactured by it even though such products may be sold or used in conjunction with Toro products.

During such warranty period, we will repair or replace, at our option, any part found to be defective.

Return the defective parts to the place of purchase.

Our liability is limited solely to the replacement or repair of defective parts. There are no other express warranties.

This warranty does not apply where equipment is used, or installation is performed, in any manner contrary to Toro's specifications and instructions, nor where equipment is altered or modified.

NEITHER THE TORO COMPANY NOR TORO WARRANTY COMPANY IS LIABLE FOR INDIRECT, INCIDENTAL OR CONSEQUENTIAL DAMAGES IN CONNECTION WITH THE USE OF EQUIPMENT, INCLUDING BUT NOT LIMITED TO: VEGETATION LOSS, THE COST OF SUBSTITUTE EQUIPMENT OR SERVICES REQUIRED DURING PERIODS OF MALFUNCTION OR RESULTING NON-USE, PROPERTY DAMAGE OR PERSONAL INJURY RESULTING FROM INSTALLER'S NEGLIGENCE.

Some states do not allow the exclusion or limitation of incidental or consequential damages, so the above limitation or exclusion may not apply to you.

ALL IMPLIED WARRANTIES, INCLUDING THOSE OF MERCHANTABILITY AND FITNESS FOR USE, ARE LIMITED TO THE DURATION OF THIS EXPRESS WARRANTY.

Some states do not allow limitations of how long an implied warranty lasts, so the above limitation may not apply to you.

This warranty gives you specific legal rights and you may have other rights which vary from state to state.

Electromagnetic Compatibility

This equipment has been tested and found to comply with the limits for a Class B digital device, pursuant to Part 15 of the FCC Rules. These limits are designed to provide reasonable protection against harmful interference in a residential installation. This equipment generates, uses and can radiate radio frequency energy and, if not installed and used in accordance with the instructions, may cause harmful interference to radio communications. However, there is no guarantee that interference will not occur in a particular installation. If this equipment does cause harmful interference to radio or television reception, which can be determined by turning the equipment off and on, the user is encouraged to try to correct the interference by one or more of the following measures:

- Reorient or relocate the receiving antenna.
- Increase the separation between the equipment and receiver.
- Connect the equipment into an outlet on a circuit different from that to which the receiver is connected.
- Consult the dealer or an experienced radio/TV technician for help.

This equipment has been verified to comply with the limits for a Class B computing device, pursuant to FCC rules. In order to maintain compliance with FCC regulations, shielded cables must be used with this equipment. Operation with non-approved equipment or unshielded cables is likely to result in interference to radio and TV reception. The user is cautioned that changes and modifications made to the equipment without the approval of manufacturer could void the user's authority to operate this equipment.

International: This equipment complies with CISPR 22 Class B.