

# TOSHIBA

Leading Innovation >>>

## Integrated High Definition LCD Television User's Guide:

32C120U

40E220U

If you need assistance:

Toshiba's Support Web site [support.toshiba.com](http://support.toshiba.com)

Call Toshiba Customer Support Center:

Within the United States at (800) 631-3811

Outside the United States at (949) 583-3050

For more information, see “Troubleshooting” on page 112 in this guide.

### Owner's Record

The model number and serial number are on the back and side of your TV.

Record these numbers in the spaces below. Refer to these numbers whenever you communicate with your Toshiba dealer about this TV.

[support.toshiba.com](http://support.toshiba.com)

Model number: \_\_\_\_\_

Serial number: \_\_\_\_\_

Note: To display a High Definition picture, the TV must be receiving a High Definition signal (such as an over-the-air High Definition TV broadcast, a High Definition digital cable program, or a High Definition digital satellite program). For details, contact your TV antenna installer, cable provider, or satellite provider

GMA300011011  
12/11

## Dear Customer,

Thank you for purchasing this Toshiba LCD TV. This manual will help you use the many exciting features of your new LCD TV. Before operating your LCD TV, carefully read this manual completely.

### Safety Precautions

**WARNING: TO REDUCE THE RISK OF FIRE OR ELECTRIC SHOCK, DO NOT EXPOSE THIS APPLIANCE TO RAIN OR MOISTURE.**



**WARNING: TO REDUCE THE RISK OF ELECTRIC SHOCK, DO NOT REMOVE COVER (OR BACK). NO USER-SERVICEABLE PARTS INSIDE. REFER SERVICING TO QUALIFIED SERVICE PERSONNEL.**



The lightning flash with arrowhead symbol, within an equilateral triangle, is intended to alert the user to the presence of uninsulated "dangerous voltage" within the product's enclosure that may be of sufficient magnitude to constitute a risk of electric shock to persons.



The exclamation point within an equilateral triangle is intended to alert the user to the presence of important operating and maintenance (servicing) instructions in the literature accompanying the appliance.

### WARNING

To prevent injury, this apparatus must be securely attached to the floor/wall in accordance with the installation instructions. See item 26) on page 4.

**WARNING:** If you decide to wall mount this television, always use a mounting bracket that has been Listed by an independent laboratory (such as UL, CSA, ETL) and is appropriate for the size and weight of this television. The use of inappropriate or non-Listed mounting brackets could result in serious bodily injury and/or property damage. See "To Display your LCD TV using a Wall Bracket:" on page 5.

### NOTE TO CATV INSTALLERS

This is a reminder to call the CATV system installer's attention to Article 820-40 of the U.S. NEC, which provides guidelines for proper grounding and, in particular, specifies that the cable ground shall be connected to the grounding system of the building, as close to the point of cable entry as practical. For additional antenna grounding information, see 33) and 34) on page 4.

## CHILD SAFETY:

It Makes A Difference How and Where You Use Your Flat Panel Display

**Congratulations on your purchase! As you enjoy your new product, please keep these safety tips in mind:**

### The Issue

The home theater entertainment experience is a growing trend and larger flat panel displays are popular purchases. However, flat panel displays are not always supported on the proper stands or installed according to the manufacturer's recommendations.

- Flat panel displays that are inappropriately situated on dressers, bookcases, shelves, desks, speakers, chests or carts may fall over and cause injury.



### TOSHIBA Cares!

- The consumer electronics industry is committed to making home entertainment enjoyable and safe.

### Tune Into Safety

- One size does NOT fit all. Follow the manufacturer's recommendations for the safe installation and use of your flat panel display.
- Carefully read and understand all enclosed instructions for proper use of this product.
- Don't allow children to climb on or play with furniture and television sets.
- Don't place flat panel displays on furniture that can easily be used as steps, such as a chest of drawers.
- Remember that children can become excited while watching a program, especially on a "larger than life" flat panel display. Care should be taken to place or install the display where it cannot be pushed, pulled over, or knocked down.
- Care should be taken to route all cords and cables connected to the flat panel display so that they cannot be pulled or grabbed by curious children.



### Wall Mounting: If you decide to wall mount your flat panel display, always:

- Use a mount that has been recommended by the display manufacturer and/or listed by an independent laboratory (such as UL, CSA, ETL).
- Follow all instructions supplied by the display and wall mount manufacturers.
- If you have any doubts about your ability to safely install your flat panel display, contact your retailer about professional installation.
- Make sure that the wall where you are mounting the display is appropriate. Some wall mounts are not designed to be mounted to walls with steel studs or old cinder block construction. If you are unsure, contact a professional installer.
- A minimum of two people are required for installation. Flat panel displays can be heavy.



www.CE.org/safety

## Important Safety Instructions

- 1) **Read these instructions.**
  - 2) **Keep these instructions.**
  - 3) **Heed all warnings.**
  - 4) **Follow all instructions.**
- 
- 5) **Do not use this apparatus near water.**
- 
- 6) **Clean only with dry cloth.**
- 
- 7) **Do not block any ventilation openings.** Install in accordance with the manufacturer's instructions.
- 
- 8) **Do not install near any heat sources** such as radiators, heat registers, stoves, or other products (including amplifiers) that produce heat.
- 
- 9) **Do not defeat the safety purpose of the polarized or grounding type plug.** A polarized plug has two blades with one wider than the other. A grounding type plug has two blades and a third grounding prong. The wide blade or the third prong are provided for your safety. If the provided plug does not fit into your outlet, consult an electrician for replacement of the obsolete outlet.
 

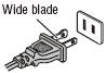

Wide blade
- 
- 10) **Protect the power cord** from being walked on or pinched, particularly at plugs, convenience receptacles, and the point where it exits from the apparatus.
- 
- 11) **Only use attachments/accessories specified by the manufacturer.**
- 
- 12) **Use only with the cart, stand, tripod, bracket, or table specified by the manufacturer, or sold with the apparatus.** When a cart is used, use caution when moving the cart/product combination to avoid injury from tip-over.
 

- 
- 13) **Unplug this apparatus during lightning storms or when unused for long periods of time.**
- 
- 14) **Refer all servicing to qualified service personnel.** Servicing is required when the apparatus has been damaged in any way, such as power-supply cord or plug is damaged, liquid has been spilled or objects have fallen into the apparatus, the apparatus has been exposed to rain or moisture, does not operate normally, or has been dropped.

## Additional Safety Precautions

- 14a) **CAUTION:** If the TV is dropped and the cabinet or enclosure surface has been damaged or the TV does not operate normally, take the following precautions:
  - ALWAYS turn off the TV and unplug the power cord to avoid possible electric shock or fire.
  - NEVER allow your body to come in contact with any broken glass or liquid from the damaged television. The LCD panel inside the TV contains

glass and a toxic liquid. If the liquid comes in contact with your mouth or eyes, or your skin is cut by broken glass, rinse the affected area thoroughly with water and contact your doctor immediately.

- ALWAYS contact a service technician to inspect the TV any time it has been damaged or dropped.

### 15) CAUTION:

- To reduce the risk of electric shock, do not use the polarized plug with an extension cord, receptacle, or other outlet unless the blades can be inserted completely to prevent blade exposure.
- To prevent electric shock, match wide blade of plug to wide slot; fully insert.

### 16) CAUTION:

Do not let children swallow any small parts included on or with the product or play with the plastic bag. Keep the small parts and the plastic bag out of the reach of children.

### 17) CAUTION:

Do not let water or other liquids come into contact with the product, as it may result in damage.

### 18) WARNING:

- To prevent the spread of fire, keep candles or other open flames away from this product at all times.
- Keep the product away from direct sunlight, fire or a heat source such as a heater. This may reduce the product lifetime or result in fire.

## Installation, Care, and Service

### Installation

Follow these recommendations and precautions and heed all warnings when installing your TV:

- 19)  **WARNING: NEVER expose the batteries to excessive heat such as sunshine, fire, or the like.**
- 
- 20) ALWAYS plug the product into an outlet that is located in such a manner that it can be easily unplugged in case the product requires service.
- 
- 21) NEVER route the product's power cord inside a wall or similar enclosed area.
- 
- 22) Never modify this equipment. Changes or modifications may void: a) the warranty, and b) the user's authority to operate this equipment under the rules of the Federal Communications Commission.
- 
- 23)  **DANGER: RISK OF SERIOUS PERSONAL INJURY, DEATH, OR EQUIPMENT DAMAGE!**



Never place the TV on an unstable cart, stand, or table. The TV may fall, causing serious personal injury, death, or serious damage to the TV.

- 24) When selecting a location for the TV,
- NEVER allow any part of the TV to hang over the edge of the supporting furniture,
  - NEVER place the TV on tall furniture (for example, entertainment centers or bookcases) without anchoring both the furniture and the TV to a suitable support,
  - Never place cloth or other material between the TV and the supporting furniture,
  - NEVER allow children to climb on the TV.
- 25) To avoid damage to this product, never place or store the TV in direct sunlight; hot, humid areas; or areas subject to excessive dust or vibration.
- 26) Always place the TV on the floor or a sturdy, level, stable surface that can support the weight of the unit. To secure the TV, use a sturdy strap from the hook(s) on the rear of the TV to a wall stud, pillar, or other immovable structure. Make sure the strap is tight, secure, and parallel to the floor.

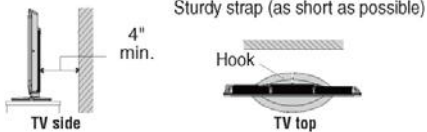

- 27) The apparatus shall not be exposed to dripping or splashing, and that no objects filled with liquids, such as vases, shall be placed on the apparatus.
- 28) Never block or cover the slots or openings in the TV cabinet back, bottom, and sides. Never place the TV:
- on a bed, sofa, rug, or similar surface;
  - too close to drapes, curtains, or walls; or
  - in a confined space such as a bookcase, built-in cabinet, or any other place with poor ventilation.
- 29) Always leave a space of at least 4 (four) inches around the TV. The slots and openings are provided to protect the TV from overheating and to help maintain reliable operation of the TV.
- 30) Never allow anything to rest on or roll over the power cord, and never place the TV where the power cord is subject to wear or abuse.
- 31) Never overload wall outlets and extension cords.
- 32) Always operate this equipment from a 120 VAC, 60HZ power source.
- 33) Always make sure the antenna system is properly grounded to provide adequate protection against voltage surges and built-up static charges (see Section 810 of the National Electric Code).

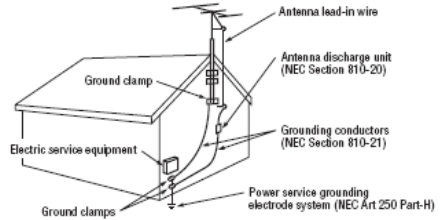

34)



**DANGER: RISK OF SERIOUS PERSONAL INJURY OR DEATH!**

- Use extreme care to make sure you are never in a position where your body (or any item you are in contact with, such as a ladder or screwdriver) can accidentally touch overhead power lines. Never locate the antenna near overhead power lines or other electrical circuits.
- Never attempt to install any of the following during lightning activity: a) an antenna system; or b) cables, wires, or any home theater component connected to an antenna or phone system.

**Care**

For better performance and safer operation of your TOSHIBA TV, follow these recommendations and precautions:

- 35) If you use the TV in a room whose temperature is 32° F (0° C) or below, the picture brightness may vary until the LCD warms up. This is not a sign of malfunction.
- 36) When cleaning:
- Always unplug the TV before cleaning. Gently wipe the display panel surface (the TV screen) using a dry, soft cloth (cotton, flannel, etc.). A hard cloth may damage the surface of the panel. Avoid contact with alcohol, thinner, benzene, acidic or alkaline solvent cleaners, abrasive cleaners, or chemical cloths, which may damage the surface. Never spray volatile compounds such as insecticide on the cabinet. Such products may damage or discolor the cabinet.
  - Never use using chemicals (such as air refreshers, cleaning agents, etc.) on or near the TV pedestal. Studies indicate that plastics may weaken and crack over time from the combination effects of chemical agents and mechanical stress (such as weight of TV). Failure to follow these instructions could result in serious injury and/or permanent damage to TV and TV pedestal.

37)



**WARNING: RISK OF ELECTRIC SHOCK!**



Never spill liquids or push objects of any kind into the TV cabinet slots.

- 38) During a lightning storm, do not touch the connecting cables or product.
- 39) For added protection of your TV from lightning and power surges, always unplug the power cord and disconnect the antenna from the TV if you leave the TV unattended or unused for long periods of time.
- 40) Always unplug the TV to completely disconnect from mains power. When the TV is turned off using the on/off switch, it is not completely disconnected from power and a minute amount of current is still consumed.
- 41) During normal use, the TV may make occasional snapping or popping sounds. This is normal, especially when the unit is being turned on or off. If these sounds become frequent or continuous, unplug the power cord and contact a Toshiba Authorized Service Provider.

42)  **WARNING: RISK OF SERIOUS PERSONAL INJURY OR EQUIPMENT DAMAGE!**

Never strike the screen with a sharp or heavy object.

- 43) • The LCD screen of this product can be damaged by ultraviolet radiation from the sun. When selecting a location for the television, avoid locations where the screen may be exposed to direct sunlight, such as in front of a window.
- Never touch, press, or place anything on the LCD screen. These actions will damage the LCD screen. If you need to clean the LCD screen, follow the instructions in item 36), on page 4.

## Service

44)

 **WARNING: RISK OF ELECTRIC SHOCK!** 

Never attempt to service the TV yourself. Opening and removing the covers may expose you to dangerous voltage or other hazards. Failure to follow this WARNING may result in death or serious injury. Refer all servicing not specified in this manual to a Toshiba Authorized Service Provider.

- 45) If you have the TV serviced:
- Ask the service technician to use only replacement parts specified by the manufacturer.
  - Upon completion of service, ask the service technician to perform routine safety checks to determine that the TV is in safe operating condition.
- 46) The cold cathode fluorescent lamp inside the LCD panel contains a small amount of mercury. When the TV reaches the end of its useful life, dispose of the used TV by the approved method for your area, or ask a qualified service technician to properly dispose of the TV.



**Note:** The lamp(s) inside this product contain mercury. Disposal may be regulated due to environmental considerations. For disposal or recycling information, contact your local authorities or the Electronics Industries Alliance ([www.eiae.org](http://www.eiae.org)).

## Choosing a location for your LCD TV

### To Display your LCD TV on the included Pedestal Stand:

Observe the following safety precautions:

- 1) Read and follow the pedestal assembly instructions included with the pedestal.  
**CAUTION:** Before beginning pedestal assembly, carefully lay the front of the LCD Panel face down on a flat, cushioned surface such as a quilt or blanket. Leave the bottom of the unit protruding over the edge of the surface and assemble the pedestal as indicated below.  
**Note:** Extreme care should always be used when attaching the pedestal stand to avoid damage to the LCD panel.
- 2) Place the TV on a sturdy, level surface that can support the weight of the TV.
- 3) Be sure to secure the TV to a wall stud, pillar, surface, or other immovable structure. See item 26) page 4.

### To Display your LCD TV using a Wall Bracket:

If you decide to wall mount your LCD TV, always use a wall bracket Listed by an independent laboratory (such as UL, CSA, ETL) that is appropriate for the size and weight of the TV (see page 2):

- 1) **CAUTION:** Two people are required for installation.
- 2) Unplug and remove any cables and/or other component connectors from the rear of the TV.
- 3) Remove the screws of the VESA Mounting Pattern show in the table on the next page.  
**CAUTION:** Do not use the screws removed from the back cover to attach the wall mount bracket to the TV.
- 4) Always use the screws supplied or recommended by the wall mount manufacturer.
- 5) Follow the instructions provided with your wall bracket. Before proceeding, make sure the appropriate bracket(s) are attached to the wall and the back of the TV as described in the instructions provided with the wall bracket.
- 6) After attaching the appropriate bracket(s) to the wall and the back of the TV, remove the pedestal stand from the TV, as described on page 6.

# 6

## 7) VESA Mounting Pattern

TV Size	Hole Pattern (HxV)	Screw Size
32"	200x200 mm	M6
40"	200x200 mm	M6

(unit in mm)

### Removing the Pedestal Stand

- 1) Carefully lay the front of the unit face down on a flat, cushioned surface such as a quilt or blanket. Leave the stand protruding over the edge of the surface.

**Note:** Extreme care should always be used when removing the pedestal stand to avoid damage to the LCD panel.

- 2) Remove the four screws shown in the below diagram. This will allow removal of the pedestal stand.
- 3) Once you have removed all four screws holding the pedestal stand in place, remove the pedestal stand from the TV.

### 32" TV

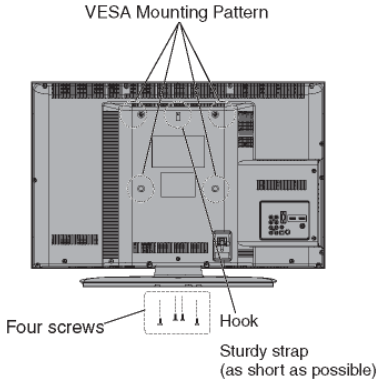

### 40" TV

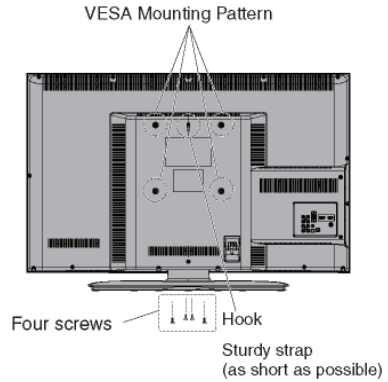

**CAUTION:** Always place the TV on the floor or a sturdy, level, stable surface that can support the weight of the unit. To secure the TV, use a sturdy strap from the hook(s) on the rear of the TV to a wall stud, pillar, or other immovable structure. Make sure the strap is tight, secure, and parallel to the floor.

## FCC Declaration of Conformity Compliance Statement (Part 15):

Toshiba 32C120U, 40E220U Television models comply with Part 15 of the FCC rules.

Operation is subject to the following two conditions:

- (1) This device may not cause harmful interference, and
- (2) This device must accept any interference received, including interference that may cause undesired operation.

The party responsible for compliance to these rules is: Toshiba America Information Systems, Inc.  
9740 Irvine Blvd., Irvine, CA 92618.  
Ph: 1-800-631-3811

**Note:** *This equipment has been tested and found to comply with the limits for a Class B digital device, pursuant to Part 15 of the FCC Rules. These limits are designed to provide reasonable protection against harmful interference in a residential installation. This equipment generates, uses, and can radiate radio frequency energy and, if not installed and used in accordance with the instructions, may cause harmful interference to radio communications. However, there is no guarantee that interference will not occur in a particular installation. If this equipment does cause harmful interference to radio or television reception, which can be determined by removing and applying power to the equipment, the user is encouraged to try to correct the interference by one of the following measures:*

- Reorient or relocate the receiving antenna.
- Increase the separation between the equipment and receiver.
- Connect the equipment into an outlet on a circuit different from that to which the receiver is connected.
- Consult the dealer or an experienced radio/TV technician for help.

**Caution:** *Changes or modifications to this equipment not expressly approved by Toshiba could void the user's authority to operate this equipment.*

## Important notes about your LCD TV

The following symptoms are technical limitations of LCD Display technology and are not an indication of malfunction; therefore, Toshiba is not responsible for perceived issues resulting from these symptoms.

- 1) An afterimage (ghost) may appear on the screen if a fixed, non-moving image appears for a long period of time. The afterimage is not permanent and will disappear in a short period of time.
- 2) The LCD panel contained in this TV is manufactured using an extremely high level of precision technology; however, there may be an occasional pixel (dot of light) that does not operate properly (does not light, remains constantly lit, etc.). This is a structural property of LCD technology, is not a sign of malfunction, and is not covered under your warranty. Such pixels are not visible when the picture is viewed from a normal viewing distance.

**Note:** *Interactive video games that involve shooting a "gun" type of joystick at an on-screen target may not work with this TV.*

## Trademark Information

- CHANNEL BROWSER, COLORSTREAM PRO, DynaLight, REGZA/REGZA-LINK, SURFLOCK are trademarks or registered trademarks of Toshiba America Information Systems, Inc. and/or Toshiba Corporation.

**AUDYSSEY**<sup>EQ</sup> •Audyssey EQ<sup>®</sup> provides clear, accurate and natural sound right out of the box. This helps ensure you enjoy your audio experience as much as your video experience.

**AUDYSSEY**<sup>ABX</sup> •Audyssey ABX<sup>™</sup> technology uses sophisticated driver analysis and low frequency monitoring to extend the range and bass of small speakers. This helps ensure you enjoy your audio experience as much as your video experience.

- Manufactured under license from Audyssey Laboratories. U.S. and foreign patents pending. Audyssey EQ<sup>®</sup> is a registered trademark, Audyssey ABX<sup>™</sup> is a trademark of Audyssey Laboratories.

**DOLBY**<sup>DIGITAL</sup> •Manufactured under license from Dolby Laboratories. Dolby and the double-D symbol are trademarks of Dolby Laboratories.

- HDMI, the HDMI Logo, and High-Definition Multimedia Interface are trademarks or registered trademarks of HDMI Licensing LLC in the United States and other countries.
- MPEG Layer-3 audio coding technology licensed from Fraunhofer IIS and Thomson.
- This production contains Bitstream Vera Sans fonts under the following copyright: Copyright © 2003 by Bitstream, Inc. All Rights Reserved. Bitstream Vera is a trademark of Bitstream, Inc.

## Copyright

This guide is copyrighted by Toshiba America Information Systems, Inc. with all rights reserved. Under the copyright laws, this guide cannot be reproduced in any form without the prior written permission of Toshiba. No patent liability is assumed, however, with respect to the use of the information contained herein.

©2011 by Toshiba America Information Systems, Inc. All rights reserved.

**Notice**

The information contained in this manual, including but not limited to any product specifications, is subject to change without notice.

**TOSHIBA CORPORATION AND TOSHIBA AMERICA INFORMATION SYSTEMS, INC. (TOSHIBA) PROVIDES NO WARRANTY WITH REGARD TO THIS MANUAL OR ANY OTHER INFORMATION CONTAINED HEREIN AND HEREBY EXPRESSLY DISCLAIMS ANY IMPLIED WARRANTIES OF MERCHANTABILITY OR FITNESS FOR ANY PARTICULAR PURPOSE WITH REGARD TO ANY OF THE FOREGOING. TOSHIBA ASSUMES NO LIABILITY FOR ANY DAMAGES INCURRED DIRECTLY OR INDIRECTLY FROM ANY TECHNICAL OR TYPOGRAPHICAL ERRORS OR OMISSIONS CONTAINED HEREIN OR FOR DISCREPANCIES BETWEEN THE PRODUCT AND THE MANUAL. IN NO EVENT SHALL TOSHIBA BE LIABLE FOR ANY INCIDENTAL, CONSEQUENTIAL, SPECIAL, OR EXEMPLARY DAMAGES, WHETHER BASED ON TORT, CONTRACT OR OTHERWISE, ARISING OUT OF OR IN CONNECTION WITH THIS MANUAL OR ANY OTHER INFORMATION CONTAINED HEREIN OR THE USE THEREOF.**



# Contents

---

Chapter 1: Introduction.....	15
Features .....	16
Overview of installation, setup, and use.....	16
TV front and side panel controls and connections .....	18
TV back panel connections .....	19
Chapter 2: Connecting Your TV .....	21
Overview of cable types .....	21
Coaxial (F-type) cable .....	21
Standard A/V cables (red/white/yellow) .....	22
Component video cables (red/green/blue) .....	22
HDMI® cable .....	22
Optical audio cable.....	23
Analog RGB (15-pin) computer cable .....	23
3.5mm Stereo to RCA Y-cable .....	23
About the connection illustrations .....	23
Connecting a VCR, antenna, cable TV, or camcorder.....	24

---

Connecting a DVD player with ColorStream® (component video), a VCR, and a satellite receiver .....	25
Connecting an HDMI® or DVI device to the HDMI® input .....	26
REGZA-LINK® connection .....	29
Connecting a digital audio system .....	30
Connecting a computer .....	32
Connecting a computer to the TV's PC IN terminal.....	32
Connection to the TV's HDMI® terminal.....	33
<b>Chapter 3: Using the Remote Control.....</b>	<b>35</b>
Installing batteries .....	35
Remote control effective range .....	36
Learning about the remote control.....	37
<b>Chapter 4: Menu Layout and Navigation .....</b>	<b>40</b>
Main menu layout .....	40
Menu setup/installation/layout .....	42
Navigating the menu system.....	42
<b>Chapter 5: Setting up your TV.....</b>	<b>44</b>
Initial Setup.....	44
Storing channels in memory (optional).....	46
Auto Tuning .....	46
Setting channel skip.....	48
Setting AV Input mode.....	50
Setting the HDMI® audio mode.....	50
Viewing the digital signal meter .....	51
Setting the time zone .....	52
Viewing the system status .....	52
Resetting Factory Defaults .....	53

---

Chapter 6: Using the TV's features .....	54
Selecting the video input source .....	54
Labeling the video input sources .....	56
Tuning channels using the Channel Browser™ .....	58
Favorites browser .....	59
Elements of the Channel Browser™ .....	60
Adding and clearing channels and inputs in the History List.....	62
Tuning to the next programmed channel .....	62
Tuning to a specific channel (programmed or unprogrammed) .....	62
Switching between two channels using Channel Return .....	63
Switching between two channels using SurfLock™ .....	63
Selecting the picture size .....	64
Full .....	65
TheaterWide 1 .....	65
TheaterWide 2 .....	66
TheaterWide 3 .....	66
Native.....	66
4:3 .....	67
Normal .....	67
Dot by Dot.....	68
Scrolling the TheaterWide® picture (TheaterWide 2 and 3 only).....	68
Using the Auto Aspect feature.....	69
Selecting the cinema mode .....	70
Using the FREEZE feature .....	70
Adjusting the picture .....	71
Selecting the picture mode .....	71
Adjusting the picture quality .....	72
Using closed captions .....	73
Digital CC settings.....	74
CC Selector .....	75

---

Adjusting the audio .....	76
Muting the sound .....	76
Using the digital audio selector .....	76
Selecting stereo/SAP broadcasts .....	77
Adjusting the audio quality .....	78
Audyssey ABX™ .....	79
Stable Sound .....	79
Selecting the optical audio output format .....	79
Using the Dolby® Digital Dynamic Range Control feature .....	80
Using the Locks menu .....	80
Entering the PIN code .....	80
Forgotten PIN code .....	81
Changing or deleting your PIN code .....	81
Using parental controls (for USA region) .....	82
Blocking TV programs and movies by rating (V-Chip) .....	82
Downloading an additional rating system .....	83
Displaying ratings .....	86
Unlocking programs temporarily .....	86
Using the input lock feature .....	87
Locking channels .....	87
Using the GameTimer® .....	88
Using the panel lock feature .....	89
Using the PC settings feature .....	90
Setting the PC Audio .....	91
Using the Media Player .....	92
Auto Start function .....	93
To open the Media Player .....	93
Viewing photo files .....	95
Playing music files .....	96
Viewing photo files and playing music files at the same time .....	98
Sorting photo or music files .....	98
Setting the sleep timer .....	99
Auto Brightness Sensor .....	99

---

Automatic Power Down .....	100
No Signal Power Down .....	100
Using REGZA-LINK® .....	101
REGZA-LINK® playback device (DVD player, etc.) control .....	101
Other REGZA-LINK® functions .....	103
Setting up REGZA-LINK® .....	104
Displaying TV status information .....	104
Understanding the last mode memory feature .....	106
<b>Chapter 7: Using the TV's Advanced Features .....</b>	<b>107</b>
Using the advanced picture settings .....	107
Dynamic Contrast .....	107
Static Gamma .....	108
Color temperature .....	108
CableClear® digital Noise Reduction .....	109
MPEG Noise Reduction .....	110
Game Mode .....	110
<b>Chapter 8: Troubleshooting.....</b>	<b>112</b>
General troubleshooting.....	112
Picture problems .....	113
Sound problems .....	115
Remote control problems .....	115
Channel tuning problems.....	115
Closed caption problems .....	116
Rating blocking (V-Chip) problems.....	116
No REGZA-LINK® operation .....	116
HDMI® problems.....	117
Media Player problems .....	117
If the problem persists after trying the solutions .....	117

---

Appendix A: Specifications.....	118
Television system .....	118
Channel coverage.....	118
Power source.....	119
Power maximum current .....	119
Power consumption.....	119
Audio power.....	119
Speaker type .....	119
Video/audio terminals .....	119
Video/audio input.....	119
ColorStream® (component video)	
HD input.....	120
HDMI® input .....	120
Digital audio output.....	120
PC input .....	120
Dimensions.....	120
Mass (weight) .....	120
Operating conditions.....	121
Supplied accessories .....	121
Acceptable signal formats for PC IN, HDMI® .....	121
PC IN signal formats .....	121
HDMI® signal formats .....	122
Appendix B: License Agreement.....	123
Index.....	127

# Chapter 1

## Introduction

---

### Safety icons

This manual contains safety instructions that must be observed to avoid potential hazards that could result in personal injuries, damage to your equipment, or loss of data. These safety cautions have been classified according to the seriousness of the risk, and icons highlight these instructions as follows:

---

**▲ DANGER**

Indicates an imminently hazardous situation which, if not avoided, will result in death or serious injury.

---

---

**▲ WARNING**

Indicates a potentially hazardous situation which, if not avoided, could result in death or serious injury.

---

---

**▲ CAUTION**

Indicates a potentially hazardous situation which, if not avoided, may result in minor or moderate injury.

---

---

**CAUTION**

Indicates a potentially hazardous situation which, if not avoided, may result in property damage.

---

---

**NOTE**

Provides important information.

---

## Features

The following are just a few of the many exciting features of your new Toshiba TV:

- ❖ **Integrated digital tuning (8VSB ATSC and QAM)**—Eliminates the need for a separate digital converter set-top box (in most cases).
- ❖ **1366 x 768 output resolution** (C120U).
- ❖ **1920 x 1080 output resolution** (E220U).
- ❖ **HDMI®**—Digital, High-Definition Multimedia Interfaces with 1080p input support, see [“Connecting an HDMI® or DVI device to the HDMI® input”](#) on page 26.
- ❖ **ColorStream® HD**—High-resolution component video input and shared composite video input, see [“Connecting a DVD player with ColorStream® \(component video\), a VCR, and a satellite receiver”](#) on page 25.
- ❖ **Digital Audio Out**—Optical audio connection with Dolby® Digital, see [“Connecting a digital audio system”](#) on page 30.
- ❖ **CableClear®**—digital picture Noise Reduction, see [“CableClear® digital Noise Reduction”](#) on page 109.
- ❖ **PC IN (Analog RGB)**—Computer terminal, see [“Connecting a computer to the TV’s PC IN terminal”](#) on page 32.
- ❖ **REGZA-LINK®**—Allows control of external devices from the TV remote via HDMI® connection.
- ❖ **Media Player**—Allows you to view photo files and play music, see [“Using the Media Player”](#) on page 92.

## Overview of installation, setup, and use

Follow these steps to set up your TV and begin using its many exciting features.

- 1 Carefully read the important safety, installation, care, and service information. Keep this manual for future reference.
- 2 To choose a location for the TV:
  - ❖ Read [“Important notes about your LCD TV”](#) on page 7.
  - ❖ Place the TV on the floor or a sturdy, level, stable surface that can support the weight of the unit. Secure the TV to a wall, pillar, or other immovable structure, see [page 4](#).



- ❖ Place the TV in a location where light does not reflect on the screen.
  - ❖ Place the TV far enough from walls and other objects to allow proper ventilation. Inadequate ventilation may cause overheating, which will damage the TV. THIS TYPE OF DAMAGE IS NOT COVERED UNDER THE TOSHIBA WARRANTY.
- 3 Do not plug in any power cords until after you have connected all cables and devices to your TV.
  - 4 Before connecting cables or devices to the TV, learn the functions of the TV's connections and controls, see [“Overview of cable types” on page 21](#).
  - 5 Connect your other electronic device(s) to the TV, see [“Connecting an HDMI® or DVI device to the HDMI® input” on page 26](#).
  - 6 Install the batteries in the remote control, see [“Installing batteries” on page 35](#).
  - 7 See [“Learning about the remote control” on page 37](#) for an overview of the buttons on the remote control.
  - 8 After connecting all cables and devices, plug in the power cords for your TV and other devices. Then press the Power button on the TV control panel or remote control to turn on the TV. If the TV stops responding to the buttons on the remote control or TV control panel and you cannot turn the TV off or on, unplug the power cords for a few seconds and then plug them in and try again.
  - 9 See [“Navigating the menu system” on page 42](#) for a quick overview of navigating the TV's menu system.
  - 10 Program channels into the TV's channel memory [“Tuning channels using the Channel Browser™” on page 58](#).
  - 11 For details on using the TV's features, see [“Using the TV's features” on page 54](#).
  - 12 For help, refer to [“Troubleshooting” on page 112](#).
  - 13 Specifications
  - 14 End User License Agreement

## TV front and side panel controls and connections

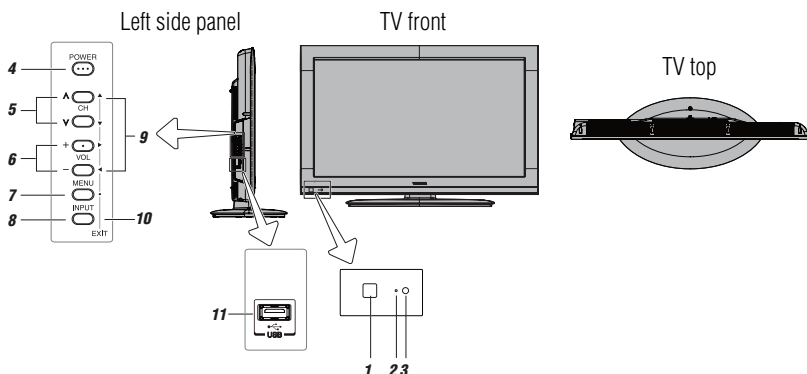

(Sample Illustration) Front and side panel controls and connections

- 1 **Remote sensor (embedded)**—Point the remote control toward this remote sensor.
- 2 **Power On LED**—Power indicator, (glows green when the TV power is On).
- 3 **Brightness sensor**—This sensor will detect the ambient light conditions to optimize the backlighting levels.
- 4 **POWER**—Turns the TV **On** and **Off**. If the TV stops responding to the buttons on the remote control or TV control panel and you cannot turn off the TV, press and hold the **POWER** button on the TV control panel for a few seconds to reset the TV.
- 5 **CHANNEL ▲ ▼**—When no menu is on-screen, these buttons change the channel (programmed channels only, see “[Storing channels in memory \(optional\)](#)” on page 46).
- 6 **VOLUME buttons ◀ ▶**—When no menu is on-screen, these buttons adjust the volume level.
- 7 **MENU (ENTER)**—Accesses the on-screen menus. When a menu is displayed, this button also functions as the ENTER button.
- 8 **INPUT**—Changes the source you are viewing. Press repeatedly to change from one source to the next.
- 9 **Arrow buttons ▲ ▼ ◀ ▶ (+ -)**—When a menu is on-screen, these buttons function as up/down/left/right menu navigation buttons.
- 10 **EXIT**—Instantly closes an on-screen menu.

- 11 USB port**—Used to access JPEG or MP3 files, or to update the TV's firmware.

## TV back panel connections

For explanations of cable types and connections, see “Overview of cable types” on page 21.

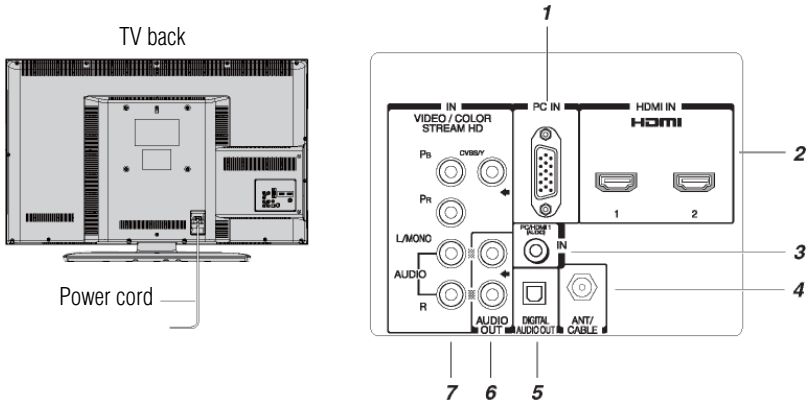

### (Sample Illustration) Back panel connections

- 1 PC IN**—For use when connecting a personal computer.
- 2 HDMI IN**—High-Definition Multimedia Interface input receives digital audio and uncompressed digital video from an HDMI® device or uncompressed digital video from a DVI device. HDMI® connection is necessary to receive 1080p signals.
- 3 PC/HDMI 1 (Audio) IN**—PC audio input terminal is shared with an HDMI 1 analog audio input terminal, and its use can be configured in the Audio Setup menu, see “Setting the PC Audio” on page 91.
- 4 ANT/CABLE**—Antenna input that supports analog (NTSC) and digital (ATSC) off-air antenna signals and analog and digital Cable TV (QAM) signals.

- 5 **Digital Audio Out**—Optical audio output in Dolby® Digital or PCM (pulse-code modulation) format for connecting an external Dolby Digital decoder, amplifier, or home theater system with optical audio input.
  - 6 **Fixed Audio Output**—Fixed audio output to connect external amplifiers.
  - 7 **ColorStream® HD**—High-resolution component video input and shared composite video input, see [“Connecting a DVD player with ColorStream® \(component video\), a VCR, and a satellite receiver”](#) on page 25.
- 

**NOTE**

Component/Standard (composite) video cables carry only video information; separate audio cables are required for a complete connection.

---

# Chapter 2

## Connecting Your TV

---

### Overview of cable types

Before purchasing cables, know the connector types your devices require. You can purchase cables from most stores that sell audio/video devices.

### Coaxial (F-type) cable



*(Sample Illustration) Coaxial cable*

Coaxial (F-type) cable connects to your antenna, cable TV service, and/or cable converter box to the **ANT/CABLE** input on your TV.

## Standard A/V cables (red/white/yellow)

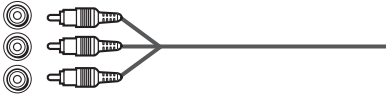

*(Sample Illustration) Standard AV cables*

Standard A/V cables (composite video) usually come in sets of three, and connects with video devices with analog audio and composite video output. These cables (and the related inputs on your TV) are typically color-coded according to use: yellow for video, red for stereo right audio, and white for stereo left (or mono) audio.

## Component video cables (red/green/blue)

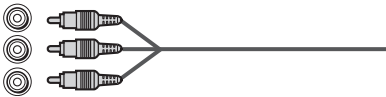

*(Sample Illustration) Component video cables*

Component video cables come in sets of three and are connects video devices with component video output. (ColorStream<sup>®</sup> is Toshiba's brand of component video.) These cables are typically color-coded red, green, and blue. Separate audio cables are required for a complete connection.

---

**NOTE** Component video cables provide better picture quality than composite video cables.

---

## HDMI<sup>®</sup> cable



*(Sample Illustration) HDMI<sup>®</sup> cable*

Use an HDMI<sup>®</sup> (High-Definition Multimedia Interface) cable with devices that have HDMI<sup>®</sup> output. An HDMI<sup>®</sup> cable delivers digital audio and video in its native format. Separate audio cables are not required, see “[Connecting an HDMI<sup>®</sup> or DVI device to the HDMI<sup>®</sup> input](#)” on page 26.

---

**NOTE** HDMI<sup>®</sup> cables provide the best audio and picture quality.

---

## Optical audio cable



*(Sample Illustration) Optical audio cable*

Optical audio cable connects receivers with Dolby® Digital or PCM (pulse-code modulation) optical audio input to the TV's **Digital Audio Out** terminal, see [“Connecting a digital audio system” on page 30](#).

## Analog RGB (15-pin) computer cable

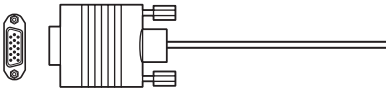

*(Sample Illustration) Analog RGB (15-pin) computer cable*

Analog RGB (15-pin) computer cable connects a computer to the TV's **PC IN** terminal, see [“Connecting a computer” on page 32](#).

---

**NOTE** Separate audio cables are required.

---

## 3.5mm Stereo to RCA Y-cable



*(Sample Illustration) 3.5mm Stereo to RCA Y-cable*

3.5mm Stereo to RCA Y-cable connects an audio signal from DVI device to TV.

## About the connection illustrations

You can connect different types and brands of devices to your TV in several different configurations. The connection illustrations in this manual are representative of typical device connections only. The input/output terminals on your devices may differ from those illustrated herein. For details on connecting and using your specific devices, refer to each device's user's guide.

## Connecting a VCR, antenna, cable TV, or camcorder

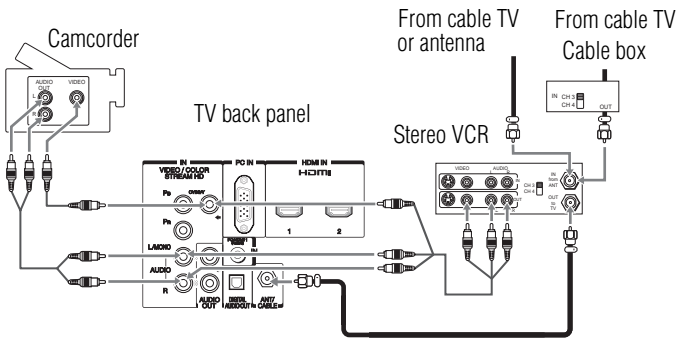

*(Sample Illustration) Connecting to a VCR, antenna, cable TV, or camcorder*

Items needed:

- ❖ Coaxial cables
- ❖ Standard AV cables

If you have a mono VCR, connect L/MONO on the TV to your VCR's audio out terminal using the white audio cable only.

- ❖ Standard audio cables

### NOTE

When you use a Cable box, you may not be able to use the remote control to program or access certain features on the TV.

#### To view the antenna or cable signal:

Select **ANT/CABLE** video input source on the TV.\*

#### To view basic and premium cable channels:

Turn OFF the VCR. Select the **ANT/CABLE** video input source on the TV.\* Tune the TV to channel 3 or 4 (whichever channel the Cable box output is set to). Use the Cable box controls to change channels.

#### To view the VCR or camcorder video:

Turn ON the VCR or camcorder video. Select **VIDEO** input source on the TV.\*

\*To select the video input source, press the **INPUT** button on the remote control, see [“Selecting the video input source”](#) on page 54.



## Connecting a DVD player with ColorStream® (component)

**NOTE**

The unauthorized recording, use, distribution, or revision of television programs, videotapes, DVDs, and other materials is prohibited under the Copyright Laws of the United States and other countries, and may subject you to civil and criminal liability.

## Connecting a DVD player with ColorStream® (component video), a VCR, and a satellite receiver

**NOTE**

ColorStream® and composite video cables cannot be connected simultaneously.

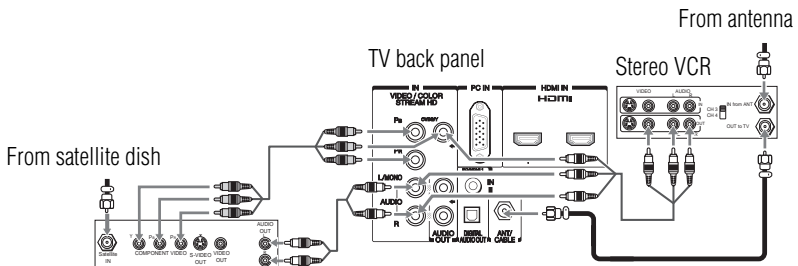

Satellite receiver with component video or  
DVD player with component video

*(Sample Illustration) Satellite receiver with component video or  
DVD player*

Items needed:

- ❖ Coaxial cables
- ❖ Standard AV cables

If you have a mono VCR, connect L/MONO on the TV to your VCR's audio out terminal using the white audio cable only.

- ❖ Standard audio cables
- ❖ Component video cables
  - ❖ You can connect the component video cables (plus audio cables) from the DVD player or satellite receiver to the **COLOR STREAM HD** terminal in the TV. The **COLOR STREAM HD** terminal can be used to display Progressive (480p, 720p) and Interlaced (480i, 1080i) scan systems. Please note that 1080p is not supported. Check the User's Guide of the DVD player in order to determine the best output signal available.

- ❖ If your DVD player does not have component video, connect a standard A/V cable to the **AUDIO/VIDEO** terminal. If your DVD player has HDMI® video, see “Connecting an HDMI® or DVI device to the HDMI® input” on page 26.

**To view antenna or Cable channels:**

Select the **ANT/CABLE** video input source on the TV.\*

**To view the DVD player:**

Turn On the DVD player. Select the **ColorStream HD video** input source on the TV.\*

**To view satellite programs using the component video connections:**

Turn On the satellite receiver. Select the **ColorStream HD video** input source on the TV.\*

**To view the VCR or view and record antenna channels:**

Turn On the VCR. Tune the VCR to the channel you want to watch. Select the **VIDEO** video input source on the TV.\*

**To record a TV program while watching a DVD:**

Turn On the VCR. Tune the VCR to the channel to record. Select the **ColorStream HD** video input source on the TV\* to view the DVD.

\*To select the video input source, press the **INPUT** button on the remote control, see “Selecting the video input source” on page 54.

---

**NOTE**

The unauthorized recording, use, distribution, or revision of television programs, videotapes, DVDs, and other materials is prohibited under the Copyright Laws of the United States and other countries, and may subject you to civil and criminal liability.

---

## **Connecting an HDMI® or DVI device to the HDMI® input**

The HDMI® input on your TV receives digital audio and uncompressed digital video from an HDMI® source device, or uncompressed digital video from a DVI (Digital Visual Interface) source device.

This input is designed to accept HDCP (High-Bandwidth Digital-Content Protection) program material in digital form from EIA/CEA-861-D–compliant consumer electronic devices (such as a set-top box or DVD player with HDMI® or DVI output).

**NOTE** EIA/CEA-861-D compliance covers the transmission of uncompressed digital video with high-bandwidth digital content protection, which is being standardized for reception of high-definition video signals. Because this is an evolving technology, it is possible that some devices may not operate properly with the TV.

The HDMI® input can accept and display VGA, SVGA, XGA, WXGA, SXGA, 480i (60Hz), 480p (60Hz), 720p (60Hz), 1080i (60Hz), and 1080p (24Hz/60Hz) signal formats. For detailed signal specifications, see “HDMI® signal formats” on page 122.

Supported Audio format: Linear PCM, sampling rate 32/44.1/48 kHz.

**NOTE** To connect a computer to the HDMI® input, see “Connection to the TV’s HDMI® terminal” on page 33.

To connect an HDMI® device, you will need one HDMI® cable (type A connector) per HDMI® device.

- ❖ For proper operation, it is recommended that you use an HDMI® cable with the HDMI® Logo (**HDMI**).
- ❖ HDMI® cables transfer both video and audio. Separate analog audio cables are not required. See “Setting the HDMI® audio mode” on page 50.

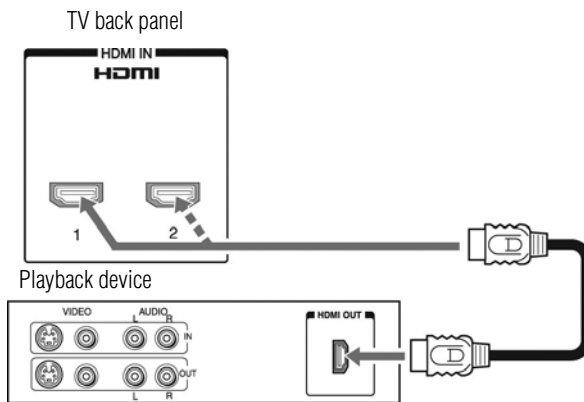

*(Sample Illustration) Connecting an HDMI® device*

**To view the HDMI® device video:**

Select HDMI 1 or HDMI 2 video input source on the TV. Press the **INPUT** button on the remote control. For more information, see “Selecting the video input source” on page 54.

**To connect a DVI device, you will need:**

- ❖ **HDMI® to DVI adapter cable**  
For proper operation, the length of an HDMI® to DVI adapter cable should not exceed 9.8 ft (3m). The recommended length is 6.6 ft (2m).
- ❖ **3.5mm Stereo to RCA Y-cable**  
An HDMI® to DVI adapter cable transfers video only. Separate analog audio cables are required (see illustration). For more information, see “Setting the HDMI® audio mode” on page 50

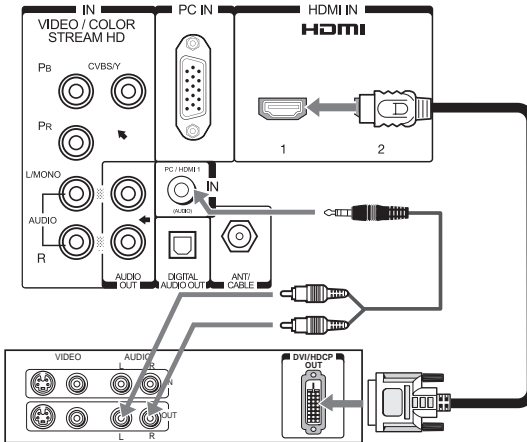

*(Sample Illustration) Connecting to a DVI device*

**NOTE**

To ensure that the HDMI® or DVI device is reset properly:

- ❖ When turning on your electronic components, turn on the TV first, and then the HDMI® or DVI device.
- ❖ When turning off your electronic components, turn off the HDMI® or DVI device first, and then the TV.

## REGZA-LINK® connection

You can control the basic functions of connected audio/video devices using the TV's remote control if you connect a REGZA-LINK® compatible audio receiver or playback device. For an explanation of setup and operations, see “REGZA-LINK® playback device (DVD player, etc.) control” on page 101.

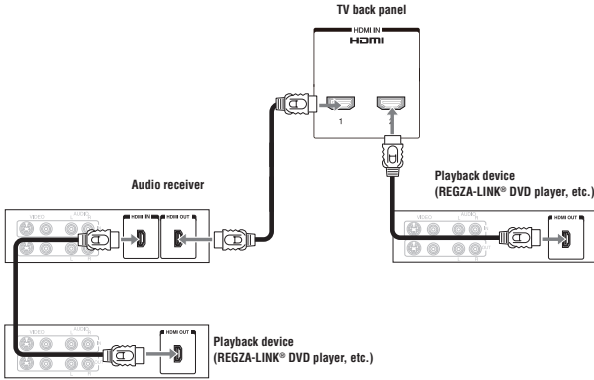

*(Sample Illustration) HDMI® REGZA-LINK® connections*

To connect an HDMI® device, you will need one HDMI® cable (type A connector) per HDMI® device (see “Overview of cable types” on page 21).

### NOTE

- ❖ If several devices are connected, REGZA-LINK® feature may not operate properly.
- ❖ For proper operation, it is recommended that you use an HDMI® cable with the HDMI® Logo (**HDMI**).

Before controlling the device(s):

- ❖ After completing the above connections, configure the REGZA-LINK® Setup menu with the desired settings, see “REGZA-LINK® input source selection” on page 103.
- ❖ The connected devices must also be set. For details, see the operation manual for each device.
- ❖ The REGZA-LINK® feature uses the CEC technology as regulated by the HDMI® standard.

- ❖ This feature is limited to models incorporating Toshiba's REGZA-LINK®. However, Toshiba is not liable for those operations. Refer to the individual instruction manuals for compatibility information.

**NOTE** This feature may not work properly depending on the devices that are connected.

## Connecting a digital audio system

The TV's DIGITAL AUDIO OUT terminal outputs a Dolby® Digital or 2-channel down-mixed PCM (pulse-code modulation) signal for use with an external Dolby Digital decoder or other external audio system with optical audio input.

You will need an Optical audio cable (Use an optical audio cable that has the larger "TosLink" connector and not the smaller "mini-optical" connector.)

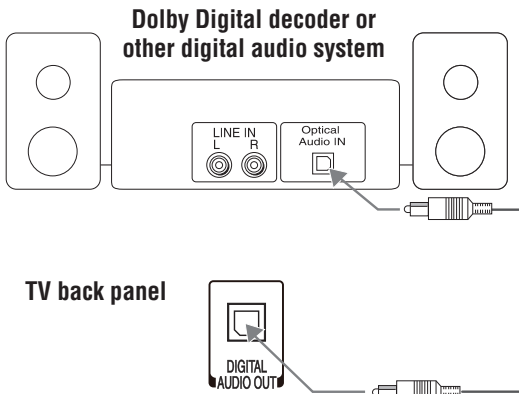

*(Sample Illustration) Connecting a digital audio system*

To control the audio:

- 1 Turn on the TV and the digital audio device.
- 2 Press the **MENU** button on the remote control and open the **Sound** menu.

- Press the (▲/▼ arrow) buttons to highlight **Audio Setup**, and then press the **ENTER** button.



*(Sample Image) Audio Setup screen*

- Press the (▲/▼ arrow) buttons to select **Optical Output Format**.
- Press the (◀/▶ arrow) buttons to select either **Dolby Digital** or **PCM**, depending on your device, see “[Selecting the optical audio output format](#)” on page 79.

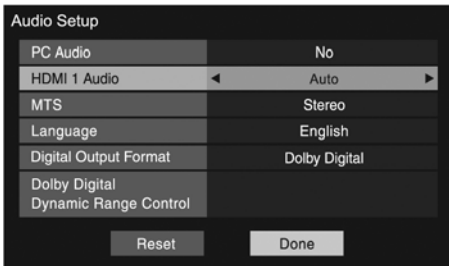

*(Sample Image) Digital Output Format screen*

- To save the new settings, highlight **Done**, and then press the **ENTER** button.

To revert to the factory defaults, highlight **Reset**, and then press the **ENTER** button.

#### NOTE

- ❖ Some audio systems may not be compatible with Dolby Digital bitstream signals. Older audio systems that are not compatible with standard optical out signals may not work properly, creating a high noise level that may damage speakers or headphones. **THIS DAMAGE IS NOT COVERED BY YOUR WARRANTY.**
- ❖ The DIGITAL AUDIO OUT terminal may not output some digital audio sources because of copy restrictions.

## Connecting a computer

With either the PC IN or HDMI® connection, you can view your computer's display on the TV and hear the sound from the TV's speakers.

### Connecting a computer to the TV's PC IN terminal

When connecting a computer to the PC IN terminal on the TV, use an analog RGB (15-pin) computer cable and a PC audio cable. For more information, see [“Overview of cable types”](#) on page 21.

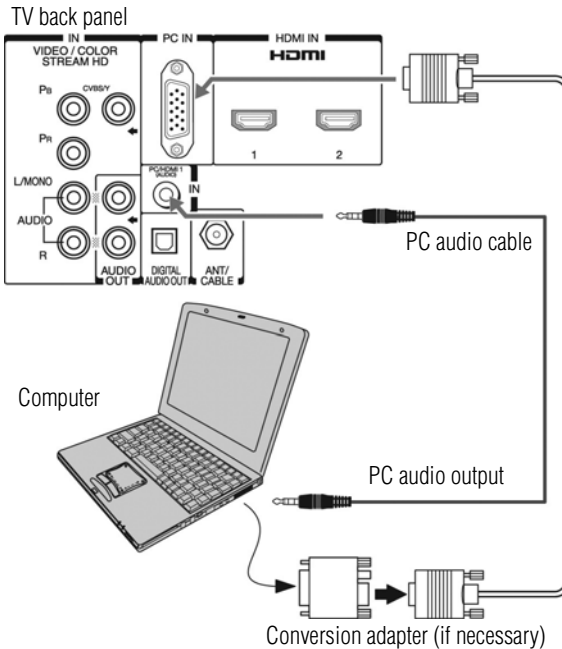

*(Sample Illustration) Computer connections*

To use a computer, set the monitor output resolution on the computer before connecting it to the TV. The supported signal formats are VGA, SVGA, XGA, WXGA and SXGA. For detailed signal specifications, see [“Acceptable signal formats for PC IN, HDMI®”](#) on page 121.



Other formats or non-standard signals will not be displayed correctly.

To display the optimum picture, use the computer setting feature, see “Using the PC settings feature” on page 90.

- NOTE**
- ❖ The PC audio input terminals on the TV are shared with the HDMI 1 analog audio input terminals. For configuration information, see “Setting the PC Audio” on page 91.
  - ❖ Some computer models cannot be connected to this TV.
  - ❖ If the computer has a compatible mini D-sub15-pin terminal, an adapter is not required.
  - ❖ Depending on the content playback and the computer's specifications, some scenes may be skipped or you may not be able to pause during multi-angle scenes.

Signal names for mini D-sub 15-pin connector:

<i>Pin No.:</i>	<i>Signal Name:</i>	<i>Pin No.:</i>	<i>Signal Name:</i>	<i>Pin No.:</i>	<i>Signal Name:</i>
1	R	6	Ground	11	Reserved
2	G	7	Ground	12	SDA
3	B	8	Ground	13	H-sync
4	Reserved	9	5V	14	V-sync
5	Ground	10	Ground	15	SCL

### Connection to the TV's HDMI® terminal

When connecting a computer to an HDMI® terminal on the TV, use an HDMI®-to-DVI adapter cable and analog audio cables.

When connecting a computer to an HDMI® terminal, use an HDMI® cable (type A connector). Separate analog audio cables may not be necessary, depending on computer hardware and setup, see “Connecting an HDMI® or DVI device to the HDMI® input” on page 26.

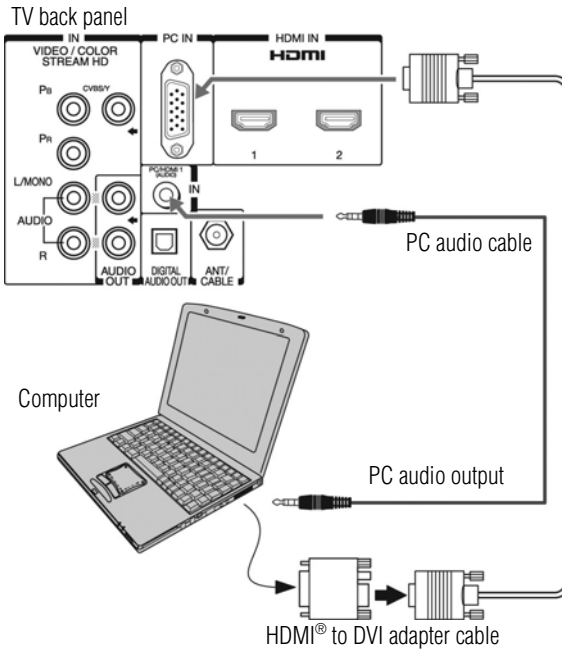

*(Sample Illustration) Connections to HDMI® terminal*

The supported signal formats are VGA, SVGA, XGA, WXGA, SXGA, 480i (60Hz), 480p (60Hz), 720p (60Hz), 1080i (60Hz), and 1080p (24Hz/60Hz). For signal specifications, see “[Acceptable signal formats for PC IN, HDMI®](#)” on page 121.

#### NOTE

- ❖ The edges of the picture may be hidden.
- ❖ If receiving a 480i (HDMI®), 480p (HDMI®), 720p, 1080i, or 1080p signal program, Native mode scales the video to display the entire picture within the borders of the screen (i.e. no overscanning).

# Chapter 3

## Using the Remote Control

### Installing batteries

To install batteries:

- 1 Remove the battery cover from the back of the remote control.



*(Sample Illustration) Removing the remote back cover*

- 2 Insert the batteries, corresponding to the (+) and (-) markings on the battery compartment.

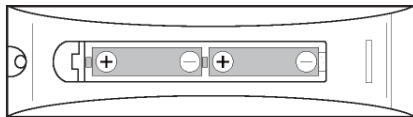

*(Sample Illustration) Installing the batteries*

- 3 Replace the battery cover.

---

**CAUTION** Do not expose batteries to excessive heat such as sunshine, fire, etc.

---

**NOTE**

- ❖ Be sure to use AAA size batteries.
- ❖ Dispose of batteries in a designated disposal area.
- ❖ Always consider the environment when disposing of batteries. Always follow applicable laws and regulations.
- ❖ If the remote does not operate correctly, or if the operating range is reduced, replace the batteries with new ones.
- ❖ Always replace both batteries with new ones. Never mix battery types or use new and used batteries together.
- ❖ Always remove batteries from the remote if they are dead or if the remote control is not to be used for an extended period of time. This prevents battery acid from leaking into the battery compartment

**Remote control effective range**

For optimum performance, aim the remote control directly at the TV and make sure there is no obstruction between the remote control and the TV.

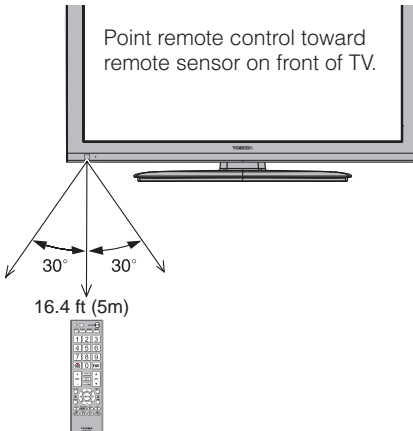

*(Sample Illustration) Remote control effective range*

## Learning about the remote control

The buttons for operating the TV are described here. For the REGZA-LINK<sup>®</sup> remote control functions, see “REGZA-LINK<sup>®</sup> playback device (DVD player, etc.) control” on page 101.

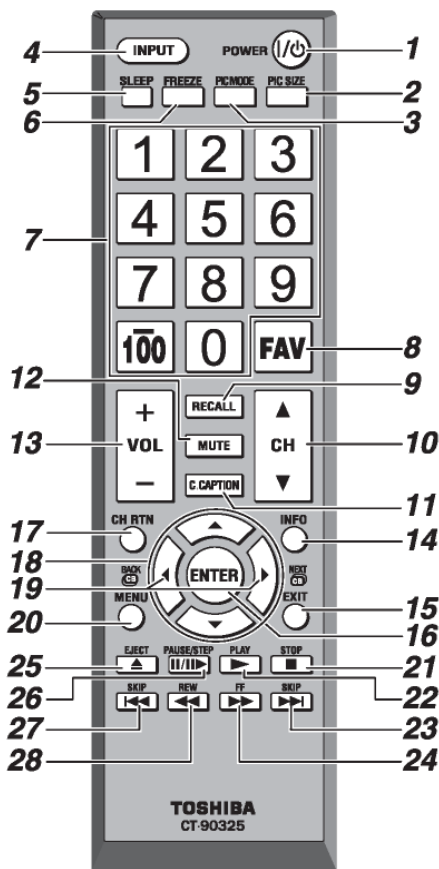



(Sample Illustration) Remote control overview









**NOTE** The error message “NOT AVAILABLE” may appear if you press a button for a function that is not available.

- 1 The **POWER** button turns the TV On and Off. When the TV is on, the power LED indicator on the TV front glows green.
- 2 The **PIC SIZE** button cycles through the picture sizes, see “Selecting the picture size” on page 64.

- 3 The **PIC MODE** button selects the picture mode, see “[Selecting the picture mode](#)” on page 71.
- 4 The **INPUT** button selects the video input source, see “[Selecting the video input source](#)” on page 54.
- 5 The **SLEEP** button accesses the sleep timer, see “[Setting the sleep timer](#)” on page 99.
- 6 The **FREEZE** button freezes the picture. Press again to restore the normal video, see “[Using the FREEZE feature](#)” on page 70.
- 7 The **Channel Number** buttons (0-9, and 100) directly tunes channels. The **100** button allows you to enter two part channel numbers, see “[Storing channels in memory \(optional\)](#)” on page 46 or to edit the Favorites List, see “[Favorites browser](#)” on page 59.
- 8 The **FAV** button accesses the Favorites List in the Channel Browser™, see “[Favorites browser](#)” on page 59.
- 9 The **RECALL** button displays TV status information.
- 10 The **CH** (**▲/▼ arrow**) buttons cycle through programmed channels.
- 11 The **C. CAPTION** accesses closed captions, see “[Using closed captions](#)” on page 73.
- 12 The **MUTE** button reduces or turns off the sound, see “[Muting the sound](#)” on page 76.
- 13 The **VOL + –** buttons adjust the volume level.
- 14 The **INFO** button displays TV status information as well as program details, when available, see “[Displaying TV status information](#)” on page 104.
- 15 The **EXIT** button closes on-screen menus.
- 16 The **ENTER** button activates highlighted items in the main menu system.
- 17 The **CH RTN** button returns to the last viewed channel or source, see “[Switching between two channels using Channel Return](#)” on page 63.
- 18 The **Arrow** buttons (**▲▼◀▶**) select or adjust programming menus when a menu is on-screen.

- 19 The **Arrow** buttons ( ) open the Channel Browser™ and tune to the previous/next channel in the channel history when TV programming is on-screen. See “[Tuning channels using the Channel Browser™](#)” on page 58.
- 20 The **MENU** button accesses the main TV menu system. See “[Navigating the menu system](#)” on page 42

The following button functions allow you to control Toshiba REGZA-LINK® compatible devices via HDMI® connection. See “[Using REGZA-LINK®](#)” on page 101



- 21 The **STOP** () button stops playback of the loaded DVD or tape.
- 22 The **PLAY** () button begins playback of the loaded DVD or tape.
- 23 The **SKIP forward** () button skips forward to locate later DVD chapters.
- 24 The **FF** () button fast-forwards the DVD or tape. (Press during play mode to view the picture moving rapidly forward.)
- 25 The **EJECT** () button ejects the DVD or tape.
- 26 The **PAUSE** () button suspends play or record temporarily. Press during play or record mode to pause the picture; press again to restart.
- 27 The **SKIP reverse** () button skips to the beginning of the current DVD chapter or locates the previous chapter.
- 28 The **REW** () button rewinds/reverses the tape or DVD. (Press during play mode to view the picture moving rapidly backward.)

# Chapter 4



## Menu Layout and Navigation

### Main menu layout

The tables below and on the next pages provide a quick overview of your TV's menu system. To open the Installation menus (illustrated below), press MENU on the remote control or TV control panel.

<i>Icon</i>	<i>Item</i>	<i>Option</i>
	Picture	Mode
		Dynamic/Standard/Movie/PC/Preference
		Picture Settings
		Opens the Picture Settings menu
		Noise Reduction
	Opens the Noise Reduction menu	
	Game Mode	
	Off/On	
	Theater Settings	
	Opens the Theater Settings menu	
	Sound	Digital Audio Selector
		Launches the temporary Audio Selector
		Audio Settings
	Opens the Audio Settings menu	
	Audio Setup	
	Opens the Audio Setup menu	



<i>Icon</i>	<i>Item</i>	<i>Option</i>
	Preferences	
	CC Selector	Launches the temporary CC Selector
	Base CC Mode	Off/CC1/CC2/CC3/CC4/T1/T2/T3/T4
	Digital CC Settings	Opens the Digital CC Setup menu
	Input Labeling	Opens the Input Labeling menu
	AV Input	Selects ColorStream HD/Video input
	Menu Language	English/Français/Español
	Channel Browser Setup	Opens the Channel Browser Setup menu
	REGZA-LINK <sup>®</sup> Player Control	Opens the REGZA-LINK <sup>®</sup> Player Control menu
	Energy Saving Settings	Opens the Energy Saving Settings menu
	Locks	
	Enable Rating Blocking	Off/On (for USA region)
	Edit Rating Limits	Opens the Edit Rating Limits menu (for USA region)
	Input Lock	Off/Video/Video+
	Panel Lock	Off/On
	GameTimer <sup>®</sup>	Off/30 min/60 min/90 min/120 min
	New PIN Code	Opens the New PIN Code entry screen
	Setup	
	Installation	Opens the Installation menu
	REGZA-LINK <sup>®</sup> Setup	Enable REGZA-LINK <sup>®</sup> / TV Auto Input Switch / TV Auto Power / Device Auto Standby / Speaker Preference
	Sleep Timer	10-minute increments, from 0 min to a maximum of 12 hours
	PC Settings	Opens the PC Settings menu
Media Player	Opens the Media Player menu	

## Menu setup/installation/layout

The Installation menu contains the Terrestrial and System Status menus.

To open the Installation menu, press the **MENU** button on the remote control or TV control panel, open the **Setup** menu, select **Installation**, and then press the **ENTER** button.

Icon	Item	Option
	Input Configuration	Opens the Input Configuration menu
	Channel Program	Start Scan > Scans for new channels on ANT/CABLE
	Channel Options	Opens the Skip/Lock Channel menu
	Time Zone	Eastern/Newfoundland/Atlantic/Hawaii/Alaska/Pacific/Mountain/Central
	Signal Meter	Opens the Signal Meter menu
System Status	System Information	Opens the System Information screen

## Navigating the menu system

You can use the buttons on the remote control or TV control panel to access and navigate your TV's on-screen menu system.

- 1 Press the **MENU** button to open the menu system.

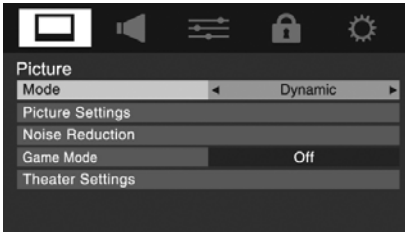

*(Sample Image) Navigating the menu system*

- 2 When a menu is open, use the (**▲/▼/◀/▶** arrow) buttons on the remote control or the (**▲/▼ + - arrow**) buttons on the TV control panel to move in the corresponding direction in the menu.

- 3** Press the **ENTER** button to save your menu settings or select a highlighted item.  
A highlighted menu item appears in a different color in the menu.
  - 4** All menus close automatically if you do not make a selection within approximately 60 seconds, except the signal meter menu, which closes automatically after a few minutes.
  - 5** To close a menu instantly, press the **EXIT** button.
- 

**NOTE** The menu background may sometimes appear black, depending on the signal the TV is receiving. This is not a sign of malfunction.

---

# Chapter 5

## Setting up your TV

---

### Initial Setup

When you first turn on or reset the TV, the Initial Setup window will appear.

- 1 In the **Menu Language** field, press the (◀/▶ arrow) buttons to select your preferred language.
- 2 Press the (▲/▼ arrow) buttons to select **Time Zone Setup**. Then set your desired time zone, using the (◀/▶ arrow) buttons and press the **ENTER** button.

The **Location** settings window appears.

- 3 For normal home use, press the (◀/▶ arrow) buttons to select **Home**, and then press the **ENTER** button.

The **ANT/CABLE** In setup window appears.

- 4 Press the (◀/▶ arrow) buttons to select the input source (**Cable** or **Antenna**), and then press **ENTER**.
- 5 Press the **ENTER** button to select **Start Scan** and continue with the Auto Tuning.

You can stop the Initial Setup by pressing the **EXIT** button. However if you do not finish the entire Initial Setup process and press the **POWER** button before completing all the steps, the Initial Setup window will appear every time you turn on the TV.

## Menu language

You can choose from three different menu language settings (English, Français, and Español) for the on-screen display of menus and messages.

To select the menu language:

- 1 Press the **MENU** button to open the **Preferences** menu, and highlight **Menu Language**.
- 2 Press the (◀/▶ arrow) buttons to select your preferred language.

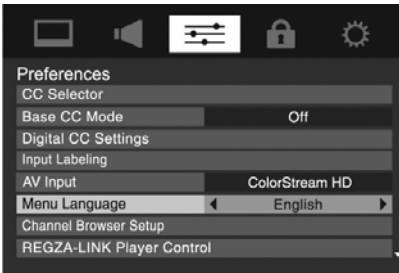

*(Sample Image) Selecting the menu language*

- 3 Press the **EXIT** button to close the **Preferences** menu.

## ANT/CABLE IN

This setting configures the input source for the ANT/CABLE terminal.

- 1 Press the **MENU** button to open the **Setup** menu.
- 2 Highlight **Installation**, and then press the **ENTER** button.

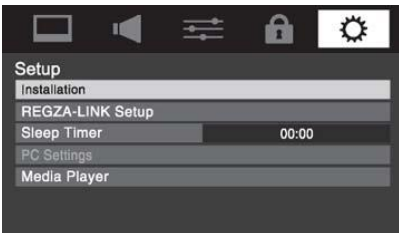

*(Sample Image) Setup menu - Installation selection*

**Setting up your TV***Storing channels in memory (optional)*

A new set of Installation menu icons appears.

- 3 Open the **Terrestrial** menu, highlight **Input Configuration**, and then press the **ENTER** button.

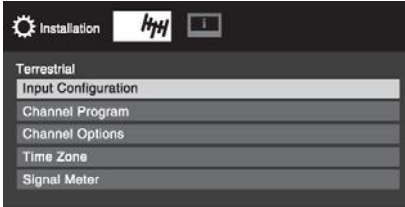

*(Sample Image) Terrestrial menu - Input Configuration selection*

- 4 Highlight **ANT/CABLE In** and press the (◀/▶) arrow buttons to select the input source (**Cable** or **Antenna**).

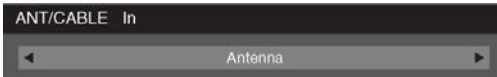

*(Sample Image) Input Configuration screen*

- 5 To save your new settings, highlight **Done**, and then press the **ENTER** button. To revert to your original settings, highlight **Cancel**, and then press the **ENTER** button.

## Storing channels in memory (optional)

To make sure your TV stops only on the channels you want when you press the **CH** (▲/▼) arrow buttons on the remote control or the control panel, store those channels in the TV's memory.

### Auto Tuning

You can set up the TV to detect all active channels in your area and store them in its memory.

**NOTE**

- ❖ You must set up the ANT/CABLE input source before programming channels.
- ❖ The automatic channel programming process will erase channels that were previously programmed into the TV's memory.
- ❖ To tune the TV to a channel not programmed in the channel memory, you must use the Channel Number buttons on the remote control.
- ❖ Programming channels when the ANT/CABLE input is configured for cable will take substantially longer than when the antenna input is configured for Antenna. This is normal; however, once channel programming is finished, you should not have to repeat the programming process again unless your cable TV service lineup changes significantly.

To program channels automatically:

- 1 Configure the antenna input source, if you have not already done so, see “ANT/CABLE IN” on page 45.
- 2 Press the **MENU** button to open the **Setup** menu.
- 3 Highlight **Installation**, and then press the **ENTER** button.

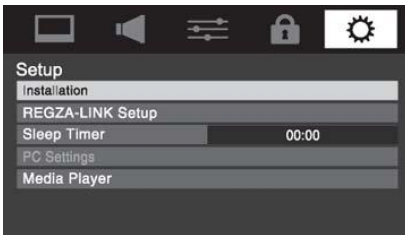

*(Sample Image) Setup menu - Installation selection*

A new set of **Installation** menu icons appears.

- 4 Open the **Terrestrial** menu, highlight **Channel Program** to open the **Start Scan** window, and then press the **ENTER** button to begin channel programming.

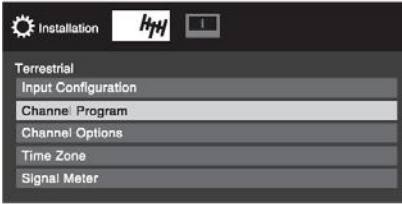

*(Sample Image) Terrestrial menu - Channel Program selection*

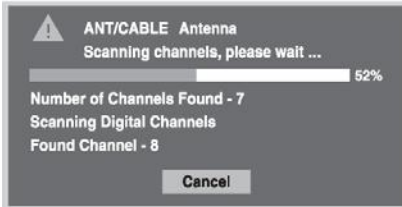

*(Sample Image) Auto tuning program channels*

The TV will automatically cycle through all the antenna channels, and store all active channels in the channel memory. While the TV is cycling through the channels, the message “Scanning channels, please wait” appears.

- 5 To cancel channel programming, press the **EXIT** button on the remote control or highlight **Cancel** in the on-screen display, and then press the **ENTER** button.

When channel programming is complete, press the **CH Up/Down** arrow buttons to view the programmed channels.

## Setting channel skip

To prevent a channel from being viewed, you can set it to be skipped.

- 1 From the **Setup** menu, highlight **Installation**, and then press the **ENTER** button.



- 2 Press the (▲/▼ arrow) buttons to select **Channel Options**, and then press the **ENTER** button.

The list of channels appears.



*(Sample Illustration) List of channels*

- 3 Press the (▲/▼ arrow) buttons to select a channel position to be skipped, and then press the **ENTER** button.

A check will appear in the box. To remove the check, press the **ENTER** button again.

To add a channel to the channel memory:

- ❖ Highlight the checked box next to the channel number you wish to add, and then press the **ENTER** button to remove the check.

---

**NOTE** You can also block specific channels so that they cannot be tuned until you unlock them. For information, see "[Locking channels](#)" on [page 87](#)

---

To manually add digital sub-channels on a physical channel:

- ❖ Use the Channel Number buttons and the Dash (**100**) on the remote control to enter the channel number (for example, 56-1).

If the channel is found, the number will be added to the list and the box will be unchecked. If the channel is not found, a message appears.

---

**NOTE** Skipped channels cannot be selected with the CH Up/Down buttons; however, they can be accessed using the number buttons on the remote control.

---

If an encrypted channel is accidentally added to the channel list while programming channels, you can remove the unwanted encrypted (non-viewable) channel while you are channel surfing.

To remove encrypted channels from the channel memory:

When you tune to an encrypted channel, the following message appears.

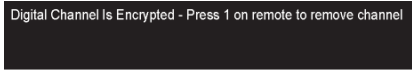

*(Sample Illustration) Removing an encrypted channel*

- ❖ Press the **1** button while the message is displayed to remove the unnecessary channel from the channel list.

## Setting AV Input mode

This setting determines the configuration of the shared AV input on your TV. You can set this input for either ColorStream HD or video.

- 1 From the **Preferences** menu, highlight **AV Input**.
- 2 Press the (◀/▶ arrow) buttons to select the desired setting.

## Setting the HDMI® audio mode

To set the HDMI® audio mode:

- 1 Press the **MENU** button to open the **Sound** menu.
- 2 Highlight **Audio Setup**, and then press the **ENTER** button.
- 3 Press the (▲/▼ arrow) buttons to select **HDMI 1 Audio**, and then press the (◀/▶ arrow) buttons to select the HDMI 1 audio mode (**Auto**, **Digital**, or **Analog**). (**Auto** is the recommended mode.) See “Connecting an HDMI® or DVI device to the HDMI® input” on page 26.

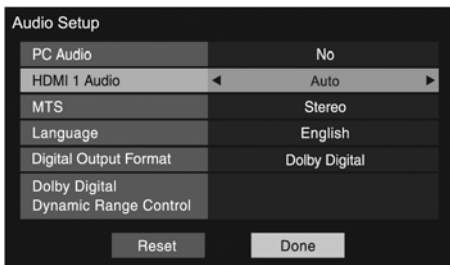

*(Sample Image) HDMI® Audio mode screen*

## Viewing the digital signal meter

<i>Mode:</i>	<i>Description:</i>
Auto	When viewing the HDMI 1 input, if digital audio from the HDMI <sup>®</sup> input is available, it will be output. If not, the TV will automatically detect and output analog audio from the PC Audio input.
Digital	When viewing the HDMI 1 input, digital audio from the HDMI <sup>®</sup> input will be output.
Analog	When viewing the HDMI 1 input, analog audio from the PC Audio input will be output.

- 4 To save the setting, highlight **Done**, and then press the **ENTER** button.

**NOTE**

Because the PC and HDMI1 inputs share the same set of analog audio inputs, the PC Audio menu setting influences the HDMI 1 Audio menu setting. If PC Audio is set to “No” the HDMI 1 Audio setting changes to “Auto.” If PC Audio is set to “Yes” the HDMI 1 Audio setting is set to “Digital” and is grayed out in the menu. See “Setting the PC Audio” on page 91.

## Viewing the digital signal meter

You can view the digital signal meter in the ANT/ CABLE digital TV input source only.

To view the digital signal meter:

- 1 Press the **MENU** button to open the **Setup** menu.
- 2 Highlight **Installation**, and then press the **ENTER** button.  
A new set of Installation menu icons appears.
- 3 Open the **Terrestrial** menu, highlight **Signal Meter**, and then press the **ENTER** button.
- 4 Press the (▲/▼/◀/▶ arrow) buttons to select the antenna input and digital channel signal you wish to check.

**NOTE**

- ❖ The physical digital channel number listed in the Signal Meter screen may not correspond to a virtual TV channel number. Contact your local broadcasters to obtain the RF channel numbers for your local digital stations.
- ❖ The signal strength does not change between virtual channels on the same physical channel.

To close the screen and return to the Terrestrial menu:

- ❖ Highlight **Done**, and then press the **ENTER** button.

To return to normal viewing, press the **EXIT** button.

## Setting the time zone

The Time Zone setup allows you to specify the correct time zone for your region. This feature allows the TV status information to display the correct time zone information for your viewing area.

To set the time zone:

- 1 In the **Setup** menu, highlight **Installation**, and then press the **ENTER** button.
- 2 Highlight **Time Zone**, and then press the **ENTER** button.
- 3 Press the (◀/▶ arrow) buttons to select the region, highlight **Done**, and then press the **ENTER** button.

After the time zone has been set, you will be asked to set the current Daylight Saving Time status.

To set the Daylight Saving Time status:

- ❖ Press the (◀/▶ arrow) buttons to select **Yes** or **No**, highlight **Done**, and then press the **ENTER** button.

## Viewing the system status

- 1 Press the **MENU** button to open the **Setup** menu.
- 2 Highlight **Installation**, and then press the **ENTER** button.  
A new set of Installation menu icons appears.
- 3 Open the **System Status** menu, highlight **System Information**, and then press the **ENTER** button.
- 4 Press the (◀/▶ arrow) buttons to scroll through the menu bar to select **Factory Defaults** or **Support Information**.

The related information appears.

To close the screen and return to the Installation menu:

- ❖ Highlight **Done** in the Support Information screen, and then press the **ENTER** button.

To return to normal viewing, press the **EXIT** button.

## Resetting Factory Defaults

To reset all settings and channels to their factory default values:

- 1 Press the **MENU** button to open the **Setup** menu.
- 2 Highlight **Installation**, and then press the **ENTER** button.  
A new set of Installation menu icons appears.
- 3 Open the **System Status** menu, highlight **System Information**, and then press the **ENTER** button.
- 4 Press the (◀/▶ arrow) buttons to scroll through the menu bar to select **Factory Defaults**.
- 5 Highlight **Yes**, and then press the **ENTER** button.
- 6 If a PIN code has been set, enter your PIN code.
- 7 Press the (◀/▶ arrow) buttons to select **Done**, and then press the **ENTER** button.  
A warning message appears.
- 8 Select **Yes**, and then press the **ENTER** button.  
The TV turns off automatically after a few seconds.
- 9 After the TV turns off, unplug the TV power cord and then plug it in again to complete the reset process.

To cancel the reset process, select **No**, and press the **ENTER** button in [step 5](#) above.

# Chapter 6

## Using the TV's features

---

### Selecting the video input source

To select the video input source to view:

- 1 Press the **INPUT** button on the remote control or TV control panel.
- 2 Do one of the following:
  - ❖ Press 0-4.
  - ❖ Repeatedly press the (▲/▼ arrow) buttons on the remote control, and then press the **ENTER** button to change the input setting.
  - ❖ Repeatedly press the **INPUT** button on the remote control or TV control panel to change the input setting.

The current signal source displays in the top right corner of the Input Selection screen.

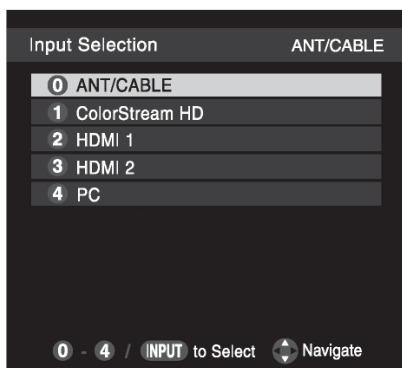

*(Sample Image) Input Selection screen*

**NOTE**

- ❖ You can label the video input sources according to the specific devices you have connected to the TV, see [“Labeling the video input sources” on page 56](#).
- ❖ Sources can be “hidden,” see [“Labeling the video input sources” on page 56](#).
- ❖ “No video signal” will appear randomly on the screen if no signal is received in video input mode.
- ❖ If CEC device is connected to an HDMI<sup>®</sup> input, the REGZA-LINK<sup>®</sup> icon appears.

If a REGZA-LINK<sup>®</sup> device with HDMI<sup>®</sup> switching capability (e.g. Audio Receiver) is connected to the HDMI<sup>®</sup> input, press the **INPUT** button on the remote control or TV control panel repeatedly to highlight **HDMI 1** or **HDMI 2**.

If the connected CEC device has any connected devices, a separate device selection pop-up window appears:

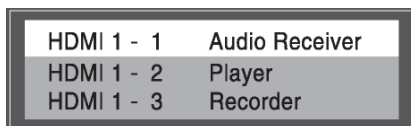

*(Sample Illustration) HDMI<sup>®</sup> setting pop-up window*

Press the **INPUT** button repeatedly to highlight the desired input source, and then press the **ENTER** button.

- NOTE**
- ❖ When you select REGZA-LINK® input sources from the pop-up window using the INPUT button, some REGZA-LINK® devices may automatically turn on.
  - ❖ When selecting input sources using the (▲/▼ arrow) buttons, you will need to press the ENTER button to actually select a particular device from the pop-up window.
- 

## Labeling the video input sources

You can label each video input source according to the type of device you have connected to each source. Choose from the following preset list of labels:

- ❖ -- (default label)
- ❖ Audio Receiver
- ❖ Cable
- ❖ Compact Disc
- ❖ DTV
- ❖ DVD
- ❖ Game Console
- ❖ HDMI® Switch (HDMI® inputs only)
- ❖ Laser Disc
- ❖ Satellite/DSS
- ❖ VCR
- ❖ Video Recorder
- ❖ Hide (to hide an unused input in the Input Selection screen and in the Channel Browser™ Inputs list)

- NOTE** If you select PC in the Input Selection screen, you can choose only "--", "Game Console", or "Hide" as the label.
-



To label the video input sources:

- 1 Press the **MENU** button and open the **Preferences** menu.
- 2 Highlight **Input Labeling**, and then press the **ENTER** button.

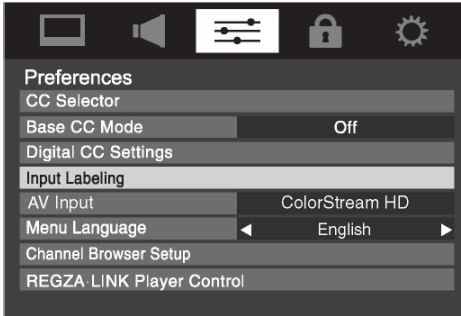

*(Sample Image) Preferences menu - Input Labeling selection*

- 3 Press the (**▲/▼** arrow) buttons to highlight the video source you wish to label.
- 4 Press the (**◀/▶** arrow) buttons to select the desired label for that input source. If a particular input is not used, **Hide** can be selected as the label. This will cause that input to be grayed out in the Input Selection screen and skipped over when you press the **INPUT** button on the remote control.

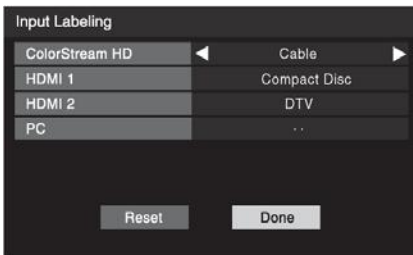

*(Sample Image) Input Labeling screen*

- 5 To save the new input labels, highlight **Done**, and then press the **ENTER** button.

To revert to the factory default labels, highlight **Reset** and press the **ENTER** button.

Input labeling example:

The screen below left shows the default Input Selection screen (with none of the inputs labeled as a specific device). The screen below (right) is an example of how you can label the inputs if you connected a VCR to ColorStream® HD, a video recorder to HDMI 1, and a DVD player to HDMI 2.

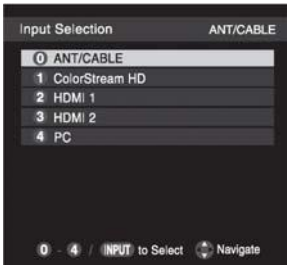

No inputs labeled



All inputs labeled

*(Sample Image) Input selection screens*

To clear the input labels:

- 1 Press the **MENU** button and open the **Preferences** menu.
- 2 Highlight **Input Labeling**, and then press the **ENTER** button.
- 3 Highlight **Reset**, and then press the **ENTER** button.

## Tuning channels using the Channel Browser™

The Channel Browser™ provides an easy navigation interface for all your channels and inputs. This feature allows you to:

- ❖ View and select entries from all of your inputs.
- ❖ Keep a list of your favorite channels, see [“Favorites browser” on page 59](#).
- ❖ Quickly surf and tune your recently viewed channels/inputs from the Channel Browser™ History List.
- ❖ Surf via Browse mode (to immediately tune channels as you highlight them in the Channel Browser™) or Select mode (to surf over channels in the Channel Browser™ before you select one to tune).
- ❖ Quickly change inputs from the Inputs List.
- ❖ Quickly select REGZA-LINK® devices from the REGZA-LINK® List.

## Favorites browser

The Favorites Browser allows you to quickly set up a favorite channels/inputs list that is integrated into the Channel Browser™.

To add a favorite channel/input:

- 1 Tune to the channel or input.
- 2 Press and hold the **FAV** button for a few seconds.

**NOTE** The channel or input is added to the beginning of the Favorites list on the left side of the Channel Browser™.

To delete a favorite channel/input:

- 1 Press the **FAV** button to open the Favorites browser list.
- 2 Highlight the channel or input to delete by pressing the **BACK CB** or **NEXT CB** arrow buttons.
- 3 Press and hold the **100** button for a few seconds. The channel/input will be removed from the Favorites list.

To set up the Channel Browser™:

- 1 In the **Preferences** menu, highlight **Channel Browser Setup**, and then press the **ENTER** button.
- 2 Press the (**▲** arrow) button to highlight **Navigation**, and then press the (**◀/▶** arrow) buttons to select either **Browse Mode** or **Select Mode**.

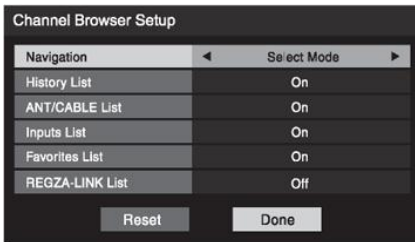

*(Sample Image) Channel browser setup screen*

- 3 Press the (**▼** arrow) button to highlight **History List**, and then press the (**◀/▶** arrow) buttons to select **On** or **Off**.

**NOTE** The History List will be cleared every time the TV is powered off.

- 4 Press the (**▼** arrow) button to highlight **ANT/CABLE List**, and then press the (**◀/▶** arrow) buttons to select **On** or **Off**.

- 5 Press the (▼ arrow) button to highlight **Inputs List**, and then press the (◀/▶ arrow) buttons to select **On** or **Off**.
- 6 Press the (▼ arrow) button to highlight **Favorites List**, and then press the (◀/▶ arrow) buttons to select **On** or **Off**.
- 7 Press the (▼ arrow) button to highlight **REGZA-LINK List**, and then press the (◀/▶ arrow) buttons to select **On** or **Off**.

**NOTE**

REGZA-LINK® List is automatically grayed out and set to Off when Enable REGZA-LINK® is switched to Off. See "Using REGZA-LINK® on page 101.

- 8 To save the new entries, highlight **Done**, and then press the **ENTER** button.

To return to factory defaults, highlight **Reset**, and then press the **ENTER** button.

To open the Channel Browser™:

- ❖ Press the **BACK CB** or **NEXT CB** arrow buttons on the remote control.
- ❖ Press the **BACK CB** arrow button to surf backward through the previously tuned channels in the History list, the channels in the ANT/ CABLE channel list, the inputs in the Inputs list, the favorite channels/inputs in the Favorites list, or the REGZA-LINK® devices in the REGZA-LINK® List.
- ❖ Press the **NEXT CB** arrow button to surf forward through the channel History, the ANT/CABLE channel list, the Inputs list, the favorite channels/inputs in the Favorites list, or the REGZA-LINK® List.

## Elements of the Channel Browser™

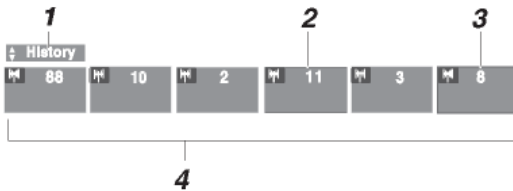

(Sample Illustration) Channel Browser™ elements

- 1 Current list (**History**, **ANT/CABLE**, **Inputs**, **Favorites**, or **REGZA-LINK®**).
- 2 Channel or input type.

*Tuning channels using the Channel Browser™*

- 3 Channel or input that is currently highlighted in the browser.
- 4 Channels stored in the History List.

To toggle among the available lists:

After opening the Channel Browser™, press the (▲/▼ arrow) buttons to toggle through the **History**, **ANT/CABLE**, **Inputs**, **Favorites**, or **REGZA-LINK®** options.

- NOTE**
- ❖ The Channel Browser™ opens in History List by default. Once another list has been selected, the Channel Browser™ will open in the last selected list.
  - ❖ If all lists are turned off, pressing the BACK CB or NEXT CB arrow buttons or the FAV button will not display the Channel Browser™. If Favorites List is turned off, the FAV button will have no effect.
  - ❖ Pressing the FAV button will display the Channel Browser™ Favorites list regardless of the last selected list in the Channel Browser™.

To tune to a channel or input in Browse mode:

- 1 While watching TV, press the **BACK CB** or **NEXT CB** arrow buttons to display the Channel Browser™ and surf back to a previous item or surf forward to the next item in the list.

In Browse mode, when you stop on an item in the Channel Browser™, it is highlighted and the TV automatically tunes to the channel or input.

- 2 Press the **EXIT** button to close the Channel Browser™.

To tune to a channel or input in Select mode:

- 1 While watching TV, press the **BACK CB** or **NEXT CB** arrow buttons to display the Channel Browser™ and surf back to a previous item or surf forward to the next item in the list.

In Select mode, when you stop on an item in the Channel Browser™, it is highlighted, but the TV is not turned to the channel until you press the **ENTER** button.

- 2 Press the **ENTER** button to tune the TV to the highlighted item.
- 3 Press the **EXIT** button to close the Channel Browser™.

---

## Adding and clearing channels and inputs in the History List

Adding channels and inputs to the History List:

As a channel or input is tuned, the Channel Browser™ adds it to the History List and displays it on the right side of the Channel Browser™. Previously tuned channels/inputs are shifted to the left, eventually moving off the left side. Press the **BACK CB** arrow button to surf backward through the previously tuned channels/inputs. Any channel or input that is tuned repeatedly will not be repeated in the History List, but instead is moved to the end of the list on the right side of the Channel Browser™.

The Channel Browser™ will store the following channels:

- ❖ All channels that are tuned using the numeric buttons on the remote control.
- ❖ All channels that are tuned using the **CH Up/CH Down** buttons on the remote control.

---

### NOTE

Whenever an item is selected that cannot be tuned (for various reasons), the TV will automatically tune to the previously viewed channel or input.

---

Clearing channels from the History List:

- ❖ Reconfiguring the ANT/CABLE input will clear the History List. see [“ANT/CABLE IN” on page 45](#)
- ❖ Turning off the TV will clear the History List.

## Tuning to the next programmed channel

To tune to the next programmed channel, press the **CH Up/CH Down** buttons on the remote control or TV control panel.

---

### NOTE

This feature will not function until you have programmed channels into the TV's channel memory, see [“Storing channels in memory \(optional\)” on page 46](#).

---

## Tuning to a specific channel (programmed or unprogrammed)

To tune analog channels:

- ❖ Press the Channel Number (0–9) on the remote control. For example, to select channel 125, press 1, 2, 5, and then press the **ENTER** button.

Tuning digital channels:

- ❖ Press the Channel Number (0–9) on the remote control, followed by the **100** button, and then the sub-channel number. For example, to select digital channel 125-1, press 1, 2, 5, -, 1, and then press the **ENTER** button.

---

**NOTE**

If a digital channel is not programmed, either through the automatic channel scan or the Channel add function, see [“Adding and clearing channels and inputs in the History List” on page 62](#), you will have to tune the RF channel using the Channel Numbers and the 100 button on the remote control.

---

### Switching between two channels using Channel Return

The Channel Return feature allows you to switch between two channels without entering an actual channel number each time.

- 1 Select the first channel you want to view.
- 2 Select a second channel using the Channel Number buttons (and the **100** button if selecting a digital channel).
- 3 Press the **CH RTN** button on the remote control.

The previous channel will display. Each time you press the **CH RTN** button, the TV will switch back and forth between the last two channels that were tuned.

---

**NOTE**

If you press the CH RTN button from a non-antenna input, the TV will return to the last-viewed input.

---

### Switching between two channels using SurfLock™

The SurfLock™ feature temporarily “memorizes” one channel to the **CH RTN** button, so you can return to that channel quickly from any other channel by pressing the **CH RTN** button.

To memorize a channel to the **CH RTN** button:

- 1 Tune the TV to the channel you wish to program into the **CH RTN** button.
- 2 Press and hold the **CH RTN** button for a few seconds until the message “Memorized” appears on the screen. The channel has been programmed to the **CH RTN** button.
- 3 You can then change channels repeatedly, and when you press the **CH RTN** button, the memorized channel will be tuned.

---

The TV will return to the memorized channel one time only. Once you press the **CH RTN** button and then change channels again, the CH RTN memory will be cleared and the button will function as Channel Return, by switching back and forth between the last two channels that are tuned. This feature also works for external inputs.

## Selecting the picture size

You can view many program formats in several picture sizes—Native, 4:3, Full, TheaterWide 1, TheaterWide 2, TheaterWide 3, Normal, and Dot by Dot.

---

**NOTE** The picture size illustrations are examples only. The format of the image (in any of the picture sizes) depends on the format of the signal you are currently watching. Select the picture size that displays the current program in the way that looks best to you.

---

You can save separate picture size preferences for each input on your TV.

To select the picture size:

- 1 Press the **PIC SIZE** button on the remote.
- 2 With the **Picture Size** menu displayed, do one of the following:
  - ❖ Repeatedly press the **PIC SIZE** button to cycle through the picture sizes.
  - ❖ Press the corresponding number button (0-5) while the **Picture Size** menu is displayed.
  - ❖ Press the (▲/▼ arrow) buttons while the **Picture Size** menu is displayed.

---

**NOTE** Using these functions to change the picture size (i.e., changing the height/width ratio) for any purpose other than your private viewing may be prohibited under the Copyright Laws of the United States and other countries, and may subject you to civil and criminal liability.

---

To select the picture size using the menus:

- 1 Select **Picture Size** in the **Theater Settings** menu.
- 2 Press the (◀/▶ arrow) buttons to select the desired picture size setting.
- 3 Highlight **Done**, and then press the **ENTER** button.



---

**NOTE** Some of the picture sizes may not be available depending on the receiving signal format (those will be grayed out in the Picture Size screen).

---

**NOTE** If you select a TheaterWide® picture size, the top and bottom edges of the picture (including subtitles or captions) may be hidden. To view these edges, adjust the Picture Position or try viewing the program in 4:3 or Full, see [“Scrolling the TheaterWide® picture \(TheaterWide 2 and 3 only\)”](#) on page 68.

---

## Full

The Full 16:9 setting is for viewing in the 16:9 (480i, 480p) source programs. If receiving a squeezed 4:3 format program, the picture is stretched horizontally to fill the width of the screen but not stretched vertically.

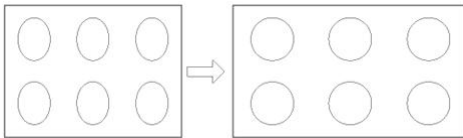

*(Sample Illustration) Picture size - Full 16:9*

The Full setting is for viewing in 1080i, 1080p, and 720p program source.

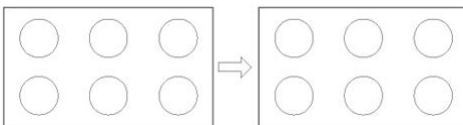

*(Sample Illustration) Picture size - Full*

The edges of the picture may be hidden.

## TheaterWide 1

This setting is for viewing in 4:3 format programs.

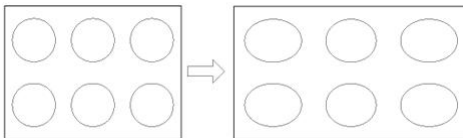

*(Sample Illustration) Picture size - TheaterWide 1*

The center of the picture remains close to its original proportion, but the left and right edges are stretched horizontally to fill the screen.

### TheaterWide 2

This setting is for viewing letter box programs.

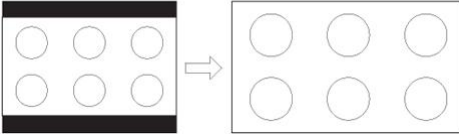

*(Sample Illustration) Picture size - TheaterWide 2, letter box*

The picture's top and bottom edges may be hidden\*.

### TheaterWide 3

This setting is for viewing letter box programs with subtitles.

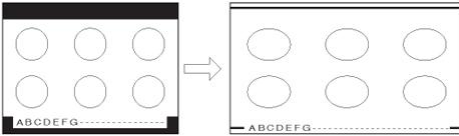

*(Sample Illustration) Picture size - TheaterWide 3, letter box with subtitles*

The picture's top and bottom edges are hidden\*.

\* To view the hidden areas (such as subtitles or captions), see “Scrolling the TheaterWide® picture (TheaterWide 2 and 3 only)” on page 68.

### Native

These settings are for viewing in 480i (HDMI®), 480p (HDMI®), 720p, 1080i, and 1080p signal programs).

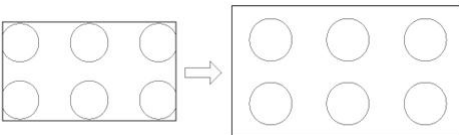

*(Sample Illustration) Picture size - Native*

- ❖ If receiving a 1080i, 1080p, 720p, 480i (HDMI<sup>®</sup>), or 480p (HDMI<sup>®</sup>) signal program, the video is scaled to display the entire picture within the borders of the screen (i.e. no over-scanning).
- ❖ This is especially useful for external HD sources such as DVD movies, Video Games, or computer graphics.

**NOTE**

- ❖ The Native mode is supported only for HDMI<sup>®</sup> (1080i, 1080p, 720p, 480i, and 480p), ColorStream<sup>®</sup> (1080i and 720p), and ANT/CABLE (digital) inputs (1080i, 1080p, and 720p).
- ❖ Depending on the input signal, the picture's border may be hidden, displayed in black, or noisy.

**4:3**

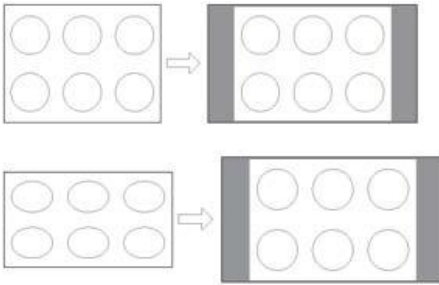

*(Sample Illustration) Picture size - 4:3*

Some program formats will display with sidebars and/or bars at the top and bottom.

**Normal**

This setting is for viewing VGA, SVGA, XGA, WXGA, and SXGA sources.

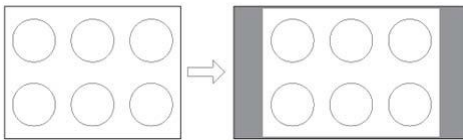

*(Sample Illustration) Picture size - Normal*

This size is a non-stretched display. Some input signal formats will display with sidebars and/or bars at the top and bottom.

## Dot by Dot

This setting is for viewing VGA, SVGA, XGA, WXGA, and SXGA sources.

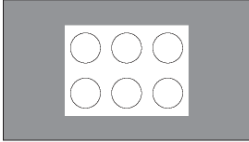

*(Sample Illustration) Picture size - Dot by Dot*

Dot by Dot is a non-scaling display. Depending on the input signal format (VGA, for example) the picture may appear with sidebars and/or bars at the top and bottom.

## Scrolling the TheaterWide® picture (TheaterWide 2 and 3 only)

You can set separate scroll settings for the TheaterWide 2 and TheaterWide 3 modes for each input.

To set the scroll settings:

- 1 Press the **MENU** button and open the **Picture** menu.
- 2 Highlight **Theater Settings**, and then press the **ENTER** button.



*(Sample Image) Picture menu - Theater Settings selection*

- 3 In the Picture Size field, select either **TheaterWide 2** or **TheaterWide 3**

---

**NOTE** You cannot scroll in any other mode.

---

- 4 Press the (▼ arrow) button to select the **Picture Scroll** field.
- 5 Press the (◀/▶ arrow) buttons to scroll the picture up and down as needed.

- 6 To save the new settings, highlight **Done**, and then press the **ENTER** button.

To revert to the factory defaults, highlight **Reset** and then press the **ENTER** button.

The adjustment range is from **-5** to **+10**.

## Using the Auto Aspect feature

When this feature is set to On, the TV will automatically select the picture size when one of the following input sources is received:

- ❖ A 480i, 480p, 720p, 1080i digital signal from the ANT/CABLE input
- ❖ A 480i signal from the ColorStream HD or Video input
- ❖ 480i, 480p, 720p, 1080i, 1080p, or VGA (60Hz) signal from the HDMI 1 or HDMI 2 input.

---

*Aspect Ratio of Signal Source*    *Automatic Aspect Size (automatically selected when Auto Aspect is On)*

---

4:3 Normal

4:3

4:3 Letter Box

TheaterWide 2

16:9 Full

Full

Not defined (no ID-1 data or HDMI® aspect data)

The current picture size you selected, see ["Selecting the picture size"](#) on page 64.

---

### NOTE

The auto aspect ratio feature is not applicable to the PC input.

---

To turn on the auto aspect ratio feature:

- 1 Press the **MENU** button and open the **Picture** menu.
- 2 Highlight **Theater Settings**, and then press the **ENTER** button.
- 3 In the **Auto Aspect Ratio** field, select **On**.
- 4 To save the new settings, highlight **Done**, and then press the **ENTER** button.

To revert to the factory defaults, highlight **Reset** and then press the **ENTER** button.

To turn off the Auto Aspect ratio feature, Select **Off** in step 3 above.

## Selecting the cinema mode

When you view a DVD (3:2 pulldown processed) from a DVD player connected to the **VIDEO**, **ColorStream HD** (component video), or **HDMI** inputs on the TV, smoother motion can be obtained by setting the **Cinema Mode** to **Film**.

To set the Cinema Mode to Film:  
(available for 480i and 1080i signals)

- 1 Press the **MENU** button and open the **Picture** menu.
- 2 Highlight **Picture Settings**, and then press the **ENTER** button.
- 3 Highlight **Advanced Picture Settings**, and then press the **ENTER** button.
- 4 In the **Cinema Mode** field, select **Film**.
- 5 To save the new settings, highlight **Done** and press the **ENTER** button.

To revert to the factory defaults, highlight **Reset** and press the **ENTER** button.

## Using the FREEZE feature

To use the FREEZE feature:

- 1 When watching the TV, press the **FREEZE** button to freeze the picture.
- 2 To unfreeze the picture, press the **FREEZE** button again (or any other button).

---

### NOTE

Using the FREEZE function for any purpose other than your private viewing may be prohibited under the Copyright Laws of the United States and other countries, and may subject you to civil and criminal liability.

---

---

### NOTE

If the TV is left in FREEZE mode for more than 15 minutes, the FREEZE mode will automatically release and the TV returns to normal video.

---

## Adjusting the picture

### Selecting the picture mode

You can select your desired picture settings from the modes described below.

<i>Mode:</i>	<i>Description:</i>
Dynamic	Bright and dynamic picture (factory setting)
Standard	Standard picture settings (factory setting)
Movie	Lower contrast for darkened room (factory setting)
PC	Designed for viewing of PC tables and documents
Preference	Your personal preferences

**NOTE** PC mode is available for HDMI® and PC inputs only (grayed out for other input sources).

To select the picture mode using the menu system:

- 1 Press the **MENU** button and open the **Picture** menu.
- 2 Highlight **Mode**, and then press the **ENTER** button.

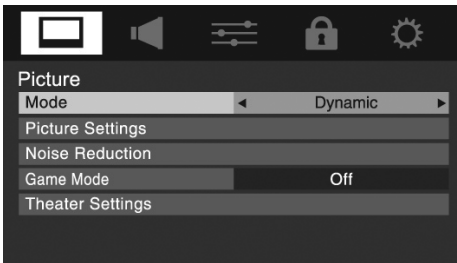

*(Sample Image) Picture menu - Mode selection*

- 3 Press the (▲/▼ arrow) buttons to select the picture mode you prefer, and then press the **ENTER** button.



(Sample Image) Mode selections screen

## Adjusting the picture quality

You can adjust the picture quality (Contrast, Backlight, DynaLight™, Brightness, Color, Tint, and Sharpness.) to your personal preferences.

Selection	Pressing (◀)	Pressing (▶)
Contrast	lower	higher
Backlight*	darker	lighter
DynaLight™**	On/Off	On/Off
Brightness	darker	lighter
Color	paler	deeper
Tint	reddish	greenish
Sharpness	softer	sharper

\* Backlight: adjusts the brightness of the entire screen. When in video mode and no signal is input, this selection is automatically set to 0. (Settings are stored in memory.)

\*\*DynaLight™: automatically strengthens the black coloring of dark areas in the video according to the level of darkness.

To adjust the picture quality:

- 1 Press the **MENU** button and open the **Picture** menu.
- 2 Highlight **Picture Settings**, and then press the **ENTER** button.
- 3 Press the (▲/▼ arrow) buttons to select the picture quality you wish to adjust (Contrast, Backlight, DynaLight™, Brightness, Color, Tint, or Sharpness), and then press the (◀/▶ arrow) buttons to adjust the setting.



- 4 To save the new settings, highlight **Done**, and then press the **ENTER** button. You can use any of the picture modes (see “Selecting the picture mode” on page 71) as a starting point for adjusting the picture settings.

To revert back to the base mode that you began adjusting the picture settings from, highlight **Reset**, and then press the **ENTER** button.

The picture qualities you adjusted are automatically saved in the Preference mode, see “Selecting the picture mode” on page 71 until **Reset** is selected.

## Using closed captions

Closed caption mode has two options:

- ❖ **Captions**—An on-screen display of the dialogue, narration and sound effects of TV programs and videos that are closed captioned (usually marked “CC” in program guides).
- ❖ **Text**—An on-screen display of information not related to the current program, such as weather or stock data (when provided by individual stations).

To view captions or text:

- 1 Press the **MENU** button and open the **Preferences** menu, and then highlight **Base CC Mode**.
- 2 Press the (◀/▶ arrow) buttons to select the desired closed caption mode, and then press the **EXIT** button.

To view captions, highlight **CC1**, **CC2**, **CC3**, or **CC4**. (CC1 displays translation of the primary language in your area.)



*(Sample Illustration) Viewing captions*

### NOTE

If the program or video you selected is not closed captioned, no captions will display on-screen.

To view text, highlight **T1**, **T2**, **T3**, or **T4**.

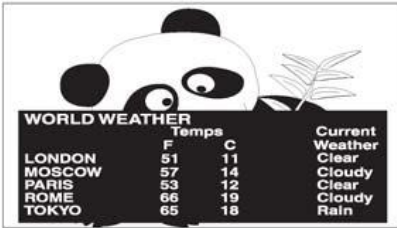

(Sample Illustration) Captions - text

**NOTE** If text is not available in your area, a black rectangle may appear on screen. If this happens, set the Base CC Mode to Off.

To turn off closed caption mode, select **Off** in step 2 above.

**NOTE** A closed caption signal may not display in the following situations:

- ❖ When a recording has been dubbed
- ❖ When the signal reception is weak
- ❖ When the signal reception is non-standard

## Digital CC settings

You can customize the closed caption display characteristics by changing the background color, opacity, text size, type, edge, and color.

**NOTE**

- ❖ These settings are available for digital channels only.
- ❖ You cannot set Caption Text and Background as the same color.

To customize closed captions:

- 1 Press the **MENU** button and open the **Preferences** menu.
- 2 Highlight **Digital CC Settings**, and then press the **ENTER** button.
- 3 Press the (**▲/▼** arrow) buttons to highlight the characteristic you wish to change, and then press the (**◀/▶** arrow) buttons to select the format for that characteristic.

- 4 To save the new settings, highlight **Done**, and then press the **ENTER** button.  
To revert to the factory defaults, highlight **Reset**, and then press the **ENTER** button.

<i>Mode:</i>	<i>Description</i>
Caption size	Auto, Small, Standard, Large
Caption text type	Auto, Default, Mono (with Serif), Prop. (with Serif), Mono (without Serif), Prop. (without Serif), Casual, Cursive, Small Capitals
Caption text edge	Auto, None, Raised, Depressed, Uniform, Left Drop Shadow, Right Drop shadow
Caption text color	Auto, Black, White, Red, Green, Blue, Yellow, Magenta, Cyan
Text foreground opacity	Auto, Transparent, Translucent, Flashing, Solid
Background color	Auto, Black, White, Red, Green, Blue, Yellow, Magenta, Cyan
Text background opacity	Auto, Transparent, Translucent, Flashing, Solid
Caption text edge color	Auto, Black, White, Red, Green, Blue, Yellow, Magenta, Cyan

## CC Selector

You can use the CC Selector to temporarily override the default analog caption mode (set in Base CC Mode) for a particular channel. However, once you change to any other channel, the closed caption setting will automatically change back to the current Base CC Mode setting.

You can also use the CC Selector to select digital closed caption services, if available. When such services are not available, the CC Selector presents a default list of services. If the selected service is not available, the next best service will be used.

To select closed captions:

- 1 Press the **MENU** button and open the **Preferences** menu.
- 2 Highlight **CC Selector**, and then press the **ENTER** button.
- 3 Press the (▲/▼ arrow) buttons to select **Closed Caption**, and then press the (◀/▶ arrow) buttons to select the desired service.

- 4 To save the new settings, highlight **Done**, and then press the **ENTER** button.
- 5 Press the **EXIT** button.

## Adjusting the audio

### Muting the sound

Press the **MUTE** button to partially reduce (1/2 Mute) or turn off (Mute) the sound. Each time you press the **MUTE** button, the mute mode changes in the following order: 1/2 Mute, Mute, Volume, 1/2 Mute, etc.



*(Sample Image) Levels of mute*

If closed caption mode is set to **Off** when you select **MUTE** mode, the closed caption feature becomes active if the TV program is closed captioned. To mute the audio without activating the closed captioning, press the **VOL-** button to set the volume to 0.

For more information, see [“Using closed captions” on page 73](#).

---

**NOTE** If you modify items in the SOUND menu while Mute is active, Mute is cancelled.

---

### Using the digital audio selector

You can use the Digital Audio Selector to conveniently switch between audio tracks on a digital channel (for those channels that have multiple audio tracks). This temporarily overrides the audio track chosen by the language option under Audio Setup, see [“Selecting stereo/SAP broadcasts” on page 77](#).

- 1 Press the **MENU** button and open the **Sound** menu.

- 2 Highlight **Digital Audio Selector**, and then press the **ENTER** button.

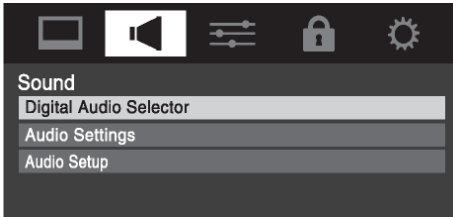

*(Sample Image) Sound menu - Digital Audio Selector selection*

- 3 Press the (▲/▼ arrow) buttons to select **Audio**, and then press the (◀/▶ arrow) buttons to select the desired service.
- 4 Press the **EXIT** button.

## Selecting stereo/SAP broadcasts

The multi-channel TV sound (MTS) feature allows you to output high-fidelity stereo sound. MTS also can transmit a second audio program (SAP) containing a second language, music or other audio information (when provided by individual stations).

When the TV receives a stereo or SAP broadcast, the “Stereo” mark and/or word “SAP” appears when the INFO button is pressed. The MTS feature is only available for analog signals on the ANT/CABLE input.

To listen in stereo sound:

- 1 Press the **MENU** button and open the **Sound** menu.
- 2 Highlight **Audio Setup**, and then press the **ENTER** button.
- 3 In the **MTS** field, select **Stereo**.
- 4 To save the new settings, highlight **Done**, and then press the **ENTER** button.

To reset the settings to the factory defaults, highlight **Reset**, and then press the **ENTER** button.

- 
- NOTE**
- ❖ You can typically leave the TV in Stereo mode because it outputs the type of sound being broadcast (stereo or monaural).
  - ❖ If the sound is noisy, select Mono to reduce the noise.
-

---

To listen to an alternate language on an ATSC digital station (if available), highlight the **Language** field in step 3 above, and then press the (◀/▶ arrow) buttons to select the language you prefer.

To listen to a second audio program on an analog station, if available, select **SAP** in step 3 above.

- 
- NOTE**
- ❖ A second audio program (SAP) can be heard only on those TV stations that offer it. For example, a station might broadcast another language as a second audio program. If you have SAP on, you will see the current program on the screen but hear the other language instead of the program's normal audio.
  - ❖ If you have SAP on and the station you are watching is not broadcasting a second audio program, the station's normal audio will be output. However, occasionally there is no sound at all in SAP mode. If this happens, set the MTS feature to Stereo mode.
- 

## Adjusting the audio quality

You can adjust the audio quality by adjusting the bass, treble and balance.

To adjust the audio quality:

- 1 Press the **MENU** button and open the **Sound** menu.
- 2 Highlight **Audio Settings**, and then press the **ENTER** button.
- 3 Press the (▲/▼ arrow) buttons to highlight the item you wish to adjust (Bass, Treble, or Balance).
- 4 Press the (◀/▶ arrow) buttons to adjust the level.
  - ❖ ◀ makes the bass or treble weaker or increases the balance in the left channel (depending on the item selected).
  - ❖ ▶ makes the bass or treble stronger or increases the balance in the right channel (depending on the item selected).
- 5 To save the new settings, highlight **Done**, and then press the **ENTER** button.

To reset the settings to the factory defaults, highlight **Reset**, and then press the **ENTER** button.

## Audyssey ABX™

Audyssey ABX™ technology uses sophisticated driver analysis and low frequency monitoring to extend the range and bass of small speakers.

To turn on Audyssey ABX™:

- 1 Press the **MENU** button and open the **Sound** menu.
- 2 Highlight **Audio Settings**, and then press the **ENTER** button.
- 3 Press the (▲/▼ arrow) buttons to highlight the **Audyssey ABX™** field.
- 4 Press the (◀/▶ arrow) buttons to select **On**.

## Stable Sound

The Stable Sound feature limits high volume levels and prevents the extreme changes in volume that can occur when channels are changed or a program switches to a commercial.

To turn on Stable Sound:

- 1 Press the **MENU** button and open the **Sound** menu.
- 2 Highlight **Audio Settings**, and then press the **ENTER** button.
- 3 Press the (▲/▼ arrow) buttons to highlight the **Stable Sound** field.
- 4 Press (◀/▶ arrow) buttons to select **On**.

## Selecting the optical audio output format

You can select the optical audio output format when you connect a Dolby® Digital decoder or other digital audio systems to the TV's Optical Audio Out terminal (see [“Connecting a digital audio system” on page 30](#)).

To select the optical audio output format:

- 1 Press the **MENU** button and open the **Sound** menu.
- 2 Highlight **Audio Setup**, and then press the **ENTER** button.
- 3 In the **Optical Output Format** field, select either **Dolby Digital** or **PCM**, depending on your device.
- 4 To save the new settings, highlight **Done**, and then press the **ENTER** button.

To reset the settings to the factory defaults, highlight **Reset**, and then press the **ENTER** button.

## Using the Dolby® Digital Dynamic Range Control feature

You can further compress Dolby Digital and Dolby Digital Plus dynamic range, allowing you to switch from digital to analog broadcasts at the same dynamic range.

To use the Dolby Digital Dynamic Range Control:

- 1 Press the **MENU** button and open the **Sound** menu.
- 2 Highlight **Audio Setup**, and then press the **ENTER** button.
- 3 In the **Dolby Digital Dynamic Range Control** field, select either **Compressed** or **Standard**. When **Standard** is selected, the audio outputs with minimal compression.
- 4 To save the new settings, highlight **Done**, and then press the **ENTER** button.

To reset the settings to the factory defaults, highlight **Reset**, and then press the **ENTER** button.

### NOTE

- ❖ This feature is available when the TV is tuned to a digital RF channel with the Dolby Digital signal.
- ❖ The Dolby Digital Dynamic Range Control will function in relation to Optical Output Format (PCM mode).

## Using the Locks menu

The Locks menu includes the Enable Rating Blocking, Edit Rating Limits, Input Lock, Panel Lock, GameTimer® and New PIN Code features. You can use these features after entering the correct PIN code.

### Entering the PIN code

- 1 Press the **MENU** button and highlight the **Locks** menu icon.



*(Sample Image) Locks menu screen (for USA region)*



- 2 Press the (▼ arrow) button to display the PIN code entry screen.

The Lock System screen appears if a PIN code has not been stored.



*(Sample Image) Lock system - store PIN screen*

- ❖ Press the Channel Number buttons to enter a new four-digit code, enter the code a second time to confirm, and then press the **ENTER** button.

The Locks/Active screen appears if the PIN code is already stored.

- ❖ Use the Number buttons to enter your four-digit code, and then press the **ENTER** button.

If the wrong PIN code is entered, the message “Incorrect PIN code, please try again!” appears.

- ❖ Highlight **Retry**, and then press the **ENTER** button.
- ❖ Enter the code again, and then press the **ENTER** button.

When the correct PIN code is entered, the **Locks** menu opens.

---

**NOTE** The PIN code cannot be set to “0000.”

---

## Forgotten PIN code

While the PIN code entering screen is displayed, press the **INFO** button four times within five seconds. The PIN code will be cleared and you can enter a new PIN code.

## Changing or deleting your PIN code

- 1 Press the **MENU** button and highlight the **Locks** menu icon.
- 2 Press the (▼ arrow) button to display the PIN code entering screen.

- 3 Enter your four-digit PIN code, and then press the **ENTER** button.
- 4 Press the (▼ arrow) button to highlight **New PIN Code**, and then press the **ENTER** button.
- 5 Press the Number buttons to enter a new four-digit code. Reenter the PIN code to confirm it.
- 6 Press the **ENTER** button.

The new PIN code is now active.

**NOTE** The PIN code cannot be set to "0000."

## Using parental controls (for USA region)

### Blocking TV programs and movies by rating (V-Chip)

Some TV programs and movies include signals that classify the content of the program (as unsuitable for younger viewers). The V-Chip feature in this TV detects the signals and blocks the programs according to the ratings you select.

- 1 Press the **MENU** button and highlight the **Locks** menu icon.
- 2 Press the (▼ arrow) button to display the PIN code entering screen.
- 3 Enter your four-digit PIN code, and then press the **ENTER** button.
- 4 Press the (▼ arrow) button to highlight **Enable Rating Blocking**.
- 5 Press the (▶ arrow) button to select **On**.



*(Sample Image) Locks menu - Enable Rating Blocking selection (for USA region)*

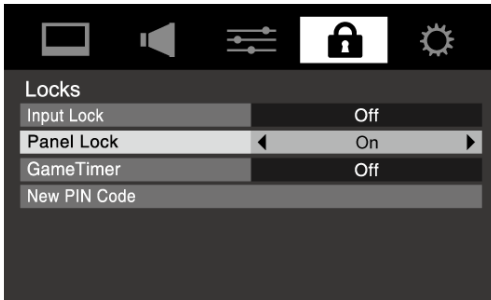

*(Sample Image) Locks menu screen for other regions*

- 6 Press the (▼ arrow) button to highlight **Edit Rating Limits**, and then press the **ENTER** button.
- 7 For each desired selection, press the (▲/▼/◀/▶ arrow) buttons to highlight the selection, and then press the **ENTER** button to select it.  
A box with an “X” is a rating that will be blocked. As you highlight a rating, a definition for the rating appears at the bottom of the screen.
- 8 To save the new settings, highlight **Done**, and then press the **ENTER** button.

**NOTE** The above blocking level selection is for the U.S V-Chip system. For the Canadian Rating menu, highlight “Canada RS,” and then press the **ENTER** button.

## Downloading an additional rating system

In the future, an additional rating system may become available for use in selectively blocking TV programs and movies.

**NOTE** The currently tuned station must be receiving a digital signal before an additional rating system can be downloaded.

To download the additional rating system, if available:

- 1 Press the **MENU** button and highlight the Locks menu icon.
- 2 Press the (▼ arrow) button to display the PIN code entering screen.
- 3 Enter your four-digit PIN code, and then press the **ENTER** button.

- 4 Press the (▼ arrow) button to highlight **Enable Rating Blocking**.
  - 5 Press the (▶ arrow) button to select **On**.
  - 6 Press the (▼ arrow) button to highlight **Edit Rating Limits**, and then press the **ENTER** button.  
The Edit Rating Limits screen appears.
  - 7 Highlight **Alt RS**, and then press the **ENTER** button.  
The Edit Alternate Ratings screen appears.
- 

**NOTE**

- ❖ The Alt RS button will only be available if an additional rating system is currently available.
  - ❖ It may take several minutes for the TV to download the additional rating system.
  - ❖ The information displayed in the Alternate Ratings screen will depend on the configuration of the additional rating system available at the time of download.
- 

- 8 For each desired selection, press the (▲/▼/◀/▶ arrow) buttons to highlight the selection, and then press the **ENTER** button to select it.  
A box with an “X” is a rating that will be blocked.
  - 9 To save the new settings, highlight **Done**, and then press the **ENTER** button.
  - 10 In the Edit Rating Limits screen, highlight **Done**, and then press the **ENTER** button.
- 

**NOTE**

- ❖ The additional rating system can only be downloaded one time. You will not be able to download any updates to the rating system should such updates become available.
  - ❖ The additional rating system is not designed, transmitted or controlled by the TV or Toshiba, nor is the availability of an additional rating system determined or controlled by Toshiba. Similarly, the rating of programs in an additional rating system is not determined, transmitted or controlled by the TV or Toshiba.
  - ❖ The additional rating system is an evolving technology; therefore, availability, content and format may vary.
-

**Rating system**

Independent rating system for broadcasters:

<i>Ratings:</i>	<i>Description and Content themes:</i>
TV-MA	Mature Audience Only (This program is specifically designed to be viewed by adults and therefore may be unsuitable for children under 17. L) Crude or indecent language S) Explicit sexual activity V) Graphic violence
TV-14	Parents Strongly Cautioned (This program contains some material that many parents would find unsuitable for children under 14 years of age.) D) Intensely suggestive dialogue L) Strong, coarse language S) Intense sexual situations V) Intense violence
TV-PG	Parental Guidance Suggested (This program contains material parents may find unsuitable for younger children.) D) Some suggestive dialogue L) Infrequent coarse language S) Some sexual situations V) Moderate violence
TV-G	General Audience (Most parents would find this program suitable for all ages)
TV-Y7, TV-Y7FV	Directed to Older Children (This program is designed for children age 7 and above.  NOTE: Programs in which fantasy violence may be more intense or more combative than other programs in this category are designated TV-Y7FV.)
TV-Y	All Children (This program is designed to be appropriate for all children)

Independent rating system for movies:

<i>Ratings:</i>	<i>Description and Content themes:</i>
X	X-rated (For adults only)
NC-17	Not intended for anyone 17 and under
R	Restricted (Under 17 requires accompanying parent or adult)
PG-13	Parents Strongly Cautioned (Some material may be inappropriate for children under 13)
PG	Parents Guidance Suggested (Some material may be not be suitable for children)

Ratings:	Description and Content themes:
G	General Audience (Appropriate for all ages)
Indication other than rating system:	
Display:	Description:
NONE	The program is rated None.
(No rating appears)	No rating information is provided.

**NOTE**

If you place an "X" in the box next to "None" Rated, programs rated "None" or "Not Rated" will be blocked; Programs that do not provide any rating information will not be blocked.

## Displaying ratings

To display the rating of the program you are watching, press the **INFO** button on the remote control. If it is rated "None" the word "NONE" appears in the INFO screen. If rating information is not provided, no rating will appear in the INFO screen.



*(Sample Image) Rating Info screens*

## Unlocking programs temporarily

If you try to tune to a program that exceeds the rating limits you have set, the TV will enter program lock mode and a warning message appears on the screen. Follow the instructions to temporarily unlock the program.

This program exceeds the rating limit you set.  
Push 'MUTE' to enter PIN.

*(Sample Illustration) Warning - exceeded rating limit*

You can either temporarily unlock the program or select an unlocked program to watch.

To temporarily unlock the program:

- 1 Press the **MUTE** button.
- 2 Enter your four-digit PIN code, and then press the **ENTER** button.

If the correct code is entered, the program lock mode is released and the normal picture appears. All locking will be enabled again when you change the channel.

## Using the input lock feature

You can use the Input Lock feature to lock the video inputs (Video, ColorStream HD, HDMI 1, HDMI 2, and PC) and channels 3 and 4. You will not be able to view the input sources or channels until you unlock the inputs.

To lock/unlock the video inputs:

- 1 From the **Locks** menu, press the (▼ arrow) button to display the PIN code entering screen.
- 2 Enter your four-digit PIN code, and then press the **ENTER** button.
- 3 Press the (▼ arrow) button to highlight **Input Lock**, and then press the (▶ arrow) button to select the level of video input locking you prefer.
- 4 Press the **EXIT** button.

<i>Mode:</i>	<i>Description:</i>
Video	Locks Video, ColorStream HD, HDMI 1, HDMI 2 and PC.
Video+	Locks Video, ColorStream HD, HDMI 1, HDMI 2, PC and channels 3 and 4. Select Video+ if you play video tapes via an ANT/CABLE input.
Off	Unlocks all video inputs and channels 3 and 4.

## Locking channels

With the Lock feature, you can lock specific channels. Locked channels can only be accessed by entering the PIN code, see “Entering the PIN code” on page 80.

To lock channels:

- 1 From the **Setup** menu, highlight **Installation**, and then press the **ENTER** button.
- 2 Press the **ENTER** button to select **Terrestrial**.

- 3 Press the (▲/▼ arrow) buttons to select **Channel Options**, and then press the **ENTER** button.

The list of channels appears.

The screenshot shows a 'Channel Options' menu with a table of channels. The table has columns for 'Ch.', 'Type', and a grid of lock icons. Channel 1 is highlighted, and its lock icon is checked.

Ch.	Type	Lock Icon
1	Digital	<input checked="" type="checkbox"/>
2	Analog	<input type="checkbox"/>
3	Digital	<input type="checkbox"/>
4	Analog	<input type="checkbox"/>
5	Analog	<input type="checkbox"/>
6	Analog	<input type="checkbox"/>
7	Analog	<input type="checkbox"/>
8	Analog	<input type="checkbox"/>

(Sample Illustration) Channel options

- 4 Press the (▶ arrow) button, and then press the (▲/▼ arrow) buttons to select a channel in the lock column.
- 5 Press the **ENTER** button.  
PIN code entry will be required to set a locked channel.

**NOTE** If the PIN code has not yet been set, a warning message appears.

- 6 A check appears in the box.
- 7 To remove the check, press the **ENTER** button.
- 8 Press the **EXIT** button.

## Using the GameTimer®

You can use the GameTimer® to set a time limit for playing a video game (30–120 minutes). When the GameTimer® expires, the TV enters Input Lock mode and locks out the input source for the video game device.

To set the GameTimer®:

- 1 From the **Locks** menu, press the (▼ arrow) button to display the PIN code entering screen.
- 2 Enter your Four-digit PIN code, and then press the **ENTER** button.
- 3 Press the (▼ arrow) button to highlight **GameTimer**, and press the (▶ arrow) button to until the desired Input Lock is activated (30, 60, 90 or 120 minutes).



To cancel the GameTimer<sup>®</sup>, select **Off** in step 3 above.

To deactivate the Input Lock once the GameTimer<sup>®</sup> has activated it:

- ❖ Set the Input Lock to **Off**, see “Using the input lock feature” on page 87.

**NOTE**

- ❖ A message appears when 10 minutes, 3 minutes, and 1 minute are remaining.
- ❖ If the TV loses power with time remaining, the TV will enter Input Lock mode when power is restored (as if the GameTimer<sup>®</sup> had been activated). To resume use, you must deactivate the Input Lock, see “Using the input lock feature” on page 87

## Using the panel lock feature

You can lock the control panel to prevent your settings from being changed accidentally (by children, for example). When Panel Lock is set to **On**, none of the controls on the control panel operate except **POWER**.

To lock the control panel:

- 1 Press the **MENU** button and highlight the **Locks** menu.
- 2 Press the (▼ arrow) button to display the PIN code entering screen.
- 3 Enter your four-digit PIN code, and then press the **ENTER** button.
- 4 Press the (▼ arrow) button to highlight **Panel Lock**.
- 5 Press the (▶ arrow) button to select **On**.

When the control panel is locked and any button on the control panel (except **POWER**) is pressed, the message “NOT AVAILABLE” appears.



(Sample Illustration) Locks menu - Panel Lock selection

To unlock the control panel, select **Off** in Step 5 in this section or press and hold the **VOLUME-** button on the TV control panel for approximately 15 seconds until the volume icon appears.

## Using the PC settings feature

You can view an image from a PC on the TV screen. When a PC is connected to the TV's PC IN terminal, you can use the PC Settings feature to make adjustments to the image. If the edges of the picture are cut off, readjust the Horizontal Position and Vertical Position. If the picture is affected by interference, readjust the Clock Phase and Sampling Clock.

To adjust the PC settings:

- 1 Repeatedly press the **INPUT** button to select **PC Input** mode, see "Selecting the video input source" on page 54.
- 2 Press the **MENU** button and open the **Setup** menu.
- 3 Press the (**▲/▼** arrow) buttons to select **PC Settings**, and then press the **ENTER** button.



(Sample Image) Setup menu - PC Settings selection

**NOTE** If a computer is not connected or there is no PC input signal, this feature will be grayed out in the Setup menu.

- 4 Press the (**▲/▼** arrow) buttons to select an item.
- 5 Press the (**◀/▶** arrow) buttons to make the appropriate adjustments.

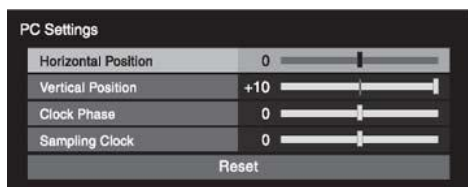

(Sample Image) PC Settings - adjustments screen

---

**NOTE** The screen is disrupted momentarily while adjusting the PC settings. This is not a sign of malfunction.

---

<i>Mode:</i>	<i>Description:</i>
Horizontal Position	Moves the picture left/right. The adjustment range is within $\pm 10$ from center.*
Vertical Position	Moves the picture up/down. The adjustment range is within $\pm 10$ from center.*
Clock Phase	Helps to reduce noise and sharpen the picture. The adjustment range is within $\pm 16$ from center.*
Sampling Clocks	Helps to reduce noise and minimize periodic vertical stripes on the screen. The adjustment range is within $\pm 10$ from center.*
Reset	Highlight this item, and then press the ENTER button to get an optimum adjustment automatically.

---

\* The default settings and/or adjustment ranges may vary depending on the input signal format.

## Setting the PC Audio

You can output or mute sound from your computer when connecting it to your TV using the AUDIO IN terminal and PC audio cable.

To set the PC Audio:

- 1 Press the **MENU** button and open the **Sound** menu.
- 2 Highlight **Audio Setup**, and then press the **ENTER** button.
- 3 Press the ( $\blacktriangle/\blacktriangledown$  arrow) buttons to select **PC Audio**, and then press the ( $\blacktriangleleft/\blacktriangleright$  arrow) buttons to select **No** or **Yes**.
  - ❖ **Yes:** When viewing the PC input, the audio from the PC Audio input can be heard.
  - ❖ **No:** When viewing the PC input, there will be no audio.

---

**NOTE** Because the PC and HDMI 1 inputs share the same set of analog audio inputs, the PC Audio menu setting influences the HDMI 1 Audio menu setting. If PC Audio is set to "No" the HDMI 1 Audio setting changes to "Auto." If PC Audio is set to "Yes" the HDMI 1 Audio setting is set to "Digital" and is grayed out in the menu. (See also "Setting the HDMI® audio mode" on page 50)

---

---

## Using the Media Player

### Using Media Player with a USB device

You can enjoy photos or music contents stored on a USB storage device.

Photo Viewer specifications:

- ❖ Data type: JPEG EXIF ver 2.1
- ❖ File format: JPEG
- ❖ Maximum photo size: 6 MB
- ❖ Maximum number of files: 500/folder
- ❖ Maximum photo resolution:  
4096 x 4096 pixels
- ❖ Best photo resolution:  
1366 x 768 pixels (C120U)  
1920 x 1080 pixels (E220U)

Music Player specifications:

- ❖ File format: MP3
- ❖ Sampling frequency: 16 kHz, 22.05 kHz, 24 kHz, 32 kHz, 44.1 kHz, 48 kHz
- ❖ Bit rate: from 8 to 320 kbps
- ❖ Maximum number of files: 500/folder

Supported file system:

- ❖ FAT16 and FAT32

- 
- NOTE**
- ❖ Gently insert the USB device into the port and do not remove while viewing Media Player.
  - ❖ USB device: USB Mass Storage Class device (MSC)
  - ❖ Connectivity is not guaranteed for all devices.
  - ❖ Connect the USB device to the TV directly.
  - ❖ Do not use a USB Hub.
  - ❖ You must obtain any required permission from copyright owners to use copyright content. Toshiba cannot and does not grant such permission.
  - ❖ Depending on the file size and amount in your USB storage device, it may take some time to load before content is viewable. A message will display on-screen when files are loading from the USB storage device.
  - ❖ Only limited types of U3 USB device are supported. Therefore, it is suggested that you not use U3 USB with Media Player.
  - ❖ Non-supported characters will be replaced with a square.
- 

## Auto Start function

When Auto Start is enabled, you will be asked if you want to start the Media Player when a USB device is inserted. If Auto Start is disabled, you must manually start the Media Player from the menu.

To change the Auto Start setting:

- 1 Press the **MENU** button and open the **Setup** menu.
- 2 Press the (▼ arrow) button to select **Media Player**, and then press the **ENTER** button.
- 3 Press the (▲/▼ arrow) buttons to highlight **Auto Start**.
- 4 Press the (◀/▶ arrow) buttons to select **On** or **Off**.

## To open the Media Player

Auto Start:

- 1 Gently insert a supported USB storage device to the USB port on the side of the TV. A prompt will appear.

- 
- NOTE** If you repeatedly insert and remove the USB connector, the prompt may not appear.
-

- 2 Press the (◀/▶ arrow) buttons to select **Yes**, and then press the **ENTER** button.

The Media Player menu appears. (If you select No, nothing happens.)

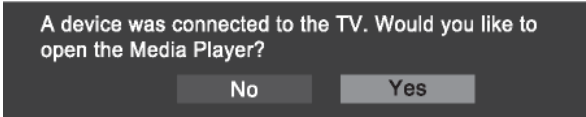

*(Sample Image) Media Play - open screen*

- NOTE**
- ❖ The prompt will disappear after about 10 sec.
  - ❖ If Auto Start is set to off, you can start the Media Player manually.

Manual Start:

- 1 Press the **MENU** button and open the **Setup** menu.
- 2 Press the (▼ arrow) button to select **Media Player**, and then press the **ENTER** button.
- 3 Press the (▲/▼ arrow) buttons to highlight **Photo** or **Music**, and then press the **ENTER** button.



*(Sample Image) Media Play screen*

- NOTE**
- ❖ The viewer will open even if there are no photo or music files.
  - ❖ While the Media Player is active, the main menus cannot be displayed.

## Viewing photo files

There are three types of view modes, multi view, single view, and slide show.

### Multi View

This view allows you to search for photos in a grid format. These pictures are displayed using thumbnail data in each image file.



*(Sample Image) Media Play - photos screen*

To use multi view:

- 1 Press the (▲/▼/◀/▶ arrow) buttons to move the highlight in one window. If all of the photos will not fit in one screen, the screen will move to the previous page when you press ◀ from the top left thumbnail. When you press ▶ from the bottom right thumbnail, the screen will move to the next page. You can also use the CH Up/CH down buttons to page up or down the in photo list when there are more photos than will fit on one screen.
- 2 When you select a folder, press the **ENTER** button to move to the next layer, or press the **CH RTN** button to return to the previous layer.
- 3 Press the **ENTER** button to view the selected photo in Single View mode.

### Single view

In this view mode, only files located in the selected directory will be displayed. This view allows you to change the photo content manually. When you move from Multi View to the Single View, the currently selected photo is displayed.

To use single view:

- ❖ Press the (▶ arrow) button to view the next photo. Press ◀ to view the previous photo.

- ❖ Press ▲ to rotate the image 90° counterclockwise. Press ▼ to rotate the image 90° clockwise.

### Slide show

This view allows you to watch a slide show of the photos. In this mode, only files located in the selected directory will be played.

To use slide show:

- 1 Press the **ENTER** button in the Single View mode.
- 2 Press the (◀▶ arrow) buttons to view the previous or next photo.

To set Interval Time and Repeat settings:

- 1 Press the **MENU** button to open the **Quick Menu**.
- 2 Press the (▲/▼ arrow) buttons to select either **Interval Time** or **Repeat**.
- 3 Press the (◀▶ arrow) buttons to adjust the setting and press the **CH RTN** button.

**NOTE** Zoom and Picture size functions are disable.

To close the Photo Viewer, press the **EXIT** button. The television will return to the last viewed channel or external input.

### Playing music files

You can listen to music from a list of available files.



*(Sample Image) Media Player - Music screen*

- 1 Press **MENU** and open the **Preferences** menu.
- 2 Highlight **Media Player** and press the **ENTER** button.



- 3 Press the (▲/▼ arrow) buttons to select a file or folder. You can use the **CH Up/CH Down** buttons to page up or down the music list when there are more files than will fit onto one screen.
- 4 Select the desired folder and press the **ENTER** button to move to the next layer. Press the **CH RTN** button to move back to the previous layer.
- 5 With the desired file selected, press the **ENTER** button or the **PLAY** button to start playback press.
- 6 Press the **STOP** button to stop playback

- NOTE**
- ❖ If playback finishes before **STOP** is pressed, the next file will automatically start to play from the beginning.
  - ❖ Depending on the file size, it may take some time for playback to begin.

During playback you can do the following:

- ❖ Press **PAUSE** to pause.
- ❖ To resume normal playback, press **PLAY**.
- ❖ To locate a specific file, press the **SKIP Reverse** or **SKIP Forward** button repeatedly.
- ❖ To adjust volume, press the **+VOL/VOL-** buttons.

- NOTE** During playback, you can adjust the **SOUND** menu functions from the **Quick Menu**.

To set the repeat mode:

- 1 Press the **MENU** button to open the **Quick Menu**.
- 2 Press the (▲/▼ arrow) buttons to select **Repeat**.
- 3 Press the (◀▶ arrow) buttons to select **Off**, **All** or **1**.
- 4 Press **CH RTN**.

To close the Music Player, press **EXIT**.

---

## Viewing photo files and playing music files at the same time

While viewing photo files, you can listen to music from a list of available files.

- 1 While viewing photos in the **Single View** or **Slide Show** mode, press **MENU** to open the **Quick Menu**.
- 2 Highlight **Background Music** and press the **ENTER** button.  
The music list appears.
- 3 Select a music file and press the **ENTER** button to start playback.
- 4 Press **CH RTN** twice to move back to photo view mode.  
The music is now playing in the background.

## Sorting photo or music files

From the photos Multi View or from the music list, you can sort your photo or music folders and files.

To sort photo or music folders and files:

- 1 From photo Multi View mode or from the music list, press the **MENU** button to open the **Quick Menu**.
- 2 Press the (▲/▼ arrow) buttons to select **Sort**.
- 3 Press the (◀/▶ arrow) buttons to select **Title**, **New**, or **Old** to set the sorting rule.

**Title**-File sorting rules:

- ❖ Unicode priority
- ❖ Numerical (0-9), Uppercase (A-Z), lowercase (a-z), Chinese
- ❖ Increasing order

**New**-From new to old according to the date and time when the picture was taken.

**Old**-From old to new according to the date and time when the picture was taken.

---

**NOTE** During playback, you can adjust the SOUND menu functions from the Quick Menu.

---

---

## Setting the sleep timer

You can set the sleep timer to turn off the TV after a set length of time (maximum of 12 hours).

To set the sleep timer using the remote control:

- 1 Press the **SLEEP** button on the remote control to set the length of time until the TV turns off.
- 2 Repeatedly press the **SLEEP** button to increase the time in 10-minute increments, or press the (▲/▼ arrow) buttons to increase or decrease the time in 10-minute increments, to a maximum of 12 hours.

To set the sleep timer using the on-screen menus:

- 1 Press the **MENU** button and open the **Setup** menu.
- 2 Highlight **Sleep Timer** and press the **ENTER** button.
- 3 Press the Number buttons to enter the length of time (maximum of 12 hours) and then press **ENTER**.  
Or press the (◀▶ arrow) buttons to increase or decrease in 10-minute increments (maximum of 12 hours).

---

**NOTE** If a power failure occurs, the sleep timer setting may be cleared.

---

To display the time remaining until the TV turns off, press the **SLEEP** button.

---

**NOTE** A message will display on-screen when there is one minute remaining on the sleep timer.

---

To cancel the sleep timer, repeatedly press **SLEEP** until it is set to 0 minutes.

## Auto Brightness Sensor

When the Auto Brightness Sensor Setting is set to **On**, the television optimizes the backlighting levels to suit ambient light conditions.

To turn on Auto Brightness:

- 1 From the **Preferences** menu, highlight **Energy Saving Settings** and press **ENTER**.
- 2 Press the (▲/▼ arrow) buttons to select **Auto Brightness Sensor**.

- 3 Press the (◀▶ arrow) buttons to select **On** or **Off**, and press **EXIT**.

## Automatic Power Down

The TV can be configured to automatically turn itself off after 4 hours if you do not operate the TV either from the remote control or the TV control panel.

- 1 From the **Preferences** menu, highlight **Energy Saving Settings** and press **ENTER**.
- 2 Press the (▲/▼ arrow) buttons to select **Automatic Power Down**.
- 3 Press the (◀▶ arrow) buttons to select **On** or **Off**, and press **EXIT**.

### NOTE

The default setting of this feature is Off.

One minute before the TV switches to standby, a warning message will appear.

When the following features are set, the feature that is set for the nearest time will function.

- ❖ Automatic Power Down
- ❖ Sleep Timer
- ❖ No signal auto power off (after 15 minutes of no signal)

## No Signal Power Down

The TV will automatically turn itself off after 15 minutes when no signal is detected.

- ❖ You can change the setting to Off for the following purposes:
- ❖ Low signal strength of analog channel (no signal detection)
- ❖ Only Audio L/R is connected to external input to listen to music through the TV speakers.

To change the no signal power down setting:

- 1 From the **Preferences** menu, highlight **Energy Saving Settings** and press **ENTER**.
- 2 Press the (▲/▼ arrow) buttons to select **No Signal Power Down** and press **ENTER**.

- 3 Press the (▲/▼ arrow) buttons to highlight the item you want to change, and press the (◀/▶ arrow) buttons to select **On** or **Off**.

- NOTE**
- ❖ Default setting for this feature is On.
  - ❖ A warning message will appear 1 minute before the TV turns off.

## Using REGZA-LINK®

This is a new feature that uses CEC technology and allows you to control Toshiba REGZA-LINK® compatible devices from the TV remote via HDMI® connection (see “REGZA-LINK® connection” on page 29).

When **Enable REGZA-LINK** in the **REGZA-LINK Setup** menu is set to **On** (see “Setting up REGZA-LINK®” on page 104), the REGZA-LINK® functions described below will be enabled.

### REGZA-LINK® playback device (DVD player, etc.) control

With your TV's remote control, or using the REGZA-LINK® Player Control menu, you can control the connected REGZA-LINK® playback device you are watching.

#### Available remote control button functions

<i>Button:</i>	<i>Description:</i>
PLAY	Begin playback
STOP	Stop playback
PAUSE	Pause the picture during play or record mode
SKIP Forward	Skip Forward
SKIP Reverse	Skip backward
FF	Fast forward
REW	Rewind/reverse
▲/▼/◀/▶	Navigates menu options
ENTER	Enters menu options
EXIT	Return to the previous menu

- NOTE** These functions depend on the devices connected.

**REGZA-LINK® Player Control menu functions**

To control the REGZA-LINK® player from the menu:

- 1 Press **MENU** and open the **Preferences** menu.
- 2 Highlight **REGZA-LINK Player Control** and press the **ENTER** button.



*(Sample Image) Preferences menu - REGZA-LINK Player Control*

- 3 Press the (**▲/▼** arrow) buttons to select the item you wish to control and press **ENTER** button.

<i>Item:</i>	<i>Description:</i>
Power	Turns the select device on and off
Root Menu	Accesses the root menu of the selected device
Contents Menu	Accesses the contents list when you press ENTER. At this time, the REGZA-LINK® Player Control menu disappears.
Setup Menu	Accesses the setup menu of a selected device
Top Menu	Accesses the top menu of a selected device
Menu	Accesses the menu of a selected device

**NOTE**

These functions depend on the devices that are connected.

The REGZA-LINK® Player Control item will be grayed out in the following conditions:

- ❖ A non-HDMI® input is currently selected.
- ❖ The Enable REGZA-LINK® item is set to Off.
- ❖ The connected CEC device is not a playback or recording device.

## REGZA-LINK® input source selection

If a REGZA-LINK® device with HDMI® switching capability (e.g. Audio Receiver) is connected to the HDMI® input, you can select another REGZA-LINK® device that is connected to the master HDMI® device using the TV's INPUT button, see [“Selecting the video input source” on page 54.](#)

## VOLUME and MUTE controls of Audio Receiver

With your TV's remote control, you can adjust or mute the sound volume of the Audio Receiver.

- ❖ **VOL+/VOL-** buttons adjust the volume level.
- ❖ **MUTE** button turns off the sound.

To use this function:

- ❖ Set **Speaker Preference** to **Audio Receiver** in the **REGZA-LINK Setup** menu.
- ❖ Confirm that a connected REGZA-LINK® device (such as DVD player, etc.) is selected for the Audio Receiver input source.

---

**NOTE** These functions depend on the device connected.

---

## Other REGZA-LINK® functions

When the **Enable REGZA-LINK** and each item in the **REGZA-LINK Setup** menu are set to **On**, the following functions will be enabled.

<i>Item:</i>	<i>Description:</i>
TV Auto Input Switch	If a connected HDMI® device starts playing video or audio, the TV will automatically switch to the appropriate HDMI® input.
TV Auto Power	If a REGZA-LINK® device is turned on, the TV turns on automatically.
Device Auto Standby	If the TV is turned off the TV will send a message to turn off all of the REGZA-LINK® devices connected to the TV.
Speaker Preference	From this item, you can set your audio output preference to the TV speakers or the audio receiver speakers. When this item is set to Audio Receiver, the TV remote can be used to adjust or mute the volume of the audio. This item will be grayed out unless a REGZA-LINK® compatible audio receiver is connected.

---

- 
- NOTE** When you turn on the Audio Receiver, change its input source or adjust the sound volume, the sound will be output from the audio receiver's speakers even if TV Speakers has been selected. Turn the TV off and on again to output the sound from the TV speakers.
- 

## Setting up REGZA-LINK®

To access the REGZA-LINK® Setup:

- 1 From the **Setup** menu, highlight **REGZA-LINK Setup** and press the **ENTER** button.
- 2 Press the (▲/▼ arrow) buttons to highlight **Enable REGZA-LINK**.
- 3 Press the (◀/▶ arrow) buttons to select **On**.

- 
- NOTE** If you select Enable REGZA-LINK® Off, the other items will be grayed out.
- 

- 4 Press the (▲/▼ arrow) buttons to highlight the **REGZA-LINK Setup** item you want to use, and press the (◀/▶ arrow) buttons to select **On** or the desired mode.

❖ **TV Auto Input Switch:** On/Off

❖ **TV Auto Power:** On/Off

❖ **Device Auto Standby:** On/Off

❖ **Speaker Preference:** TV Speakers/Audio Receiver

- 5 To save the new settings, highlight **Done** and press the **ENTER** button.

To revert to the factory defaults, highlight **Reset** and press the **ENTER** button.

## Displaying TV status information

To display TV status information using the **RECALL** button:

- ❖ Press the **RECALL** button on the remote control.

The following information will be displayed (if applicable):

- ❖ Current input (**ANT/CABLE**, **Video**, etc.)
- ❖ If ANT/CABLE is the current input, either “CABLE” (for cable TV) or “ANT” (for over-the-air broadcasts).
- ❖ Channel number (if in **ANT/CABLE** mode)



- ❖ Digital signal strength indicator (bar graph in lower right corner of box; for ATSC signals only)
- ❖ Stereo, Mono, or SAP audio status (when in HDMI® input mode, Dolby® Digital, or PCM)
- ❖ Video resolution
- ❖ Aspect ratio of incoming video signal (4:3 or 16:9)
- ❖ V-Chip rating status
- ❖ GameTimer® (if set)

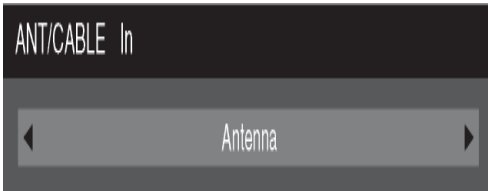

*(Sample Illustration) Recall banner*

To close the Recall screen, press the **RECALL** button again.

To display TV status information using **INFO**:

- ❖ Press the **INFO** button.

The following additional information will display for off air digital channels, if applicable:

- ❖ Title
- ❖ Duration
- ❖ Detailed description

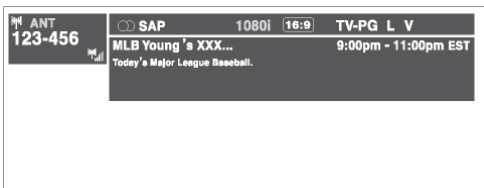

*(Sample Illustration) Info banner*

To close the **INFO** screen, press the **INFO** button again.

#### **NOTE**

The location of the banner can be moved to the top or bottom of the screen by pressing **▲** or **▼** while the **RECALL** or **INFO** display is on-screen.

## Understanding the last mode memory feature

If the AC power is cut off while you are viewing the TV, the Last Mode Memory feature automatically turns on the TV when the AC power is resupplied.

---

**NOTE**

If you know you will be away from the TV for an extended period of time you should unplug the power cord.

---

# Chapter 7

## Using the TV's Advanced Features

### Using the advanced picture settings

#### Dynamic Contrast

Dynamic Contrast detects changes in picture quality that affect the appearance of your contrast settings and then automatically adjusts the video.

To select Dynamic Contrast preference:

- 1 From the **Picture** menu, highlight **Picture Settings** and press the **ENTER** button.

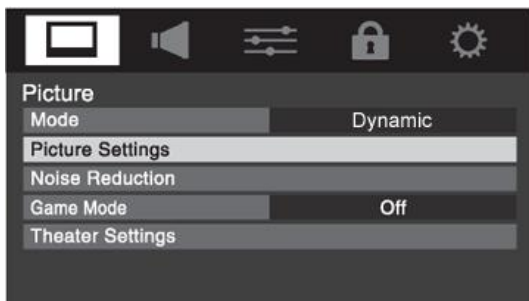

*(Sample Image) Dynamic Contrast screen*

- 2 Highlight **Advanced Picture Settings**, and then press the **ENTER** button.

- 3 Press the (▲/▼ arrow) buttons to select **Dynamic Contrast**.
- 4 Press the (◀/▶ arrow) buttons to select **High, Middle, Low** or **Off**.

## Static Gamma

The static gamma feature lets you adjust the levels of black in the picture.

To adjust the static gamma settings:

- 1 Press the **MENU** button to open the **Picture** menu.
- 2 Highlight **Picture Settings**, and then press the **ENTER** button.
- 3 Highlight **Advanced Picture Settings**, and then press the **ENTER** button.
  - ❖ In the **Static Gamma** field, press the (◀/▶ arrow) buttons to adjust the Static Gamma.)The adjustment range is within  $\pm 5$  from center).
  - ❖ If the setting is decreased, the detail of black colors is decreased.
  - ❖ If the setting is increased, the detail of black colors is increased.
- 4 To save the new settings, highlight **Done**, and then press the **ENTER** button.

To revert the factory defaults, highlight **Reset**, and then press the **ENTER** button.

### NOTE

If you select one of the factory-set picture modes (Dynamic, Standard, Movie, or PC) and then change the Static Gamma setting, the picture mode automatically changes to Preference.

## Color temperature

You can change the quality of the picture by selecting from three preset Color Temperatures (**Cool, Medium, and Warm**), as described below.

<i>Mode:</i>	<i>Picture Quality:</i>
Cool	blueish
Medium	neutral
Warm	reddish

---

To select the color temperature:

- 1 Press the **MENU** button to open the **Picture** menu.
- 2 Highlight **Picture Settings**, and then press the **ENTER** button.
- 3 Highlight **Advanced Picture Settings**, and then press the **ENTER** button.
- 4 Highlight **Color Temperature**, and then press the **ENTER** button.
- 5 In the **Color Temperature** field, press the (◀/▶ arrow) buttons to select the mode you prefer (**Cool**, **Medium**, or **Warm**).
- 6 Press the (▲/▼ arrow) buttons to select either **B Drive** or **G Drive**, and then press the (◀/▶ arrow) buttons to adjust the settings:
  - ❖ **B Drive:** press the (▶ arrow) button to make the picture blueish.
  - ❖ **G Drive:** press the (▶ arrow) button to make the picture greenish.

---

**NOTE** The B Drive and G Drive settings are connected to the Color Temperature settings and will change based on which setting is selected in step 5 above.

---

- 7 To save your new settings, highlight **Done**, and then press the **ENTER** button.  
To revert to your original settings, highlight **Reset**, and then press the **ENTER** button.

---

**NOTE** If you select one of the factory set picture modes (Dynamic, Standard, Movie, or PC) and then change the Color Temperature mode, the picture mode automatically changes to Preference.

---

## CableClear® digital Noise Reduction

The CableClear® digital Noise Reduction feature allows you to reduce visible interference in your TV picture. This may be useful when receiving a broadcast with a weak signal (especially a cable channel) or playing a noisy video cassette or disc.

To change the CableClear® settings:

- 1 Press the **MENU** button and open the **Picture** menu.

- 2 Highlight **Noise Reduction**, and then press the **ENTER** button.
  - 3 In the **CableClear** field, select the desired setting. The available selections are **Off**, **Low**, **Middle**, and **High**. **Low**, **Middle**, and **High** will reduce the noise in varying degrees, from lowest to highest, respectively.
- 

**NOTE**

If the current input is ANT/CABLE or VIDEO, the menu will display the text "CableClear". If the current input is ColorStream HD, HDMI 1 or HDMI 2, the menu will display the text "DNR".

---

- 4 To save your new settings, highlight **Done**, and then press the **ENTER** button.

To revert to your original settings, highlight **Reset**, and then press the **ENTER** button.

## MPEG Noise Reduction

The MPEG Noise Reduction feature allows you to reduce visible interference caused by MPEG compression. Choices for MPEG Noise Reduction are Off, Low, Middle, and High. Off is automatically selected when this feature is disabled ("grayed out").

To select the MPEG Noise Reduction level:

- 1 Press the **MENU** button and open the **Picture** menu.
- 2 Highlight **Noise Reduction**, and then press the **ENTER** button.
- 3 Press the (**▲/▼** arrow) buttons to highlight the **MPEG Noise Reduction** field, and then press the (**◀/▶** arrow) buttons to select either **Off**, **Low**, **Middle**, or **High**.
- 4 To save your new settings, highlight **Done**, and then press the **ENTER** button.

To revert to your original settings, highlight **Reset**, and then press the **ENTER** button.

---

## Game Mode

You can use the Game Mode feature for shorter frame delays when playing a video game requiring split-second timing between the on-screen display and input from the controller (such as music creation and high-action games).

This feature is more effective for 480i and 1080i input signals.

---

**NOTE** To use the Game Mode feature, the current video input must be Video, ColorStream HD, HDMI 1 or HDMI 2. The Game Mode cannot be turned on when any other video input, other than the above mentioned is selected.

---

To turn on Game Mode:

- 1 Press the **MENU** button to open the **Picture** menu.
- 2 Press the (◀/▶ arrow) buttons to select **On**.

To turn off Game Mode, select **Off** in step 2 above, change the video input, or turn the TV off and then on again.

---

**NOTE** You can change the video input by pressing INPUT on the remote control, see "[Selecting the video input source](#)" on page 54.

---

# Chapter 8

## Troubleshooting

---

### General troubleshooting

Before calling a service technician, review this chapter or visit the Toshiba technical support Web site at [support.toshiba.com](http://support.toshiba.com) for possible causes/solutions for the problem you are experiencing.

Before you begin to troubleshoot any problem, first unplug the TV from the AC wall outlet, wait approximately one minute, and then plug the TV back into the AC wall outlet. If the problem still exists attempt to troubleshoot the problem.

#### **Black box on-screen.**

The closed caption feature is set to one of the Text modes (T1, T2, T3, or T4). Set the closed caption feature to Off, see “[Using closed captions](#)” on page 73.

#### **TV stops responding to controls.**

If the TV stops responding to the buttons on the remote control or TV control panel and you cannot turn off the TV, press and hold **POWER** button on the TV control panel for several seconds to reset the TV. If the TV does not power off using this method, unplug the TV from the AC wall outlet and plug it back in.

If you cause a static discharge when touching the TV and the TV fails to function, simply unplug the TV from the AC outlet and plug it back in. The TV should return to normal operation.



### Other problems.

If your TV's problem is not addressed in this Troubleshooting section or the recommended solution has not worked, use the Reset Factory Defaults procedure, see [“Resetting Factory Defaults” on page 53](#).

### TV will not turn on.

Ensure the power cord is plugged in properly, and then press the **POWER** button.

Replace the batteries in the remote control, see [“Installing batteries” on page 35](#).

Try the control panel buttons on the TV.

## Picture problems

### General picture problems.

Check the antenna/cable connections, see [“Connecting Your TV” on page 21](#).

Press the **INPUT** button on the remote control or on the TV and select a valid video input source, see [“Selecting the video input source” on page 54](#). If no device is connected to an input on the TV, no picture appears when you select that particular input source. For device connection details, see [“Connecting Your TV” on page 21](#).

Antenna reception may be poor. Use a highly directional outdoor antenna (if applicable).

The station may be having broadcast difficulties. Try another channel.

Adjust the picture quality, see [“Using the advanced picture settings” on page 107](#).

### Cannot view external signals or channel 3 or 4.

If you cannot view signals from external devices connected to VIDEO, ColorStream HD1, ColorStream® HD, HDMI 1, HDMI 2, PC, or from channel 3 or 4, ensure that the Input Lock is set to **Off**, see [“Using the Locks menu” on page 80](#).

### Noisy picture.

If you are watching an analog channel (off-air broadcast or cable TV), you can set the CableClear® feature to reduce visible interference in the TV picture, see [“CableClear® digital Noise Reduction” on page 109](#).

### Video Input Selection problems.

If the Input Selection window does not appear when you press **INPUT** on the remote control or TV, press **INPUT** a second time. This will cause a change to the next video input source and display the Input Selection window.

### Cannot view external signals or channel 3 or 4.

If you cannot view signals from external devices connected to VIDEO, ColorStream® HDMI 1, HDMI 2, PC or from channels 3 or 4, make sure the Input Lock is set to **Off**, see [“Using the input lock feature” on page 87](#).

### Poor display color or no color.

The station may be having broadcast difficulties. Try another channel.

Adjust the Tint and/or Color, see [“Color temperature” on page 108](#).

### Poor composite picture.

If the TV is connected to an external A/V device (e.g. DVD player, video game system, set-top box, etc.) try using a ColorStream® or HDMI® video connection instead.

### Picture and sound are out of sync.

As with all products that contain a digital display, this may occur in rare instances, when viewing certain content (e.g. television broadcasts, video games, DVDs). The cause may include, without limitation, video processing within the TV, video processing in an attached gaming system, and video processing or different compression rates used by broadcasters in their programming.

Try the following:

- ❖ If the TV is connected to an A/V receiver that has a programmable audio delay feature, use this feature to help synchronize the sound to the picture.
- ❖ If the problem occurs only on certain TV channels, inform your local broadcast, cable, or satellite provider.
- ❖ Digital audio settings may not be correct. Check the connections, see [“Connecting a digital audio system” on page 30](#).
- ❖ Turn off and unplug the TV from the AC wall outlet for a few seconds and plug it back in.

## Sound problems

Check the antenna/cable connections, see [“Connecting a VCR, antenna, cable TV, or camcorder” on page 24](#).

The station may be having broadcast difficulties. Try another channel.

The sound may be muted. Press the **VOL+** button.

If you hear no sound, try setting the MTS feature to Stereo mode, see [“Selecting stereo/SAP broadcasts” on page 77](#).

If you are not receiving a second audio program from a known SAP source, make sure the MTS feature is set to SAP mode, see [“Selecting stereo/SAP broadcasts” on page 77](#).

If you hear audio that seems incorrect for the program you are watching (such as music or a foreign language), the SAP mode may be on. Set the MTS feature to Stereo mode, see [“Selecting stereo/SAP broadcasts” on page 77](#).

If you connect a computer using either the PC IN terminal or an HDMI<sup>®</sup> terminal, make sure that the audio setting is properly set, see [“Connecting a digital audio system” on page 30](#).

## Remote control problems

Remove all obstructions between the remote control and the TV.

Replace the remote control’s batteries, see [“Installing batteries” on page 35](#).

Your TV’s remote control may not operate certain features on your external devices. Refer to the user’s guide for your other device to determine its available features. If your TV remote control does not operate a specific feature on another device, use the remote control that came with the device, see [“Learning about the remote control” on page 37](#).

If the TV still does not act as expected, perform the Reset Factory Defaults procedure, see [“Resetting Factory Defaults” on page 53](#).

## Channel tuning problems

Ensure that the remote control is set to the correct device mode, see [“Learning about the remote control” on page 37](#).

The Auto Tuning feature may have erased the channel from memory. Add the channel to the channel memory, see [“Storing channels in memory \(optional\)” on page 46](#).

The Lock feature may have blocked the channel. Unblock the channel, see [“Locking channels” on page 87](#).

If you cannot tune digital channels, check the antenna configuration. If the problem persists, clear all channels from the channel list and reprogram channels into memory, see [“Storing channels in memory \(optional\)” on page 46](#). For additional information, see [“TV stops responding to controls.” on page 112](#). If the problem persists, use the Reset Factory Defaults procedure, see [“Resetting Factory Defaults” on page 53](#)

## Closed caption problems

If the program or video you have selected is not closed captioned, no captions appear on the screen.

If text is not available, a black rectangle may appear. If this happens, turn off the closed caption feature, see [“Using closed captions” on page 73](#).

A closed caption signal may not display correctly under the following circumstances:

- ❖ The videotape is dubbed
- ❖ The signal reception is weak
- ❖ The signal reception is non-standard

For additional information, see [“Using closed captions” on page 73](#).

## Rating blocking (V-Chip) problems

### Forgotten PIN code.

When the PIN code screen appears, press the **INFO** button 4 times within approximately 5 seconds. The old PIN code is cleared, see [“Forgotten PIN code” on page 81](#).

The V-Chip feature is available for U.S. V-Chip systems only, see [“Using parental controls \(for USA region\)” on page 82](#).

## No REGZA-LINK<sup>®</sup> operation

The REGZA-LINK<sup>®</sup> feature is available for Toshiba REGZA-LINK<sup>®</sup> compatible devices.

Ensure that HDMI<sup>®</sup> cables with the (**HDMI**) Logo are used.

When the connected REGZA-LINK<sup>®</sup> device does not work correctly after you have changed settings of the device, turn off your TV and unplug the power cord, then plug in and turn on again.

If several devices are connected, the REGZA-LINK® feature may not operate properly.

Read the instruction manual furnished with the connected REGZA-LINK® device.

## HDMI® problems

### HDMI® cables.

Ensure that HDMI® cables with the (HDMI) Logo are used, see “Connecting an HDMI® or DVI device to the HDMI® input” on page 26.

### Legacy HDMI® sources.

Some legacy HDMI® sources may not work properly with the latest HDMI® TV products due to new standard adoption.

## Media Player problems

Ensure that the devices (Display and Server) are connected correctly.

Incorrect functionality may occur when using a USB HUB connection.

Photo files that were processed and edited using the computer’s application software may not be viewable.

The TV may select one format automatically and play it when contents that support two or more formats are played.

Confirm that the contents of the USB storage device are in formats that are supported by this TV, see “Using the Media Player” on page 92.

## If the problem persists after trying the solutions

Contact Toshiba at:

Toshiba’s Support Web site: [support.toshiba.com](http://support.toshiba.com).

For technical support, call the Toshiba Customer Support Center:

Within the United States, at 1-800-631-3811

Outside the United States, at (949) 583-3050

# Appendix A

## Specifications

---

---

**NOTE**

- ❖ These models comply with the specifications listed below.
  - ❖ Designs and specifications are subject to change without notice.
  - ❖ These models may not be compatible with features and/or specifications that may be added in the future.
- 

### Television system

NTSC standard	
ATSC standard	8VSB
Digital Cable	64 QAM, 256 QAM; in-the-clear, unencrypted

### Channel coverage

VHF	2 through 13
UHF	14 through 69
Cable TV	Mid band (A-8 through A-1, A through I)
	Super band (J through W)
	Hyper band (AA through ZZ, AAA, BBB)
	Ultra band (65 through 94, 100 through 135)

## Power source

120 V AC, 60 Hz

## Power maximum current

32C120U	1.6 A
40E220U	1.7 A

## Power consumption

32C120U	1.6 A (maximum current)
	0.6 W in Standby mode
40E220U	1.7 A (maximum current)
	0.6 W in Standby mode

## Audio power

32C120U	7 W + 7 W
40E220U	7 W + 7 W

## Speaker type

32C120U	Two 5 5/8 x 1 1/5 x 4/5" (142 x 30 x 20mm)
40E220U	Two 5 5/8 x 1 1/5 x 4/5" (142 x 30 x 20mm)

## Video/audio terminals

### Video/audio input

Video	1 V (p-p), 75 ohm, negative sync.
Audio	200 mV(rms) (-20dBFS, 47K ohm or greater)

**ColorStream® (component video) HD input**

Video	Y: 1V(p-p), 75 ohm.
	PR: 1V(p-p), 75 ohm.
	PB: 0.7 V(p-p), 75 ohm
	Suggested formats: 1080i, 720p, 480p, 480i
Audio	200 mV(rms) (-20dBFS, 47K ohm or greater)

**HDMI® input**

HDMI® compliant (type A connector)	
HDCP compliant	
HDMI® Audio	2-channel Linear-PCM; 32/44.1/48 kHz sampling frequency; 16/ 20/24 bits per sample

**Digital audio output**

Optical type

**PC input**

15-Pin D-sub Analog RGB

**Dimensions**

32C120U	Width	2'7-1/4 inches (792.8mm)
	Height	1'9-3/4 inches (553.6mm)
	Depth	9-5/8 inches (245mm)
40E220U	Width	3'2-3/4 inches (984.9mm)
	Height	2'-2" inches (661.5mm)
	Depth	11-5/8 inches (295mm)

**Mass (weight)**

32C120U	19.8 lbs (9.0kg)
40E220U	30.9 lbs (14.0kg)



## Operating conditions

Temperature	32 - 95° F (0 - 35° C)
Humidity	20 - 80% (no moisture condensation)

## Supplied accessories

- ❖ Remote control with two size “AAA” batteries
- ❖ Resource Guide
- ❖ Quick Setup Guide
- ❖ Four screws (for pedestal stand) and hardware

## Acceptable signal formats for PC IN, HDMI®

### PC IN signal formats

#### NOTE

Depending on the connected PC, the following status may occur; incorrect display, false format detection, picture position failure, blur, or judder. But this is not a malfunction of your TV.

<i>Format</i>	<i>Resolution</i>	<i>V. Frequency</i>	<i>H. Frequency</i>	<i>Pixel Clock Frequency</i>
VGA	640 x 480	59.940 Hz	31.469 kHz	25.175 MHz
SVGA	800 x 600	60.317 Hz	37.879 kHz	40.000 MHz
XGA	1024 x 768	60.004 Hz	48.363 kHz	65.000 MHz
WXGA	1280 x 768	59.870 Hz	47.776 kHz	79.500 MHz
	1360 x 768	60.015 Hz	47.712 kHz	85.500 MHz
SXGA	1280 x 1024	60.020 Hz	63.981 kHz	108.000 MHz (for E210U1)

**HDMI® signal formats**

<i>Format</i>	<i>Resolution</i>	<i>V. Frequency</i>	<i>H. Frequency</i>	<i>Pixel Clock Frequency</i>
VGA	640 x 480	59.940 Hz	31.469 kHz	25.175 MHz
SVGA	800 x 600	60.317 Hz	37.879 kHz	40.000 MHz
XGA	1024 x 768	60.004 Hz	48.363 kHz	65.000 MHz
WXGA	1280 x 768	59.870 Hz	47.776 kHz	79.500 MHz
	1360 x 768	60.015 Hz	47.712 kHz	85.500 MHz
SXGA	1280 x 1024	60.020 Hz	63.981 kHz	108.000 MHz
480i	720 x 480i	59.940 Hz	15.734 kHz	27.000 MHz
480p	720 x 480p	59.940 Hz	31.469 kHz	27.000 MHz
720p	1280 x 720p	60.000 Hz	45.000 kHz	74.250 MHz
1080i	1920 x 1080i	60.000 Hz	33.750 kHz	74.250 MHz
1080p	1920 x 1080p	24.000 Hz	27.000 kHz	74.250 MHz
		60.000 Hz	67.500 kHz	148.500 MHz

**NOTE**

- ❖ Some illustrations in this User's Guide are for explanation purposes and may differ from the actual unit.
- ❖ Designs and specifications are subject to change without notice.
- ❖ These models may not be compatible with features and/or specifications that may be added in the future.

# Appendix B

## License Agreement

---

### **License Information on the software used in the TOSHIBA Digital TV**

The software pre-installed in the TOSHIBA Digital Televisions consists of multiple, independent software components. Each software component is copyrighted by TOSHIBA or a third party.

The TOSHIBA Digital Televisions uses software components that are distributed as freeware under a third-party end-user license agreement or copyright notice (hereinafter referred to as a "EULA"). Some EULAs require that the source code of the applicable component be disclosed as the condition for distributing the software component in executable format.

In addition, some of the software components which are used in Toshiba Digital Televisions include the software that are made or developed originally by TOSHIBA. These software and accompanied documents are copyrighted by TOSHIBA, and protected by Copyright Act, an international treaty's articles and other governing laws. The software components which are made or developed originally by TOSHIBA and not subject to EULAs are not a target of source code offering.

The Toshiba warranty provided in respect of the Digital TV is the only warranty provided and no additional warranties are provided in respect of the software components subject to EULAs.

Some of the software components distributed under EULAs are made available for use by the user on the premise that they are not copyrighted or warranted by TOSHIBA or any third party. These software components are licensed to the user free of charge and therefore not covered by any warranty within the scope of the applicable laws. These software components are provided in "as is" condition without any warranty, whether express or implied. "Warranty" here includes, but not limited to, an implied warranty for marketability

or fitness for specific uses. All risks associated with the quality or performance of these software components are assumed by the user. TOSHIBA shall not be liable whatsoever for any cost of repair or correction or other incidental expense incurred in connection with a defect found in any of these software components. Unless specified under the applicable laws or in a written agreement, a party who changes or redistributes the software with consent from the copyright holders or based on the aforementioned licenses shall not be held liable whatsoever for any loss arising from the use of or inability to use such software components. The same applies even when the copyright holders or relevant third parties have been informed of the possibility of such loss. "Loss" here includes normal, special, incidental and indirect loss (including, but not limited to, the loss of data or its accuracy; loss incurred by the user or any third party; and interface incompatibility with other software). Please read each EULA for details on the use conditions and items that must be observed regarding these software components.

The table below lists the software components pre-installed in the TOSHIBA Digital Televisions, which are subject to EULAs. The user should read the applicable EULAs carefully before using these software components. The EULAs are exhibited in their original text (English) as exactly written by the respective parties other than TOSHIBA.

For at least three (3) years from the date of distribution of the this product, Toshiba will give to anyone who contacts Toshiba Consumer Solutions at (800) 631-3811, for a charge of no more than our cost of physically performing source code distribution, a complete machine-readable copy of the complete corresponding GPL and LGPL source code for the version of the GPL and LGPL code that we distributed to you in this product.

## Pre-Installed Software - EULA

jpeglib.h - Exhibit A

FreeType 2.2.0 - Exhibit B

scalfact.c - Exhibit C

### Exhibit A

The authors make NO WARRANTY or representation, either express or implied, with respect to this software, its quality, accuracy, merchantability, or fitness for a particular purpose. This software is provided "AS IS", and you, its user, assume the entire risk as to its quality and accuracy.

This software is copyright (C) 1991-2011, Thomas G. Lane, Guido Vollbeding.

All Rights Reserved except as specified below.

Permission is hereby granted to use, copy, modify, and distribute this software (or portions thereof) for any purpose, without fee, subject to these conditions:

(1) If any part of the source code for this software is distributed, then this README file must be included, with this copyright and no-warranty notice unaltered; and any additions, deletions, or changes to the original files must be clearly indicated in accompanying documentation.

(2) If only executable code is distributed, then the accompanying documentation must state that "this software is based in part on the work of the Independent JPEG Group".

(3) Permission for use of this software is granted only if the user accepts full responsibility for any undesirable consequences; the authors accept NO LIABILITY for damages of any kind.

These conditions apply to any software derived from or based on the IJG code, not just to the unmodified library. If you use our work, you ought to acknowledge us.

Permission is NOT granted for the use of any IJG author's name or company name in advertising or publicity relating to this software or products derived from it. This software may be referred to only as "the Independent JPEG Group's software".

We specifically permit and encourage the use of this software as the basis of commercial products, provided that all warranty or liability claims are assumed by the product vendor. `ansi2knr.c` is included in this distribution by permission of L. Peter Deutsch, sole proprietor of its copyright holder, Aladdin Enterprises of Menlo Park, CA. `ansi2knr.c` is NOT covered by the above copyright and conditions, but instead by the usual distribution terms of the Free Software Foundation; principally, that you must include source code if you redistribute it. (See the file `ansi2knr.c` for full details.) However, since `ansi2knr.c` is not needed as part of any program generated from the IJG code, this does not limit you more than the foregoing paragraphs do.

The Unix configuration script "configure" was produced with GNU Autoconf. It is copyright by the Free Software Foundation but is freely distributable. The same holds for its supporting scripts (`config.guess`, `config.sub`, `ltmain.sh`). Another support script, `install-sh`, is copyright by X Consortium but is also freely distributable.

The IJG distribution formerly included code to read and write GIF files. To avoid entanglement with the Unisys LZW patent, GIF reading support has been removed altogether, and the GIF writer has been simplified to produce "uncompressed GIFs". This technique does not use the LZW algorithm; the resulting GIF files are larger than usual, but are readable by all standard GIF decoders.

We are required to state that

"The Graphics Interchange Format(c) is the Copyright property of CompuServe Incorporated. GIF(sm) is a Service Mark property of CompuServe Incorporated."

## Exhibit B

The FreeType Project LICENSE

2002-Apr-11

Copyright 1996-2002 by

David Turner, Robert Wilhelm, and Werner Lemberg

## Introduction

The FreeType Project is distributed in several archive packages; some of them may contain, in addition to the FreeType font engine, various tools and contributions which rely on, or relate to, the FreeType Project.

This license applies to all files found in such packages, and which do not fall under their own explicit license. The license affects thus the FreeType font engine, the test programs, documentation and makefiles, at the very least.

This license was inspired by the BSD, Artistic, and IJG (Independent JPEG Group) licenses, which all encourage inclusion and use of free software in commercial and freeware products alike. As a consequence, its main points are that:

- ❖ We don't promise that this software works. However, we will be interested in any kind of bug reports. ( 'as is' distribution)
- ❖ You can use this software for whatever you want, in parts or full form, without having to pay us. ( 'royalty-free' usage)
- ❖ You may not pretend that you wrote this software. If you use it, or only parts of it, in a program, you must acknowledge somewhere in your documentation that you have used the FreeType code. ( 'credits')

We specifically permit and encourage the inclusion of this software, with or without modifications, in commercial products. We disclaim all warranties covering The FreeType Project and assume no liability related to The FreeType Project.

Finally, many people asked us for a preferred form for a credit/disclaimer to use in compliance with this license. We thus encourage you to use the following text:

Portions of this software are copyright © 1996-2002 The FreeType  
Project ([www.freetype.org](http://www.freetype.org)). All rights reserved.

### Exhibit C

scalfact.c Scalefactors for layer I and II This program is free software; you can redistribute it and/or modify it under the terms of the GNU General Public License as published by the Free Software Foundation; either version 2 of the License, or (at your option) any later version. This program is distributed in the hope that it will be useful, but WITHOUT ANY WARRANTY; without even the implied warranty of MERCHANTABILITY or FITNESS FOR A PARTICULAR PURPOSE. See the GNU General Public License for more details. You should have received a copy of the GNU General Public License along with this program; if not, write to the Free Software Foundation, Inc., 675 Mass Ave, Cambridge, MA 02139, USA.

# Index

---

## A

- advanced picture settings
  - CableClear® digital Noise Reduction 109
  - Color temperature 108
  - Dynamic Contrast 107
  - MPEG Noise Reduction 110
  - Static Gamma 108
  - using 107
- audio
  - adjusting quality 78
  - Audyssey ABX™ 79
  - Dolby® Digital Dynamic Range Control 80
  - muting sound 76
  - optical audio output format 79
  - stereo/SAP broadcasts 77
- Auto Aspect
  - using 69
- Auto Brightness sensor
  - set 99
- auto power down
  - set 100
- Auto Start function

Media Player 93

- AV Input mode
  - setting 50

## C

- cables
  - 3.5mm to RCA Y-cable 23
  - analog RGB (15-pin) 23
  - coaxial (F-type) 21
  - component video (red/white/yellow) 22
  - HDMI® 22
  - optical audio 23
  - overview of cables 21
  - standard A/V (red/white/yellow) 22
- channel
  - switching between two channels 63
  - tuning to the next 62
- Channel Browser™
  - elements 60
  - tuning channels 58
- Channel Return

- switching between two channels  
63
- channels
  - auto tuning 46
  - locking channels 87
  - skipping 48
  - specific channel 62
  - storing in memory 46
- cinema mode
  - selecting 70
- closed captions
  - CC selector 75
  - Digital CC settings 74
  - using 73
- computer
  - setting the audio 91
  - using with the TV 90
- connecting
  - a computer 32
  - audio system 30
  - cable TV 24
  - computer to TV's PC IN 32
  - DVD player with ColorStream®  
25
  - DVI device to HDMI® input 26
  - HDMI® device to HDMI® input  
26
  - REGZA-LINK® 29
  - TV's HDMI® 33
  - VCR and antenna 24
- D**
- digital audio selector
  - using 76
- digital signal meter
  - viewing 51
- F**
- factory defaults
  - reset 53
- favorites browser 59
- features 16
- Freeze
  - feature 70
- G**
- GameTimer®
  - using 88
- H**
- HDMI® audio mode
  - setting 50
- History List
  - adding/clearing channels 62
  - adding/clearing inputs 62
- I**
- icon
  - safety 15
- Initial setup 44
- initial setup
  - main menu layout 40
- input lock feature
  - using 87
- L**
- last mode memory feature 106
- Locks menu
  - setting pin code 80
- M**
- Media Player
  - open 93
  - photo files 95
  - playing music files 96
  - using 92
- menu
  - layout 42
  - navigation 42
  - setup 42
- N**
- no signal power down
  - set 100
- O**
- overview
  - installation 16
  - setup 16



use 16

## P

panel lock feature  
using 89

parental controls  
blocking programs/movies by  
rating (V-Chip) 82  
using 82

PC Audio  
setting 91

PC settings feature  
using 90

picture  
adjusting 71  
adjusting quality 72

picture mode  
selecting 71

picture size  
4  
3 67  
Dot by Dot 68  
Full 65  
Native 66  
Normal 67  
selecting 64  
TheaterWide 1 65  
TheaterWide 2 66  
TheaterWide 3 66

pin code  
changing 81  
deleting 81  
entering PIN code 80  
forgotten 81

program ratings  
displaying 86  
unlocking programs 86

## Q

quick setup  
ANT/CABLE IN 45  
menu language 45

## R

rating system 85  
downloading additional 83  
REGZA-LINK®  
additional functions 103  
using 101  
volume/mute buttons 103

## S

safety  
icons 15

scrolling  
TheaterWide® picture 68

specifications  
acceptable signal formats 121  
audio power 119  
channel coverage 118  
ColorStream® HD input 120  
Digital audio output 120  
dimensions 120  
HDMI® input 120  
HDMI® signal formats 122  
mass (weight) 120  
operating conditions 121  
PC IN signal formats 121  
PC input 120  
power consumption 119  
power maximum current 119  
power source 119  
speaker type 119  
supplied accessories 121  
TV system 118  
video/audio terminals 119

SurfLock™  
switching between two channels  
63

system status  
viewing 52

## T

time zone  
setting 52

timer

- sleep timer 99
- troubleshooting 112
  - channel tuning problems 115
  - closed caption problems 116
  - contact Toshiba 117
  - HDMI® 117
  - media player problems 117
  - No REGZA-LINK® operation 116
  - picture problems 113
  - Rating blocking problems 116
  - remote control problems 115
  - sound problems 115
- TV connections
  - front 18
  - side 18
- TV panel connections
  - back 19
- TV panel controls
  - front 18
  - left side 18
  - side 18
- TV remote
  - functionality 37
  - install batteries 35
- TV status information
  - show 104

## V

- video input source
  - selecting 54
- video input sources
  - labeling 56