

TOSHIBA

Leading Innovation >>>

Integrated High Definition LED Television User's Guide:

40L3400U

50L3400U

If you need assistance:

Toshiba's Support Web site support.toshiba.com

For more information, see "Troubleshooting" on page 121 in this guide.

Owner's Record

The model number and serial number are on the back and side of your television.

Print out this page and write these numbers in the spaces below. Refer to these numbers whenever you communicate with your Toshiba dealer about this television.

Model number: _____

Serial number: _____

Register your Toshiba television at register.toshiba.com

Note: To display a High Definition picture, the TV must be receiving a High Definition signal (such as an over-the-air High Definition TV broadcast, a High Definition digital cable program, or a High Definition digital satellite program). For details, contact your TV antenna installer, cable provider, or satellite provider

GMA300034012

12/14

Dear Customer,

Thank you for purchasing this Toshiba LED TV. This document will help you use the many exciting features of your new LED TV. Before operating your LED TV, carefully read this document completely.

Safety Precautions

WARNING: TO REDUCE THE RISK OF FIRE OR ELECTRIC SHOCK, DO NOT EXPOSE THIS APPLIANCE TO RAIN OR MOISTURE.



WARNING: TO REDUCE THE RISK OF ELECTRIC SHOCK, DO NOT REMOVE COVER (OR BACK). NO USER-SERVICEABLE PARTS INSIDE. REFER SERVICING TO QUALIFIED SERVICE PERSONNEL.



The lightning flash with arrowhead symbol, within an equilateral triangle, is intended to alert the user to the presence of uninsulated "dangerous voltage" within the product's enclosure that may be of sufficient magnitude to constitute a risk of electric shock to persons.



The exclamation point within an equilateral triangle is intended to alert the user to the presence of important operating and maintenance (servicing) instructions in the literature accompanying the appliance.

WARNING

Improper location and installation of a television can lead to the death of your child. Never place the television on furniture or in a location where children can climb up on and tip over the television. Please refer to the Child Safety information in item 26) on page 5 of the Important Safety Instructions/Installation section.

WARNING: If you decide to wall mount this television, always use a mounting bracket that has been Listed by an independent laboratory (such as UL, CSA, ETL) and is appropriate for the size and weight of this television. The use of inappropriate or non-Listed mounting brackets could result in serious bodily injury and/or property damage. See "To Display your LED TV on the included Pedestal Stand:" on page 6.

NOTE TO CATV INSTALLERS

This is a reminder to call the CATV system installer's attention to Article 820-40 of the U.S. NEC, which provides guidelines for proper grounding and, in particular, specifies that the cable ground shall be connected to the grounding system of the building, as close to the point of cable entry as practical. For additional antenna grounding information, see item 33) and item 35) on page 5.

CHILD SAFETY:

PROPER TELEVISION PLACEMENT MATTERS



TOSHIBA CARES

- Manufacturers, retailers and the rest of the consumer electronics industry are committed to making home entertainment safe and enjoyable.
- As you enjoy your television, please note that all televisions – new and old- must be supported on proper stands or installed according to the manufacturer's recommendations. Televisions that are inappropriately situated on dressers, bookcases, shelves, desks, speakers, chests, carts, etc., may fall over, resulting in injury.



TUNE IN TO SAFETY

- **ALWAYS** follow the manufacturer's recommendations for the safe installation of your television.
- **ALWAYS** read and follow all instructions for proper use of your television.
- **NEVER** allow children to climb on or play on the television or the furniture on which the television is placed.
- **NEVER** place the television on furniture that can easily be used as steps, such as a chest of drawers.
- **ALWAYS** install the television where it cannot be pushed, pulled over or knocked down.
- **ALWAYS** route cords and cables connected to the television so that they cannot be tripped over, pulled or grabbed.



WALL OR CEILING MOUNT YOUR TELEVISION

- **ALWAYS** contact your retailer about professional installation if you have any doubts about your ability to safely mount your television.
- **ALWAYS** use a mount that has been recommended by the television manufacturer and has a safety certification by an independent laboratory (such as UL, CSA, ETL).
- **ALWAYS** follow all instructions supplied by the television and mount manufacturers.
- **ALWAYS** make sure that the wall or ceiling where you are mounting the television is appropriate. Some mounts are not designed to be mounted to walls and ceilings with steel studs or cinder block construction. If you are unsure, contact a professional installer.
- Televisions can be heavy. A minimum of two people is required for a wall or ceiling mount installation.





MOVING AN OLDER TELEVISION TO A NEW PLACE IN YOUR HOME

- Many new television buyers move their older CRT televisions into a secondary room after the purchase of a flat-panel television. Special care should be made in the placement of older CRT televisions.
- **ALWAYS** place your older CRT television on furniture that is sturdy and appropriate for its size and weight.
- **NEVER** place your older CRT television on a dresser where children may be tempted to use the drawers to climb.
- **ALWAYS** make sure your older CRT television does not hang over the edge of your furniture.

CEA.org/safety

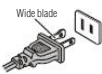

Important Safety Instructions

- 1) **Read these instructions.**
 - 2) **Keep these instructions.**
 - 3) **Heed all warnings.**
 - 4) **Follow all instructions.**
-
- 5) **Do not use this apparatus near water.**
-
- 6) **Clean only with dry cloth.**
-
- 7) **Do not block any ventilation openings.** Install in accordance with the manufacturer's instructions.
-
- 8) **Do not install near any heat sources** such as radiators, heat registers, stoves, or other apparatus (including amplifiers) that produce heat.
-
- 9) **Do not defeat the safety purpose of the polarized or grounding type plug.** A polarized plug has two blades with one wider than the other. A grounding type plug has two blades and a third grounding prong. The wide blade or the third prong are provided for your safety. If the provided plug does not fit into your outlet, consult an electrician for replacement of the obsolete outlet.
 
-
- 10) **Protect the power cord** from being walked on or pinched, particularly at plugs, convenience receptacles, and the point where they exit from the apparatus.
-
- 11) **Only use attachments/accessories specified by the manufacturer.**
-
- 12) **Use only with the cart, stand, tripod, bracket, or table specified by the manufacturer, or sold with the apparatus.** When a cart is used, use caution when moving the cart/apparatus combination to avoid injury from tip-over.
 
-
- 13) **Unplug this apparatus during lightning storms or when unused for long periods of time.**
-
- 14) **Refer all servicing to qualified service personnel.** Servicing is required when the apparatus has been damaged in any way, such as when power-supply cord or plug is damaged, liquid has been spilled or objects have fallen into the apparatus, the apparatus has been exposed to rain or moisture, does not operate normally, or has been dropped.

Additional Safety Precautions

- 14a) **CAUTION:** If the TV is dropped and the cabinet or enclosure surface has been damaged or the TV does not operate normally, take the following precautions:
 - ALWAYS turn off the TV and unplug the power cord to avoid possible electric shock or fire.
 - NEVER allow your body to come in contact with any broken glass or liquid from the damaged television. The LCD panel inside the TV contains glass and a

toxic liquid. If the liquid comes in contact with your mouth or eyes, or your skin is cut by broken glass, rinse the affected area thoroughly with water and contact your doctor immediately.



- ALWAYS contact a service technician to inspect the TV any time it has been damaged or dropped.

- 15) **CAUTION:**
 - To reduce the risk of electric shock, do not use the polarized plug with an extension cord, receptacle, or other outlet unless the blades can be inserted completely to prevent blade exposure.
 - To prevent electric shock, match wide blade of plug to wide slot; fully insert.
- 16) **CAUTION:**
 - Do not let children swallow any small parts included on or with the product or play with the plastic bag. Keep the small parts and the plastic bag out of the reach of children.
- 17) **CAUTION:**
 - Do not let water or other liquids come into contact with the product, as it may result in damage.
- 18) **WARNING:**
 - To prevent the spread of fire, keep candles or other open flames away from this product at all times.
 - Keep the product away from direct sunlight, fire or a heat source such as a heater. This may reduce the product life time or result in fire.

Installation, Care, and Service

Installation

Follow these recommendations and precautions and heed all warnings when installing your TV:

- 19)  **WARNING: Never expose the batteries to excessive heat such as sunshine, fire, or the like.**
- 20) ALWAYS plug the product into an outlet that is located in such a manner that it can be easily unplugged in case the product requires service.
- 21) NEVER route the product's power cord inside a wall or similar enclosed area.
- 22) Never modify this equipment. Changes or modifications may void: a) the warranty, and b) the user's authority to operate this equipment under the rules of the Federal Communications Commission.
- 23)  **DANGER: RISK OF SERIOUS PERSONAL INJURY, DEATH, OR EQUIPMENT DAMAGE!**

Never place the TV on an unstable cart, stand, or table. The TV may fall, causing serious personal injury, death, or serious damage to the TV.

- 24) When selecting a location for the TV,
- NEVER allow any part of the TV to hang over the edge of the supporting furniture,
 - NEVER place the TV on tall furniture (for example, entertainment centers or bookcases) without anchoring both the furniture and the TV to a suitable support,
 - Never place cloth or other material between the TV and the supporting furniture.
 - NEVER allow children to climb on the TV

- 25) To avoid damage to this product, never place or store the TV in direct sunlight; hot, humid areas; or areas subject to excessive dust or vibration.

- 26) Always place the TV on the floor or a sturdy, level, stable surface that can support the weight of the unit. Secure the TV using one of the following methods:
- (1) Secure the TV with a mounting screw (Recommended).
- Place the TV on a sturdy surface that has a sufficient thickness and screw the unit on the surface securely by using the mounting screw and the fall-prevention screw hole.
 - If secured to furniture or other movable objects, the furniture must be secured to an immovable structure using the method shown in item 2 below.
- (2) Secure the TV with a sturdy strap to a wall stud, pillar, or other immovable structure. When connecting the strap:
- attach the strap to the TV using the hooks on the back of the TV, the clips on the pedestal, or the hole in the base of the pedestal as available.
 - make sure the strap is tight, secure, and parallel to the floor.

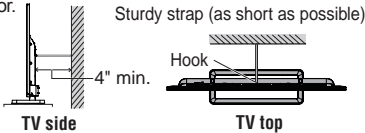

- 27) The product shall not be exposed to dripping or splashing, and that no objects filled with liquids, such as vases, shall be placed on the apparatus.
- 28) Never block or cover the slots or openings in the TV cabinet back, bottom, and sides. Never place the TV:
- on a bed, sofa, rug, or similar surface;
 - too close to drapes, curtains, or walls; or
 - in a confined space such as a bookcase, built-in cabinet, or any other place with poor ventilation.
- 29) Always leave a space of at least 4 (four) inches around the TV. The slots and openings are provided to protect the TV from overheating and to help maintain reliable operation of the TV.
- 30) Never allow anything to rest on or roll over the power cord, and never place the TV where the power cord is subject to wear or abuse.
- 31) Never overload wall outlets and extension cords.

- 32) Always operate this equipment from a 120V AC, 60 Hz power source.

- 33) Always make sure the antenna system is properly grounded to provide adequate protection against voltage surges and built-up static charges (see Section 810 of the National Electric Code).

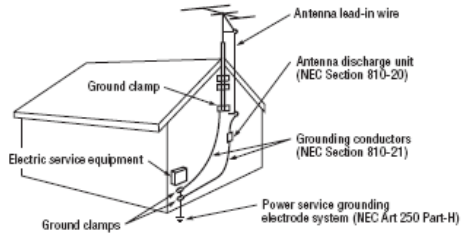

- 34) **! DANGER: RISK OF SERIOUS PERSONAL INJURY OR DEATH!**

- When installing a rooftop antenna, use extreme care to make sure you are never in a position where your body (or any item you are in contact with, such as a ladder or screwdriver) can accidentally touch overhead power lines. Never locate the antenna near overhead power lines or other electrical circuits.
- Never attempt to install any of the following during lightning activity: a) an antenna system; or b) cables, wires, or any home theater component connected to an antenna or phone system.



Care

For better performance and safer operation of your TOSHIBA TV, follow these recommendations and precautions:

- 35) If you use the TV in a room where the temperature is 32° F (0° C) or below, the picture brightness may vary until the LED warms up. This is not a sign of malfunction.
- 36) **! WARNING: RISK OF SERIOUS PERSONAL INJURY OR EQUIPMENT DAMAGE!**
- Never use chemicals (such as air fresheners, cleaning agents, etc.) on or near the TV pedestal. Studies indicate that plastics may weaken and crack over time from the combined effects of chemical agents and mechanical stress (such as the weight of the TV). Failure to follow these instructions could result in serious injury and/or permanent damage to TV and TV pedestal.
 - Always unplug the TV before cleaning. Gently wipe the display panel surface (the TV screen) using a dry, soft cloth (cotton, flannel, etc.). A hard cloth may damage the surface of the panel. Avoid contact with alcohol, thinner, benzene, acidic or alkaline solvent cleaners, abrasive cleaners, or chemical cloths,

which may damage the surface. Never spray volatile compounds such as insecticide on the cabinet. Such products may damage or discolor the cabinet.

- 37) Never hit, press, or place anything on the back cover. These actions will damage internal parts.

38)  **WARNING:** 
RISK OF ELECTRIC SHOCK!
 Never spill liquids or push objects of any kind into the TV cabinet slots.

- 39) During a lightning storm, do not touch the connecting cables or product.

- 40) For added protection of your TV from lightning and power surges, always unplug the power cord and disconnect the antenna from the TV if you leave the TV unattended or unused for long periods of time.

- 41) Always unplug the TV to completely disconnect from mains power. When the TV is turned off using the on/off switch, it is not completely disconnected from power and a minute amount of current is still consumed.

- 42) During normal use, the TV may make occasional snapping or popping sounds. This is normal, especially when the unit is being turned on or off. If these sounds become frequent or continuous, unplug the power cord and contact a Toshiba Authorized Service Provider.

43)  **WARNING: RISK OF SERIOUS PERSONAL INJURY OR EQUIPMENT DAMAGE!**
 Never strike the screen with a sharp or heavy object.

- 44)
- The LCD screen of this product can be damaged by ultraviolet radiation from the sun. When selecting a location for the television, avoid locations where the screen may be exposed to direct sunlight, such as in front of a window.
 - Never touch, press, or place anything on the LCD screen. These actions will damage the LCD screen. If you need to clean the LCD screen, follow the instructions in item 35) on page 5.

Service

45)  **WARNING:** 
RISK OF ELECTRIC SHOCK!

Never attempt to service the TV yourself. Opening and removing the covers may expose you to dangerous voltage or other hazards. Failure to follow this WARNING may result in death or serious injury. Refer all servicing not specified in this manual to a Toshiba Authorized Service Provider.

- 46) If you have the TV serviced:
- Ask the service technician to use only replacement parts specified by the manufacturer.

- Upon completion of service, ask the service technician to perform routine safety checks to determine that the TV is in safe operating condition.

Choosing a location for your LED TV

To Display your LED TV on the included Pedestal Stand:

Observe the following safety precautions:

- 1) Read and follow the pedestal assembly instructions included with the pedestal.

CAUTION: Before beginning pedestal assembly, carefully lay the front of the LCD Panel face down on a flat, cushioned surface such as a quilt or blanket. Leave the bottom of the unit protruding over the edge of the surface and assemble the pedestal as described in this instruction document.

Note: *Extreme care should always be used when attaching the pedestal stand to avoid damage to the LCD panel.*

- 2) Place the TV on a sturdy, level surface that can support the weight of the TV.
- 3) Be sure to secure the TV to a wall, pillar, surface, or other immovable structure see item 26) on page 5 for additional details.

To Display your LED TV using a Wall Bracket:

If you decide to wall mount your LED TV, always use a wall bracket Listed by an independent laboratory (such as UL, CSA, ETL) that is appropriate for the size and weight of the TV:

- 1) **CAUTION:** Two people are required for installation.
- 2) Unplug and remove any cables and/or other component connectors from the rear of the TV.
- 3) Remove the screws of the VESA Mounting Pattern shown in the table below, if applicable.
CAUTION: Do not use the screws removed from the back cover to attach the wall mount bracket to the TV.
- 4) Always use the screws supplied or recommended by the wall mount manufacturer.
- 5) Follow the instructions provided with your wall bracket. Before proceeding, make sure the appropriate bracket(s) are attached to the wall and the back of the TV as described in the instructions provided with the wall bracket.
- 6) After attaching the appropriate bracket(s) to the wall and the back of the TV, remove the pedestal stand from the TV, as described in this instruction document.
- 7) VESA Mounting Pattern

TV Size	Hole Pattern (HxV)	Screw Size
40"	200mm x 200mm	M6
50"	400mm x 200mm	M8

Removing the Pedestal Stand

- 1) Carefully lay the front of the unit face down on a flat, cushioned surface such as a quilt or blanket. Leave the stand protruding over the edge of the surface.
Note: *Extreme care should always be used when removing the pedestal stand to avoid damage to the LCD panel.*
- 2) Remove the stand screws shown in the diagram below. This will allow removal of the pedestal stand.
- 3) Once you have removed the screws holding the pedestal stand in place, remove the pedestal stand from the TV.

L3400U Series

40" TV.

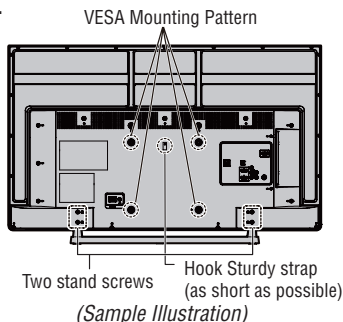

50" TV.

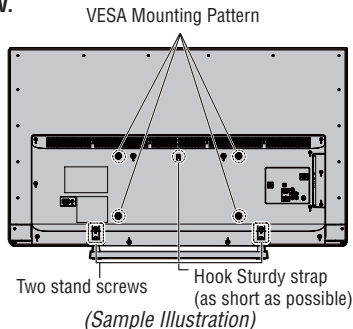

CAUTION: Always place the TV on the floor or a sturdy, level, stable surface that can support the weight of the unit. To secure the TV, use a sturdy strap from the hook(s) on the rear of the TV to a wall stud, pillar, or other immovable structure. Make sure the strap is tight, secure, and parallel to the floor.

FCC Declaration of Conformity Compliance Statement (Part 15):

Toshiba 40L3400U and 50L3400U Television models comply with Part 15 of the FCC Rules.

Operation is subject to the following two conditions:

- (1) This device may not cause harmful interference, and
- (2) This device must accept any interference received, including interference that may cause undesired operation.

The party responsible for compliance to these rules is:

Toshiba America Information Systems, Inc.

9740 Irvine Blvd., Irvine, CA 92618. Ph: 800-631-3811

Note: *This equipment has been tested and found to comply with the limits for a Class B digital device, pursuant to Part 15 of the FCC Rules. These limits are designed to provide reasonable protection against harmful interference in a residential installation. This equipment generates, uses, and can radiate radio frequency energy and, if not installed and used in accordance with the instructions, may cause harmful interference to radio or television reception. However, there is no guarantee that interference will not occur in a particular installation. If this equipment does cause harmful interference to radio or television reception, which can be determined by removing and applying power to the equipment, the user is encouraged to try to correct the interference by one of the following measures:*

- Reorient or relocate the receiving antenna.
- Increase the separation between the equipment and receiver.
- Connect the equipment into an outlet on a circuit different from that to which the receiver is connected.
- Consult the dealer or an experienced radio/TV technician for help.

Caution: *Changes or modifications to this equipment not expressly approved by Toshiba could void the user's authority to operate this equipment.*

Wireless Radio

For product available in the USA/Canada market, only channel 1-11 can be operated. Selection of other channels is not possible. The device could automatically discontinue transmission in case of absence of information to transmit, or operational failure. Note that this is not intended to prohibit transmission of control or signaling information or the use of repetitive codes where required by the technology. If this device is going to be operated in 5.15-5.25GHz frequency range, then it is restricted to an indoor environment only.

Important: *Any changes or modifications not expressly approved by the party responsible for compliance could void the user's authority to operate this equipment.*

This device and its antenna(s) must not be co-located or operating in conjunction with any other antenna or transmitter.

FCC Radiation Exposure Statement

This equipment complies with FCC radiation exposure limits set forth for an uncontrolled environment. This equipment should be installed and operated with minimum distance 20cm between the radiator & your body.

ENERGY STAR® User Information

ENERGY STAR User Information Statement: the factory default settings of this television meet ENERGY STAR® requirements. Changing Picture Settings may increase energy consumption, possibly beyond the limits required for ENERGY STAR qualification.

To ensure your television is operating at optimal energy efficiency, select [Home] mode during initial activation. To return to [Home] mode settings, select the [Installation] icon from the menu, select [Store / Home Mode], then select [Home]. This places the TV in [Standard] mode. [Standard] mode is recommended for normal home use.



ENERGY STAR® qualified TV. Products that earn the ENERGY STAR prevent green house gas emissions by meeting strict guidelines set by the U.S. Environmental Protection Agency. ENERGY STAR and the ENERGY STAR mark are registered U.S. marks.

Important notes about your TV

The following symptoms are technical limitations of LCD Display technology and are not an indication of malfunction; therefore, Toshiba is not responsible for perceived issues resulting from these symptoms.

- 1) An afterimage (ghost) may appear on the screen if a fixed, non-moving image appears for a long period of time. The afterimage is not permanent and will disappear in a short period of time.
- 2) The LCD panel contained in this TV is manufactured using an extremely high level of precision technology; however, there may be an occasional pixel (dot of light) that does not operate properly (does not light, remains constantly lit, etc.). This is a structural property of LCD technology, is not a sign of malfunction, and is not covered under your warranty. Such pixels are not visible when the picture is viewed from a normal viewing distance.

Note: Interactive video games that involve shooting a "gun" type of joystick at an on-screen target may not work with this TV.

WARNING: This product contains chemicals, including lead, known to the State of California to cause cancer and birth defects or other reproductive harm. Wash hands after handling.

Trademark Information

- ClearScan, ColorMaster, ColorStream, CQ Engine, DynaLight, GameTimer, Native Mode, Stable Sound, Surflock, TheaterWide, and TosLink are trademarks or registered trademarks of Toshiba America Information Systems, Inc. and/or Toshiba Corporation.
- Blu-ray Disc™, Blu-ray™, and the logos are trademarks of the Blu-ray Disc Association.



- For DTS patents, see <http://patents.dts.com>. Manufactured under license from DTS Licensing Limited. DTS, the Symbol, & DTS and the Symbol together are registered trademarks, and DTS TruSurround is a trademark of DTS, Inc. © DTS, Inc. All Rights Reserved.



- Manufactured under license from Dolby® Laboratories. Dolby® and the double-D symbol are trademarks of Dolby® Laboratories.



- DivX®, DivX Certified® and associated logos are trademarks of Rovi Corporation or its subsidiaries and are used under license.



- GameNow is a trademark of Ubitus Inc.
- The terms HDMI and HDMI High-Definition Multimedia Interface, and the HDMI Logo are trademarks or registered trademarks of HDMI Licensing LLC in the United States and other countries.

- MPEG Layer-3 audio coding technology licensed from Fraunhofer IIS and Thomson.

- Netflix is a registered trademark of Netflix, Inc.

- Pandora is a registered trademark of Pandora Media, Inc.

- Samba and Samba TV are trademarks of Free Stream Media Corp.

- WiFi is a registered trademark of Wi-Fi Alliance®.

- YouTube is a trademark of Google Inc.

- This production contains Bitstream Vera Sans fonts under the following copyright: Copyright © 2003 by Bitstream, Inc. All Rights Reserved. Bitstream Vera is a trademark of Bitstream, Inc.

- All other brand and product names are trademarks or registered trademarks of their respective companies.

Copyright

© 2014 by Toshiba America Information Systems, Inc. All rights reserved. Under the copyright laws, this guide cannot be reproduced in any form without the prior written permission of Toshiba. No patent liability is assumed, however, with respect to the use of the information contained herein.

Notice

The information contained in this manual, including but not limited to any product specifications, is subject to change without notice.

TOSHIBA AMERICA INFORMATION SYSTEMS, INC., TOSHIBA OF CANADA LIMITED, AND TOSHIBA DE MEXICO, S.A. DE C.V. (COLLECTIVELY TOSHIBA) PROVIDES NO WARRANTY WITH REGARD TO THIS MANUAL OR ANY OTHER INFORMATION CONTAINED HEREIN AND HEREBY EXPRESSLY DISCLAIMS ANY IMPLIED WARRANTIES OF MERCHANTABILITY OR FITNESS FOR ANY PARTICULAR PURPOSE WITH REGARD TO ANY OF THE FOREGOING. TOSHIBA ASSUMES NO LIABILITY FOR ANY DAMAGES INCURRED DIRECTLY OR INDIRECTLY FROM ANY TECHNICAL OR TYPOGRAPHICAL ERRORS OR OMISSIONS CONTAINED HEREIN OR FOR DISCREPANCIES BETWEEN THE PRODUCT AND THE MANUAL. IN NO EVENT SHALL TOSHIBA BE LIABLE FOR ANY INCIDENTAL, CONSEQUENTIAL, SPECIAL, OR EXEMPLARY DAMAGES, WHETHER BASED ON TORT, CONTRACT OR OTHERWISE, ARISING OUT OF OR IN CONNECTION WITH THIS MANUAL OR ANY OTHER INFORMATION CONTAINED HEREIN OR THE USE THEREOF.

Contents

Chapter 1: Introduction	17
Features	18
Overview of installation, setup, and use	20
TV front and side panel controls and connections	21
TV back panel connections	22
Chapter 2: Connecting Your TV	24
Overview of cable types	24
Coaxial (F-type) cable	24
Standard A/V cables (red/white/yellow)	25
Component video cables (red/green/blue)	25
HDMI® cable (with HDMI Logo)	25
Optical audio cable	26
LAN cable	26
About the connection illustrations	26
Connecting a VCR, antenna, cable TV, or camcorder	26
Connecting a Blu-ray™ / DVD player, satellite receiver with ColorStream™ or VCR	28
Connecting an HDMI® or DVI device to the HDMI® input	29

HDMI® CEC connection	31
Connecting a digital audio system	33
Connecting a computer	34
Connection to the TV's HDMI® terminal	34
Connecting to a home network	35
Connecting the TV directly to a computer without an Internet connection	35
Connecting the TV to a home network without an Internet connection	36
Connecting the TV to a home network with an Internet connection - wired.....	37
Connecting the TV to a home network with an Internet connection - wireless	38
Chapter 3: Using the Remote Control.....	39
Installing batteries.....	39
Remote control effective range.....	40
Learning about the remote control.....	41
Chapter 4: Menu Layout and Navigation	44
Main menu layout.....	44
Navigating the menu system	46
Chapter 5: Setting up your TV	47
Initial Setup	47
Installation setup selection	48
Storing channels in memory (optional)	49
Auto Tuning	49
Manual Tuning.....	51
Setting channel skip	51
Setting the AV input mode	52
Setting the time zone	52
Viewing the system status.....	53
Resetting Factory Defaults.....	53

Chapter 6: Setting up your TV	54
Selecting the video input source	54
Labeling the video input sources	56
Tuning to the next programmed channel.....	58
Tuning to a specific channel (programmed or unprogrammed).....	58
Switching between two channels using Channel Return	58
Switching between two channels using SurfLock™	59
Selecting the picture size	60
Full	61
TheaterWide 1	61
TheaterWide 2	61
TheaterWide 3	62
Native	62
4:3.....	63
Normal	63
Dot by Dot	63
Scrolling the TheaterWide™ picture (TheaterWide 2 and 3 only)	64
Using the Auto Aspect feature	65
Using the 4:3 Stretch.....	65
Adjusting the picture	66
Selecting the picture mode	66
Adjusting the picture quality	67
Using closed captions	68
Base closed captions	68
Digital CC settings	69
Adjusting the audio	71
Muting the sound	71
Using the Digital Audio Selection.....	71
Selecting stereo/SAP broadcasts.....	72
Adjusting the audio quality	73
DTS TruSurround™	73

Sound Mode.....	73
Stable Sound™	73
Using the Dolby® Digital Dynamic Range	
Control feature	74
Selecting the PIN code	74
Enter a new PIN code.....	74
Forgotten PIN code	74
Changing or deleting your PIN code	75
Using parental controls (for USA region).....	75
Blocking TV programs and movies by	
rating (V-Chip)	75
Downloading an additional rating system	76
Displaying ratings	79
Unlocking programs temporarily.....	79
Using the input lock feature	80
Locking channels	80
Using the GameTimer™.....	81
Using the panel lock feature.....	82
MediaShare (Videos, Music, and Photos).....	83
Auto Start function	85
To open the MediaShare	85
Viewing photo files	86
Playing music files	88
Viewing photo files and playing music files	
at the same time	89
Playing video files	89
During playback you can do the following:.....	90
To set the repeat mode:	90
DivX®	91
To register your TV to a DivX® account:	91
To unregister your device:	91
To playback DivX HD content:.....	92
Setting the sleep timer.....	92
No Signal Power Down.....	93
Using HDMI® CEC	93

HDMI® CEC playback device (Blu-ray™/DVD player, etc.) control	94
Other HDMI® CEC functions	96
Setting up HDMI® CEC.....	96
Using the HDMI® settings feature	97
HDMI® 1(2, or 3) RGB Range	97
HDMI® Information Display	97
Displaying TV status information.....	98
Understanding the last mode memory feature	99
Chapter 7: Using the TV's Advanced Features	100
Using the advanced picture settings	100
ColorMaster™	100
Base Color Adjustment.....	100
Color Temperature.....	101
Static Gamma.....	101
DynaLight™.....	102
Dynamic Contrast.....	102
Cinema Mode	102
Noise Reduction.....	102
Using your home network	104
When using a Wireless network connection	105
Wireless LAN and your Health:	105
Using the TV in a wireless LAN environment:...	105
Setting up the Network	106
Wireless Setup	106
Easy Setup using PBC (Push button configuration)	107
Easy Setup using PIN (Personal Identification Number)	107
Advanced Network Setup	111
Network Connection Test.....	113
Using the software keyboard	114
Enter text using the software keyboard	115
Performing a Software Upgrade	116

Viewing the Software Licenses	116
Using the TV Application Services features	117
Watching movies with Netflix®	118
YouTube™	119
Pandora®	119
Samba TV™	120
HOTLIST	120
Chapter 8: Troubleshooting	121
General troubleshooting	121
Picture problems	122
Sound problems	123
Remote control problems	124
Channel tuning problems	124
Closed caption problems	125
Rating blocking (V-Chip) problems	125
No HDMI® CEC operation	125
HDMI® problems	125
Network problems	126
Wireless network problems	128
MediaShare problems	128
If the problem persists after trying the solutions	129
Appendix A: Specifications	130
Television system	130
Channel coverage	130
Power source	131
Power maximum current	131
Power consumption	131
Audio power	131
Speaker type	131
Video/audio terminals	131
Video/audio input	131
ColorStream™ (component video) HD input	131
HDMI® input	132
Digital audio output	132

16 Contents

Wireless connection	132
Ethernet	132
USB.....	132
Dimensions (with stand)	132
Weight (mass).....	133
Operating conditions	133
Supplied accessories.....	133
Acceptable signal formats for HDMI®	134
HDMI® signal formats.....	134
Appendix B: License Agreement.....	135
Appendix C: Index.....	139

Chapter 1

Introduction

Safety icons

This manual contains safety instructions that must be observed to avoid potential hazards that could result in personal injuries, damage to your equipment, or loss of data. These safety cautions have been classified according to the seriousness of the risk, and icons highlight these instructions as follows:

▲ DANGER

Indicates an imminently hazardous situation which, if not avoided, will result in death or serious injury.

▲ WARNING

Indicates a potentially hazardous situation which, if not avoided, could result in death or serious injury.

▲ CAUTION

Indicates a potentially hazardous situation which, if not avoided, may result in minor or moderate injury.

CAUTION

Indicates a potentially hazardous situation which, if not avoided, may result in property damage.

NOTE

Provides important information.

Features

The following are just a few of the many exciting features of your new Toshiba wide screen, integrated HD LED TV:

- ❖ **Integrated digital tuning (8VSB ATSC and QAM)**—Eliminates the need for a separate digital converter set-top box (in most cases)
- ❖ **1920 x 1080 output resolution**
- ❖ **Three HDMI®**—Digital, High-Definition Multimedia Interfaces with 1080p input support. See [“Edge Enhancer” on page 103](#).
- ❖ **Built-in WLAN**—Allows the television to access your home wireless network.
- ❖ **ColorStream™ HD**—High-resolution component video input and shared composite video input, see [“DynaLight™” on page 102](#).
- ❖ **Digital Audio Out**—Optical audio connection with Dolby® Digital optical output form. See [“Using the advanced picture settings” on page 100](#).
- ❖ **DTS TruSurround™**—Delivers high quality surround and expanded sound field over two speakers.
- ❖ **Game Mode**—Reduces controller delay for faster video gaming action. See [“Selecting the picture mode” on page 66](#).
- ❖ **Dynamic Picture Mode**—Delivers maximum contrast, clarity, and color saturation. See [“Selecting the picture mode” on page 66](#).
- ❖ **GameTimer™**—Allows you to set time limits for video games play and locks the input source for gaming modules when the pre-set time expires. See [“Using the GameTimer™” on page 81](#).
- ❖ **HDMI® CEC control**—Allows control of external devices from the TV remote via HDMI® connection, see [“DNR \(Dynamic Noise Reduction\)” on page 103](#).
- ❖ **ColorMaster™**—Allows you to adjust the TV’s standard colors, see [“ColorMaster™” on page 100](#).
- ❖ **CQ Engine™**—Is a powerful advanced Dual Core processor that creates enhanced picture quality, and enables superior Smart TV capability.
- ❖ **Cinema Mode**—This picture quality feature provides a smoother motion and a crisper image. See [“Cinema Mode” on page 102](#).

- ❖ **ClearScan™ 120Hz Technology**—Utilizes frame interpolation technology to double the television refresh rate for clear fast motion video. This technology is ideal for watching action movies, sports and video games.
- ❖ **DynaLight™**—Backlight control monitors the brightness of each video frame and automatically adjusts backlight intensity based on the content to create higher dynamic contrast, for deeper blacks and increased depth, see [“DynaLight™” on page 102.](#)
- ❖ **DNR**—Digital picture Noise Reduction, see [“DNR \(Dynamic Noise Reduction\)” on page 103.](#)
- ❖ **Edge Enhancer**—Enhanced video processing that defines the edges and textures for greater image details to make the picture look crisp and clear, see [“Edge Enhancer” on page 103.](#)
- ❖ **HDMI® CEC**—Allows control of external devices from the TV remote via HDMI® connection, see [“DNR \(Dynamic Noise Reduction\)” on page 103.](#)
- ❖ **MediaShare**—Allows you to view photo files and play music files, see [“MediaShare \(Videos, Music, and Photos\)” on page 83.](#)
- ❖ **Smart TV**—Connects you to online content and your home network. You can access key media apps including Netflix®, Pandora®, and YouTube™, see [“Using the TV Application Services features” on page 117.](#)
- ❖ **ENERGY STAR® qualified**



Overview of installation, setup, and use

Follow these steps to set up your TV and begin using its many exciting features.

- 1 Carefully read the important safety, installation, care, and service information. Keep this document for future reference.
- 2 To choose a location for the TV:
 - ❖ Read [“Important notes about your TV”](#) on page 8.
 - ❖ Place the TV on the floor or a sturdy, level, stable surface that can support the weight of the unit. Secure the TV to a wall, pillar, or other immovable structure, see [26\) on page 5](#).
 - ❖ Place the TV in a location where light does not reflect on the screen.
 - ❖ Always leave a space of at least 4 (four) inches around the TV. The slots and openings are provided to protect the TV from overheating and to help maintain reliable operation of the TV.
- 3 Do not plug in any power cords until after you have connected all cables and devices to your TV.
- 4 Before connecting cables or devices to the TV, learn the functions of the TV’s connections and controls, see [“Advanced Network Setup”](#) on page 111.
- 5 Connect your other electronic device(s) to the TV, see [“DNR \(Dynamic Noise Reduction\)”](#) on page 103.
- 6 Install the batteries in the remote control, see [“Installing batteries”](#) on page 39.
- 7 See [“Using the Remote Control”](#) on page 39 for an overview of the buttons on the remote control.
- 8 After connecting all cables and devices, plug in the power cords for your TV and other devices. Then press the **POWER** button on the TV control panel or remote control to turn on the TV.

NOTE

If the TV stops responding to the buttons on the remote control or TV control panel and you cannot turn the TV off or on, unplug the power cords for a few seconds and then plug them in and try again.

- 9 See [“Navigating the menu system”](#) on page 46 for a quick overview of navigating the TV’s menu system.
- 10 Program channels into the TV’s channel memory, see [“Auto Tuning”](#) on page 49.

- 11 For details on using the TV's features, see [Chapter 6](#) and [Chapter 7](#).
- 12 For help, refer to “[Troubleshooting](#)” on page 121.
- 13 For technical specifications, see “[Specifications](#)” on page 130.
- 14 For the End User License Agreement, see “[License Agreement](#)” on page 135.

TV front and side panel controls and connections

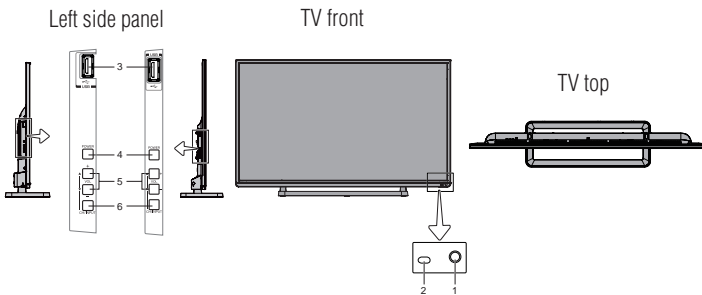

(Sample Illustration) 40/50L3400U - Front and side panel controls and connection

- 1 **Power On/Standby LED**—Power indicator light, (glows red when the TV power is Off).
- 2 **Remote sensor (embedded)**—Point the remote control toward this remote sensor.
- 3 **USB port**—Used to access video, music, or photo files with USB device.
- 4 **POWER**—Turns the TV On/Off.
- 5 **▲/▼/+/-** —Adjusts the volume level, changes the channel, or changes the input or source you are viewing, depending on the mode, which is selected by the **CH/INPUT** button.
- 6 **CH/INPUT**—Switches the function of the **▲/▼/+/-** buttons to select the volume, channel, or input mode.
 - In Volume mode, the buttons increase or decrease the volume.
 - In Channel mode, the buttons change the channel up or down.
 - In Source mode, the buttons toggle the input from one source to the next.

TV back panel connections

For explanations of cable types and connections, see page 102.

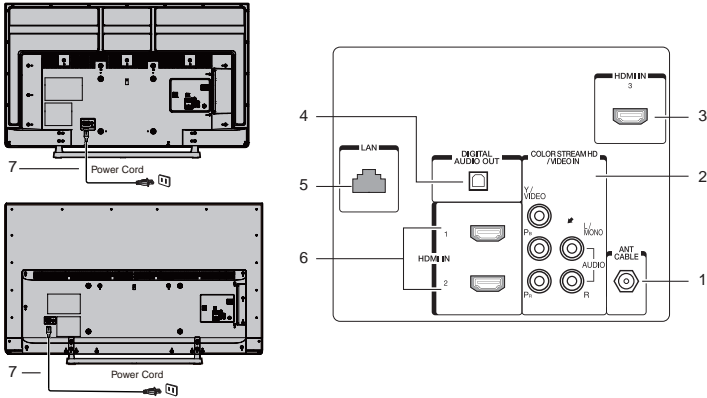

(Sample Illustration) 40/50L3400U - Back panel connections

- 1 **ANT/CABLE**—Antenna input that supports analog (NTSC) and digital (ATSC) off-air antenna signals and analog and digital cable TV (QAM) signals.
- 2 **ColorStream™ HD/ Video IN**—High-resolution component video input and shared composite video input, see “DynaLight™” on page 102.
- 3 **HDMI® IN**—High-Definition Multimedia Interface input receives digital audio and uncompressed digital video from an HDMI® device or uncompressed digital video from a DVI device. HDMI® connection is necessary to receive 1080p signals.
- 4 **Digital Audio out**—Optical audio output in Dolby® Digital or PCM (pulse-code modulation) format for connecting an external Dolby® Digital decoder, amplifier, or home theater system with optical audio input.
- 5 **LAN IN**—Connects the TV to your home network.
- 6 **Two HDMI® IN**—High-Definition Multimedia Interface input receives digital audio and uncompressed digital video from an HDMI® device or uncompressed digital video from a DVI device. HDMI® connection is necessary to receive 1080p signals.
- 7 **Power Cord**—Plug one end of the power cord into the jack on the back of the unit, and the other end into a live electrical outlet.

CAUTION

The included power cord is for use with this unit only. Do not use it with other equipment.

If you are not going to use the unit for an extended period of time, disconnect the power cord from the wall outlet. Whenever the power cord is plugged into the wall outlet, it will draw some power, even when the unit is off.

NOTE

Component/Standard (composite) video cables carry only video information; separate audio cables are required for a complete connection.

Chapter 2

Connecting Your TV

Overview of cable types

Before purchasing cables, know the connector types your devices require. You can purchase cables from most stores that sell audio/video devices.

Coaxial (F-type) cable



(Sample Illustration) Coaxial cable

Coaxial (F-type) cable connects your antenna, cable TV service, and/or cable converter box to the ANT/CABLE input on your TV.

NOTE Please tighten this connection by hand. Using tools may damage the connection.

Standard A/V cables (red/white/yellow)

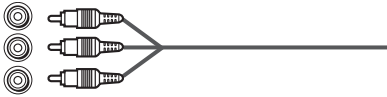

(Sample Illustration) Standard AV cables

Standard A/V cables (composite video) usually come in sets of three, and connect to video devices with analog audio and composite video output. These cables (and the related inputs on your TV) are typically color-coded according to use: yellow for video, red for stereo right audio, and white for stereo left (or mono) audio.

Component video cables (red/green/blue)

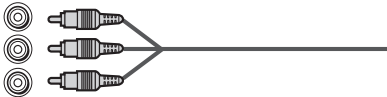

(Sample Illustration) Component video cables (red/green/blue)

Component video cables come in sets of three and connect with video devices with component video output. (ColorStream™ is Toshiba's brand of component video). These cables are typically color-coded red, green, and blue. Separate audio cables are required for a complete connection.

NOTE Component video cables provide better picture quality than composite video cables.

HDMI® cable (with HDMI Logo)



(Sample Illustration) HDMI® cable

HDMI® (High-Definition Multimedia Interface) cable connects to devices that have an HDMI® output. An HDMI® cable delivers digital audio and video in its native format. Separate audio cables are not required, see [“Connecting an HDMI® or DVI device to the HDMI® input”](#) on page 29.

NOTE HDMI® cables provide the best audio and picture quality.

26 Connecting Your TV

Connecting a VCR, antenna, cable TV, or camcorder

Optical audio cable



(Sample Illustration) Optical audio cable

Optical audio cable connect receivers with Dolby® Digital or PCM (pulse-code modulation) optical audio input to the TV’s Digital Audio Out terminal, see “Connecting a digital audio system” on page 30.

LAN cable



(Sample Illustration) LAN cable

Standard LAN cable connects the TV to your home network, see “Connecting the TV to a home network with an Internet connection - wired” on page 37.

Crossover LAN cable connects the TV directly to a computer, see “Connecting the TV directly to a computer without an Internet connection” on page 35.

About the connection illustrations

You can connect different types and brands of devices to your TV in several different configurations. The connection illustrations in this manual are representative of typical device connections only. The input/output terminals on your devices may differ from those illustrated herein. For details on connecting and using your specific devices, refer to each device’s User’s Guide.

Connecting a VCR, antenna, cable TV, or camcorder

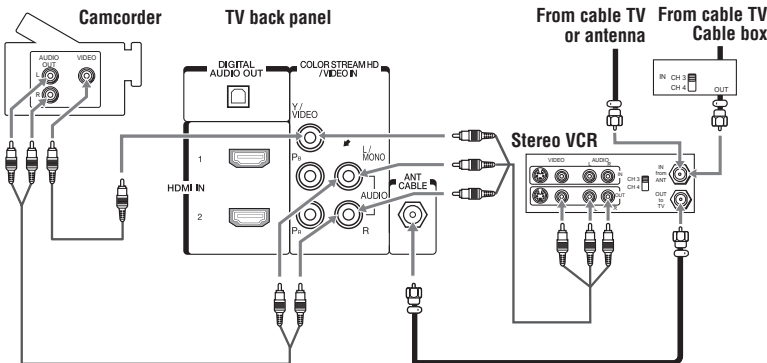

(Sample Illustration) 40/50L3400U—Connecting to a VCR, antenna, or cable TV, or camcorder

Items needed:

- ❖ Coaxial cables
 - ❖ Standard AV cables
- If you have a mono VCR, connect L/MONO on the TV to your VCR's audio out terminal using the white audio cable only.
- ❖ Standard audio cable
-

NOTE The menu setting may need to be changed in order to watch the shared input between composite and component video. Composite and component video cannot be used simultaneously.

NOTE When you use a cable box, you may not be able to use the remote control to program or access certain features on the TV. When you use ColorStream™ HD or Video, switch AV input mode appropriately.

To view the antenna or cable signal:

Select **ANT/CABLE** video input source on the TV.*

To view basic and premium cable channels:

Turn off the VCR. Select the **ANT/CABLE** video input source on the TV.* Tune the TV to channel 3 or 4 (whichever channel the cable box output is set to). Use the cable box controls to change channels.

To view the VCR or camcorder video:

Turn on the VCR or camcorder video. Select **VIDEO** input source on the TV.*

*To select the video input source, press the **INPUT** button on the remote control, see [“Selecting the video input source” on page 54](#).

NOTE The unauthorized recording, use, distribution, or revision of television programs, videotapes, DVDs, and other materials is prohibited under the Copyright Laws of the United States and other countries, and may subject you to civil and criminal liability.

Connecting a Blu-ray™ / DVD player, satellite receiver with ColorStream™ or VCR

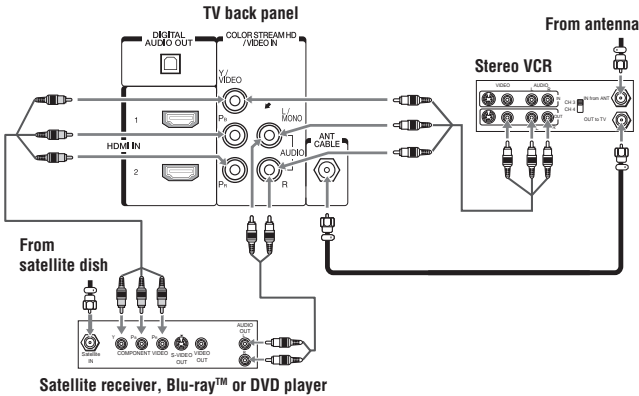

(Sample Illustration) 40/50L3400U—Connecting a Blu-ray™/DVD player or Satellite receiver with Colorstream™ (or VCR).

NOTE ColorStream™ and composite video cables cannot be connected simultaneously.

Items needed:

- ❖ Coaxial cables
- ❖ Standard AV cables
 - If you have a mono VCR, connect L/MONO on the TV to your VCR’s audio out terminal using the white audio cable only.
- ❖ Standard audio cables
- ❖ Component video cables
 - ❖ You can connect the component video cables (plus audio cables) from the DVD player or satellite receiver to the COLOR STREAM HD terminal in the TV. The COLOR STREAM HD terminal can be used to display Progressive (480p, 720p) and Interlaced (480i, 1080i) scan systems. Please note that 1080p is not supported. Check the User’s Guide of the DVD player in order to determine the best output signal available.
 - ❖ If your DVD player or satellite receiver does not have component video, connect a standard A/V cable to the AUDIO/VIDEO terminal. If your DVD player has HDMI® video, see [“Connecting an HDMI® or DVI device to the HDMI® input”](#) on page 29.

NOTE When you use ColorStream™ HD or Video, switch AV input mode appropriately.

To view antenna or Cable channels:

Select the **ANT/CABLE** video input source on the TV.*

To view the DVD player:

Turn on the DVD player. Select the **COLORSTREAM HD** video input source on the TV.*

To view satellite programs using the component video connections:

Turn on the satellite receiver. Select the **COLORSTREAM HD** video input source on the TV.*

To view the VCR or view and record antenna channels:

Turn on the VCR. Tune the VCR to the channel you want to watch. Select the **VIDEO** input source on the TV.*

To record a TV program while watching a DVD:

Turn on the VCR. Tune the VCR to the channel to record. Select the **COLORSTREAM HD** video input source on the TV* to view the DVD.

*To select the video input source, press the **INPUT** button on the remote control, see [“Selecting the video input source” on page 54](#).

NOTE The unauthorized recording, use, distribution, or revision of television programs, videotapes, DVDs, and other materials is prohibited under the Copyright Laws of the United States and other countries, and may subject you to civil and criminal liability.

Connecting an HDMI® or DVI device to the HDMI® input

The HDMI® input on your TV receives digital audio and uncompressed digital video from an HDMI® source device, or uncompressed digital video from a DVI (Digital Visual Interface) source device.

This input is designed to accept HDCP (High-Bandwidth Digital-Content Protection) program material in digital form from EIA/CEA-861-D-compliant^[1] consumer electronic devices (such as a set-top box or DVD player with HDMI® or DVI output).

The HDMI® input can accept and display various signal formats. For detailed signal specifications, see [“HDMI® signal formats” on page 134](#). Supported Audio format: Linear PCM, sampling rate 32/44.1/48 kHz.

30 Connecting Your TV

Connecting an HDMI® or DVI device to the HDMI® input

NOTE To connect a computer to the HDMI® input, see “[Connection to the TV’s HDMI® terminal](#)” on page 34.

To connect an HDMI® device, you will need one HDMI® cable (type A connector) per HDMI® device.

- ❖ For proper operation, it is recommended that you use an HDMI® cable with the HDMI® Logo (HDMI®).
- ❖ HDMI® cables transfer both video and audio. Separate analog audio cables are not required (see illustration).

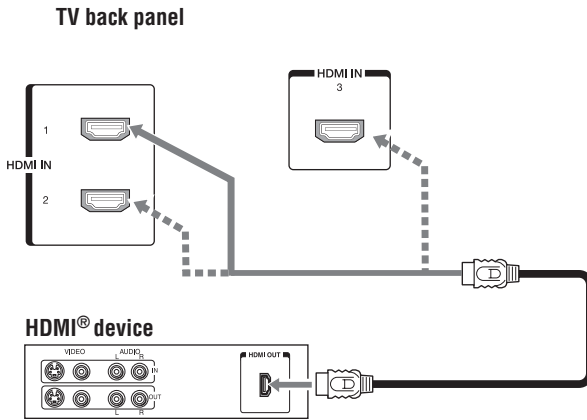

(Sample Illustration) 40/50L3400U—HDMI® connections

To view the HDMI® device video:

Select **HDMI 1**, **HDMI 2** or **HDMI 3** video input source on the TV. (Press the **INPUT** button on the remote control. For more information, see “[Selecting the video input source](#)” on page 54).

To connect a DVI device, you will need:

- ❖ HDMI® to DVI adapter cable
For proper operation, the length of an HDMI® to DVI adapter cable should not exceed 9.8 ft (3m). The recommended length is 6.6 ft (2m).

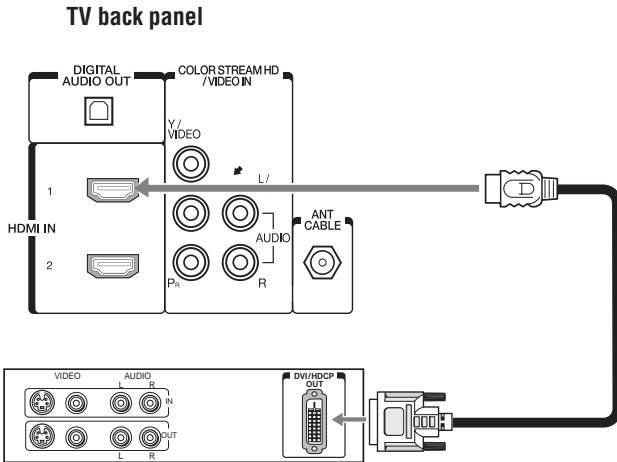

(Sample Illustration) 40/50L3400U—DVI connections

NOTE To ensure that the HDMI® or DVI device is reset properly:

- ❖ When turning on your electronic components, turn on the TV first, and then the HDMI® or DVI device.
- ❖ When turning off your electronic components, turn off the HDMI® or DVI device first, and then the TV.

NOTE EIA/CEA-861-D compliance covers the transmission of uncompressed digital video with high-bandwidth digital content protection, which is being standardized for reception of high-definition video signals. Because this is an evolving technology, it is possible that some devices may not operate properly with the TV.

HDMI® CEC connection

You can control the basic functions of connected audio/video devices using the TV's remote control if you connect a HDMI® CEC compatible audio receiver or playback device. The HDMI® CEC Control feature uses CEC technology as regulated by the HDMI® standard.

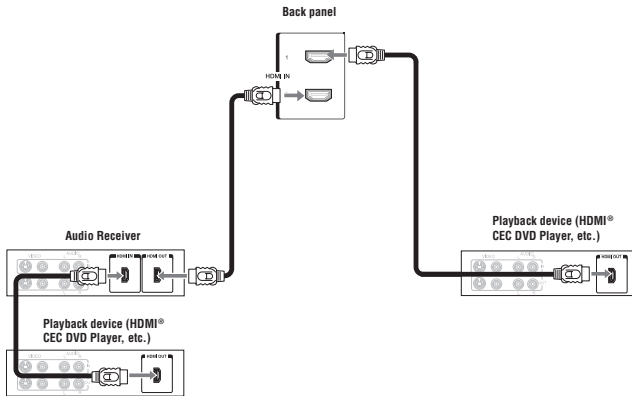

(Sample Illustration) 40/50L3400U—HDMI® CEC compatible audio receiver and playback device connections

To connect an HDMI® device, you will need one HDMI® cable (type A connector) per HDMI® device (see “[Overview of cable types](#)” on page 24).

-
- NOTE**
- ❖ If several devices are connected, HDMI® CEC Control feature may not operate properly.
 - ❖ For proper operation, it is recommended that you use an HDMI® cable with the HDMI® Logo ().
-

Before controlling the device(s):

- ❖ After completing the above connections, configure the HDMI® CEC Setup menu with the desired settings, see “[Setting up HDMI® CEC](#)” on page 96.
- ❖ The connected devices must also be configured. For details, see the operation manual for each device.
- ❖ This feature uses the CEC technology as regulated by the HDMI® standard.
- ❖ This feature is limited to models incorporating Toshiba’s HDMI® CEC. However, Toshiba is not liable for those operations. Refer to the individual instruction manuals for compatibility information.

-
- NOTE** This feature may not work properly depending on the devices that are connected.
-

Connecting a digital audio system

The TV's Digital Audio Out terminal outputs a Dolby® Digital, 2-channel down-mixed PCM (pulse-code modulation) signal for use with an external Dolby® Digital decoder or other external audio system with optical audio input.

You will need an optical audio cable (Use an optical audio cable that has the larger “TosLink™” connector and not the smaller “mini-optical” connector.)

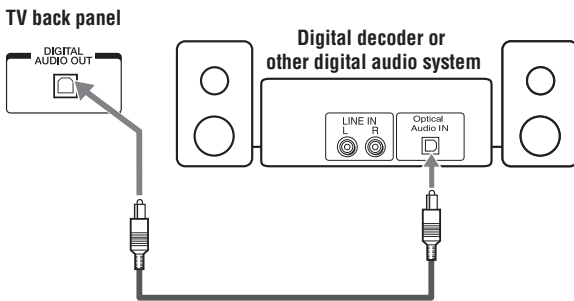

(Sample Illustration) 40/50L3400U—Connecting a digital audio system

NOTE Some audio systems may not be compatible with Dolby® Digital, or bitstream signal. Older audio systems that are not compatible with standard optical out signals may not work properly, creating a high noise level that may damage speakers or headphones. THIS DAMAGE IS NOT COVERED BY YOUR WARRANTY. The DIGITAL AUDIO OUT terminal may not output some digital audio sources because of copy restrictions.

- ❖ The Dolby® Digital format is available in the following situations:
 - When tuned to a digital RF channel
 - When an HDMI® input is used
 - When network devices are used

34 Connecting Your TV

Connecting a computer

To control the audio:

- 1 Turn on the TV and the digital audio device.
- 2 Press the **MENU** button on the remote control and open the Sound menu.
- 3 Select **Sound > Digital Audio Output > Audio Format** and then press the **OK** button.
- 4 Press the **▲/▼** (arrow) buttons to select either **Auto** or **PCM**, depending on your device.

Connecting a computer

With HDMI® connection, you can view your computer's display on the TV and hear the sound from the TV's speakers.

Connection to the TV's HDMI® terminal

When connecting a computer with a DVI terminal, use an HDMI®-to-DVI adapter cable.

When connecting a computer with an HDMI® terminal, use an HDMI® cable (type A connector). Separate analog audio cables may not be necessary, depending on computer hardware and setup, see [“Connecting an HDMI® or DVI device to the HDMI® input” on page 29.](#)

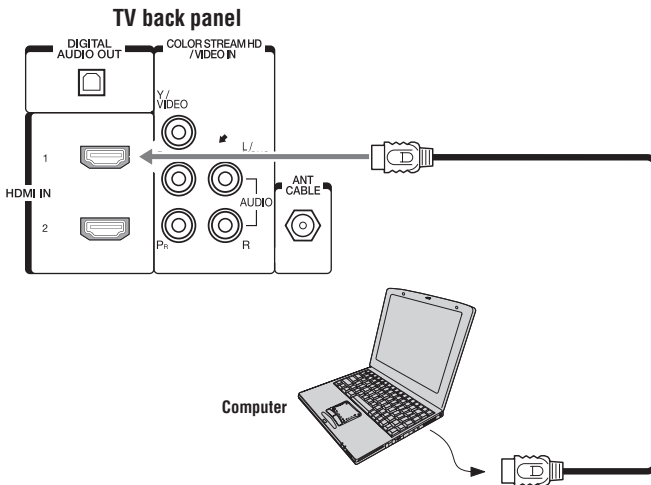

(Sample Illustration) 40/50L3400U Series - Connecting a computer to the TV through the HDMI® terminal.

- NOTE**
- ❖ The edges of the picture may be hidden.
 - ❖ If receiving a 480i (HDMI®), 480p (HDMI®), 720p, 1080i, or 1080p signal program, Native Mode™ scales the video to display the entire picture within the borders of the screen (i.e. no overscan).

Connecting to a home network

The LAN port allows your Toshiba TV to connect to your home network.

You can use this home network to access photos, movies, and music files that are stored on a connected Media Server and play them on your TV.

Connecting the TV directly to a computer without an Internet connection

You will need a Crossover LAN cable.

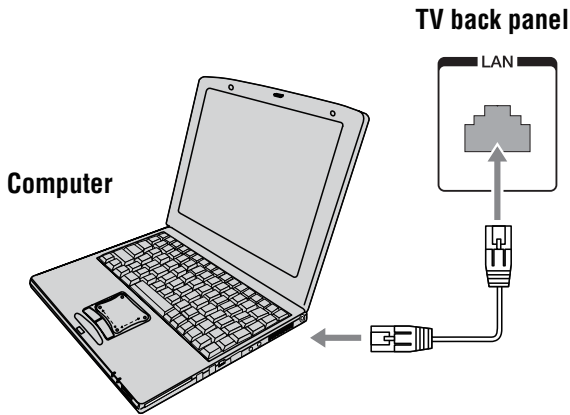

(Sample Illustration) 40/50L3400U Series - Connecting a computer without Internet connection.

Connecting the TV to a home network without an Internet connection

Items needed:

- ❖ Standard LAN cables
- ❖ Router with a hub

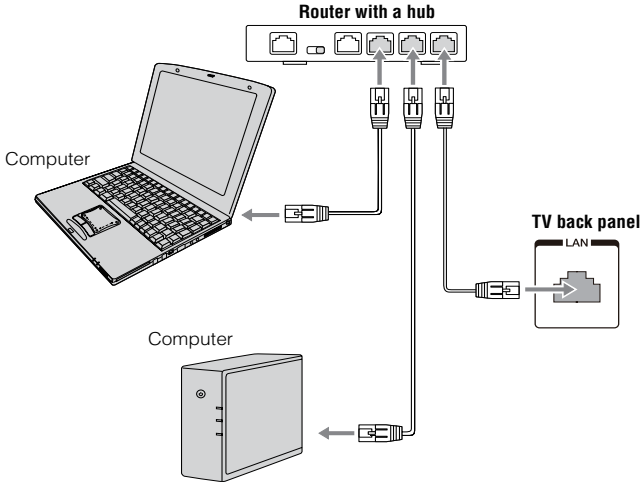

(Sample Illustration) 40/50L3400U Series - Connecting a network without Internet connection

Connecting the TV to a home network with an Internet connection - wired

Items needed:

- ❖ Coaxial or telephone cable (depending on your modem type)
- ❖ Standard LAN cables
- ❖ Router with Hub
- ❖ Modem (DSL or cable)

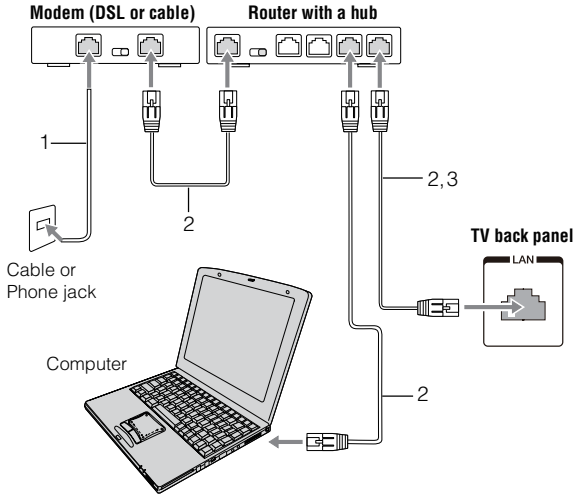

(Sample Illustration) 40/50L3400U Series - Connecting with Internet connection - wired

<i>Item:</i>	<i>Description:</i>
1	Coaxial or telephone cable (depending on your modem type)
2	Standard LAN cable
3	Do NOT connect a phone jack directly to the TV's LAN port.

Connecting the TV to a home network with an Internet connection - wireless

Items needed:

- ❖ Coaxial or telephone cable (depending on your modem type)
- ❖ Standard LAN cables
- ❖ Wireless LAN access point or wireless router
- ❖ Modem (DSL or cable)

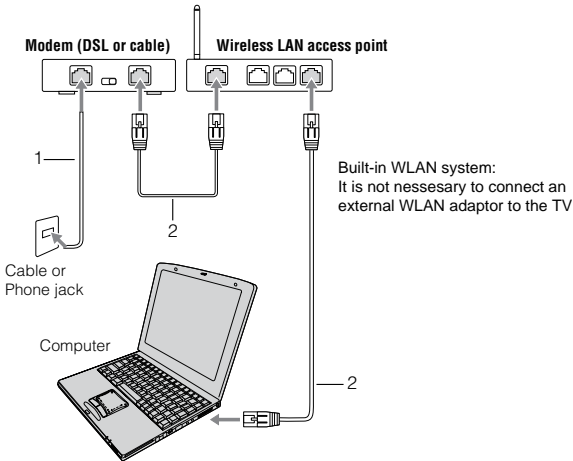

(Sample Illustration) 40/50L3400U Series - Connecting with Internet connection - wireless

Item:	Description:
1	Coaxial or telephone cable (depending on your modem type)
2	Standard LAN cable

The transmission speed over the wireless LAN and the distance over which wireless LAN can reach may vary depending on surrounding electromagnetic environment, obstacles, access point design and configuration, and client design and software/hardware configurations.

The actual transmission speed will be lower than the theoretical maximum speed.

NOTE The Built-in WLAN Adapter is based on the IEEE 802.11n specification and may not be fully compatible with, or support some features (e.g., security) of certain Wi-Fi equipment that are based on the draft version of IEEE 802.11n.

Chapter 3

Using the Remote Control

Installing batteries

To install batteries :

- 1 Remove the battery cover from the back of the remote control.

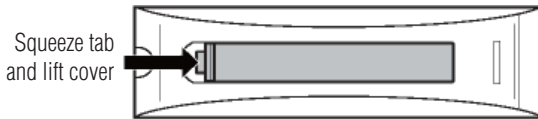

(Sample Illustration) Removing the remote back cover

- 2 Insert two AAA batteries, corresponding to the (+) and (-) markings on the battery compartment.

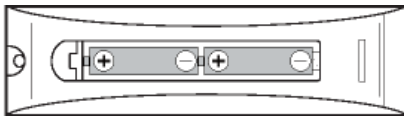

(Sample Illustration) Installing the batteries

- 3 Replace the battery cover.

CAUTION

Do not expose batteries to excessive heat such as sunshine, fire, etc.

NOTE

- ❖ Be sure to use AAA size batteries.
- ❖ Dispose of batteries in a designated disposal area.
- ❖ Always consider the environment when disposing of batteries.
- ❖ Always follow applicable laws and regulations.
- ❖ If the remote does not operate correctly, or if the operating range is reduced, replace the batteries.
- ❖ Always replace both batteries with new ones. Never mix battery types or use new and used batteries together.
- ❖ Always remove batteries from the remote if they are dead or if the remote control is not to be used for an extended period of time. This prevents battery acid from leaking into the battery compartment.

Remote control effective range

For optimum performance, aim the remote control directly at the TV and make sure there is no obstruction between the remote control and the TV.

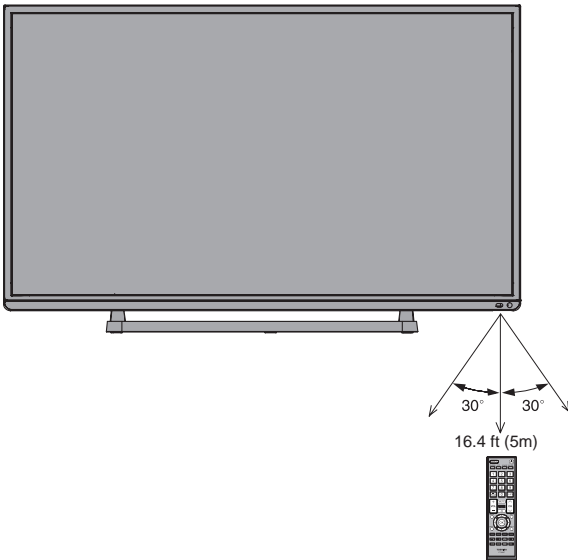

(Sample Illustration) 40/50L3400U-Remote control effective range

Learning about the remote control

The buttons used for operating the TV are described below. For the HDMI® CEC remote control functions, see “HDMI® CEC playback device (Blu-ray™/DVD player, etc.) control” on page 94.

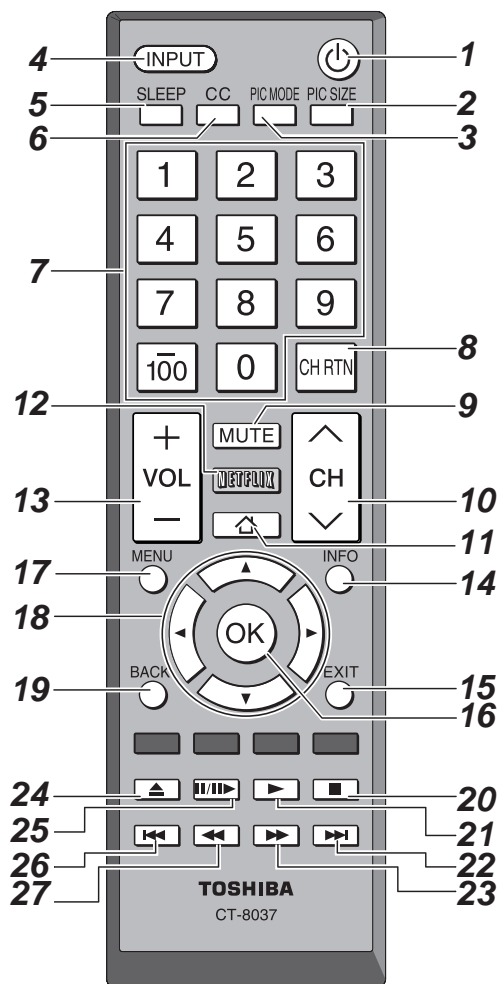

(Sample Illustration) Remote control overview

NOTE The error message “NOT AVAILABLE” may appear if you press a button for a function that is not available.

- 1 The **POWER** button turns the TV **On/Off**. When the TV is off, the power LED indicator on the TV front glows red.
- 2 The **PIC SIZE** button cycles through the picture sizes, see “[Selecting the picture size](#)” on page 60.
- 3 The **PIC MODE** button selects the picture mode, see “[Adjusting the picture](#)” on page 66.
- 4 The **INPUT** button selects the video input source, see “[Selecting the video input source](#)” on page 54.
- 5 The **SLEEP** button accesses the sleep timer, see “[Setting the sleep timer](#)” on page 92.
- 6 The **C. CAPTION** button accesses closed captions, see “[Using closed captions](#)” on page 68.
- 7 The **Channel Number** buttons (**0-9**, and **Dash 100**) directly tune channels. The (**Dash 100**) button allows you to enter two part channel numbers, see “[Storing channels in memory \(optional\)](#)” on page 49.
- 8 The **CH RTN** button returns to the last viewed channel or source, see “[Switching between two channels using Channel Return](#)” on page 58.
- 9 The **MUTE** button reduces or turns off the sound, see “[Muting the sound](#)” on page 71.
- 10 The **CH ▲/▼** (arrow) buttons cycle through programmed channels (when no on-screen menu is present), see “[Storing channels in memory \(optional\)](#)” on page 49.
- 11 The **HOME** button launches the applications bar.
- 12 The **NETFLIX** button launches the Netflix® application on-screen.
- 13 The **VOL (+ -)** buttons adjust the volume level.
- 14 The **INFO** button displays TV status information as well as program details, when available, see “[Displaying TV status information](#)” on page 98.
- 15 The **EXIT** button closes on-screen menus.
- 16 The **OK** button activates highlighted items in the main menu system.
- 17 The **MENU** button accesses the main TV menu system. See “[Navigating the menu system](#)” on page 46.
- 18 The **Arrow** buttons (**▲/▼/◀/▶**) select or adjust programming menus when a menu is on-screen.

- 19** The **BACK** button returns to the previous screen.
- The following key functions allow you to control Toshiba HDMI® CEC compatible devices via HDMI® connection. See “Using HDMI® CEC” on page 93.
- 20** The **STOP** button stops playback of the loaded playback device.
- 21** The **PLAY** button begins playback of the loaded playback device.
- 22** The **SKIP** forward button skips forward to locate later DVD chapters.
- 23** The **FF** button fast-forwards the playback device. (Press during play mode to view the picture moving rapidly forward.)
- 24** The **EJECT** button ejects the DVD or tape.
- 25** The **PAUSE/STEP** button suspends play or record temporarily. Press during play or record mode to pause the picture; press again to restart.
- 26** The **SKIP** reverse button skips to the beginning of the current DVD chapter or locates the previous chapter.
- 27** The **REW** button rewinds/reverses the playback device. (Press during play mode to view the picture moving rapidly backward).





Chapter 4

Menu Layout and Navigation

Main menu layout

The tables below and on the next pages provide a quick overview of your TV's menu system. To open the menus (illustrated below), press **MENU** on the remote control.

<i>Icon</i>	<i>Item</i>	<i>Option</i>
	Picture Mode	Dynamic / Standard / Movie / Game / PC / Store NOTE Store Mode is only available if the TV is set to Store Mode at initial setup. This option is hidden in the Home Mode. NOTE When the TV is set to Store in the initial menu or Store in the Installation Menu, the set will always reset to Store Picture Mode.
	Reset	Reverts to the factory defaults for the selected picture mode
	Backlight	Adjusts Backlight
	Contrast	Adjusts Contrast
	Brightness	Adjusts Brightness
	Color	Adjusts Color
	Tint	Adjusts Tint
	Sharpness	Adjusts Sharpness
	Advanced Picture Settings	Opens the Advanced Picture Settings menu
	Display Settings	Opens the Display Settings menu

<i>Icon</i>	<i>Item</i>	<i>Option</i>		
	Sound	Balance	Adjusts Balance	
	Bass	Adjusts Bass		
	Treble	Adjusts Treble		
	DTS TruSurround	On / Off		
	Sound Mode	Standard/Music/Movie/Clear Voice		
	Stable Sound	On / Off		
	Dynamic Range Control	On / Off		
	TV Speakers	On/Off		
	MTS	Stereo / Mono / SAP		
	Digital Audio Selection	Offers different audio choices for digital channels		
	Primary Audio Language	Primary audio choice for digital channels		
	Digital Audio Output	Opens the Digital Audio Output menu		
		Options	Channel Options	Opens Channel Options menu
Closed Captions		Opens Closed Captions menu		
MediaShare Setup		Opens MediaShare Setup menu		
HDMI CEC Control Setup		Opens HDMI CEC Control Setup menu		
HDMI CEC Player Control		Opens HDMI CEC Player Control menu		
Input Options		Opens Input Options menu		
Power Management		Opens Power Management menu		
Panel Lock		On / Off		
HDMI Information Display		On / Off		
Parental PIN Setup		Opens Parental PIN Setup menu		
Parental Control and Locks		Opens Parental Control and Locks menu		
		Installation	Menu Language	English / Français / Español
		Time Zone	Eastern / Newfoundland / Atlantic / Hawaii / Alaska / Pacific / Mountain / Central	
	Daylight Saving Time	On / Off		
	Store / Home Mode	Home / Store		
	Channel Tuning	Opens Channel Tuning menu		
	Quick Setup	Executes Quick Setup		
	Reset TV	Resets to Factory Defaults		
		Network	Network Setup	Opens Network Setup menu
Smart Apps Setup		Opens Smart Apps Setup menu		
	Timers	Sleep Timer	10-minute increments, from 0 min to a maximum of 12 hours	
	Game Timer	Off/30 min/60 min/90 min/120 min		

Icon	Item	Option
Get Help 	Software License	Views the software licenses
	Software Upgrade	Performs a software upgrade via the Network
	System Information	Opens the System Information screen
	Auto Demo	Opens Auto Demo menu

NOTE Only available if the TV is set to Store mode.

Navigating the menu system

You can use the buttons on the remote control to access and navigate your TV's on-screen menu system.

- 1 Press the **MENU** button to open the menu system.

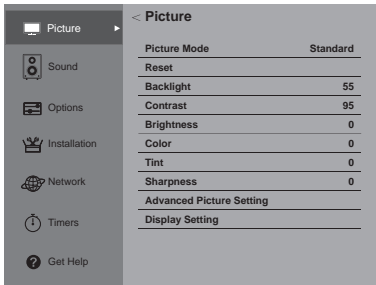

(Sample Image) Navigating the menu system

- 2 When a menu is open, use the **▲/▼/◀/▶** (arrow) buttons on the remote control to move in the corresponding direction in the menu.
- 3 Press the **OK** button to save your menu settings or select a highlighted item.
A highlighted menu item appears in a different color in the menu.
- 4 All menus close automatically if you do not make a selection within approximately 30 seconds.
- 5 To close a menu instantly, press the **EXIT** button.

NOTE The menu background may sometimes appear black, depending on the signal the TV is receiving. This is not a sign of malfunction.

- 6 For information on how to contact Customer Support, press the **MENU** button > **Get Help** > **System Information** > **OK** button.

Chapter 5

Setting up your TV

Initial Setup

When you first turn on or reset the TV, the Initial Setup window will appear.

- 1 In the **Menu Language** field, press the ◀/▶ (arrow) buttons to select your preferred language.
- 2 Press the ▲/▼ (arrow) buttons to select **Time Zone**. Then set your desired time zone, using the ◀/▶ (arrow) buttons and press the **OK** button.

The **Store / Home Mode** settings window appears.

- 3 For normal home use, press the ◀/▶ (arrow) buttons to select **Home**, and then press the **OK** button.

The **ANT/CABLE In** setup window appears.

- 4 Press the ◀/▶ (arrow) buttons to select the input source (**Cable** or **Antenna**), and then press the **OK** button.
- 5 Press the **OK** button to select **Start Scan** and continue with the **Auto Tuning**.

You must select a Language and either **Home/Store** mode, before you can exit out of the Setup Menu. The **EXIT** button will not function until these selections have been made.

Installation setup selection

Menu language

You can choose from three different menu language settings (English, Français, and Español) for the on-screen display of menus and messages.

To select the menu language:

- 1 Press the **MENU** button and open the **Installation** menu, then highlight **Menu Language**.
- 2 Press the ◀/▶/▲/▼ (arrow) buttons to select your preferred language.

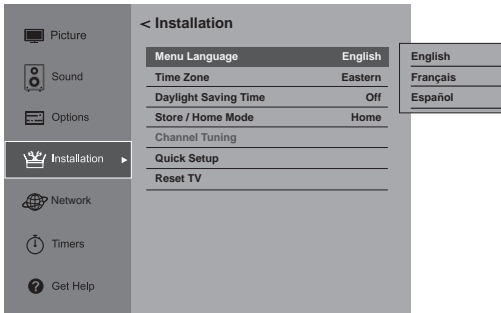

(Sample Image) Selecting the menu language

- 3 Press the **EXIT** button to close the **Installation** menu.

ANT/CABLE IN

This setting configures the input source for the **ANT/CABLE** terminal.

- 1 Press the **MENU** button and open the **Installation** menu.
- 2 Highlight **Channel Tuning**, and then press the **OK** button.

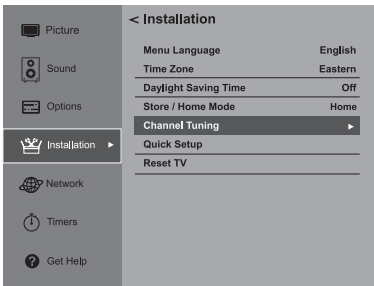

(Sample Image) Installation - Setup selection

- 3 Open the **Channel Tuning** menu, highlight **ANT/CABLE In**, and then press the **OK** button.

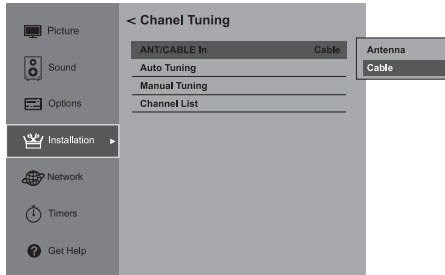

(Sample Image) Channel tuning menu - Input configuration selection

- 4 Press the **▲/▼** (arrow) buttons to select the input source (**Cable** or **Antenna**), and then press the **OK** button to save your new settings.

Storing channels in memory (optional)

To make sure your TV stops only on the channels you want when you press the **▲/▼** (arrow) buttons on the remote control or the control panel, store those channels in the TV's memory.

Auto Tuning

You can set up the TV to detect all active channels in your area and store them in its memory. Then you can manually add or erase individual channels from memory.

NOTE

- ❖ You must set up the ANT/CABLE input source before programming channels. See “ANT/CABLE IN” on page 48.
- ❖ The automatic channel programming process will erase channels that were previously programmed into the TV's memory.
- ❖ To tune the TV to a channel not programmed in the channel memory, you must use the **Channel Number** buttons on the remote control.
- ❖ Programming channels when the **ANT/CABLE** input is configured for Cable will take substantially longer than when the antenna input is configured for Antenna. This is normal; however, once channel programming is finished, you should not have to repeat the programming process again unless your Cable TV service lineup changes significantly.

To program channels automatically:

- 1 Configure the antenna input source, if you have not already done so, see “**ANT/CABLE IN**” on page 48.
- 2 Press the **MENU** button and open the **Installation** menu.
- 3 Highlight **Channel Tuning**, and then press the **OK** button.

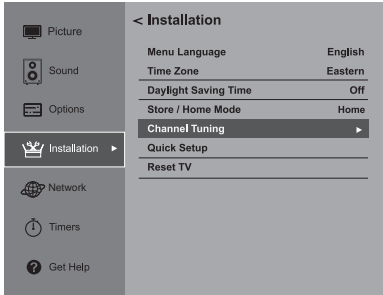

(Sample Image) Setup menu - Installation selection

- 4 Highlight **Auto Tuning**, and then press the **OK** button to open the **Channel Program menu** to begin channel programming.

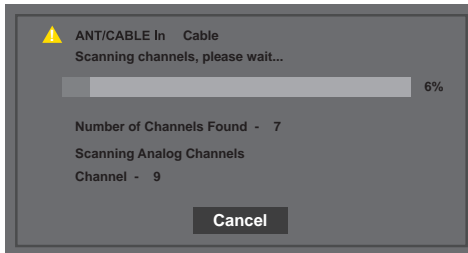

(Sample Image) Installation menu - Channel selection

The TV will automatically cycle through all the antenna/cable channels, and store all active channels in the channel memory. While the TV is cycling through the channels, the message “Scanning channels, please wait” appears. When channel programming is complete, press the **CH** **▲/▼** (arrow) buttons to view the programmed channels.

NOTE To cancel channel programming, press the **EXIT** button on the remote control or highlight **Cancel** in the on-screen display, and then press the **OK** button.

Manual Tuning

After storing channels in memory, you can manually enter channels if the physical channel is known.

- 1 Press the **MENU** button and open the **Installation** menu.
- 2 Highlight **Channel Tuning** and then press the **OK** button.
- 3 Highlight **Manual Tuning** and then press the **OK** button, the **Manual Tuning** form will appear.
- 4 Use buttons 0–9 on the remote control to enter the channel number (for example, 56)
- 5 Press the **OK** button to start Manual Tuning.

Type:	Description:
ATV	Analog channel.
DTV	Digital channel.

Setting channel skip

To prevent a channel from being viewed, you can set it to be skipped.

- 1 From the **Options** menu, highlight **Channel Options**, and then press the **OK** button.
The list of channels appears.

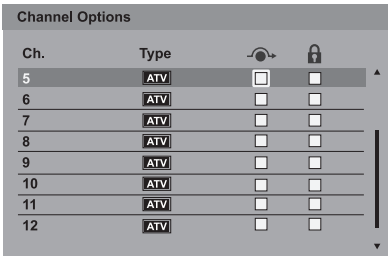

(Sample Illustration) Channel Options

- 2 Press the **▲/▼** (arrow) buttons to select a channel position to be skipped, and then press the **OK** button .
A check will appear in the box. To remove the check, press the **OK** button again.

To add a channel to the channel memory:

- ❖ Highlight the checked box next to the channel number you wish to add, and then press the **OK** button to remove the check.

NOTE You can also block specific channels so that they cannot be tuned until you unlock them. For information, see “[Locking channels](#)” on page 80.

To manually add digital sub-channels on a physical channel:

- ❖ Use the Channel Numbers and the (**Dash 100**) on the remote control to enter the channel number (for example, 56-1). If the channel is found, the number will be added to the list and the box will be unchecked. If the channel is not found, a message appears.

NOTE Skipped channels cannot be selected with the **CH ▲/▼** (arrow) buttons; however, they can be accessed using the number keys on the remote control.

Setting the AV input mode

This setting determines the configuration of the shared AV input on your TV. You can set this input for either **ColorStream HD** or **Video**.

Add the following descriptions:

To set the **AV Input** mode:

- 1 From **Options** menu, highlight **Input Options**, and then press the **OK** button.
- 2 Press **▲/▼** (arrow) buttons to select **AV Input**, and then press the **OK** button.
- 3 Press **▲/▼** (arrow) buttons to select **Video** or **ColorStream HD**, and then press the **OK** button to save your new setting.

Setting the time zone

The Time Zone setup allows you to specify the correct time zone for your region. This feature allows the TV status information to display the correct time zone information for your viewing area.

To set the time zone:

- 1 In the **Installation** menu, highlight **Time Zone**, and press the **OK** button.
- 2 Press the **▲/▼** (arrow) buttons to select the region, and then press the **OK** button.

To set the Daylight Saving Time status:

- 1 In the **Installation** menu, highlight **Daylight Saving Time**, and press the **OK** button.
- 2 Press the **▲/▼** (arrow) buttons to select **On** or **Off**, and then press the **OK** button.

Viewing the system status

- 1 In the **Get Help** menu, highlight **System Information**, and then press the **OK** button. The related information appears.

To close the screen and return to the **Get Help** menu:

- ❖ Press the **OK** or the **BACK** button.

To return to normal viewing, press the **EXIT** button.

Resetting Factory Defaults

To reset all settings and channels to their factory default values:

- 1 Press the **MENU** button and open the **Installation** menu.
- 2 Highlight **Reset TV**, and then press the **OK** button.
- 3 Enter your PIN code (If a PIN code has been set).
- 4 A confirmation screen appears. Select **Yes**, and press the **OK** button. The TV will turn off automatically.

To cancel the reset process, select **No**, and press the **OK** button.

Chapter 6

Setting up your TV

Selecting the video input source

To select the video input source to view:

- 1 Press the **INPUT** button on the remote control or TV control panel.
- 2 Do one of the following:
 - ❖ Press 0-4.
 - ❖ Repeatedly press the **▲/▼** (arrow) buttons on the remote control, and then press the **OK** button to change the input setting.
 - ❖ Repeatedly press the **INPUT** button to cycle through all the inputs. Stop pressing the **INPUT** button when the desired input is selected.

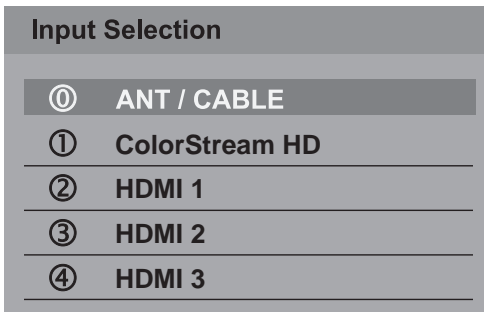

(Sample Image) Input Selection screen

- NOTE**
- ❖ You can label the video input sources according to the specific devices you have connected to the TV, see “Labeling the video input sources” on page 56.
 - ❖ Sources can be “hidden,” see “Labeling the video input sources” on page 56.
 - ❖ “NO VIDEO” will appear randomly on the screen if no signal is received in video input mode.
 - ❖ If a CEC device is connected to an HDMI® input, the HDMI® CEC icon appears.
-

If a HDMI® CEC device with HDMI® switching capability (e.g. Audio Receiver) is connected to the HDMI® input, press the **INPUT** button on the remote control repeatedly to highlight **HDMI 1** or **HDMI 2**.

If the connected CEC device has any connected devices, a separate device selection pop-up window appears:

HDMI 1 - 1	Audio Receiver
HDMI 1 - 2	Player

(Sample Illustration) HDMI® setting pop-up window

Press the **INPUT** button repeatedly to highlight the desired input source, and then press the **EXIT** button.

- NOTE**
- ❖ When you select HDMI® CEC input sources from the pop-up window using the **INPUT** button, some HDMI® CEC devices may automatically turn on.
 - ❖ When selecting input sources using the ▲/▼/+/– (arrow) buttons, you will need to press the **OK** button to actually select a particular device from the pop-up window or wait 5 seconds after highlighting desired input.
-

Labeling the video input sources

You can label each video input source according to the type of device you have connected to each source. Choose from the following preset list of labels:

- ❖ -- (default label)
- ❖ Receiver
- ❖ Cable
- ❖ DVD
- ❖ Game
- ❖ PC
- ❖ Recorder
- ❖ Satellite
- ❖ VCR
- ❖ Blu-Ray
- ❖ Hide (to hide an unused input in the Input Selection screen and in the Channel Browser Inputs list)

To label the video input sources:

- 1 In **Options** menu, highlight **Input Options** and then press the **OK** button.
- 2 Highlight **Input Labeling**, and then press the **OK** button.
- 3 Press the **▲/▼** (arrow) buttons to highlight the video source you wish to label.
- 4 Press the **◀/▶** (arrow) buttons to select the desired label for that input source. If a particular input is not used, **Hide** can be selected as the label. This will cause that input to be grayed out in the Input Selection screen and skipped over when you press the **INPUT** button on the remote control.

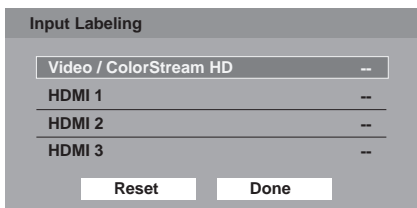

(Sample Image) Input Labeling screen

- 5 To save the new input labels, highlight **Done**, and then press the **OK** button.
To revert to the factory default labels, highlight **Reset** and press the **OK** button.

Input labeling example:

The screen below left shows the default Input Selection screen (with none of the inputs labeled as a specific device). The screen below (right) is an example of how you can label the inputs if you connected a VCR to ColorStream™ HD, a video recorder to HDMI 1, and a DVD player to HDMI 2.

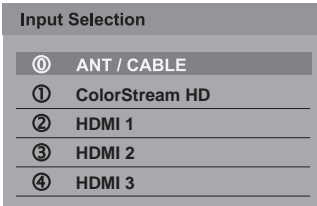

No inputs labeled

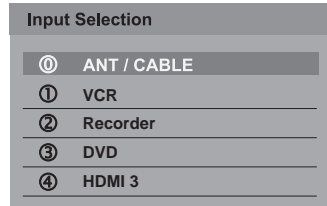

All inputs labeled

(Sample Image) Input selection screens

To clear the input labels:

- 1 In **Options** menu, highlight **Input Options** and then press the **OK** button.
- 2 Highlight **Input Labeling**, and then press the **OK** button.
- 3 Highlight **Reset**, and then press the **OK** button.

Tuning to the next programmed channel

To tune to the next programmed channel, press the **CH ▲/▼** (arrow) buttons on the remote control or TV control panel.

NOTE This feature will not function until you have programmed channels into the TV's channel memory, see [“Storing channels in memory \(optional\)” on page 49](#).

Tuning to a specific channel (programmed or unprogrammed)

To tune analog channels:

Press the Channel Number (0–9) on the remote control. For example, to select channel 125, press 1, 2, 5, and then press the **OK** button.

Tuning digital channels:

Press the Channel Number (0–9) on the remote control, followed by the **(Dash 100)** button, and then the sub-channel number. For example, to select digital channel 125-1, press 1, 2, 5, -, 1, and then press the **OK** button.

NOTE If a digital channel is not programmed, either through the automatic channel scan or the Channel add function, see [“Auto Tuning” on page 49](#), you will have to tune the RF channel using the Channel Numbers and the **(Dash 100)** button on the remote control.

Switching between two channels using Channel Return

The Channel Return feature allows you to switch between two channels without entering an actual channel number each time.

- 1 Select the first channel you want to view.
- 2 Select a second channel using the **Channel Number** buttons (and the **(Dash 100)** button if selecting a digital channel).
- 3 Press the **CH RTN** button on the remote control. The previous channel will display. Each time you press the **CH RTN** button, the TV will switch back and forth between the last two channels that were tuned.

NOTE If you press the **CH RTN** button from a non-antenna input, the TV will return to the last-viewed input.

Switching between two channels using SurfLock™

The SurfLock™ feature temporarily “memorizes” one channel to the **CH RTN** button, so you can return to that channel quickly from any other channel by pressing the **CH RTN** button.

To memorize a channel to the **CH RTN** button:

- 1** Tune the TV to the channel you wish to program into the **CH RTN** button.
- 2** Press and hold the **CH RTN** button for a few seconds until the message “Memorized” appears on the screen. The channel has been programmed to the **CH RTN** button.
- 3** You can then change channels repeatedly, and when you press the **CH RTN** button, the memorized channel will be tuned.

The TV will return to the memorized channel one time only. Once you press the **CH RTN** button and then change channels again, the **CH RTN** memory will be cleared and the button will function as Channel Return, by switching back and forth between the last two channels that are tuned. This feature also works for external inputs.

Selecting the picture size

You can view many program formats in several picture sizes—Native, 4:3, Full, TheaterWide 1, TheaterWide 2, TheaterWide 3, Normal, and Dot by Dot.

NOTE The picture size illustrations are examples only. The format of the image (in any of the picture sizes) depends on the format of the signal you are currently watching. Select the picture size that displays the current program in the way that looks best to you.

You can save separate picture size preferences for each input on your TV.

To select the picture size:

- 1 Press the **PIC SIZE** button on the remote.
 - 2 With the **Picture Size** menu displayed, do one of the following:
 - ❖ Repeatedly press the **PIC SIZE** button.
 - ❖ Press the corresponding number button (0-5) while the **Picture Size** menu is displayed.
 - ❖ Press the **▲/▼** (arrow) buttons while the **Picture Size** menu is displayed.
-

NOTE Some of the picture sizes may not be available depending on the receiving signal format.

NOTE Using these functions to change the picture size (i.e., changing the height/width ratio) for any purpose other than your private viewing may be prohibited under the Copyright Laws of the United States and other countries, and may subject you to civil and criminal liability.

NOTE If you select a TheaterWide™ picture size, the top and bottom edges of the picture (including subtitles or captions) may be hidden. To view these edges, adjust the Picture Position or try viewing the program in 4:3 or Full, see “[Scrolling the TheaterWide™ picture \(TheaterWide 2 and 3 only\)](#)” on page 64.

Full

The Full setting is for viewing in the 16:9 (480i, 480p) source programs. If receiving a squeezed 4:3 format program, the picture is stretched horizontally to fill the width of the screen but not stretched vertically.

The Full setting is for viewing in 1080i, 1080p, and 720p program source.

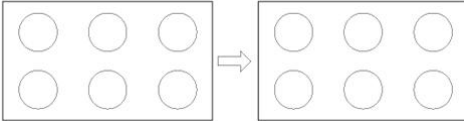

(Sample Illustration) Picture size - Full

The edges of the picture may be hidden.

TheaterWide 1

This setting is for viewing 4:3 format programs.

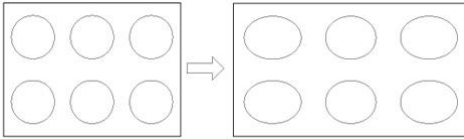

(Sample Illustration) Picture size - TheaterWide 1

The center of the picture remains close to its original proportion, but the left and right edges are stretched horizontally to fill the screen.

TheaterWide 2

This setting is for viewing letter box programs.

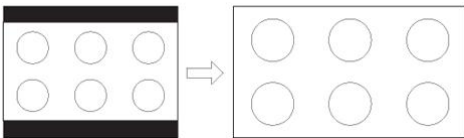

(Sample Illustration) Picture size - TheaterWide 2, letter box

The picture's top and bottom edges may be hidden*.

TheaterWide 3

This setting is for viewing letter box programs with subtitles.

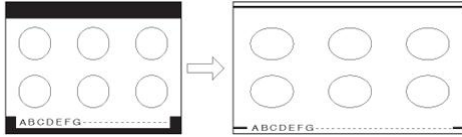

(Sample Illustration) Picture size - TheaterWide 3, letter box with subtitles

The picture's top and bottom edges are hidden*.

* To view the hidden areas (such as subtitles or captions), see “Scrolling the TheaterWide™ picture (TheaterWide 2 and 3 only)” on page 64.

Native

These settings are for viewing in 480i (HDMI®), 480p (HDMI®), 720p, 1080i, and 1080p signal programs).

This applies pixel-for-pixel image reproductions of Full HD content and eliminates overscanning; you see all the original picture within the screen and scaling artifacts are eliminated.

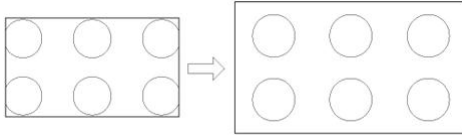

(Sample Illustration) Picture size - Native

- ❖ If receiving a 1080i, 1080p, 720p, 480i (HDMI®), or 480p (HDMI®) signal program, the video is scaled to display the entire picture within the borders of the screen (i.e. no overscanning).
- ❖ This is especially useful for external HD sources such as DVD movies, Video Games, or computer graphics.

NOTE

- ❖ The Native mode is supported only for HDMI® (1080i, 1080p, 720p, 480i, and 480p), ColorStream™ (1080i and 720p), and ANT/CABLE (digital) inputs (1080i, 1080p, and 720p).
- ❖ Depending on the input signal, the picture's border may be hidden, displayed in black, or noisy.

4:3

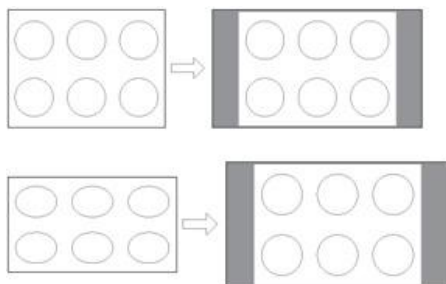

(Sample Illustration) Picture size - 4:3

Some program formats will display with sidebars and/or bars at the top and bottom.

Normal

This setting is for viewing VGA, SVGA, XGA, WXGA, and SXGA sources.

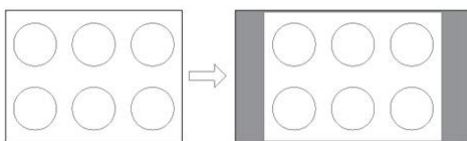

(Sample Illustration) Picture size - Normal

This size is a non-stretched display. Some input signal formats will display with sidebars and/or bars at the top and bottom.

Dot by Dot

This setting is for viewing VGA, SVGA, XGA, WXGA, and SXGA sources.

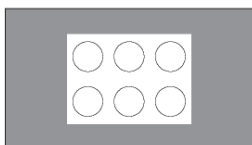

(Sample Illustration) Picture size - Dot by Dot

Dot by Dot is a non-scaling display. Depending on the input signal format (VGA, for example) the picture may appear with sidebars and/or bars at the top and bottom.

Scrolling the TheaterWide™ picture (TheaterWide 2 and 3 only)

You can set separate scroll settings for the TheaterWide 2 and TheaterWide 3 modes for each input.

To set the scroll settings:

- 1 In the **Picture** Menu, highlight **Display Settings**, and then press the **OK** button.
- 2 Highlight **Picture Position**, and then press the **OK** button. (The **Picture Position** will be available when **Picture Size** is **TheaterWide 2** or **TheaterWide 3**.)

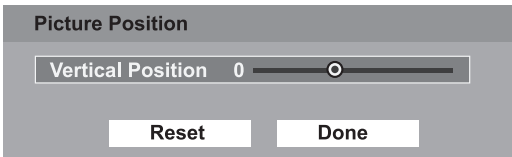

(Sample Image) Picture menu - Theater Settings selection

- 3 The **Picture Position** screen will appear, press ◀/▶ (arrow) button to scroll the picture up and down as needed.
- 4 To save the new settings, highlight **Done**, and then press the **OK** button.

To revert to the factory defaults, highlight **Reset** and then press the **OK** button.

The adjustment range is from **-5** to **+10**.

NOTE When receiving a signal at 480i resolution, the picture scroll function may have limited adjustment range.

Using the Auto Aspect feature

When this feature is set to On, the TV will automatically select the picture size when one of the following input sources is received:

- ❖ A 480i, 480p, 720p, 1080i digital signal from the ANT/CABLE input.
- ❖ 480i, 480p, 720p, 1080i, 1080p, or VGA (60Hz) signal from the HDMI® inputs.

<i>Aspect Ratio of Signal Source</i>	<i>Automatic Aspect Size (automatically selected when Auto Aspect is On)</i>
4:3 Normal	4:3
4:3 Letter Box	TheaterWide 2
16:9 Full	Full
Not defined (no ID-1 data or HDMI® aspect data)	The current picture size you selected, see "Selecting the picture size" on page 60.

To turn on the auto aspect ratio feature:

- 1 Press the **MENU** button and open the **Picture** menu.
- 2 Highlight **Display Settings**, and then press the **OK** button.
- 3 In the **Auto Aspect** field, press the **OK** button, and then select **On**.

To turn off the Auto Aspect ratio feature, Select **Off** in step 3 above.

Using the 4:3 Stretch

When 4:3 Stretch is activated, the TV displays 4:3 programs as a full-screen picture.

- 1 From the **Picture** menu, highlight **Display Settings**, and then press the **OK** button.
- 2 Press the **▲/▼** (arrow) buttons to select 4:3 Stretch, and then press the **OK** button.
- 3 Press the **▲/▼** (arrow) buttons to select **On** or **Off**, and then press the **OK** button

NOTE This feature is available when **Auto Aspect** is set to On.

Adjusting the picture

Toshiba HDTVs provide a series of preset Picture Modes with color, contrast and other settings specifically tuned for different types of video content. These Picture Modes include Store, Dynamic, Standard, Movie, Game, and PC. Your personal picture quality adjustments will also be saved as preferences in each Picture Mode for complete control of your viewing experience.

Selecting the picture mode

You can select your desired picture settings from the modes described below.

<i>Mode:</i>	<i>Description:</i>
Dynamic	Maximizes contrast, color saturation, sharpness, gray scale, and brightness to create more vivid and dynamic images.
Standard	Standard picture settings.
Movie	Optimizes the backlight, contrast, brightness, color saturation, sharpness, color temperature, gray scale, noise reduction and motion compensation to create the perfect picture settings for watching movies in a dark room.
Game	Game Mode reroutes the video signal to bypass select internal TV circuitry and shorten signal-to-screen time for reduced controller delay and faster video gaming action.
PC	Fine tunes the video processing and optimizes sharpness, color saturation, aspect ratio, color temperature and noise reduction to produce the best picture settings when displaying video from a PC or a notebook.

NOTE Store Mode is only available if the TV is set to Store Mode at initial setup. This option is hidden in the Home Mode. When the TV is set to **Store** in the initial menu or **Store** in the Installation Menu, the set will always reset to **Store** Picture Mode.

NOTE PC mode is available for HDMI® only (grayed out for other input sources).

To select the picture mode using the menu system:

- 1 Press the **MENU** button and open the **Picture** menu.
- 2 Highlight **Picture Mode**, and then press the **OK** button.

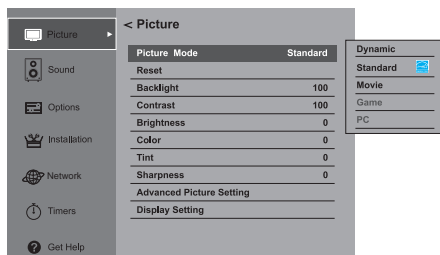

(Sample Image) Picture menu - Mode selection

- 3 Press the **▲/▼** (arrow) buttons to select the picture mode you prefer, and then press the **OK** button.

Adjusting the picture quality

You can adjust the picture quality (Contrast, Backlight, DynaLight™, Brightness, Color, Tint, and Sharpness) to your personal preferences.

Selection	Press (◀)	Press (▶)
Backlight*	darker	lighter
Contrast	lower	higher
Brightness	darker	lighter
Color	paler	deeper
Tint	reddish	greenish
Sharpness	softer	sharper

* **Backlight**: adjusts the brightness of the entire screen. When in video mode and no signal is input, this selection is automatically set to 0 (Settings are stored in memory).

To adjust the picture quality:

- 1 Press the **MENU** button and open the **Picture** menu.
- 2 Press the **▲/▼** (arrow) buttons to select the picture quality you wish to adjust (Backlight, Contrast, Brightness, Color, Tint, or Sharpness), press the **OK** button. Then press the **◀/▶** (arrow) buttons to adjust the setting.

To reset to the factory defaults:

- 1 Press the **Menu** button.
- 2 Select **Picture ► Reset**.
- 3 Press the **OK** button. A confirmation screen appears.
- 4 Select the **Yes**, and then press the **OK** button.

NOTE Any picture setting that you adjust affects the current input only. You can adjust the picture quality separately for each input. Depending on a Sharpness value, the Edge Enhancer effect may be reduced.

Using closed captions

Base closed captions

Closed caption mode has two options:

- ❖ **Captions**—An onscreen display of the dialogue, narration and sound effects of TV programs and videos that are closed captioned (usually marked “CC” in program guides).
- ❖ **Text**—An onscreen display of information not related to the current program, such as weather or stock data (when provided by individual stations).

To view captions or text:

- 1 In **Options** menu, highlight **Closed Captions**, and then press the **OK** button.
- 2 In the **Closed Caption Display** field, select **On**.
- 3 In the **Analog CC Mode** field, select the desired closed caption mode, and then press the **OK** button.

To view captions, highlight **CC1**, **CC2**, **CC3**, or **CC4**.

(CC1 displays translation of the primary language in your area.)



(Sample Illustration) Viewing captions

NOTE If the program or video you selected is not closed captioned, no captions will display onscreen.

To view text, highlight **T1**, **T2**, **T3**, or **T4**.

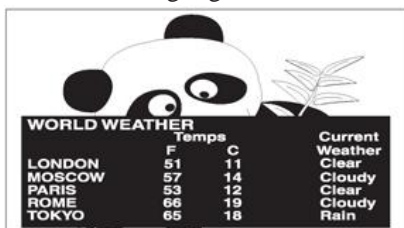

(Sample Illustration) Captions - text

NOTE If text is not available in your area, a black rectangle may appear on screen. If this happens, set the Base CC Mode to **Off**.

To turn off closed caption mode, select **Off** in step 2 above.

NOTE A closed caption signal may not display in the following situations:

- ❖ When a recording has been dubbed
- ❖ When the signal reception is weak
- ❖ When the signal reception is non-standard

Digital CC settings

You can customize the closed caption display characteristics by changing the background color, opacity, text size, type, edge, and color.

NOTE ❖ These settings are available for digital channels only.
❖ You cannot set Caption Text and Background as the same color.

To customize closed captions:

- 1** In **Options** menu, highlight **Closed Captions**, and then press the **OK** button.
- 2** Highlight **Digital CC Settings**, and then press the **OK** button.

- 3 Press the ▲/▼ (arrow) buttons to highlight the characteristic you wish to change, and then press the ◀/▶ (arrow) buttons to select the format for that characteristic.
- 4 To save the new settings, highlight **Done**, and then press the **OK** button.
To revert to the factory defaults, highlight **Reset**, and then press the **OK** button.

<i>Mode:</i>	<i>Description</i>
Caption Size	Auto, Small, Standard, Large
Caption Text Type	Auto, Default, Mono (with Serif), Prop. (with Serif), Mono (without Serif), Prop. (without Serif), Casual, Cursive, Small Capitals
Caption Text Edge	Auto, None, Raised, Depressed, Uniform, Left Drop Shadow, Right Drop shadow
Caption Text Color	Auto, Black, White, Red, Green, Blue, Yellow, Magenta, Cyan
Text Foreground Opacity	Auto, Transparent, Translucent, Flashing, Solid
Background Color	Auto, Black, White, Red, Green, Blue, Yellow, Magenta, Cyan Magenta, Cyan
Text Background Opacity	Auto, Transparent, Translucent, Flashing, Solid
Caption Text Edge Color	Auto, Black, White, Red, Green, Blue, Yellow, Magenta, Cyan

Using the Closed caption button

If you press the CC button when an analog channel is tuned or from an external input (480i signal from the video input):

- ❖ The CC bar will appear and will display the options, CC1-4, T1-4.

If you press the CC button when a digital channel is tuned:

- ❖ The CC bar will appear and will display the available caption options for that channel or service.

Adjusting the audio

Muting the sound

Press the **MUTE** button to partially reduce (1/2 Mute) or turn off (Mute) the sound. Each time you press the **MUTE** button, the mute mode changes in the following order: 1/2 Mute, Mute, Volume, 1/2 Mute, etc.



(Sample Image) Levels of mute

NOTE If you modify items in the **Sound** menu while Mute is active, Mute is cancelled.

Using the Digital Audio Selection

You can use the **Digital Audio Selection** to conveniently switch between audio tracks on a digital channel (for those channels that have multiple audio tracks). This temporarily overrides the audio track chosen by the **Primary Audio Language** option under the **Sound** menu, see [“Selecting stereo/SAP broadcasts” on page 72](#).

- 1 Press the **MENU** button and open the **Sound** menu.
- 2 Highlight **Digital Audio Selection**, and then press the **OK** button.

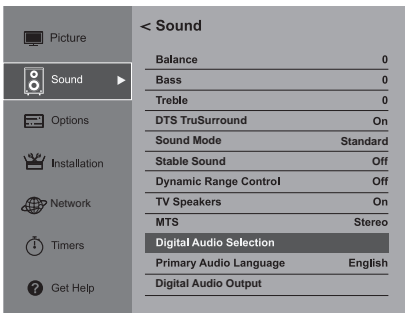

(Sample Image) Sound menu - Digital Audio Selector selection

- 3 Press the **◀/▶** (arrow) buttons to select the desired service.
- 4 Press the **EXIT** button.

Selecting stereo/SAP broadcasts

The multi-channel TV sound (MTS) feature allows you to output high-fidelity stereo sound. MTS also can transmit a second audio program (SAP) containing a second language, music or other audio information (when provided by individual stations).

When the TV receives a stereo or SAP broadcast, the icon **Stereo** or **SAP** appears when the **INFO** button is pressed. The MTS feature is only available for analog signals on the ANT/CABLE input.

To listen in stereo sound:

- 1 Press the **MENU** button and open the **Sound** menu.
- 2 Highlight **MTS**, and then press the **OK** button.
- 3 Select **Stereo**, and then press the **OK** button.

-
- NOTE** ❖ You can typically leave the TV in Stereo mode because it outputs the type of sound being broadcast (stereo or monaural).
- ❖ If the sound is noisy, select Mono to reduce the noise.
-

To listen to an alternate language on an ATSC digital station (if available), highlight the **Primary Audio Language** field in step 2 above, and then select the language you prefer.

To listen to a second audio program on an analog station, if available, select **SAP** in step 2 above.

-
- NOTE** ❖ A second audio program (SAP) can be heard only on those TV stations that offer it. For example, a station might broadcast another language as a second audio program. If you have SAP on, you will see the current program on the screen but hear the other language instead of the program's normal audio.
- ❖ If you have SAP on and the station you are watching is not broadcasting a second audio program, the station's normal audio will be output. However, occasionally there is no sound at all in SAP mode. If this happens, set the MTS feature to Stereo mode.
-

Adjusting the audio quality

You can adjust the audio quality by adjusting the bass, treble and balance.

To adjust the audio quality:

- 1 Press the **MENU** button and open the **Sound** menu.
- 2 Press the **▲/▼** (arrow) buttons to highlight the item you wish to adjust (Bass, Treble, or Balance), and then press the **OK** button.
- 3 Press the **◀/▶** (arrow) buttons to adjust the level.
 - ❖ **◀** makes the bass or treble weaker or increases the balance in the left channel (depending on the item selected).
 - ❖ **▶** makes the bass or treble stronger or increases the balance in the right channel (depending on the item selected).

DTS TruSurround™

This technology delivers high quality surround sound and expanded sound field over two speakers.

To turn on **DTS TruSurround™**:

- 1 Press the **MENU** button and open the **Sound** menu.
- 2 Highlight **DTS TruSurround** field, and then press the **OK** button.
- 3 Press the **▲/▼** (arrow) buttons to select **On**, and then press the **OK** button

Sound Mode

Select the **Sound Mode** your prefer.

To select a **Sound Mode**:

- 1 Press the **MENU** button and open the **Sound** menu.
- 2 Highlight **Sound Mode** field, and then press the **OK** button.
- 3 Press the **▲/▼** (arrow) buttons to select **Sound Mode**, and then press the **OK** button.

Stable Sound™

The **Stable Sound™** feature limits high volume levels and prevents the extreme changes in volume that can occur when channels are changed or a program switches to a commercial.

To turn on **Stable Sound™**:

- 1 Press the **MENU** button and open the **Sound** menu.

74 **Setting up your TV** *Selecting the PIN code*

- 2 Highlight **Stable Sound**, and then press the **OK** button.
 - 3 Press the **▲/▼** (arrow) buttons to select **On**.
-

NOTE Stable Sound™ cannot be used at the same time as DTS TruSurround™. The feature is greyed out until DTS TruSurround™ is turned Off.

Using the Dolby® Digital Dynamic Range Control feature

You can further compress Dolby® Digital dynamic range, allowing you to switch from digital to analog broadcasts at the same dynamic range.

To use the **Dolby® Digital Dynamic Range Control**:

- 1 Press the **MENU** button and open the **Sound** menu.
 - 2 Highlight **Dynamic Range Control**, and then press the **OK** button.
 - 3 Press the **▲/▼** (arrow) buttons to select **On**, and then press the **OK** button.
-

NOTE ❖ This feature is available when the TV is tuned to a digital RF channel or an HDMI® input with the Dolby® Digital signal.

Selecting the PIN code

A PIN code is necessary for some menus.

NOTE ❖ The Parental Control and Locks menu is grayed out if no PIN has been set.

Enter a new PIN code

- 1 Press the **MENU** button and open the **Options** menu.
- 2 Highlight **Parental PIN Setup**, and then press the **OK** button.
- 3 Use the number buttons to enter a 4-digit number. Confirm the code.

Forgotten PIN code

While the PIN code entering screen is displayed, press the **INFO** button four times within five seconds. The PIN code will be cleared and you can enter a new PIN code.

Changing or deleting your PIN code

- 1 Press the **MENU** button and open the **Options** menu.
- 2 Highlight **Parental PIN Setup**, and then press the **OK** button.
- 3 Use the number button to enter a 4-digit number.
- 4 Select Change PIN or Delete PIN. Press the **OK** button.

Using parental controls (for USA region)

Blocking TV programs and movies by rating (V-Chip)

Some TV programs and movies include signals that classify the content of the program (as unsuitable for younger viewers). The V-Chip feature in this TV detects the signals and blocks the programs according to the ratings you select.

- 1 Press the **MENU** button and open the **Options** menu.
- 2 Highlight **Parental Control and Locks**, and then press the **OK** button.
- 3 Enter your four-digit PIN code.
- 4 Press the **▲/▼** (arrow) buttons to highlight **Enable Rating Blocking**, and press **OK** button.
- 5 Press the **▲/▼** (arrow) buttons to select **On**, and then press the **OK** button.

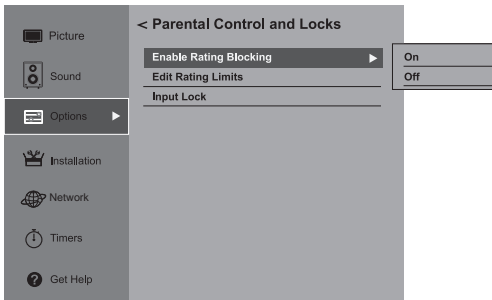

(Sample Image) Locks menu - Enable Rating Blocking selection

- 6 Press the **▼** (arrow) button to highlight **Edit Rating Limits**, and then press the **OK** button. The Edit Rating Limits screen appears.
- 7 For each desired selection, press the **▲/▼/◀/▶** (arrow) buttons to highlight the selection, and then press the **OK** button to select it.
A box with an “**X**” is a rating that will be blocked. As you highlight a rating, a definition for the rating appears at the bottom of the screen.

- 8 To save the new settings, highlight **Done**, and then press the **OK** button.
-

NOTE This feature will be not available if no PIN code is set.

Downloading an additional rating system

In the future, an additional rating system may become available for use to selectively block TV programs and movies.

NOTE The currently tuned station must be receiving a digital signal before an additional rating system can be downloaded.

To download the additional rating system, if available:

- 1 Press the **MENU** button and open the **Options** menu.
 - 2 Highlight **Parental Control and Locks**, and then press the **OK** button.
 - 3 Enter your four-digit PIN code.
 - 4 Press the **▲/▼** (arrow) buttons to highlight **Enable Rating Blocking**, and press the **OK** button.
 - 5 Press the **▲/▼** (arrow) buttons to select **On**, and then press the **OK** button.
 - 6 Press the **▼** (arrow) button to highlight **Edit Rating Limits**, and then press the **OK** button.
The Edit Rating Limits screen appears.
 - 7 Highlight **Alt RS**, and then press the **OK** button.
The Edit Alternate Ratings screen appears.
-

NOTE

- ❖ The **ALT RS** button will only be available if an additional rating system is currently available.
- ❖ It may take several minutes for the TV to download the additional rating system.
- ❖ The information displayed in the Alternate Ratings screen will depend on the configuration of the additional rating system available at the time of download.

- 8 For each desired selection, press the ▲/▼/◀/▶ (arrow) buttons to highlight the selection, and then press the **OK** button to select it.
A box with an “**X**” is a rating that will be blocked.
 - 9 To save the new settings, highlight **Done**, and then press the **OK** button.
 - 10 In the Edit Rating Limits screen, highlight **Done**, and then press the **OK** button.
-

- NOTE**
- ❖ The additional rating system can only be downloaded one time. You will not be able to download any updates to the rating system should such updates become available.
 - ❖ The additional rating system is not designed, transmitted or controlled by the TV or Toshiba, nor is the availability of an additional rating system determined or controlled by Toshiba. Similarly, the rating of programs in an additional rating system is not determined, transmitted or controlled by the TV or Toshiba.
 - ❖ The additional rating system is an evolving technology; therefore, availability, content and format may vary.
-

Rating system

Independent rating system for broadcasters:

<i>Ratings:</i>	<i>Description and Content themes:</i>
TV-MA	Mature Audience Only (This program is specifically designed to be viewed by adults and therefore may be unsuitable for children under 17.) L) Crude or indecent language S) Explicit sexual activity V) Graphic violence
TV-14	Parents Strongly Cautioned (This program contains some material that many parents would find unsuitable for children under 14 years of age.) D) Intensely suggestive dialogue L) Strong, coarse language S) Intense sexual situations V) Intense violence
TV-PG	Parental Guidance Suggested (This program contains material parents may find unsuitable for younger children.) D) Some suggestive dialogue L) Infrequent coarse language S) Some sexual situations V) Moderate violence
TV-G	General Audience (Most parents would find this program suitable for all ages)
TV-Y7, TV-Y7FV	Directed to Older Children (This program is designed for children age 7 and above. NOTE: Programs in which fantasy violence may be more intense or more combative than other programs in this category are designated TV-Y7FV.)
TV-Y	All Children (This program is designed to be appropriate for all children)

Independent rating system for movies:

<i>Ratings:</i>	<i>Description and Content themes:</i>
X	X-rated (For adults only)
NC-17	Not intended for anyone 17 and under
R	Restricted (Under 17 requires accompanying parent or adult)
PG-13	Parents Strongly Cautioned (Some material may be inappropriate for children under 13)
PG	Parents Guidance Suggested (Some material may be not be suitable for children)
G	General Audience (Appropriate for all ages)

Indication other than rating system:

<i>Display:</i>	<i>Description:</i>
TV-NONE	TV None
MPAA N/A	Movie Not Applicable
NOT RATE	Movie Not Rated
(No rating appears)	No rating information is provided

NOTE If you place an “X” in the box next to “None” Rated, programs rated “None” or “Not Rated” will be blocked; Programs that do not provide any rating information will not be blocked.

Displaying ratings

To display the rating of the program you are watching, press the **INFO** button on the remote control. If it is rated “None” the word “NONE” appears in the **INFO** screen. If rating information is not provided, no rating will appear in the **INFO** screen.

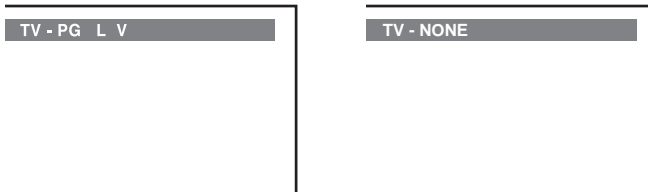

(Sample Image) Rating Info screens

Unlocking programs temporarily

If you try to tune to a program that exceeds the rating limits you have set, the TV will enter program lock mode and a warning message appears on the screen.

This program exceeds the rating limit you set.
Push " MUTE " to enter PIN.

(Sample Illustration) Warning - exceeded rating limit

You can either temporarily unlock the program or select an unlocked program to watch.

To temporarily unlock the program:

- 1 Press the **MUTE** button.
- 2 Enter your four-digit PIN code, and then press the **OK** button.

If the correct code is entered, the program lock mode is released and the normal picture appears. All locking will be enabled again when you change the channel.

Using the input lock feature

You can use the Input Lock feature to lock the video inputs (Video, ColorStream™ HD, HDMI 1, HDMI 2 and HDMI 3). You will not be able to view the input sources until you unlock the inputs.

To lock/unlock the video inputs:

- 1 In the **Options** menu, highlight the **Parental Control and Locks**, and then press the **OK** button.
- 2 Enter your four-digit PIN code.
- 3 Highlight **Input Lock**, and then press the **OK** button.
- 4 Press the **▲/▼** (arrow) buttons to select the level of video input locking you prefer (see table below for descriptions), and then press the **OK** button.

Mode:	Description:
Video	Locks Video, ColorStream™ HD, HDMI 1 and HDMI 2.
Off	Unlocks all video inputs.

Locking channels

With the Lock feature, you can lock specific channels. Locked channels can only be accessed by entering the PIN code, see [“Enter a new PIN code” on page 74](#).

To lock channels:

- 1 From the **Options** menu, highlight **Channel Options**, and then press the **OK** button.

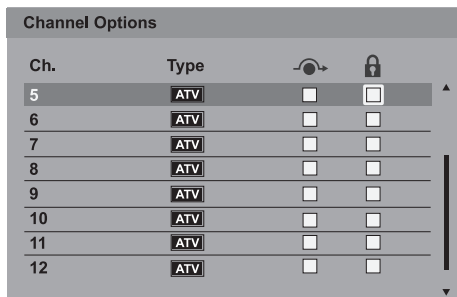

(Sample Illustration) Channel options

- 2 Press the ▲/▼ (arrow) buttons to select a channel in the lock column.
- 3 Press the **OK** button. PIN code entry will be required to set a locked channel.

NOTE If the PIN code has not yet been set, a warning message appears.

- 4 A check appears in the box.
- 5 To remove the check, press the **OK** button.
- 6 Press the **EXIT** button.

Using the GameTimer™

You can use the GameTimer™ to set a time limit for playing a video game (30–120 minutes). When the GameTimer™ expires, the TV enters Input Lock mode and locks out the input source for the video game device.

To set the GameTimer™:

- 1 In the **Timers** menu, highlight **GameTimer**, and then press the **OK** button.
- 2 Enter your four-digit PIN code.
- 3 Press the ▼ (arrow) button to select 30, 60, 90 or 120 minutes, and then press the **OK** button.

To cancel the GameTimer™, select **Off** in step 3 above.

To deactivate the Input Lock once the GameTimer™ has activated it:

- ❖ Set the Input Lock to **Off**, see [“Using the input lock feature” on page 80](#).

-
- NOTE**
- ❖ A message appears when 10 minutes, 3 minutes, and 1 minute are remaining.
 - ❖ If the TV loses power with time remaining, the TV will enter Input Lock mode when power is restored (as if the GameTimer had been activated). To resume use, you must deactivate the Input Lock, see [“Using the input lock feature” on page 80](#).
-

Using the panel lock feature

You can lock the control panel to prevent your settings from being changed accidentally (by children, for example). When Panel Lock is set to **On**, none of the controls on the control panel operate except the **POWER** button.

To lock the control panel:

- 1 In the **Options** menu, highlight **Panel Lock**, and then press the **OK** button.
- 2 Enter your four-digit PIN code.
- 3 Press the **▼** (arrow) button to select **On**.

When the control panel is locked and any button on the control panel (except the **POWER** button) is pressed, the message “NOT AVAILABLE” appears.

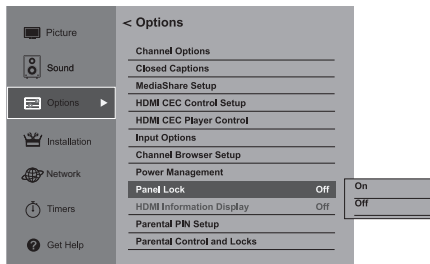

(Sample Illustration) Locks menu - Panel Lock selection

To unlock the control panel, select **Off** in Step 3 in this section or press and hold the **VOLUME** (–) button on the TV control panel for approximately 15 seconds until the volume icon appears.

MediaShare (Videos, Music, and Photos)

MediaShare provides a simple graphical interface to quickly access and play videos, music, and photos located on a USB flash drive, compatible powered USB hard drives, or a PC, tablet or NAS HDD connected to your home network.

To access MediaShare, press the **HOME** button on the remote control.

Using MediaShare with a USB device or a Media Server

You can enjoy photo, music or video content stored on a USB storage device or Media Server.

Photo Viewer specifications:

USB use:

- ❖ **Data Type:** JPEG Exif ver 2.1
- ❖ **File format:** JPEG
- ❖ **Maximum photo resolution:** 4096 x 4096
- ❖ **Maximum number of files:** 500 per folder

Content on a connected Media Server:

- ❖ **Data Type:** JPEG Exif ver 2.1
- ❖ **File format:** JPEG
- ❖ **Maximum photo resolution:** 4096 × 4096
- ❖ **Maximum number of files:** 500 per folder

Music Player specifications:

USB use:

- ❖ **File format:** MP3
- ❖ **Sampling frequency:** 32 kHz, 44.1 kHz, 48 kHz
- ❖ **Bit rate:** From 32 to 320 kbps
- ❖ **Maximum number of files:** 500 per folder

Content on a connected Media Server:

- ❖ **File format:** MP3
- ❖ **Sampling frequency:** 32 kHz, 44.1 kHz, 48 kHz
- ❖ **Bit rate:** From 32 to 320 kbps
- ❖ **Maximum number of files:** 500 per folder

Video Player specifications:

USB use:

- ❖ **File format:** MPEG2-PS/TS/VOB, AVI, MOV, MP4, ASF, DivX, Xvid, MKV, Motion JPEG

- ❖ **Video:** MPEG2, H.264, MPEG-4 part2, DivX, Xvid, JPEG
- ❖ **Audio:** MPEG1-Layer1/Layer2/Layer3, MPEG2-Layer1/Layer2/Layer3, Dolby® Digital(AC3), LPCM
- ❖ **Maximum number of files:** 500 per folder
- ❖ **Maximum video resolution:** 640x480 (Motion JPEG), 1920 x 1080 (other)

Content on a connected Media Server:

- ❖ **File format:** MPEG2-PS/TS, MP4 (Low resolution)
- ❖ **Video:** MPEG2, H.264
- ❖ **Audio:** MPEG1-Layer1/Layer2/Layer3, MPEG2-Layer1/Layer2/Layer3, Dolby® Digital(AC3), LPCM
- ❖ **Maximum number of files:** 500 per folder
- ❖ **Maximum video resolution:** 1920 x 1080

Supported file system: FAT16 and FAT32

NOTE

- ❖ Gently insert the USB device into the port and do not remove while viewing MediaShare.
 - ❖ To use MediaShare please configure the network settings on your TV. For more information, see [“Connecting to a home network” on page 35](#).
 - ❖ USB device: USB Mass Storage Class device (MSC)
 - ❖ Connectivity is not guaranteed for all devices.
 - ❖ Connect the USB device to the TV directly.
 - ❖ Do not use a USB Hub.
 - ❖ You must obtain any required permission from copyright owners to use copyright content. Toshiba cannot and does not grant such permission.
 - ❖ Depending on the file size and amount in your USB storage device, it may take some time to load before content is viewable. A message will display on-screen when files are loading from the USB storage device.
 - ❖ Only limited types of U3 USB device are supported. Therefore, it is suggested that you not use U3 USB with MediaShare.
 - ❖ Non-supported characters will be replaced with a square.
-

Auto Start function

When Auto Start is enabled, you will be asked if you want to start the MediaShare when a USB device is inserted. If Auto Start is disabled, you must manually start the MediaShare from the menu.

To change the Auto Start setting:

- 1 In the **Options** menu, highlight **MediaShare Setup**, and then press the **OK** button.
- 2 Highlight **USB Auto Start**, and then press the **OK** button.
- 3 Press the **▲/▼** (arrow) buttons to select **On** or **Off**.

To open the MediaShare

There are two methods for starting the MediaShare: auto start and manual start.

Auto Start:

- 1 Gently insert a supported USB storage device to the USB port on the back of the TV. A prompt will appear.

NOTE If you repeatedly insert and remove the USB connector, the prompt may not appear.

- 2 Press the **◀/▶** (arrow) buttons to select **Yes**, and then press the **OK** button.

The MediaShare menu appears. (If you select **No**, nothing happens.)

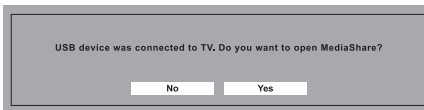

(Sample Image) MediaShare - open screen

NOTE ❖ If Auto Start is set to **Off**, you can start the MediaShare manually.

Manual Start:

- 1 In the **Options** menu, highlight **MediaShare Setup**, and then press the **OK** button.
- 2 Press the **▲/▼** (arrow) buttons to highlight **MediaShare**, and then press the **OK** button.
- 3 Press the **◀/▶** (arrow) buttons to highlight **Photo**, **Music**, or **Videos** and then press the **OK** button.

- The focus will jump to one of the supported devices at the bottom, select one of them, and then press the **OK** button.

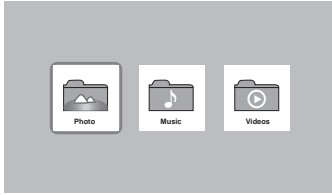

(Sample Image) MediaShare setup screen

NOTE

- ❖ The viewer will open even if there are no photo or music files.
- ❖ While the MediaShare is active, the main menus cannot be displayed.

Viewing photo files

There are three types of view modes: multi view, single view, and slide show. Within Slide show, you can skip forward, repeat, and set time interval.

Multi View

This view allows you to search for photos in a grid format.



(Sample Image) Media Play - photos screen

To use multi view:

- Press the **▲/▼/◀/▶** (arrow) buttons to move the highlight in one window. If all of the photos will not fit in one screen, the screen will move to the previous page when you press **◀** from the top left icon. When you press **▶** from the bottom right icon, the screen will move to the next page. You can also use the **▲/▼** (arrow) buttons to page up or down the in photo list when there are more photos than will fit on one screen.

- 2 When you select a folder, press the **OK** button to move to the next layer, or press the **BACK** button to return to the previous layer.
- 3 Press the **OK** button to view the selected photo in Single View mode.

Single view

In this view mode, only files located in the selected directory will be displayed. This view allows you to change the photo content manually. When you move from Multi View to the Single View, the currently selected photo is displayed.

To use single view:

- ❖ Press the ► (arrow) button to view the next photo. Press ◀ to view the previous photo.
- ❖ Press ▲ to rotate the image 90° counterclockwise. Press ▼ to rotate the image 90° clockwise.

Slide show

This view allows you to watch a slide show of the photos. In this mode, only files located in the selected directory will be played.

To use slide show:

- 1 Press the **OK** button in the Single View mode.
- 2 Press the ◀/▶ (arrow) buttons to view the previous or next photo.

To set Interval Time and Repeat settings:

- 1 Press the **MENU** button to open the **Quick Menu**.
- 2 Press the ▲/▼ (arrow) buttons to select either **Interval Time** or **Repeat**.
- 3 Press the ◀/▶ (arrow) buttons to adjust the setting and press the **BACK** button.

NOTE Picture size functions are disabled.

To close the Photo Viewer, press the **EXIT** button. The television will return to the last viewed channel or external input.

Playing music files

You can listen to music from a list of available files. When listening to music files, you can select music lists, play, pause, stop, skip, repeat play, and adjust sound settings.

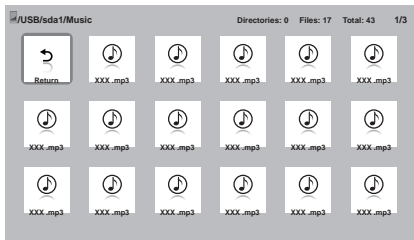

(Sample Image) MediaShare - music list

- 1 After opening MediaShare and selecting **Music** (see “To open the MediaShare” on page 85). Press the ▲/▼/◀/▶ (arrow) buttons to select a file or folder. You can use the ▲/▼ (arrow) buttons to page up or down the music list when there are more files than will fit onto one screen.
- 2 Select the desired folder and press the **OK** button to move to the next layer. Press the **BACK** button to move back to the previous layer.
- 3 With the desired file selected, press the **OK** button or the **PLAY** button to start playback.
- 4 Press the **STOP** button to stop playback

- NOTE**
- ❖ If playback finishes before **STOP** is pressed, the next file will automatically start to play from the beginning.
 - ❖ Depending on the file size, it may take some time for playback to begin.

During playback you can do the following:

- ❖ Press **PAUSE** to pause.
- ❖ To resume normal playback, press **PLAY**.
- ❖ To locate a specific file, press the **SKIP Reverse** or **SKIP Forward** button repeatedly.
- ❖ To adjust volume, press the **VOL (+ -)** buttons.

- NOTE** To play in fast reverse or fast forward, press **REV** or **FF** during playback. Each time you press **REV** or **FF**, the playback speed changes.

NOTE During playback, you can adjust the **Sound** functions from the Quick Menu.

To set the repeat mode:

- 1 Press the **MENU** button to open the **Quick Menu**.
- 2 Press the **▲/▼** (arrow) buttons to select **Repeat**.
- 3 Press the **◀/▶** (arrow) buttons to select **Off**, **All** or **1**.
- 4 Press the **BACK** button.

To close the Music Player, press the **EXIT** button.

Viewing photo files and playing music files at the same time

While viewing photo files, you can listen to music from a list of available files.

- 1 While viewing photos in the **Single View** or **Slide Show** mode, press the **MENU** button to open the **Quick Menu**.
- 2 Highlight **Background Music** and press the **OK** button. The file list appears.
- 3 Select a music file and press the **OK** button to start playback. The music is now playing in the background.

Playing video files

You can watch a video from a list of available files. When watching video files, you can select lists, play, pause, stop, skip, repeat play, adjust picture and sound settings.

- 1 After opening **MediaShare** and selecting **Videos** (see “[To open the MediaShare](#)” on page 85). Press the **▲/▼/◀/▶** (arrow) buttons to select a file or folder. You can use the **▲/▼** (arrow) buttons to page up or down the file list when there are more files than will fit onto one screen.
- 2 Select the desired folder and press the **OK** button to move to the next layer. Press the **BACK** button to move back to the previous layer.
- 3 With the desired file selected, press the **OK** button or the **PLAY** button to start playback.
- 4 Press the **STOP** button to stop playback.

- NOTE**
- ❖ If playback finishes before **STOP** is pressed, the next file will automatically start to play from the beginning.
 - ❖ Depending on the file size, it may take some time for playback to begin.
-

During playback you can do the following:

- ❖ Press **PAUSE** to pause.
 - ❖ To resume normal playback, press **PLAY**.
 - ❖ To locate a specific file, press the **SKIP Reverse** or **SKIP Forward** button repeatedly.
 - ❖ To adjust volume, press the **VOL (+ -)** buttons.
-

- NOTE**
- ❖ To play in fast reverse or fast forward, press **REV** or **FF** during playback. Each time you press **REV** or **FF**, the playback speed changes.
 - ❖ During playback, you can adjust the picture and sound functions from the Quick Menu.
-

To set the repeat mode:

- 1 Press the **MENU** button to open the **Quick Menu**.
- 2 Press the **▲/▼** (arrow) buttons to select **Repeat**.
- 3 Press the **◀/▶** (arrow) buttons to select **Off, All** or **1**.
- 4 Press the **BACK** button.

To close the Video Player, press the **EXIT** button.

To select subtitle or audio track (if available in the video content):

- 1 Press the **MENU** button to open the **Quick Menu**.
- 2 Press the **▲/▼** (arrow) buttons to select **Options**.
- 3 Highlight **Subtitle Track** or **Audio Track**, and then press the **◀/▶** to select track you prefer.
- 4 Press the **BACK** button.

To close the Video Player, press the **EXIT** button.

DivX®

To register your TV to a DivX® account:

This TV allows you to play back files purchased or rented from DivX® Video-On Demand (VOD) services. When you purchase or rent DivX® VOD files on the internet, you will be asked to enter a registration code.

- 1 Press the **MENU** button.
- 2 Select **Options > MediaShare Setup > DivX® VOD** and press the **OK** button.
- 3 Press the **▲/▼** (arrow) buttons to select **DivX® VOD Registration**, and then press the **OK** button.
- 4 The **DivX® VOD** window will appear and you will see the registration code. For details on registration, please visit the DivX® website at <http://vod.divx.com>
- 5 Copy the activation file to a memory device and play it on the TV.

To unregister your device:

- 1 Press the **MENU** button.
- 2 Select **Options > MediaShare Setup > DivX® VOD** and press the **OK** button.
- 3 Press **▲/▼** (arrow) buttons to select **DivX® VOD Registration**, and then press the **OK** button.
- 4 A confirmation message will appear. Select **Yes** and press the **OK** button.
- 5 The **DivX® VOD** window will appear and you will see the registration code. For details on registration, please visit the DivX® website at <http://vod.divx.com>

ABOUT DIVX VIDEO: DivX® is a digital video format created by DivX, LLC, a subsidiary of Rovi Corporation. This is an official DivX Certified® device that has passed rigorous testing to verify that it plays DivX video. Visit divx.com for more information and software tools to convert your files into DivX videos.

ABOUT DIVX VIDEO-ON-DEMAND: This DivX Certified® device must be registered in order to play purchased DivX Video-on-Demand (VOD) movies. To obtain your registration code, locate the DivX VOD section in your device setup menu. Go to vod.divx.com for more information on how to complete your registration. DivX Certified® to play DivX® video up to HD 1080p, including premium content.

To playback DivX HD content:

- ❖ To play in fast reverse or fast forward directions, press the ◀◀ or ▶▶ button during playback. Each time you press the ◀◀ or ▶▶ button, the playback speed will change.
- ❖ If the content contains no chapter, this TV generates original chapter point in 10% increments for 10 chapters in total, that are accessible by using the Number buttons on the remote control.

During playback, press the ▶▶| button to skip to the beginning of the next chapter.

When the ▶▶| button is pressed twice in succession, it will repeat two times of above.

If the ▶▶| button is pressed at the last chapter, the confirmation message will appear.

If **Yes** is selected, playback will skip to the beginning of the next content.

Press the ◀◀| button to skip to the beginning of the current chapter.

When the ◀◀| button is pressed twice in succession, it will skip to the beginning of the previous chapter. If the ◀◀| button is pressed twice continuously at the first chapter, playback of the current content will stop and the confirmation message will appear. If **Yes** is selected, playback will skip to the beginning of the previous content.

Setting the sleep timer

You can set the sleep timer to turn off the TV after a set length of time (maximum of 12 hours).

To set the sleep timer using the remote control:

- 1 Press the **SLEEP** button on the remote control to set the length of time the TV remains on until the TV turns off.
- 2 Repeatedly press the **SLEEP** button to increase the time in 10-minute increments, or press the ▲/▼ (arrow) buttons to increase or decrease the time in 10-minute increments, to a maximum of 12 hours.

To set the sleep timer using the on-screen menus:

- 1 In **Timers** menu, highlight **Sleep Timer**, and then press the **OK** button.

- 2 Press the **Number** buttons to enter the length of time (maximum of 12 hours) and then press the **OK** button. Or press the **▲/▼** (arrow) buttons to increase or decrease in 10-minute increments (maximum of 12 hours).
-

NOTE If a power failure occurs, the sleep timer setting may be cleared.

To display the time remaining until the TV turns off, press the **SLEEP** button.

To cancel the sleep timer, repeatedly press **SLEEP** until it is set to 0 minutes.

No Signal Power Down

The TV will automatically turn itself off after 15 minutes when no signal is detected. You can change the setting to Off for the following purposes:

- ❖ Low signal strength of analog channel (no signal detection)
- ❖ Only Audio L/R is connected to external input to listen to music through the TV speakers.

To change the no signal power down setting:

- 1 From the **Options** menu, highlight **Power Management**, and then press the **OK** button.
- 2 Highlight **No Signal Power Down**, and then press the **OK** button.
- 3 Press the **▲/▼** (arrow) buttons to highlight the item you want to change, and press the **◀/▶** (arrow) buttons to select **On** or **Off**.

NOTE ❖ Default setting for this feature is **On**.
❖ A warning message will appear 1 minute before the TV turns off.

Using HDMI® CEC

This is a new feature that uses CEC technology and allows you to control Toshiba HDMI® CEC compatible devices from the TV remote via HDMI® (see “[HDMI® CEC connection](#)” on page 31).

When **Enable HDMI CEC Control** in the **HDMI CEC Control Setup** menu is set to **On** (see “[Setting up HDMI® CEC](#)” on page 96), the HDMI® CEC functions described below will be enabled.

HDMI® CEC playback device (Blu-ray™/DVD player, etc.) control

With your TV's remote control, or using the HDMI® CEC Player Control menu, you can control the connected HDMI® CEC playback device you are watching.

Available remote control key functions

Button:	Description:
PLAY	Begin playback
STOP	Stop playback
PAUSE	Pause the picture during play or record mode
SKIP Forward	Skip forward
SKIP Reverse	Skip backward
FF	Fast forward
REW	Rewind/reverse
▲/▼/◀/▶	Navigates menu options
OK	Enters menu options
EXIT	Return to the previous menu

NOTE These functions depend on the devices connected.

HDMI® CEC Player Control menu functions

To control the HDMI® CEC player from the menu:

- 1 From the **Options** menu, highlight **HDMI CEC Player Control**, and then press the **OK** button.

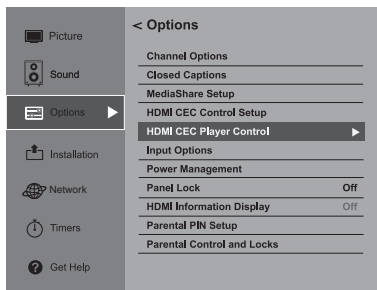

(Sample Image) Preferences menu - HDMI® CEC Player Control

- 2 Press the ▲/▼ (arrow) buttons to select the item you wish to control and press the **OK** button.

<i>Item:</i>	<i>Description:</i>
Power	Turns the select device On/Off
Root Menu	Accesses the root menu of the selected device
Contents Menu	Accesses the contents list when you press OK . At this time, the HDMI CEC Player Control menu disappears.
Setup Menu	Accesses the setup menu of a selected device
Top Menu	Accesses the top menu of a selected device
Menu	Accesses the menu of a selected device

NOTE These functions depend on the devices that are connected. The HDMI® CEC Player Control item will be grayed out in the following conditions:

- ❖ A non-HDMI® input is currently selected.
- ❖ The **Enable HDMI CEC** item is set to **Off**.
- ❖ The connected CEC device is not a playback or recording device.

HDMI® CEC input source selection

If an HDMI® CEC device with HDMI® switching capability (e.g. Audio Receiver) is connected to the HDMI® input, you can select another HDMI® CEC device that is connected to the master HDMI® device using the TV's **INPUT** button, see [“Selecting the video input source” on page 54](#).

VOLUME and MUTE controls of Audio Receiver

With your TV's remote control, you can adjust or mute the sound volume of the Audio Receiver.

- ❖ **VOL (+ -)** buttons adjust the volume level.
- ❖ **MUTE** button turns off the sound.

To use this function:

- ❖ Set **Initial Speaker Setting to Receiver** in the **HDMI CEC Control Setup** menu.
- ❖ Confirm that a connected HDMI® CEC device (such as DVD player, etc.) is selected for the Audio Receiver input source.

NOTE

- ❖ These functions depend on the device connected.
- ❖ **Initial Speaker Setting** will be grayed out if **Amplifier Control** is set to **Off**.

Other HDMI® CEC functions

When the **Enable HDMI CEC Control** and each item in the **HDMI CEC Control Setup** menu are set to **On**, the following functions will be enabled.

<i>Item:</i>	<i>Description:</i>
TV Auto Power	If an HDMI® CEC device is turned on, the TV turns on automatically.
Auto Standby	If the TV is turned off, the TV will send a message to turn off all of the HDMI® CEC devices connected to the TV.
Amplifier Control	If Amplifier Control is set to On , you can adjust the sound volume or turn off the sound using the remote control.
Initial Speaker Setting	From this item, you can set your audio output preference to the TV speakers or the audio receiver speakers. When this item is set to Receiver, the TV remote can be used to adjust or mute the volume of the audio. This item will be grayed out when Amplifier Control is set to Off .

NOTE When you turn on the Audio Receiver, change its input source or adjust the sound volume, the sound will be output from the audio receiver's speakers even if TV Speakers have been selected. Turn the TV off and on again to output the sound from the TV speakers.

Setting up HDMI® CEC

To set the HDMI® CEC Setup:

- 1 From the **Options** menu, highlight **HDMI CEC Control Setup** and press the **OK** button.
- 2 Highlight **Enable HDMI CEC Control**, and then press the **OK** button.
- 3 Select **On**, and then press the **OK** button.

NOTE If you select **Enable HDMI CEC Control Off**, the other items will be grayed out.

- 4 Press the **▲/▼** (arrow) buttons to highlight the HDMI® CEC Setup item you want to use, and press the **OK** button, follow by **▲/▼** (arrow) buttons.
 - ❖ **TV Auto Power:** On/Off
 - ❖ **Auto Standby:** On/Off
 - ❖ **Amplifier Control:** On/Off
 - ❖ **Initial Speaker Setting:** TV/Receiver

Using the HDMI® settings feature

HDMI® 1(2, or 3) RGB Range

You can select RGB range of HDMI inputs from the following modes, as described below:

- 1 From the **Options** menu, highlight **Input Options**, and then press the **OK** button.
- 2 Highlight **HDMI 1(2, or 3) RGB Range** and then press the **OK** button.
- 3 Press the **▲/▼** (arrow) buttons to select **Auto**, **Full**, or **Limited**, and then press the **OK** button.

<i>Mode</i>	<i>Description</i>
Auto(default)	Adjusts RGB full range signal automatically.
Full	RGB input signal is displayed in the range from 0 to 255.
Limited	RGB input signal is displayed in the range from 16 to 235.

The HDMI® setting (RGB Range) needs proper HDMI™ source devices. If your HDMI® source device does not support these features, the TV may not work properly when this feature is enabled.

HDMI® Information Display

Viewing the HDMI® signal information:

- 1 From the **Options** menu, highlight **HDMI Information Display**, and then press the **OK** button.
- 2 Press the **▲/▼** (arrow) buttons to select **On** or **Off**, and then press the **OK** button.
- 3 When the HDMI Information is set to **On**, pressing the **INFO** button displays the **HDMI Information** banner (Resolution, Scan Type, Frame Rate, Aspect, Bit Depth, Color Space, RGB/YUV, Chroma Format). When the **HDMI Information** is set to **Off**, the normal banner is displayed.

- NOTE**
- ❖ The signal information banner will appear when this feature is set to **On** and you watch an HDMI® input and press the **INFO** button. The signal information will disappear after approximately 60 seconds.
 - ❖ If you press the **INFO** button when this feature is set to **Off**, only the normal banner will appear.

Displaying TV status information

To display TV status information using the **INFO** button:

- ❖ Press the **INFO** button on the remote control.

The following information will be displayed (if applicable):

- ❖ Current input (**ANT/CABLE, Video**, etc.)
- ❖ If ANT/CABLE is the current input, either “CABLE” (for cable TV) or “ANT” (for over-the-air broadcasts).
- ❖ Channel number (if in **ANT/CABLE** mode)
- ❖ Digital signal strength indicator (bar graph in lower right corner of box; for digital signals only)
- ❖ Stereo, Mono, or SAP audio status (when in HDMI® input mode, Dolby® Digital, or PCM)
- ❖ Video resolution
- ❖ Aspect ratio of incoming video signal (4:3 or 16:9)
- ❖ V-Chip rating status
- ❖ GameTimer (if set)
- ❖ Title
- ❖ Duration
- ❖ Detailed description



(Sample Illustration) Info banner

To close the **INFO** screen, press the **INFO** button again.

Understanding the last mode memory feature

If the power is cut off while you are viewing the TV, the Last Mode Memory feature automatically turns on the TV when the power is resupplied.

NOTE If you know you will be away from the TV for an extended period of time you should unplug the power cord.

Chapter 7

Using the TV's Advanced Features

Using the advanced picture settings

ColorMaster™

The ColorMaster™ feature gives you precise control of Hue, Saturation, and Brightness for six primary colors: Red, Green, Blue, Yellow, Magenta, and Cyan. Now you can adjust the image color exactly the way you want it.

- 1 From the **Picture** menu, highlight **Advanced Picture Settings**, and then press the **OK** button.
- 2 Highlight **ColorMaster**, and then press the **OK** button.
- 3 Press the **▲/▼** (arrow) buttons to select **On**, and then press the **OK** button.

Base Color Adjustment

When **ColorMaster™** is set to **On**, the list of base colors appears. You can select a base color to adjust.

- 1 From the **Picture** menu, highlight **Advanced Picture Settings**, and then press the **OK** button.
- 2 Highlight **Base Color Adjustment** and then press the **OK** button.

- 3** Press the ▲/▼ (arrow) buttons to select a color. Press the **OK** button.
- 4** Press the ◀/▶ (arrow) buttons to select **Hue, Saturation, or Brightness**.
- 5** Press the ▲/▼ (arrow) buttons to adjust the setting.
- 6** Repeat Steps 3 through 5 to adjust other colors.
 To reset the adjustments to the factory defaults, select **Reset** on the screen. Press the **OK** button.

Color Temperature

You can change the quality of the picture by adjusting three preset Color Temperatures (Cool, Medium, and Warm), as described below.

<i>Mode:</i>	<i>Picture Quality:</i>
Cool	blueish
Medium	neutral
Warm	reddish

- 1** From the **Picture** menu, highlight **Advanced Picture Settings**, and then press the **OK** button.
- 2** Highlight **Color Temperature** and then press the **OK** button.
- 3** Press the **OK** button, follow by ▲/▼ (arrow) buttons to select the desired color temperature, and then press the **OK** button.
- 4** Press the ▲/▼ (arrow) buttons to highlight **Red, Green, or Blue** level, and then press the ◀/▶ (arrow) buttons to adjust the level. Press the **EXIT** button.

NOTE The Red, Green, and Blue level settings are connected to the Color Temperature settings and will change based on which preset color temperature (Cool, Medium, or Warm) is selected.

Static Gamma

The static gamma feature lets you adjust the levels of black in the picture.

- 1** From the **Picture** menu, highlight **Advanced Picture Settings**, and then press the **OK** button.
- 2** Highlight **Static Gamma** and then press the **OK** button.
- 3** Press the ◀/▶ (arrow) buttons to adjust the level of black detail. Press the **EXIT** button.

102 Using the TV's Advanced Features

Using the advanced picture settings

- ❖ If the setting is decreased, the detail of black colors is decreased.
- ❖ If the setting is increased, the detail of black colors is increased.

DynaLight™

The DynaLight™ feature automatically strengthens the black coloring of dark areas in the video according to the level of darkness.

- 1 From the **Picture** menu, highlight **Advanced Picture Settings**, and then press the **OK** button.
- 2 Highlight **DynaLight** and then press the **OK** button.
- 3 Press the **▲/▼** (arrow) buttons to select **High**, **Low**, or **Off**. Press the **OK** button.

Dynamic Contrast

Dynamic Contrast detects changes in picture quality that affect the appearance of your contrast settings and then automatically adjusts the video.

- 1 From the **Picture** menu, highlight **Advanced Picture Settings**, and then press the **OK** button.
- 2 Highlight **Dynamic Contrast** and then press the **OK** button.
- 3 Press the **▲/▼** (arrow) buttons to select **High**, **Middle**, **Low**, or **Off**. Press the **OK** button.

Cinema Mode

When you view a DVD (3:2 pulldown processed) from a DVD player connected to the VIDEO, ColorStream™ HD (component video), or HDMI® inputs on the TV, smoother motion can be obtained by setting the Cinema Mode to **On**. (available for 480i and 1080i signals).

- 1 From the **Picture** menu, highlight **Advanced Picture Settings**, and then press the **OK** button.
- 2 Highlight **Cinema Mode** and then press the **OK** button.
- 3 Press the **▲/▼** (arrow) buttons to select **On** or **Off**. Press the **OK** button.

Noise Reduction

MPEG NR

The MPEG noise reduction feature allows you to reduce visible interference caused by MPEG compression.

- 1 From the **Picture** menu, highlight **Advanced Picture Settings**, and then press the **OK** button.
- 2 Highlight **Noise Reduction** and then press the **OK** button.
- 3 Press the **▲/▼** (arrow) buttons to select **MPEG NR** and then press the **OK** button.
- 4 Press the **▲/▼** (arrow) buttons to select **High, Middle, Low**, or **Off**, and then press the **OK** button.

DNR (Dynamic Noise Reduction)

DNR lets you soften the screen representation of a weak signal to reduce the noise effect.

- 1 From the **Picture** menu, highlight **Advanced Picture Settings**, and then press the **OK** button.
- 2 Highlight **Noise Reduction** and then press the **OK** button.
- 3 Press the **▲/▼** (arrow) buttons to select **DNR** and then press the **OK** button.
- 4 Press the **▲/▼** (arrow) buttons to select **High, Middle, Low**, or **Off**, and then press the **OK** button.

Edge Enhancer

The Edge Enhancer feature defines the edges and textures for greater image details to make the picture look crisp and clear.

- 1 From the **Picture** menu, highlight **Advanced Picture Settings**, and then press the **OK** button.
- 2 Highlight **Edge Enhancer** and then press the **OK** button.
- 3 Press the **▲/▼** (arrow) buttons to select **On** or **Off**. Press the **OK** button.

NOTE This feature may not work properly depending on the content.

Using your home network

- ❖ This TV can share videos, music, and photos across your home network and other connected products through the MediaShare feature. In order to do this, you will have to configure the network settings on your TV, see “[MediaShare \(Videos, Music, and Photos\)](#)” on page 83.
- ❖ If you want to use your home network with an Internet connection, you will have to configure the network settings on your TV. Change the network settings, see “[Setting up the Network](#)” on page 106.

If you use Internet services, see the following note before use.

-
- NOTE**
- ❖ Some features may require an always-on broadband Internet connection, firmware update, and/or additional bandwidth.
 - ❖ Third party Internet services are not provided by Toshiba, may change or be discontinued at any time, and may be subject to third party restrictions. Toshiba makes no warranties, representations, or assurances about the content, availability, or functionality of third party content or services. Third party Internet services may require the creation of a separate account through a computer with Internet access, and payment of one-time and/or recurring charges.
-

When using a Wireless network connection

Wireless LAN and your Health:

Wireless LAN products, like other radio devices, emit radio frequency electromagnetic energy. However, the level of energy emitted by Wireless LAN devices is much less than the electromagnetic energy emitted by wireless devices like mobile phones.

Because Wireless LAN products operate within the guidelines found in radio frequency safety standards and recommendations, Toshiba believes Wireless LAN is safe for use by consumers. These standards and recommendations reflect the consensus of the scientific community and result from deliberations of panels and committees of scientists who continually review and interpret the extensive research literature.

In some situations or environments, the use of Wireless LAN may be restricted by the proprietor of the building or responsible representatives of the organization. Such restrictions may apply in environments where the risk of interference to other devices or services is perceived or identified as harmful.

If you are uncertain of the policy that applies to the use of wireless devices in a specific organization or environment, you are encouraged to ask for authorization to use the Wireless LAN device prior to turning on the equipment.

Using the TV in a wireless LAN environment:

- ❖ It is recommended to use IEEE 802.11a or IEEE 802.11n on 5 GHz for audio and SD video streaming.
- ❖ It is recommended to use IEEE 802.11n on 5 GHz for HD video streaming.
- ❖ It is recommended that the encoding rate of video content be 20 Mbps or less.
- ❖ It is not recommended to use 2.4 GHz for audio and video streaming.
- ❖ Content playback may be interrupted by surrounding interference.

Setting up the Network

You can select the Network Type.

- 1 Press the **MENU** button.
- 2 Select **Network > Network Setup > Connection Type** and press the **OK** button.
- 3 Press **▲/▼** (arrow) buttons to select **Wired** or **Wireless**.
- 4 Press the **OK** button.
 - ❖ If you select Wired, see [“Advanced Network Setup” on page 111](#).
 - If you select Wireless, see the next section.

Wireless Setup

NOTE Continued AP (Access Point) connection is not guaranteed. Connection may be lost while watching TV.

There are three methods for wireless setup:

- ❖ Easy Setup (WPS) - if AP supports WPS, this can be used.
 - ❖ WPS is a standard designed to simplify the connection of wireless LAN equipment and the setup of network security features.
 - ❖ Assisted Setup (setup using the AP's notification information) - Network Name, Authentication, and Encryption are decided based on information from the AP. You need to manually set the Security Key.
 - ❖ Manual Setup - requires manually entering all settings.
-

NOTE ❖ In order to secure your home network, it is strongly recommended that you use a wireless access point with encryption.

❖ When Encryption is set to “None”, data transmitted over a wireless LAN is not securely protected. Unauthorized users may access your data and network without appropriate security measures. Selecting an encryption setting from your Toshiba TV and using a secure network for wireless LAN transmissions may help avoid unauthorized access to your important data and/or TV. Toshiba disclaims any and all responsibility or liability resulting from any wireless transmissions over the Internet through your Toshiba TV.

Easy Setup using PBC (Push button configuration)

- 1 Press the **MENU** button.
- 2 Select **Network > Network Setup > Wireless Setup** and press the **OK** button.
- 3 Press **▲/▼** (arrow) buttons to select **Easy Setup** and press the **OK** button.
- 4 Press **▲/▼** (arrow) buttons to select **PBC** and then press the **OK** button.
- 5 Press **▼** (arrow) button to select **Start Scan**, and then press the **OK** button.
- 6 Following the on-screen instructions, push the appropriate button on your AP.
- 7 When a screen reporting that “Wireless configuration is complete” appears, press the **EXIT** button.

To cancel searching for the AP:

- ❖ Press the **BACK** button while searching for the AP. A message appears. Press **◀/▶** (arrow) buttons to select **Yes**, and then press the **OK** button.

Easy Setup using PIN (Personal Identification Number)

- 1 Press the **MENU** button.
- 2 Select **Network > Network Setup > Wireless Setup** and press the **OK** button.
- 3 Press **▲/▼** (arrow) buttons to select **Easy Setup** and press the **OK** button.
- 4 Press **▲/▼** (arrow) buttons to select **PIN**.
- 5 Press **▼** (arrow) button to select **Start Scan**, and then press the **OK** button.
- 6 Enter the PIN displayed on this screen into your computer or AP.
- 7 Press **▲/▼** (arrow) buttons to select the desired AP, and then press the **OK** button.

NOTE Check the MAC address on the label or in the manual of the AP and select an AP.

- 8 When a screen reporting that “Wireless configuration is complete” appears, press the **EXIT** button.

To cancel searching for the AP:

- ❖ Press the **BACK** button while searching for the AP. A message appears. Press ◀/▶ (arrow) buttons to select **Yes**, and then press the **OK** button.

Assisted Setup

- 1 Press the **MENU** button.
 - 2 Select **Network > Network Setup > Wireless Setup** and press the **OK** button.
 - 3 Press the ▲/▼ (arrow) buttons to select **Assisted Setup** and press the **OK** button.
 - 4 Press the ▲/▼ (arrow) buttons to select the desired AP, and then press the **OK** button.
-

NOTE Check the MAC address on the label or in the manual of the AP and select an AP.

- 5 Select **Security Key**, and then press the **OK** button. The Software Keyboard appears.
 - 6 Input the Security Key using the Software Keyboard. For more information, see [“Using the software keyboard” on page 114](#).
 - 7 To save your settings, press the **Enter** button of the Software Keyboard.
-

NOTE The Security Key must adhere to the following conditions:

- ❖ TKIP/AES: 8-63 ASCII or 64 Hex characters
 - ❖ WEP: 5 or 13 ASCII or 10 or 26 Hex characters
-

- 8 Select **Done**, and then press the **OK** button.
-

NOTE Settings are not saved if the **BACK** button is pressed before Done is selected.

Manual Setup

- 1 Press the **MENU** button.
- 2 Select **Network > Network Setup > Wireless Setup** and press the **OK** button.
- 3 Press the ▲/▼ (arrow) buttons to select **Manual Setup** and then press the **OK** button.

- 4** Press the ▲/▼ (arrow) buttons to select the **Network Name**, and then press the **OK** button.
The Software Keyboard window appears.
- 5** Input the Network Name using the Software Keyboard. For more information, see [“Using the software keyboard” on page 114](#).
- 6** To save your settings, press the **Enter** button of the Software Keyboard.
- 7** Press the ▲/▼ (arrow) buttons to select **Authentication** and then press the **OK** button.
Press the ▲/▼ (arrow) buttons to select **Open System, Shared Key, WPA-PSK, WPA2-PSK, or WPA2/WPA-PSK**, and then press the **OK** button.
- 8** Press the ▲/▼ (arrow) buttons to select **Encryption** and then press the **OK** button.
Press the ▲/▼ (arrow) buttons to select **None, WEP, TKIP, or AES**.

NOTE Certain encryption types are only compatible with specific authentication types.

- ❖ When Authentication is Open System and Shared Key, only WEP or None are compatible.
- ❖ When Authentication is Shared Key, only Encryption, None and WEP can be selected.
- ❖ When Authentication is WPA2-PSK, only Encryption, AES can be selected.

When incompatible Authentication/Encryption pairings are attempted, a warning message will be displayed, and no connection attempt will be made until the incompatibility is resolved.

-
- 9** Press the ▲/▼ (arrow) buttons to select **Security Key** and then press the **OK** button.
The Software Keyboard window appears.
 - 10** Input the Security Key using the Software Keyboard. For more information, see [“Using the software keyboard” on page 114](#).
 - 11** To save your settings, press the **Enter** button of the Software Keyboard.

NOTE This item is grayed out when Encryption is set to None.

-
- 12** Select **Done**, and then press the **OK** button.
When Encryption is set to **None**, a message appears.

- 13 Press the ◀/▶ (arrow) buttons to select **Yes**, and then press the **OK** button.

NOTE Settings are not saved if the **BACK** button is pressed before Done is selected.

Wireless Information

The settings configured in Wireless Setup can be confirmed.

- 1 Press the **MENU** button.
- 2 Select **Network > Network Setup > Wireless Setup**, and then press the **OK** button.
- 3 Press the ▲/▼ (arrow) buttons to select **Wireless Information** and press the **OK** button.
- 4 Press the **RED** button to check the availability of surrounding APs.
A Wireless Information screen appears when a connection is successfully made.

<i>Item:</i>	<i>Description:</i>
Status	The message, "Connected" appears when the TV is connected to the AP The message, "Disconnected" appears when the TV is disconnected from the AP
Signal	Connection signal strength with the AP (STRONG/MEDIUM/WEAK)
Speed	The link speed with the AP
Mode	Working mode (11a, 11b, 11g, 11n)
Channel	The channel in use (1-165)
Network name	SSID set
Authentication	Authentication set
Encryption	Encryption set
Security key	Security Key set
AP MAC address	The AP's MAC address appears when the TV is connected to the AP
TV MAC address	The TV's MAC address
DHCP	The message, "Enabled" appears when you use DHCP. The message, "Disabled" appears when you do not use DHCP.
IP address	The TV's IP address
Subnet Mask	Value of the Subnet Mask
Default Gateway	Default GATEWAY's address
DNS	DNS's address

NOTE Even if an AP for IEEE 802.11n is used when Encryption is set to WEP or TKIP, the Speed value might be low. We recommend that the Encryption setting is changed to AES (Under manual setup).

NOTE When manually setting the IP Address, set Auto Setup to Off.

Advanced Network Setup

IP Address Setup

NOTE The settings in Auto Setup are linked to those selected in the DNS Setup menu. If Auto Setup is set to On, then Auto Setup in the DNS Setup menu will also be set to On.

Auto Setup:

- 1 Press the **MENU** button.
 - 2 Select **Network > Network Setup > Advanced Network Setup** and press the **OK** button.
 - 3 Press the **▲/▼** (arrow) buttons to select **IP Address Setup** and then press the **OK** button.
 - 4 Press the **▲/▼** (arrow) buttons to select **Auto Setup** and press the **OK** button.
 - 5 Press the **▲/▼** (arrow) button to select **On**.
-

NOTE Other items are grayed out when Auto Setup is set to On.

Manual Setup:

- 1 Press the **MENU** button.
- 2 Select **Network > Network Setup > Advanced Network Setup** and press the **OK** button.
- 3 Press the **▲/▼** (arrow) buttons to select **IP Address Setup** and then press the **OK** button.
- 4 Press the **▲/▼** (arrow) buttons to select **Auto Setup** and press the **OK** button.
- 5 Press the **▲/▼** (arrow) button to select **Off**.
- 6 Press the **▲/▼** (arrow) button to select **IP Address**.

112 Using the TV's Advanced Features

Setting up the Network

- 7 Press the ◀/▶ (arrow) buttons to select the **IP Address** field and use the 0-9 buttons to enter in a digit. Press the ▶ (arrow) button to select the subsequent fields. To save the setting, press the **OK** button.
-

NOTE IP address field numbers must be between 0 and 255.

- 8 Press the ▲/▼ (arrow) buttons to highlight **Subnet Mask**, edit in the same way as IP Address.
 - 9 Press the ▲/▼ (arrow) buttons to highlight **Default Gateway**, and edit in the same way as IP Address.
-

NOTE If you manually set the IP address, you must not use the same IP address with any other device. The IP address you use should be a private address.
If you do not know the correct values to use, contact your network administrator or internet service provider.

DNS Setup

- NOTE**
- ❖ When the DHCP function of the router connected to this TV is Off, set Auto Setup to Off, and manually set the DNS address(es). Your Internet Service Provider should have provided these to you.
 - ❖ The settings in Auto Setup are linked to those selected in the IP Address Setup menu. If Auto Setup in the IP Address Setup menu is set to On, then Auto Setup will also be set to On.
-

Auto Setup:

- 1 Press the **MENU** button.
 - 2 Select **Network > Network Setup > Advanced Network Setup** and press the **OK** button.
 - 3 Press the ▲/▼ (arrow) buttons to select **DNS Setup** and then press the **OK** button.
 - 4 Press the ▲/▼ (arrow) buttons to select **Auto Setup** and press the **OK** button.
 - 5 Press the ▲/▼ (arrow) button to select **On**.
-

NOTE Other items are grayed out when Auto Setup is set to On.

Manual Setup:

- 1 Press the **MENU** button.
- 2 Select **Network > Network Setup > Advanced Network Setup** and press the **OK** button.
- 3 Press the **▲/▼** (arrow) buttons to select **DNS Setup** and then press the **OK** button.
- 4 Press the **▲/▼** (arrow) buttons to select **Auto Setup** and press the **OK** button.
- 5 Press the **▲/▼** (arrow) button to select **Off**.
- 6 Press the **▲/▼** (arrow) button to select **Primary DNS Address**.
- 7 Press the **◀/▶** (arrow) buttons to select the field you want to change, and then use the number buttons to input the Primary DNS Address.
To save the setting, press the **OK** button.

NOTE DNS address field numbers must be between 0 and 255.

- 8 Press the **▲/▼** (arrow) buttons to highlight **Secondary DNS Address**, and edit in the same way as Primary DNS Address.

MAC Address

You can view the fixed MAC address for the TV.

- 1 Press the **MENU** button.
- 2 Select **Network > Network Setup > Advanced Network Setup** and press the **OK** button.
- 3 Press the **▲/▼** (arrow) buttons to select **MAC Address**, and then press the **OK** button.

Network Connection Test

This function checks Internet connectivity.

- 1 Press the **MENU** button.
- 2 Select **Network > Network Setup > Network Connection Test**, and press the **OK** button.
A message appears to indicate whether the connection was successful or not.

NOTE Favorable Network Connection Test results do not guarantee an Internet Connection. Depending on the situation, some Internet features may not be available.

To cancel Network Connection Test, press the **EXIT** button while searching for the Internet connection.

Using the software keyboard

You can enter text using the Software Keyboard.

The Software Keyboard window will appear when you press the **OK** on a field that accepts character input.

NOTE ❖ When using the SmartTV features, software keyboard availability depends on the Internet service being accessed.

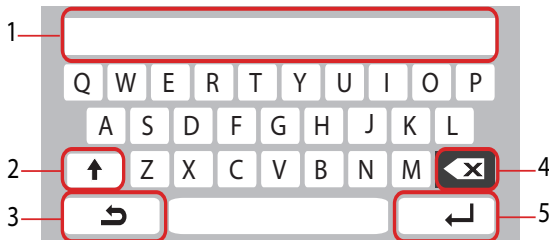

(Sample Illustration) Software keyboard

<i>Item:</i>	<i>Description:</i>
1	Text entry field To show the characters you input.
2	Shift To switch small letter, capital letter, or symbol character.
3	Return Exits software keyboard.
4	Delete Deletes one character to the left of the cursor.
5	Done Saves whatever text was entered, exits the software keyboard and enters that text into the appropriate text field on the previous screen.

Enter text using the software keyboard

- 1 Highlight the desired character on the on-screen software keyboard.
- 2 Press the **OK** button.
- 3 Repeat Step 1 and 2 until you have entered all desired text.
- 4 Select Done to save your settings and return to the previous screen.

NOTE If the **BACK** button is pressed, changes are not saved and the software keyboard window is closed.

Input operation on the remote control:

<i>Item:</i>	<i>Description:</i>
OK	Inputs the selected character
0-9	These keys are used to select a character for entry.
▲/▼/◀/▶	Moves the character highlight.
BACK	Closes the Software Keyboard window without saving changes

Performing a Software Upgrade

TOSHIBA may offer upgrades for the TV's software in the future. The TV's software is upgraded via the Network.

NOTE An Internet connection is required.

Before downloading software:

- 1 Configure your TV to connect to the Internet.
-

NOTE

- ❖ You will not be able to use the TV set while performing the upgrade.
- ❖ Do not turn off the TV during the upgrade.
- ❖ By upgrading, the factory default values may be changed.

- 2 Press the **MENU** button.
 - 3 Select **Get Help > Software Upgrade**.
 - 4 Press the **OK** button.
The Network Upgrade screen appears.
 - 5 Press the **OK** button.
-

NOTE If the network is not available, a warning message appears.

- 6 After a successful download, the TV software upgrade will start automatically.
-

Viewing the Software Licenses

The Licenses for the software used in this TV are available for viewing.

- 1 Press the **MENU** button.
- 2 Select **Get Help > Software Licenses**.
- 3 Press the **OK** button.
A screen appears displaying all the licensing information required for the television's software.

Using the TV Application Services features

This Smart TV is a connected TV that provides key media Apps and built-in Wi-Fi® for direct access to select Internet content like Netflix® Pandora®, and YouTube™. The Smart TV also includes MediaShare to allow playback of applicable media content from your USB stick or home network.

You can access all of your Smart TV applications by the icon bar at the bottom of the screen.

- NOTE**
- ❖ You need to connect to the Internet before using this feature, see [“Setting up the Network” on page 106](#).
 - ❖ Some services depicted in this document and provided through your TV may not be available in your region and may not be available to you.
 - ❖ User registration or login may be required to use some services.
 - ❖ Some features may require an always-on broadband Internet connection, firmware update, and/or additional bandwidth. Third party Internet services are not provided by Toshiba, may change or be discontinued at any time and may be subject to Internet service provider restrictions. Toshiba makes no warranties, representations, or assurances about the content, availability or functionality of thirdparty content or services. Use of third party Internet services may require the creation of a separate account through a computer with Internet access and/or payment of one-time and/or recurring charges and membership. Not all third party services may be available on or compatible with this product. In order to experience the full suggested capabilities of this product, fully-compatible devices may be required.
-

- NOTE**
- ❖ If the display of the date and time is wrong, try to turn off the TV, and turn it on again.
 - ❖ The menu items for features like the Apps may change in the upgrade process.
-

Watching movies with Netflix®

- 1 Press the **NETFLIX** button on the remote control.
- 2 Follow the on-screen instructions.

After having activated Netflix® player and prepared an Instant Queue, movies and TV episodes in your Instant Queue will appear on the TV screen. Select the desired content using the remote control.

-
- NOTE**
- ❖ The resolution of video content streamed from Netflix® varies depending on the communication speed and bit-rate.
 - ❖ Future upgrades can change the screens and messages displayed in the Netflix® feature.
 - ❖ Netflix® is supported in the U.S. and Canada, and may not be available in other countries or regions.
-

To close Netflix®, press the **EXIT** button.

To confirm the Netflix ESN (Electronic Serial Number):

- 1 Press the **MENU** button.
- 2 Select **Network > Smart Apps Setup > Netflix Setup** and press the **OK** button.
- 3 Press the **▲/▼** (arrow) buttons to select **ESN** and then press the **OK** button.
The Netflix ESN screen appears.

To deactivate your device:

- 1 Press the **MENU** button.
- 2 Select **Network > Smart Apps Setup > Netflix Setup** and press the **OK** button.
- 3 Press the **▲/▼** (arrow) buttons to select **Deactivation** and then press the **OK** button.
- 4 Press the **◀/▶** (arrow) buttons to select **Yes** and then press the **OK** button.

YouTube™

YouTube is a video-sharing service managed by YouTube, LLC.

This TV allows you to view YouTube content.

- 1 Press the **HOME** button to launch the applications bar.
- 2 Press the ◀/▶ (arrow) buttons to select **YouTube** and press the **OK** button.

To close **YouTube**:

- 1 Press the **EXIT** button.

Pandora®

Pandora® is an on-demand service that offers music on the web.

- 1 Press the **HOME** button to launch the applications bar.
- 2 Press the ◀/▶ (arrow) buttons to select **Pandora** and press the **OK** button.

To close **Pandora**:

- 1 Press the **EXIT** button.

Samba TV™

By recognizing what's on screen, Samba TV™ learns what you like, and connects you to the shows and actors you love. Across TV, Samba TV delivers a personal television experience.

At the first time your home network connects to the Internet, the **Enable Samba TV** menu will pop up, select the **ACCEPT & ENABLE** button to enable Samba TV™, or select the **DECLINE & DISABLE** button to disable it.

If **Samba TV** had configured and then you would like to change the setting:

- 1 Press the **MENU** button and open the **Network** menu.
- 2 Select **Network > Samba Interactive TV Settings** and press the **OK** button.
- 3 Follow the indication on the web page to **ENABLE** or **DISABLE** Samba TV.
- 4 Press the **EXIT** button.

Hotlist

Hotlist is powered by Samba TV™ that provides on-demand streaming of video content. **Hotlist** offers access to video content channels and thousands of videos on the web.

- 1 Press the **HOME** button to launch the applications bar.
- 2 Press the ◀/▶ (arrow) buttons to select **HOTLIST** and press the **OK** button.

To close **HOTLIST**:

- 1 Press the **EXIT** button.

Chapter 8

Troubleshooting

General troubleshooting

Before calling a service technician, review this chapter or visit the Toshiba technical support Web site at support.toshiba.com for possible causes/solutions for the problem you are experiencing.

Before you begin to troubleshoot any problem, first unplug the TV from the AC wall outlet, wait approximately one minute, and then plug the TV back into the AC wall outlet. If the problem still exists attempt to troubleshoot the problem.

Black box on-screen.

The closed caption feature is set to one of the Text modes (T1, T2, T3, or T4). Set the closed caption feature to Off, see “[Using closed captions](#)” on page 68.

TV stops responding to controls.

If the TV stops responding to the buttons on the remote control or TV control panel and you cannot turn off the TV, unplug the TV from the AC wall outlet and plug it back in.

If you cause a static discharge when touching the TV and the TV fails to function, simply unplug the TV from the AC outlet and plug it back in. The TV should return to normal operation.

Other problems.

If your TV’s problem is not addressed in this Troubleshooting section or the recommended solution has not worked, use the Reset Factory Defaults procedure, see “[Resetting Factory Defaults](#)” on page 53.

Onscreen Demo Pop-up

If your TV is displaying a Demo pop-up screen, reset the Store / Home mode setting to Home. For more information see [“Installation setup selection” on page 48.](#)

TV will not turn on.

Ensure the power cord is plugged in properly, and then press the **POWER** button. Ensure the TV is plugged into a working AC power outlet by plugging another device into the AC power outlet to verify the AC power outlet is working.

Replace the batteries in the remote control, see [“Installing batteries” on page 39.](#)

Try the control panel buttons on the TV.

Picture problems

General picture problems.

Check the antenna/cable connections, see [“Connecting Your TV” on page 24.](#)

Press the **INPUT** button on the remote control or on the TV and select a valid video input source, see [“Selecting the video input source” on page 54.](#) If no device is connected to an input on the TV, no picture appears when you select that particular input source. For device connection details, see [“Connecting Your TV” on page 24.](#)

Antenna reception may be poor. Use a highly directional outdoor antenna (if applicable).

The station may be having broadcast difficulties. Try another channel.

Adjust the picture quality, see [“Using the advanced picture settings” on page 100.](#)

Picture size changes by itself or when the TV is turned OFF and back ON.

Turn the Auto Aspect feature of the TV to OFF. see [“Using the advanced picture settings” on page 100.](#)

Cannot select external video sources.

If you cannot view signals from external devices connected to VIDEO, ColorStream™ HD, HDMI 1, HDMI 2, or HDMI 3, ensure that the Input Lock is set to Off, see [“Using the input lock feature” on page 80.](#)

Noisy picture.

If you are watching an analog channel (off-air broadcast or Cable TV), you can set the DNR feature to reduce visible interference in the TV picture, see “[DNR \(Dynamic Noise Reduction\)](#)” on page 103.

Video Input Selection problems

If the Input Selection window does not appear when you press **INPUT** on the remote control or TV, press **INPUT** a second time. This will cause a change to the next video input source and display the Input Selection window.

Poor display color or no color.

The station may be having broadcast difficulties. Try another channel.

Adjust the Tint and/or Color, see “[Adjusting the picture quality](#)” on page 67.

Poor composite picture.

If the TV is connected to an external A/V device (e.g. DVD player, video game system, set-top box, etc.) try using a ColorStream™ or HDMI® video connection instead.

Picture and sound are out of sync.

As with all products that contain a digital display, this may occur in rare instances, when viewing certain content (e.g. television broadcasts, video games, DVDs). The cause may include, without limitation, video processing within the TV, video processing in an attached gaming system, and video processing or different compression rates used by broadcasters in their programming.

Try the following:

- ❖ If the TV is connected to an A/V receiver that has a programmable audio delay feature, use this feature to help synchronize the sound to the picture.
- ❖ If the problem occurs only on certain TV channels, inform your local broadcast, cable, or satellite provider.
- ❖ Turn off and unplug the TV from the AC wall outlet for a few seconds and plug it back in.

Sound problems

Check the antenna/cable connections, see “[Connecting a VCR, antenna, cable TV, or camcorder](#)” on page 26.

The station may be having broadcast difficulties. Try another channel.

The sound may be muted. Press the **VOL (+)** button.

If you hear no sound, try setting the MTS feature to Stereo mode, see [“Selecting stereo/SAP broadcasts” on page 72](#).

If you are not receiving a second audio program from a known SAP source, make sure the MTS feature is set to SAP mode, see [“Selecting stereo/SAP broadcasts” on page 72](#).

If you hear audio that seems incorrect for the program you are watching (such as music or a foreign language), the SAP mode may be on. Set the MTS feature to Stereo mode, see [“Selecting stereo/SAP broadcasts” on page 72](#).

Remote control problems

Remove all obstructions between the remote control and the TV.

Replace the remote control’s batteries, see [“Installing batteries” on page 39](#).

Your TV’s remote control may not operate certain features on your external devices. Refer to the User’s Guide for your other device to determine its available features. If your TV remote control does not operate a specific feature on another device, use the remote control that came with the device, see [“Learning about the remote control” on page 41](#).

If the TV still does not act as expected, perform the Reset Factory Defaults procedure, see [“Resetting Factory Defaults” on page 53](#).

Channel tuning problems

The Auto Tuning feature may have erased the channel from memory. Add the channel to the channel memory, see [“Storing channels in memory \(optional\)” on page 49](#).

The Lock feature may have blocked the channel. Unblock the channel, see [“Locking channels” on page 80](#).

If you cannot tune digital channels, check the antenna configuration. If the problem persists, clear all channels from the channel list and reprogram channels into memory, see [“Storing channels in memory \(optional\)” on page 49](#). For additional information, see [“TV stops responding to controls.” on page 121](#). If the problem persists, use the Reset Factory Defaults procedure, see [“Resetting Factory Defaults” on page 53](#).

Closed caption problems

If the program or video you have selected is not closed captioned, no captions appear on the screen. If text is not available, a black rectangle may appear.

If this happens, turn off the closed caption feature, see [“Using closed captions” on page 68](#).

A closed caption signal may not display correctly under the following circumstances:

- ❖ The recording is dubbed
- ❖ The signal reception is weak
- ❖ The signal reception is non-standard

For additional information, see [“Using closed captions” on page 68](#).

Rating blocking (V-Chip) problems

Forgotten PIN code.

When the PIN code screen appears, press the **INFO** button 4 times within approximately 5 seconds. The old PIN code is cleared, see [“Forgotten PIN code” on page 74](#).

The V-Chip feature is available for U.S. V-Chip systems only, see [“Using parental controls \(for USA region\)” on page 75](#).

No HDMI® CEC operation

The HDMI® CEC feature is available for Toshiba HDMI® CEC compatible devices.

Ensure that HDMI® cables with the () Logo are used.

When the connected HDMI® CEC device does not work correctly after you have changed settings of the device, turn off your TV and unplug the power cord, then plug in and turn on again.

If several devices are connected, the HDMI® CEC feature may not operate properly.

Read the instruction manual furnished with the connected HDMI® CEC device.

HDMI® problems

HDMI® cables.

Ensure that HDMI® cables with the () Logo are used, see [“Connecting an HDMI® or DVI device to the HDMI® input” on page 29](#).

Legacy HDMI® sources.

Some legacy HDMI® sources may not work properly with the latest HDMI® TV products due to new standard adoption.

Network problems

Cannot connect to the Internet.

Check the modem and its incoming cable/telephone connections, see [“Connecting to a home network” on page 35](#).

Confirm your modem’s operation.

Ensure your IP address is set up correctly.

No network connection.

If using a wired network connection, check to ensure that the LAN cables are connected properly, see [“Connecting the TV to a home network with an Internet connection - wired” on page 37](#).

Ensure that the modem and router power cords are plugged in and the devices are operating properly.

Ensure that your IP address is set up correctly, see [“IP Address Setup” on page 111](#).

Check to ensure proper operation of other network connected devices.

Network Setup fails (Auto).

Check to ensure that the LAN cables are connected properly, see [“Connecting the TV to a home network with an Internet connection - wired” on page 37](#).

DHCP is not enabled on the router, or no router is present. Refer to your router’s documentation for instructions on enabling DHCP. If your router does not support DHCP, you must manually set up the IP address.

Internet service is not available. Check your cable/DSL modem or contact your ISP for Internet service issues.

Network Setup fails (Manual).

Ensure that the TV IP address is not the same as any other device on the network.

❖ Example: IP address 192.168.0.100 and IP address 192.168.0.101

are different addresses on the same network.

Make sure the TV IP address is on the same subnet as the networked computer.

- ❖ Example of proper setup: The computer has the IP address 192.168.0.100 with the Subnet mask 255.255.255.0, the TV has the IP address 192.168.0.101 with the Subnet mask 255.255.255.0; both are on the same subnet.
- ❖ Example: of improper setup: The computer has the IP address 192.168.1.100 with the Subnet mask 255.255.255.0, the TV has the IP address 192.168.0.101 with the Subnet mask 255.255.253.0; they are on different subnets.

Unstable network connection.

When using a wired home network connection, unplug the LAN cables, and then reconnect them.

When using a wireless home network connection:

- ❖ Reboot the router:
 - 1 Remove AC power from the router and the television for approximately one minute.
 - 2 Reconnect AC power to the router.
 - 3 Reconnect AC power to the television and turn it On.
 - 4 After approximately two minutes, check connection stability.
- ❖ Connect with LAN cables, if possible, and check connection stability.
- ❖ Repeat the wireless network setup procedure and check connection stability.

The media server name is not displayed.

The LAN cables, if used, are not connected properly, see [“Connecting the TV to a home network with an Internet connection - wired” on page 37.](#)

The WLAN, if used, is not configured properly.

The network setup on the Server is incorrect. Make sure both the media server and TV are using the same network type (DHCP/manual) and have compatible network settings.

Too many devices are connected. You cannot connect more than 32 sharing devices at one time.

The media server is not turned On.

The “server” is not a media server device.

Check the firewall and streaming settings on the media server.

Wireless network problems

Check that the router/AP (Access point) power is On.

After starting wireless network setup, confirm that the network is configured properly by performing the network connection test, see [“Network Connection Test” on page 113](#).

Check the router/AP’s connection status.

If the router/AP does not support PBC or WPS, Easy Setup (PBC) will not work even if the push-button is pressed, see [“Wireless Setup” on page 106](#).

If the available router/AP list is not displayed in Easy Setup (PBC) or Assisted Setup, the power of the router/AP may be Off. Check that it is On, and then try restarting the scan for available routers/APs, see [“Easy Setup using PBC \(Push button configuration\)” on page 107](#).

Refer to the router/AP’s instruction manual.

MediaShare problems

Incorrect functionality may occur when using a USB HUB connection.

Photo files that were processed and edited using the computer’s application software may not be viewable.

The TV may select one format automatically and play it when contents that support two or more formats are played.

Confirm that the contents of the USB storage device are in formats that are supported by this TV, see [“MediaShare \(Videos, Music, and Photos\)” on page 83](#).

Copyright protected content stored on the media server may not be playable on the TV.

Content playback stability may be affected by heavy network traffic.

Content originally recorded on a computer may not play correctly.

Set the media sharing of the media server to the correct settings, according to the media server instruction manual.

Depending on the media server, access may be limited by the MAC address. Set the server according to the media server’s instruction manual.

This TV’s MAC Address can be confirmed in the Network Setup portion of the User Menu, see [“MAC Address” on page 113](#).

For Connected MediaShare

Depending on the media server, it may take time to display the list.

If the problem persists after trying the solutions

Contact Toshiba at: support.toshiba.com.

Appendix A

Specifications

- NOTE**
- ❖ These models comply with the specifications listed below.
 - ❖ Designs and specifications are subject to change without notice.
 - ❖ These models may not be compatible with features and/or specifications that may be added in the future.

Television system

NTSC standard	
ATSC standard	8VSB
Digital Cable	64 QAM, 256 QAM; in-the-clear, unencrypted

Channel coverage

VHF	2 through 13
UHF	14 through 69
Cable TV	Mid band (A-8 through A-1, A through I)
	Super band (J through W)
	Hyper band (AA through ZZ, AAA, BBB)
	Ultra band (65 through 94, 100 through 135)

Power source

120V AC, 60 Hz

Power maximum current

40L3400U	1.1 A
50L3400U	1.4 A

Power consumption

40L3400U	0.3 W in Standby mode
50L3400U	0.3 W in Standby mode

Audio power

40L3400U	6Ω 7W
50L3400U	6Ω 7W

Speaker type

40L3400U	Two 5.98 x 1.57 x 1.42"
50L3400U	Two 5.98 x 1.57 x 1.42"

Video/audio terminals

Video/audio input

Video	1 V (p-p), 75 ohm, negative sync.
Audio	200 mV(rms) (-20dBFS, 47K ohm or greater)

ColorStream™ (component video) HD input

Video	Y: 1V(p-p), 75 ohm
	PR: 0.7 V(p-p), 75 ohm
	PB: 0.7 V(p-p), 75 ohm
	Suggested formats: 1080i, 720p, 480p, 480i
Audio	200 mV(rms) (-20dBFS, 47K ohm or greater)

132 Specifications

Digital audio output

HDMI® input

HDMI® compliant (type A connector)	
HDCP compliant	
HDMI® Audio	2-channel Linear-PCM/ Dolby® Digital; 32/44.1/48kHz sampling frequency; 16/20/24 bits per sample

Digital audio output

Optical type

Wireless connection

Standard	IEEE 802.11a/b/g/n/
Host Interface	USB 2.0 compatible
Frequency Range	5.15-5.35 GHz, 5.47-5.725 GHz, 5.725-5.850 GHz, 2.400–2.473 GHz
Security	WEP 64/128, TKIP, AES, WPA/WPA2-PSK, WPS, None

Ethernet

IEEE 802.3.

USB

Universal Serial Bus Specification, Revision 1.1.

Universal Serial Bus Specification, Revision 2.0.

Dimensions (with stand)

40L3400U	Width	36.5" (928 mm)
	Height	23.1" (588 mm)
	Depth	7.6" (194 mm)
50L3400U	Width	44.2" (1122 mm)
	Height	27.6" (702 mm)
	Depth	8.5" (217 mm)

Weight (mass)

40L3400U	20.9 lbs (9.5 kg)
50L3400U	35.1 lbs (15.9 kg)

Operating conditions

Temperature	32°F - 95°F (0°C - 35°C)
Humidity	20 - 80 % (no moisture condensation)

Supplied accessories

- ❖ Remote control with two size “AAA” batteries
- ❖ Resource Guide
- ❖ Quick Start Guide
- ❖ Pedestal and hardware
- ❖ Warranty information
- ❖ Power cord (available on certain models)

Acceptable signal formats for HDMI®

HDMI® signal formats

<i>Format</i>	<i>Resolution</i>	<i>V. Frequency</i>	<i>H. Frequency</i>	<i>Pixel Clock Frequency</i>
VGA	640 x 480	59.940 Hz	31.469 kHz	25.175 MHz
SVGA	800 x 600	60.317 Hz	37.879 kHz	40.000 MHz
XGA	1024 x 768	60.004 Hz	48.363 kHz	65.000 MHz
WXGA	1280 x 768	59.870 Hz	47.776 kHz	79.500 MHz
	1360 x 768	60.015 Hz	47.712 kHz	85.500 MHz
SXGA	1280 x 1024	60.020 Hz	63.981 kHz	108.000 MHz
480i	720 x 480i	59.940 Hz	15.734 kHz	27.000 MHz
480p	720 x 480p	59.940 Hz	31.469 kHz	27.000 MHz
720p	1280 x 720p	60.000 Hz	45.000 kHz	74.250 MHz
1080i	1920 x 1080i	60.000 Hz	33.750 kHz	74.250 MHz
		24.000 Hz	27.000 kHz	74.250 MHz
1080p	1920 x 1080p	60.000 Hz	67.500 kHz	148.500 MHz
		60.000 Hz	67.500 kHz	148.500 MHz

- NOTE** ❖ Some illustrations in this User's Guide are for explanation purposes and may differ from the actual unit.
- ❖ Designs and specifications are subject to change without notice.
- ❖ These models may not be compatible with features and/or specifications that may be added in the future.

Appendix B

License Agreement

License Information on the software used in the TOSHIBA Digital TV

The software pre-installed in the TOSHIBA* Digital Televisions consists of multiple, independent software components. Each software component is copyrighted by TOSHIBA or a third party.

The TOSHIBA Digital Televisions uses software components that are distributed as freeware under a third-party end-user license agreement or copyright notice (hereinafter referred to as a “EULA”). Some EULAs require that the source code of the applicable component be disclosed as the condition for distributing the software component in executable format.

In addition, some of the software components which are used in Toshiba Digital Televisions include the software that are made or developed originally by TOSHIBA. These software and accompanied documents are copyrighted by TOSHIBA, and protected by the Copyright Act, an international treaty’s articles and other governing laws. The software components which are made or developed originally by TOSHIBA and not subject to EULAs are not a target of source code offering.

The Toshiba Standard Limited Warranty provided in respect of the Digital TV is the only warranty provided and no additional warranties are provided in respect of the software components subject to EULAs.

Some of the software components distributed under EULAs are made available for use by the user on the premise that they are not copyrighted or warranted by TOSHIBA or any third party.

*This End User License Agreement (“EULA”) is a legal agreement between you and TOSHIBA CORPORATION (for the purposes of this License Agreement, “TOSHIBA” shall refer to Toshiba Corporation).

These software components are licensed to the user free of charge and therefore not covered by any warranty within the scope of the applicable laws. These software components are provided in “as is” condition without any warranty, whether express or implied. “Warranty” here includes, but not limited to, an implied warranty for marketability or fitness for specific uses. All risks associated with the quality or performance of these software components are assumed by the user. TOSHIBA shall not be liable whatsoever for any cost of repair or correction or other incidental expense incurred in connection with a defect found in any of these software components. Unless specified under the applicable laws or in a written agreement, a party who changes or redistributes the software with consent from the copyright holders or based on the aforementioned licenses shall not be held liable whatsoever for any loss arising from the use of or inability to use such software components. The same applies even when the copyright holders or relevant third parties have been informed of the possibility of such loss. “Loss” here includes normal, special, incidental and indirect loss (including, but not limited to, the loss of data or its accuracy; loss incurred by the user or any third party; and interface incompatibility with other software). Please read each EULA for details on the use conditions and items that must be observed regarding these software components.

The table below lists the software components pre-installed in the TOSHIBA Digital Televisions, which are subject to EULAs. The user should read the applicable EULAs carefully before using these software components. The EULAs are exhibited in their original text (English) as exactly written by the respective parties other than TOSHIBA.

For at least three (3) years from the date of distribution of the this product, Toshiba will give to anyone who contacts Toshiba Consumer Solutions at (800) 631-3811, for a charge of no more than our cost of physically performing source code distribution, a complete machine-readable copy of the complete corresponding GPL and LGPL source code for the version of the GPL and LGPL code that we distributed to you in this product.

Pre-Installed Software - EULA

jpeglib.h - Exhibit A

FreeType 2.2.0 - Exhibit B

scalfact.c - Exhibit C

Exhibit A

The authors make NO WARRANTY or representation, either express or implied, with respect to this software, its quality, accuracy, merchantability, or fitness for a particular purpose.

This software is provided “AS IS”, and you, its user, assume the entire risk as to its quality and accuracy. This software is copyright (C) 1991-2011, Thomas G. Lane, Guido Vollbeding.

All Rights Reserved except as specified below. Permission is hereby granted to use, copy, modify, and distribute this software (or portions thereof) for any purpose, without fee, subject to these conditions:

(1) If any part of the source code for this software is distributed, then this README file must be included, with this copyright and no-warranty notice unaltered; and any additions,

deletions, or changes to the original files must be clearly indicated in accompanying documentation.

(2) If only executable code is distributed, then the accompanying documentation must state that “this software is based in part on the work of the Independent JPEG Group”.

(3) Permission for use of this software is granted only if the user accepts full responsibility for any undesirable consequences; the authors accept NO LIABILITY for damages of any kind.

These conditions apply to any software derived from or based on the IJG code, not just to the unmodified library. If you use our work, you ought to acknowledge us.

Permission is NOT granted for the use of any IJG author’s name or company name in advertising or publicity relating to this software or products derived from it. This software may be referred to only as “the Independent JPEG Group’s software”.

We specifically permit and encourage the use of this software as the basis of commercial products, provided that all warranty or liability claims are assumed by the product vendor. `ansi2knr.c` is included in this distribution by permission of L. Peter Deutsch, sole proprietor of its copyright holder, Aladdin Enterprises of Menlo Park, CA. `ansi2knr.c` is NOT covered by the above copyright and conditions, but instead by the usual distribution terms of the Free Software Foundation; principally, that you must include source code if you redistribute it. (See the file `ansi2knr.c` for full details.) However, since `ansi2knr.c` is not needed as part of any program generated from the IJG code, this does not limit you more than the foregoing paragraphs do.

The Unix configuration script “`configure`” was produced with GNU Autoconf. It is copyright by the Free Software Foundation but is freely distributable. The same holds for its supporting scripts (`config.guess`, `config.sub`, `ltmain.sh`). Another support script, `install-sh`, is copyright by X Consortium but is also freely distributable.

The IJG distribution formerly included code to read and write GIF files. To avoid entanglement with the Unisys LZW patent, GIF reading support has been removed altogether, and the GIF writer has been simplified to produce “uncompressed GIFs”. This technique does not use the LZW algorithm; the resulting GIF files are larger than usual, but are readable by all standard GIF decoders.

We are required to state that

“The Graphics Interchange Format(c) is the Copyright property of CompuServe Incorporated. GIF(sm) is a Service Mark property of CompuServe Incorporated.”

Exhibit B

The FreeType Project LICENSE

2002-Apr-11

Copyright 1996-2002 by

David Turner, Robert Wilhelm, and Werner Lemberg

Introduction

The FreeType Project is distributed in several archive packages; some of them may contain, in addition to the FreeType font engine, various tools and contributions which rely on, or relate to, the FreeType Project.

This license applies to all files found in such packages, and which do not fall under their own explicit license. The license affects thus the FreeType font engine, the test programs, documentation and makefiles, at the very least.

This license was inspired by the BSD, Artistic, and IJG (Independent JPEG Group) licenses, which all encourage inclusion and use of free software in commercial and freeware products alike. As a consequence, its main points are that:

- ❖ We don't promise that this software works. However, we will be interested in any kind of bug reports. ('as is' distribution)
- ❖ You can use this software for whatever you want, in parts or full form, without having to pay us. ('royalty-free' usage)
- ❖ You may not pretend that you wrote this software. If you use it, or only parts of it, in a program, you must acknowledge somewhere in your documentation that you have used the FreeType code. ('credits')

We specifically permit and encourage the inclusion of this software, with or without modifications, in commercial products. We disclaim all warranties covering The FreeType Project and assume no liability related to The FreeType Project.

Finally, many people asked us for a preferred form for a credit/disclaimer to use in compliance with this license. We thus encourage you to use the following text:

Portions of this software are copyright © 1996-2002 The FreeType
Project (freetype.org). All rights reserved.

Exhibit C

scalfact.c Scalefactors for layer I and II This program is free software; you can redistribute it and/or modify it under the terms of the GNU General Public License as published by the Free Software Foundation; either version 2 of the License, or (at your option) any later version. This program is distributed in the hope that it will be useful, but WITHOUT ANY WARRANTY; without even the implied warranty of MERCHANTABILITY or FITNESS FOR A PARTICULAR PURPOSE. See the GNU General Public License for more details. You should have received a copy of the GNU General Public License along with this program; if not, write to the Free Software Foundation, Inc., 675 Mass Ave, Cambridge, MA 02139, USA.

Appendix C

Index

A

- Acceptable signal formats for HDMI®
 - HDMI® signal formats 132
- Additional Safety Precautions
 - Installation, Care, and Service
 - Choosing a location for your LED TV
 - To Display your LED TV on the included Pedestal Stand 4
- Adjusting the picture
 - Selecting the picture mode
 - Adjusting the picture quality
 - Using closed captions 66, 67
- ANT/CABLE IN
 - Storing channels in memory (optional)
 - Auto Tuning
 - Manual Tuning 48
- Auto Aspect
 - using 65
- Auto Start function
 - Media Player 85
- Available remote control key functions
 - HDMI® CEC Player Control menu

- functions
 - HDMI® CEC input source selection
- VOLUME and MUTE controls of Audio Receiver 94

B

- Base closed captions
 - Digital CC settings
 - Adjusting the audio
 - Muting the sound 68
- Blocking TV programs and movies by rating (V-Chip)
 - Downloading an additional rating system
 - Rating system
 - Displaying ratings 75

C

- Cinema Mode
 - Noise Reduction
 - MPEG NR
 - DNR 102
- Color Temperature

- Static Gamma
 DynaLight™
- Dynamic Contrast 101
- Component video cables (red/green/blue)
 - HDMI® cable (with HDMI Logo)
 - Optical audio cable
- About the connection illustrations 25
- Connecting a digital audio system
 - Connecting a computer
 - Connection to the TV's HDMI® terminal 26, 33
- Connecting a VCR, antenna, cable TV, or camcorder
 - Connecting a Blu-ray™ / DVD player, satellite receiver with ColorStream™ or VCR
 - Connecting an HDMI® or DVI device to the HDMI® input
 - HDMI® CEC connection 26
- Connecting Your TV
 - Overview of cable types
 - Coaxial (F-type) cable
 - Standard A/V cables (red/white/yellow) 24

D

- Dimensions (with stand)
 - Weight (mass)
 - Operating conditions
- Supplied accessories 131

E

- Edge Enhancer 103
- Enter a new PIN code
 - Forgotten PIN code
 - Changing or deleting your PIN code

- Using parental controls (for USA region) 74

- Exhibit B
 - Introduction
 - Exhibit C
- Index 135, 136

F

- featurColorStreames 18, 20
- Full
 - TheaterWide 1
 - TheaterWide 2
 - TheaterWide 3 60, 61, 65, 97

G

- GameNow® 119

H

- HDMI® 1(2, or 3) RGB Range 97
- HDMI®-CEC
 - using 93
- HDMI® Information Display
 - Displaying TV status information
 - Understanding the last mode memory feature 97

I

- Introduction
 - Safety icons
 - Features
- Overview of installation, setup, and use 17

L

- last mode memory feature 99
- License Agreement
 - License Information on the software used in the TOSHIBA Digital TV

- Pre-Installed Software - EULA
 - Exhibit A 134
- Locks menu
 - setting pin code 74
- M**
- MediaShare 83
- Menu Layout and Navigation
 - Main menu layout
 - Navigating the menu system 44
- N**
- Native
 - 4:3
 - Normal
 - Dot by Dot 60, 62
 - No HDMI® CEC operation
 - HDMI® problems
 - Media Player problems
 - If the problem persists after trying the solutions 124
- O**
- Other HDMI® CEC functions
 - Setting up HDMI® CEC
 - Using the HDMI® settings feature
 - HDMI® 1(or 2) RGB Range 96
- P**
- Panel Lock 82
- parental controls
 - using 75
- picture
 - adjusting quality 67
- picture size
 - 4
 - 3 63
 - Normal 63
 - TheaterWide 1 61
 - TheaterWide 2 61
 - TheaterWide 3 62
- pin code
 - changing 75
 - deleting 75
 - entering PIN code 74
 - forgotten 74
- Power maximum current
- Power consumption
 - Audio power
 - Speaker type 130
- program ratings
 - displaying 79
 - unlocking programs 79
- Q**
- Quick setup
 - ANT/CABLE IN 48
- R**
- Remote control problems
 - Channel tuning problems
 - Closed caption problems
 - Rating blocking (V-Chip) problems 123
- Resetting Factory Defaults 53
- S**
- safety
 - icons 17
- Safety Precautions
 - WARNING
 - CHILD SAFETY
 - Important Safety Instructions 2, 4
- Samba TV™ 119
- Scrolling the TheaterWide™ picture (TheaterWide 2 and 3 only)
 - Using the Auto Aspect feature

- Using the 4:3 Stretch
- Using the FREEZE feature 64
- Setting channel skip
 - Setting the AV input mode
 - Setting the time zone
 - Viewing the system status 51
- Setting the sleep timer
 - No Signal Power Down
 - Using HDMI® CEC
 - HDMI® CEC playback device (Blu-ray™/DVD player, etc.) control 91
- Setting up your TV
 - Initial Setup
 - Installation setup selection
 - Menu language 47
- Slide show
 - Playing music files
 - Viewing photo files and playing music files at the same time
 - Sorting photo or music files 86, 87
- Sound Mode
 - Stable Sound™
 - Using the Dolby® Digital Dynamic Range Control feature
 - Selecting the PIN code 73
- Specifications
 - Television system
 - Channel coverage
 - Power source 129

T

- timer
 - sleep timer 92
- time zone
 - setting 52
- To Display your LED TV using a Wall Bracket
 - FCC Declaration of Conformity Compliance Statement (Part 15)

- ENERGY STAR® User Information

- Important notes about your TV 6

- Trademark Information

- Copyright

- Notice 9

- Troubleshooting

- General troubleshooting

- Picture problems

- Sound problems 120

- Tuning to a specific channel (programmed or unprogrammed)

- Switching between two channels using Channel Return

- Switching between two channels using SurfLock™

- Selecting the picture size 58

- TV front and side panel controls and connections

- TV back panel connections 21

- TV panel controls

- left side 21

- TV remote

- functionality 41

U

- Unlocking programs temporarily

- Using the input lock feature

- Locking channels

- Using the GameTimer™ 79

- Using the Digital Audio Selection

- Selecting stereo/SAP broadcasts

- Adjusting the audio quality

- DTS TruSurround™ 71

- Using the panel lock feature

- Using the Media Player

- Using Media Player with a USB device

- Auto Start function 82

- Using the Remote Control

Installing batteries
Remote control effective range

Learning about the remote control
39

Using the TV's Advanced Features

Using the advanced picture settings
ColorMaster™

Base Color Adjustment 100

V

Video/audio terminals

Video/audio input
ColorStream™ (component
video) HD input

HDMI® input 130

video input sources

labeling 56