

TOSHIBA

50"/55" 2160p (4K), 60Hz, LED Chromecast™ built-in TV

50L711U18/55L711U18

50L711M18/55L711M18

Before using your new product, please read these instructions to prevent any damage.

Contents

CHILD SAFETY	6
Important Safety Instructions	7
WARNING	7
CAUTION	8
Introduction	10
Google Chromecast™ built-in	10
HDMI®CEC Control	10
DTS Studio Sound®	10
GameTimer™	10
Audio accessibility	10
Installing the stands or wall-mount bracket	11
Installing the stands (50" model)	11
Installing the stands (55" model)	12
Installing a wall-mount bracket	14
TV components	17
Package contents	17
Front	17
Power/INPUT button	17
Side jacks	18
Back jacks	19
Remote control	20
Virtual Remote control	21
What connection should I use?	23
Connecting a cable or satellite box	24
HDMI (best)	24
DVI (same as HDMI but requires an audio connection)	25
AV (good)	26
Coaxial (good).....	27
Connecting an antenna or cable TV (no box)	28
Connecting a DVD or Blu-ray player	29
HDMI (best)	29
AV (good)	30
Connecting a game console	31
HDMI (best)	31
AV (good)	32

Connecting a network router	33
Connecting a computer	34
HDMI (best)	34
DVI (same as HDMI but requires an audio connection)	35
Connecting a USB flash drive	36
Connecting headphones	37
Connecting external speakers or a soundbar	38
Digital audio	38
Analog audio	39
Connecting a home theater system with multiple devices	40
Connecting power	41
Using the remote control	42
Installing remote control batteries	42
Aiming the remote control	42
Programming universal remote controls	43
Turning on your TV for the first time	44
Using an Android mobile device	44
Using an iOS (Apple) mobile device	49
Casting a video, movie, or TV show	53
Setting up the ANT / CABLE IN jack	54
Understanding the basics	54
Turning your TV on or off	54
Selecting the video input source	55
On-screen menu overview	56
Navigating the menus	57
Adjusting the volume	57
Selecting a channel	57
Viewing channel information	58
Controlling CEC-compatible devices	58
Turning HDMI-CEC Control on or off	59
Turning TV Auto Power on or off	59
Turning Auto Standby on or off	60
Turning Amplifier Control on or off	60
Using the TV remote to control CEC-compatible devices	61
Using the TV menu to control CEC-compatible devices	61
Selecting the HDMI input mode	62
Viewing photos on a USB flash drive	62
Supported photo file formats	62
Opening the Media Player	63
Viewing photos	63
Viewing photos in a slideshow	64

Adjusting accessibility settings	64
Adjusting the picture	65
Adjusting the TV picture	65
Adjusting the picture size	67
Scrolling the TheaterWide™ picture	69
Automatically adjusting the aspect ratio	69
Using the 4:3 Stretch	70
Adjusting the sound	70
Adjusting sound settings	70
Playing TV audio only	71
Changing channel settings	72
Automatically scanning for channels	72
Manually adding channels to the channel list	72
Hiding channels	73
Setting parental controls	74
Setting a new PIN	74
Changing or deleting the PIN	75
Blocking TV programs and movies (for USA region)	75
Downloading rating information (for USA region)	76
Temporarily unlocking programs	77
Locking video inputs	78
Locking channels	78
Setting the GameTimer™	79
Using closed captioning	79
Turning closed captioning on or off	79
Selecting the analog closed captioning mode	80
Selecting the closed captioning mode with the CCD button	80
Customizing digital closed captioning settings	81
Adjusting time settings	82
Setting the time zone and Daylight Saving Time status	82
Setting the sleep timer	82
Adjusting menu settings	83
Selecting the menu language	83
Labeling a video input source	83
Turning the input sensor on or off	84
Maintaining	84
Cleaning the TV cabinet	84
Cleaning the TV screen	84
Troubleshooting	84
Viewing support information	84
Testing the TV speakers	85
Restoring settings to the defaults	85

Turning off the automatic power-off feature	86
Making your TV turn on faster	86
Chromecast built-in TV FAQ	87
Video and audio	88
Remote control	91
General	91
CEC-compatible devices	92
Specifications	94
50-inch (50L711U18/50L711M18)	94
55-inch (55L711U18/55L711M18)	95
Legal notices	96
One-year limited warranty - Toshiba Televisions	97
One-year limited warranty - Toshiba Televisions—Mexico	98

CHILD SAFETY

PROPER TELEVISION PLACEMENT MATTERS



THE CONSUMER ELECTRONICS INDUSTRY CARES

- Manufacturers, retailers and the rest of the consumer electronics industry are committed to making home entertainment safe and enjoyable.
- As you enjoy your television, please note that all televisions - new and old - must be supported on proper stands or installed according to the manufacturer's recommendations. Televisions that are inappropriately situated on dressers, bookcases, shelves, desks, speakers, chests, carts, etc., may fall over, resulting in injury.

TUNE IN TO SAFETY

- **ALWAYS** follow the manufacturer's recommendations for the safe installation of your television.
- **ALWAYS** read and follow all instructions for proper use of your television.
- **NEVER** allow children to climb on or play on the television or the furniture on which the television is placed.
- **NEVER** place the television on furniture that can easily be used as steps, such as a chest of drawers.
- **ALWAYS** install the television where it cannot be pushed, pulled over or knocked down.
- **ALWAYS** route cords and cables connected to the television so that they cannot be tripped over, pulled or grabbed.

WALL OR CEILING MOUNT YOUR TELEVISION

- **ALWAYS** contact your retailer about professional installation if you have any doubts about your ability to safely mount your television.
- **ALWAYS** use a mount that has been recommended by the television manufacturer and has a safety certification by an independent laboratory (such as UL, CSA, ETL).
- **ALWAYS** follow all instructions supplied by the television and mount manufacturers.
- **ALWAYS** make sure that the wall or ceiling where you are mounting the television is appropriate. Some mounts are not designed to be mounted to walls and ceilings with steel studs or cinder block construction. If you are unsure, contact a professional installer.
- Televisions can be heavy. A minimum of two people is required for a wall or ceiling mount installation.

MOVING AN OLDER TELEVISION TO A NEW PLACE IN YOUR HOME

- Many new television buyers move their older CRT televisions into a secondary room after the purchase of a flat-panel television. Special care should be made in the placement of older CRT televisions.
- **ALWAYS** place your older CRT television on furniture that is sturdy and appropriate for its size and weight.
- **NEVER** place your older CRT television on a dresser where children may be tempted to use the drawers to climb.
- **ALWAYS** make sure your older CRT television does not hang over the edge of your furniture.

Consumer
Technology
Association

Important Safety Instructions

CAUTION

RISK OF ELECTRIC SHOCK

DO NOT OPEN

CAUTION: TO REDUCE THE RISK OF ELECTRIC SHOCK, DO NOT REMOVE COVER (OR BACK). NO USER-SERVICEABLE PARTS INSIDE. REFER SERVICING TO QUALIFIED SERVICE PERSONNEL.



The lightning flash with arrowhead symbol within an equilateral triangle is intended to alert the user to the presence of uninsulated "hazardous voltage" within the product's enclosure, which may be of sufficient magnitude to induce a risk of electric shock to persons.



The exclamation point within an equilateral triangle is intended to alert the user to the presence of important operating and maintenance (servicing) instructions in the literature accompanying the appliance.

- 1 Read these instructions.
- 2 Keep these instructions.
- 3 Heed all warnings.
- 4 Follow all instructions.
- 5 Do not use this apparatus near water.
- 6 Clean only with dry cloth.
- 7 Do not block any ventilation openings. Install in accordance with the manufacturer's instructions.
- 8 Do not install near any heat sources such as radiators, heat registers, stoves, or other apparatus (including amplifiers) that produce heat.
- 9 Do not defeat the safety purpose of the polarized or grounding-type plug. A polarized plug has two blades with one wider than the other. A grounding type plug has two blades and a third grounding prong. The wide blade or the third prong are provided for your safety. If the provided plug does not fit into your outlet, consult an electrician for replacement of the obsolete outlet.
- 10 Protect the power cord from being walked on or pinched particularly at plugs, convenience receptacles, and the point where they exit from the apparatus.
- 11 Only use attachments/accessories specified by the manufacturer.

- 12 Use only with the cart, stand, tripod, bracket, or table specified by the manufacturer, or sold with the apparatus. When a cart is used, use caution when moving the cart/apparatus combination to avoid injury from tip-over.



- 13 Unplug this apparatus during lightning storms or when unused for long periods of time.
- 14 Refer all servicing to qualified service personnel. Servicing is required when the apparatus has been damaged in any way, such as power-supply cord or plug is damaged, liquid has been spilled or objects have fallen into the apparatus, the apparatus has been exposed to rain or moisture, does not operate normally, or has been dropped.
- 15 The *wall plug* is the disconnecting device. The plug must remain readily operable.
- 16 Remote control batteries should not be exposed to excessive heat such as sunshine, fire, or the like.
- 17 The apparatus should not be exposed to dripping or splashing, and no objects filled with liquids, such as vases, should be placed on the apparatus.
- 18 Your TV has four VESA mounting holes on the back. If you attach a wall-mount bracket or TV stand to the back of your TV, **the bracket or stand must be securely attached using all four holes.** If you do not use all four mounting holes, your TV may fall and cause property damage or personal injury. See the documentation that came with your wall mount or TV stand for complete mounting instructions.

WARNING

Electric shock hazard

To reduce the risk of fire or electric shock, do not remove any cover or expose the device to rain or moisture. No user-serviceable parts are inside. Refer servicing to qualified service technicians.

Lightning

For added protection for your device receiver during a lightning storm, or when it is left unattended and unused for long periods of time, unplug it from the power outlet and disconnect any antenna or cable system. This helps prevent property damage and personal injury from lightning and power line surges.

Power lines

An outside antenna system should not be located in the vicinity of overhead power lines or other electric light or power circuits, or where it can fall into such power lines or circuits. When installing an outside antenna system, take extreme care to keep from touching such power lines or circuits as contact with them might be fatal.

Handling the LCD panel

- Your TV's screen is made of glass. Do not drop your TV or hit, jolt, or press hard against the LCD panel. If the screen breaks, be careful of broken glass.
- If the LCD panel is broken, make absolutely sure that you do not touch the liquid in the panel. This may cause skin inflammation.
- If the liquid gets in your mouth, immediately gargle, rinse, and consult with your doctor. Also, if the liquid gets in your eyes or touches your skin, consult with your doctor after rinsing for at least 15 minutes or longer in clean water.

Replacement parts

When replacement parts are required, make sure that the service technician uses replacement parts specified by the manufacturer that have the same characteristics as the original part. Unauthorized substitutions may result in fire, electric shock, personal injury, or other hazards.

Safety check

After completing any service or repair to this device, ask the service technician to perform routine safety checks to determine that your TV is in correct operating condition.

Power source

Operate your TV only from the type of power source indicated on the marking label. If you are not sure of the type of power supplied to your home, consult an electrician or your local power company.

Servicing

These servicing instructions are for use by qualified service personnel only. To reduce the risk of electric shock, do not perform any servicing other than that contained in the operating instructions unless you are qualified to do so.

CAUTION**Damage requiring service**

Unplug this TV from the power outlet and refer servicing to qualified service personnel under the following conditions:

- When the power supply cord or plug is damaged or frayed.
- If liquid has been spilled or objects have fallen into your TV.
- If your TV has been exposed to rain or water.
- If your TV does not operate normally by following the operating instructions. Adjust only those controls covered by the operating instructions because incorrect adjustment of other controls may result in damage and will often require extensive work by a qualified technician to restore your TV to its normal operation.
- If your TV has been dropped or damaged in any way.
- When your TV exhibits a distinct change in performance.

Outdoor antenna grounding

If an outside antenna or cable system is connected to your TV, make sure that the antenna or cable system is grounded to provide some protection against voltage surges and built-up static charges. Article 810 of the National Electrical Code, ANSI/NFPA No. 70, provides information with respect to correct grounding of the mast and supporting structure, grounding of the lead-in wire to an antenna discharge unit, size of grounding conductors, location of the antenna-discharge unit, connection to grounding electrodes, and requirements for the grounding electrode.

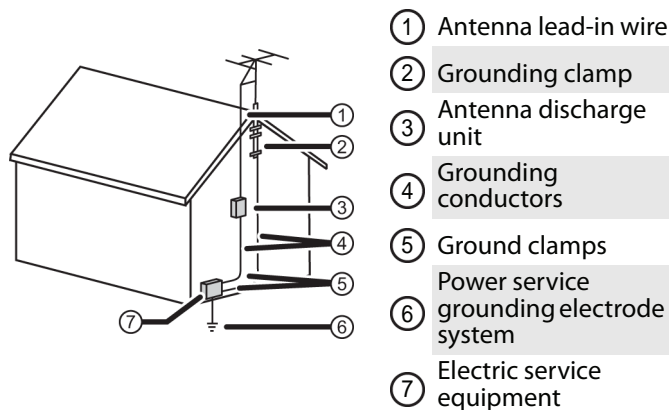

- ① Antenna lead-in wire
- ② Grounding clamp
- ③ Antenna discharge unit
- ④ Grounding conductors
- ⑤ Ground clamps
- ⑥ Power service grounding electrode system
- ⑦ Electric service equipment

Note to CATV system installer

Article 820 of the National Electrical Code, ANSI/NFPA No. 40 provides guidance for correct grounding. Specifically, it states that the cable ground must be connected to the grounding system of the building as close to the point of cable entry as practical.

Condensation

Moisture will form on the TV if the TV is brought from cool surroundings into a warm room or if the temperature of the room rises suddenly. When this happens, the TV's performance may be impaired. To prevent this, let the TV stand in its new surroundings for about an hour before switching it on, or make sure that the room temperature rises gradually.

Condensation may also form during the summer if the TV is exposed to the breeze from an air conditioner. In such cases, change the location of the TV.

Mobile telephone warning

To avoid interference with your TV picture and sound, operating problems, or even damage, keep your cordless and cellular telephones away from the TV.

End of life directives

Your TV may contain materials that are regulated for environmental reasons. Your TV also contains materials that can be recycled and reused. To help protect the environment, contact your local authorities for information about disposal or recycling and about finding a recycler in your area before you dispose of your TV.

Non-active pixels

The LCD panel contains almost 3 million thin film transistors, which provide exceptionally sharp video quality. Occasionally, a few non-active pixels may appear on the screen as a fixed blue, green, or red point. These non-active pixels do not adversely affect the performance of your TV, and are not considered defects.

50" / 55" 2160p (4K), 60Hz, LED Chromecast built-in TV

Introduction

Congratulations on your purchase of a high-quality Toshiba product. Your 50L711U18, 50L711M18, 55L711U18, or 55L711M18 represents the state of the art in LED TV design and is designed for reliable and trouble-free performance.

Google Chromecast™ built-in

UNLIMITED ENTERTAINMENT, ALL ON YOUR SCHEDULE

- With Google Chromecast™ built-in, you are in command. Access more than 200,000 TV shows and movies, millions of songs and more through apps like Netflix, YouTube, and Google Play. Discover new content, with more apps being added all the time at <https://g.co/castapps>.

USE YOUR PHONE AS A REMOTE

- By using your phone, there's nothing new to learn—cast your apps, your playlists, your TV shows—without new log-ins or downloads. It's simple to search, browse, queue, and control from anywhere in the home.

MULTI-TASK WITHOUT INTERRUPTING WHAT'S PLAYING

- While you are casting, you can keep using your phone for other things without disrupting what is playing on the TV.

HDMI® CEC Control

Enjoy the benefit of having HDMI CEC-compatible products plug and play! No setup is needed! CEC technology lets different devices discover and communicate with each other. (See page 58 for instructions on how to use HDMI® CEC Control.)

DTS Studio Sound®

DTS Studio Sound is an advanced surround sound solution suite that accurately extracts and places audio cues for an immersive surround experience over the TV's built-in speakers. To complete the audio experience, post processing and psychoacoustic techniques are implemented to provide 3D audio rendering to match 3D video content, for bass and dialog enhancement and to deliver consistent and level volume across content.

GameTimer™

Use the GameTimer™ to set a time limit for playing a video game (from 30 to 120 minutes). When the GameTimer expires, your TV locks out the input source for the video game device.

Audio accessibility

Your TV provides audio descriptions of menus and some remote control functions. Depending on the broadcaster, audio narration of key elements in programs may also be available. (See page 64 for instructions on how to turn on audio narration.)

Installing the stands or wall-mount bracket

- If you want to place your TV on a table or in an entertainment center, go to [Installing the stands \(50" model\)](#) or [Installing the stands \(55" model\)](#).
- If you want to mount your TV on a wall, go to [Installing a wall-mount bracket](#).

Notes

- If you plan to wall-mount your TV, do not install the stands.
- Store the stands and stand screws in case you decide to use the stands in the future.

Installing the stands (50" model)

- 1 Carefully place your TV face-down on a cushioned, clean surface to protect the screen from damages and scratches.

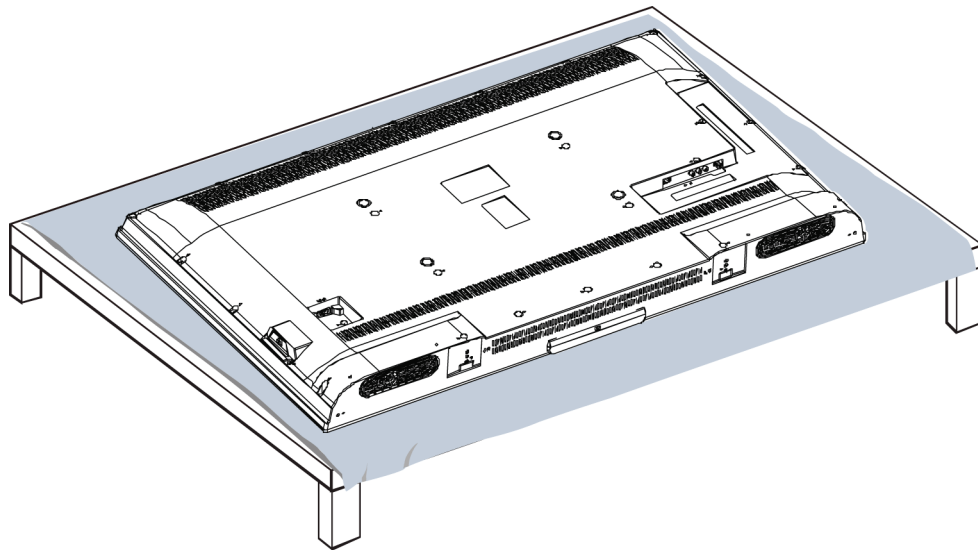

- 2 Secure the TV stands to the back of your TV with the provided screws.

Screw type	Screw length	# of screws
M5	17 mm	4

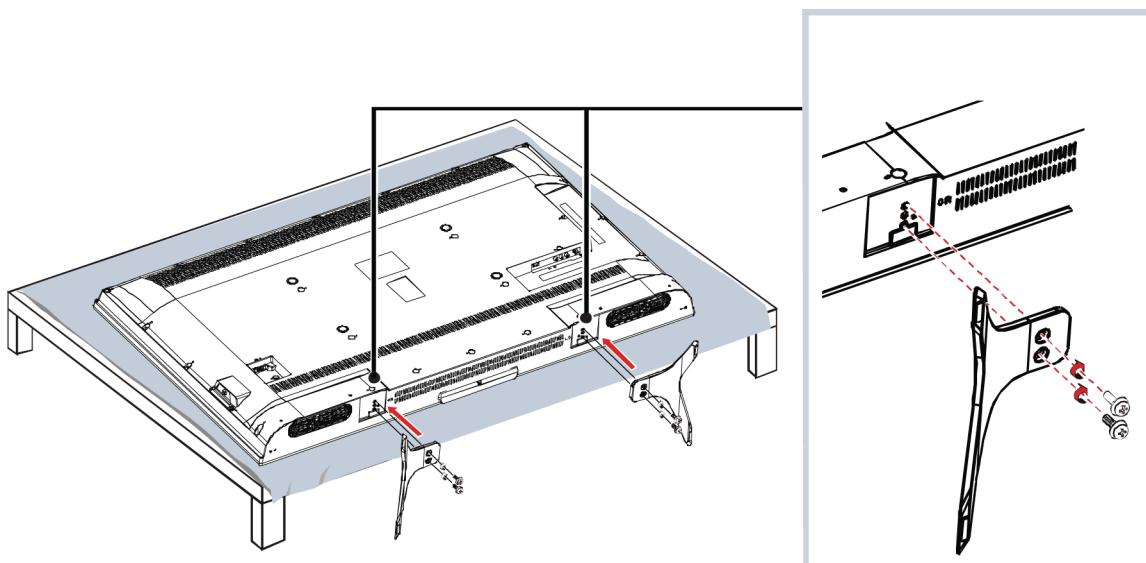

Installing the stands (55" model)

- 1 Carefully place your TV face-down on a cushioned, clean surface to protect the screen from damages and scratches.

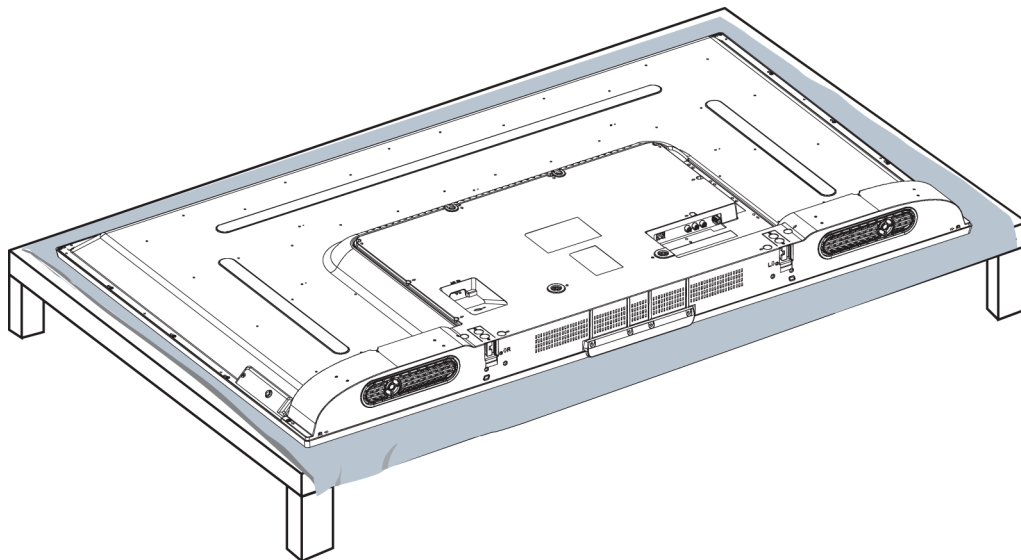

- 2 Attach a stand neck to each of the stand legs with two of the provided 12 mm screws (the long screws).

Screw type	Screw length	# of screws
M4	12 mm	4

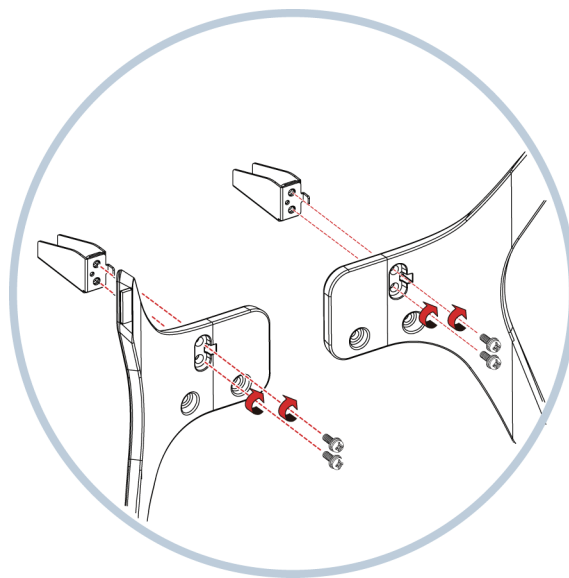

- 3** Slide the stand necks into the slots on the bottom of your TV. Secure each neck to the back of your TV using two of the provided 10 mm screws (the short screws) and to the bottom of your TV using two of the 12 mm screws (the long screws).

Screw type	Screw length	# of screws
M5	10 mm	4
M4	12 mm	4

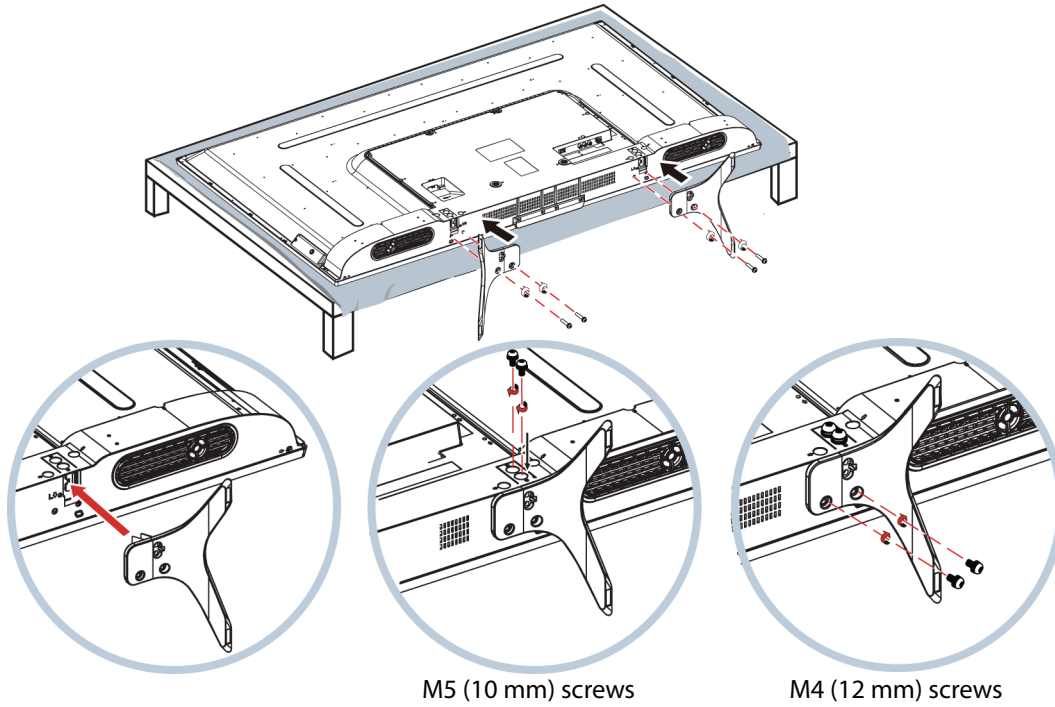

Installing a wall-mount bracket

Warning

- Your TV has four VESA mounting holes on the back. If you attach a wall-mount bracket to the back of your TV, **the bracket must be securely attached, using all four holes.** If you do not use all four mounting holes, your TV may fall and cause property damage or personal injury. See the documentation that came with your wall mount for complete mounting instructions.
- This TV is intended to be supported by a UL Listed wall mount bracket with suitable weight/load. (See [Miscellaneous](#) on page 94 or page 95.)

- 1 Carefully place your TV face-down on a cushioned, clean surface to protect the screen from damages and scratches.

50" model

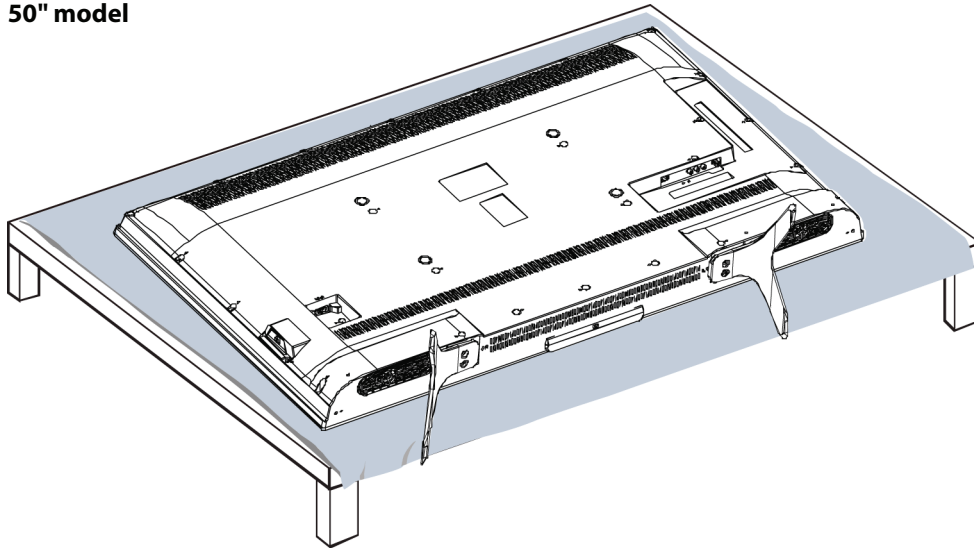

55" model

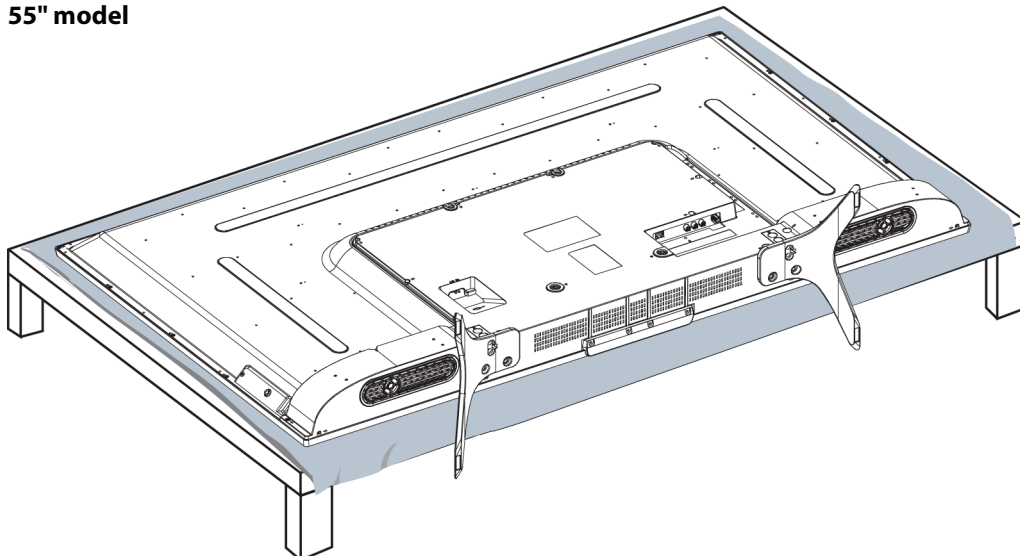

- 2 If the stands are installed, remove the screws that secure the stands to your TV, then remove the stands.

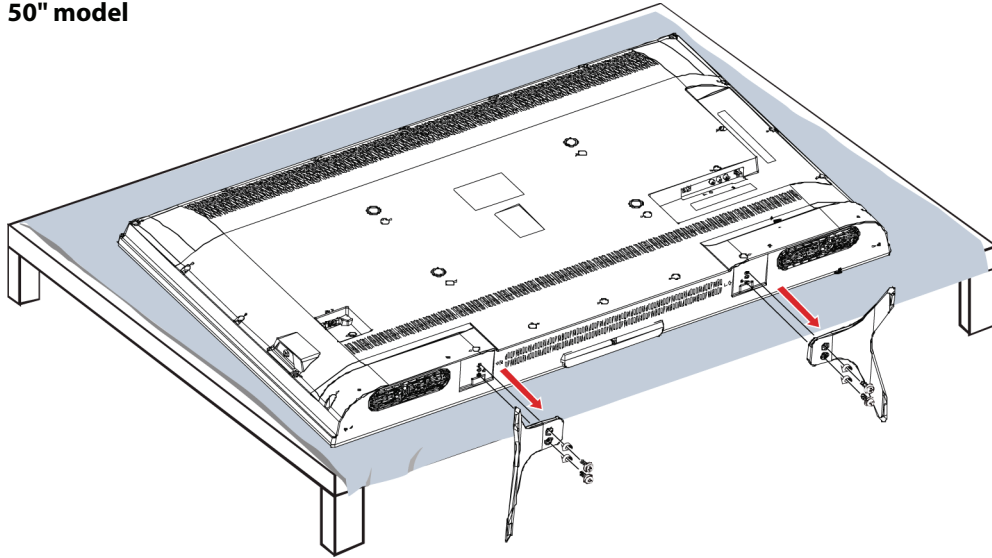
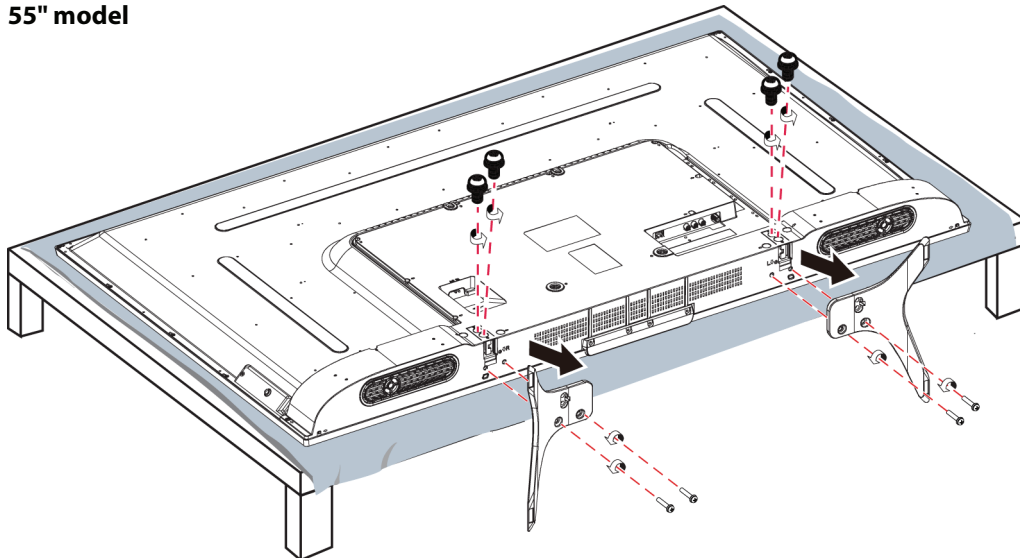
50" model**55" model**

- 3 See the instructions that came with the wall-mount bracket for information about which screws to use and how to correctly hang your TV.

Notes

- The length of the wall-mount screws vary depending on the wall-mount bracket you purchased. See the instructions that came with the wall-mount bracket for screw lengths.
- The mounting holes on the back of your TV take type M6 screws.

50" model

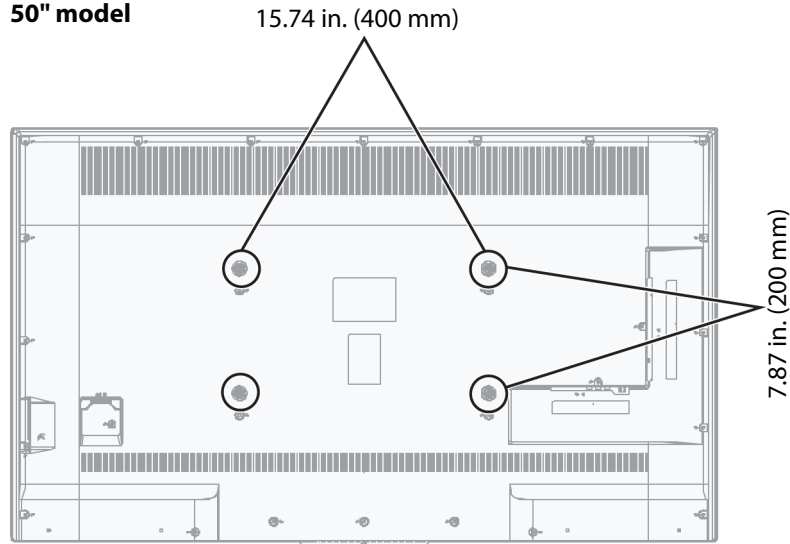

55" model

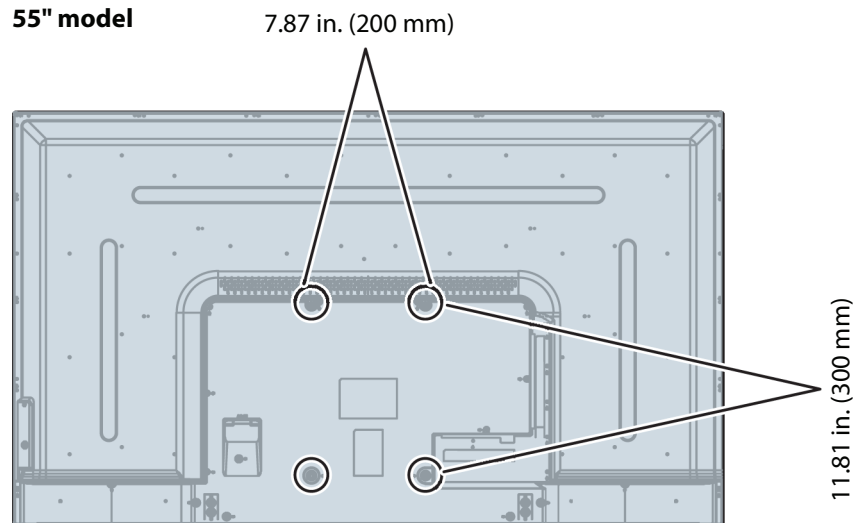

TV components

This section contains information about:

- Package contents
- Front
- Power/INPUT button
- Side jacks
- Back jacks
- Remote control
- Virtual Remote control

Package contents

- 50" or 55" LED Chromecast™ built-in TV
- Remote control and batteries (2 AAA)
- TV stands (2)
- TV stand necks (55" model) (2)
- Stand screws
 - 50" model—M5 (17 mm length) (4)
 - 55" model—
 - M4 (12 mm length) (8)
 - M5 (10 mm length) (4)
- Power cord
- *Quick Setup Guide*
- *Important Information*

Front

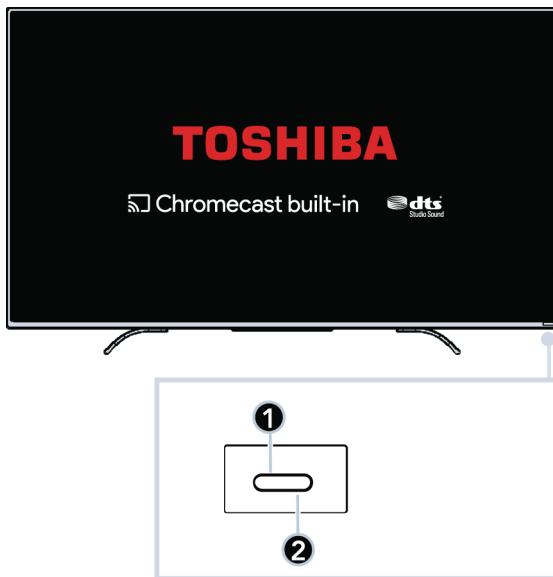

#	Item	Description
1	Remote control sensor	Receives signals from the remote control. Do not block.
2	Power indicator	Turns off when your TV is on. Lights red when your TV is off (standby mode).

Power/INPUT button

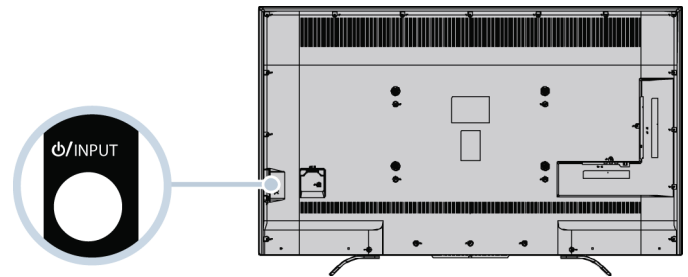

Item	Description
<p>⏻/INPUT</p>	<p>⏻—Press to turn on your TV when your TV is off (in standby mode). Press and hold to turn off your TV when your TV is on.</p> <p>Warning: When your TV is off, power still flows through it. To completely disconnect power, unplug the power cord.</p> <p>INPUT—When your TV is on, quickly press and release to open the <i>Input Selection</i> list, press one or more times to select a video input source, then wait a few seconds. Your TV switches to the source you selected. For more information, see Selecting the video input source on page 55.</p>

Side jacks

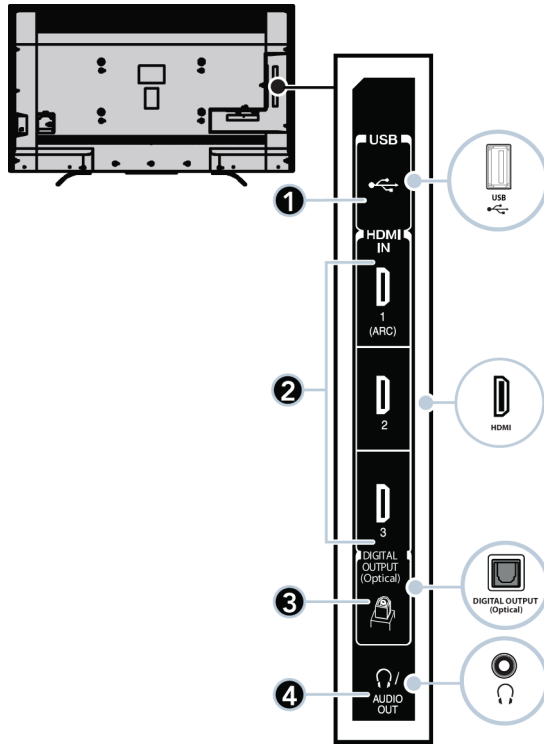

#	Item	Description
1	USB	Connect a USB flash drive to this jack to view compatible JPEG picture files. For more information, see Connecting a USB flash drive on page 36 and Viewing photos on a USB flash drive on page 62.
2	HDMI IN 1 (ARC)/ HDMI IN 2/ HDMI IN 3	Connect HDMI or DVI devices to these jacks. For more information, see HDMI (best) on page 24, 29, 31, or 34 or DVI (same as HDMI but requires an audio connection) on page 25 or 35. OR Connect an ARC-enabled home theater receiver to the HDMI IN 1 (ARC) jack.
3	DIGITAL OUTPUT (Optical)	Connect a soundbar, digital speaker system, or home theater system to this jack to listen to TV audio through external speakers. For more information, see Connecting external speakers or a soundbar on page 38.
4	🎧 / AUDIO OUT	Connect headphones to this jack. See Connecting headphones on page 37. OR Connect an analog soundbar, speaker system, or home theater system to this jack to listen to TV audio through external speakers. For more information, see Analog audio on page 39.

Back jacks

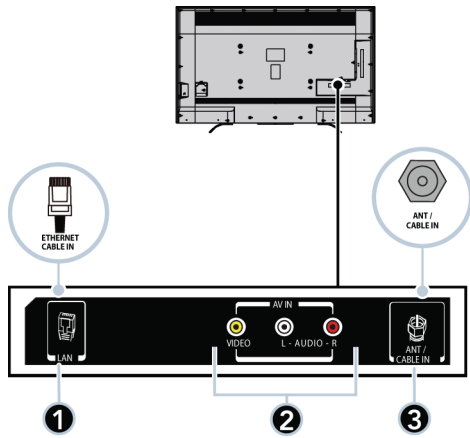

#	Item	Description
1	LAN	Connect a network router to this jack to use a wired network connection to access Chromecast built-in. For more information, see Connecting a network router on page 33.
2	VIDEO and AUDIO L and R	Connect the video and audio for an AV device to these jacks. For more information, see AV (good) on page 26, 30, or 32.
3	ANT / CABLE IN	Connect an antenna or cable TV to this jack. For more information, see Coaxial (good) on page 27 or Connecting an antenna or cable TV (no box) on page 28.

Remote control

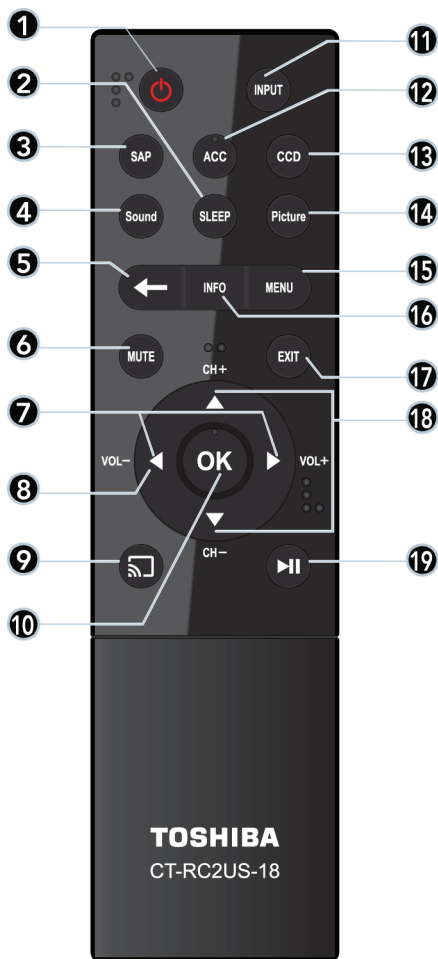

#	Button	Press to...
1	(power)	Turn your TV on or off (standby mode). When your TV is off, the power indicator lights red. Warning: When your TV is off, power still flows through it. To disconnect power, unplug the power cord.
2	SLEEP	Set the sleep timer. You can select Off, 5 min, 10 min, 15 min, 30 min, 60 min, 90 min, 120 min, 150 min, 180 min, or 240 min. See Setting the sleep timer on page 82.
3	SAP	To listen to a secondary audio program, if available.
4	Sound	Select the sound mode. You can select Standard, Music, Movie, Clear Voice, or Enhanced Bass. See the Sound Mode option in Adjusting sound settings on page 70.
5	← (back)	Return to the previous level or channel.
6	MUTE	Mute the sound or un-mute the sound. See Adjusting the volume on page 57.
7	VOL+ / VOL-	Adjust the volume.
8		TV menu: Navigate in on-screen menus. USB: Rotate a photo in a slideshow (▲ or ▼) or go to the previous or next photo in a slideshow (◀ or ▶).
9		Switch to Chromecast built-in.
10	OK	Confirm selections or changes in TV menus.
11	INPUT	Open the <i>Input Selection</i> list. Press INPUT one or more times or press ▲ or ▼ to select the video input source, then press OK. See Selecting the video input source on page 55.
12	ACC	Open the <i>Accessibility</i> menu. See Adjusting accessibility settings on page 64.
13	CCD	Turn closed captioning on or off. Select the language (like English) to turn on closed captioning or Off to turn off closed captioning. See Turning closed captioning on or off on page 79.
14	Picture	Select the picture mode. You can select Dynamic, Standard, Natural, Movie, Game, or PC. See the Picture Mode option in Adjusting the TV picture on page 65.
15	MENU	Open the on-screen menu.
16	INFO	Display TV status information, such as the channel number, channel name (if available), or signal source. See Viewing channel information on page 58.
17	EXIT	Close the on-screen TV menu.
18	CH+ / CH-	Change to the next higher or lower channel in the channel list.
19	(play/pause)	Start or stop playback.

Virtual Remote control

To download the *Toshiba Cast TV Remote* app on your mobile phone or tablet, search for the app in your device's app store and install it.



Toshiba TV Remote icon on Android device.



Toshiba TV Remote icon on iOS device.

The buttons on the Toshiba TV remote function the same as the corresponding buttons on the remote control that came with your TV. For more information, see [Remote control](#) on page 20.

Note

When performing tasks, you can use either your physical remote control or the virtual remote control.

Main page

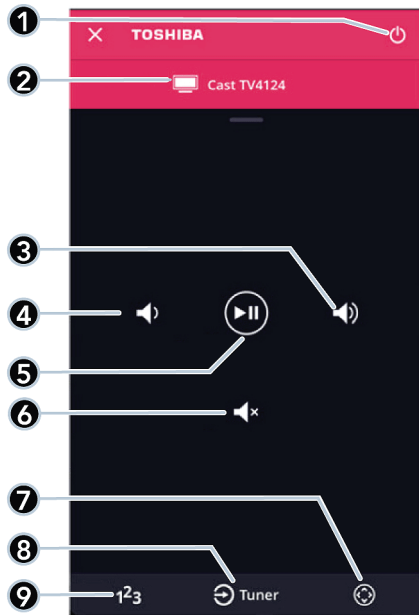

#	Item	Description
1	Power	Tap to turn your TV on or off (standby mode). When your TV is off, the power indicator lights red. Warning: When your TV is off, power still flows through it. To disconnect power, unplug the power cord.
2	TV name	Displays your TV's name and icon.
3	Volume up	Tap to increase the volume one step. Touch and hold to continuously increase the volume.
4	Volume down	Tap to decrease the volume one step. Touch and hold to continuously decrease the volume.

#	Item	Description
5	Play/Pause	Tap to pause casting video. Tap again to resume playback.
6	Mute	Tap to mute the sound or un-mute the sound.
7	Direction key	Tap to go to the <i>Direction key</i> page. See Direction key page on page 22.
8	Input source	Tap to switch to the video input source to the TV tuner and go to the <i>Channel and Long Press</i> page.
9	Number	Tap to go to the <i>Number</i> page and enter channel numbers. See Number page on page 22.

Channel and Long Press page

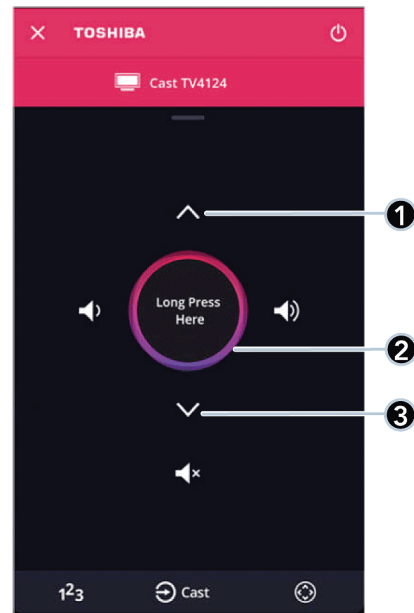

#	Item	Description
1	Channel up	Tap to go to the next channel in the channel list.
2	Long Press	Touch and hold this button, then tilt your mobile device to change a value continuously. For example, to decrease the volume, press and hold this button then tilt your mobile device to the left (volume down button). Or to change channels, press and hold this button, then tilt your mobile device toward your TV.
3	Channel down	Tap to go to the previous channel in the channel list.

Number page

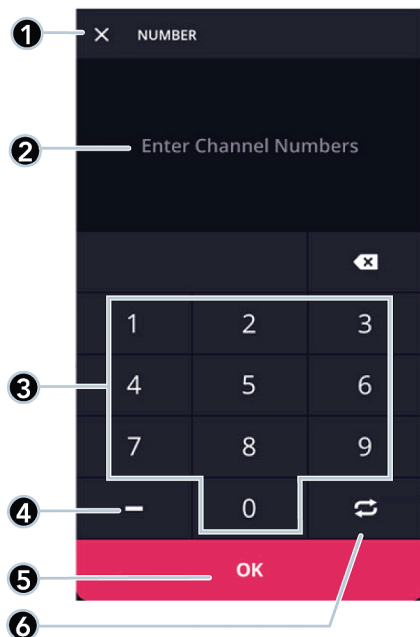

Direction key page

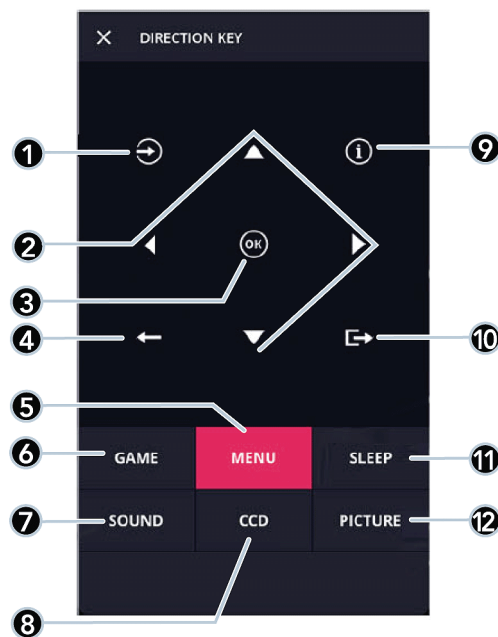



#	Item	Description
1	Close	Tap to close this page and return to the <i>Main</i> page.
2	Channel number	Displays the channel or sub-channel numbers (up to three numbers) you enter with the number buttons.
3	Number pad	Tap numbers to enter channel numbers.
4	Dash	Tap to enter a sub-channel number.
5	OK	Tap to confirm the channel number you entered and go to that channel.
6	Return	Tap to return to the previous channel.

#	Item	Description
1	Input source	Tap to open the <i>Input Selection</i> list. Press this button one or more times or press ▲ or ▼ to select the video input source, then press OK .
2	Arrows	Use these buttons to browse through on-screen menus.
3	OK	Tap to confirm selections or changes in TV menus.
4	Back	Tap to go to the previous channel or go back to the previous step.
5	Menu	Tap to open on-screen menus.
6	Game	Tap to turn Game mode on or off.
7	SOUND	Tap to select the sound mode. You can select Standard , Music , Movie , Clear Voice , or Enhanced Bass . See the Sound Mode option in Adjusting sound settings on page 70.
8	CCD	Tap to turn closed captioning on or off.
9	Info	Tap to display information on your TV about the currently selected channel.
10	Exit	Tap to exit the on-screen menus.
11	Sleep	Tap to set the sleep timer.
12	Picture mode	Tap to select the picture mode. You can select Dynamic , Standard , Natural , Movie , Game , or PC . See the Picture Mode option in Adjusting the TV picture on page 65.

What connection should I use?

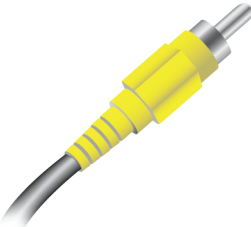
Your TV has several connection types for connecting devices to your TV. For the best video quality, you should connect a device to the best available connection. Use the following tables to identify cables:

Video quality	Connection type and jack	Cable connector
Best (use this if your devices have HDMI)	HDMI video/audio	
Good	AV (requires an audio connection)	
Good	Coaxial video/audio	

Connection type and jack

Optical digital audio output



Analog audio input

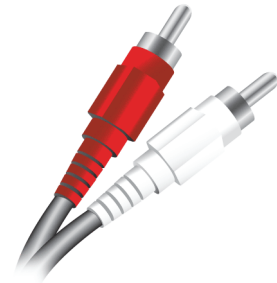

3.5mm analog audio output



You can use an **HDMI IN** jack on your TV to connect a DVI device to your TV. For more information, see [DVI](#) (same as HDMI but requires an audio connection) on page 25 or 35.

Cautions

- Check the jacks for position and type before making any connections.
- Loose connections can cause poor audio or video quality. Make sure that all connections are tight and secure.
- The external audio/video equipment shown may be different from your equipment. If you have questions, refer to the documentation that came with your equipment.
- Always unplug the power cord when connecting external equipment.

Connecting a cable or satellite box

Many cable or satellite TV boxes have more than one connection type. To get the best video, you should use the best connection type available. For more information, see [What connection should I use?](#) on page 23.

You can connect a cable or satellite box using:

- HDMI (best)
- DVI (same as HDMI but requires an audio connection)
- AV (good)
- Coaxial (good)

HDMI (best)

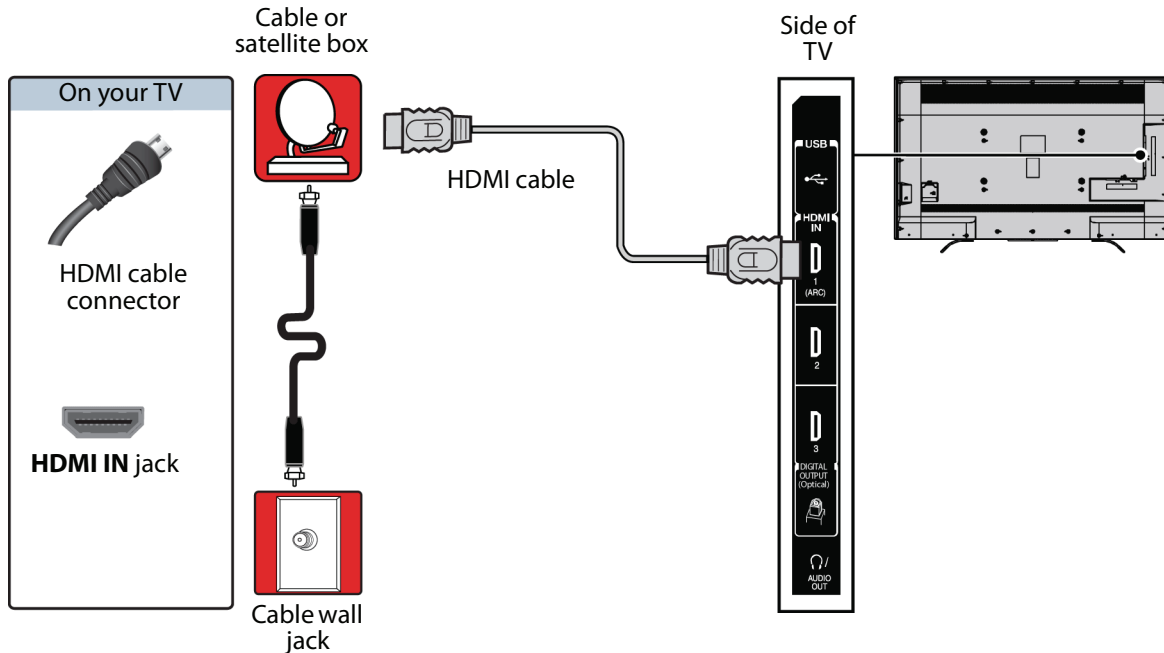

- 1 Make sure that your TV's power cord is unplugged and all connected equipment is turned off.
- 2 Connect the incoming cable from the cable wall jack to the cable-in jack on the cable or satellite box.
- 3 Connect an HDMI cable (not provided) to one of the **HDMI IN** jacks on the side of your TV and to the **HDMI OUT** jack on the cable or satellite box.
- 4 Plug your TV's power cord into a power outlet, turn on your TV, then turn on the cable or satellite box.
- 5 Press **INPUT** to open the *Input Selection* list.
- 6 Press **▲** or **▼** to highlight **HDMI1**, **HDMI2**, or **HDMI3**, then press **OK**.

Note

An HDMI cable carries both audio and video. You do not need to use any audio cables.

DVI (same as HDMI but requires an audio connection)

Note
Your TV supports DVI video only. To add sound for a DVI connection, connect external speakers or a soundbar to the cable or satellite box.

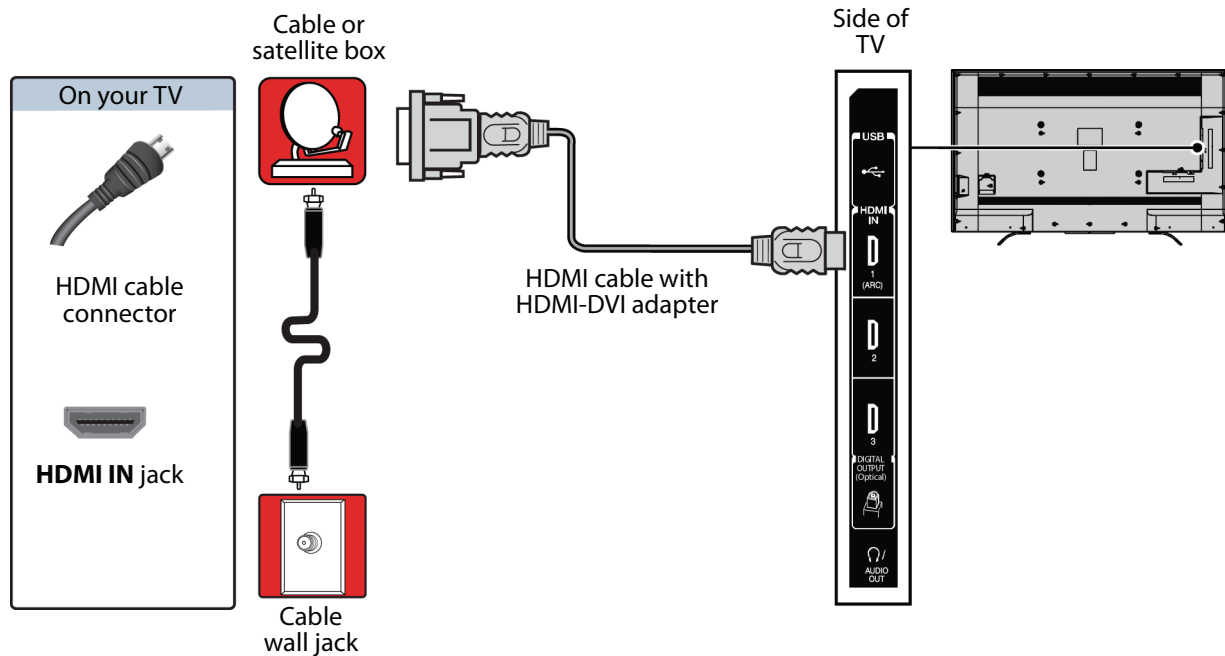

- 1 Make sure that your TV's power cord is unplugged and all connected equipment is turned off.
- 2 Connect the incoming cable from the cable wall jack to the cable-in jack on the cable or satellite box.
- 3 Connect an HDMI-DVI adapter (not provided) to one end of an HDMI cable (not provided), then connect the adapter to the **DVI OUT** jack on the cable or satellite box.
- 4 Connect the other end of the cable to one of the **HDMI IN** jacks on the side of your TV.
- 5 Plug your TV's power cord into a power outlet, turn on your TV, then turn on the cable or satellite box.
- 6 Press **INPUT** to open the *Input Selection* list.
- 7 Press **▲** or **▼** to highlight **HDMI1**, **HDMI2**, or **HDMI3**, then press **OK**.

AV (good)

Notes

Cables are often color-coded to match color-coded jacks.

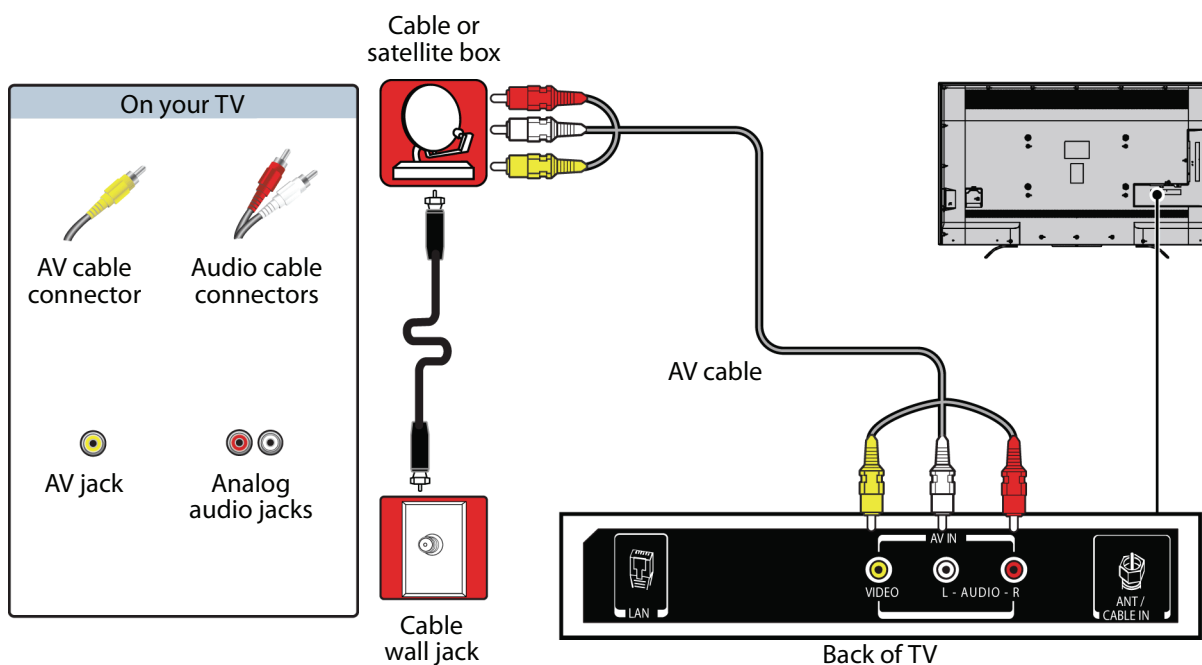

- 1 Make sure that your TV's power cord is unplugged and all connected equipment is turned off.
- 2 Connect the incoming cable from the cable wall jack to the cable-in jack on the cable or satellite box.
- 3 Connect an AV cable (not provided) to the **VIDEO** jack and **AUDIO L** and **R** jacks on the back of your TV and to the AV and audio out jacks on the cable or satellite box.

Important

When you connect the audio using the **AUDIO L** and **R** jacks, the audio output is analog.

- 4 Plug your TV's power cord into a power outlet, turn on your TV, then turn on the cable or satellite box.
- 5 Press **INPUT** to open the *Input Selection* list.
- 6 Press **▲** or **▼** to highlight **AV**, then press **OK**.

Coaxial (good)

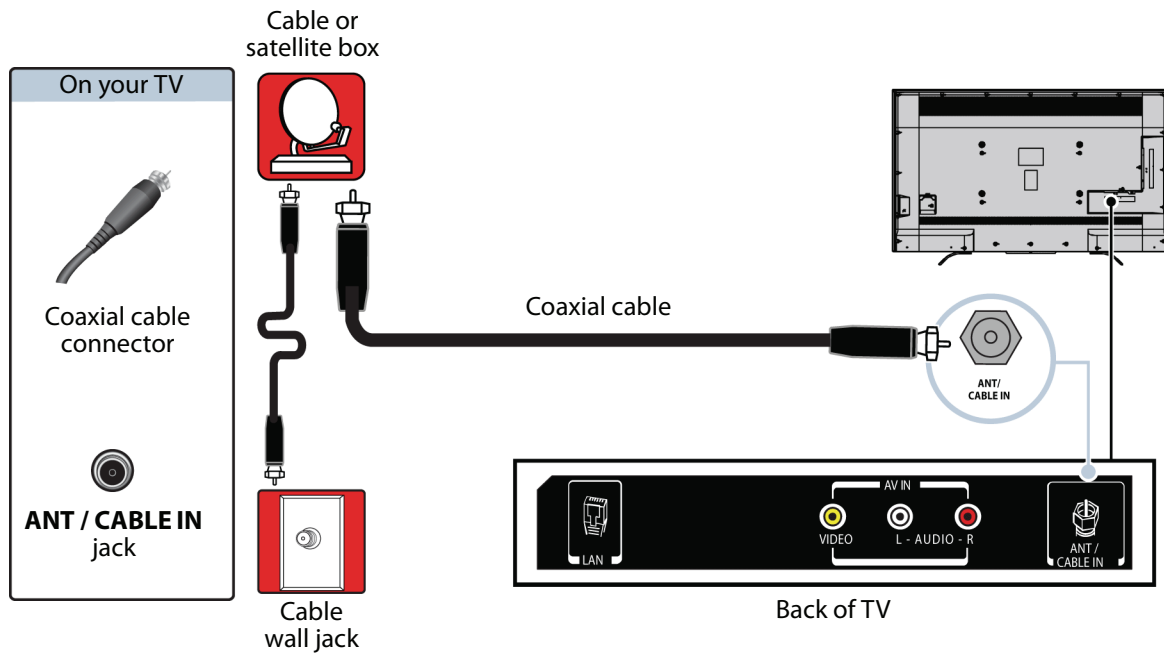

- 1 Make sure that your TV's power cord is unplugged and all connected equipment is turned off.
- 2 Connect the incoming cable from the cable wall jack to the cable-in jack on the cable or satellite box.
- 3 Connect a coaxial cable (not provided) to the **ANT / CABLE IN** jack on the back of your TV and to the coaxial out jack on the cable or satellite box.
- 4 Plug your TV's power cord into a power outlet, turn on your TV, then turn on the cable or satellite box.
- 5 Press **INPUT** to open the *Input Selection* list.
- 6 Press **▲** or **▼** to highlight **ANT/CABLE**, then press **OK**.
- 7 If you cannot tune to channels you know exist, scan for channels. See [Automatically scanning for channels](#) on page 72.

Notes

- Use a coaxial cable to eliminate interference and noise from radio waves.
- Do not bundle the coaxial cable with the power cord or other cables.

Connecting an antenna or cable TV (no box)

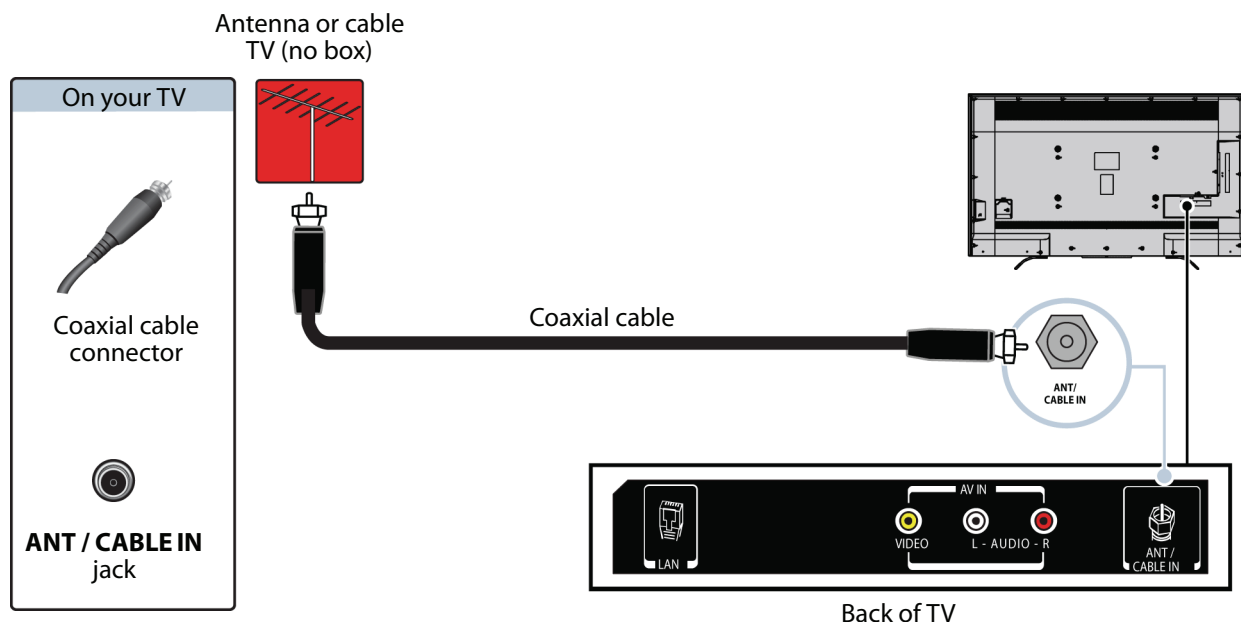

- 1 Make sure that your TV's power cord is unplugged and all connected equipment is turned off.
- 2 Connect a coaxial cable (not provided) to the **ANT / CABLE IN** jack on the back of your TV and to the antenna or cable TV wall jack.
- 3 Plug your TV's power cord into a power outlet, then turn on your TV.
- 4 Press **INPUT** to open the *Input Selection* list.
- 5 Press **▲** or **▼** to highlight **ANT/CABLE**, then press **OK**.
- 6 If you cannot tune to channels you know exist, scan for channels. See [Automatically scanning for channels](#) on page 72.

Notes

- Use a coaxial cable to eliminate interference and noise from radio waves.
- Do not bundle the coaxial cable with the power cord or other cables.
- If the antenna is not installed correctly, contact qualified service personnel to correct the problem.
- If the signal level for a channel is weak, the picture may be distorted. Adjust the antenna or use a highly directional outdoor or set-top antenna with a built-in amplifier.
- If the picture quality is good on some channels and poor on others, the problem may be caused by a poor or weak signal from the broadcaster or cable TV provider.
- If you connect to cable TV without a set-top box and experience poor picture quality, you may need to install a set-top box to improve signal reception and picture quality. Contact your cable TV provider about upgrading to a set-top box.
- Many high-definition (HD) channels upscale standard-definition (SD) content. The picture displayed on your TV is still displayed as SD, thus the picture quality will not be as clear or crisp as it would be if the content was originally recorded in HD.

Connecting a DVD or Blu-ray player

Many DVD or Blu-ray players have more than one connection type. To get the best video, you should use the best connection type available. For more information, see [What connection should I use?](#) on page 23.

You can connect a DVD or Blu-ray player using:

- HDMI (best)
- AV (good)

HDMI (best)

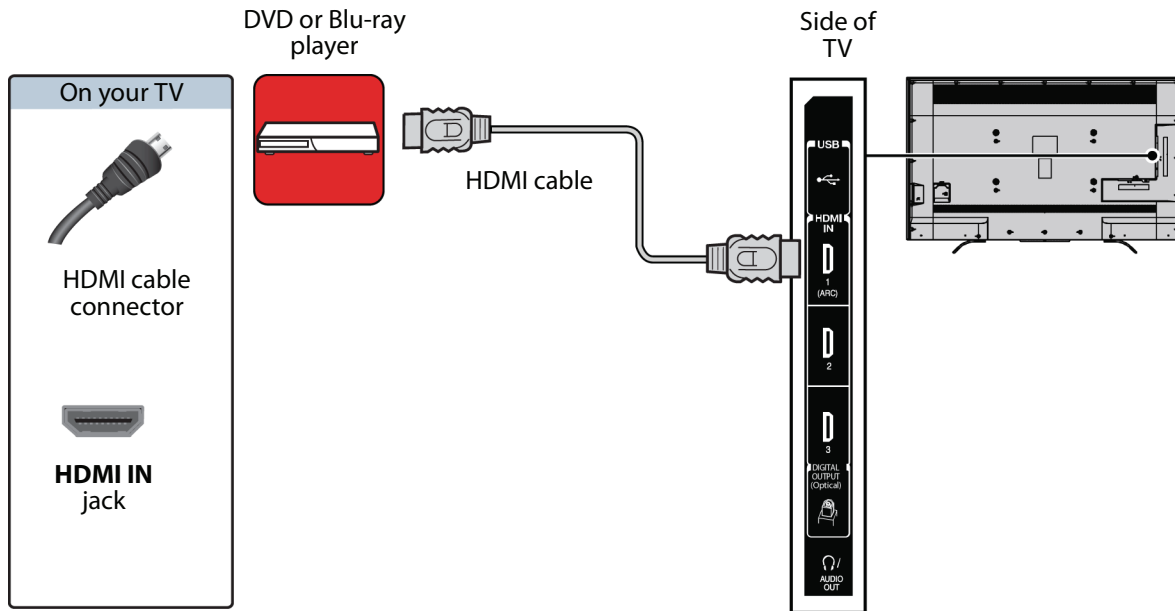

- 1 Make sure that your TV's power cord is unplugged and the DVD or Blu-ray player is turned off.
- 2 Connect an HDMI cable (not provided) to one of the **HDMI IN** jacks on the side of your TV and to the **HDMI OUT** jack on the DVD or Blu-ray player.
- 3 Plug your TV's power cord into a power outlet, then turn on your TV and DVD or Blu-ray player.
- 4 Press **INPUT** to open the *Input Selection* list.
- 5 Press **▲** or **▼** to highlight **HDMI1**, **HDMI2**, or **HDMI3**, then press **OK**.

Note

An HDMI cable carries both audio and video. You do not need to use any audio cables.

AV (good)

Note

Cables are often color-coded to match color-coded jacks.

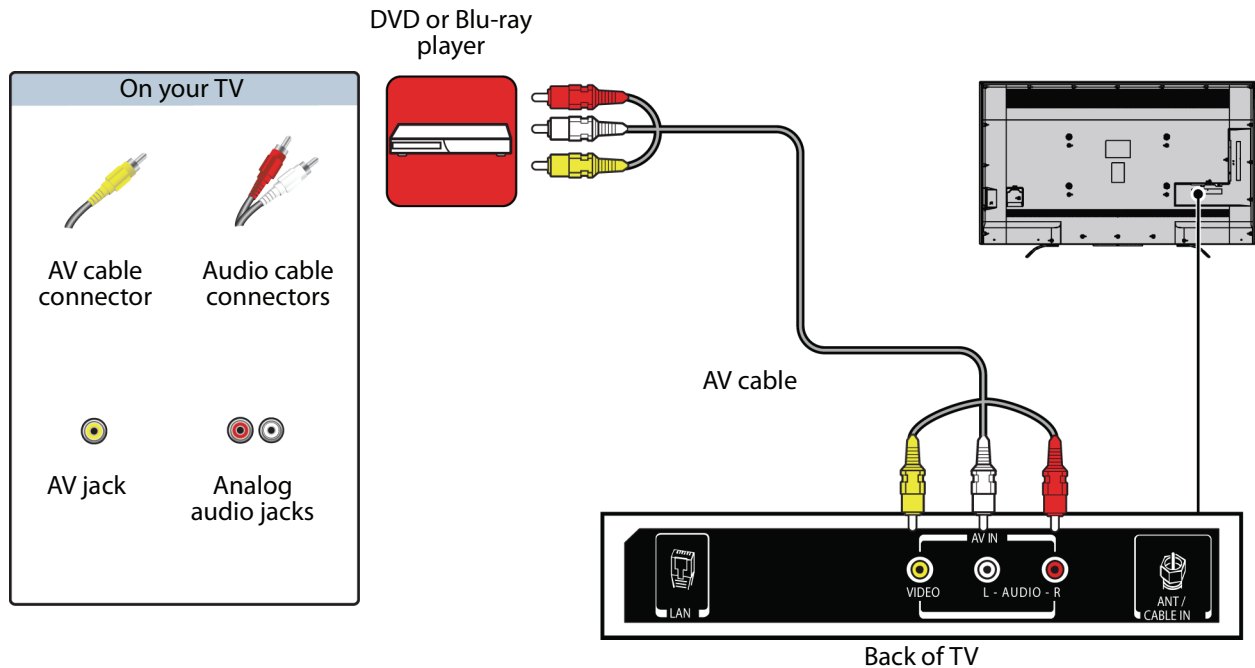

- 1 Make sure that your TV's power cord is unplugged and the DVD or Blu-ray player is turned off.
- 2 Connect an AV cable (not provided) to the **VIDEO** jack and **AUDIO L** and **R** jacks on the back of your TV and to the **AV OUT** jacks on the DVD or Blu-ray player.

Important

When you connect the audio using the **AUDIO L** and **R** jacks, the audio output is analog.

- 3 Plug your TV's power cord into a power outlet, then turn on your TV and DVD or Blu-ray player.
- 4 Press **INPUT** to open the *Input Selection* list.
- 5 Press **▲** or **▼** to highlight **AV**, then press **OK**.

Connecting a game console

You can connect a game console using:

- HDMI (best)
- AV (good)

HDMI (best)

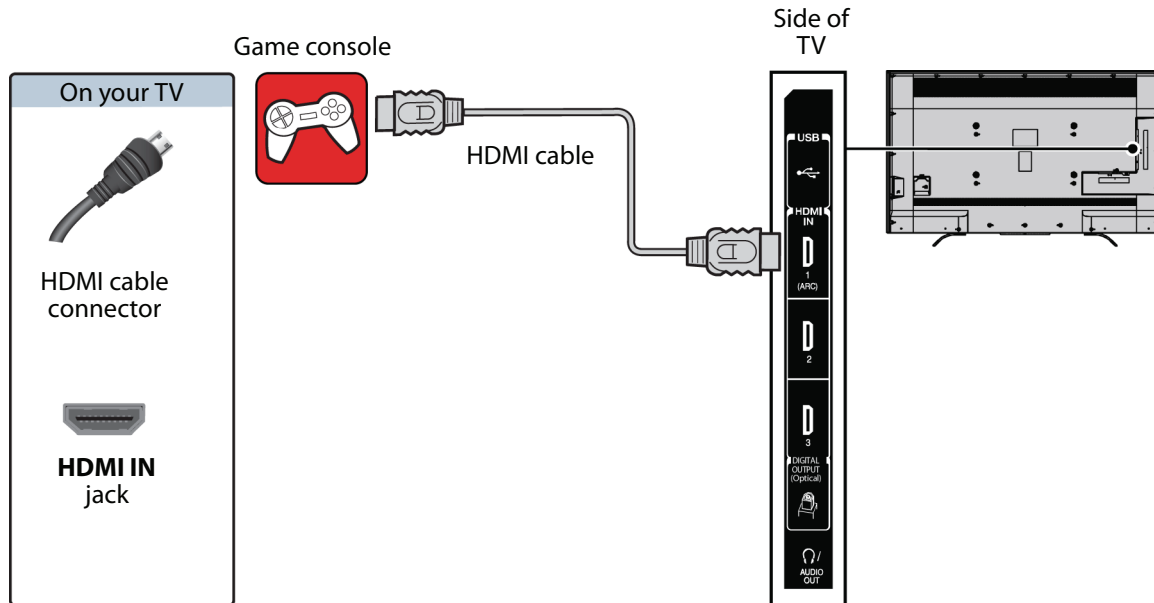

- 1 Make sure that your TV's power cord is unplugged and the game console is turned off.
- 2 Connect an HDMI cable (not provided) to one of the **HDMI IN** jacks on the side of your TV and to the **HDMI OUT** jack on the game console.
- 3 Plug your TV's power cord into a power outlet, then turn on your TV.
- 4 Turn on the game console, then set it to the correct output mode. For more information, see the documentation that came with the console.
- 5 Press **INPUT** to open the *Input Selection* list.
- 6 Press **▲** or **▼** to highlight **HDMI1**, **HDMI2**, or **HDMI3**, then press **OK**.

Note
An HDMI cable carries both audio and video. You do not need to use any audio cables.

AV (good)

Note

Cables are often color-coded to match color-coded jacks.

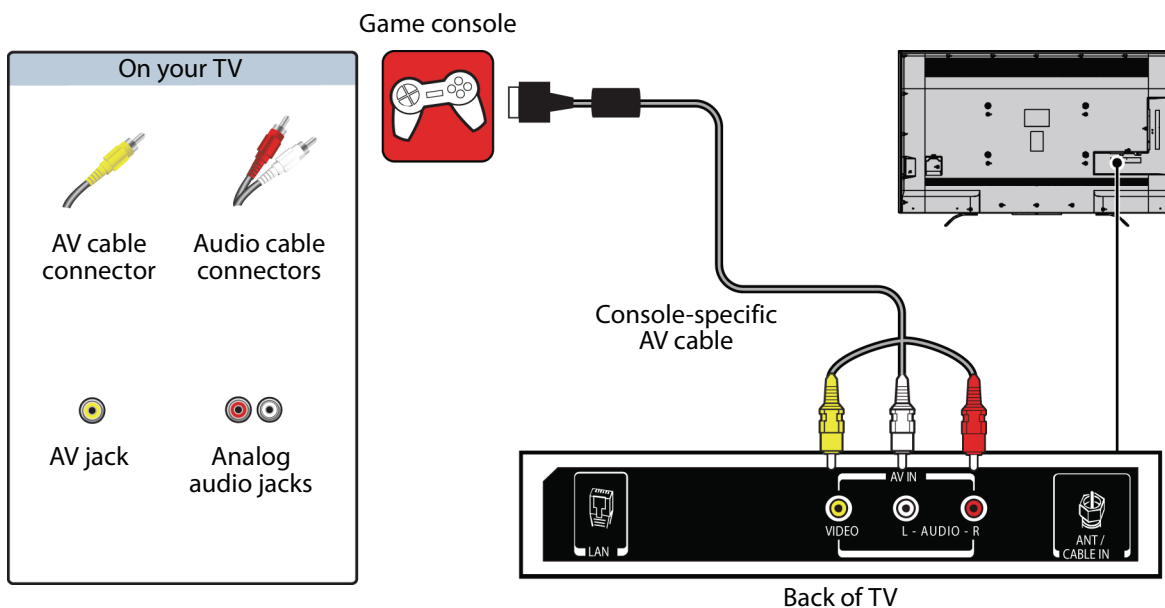

- 1 Make sure that your TV's power cord is unplugged and the game console is turned off.
- 2 Connect the video and audio connectors on the game console's AV cable (not provided) to the **VIDEO** jack and **AUDIO L** and **R** jacks on the back of your TV and to the composite jack(s) on the game console.

Important

- Some older game consoles come with a special AV cable. See the documentation that came with your game console or check the manufacturer's website.
- When you connect the audio using the **AUDIO L** and **R** jacks, the audio output is analog.

- 3 Plug your TV's power cord into a power outlet, then turn on your TV.
- 4 Turn on the game console, then set it to the correct output mode. For more information, see the documentation that came with the console.
- 5 Press **INPUT** to open the *Input Selection* list.
- 6 Press **▲** or **▼** to highlight **AV**, then press **OK**.

Connecting a network router

You can connect your TV to a network router using an Ethernet cable and the **LAN** jack on the back of your TV.

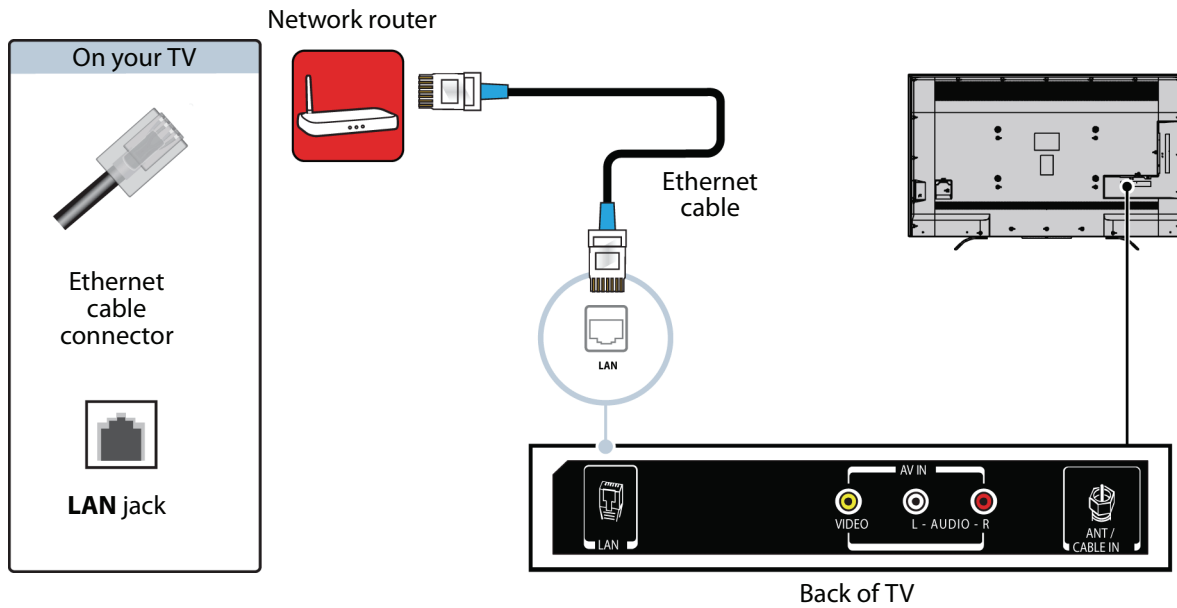

- 1 Make sure that your TV's power cord is unplugged and the router is turned off.
- 2 Connect an Ethernet cable (not provided) to the **LAN** jack on the back of your TV and to an Ethernet jack on the router.
- 3 Plug your TV's power cord into a power outlet, then turn on your TV and the router.

Connecting a computer

You can connect a computer using:

- HDMI (best)
- DVI (same as HDMI but requires an audio connection)

HDMI (best)

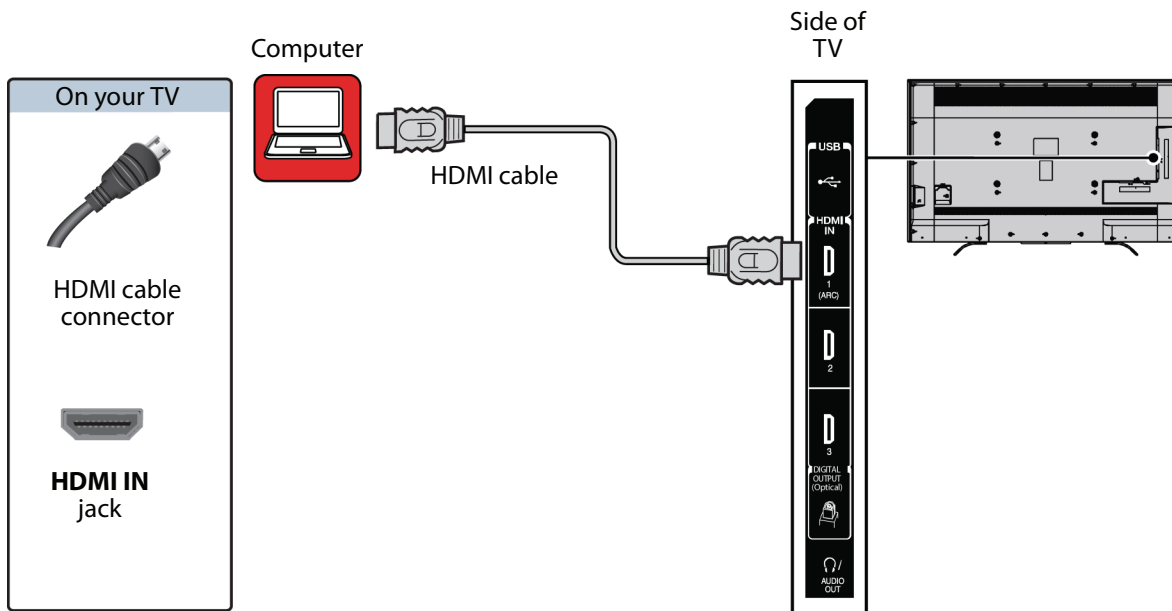

- 1 Make sure that your TV's power cord is unplugged and the computer is turned off.
- 2 Connect an HDMI cable (not provided) to one of the **HDMI IN** jacks on the side of your TV and to the **HDMI OUT** jack on the computer.
- 3 Plug your TV's power cord into a power outlet, then turn on your TV and the computer.
- 4 Press **INPUT** to open the *Input Selection* list.
- 5 Press **▲** or **▼** to highlight **HDMI1**, **HDMI2**, or **HDMI3**, then press **OK**.
- 6 Adjust the display properties on the computer, if necessary.

Note

Set the picture mode to **PC** to optimize the computer image. See the **PC** picture mode option in [Adjusting the TV picture](#) on page 65.

DVI (same as HDMI but requires an audio connection)

Notes
 Your TV supports DVI video only. To add sound for a DVI connection, connect external speakers or a soundbar to the computer.

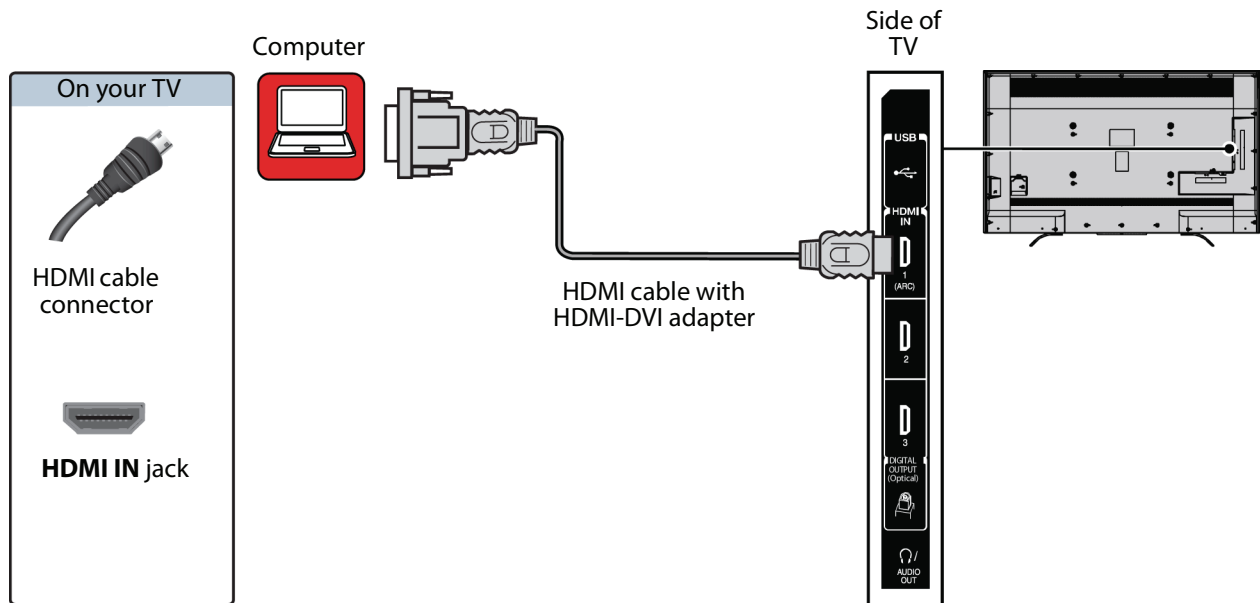

- 1 Make sure that your TV's power cord is unplugged and the computer is turned off.
- 2 Connect an HDMI-DVI adapter (not provided) to one end of an HDMI cable (not provided), then connect the adapter to the **DVI OUT** jack on the computer.
- 3 Connect the other end of the cable to one of the **HDMI IN** jacks on the side of your TV.
- 4 Plug your TV's power cord into a power outlet, then turn on your TV and the computer.
- 5 Press **INPUT** to open the *Input Selection* list.
- 6 Press **▲** or **▼** to highlight **HDMI1**, **HDMI2**, or **HDMI3**, then press **OK**.
- 7 Adjust the display properties on the computer, if necessary.

Note
 Set the picture mode to **PC** to optimize the computer image. See the **PC** picture mode option in [Adjusting the TV picture](#) on page 65.

Connecting a USB flash drive

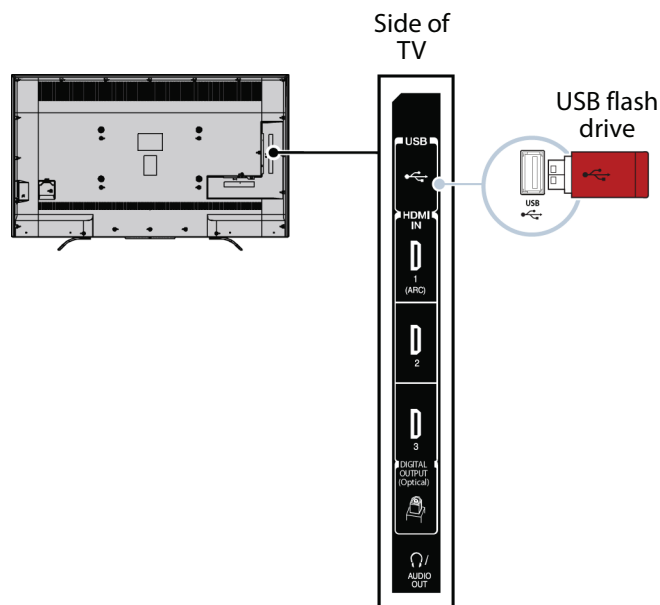

- 1 Plug a USB flash drive into the **USB** port on the side of your TV.

Caution

Do not remove the USB flash drive or turn off the TV while using the USB flash drive. You may lose data or damage the USB flash drive.

- 2 Press **INPUT**, press **▲** or **▼** to highlight **USB**, then press **OK**. The *Media Player* menu opens.

Note

For information about supported file types, see [Supported photo file formats](#) on page 62.

Connecting headphones

If the **TV Speakers** option on the *Sound* menu is set to **Auto**, the TV speakers are muted when you connect headphones.

Warning

Loud noise can damage your hearing. When using headphones, use the lowest volume setting on your headphones that still lets you hear the sound.

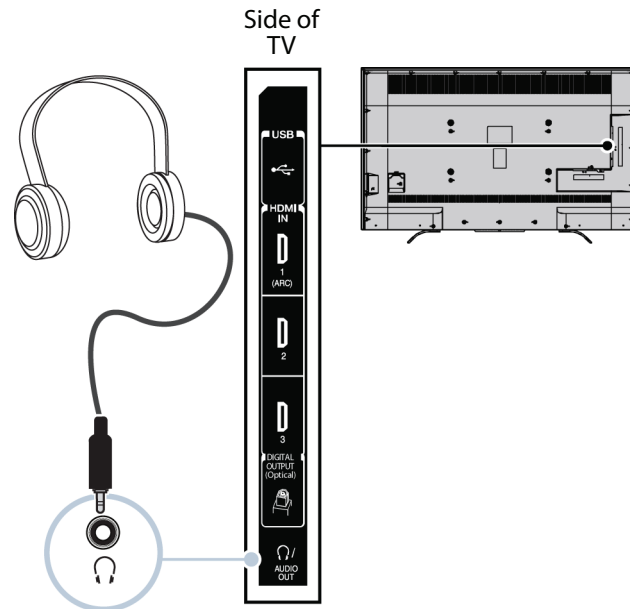

- 1 Make sure that your TV is turned on, then connect the headphones to the  / **AUDIO OUT** jack on the side of your TV.
- 2 In the *Headphones/Audio Output* screen that opens, press ◀ or ▶ to highlight **Headphones/Audio Out Variable**, then press **OK**.

Note

The *Headphones/Audio Output* screen closes after 30 seconds without any action. To open the screen again, unplug the headphones, then plug them back in.

Connecting external speakers or a soundbar

You can connect external speakers using:

- Digital audio
- Analog audio

Digital audio

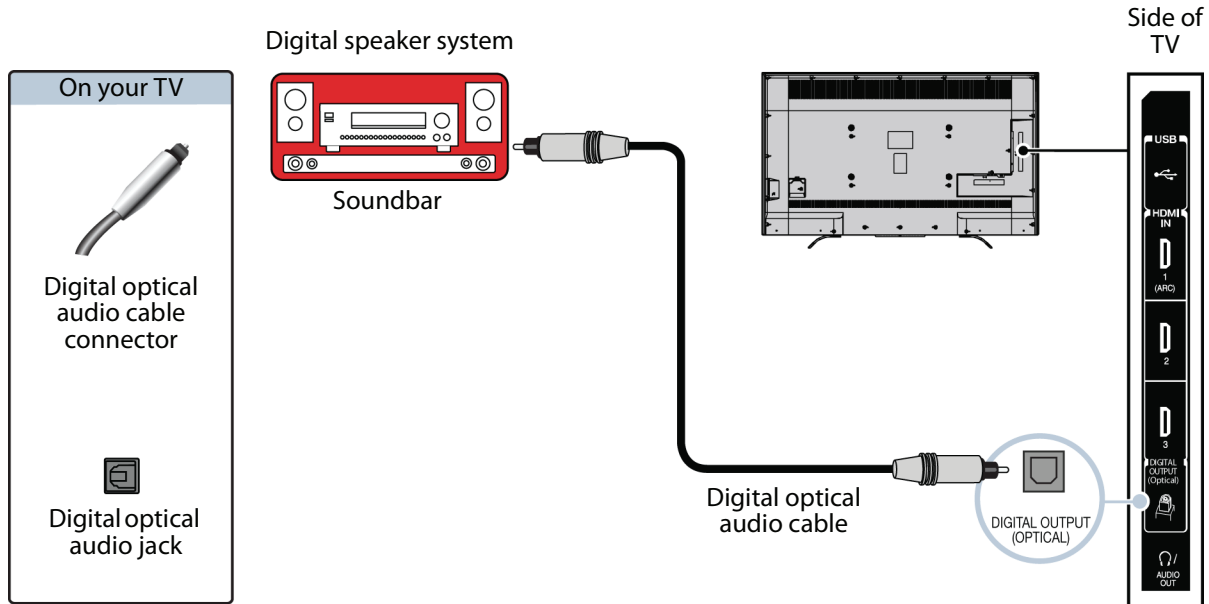

- 1 Make sure that your TV's power cord is unplugged and the digital speaker system or soundbar is turned off.
- 2 Connect a digital optical audio cable (not provided) to the **DIGITAL OUTPUT (Optical)** jack on the side of your TV and to the optical **AUDIO IN** jack on the digital speaker system or soundbar.
- 3 Plug your TV's power cord into a power outlet, then turn on your TV.
- 4 Turn on the digital speaker system or soundbar, then set it to the correct source. For more information, see the documentation that came with the digital speaker system or soundbar.
- 5 On your TV's *Sound* menu, highlight **Digital Audio Output**, then press **OK**. Highlight **Audio Format**, then press **OK**. Press **▲** or **▼** to select **PCM**, then press **OK**. See the **Digital Audio Output** option in [Adjusting sound settings](#) on page 70.

Analog audio

Note
 If the **TV Speakers** option on the *Sound* menu is set to **Auto** or **Off**, the TV speakers are muted when you connect an analog sound system or soundbar.

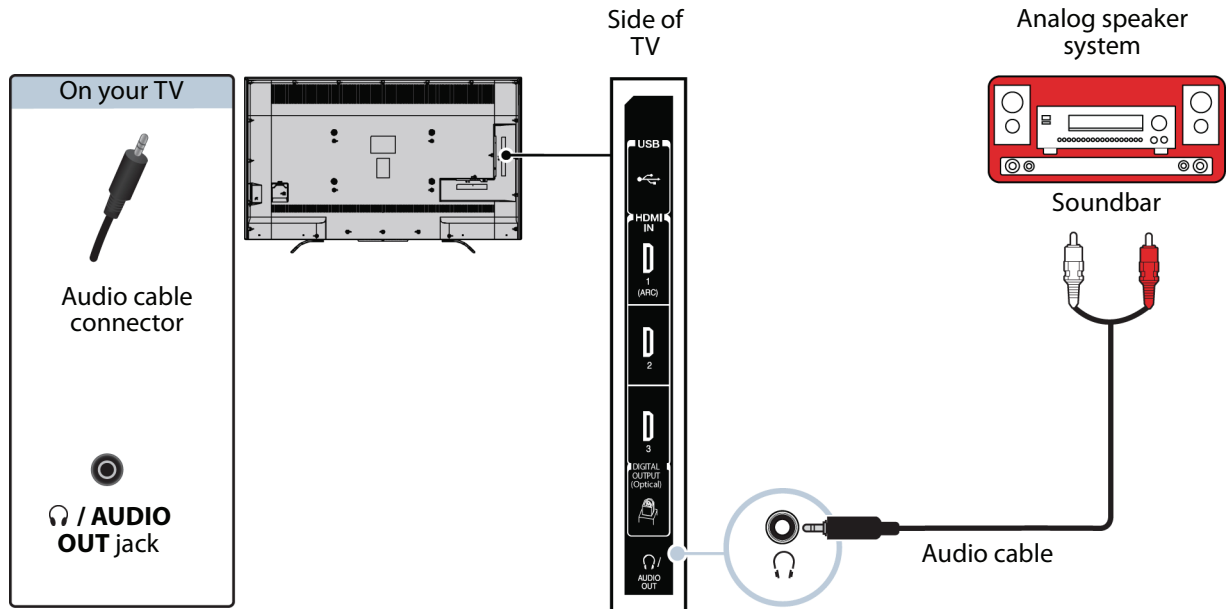

- 1 Make sure that your TV is turned on and the analog speaker system or soundbar is turned off.
- 2 Connect an audio cable (not provided) to the  / **AUDIO OUT** jack on the side of your TV and to the **AUDIO IN** jacks on the analog speaker system or soundbar.
- 3 In the screen that opens, press **◀** or **▶** to highlight **Audio Output Fixed**, then press **OK**.

Note
 If you want to mute the TV speakers, set the **TV Speakers** option on the *Sound* menu to **Off** or **Auto**.

- 4 Turn on the analog speaker system or soundbar, then set it to the correct source. For more information, see the documentation that came with the analog speaker system or soundbar.

Connecting a home theater system with multiple devices

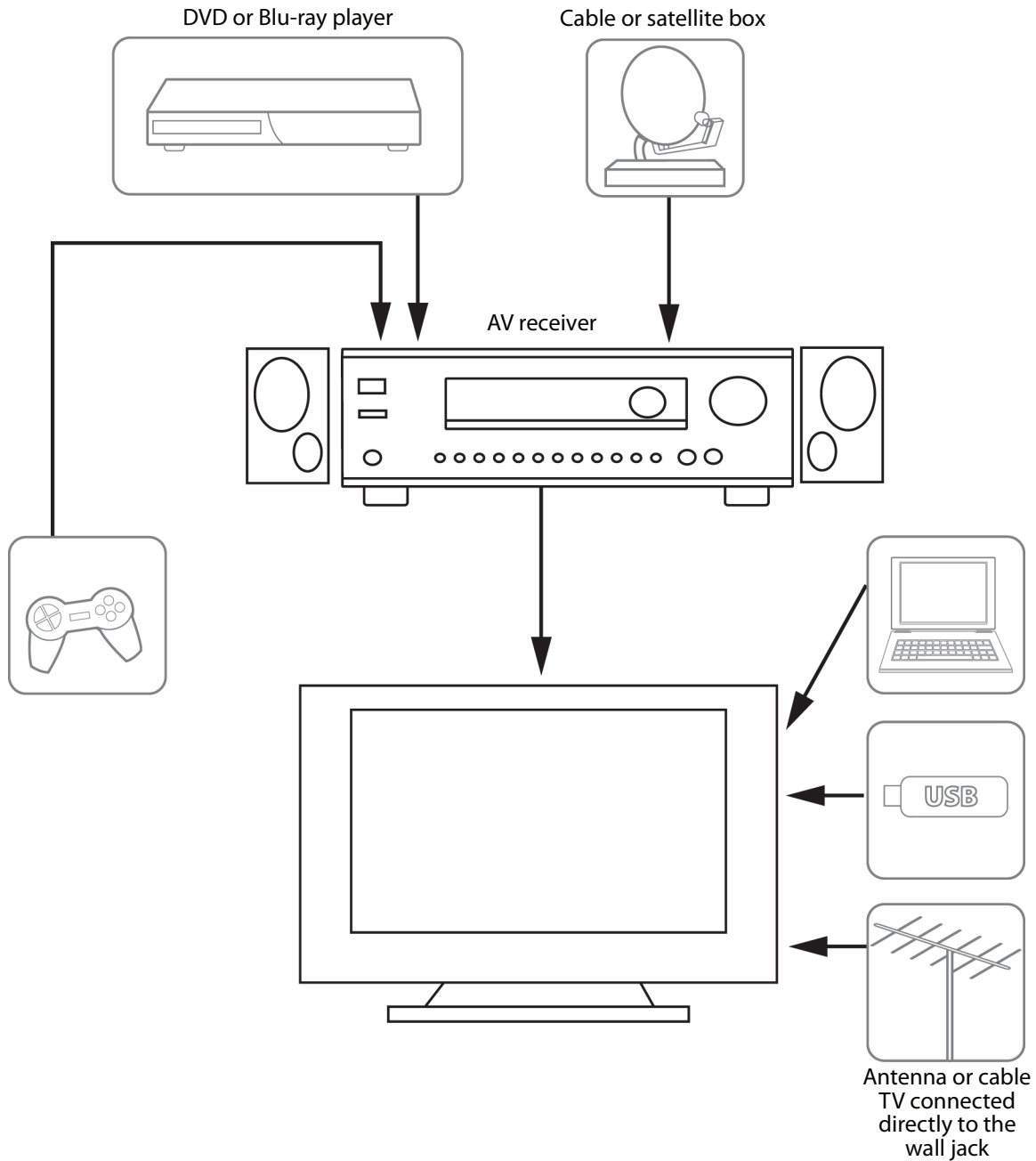

The connections you make depend on the video and audio jacks available on your devices. Refer to the documentation that came with your devices for connection information.

Just remember to use the best connection types available for the best picture and sound. For information about connection types, see [What connection should I use?](#) on page 23.

Connecting power

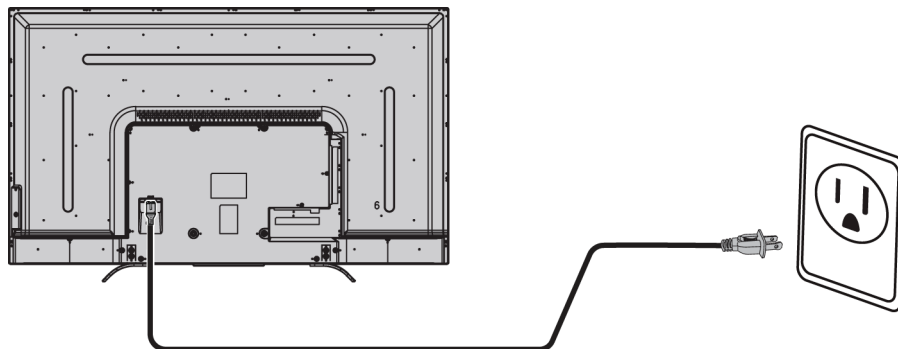

- Connect the power cord to a power outlet.

Cautions

- Your TV should only be operated from the power source indicated on the label.
- Always unplug the power cord from the power outlet when you will not be using your TV for an extended period of time.
- The power cord is permanently attached to your TV. Do not try to unplug it from the back of your TV.

Using the remote control

This section includes topics about:

- Installing remote control batteries
- Aiming the remote control
- Programming universal remote controls

Installing remote control batteries

- 1 Slide the battery compartment cover open, then lift the cover off the remote control.

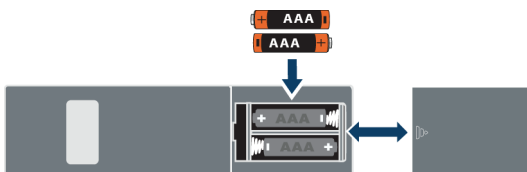

- 2 Insert two AAA batteries into the battery compartment. Make sure that you match the + and – symbols on the batteries with the + and – symbols in the battery compartment.
- 3 Replace the battery compartment cover.

Cautions

- Batteries should not be exposed to excessive heat, such as sunshine, heat registers, or fire.
- Battery chemicals can cause a rash. If the batteries leak, clean the battery compartment with a cloth. If chemicals touch your skin, wash immediately.
- Make sure that batteries are disposed of correctly. Do not burn or incinerate.

Notes

- Do not mix batteries of different types.
- Do not mix old and new batteries.
- Remove batteries when the charge is depleted.
- If the remote control is not going to be used for an extended period of time, remove the batteries.

Aiming the remote control

- Point the remote control towards the remote control sensor on the front of your TV.



Remote control sensor

Programming universal remote controls

You can operate your Toshiba TV with a new or existing universal remote control.

- 1 See the table in [Common universal remote control codes](#) on page 43 for common codes.

If you have problems programming your remote or need a different remote control code:

Contact the universal remote control maker.

OR

Contact the cable or satellite company that provided the remote control you are trying to program.

- 2 Follow your universal remote control's instructions to enter the TV code you found in Step 1.

Tips

- If your universal remote control has a code search feature, run a code search to identify a code that matches your TV. See your universal remote control's instructions for details.
- If your universal remote control has a "Learn" feature, you can manually program it using the Toshiba TV remote to "teach" the commands one at a time. See your universal remote control's instructions for details.

Common universal remote control codes

The following is a list of the most common remote control codes.

Brand	Remote control codes
AT&T U-verse	1127, 1179, 1203, 1204, 1222, 1223, 1332, 1340, 1341, 1345, 1353, 1010, 1098, 1104, 1147, 1148, 1149, 1150, 1151, 1173, 1174, 1210, 1215, 1256, 1257, 1263, 1267, 1272, 1302, 1311, 1312, 1322, 1343, 1376, 1585, 1589, 1592, 11524, 12724, 10156, 11935, 11704, 11959, 10650, 11343, 11369, 10060
Cablevision	015, 101, 045, 030, 007, 040, 062, 142, 137, 382, 703
Charter	11524, 10822, 10845, 11656, 12006, 10154, 11256, 10156, 11265, 10060, 10650, 11156, 11356, 11704, 0154, 0156, 0060, 1256, 0832, 1704, 1936, 0650, 1156, 1656, 1935, 0845, 1356, 1918, 1945, 015, 030, 007, 040, 062, 101, 142, 045, 137, 138, 325, 258, 031, 038, 039, 423, 571
Comcast	11656, 11156, 11256, 11704, 10845, 11356, 10060, 10650, 11265, 10154, 10765, 10767, 10178, 11314, 10700, 10702, 11935, 10832, 11959, 10036, 10149, 11343, 11369, 10781, 10003, 10250, 10156, 0060, 003, 0154, 0156
Cox	074, 168, 170, 822, 093, 991, 156, 060, 154, 093, 030, 031, 038, 039, 0170, 0074, 0168, 1270, 0060, 0154, 0156, 1256, 1265, 1945, 1704, 1656, 1635, 1356, 1343, 1325, 1306, 1156, 0845, 0832, 0650, 0149, 0036, 1369, 1042, 1060, 1061, 1062, 1087, 1091, 1097, 1098, 1130, 1131, 1183, 1524, 1935, 2006, 1959, 1936, 1164, 2724

Brand	Remote control codes
DirecTV	10156, 11656, 11256, 11704, 11356, 10060, 10650, 10154, 10765, 10178, 10700, 10702
Dish Network	617, 631, 590, 618, 635, 680, 688, 750, 847, 800, 526, 851, 852, 595, 908, 757, 850, 802, 785, 743, 849, 622, 789, 771, 744, 243, 117
RCA	11524, 11656, 10156, 11156, 11256, 12006, 11265, 11704, 11945, 10845, 1356, 12724
Rogers	1524
Time Warner	0156, 0060, 0154, 1042, 1060, 1061, 1062, 1087, 1091, 1097, 1098, 1130, 1131, 1172, 1173, 1183, 1286, 1317, 1325, 1327, 1334, 1345, 1346, 1355, 1364, 1365, 0016, 0017, 0090, 0096, 0117, 0118, 0129, 0131, 0180, 0206, 2001, 0011, 0021, 0041, 0051, 0061, 0081, 0101, 0111, 0171, 0191, 0211, 0471, 0701, 0411, 0501, 1301, 1351, 1441, 1781, 1951, 2021, 0341, 2341, 2481, 0861, 2351, 3671, 2801, 3821, 4151, 3921, 3931, 1256, 1265, 1945, 1935, 1704, 1656, 1635, 1356, 1343, 1306, 1156, 0845, 0832, 0650, 0149, 0036, 1190, 1014, 1015, 1127, 1007, 1252, 1246, 1219, 1212, 1168, 1163, 1018, 1114, 1028, 1071, 1300, 1338, 1353, 1369, 030, 007, 040, 062, 101, 045, 015, 062, 142, 137, 703, 138, 230, 258, 325
Verizon	0087, 0181, 0183, 0677, 0859, 0872, 1172, 1183, 1283, 1292, 1383, 1683, 1731, 3015, 3022, 3023, 3051, 3052, 3053, 3055, 3059, 3062, 3066, 3072, 3074, 3078, 3080, 3087, 3089, 3093, 3147, 3167, 3168, 3169, 3171, 3173, 3182, 3187, 3188, 3207, 3214, 3220, 397

Tips

- The brand name is often visible on the front of the universal remote control, and the model number is often visible on the back.
- If your universal remote control isn't listed in the table, refer to your universal remote control's instructions and try codes for the brands Orion, Emerson, Memorex, Sansui, Sylvania, or Zenith. You may need to try several codes before finding a match.

Turning on your TV for the first time

The first time you turn on your TV, the initial setup wizard opens. The wizard guides you through setting up your TV including the Chromecast built-in setup, menu language, time zone, TV signal source, and the channel list.

- If you are using an Android mobile device, go to [Using an Android mobile device](#).
- If you are using an iOS (Apple) mobile device, go to [Using an iOS \(Apple\) mobile device](#).

Using an Android mobile device

1 Make sure that you:

- Turn off the smart network switch option (if your device has this option). On your phone, go to the Wi-Fi menu in the settings app.
- Install the remote control batteries (see page 42) and connect the power cord (see page 41).
- Connect the correct device to watch standard broadcast TV channels using a cable box, satellite box, or external antenna. (See page 24 through 28.)
- Know the Wifi network name and password if you are using a wireless network to set up your TV.

Note

If you want to use a wired connection instead of Wifi to set up your TV, connect your TV to an Internet router using the **LAN** jack. For more information, see [Connecting a network router](#) on page 33.

With a wired connection, you cannot connect to Chromecast built-in with an LTE or 3G network.

2 Press  (power) to turn on your TV. The *Welcome* screen opens.

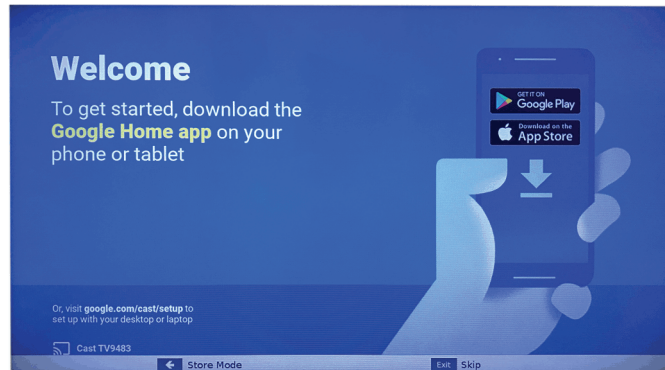

3 Type google.com/cast/setup in the search bar of your device's browser.

4 Tap GET IT ON Google Play.

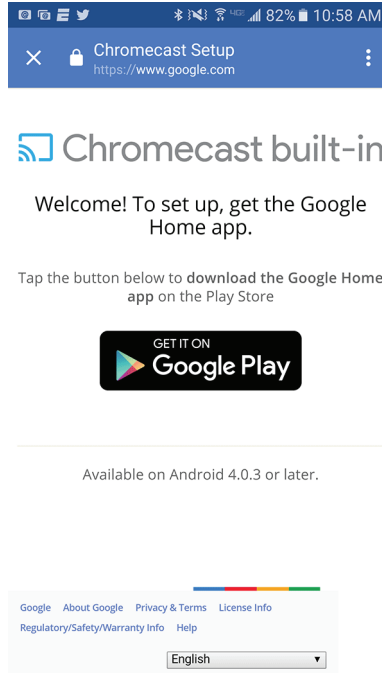

5 Tap INSTALL. The app installs.

6 Tap OPEN.

7 Tap ACCEPT to agree to the *Terms of Service and Privacy Policy*.

Note

If you have not turned on Wi-Fi on your device, a message tells you to turn on Wi-Fi.

8 Tap TURN ON LOCATION.

9 Tap ALLOW. Your mobile device searches for Cast TVs in range.

10 Tap **CONTINUE** after your device finds your Cast TV.

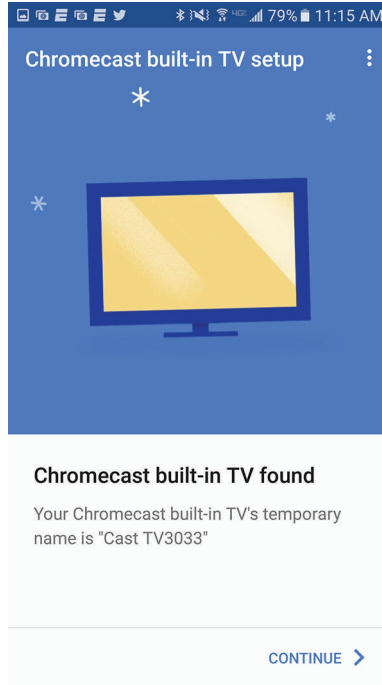

11 Make sure that the codes on your device and TV match, then on your mobile device, tap **YES**.



- 12 Optional:** To change the name of your TV to something distinct, delete the current name, type in a new one, then tap **CONTINUE**.

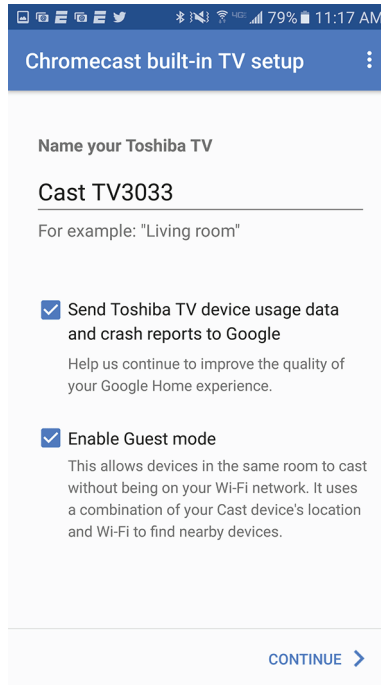

- 13** Choose your Wifi network, enter the Wifi password (if necessary), then tap **CONTINUE**. Your TV connects to the network and is ready to cast.

Note

If your TV receives an update, wait for the update to finish.

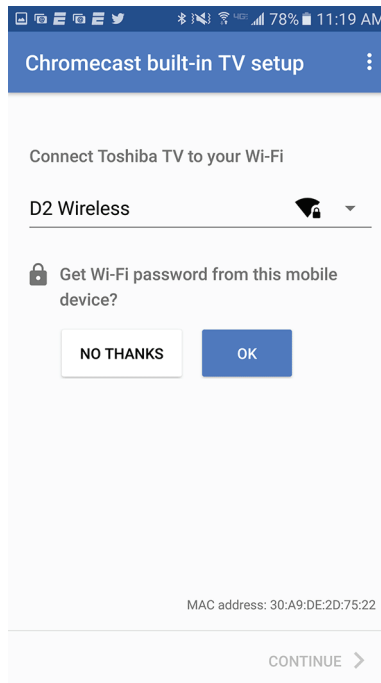

- 14 Sign in to your Google account to personalize your casting experience.
OR
Tap **LEAVE SETUP** to start casting right away.
- 15 Tap the slider to turn email notifications on or off, then tap **CONTINUE**.
- 16 Tap **LEARN HOW TO CAST** to go through a tutorial.
OR
Tap **SKIP** to skip the tutorial.
- 17 Tap  (Manage your devices) to set up, manage, and control the devices on your network.

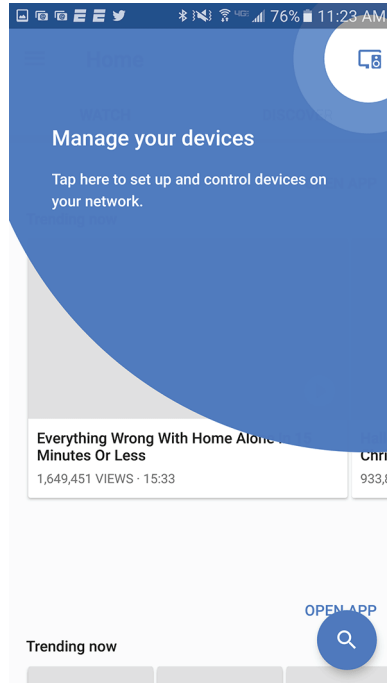

After setting up Chromecast built-in, your TV's menu language, time zone, and daylight savings time settings should be set automatically to match the settings on your mobile device.

If the settings are not correct or you want to change the settings, see:

- [Setting the time zone and Daylight Saving Time status](#) on page 82.
- [Selecting the menu language](#) on page 83.

If you connected cable TV without a box or an external antenna to the **ANT / CABLE IN** jack, set up the **ANT / CABLE IN** jack and scan for channels. See:

- [Setting up the ANT / CABLE IN jack](#) on page 54
- [Automatically scanning for channels](#) on page 72.

Using an iOS (Apple) mobile device

- 1 Make sure that you:
 - Turn off the smart network switch option (called **Wi-Fi Assist**) under **Settings > Cellular**.
 - Install the remote control batteries (see page 42) and connect the power cord (see page 41).
 - Connect the correct device to watch standard broadcast TV channels using a cable box, satellite box, or external antenna. (See page 24 through 28.)
 - Know the Wifi network name and password if you are using a wireless network to set up your TV.

Note

If you want to use a wired connection instead of Wifi to set up your TV, connect your TV to an Internet router using the **LAN** jack. For more information, see [Connecting a network router](#) on page 33.

With a wired connection, you cannot connect to Chromecast built-in with an LTE or 3G network.

- 2 Turn on Wifi on your mobile device and connect it to your home Wifi network.
- 3 Turn on Bluetooth on your mobile device.
- 4 Press  (power) to turn on your TV. The *Welcome* screen opens.

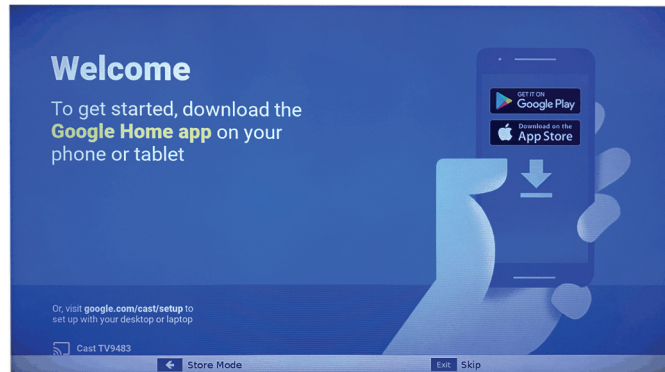

- 5 Type *google.com/cast/setup* in the search bar of your device's browser.
- 6 Tap **Download on the App Store**.

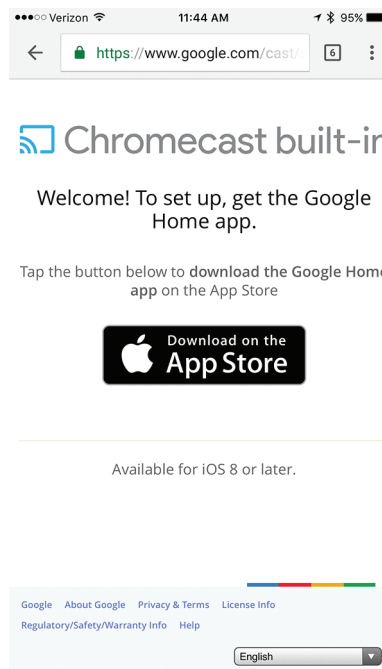

- 7 Tap **GET**, then tap **Install**.
- 8 Tap **OPEN**.
- 9 Tap **ACCEPT** to agree to the *Terms of Service* and *Privacy Policy*. Your mobile device searches for Cast TVs in range.

Note

If you have not turned on Wi-Fi on your device, a message tells you to turn on Wi-Fi.

- 10 Tap **CONTINUE** after your device finds your Cast TV.

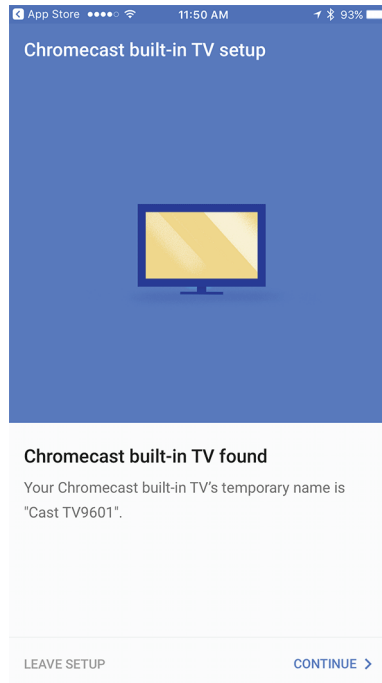

11 Make sure that the codes on your device and TV match, then on your mobile device, tap **I SEE IT**.



12 Select your region, then tap **CONTINUE**.

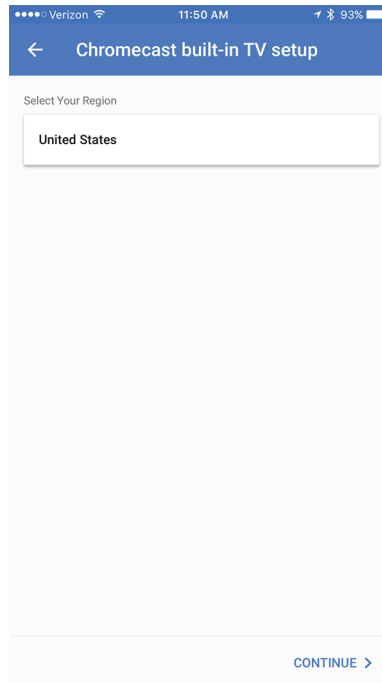

- 13 Optional:** To change the name of your TV to something distinct, delete the current name, type in a new one, then tap **CONTINUE**.

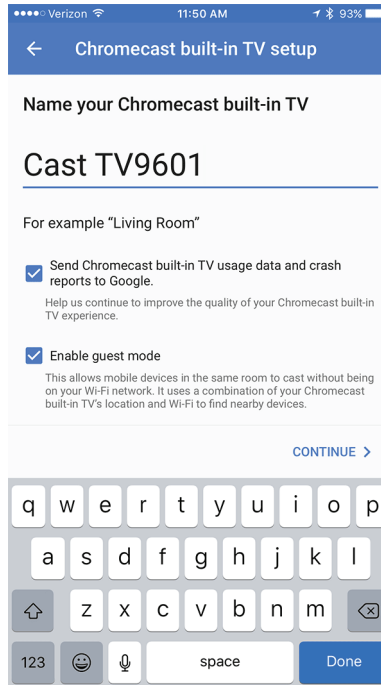

- 14** Choose your Wifi network, enter the Wifi password (if necessary), then tap **CONTINUE**. Your TV connects to the network and is ready to cast.

Note

If your TV receives an update, wait for the update to finish.

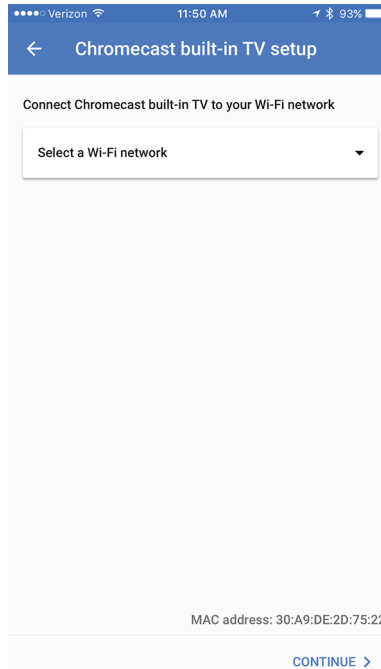

- 15 Sign in to your Google account to personalize your casting experience.
OR
Tap **LEAVE SETUP** to start casting right away.
- 16 Tap the slider to turn email notifications on or off, then tap **CONTINUE**.
- 17 Tap **LEARN HOW TO CAST** to go through a tutorial.
OR
Tap **SKIP** to skip the tutorial.
- 18 Tap  (Manage your devices) to set up, manage, and control the devices on your network.

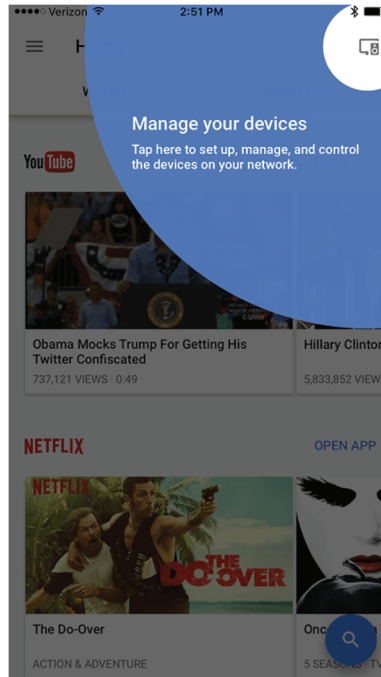

After setting up Chromecast built-in, your TV's menu language, time zone, and daylight savings time settings should be set automatically to match the settings on your mobile device.

If the settings are not correct or you want to change the settings, see:



- [Setting the time zone and Daylight Saving Time status](#) on page 82.
- [Selecting the menu language](#) on page 83.

If you connected cable TV without a box or an external antenna to the **ANT / CABLE IN** jack, set up the **ANT / CABLE IN** jack and scan for channels. See:

- [Setting up the ANT / CABLE IN jack](#) on page 54
- [Automatically scanning for channels](#) on page 72.

Casting a video, movie, or TV show

After you set up Chromecast built-in on your TV and mobile device, you are ready to cast videos, movies, and TV shows.

- 1 On your mobile device, make sure that Wifi is turned on.
- 2 Open a Chromecast-enabled app.
- 3 Tap the video, movie, or TV program you want to cast, then tap  (Chromecast button).
- 4 Tap the device you want to cast to.
- 5 To stop casting, tap , then tap **Disconnect**.

Setting up the ANT / CABLE IN jack

If you connect an antenna or cable TV without a box to the **ANT / CABLE IN** jack, you need to set up the jack so your TV correctly displays channels.

- 1 Press **MENU**, press **▲** or **▼** to highlight **Installation**, then press **OK**.

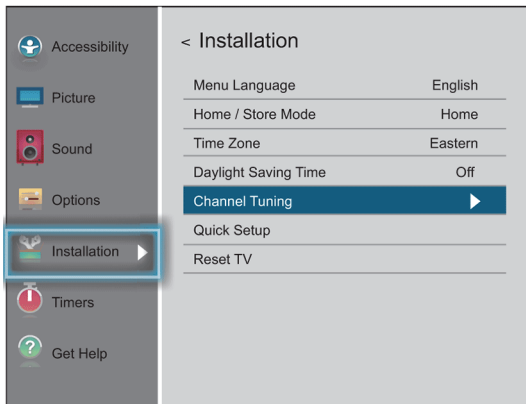

- 2 Highlight **Channel Tuning**, then press **OK**.

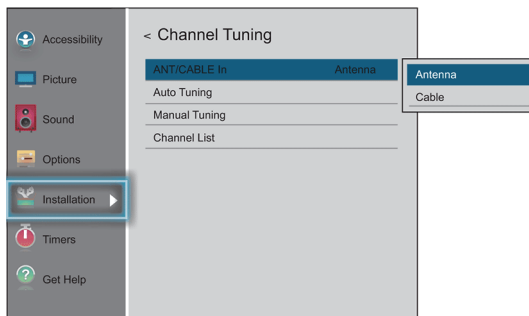

- 3 Highlight **ANT/CABLE In**, then press **OK**.
- 4 Highlight your TV input source, then press **OK**. Select:
 - **Antenna** if you connected an antenna to the **ANT / CABLE IN** jack
 - **Cable** if you connected cable TV without a box to the **ANT / CABLE IN** jack
- 5 Press **EXIT** to close the menu.

Understanding the basics

This section covers basic information for:

- Turning your TV on or off
- Selecting the video input source
- On-screen menu overview
- Navigating the menus
- Adjusting the volume
- Selecting a channel
- Viewing channel information

Turning your TV on or off

- 1 Make sure that the power cord is connected securely and correctly. For more information, see [Connecting power](#) on page 41.
- 2 Press **⏻** (power) to turn on your TV. The power indicator turns off.
- 3 Press **⏻** (power) again to turn off your TV. Your TV enters standby mode, and the power indicator turns red.

Warning

When your TV is in standby mode, it is still receiving power. To completely disconnect power, unplug the power cord.

Note

If your TV does not receive an input signal for 15 minutes, it automatically goes into standby mode.

Last Mode Memory

If power is interrupted while you are viewing TV, the Last Mode Memory feature automatically turns on your TV when the power is restored.

Selecting the video input source

1 Press **INPUT**. The *Input Selection* list opens.

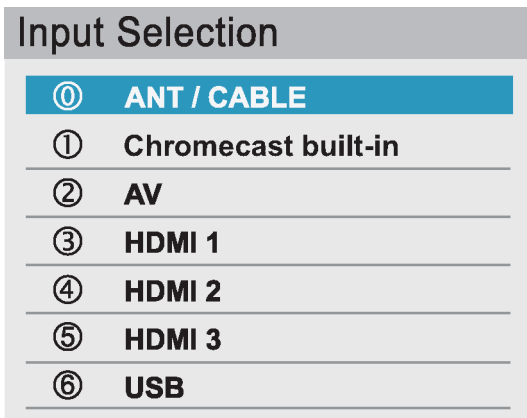

2 Do one of the following:

- Press **INPUT** one or more times until the video input you want is selected.
- Press **▲** or **▼** to highlight the video input you want, then press **OK**.

Note

If you have not scanned for channels, **Chromecast built-in** appears at the top of the *Input Selection* list.

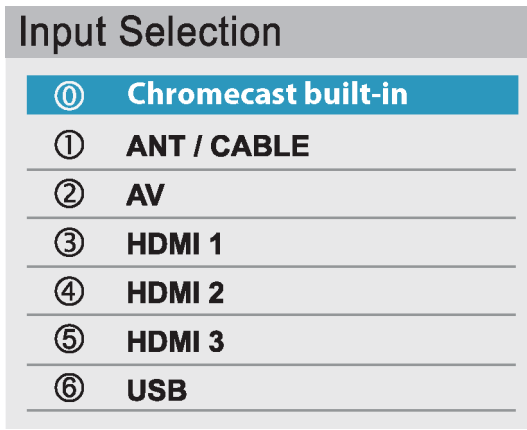

3 Press **EXIT** to close the menu.

Notes

- If a CEC-compatible device is connected to an HDMI jack, the HDMI® CEC icon appears in the list.
- If a connected CEC-compatible device has CEC-compatible devices connected to it, a separate device selection pop-up window appears. For example, the pop-up window for a CEC-compatible DVD player with a CEC-compatible audio receiver connected might appear as follows:



- If you press **INPUT** to select a CEC-compatible device from the pop-up window, the device may turn on.

Note

You can also change the video input source using the virtual remote control. On the *Direction key* page, tap  (input source), then use the arrows to select the video input source. See [Direction key page](#) on page 22.

On-screen menu overview

Notes

- Depending on the signal source selected, you may see different options on your screen.
- Menu items that are not selectable are grayed out.

Accessibility menu

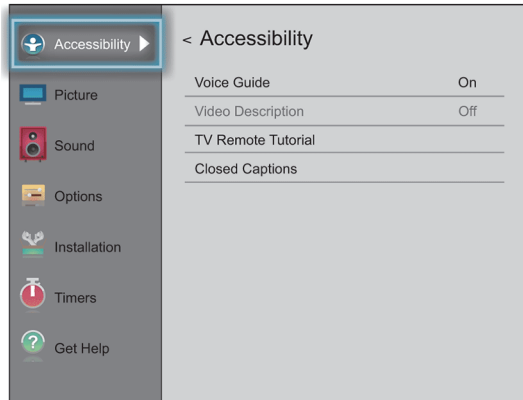

Picture menu

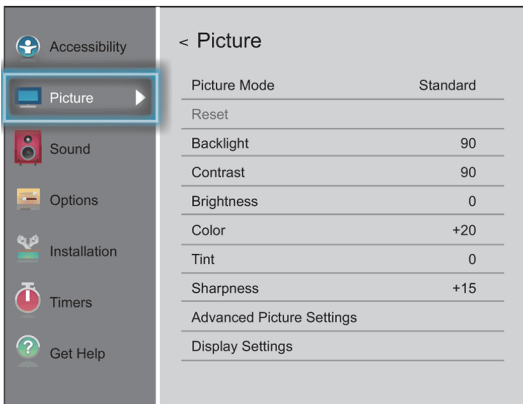

Sound menu

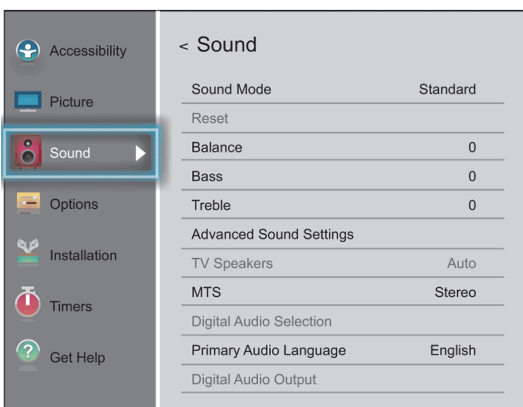

Options menu

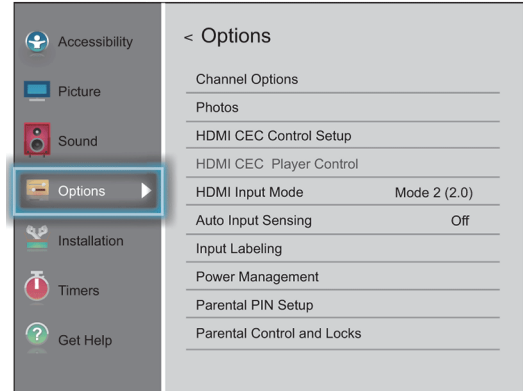

Installation menu

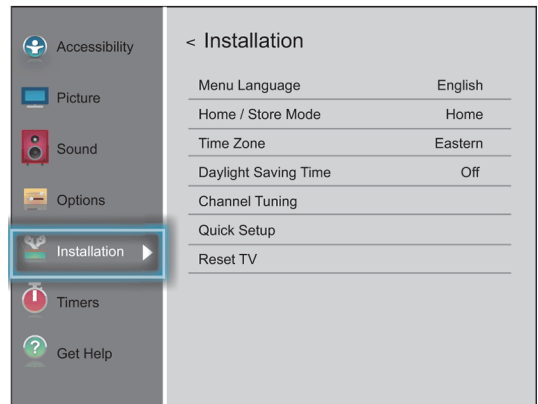

Timers menu

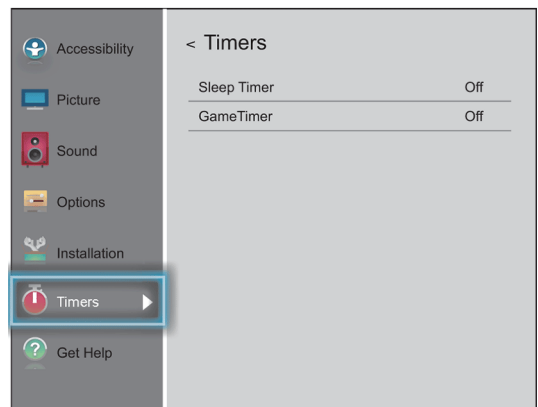

Get Help menu

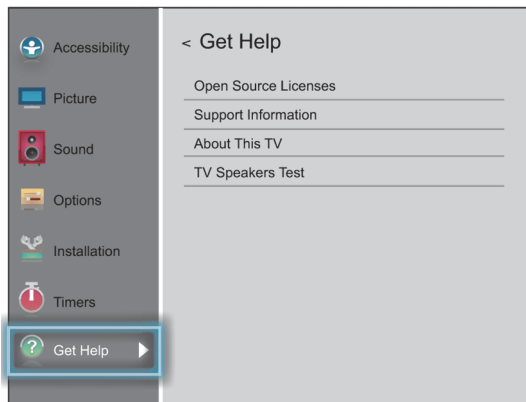

Navigating the menus

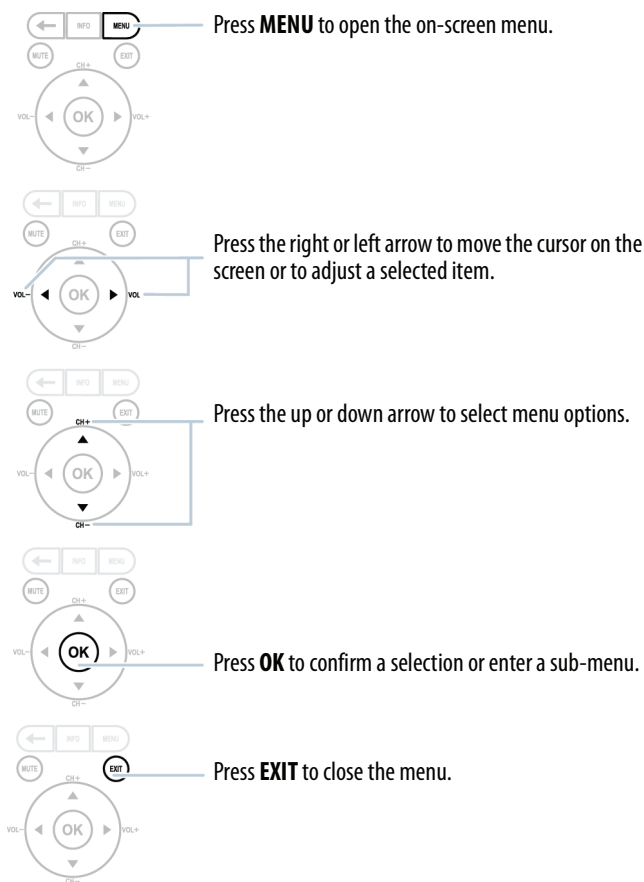

Adjusting the volume

- Press **VOL+** or **VOL-** to increase or decrease the volume.
- Press **MUTE** to mute the sound. Press **MUTE** again to turn the sound back on.

Note

If you adjust a setting on the *Sound* menu while the mute is active, the mute feature is cancelled.

Selecting a channel

- Press **CH+** or **CH-** to go to the next or previous channel on the memorized channel list.
- To select a channel from the Channel List, press **MENU**, select **Installation > Channel Tuning > Channel List**. Press **CH+** or **CH-** to go to the next or previous channel on the memorized channel list.
- To select a digital sub-channel, press the **CH+** or **CH-** button to select the sub-channel or select the sub-channel from the channel list.

Note

Button presses must be within two seconds of each other.

- On the virtual remote control on your mobile device, press the number buttons to enter the channel number you want, then press **OK** to immediately change the channel. To change the channel to a sub-channel, enter the main channel number, press **—**, enter the sub-channel button, then press **OK**. See [Virtual Remote control](#) on page 21.
- Press **←** (back) to go to the last viewed channel.

Viewing channel information

Press **INFO**. The following status information is displayed:

- Current video input (for example ANT/CABLE or AV)
- If ANT/CABLE is the current video input, either *CABLE* (for cable TV) or *ANT* (for over-the-air broadcasts)
- If ANT/CABLE is the current video input, channel number
- Digital signal strength indicator
- If the input mode is HDMI®, Dolby® Digital, or PCM
- Video resolution
- Aspect ratio of incoming video signal (4:3 or 16:9)
- TV program or movie rating
- GameTimer (if set)

Pressing **INFO** also displays the following status information for digital channels:

- Title
- Duration
- Detailed program description

Note

If you pressed **INFO**, press **INFO** again to close the banner.

Controlling CEC-compatible devices

This section covers:

- Turning HDMI-CEC Control on or off
- Turning TV Auto Power on or off
- Turning Auto Standby on or off
- Turning Amplifier Control on or off
- Using the TV remote to control CEC-compatible devices
- Using the TV menu to control CEC-compatible devices

HDMI CEC Control lets you control HDMI CEC-compatible devices connected to the HDMI jacks on your TV using the remote control that came with your TV. To use HDMI CEC Control, you must set the **Enable HDMI CEC Control** setting on the *HDMI CEC Control Setup* menu to **On**.

Notes

- HDMI cables must be used to connect HDMI CEC-compatible devices to your TV.
- The connected device's HDMI CEC feature must be turned on.
- If you connect an HDMI device that is not HDMI CEC-compatible, none of the HDMI CEC Control features work.
- Depending on the connected HDMI device, some HDMI CEC Control features may not work.

Note

When you press **INPUT**, the *Input Selection* list opens. If you select a CEC-compatible video device connected to an HDMI jack and that device is connected to a CEC-compatible audio device, a second selection list opens that shows both devices.

For example, if you connect a CEC-compatible Blu-ray player to an HDMI jack and the Blu-ray player is connected to a CEC-compatible soundbar, the second input selection list might appear as follows:



See [Selecting the video input source](#) on page 55.

Turning HDMI-CEC Control on or off

Note

If **Enable HDMI CEC Control** is set to Off, the other options on the menu are grayed and cannot be used.

- 1 Press **MENU**, press **▲** or **▼** to highlight **Options**, then press **OK**.

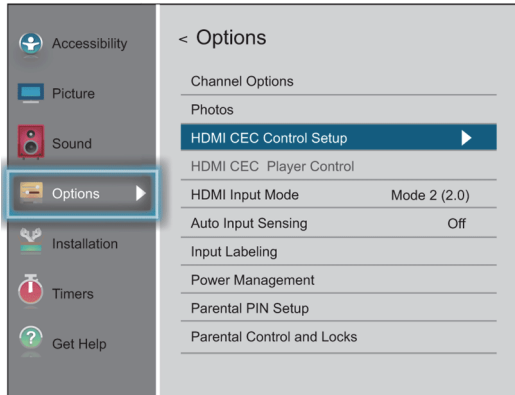

- 2 Highlight **HDMI CEC Control Setup**, then press **OK**.

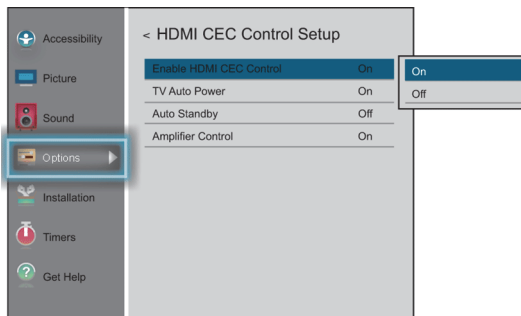

- 3 Highlight **Enable HDMI CEC Control**, then press **OK**.
- 4 Highlight **On** or **Off**, then press **OK**.
- 5 Press **EXIT** to close the menu.

Turning TV Auto Power on or off

TV Auto Power automatically turns on your TV when an HDMI CEC device is turned on, if the device has this feature.

- 1 Press **MENU**, press **▲** or **▼** to highlight **Options**, then press **OK**.

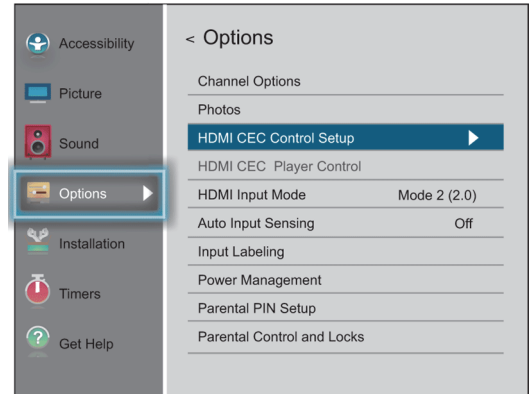

- 2 Highlight **HDMI CEC Control Setup**, then press **OK**.

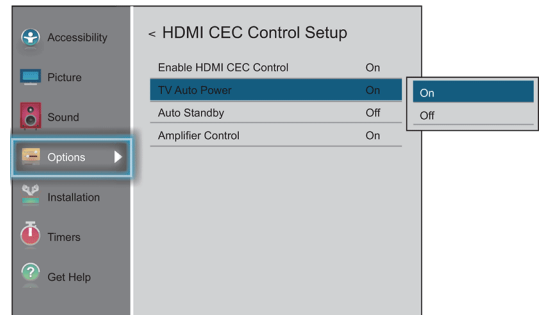

- 3 Make sure that **Enable HDMI CEC Control** is set to **On**.
- 4 Highlight **TV Auto Power**, then press **OK**.
- 5 Highlight **On** or **Off**, then press **OK**.
- 6 Press **EXIT** to close the menu.

Turning Auto Standby on or off

Auto Standby automatically turns off HDMI CEC devices when you turn off your TV.

- 1 Press **MENU**, press **▲** or **▼** to highlight **Options**, then press **OK**.

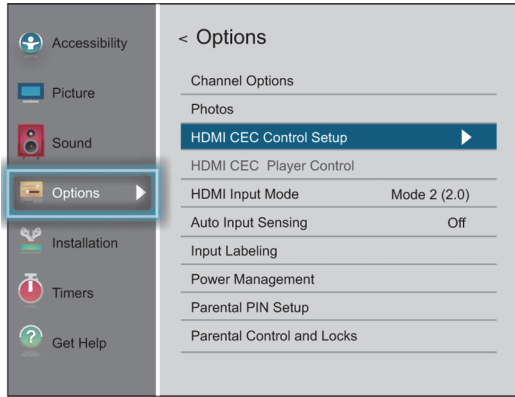

- 2 Highlight **HDMI CEC Control Setup**, then press **OK**.

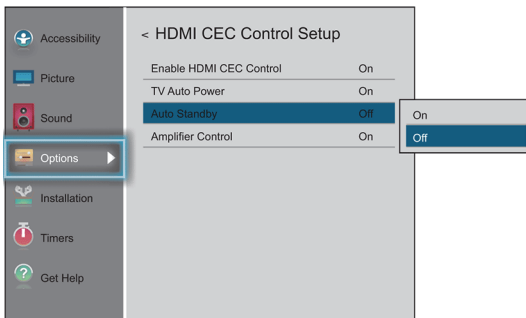

- 3 Make sure that **Enable HDMI CEC Control** is set to **On**.
- 4 Highlight **Auto Standby**, then press **OK**.
- 5 Highlight **On** or **Off**, then press **OK**.
- 6 Press **EXIT** to close the menu.

Turning Amplifier Control on or off

Amplifier Control lets you use your TV's remote control to control the volume and mute the sound on an audio receiver.

- 1 Press **MENU**, press **▲** or **▼** to highlight **Options**, then press **OK**.

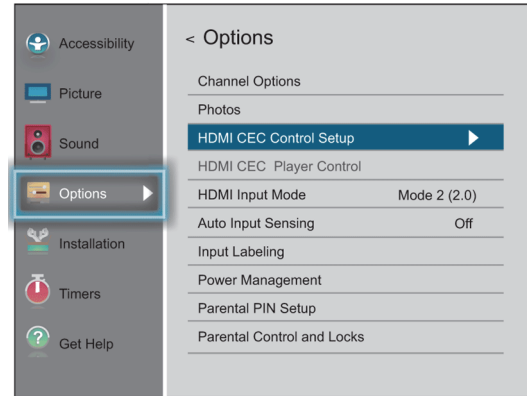

- 2 Highlight **HDMI CEC Control Setup**, then press **OK**.

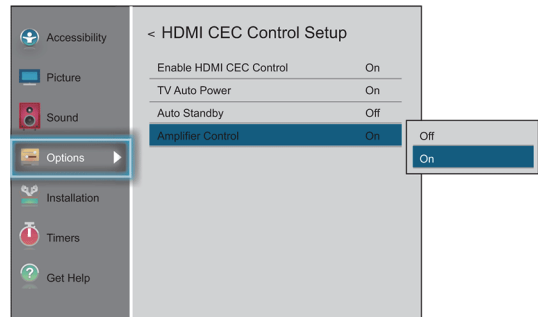

- 3 Make sure that **Enable HDMI CEC Control** is set to **On**.
- 4 Highlight **Amplifier Control**, then press **OK**.
- 5 Highlight **Off** or **On**, then press **OK**.
- 6 Press **EXIT** to close the menu.

Using the TV remote to control CEC-compatible devices

When **Enable HDMI CEC Control** on the *HDMI CEC Control Setup* menu is set to **On**, you can use the remote control that came with your TV to control a CEC-compatible device (such as a DVD or Blu-ray player).

Button	Press to...
▶ (play/pause)	Start or pause playback.
OK	Enter menu options.
EXIT	Return to the previous menu.

Note
These functions depend on the devices connected.

Using the TV menu to control CEC-compatible devices

When **Enable HDMI CEC Control** on the *HDMI CEC Control Setup* menu is set to **On**, you can use the TV menu to turn on a CEC-compatible device (such as a DVD or Blu-ray player) and access features on the device.

Note
These functions depend on the devices connected.
The HDMI CEC Player Control option is grayed if:

- A non-HDMI input is currently selected.
- The **Enable HDMI CEC Control** option is set to **Off**.

- 1 Make sure that **Enable HDMI CEC Control** is set to **On**. See [Turning HDMI-CEC Control on or off](#) on page 59.
- 2 Press **MENU**, press **▲** or **▼** to highlight **Options**, then press **OK**.

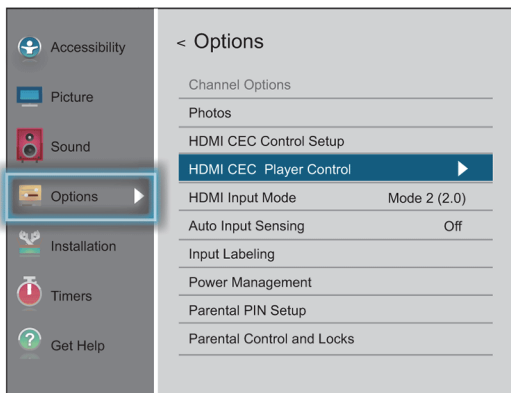

- 3 Highlight **HDMI CEC Player Control**, then press **OK**.

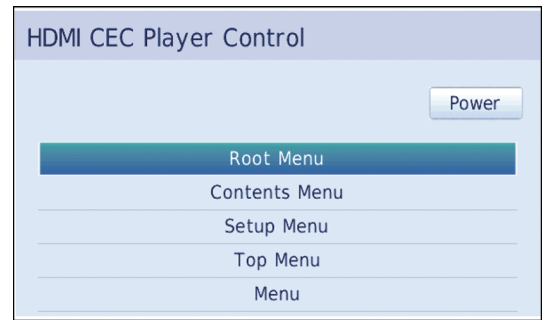

- 4 Highlight an option, then press **OK**. You can select:
 - **Power**—Turns the selected device on or off.
 - **Root Menu**—Accesses the root menu of the selected device.
 - **Contents Menu**—Accesses the contents list of the device.
 - **Setup Menu**—Accesses the setup menu of a selected device.
 - **Top Menu**—Accesses the top menu of a selected device.
 - **Menu**—Accesses the menu of a selected device.
- 5 Press **EXIT** to close the menu.

Selecting the HDMI input mode

The HDMI jacks on your TV are Ultra HD (UHD) jacks. Depending on the UHD device you connect to the HDMI jack or the streaming content you watch, you may need to adjust the timing.

Mode 1(1.4)	YCbCr 422/444 (supports timing limit on 3840x2160@30Hz) HDMI 1.4 mode for 4K / 30Hz or lower
Mode 2 (2.0)	YCbCr 420 (supports timing up to 3840x2160@60Hz) HDMI 2.0 mode for 4K / 60Hz and HDR (for older devices you may need to switch to Mode 1)

- 1 Make sure that **Enable HDMI CEC Control** is set to **On**. See [Turning HDMI-CEC Control on or off](#) on page 59.
- 2 Press **MENU**, press **▲** or **▼** to highlight **Options**, then press **OK**.

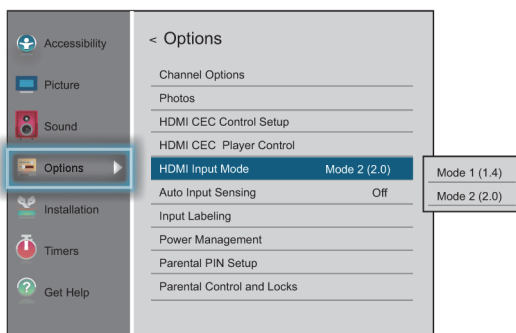

- 3 Highlight **HDMI Input Mode**, then press **OK**.
- 4 Highlight **Mode 1** or **Mode 2**, then press **OK**.

Viewing photos on a USB flash drive

You can connect a USB flash drive to your TV to view photos stored on the flash drive.

This section includes topics about:

- [Supported photo file formats](#)
- [Opening the Media Player](#)
- [Viewing photos](#)
- [Viewing photos in a slideshow](#)

Supported photo file formats

Your TV supports the following photo file formats:

- Data type: JPEG EXIF ver 2.1
- File format: JPEG
- Maximum photo size: 6 MB
- Maximum number of files or folders: 500 files per folder
- Base-line format, maximum photo resolution: 4096 x 4096 pixels
- Progressive format, maximum photo resolution: 1024 x 768 pixels

Notes

- Connectivity is not guaranteed for all devices.
- Connect the USB flash drive to the TV directly. Do not use a USB Hub.
- You must obtain any required permission from copyright owners to use copyright content.
- Depending on the file size and amount stored on the USB flash drive, it may take some time to load before content is viewable.
- A message appears on-screen when files are loading from the USB flash drive.
- Only limited types of U3 USB devices are supported. We recommend that you not use U3 USB to view photos.
- Non-supported characters are replaced with squares.

Opening the Media Player

- 1 Gently insert a USB flash drive into the USB port on your TV.
- 2 Press **MENU**, press **▲** or **▼** to highlight **Options**, then press **OK**.

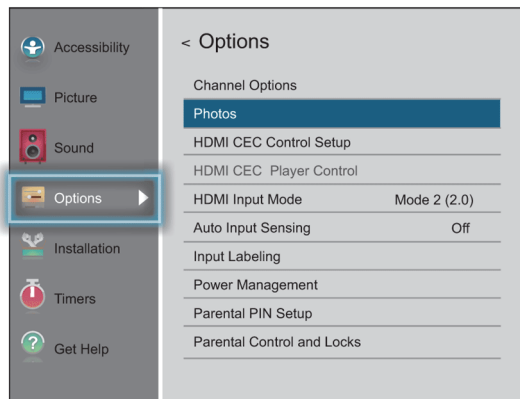

- 3 Highlight **Photos**, then press **ENTER**. The Media player opens.

Note

You can also select USB from the Input Selection list to open the Media Player. For more information, see [Selecting the video input source](#) on page 55.

Viewing photos

When you connect a USB flash drive that has photos on it and open the Photo viewer, a thumbnail index screen opens that shows the files and folders on the flash drive.

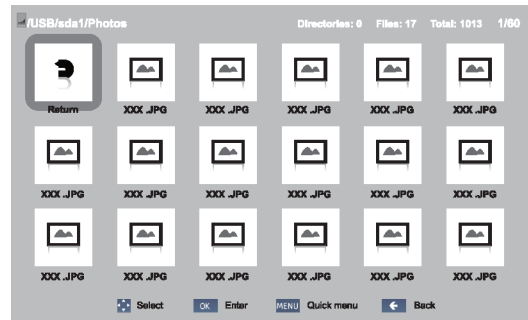

To navigate the thumbnail index screen:

- Press **▲** **▼** **◀** or **▶** to highlight a folder or photo, then press **OK**.
 - If you select a folder and press **OK**, the folder opens and displays thumbnails of the photos in the folder. Press **◀** to return to the previous thumbnail screen or folder.
 - If you select a photo and press **OK**, the photo is displayed full-screen.
 - If all the photos do not fit on one screen:
 - Highlight the top left thumbnail, then press **◀** to move to the previous screen.
 - Highlight the bottom right thumbnail, then press **▶** to move to the next screen.

To navigate on a full-screen photo:

- Press **◀** or **▶** to view the previous or next photo.
- Press **▲** to rotate the photo 90° counter-clockwise or press **▼** to rotate the photo 90° clockwise.
- Press **EXIT** to close the Photo viewer.

Viewing photos in a slideshow

When viewing photos in a slideshow, you can:

- Skip backward or forward through the photos in the current folder
- Set the time interval between photo displays
- Repeat the slideshow

To view photos in the slideshow:

- 1 Select a photo, then press **OK** to view it full-screen. Press **OK** again to start a slideshow in the current folder.
- 2 Press **◀** or **▶** to view the previous or next photo in the slideshow.

To set the time interval:

- 1 With a photo displayed full-screen, press **OK**.
- 2 Press **MENU**, then press **▲** or **▼** to highlight **Interval Time**.



- 3 Press **◀** or **▶** to select the time interval.
- 4 Press **←** to continue the slideshow.

To set the repeat mode:

- 1 With a photo displayed full-screen, press **OK**.
- 2 Press **MENU**, then press **▲** or **▼** to highlight **Repeat**.

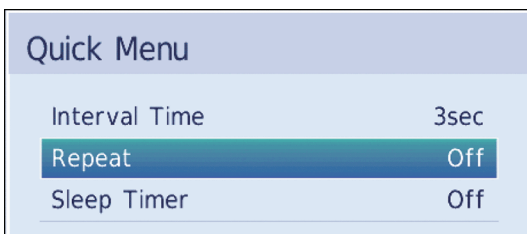

- 3 Press **◀** or **▶** to select **On**.
- 4 Press **←** to continue the slideshow.

Adjusting accessibility settings

Your TV provides audio descriptions of menus and some remote control functions. Depending on the broadcaster, audio narration of key elements in programs may also be available.

- 1 Press **MENU**, press **▲** or **▼** to highlight **Accessibility**, then press **OK**.

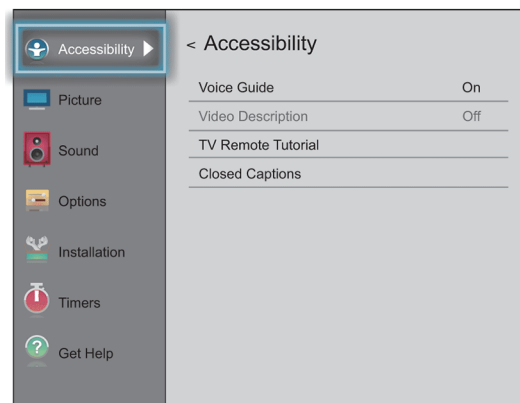

- 2 Highlight an option, then press **OK**. You can select:

- **Voice Guide**—Audibly narrates menu selections and some remote control functions. You can select **On** or **Off**.

Note

The **Voice Guide** option is only available in the English language.

- **Video Description**—Audibly narrates key visual elements in TV programs (not available on all broadcasts). You can select **On** or **Off**. This option is only available when the video input is **ANT/CABLE**.
- **TV Remote Tutorial**—Provides information about using the remote control.

Note

The **Voice Guide** option must be set to **On** to access the **TV Remote Tutorial**.

- **Closed Captions**—Displays a text version of the TV program audio or displays information provided by the broadcaster. See [Using closed captioning](#) on page 79 for instructions about using closed captioning features.
- 3 Press **◀▶▲▼** to adjust the option or select a setting, then press **OK**.
 - 4 Press **EXIT** to close the menu.

Note

For more information about accessibility, call Product Support (855) 527-2411 (U.S.) or 01-800-926-3080 (Mexico).

Adjusting the picture

This section covers:

- Adjusting the TV picture
- Adjusting the picture size
- Scrolling the TheaterWide™ picture
- Automatically adjusting the aspect ratio
- Using the 4:3 Stretch

Adjusting the TV picture

You can adjust various settings to improve the quality of the TV picture. Also, you can reset all picture settings to the factory default.

- 1 Press **MENU**, press **▲** or **▼** to highlight **Picture**, then press **OK**.

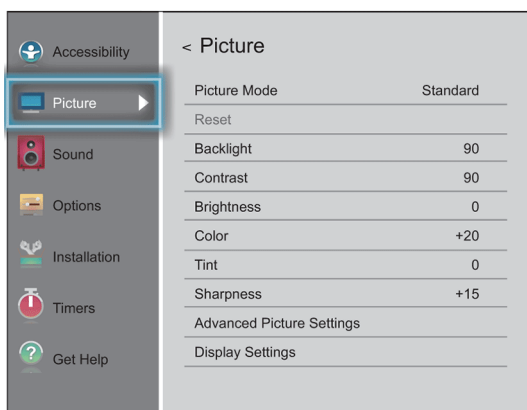

Note

Your TV automatically determines the dynamic range of UHD streaming video: *Standard Dynamic Range (SDR)* or *High Dynamic Range (HDR)*.

If you are watching HDR streaming video, the *Picture* menu displays **HDR Picture Mode** instead of **Picture Mode**.

- 2 Highlight an option, then press **OK**. You can select:

- **Picture Mode**—(SDR) Selects the picture mode. You can select:
 - **Dynamic**—Significantly increases the contrast, color saturation, sharpness, gray scale, and brightness to create more vivid and dynamic images.
 - **Standard**—Uses the default settings.
 - **Natural**—Preserves original video content.
 - **Movie**—Lowers the contrast for a darkened room.
 - **Game**—Reduces controller delay for faster video gaming action.

- **PC**—Optimizes the image of a connected computer.

Note

The **PC** option is only available for HDMI. The option is grayed for other input sources.

- **Store**—The **Store** picture mode is only available if you selected **Store Mode** during initial setup. This option is hidden in the Home mode.

Note

When your TV is set to **Store Mode** (during the initial setup or from the *Installation* menu), your TV will always revert to **Store Mode** when you turn it on.

- **HDR Picture Mode**—(HDR) Selects the picture mode. You can select:
 - **Vivid**—Provides brighter HDR picture viewing.
 - **Normal**—Provides enhanced HDR picture viewing.
 - **Movie**— Provides a natural HDR picture.
 - **Game**— Provides an optimized picture for HDR gaming content.
 - **Store**—The Store picture mode is only available if you selected **Store Mode** during initial setup. This option is hidden in the **Home** mode.
- **Reset**—Resets all picture settings to the factory default.
- **Backlight**—Sets the overall brilliance of the screen.
- **Contrast**—Adjusts the brightness of the light areas of the picture.
- **Brightness**—Adjusts the brightness of the dark areas of the picture.
- **Color**—Adjusts the color intensity of the picture. A low setting may make the color look faded. A high setting may make the color look artificial.
- **Tint**—Adjusts the color balance of the picture. Use this control to make skin tones look more natural.
- **Sharpness**—Adjusts the color detail of images. If you set this control too high, dark images may appear with light or white edges.

- **Advanced Picture Settings**—Opens the *Advanced Picture Settings* menu where you can adjust additional video options.

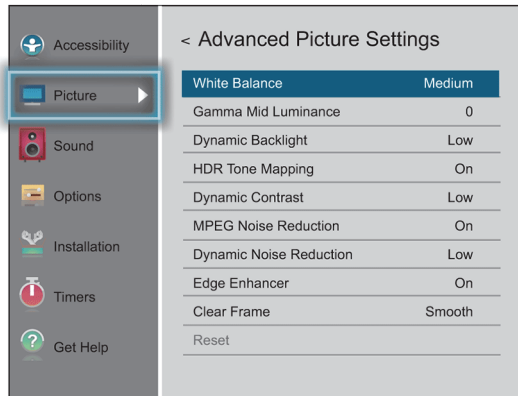

Note

Your TV automatically determines the dynamic range of UHD streaming video: *Standard Dynamic Range* (SDR) or *High Dynamic Range* (HDR).

If you are watching SDR video, the *Advanced Picture Settings* menu displays **Dynamic Contrast** instead of **HDR Tone Mapping**.

- **White Balance**—Adjusts the color temperature.
 - A** Highlight **Color Temperature**.
 - B** Press ◀ or ▶ to select a setting.
 - If you selected the **Picture Mode** option on the *Picture* menu, you can select **Cool**, **Medium**, or **Warm**.
 - If you selected the **HDR Picture Mode** option on the *Picture* menu, you can select **Cool**, **Medium**, **Warm1**, or **Warm2**.
 - C** Highlight **Red Intensity**, **Green Intensity**, or **Blue Intensity**, then press **OK**. Press ◀ or ▶ to adjust the setting.
 - D** Press ▼ to highlight **Done**, then press **OK**.
- **Gamma Mid Luminance**—Lets you adjust the levels of black in the picture.
 - A** Highlight this option, then press **OK**.
 - B** Press ◀ or ▶ to decrease or increase the black level detail.
- **Dynamic Backlight**—Automatically strengthens the black coloring of dark areas in the video according to the level of darkness. You can select **High**, **Low**, or **Off**.
- **HDR Tone Mapping**—(HDR) Optimizes the luminance response. You can select **On** or **Off**.
- **Dynamic Contrast**—(SDR) Automatically detects changes in picture quality that affect the appearance of your contrast settings and automatically adjusts the video. You can select **High**, **Middle**, **Low**, or **Off**.
- **MPEG Noise Reduction**—Reduces artifact noise and mosquito noise by MPEG encoding. You can select **On** or **Off**.
- **Dynamic Noise Reduction**—Reduces picture noise (snow). You can select **Off**, **Low**, or **High**.
- **Edge Enhancer**—Adjusts the picture to achieve a sharper image. You can select **On** or **Off**.
- **Clear Frame**—(Smooths the video motion when watching a movie on DVD. You can select **Standard**, **Smooth**, **Cinema**, or **Off**. (This option is available for the 55" model.)
- **Reset**—Resets all advanced picture settings to factory defaults.

- **Display Settings**—Opens the *Display Settings* menu where you can adjust how the picture is displayed on the screen.

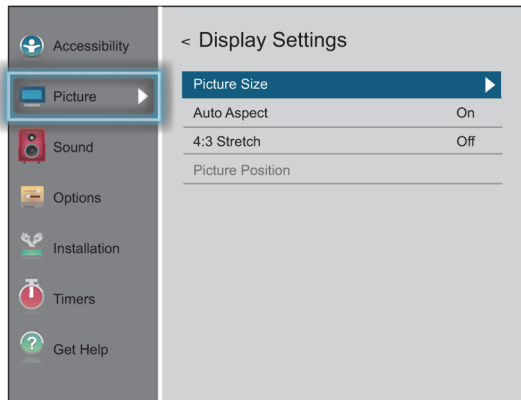

Adjusting the picture size

- 1 Press **MENU**, press **▲** or **▼** to highlight **Picture**, then press **OK**.

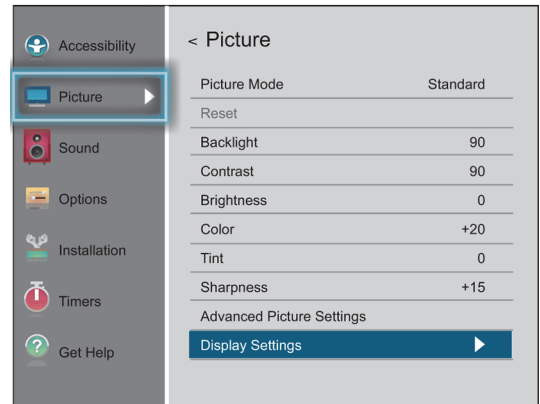

You can adjust:

- **Picture Size**—See [Adjusting the picture size](#) on page 67.
- **Auto Aspect**—See [Automatically adjusting the aspect ratio](#) on page 69.
- **4:3 Stretch**—See [Using the 4:3 Stretch](#) on page 70.
- **Picture Position**—See [Scrolling the TheaterWide™ picture](#) on page 69.

Note

The **Picture Position** option may be grayed and unavailable for some **Picture Size** settings.

- 3 Press **◀▶▲▼** to adjust the option or select a setting, then press **OK**.
- 4 Press **EXIT** to close the menu.

Notes

- Picture setting adjustments affects the current video input only. You can adjust the picture quality separately for each input.
- Depending on the **Sharpness** setting, the **Edge Enhancer** effect may be reduced.

- 2 Highlight **Display Settings**, then press **OK**.

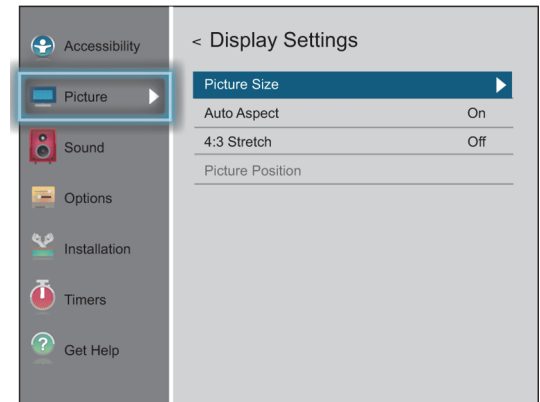

- 3 Highlight **Picture Size**, then press **OK**.
- 4 Press **▲** or **▼** to select a picture size, then press **OK** or wait a few seconds. The menu closes.

Picture size	Example
<p>Full</p> <p>Displays the picture in a 16:9 format (aspect ratio). If the picture is in a 4:3 format, the picture is stretched horizontally to fill the width of the screen but is not stretched vertically. The edges of the picture may be hidden.</p>	
<p>TheaterWide 1</p> <p>The center of the picture remains close to its original proportion, but the left and right edges are stretched horizontally to fill the screen.</p>	

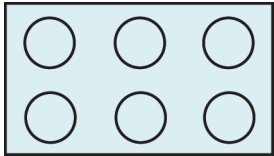
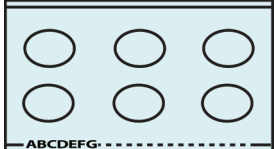
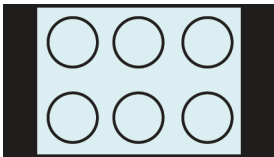
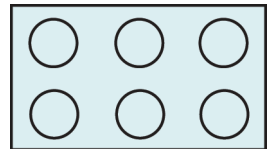
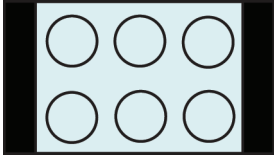
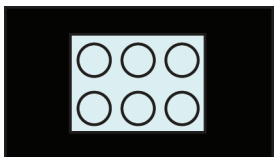
Picture size	Example
<p>TheaterWide 2 This setting is for viewing letter box (4:3) programs.</p>	
<p>TheaterWide 3 This setting is for viewing letter box programs with subtitles. The top and bottom edges of the picture are hidden.</p>	
<p>4:3 Displays the picture in letter box format. Some program formats will display with sidebars and/or bars at the top and bottom.</p>	
<p>Native: If the program is a 2160p, 1080i, 1080p, 720p, 480i (HDMI®), or 480p (HDMI®) program, the picture is scaled to display the entire picture within the borders of the screen (no overscanning). This picture size is especially useful for viewing external HD sources, such as DVD movies, video games, or computer graphics.</p>	
<p>Normal Displays the image in the original aspect ratio. You may see black bars if the original content is not widescreen. This setting is for viewing VGA, SVGA, XGA, WXGA, and SXGA sources.</p>	
<p>Note: This option adjusts the timing when a computer is connected to an HDMI IN jack.</p>	
<p>Dot by Dot Dot by Dot is a non-scaling display. Depending on the input signal format (VGA, for example), the picture may appear with sidebars and/or bars at the top and bottom. This setting is for viewing VGA, SVGA, XGA, WXGA, and SXGA sources. This option is only available when the video input source is HDMI and the video signal is VGA, SVGA, XGA, WXGA, or SXGA.</p>	

- Notes**
- If you select a TheaterWide™ picture size, the top and bottom edges of the picture (including subtitles or captions) may be hidden. To view these edges, try adjusting the **Picture Position**, viewing the program in **4:3** or **Full**, or scroll the picture. See [Scrolling the TheaterWide™ picture](#) on page 69.
 - The **Native** mode is supported only for HDMI® (2160p, 1080i, 1080p, 720p, 480i, and 480p), and ANT/CABLE (digital) inputs (1080i, 1080p, and 720p).
 - In **Native** mode, the picture's border may be hidden, displayed in black, or noisy, depending on the input signal.

Scrolling the TheaterWide™ picture

You can set separate scroll settings for the **TheaterWide 2** and **TheaterWide 3** picture size modes for each input. For more information about pictures sizes, see [Adjusting the picture size](#) on page 67.

- 1 Press **MENU**, press **▲** or **▼** to highlight **Picture**, then press **OK**.

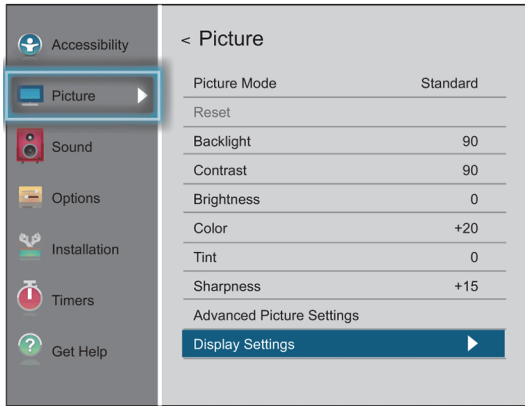

- 2 Highlight **Display Settings**, then press **OK**.

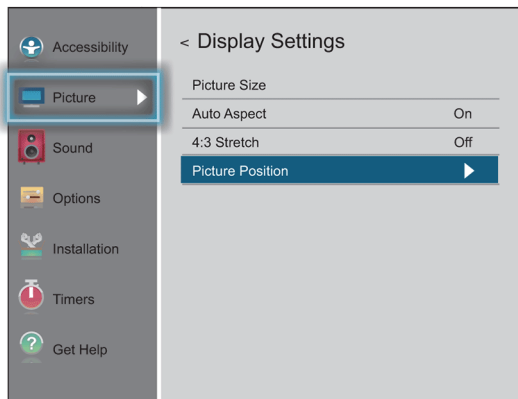

- 3 Highlight **Picture Position**, then press **OK**.

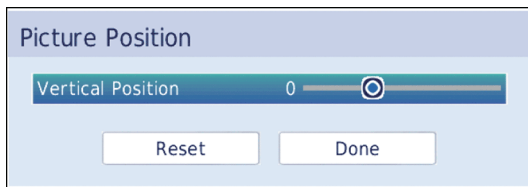

- 4 Press **◀** or **▶** to move the picture up and down as needed, then press **OK**. To save the new settings, press **▲** or **▼** to highlight **Done**, then press **OK**.

OR

To revert to the factory defaults, highlight **Reset** then press **OK**.

- 5 Press **EXIT** to close the menu.

Automatically adjusting the aspect ratio

When the **Auto Aspect** option is set to **On**, your TV automatically selects the picture size when one of the following input sources is received:

- 480i, 480p, 720p, 1080i digital signal from the **ANT/CABLE IN** jack
- 480i, 480p, 720p, 1080i, 1080p, 2160p, or VGA (60Hz) signal from an **HDMI** jack

Aspect Ratio of Signal Source	Auto Aspect is set to On)
4:3 Normal	4:3
4:3 Letter Box	TheaterWide 2
16:9	Full
Not defined (no ID-1 data or HDMI® aspect data)	The current picture size you selected, see Adjusting the picture size on page 67.

- 1 Press **MENU**, press **▲** or **▼** to highlight **Picture**, then press **OK**.

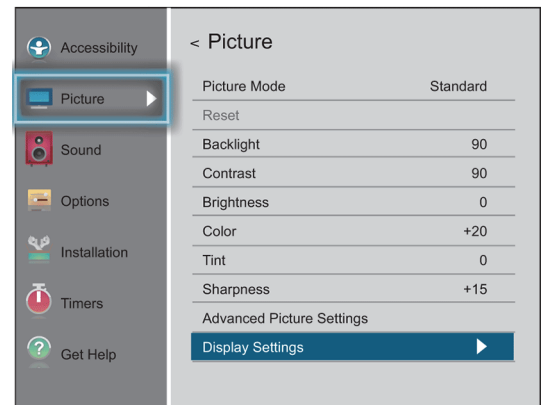

- 2 Highlight **Display Settings**, then press **OK**.

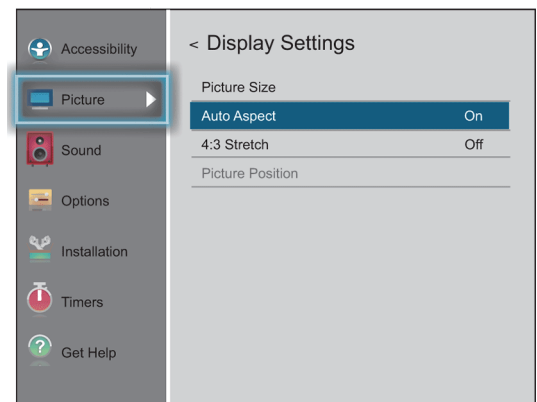

- 3 Highlight **Auto Aspect**, then press **OK**.

- 4 Highlight **On**, then press **OK**. (To turn off **Aspect Ratio**, select **Off**.)

- 5 Press **EXIT** to close the menu.

Using the 4:3 Stretch

When 4:3 Stretch is turned on, your TV displays 4:3 programs as a full-screen picture.

- 1 Press **MENU**, press **▲** or **▼** to highlight **Picture**, then press **OK**.

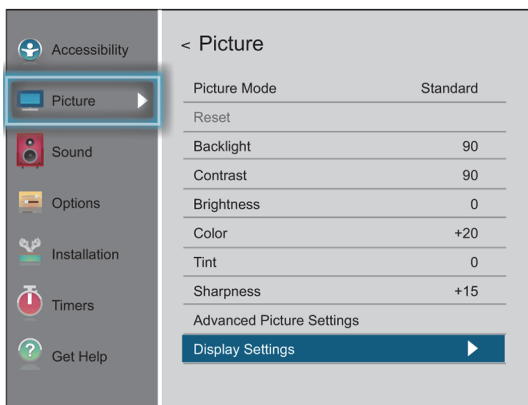

- 2 Highlight **Display Settings**, then press **OK**.

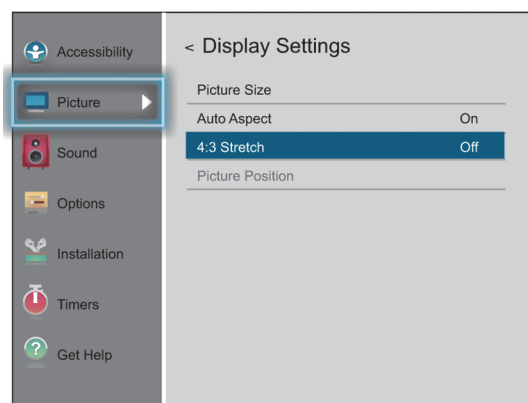

- 3 Highlight **4:3 Stretch**, then press **OK**.
- 4 Highlight **On**, then press **OK**. (To turn off **4:3 Stretch**, select **Off**.)
- 5 Press **EXIT** to close the menu.

Adjusting the sound

This section covers:

- [Adjusting sound settings](#)
- [Playing TV audio only](#)

Adjusting sound settings

You can adjust sound settings to improve the sound quality.

- 1 Press **MENU**, press **▲** or **▼** to highlight **Sound**, then press **OK**.

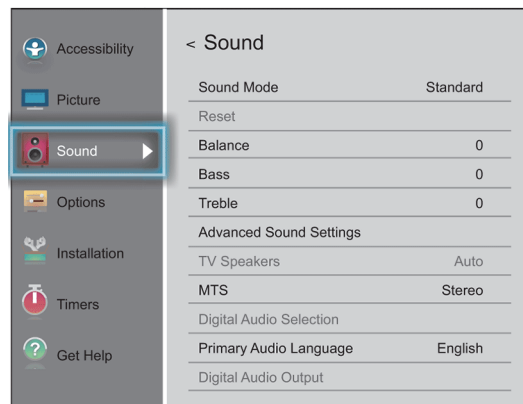

- 2 Highlight an option, then press **OK**. You can select:

- **Sound Mode**—Selects the sound mode. You can select **Standard**, **Music**, **Movie**, **Clear Voice**, or **Enhanced Bass**.
- **Reset**—Resets all sound settings to the factory default.
- **Balance**—Adjusts the balance between the left and right audio channels.
- **Bass**—Adjusts the low sounds.
- **Treble**—Adjusts the high sounds.
- **Advanced Sound Settings**—Adjusts advanced sound settings. You can select:
 - **Dialog Clarity**—Adjusts the volume of dialog when watching movies or TV programs. You can select **Off**, **Low**, or **High**.
 - **Surround**—Delivers clear, crisp, and natural sound over front facing speaker configurations, complete with rich bass, high frequency detail, and clear dialog. You can select **Off** or **TruSurround**.
 - **TruVolume**—Keeps the volume level consistent when switching between content types, for example when switching between a program and a commercial. You can select **On** or **Off**.

- **TV Speakers**—Turns your TV’s speakers on or off. You can select:
 - **Auto**—Turns off the TV speakers when you connect a device to the **Q/AUDIO OUT** jack.
 - **On**—Keeps the TV speakers on when you connect a device to the **Q/AUDIO OUT** jack.
 - **Off**—Turns off the TV speakers.

Note
If the Voice Guide is turned on, the **TV Speakers** option can only be set to **Auto**.

- **MTS**—(Analog channels received through the **ANT / CABLE IN** jack only) Selects the audio mode. You can select:
 - **Stereo**—Select this option for programs broadcast in stereo. You can typically leave your TV in Stereo mode because **Stereo** outputs the type of sound being broadcast (stereo or mono).
 - **Mono**—Select this option if there is noise or static on weak stereo broadcasts.
 - **SAP**—Select this option to listen to a secondary audio program, if available. If you select this option and no secondary audio program is available, you may not hear sound. Change the **MTS** option to **Stereo**.
- **Digital Audio Selection**—Lets you conveniently switch between audio tracks on a digital channel (when available). This option temporarily overrides the **Primary Audio Language** option on the **Sound** menu.
- **Primary Audio Language**—Selects the language for digital channels.
- **Digital Audio Output**—Opens the *Digital Audio Output* menu where you can adjust digital audio.

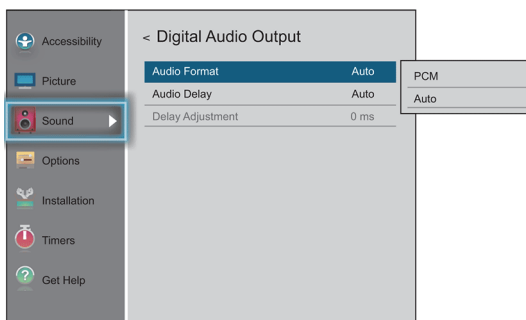

- **Audio Format**—Selects the digital audio format sent to an external audio system. You can select:
 - **PCM** (to convert and output sound as PCM (pulse-code modulation) format).
 - **Auto** (to pass through the original digital sound).

Note
If the Voice Guide is turned on, the **Audio Format** option can only be set to **PCM**.

- **Audio Delay**—Fine tunes the audio when it is not in sync with the video. You can select **Auto** or **Manual**.
- **Delay adjustment**—Lets you set the amount of delay to manually sync the audio with the video. To use this option, **Audio Delay** must be set to **Manual**.

- 3 Press **◀▶▲▼** to adjust the option or select a setting, then press **OK**.
- 4 Press **EXIT** to close the menu.

Playing TV audio only

You can turn off the picture on your TV and listen to the program audio only.

- 1 Press **MENU**, press **▲** or **▼** to highlight **Options**, then press **OK**.

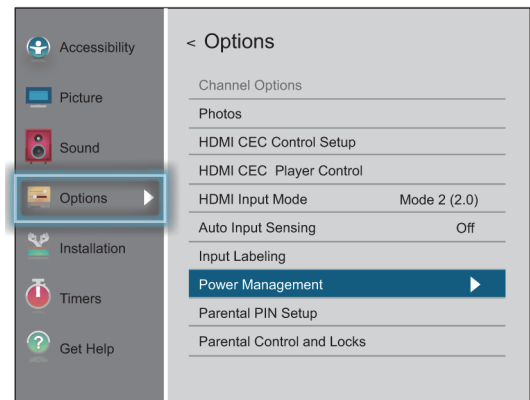

- 2 Highlight **Power Management**, then press **OK**.

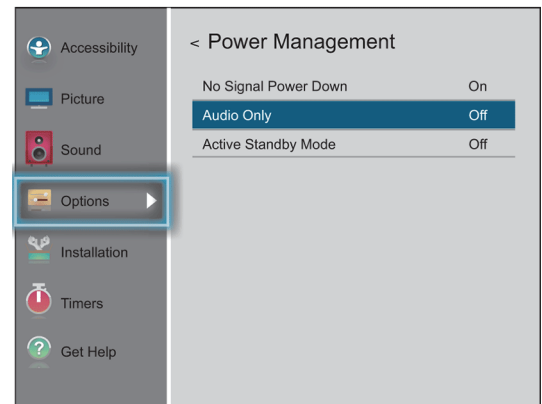

- 3 Highlight **Audio Only**, then press **OK**.
- 4 Highlight **On** or **Off**, then press **OK**.
- 5 Press **EXIT** to close the menu.

Notes

- The picture turns off in about five seconds.
- Press any button to turn on the picture for about five seconds.
- To exit audio only mode, repeat this task and select **Off**.

Changing channel settings

This section covers:

- Automatically scanning for channels
- Manually adding channels to the channel list
- Hiding channels

Automatically scanning for channels

When you scan for channels, your TV searches for channels with signals and stores the channel information in the channel list. When you press **CH+** or **CH-**, your TV goes to the next or previous channel in the channel list. The channel scan may take several minutes.

Note

When you scan for channels, your TV erases any channels already stored in the channel list.

If a channel is not stored in the channel list, you can:

- Use the number buttons on the virtual remote control to enter the channel number. See [Virtual Remote control](#) on page 21.
- Manually add the channel to the channel list. See [Manually adding channels to the channel list](#) on page 72.

- 1 Make sure that you have set up the **ANT / CABLE IN** jack before programming channels. See [Setting up the ANT / CABLE IN jack](#) on page 54.
- 2 Press **MENU**, press **▲** or **▼** to highlight **Installation**, then press **OK**.

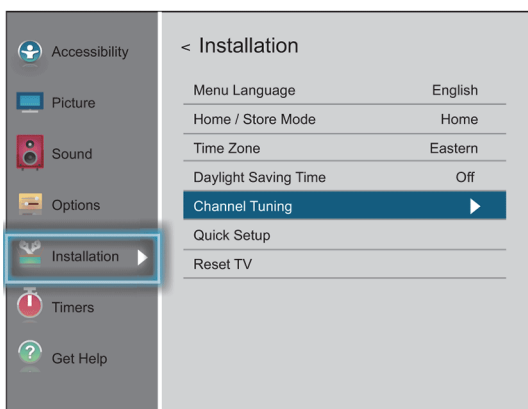

- 3 Highlight **Channel Tuning**, then press **OK**.

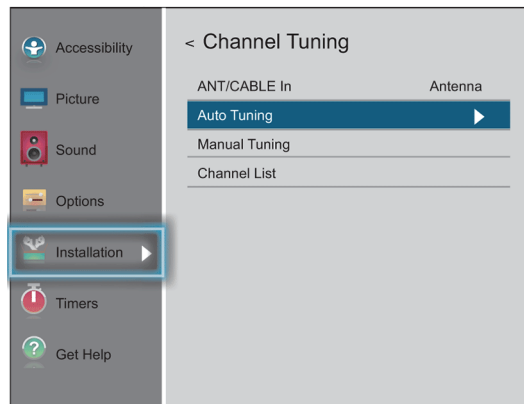

- 4 Highlight **Auto Tuning**, then press **OK**. Press **OK** again to start the scan. Your TV scans for available channels. The scan may take several minutes.

Notes

- If you have created a PIN, press **◀** or **▶** on the number bar at the bottom of the screen to select a number, then press **OK**. Repeat this step to enter the other three numbers in your PIN. For more information, see [Setting a new PIN](#) on page 74. The channel scan starts after you enter your PIN.
- You can press **EXIT** to stop the auto channel search, but you will need to run the auto channel search again to create a channel list.

- 5 When the scan is complete, press **EXIT** to close the menu. Your TV tunes to the first scanned channel.

Manually adding channels to the channel list

Channels with weak signals may not be added to the channel list when you scan for channels. You can manually add a channel to the channel list if you know the channel number.

- 1 Press **MENU**, press **▲** or **▼** to highlight **Installation**, then press **OK**.

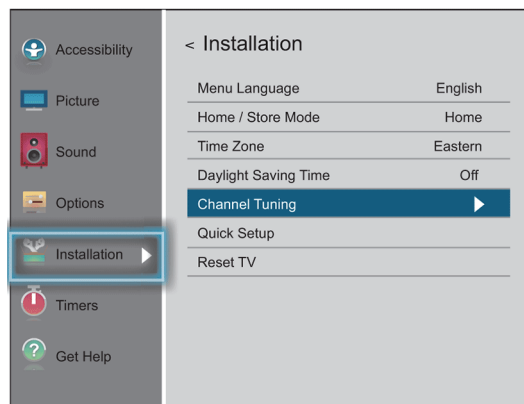

2 Highlight **Channel Tuning**, then press **OK**.

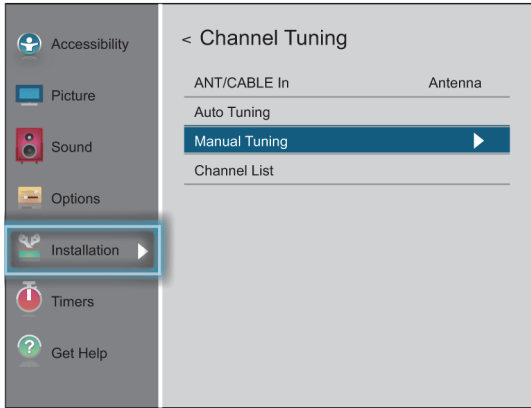

3 Highlight **Manual Tuning**, then press **OK**.

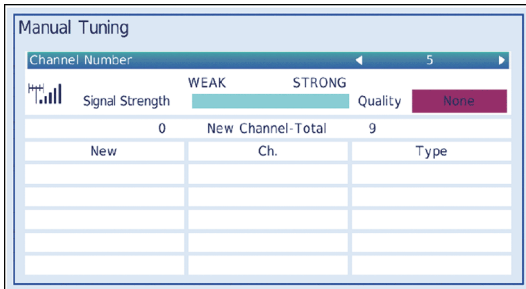

4 Use the number buttons on the virtual remote control to enter the channel number, then press **OK**. See [Virtual Remote control](#) on page 21.

OR

Press **◀** or **▶** to select previous or next channel, then press **OK**.

5 Press **OK** to start manual tuning.

6 Press **EXIT** to close the menu.

Hiding channels

You can hide channels in the channel list. When you press **CH+** or **CH-**, your TV skips the hidden channels. You can still tune to a hidden channel by pressing the number buttons on the virtual remote control for the channel. If you tune to a hidden channel, the channel appears in the *History* list.

1 Press **MENU**, press **▲** or **▼** to highlight **Options**, then press **OK**.

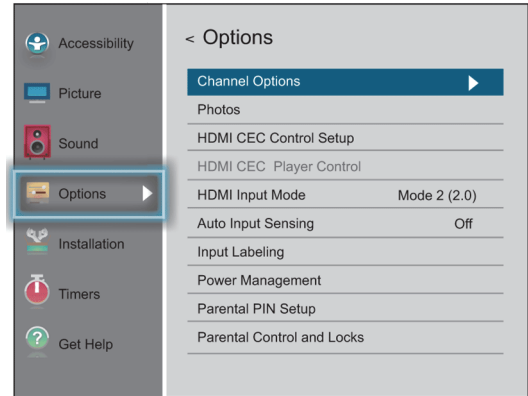

2 Highlight **Channel Options**, then press **OK**.



3 Highlight a channel you want to hide, then press **OK**. A check appears in the box next to the channel.

Notes

- Channels labeled ATV are analog channels. Channels labeled DTV are digital channels.
- To un-hide a channel, highlight the channel, then press **OK** to remove the check.
- You can also lock specific channels so that they cannot be tuned until you unlock them. See [Locking channels](#) on page 78.

4 Press **EXIT** to close the menu.

Setting parental controls

Parental controls let you prevent your children from watching inappropriate material on TV. When set, parental controls read the rating of the program (with some exceptions, such as news and sports) and deny access to programs that exceed the ratings level you select.

Parental controls let you:

- Set ratings for TV programs and movies so you can prevent your children from watching inappropriate material on TV
- Lock video input sources
- Set a timer to limit how long you can play a game

Note

To watch blocked programs, you must enter a PIN.

Parental control topics include:

- Setting a new PIN
- Changing or deleting the PIN
- Blocking TV programs and movies (for USA region)
- Downloading rating information (for USA region)
- Temporarily unlocking programs
- Locking video inputs
- Locking channels
- Setting the GameTimer™

Setting a new PIN

A PIN is necessary for some menus. The *Parental Control and Locks* menu is grayed out if no PIN has been set.

- 1 Press **MENU**, press **▲** or **▼** to highlight **Options**, then press **OK**.

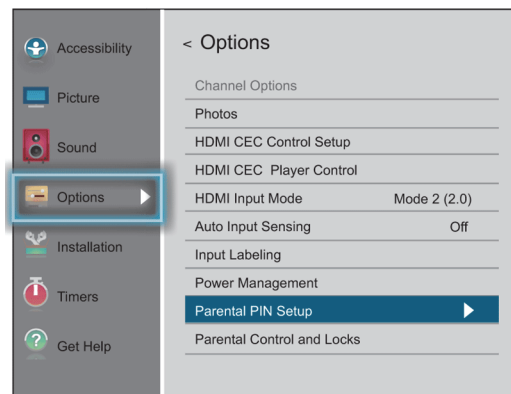

- 2 Highlight **Parental PIN Setup**, then press **OK**.



- 3 Press **◀** or **▶** on the number bar at the bottom of the screen to select a number, then press **OK**. Repeat this step to enter the other three numbers in your PIN.

After you enter the fourth number, a confirmation screen opens.

- 4 Enter your PIN again to confirm, then press **OK**. The *Parental PIN Setup* menu opens.
- 5 Press **EXIT** to close the menu.

Note

If you have set a PIN, the *Locks Active* screen opens where you enter your PIN. If you forget your PIN, highlight **Cancel** or **Done** on the *Locks Active* screen, then press **INFO** four times within five seconds. Your PIN is cleared and the *Lock System* screen opens where you can enter a new PIN.

Changing or deleting the PIN

- 1 Press **MENU**, press **▲** or **▼** to highlight **Options**, then press **OK**.

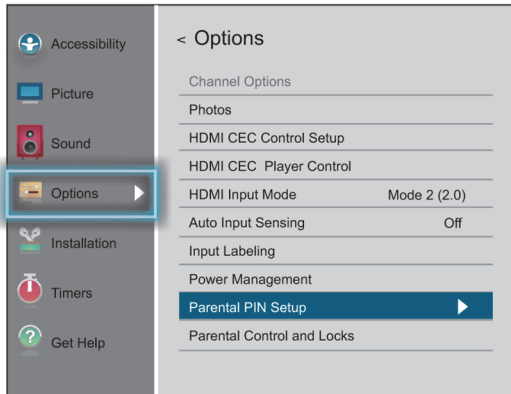

- 2 Highlight **Parental PIN Setup**, then press **OK**.

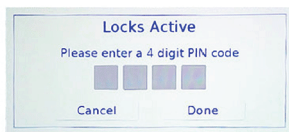

- 3 Press **◀** or **▶** on the number bar at the bottom of the screen to select a number, then press **OK**. Repeat this step to enter the other three numbers in your PIN.

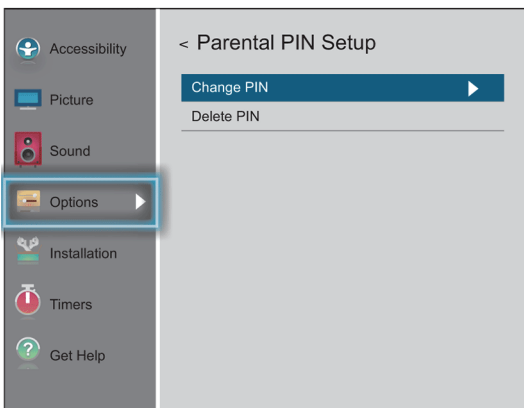

- 4 Highlight **Change PIN** or **Delete PIN**, then press **OK**.
- 5 If you select **Change PIN**, enter your new PIN, then enter it again.
OR
If you select **Delete PIN**, press **◀** or **▶** to select **Yes**, then press **OK**.
- 6 Press **EXIT** to close the menu.

Blocking TV programs and movies (for USA region)

Some TV programs and movies include ratings that classify the content of the program as unsuitable for younger viewers. Your TV detects the ratings and blocks the programs and movies according to the ratings you select.

Notes

- You must create a PIN before you can block TV programs and movies. See [Setting a new PIN](#) on page 74.
- To view a program or movie rating, tune to the program or movie, then press **INFO**.

TV rating levels

U.S. TV ratings	
TV-Y	Suitable for all children.
TV-Y7	Suitable for children 7 and older.
TV-Y7FV	Note: Programs in which fantasy violence may be more intense or more combative than other programs in this category are designated TV-Y7FV.
TV-G	General audiences
TV-PG	Parental guidance suggested. May contain: <ul style="list-style-type: none"> D—Some suggestive dialog L—Infrequent coarse language S—Some sexual situations V—Moderate violence
TV-14	Parental guidance strongly suggested. May contain: <ul style="list-style-type: none"> D—Intensely suggestive dialog L—Strong, coarse language S—Intense sexual situations V—Intense violence
TV-MA	Mature audiences only. May contain: <ul style="list-style-type: none"> L—Crude or indecent language S—Explicit sexual activity V—Graphic violence

Movie rating levels

U.S. movie (MPAA) ratings	
G	General audiences (Appropriate for all ages)
PG	Parental guidance suggested
PG-13	Parents Strongly Cautioned (Some material may be inappropriate for children under 13)
R	Restricted (Under 17 requires accompanying parent or adult)
NC-17	Not suitable for children under 17
X	Adults only
None Rated	Content is not rated. Selecting this option may block emergency messages.

- 1 Press **MENU**, press **▲** or **▼** to highlight **Options**, then press **OK**.

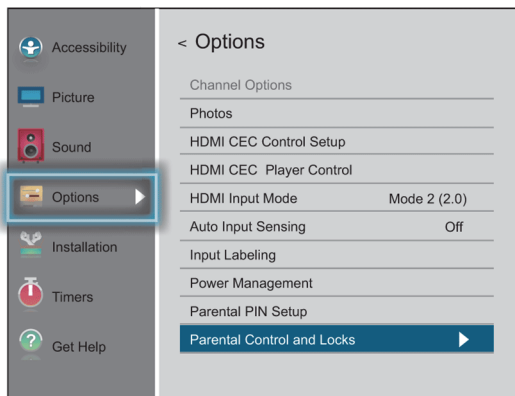

- 2 Highlight **Parental Control and Locks**, then press **OK**.



- 3 Press **◀** or **▶** on the number bar at the bottom of the screen to select a number, then press **OK**. Repeat this step to enter the other three numbers in your PIN.

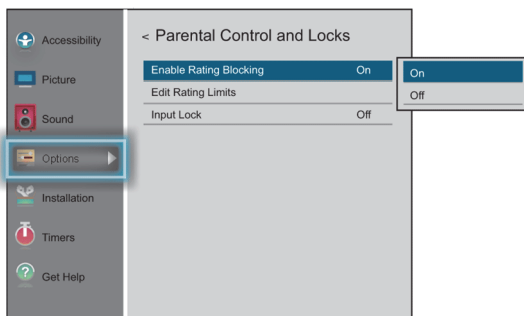

- 4 Highlight **Enable Rating Blocking**, then press **OK**.
- 5 Highlight **On**, then press **OK**.

- 6 Press **▼** to highlight **Edit Rating Limits**, then press **OK**.

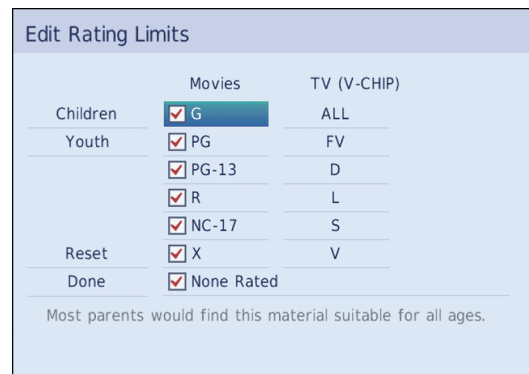

- 7 Press **▲** **▼** **◀** or **▶** to highlight a rating then press **OK**.

Notes

- As you highlight a rating, a definition for the rating appears at the bottom of the screen.
- A blocked rating has a check mark next to it.

- 8 When you have finished, highlight **Done**, then press **OK** to save your changes.
- 9 Press **EXIT** to close the menu.

Downloading rating information (for USA region)

In the future, an additional rating system may become available for use in selectively blocking TV programs and movies.

The currently tuned station must be receiving a digital signal before an additional rating system can be downloaded.

- 1 Tune to the channel you want to download ratings for.
- 2 Press **MENU**, press **▲** or **▼** to highlight **Options**, then press **OK**.

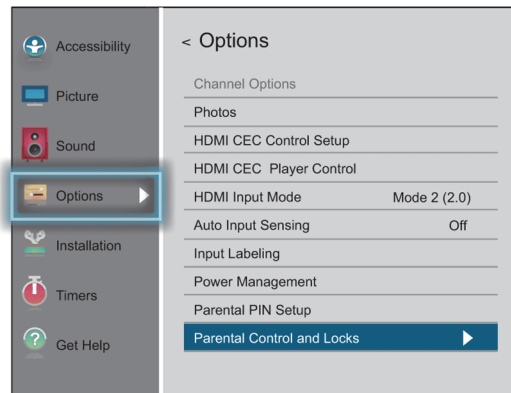

- Highlight **Parental Control and Locks**, then press **OK**.



- Press **◀** or **▶** on the number bar at the bottom of the screen to select a number, then press **OK**. Repeat this step to enter the other three numbers in your PIN.

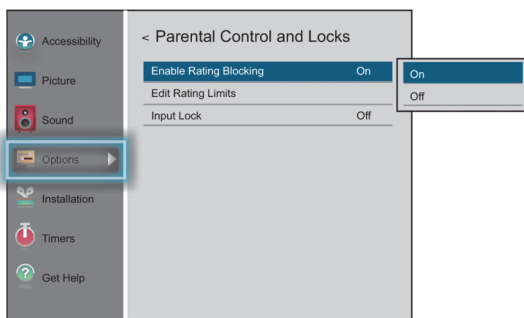

- Highlight **Enable Rating Blocking**, then press **OK**.
- Highlight **On**, then press **OK**.
- Press **▼** to highlight **Edit Rating Limits**, then press **OK**.

Edit Rating Limits		
	Movies	TV (V-CHIP)
Children	<input checked="" type="checkbox"/> G	ALL
Youth	<input checked="" type="checkbox"/> PG	FV
	<input checked="" type="checkbox"/> PG-13	D
	<input checked="" type="checkbox"/> R	L
Alt RS	<input checked="" type="checkbox"/> NC-17	S
Reset	<input checked="" type="checkbox"/> X	V
Done	<input checked="" type="checkbox"/> Noe Rated	

- Highlight **Alt RS**, then press **OK**.

Notes

- The **ALT RS** option is only available if an additional rating system is currently available.
- Your TV may take several minutes to download the additional rating system.
- The information displayed in the *Alternate Ratings* screen depends on the rating system available at the time of download.

- Press **▲ ▼ ◀ ▶** to highlight a rating then press **OK**.

Notes

- A blocked rating has an **X** next to it.
- You can only download the additional rating system one time.
- To view a program or movie rating, tune to the program or movie, then press **INFO**.
- You will not be able to download any updates to the rating system should such updates become available.
- The available rating information is controlled by the broadcaster. Content and format may vary.

- When you have finished, highlight **Done**, then press **OK**.
- Press **EXIT** to close the menu.

Temporarily unlocking programs

If you try to tune to a program that exceeds the rating limits you have set, your TV enters program lock mode and a warning message appears on the screen. You can temporarily unlock the program.

- Press **MUTE**.
- Enter your four-digit PIN, then press **OK**.

The program is unlocked and the normal picture appears. The program is locked again when you change the channel.

Locking video inputs

You can use the Input Lock option to lock the video inputs (**AV**, **HDMI 1**, **HDMI 2**, and **HDMI 3**).

- 1 Press **MENU**, press **▲** or **▼** to highlight **Options**, then press **OK**.

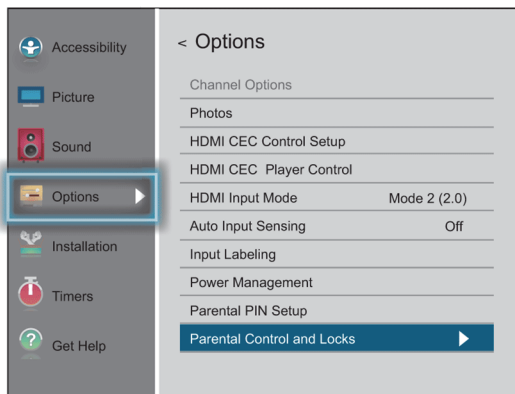

- 2 Highlight **Parental Control and Locks**, then press **OK**.

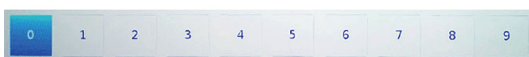

- 3 Press **◀** or **▶** on the number bar at the bottom of the screen to select a number, then press **OK**. Repeat this step to enter the other three numbers in your PIN.

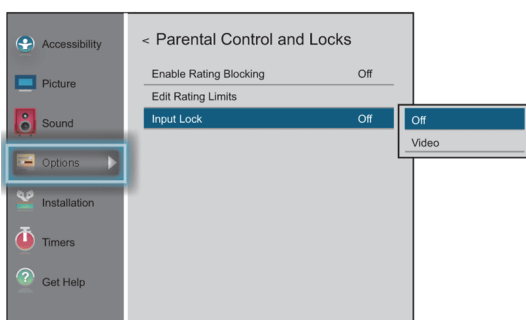

- 4 Press **▼** to highlight **Input Lock**, then press **OK**.
- 5 Highlight a video input locking level, then press **OK**. You can select:
 - **Video**—Locks **AV**, **HDMI 1**, **HDMI 2**, and **HDMI 3**.
 - **Off**—Unlocks all video inputs.
- 6 Press **EXIT** to close the menu.

Locking channels

Note

You must create a PIN before you can block channels. See [Setting a new PIN](#) on page 74.

- 1 Press **MENU**, press **▲** or **▼** to highlight **Options**, then press **OK**.

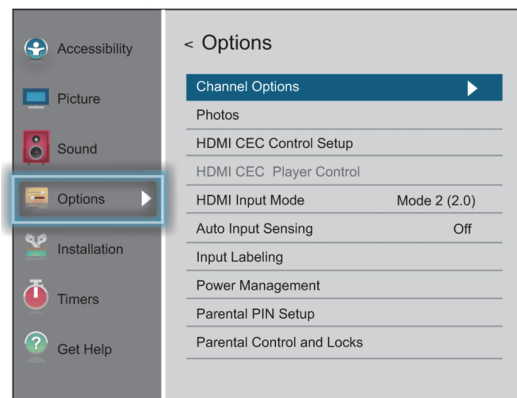

- 2 Highlight **Channel Options**, then press **OK**.



- 3 Press **◀** or **▶** on the number bar at the bottom of the screen to select a number, then press **OK**. Repeat this step to enter the other three numbers in your PIN.



- 4 Highlight a channel, press ◀ or ▶ to move to the column with the padlock icon, then press **OK**.

Notes

- Channels labeled ATV are analog channels.
- Channels labeled DTV are digital channels.

Note

To unlock a channel, highlight the channel, then press **OK** to remove the check.

- 5 Press **EXIT** to close the menu.

Setting the GameTimer™

You can use the GameTimer™ to set a time limit for playing a video game (30–120 minutes). When the GameTimer expires, your TV locks out the input source for the video game device.

- 1 Press **MENU**, press ▲ or ▼ to highlight **Timers**, then press **OK**.

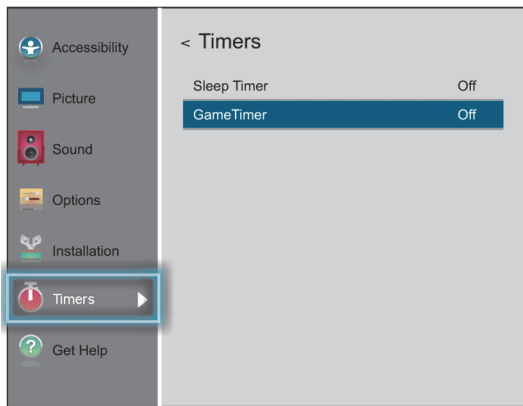

- 2 Highlight **Game Timer**, then press **OK**.

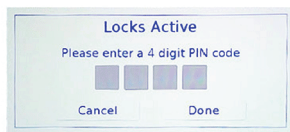

- 3 Press ◀ or ▶ on the number bar at the bottom of the screen to select a number, then press **OK**. Repeat this step to enter the other three numbers in your PIN.

- 4 Highlight the amount of time you want to let the game run before it turns off, then press **OK**. You can select **Off**, **30 min**, **60 min**, **90 min**, or **120 min**.

Note

To turn off the game timer, select **Off**.

- 5 Press **EXIT** to close the menu.

Notes

- A message appears when 10 minutes, 3 minutes, and 1 minute are remaining.
- If your TV loses power with time remaining, your TV enters input lock mode when power is restored (as if the GameTimer had been activated). To resume use, you must deactivate the input lock. See [Locking video inputs](#) on page 78.

Using closed captioning

Closed captioning displays a text version of the TV program audio or displays information provided by the broadcaster.

Closed caption controls include:

- [Turning closed captioning on or off](#)
- [Selecting the analog closed captioning mode](#)
- [Selecting the closed captioning mode with the CCD button](#)
- [Customizing digital closed captioning settings](#)

Turning closed captioning on or off

Note

You may not see closed captioning when:

- A program or video has been dubbed
- Signal reception is weak or non-standard

- 1 Press **MENU**, press ▲ or ▼ to highlight **Accessibility**, then press **OK**.

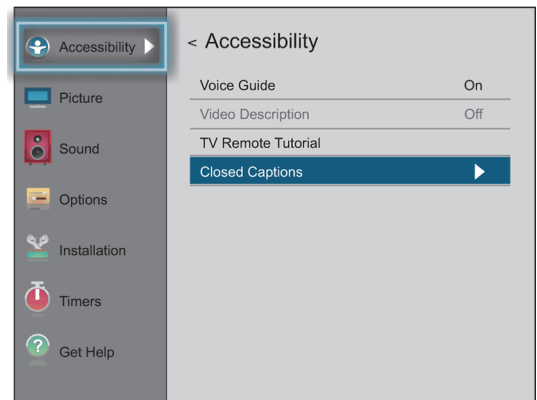

2 Highlight **Closed Captions**, then press **OK**.

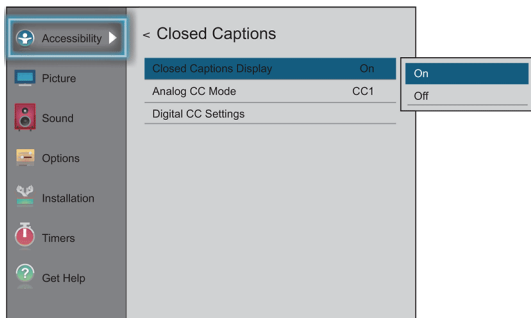

2 Highlight **Closed Captions**, then press **OK**.

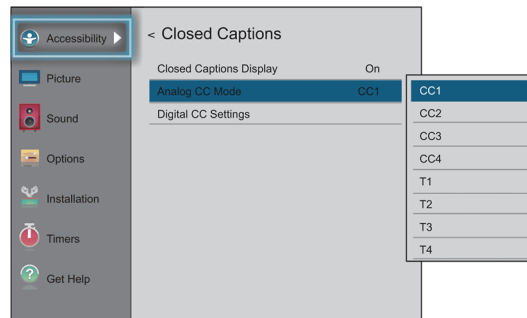

3 Highlight **Closed Captions Display**, then press **OK**.

4 Highlight **On** (turns on closed captioning) or **Off** (turns off closed captioning), then press **OK**.

5 Press **EXIT** to close the menu.

Note

You can also press **CCD** to turn closed captioning on or off.

3 Highlight **Analog CC Mode**, then press **OK**.

4 Highlight an analog captioning mode, then press **OK**. You can select:

- **CC1** through **CC4**—Closed captioning appears in a small banner across the bottom of the screen. **CC1** is usually the “printed” version of the audio. **CC2** through **CC4** display content provided by the broadcaster.
- **T1** through **T4**—Closed captioning covers half or all of the screen. **T1** through **T4** display content provided by the broadcaster.

5 Press **EXIT** to close the menu.

Notes

If the program or video you are watching does not have closed captioning, no captions are displayed.
If **T1** through **T4** is not available in your area, a black rectangle may appear.

Selecting the analog closed captioning mode

Analog channels usually have one or more closed captioning modes. The CC1 mode usually displays a text version of the TV program audio in a small banner. The other CC modes display information provided by the broadcaster. The Text modes display information in a box that covers half of the screen.

1 Press **MENU**, press **▲** or **▼** to highlight **Accessibility**, then press **OK**.

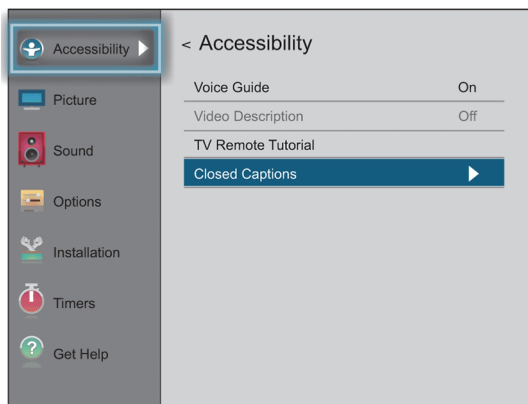

Selecting the closed captioning mode with the CCD button

Press **CCD**. The CC bar appears:

- If you are tuned to an analog channel (or a video device with a 480i signal), you can select **CC1** through **CC4**, **T1** through **T4** or **Off**.
- If you are tuned to a digital channel, the available closed captioning modes vary for digital channels.

Customizing digital closed captioning settings

- 1 Press **MENU**, press **▲** or **▼** to highlight **Accessibility**, then press **OK**.

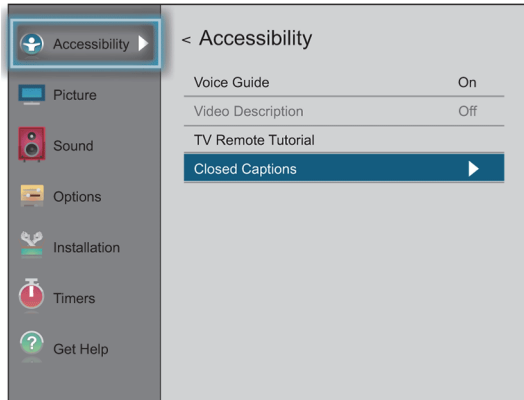

- 2 Highlight **Closed Captions**, then press **OK**.

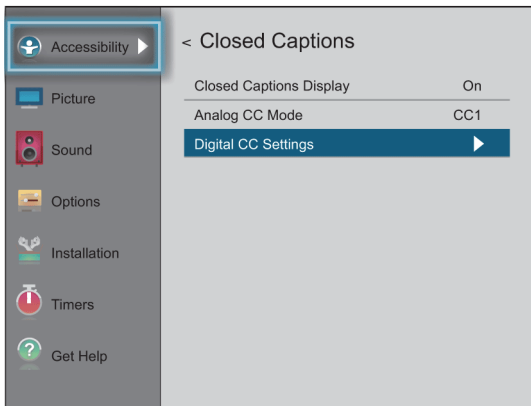

- 3 Highlight **Digital CC Settings**, then press **OK**.



- 4 Highlight an option, then press **◀** or **▶** to adjust the setting. You can select:

- **Caption Size**—Selects the font size.
- **Caption Text Type**—Selects the font type.
- **Caption Text Edge**—Selects the style of the letter edge.
- **Caption Text Color**—Selects the color for the words.
- **Text Foreground Opacity**—Selects the opacity level for the words.
- **Background Color**— Selects the color for the background.
- **Text Background Opacity**—Selects the opacity level of the background.
- **Caption Text Edge Color**—Selects the color of the letter edge.

- 5 To adjust another option, press **▲** or **▼** to highlight the option, then press **◀** or **▶** to adjust the setting.

- 6 Press **EXIT** to close the menu.

Adjusting time settings

This section includes:

- Setting the time zone and Daylight Saving Time status
- Setting the sleep timer

Setting the time zone and Daylight Saving Time status

Your TV uses the time zone and Daylight Saving Time settings to correctly display program and channel status information.

- 1 Press **MENU**, press **▲** or **▼** to highlight **Installation**, then press **OK**.

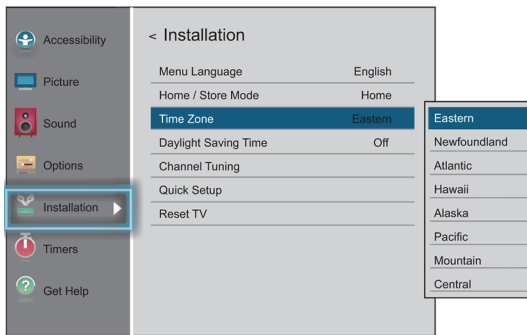

- 2 Highlight **Time Zone**, then press **OK**.
- 3 Highlight a time zone, then press **OK**. The *Installation* menu opens.

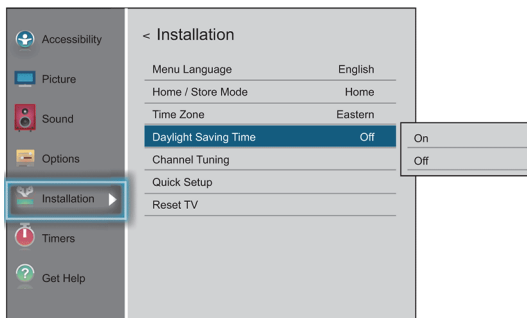

- 4 Highlight **Daylight Saving Time**, then press **OK**.
- 5 Highlight **On** (if your viewing area observes Daylight Saving Time) or **Off** (if your viewing area does not observe Daylight Saving Time), then press **OK**.
- 6 Press **EXIT** to close the menu.

Setting the sleep timer

You can specify the amount of time before your TV automatically turns off.

- 1 Press **MENU**, press **▲** or **▼** to highlight **Timers**, then press **OK**.

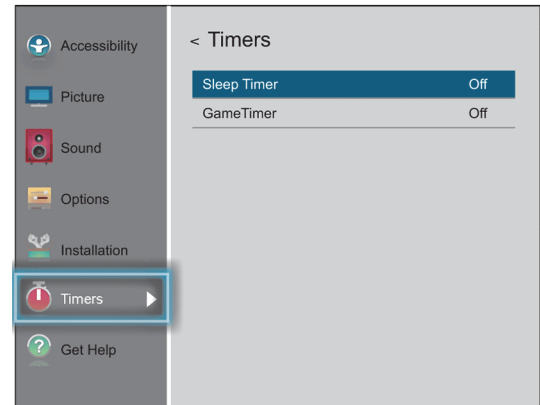

- 2 Highlight **Sleep Timer**, then press **OK**.
- 3 Press **▲** or **▼** to select the amount of time before your TV turns off automatically. You can select Off, 5, 10, 15, 30, 60, 90, 120, 150, 180, and 240 min.

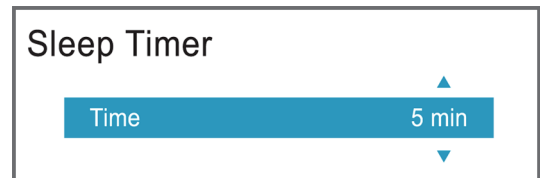

- 4 Press **EXIT** to close the menu.

Notes

- You can also press **SLEEP** to set the sleep timer.
- To display the time remaining until the TV turns off, press **SLEEP**.
- To cancel the sleep timer, press **SLEEP**, then press **▼** to select **Off**.
- If a power failure occurs, the sleep timer setting may be cleared.

Adjusting menu settings

You can adjust how the TV menus look by:

- Selecting the menu language
- Labeling a video input source

Selecting the menu language

You can choose from three different menu language settings (English, Français, and Español) for the on-screen display of menus and messages.

- 1 Press **MENU**, press **▲** or **▼** to highlight **Installation**, then press **OK**.

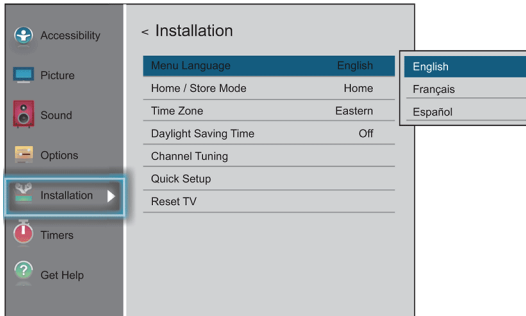

- 2 Highlight **Menu Language**, then press **OK**.
- 3 Press **▲** or **▼** to select a language, then press **OK**.
- 4 Press **EXIT** to close the menu.

Labeling a video input source

You can add a label to a video input source to make it easier to identify.

You can also hide a video input source so that it is grayed on the *Input Selection* list and your TV skips the video input source when you press **INPUT**.

- 1 Press **MENU**, press **▲** or **▼** to highlight **Options**, then press **OK**.

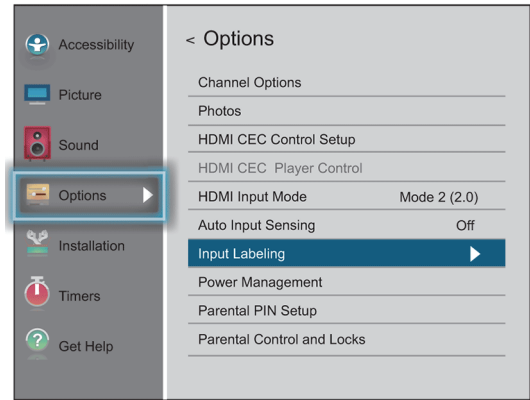

- 2 Highlight **Input Labeling**, then press **OK**.

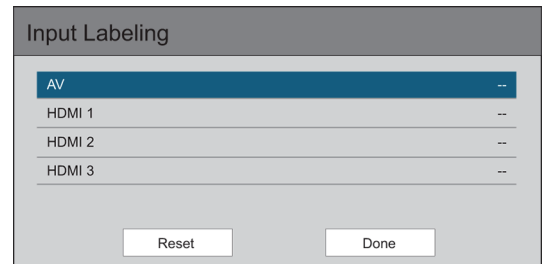

- 3 Highlight the video input source you want to label, then press **◀** or **▶** to select a label from the list.

Note
If you are not using an input, you can select **Hide** for the label. **Hide** grays the input in the *Input Selection* list and skips the input when you press **INPUT** on the remote control.

- 4 Repeat steps 2 and 3 to label another input.
- 5 Press **▲** or **▼** to highlight **Done**, then press **OK** to save the label.
- 6 Press **EXIT** to close the menu.

Notes
To reset the input labels to the default labels, highlight **Reset**, then press **OK**.

Turning the input sensor on or off

When the Input Sensor feature is turned on, your TV automatically detects which video jacks have devices connected to them and turned on. Your TV uses this information to determine what options you can select on the *Input Selection* list when you press **INPUT**.

- 1 Press **MENU**, press **▲** or **▼** to highlight **Options**, then press **OK**.

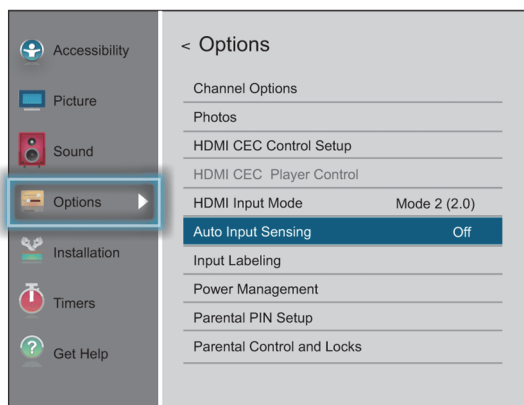

- 2 Highlight **Auto Input Sensing**, then press **OK**.
- 3 Highlight **On** or **Off**, then press **OK**.

Maintaining

- Do not use your TV in areas that are too hot or too cold, because the cabinet may warp or the screen may malfunction. Your TV works best in temperatures that are comfortable to you.
- Storage temperatures are 32° to 122°F (0° to 50°C).
- Working temperatures are 41° to 104°F (5° to 40°C).
- Do not place your TV in direct sunlight or near a heat source.

This section includes topics about:

- [Cleaning the TV cabinet](#)
- [Cleaning the TV screen](#)

Cleaning the TV cabinet

Clean the cabinet with a soft, lint-free cloth. If the cabinet is especially dirty, moisten a soft, lint-free cloth in a weak detergent solution, squeeze the excess moisture from the cloth, then wipe the cabinet with the cloth. Use a clean cloth to dry the cabinet.

Cleaning the TV screen

Clean the screen with a soft, lint-free cloth.

Troubleshooting

Use the following troubleshooting information to solve common problems.

Warning

Do not try to repair your TV yourself. Contact authorized service personnel.

Troubleshooting topics include:

- [Viewing support information](#)
- [Testing the TV speakers](#)
- [Restoring settings to the defaults](#)
- [Turning off the automatic power-off feature](#)
- [Making your TV turn on faster](#)
- [Chromecast built-in TV FAQ](#)
- [Video and audio problems](#)
- [Remote control problems](#)
- [General problems](#)
- [CEC-compatible devices problems](#)

Viewing support information

You may need to view system information during troubleshooting.

- 1 Press **MENU**, press **▲** or **▼** to highlight **Get Help**, then press **OK**.

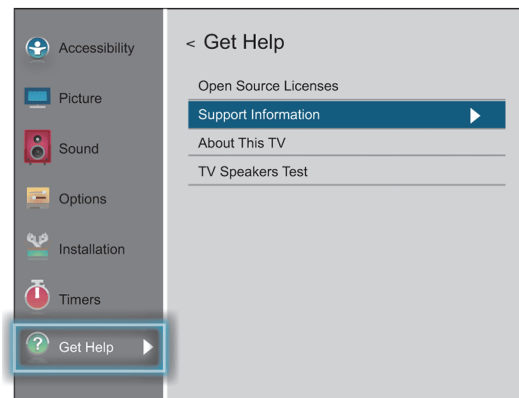

- 2 Highlight **Support Information**, then press **OK**. Your TV displays information about your system.
- 3 To close the screen and return to the *Get Help* menu, press **OK**.

OR

To close the menu, press **EXIT**.

Testing the TV speakers

You can test your TV's speakers to make sure they are working correctly.

- 1 Press **MENU**, press **▲** or **▼** to highlight **Get Help**, then press **OK**.

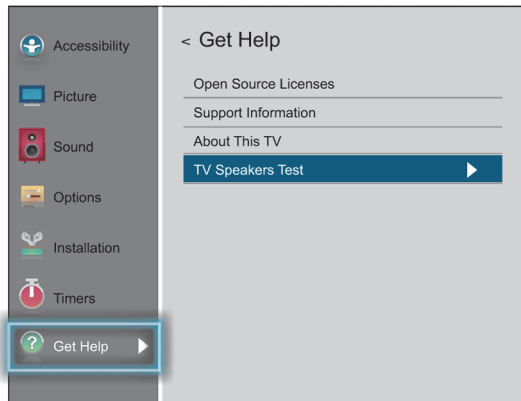

- 2 Highlight **TV Speakers Test**, then press **OK**.

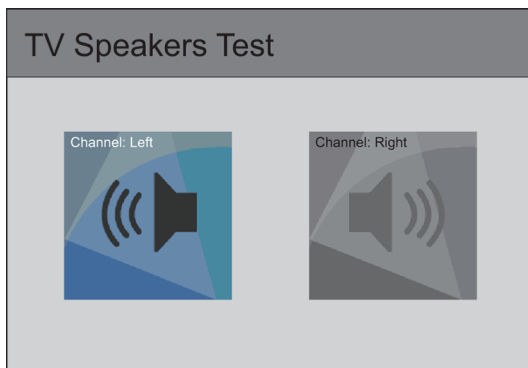

- 3 Your TV tests the left speaker, then the right speaker. You hear a voice, and as each speaker is tested, its icon is highlighted.
If one or both of the speakers fail the test, see [Video and audio](#) on page 88.

Restoring settings to the defaults

When you restore default settings, all the settings you have customized are reset.

- 1 Press **MENU**, press **▲** or **▼** to highlight **Installation**, then press **OK**.

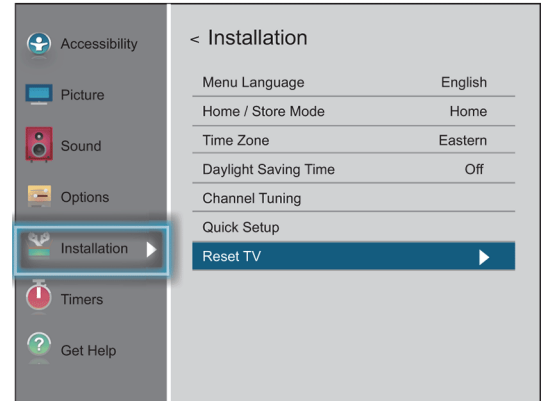

- 2 Press **▲** or **▼** to highlight **Reset TV**, then press **OK**.
A confirmation screen opens.

Note
If you have created a PIN, press **◀** or **▶** on the number bar at the bottom of the screen to select a number, then press **OK**. Repeat this step to enter the other three numbers in your PIN.

- 3 Highlight **Yes**, (to reset) or **No** (to not reset), then press **OK**.
If you select **Yes**, your TV turns off, then turns on again. Complete the *Initial Setup* wizard and set up the **ANT / CABLE IN** jack. For more information, see [Turning on your TV for the first time](#) on page 44 and [Setting up the ANT / CABLE IN jack](#) on page 54.
OR
If you do not want to reset your TV to the factory defaults, highlight **No**, then press **OK**.

Turning off the automatic power-off feature

Your TV automatically turns off after 15 minutes when no video signal is detected.

You might want to change this setting to **Off** if:

- The incoming signal for an analog channel is too weak for your TV to detect.
- You connected an audio-only device (such as a CD player) to the **AUDIO L** and **R** jacks to listen to music through the TV speakers.

- 1 Press **MENU**, press **▲** or **▼** to highlight **Options**, then press **OK**.

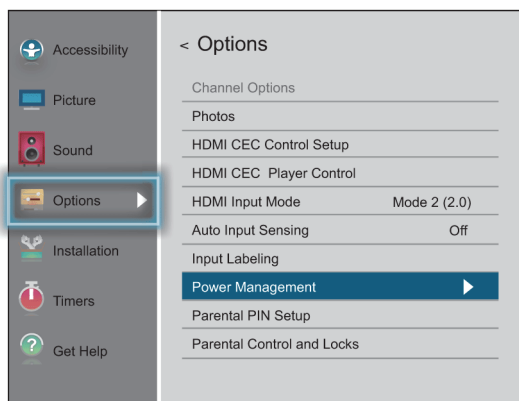

- 2 Highlight **Power Management**, then press **OK**.

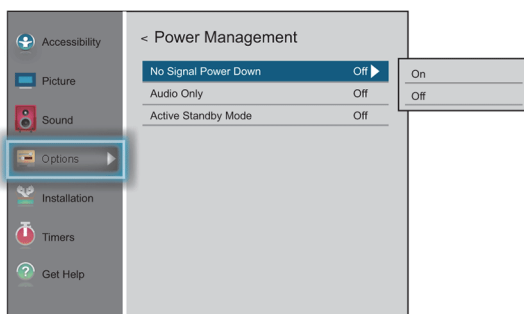

- 3 Highlight **No Signal Power Down**, then press **OK**.
- 4 Press **▲** or **▼** to select **On** or **Off**, then press **OK**.
- 5 Press **EXIT** to close the menu.

Making your TV turn on faster

When you turn off your TV, it normally goes into a power savings mode to conserve energy. When you turn your TV back on, it takes several seconds to exit the power saving mode and display a picture.

You can turn on your TV faster by bypassing the power savings mode. When the **Active Standby Mode** option is set to **On**, your TV turns on faster and links to Google Home faster.

Note

When using Active Standby Mode, your TV uses more power.

- 1 Press **MENU**, press **▲** or **▼** to highlight **Options**, then press **OK**.

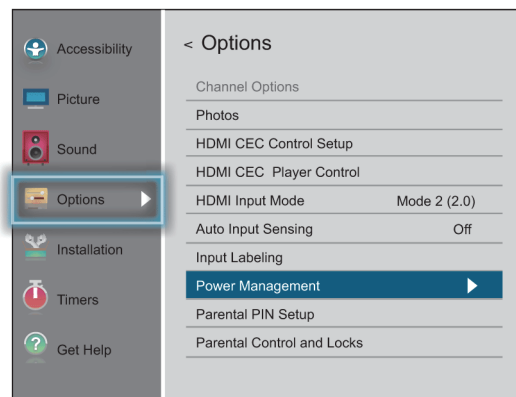

- 2 Highlight **Power Management**, then press **OK**.

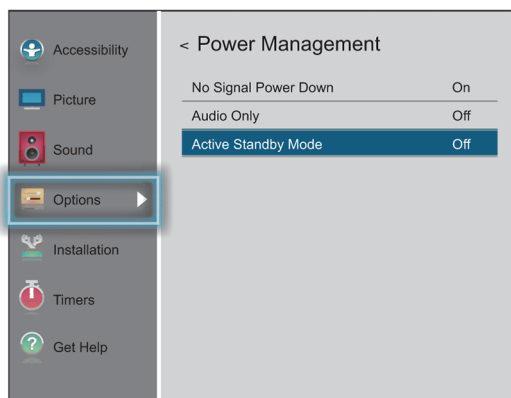

- 3 Highlight **Active Standby Mode**, then press **OK**.
- 4 Highlight **On** (to turn on the power savings mode or **Off** (to turn off the power savings mode), then press **OK**.

Chromecast built-in TV FAQ

Problem	Solution
My TV will not connect to the network.	<ul style="list-style-type: none"> • Make sure your router's firewall is configured to accept new devices. See your router's documentation for more information. If you are renting a router, you may need to contact your ISP. If you are on a private network, such as a university network, you may need to contact your network administrator. • You may have entered incorrect information during setup. Reset your TV, then set up your TV again. See Restoring settings to the defaults on page 85.
How do I prevent others from casting to my TV?	<ul style="list-style-type: none"> • By design, anyone who has access to your Wifi network can cast to your TV. This makes devices with Chromecast built-in great for sharing videos between friends! If you want to prevent people from casting to your TV, make sure that your Wifi network is password protected and only give out the password to people you trust.

Problem	Solution
I see the error "No Cast Devices Found."	<ul style="list-style-type: none"> • Make sure that your TV and mobile device are set up correctly and connected to Wifi. You should see Chromecast on your TV, with its assigned name and the current time, and a photo slideshow playing. • Try casting from the Google Home app to see if the device is correctly connected or requires setup. • If you're using an iOS device, turn on Bluetooth when setting up your TV. • Try rebooting your Wifi router by unplugging the power cord and turning off your TV. Plug your router back in and turn on your TV. • Try uninstalling and reinstalling the Google Home app. • Certain operating system settings and installed applications can conflict with the use of Chromecast built-in. If other devices (such as phones or tablets) are also unable to cast successfully, the problem is likely an issue with your router or network. <ul style="list-style-type: none"> • Try rebooting your Wifi router by unplugging the power cord, then plugging it back in. • Make sure that Chromecast built-in, your TV, and your mobile device are connected to the same network. After Chromecast built-in starts, the network name displayed on your TV should be the same network name selected in your mobile device's available Wifi list. • Make sure that firewall and antivirus software on your router are up-to-date and are not blocking connections to Google Chromecast. If you are renting a router, contact your Internet service provider about firewall settings. If you purchased the router, check your network firewall settings.

Problem	Solution
Content is cut off when casting.	<ul style="list-style-type: none"> Try changing the picture size on your mobile device to a lower resolution. The full screen mode is optimized for screens with 16:9 aspect ratio. To change this, go to the Cast settings page.
Audio and video are out of sync.	<ul style="list-style-type: none"> Restart your TV and mobile device, then try again. Try decreasing the distance between your TV, router, and mobile device.
I don't see the Cast button in the youtube.com player.	<ul style="list-style-type: none"> Make sure your TV is connected to your Wifi network and make sure that Chromecast built-in is set up on your mobile device and the device is connected to the same network. Disconnect from a Virtual Private Network (VPN) or proxy server, if applicable. Chromecast built-in cannot communicate with your TV over these networks.
The YouTube video quality keeps changing throughout the video.	<ul style="list-style-type: none"> Because YouTube uses adaptive bitrate streaming, videos may appear at lower quality at first but quickly switch to the highest possible quality after a few seconds. <p>Note: Not all videos on YouTube are available in HD. Videos recorded in SD play in the same quality it was recorded. If the video does not buffer at playback speed, the video is downgraded to a lower quality allowing for smoother playback.</p>
Netflix.com does not cast.	<ul style="list-style-type: none"> Make sure that your TV is connected to your Wifi network and make sure that you set up Chromecast built-in on your mobile device and connected the device to the same network. Disconnect what you're currently casting from Netflix. Try casting again. Disconnect from a Virtual Private Network (VPN) or proxy server, if applicable over these networks. If you are seeing an error, such as Error 16003 or 16001, try setting up and casting from another mobile device.

Video and audio

Problem	Solution
Picture does not fill the screen. There are black bars around the picture.	<ul style="list-style-type: none"> Change the picture size (aspect ratio). See Adjusting the picture size on page 67.
No picture (screen is not lit) and no sound.	<ul style="list-style-type: none"> Press ⏻ on the TV or the remote control. Make sure that the Audio Only option is set to Off. See Playing TV audio only on page 71. Make sure that the video cables are connected correctly and securely to your TV. Adjust the contrast and brightness. See Adjusting the TV picture on page 65. Make sure that the power cord is plugged into a working outlet. Press INPUT and make sure that the correct video input source is selected. See Selecting the video input source on page 55. Try another channel. The station may be experiencing problems. Make sure that the incoming signal is compatible. Make sure that the antenna or cable TV is connected correctly and securely. See Connecting a cable or satellite box on page 24 or Connecting an antenna or cable TV (no box) on page 28. Check the closed caption settings. Some TEXT modes can block the screen. See Using closed captioning on page 79.

Problem	Solution
Dark, poor, or no picture (screen is lit), but sound is good.	<ul style="list-style-type: none"> • Try another channel. The station may be experiencing problems. • Make sure that the antenna or cable TV is connected correctly and securely. See Connecting a cable or satellite box on page 24 or Connecting an antenna or cable TV (no box) on page 28. • Adjust the brightness. See Adjusting the TV picture on page 65. • If you are using an antenna and the signal strength is low, adjust the antenna or use a highly directional outdoor antenna or set-top antenna with a built-in amplifier. • Make sure that the video cables are connected correctly and securely to your TV. • The video cable(s) you are using may be bad. Try a new set.
No color, dark picture, or color is not correct.	<ul style="list-style-type: none"> • Try another channel. The station may be experiencing problems. • Adjust the color settings. See Adjusting the TV picture on page 65. • Make sure that the video cables are connected correctly and securely to your TV. • Make sure that the antenna or cable TV is connected correctly and securely. See Connecting a cable or satellite box on page 24 or Connecting an antenna or cable TV (no box) on page 28. • If you are using an antenna and the signal strength is low, adjust the antenna or use a highly directional outdoor antenna or set-top antenna with a built-in amplifier.
Only snow (noise) appears on the screen.	<ul style="list-style-type: none"> • Try another channel. The station may be experiencing problems. • Make sure that the antenna or cable TV is connected correctly and securely. See Connecting a cable or satellite box on page 24 or Connecting an antenna or cable TV (no box) on page 28. • If you are using an antenna and the signal strength is low, adjust the antenna or use a highly directional outdoor antenna or set-top antenna with a built-in amplifier.

Problem	Solution
Picture quality is good on some channels and poor on others. Sound is good.	<ul style="list-style-type: none"> • The problem may be caused by a poor or weak signal from the broadcaster or cable TV provider. • If you connect to cable without a set-top box and experience poor picture quality, you may need to install a set-top box to improve signal reception and picture quality. Contact your cable TV provider about upgrading to a set-top box.
Dotted lines or stripes appear on the screen.	<ul style="list-style-type: none"> • Make sure that the antenna or cable TV is connected correctly and securely. See Connecting a cable or satellite box on page 24 or Connecting an antenna or cable TV (no box) on page 28. • If you are using an antenna and the signal strength is low, adjust the antenna or use a highly directional outdoor antenna or set-top antenna with a built-in amplifier. • Make sure that the video cables are connected correctly and securely to your TV. • The video cable(s) you are using may be bad. Try a new set. • Other devices (for example, a surround sound receiver, external speakers, fans, or hair dryers) may be interfering with your TV. Try turning off one device at a time, then back on to determine which device is causing interference. After you have determined which device is causing interference, move it further from the TV to eliminate the interference.
Double images.	<ul style="list-style-type: none"> • Use a highly directional outdoor antenna, cable TV, or satellite TV.
The picture has a few bright or dark spots.	<ul style="list-style-type: none"> • A few bright or dark spots on an LCD screen is normal. It does not affect the operation of your TV.

Problem	Solution
Video description or voice guide does not work.	<ul style="list-style-type: none"> • Make sure that your TV is not muted and the volume is turned up. • Make sure that the options listed under the Accessibility menu are turned on. See Adjusting accessibility settings on page 64. • Video descriptions are not available on all broadcasts. • Some remote functions are not narrated.
Good picture, but no sound.	<ul style="list-style-type: none"> • Increase the volume. • Make sure that the sound is not muted. • Make sure that you do not have headphones connected. When headphones are connected, the TV speakers are muted. • Make sure that the TV Speakers option on the <i>Sound</i> menu is not set to Off. • If you are using a home theater system, soundbar, or external speaker system, make sure it is turned on and is not muted. • If you are using a home theater system, soundbar, or external speaker system, make sure that you have selected the correct output mode. • If you are using a home theater system, soundbar, or external speaker system and have connected it with a digital optical cable, go to the <i>Sound</i> menu, highlight Digital Audio Output, then press OK. Highlight Audio Format, then press OK. Press ▲ or ▼ to select PCM, then press OK. See the Digital Audio Output option in Adjusting sound settings on page 70. • Make sure that the audio cables are connected correctly and securely to your TV. • Make sure that the antenna or cable TV is connected correctly and securely. See Connecting a cable or satellite box on page 24 or Connecting an antenna or cable TV (no box) on page 28. • The audio cables you are using may be bad. Try a new set.

Problem	Solution
Poor picture.	<ul style="list-style-type: none"> • Make sure that the room is not too bright. Light reflecting off the screen can make the picture difficult to see. • If an S-VHS camera or a camcorder is connected while another connected device is turned on, the picture may be poor. Turn off one or more devices.
Good sound, but poor color.	<ul style="list-style-type: none"> • Adjust the contrast, color, and brightness settings. See Adjusting the TV picture on page 65.
Audio noise.	<ul style="list-style-type: none"> • Other devices (for example, a surround sound receiver, external speakers, fans, or hair dryers) may be interfering with your TV. Try turning off one device at a time to determine which device is causing interference. After you have determined which device is causing interference, move it further from the TV to eliminate the interference.
No output from one of the speakers.	<ul style="list-style-type: none"> • Adjust the audio balance. See Adjusting sound settings on page 70. • Make sure that the audio cables are connected correctly and securely to your TV.
After images appear.	<ul style="list-style-type: none"> • Do not display a still image, such as a logo, game, or computer image, for an extended period of time. This can cause a permanent after-image to be burned into the screen. This type of damage is not covered by your warranty.

Remote control

Problem	Solution
Remote control does not work.	<ul style="list-style-type: none"> • Make sure that the power cord is plugged into a working outlet. • Make sure that there are no obstructions between the remote control and the remote control sensor on the front of the TV. • Point the remote control directly at the remote control sensor on your TV. For the location of the remote control sensor, see Aiming the remote control on page 42. • The supplied batteries are wrapped tightly in clear plastic. Make sure that you have removed this plastic from the batteries. • Make sure that the batteries are installed correctly. See Installing remote control batteries on page 42. • Replace dead batteries with new batteries. See Installing remote control batteries on page 42.

General

Problem	Solution
No power.	<ul style="list-style-type: none"> • Make sure that the power cord is plugged into a working outlet. • Unplug the power cord, wait 60 seconds, then plug the cord back in and turn on your TV. • Other devices (for example, a surround sound receiver, external speakers, fans, or hair dryers) may be interfering with your TV. Try turning off one device, at a time, then turning on your TV to determine which device is causing interference. After you have determined which device is causing interference, move it further from the TV to eliminate the interference.
"No video" error message is displayed.	<ul style="list-style-type: none"> • Press INPUT and make sure that you have selected the correct input for the device or service you are trying to use. • If you are using a cable or satellite box, use the remote that came with that box to change channels.

Problem	Solution
After Auto Channel Search, there are no channels.	<ul style="list-style-type: none"> • Reception can vary by channel depending on the broadcast power level of a given station. Contact your cable or satellite TV provider. • Make sure that the antenna or cable/satellite TV is connected securely to your TV. • Try replacing the cable between the antenna/cable or cable/satellite box and your TV.
When I press INPUT , I cannot select my device (it is grayed out).	<ul style="list-style-type: none"> • Make sure that the video input source for the device is not hidden. See Labeling a video input source on page 83. • Make sure that the video input sources are not locked. See Locking video inputs on page 78.
One or more channels do not display.	<ul style="list-style-type: none"> • Make sure that the channels are not blocked. See Locking channels on page 78. • Make sure that the channels are not hidden. The channel may have been deleted from the channel list. You can tune to the channel by pressing the number buttons on the virtual remote control or you can add the channel back to the channel list. See Hiding channels on page 73. • If you are using a cable or satellite box, use the remote that came with that box to change channels. • Press INPUT and make sure that you have selected the correct input for the device or service you are trying to use.
Password is lost.	<ul style="list-style-type: none"> • If you forget your PIN, open the screen where you enter your PIN, highlight Cancel or Done, then press INFO four times within five seconds. The PIN is cleared and you can enter a new PIN. See Setting a new PIN on page 74.
Some settings cannot be accessed.	<ul style="list-style-type: none"> • If a setting is grayed, the setting is not available in the current video input mode (for example TV mode). Change to a different video input source. See Selecting the video input source on page 55.

Problem	Solution
TV cabinet creaks.	<ul style="list-style-type: none"> When the TV is in use, the temperature rises naturally and may cause the cabinet to expand or contract which can cause a creaking noise. This is not a malfunction.
Control buttons do not work.	<ul style="list-style-type: none"> Unplug the power cord, wait a few seconds, then plug the cord back in and turn on your TV.
TV keeps turning off.	<ul style="list-style-type: none"> Make sure that the sleep timer is not turned on. See Setting the sleep timer on page 82.
A retail banner is displayed.	<ul style="list-style-type: none"> You selected Store Mode when you ran the Initial Setup wizard. Go to the <i>Installation</i> menu, highlight Store / Home Mode, then press ◀ or ▶ to select Home, then press OK.

CEC-compatible devices

Problem	Solution
My TV is not displaying the video from the connected CEC device.	<ul style="list-style-type: none"> Make sure that the HDMI cable is connected securely to your TV and the device. Make sure that the device is connected to your TV with an HDMI cable. Make sure that the device is a CEC device. See the documentation that came with the device for more information. Press INPUT and make sure that the correct video input source is selected. See Selecting the video input source on page 55. Make sure that the HDMI-CEC Control feature is turned on. See Turning HDMI-CEC Control on or off on page 59. Try adjusting the TV picture. See Adjusting the TV picture on page 65.

Problem	Solution
My TV is not playing the audio from the connected CEC device.	<ul style="list-style-type: none"> Make sure that the HDMI cable is connected securely to your TV and the device. Make sure that the device is connected to your TV with an HDMI cable. Make sure that the device is a CEC device. See the documentation that came with the device. Make sure that the TV volume is turned up and not muted. Try adjusting the TV sound. See Adjusting sound settings on page 70. Make sure that the TV speakers are turned on and not muted. See Adjusting sound settings on page 70. Make sure that the HDMI-CEC Control feature is turned on. See Turning HDMI-CEC Control on or off on page 59. If you have connected an HDMI CEC audio receiver, adjust the volume on the receiver. When your TV detects an audio receiver, the TV speakers may turn off and sound plays through receiver speakers only. If you are using a home theater system, soundbar, or external speaker system, make sure that it is turned on and is not muted. If you are using a home theater system, soundbar, or external speaker system, make sure that you have selected the correct output mode. If you are using a home theater system, soundbar, or external speaker system and have connected with a digital optical cable, go to the <i>Sound</i> menu, highlight Digital Audio Output, then press OK. Highlight Audio Format, then press OK. Press ▲ or ▼ to select PCM, then press OK. See the Digital Audio Output option in Adjusting sound settings on page 70.

Problem	Solution
My TV's remote control does not control the device.	<ul style="list-style-type: none"> • Make sure that there are no obstructions between the remote control and the remote control sensors on your TV and the device. • Depending on the device, all the buttons may not work. • Make sure that the HDMI-CEC Control feature is turned on. See Turning HDMI-CEC Control on or off on page 59. • If you are trying to control the volume on an HDMI CEC audio receiver using your TV remote control, make sure that the Amplifier Control option is set to On. See Turning Amplifier Control on or off on page 60. • The device may not support this feature. See the documentation that came with the device for more information.
The device does not show up in the list of CEC devices.	<ul style="list-style-type: none"> • Make sure that the device is turned on. • Make sure that the HDMI cable is connected securely to your TV and the device. • Make sure that the device is connected to your TV with an HDMI cable. • Make sure that the HDMI-CEC Control feature is turned on. See Turning HDMI-CEC Control on or off on page 59. • Make sure that the device is a CEC device. See the documentation that came with the device.

Problem	Solution
My device does not turn off when I turn off my TV.	<ul style="list-style-type: none"> • Make sure that the HDMI-CEC Control feature is turned on. See Turning HDMI-CEC Control on or off on page 59. • Make sure that Auto Standby is set to On. See Turning Auto Standby on or off on page 60. • The device may not support this feature. See the documentation that came with the device for more information.
My TV does not turn on when I turn on my device.	<ul style="list-style-type: none"> • Make sure that the HDMI-CEC Control feature is turned on. See Turning HDMI-CEC Control on or off on page 59. • Make sure that TV Auto Power is set to On. See Turning TV Auto Power on or off on page 59. • The device may not support this feature. See the documentation that came with the device for more information.
I cannot select the Root Menu option. OR The device's root menu does not open when I select Root Menu .	<ul style="list-style-type: none"> • The device may not support this feature. See the documentation that came with the device for more information.

Note

If the problem is not solved by using these troubleshooting instructions, turn off your TV, then turn it on again.

Specifications

Specifications are subject to change without notice.

50-inch (50L711U18/50L711M18)

Dimensions and weight

Without stand H × W × D	26.4 × 44.6 × 3.7 in. (67.1 × 113.3 × 9.4 cm) 30.6 lbs (13.9 kg)
With stand	28.3 × 44.6 × 11.1 in. (71.9 × 113.3 × 28.2 cm) 32 lbs (14.5 kg)

Screen

Screen size measured diagonally	49.5 in. (125.7 cm)
Panel	LCD
Panel backlight type	LED
Panel refresh rate	60Hz
Display resolution	2160p
Panel resolution H × V	3840 × 2160
Aspect ratio	16:9
Contrast ratio (typical)–panel	4,000:1
Comb filter	3d y/c digital
Response time	8 ms
Horizontal viewing angle	178°
Vertical viewing angle	178°

Tuner

Analog	NTSC
Digital	ATSC, 8-VSB, Clear-QAM

Inputs

HDMI	3
Composite video	1
DVI (shared with HDMI)	HDMI IN
USB	1 Supports JPEG
Antenna/Cable	1

Outputs

Analog audio/Headphone	1
Digital audio	1 (optical)
WiFi	Yes
LAN (Ethernet)	Yes

Audio

Audio enhancement	DTS Studio Sound
Speakers	Number: 2 Watts per channel: 10W

Power

Power consumption ON	109.6W
Power consumption in standby	<0.5W
Power input	120V~, 60Hz, 1.3A

Miscellaneous

OSD languages	English, French, Spanish
HDMI CEC	Yes
Game Mode	Yes
GameTimer™	Yes
Chromecast built-in	Yes
V-Chip (version 2.0)	Yes
Sleep timer	Yes
Text-to-Speech	Yes
VESA mount (mm) (hor. × ver.)	400 × 200
VESA mount screws	M6 type

Note

The length of the wall-mount screws vary depending on the wall-mount bracket you purchased. See the instructions that came with the wall-mount bracket for screw lengths.

55-inch (55L711U18/55L711M18)

Dimensions and weight

Without stand H × W × D	28.7 × 49.1 × 3.7 in. (73 × 124.7 × 9.3 cm) 32.4 lbs. (14.7 kg)
With stand	30.2 × 49.1 × 9.7 in. (76.6 × 124.7 × 24.7 cm) 33.5 lbs. (15.2 kg)

Screen

Screen size measured diagonally	54.6 in. (138.7 cm)
Panel	LCD
Panel backlight type	LED
Panel refresh rate	60Hz
Display resolution	2160p
Panel resolution H × V	3840 × 2160
Aspect ratio	16:9
Contrast ratio (typical)–panel	4,000:1
Comb filter	3d y/c digital
Response time	8 ms
Horizontal viewing angle	178°
Vertical viewing angle	178°

Tuner

Analog	NTSC
Digital	ATSC, 8-VSB, Clear-QAM

Inputs

HDMI	3
Composite video	1
DVI (shared with HDMI)	HDMI IN
USB	1 Supports JPEG
Antenna/Cable	1

Outputs

Analog audio/Headphone	1
Digital audio	1 (optical)
WiFi	Yes
LAN (Ethernet)	Yes

Audio

Audio enhancement	DTS Studio Sound
Speakers	Number: 2 Watts per channel: 10W

Power

Power consumption ON	147.3W
Power consumption in standby	<0.5W
Power input	120V~, 60Hz, 1.7A

Miscellaneous

OSD languages	English, French, Spanish
HDMI CEC	Yes
Game Mode	Yes
GameTimer™	Yes
Chromecast built-in	Yes
V-Chip (version 2.0)	Yes
Sleep timer	Yes
Text-to-Speech	Yes
VESA mount (mm) (hor. × ver.)	200 × 300
VESA mount screws	M6 type

Note

The length of the wall-mount screws vary depending on the wall-mount bracket you purchased. See the instructions that came with the wall-mount bracket for screw lengths.

Legal notices

FCC Statement

This device complies with Part 15 of the FCC Rules. Operation is subject to the following two conditions: (1) this device may not cause harmful interference, and (2) this device must accept any interference received, including interference that may cause undesired operation.

This equipment has been tested and found to comply with the limits for a Class B digital device, pursuant to Part 15 of the FCC Rules. These limits are designed to provide reasonable protection against harmful interference in a residential installation. This equipment generates, uses and can radiate radio frequency energy and, if not installed and used in accordance with the instructions, may cause harmful interference to radio communications. However, there is no guarantee that interference will not occur in a particular installation. If this equipment does cause harmful interference to radio or television reception, which can be determined by turning the equipment off and on, the user is encouraged to try to correct the interference by one or more of the following measures:

- Reorient or relocate the receiving antenna.
- Increase the separation between the equipment and receiver.
- Connect the equipment into an outlet on a circuit different from that to which the receiver is connected.
- Consult the dealer or an experienced radio/TV technician for help.

Warning

Changes or modifications not expressly approved by the party responsible for compliance could void the user's authority to operate the equipment.

Mexico IFETEL

WiFi/BT Combo module
TWCM-K007D
IFETEL ID: RCPLGTW16-0200

Cables

Connections to this device must be made with shielded cables with metallic RF/EMI connector hoods to maintain compliance with FCC Rules and Regulations.

Canadian Notice

Analog and Digital Television Receiving Apparatus - Appareil de réception de télévision analogique et numérique,
Canada BETS-7 / NTMR-7.

IC Statement

This device complies with Industry Canada licence—exempt RSS standard(s).

Operation is subject to the following two conditions: (1) this device may not cause interference, and (2) this device must accept any interference, including interference that may cause undesired operation of the device.

This equipment complies with IC radiation exposure limits set forth for an uncontrolled environment.

Dolby License Notice and Trademark Acknowledgement

 **DOLBY AUDIO**™ Manufactured under license from Dolby Laboratories. Dolby, Dolby Audio, and the double-D symbol are trademarks of Dolby Laboratories.

HDMI®

 **HDMI**® The terms HDMI and HDMI High-Definition Multimedia Interface, and the HDMI Logo are trademarks or registered trademarks of HDMI Licensing LLC in the United States and other countries.

DTS Studio Sound™

 **dts**™ For DTS patents, see <http://patents.dts.com>. Manufactured under license from DTS Licensing Limited. DTS, the Symbol, & DTS and the Symbol together are registered trademarks, and DTS Studio Sound is a trademark of DTS, Inc. © DTS, Inc. All Rights Reserved.

Open Source

This production contains Bitstream Vera Sans fonts under the following copyright:

Copyright © 2003 by Bitstream, Inc. All Rights Reserved. Bitstream Vera is a trademark of Bitstream, Inc.

For Toshiba OPEN SOURCE SOFTWARE information, refer to the Get Help – Open Source Licenses section in the on-screen display (OSD) on the TV. If you wish to receive the complete corresponding licensed source code, please refer to TV.Toshiba.com or call the Toshiba support center at 1-855-527-2411. This source code is available for a period of three (3) years from the date of the distribution of this product by Toshiba.

For Google Cast OPEN SOURCE SOFTWARE information, refer to <https://support.google.com/googlecast/answer/6121012?hl=en>.

One-year limited warranty - Toshiba Televisions

Definitions:

Best Buy ("Warrantor") warrants to you, the original purchaser of this new Toshiba-branded television ("Product"), that the Product shall be free of defects in the original manufacturer of the material or workmanship for a period of one (1) year from the date of your purchase of the Product ("Warranty Period"). For this warranty to apply, your Product must be purchased in the United States or Canada from a Best Buy authorized dealer of Toshiba brand products only that are packaged with this warranty statement.

How long does the coverage last?

The Warranty Period lasts for 1 year (365 days) from the date you purchased the Product. Your purchase date is printed on the receipt you received with the Product.

What does this warranty cover?

During the Warranty Period, if the original manufacture of the material or workmanship of the Product is determined to be defective by an authorized Warrantor repair center or store personnel, Warrantor will (at its sole option): (1) repair the Product with new or rebuilt parts; or (2) replace the Product at no charge with new or rebuilt comparable products or parts. Products and parts replaced under this warranty become the property of Warrantor and are not returned to you. If service of Products or parts are required after the Warranty Period expires, you must pay all labor and parts charges. This warranty lasts as long as you own your Toshiba Product during the Warranty Period. Warranty coverage terminates if you sell or otherwise transfer the Product.

How to obtain warranty service?

If you purchased the Product at a Best Buy retail store location and your television Product has a screen size of less than 42 inches, please take your original receipt and the Product to any Best Buy store. Make sure that you place the Product in its original packaging or packaging that provides the same amount of protection as the original packaging. If you purchased the Product from a Best Buy online web site, mail your original receipt and the Product to the address listed on the web site. Make sure that you put the Product in its original packaging or packaging that provides the same amount of protection as the original packaging.

To obtain in-home warranty service for a television with a screen 42 inches or larger, in the United States call 1-888-BESTBUY, Canada call 1-866-BESTBUY. Call agents will diagnose and correct the issue over the phone or will have an Toshiba-approved repair technician dispatched to your home.

Where is the warranty valid?

This warranty is valid only in the United States and Canada at Best Buy branded retail stores or websites to the original purchaser of the product in the county where the original purchase was made.

What does the warranty not cover?

This warranty does not cover:

- Customer instruction/education.
- Installation.
- Set up adjustments.
- Cosmetic damage.
- Damage due to acts of God, such as power surges.
- Accident(s).
- Misuse, unintentional or intentional.
- Abuse, unintentional or intentional.
- Negligence.
- Commercial purposes/use, including but not limited to use in a place of business or in communal areas of a multiple dwelling condominium or apartment complex, or otherwise used in a place of other than a private home.
- Modification of any part of the Product, including the antenna.
- Damage due to incorrect operation or maintenance.
- Connection to an incorrect voltage or power supply.

- Outages, static or other problems with over-the-air reception of the television broadcast signals.
- Attempted repair by any person not authorized by Warrantor to service the Product.
- Products sold "as is" or "with all faults."
- Consumables, including but not limited to batteries (i.e. AA, AAA, C etc.).
- Products where the factory applied serial number has been altered or removed.
- Loss or Theft of this product or any part of the product
- Failures or Damage caused by any contact including but not limited to liquids, gels or pastes.
- Up to three (3) pixel failures (dots that are dark or incorrectly illuminated) grouped in an area smaller than one tenth (1/10) of the display size or up to five (5) pixel failures throughout the display. (Pixel based displays may contain a limited number of pixels that may not function normally.)
- Problems with delay in motion or action of video images while playing first-person style video games.

REPAIR REPLACEMENT AS PROVIDED UNDER THIS WARRANTY IS YOUR EXCLUSIVE REMEDY FOR BREACH OF WARRANTY. WARRANTOR SHALL NOT BE LIABLE FOR ANY INCIDENTAL OR CONSEQUENTIAL DAMAGES FOR THE BREACH OF ANY EXPRESS OR IMPLIED WARRANTY ON THIS PRODUCT, INCLUDING, BUT NOT LIMITED TO, LOST DATA, LOSS OF USE OF YOUR PRODUCT, LOST BUSINESS OR LOST PROFITS. WARRANTOR MAKES NO OTHER EXPRESS WARRANTIES WITH RESPECT TO THE PRODUCT, ALL EXPRESS AND IMPLIED WARRANTIES FOR THE PRODUCT, INCLUDING, BUT NOT LIMITED TO, ANY IMPLIED WARRANTIES OF AND CONDITIONS OF MERCHANTABILITY AND FITNESS FOR A PARTICULAR PURPOSE, ARE LIMITED IN DURATION TO THE WARRANTY PERIOD SET FORTH ABOVE AND NO WARRANTIES, WHETHER EXPRESS OR IMPLIED, WILL APPLY AFTER THE WARRANTY PERIOD. SOME STATES, PROVINCES AND JURISDICTIONS DO NOT ALLOW LIMITATIONS ON HOW LONG AN IMPLIED WARRANTY LASTS, SO THE ABOVE LIMITATION MAY NOT APPLY TO YOU. THIS WARRANTY GIVES YOU SPECIFIC LEGAL RIGHTS, AND YOU MAY ALSO HAVE OTHER RIGHTS, WHICH VARY FROM STATE TO STATE OR PROVINCE TO PROVINCE.

Product information: www.tv.toshiba.com

Product support (855) 527-2411 For US and Canada

This product is distributed and warranted by Best Buy Purchasing, LLC

©2017 Best Buy China LTD. All rights reserved.

Toshiba is a registered trademark of Toshiba Corporation; All other trademarks are property of their respective owners.

ColorMaster, DynaLight, GameTimer, Native Mode, Stable Sound, Surflock and TheaterWide are trademarks or registered trademarks of Toshiba America Information Systems, Inc.

Chromecast is a trademark of Google inc.

One-year limited warranty - Toshiba Televisions—Mexico

Esta póliza de garantía, expedida por Best Buy Imports, S. de R.L. de C.V. (Best Buy), con domicilio en Av. Santa Fe No.440 Piso 2 OFNA 202 y 203 P3 y P4, Col. Santa Fe Cuajimalpa, C.P. 05348, Del. Cuajimalpa de Morelos, México, Ciudad De México, teléfono (01) (52) (55) 88-50-20-00 para productos de la marca **TOSHIBA** (el "Producto" o los "Productos") establece las normas y condiciones de garantía para el Producto que se describe en la siguiente tabla de Productos adquiridos por el cliente (cómo se define más adelante) en tiendas Best Buy localizadas dentro de la República Mexicana.

El tiempo de garantía aplicable a cada producto será marcado con una "x" por el vendedor en el listado que antecede al momento de su venta. El tiempo de garantía correspondiente empieza a correr a partir de la **Fecha de compra y recepción** * que se coloca al momento de su venta.

Para efectos de esta Póliza, se entenderá como Cliente, aquellos que adquieran con carácter de usuario final, cualesquiera de los Productos vendidos en las tiendas Best Buy, localizadas dentro de los Estados Unidos Mexicanos ("México").

CONCEPTOS

Mediante esta garantía, Best Buy se compromete a respaldar el Producto contra cualquier defecto de los materiales y/o mano de obra empleados en la fabricación del Producto. Asimismo, la presente garantía ampara todas las piezas y componentes de este producto. Best Buy reparará el Producto en caso de estar defectuoso, y reemplazará la pieza o componente defectuosos, sin costo para el Cliente, incluyendo la mano de obra y los gastos de transportación derivados de su cumplimiento en nuestra red de servicio que más adelante se detallará.

CONDICIONES

1. Notificación de las reclamaciones.

Solamente será necesario para ejercer la garantía, presentar el Producto y la póliza de garantía debidamente sellada por el establecimiento de Best Buy que lo vendió o se puede presentar la factura, o recibo, o el comprobante en el que consten los datos específicos del producto adquirido.

Garantía de Servicio: Si el Cliente identifica que el Producto tiene partes, componentes o materiales defectuosos, o defectos por mano de obra, deberá dar aviso con prontitud y una explicación de la reclamación a la tienda Best Buy donde adquirió su Producto y/o al centro de servicio especializado señalado en esta póliza. Todas las reclamaciones para efectos de la presente garantía deberán hacerse dentro de la vigencia de la misma. El personal especializado del centro de servicio, realizará una inspección al Producto con el fin de determinar la procedencia de la garantía. Ninguna reparación o reposición de cualquier Producto o parte del mismo se hará sin cargo fuera de la vigencia de la garantía del Producto. La garantía sobre la reparación de una falla específica así como de las partes empleadas para la misma, estará vigente por el período restante de la garantía del Producto o por un período de 90 (noventa) días contados a partir de la fecha de reparación del Producto o instalación de los repuestos, lo que resulte mayor.

Durante el período de garantía, para reparar el Producto defectuoso, el Cliente podrá llevarlo a la tienda Best Buy en que lo adquirió, o al centro de servicio especializado señalado en esta póliza. El Cliente deberá presentar el Producto defectuoso con la póliza de garantía debidamente sellada por la tienda Best Buy. Una vez reparado, Best Buy, o sus representantes, entregarán el Producto al Cliente, en la misma tienda Best Buy en la que fue reclamada la garantía. Best Buy no está obligado a proporcionar al Cliente un Producto sustituto durante el período de evaluación y en su caso de reparación en que el Producto defectuoso se encuentre en el centro de servicio autorizado.

2. Recurso exclusivo.

Aceptación: El recurso exclusivo del Cliente y la única obligación de Best Buy consiste en realizar todos los trabajos necesarios para reparar cualquier Producto que se determine como defectuoso dentro del periodo de esta garantía y proporcionar, sin cargo extra para el Cliente, los repuestos de las partes defectuosas. [En el caso de que la reparación del Producto o el reemplazo de partes no solucione el defecto, o que hayan transcurrido 30 días posteriores a la recepción del Producto para su reparación, o se hayan realizado 3 (tres) reparaciones consecutivas sobre la misma falla e incurra en una cuarta entonces y sólo en dichos casos, Best Buy substituirá el Producto defectuoso por otro igual ó de similares características, o reembolsará al Cliente el precio de adquisición de dicho Producto, en la fecha en que fue adquirido

3. Excepciones de la Garantía Limitada:

Best Buy no tendrá responsabilidad ni obligación ante el Cliente y por lo tanto se exime de hacer efectiva la garantía en los siguientes casos: (i) cuando el Producto se hubiese utilizado en condiciones distintas a las normales; (ii) cuando el Producto no hubiese sido operado de acuerdo con el instructivo de uso que se le acompaña; y (iii) cuando el Producto hubiese sido alterado o reparado por personas no autorizadas por Best Buy. Best Buy excluye también todos aquellos Productos que no hayan sido vendidos por Best Buy en cualquiera de sus tiendas localizadas dentro de la República Mexicana. No están cubiertas por la presente garantía las partes consumibles del Producto. Esta garantía cubrirá defectos y/o fallos dentro del período de garantía derivado de cualquier defecto de los materiales en la fabricación del Producto.

4. Validez territorial: La presente póliza de garantía es válida únicamente en la República Mexicana.

RENUNCIA DE LA GARANTIA:

Excepto por la garantía aquí estipulada, la cual cumple con lo dispuesto por la NOM-024-SCFI-2013, Best Buy excluye expresamente del alcance de la presente garantía cualquier otra garantía explícita o implícita incluyendo, sin limitar, todas o cualquier declaración o garantías de comerciabilidad y/o aplicación o uso del Producto para propósitos específicos. Best Buy excluye expresamente, a toda y cualesquiera garantía relativas a que su Producto sea compatible con cualquier otro Producto o combinación de productos diferentes a los Productos de la marca TOSHIBA a los que el Cliente decida conectar el Producto.

DATOS DEL PRODUCTO ADQUIRIDO:

Modelo: _____

No. de serie: _____

Tienda donde se adquirió: _____

Dirección de la tienda:

Calle _____ no _____

Col. _____ C.P. _____

Delegación/Municipio _____ Ciudad/ Estado _____

Las Tiendas Best Buy en la Republica Mexicana, son los establecimientos donde se puede hacer efectiva la garantía donde se pueden obtener componentes, consumibles y accesorios del Producto: Centro de Servicio (y/o red de servicio):

- BEST BUY MUNDO E: Bvd. Manuel Ávila Camacho, No. 1007, San Lucas Tepetlatalco, Tlalnepantla, C.P. 54055, Estado de México.
- BEST BUY INTERLOMAS: Boulevard Magnocentro 35, Col. Centro Urbano San Fernando la Herradura C.P 52784 Huixquilucan, Estado de México.
- BEST BUY ACOXPA: Avenida Acoxpa 430 Col. Ex Hacienda Coapa, Del. Tlalpan, C.P 14300, Ciudad de México.
- BEST BUY POLANCO: Francisco Petrarca 202 Col. Polanco, Del. Miguel Hidalgo, C.P. 11570, Ciudad de México.
- BEST BUY CIUADDELA: Calle Labna 1437, Col. Ciudad del Sol, C.P. 45071, Zapopan, Jalisco.
- BEST BUY GALERIAS: Av. Rafael Sanzio 150, Sub Ancla 3, Col. La Estancia, C.P. 45030, Zapopan, Jalisco.
- BEST BUY TLAQUEPAQUE: Boulevard Marcelino García Barragán, N° 2077 y 2377, Col. Prados del Nilo, C.P. 44840, Guadalajara, Jalisco.
- BEST BUY CUAUTITLAN: Av. Primero de Mayo, S/N, Manzana C-34-C', Col. Centro Urbano, Cuautitlán Izcalli, Estado de México.
- BEST BUY MORELIA: Avenida Montaña Monarca Norte N° 1000, Col. Desarrollo Montaña Monarca C.P. 58350, Morelia, Michoacán.
- BEST BUY PEDREGAL: Calle de Ladera no. 16 Col. Jardines del Pedregal de San Ángel, C.P. 04500, Del. Coyoacán Ciudad de México.
- BEST BUY MONTERREY: Av. Batallón de San Patricio No. 1000 Col. Residencial San Agustín, C.P. 66260, San Pedro Garza García, Nuevo León, Monterrey.
- BEST BUY ANDARES: Blvd. Puerta de Hierro no. 4965 Fracc. Plaza Andares, C.P. 45116, Zapopan, Jalisco

También consulte el listado de los nuevos establecimientos en <http://www.bestbuy.com.mx/tiendas>

Sello del establecimiento que vendió el Producto:

(O puede presentar la factura, o recibo, o el comprobante en el que consten los datos específicos del producto adquirido)

Fecha de compra y recepción*

DÍA	MES	AÑO
-----	-----	-----

Fecha de Instalación (en caso de ser aplicable)

____/____/____

Centro de atención telefónica para la Ciudad de México e interior de la República:

01-800 BESTBUY (2378289)

<http://www.bestbuy.com.mx/>

TOSHIBA

If the power cord is damaged, it must be replaced by the manufacturer or its service agent or qualified personnel to avoid risk.

For product inquires or accessibility assistance, please contact us with the information below.

U.S. and Canada:

www.tv.toshiba.com

Product support (855) 527-2411

Distributed and warranted by Best Buy Purchasing LLC

©2017 Best Buy China LTD. All rights reserved.

Mexico:

01-800-926-3080

Best Buy Imports S. DE R.L. DE C.V.

Avenida Santa Fe No. 440 Piso 2 Ofna 202 Y 203 P3 Y P4

Colonia Santa Fe Cuajimalpa, C.P. 05348, Cuajimalpa De Morelos, México, Ciudad De México

©2017 Best Buy. All rights reserved.

Made in China