



Dear VIZIO Customer,

Congratulations on your new VIZIO E420VL, E470VL, or E550VL television purchase. To get the most out of your new VIZIO HDTV, read these instructions before making any adjustments, and retain them for future reference. We hope you will experience many years of enjoyment from your new VIZIO HDTV High Definition Television.

For assistance, call **877-MYVIZIO** (877-698-4946) or e-mail us at www.VIZIO.com.

To purchase or inquire about accessories and installation services for your VIZIO HDTV, visit our website at www.VIZIO.com or call toll free at **888-849-4623**.

We recommend you register your VIZIO HDTV either at our website www.VIZIO.com or fill out and mail your registration card. For peace of mind and to protect your investment beyond the standard warranty, VIZIO offers on-site extended warranty service plans. These plans give additional coverage during the standard warranty period. Visit our website or call us to purchase a plan.

Write down the serial number located on the back of your HDTV for easy reference when obtaining warranty support:

Serial #: _____	Purchase Date _____
-----------------	---------------------

VIZIO is a registered trademark of VIZIO, Inc. dba V, Inc.

HDMI logo and "High Definition Multimedia Interface" are registered trademarks of HDMI Licensing LLC.

Manufactured under license from Dolby Laboratories.

Dolby and the double-D symbol are trademarks of Dolby Laboratories.



TruSurround HD and TruVolume are trademarks of SRS Labs, Inc.

TruSurround HD and TruVolume technologies are incorporated under license from SRS Labs, Inc.



This product qualifies for ENERGY STAR in the "factory default (Home Use)" setting and this is the setting in which power savings will be achieved. Changing the factory default picture setting or enabling other features will increase power consumption that could exceed the limits necessary to qualify for Energy Star rating.

THE TRADEMARKS SHOWN HEREIN ARE THE PROPERTY OF THEIR RESPECTIVE OWNERS; IMAGES USED ARE FOR ILLUSTRATION PURPOSES ONLY. VIZIO, THE V LOGO, WHERE VISION MEETS VALUE AND OTHER VIZIO TRADEMARKS ARE THE INTELLECTUAL PROPERTY OF VIZIO INC. PRODUCT SPECIFICATIONS ARE SUBJECT TO CHANGE WITHOUT NOTICE. © 2010 VIZIO INC. ALL RIGHTS RESERVED.

Important Safety Instructions

Your HDTV is designed and manufactured to operate within defined design limits. Misuse may result in electric shock or fire. To prevent your HDTV from being damaged, the following rules should be observed for the installation, use, and maintenance of your HDTV. Read the following safety instructions before operating your HDTV. Keep these instructions in a safe place for future reference.

- To reduce the risk of electric shock or component damage, switch off the power before connecting other components to your HDTV.
- Unplug the power cord before cleaning your HDTV. A damp cloth is sufficient for cleaning your HDTV. Do not use a liquid or a spray cleaner for cleaning your HDTV. Do not use abrasive cleaners.
- Always use the accessories recommended by the manufacturer to insure compatibility.
- When moving your HDTV from an area of low temperature to an area of high temperature, condensation may form in the housing. Wait before turning on your HDTV to avoid causing fire, electric shock, or component damage.
- Use only with the cart, stand, tripod, bracket, or table specified by manufacturer or sold with your HDTV. When a cart is used, use caution when moving the cart/HDTV combination to avoid injury from tip-over. Do not place your HDTV on an unstable cart, stand, or table. If your HDTV falls, it can injure a person and cause serious damage to your HDTV. Use only a cart or stand recommended by the manufacturer or sold with your HDTV.
- A distance of at least three feet should be maintained between your HDTV and any heat source, such as a radiator, heater, oven, amplifier etc. Do not install your HDTV close to smoke. Operating your HDTV close to smoke or moisture may cause fire or electric shock.
- Slots and openings in the back and bottom of the cabinet are provided for ventilation. To ensure reliable operation of your HDTV and to protect it from overheating, be sure these openings are not blocked or covered. Do not place your HDTV in a bookcase or cabinet unless proper ventilation is provided.
- Never push any object into the slots and openings on your HDTV cabinet. Do not place any objects on the top of your HDTV. Doing so could short circuit parts causing a fire or electric shock. Never spill liquids on your HDTV.
- Your HDTV should be operated only from the type of power source indicated on the label. If you are not sure of the type of power supplied to your home, consult your dealer or local power company.
- Do not apply pressure or throw objects at your HDTV. This may compromise the integrity of the display. The manufacturer's warranty does not cover user abuse or improper installations.
- The power cord must be replaced when using different voltage than the voltage specified. For more information, contact your dealer.
- Your HDTV is equipped with a **three-pronged grounded plug (a plug with a third grounding pin)**. This plug will fit only into a grounded power outlet. This is a safety feature. If your outlet does not accommodate the three-pronged, have an electrician install the correct outlet, or use an adapter to ground your HDTV safely. **Do not defeat the safety purpose of the grounded plug.**
- When connected to a power outlet, power is always flowing into your HDTV. To totally disconnect power, unplug the power cord.



- The lightning flash with arrowhead symbol within an equilateral triangle is intended to alert the user to the presence of un-isolated, dangerous voltage within the inside of your HDTV that may be of sufficient magnitude to constitute a risk of electric shock to persons.



- The exclamation point within an equilateral triangle is intended to alert the user to the presence of important operating and servicing instructions in the literature accompanying your HDTV.
- Do not overload power strips and extension cords. Overloading can result in fire or electric shock.

- The wall socket should be installed near your HDTV and easily accessible.
- Only power of the marked voltage can be used for your HDTV. Any other voltage than the specified voltage may cause fire or electric shock
- Do not touch the power cord during lightning. To avoid electric shock, avoid handling the power cord during electrical storms.
- Unplug your HDTV during a lightning storm or when it will not be used for long period of time. This will protect your HDTV from damage due to power surges.
- Do not attempt to repair or service your HDTV yourself. Opening or removing the back cover may expose you to high voltages, electric shock, and other hazards. If repair is required, contact your dealer and refer all servicing to qualified service personnel.
- Keep your HDTV away from moisture. Do not expose your HDTV to rain or moisture. If water penetrates into your HDTV, unplug the power cord and contact your dealer. Continuous use in this case may result in fire or electric shock.
- Do not use your HDTV if any abnormality occurs. If any smoke or odor becomes apparent, unplug the power cord and contact your dealer immediately. Do not try to repair your HDTV yourself.
- Avoid using dropped or damaged appliances. If your HDTV is dropped and the housing is damaged, the internal components may function abnormally. Unplug the power cord immediately and contact your dealer for repair. Continued use of your HDTV may cause fire or electric shock.
- Do not install your HDTV in an area with heavy dust or high humidity. Operating your HDTV in environments with heavy dust or high humidity may cause fire or electric shock.
- Follow instructions for moving your HDTV. Ensure that the power cord and any other cables are unplugged before moving your HDTV.
- When unplugging your HDTV, hold the power plug, not the cord. Pulling on the power cord may damage the wires inside the cord and cause fire or electric shock. When your HDTV will not be used for an extended period of time, unplug the power cord.
- To reduce risk of electric shock, do not touch the connector with wet hands.
- Insert batteries in accordance with instructions. Incorrect polarities may cause the batteries to leak which can damage the remote control or injure the operator.
- If any of the following occurs, contact the dealer:
 - The power cord fails or frays.
 - Liquid sprays or any object drops into your HDTV.
 - Your HDTV is exposed to rain or other moisture.
 - Your HDTV is dropped or damaged in any way.
 - The performance of your HDTV changes substantially.

Television Antenna Connection Protection

External Television Antenna Grounding

If an outside antenna/satellite dish or cable system is to be connected to the TV, make sure that the antenna or cable system is electrically grounded to provide some protection against voltage surges and static charges.

Article 810 of the National Electrical Code, ANSI/NFPA 70, provides information with regard to proper grounding of the mast and supporting structure, grounding of the lead-in wire to an antenna discharge unit, size of the grounding conductors, location of antenna discharge unit, connection to grounding electrodes, and requirements of the grounding electrode.

Lightning Protection

For added protection of the TV during a lightning storm or when it is left unattended or unused for long periods of time, unplug the TV from the wall outlet and disconnect the antenna or cable system.

Power Lines

Do not locate the antenna near overhead light or power circuits, or where it could fall into such power lines or circuits.

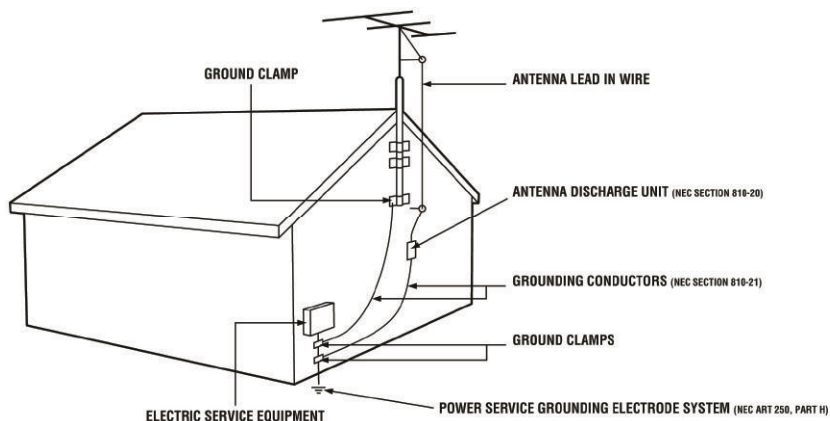

Remember, the screen of the coaxial cable is intended to be connected to earth in the building installation.

Advisory of the DTV Transition

The nationwide switch to digital television broadcasting will be complete on June 12, 2009, but your local television stations may switch sooner. After the switch, analog-only television sets that receive TV programming through an antenna will need a converter box to continue to receive over-the-air TV. Watch your local stations to find out when they will turn off their analog signal and switch to digital-only broadcasting. Analog-only TVs should continue to work as before to receive low power, Class A or translator television stations and with cable and satellite TV services, gaming consoles, VCRs, DVD players, and similar products.

For additional information, contact the parties listed below, as appropriate:

FCC (US Federal Communications Commission)

<http://www.fcc.gov/>

Phone: 1-888-CALL-FCC (1-888-225-5322)

TTY: 1-888-TELL-FCC (1-888-835-5322)

Fax: 1-866-418-0232

E-mail: fccinfo@fcc.gov

NTIA (National Telecommunications and Information Administration)

<http://www.ntia.doc.gov/>

1-888-DTV-2009

Listings of US Television Stations

<http://www.high-techproductions.com/usTVstations.htm>

Note: Your VIZIO HDTV is capable of receiving Digital Broadcasts, and no Digital Converter Box is required.

Table of Contents

Important Safety Instructions..... 2
 Television Antenna Connection Protection 4
 Advisory of the DTV Transition..... 5

CHAPTER 1 SETTING UP YOUR HDTV 10

Attaching the E420VL TV Stand..... 11
 Attaching the E470VL TV Stand..... 12
 Wall Mounting your HDTV 13

CHAPTER 2 BASIC CONTROLS AND CONNECTIONS..... 14

Front Panel 14
 Side Panel Controls..... 14
 Side Panel Connection..... 14
 Rear Panel Connections..... 15

CHAPTER 3 VIZIO REMOTE CONTROL 16

Installing the Batteries 16
 Remote Control Range..... 16
 VIZIO Remote Control Precautions..... 16
 E420VL Remote Control Buttons 17
 E470VL & E550VL Remote Control Buttons..... 18

CHAPTER 4 GETTING STARTED..... 19

CHAPTER 5 USING YOUR HDTV FOR THE FIRST TIME 20

Select Input Source 20
 Watching a TV Program 20
 Viewing Digital TV Program Information 21

CHAPTER 6 CONNECTING EQUIPMENT 22

Which Video Connection Should I Use? 22
 Connecting Your Cable or Satellite Box..... 23
 Using HDMI (Best) 23
 HDMI Connections for Cable or Satellite Boxes with DVI 23
 Using Component Video (Better)..... 24
 Using Composite Video (Good)..... 24
 Using Coaxial (Antenna) (Good)..... 24
 Connecting Your DVD Player..... 25
 Using HDMI (Best) 25
 HDMI Connections for DVD Players with DVI 25
 Using Component Video (Better)..... 26
 Using Composite (AV) Video (Good)..... 26
 Connecting Coaxial (RF) 27
 Using Your Antenna or Digital Cable for Standard or Digital TV 27
 Connecting Your VCR or Video Camera..... 27
 Connecting a Home Theater System 28
 Using RCA..... 28
 Using Optical (S/PDIF) 28
 Connecting a Computer..... 29
 Using RGB (VGA) 29
 Using HDMI..... 29

CHAPTER 7 VIEWING PICTURES 30

Viewing Pictures 30

Slideshow Mode.....	31
Repeat.....	31
Sort By	31
Duration	31
Slideshow Effect	31
Thumbnail Size	31
Info	31
CHAPTER 8 ADJUSTING YOUR HDTV SETTINGS.....	32
Using the On-screen Display (OSD)	32
Input Menu.....	32
Wide Menu	33
Normal.....	33
Wide.....	33
Zoom.....	33
Panoramic.....	33
Stretch.....	33
CC (Closed Caption) Menu	34
Analog Closed Caption	34
Digital Closed Caption	34
Digital CC Style.....	34
Sleep Timer Menu	34
Picture Menu	34
Picture Mode.....	34
Backlight	34
Brightness	34
Contrast	35
Color.....	35
Tint	35
Sharpness.....	35
More	35
PIP Menu.....	37
PIP Mode	37
Source.....	37
Position	37
Size	37
Audio.....	37
Settings Menu.....	38
Audio Menu	38
Tuner.....	40
Name Input	41
Parental Controls	41
Menu Language	43
Time & Local Settings	43
CEC.....	44
Media Menu.....	44
Slideshow Mode.....	44
Repeat.....	44
Sort By	44
Duration	45
Slideshow Effect	45
Thumbnail Size	45
Info	45
Help Menu	45
System Info	45
Reset TV Settings.....	45

Clear Memory (Factory Default)	45
Start Setup Wizard.....	45
CHAPTER 9 PROGRAMMING THE VIZIO UNIVERSAL REMOTE CONTROL	46
Using a Cable or Satellite Box Remote	46
Programming other devices	46
Programming your Blu-Ray or DVD Player	46
Programming your Home Theater System	46
Programming your Cable or Satellite Set-Top Box.....	47
Searching for Device Codes	47
Reset Remote to Factory Settings	47
Remote Control Codes	48
Television Codes	48
Cable Box Codes	54
Satellite Receiver Codes.....	55
PVR Codes	56
DVD Player Codes.....	56
Amplifier / Receiver / Tuner Codes.....	58
Audio Accessory Codes.....	60
VCR Codes	60
CHAPTER 10 MAINTENANCE AND TROUBLESHOOTING	62
Cleaning the TV and Remote Control	62
Troubleshooting Guide	62
Telephone & Technical Support.....	65
Compliance.....	65
FCC Class B Radio Interference Statement	65
CHAPTER 11 SPECIFICATIONS	66
E420VL Specifications.....	66
E470VL Specifications.....	67
E550VL Specifications.....	68
Preset PC Resolutions	70
Resolution through RGB Input	70
WARRANTY	71
INDEX	72

Opening the Package

Your HDTV and its accompanying accessories are carefully packed in a cardboard carton that has been designed to protect it from transportation damage. After you have opened the carton, check that your HDTV is in good condition and that all of the contents are included.

The glass surface can easily be scratched or broken, so handle your HDTV gently and never place your HDTV with the glass facing downwards on a surface without protective padding.

IMPORTANT: Save the carton and packing material for future shipping.

Package Contents

- VIZIO E420VL or E470VL or E550VL
- VIZIO remote control VR15 (E420VL only)
- VIZIO remote control VUR13 (E470VL and E550VL only)
- AA batteries for the VR15 remote control (2)
- AAA batteries for the VUR13 remote control (2)
- Power cord
- Detachable base with thumbscrew (E420VL and E470VL only)
- Quick Setup Guide
- Registration Card



HDTV Accessories and Services

Additional certified accessories for your HDTV are sold separately, including:

- Wall mounts
- High Definition cables
- Extra or replacement remote controls
- Sound Bars
- Blu-ray DVD Players

VIZIO also offers installation services and extended warranty services for your HDTV.

To purchase or inquire about additional accessories and services for your VIZIO HDTV, visit our website at www.VIZIO.com or call us toll free at **877-MYVIZIO** (877-698-4946).

Caution: Do not apply pressure or throw objects at your HDTV (including game controllers). This may compromise the integrity of the display. The manufacturer's warranty does not cover user abuse or improper installations.

Chapter 1 Setting Up Your HDTV

- Read this user manual carefully before installing your HDTV.
- The power consumption of your HDTV is about 111W (E420VL); 134W (E470VL); 138W (E550VL) average. Use the included AC/DC power adapter. When an extension cord is required, use one with the correct power rating. The cord must be grounded and the grounding feature must not be compromised.
- Install your HDTV on a flat surface to avoid tipping.
- For proper ventilation, you must allow a 1" space between the back of your HDTV and the wall.
- Avoid installing your HDTV in places with high humidity, dust, or smoke so you do not shorten the service life of the electronic components.
- Install your HDTV in a level, landscape orientation, with the VIZIO logo at the bottom to prevent poor ventilation and excessive component damage.
- If you want to mount your HDTV on the wall, see below for additional information.
- Read this user manual carefully before installing your HDTV.

VIZIO offers professional installation services including home networking. Contact VIZIO for more information on these services at **877-MYVIZIO** (877-698-4946) or www.VIZIO.com.

Attaching the E420VL TV Stand

Note: We strongly recommend that two people perform the setup and assembly due to the weight and size of the TV.

Unpack the TV and stand base:

1. Remove the remote control, batteries, and power cord from the foam end caps.
2. Remove the two top foam end caps.
3. Remove the stand base from the packaging.
4. Remove the TV from the box and lay it face down on a clean, flat surface.

Note: Make sure that the surface is free of debris to prevent the TV screen from getting scratched.

Attach the TV stand base:

1. Push the stand base onto the stand neck (already connected to TV).
2. On the bottom of the base, insert the thumb screw and tighten. Move the TV into an upright position.

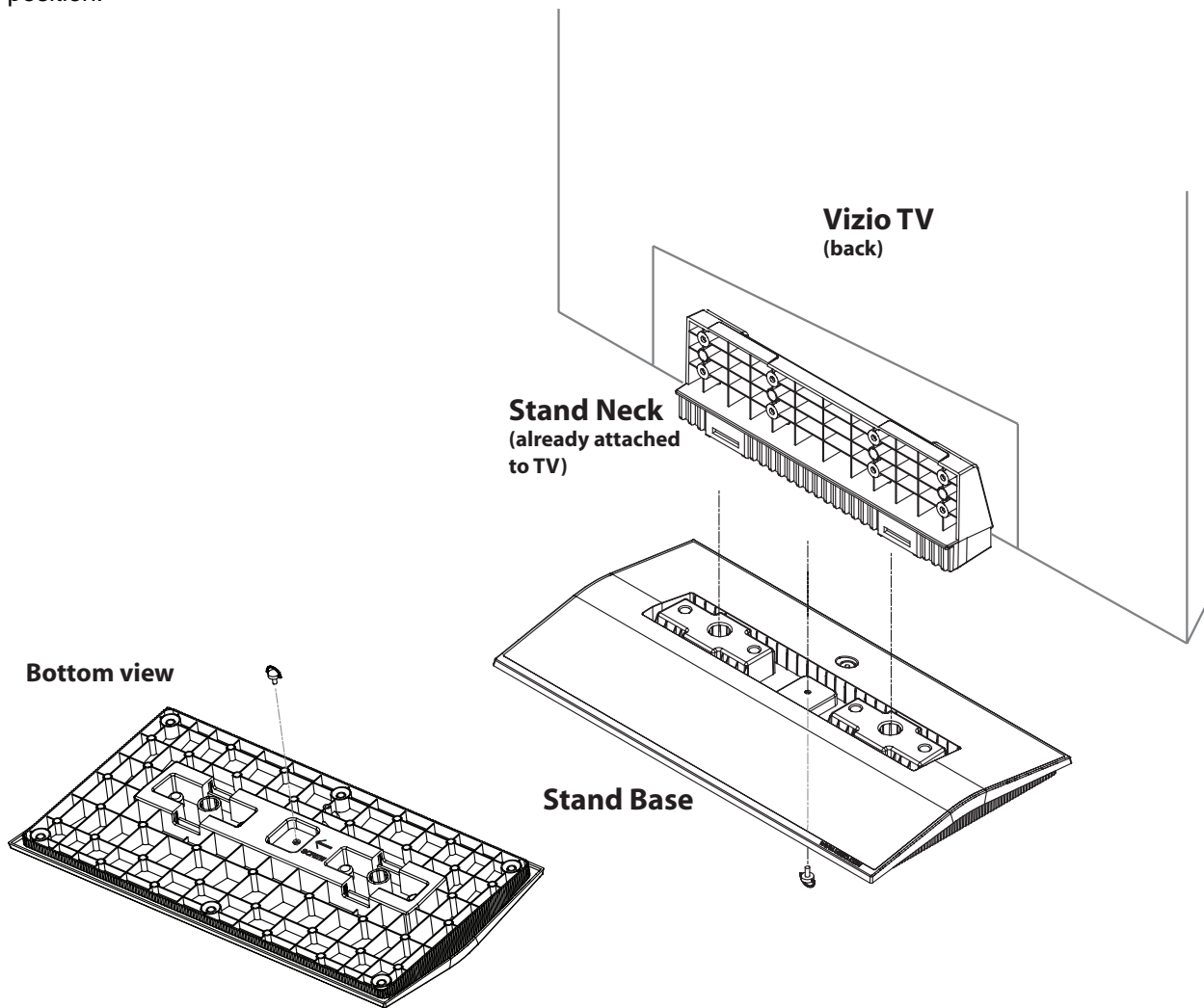

Attaching the E470VL TV Stand

Note: We strongly recommend that two people perform the setup and assembly due to the weight and size of the TV.

Unpack the TV and stand base:

1. Remove the remote control, batteries, and power cord from the foam end caps.
2. Remove the two top foam end caps.
3. Remove the stand base from the packaging.
4. Remove the TV from the box and lay it face down on a clean, flat surface.

Note: Make sure that the surface is free of debris to prevent the TV screen from getting scratched.

Attach the TV stand base:

1. Align the stand base to the back of the TV.
2. Insert the four screws provided and tighten.

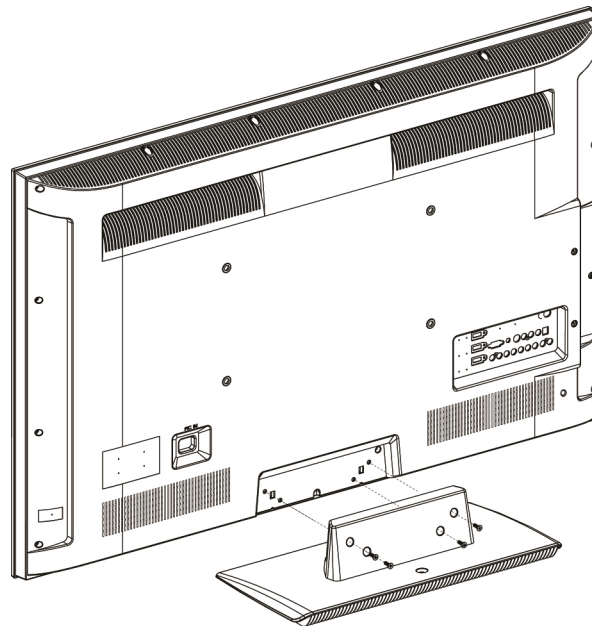

Wall Mounting your HDTV

Your HDTV can be mounted on the wall for viewing. If you choose to mount your HDTV on the wall, follow the instructions below.

1. Write down the serial number located on the back of your HDTV in the space provided on page 1 to have it handy if you need to call for support.
2. Remove the stand base and neck:
 - a. Disconnect the cables from your HDTV.
 - b. Place your HDTV face down on a soft, flat surface to prevent damage to the screen.
 - c. Remove the six (6) screws holding the stand neck, and then remove the neck and base.

Note: To remove the base from the neck, unscrew thumbscrew on bottom.

3. Mount your HDTV on the wall:
 - a. Attach your HDTV to a wall mount (sold separately) using the mounting holes in the back panel of your HDTV.
 - b. Read the instructions that came with your specific wall mount to properly hang your HDTV.

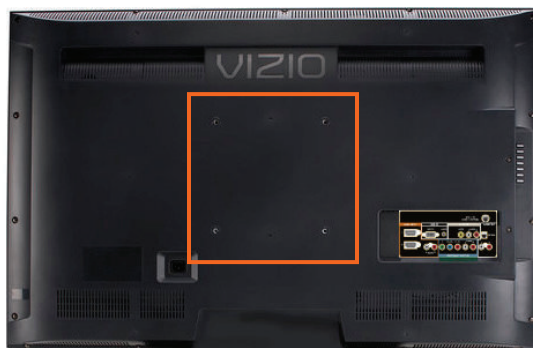

Wall Mounting Specifications (E420VL & E470VL)	
Screw Size	M6
Screw Length	20.0 mm
Screw Pitch	1.0 mm
Hole Pattern	VESA standard 200 x 200 mm spacing

Wall Mounting Specifications (E550VL)	
Screw Size	M8
Screw Length	25 mm
Screw Pitch	1.25 mm
Hole Pattern	VESA standard 400 x 200 mm spacing

Chapter 2 Basic Controls and Connections

Front Panel

1. **Remote Control Sensor**—Point the remote control directly at this window on the lower left corner of your HDTV for the best response to the remote signal.
2. **POWER 'VIZIO' LIGHT**—The VIZIO name lights white when powered on and orange when powered off.



Side Panel Controls

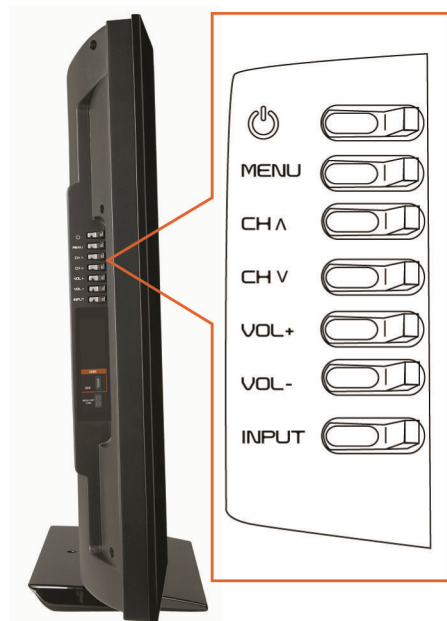

POWER ()—Turn your HDTV on by pressing the button once. Press the button again to turn your HDTV off.

MENU—Press to launch the on-screen menu. If a sub-menu is active, this button will proceed to the next level.

CH ▲/▼—Press to change the channels up or down. While the menu is active, these buttons function as up and down controls.

VOL + / -—Press to increase or decrease the speaker volume. While the menu is active, these buttons function as left and right controls.

INPUT (ENTER) —Press to cycle through the various devices connected to your TV (called Inputs). The inputs cycle in the following sequence: TV, AV, Comp, HDMI-1, HDMI-2, HDMI SIDE, RGB, and Media. After you have stepped through the entire sequence, you will return to the beginning.

Additionally, when the OSD is active, this button confirms the menu function to be adjusted.

Side Panel Connection

HDMI—Connect digital video devices such as a DVD player or Set-Top Box through this all digital connector. There are additional HDMI connectors on the back.

USB:

- Insert a FAT/FAT32 formatted USB drive to view pictures.
- Service port for use by a professional service technician.

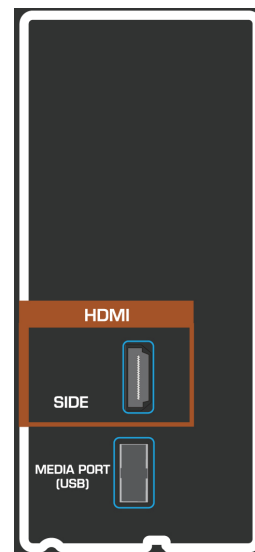

Rear Panel Connections

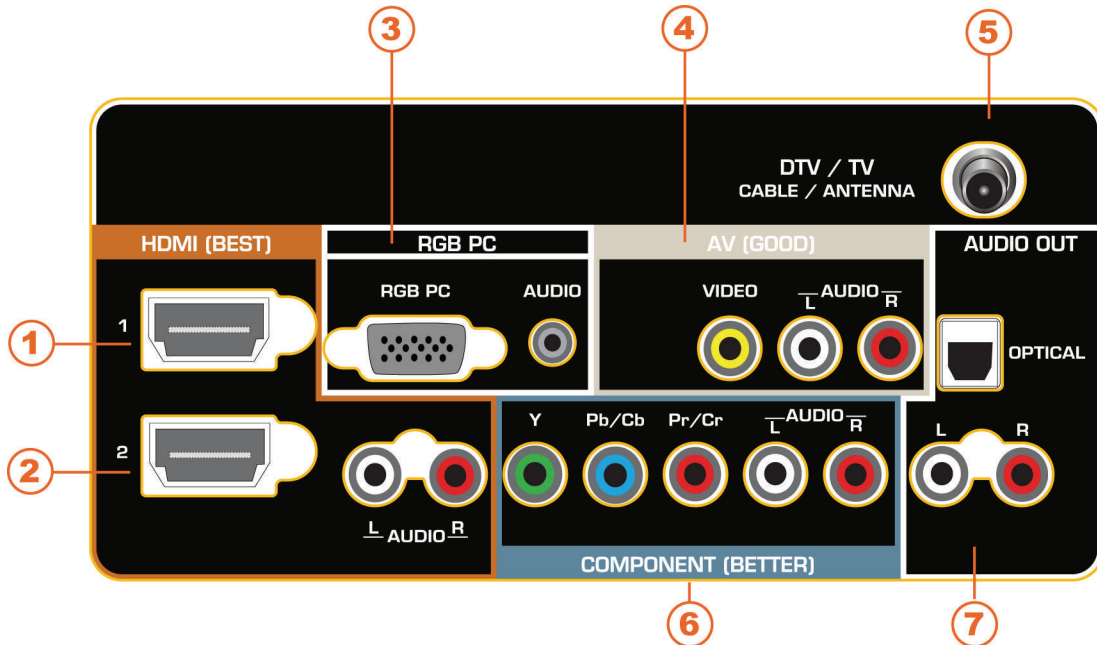

1. **HDMI 1**—Connect digital video devices such as a DVD player or Set-Top Box through this all digital connector. There is an additional HDMI connector on the side.
2. **HDMI 2 with L/R Audio**—Connect another digital video device such as a DVD player or Set-Top Box through this all digital connector. For users who want to connect to a DVI enabled device, use a DVI-HDMI cable and connect the analog audio output of the device to the **L / R AUDIO** here. Your VIZIO Certified HDMI-DVI cables are available for purchase from www.VIZIO.com or by calling **877-MYVIZIO** (877-698-4946).
3. **RGB PC**—Connect the video and audio from a computer here. Connect a 1/8" mini plug stereo connector from the computer to the TV if you want the sound to come from the HDTV speakers.
4. **AV**—Connect composite video devices, such as a VCR or game console. Use the white and red connectors to connect the external audio from the same source.
5. **DTV/TV**— Connect to an antenna or digital cable source. For digital TV stations in your area visit www.antennaweb.org. For cable and satellite Set-Top boxes, we recommend that you use a HDMI or component cable connection for high definition image quality.
6. **COMPONENT (Y Pb/Cb Pr/Cr with L/R Audio)**—Connect component video devices such as a DVD Player or set top box here.
7. **AUDIO OUT:**
 - **OPTICAL**—When digital TV is selected for viewing, the audio associated with the programming will be available on the S/PDIF Optical connector for connection to a VIZIO Sound Bar or your Home Theater system.
 - **ANALOG L/R**—Connect the audio from the HDTV to an external device, such as a home theater system, external amplifier, or stereo. Speakers cannot be connected directly here.

Chapter 3 VIZIO Remote Control

Installing the Batteries

1. Remove the battery cover.
2. Insert the batteries into the remote control. Make sure that you match the (+) and (-) symbols on the batteries with the (+) and (-) symbols inside the battery compartment.
3. Replace the battery cover.



Precautionary Tips for Inserting the Batteries:

- Do not mix new and old batteries. This may result in cracking or leakage that may cause a fire or lead to personal injury.
- Inserting the batteries incorrectly may also result in cracking or leakage that may cause a fire or lead to personal injury.
- Dispose of batteries according to local hazardous waste regulations.
- Keep the batteries away from children and pets.

Remote Control Range

- Point the remote control directly at this sensor for the best response to the remote signal.
- Do not place any obstacles between the remote control and the remote control sensor.
- The effective range of the remote control is approximately 22 feet (7 meters) from the front of the remote control sensor, 30° to the left and right, 20° up and down.



VIZIO Remote Control Precautions

- The remote control should be kept dry and away from heat sources. Avoid humidity.
- If the TV responds erratically to the remote control or does not respond at all, check the batteries. If the batteries are low or exhausted, replace them with fresh batteries.
- When not using the remote control for a long period of time, remove the batteries.
- Do not take the batteries apart, heat them, or throw them into a fire.
- Do not subject the remote control to undue physical stress, such as striking or dropping it.
- Do not attempt to clean the remote control with a volatile solvent. Wipe it with a clean, damp cloth.

E420VL Remote Control Buttons

POWER ()—Press to turn the TV on from the Standby mode. Press it again to return to the Standby mode.

CEC-Supported Buttons:

CEC needs to be set up and enabled for these buttons to work. See *CEC* on page 44 for more information.

- (Record)—Press to begin recording on your CEC-supported device.
- ⏸ (Pause)—Press to pause playback on your CEC-supported device.
- ▶ (Play)—Press to start Playback on your CEC-supported device.
- (Stop)—Press to stop playback/recording on your CEC-supported device.
- ⏮ (Previous)—Press to skip the previous track on your CEC-supported device.
- ◀ (Reverse)—Press to reverses playback on your CEC-supported device.
- ▶▶ (Fast Forward)—Press to fast forward playback on your CEC-supported device.
- ▶▶ (Next)—Press to skip to the next chapter on your CEC-supported device.

EXIT—Press to exit from open menus.

MENU—Press to open the On-Screen Display (OSD) menu.

OK—Press this button to display the Channel List. Press to confirm selections for On-Screen Display (OSD) menus.

Silver Diamond (represented by ▲▼◀▶ in the manual instructions)—Pressing up, down, left, or right on the points of the diamond are used to navigate the OSD menu. They will also be used as value settings when the slide bar is shown on the screen and option settings to turn a feature off or on.

BACK—Press to return to a previous OSD menu.

GUIDE—Press to display detailed program information when viewing a digital TV program.

Color Buttons (Yellow, Blue, Red, & Green)—These buttons currently do not operate any functions on your HDTV.

VOL +/- —Press to turn the volume up or down.

MEDIA – Use this button to access the USB drive to view your pictures.

MUTE—Press to turn the sound on and off.

LAST— Press to recall the previously viewed channel.

CH +/- —Press to change the channels up or down

HDMI—Press to select the HDMI input. Press repeatedly to cycle between both HDMI inputs.

AV—Press to select the AV input.

TV—Press to select the TV input.

Number Button Pad—Press to select a channel or enter a password.

INPUT—Press to cycle through the various devices connected to your TV (called Inputs). The inputs cycle in the following sequence: TV, AV, Comp, HDMI-1, HDMI-2, HDMI SIDE, RGB, and Media. After you have stepped through the entire sequence, you will return to the beginning.

- (**DASH**)—Press to insert a dash between the main and sub-channels. For example, channel 28-2 would be selected by the button sequence 2, 8, DASH, 2.



E470VL & E550VL Remote Control Buttons

POWER ()—Press to turn the TV on from the Standby mode. Press it again to return to the Standby mode.

Device Buttons:

- **DVD**—Press to select a DVD player that has been programmed to work with this remote. See page 46 to program your remote control.
- **AUDIO**—Press to select a Home Theater System or Audio Amplifier that has been programmed to work with this remote. See page 46 to program your remote control.
- **CABLE**—Press to select a cable or satellite Set-Top box that has been programmed to work with this remote. See page 46 to program your remote control.
- **TV**—Press to return to TV mode. If the remote is not working, press this button to return the functions back to TV.

CEC-Supported Buttons:

CEC needs to be set up and enabled for these buttons to work. See *CEC* on page 44 for more information.

- (Record)—Press to begin recording on your CEC-supported device.
- **II** (Pause)—Press to pause playback on your CEC-supported device.
- **▶** (Play)—Press to start Playback on your CEC-supported device.
- **■** (Stop)—Press to stop playback/recording on your CEC-supported device.
- **⏮** (Previous)—Press to skip the previous track on your CEC-supported device.
- **⏪** (Reverse)—Press to reverses playback on your CEC-supported device.
- **⏩** (Fast Forward)—Press to fast forward playback on your CEC-supported device.
- **⏭** (Next)—Press to skip to the next chapter on your CEC-supported device.

EXIT—Press to exit from open menus.

MENU—Press to open the On-Screen Display (OSD) menu.

OK—Press this button to display the Channel List. Press to confirm selections for On-Screen Display (OSD) menus.

Silver Diamond (represented by **▲ ▼ ◀ ▶** in the manual instructions)—Pressing up, down, left, or right on the points of the diamond are used to navigate the OSD menu. They will also be used as value settings when the slide bar is shown on the screen and option settings to turn a feature off or on.

BACK—Press to return to a previous OSD menu.

GUIDE—Press to display detailed program information when viewing a digital TV program.

Color Buttons (Yellow, Blue, Red, & Green)—These buttons currently do not operate any functions on your HDTV.

VOL +/- —Press to turn the volume up or down.

MEDIA – Use this button to access the USB drive to view your pictures.

MUTE—Press to turn the sound on and off.

LAST— Press to recall the previously viewed channel.

CH +/- —Press to change the channels up or down

HDMI—Press to select the HDMI input. Press repeatedly to cycle between both HDMI inputs.



AV—Press to select the AV input.

TV—Press to select the TV input.

Number Button Pad—Press to select a channel or enter a password.

INPUT—Press to cycle through the various devices connected to your TV (called Inputs). The inputs cycle in the following sequence: TV, AV, Comp, HDMI-1, HDMI-2, HDMI SIDE, RGB, and Media. After you have stepped through the entire sequence, you will return to the beginning.

- **(DASH)**—Press to insert a dash between the main and sub-channels. For example, channel 28-2 would be selected by the button sequence 2, 8, DASH, 2.



Chapter 4 Getting Started

Your HDTV has a built-in setup App that runs when you turn on your TV for the first time. Follow the on-screen directions to easily setup your new HDTV.

1. Insert the batteries into the remote control.
2. Connect the power cord to the power cord connector on the back of your HDTV, and then plug the power cord into an AC wall socket.
3. Connect your devices to your HDTV (see Chapter 6 for detailed steps).
4. Turn on your TV. The Setup App will automatically play and guide you thru the initial setup of your HDTV. Use the Arrow and OK buttons to navigate through the setup App. During the setup process you will:
 - Choose your Menu language
 - Set the TV to Home Mode for the best picture and most efficient energy usage.
 - Set your Time Zone and Daylight Savings preferences
 - Add your TV channels (unless you have a Cable/Satellite Set-Top Box)

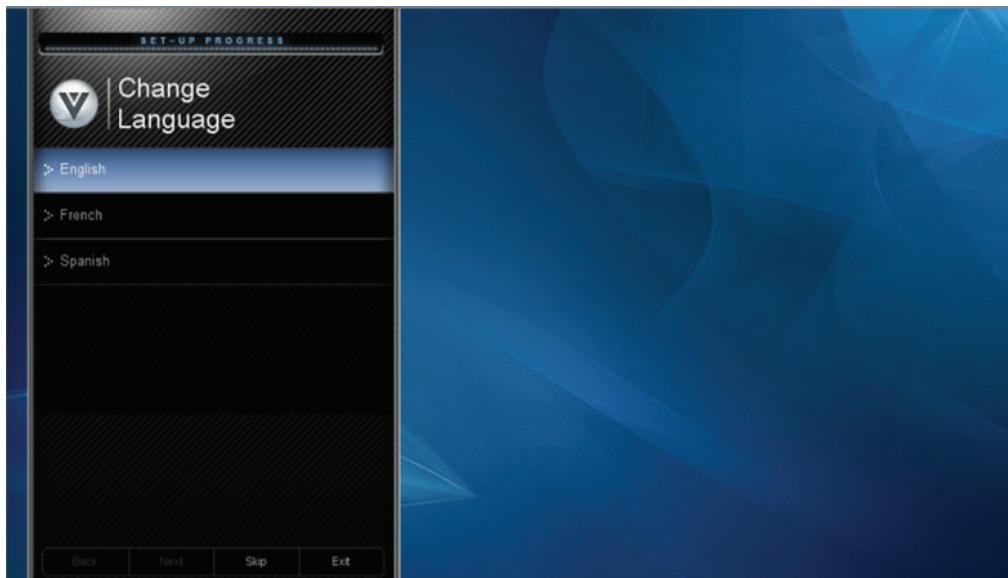

Chapter 5 Using your HDTV for the first time

Select Input Source

Select the input source for your HDTV by pressing the **INPUT** button on the remote control or the side of your TV. Pressing this button will cycle you through the following options: TV, AV, Comp, HDMI-1, HDMI-2, HDMI SIDE, RGB, and Media.

Turn on your device and you will see a picture on your HDTV. If there is no picture, make sure you have selected the correct input on your HDTV.

Note: If the selected device is RF connected, your HDTV needs to be in **TV** mode and on either channel 3 or channel 4 matching the channel which has been selected on the back of the VCR, Cable Box, External TV Tuner or Satellite Receiver. Refer to Owner or User's Manual of such equipment for details.

Watching a TV Program

Before you start watching TV, make sure that any cable, satellite or off-air antenna connections are secure. Also, verify that the AC/DC power adapter is plugged into a correctly grounded electrical outlet or surge protector.

1. Press the power button on the remote control. The VIZIO logo on the front will light up white.
2. Select the input to which your device is connected that provides TV programming (i.e. TV, HDMI, COMP).

Note: You should be able to see a picture. If you do not, make sure that all of your HDTV connections are secure and you have selected the correct video input source. Each press of the **INPUT** button on the remote control will cycle through the available inputs. Press the button until the input associated with the device you want to view is shown.

3. When using the TV input, press the channel buttons on the remote control or the TV to change the channel. The channel buttons will not work if you are watching a program using HDMI, Component, or AV inputs.



Viewing Digital TV Program Information

When the channel is changed or when you press the **GUIDE** button, an information header is shown over the picture for a few seconds. Each press of the **GUIDE** button will display more information about the program:



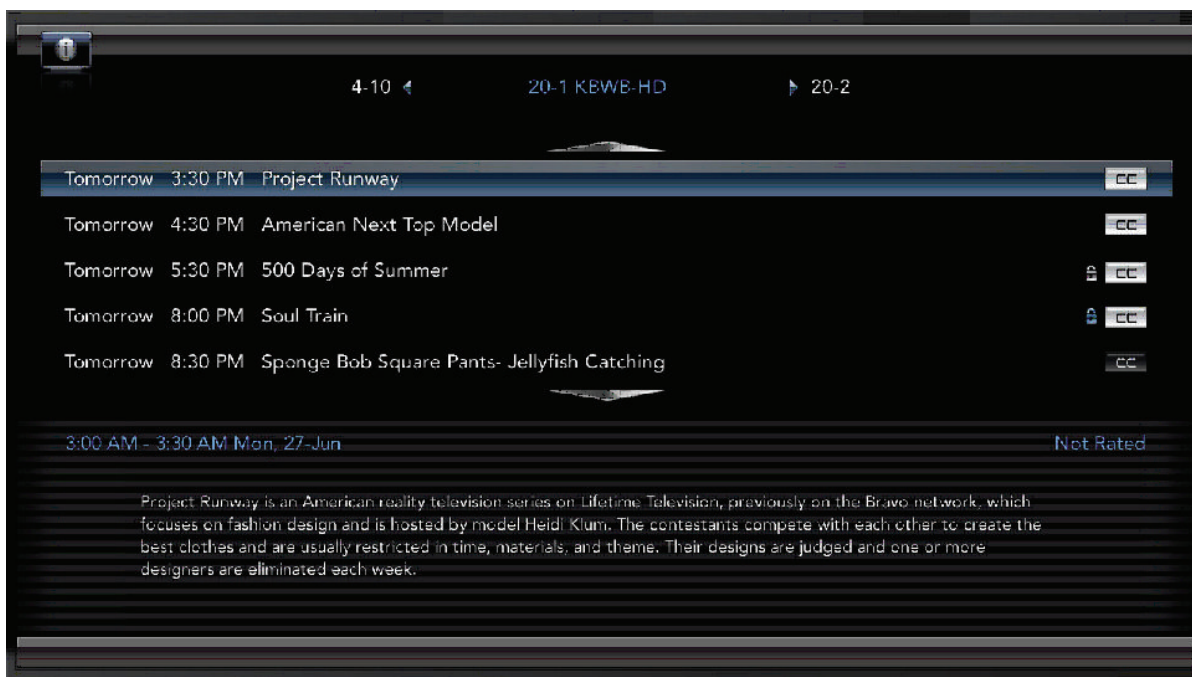

Time Warp: Mouse Trap		Ch 50-123	KCAL DTV	CABLE
11:00 AM - 12:00 AM	TV-PG (V)	CC-OFF	ENGLISH	DOLBY 5.1
In this hour-long special, the Time Warp team runs off to join the circus with trap-testing Rev. Tommy Gunn and with high-flying Cirque du Soleil, explore their inner stuntmen, and put everything but wood in a chipper.				



Chapter 6 Connecting Equipment

Which Video Connection Should I Use?

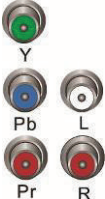
You have six options for connecting your video equipment box to your HDTV from a basic connection to the most advanced for digital displays. Based on your Home Theater configuration, you can decide which option is the right one for you.

Connection Quality (type)	Connector	Description
Best (digital)	 HDMI	HDMI delivers the best image quality of any of the cable types available and it's all done over one cable. You get a great picture and cut down on your cable clutter. HDMI provides digital quality and amazing sound so if your TV has HDMI, this is the connection type you should be using.
Best (digital) ----- Good (analog)		Connect your antenna or coaxial cable to watch TV programming. This cable usually comes from your cable box or right out of the wall.
Best (analog)	 VGA	The RGB (VGA) port allows you to connect your computer so you can use the TV as your monitor.
Better (analog)	 Y Pb L Pr R	Component consists of three cables for transmitting video and two cables for transmitting audio: one red and one white. Component video provides a sharper image than Composite video and should be used instead of composite when possible. However, because it is still an analog connection, it won't provide the high-quality video and audio that HDMI can produce.
Good (analog)	 VIDEO L R	Composite consists of one yellow cable for transmitting video and two cables for transmitting audio: one red and one white. It is capable of transmitting stereo sound and standard definition video (480i). While it provides a good image, it has lower image quality than HDMI or Component. So try to use one of those connections first.

Note: To maintain the display quality, use a VIZIO certified HDMI cable. This cable is available in 6, 8, and 12 foot lengths. Visit www.vizio.com or call 1-888-VIZIOCE (1-888-849-4623) for details.

Connecting Your Cable or Satellite Box

Using HDMI (Best)

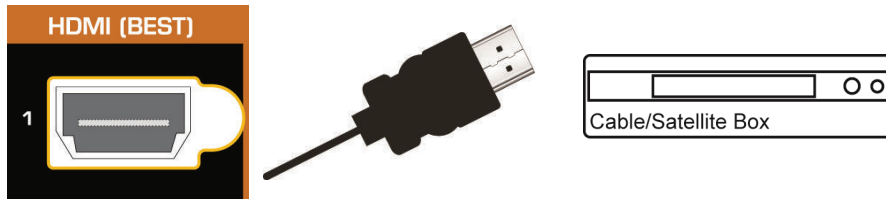

Cable and Satellite Boxes that have a HDMI digital interface should be connected using HDMI for optimal results. To maintain image quality, use a VIZIO certified HDMI cable. This cable is available in 6, 15, and 30 foot lengths. Visit www.VIZIO.com or call **877-MYVIZIO** (877-698-4946) for details.

1. Turn off your HDTV and cable/satellite box.
2. Connect an HDMI cable to the **HDMI** output of your cable/satellite box and the other end to the **HDMI 1** or **2** jack on your HDTV.
3. Turn on the power to your HDTV and your cable/satellite box.
4. Select **HDMI-1**, **HDMI-2**, or **HDMI SIDE** using the **INPUT** button on the remote control or side of the TV.

Note:

- The HDMI input on your HDTV supports High-bandwidth Digital Content Protection (HDCP). HDCP encrypts the transmission between the video source and the digital display for added security and protection.
- Refer to your cable/satellite Set-Top box user manual for more information about the video output requirements of the product or consult your cable or satellite operator.

HDMI Connections for Cable or Satellite Boxes with DVI

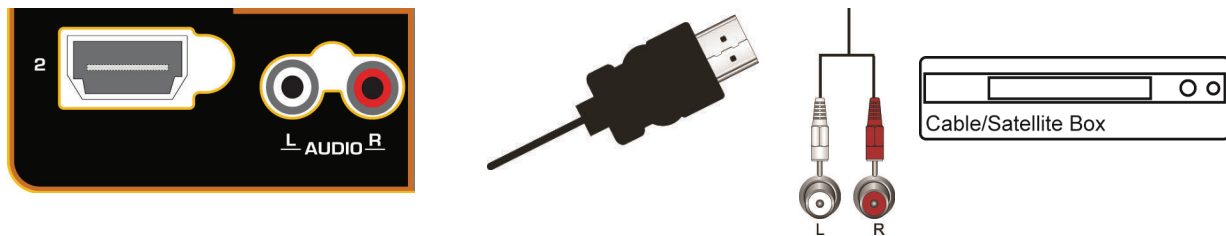

1. Turn off the power to your HDTV and HDTV cable/satellite box.
2. Using a HDMI-DVI cable, connect the DVI end to your cable/satellite box and the HDMI end to the **HDMI 2** jack on your HDTV.
3. Connect the audio cables (white and red) from the DVI audio output jacks on the cable/satellite box to the **HDMI 2 L** and **R AUDIO** jacks on your HDTV.
4. Turn on the power to your HDTV and your cable/satellite box.
5. Select **HDMI-2** using the **INPUT** button on the remote control or side of the TV.

Using Component Video (Better)

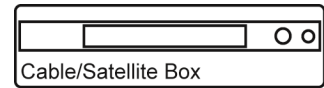
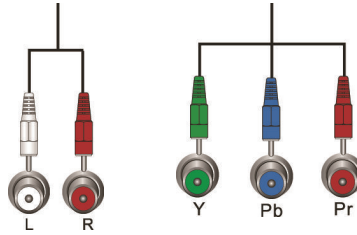
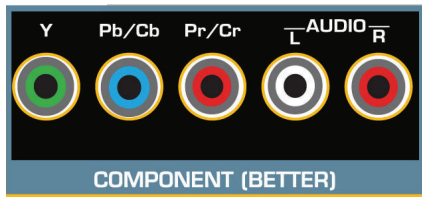

1. Turn off your HDTV and cable/satellite box.
2. Connect the component cables (green, blue, and red) from your cable/satellite box to the **COMPONENT** jacks on your HDTV.
3. Connect the audio cables (white and red) from your Set-Top box to the **COMPONENT L** and **R AUDIO** jacks on your HDTV.
4. Turn on your HDTV and cable/satellite box.
5. Select **Comp** using the **INPUT** button on the remote control or side of the TV.

Using Composite Video (Good)

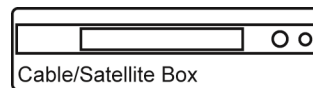
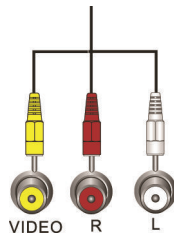
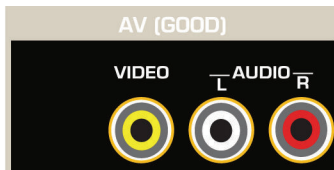

1. Turn off your HDTV and Set-Top box.
2. Connect the video cable (yellow) from your Set-Top box to the **AV** jack (yellow) on your HDTV.
3. Connect the audio cables (white and red) on your Set-Top box to the **AV L** and **R AUDIO** jacks on your HDTV.
4. Turn on your HDTV and Set-Top box.
5. Select **AV** using the **INPUT** button on the remote control or side of the TV.

Using Coaxial (Antenna) (Good)



COAXIAL

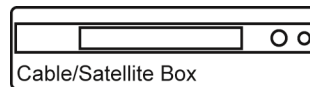

1. Turn off the power to your HDTV.
2. Connect the coaxial (RF) connector from your antenna or digital cable to the **DTV/TV CABLE/ANTENNA** connector on your HDTV.
3. Turn on the power to your HDTV.
4. Select **TV** using the **INPUT** button on the remote control or side of the TV.
5. Search for new channels. See *Auto Channel Scan* on page 24 for more information on scanning for channels.

Connecting Your DVD Player

Using HDMI (Best)



DVD players that have a HDMI digital interface should be connected using HDMI for optimal results. To maintain image quality, use a VIZIO certified HDMI cable. This cable is available in 6, 15, and 30 foot lengths. Visit www.VIZIO.com or call **877-MYVIZIO** (877-698-4946) for details.

1. Turn off your HDTV and DVD player.
2. Connect a HDMI cable to the HDMI output of your DVD player and the other end to the **HDMI 1** or **2** jack on your HDTV.
3. Turn on the power to your HDTV and your DVD player.
4. Select **HDMI-1**, **HDMI-2**, or **HDMI SIDE** using the **INPUT** button on the remote control or side of the TV.

Note:

- The HDMI input on your HDTV supports High-bandwidth Digital Content Protection (HDCP). HDCP encrypts the transmission between the video source and the digital display for added security and protection.
- Refer to your DVD player user manual for more information about the video output requirements.

HDMI Connections for DVD Players with DVI



1. Turn off your HDTV and DVD player.
2. Using a HDMI-DVI cable, connect the DVI end to your DVD player and the HDMI end to the **HDMI 2** Jack on your HDTV.
3. Connect the audio cables (white and red) from the DVI audio output jacks on the DVD player to the **HDMI 2 L** and **R AUDIO** jacks on your HDTV.
4. Turn on the power to your HDTV and your DVD player.
5. Select **HDMI-2** using the **INPUT** button on the remote control or side of the TV.

Using Component Video (Better)

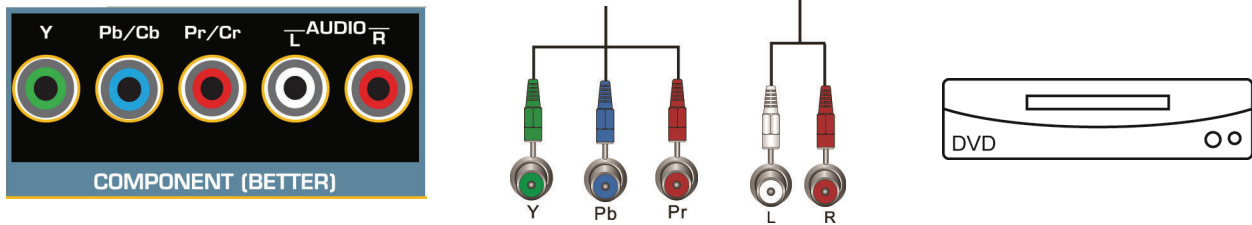

1. Turn off the power to your HDTV and DVD player.
2. Connect the component cable (green, blue, and red) from your DVD player to the **COMPONENT** jacks on your HDTV.
3. Connect the audio cables (white and red) from your DVD player to the **COMPONENT L and R AUDIO** jacks on your HDTV.
4. Turn on the power to your HDTV and DVD player.
5. Select **COMP** using the **INPUT** button on the remote control or side of the TV.

Using Composite (AV) Video (Good)

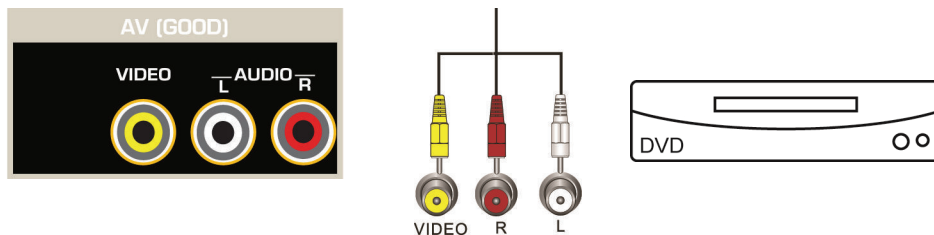

1. Turn off the power to your HDTV and DVD player.
2. Connect the Video cable (yellow) from your DVD player to the **AV** jack on your HDTV.
3. Connect the audio cables (white and red) on your DVD player to the **AV L and R AUDIO** jacks on your HDTV.
4. Turn on the power to your HDTV and DVD Player.
5. Select **AV** using the **INPUT** button on the remote control or side of the TV.

Connecting Coaxial (RF)

Using Your Antenna or Digital Cable for Standard or Digital TV



COAXIAL

1. Turn off the power to your HDTV.
2. Connect the coaxial (RF) connector from your antenna or cable to the **DTV/TV CABLE/ANTENNA** connector on your HDTV.
3. Turn on the power to your HDTV.
4. Select **TV** using the **INPUT** button on the remote control or side of the TV.
5. Search for new channels. See *Auto Channel Scan* on page 40 for more information on scanning for channels.

Connecting Your VCR or Video Camera

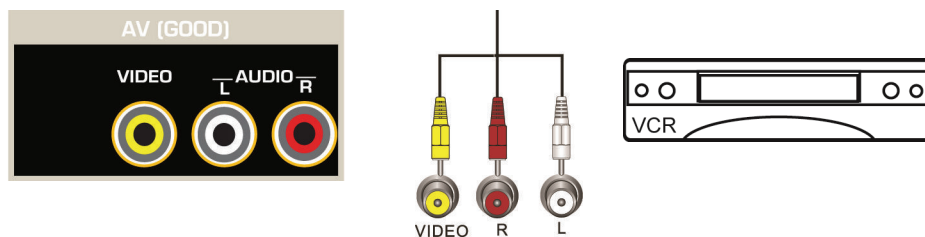

Note: Refer to your VCR or Video Camera user manual for more information about the video output requirements of the product.

1. Turn off the power to your HDTV and VCR or video camera.
2. Connect the yellow AV cable from your VCR or video camera to the **AV** jack on your HDTV.
3. Connect the audio cables on your VCR or video camera to the corresponding **L** and **R AUDIO** jacks on your HDTV.
4. Turn on the power to your HDTV and VCR or video camera.
5. Select **AV** using the **INPUT** button on the remote control or side of the TV.

Connecting a Home Theater System

Using RCA

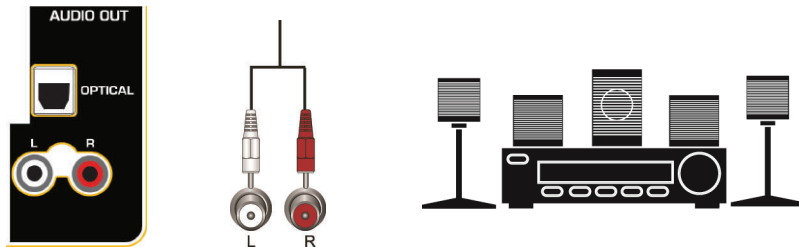

1. Turn off the power to the HDTV and Receiver/Amp.
2. Using an audio cable (white and red connectors), connect the cable to the audio input connectors on the Receiver/Amp and connect the other end to the **AUDIO OUT** audio connectors on the back of the HDTV.
3. Turn on the power to the HDTV and Receiver/Amp.
4. Press the **MENU** button on the remote control to open the On-Screen Display (OSD) menu.
5. Press **▼** on the remote control to highlight the Audio menu, and then press **OK** to select.
6. Press **▼** on the remote control to select **TV SPEAKERS**.
7. Press **▶** on the remote control to select **OFF** so the sound from the HDTV will be routed through your Receiver/Amp system.

Notes:

- Refer to your Receiver/Amp user manual to select the corresponding audio input.
- The audio output is not amplified and cannot be connected directly to external speakers.

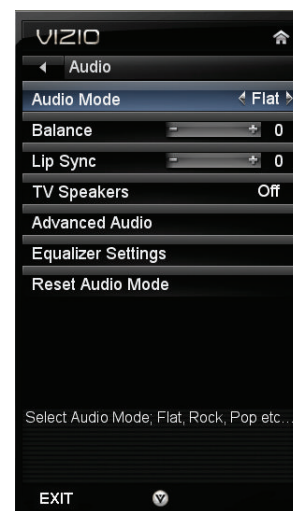

Using Optical (S/PDIF)

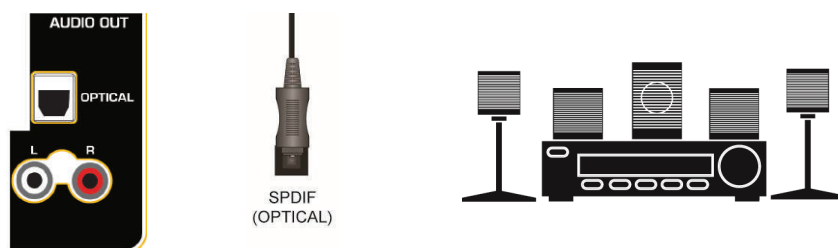

If your sound system has a S/PDIF (optical) digital audio input you can connect it from your sound system to the **OPTICAL** digital audio out on your HDTV. This is active when receiving audio with the programs being viewed no matter what input is being used.

1. Connect one end of the optical cable to optical connectors on the home theater and the other end to the **OPTICAL** jack on your HDTV.
2. Turn on the power to your HDTV and home theater.
3. Change the input on your home theater to optical. See your home theater user manual for more information.

Connecting a Computer Using RGB (VGA)

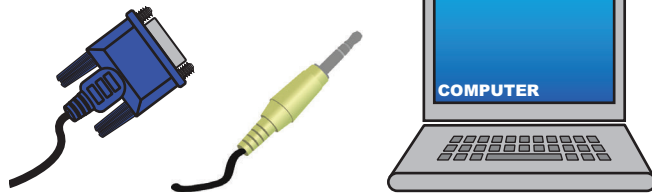
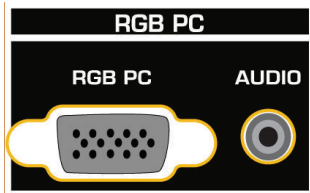

1. Set computer to a resolution supported by your HDTV (see *Preset PC Resolutions* on page 70). If your computer supports it, we recommend 1920x1080.
2. Turn off the power to your HDTV and computer.
3. Connect the RGB (VGA) cable from your computer to the **RGB PC** jack on of your HDTV.
4. Connect the 1/8-inch audio cable from your computer to the **RGB PC Audio** jack on your HDTV. This step is optional and only needed if you want to transmit audio from the computer through the TV.
5. Turn on the power to your HDTV and computer.
6. Select **RGB** (VGA) using the **INPUT** button on the remote control or side of the TV.

Note: Refer to your PC computer user manual for more information about the video output requirements.

Using HDMI

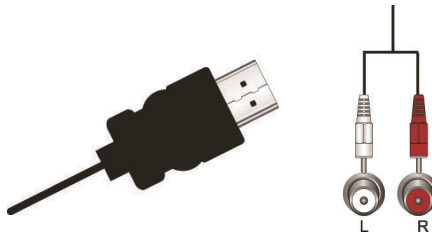
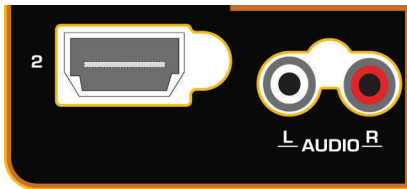

1. Turn off your HDTV and computer.
2. Connect a HDMI cable to the HDMI output of your computer and the other end to the **HDMI 3** jack on your HDTV.
3. Connect the audio cables (white and red) from the audio output jacks on the computer to the **HDMI 2 L** and **R AUDIO** jacks on your HDTV.
4. Turn on the power to your HDTV and your computer.
5. Select **HDMI-2** using the **INPUT** button on the remote control or side of the TV.

Chapter 7 Viewing Pictures

Connect a USB flash drive to the USB port on your HDTV to view pictures.

- USB drives that are USB 2.0 and FAT or FAT32 are supported. The USB Port does not support external hard drives or USB hubs.
- If your USB drive is oversized and does not physically fit in the USB port, use a USB extension cable. Connect one end of the cable to your USB drive and the other end to the USB port.
- Supported file extensions include .jpg and .jpeg.

Note: Even the supported format files listed above may or may not play properly or completely, depending on the USB device, bit rate stream, and other content characteristics, as well as other factors.

Viewing Pictures

1. Insert a USB device with digital content containing photos into the USB port on the side of your HDTV. If a USB device is already connected, press **MENU** on the remote control and select *Media*. A message will appear asking if you want to play multimedia content.
2. Press ◀ or ▶ to highlight **OK**, and then press **OK** to select it. The *Picture* folder will be displayed.
3. Press **OK** to select it. A menu will be displayed showing the folders and files that are on your USB device.
4. Press ◀ or ▶ to highlight the folder or file you want to play, and then press **OK** to select it. The file will play. See *Adjusting Photo Settings* on page 31 below to adjust various settings including setting up a slideshow and setting picture duration.
5. When finished, press **MEDIA** once to return to the previous screen or repeatedly to return to the main menu.

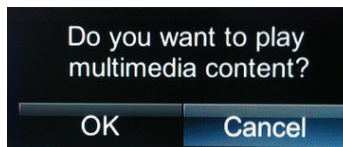

Adjusting Photo Settings

When viewing pictures you can adjust various settings, including slideshow, picture duration, etc.

1. Insert a USB device containing pictures and select the folder or files that you want to play.
2. Press **MENU**. The Picture menu will be displayed.
3. Press **▲** or **▼** on the remote control to highlight a Picture menu option, and then press **◀** or **▶** to adjust the setting.
4. Press **MENU** once to close the menu.

Slideshow Mode

Choose from **Shuffle**, **Single**, and **Sequence** to set the slideshow mode. Press **OK** to start and stop the slideshow.

- **Single** will display one picture selected from the thumbnails for the interval set in the *Duration* option and return to the thumbnails. If the *Repeat* option is set to **On**, the selected picture will be displayed until you press **EXIT**.
- **Sequence** will show your pictures in the order they are listed on your USB device until you stop the slideshow.
- **Shuffle** will show your pictures in random order until you stop the slideshow.

Repeat

Choose from **On** or **Off** to repeat the slideshow.

Sort By

You can choose to sort the pictures on the USB device by **Photo Date**, **File Date**, or alphabetically (**File A-Z**).

Duration

Set the amount of time the picture will remain on the screen during the slideshow. Choose a time between 5 seconds and 32 seconds.

Slideshow Effect

Choose from **Random**, **Dissolve**, **Wipe Right**, **Wipe Left**, **Wipe Up**, **Wipe Down**, **Box In**, or **Box Out** to set the transition type when changing from one picture to another during a slideshow.

Thumbnail Size

Set the size of the preview pictures (thumbnails) in the menu. Choose from **Small**, **Medium**, or **Large**.

Info

When set to **On**, information about the picture briefly appears on your HDTV.



Chapter 8 Adjusting Your HDTV Settings

Using the On-screen Display (OSD)

The remote control or the control buttons on the side of the TV can control all the function settings. The *OSD* allows you to adjust contrast, brightness and other settings. The TV will save changes made to the settings, even if the TV is turned off.

The OSD consists of several menu options. The main menu options may vary depending on your selected input source.

Note: Some of the main menu options may have additional submenus, for example, the TV Rating submenu for Parental Controls.

1. Press **MENU**. The *OSD* opens.
2. Press **◀**, **▶**, **▲**, or **▼** on the remote control to select one of the menu options:
 - Input
 - Wide
 - CC
 - Sleep Timer
 - Picture
 - PIP
 - Settings
 - Media
 - Help
3. Press **OK** to select the option or feature you want to adjust.
4. After the menu option is displayed, press **▲** or **▼** on the remote control to select one of the items to adjust.
5. Press **OK** to select it, and then press **◀**, **▶**, **▲**, or **▼** to adjust the selection.
6. Press **BACK** once to return to the previous screen. To return to your program once adjustments have been completed, you can do one of the following:
 - a. Press the **EXIT** button on the remote control.

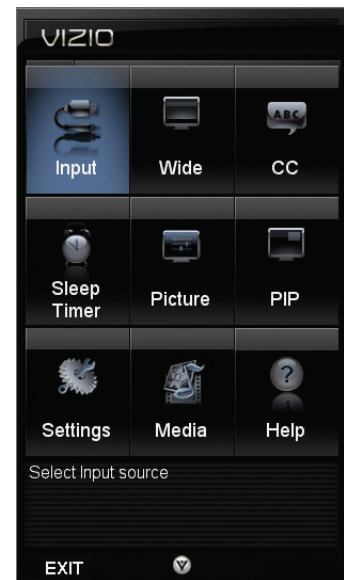

Input Menu

Select the Input Source for your HDTV. Choose from *TV*, *AV*, *Comp*, *HDMI-1*, *HDMI-2*, *HDMI SIDE*, *RGB*, and *Media*.

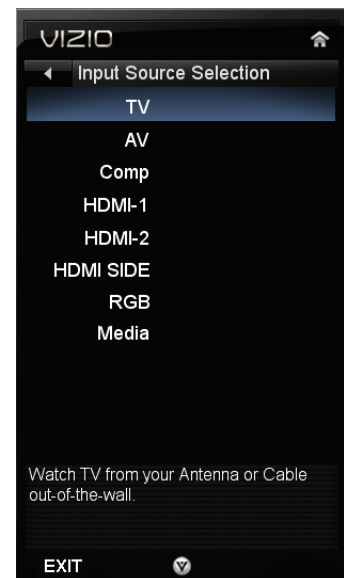

Wide Menu

Select how the picture displays on the screen. As you select an option, you will see the screen adjusting to the different sizes. The options vary depending on the selected input and the TV program:

Normal

The original 4:3 aspect ratio (1.33:1 source) is preserved, so black bars are added to the left and right of the display image. Standard TV broadcasts are displayed with a 4:3 Aspect Ratio. Movies in 4:3 Aspect Ratio may be referred to as pan-and-scan or full frame. These movies were originally filmed in 16:9 (widescreen), and then modified to fit a traditional TV screen (4:3).

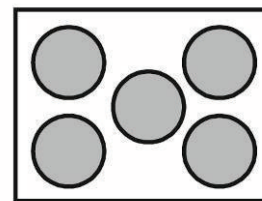

Wide

Wide mode allows you to view the entire picture. This is recommended for HDMI and RGB (Computer) viewing so you can see the complete picture without the image overstretching beyond the viewing area. For 720p, 1080i, 1080p only.

Zoom

Zoom mode will "zoom in" to the center of the image, allowing 4:3 images to be viewed in original aspect ratio without stretching the black bars. The top and the bottom of the image are cropped out, though.

Panoramic

When watching a standard broadcast or full frame movie in this mode, the 4:3 Aspect Ratio (1.33:1 source) display image is stretched horizontally on the left and right sides to fill the TV screen. The center of the image is not stretched.

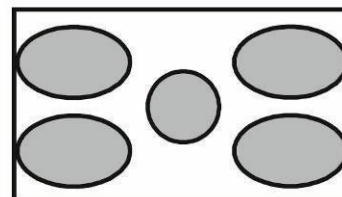

Stretch

When watching a widescreen program (1.78:1 source) with black bars on the sides, the display image will stretch to fill the TV screen. People will appear wider than they really are. If you are watching a widescreen (1.85:1 or 2.35:1 source) program or movie, there will still be black bars at the top and bottom. This mode is available only when watching a widescreen program.

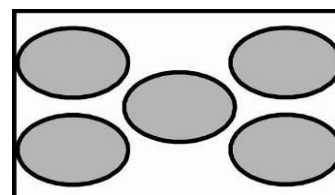

CC (Closed Caption) Menu

Adjust closed caption options.

Analog Closed Caption

The CC feature is available when watching regular analog TV. Select from **Off**, **CC1**, **CC2**, **CC3**, and **CC4**. Closed Caption for regular TV is usually **CC1** or **CC2**.

Digital Closed Caption

The CC feature is available when watching digital TV. Select from **CC1**, **CC2**, **CC3**, **CC4**, or **CS1**, **CS2**, **CS3**, **CS4**, **CS5**, **CS6**, or **Off**.

Digital CC Style

The Digital CC Style feature is available when watching digital TV.

- **Caption Style:** Select either **As Broadcaster** or **Custom**. If Custom is selected you can customize the way Closed Caption is displayed. The options available are:
 - **Text Size:** Make CC text larger or smaller.
 - **Color:** Choose a text color for CC display
 - **Opacity:** Make text more or less transparent.
 - **BG Color:** Choose a background color for CC text.
 - **BG Opacity:** Make the background for CC text more or less transparent.
 - **Window Color:** Choose a text frame color for CC text.
 - **Window Opacity:** Make the text frame for CC text more or less transparent.

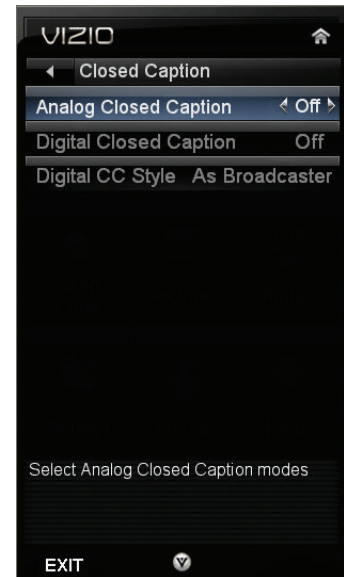

Sleep Timer Menu

Select the timer to turn off the TV in **30**, **60**, **90**, **120** or **180** minutes.

Picture Menu

Adjust picture options including brightness, contrast, and advanced picture settings.

Picture Mode

Choose from **Standard**, **Movie**, **Game**, **Vivid**, **Football**, **Golf**, **Basketball**, or **Custom**. Each input (i.e. HDMI, COMP, etc) remembers the custom setting you created. Select **Custom** to manually adjust *Backlight*, *Brightness*, *Contrast*, *Color*, *Tint*, *Sharpness*, and to access the *More* menu where further adjustments can be made.

Backlight

Adjust the brightness to affect the overall brilliance of the picture not the Brightness (black level) or Contrast (white level) of the picture.

Brightness

Adjust black levels in the picture. If the brightness is too low you will not be able to see the detail in darker parts of the picture and if the brightness is too high the picture will look washed out.

Note: Brightness is only available when *Picture Mode* is set to **Custom**.



Contrast

Adjust the white levels in the picture. If the contrast is too low the picture will look washed out and if the contrast is too high you will not be able to see any detail in the bright parts of a picture.

Note: Contrast is only available when *Picture Mode* is set to **Custom**.

Color

Adjust the amount of color in the picture.

Note: Color is only available when *Picture Mode* is set to **Custom**.

Tint

Adjust the hue of the picture. The easiest way to set tint is to look at flesh tones and adjust for a realistic appearance. In most cases, the default middle position is correct. If people's faces look too orange try reducing the level of color first.

Note: Tint is only available when *Picture Mode* is set to **Custom**.

Sharpness

Adjust the sharpness of the edges of elements in the picture. It does not produce detail that otherwise does not exist. This adjustment is helpful when viewing Standard Definition sources.

Note: Sharpness is only available when *Picture Mode* is set to **Custom**.

More

Select **More** to adjust advanced options for fine tuning the picture.

Note: The *More* menu is only available when *Picture Mode* is set to **Custom**.

Size & Position

To select the options in the Size & Position sub-menu, press **OK**. A new menu will be displayed showing the following Size & Position settings:

- **Horiz. Position**
Adjust the horizontal position of the picture.
- **Vertical Position**
Adjust the vertical position of the picture.
- **Horizontal Size**
Adjust the horizontal size of the picture.
- **Vertical Size**
Adjust the vertical size of the picture.

Note: The Size & Position function is only available in HDMI, Component, or RGB modes.

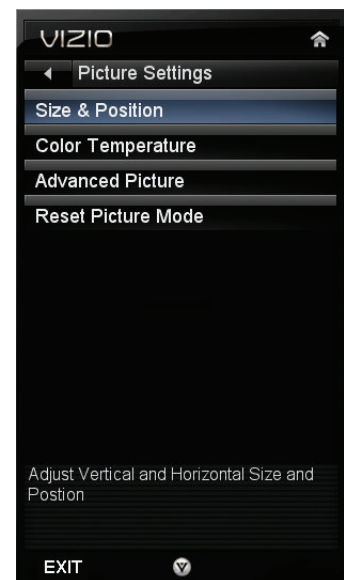

Color Temperature

Color Temperature is the “warmness” or “coolness” of the white areas of the picture. Choose from **Custom**, **Cool**, **Normal**, or **Computer**. **Normal** is the setting for television broadcasting. **Custom** allows you to set a preset calibrated for a white point to suit individual preferences. **Cool** produces a blue-hued image. **Computer** sets the white point at the established setting for a computer display (9300K). Each preset may also be adjusted for a customized setting.

Advanced Picture

To select the options in the Advanced Picture sub-menu, press **OK**. A new menu will be displayed showing the advanced functions available for fine tuning of the picture.

- **Smooth Motion Effect**

The Smooth Motion™ Effect option activates Motion Estimation/Motion Compensation (ME/MC), which suppresses motion judder, or “stuttering” of the image when the camera pans across a scene, or there is horizontal motion in the scene. Choose from **Off**, **Low**, **Middle**, or **High**.

- **Real Cinema Mode**

The Real Cinema Mode option allows selection of the type of compensation used for the Smooth Motion™ Effect option. Choose from **Off**, **Precision** and **Smooth**.

- **Noise Reduction**

This feature diminishes picture artifacts caused by the digitizing of image motion content that may be present in the picture. Choose from **Off**, **Low**, **Medium**, or **High**.

- **MPEG NR**

Reduces white areas between color boundaries. Choose from **Off**, **Low**, **Medium** or **Strong**.

- **Color Enhancement**

This feature increases the picture reproduction performance of the picture by reducing oversaturation of certain colors and improving flesh tones. Choose from **Off**, **Normal**, **Rich Color**, **Grn/Flesh**, and **Grn/Blue**.

- **Adaptive Luma**

Large areas of brightness in the picture will result in a higher Average Picture Level (APL) and the overall picture will look too light. This feature will lower the APL to counteract this effect. Choose from **Off**, **Low**, **Medium**, **Strong**, or **Extend**.

- **Film Mode**

Choose from **Off** or **Auto**. When set to **Off** it will stay at 60 fps. When set to **Auto**, the TV will detect the cadence (for example at 24 frames/second for film, or normal video at 60 fps).

- **Backlight Control**

Set this feature to **OFF**, **DCR**, or **OPC**. **DCR** (Dynamic Contrast Ratio) improves the black level performance and increases contrast ratio. **OPC** (Optimum Power Control) Reduces power consumption while maintaining the same picture brightness.

- **Ambient Light Sensor**

Choose **Off**, **Low**, **Medium**, or **High**. When set to **Low**, **Medium**, or **High**, your HDTV will automatically adjust to light changes in the room.

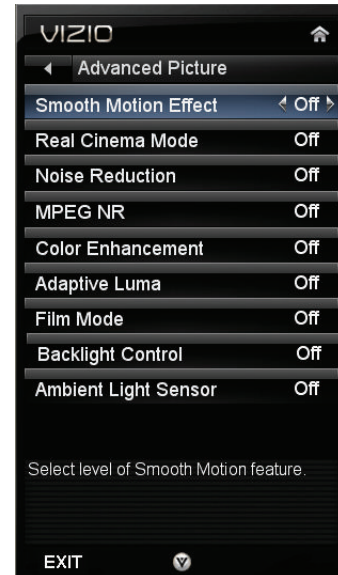

Reset Picture Mode

Return all Picture settings to factory default. A screen will come up to confirm your selection or to cancel it. Press ◀ or ▶ to make the selection, and then press **OK** to accept it.

Note: Only settings under the Picture will be reset.

PIP Menu

Your TV features PIP mode so you can watch two pictures at the same time. One picture is displayed as the full screen (main screen) and the other picture is displayed in a small window (sub screen).

Note: PIP is only available when the *Rating Enable* option in *Parental Controls* is set to **Off**.

PIP Mode

Select from **Off**, **PIP** (Picture-inside-picture) or **POP** (Picture-outside-picture). In **PIP** mode a smaller sub-screen is displayed on top of the main screen. In **POP** mode the main screen and sub-screen are of equal size and are positioned side-by-side.

Source

Select the input source for the sub-screen. The input sources available will vary according to which input is used for the main screen.

“✓” – Indicates which inputs are available for PIP and POP modes.

SUB MAIN	SUB				
	TV	AV (Composite)	Component	HDMI-1 HDMI-2 HDMI SIDE	RGB (Computer)
TV			✓	✓	✓
AV (Composite)			✓	✓	✓
Component	✓	✓		✓	
HDMI-1	✓	✓	✓		✓
HDMI-2	✓	✓	✓		✓
HDMI Side	✓	✓	✓		✓
RGB (Computer)	✓	✓		✓	

Position

Select where you want the PIP screen positioned over the main screen. Choose from **Top Left**, **Top Right**, **Bottom Left**, and **Bottom Right**.

Size

Set the size of the PIP window. Choose from **Small**, **Medium** or **Large**.

Audio

Select which source will play the audio. Choose from the **Main** screen or the **PIP** (sub) screen.

Settings Menu

Adjust various options including audio settings, scanning for channels, parental controls, date and time, and more.

Audio Menu

Adjust audio options including balance, equalizer, and advanced audio settings.

Audio Mode

Choose from Flat, Rock, Pop, Classic or Jazz.

Balance

Adjust the sound to the left or the right.

Lip Sync

Lip Sync is designed to adjust the audio of the program being viewed so that it matches the movement of the lips of someone talking on the screen.

TV Speakers

Turn the internal speakers On or Off. You may want to turn the internal speakers off when listening to the audio through your Home Theater System.

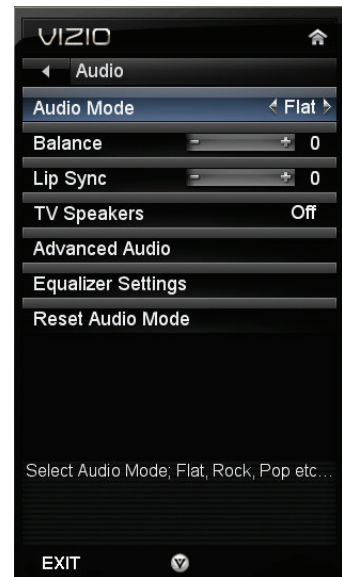
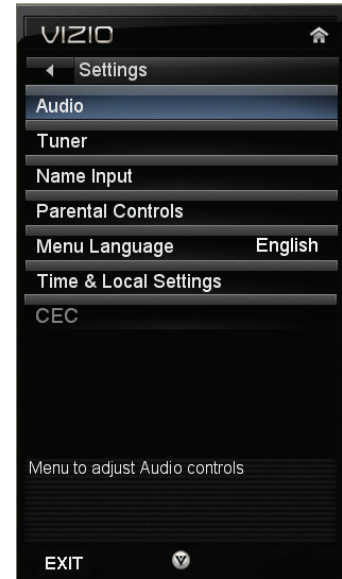

Advanced Audio

To select the options in the Advanced Audio sub-menu, press **OK**. A new menu will be displayed showing the advanced functions available for fine tuning of the audio.

- **SRS TruSurround HD**

When watching TV or a movie, TruSurround HD™ creates an immersive surround sound experience from only two speakers and provides rich bass, clear dialog and high frequency detail.

Note: When SRS TruSurround HD is ON, Equalizer adjustments are not available.

- **SRS TruVolume**

When the programming switches to a commercial or when changing from channel to channel, volume fluctuations occur. When turned ON, SRS TruVolume™ provides the listener with a comfortable and consistent volume level. Turn this option off when listening to music.

- **Digital Audio Out**

This option allows selection of the type of processing for the S/PDIF (Optical connector) when used with a Receiver/Amplifier/Home Theater system. Select to choose from OFF, Dolby Digital or PCM.

- **Analog Audio Out**

This option sets the volume control properties when using the RCA (white and red) connectors as audio line out to connect a Receiver/Amplifier/Home Theater system. Choose from Fixed or Variable. When set to Variable, volume from the external speakers will change according to the volume setting on the TV. If it is set to Fixed, the volume can only be changed by the settings on the external stereo system.

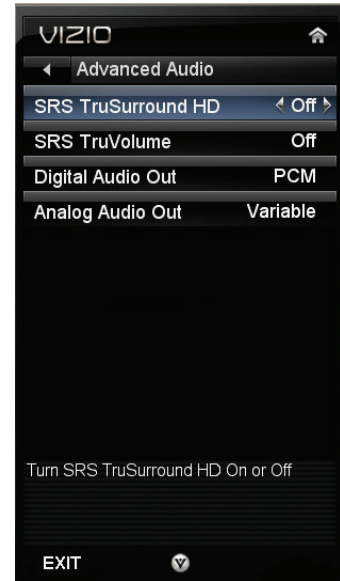

Equalizer Settings

To select the options in the Equalizer Settings sub-menu, press **OK**. A new menu will be displayed showing the available equalizer functions. Press **◀** or **▶** to select *Basic* or *Advanced*.

- **EQ Mode (Basic)**

Adjust Bass and Treble.

- **EQ Mode (Advanced)**

Adjust volumes of different frequencies.

Starting from lowest to the highest, they are 120 Hz, 500Hz, 1.5 kHz, 5 kHz and 10 kHz.

1. Press **◀** or **▶** to select the frequency to be adjusted.
2. Use **▲** or **▼** to adjust the selected frequency to your preference. Values above 0 will boost the frequency and values below 0 will attenuate the frequency.

Note: The Equalizer adjustment will only be available when SRS TSHD is set to Off.

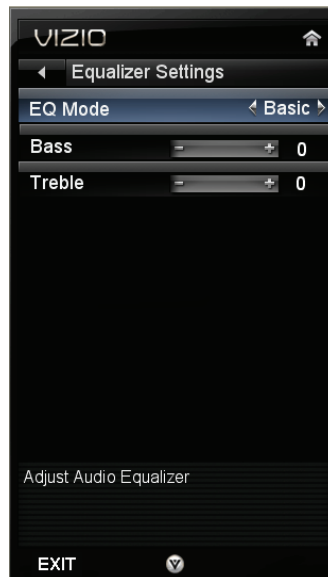

Reset Audio Mode

Return all Audio settings to factory default. A screen will come up to confirm your selection or to cancel it. Press ◀ or ▶ to make the selection, and then press OK to accept it.

Note: Only settings under the Audio menu will be reset.

Tuner

Note: The tuner option can only be selected when your HDTV is in TV input mode.

Tuner Mode

Select Cable or Antenna depending upon which you have attached to the DTV / TV Input.

Auto Channel Scan

Automatically search for TV channels that are available in your area. Be sure to first select the correct tuner mode above. The TV will search for analog and digital channels. When the search is done, press **OK** to begin watching your programs.

Partial Channel Search

If you believe channels are missed from the auto search, you can do a partial channel search to look for channel in a certain channel range again. Select to scan for Analog, Digital, or both Analog/Digital channels, then press ▼ to highlight the “From” and “To” selection. Press ▶ to select the range of channel numbers you want to start searching in. Press **OK** to start channel search.

Add Analog Channel

If your are in fringe/marginal reception areas or you want to receive local broadcasts where *Auto Channel Search* may not pick up the signals you can manually add channels. Press **OK** and a new menu will open. Enter the channel number, press ▼ to select *Add Channel*, and then press **OK** to add the channel.

Skip Channel

After the TV has stored all of the available digital channels in memory you will find that some channels are too weak to watch comfortably or they may be channels you do not want to see. Press **OK** to select the channel to be skipped when using the CH▲ or CH▼ button. An X will appear in channels you have selected to skip. You will still be able to select this channel using the number buttons on the remote control.

Analog MTS

This feature allows you to select the different languages the broadcaster is transmitting the audio with the program you are watching. This signal is usually Spanish. Choose from **Mono**, **Stereo**, or **SAP**.

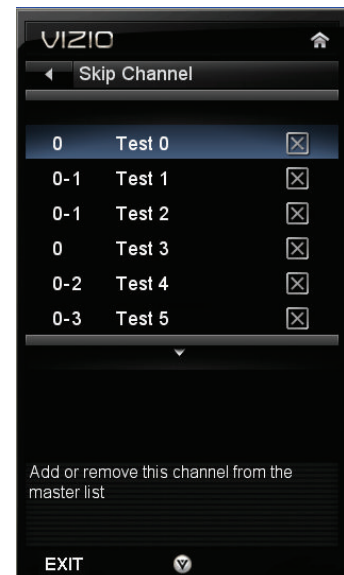
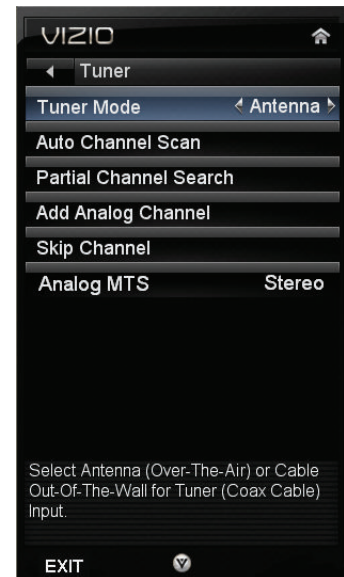

Name Input

This feature makes it easier for you to recognize the devices you have connected to your HDTV when you press **INPUT**. For example, if you have a Blu-Ray DVD player connected to the HDMI-1 input, you can have the input label read *HDMI-1 BluRay* instead of just *HDMI-1*. You can select from 10 preset labels.

To use one of the 10 preset labels:

1. Select *Input Source*, and then press **OK** to show the list of inputs.
2. Press **▼** to select the input label you want to change, and then press **OK**.
3. Press **▼** to select *Input Labels*, and then press **OK** to show the list of 10 preset labels.
4. Press **▼** to select the new input label name, and then press **OK**.

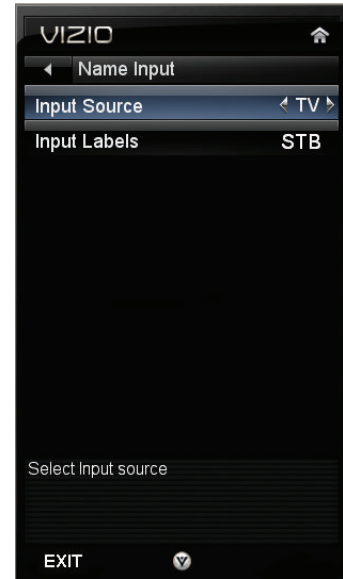

Parental Controls

If you want to restrict certain channel and program viewing, you can do this by turning on the Parental Control. Selected programs, movies and channels can then be made available only after an authorized password has been entered and accepted by the TV.

To select the options in the Parental sub-menu, press **OK** and then create and/or enter a password. A new menu will be displayed showing the following Parental settings:

Note: The Parental menu does not appear when the input mode is set to HDMI or RGB.

Rating Enable

This feature does not operate on this TV.

Channel Locks

Block individual channels from being displayed.

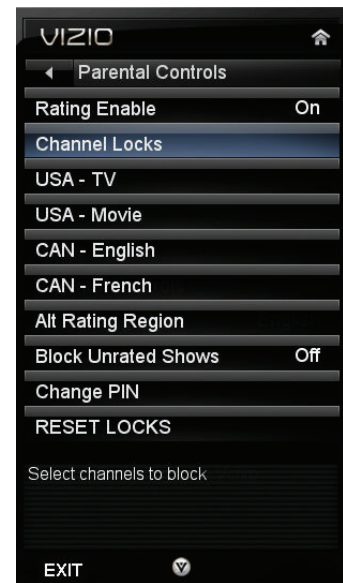

USA-TV

Note: When Rating Enable is **OFF**, the USA-TV Rating adjustments are not available.

Press **OK** to block (locked) or allow (unlocked) channels by the following US TV ratings:

- TV-Y – All children
- TV-Y7 – Older children
- TV-G – General audience
- TV-PG – Guidance suggested
- TV-14 – Strongly cautioned
- TV-MA – Mature audience

You can also customize the TV ratings for the following content:

- A – All sub-ratings
- FV – Fantasy violence
- D – Sexual dialog
- L – Adult language
- S – Sexual situations
- V - Violence

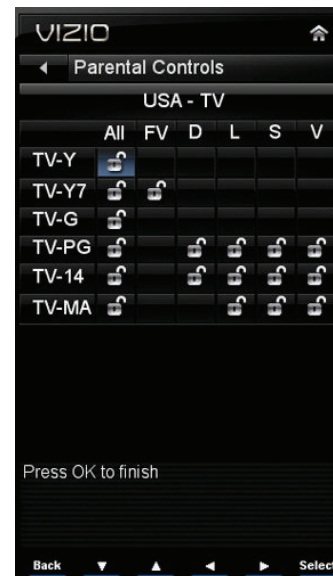

USA-Movie

Note: When Rating Enable is **OFF**, USA-Movie Rating adjustments are not available.

Press the **OK** button to block (locked) or allow (unlocked) channels by the following US Movie ratings:

- G – General audience
- PG – Parental guidance suggested
- PG-13 – Recommended for children 13 years of age or older
- R – Mature audience
- NC-17 – No one under 17 years of age
- X – No one under 17 years of age

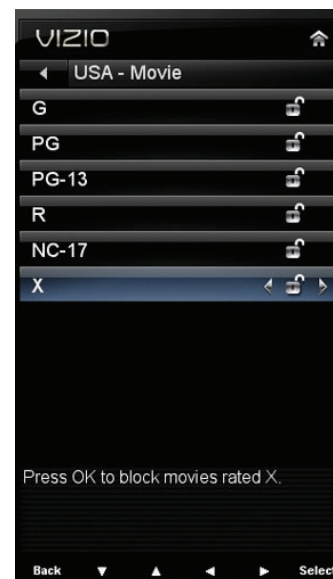

CAN-English

Note: When Rating Enable is **OFF**, Canadian English Rating adjustments are not available.

Press the **OK** button to block (locked) or allow (unlocked) channels by the following Canadian English ratings:

- C – Children
- C8+ – Children 8 years or older
- G – General Programming, suitable for all audiences
- PG – Parental guidance
- 14+ – Viewers 14 years or older
- 18+ – Adult programming

CAN-French

Note: When Rating Enable is **OFF**, Canadian French Rating adjustments are not available.

Press the **OK** button to block (locked) or allow (unlocked) channels by the following Canadian French ratings:

- G – General audience
- 8 ans+ – General – not recommended for young children
- 13 ans+ – Not suitable for children under 13 years of age
- 16 ans+ – Not suitable for under 16 years of age
- 18 ans+ – Adults only

Alt Rating Region

This is reserved for future use in the event the parental control system is ever updated. Your HDTV will be able to receive and update the new rating system to it.

Block Unrated TV

Block programming that does not have a rating.

Change PIN (Password)

Enter a new, 4-digit password using the number buttons on the remote control. Enter it a second time to confirm you entered it correctly.

Note: Make sure you write down and store the new password in a secure place. The *Reset Locks* feature does NOT reset the password.

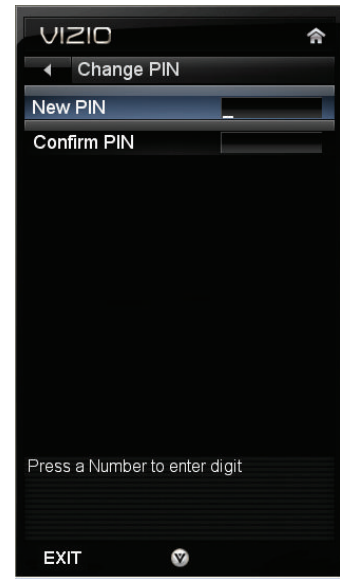

RESET LOCKS

Return all Parental Control lock settings to factory default. A screen will come up to confirm your selection or to cancel it. Press **◀** or **▶** to make the selection, and then press **OK** to accept it.

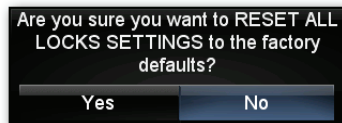

Menu Language

Select to change the language of the menu. The default is **English**. You can also select **French** or **Spanish**.

Time & Local Settings

Time Zone

Setting the correct Time Zone for your area will ensure that the correct time is shown after pressing the **GUIDE** button on the remote control.

Daylight Saving

Setting the daylight saving time for your area will ensure that the correct time is shown after pressing the **GUIDE** button on the remote control.

CEC

Consumer Electronics Control allows you to control other devices using your HDTV remote control when those devices are connected via HDMI. For example, if a CEC-supported Blu-ray DVD player is connected to your HDTV through HDMI-2 and that player is powered on, your HDTV will automatically change to the HDMI-2 input. Similarly, if your HDTV is powered on first and you change the input to HDMI-2, your Blu-ray player will automatically power on.

Also, you can control your CEC-supported device using the transport keys on your HDTV remote control (e.g. Play, Stop, Prev, etc.). When you press one of the buttons on your HDTV, the action will occur on your device.

Contact your devices' user manual or manufacturer to check whether your device supports CEC.

CEC Function

Turn CEC On or Off. When set to Off, your HDTV will not send or receive any CEC commands.

Device Discovery

Register device with TV. Before CEC will work, perform a Device Discovery to see if there are any CEC supported devices connected to your HDTV.



Media Menu

When viewing pictures you can adjust various settings, including slideshow, picture duration, etc.

1. Insert a USB device containing pictures and select the folder or files that you want to play.
2. Press **MENU**. The Picture menu will be displayed.
3. Press **▲** or **▼** on the remote control to highlight a Picture menu option, and then press **◀** or **▶** to adjust the setting.
4. Press **MENU** once to close the menu.

Slideshow Mode

Choose from **Shuffle**, **Single**, and **Sequence** to set the slideshow mode. Press **OK** to begin the slideshow. Press **EXIT** to stop the slideshow.

- **Single** will display one picture selected from the thumbnails for the interval set in the *Duration* option and return to the thumbnails. If the *Repeat* option is set to **On**, the selected picture will be displayed until you press **EXIT**.
- **Sequence** will show your pictures in the order they are listed on your USB device until you stop the slideshow.
- **Shuffle** will show your pictures in random order until you stop the slideshow.

Repeat

Choose from **On** or **Off** to repeat the slideshow.

Sort By

You can choose to sort the pictures on the USB device by **Photo Date**, **File Date**, or alphabetically (**File A-Z**).

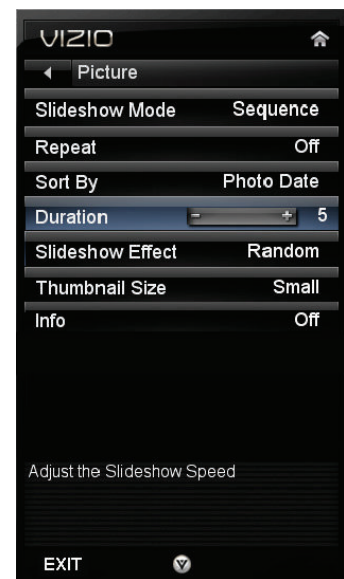

Duration

Set the amount of time the picture will remain on the screen during the slideshow. Choose a time between 5 seconds and 32 seconds.

Slideshow Effect

Choose from **Random**, **Dissolve**, **Wipe Right**, **Wipe Left**, **Wipe Up**, **Wipe Down**, **Box In**, or **Box Out** to set the transition type when changing from one picture to another during a slideshow.

Thumbnail Size

Set the size of the preview pictures (thumbnails) in the menu. Choose from **Small**, **Medium**, or **Large**.

Info

When set to **On**, information about the picture briefly appears on your HDTV.

Help Menu

System Info

Display the technical information including model name, version and revision of firmware, source type, and resolution.

Reset TV Settings

Return all Picture and Audio settings to factory default. A screen will come up to confirm your selection or to cancel it. Press Left or Right Navigation buttons to make the selection, and then press **OK** to accept it.

Note: This does **NOT** reset the Parental Control Password.

Clear Memory (Factory Default)

Use this function to reset the TV to the default factory settings. The screen will display a message to confirm that you want to reset the values to factory settings. Press ◀ or ▶ to make the selection, and then press **OK** to accept it.

Note: This does **NOT** reset the Parental Control Password.

Start Setup Wizard

Use this function to return to the Initial Setup menu. Use this function if you want to have a guided setup when you move your TV.

Note: Previously scanned channels will be removed.



Chapter 9 Programming the VIZIO Universal Remote Control

Program your **E470VL** and **E550VL** remote control to work with other devices.

Using a Cable or Satellite Box Remote

Your VIZIO remote uses codes 000, 047, 050, 067, 329, 331 and 339 to work your HDTV. To use a cable or satellite remote to work the HDTV, refer to your cable or satellite remote user guide for more information on how to program the remote.

If your cable or satellite remote uses a 5-digit code (like most Direct TV units), first try 11758 and then, if that does not work, 10178. If your cable or satellite remote uses a 4-digit code, try 1758 and then 0178 as an alternative. If your cable or satellite remote uses a 3-digit code (EchoStar or Dish Network for example), use code 627.

Note: Some buttons may not function as expected on your cable or satellite remote. Typically power, volume and mute will work.

Programming other devices

Your remote control is programmable and supports up to three different devices. Listed below are the steps for programming your DVD player, Home Theater System, and a Cable or Satellite box. After you find your codes, write them in the table provided.

Notes:

- If the codes do not work or your brand is not listed, see "Searching for Component Codes."
- Sometimes a code listed will only include limited functions. Try other codes that may include more functionality.

Programming your Blu-Ray or DVD Player

1. Turn on the DVD player.
2. Press and release the **DVD** button on your VIZIO universal remote control.
3. Press and hold the **SET** button until the LED flashes twice.
4. Find the programming code for your DVD player in the code list below and enter it using the number buttons. If the code is accepted, the LED flashes twice after the last digit is entered. If the LED does not flash twice, repeat Steps 2 through 4 with the next code listed.
5. Point the remote control at the DVD player and press **POWER**. The DVD player will turn off. If the DVD player does not turn off, repeat Steps 2 through 4 with the next code listed for the component and manufacturer.

Programming your Home Theater System

1. Turn on the home theater system.
2. Press and release the **AUDIO** button on your VIZIO universal remote control.
3. Press and hold the **SET** button until the LED flashes twice.
4. Find the programming code for your home theater system and enter it using the number buttons. If the code is accepted, the LED flashes twice after the last digit is entered. If the LED does not flash twice, repeat Steps 2 through 4 with the next code listed.
5. Point the remote control at the Home Theater System and press **POWER**. The Home Theater System will turn off. If the Home Theater System does not turn off, repeat Steps 2 through 4 with the next code listed for the component and manufacturer.

Programming your Cable or Satellite Set-Top Box

1. Turn on the Cable or Satellite Set-Top Box.
2. Press and release the **CABLE** button on your VIZIO universal remote control.
3. Press and hold the **SET** button until the LED flashes twice.
4. Find the programming code for your Cable or Satellite Set-Top Box and enter it using the number buttons. If the code is accepted, the LED flashes twice after the last digit is entered. If the LED does not flash twice, repeat Steps 2 through 4 with the next code listed.
5. Point the remote control at the Cable or Satellite Set-Top Box and press **POWER**. The Cable or Satellite Set-Top Box will turn off. If the Cable or Satellite Set-Top Box does not turn off, repeat Steps 2 through 4 with the next code listed for the component and manufacturer.

My Codes	
DVD Player	
Home Theater	
Cable Box	
Satellite Box	
VCR	
Other	
Other	
Other	

Searching for Device Codes

If you cannot find the manufacturer in the list or the program code does not work, you can use the remote control to search for the correct device code.

1. Turn on the device.
2. Press the matching device button on your VIZIO universal remote control.
3. Press and hold **SET** until the LED flashes twice.
4. Press **9 9 1**. The LED flashes twice.
5. Point the remote control at the device and then press and hold **POWER** until the device turns off.

Reset Remote to Factory Settings

1. Press and hold **SET** until the LED flashes twice.
2. Press **9 1 9 1 9**. The LED flashes twice.

Remote Control Codes

Television Codes

(Including TV/DVD, TV/VCR, and TV/DVD/VCR)

3M 10195, 888, 10462	Asberg 10353	Bush 10348, 10352, 10353
A.R. Systems 10352	Astar 10163	byd:sign 10214
Abex 10065, 10256	Atlantic 10353	Caihong 10360, 10362, 10368, 10457, 10460
ACE 10449	Audinac 10234, 10278	Cailing 10464
Acer 10164	Audiosonic 10352, 10353	Caixing 10366, 10367, 10378, 10380, 10390, 10461
Addison 10048, 10231	Audiovox 10054, 10099, 10231, 10234, 10248, 10280, 10287, 10326	Candle 10047, 10049, 10050, 10066, 10229, 10254, 10261, 10265
Admiral: 10045, 10078, 10232, 10236	Aventura 10042	Carena 10353
Advent 10221, 10291	Awa 10048, 10351	Carnivale 10229, 10254
Adventura 10066, 10261	Axion 10154, 10326	Carver 10034, 10044, 10271
Aiko 10053, 10231	Baihehua 10461	Cascade 10353
Aim 10353	Baihua 10460, 10462	Casio 10353
Aiwa 10178, 10207	Baile 10458, 10460	Cathay 10353
Akai 10027, 10046, 10127, 10153, 10196, 10229, 10238, 10240, 10254, 10267, 10304, 10353	Bang & Olufsen 10244	Caton 10355
Akiba 10353	BaoHuaShi 10462	CCE 10246, 10258, 10353
Akito 10348, 10353	Baosheng 10457, 10460	Celebrity 10046
Akura 10277, 10353	Barco 10282	Celera 10075
Alaron 10246, 10273, 10275	Basic Line 10352, 10353	Centurion 10051, 10353
Alba 10353	Baur 10249, 10281, 10353	Changcheng 10357, 10360, 10362, 10363, 10364, 10366, 10367, 10368, 10369, 10370, 10371, 10372, 10373, 10374, 10376, 10378, 10379, 10380, 10384, 10385, 10392, 10448, 10455, 10457, 10458, 10460, 10461, 10462
Albatron 10219, 10222, 10286	Baysonic 10234	Changfei 10360, 10362, 10368, 10379, 10457, 10460, 10467
Alfide 10240	Beijing 10358, 10360, 10362, 10364, 10365, 10366, 10367, 10368, 10369, 10370, 10371, 10372, 10373, 10374, 10376, 10377, 10378, 10379, 10380, 10383, 10384, 10385, 10392, 10394, 10428, 10431, 10448, 10457, 10458, 10460, 10461, 10462	Changfeng 10360, 10367, 10376, 10381, 10382, 10384, 10385, 10392, 10457, 10462
Alleron 10055	Belcor 10047, 10252	Changhai 10360, 10362, 10368, 10457, 10460, 10467
Allstar 10353	Bell & Howell 10045	Changhong 10075, 10356, 10358, 10359, 10360, 10361, 10362, 10369, 10371, 10376, 10383, 10386, 10387, 10388, 10389, 10393, 10394, 10412, 10427, 10433, 10436, 10448, 10457, 10460
A-Mark 10248	Benq 10116, 10159, 10226, 10300	Chaparral 10442
America Action 10234	Beon 10353	Chengdu 10360, 10368, 10457
Ampro 10220, 10289	Bestar 10352, 10353	Chimei 10217
Amstrad 10279, 10353	Bestar-Daewoo 10352	Ching Tai 10231
Amtron 10054	Blaupunkt 10281	Chun Yun 10222, 10231, 10234, 10329, 10342
Anam 10234	Blue Sky 10282, 10353	
Anam National 10054, 10264	Boots 10348	
Anhua 10455	Boxlight 10290	
Anitech 10353	BPL 10275, 10353	
AOC 10047, 10048, 10049, 10112, 10229, 10248, 10252, 10254, 10263, 10274, 10316	Bradford 10054, 10234	
Aolinpiya 10462	Brilliant 10160	
Aolinpu 10465	Brinkmann 10353	
Apex 10075, 10095, 10233	Brockwood 10047, 10252	
Apex Digital 10288	Broksonic 10078, 10234, 10236, 10248	
Archer 10248		
Archos 10156		
Ardem 10353		
Aristona 10353		

Chunfeng 10362, 10368, 10376,
 10384, 10385, 10392, 10405,
 10460, 10462
 Chung Hsin 10048, 10234,
 10332
 Chunlan 10397, 10468
 Chunsun 10360, 10362, 10368,
 10457, 10460
 Cinego 10327
 Cinal 10231, 10280
 Citizen 10047, 10049, 10050,
 10053, 10054, 10062, 10064,
 10229, 10231, 10238, 10254,
 10259, 10261, 10265, 10325,
 10347
 Clairtone 10274
 Clarion 10234
 Clarivox 10353
 Clatronic 10353
 Coby 10108
 Colortyme 10047, 10049
 Colt 10344
 Commercial Solutions 10230
 Concerto 10047, 10049, 10265
 Condor 10353
 Conrowa 10422, 10460, 10462
 Contec 10234, 10268, 10269,
 10274, 10353
 Contec/Cony 10052, 10054
 Cosmel 10353
 Craig 10054, 10234
 Crosley 10034, 10044, 10076
 Crown 10054, 10058, 10234,
 10240, 10259, 10353
 Crown Mustang 10240
 CTX 10115
 Curtis Mathes 10016, 10027,
 10034, 10044, 10047, 10049,
 10062, 10064, 10229, 10230,
 10232, 10238, 10239, 10254,
 10259, 10265, 10280
 CXC 10054, 10234
 CyberHome 10294
 Cytron 10152, 10310
 Daewoo 10047, 10048, 10049,
 10053, 10064, 10076, 10231,
 10240, 10252, 10259, 10280,
 10325, 10347, 10352, 10353
 Dansai 10353
 Dawa 10353
 Daytron 10047, 10049, 10064,
 10252, 10352, 10353
 Dayu 10458
 De Graaf 10275
 Decca 10348, 10353
 Dell 10019, 10124
 Denon 10239
 Denstar 10284
 Denver 10353
 Desmet 10353
 Diamant 10353
 Diamond Vision 10216, 10328
 Digatron 10353
 Dimensia 10016
 Disney 10093
 Dixi 10353
 DongBao 10448
 DongDa 10362, 10368, 10448,
 10460
 Donghai 10362, 10368, 10460
 DongHua 10448
 Donglin 10391
 Dual 10353
 Dumont 10020, 10047, 10228,
 10252, 10266
 Durabrand 10042, 10078, 10227,
 10234, 10236, 10248, 10272
 Dux 10353
 D-Vision 10353
 Dwin 10232, 10293
 Dynatech 10262
 Dynatron 10353
 Dynex 10143, 10189
 Ectec 10278
 Eiki 10169, 10170
 Electroband 10046, 10274
 Electrograph 10206, 10321
 Electrohome 10046, 10047,
 10049, 10078
 Elektra 10228
 Element 10136
 ELG 10353
 Elin 10353
 Emerson 10042, 10047, 10049,
 10052, 10054, 10055, 10064,
 10076, 10078, 10135, 10234,
 10236, 10252, 10259, 10269,
 10272, 10273, 10274, 10325,
 10347, 10353
 Emprex 10215
 Envision 10047, 10049, 10112,
 10229, 10254, 10316
 Epson 10113, 10302
 Erres 10250, 10353
 ESA 10042, 10127
 ESC 10353
 Ether 10330
 Euroman 10353
 Europa 10353
 Exquisit 10353
 Feilang 10362, 10368, 10460
 Feilu 10360, 10362, 10368,
 10457, 10460
 Feiyan 10376, 10384, 10385,
 10392, 10462
 Feiyue 10360, 10362, 10366,
 10367, 10368, 10378, 10380,
 10457, 10460, 10461
 Fenmenti 10353
 Fenner 10352
 Ferguson 10048
 Fidelity 10353
 Filmnet 10440
 Finlandia 10275
 Finlux 10266
 Firstline 10352, 10353
 Firstar 10340
 Fisher 10270, 10275
 FlexVision 10287
 Flint 10353
 Fraba 10353
 Friac 10353
 Frontech 10277
 Fujitsu 10050, 10055, 10208,
 10273
 Funai 10042, 10054, 10055,
 10234, 10273, 10324
 Furi 10336
 Futuretech 10054, 10234, 10277
 Galaxis 10353
 Ganxin 10457, 10461
 Gateway 10119, 10206, 10241,
 10322
 GBC 10352
 GE 10016, 10047, 10049, 10056,
 10057, 10070, 10088, 10230,
 10253, 10264, 10272, 10280,
 10345
 GEC 10353
 Geloso 10352
 Genexxa 10353
 GFM 10040, 10140
 Gibraltar 10020, 10047, 10228,
 10229, 10252, 10254

GoldStar 10047, 10048, 10049, 10052, 10064, 10065, 10229, 10252, 10254, 10256, 10272, 10346, 10353
 Goodmans 10352, 10353
 Gradiente 10036, 10118, 10265, 10271
 Granada 10048, 10275, 10353
 Grandin 10352, 10353
 Great Wall 10349
 Grundig 10240, 10258, 10266, 10281, 10353
 Grunpy 10054, 10055, 10234, 10273
 Haier 10139, 10148, 10174, 10209, 10227, 10247, 10354, 10380, 10395, 10396, 10399, 10403, 10404, 10414, 10416, 10417, 10418, 10419, 10421, 10423, 10424, 10466
 HaiHong 10362, 10368, 10369, 10370, 10371, 10372, 10373, 10391, 10395, 10448, 10460
 Haile 10375
 Haiyan 10360, 10366, 10367, 10376, 10378, 10380, 10384, 10385, 10392, 10457, 10461, 10462
 Hallmark 10047, 10049, 10272
 Hankook 10234, 10330, 10339
 Hannspree 10315
 Hanseatic 10353
 Hantarex 10313, 10353
 Hantor 10353
 Harley Davidson 10260, 10273, 10324
 Harman/Kardon 10034, 10044
 Harvard 10054, 10234
 Harwood 10353
 Hauppauge 10353
 Havermy 10232
 HCM 10279, 10353
 Helios 10145
 Hello Kitty 10210, 10280
 Hewlett Packard 10101, 10301
 Highline 10353
 Himitsu 10234, 10284
 Hinari 10353
 Hisense 10121, 10288, 10338, 10350, 10356, 10358, 10361, 10368, 10381, 10382, 10386, 10395, 10396, 10397, 10400, 10401, 10407, 10408, 10416, 10417, 10418, 10419, 10426, 10428, 10431, 10459
 Hitachi 10047, 10048, 10049, 10052, 10131, 10184, 10239, 10256, 10265, 10324, 10353
 Hitachi Fujian 10048, 10457, 10459, 10461, 10462
 Hornyphone 10353
 Hongmei 10359, 10360, 10362, 10366, 10367, 10368, 10376, 10378, 10380, 10385, 10386, 10387, 10392, 10457, 10460, 10461, 10462
 Hongyan 10457, 10462
 Hotel TV 10447
 HP 10301
 Huafa 10460
 Huanghaimei 10362, 10368, 10460
 Huanghe 10360, 10362, 10366, 10367, 10368, 10378, 10380, 10383, 10395, 10406, 10457, 10460, 10461
 Huanglong 10362, 10368, 10460
 Huangshan 10360, 10362, 10366, 10367, 10368, 10375, 10376, 10378, 10380, 10384, 10385, 10392, 10457, 10460, 10461, 10462
 Huanyu 10352, 10359, 10360, 10366, 10367, 10376, 10378, 10380, 10384, 10385, 10386, 10387, 10392, 10457, 10459, 10461, 10462
 Huaqiang 10376, 10384, 10385, 10392, 10462
 Huari 10462
 Humax 10197
 Huodateji 10455
 Hypson 10277, 10353
 Hyundai 10171, 10224
 Iberia 10353
 ICE 10277
 Ilo 10149, 10151, 10307, 10320
 IMA 10054
 Imperial 10353
 Imperial Crown 10458, 10462
 Indiana 10353
 Infinity 10034, 10044, 10058
 InFocus 10125, 10290
 Initial 10151, 10320
 Innova 10258
 Insignia 10141, 10142, 10143, 10181, 10310
 Inteq 10228
 Interbuy 10353
 Interfunk 10353
 Internal 10353
 Intervision 10277, 10353
 IR 10351, 10352, 10353
 Irradio 10353
 IRT 10280, 10284
 Isukai 10353
 ITS 10353
 ITV 10352, 10353
 Janeil 10066, 10261
 JBL 10034, 10044, 10058
 JC Penney 10016, 10047, 10048, 10049, 10050, 10056, 10057, 10062, 10064, 10065
 JCB 10046
 Jean 10231, 10331, 10338, 10340
 Jensen 10047, 10049, 10291
 Jiahua 10357, 10363, 10375, 10376, 10411, 10455
 JiaLiCai 10414, 10448, 10460, 10462
 Jinfeng 10357, 10360, 10365, 10455, 10457
 Jinhai 10359, 10386, 10387
 Jinlipu 10386
 Jinqe 10457, 10460, 10462
 Jinta 10460, 10461, 10462
 Jinxing 10333, 10336, 10338, 10358, 10360, 10367, 10368, 10375, 10376, 10377, 10383, 10386, 10389, 10390, 10392, 10394, 10397, 10408, 10426, 10457, 10462
 Juhua 10457, 10461, 10462
 JVC 10036, 10037, 10038, 10052, 10057, 10059, 10078, 10257
 Kaige 10457, 10460, 10461, 10462
 Kaisui 10353
 Kamp 10246
 Kangchong 10359, 10386, 10387
 Kanghua 10395

Kangli 10422, 10448, 10457, 10458, 10460, 10461, 10462
 Kangyi 10390, 10460, 10462
 Kawasho 10046, 10047, 10049, 10246, 10269
 Kaypani 10263
 KDS 10295
 KEC 10234
 Kendo 10353
 Kenwood 10047, 10049, 10229, 10252, 10254
 Kioto 10034, 10282
 Kiton 10353
 KLH 10075
 Kloss 10261
 Kloss Novabeam 10054, 10066
 Kneissel 10352, 10353
 Kolin 10048, 10234, 10337
 Kongque 10457, 10460, 10461, 10462
 Konka 10211, 10237, 10284, 10353, 10355, 10360, 10363, 10372, 10375, 10388, 10389, 10391, 10392, 10397, 10402, 10430
 Korpel 10353
 Kost 10306
 Kreisen 10298
 KTV 10054, 10064, 10229, 10234, 10246, 10254, 10259, 10274
 Kuaile 10460, 10462
 Kunlun 10357, 10360, 10365, 10368, 10376, 10377, 10378, 10379, 10455, 10457, 10458, 10462
 Lecson 10353
 Lenco 10352, 10353
 Leyco 10277, 10353
 LG 10019, 10048, 10100, 10129, 10167, 10175, 10185, 10198, 10199, 10200, 10219, 10225, 10245, 10254, 10265, 10272, 10286, 10323, 10353
 Liesenk & Tter 10353
 Lifetec 10352, 10353
 Lihua 10457
 Lloyd's 10324
 Local India TV 10275
 Loewe 10058
 Loewe Opta 10353
 Logik 10045, 10351
 Longjiang 10360, 10376, 10384, 10385, 10392, 10457, 10462
 Lumatron 10353
 Lux May 10353
 Luxman 10047, 10049, 10265
 LXI 10016, 10034, 10044, 10049, 10058, 10230, 10233, 10272
 M & S 10034
 Melectronic 10352, 10353
 Madison 10353
 MAG 10295
 Magnasonic 10325, 10347
 Magnavox 10034, 10044, 10047, 10049, 10050, 10058, 10073, 10086, 10089, 10134, 10229, 10254, 10257, 10273, 10316, 10324, 10351
 Magnin 10345
 Magnum 10353
 Majestic 10045
 Manesth 10277, 10353
 Manhattan 10353
 Marantz 10034, 10044, 10047, 10049, 10058, 10114, 10212, 10229, 10254, 10258, 10353
 Mark 10352, 10353
 Matsui 10275, 10348, 10351, 10353
 Matsushita 10235, 10285
 Maxent 10144, 10201, 10206, 10292
 Mediator 10250, 10353
 Medion 10353
 Megapower 10219, 10286
 Megatron 10049, 10239, 10248, 10272
 MEI 10274
 Meile 10457, 10461, 10462
 MeiShi 10390
 Memorex 10042, 10045, 10048, 10049, 10078, 10236, 10272, 10273, 10343, 10346
 Mengmei 10461
 Mercury 10353
 Metz 10281, 10353
 MGA 10047, 10048, 10049, 10229, 10252, 10254, 10272, 10345
 Micromaxx 10353
 Midland 10020, 10057, 10064, 10065, 10228, 10230, 10256, 10259
 Minato 10353
 Minerva 10048, 10266, 10281
 Minoka 10279, 10353
 Mintek 10151, 10320
 Minutz 10056, 10253
 Mitsubishi 10047, 10048, 10049, 10092, 10182, 10183, 10232, 10252, 10267, 10272, 10281, 10353
 MoDeng 10390
 Monivision 10219, 10222, 10286
 Montgomery Ward 10045
 Morgans 10353
 Motorola 10232, 10264, 10295
 Moxell 10295
 MTC 10047, 10048, 10049, 10062, 10229, 10238, 10246, 10252, 10254, 10262, 10265, 10274
 MTEC 10348
 MuDan 10380, 10411, 10438, 10455, 10457, 10460, 10462
 Multitec 10353
 Multitech 10054, 10234, 10246, 10262, 10353
 Multivision 10060
 NAD 10049, 10233, 10258, 10265, 10272
 Naiko 10353
 Nakamichi 10318
 Nanbao 10460, 10462
 Nansheng 10360, 10376, 10384, 10385, 10392, 10457, 10462
 NEC 10047, 10048, 10049, 10162, 10212, 10218, 10229, 10252, 10254, 10257, 10265, 10271, 10351, 10352
 Neckermann 10353
 NEI 10353
 Neovia 10313
 Netsat 10258, 10353
 Net-TV 10158, 10206, 10292
 Neufunk 10353
 New Tech 10353
 Newave 10231, 10335, 10339
 Nikkai 10277, 10353
 Nikko 10049, 10053, 10229, 10231, 10254, 10272
 Nisato 10278
 Nokia 10352
 Norcent 10112, 10288, 10301, 10316

Nordmende 10353	Philco 10034, 10044, 10047, 10048, 10049, 10050, 10052, 10058, 10078, 10229, 10252, 10254, 10353	Quasar 10057, 10235, 10264, 10285, 10343
Normerel 10353		Quelle 10249, 10266, 10281, 10351, 10353, 10437
Norwood Micro 10307		Radio Shack/Realistic 10016, 10047, 10049, 10052, 10054, 10061, 10064, 10065
Noshi 10251	Philips 10029, 10030, 10031, 10032, 10033, 10034, 10035, 10044, 10047, 10048, 10050, 10052, 10058, 10072, 10074, 10104, 10134, 10177, 10187, 10250, 10258, 10282, 10352, 10353	Radiola 10250, 10353
Novatronic 10352, 10353		Radiomarelli 10353
NTC 10053, 10231	Philips Magnavox 10031, 10034, 10072, 10073	RadioShack 10016, 10229, 10230, 10234, 10252, 10254, 10256, 10259, 10265, 10272, 10324, 10353
Okano 10353	Phoenix 10353	Radiotone 10353
Olevia 10096, 10105, 10111, 10242, 10243, 10303, 10305, 10311	Phonola 10250, 10353	RBM 10266
Olympus 10314	Pilot 10047, 10064, 10229, 10252, 10254, 10259, 10450, 10451, 10452, 10453, 10454	RCA 10016, 10017, 10018, 10047, 10048, 10049, 10068, 10077, 10081, 10188, 10230, 10238, 10251, 10252, 10345
Onwa 10054, 10234	Pioneer 10047, 10049, 10212, 10353	Realistic 10016, 10229, 10234, 10252, 10254, 10256, 10259, 10265, 10272
Opera 10353	Pionier 10353	Recor 10353
Oppo 10155	Plantron 10353	Rectiligne 10353
Optimus 10235, 10285, 10343	Plasmsync 10165	Reflex 10353
Optoma 10126, 10194	Playsonic 10353	Revox 10353
Optonica 10061, 10232	Polaroid 10075, 10100, 10109, 10136, 10145, 10190, 10295, 10306, 10310	Rex 10277
Orbit 10353	Polestar 10441	RFT 10353
Orion 10078, 10193, 10236, 10273, 10351, 10353	Portland 10047, 10048, 10049, 10053, 10064, 10231, 10252, 10259, 10352	Rhapsody 10246, 10274
Orline 10353	Powerpoint 10353	R-Line 10353
Osaki 10277, 10279, 10348, 10352, 10353	Praxis 10443	Roadstar 10277, 10353
Osio 10353	Price Club 10062	Rowa 10429
Osume 10353	Prima 10117, 10148, 10213, 10221, 10291	Runco 10020, 10212, 10218, 10228, 10229, 10254
Otto Versand 10249, 10281, 10353	Princeton 10219, 10286	Ruyi 10457, 10459, 10461
Palladium 10353	Prism 10057	Saige 10457, 10460
Palsonic 10353	Profitronic 10353	Saisho 10277, 10351
Panama 10277, 10353	Proline 10353	Saivod 10353
Panasonic 10010, 10011, 10012, 10013, 10014, 10015, 10048, 10057, 10058, 10080, 10085, 10102, 10173, 10176, 10235, 10264, 10285, 10343	Proscan 10016, 10230	Sampo 10047, 10049, 10064, 10065, 10161, 10206, 10229, 10254, 10256, 10259, 10263, 10292
Panasonic/National 10353	Prosonic 10352, 10353	Samsung 10026, 10027, 10028, 10047, 10048, 10049, 10052, 10062, 10064, 10065, 10127, 10128, 10132, 10137, 10138, 10168, 10229, 10238, 10252, 10254, 10256, 10258, 10265, 10272, 10277, 10353
Panavision 10353	Protech 10277, 10353	Samsux 10259
Panda 10357, 10359, 10360, 10362, 10365, 10366, 10367, 10368, 10369, 10371, 10376, 10378, 10380, 10383, 10384, 10385, 10386, 10387, 10390, 10392, 10394, 10405, 10406, 10415, 10422, 10455, 10457, 10460, 10461, 10462	Proton 10047, 10049, 10052, 10248, 10255, 10263, 10272	Sanjian 10462
Penney 10229, 10230, 10233, 10238, 10248, 10251, 10252, 10253, 10254, 10256, 10259, 10272, 10345, 10346	Prottron 10106, 10309	Sansei 10280
Perdio 10353	Proview 10120, 10136, 10295	Sansui 10078, 10107, 10236, 10324, 10353
Perfekt 10353	Provision 10353	
	Pulsar 10020, 10047, 10228, 10252	
	Pye 10250, 10352, 10353	
	Qingdao 10455, 10457, 10462	

Sanyo 10047, 10048, 10097, 10192, 10202, 10270, 10275, 10345, 10351
 Sanyuan 10360, 10362, 10366, 10367, 10368, 10378, 10380, 10457, 10460, 10461
 SBR 10250, 10353
 Sceptre 10123
 Schneider 10353
 Scimitsu 10252
 Scotch 10049, 10272
 Scott 10047, 10049, 10052, 10054, 10055, 10150, 10234, 10252, 10272, 10273
 Sears 10016, 10034, 10042, 10044, 10047, 10049, 10055, 10059, 10067, 10160, 10230, 10233, 10265, 10270, 10272, 10273, 10324, 10346
 Seg 10277, 10353
 SEI 10249, 10353
 SEI-Sinudyne 10353
 Semivox 10234
 Shancha 10457, 10462
 Shangguangdian 10445
 Shanghai 10359, 10360, 10362, 10363, 10366, 10367, 10368, 10376, 10378, 10380, 10384, 10385, 10386, 10387, 10392, 10457, 10460, 10461, 10462, 10467
 Shanshui 10358
 Shaofeng 10356, 10360, 10366, 10457, 10459, 10461
 Sharp 10022, 10023, 10024, 10025, 10047, 10049, 10052, 10061, 10064, 10103, 10232, 10259, 10268
 Shen Ying 10231
 Shencai 10362, 10368, 10376, 10384, 10385, 10392, 10460, 10462
 Sheng Chia 10232, 10335
 ShengCai 10386, 10448
 Shengli 10456
 Shenyang 10360, 10362, 10368, 10376, 10381, 10382, 10457, 10460, 10462
 Sherwood 10460
 Shintoshi 10353
 Shivaki 10353
 Shogun 10047, 10252
 Shuyuan 10422
 Siemens 10281, 10353
 Signature 10045
 Signet 10306
 Silva 10353
 Silva Schneider 10353
 SIM2 Multimedia 10308
 Simpson 10050
 Singer 10353
 Sinudyne 10249, 10353
 Sky 10258, 10353
 Skygiant 10234
 Skyworth 10360, 10368, 10376, 10381, 10382, 10389, 10390, 10392, 10397, 10409, 10413, 10415, 10420, 10432, 10457, 10462
 Solavox 10353
 Songbai 10460
 SongRi 10448
 Soniko 10353
 Sonitron 10275
 Sonneclair 10353
 Sonoko 10353
 Sonolor 10275
 Sontec 10353
 Sony 10000, 10001, 10002, 10003, 10004, 10005, 10046, 10071, 10084, 10130, 10172, 10249, 10324, 10351, 10353
 Sound & Vision 10352
 Soundesign 10047, 10049, 10050, 10054, 10055, 10234, 10272, 10273
 Soundwave 10353
 Sova 10309
 Sowa 10334, 10338
 SOYO 10180, 10319
 Spectricon 10248
 Spectroniq 10295
 Squareview 10042, 10067
 Srypton 10353
 SSS 10047, 10054, 10234, 10252
 Standard 10352, 10353
 Starlite 10054, 10234, 10353
 Strato 10353
 Studio Experience 10222
 Sunstar 10353
 Sunwood 10353
 SuperScan 10041, 10232, 10297
 SuperTech 10353
 Supre-Macy 10066, 10261
 Supreme 10046
 SVA 10145, 10247, 10283, 10288
 Sylvania 10034, 10035, 10039, 10040, 10041, 10042, 10043, 10044, 10047, 10049, 10050, 10058, 10133, 10229, 10254
 Symphonic 10041, 10042, 10054, 10067, 10234, 10324
 Synco 10231, 10280, 10329, 10334, 10335, 10339
 Syntax 10105, 10243, 10303, 10305, 10311
 Syntax-Brilliant 10105, 10160
 Sysline 10353
 Tacico 10231, 10339
 Tactus 10348
 Tai Wah 10444
 Taishan 10360, 10362, 10368, 10370, 10371, 10372, 10373, 10374, 10379, 10457, 10460
 Tandy 10232
 Tantec 10348
 Tashiko 10353
 Tatung 10147, 10179, 10241, 10248, 10262, 10264, 10307, 10322, 10331, 10334, 10338, 10348, 10351
 TCL 10383, 10384, 10389, 10390, 10398, 10410, 10420, 10425, 10429, 10463
 Teac 10277, 10279, 10353
 Tec 10353
 Tech Line 10353
 Technics 10057, 10235
 Technol Ace 10273
 Technovision 10446
 Techview 10223, 10296
 Techwood 10047, 10049, 10057, 10248, 10265
 Teco 10331, 10335, 10339
 Teknika 10034, 10044, 10045, 10047, 10048, 10049, 10050, 10052, 10053, 10054, 10055, 10062, 10064, 10231, 10234, 10238, 10252, 10259, 10265, 10273
 Telecaption 10063
 Telecor 10353
 Telefunken 10027, 10265, 10353
 Telefusion 10353

Telegazi 10353	Vibrant 10348	Xingfu 10362, 10368, 10460
Telesonic 10353	Victor 10036, 10059	Xinghai 10362, 10368, 10376, 10384, 10385, 10392
Telestar 10353	Video Concepts 10267	Xinsida 10467
Teletech 10353	Videocon 10436	Xuelian 10359, 10366, 10367, 10378, 10380, 10386, 10387, 10461
Televue 10353	Videosystem 10353	Yamaha 10047, 10048, 10049, 10229, 10252, 10254
Tennessee 10353	Vidikron 10034, 10044, 10212, 10276	Yamishi 10353
Tensai 10352, 10353	Vidtech 10047, 10048, 10049, 10252, 10257, 10272	Yapshe 10341
Tera 10255	Viewsonic 10094, 10110, 10191, 10203, 10204, 10205, 10206, 10297, 10299, 10314	YingGe 10448, 10460, 10461
Tevion 10353	Viking 10066, 10261	Yoko 10277
Texet 10352	Viore 10149, 10304	Yonggu 10460, 10461
Thomas 10324	Visart 10312	Youlanasi 10457, 10461
Thomson 10016, 10353	Visco 10157	Yousida 10460
Thorn 10348, 10353	Vision 10353	Yuhang 10362, 10368, 10460
Thorn-Ferguson 10438	Vito 10434	Zenith 10019, 10020, 10021, 10045, 10047, 10069, 10078, 10198, 10228, 10231, 10236, 10245, 10272, 10324
Tiane 10457	Vizio 10047, 10094, 10122, 10166, 10241, 10297, 10299, 10322, 10323, 11000	Zhuhai 10362, 10368, 10379, 10460
TMK 10047, 10049, 10265, 10272	Vortec 10353	Zonda 10248
TNCi 10228	Waltham 10353	
TOBO 10460, 10462	Wards 10016, 10034, 10044, 10045, 10047, 10048, 10049, 10055, 10056, 10058, 10061, 10229, 10252, 10253, 10254, 10265, 10272, 10273	
Tokai 10352, 10353	Warumaia 10458	
Tongguang 10376, 10384, 10385, 10392, 10462	Watson 10353	
Tophouse 10234	Wega 10353	
Toshiba 10006, 10007, 10008, 10009, 10062, 10063, 10079, 10082, 10083, 10087, 10090, 10091, 10212, 10233, 10238, 10245, 10257, 10266, 10285	Wega Color 10435	
Tosonic 10274	Weipai 10460	
Totevision 10064, 10259	Westinghouse 10094, 10098, 10186, 10299	
Trans Continens 10353	Wharfedale 10353	
Transonic 10353	White Westinghouse 10076, 10078, 10236, 10353	
Trical 10268	WinBook 10317	
Trutech 10146	Wyse 10316	
Tuntex 10231, 10330	Xiahua 10360, 10362, 10367, 10368, 10370, 10376, 10380, 10384, 10385, 10390, 10392, 10425, 10457, 10460, 10462	
TVS 10078, 10236	Xiangyang 10376, 10384, 10385, 10392, 10462	
Uher 10352, 10353	Xiangyu 10362, 10368, 10375, 10460	
Ultra 10278	Xihu 10360, 10366, 10367, 10376, 10378, 10380, 10384, 10392, 10422, 10457, 10461, 10462	
Ultravox 10353	Xinaghai 10460, 10462	
Unic Line 10353		
United 10353		
Universal 10056, 10353		
Universum 10277, 10281, 10351, 10353		
Univox 10353		
US Logic 10307		
Vector Research 10229, 10254		
Vegavox 10439		
Vestel 10353		
Vexa 10353		

Cable Box Codes (Including Cable / PVR Boxes)

ABC 40030, 40031, 40032,
40034, 40053, 40107, 40126,
40127

Adelphia 40001

Allegro 40038

Antronix 40036, 40037

Apache 40124

Archer 40037, 40038, 40123

AT&T 40003

BBT 40129

Belcor 40125

Bell & Howell 40033

Bell South 40113

Cable Star 40125

Cable Vision 40005

Cabletenna 40036

Cableview 40035

Century 40038

Citizen 40038, 40118

Clearmaster 40112

ClearMax 40112

Colour Voice 40039

Comcast 40000, 40007

Comtronics 40040

Contec 40041
 Coolmax 40112
 COX 40000
 Daeryung 40071
 Digi 40117
 Director 40007
 Dumont 40117
 Eastern 40042
 Emerson 40123
 Everquest 40040, 40108
 Focus 40111
 Garrard 40038
 GC Electronics 40037, 40125
 GE 40030, 40031
 Gehua 40007
 Gemini 40043, 40108, 40123
 General Instrument 40007,
 40031, 40105
 GoldStar 40040, 40109
 Goodmind 40123, 40124
 Hamlin 40044, 40045
 Hitachi 40031
 Hytex 40126
 Illico 40119
 Jasco 40038, 40108
 Jerrold 40007, 40031, 40043,
 40053, 40067, 40105, 40108
 LG 40116
 Linsay 40132
 Magnavox 40046
 MegaCable 40007
 Memorex 40047, 40107
 Motorola 40000, 40003, 40007,
 40072, 40105
 Movie Time 40048
 Multitech 40112
 Multivision 40120
 NEC 40033
 NET Brazil 40070
 Nexus 40124
 Nova Vision 40121
 Novaplex 40134
 NSC 40048
 Oak 40041, 40126
 Pace 40006, 40110
 Panasonic 40051, 40107
 Panther 40117
 Paragon 40107
 Philips 40038, 40039, 40046

Pioneer 40002, 40049, 40071,
 40109
 Popular Mechanics 40111
 Prelude 40124
 Proscan 40030, 40031
 Pulsar 40107
 Quasar 40107
 RadioShack 40108, 40112,
 40123
 RCA 40035
 Realistic 40037
 Recoton 40111
 Regal 40045
 Regency 40042
 Rembrandt 40031
 Rogers 40119
 Runco 40107
 Samsung 40006, 40040, 40049,
 40069, 40109
 Scientific Atlanta 40001, 40002,
 40003, 40034, 40071, 40106
 Signal 40040, 40043, 40108
 Signature 40031
 SL Marx 40040
 Sony 40005, 40114
 Standard Component 40050
 Starcom 40043, 40053, 40108
 Stargate 40040, 40043, 40108,
 40123, 40124
 Starquest 40043, 40108
 StarSight 40131
 Supercable 40105
 Supermax 40112
 Sylvania 40127
 Tandy 40128
 Telecaption 40130
 TeleView 40040
 Texscan 40127
 TFC 40133
 Time Warner 40004
 Timeless 40040
 Tocom 40032
 Torx 40115
 Toshiba 40107
 Trans PX 40105
 Tristar 40112
 TS 40115
 Tusa 40043, 40108
 TV86 40048
 US Electronics 40105

Unika 40036, 40037, 40038
 United Artists 40126
 United Cable 40053
 Universal 40036, 40037, 40038,
 40125
 V2 40112
 Videotron 40122
 View Star 40041, 40046, 40048
 Viewmaster 40112
 ViewStar 40128
 Vision 40112
 Vortex View 40112
 Zenith 40052, 40068, 40107,
 40113
 Zentek 4011

Satellite Receiver Codes (Including Sat / PVR Boxes)

AccessHD 40096
 Alpha Digital 40096
 AlphaStar 40064
 Apex Digital 40103
 Artec 40092
 CaptiveWorks 40088
 Channel Master 40097
 Chaparral 40056
 Coolsat 40089
 Coship 40093
 Crossdigital 40146
 Digital Stream 40102
 DirecTV 40014, 40015, 40016,
 40017, 40018, 40019, 40020,
 40023, 40024, 40025, 40028,
 40029, 40054, 40055, 40077,
 40078, 40079, 40135, 40136,
 40138, 40141
 Dish Network System 40008,
 40009, 40010, 40011, 40021,
 40137, 40139, 40144
 Dishpro 40137, 40139, 40144
 Drake 40057
 Echostar 40008, 40021, 40137,
 40139, 40144, 40145
 Expressvu 40139, 40144, 40145
 GE 40012, 40013, 40098
 General Instrument 40058,
 40142
 GOI 40144
 Goodmind 40098
 Hisense 40143
 Hitachi 40029, 40065

HTS 40144
Hughes Network Systems 40016,
40018, 40019, 40023, 40025,
40054, 40135
Humax 40090
Ilo 40143
Insignia 40082
Jerrold 40142
JVC 40008, 40021, 40144
Lasonic 40099
LG 40082
Magnavox 40028, 40094
Memorex 40028
MicroGem 40100
Mitsubishi 40023, 40085
Motorola 40140, 40142
Next Level 40142
Panasonic 40017, 40083
Pansat 40086
Paysat 40028
PCT 40097
Philco 40094
Philips 40016, 40023, 40025,
40027, 40028, 40079, 40135
Pioneer 40016
Primestar 40063
Proscan 40012, 40013, 40138
Proton 40143
RadioShack 40142
RCA 40012, 40013, 40014,
40025, 40055, 40073, 40075,
40077, 40078, 40080, 40091
Realistic 40059
Samsung 40016, 40018, 40024,
40025, 40026, 40081
Sharp 40084
Sonicview 40101
Sony 40015, 40022, 40074,
40076, 40136
Star Choice 40140, 40142
STS 40066
STS1 40060
STS3 40061
STS4 40062
Tivax 40096
Tivo 40016, 40025
Toshiba 40019
UltimateTV 40136
Uniden 40028
US Digital 40143

Viewsat 40087
Voom 40142
Winegard 40104
Zenith 40020, 40082
Zentech 40095

PVR Codes

ABS 20410
Alienware 20410
AT&T 20245
Bang & Olufsen 20412
CyberPower 20410
Dell 20410
DirecTV 20238, 20240, 20241,
20243, 20405, 20406, 20409,
20411
Dish Network 20408
Dishpro 20408
Echostar 20408
Expressvu 20408
Gateway 20410
GOI 20408
Hewlett Packard 20410
Howard Computers 20410
HTS 20408
Hughes Network Systems 20240,
20238, 20241, 20243, 20407
Humax 20238
Hush 20410
iBUYPOWER 20410
JVC 20238, 20408
Linksys 20410
Media Center PC 20410
Microsoft 20410
Mind 20410
Niveus Media 20410
Northgate 20410
Panasonic 20245
Philips 20238, 20240, 20241,
20242, 20243, 20407
RCA 20238, 20243, 20407,
20409, 20411
ReplayTV 20244
Samsung 20241, 20243, 20407
Sonic Blue 20244
Sony 20239, 20410
Stack 20410
Systemax 20410
Tagar Systems 20410

Tivo 20238, 20239, 20240,
20242, 20243
Toshiba 20410
Touch 20410
UltimateTV 20411
Viewsonic 20410
Voodoo 20410
ZT Group 20410
Blu-Ray DVD Player Codes
Denon 20143, 20144
Insignia 20142
LG 20132
Marantz 20145, 20146
Panasonic 20128, 20129, 20130,
20197, 20198
Pioneer 20134, 20147
Samsung 20015, 20125
Sharp 20139, 20140, 20141
Sony 20005
Vizio 22000

DVD Player Codes

Accele Vision 20137
Accurian 20311
Advent 20288
Aiko 20348
Aiwa 20207
Akai 20161, 20282, 20317
Akishi 20349
Akustic 20348
Alco 20286
Allegro 20306
Alpine 20152
Amphion Media Works 20151,
20330
AMW 20151
Anam 20392
Aodeiong 20358
Apex 20024, 20025, 20026,
20027, 20085, 20111, 20300,
20301
Apple 20189
Arrgo 20307
Aspire 20209, 20290
Astar 20181
ATLM 20369
Audiovox 20106, 20116, 20286
Axion 20162
Bang & Olufsen 20302
Blaupunkt 20136, 20301

Blue Parade 20298
 Bose 20076, 20086, 20393, 20394
 BOSS 20138
 Boston Acoustics 20331
 Brand 20383
 Broksonic 20007, 20282
 Caixing 20389
 California Audio Labs 20284
 Cambridge Sound Works 20203
 Caravell 20362
 CAVS 20210
 Changhong 20285, 20345
 CineVision 20114, 20306
 Clarion 20154
 Classic 20131
 Coby 20087, 20095, 20123, 20289
 Conic 20370
 Curtis 20095
 Curtis Mathes 20308
 CyberHome 20028, 20070, 20307, 20323, 20326
 Cytron 20160
 Daewoo 20093, 20306, 20317
 Dayu 20388
 DCS 20363
 Denca 20367
 Denon 20108, 20115, 20143, 20144, 20284
 Desay 20185
 Diamond Vision 20237
 Dihe 20338
 Ding Tian 20342
 Disney 20090, 20096
 Dual 20172
 Durabrand 20309
 DVD2000 20295
 Dynex 20193
 Eclipse 20126
 Electrohome 20395
 Emerson 20041, 20135, 20283, 20303, 20310
 Enterprise 20303
 ESA 20182, 20310
 Fisher 20168, 20304
 Funai 20310
 Gateway 20327
 GE 20082, 20296, 20301
 Gewang 20361
 GFM 20149
 Giec 20355
 Go Video 20306, 20327, 20396
 GoldStar 20167
 GPX 20112
 Gradiente 20158, 20284
 Greenhill 20301
 Grundig 20297
 Haier 20165, 20340
 Haitai 20364
 Haoji 20384
 Harman/Kardon 20124, 20305
 Hisense 20344
 Hitachi 20013, 20232
 Hiteker 20300
 Huabao 20375
 Huabaojamo 20334
 iLive 20205
 Ilo 20159
 iLuv 20174
 Initial 20159, 20301
 Insignia 20142, 20150, 20164, 20202, 20310
 Integra 20285, 20298
 iSymphony 20190
 Jamo 20206
 JBL 20104, 20305
 Jensen 20171, 20289, 20397
 Jieke 20390
 Jingewangpai 20375
 Jingwei 20336
 Jinwang 20377
 Jugao 20359
 JVC 20029, 20030, 20031, 20032, 20033, 20034, 20035, 20036, 20037, 20098, 20119, 20195, 20299
 Jwin 20169, 20219
 Kawasaki 20286
 KEF 20398
 Kenwood 20386
 Kenwood 20122, 20284
 Ketai 20376
 KLH 20286, 20301
 Klipsch 20332
 Konka 20316
 Koss 20101, 20199, 20292
 Lafayette 20351
 Landel 20312
 Lasonic 20155, 20220, 20399
 Legend-V 20365
 Lennox 20291, 20309
 Lexicon20314
 LG 20091, 20100, 20117, 20132, 20180, 20303, 20306
 Linshuma 20378
 Liquid Video 20292
 LiteOn 20102, 20235, 20236, 20311, 20327
 Loewe 20313, 20320
 Longzhipai 20354
 Magnavox 20081, 20142, 20283, 20294, 20297, 20310
 Malata 20346
 Marantz 20145, 20146, 20297
 Maxview 20368
 McIntosh 20211
 Memorex 20090, 20282
 Microsoft 20296
 Mintek 20159, 20301
 Mitsubishi 20092, 20295
 Mitsui 20353
 Mizu 20348
 NAD 20156, 20333
 Nakamichi 20170, 20400
 Napa 20350
 Nesa 20301
 Next Base 20312
 NexxTech 20187
 Niro 20401
 Norcent 20095, 20221
 Okon 20385
 Onkyo 20099, 20110, 20285, 20294
 Oppo 20163, 20188
 Oritron 20101, 20292
 Other Brand 20373
 Pai Gao 20360
 Panasonic 20016, 20017, 20018, 20019, 20020, 20021, 20022, 20023, 20073, 20075, 20080, 20118, 20128, 20129, 20130, 20197, 20198, 20222, 20229, 20230, 20232, 20233, 20284, 20294
 Panda 20379
 Parasound 20212
 Philco 20286, 20351
 Philips 20006, 20040, 20041, 20081, 20294, 20297, 20314

Pioneer 20042, 20043, 20044, 20045, 20134, 20147, 20234, 20298
 Polaroid 20027, 20133, 20208, 20402
 Polk Audio 20297
 Portland 20317
 Power Sound 20348
 Prima 20192, 20403
 Primas 20335
 Princeton 20315
 Proceed 20300
 Proscan 20082, 20296
 Prottron 20213
 Pye 20166
 Qinghuatongfang 20382
 Qisheng 20372
 Qixing 20391
 Qwestar 20101
 RCA 20038, 20039, 20082, 20286, 20296, 20298, 20301
 Regent 20291
 Rio 20306
 Rotel 20214, 20299
 Rowa 20287
 Royal 20351
 Saba 20404
 Sampo 20157, 20325, 20328
 Samsung 20011, 20012, 20013, 20014, 20015, 20077, 20079, 20083, 20088, 20125, 20176, 20191, 20231, 20284
 Sansui 20127, 20282
 Sanyo 20200, 20282, 20304
 Sast 20336
 Sensory Science 20327
 Shanshui 20374
 Sharp 20120, 20139, 20140, 20141, 20204, 20328
 Sharper Image 20323
 Sherwood 20203, 20317
 Shinco 20136
 Shinsonic 20159, 20293
 Shumaling 20337
 Sigma Designs 20315
 Skyworth 20375
 Sonashi 20356
 Sonic Blue 20306, 20396
 Sonico 20352

Sony 20000, 20001, 20002, 20003, 20004, 20005, 20071, 20074, 20078, 20084, 20089, 20177, 20178, 20179, 20194, 20223, 20224, 20225, 20293
 Sowa 20347
 Spectroniq 20215
 Sungale 20184
 Superscan 20103, 20283
 Supersonic 20351
 SVA 20319
 Sylvania 20041, 20103, 20148, 20149, 20283, 20310, 20329
 Symphonic 20103, 20183
 Tatung 20366
 TCL 20371
 Teac 20136, 20286
 Technics 20284
 Techwood 20153
 Terapin 20321
 Theta Digital 20298
 Tianli 20343
 Toshiba 20006, 20007, 20008, 20009, 20010, 20072, 20105, 20109, 20121, 20196, 20226, 20227, 20228, 20282, 20294
 Tredex 20318
 Trutech 20186, 20218
 Tsinghuatongfang 20357
 Tview 20173
 Urban Concepts 20294
 US Logic 20159
 Venturer 20201, 20286
 Victor 20380
 Vizio 20322, 20324, 22000
 Vocopro 20175, 20216
 VocoStar 20217
 Wanbao 20355
 Wanyan 20346
 Weifa 20381
 Westinghouse 20113
 Xbox 20296
 Xianpai 20338
 Xindai 20387
 Yamaha 20016, 20107, 20284, 20297
 YMT 20356
 Youbishen 20341
 Yuxing 20339
 Zenith 20091, 20094, 20097, 20294, 20303, 20306

Amplifier / Receiver / Tuner Codes

Accurian 30164
 ADA 30165
 ADC 30133
 Adcom 30104
 Aiwa 30087, 30162, 30260
 Alco 30139
 Altec Lansing 30166
 AMC 30167
 Amphion Media Works 30140, 30145
 Amplifier Technologies 30200
 AMW 30140
 Anam 30135, 30149
 Antex 30168
 Apex 30099
 Apple 30169
 Aragon 30201
 Atlantic Technology 30170
 Audio Access 30202
 Audio Authority 30203
 Audio Tron 30171
 Audiophase 30204
 AudioSource 30205
 Audiotronic 30136
 Audiovox 30098, 30139
 B & K 30105
 Bang & Olufsen 30144
 Blaupunkt 30206
 Bondstec 30207
 Bose 30062, 30076, 30150, 30151, 30261
 Boston Acoustics 30146
 Cambridge Soundworks 30121
 Capetronic 30133, 30208
 Carver 30136, 30162
 Casio 30209
 Celestion 30210
 Clarion 30211
 Classic 30109
 Clatronic 30212
 Coby 30092, 30213, 30262
 Compaq 30172
 Creative 30173
 Crown 30214
 Curtis 30103, 30215
 Curtis Mathes 30129
 Daewoo 30216

DBX 30174
 Dell 30217
 Delphi 30218
 Denon 30051, 30052, 30053, 30054, 30055, 30102
 D-Link 30175
 EAD 30219
 Eclipse 30220
 Elan 30176
 Electrohome 30152
 Emerson 30112, 30256
 Fahrenheit 30221
 Felston 30177
 Fonmix 30163
 Fosgate 30170
 GE 30046, 30128
 Go Video 30153
 GPX 30100, 30257
 Griffin 30178
 Hanwah 30222
 Harman/Kardon 30130, 30162
 iHome 30263
 iLive 30124
 iLuv 30258
 Imerge 30179
 Inkel 30223
 Insignia 30120
 Insten 30180
 Integra 30132
 iPort 30181
 iSymphony 30125, 30258
 Jamo 30126
 JBL 30097
 Jensen 30154
 Jerrold 30182
 JVC 30031, 30032, 30033, 30034, 30035, 30259
 Jwin 30265
 KEF 30155
 Kenwood 30036, 30037, 30038, 30039, 30040, 30065, 30071, 30077, 30137
 KLH 30139
 Klipsch 30147
 Koss 30117, 30138
 Krell 30110
 Lasonic 30156
 Left Coast 30130
 Lexicon 30224
 LG 30093, 30264
 Ligitek 30183
 Linn 30162
 Luxman 30184
 LXI 30225
 Magnadyne 30226
 Magnat 30227
 Magnavox 30066, 30133, 30136, 30162
 Magnum Dynalab 30228
 Marantz 30106, 30130, 30136, 30162
 Mark Levinson 30185
 Matrix Audio 30229
 MCE 30230
 McIntosh 30111
 Mediacom 30231
 Memorex 30186
 Meridian 30232
 Micromega 30233
 Mitsubishi 30096
 Motorola 30234
 Musical Fidelity 30235
 NAD 30143, 30148
 Nakamichi 30142, 30157
 NEC 30131, 30236
 Netgear 30187
 Nikko 30237
 Niles 30238
 Niro 30158
 Nubert 30188
 Nuvo 30239
 Olive 30189
 Omnifi 30190
 Onkyo 30041, 30042, 30043, 30044, 30045, 30067, 30069, 30070, 30075, 30080, 30091
 Optimus 30129, 30133, 30134, 30135
 Oritron 30138
 Panasonic 30019, 30020, 30021, 30022, 30023, 30115, 30116, 30255
 Parasound 30113
 Penney 30240
 Performance Technique 30241
 Philips 30094, 30130, 30136, 30162
 Pioneer 30024, 30025, 30026, 30027, 30028, 30029, 30030, 30060, 30063, 30078, 30127, 30129, 30133, 30134
 Polaroid 30159
 Polk Audio 30107, 30130, 30162
 Prima 30160
 Primare 30242
 Proscan 30046
 RCA 30046, 30047, 30048, 30049, 30088, 30129, 30133, 30134, 30135, 30139
 Revox 30243
 Rio 30141
 Roku 30191
 Russound 30244
 Saba 30161
 Samsung 30073
 Sangean 30245
 Sansui 30162, 30246
 Sanyo 30118
 Sharp 30101, 30122, 30259
 Sherwood 30089, 30123
 Shure 30131
 SII 30247
 Sonic Blue 30141, 30153
 Sony 30000, 30001, 30002, 30003, 30004, 30005, 30006, 30007, 30056, 30057, 30058, 30059, 30061, 30064, 30074, 30077, 30082, 30083, 30084, 30085, 30086
 Soundesign 30128
 Soundmatters 30114
 Soundstream 30248
 Spatializer 30192
 SpeakerCraft 30249
 Stereophonics 30134
 Sunfire 30137
 SuperTech 30250
 Teac 30135, 30139, 30258
 Technics 30022, 30050
 Techwood 30251
 Teknika 30193
 Thorens 30136
 Tivoli Audio 30194
 Topline 30252
 Toshiba 30108
 Universum 30253
 Vector Research 30254
 Velodyne 30195

Venturer 30119, 30139
Wards 30127, 30128, 30162
Xantech 30196
Xitel 30197
Yamaha 30008, 30009, 30010,
30011, 30012, 30013, 30014,
30015, 30016, 30017, 30018,
30068, 30072, 30079, 30081,
30095, 30132
Zektor 30198
Zenith 30090
Zon 30199

Audio Accessory Codes (Including CD Players and Soundbars)

Acoustic Research 30294
ADC 30291
ADS 30295
Aiwa 30283
Akai 30292
ASI 33000
Audiophase 30282
Bose 30284
California Audio Labs 30296
Cambridge Audio 30297
Capetronic 30298
Carrera 30299
Carver 30300, 30331, 30332
Cary Audio Design 30301
CCE 30302
Clarion 30303
Classic 30304
Coby 30287
Cox Cable 33001
Creative 30305
DBX 30306
Denon 30267
Direct TV 33002
Dish Network 33003
DKK 30328
DMX Electronics 30331
Dynamic Bass 30332
Emerson 30279
Garrard 30307
Genexxa 30329
GPX 30280
Harman/Kardon 30273
Hitachi 30308
iHome 30288

iLuv 30286
Inkel 30309
iSymphony 30286
JVC 30269, 30281
Jwin 30290
Kenwood 30310, 30330
KLH 30311
Koss 30312
Krell 30331
LG 30289
Linn 30331
Luxman 30293
Magnavox 30313
Marantz 30314
Mark Levinson 30315
McIntosh 30316
Memorex 30317
Miro 30328
Mission 30331
Musical Fidelity 30318
NAD 30319
Nakamichi 30320
NEC 30321
Nikko 30322
NSM 30331
Onkyo 30268
Optimus 30328, 30329, 30332
Panasonic 30278
Philips 30275, 30276
Pioneer 30272
Polk Audio 30331
Proton 30331
QED 30331
Quad 30331
RCA 30266
Realistic 30332
Rotel 30331
SAE 30331
Samsung 30323
Sansui 30331
Sanyo 30324
SAST 30331
Sharp 30281
Sherwood 30325
Silsonic 30330
Sonic Frontiers 30331
Sony 30270, 30271, 30274
Super Atlas 33004
TAG McLaren 30331

Teac 30286
Technics 30277
Techwood 30326
Tivoli Audio 30327
Vizio 33005
Wards 30331
Yamaha 30285
Zonda 30331

VCR Codes

ABS 20410
Adventura 20050, 20250
Aiwa 20050, 20250
Akai 20061
Alienware 20410
American High 20249
Apex 20415
Asha 20054, 20247
Audio Dynamics 20058
Audiovox 20248, 20267
Beaumarck 20054, 20247
Bell & Howell 20246
Broksonic 20279
Calix 20248
Candle 20247, 20248
Canon 20249
CineVision 20280
Citizen 20247, 20248, 20420
Colortyme 20058
Colt 20417
Craig 20054, 20247, 20248
Curtis Mathes 20058, 20247,
20249
Cybernex 20054, 20247
CyberPower 20410
Daewoo 20060, 20250, 20420
Davidson 20050
DBX 20058
Dell 20410
Denon 20055
DIRECTV 20407
Durabrand 20067
Dynatech 20050, 20250
Electrohome 20052, 20248
Electroponic 20248
Emerson 20050, 20052, 20062,
20248, 20249, 20250, 20420
Fisher 20246
Fuji 20249

Funai 20050, 20062, 20250	Mitsubishi 20052, 20255	Sanyo 20054, 20246, 20247, 20418
Garrard 20050, 20250	Motorola 20249	Scott 20052, 20060
Gateway 20410	MTC 20050, 20054, 20247	Sears 20050, 20055, 20246, 20248, 20249, 20419
GE 20054, 20247, 20249, 20418	Multitech 20050, 20247, 20250	Sharp 20064, 20065, 20257
Go Video 20054	NEC 20058, 20246	Shogun20054, 20247
GoldStar 20058, 20066, 20248, 20419	Nikko 20248	Singer 20249
Gradiente 20050, 20250	Niveus Media 20410	Sonic Blue 20413
Harley Davidson 20250	Noblex 20054, 20247	Sony 20047, 20048, 20049, 20050, 20251, 20253, 20260, 20261, 20262, 20272, 20410
Harman/Kardon 20058	Northgate 20410	Stack 20410
Headquarter 20246	Olympus 20249	STS 20055, 20249
Hewlett Packard20410	Optimus 20062, 20248, 20416	SuperScan 20063
Hitachi 20050, 20055	Optonica 20065	Sylvania 20050, 20052, 20062, 20063, 20249, 20250
Howard Computers 20410	Orion 20258, 20414	Symphonic 20050, 20062, 20063, 20250
Hughes Network Systems 20055, 20407	Panasonic 20017, 20018, 20019, 20046, 20249, 20273, 20274, 20413, 20416	Systemax 20410
Humax 20407	Penney 20054, 20055, 20418, 20419	Tagar Systems 20410
Hush 20410	Pentax 20055	Tandy 20246
iBUYPOWER 20410	Philco 20249	Tashiko 20248
Instant Replay 20249	Philips 20065, 20249, 20256, 20278, 20407	Teac 20050, 20250
JC Penney 20058, 20246, 20247, 20248, 20249	Philips Magnavox 20256	Technics 20249
JCL 20249	Pilot 20248	Teknika 20050, 20248, 20249, 20250
JVC 20056, 20057, 20058, 20246, 20254, 20264, 20265, 20266, 20268, 20269, 20270, 20271	Polaroid 20415	Thomas 20050
Kenwood 20058, 20246	Profitronic 20054	Tivo 20407
Kodak 20248, 20249	Pulsar 20067	TMK 20054, 20247
LG 20248	Pye 20281	Toshiba 20051, 20052, 20060, 20259, 20410
Linksys 20410	Quarte 20246	Totevision20054, 20247, 20248
Lloyd's 20050, 20250	Quartz 20246	Touch 20410
LXI 20248	Quasar 20249, 20416	Unitech 20054, 20247
Magnasonic 20062, 20420	RadioShack 20050, 20065, 20248, 20249, 20065, 20246, 20247, 20250	Vector 20060
Magnavox 20050, 20062, 20067, 20069, 20249	Radix 20248	Vector Research 20058
Magnin 20054, 20248, 20418	Randex 20248	Video Concepts 20058, 20060
Marantz 20058, 20246, 20249	RCA 20053, 20054, 20055, 20247, 20249, 20252, 20275, 20276, 20418	Videosonic 20054, 20247
Marta20248	Realistic 20050, 20065, 20246, 20247, 20248, 20249, 20250, 20065	Viewsonic 20410
Matsushita 20249	ReplayTV 20413	Villain 20050
Media Center PC 20410	Ricavision 20410	Voodoo 20410
MEI 20249	Runco 20067	Wards 20050, 20054, 20055, 20065, 20247, 20248, 20249, 20250
Memorex 20050, 20054, 20067, 20246, 20247, 20248, 20249, 20250, 20414, 20416, 20419	Samsung 20054, 20059, 20060, 20061, 20247, 20263, 20277, 20407	XR-1000 20050, 20249, 20250
MGA 20052, 20054, 20418	Sanky 20067	Yamaha 20058, 20246
MGN Technology 20054, 20247	Sansui 20050, 20258, 20414	Zenith 20050, 20066, 20067, 20068
Microsoft 20410		ZT Group 20410
Mind 20410		
Minolta 20055		

Chapter 10 Maintenance and Troubleshooting

Cleaning the TV and Remote Control

1. Remove the power adapter cable from the TV.
2. Use a soft cloth moistened with diluted neutral cleaner to clean the TV and remote control. VIZIO recommends using an HDTV cleaning solution which can be purchased at any major retailer.
3. Wring liquid out of the cloth before cleaning to prevent water from penetrating into the housing.
4. Wipe the TV and remote control with a dry cloth after cleaning.

Important:

- Do not use volatile solvent (such as toluene, rosin and alcohol). Such chemicals may damage the housing, screen glass, and remote control, and cause labeling to peel.
- The screen glass is very fragile. Do not scrape it with any sharp object.
- Do not press or tap the screen to avoid cracking.

Troubleshooting Guide

If the TV fails or the performance changes dramatically, check the following troubleshooting guide for possible solutions. Remember to check the peripherals to pinpoint the source of the failure. If the display still fails to perform as expected, contact the VIZIO for assistance by calling 1-877-MYVIZIO (698-4946) or e-mail us at techsupport@vizio.com.

General TV Problems	Solution
Receive the error message "No Signal."	<ul style="list-style-type: none"> • Press the INPUT button on the remote control to select a different input source. • If you are using cable connected directly to the TV or an antenna, scan for channels from the Tuner menu in the OSD. • Press the TV button on the top of the remote to return to the TV mode.
No power.	<ul style="list-style-type: none"> • Make sure the power button is ON (VIZIO logo glows white). • Make sure the AC power cord is securely connected to the AC socket. • Plug another electrical device to the power outlet to verify that the outlet is working.
No sound.	<ul style="list-style-type: none"> • Press Volume + (Up) on the remote control. • Press MUTE on the remote control to make sure that MUTE is not ON. • Check your audio settings. The audio may be set to SAP, or the speakers are set to off. • Check the audio connections of external devices that may be connected to the HDTV. • If you are using an antenna, the signal strength of the channel may be low. Make sure your antenna is connected securely to the TV and move the antenna around the room or close to a window.
If the screen is black.	<ul style="list-style-type: none"> • Make sure the power button is ON (VIZIO Logo glows white). • Press the INPUT button on the remote control to select a different input source. • Check the connections of external devices that may be connected to the HDTV. • Press the TV button on the top of the remote to return to the TV mode.

General TV Problems	Solution
Power is ON but there is no image on the screen.	<ul style="list-style-type: none"> • Make sure all cables attached to the HDTV are connected to the correct output on the external device. • Adjust brightness, contrast or backlight. • Press the INPUT button on the remote control to select a different input source. • Press the TV button on the top of the remote to return to the TV mode.
Wrong or abnormal colors appear.	<ul style="list-style-type: none"> • Check Color and Tint settings in Picture Menu. • Reset Picture settings. • Check the video cables to make sure they are securely connected. • If you are using an antenna, the signal strength of the channel may be low. Make sure your antenna is connected securely to the TV and move the antenna around the room or close to a window.
Control buttons do not work.	<ul style="list-style-type: none"> • Press only one button at a time. • Press the TV button on the top of the remote to return to the TV mode.
Remote control does not work.	<ul style="list-style-type: none"> • Point the remote control directly at the remote sensor on your TV. • Remove any obstacles between the remote control and the remote sensor. • Replace dead batteries with new ones. • Press the TV button on the top of the remote to return to the TV mode.
There appear to be image quality issues.	<ul style="list-style-type: none"> • If you are using an antenna, the signal strength of the channel may be low. Make sure your antenna is connected securely to the TV and move the antenna around the room or close to a window. • For best image quality, view HD wide-screen programs where possible. • If HD content is not available view "Standard Definition" from a digital source. • Standard, analog TV will always be noticeably inferior to HD because your digital flat panel TV has video that is many times better than old TV so you will see interference and deficiencies you did not know you had.
You cannot see a picture.	<ul style="list-style-type: none"> • Make sure the power button is ON (VIZIO logo glows white). • Make sure the AC power cord is securely connected to the AC socket. • Press the INPUT button on the remote control to select a different input source. • Press the TV button on the top of the remote to return to the TV mode. • Check the connections of external devices that may be connected to the HDTV. • If your HDTV is connected to a computer, press any button on your keyboard to "wake" your computer. • If you are using an antenna, the signal strength of the channel may be low. Make sure your antenna is connected securely to the TV and move the antenna around the room or close to a window.
You see a distorted picture or hear unusual sound.	<ul style="list-style-type: none"> • You may be getting interference from electrical appliances, cars, motorcycles, or fluorescent lights. If you have not mounted it on the wall, try moving your HDTV to another location to see if this is the cause of the problem.
The picture has abnormal patterns.	<ul style="list-style-type: none"> • Check the connections of external devices that may be connected to the HDTV. • Make sure the specifications of external devices meet the specifications of your HDTV (like resolution). • If you are using an antenna, the signal strength of the channel may be low. Make sure your antenna is connected securely to the TV and move the antenna around the room or close to a window.

General TV Problems	Solution
The display image does not cover the entire screen.	<ul style="list-style-type: none"> • If you are in RGB mode (Computer), make sure that H-Size and V-Position in the On Screen Display (OSD) are set correctly. • If you are using TV, AV1, AV2 or Component with 480i input, press the WIDE button on the remote control to scroll through various screen modes.
You can see a picture but you cannot hear sound.	<ul style="list-style-type: none"> • Press Volume + (Up) on the remote control. • Press MUTE on the remote control to make sure that MUTE is not ON. • Check your audio settings. The audio may be set to SAP, or the speakers are set to off. • Check the audio connections of external devices that may be connected to the HDTV.
The TV has pixels (dots) that are always dark or colored.	<ul style="list-style-type: none"> • Your HDTV is manufactured using an extremely high level of precision technology, however, sometimes some pixels of your HDTV may not display. Pixel defects within industry specifications are inherent to this type of product and do not constitute a defective product.
You see “noise” or “trash” on the screen.	<ul style="list-style-type: none"> • When your HDTV’s digital capabilities exceed a digital broadcast signal, the signal is up-converted (increased) to match your TV’s display capabilities. Up-converting can cause noise or trash. • If you are using an antenna, the signal strength of the channel may be low. Make sure your antenna is connected securely to the TV and move the antenna around the room or close to a window.
You switch to a different input and the volume changes.	<ul style="list-style-type: none"> • The TV remembers the volume level from the last time you adjusted it. If the sound level is higher or lower from another source, then the volume will change.
You switch to a different input and the screen size changes.	<ul style="list-style-type: none"> • The TV remembers the viewing mode from the last time you used a particular input (AV-1, AV-2, Component, HDMI and TV).
Tips for High-Definition Users.	<ul style="list-style-type: none"> • Your HDTV is an ideal platform for viewing High Definition Content. • Best image quality will be achieved by HDMI. The next best is Component, followed by Composite. • Due to variances in broadcast practices, it is possible some image distortions can occur.
Tips for Letterbox Content Users.	<ul style="list-style-type: none"> • Some Letterboxed (or “Widescreen”) versions of DVD movies are formatted for standard 4:3 Televisions. Your HDTV has the ability to expand this content so the entire screen is filled at the expense of image accuracy. To use this function, press ZOOM on the remote control to cycle among the options.

Media Viewer Problems	Solution
USB device is not recognized.	<ul style="list-style-type: none"> • Make sure the device is correctly inserted. • Make sure the device is FAT or FAT32 • Make sure it contains the supported files.
Image or sound is interrupted or distorted.	<ul style="list-style-type: none"> • Make sure the device is correctly inserted. • Make sure that the file complies with the supported format, bit rate and/or profile. Also check the file for damage. • Some files that comply with the supported format may not play back or display properly.
Slideshow doesn’t start.	<ul style="list-style-type: none"> • Make sure the viewer isn’t in pause, rotation, or zoom mode.

Telephone & Technical Support

Products are often returned due to a technical problem rather than a defective product that may result in unnecessary shipping charges billed to you. Our trained support personnel can often resolve the problem over the phone. For more information on warranty service or repair, after the warranty period, contact our Support Department at the number below.

Customer support and quality service are integral parts of VIZIO's commitment to service excellence. For technical assistance contact our VIZIO Technical Support Department via email or phone.

Email: techsupport@VIZIO.com

(877) 698-4946 Fax: (949) 585-9563

Hours of operation: Monday - Friday: 6 am to 9 pm

Saturday – Sunday: 8 am to 4 pm

Have your VIZIO model number, serial number, and date of purchase available before you call.

VIZIO

Address:

39 Tesla

Irvine, CA 92618, USA

Telephone: (888) 849-4623 (949) 428-2525 Fax: (949) 585-9514

Web: www.VIZIO.com

Compliance

Caution: Always use a power cable that is properly grounded. Use the AC cords listed below for each area.

USA: UL

Canada: CSA

Germany: VDE

UK: BASE/BS

Japan: Electric Appliance Control Act

FCC Class B Radio Interference Statement

NOTE: This equipment has been tested and found to comply with the limits for a Class B digital device, pursuant to Part 15 of the FCC Rules. These limits are designed to provide reasonable protection against harmful interference in a residential installation. This equipment generates, uses and can radiate radio frequency energy, and if not installed and used in accordance with the instructions, may cause harmful interference to radio communications. However, there is no guarantee that interference will not occur in a particular installation. If this equipment does cause harmful interference to radio or television reception, which can be determined by turning the equipment off and on, the user is encouraged to try to correct the interference by one or more of the following measures:

1. Reorient or relocate the receiving antenna.
2. Increase the separation between the equipment and receiver.
3. Connect the equipment into an outlet on a circuit different from that to which the receiver is connected.
4. Consult the dealer or an experienced radio/TV technician for help.

Notice:

1. The changes or modifications not expressly approved by the party responsible for compliance could void the user's authority to operate the equipment.
2. Shielded interface cables and AC AC/DC power adapter, if any, must be used in order to comply with the emission limits.
3. The manufacturer is not responsible for any radio or TV interference caused by unauthorized modification to this equipment. It is the responsibilities of the user to correct such interference.

Chapter 11 Specifications

Product specifications may change without notice or obligation.

E420VL Specifications

E420VL Specifications	
Panel	42.02" Diagonal, 16:9 Aspect Ratio
Resolution	1920 x 1080 pixels
Pixel (Dot) Pitch	0.4845mm (H) x 0.4845mm (H)
Display Compatibility	1080P (FHDTV)
Colors	1.06 billion @ 10 bit
Brightness cd/m2 (typical)	500nits
Contrast	Dynamic Contrast Ratio: 100,000:1
Response Time	5ms (typical)
Viewing Angle	178° (horizontal/vertical)
Inputs	3 x HDMI with HDCP (1 with L/R audio inputs) 1 x RF (F connector for internal tuner) 1x Composite Video and Stereo Audio 1x Component YPbPr plus Stereo Audio 1x Computer RGB plus Stereo Audio 1x USB (side)
Outputs	1x 5.1 S/PDIF Optical Digital Audio, 1x Stereo Audio
Features	MEMC, 1080P FHDTV, 120Hz PANEL, 10-BIT VIDEO PROCESSING, MTS STEREO DECODER, HDMI v1.3, 3D COMB FILTER, DIGITAL AUDIO AMPLIFIER, DYNAMIC CONTRAST RATIO TECHNOLOGY, ZERO BRIGHT PIXEL GUARANTEE, HD GAME PORT, DIGITAL AUDIO AMPLIFIER, NOISE REDUCTION, DOLBY DIGITAL FOR ATSC/QAM, SIGNAL COMPATIBILITY: 480I(SDTV), 480P(EDTV), 720P(HDTV), 1080I(HDTV), 1080P(FHDTV), CHANNEL SKIP/ADD, FAVORITE CHANNEL, VIDEO/INPUT NAMING CAPABILITY, CLOSED CAPTION, PARENTAL CONTROL/V-CHIP 2.0, PROGRAMMABLE TIMER, PIP/POP, SRS TSHD, SRS TruVolume, VESA MOUNT COMPATIBLE, MULTIMEDIA.
Special Features	<ul style="list-style-type: none"> • 120Hz panel W/O scanning backlight • Multimedia(JPEG) • HDMI CEC • Ambient light sensor • 1080 FHDTV • HDMI v1.3 • DYNAMIC CONTRAST RATIO TECHNOLOGY • DOLBY DIGITAL FOR ATSC/QAM • 480I(SDTV), 480P(EDTV), 720P(HDTV), 1080I(HDTV), 1080P (FHDTV) • CHANNEL SKIP VIDEO/INPUT NAMING CAPABILITY • CLOSED CAPTION • PARENTAL CONTROL/V-CHIP 2.0 • PROGRAMMABLE TIMER • SRS TSHD • SRS TruVolume • DETACHABLE BASE
Speakers	2xBuilt-in, 10W Speakers
Panel Life	50,000 hours to half the original brightness

Power	
Input	IEC Connector for direct power line connection
Voltage Range	100~240Vac at 50/60Hz
Power Consumption	111W (Avg), 0.37W standby
Environmental Conditions	
Operating	Temperature: 5°C~35°C, Relative Humidity: 20~80%, Altitude: 0~14,000 ft
Non-Operating	Temperature: -20°C~50°C, Relative Humidity: 10~70%, Altitude: 0~40,000 ft
Dimensions	40.26" W x 27.48" H x 8.99" D with stand; 40.26" W x 25.91" H x 3.51" D without stand 1022.6 x 698 x 228.4 mm with stand; 1022 x 658 x 91.19 mm without stand
Net Weight	32.85 lbs with stand; 31.09 lbs without stand 14.9 kg with stand; 14.1 kg without stand
Gross Weight	42.99 lbs; 19.50 kg
Certifications	CSA, CSA-US, FCC Class B
Compliances	Energy Star 4.0. ATSC Spec A/65, EIA/CEA-766-A

E470VL Specifications

E470VL	Specifications
Panel	46.96" Diagonal, 16:9 Aspect Ratio
Resolution	1920 x 1080 pixels
Pixel (Dot) Pitch	0.5415mm (H) x 0.5415mm (V)
Display Compatibility	1080P (FHDTV)
Colors	1.06 Billion @ 10 bit color depth
Brightness cd/m2 (typical)	500nits
Contrast	Dynamic Contrast Ratio: 100,000:1
Response Time	5ms (typical)
Viewing Angle	178° (horizontal/vertical)
Inputs	3 x HDMI with HDCP (1 with L/R audio inputs) 1 x RF (F connector for internal tuner) 1x Composite Video and Stereo Audio 1x Component YPbPr plus Stereo Audio 1x Computer RGB plus Stereo Audio 1x USB (side)
Outputs	1x 5.1 S/PDIF Optical Digital Audio, 1x Stereo Audio
Features	MEMC, 1080P FHDTV, 120Hz PANEL, 10-BIT VIDEO PROCESSING, MTS STEREO DECODER, HDMI v1.3, 3D COMB FILTER, DIGITAL AUDIO AMPLIFIER, DYNAMIC CONTRAST RATIO TECHNOLOGY, ZERO BRIGHT PIXEL GUARANTEE, HD GAME PORT, DIGITAL AUDIO AMPLIFIER, NOISE REDUCTION, DOLBY DIGITAL FOR ATSC/QAM, SIGNAL COMPATIBILITY: 480I(SDTV), 480P(EDTV), 720P(HDTV), 1080I(HDTV), 1080P(FHDTV), CHANNEL SKIP/ADD, FAVORITE CHANNEL, VIDEO/INPUT NAMING CAPABILITY, CLOSED CAPTION, PARENTAL CONTROL/V-CHIP 2.0,

	PROGRAMMABLE TIMER, PIP/POP, SRS TSHD, SRS TruVolume, VESA MOUNT COMPATIBLE, MULTIMEDIA.	
Special Features	<ul style="list-style-type: none"> • 120Hz panel W/O scanning backlight • Multimedia(JPEG) • HDMI CEC • Ambient light sensor • 1080 FHDTV • HDMI v1.3 • DYNAMIC CONTRAST RATIO TECHNOLOGY • DOLBY DIGITAL FOR ATSC/QAM 	<ul style="list-style-type: none"> • 480I(SDTV), 480P(EDTV), 720P(HDTV), 1080I(HDTV), 1080P (FHDTV) • CHANNEL SKIP VIDEO/INPUT NAMING CAPABILITY • CLOSED CAPTION • PARENTAL CONTROL/V-CHIP 2.0 • PROGRAMMABLE TIMER • SRS TSHD • SRS TruVolume • DETACHABLE BASE
Speakers	2xBuilt-in, 10W Speakers	
Panel Life	50,000 hours to half the original brightness	
Power		
Input	IEC Connector for direct power line connection	
Voltage Range	100~240Vac at 50/60Hz	
Power Consumption	134W (Avg), 0.37W standby	
Environmental Conditions		
Operating	Temperature: 5°C~35°C, Relative Humidity: 20~80%, Altitude: 0~14,000 ft	
Non-Operating	Temperature: -20°C~50°C, Relative Humidity: 10~70%, Altitude: 0~40,000 ft	
Dimensions	44.65" W x 29.99" H x 10.43" D with stand; 44.65" W x 28.44" H x 3.66" D without stand 1134 x 761.8 x 265 mm with stand; 1134 x 722.4 x 92.96 mm without stand	
Net Weight	44.75 lbs with stand; 39.68 lbs without stand; 20.3 kg with stand; 18 kg without stand	
Gross Weight	58.86 lbs; 26.7 kg	
Certifications	CSA, CSA-US, FCC Class B	
Compliances	Energy Star 4.0. ATSC Spec A/65, EIA/CEA-766-A	

E550VL Specifications

E550VL Specifications	
Panel	54.64" Diagonal, 16:9 Aspect Ratio
Resolution	1920 x 1080 pixels
Pixel (Dot) Pitch	0.630 mm (H) x 0.630 mm (V)
Display Compatibility	1080P (FHDTV)
Colors	1.06 Billion @ 10 bit color depth
Brightness cd/m2 (typical)	500nits
Contrast	Dynamic Contrast Ratio: 100,000:1
Response Time	5ms (typical)
Viewing Angle	178° (horizontal/vertical)

Inputs	3 x HDMI with HDCP (1 with L/R audio inputs) 1 x RF (F connector for internal tuner) 1x Composite Video and Stereo Audio 1x Component YPbPr plus Stereo Audio 1x Computer RGB plus Stereo Audio 1x USB (side)
Outputs	1x 5.1 S/PDIF Optical Digital Audio, 1x Stereo Audio
Features	MEMC,1080P FHDTV,120Hz PANEL, 10-BIT VIDEO PROCESSING,MTS STEREO DECODER, HDMI v1.3, 3D COMB FILTER, DIGITAL AUDIO AMPLIFIER, DYNAMIC CONTRAST RATIO TECHNOLOGY, ZERO BRIGHT PIXEL GUARRANTEE, HD GAME PORT, DIGITAL AUDIO AMPLIFIER, NOISE REDUCTION, DOLBY DIGITAL FOR ATSC/QAM, SIGNAL COMPATIBILITY: 480I(SDTV), 480P(EDTV), 720P(HDTV), 1080I(HDTV), 1080P(FHDTV), CHANNEL SKIP/ADD, FAVORITE CHANNEL, VIDEO/INPUT NAMING CAPABILITY, CLOSED CAPTION, PARENTAL CONTROL/V-CHIP 2.0, PROGRAMMABLE TIMER, PIP/POP, SRS TSHD, SRS TruVolume, VESA MOUNT COMPATIBLE, MULTIMEDIA.
Special Features	<ul style="list-style-type: none"> • 120Hz panel W/O scanning backlight • Multimedia(JPEG) • HDMI CEC • Ambient light sensor • 1080 FHDTV • HDMI v1.3 • DYNAMIC CONTRAST RATIO TECHNOLOGY • DOLBY DIGITAL FOR ATSC/QAM <ul style="list-style-type: none"> • 480I(SDTV), 480P(EDTV), 720P(HDTV), 1080I(HDTV), 1080P (FHDTV) • CHANNEL SKIP VIDEO/INPUT NAMING CAPABILITY • CLOSED CAPTION • PARENTAL CONTROL/V-CHIP 2.0 • PROGRAMMABLE TIMER • SRS TSHD • SRS TruVolume • DETACHABLE BASE
Speakers	2xBuilt-in, 15W Speakers
Panel Life	50,000 hours to half the original brightness
Power	
Input	IEC Connector for direct power line connection
Voltage Range	100~240Vac at 50/60Hz
Power Consumption	138W (Avg), 0.37W standby
Environmental Conditions	
Operating	Temperature: 5°C~35°C, Relative Humidity: 20~80%, Altitude: 0~14,000 ft
Non-Operating	Temperature: -20°C~50°C, Relative Humidity: 10~70%, Altitude: 0~40,000 ft
Dimensions	52.13" W x 34.44" H x 13.15" D with stand; 52.13" W x 32.56" H x 4.95" D without stand 1324 x 875 x 334 mm with stand;1324 x 827 x 125.7 mm without stand
Net Weight	78.71 lbs with stand; 67.68 lbs without stand 35.7 kg with stand; 30.7 kg without stand
Gross Weight	95.9 lbs; 43.5 kg
Certifications	CSA, CSA-US, FCC Class B
Compliances	Energy Star 4.0. ATSC Spec A/65, EIA/CEA-766-A

Preset PC Resolutions

If connecting to a PC through the RGB PC input, set the TV timing mode to VESA 1920x1080 at 60Hz for best picture quality (refer to the graphic card's user guide for questions on how to set this timing mode). See the table below for the factory preset resolutions.

Mode No.	Resolution	Refresh Rate (Hz)	Horizontal Frequency (KHz)	Vertical Frequency (Hz)	Horizontal Sync Polarity (TTL)	Vertical Sync Polarity (TTL)	Pixel Rate (MHz)	Remark
1	640 x 480	60	31.469	59.941	N	N	25.175	Windows
2	640 x 480	75	37.500	75.000	N	N	31.500	Windows
3	800 x 600	60	37.879	60.317	P	P	40.000	Windows
4	800 x 600	72	48.077	72.188	P	P	50.000	Windows
5	800 x 600	75	46.875	75.000	P	P	49.500	Windows
6	1024 x 768	60	48.363	60.004	N	N	65.000	Windows
7	1024 x 768	70	56.476	70.069	N	N	75.000	Windows
8	1024 x 768	75	60.023	75.029	P	P	78.750	Windows
9	720 x 400	70	31.469	70.087	N	P	28.322	DOS
10	Ⓢ1920 x 1080	60	66.587	59.934	P	N	138.50	Windows

Note: P: positive, N: negative, Ⓢ: Primary mode

Resolution through RGB Input

If your PC supports VESA Reduce Blanking timing via the VGA card drive program (usually offered by the VGA Card Manufacturer), your TV set is equipped to have the 1920x1080 resolution display through this connection using the following timing 138.5MHz. The following parameters are often the values required by the software or programs to set up the display:

Parameters	Horizontal Values (Pixels)	Vertical Values (Lines)
Address	1920	1080
Front Porch	48	3
Sync Width	32	5
Back Porch	80	23
Total	2080	1111
Frequency	66.587 KHz	59.934 Hz
Sync Polarity	P	N
Pixel Rate (MHz)	138.5	
Refresh Rate (Hz)	60	

Warranty

ONE-YEAR LIMITED WARRANTY ON PARTS AND LABOR

(Covers units purchased as new in United States and Puerto Rico Only)

VIZIO provides a warranty to the original purchaser of its products against defects in materials and workmanship for a period of one year of non-commercial usage and ninety (90) days of commercial use. If a VIZIO product is defective within the warranty period, VIZIO will either repair or replace the unit at its sole option and discretion.

To obtain warranty service, contact VIZIO Technical Support via email: TechSupport@VIZIO.com or via phone at 877 MY VIZIO (877.698.4946) from 6:00AM to 9:00PM Monday through Friday and 8:00AM to 4:00PM Saturday and Sunday, Pacific Time, or visit www.VIZIO.com. Proof of purchase in the form of a purchase receipt or copy thereof is required.

Parts and Labor

There will be no charge for parts or labor during the warranty period. Replacement parts and units may be new or recertified at VIZIO's option and sole discretion. Replacement parts and units are warranted for the remaining portion of the original warranty or for ninety (90) days from warranty service or replacement, whichever is later.

Types of Service

Units 30" or larger will usually be serviced in-home. In-home service requires complete and easy access to the unit and does not include de-installation or re-installation of the product. However, in some cases, it may be necessary to send the unit to a VIZIO service center. VIZIO will cover the transportation charges to and from the same customer location.

Units less than 30" must be sent to a VIZIO service center. VIZIO is not responsible for transportation costs to the service center, but VIZIO will cover return shipping to the customer. **PRE-AUTHORIZATION IS REQUIRED BEFORE SENDING ANY UNIT IN FOR SERVICE.**

Any returns to VIZIO's service centers must utilize either the original carton box and shipping material or a replacement box and material provided by VIZIO. VIZIO technical support will provide instructions for packing and shipping the unit to the VIZIO service center.

Limitations and Exclusions

VIZIO's one-year limited warranty only covers defects in materials and workmanship. Items not covered include but are not limited to cosmetic damage, normal wear and tear, misuse, signal issues, power surges, and damages from shipping, acts of God, any sort of customer misuse, installation, customer modifications, adjustments, and set-up issues. Units with unreadable or removed serial numbers, "image burn-in", and routine maintenance are not covered. This warranty does not cover products sold "AS IS", "FACTORY RECERTIFIED", or by a non-authorized reseller.

THERE ARE NO EXPRESS WARRANTIES OTHER THAN THOSE LISTED OR DESCRIBED ABOVE. ANY IMPLIED WARRANTIES, INCLUDING ANY IMPLIED WARRANTY OF MERCHANTABILITY AND FITNESS FOR A PARTICULAR PURPOSE, SHALL BE LIMITED IN DURATION TO THE PERIOD OF TIME SET FORTH ABOVE. VIZIO'S TOTAL LIABILITY FOR ANY AND ALL LOSSES AND DAMAGES RESULTING FROM ANY CAUSE WHATSOEVER SHALL IN NO EVENT EXCEED THE PURCHASE PRICE OF THE DISPLAY. VIZIO SHALL NOT BE RESPONSIBLE FOR LOSS OF USE, COMMERCIAL LOSS, LOST REVENUE OR LOST PROFITS, OR OTHER INCIDENTAL OR CONSEQUENTIAL DAMAGES. SOME STATES DO NOT ALLOW LIMITATIONS ON HOW LONG AN IMPLIED WARRANTY LASTS OR THE EXCLUSION OF INCIDENTAL OR CONSEQUENTIAL DAMAGES, SO THE ABOVE LIMITATIONS OR EXCLUSIONS MAY NOT APPLY TO YOU. THIS WARRANTY GIVES YOU SPECIFIC LEGAL RIGHTS, AND YOU MAY ALSO HAVE OTHER RIGHTS, WHICH VARY FROM STATE TO STATE. THIS WARRANTY IS SUBJECT TO CHANGE WITHOUT NOTICE. CHECK www.VIZIO.com FOR THE MOST CURRENT VERSION.

Personal Data

If your VIZIO product is capable of storing personal data and other information, **ALL CONTENTS AND INFORMATION WILL BE DELETED IN THE COURSE OF SOME IN-HOME AND ALL SHIP-IN WARRANTY SERVICE.** If this occurs, your product will be restored to you configured **as originally purchased.** You will be **responsible for restoring all applicable data and passwords.** Recovery and reinstallation of user data is not covered under this Limited Warranty. **In order to protect your personal information, VIZIO recommends that you always clear all personal information from the unit before it is serviced, regardless of the servicer.**

ZERO BRIGHT PIXEL DEFECT GUARANTEE

This policy covers "zero bright pixel" defects for the duration of the limited "ONE YEAR WARRANTY" on select new product purchases. To determine if this guarantee applies to your product, refer to the "DETAILS" tab of the model's product information page (www.VIZIO.com) or look for the "zero bright pixel" guarantee on the box.

Index

16:9.....	33	Controls	
4:3.....	33	Front Panel.....	14
Accessories.....	9	Side Panel.....	14
Adjustments		Daylight Savings setting.....	43
Advanced.....	32	DTV Transition.....	5
Volume.....	14	DVD Player	
Advanced Adjustments.....	32	Connecting.....	25
Ambient Light Sensor.....	36	DVI	
Antenna.....	22	Cable Box.....	23
Aspect Ratio.....	33	DVD Player.....	25
Audio Menu		Satellite Box.....	23
Advanced Audio.....	39	EPG.....	21
Analog Audio Out.....	39	Equalizer Settings.....	39
Audio Mode.....	38	Getting Started.....	19
Balance.....	38	Grounding.....	4
Digital Audio Out.....	39	GUIDE Button.....	21
Equalizer adjustments.....	39	HDMI.....	22
Lip Sync.....	38	Help Menu	
Reset Audio Mode.....	40	Reset All Settings.....	45
SRS TruSurroundHD.....	39	Setup Wizard.....	45
SRS TruVolume.....	39	System Info.....	45
TV Speakers.....	38	Help Menu.....	45
AV connector.....	22	Home Theater	
Bass.....	39	Connecting.....	28
Blackbars.....	33	Horizontal/Vertical Position adjustments.....	35
Blocking Channels.....	41	Input Source	
Brightness.....	34	Choosing.....	20
Cable Box		Inputs	
Connecting.....	23	Antenna.....	4
CC Closed Caption.....	34	Connectors.....	22
CEC.....	44	Maintenance of TV.....	62
Cleaning.....	62	Media Menu	
Coaxial connection		Duration.....	31, 45
Satellite box.....	27	Info.....	31, 45
Coaxial Connection		Repeat.....	31, 44
Cable TV.....	27	Slideshow.....	31, 44
Color.....	35	Slideshow Effect.....	31, 45
Component Connector.....	22	Sort By.....	31, 44
Composite Connector.....	22	Thumbnail Size.....	31, 45
Computer		Menu Language.....	43
Connecting.....	29	Name Input.....	41
Preset Resolutions.....	70	OSD.....	32
Resolution through RGB.....	70	CC Menu.....	34
Connecting		Help Menu.....	45
Computer.....	29	Input Menu.....	32
RGB.....	29	Photo Menu.....	44
VGA.....	29	Picture Menu.....	34
Connecting Equipment		PIP Menu.....	37
Cable.....	23	Settings Menu.....	38
DVD.....	25	Sleep Timer Menu.....	34
Home Theater.....	28	Wide Menu.....	33
Rear Panel Connections.....	15	Parental Controls	
Satellite Box.....	23	Alt Rating Region.....	43
Sound system.....	28	Block Unrated TV.....	43
Stereo.....	28	Canadian English Rating.....	42
VCR.....	27	Canadian French Rating.....	43
Video Camera.....	27	Change the Password.....	43
Contents.....	9	Channel Block.....	41
Contrast.....	35	Rating Enable.....	41

Reset Locks	43	All TV Settings.....	45
USA Movie Rating	42	Audio Settings.....	40
USA TV Rating.....	42	Factory Default.....	45
Parental Controls	41	Picture Settings.....	37
Password	43	RGB	22
Photo Menu.....	44	Safety Instructions.....	2
Photos		Satellite Box	
Adjusting Settings	31	Connecting.....	23
Viewing	30	Search for channels	40
Picture		Setting Up	10
Reset Picture Mode.....	37	Settings Menu	
Picture Menu.....	34	Audio.....	38, 41
Adaptive Luma	36	CEC	44
Ambient Light Sensor.....	36	Menu Language	43
Backlight	34	Parental Controls Menu	41
Backlight Control.....	36	Time & Local Settings	43
Brightness	34	Setup Wizard.....	19
Color	35	Sharpness.....	35
Color Enhancement	36	Skip Channel.....	40
Color Temperature	36	Slideshow	
Contrast	35	Duration	31, 45
Film Mode	36	Effect.....	31, 45
MPEG NR	36	Mode	31, 44
Noise Reduction.....	36	Repeat	31, 44
Picture Mode.....	34	Specifications	66
Real Cinema	36	Stereo	
Sharpness.....	35	Connecting.....	28
Smooth Motion.....	36	Surround Sound.....	39
Tint	35	System Information	45
Pictures		Technical Support	65
Adjusting Settings	31	Time Zone setting	43
Create Slideshow.....	31, 44	Tint.....	35
Info	31, 45	Treble.....	39
Sort	31, 44	Troubleshooting	62
Thumbnail Size	31, 45	Tuner Menu	
Viewing	30	Analog MTS	40
PIP	37	Auto Search	40
Audio.....	37	Skip Channel.....	40
Mode	37	Tuner Mode.....	40
Position	37	TV Menu	32
Size	37	Partial Channel Search	40
Source.....	37	USB Port	30
Remote		VCR	
Programming Cable Box.....	47	Connecting.....	27
Programming DVD Player.....	46	Video Camera	
Programming Home Theater System.....	46	Connecting.....	27
Programming Satellite Box.....	47	Wall mounting	13
Remote Control.....	16	Warranty	71
Batteries.....	16	Watching TV	
Buttons	17, 18	Getting your Programs	20
Precautions	16	Program Information	21
Range	16	Wide.....	33
Reset		Wizard.....	45