

VIZIO



USER MANUAL

M50-E1, M55-E0, M65-E0, M70-E3 & M75-E1

THANK YOU FOR CHOOSING VIZIO

And congratulations on your new VIZIO Display.

To get the most out of your new VIZIO product, read these instructions before using your product and retain them for future reference. Be sure to inspect the package contents to ensure there are no missing or damaged parts.

PRODUCT REGISTRATION

To purchase or inquire about accessories and installation services for your VIZIO product, visit our website at www.VIZIO.com or call toll free at (877) 698-4946.

We recommend that you register your VIZIO product at www.VIZIO.com

Extended Warranties

For peace of mind, and to protect your investment beyond the standard warranty, VIZIO offers on-site extended warranty service plans. These plans provide additional coverage during the standard warranty period. To purchase an extended warranty service plan, visit www.VIZIO.com.

WHEN READING THIS MANUAL



When you see this symbol, please read the accompanying important warning or notice. It is intended to alert you to the presence of important operating instructions.



When you see this symbol, please read the accompanying helpful tip.

IMPORTANT SAFETY INSTRUCTIONS

Your Display is designed and manufactured to operate within defined design limits. Misuse may result in electric shock or fire. To prevent your Display from being damaged, the following instructions should be observed for the installation, use, and maintenance of your Display. Read the following safety instructions before operating your Display. Keep these instructions in a safe place for future reference.

- To reduce the risk of electric shock or component damage, switch off the power before connecting other components to your Display.
- Read these instructions.
- Keep these instructions.
- Heed all warnings.
- Follow all instructions.
- Do not use this apparatus near water.
- Clean only with dry cloth.
- Do not block any ventilation openings. Install in accordance with the manufacturer's instructions.
- Do not install near any heat sources such as radiators, heat registers, stoves, or other apparatus (including amplifiers) that produce heat.
- Do not defeat the safety purpose of the polarized or grounding-type plug. A polarized plug has two blades with one wider than the other. A grounding type plug has two blades and a third grounding prong. The wide blade or the third prong are provided for your safety. If the provided plug does not fit into your outlet, consult an electrician for replacement of the obsolete outlet.
- Protect the power cord from being walked on or pinched particularly at plugs, convenience receptacles, and the point where they exit from the apparatus.
- Only use attachments/accessories specified by the manufacturer.
- Use only with the cart, stand, tripod, bracket, or table specified by the manufacturer, or sold with the apparatus. When a cart is used, use caution when moving the cart/apparatus combination to avoid injury from tip-over.



- Unplug this apparatus during lightning storms or when unused for long periods of time.
- Refer all servicing to qualified service personnel. Servicing is required when the apparatus has been damaged in any way, such as the power-supply cord or plug is damaged, liquid has been spilled or objects have fallen into the apparatus, the apparatus has been exposed to rain or moisture, does not operate normally, or has been dropped.
- Unplug the power cord before cleaning your Display.
- When moving your Display from an area of low temperature to an area of high temperature, condensation may form in the housing. Wait before turning on your Display to avoid causing fire, electric shock, or component damage.
- A distance of at least three feet should be maintained between your Display and any heat source, such as a radiator, heater, oven, amplifier etc. Do not install your Display close to smoke. Operating your Display close to smoke or moisture may cause fire or electric shock.
- Slots and openings in the back and bottom of the cabinet are provided for ventilation. To ensure reliable operation of your Display and to protect it from overheating, be sure these openings are not blocked or covered. Do not place your Display in a bookcase or cabinet unless proper ventilation is provided.
- Never push any object into the slots and openings on your Display cabinet. Do not place any objects on the top of your Display. Doing so could short circuit parts causing a fire or electric shock. Never spill liquids on your Display.
- Your Display should be operated only from the type of power source indicated on the label. If you are not sure of the type of power supplied to your home, consult your dealer or local power company.
- Do not apply pressure or throw objects at your Display. This may compromise the integrity of the display. The manufacturer's warranty does not cover user abuse or improper installations.
- The power cord must be replaced when using different voltage than the voltage specified. For more information, contact your dealer.

- When connected to a power outlet, power is always flowing into your Display. To totally disconnect power, unplug the power cord.
- The lightning flash with arrowhead symbol within an equilateral triangle is intended to alert the user to the presence of un-isolated, dangerous voltage within the inside of your Display that may be of sufficient magnitude to constitute a risk of electric shock to persons.
- Do not overload power strips and extension cords. Overloading can result in fire or electric shock.
- The wall socket should be installed near your Display and easily accessible.
- Only power of the marked voltage can be used for your Display. Any other voltage than the specified voltage may cause fire or electric shock.
- Do not touch the power cord during lightning. To avoid electric shock, avoid handling the power cord during electrical storms.
- Unplug your Display during a lightning storm or when it will not be used for long period of time. This will protect your Display from damage due to power surges.
- Do not attempt to repair or service your Display yourself. Opening or removing the back cover may expose you to high voltages, electric shock, and other hazards. If repair is required, contact your dealer and refer all servicing to qualified service personnel.
- **WARNING:** Keep your Display away from moisture. Do not expose your Display to rain or moisture. If water penetrates into your Display, unplug the power cord and contact your dealer. Continuous use in this case may result in fire or electric shock.
- Do not use your Display if any abnormality occurs. If any smoke or odor becomes apparent, unplug the power cord and contact your dealer immediately. Do not try to repair your Display yourself.
- Avoid using dropped or damaged appliances. If your Display is dropped and the housing is damaged, the internal components may function abnormally. Unplug the power cord immediately and contact your dealer for repair. Continued use of your Display may cause fire or electric shock.
- Do not install your Display in an area with heavy dust or high

humidity. Operating your Display in environments with heavy dust or high humidity may cause fire or electric shock.

- Follow instructions for moving your Display. Ensure that the power cord and any other cables are unplugged before moving your Display.
- When unplugging your Display, hold the AC/DC power adapter, not the cord. Pulling on the power cord may damage the wires inside the cord and cause fire or electric shock. When your Display will not be used for an extended period of time, unplug the power cord.
- To reduce risk of electric shock, do not touch the connector with wet hands.
- Insert batteries in accordance with instructions. Incorrect polarities may cause the batteries to leak which can damage the remote control or injure the operator. Do not expose batteries to excessive heat such as sunshine, fire or the like.
- If any of the following occurs, contact the dealer:
 - The power cord fails or frays.
 - Liquid sprays or any object drops into your Display.
 - Your Display is exposed to rain or other moisture.
 - Your Display is dropped or damaged in any way.
 - The performance of your Display changes substantially.
- This apparatus shall not be exposed to dripping or splashing and no objects filled with liquids, such as vases, shall be placed on the apparatus.
- The mains plug or appliance coupler is used as the disconnect device, the disconnect device shall remain readily operable.
- **CAUTION** - These servicing instructions are for use by qualified service personnel only. To reduce the risk of electric shock, do not perform any servicing other than that contained in the operating instructions unless you are qualified to do so.
- The lightning flash with arrowhead symbol within an equilateral triangle is intended to alert the user to the presence of uninsulated **DANGEROUS VOLTAGE** within the product's enclosure that may be of sufficient magnitude to constitute a risk of electrical shock to persons. 
- **WARNING:** Exposure to loud sounds can damage your hearing causing hearing loss and tinnitus (ringing or buzzing in the ears). with continued exposure to loud noises, ears may

become accustomed to the sound level, which may result in permanent damage to hearing without any noticeable discomfort.

- Install the Display where it cannot be pulled, pushed or knocked over.
- Do not allow children to hang onto the product.
- Store the accessories (remote, batteries, etc.) in a location safely out of the reach of children.
- The American Academy of Pediatrics discourages television viewing for children younger than two years of age.
- **WARNING:** Never place a television set in an unstable location. A television set may fall, causing serious personal injury or death. Many injuries, particularly to children, can be avoided by taking simple precautions such as: 
 - Using cabinets or stands recommended by the manufacturer of the television set.
 - Only using furniture that can safely support the television set
 - Ensuring the television set is not overhanging the edge of the supporting furniture.
 - Not placing the television set on tall furniture (for example, cupboards or bookcases) without anchoring both the furniture and the television set to a suitable support.
 - Not placing the television set on cloth or other materials that may be located between the television set and the supporting furniture.
 - Educating children about the dangers of climbing on furniture to reach the television set or its controls.
- If your existing television set is being retained and relocated, the same considerations as above should be applied.



For DTS patents, see <http://patents.dts.com>.

Manufactured under license from DTS Licensing Limited. DTS, the Symbol, & DTS and the Symbol together are registered trademarks, and DTS Studio Sound II is a trademark of DTS, Inc. © DTS, Inc. All Rights Reserved.



Manufactured under license from Dolby Laboratories. Dolby, Dolby Audio, and the double-D symbol are registered trademarks of Dolby Laboratories.



HDMI, the HDMI logo and High-Definition Multimedia Interface are trademarks or registered trademarks of HDMI Licensing LLC.

Table Of Contents

Getting to Know Your Display	6	Viewing System Information	25
Installing the Display on a wall	7	Setting the Time and Local Settings	25
Rear Panel	8	Changing the On-Screen Menu Language	26
Completing The First-Time Setup	10	Adjusting the CEC Settings.....	26
Using the On-Screen Menu	11	Adjusting the Power Mode.....	26
Navigating the On-Screen Menu.....	11	Turning the Power Indicator On or Off	27
Changing the Input Source	11	Changing the Display Name.....	27
Changing the Screen Aspect Ratio.....	12	Managing Mobile Devices	27
Adjusting the Picture Settings.....	13	Using the Reset & Admin Menu.....	28
Adjusting More Picture Settings	14	Restoring the Display to Factory Default Settings.....	28
Adjusting the Color Temperature.....	14	About Viewing Data	28
Adjusting the Picture Mode Edit Settings	15	Using the Info Window	29
Saving a Custom Picture Mode.....	15	Playing USB Media	30
Locking/Unlocking a Custom Picture Mode.....	15	Preparing Your USB Drive to Play USB Media	30
Deleting a Custom Picture Mode.....	16	Displaying USB Media	30
Resetting a Picture Mode.....	16	Removing the USB Drive from the Display	30
Adjusting the Color Tuner Settings	17	Troubleshooting & Technical Support.....	31
Adjusting the Audio Settings.....	20	Specifications	35
Changing the Equalizer Settings.....	20	Regulatory Information	40
Using the Network Connection Menu	21	Limited Warranty	41
Connecting to a Wireless Network	21	Mexico Limited Warranty	43
Changing the Manual Setup Settings	21	Legal Information.....	45
Finding MAC Addresses for Network Setup.....	21		
Connecting to a Hidden Network	22		
Testing Your Network Connection	22		
Setting Timers	23		
Setting the Sleep Timer	23		
Setting the Auto Power Off Feature	23		
Renaming Devices on the Input Menu	24		
Changing the Display Settings	25		
Checking for System Updates.....	25		

Getting to Know Your Display

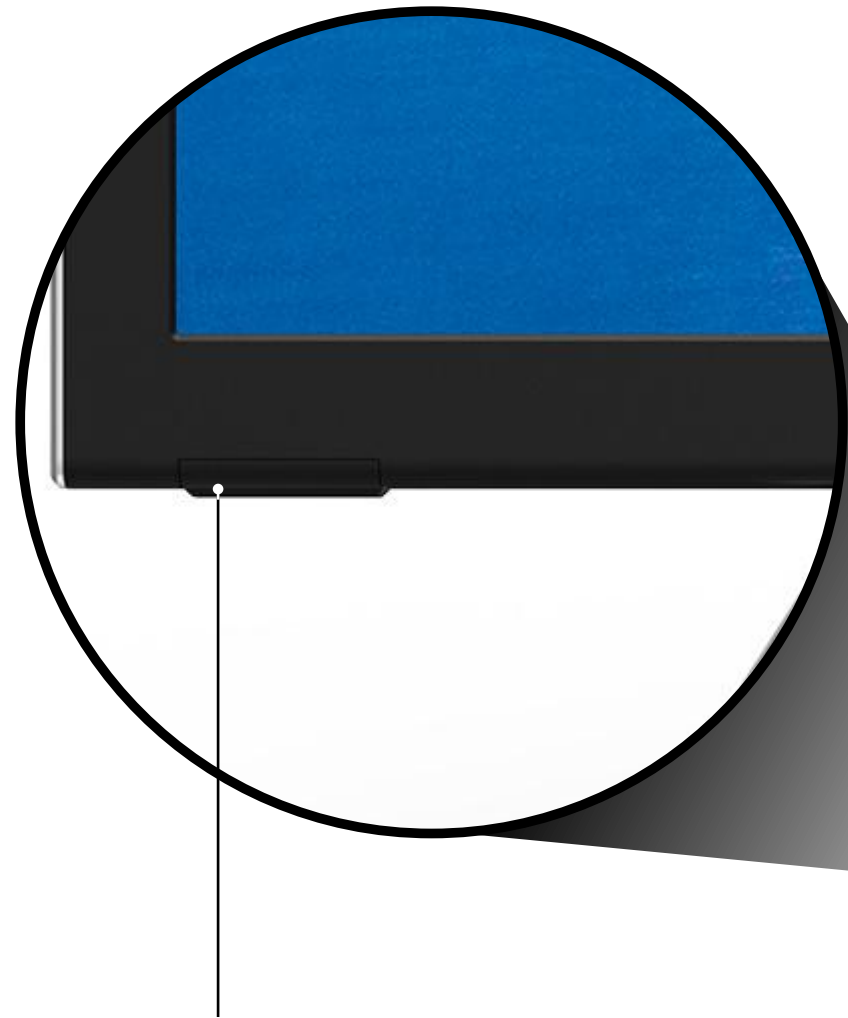

REMOTE SENSOR & POWER INDICATOR

When using the remote, aim it directly at this sensor.

The power indicator flashes on when the Display turns on, then goes out after several seconds.

To keep the power indicator on as long as the Display is on, see *Turning the Power Indicator On or Off*.

INSTALLING THE DISPLAY ON A WALL

To mount your display on a wall, you will need a wall mount. Consult the information on this page to find the appropriate mount for your display model.



Installing a Display on a wall requires lifting. To prevent injury or damage to the Display, ask someone to help you.

Be sure the mount you choose is capable of supporting the weight of the display. After you have determined that you have the correct mount for your display, you can begin the installation.

To install your display on a wall:

1. Disconnect any cables connected to your display.
2. Place the display face-down on a clean, flat, stable surface. Be sure the surface is clear of debris that can scratch or damage the display.
3. Remove the stands by loosening and removing the screws.
4. Attach your display and wall mount to the wall, carefully following the instructions that came with your mount. Use only with a UL-listed wall mount bracket rated for the weight/load of this display.

	M50-E1	M55-E0	M65-E0	M70-E3	M75-E1
Screw Size:	M6	M6	M6	M6	M8
Hole Pattern:	200 mm x 200 mm	400 mm x 400 mm	400 mm x 400 mm	400 mm x 400 mm	400 mm x 400 mm
Weight w/o Stands:	29.32 lb	34.17 lb	55.33 lb	58.64 lb	77.16 lb

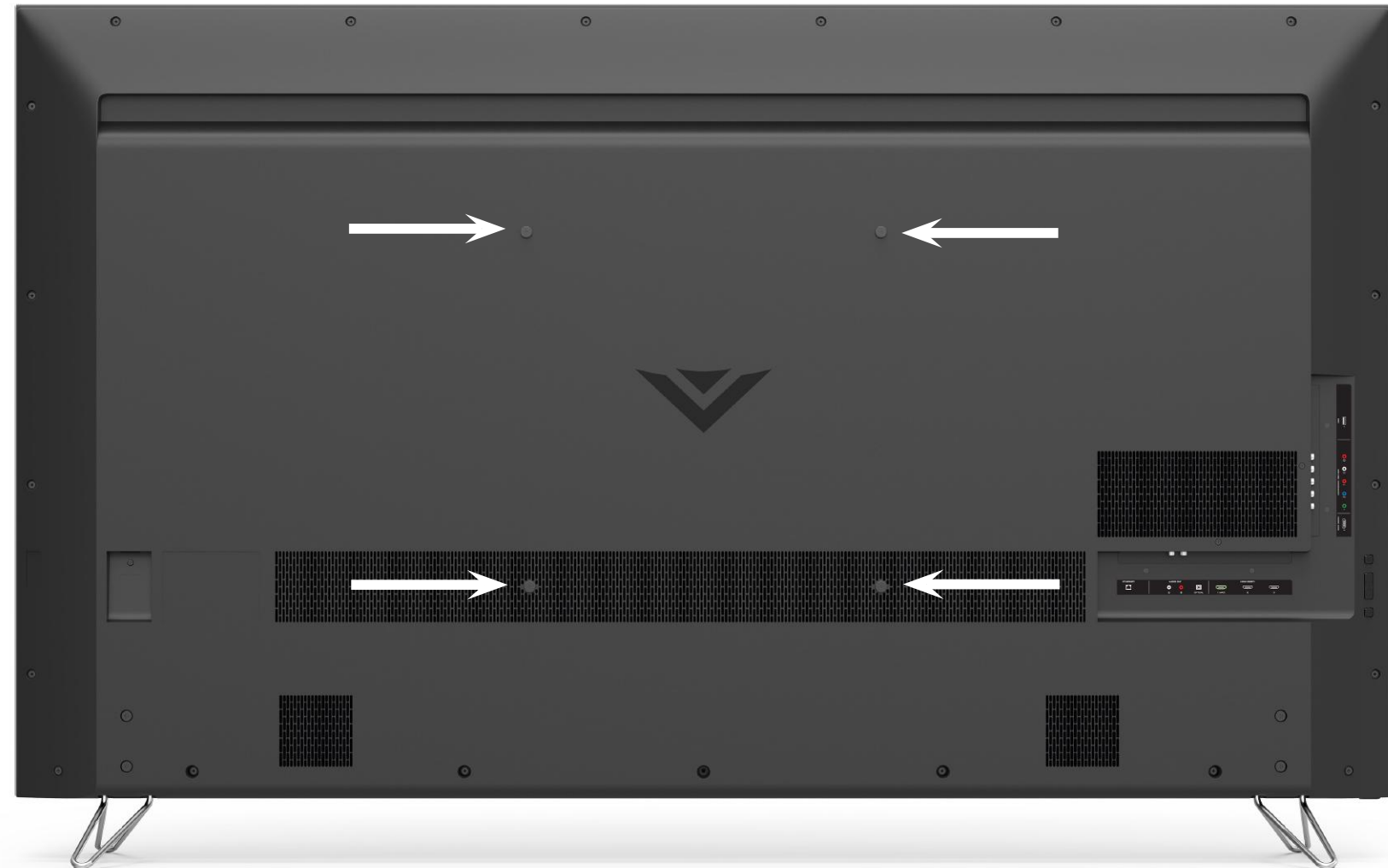

WALL MOUNT SCREW LOCATIONS

Note: The image shown here is for illustrative purposes only and may be subject to change. The actual number of ports and their locations may vary, depending on the model.

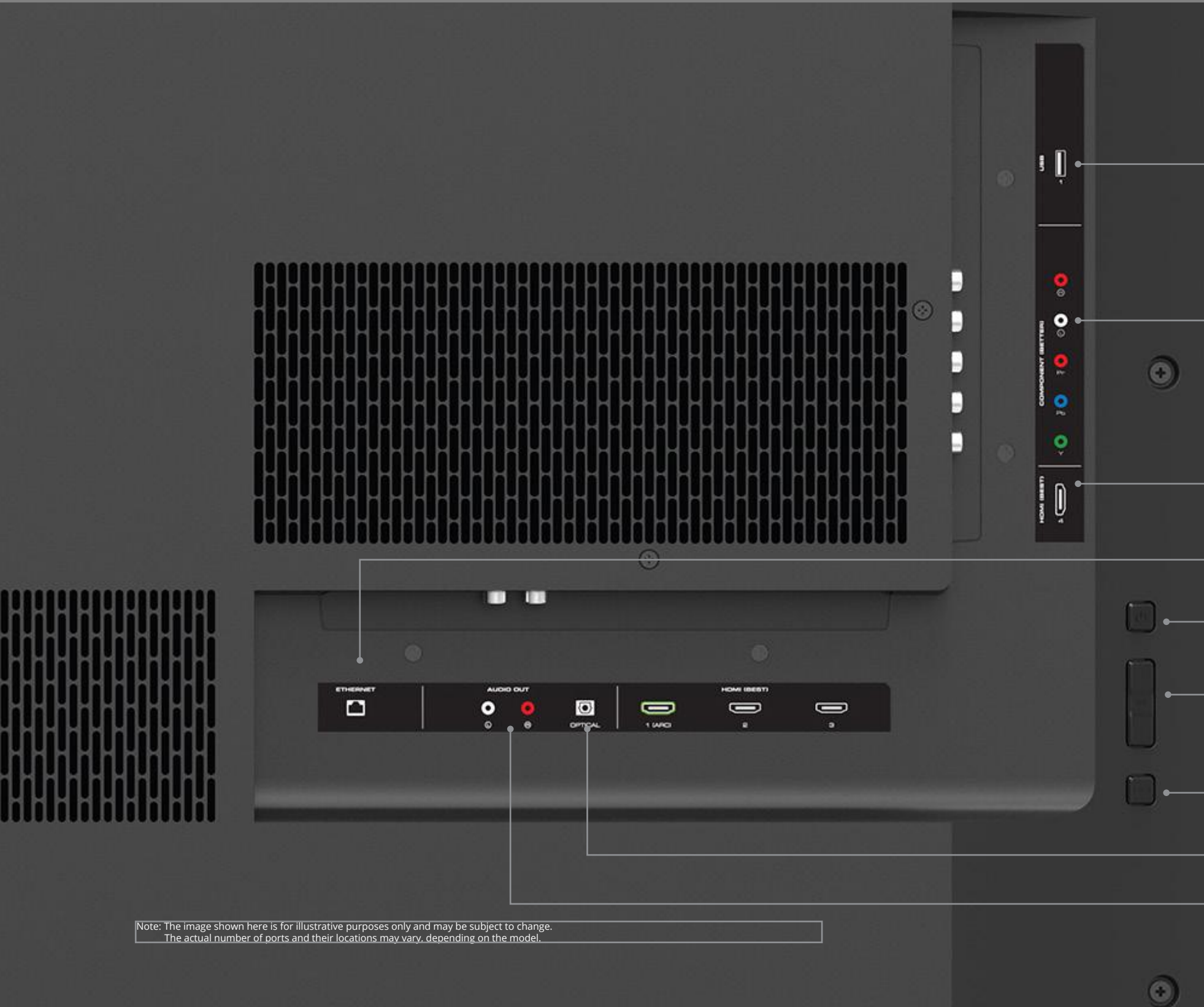

USB - Connect a USB thumb drive to view videos

Component - Connect a component device.

HDMI - Connect an HDMI device.

Ethernet - Connect an Ethernet cable to modem/ router.

Power - Press to turn the Display on or off.

Volume - Press to adjust the Display volume.

Input - Press once to access the input menu.

Optical Audio Out - Connect an optical/SPDIF audio device, such as home audio receiver.

Stereo Audio Out- Connect an RCA audio device, such as sound bar.

Note: The image shown here is for illustrative purposes only and may be subject to change.
The actual number of ports and their locations may vary, depending on the model.

USING THE REMOTE

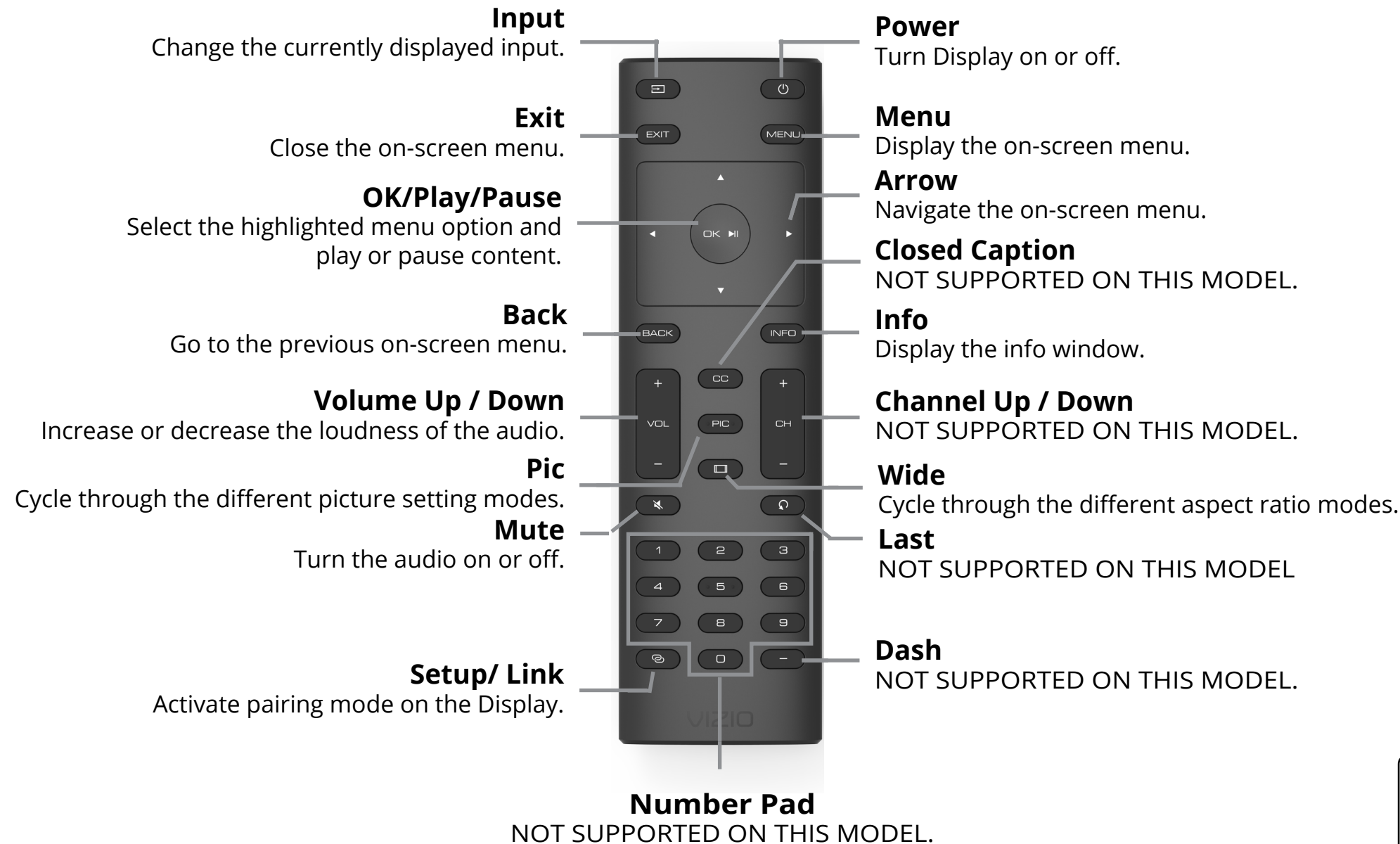

Inserting and replacing batteries.

Two AAA alkaline batteries are included for you to use with the basic remote control.

To insert/replace the batteries:

1. Find the notch on the back of the remote. Insert a coin and pry open the back cover.
2. Remove the back cover and insert two AAA batteries (included). Be sure to align the + and - signs on the batteries and remote.

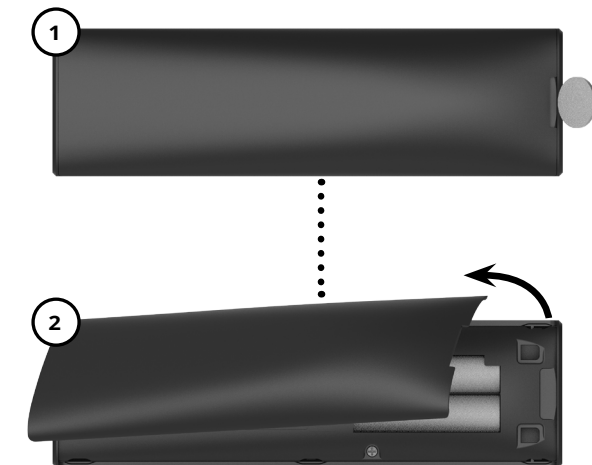

VIZIO supports the proper handling and disposal of batteries. Please visit <https://www.duracell.com/en-us/technology/battery-care-use-and-disposal/> for more information.



WARNING:
Keep the remote control batteries away from children. It may cause choking and/or lead to a fire or chemical burn if mishandled. Do not dispose of batteries in fire. Replace only with batteries of the correct type.



When needed, VIZIO recommends replacing the batteries that came with this remote with two, new Duracell AAA alkaline batteries.



The first time you turn on the Display, you can choose between two setup methods.

Complete Setup with the VIZIO SmartCast™ App (recommended): Download the free VIZIO SmartCast™ App on your smartphone or tablet to set up your VIZIO display.

Use your phone to power on your display, adjust the volume, switch inputs, play and control streaming content from your iOS or Android device.

Go to <http://www.vizio.com/setup> to get started.



-OR-

Complete Setup with the IR Remote:

Use the included IR remote to manually set up your display.

The VIZIO SmartCast™ App is still VIZIO's recommended setup method. Please note that a mobile device (not included) is still required to cast content from apps like Netflix and YouTube.

Before you begin the first-time setup:

- Your Display should be installed and the power cord should be connected to an electrical outlet.
- Your devices should be connected.
- If you have a wireless network, have the network password ready.
- If you are connecting to your network with an Ethernet cable, connect it to the Ethernet port on the Display.

Setup with the VIZIO SmartCast™ App

1. Download the free VIZIO SmartCast™ App on to your mobile device and launch the app.

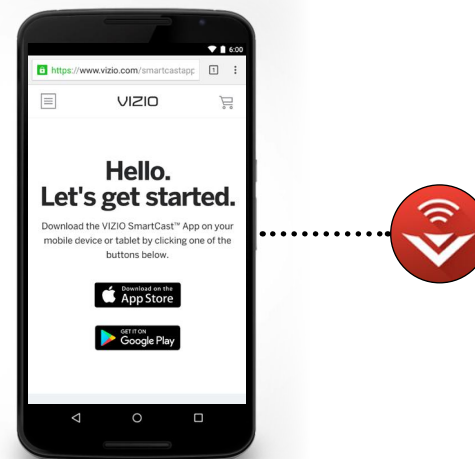

2. Pair your mobile device to your display.

iOS Device Pairing:

- a. Select **Get Started**
- b. Hold your mobile device next to the VIZIO logo on your Display.

Android Device Pairing:

Note the Wi-Fi setup name on the top corner of your Display.

- a. Select **Get Started** and Select your preferred language
 - b. Select your Display name from the list shown on your device
3. Follow the instructions on your mobile device and display screen to complete setup.



Need help installing the display?

Refer to the printed Quick Start Guide for detailed instructions on how to install your new M-Series display. You can also find a digital copy on support.vizio.com

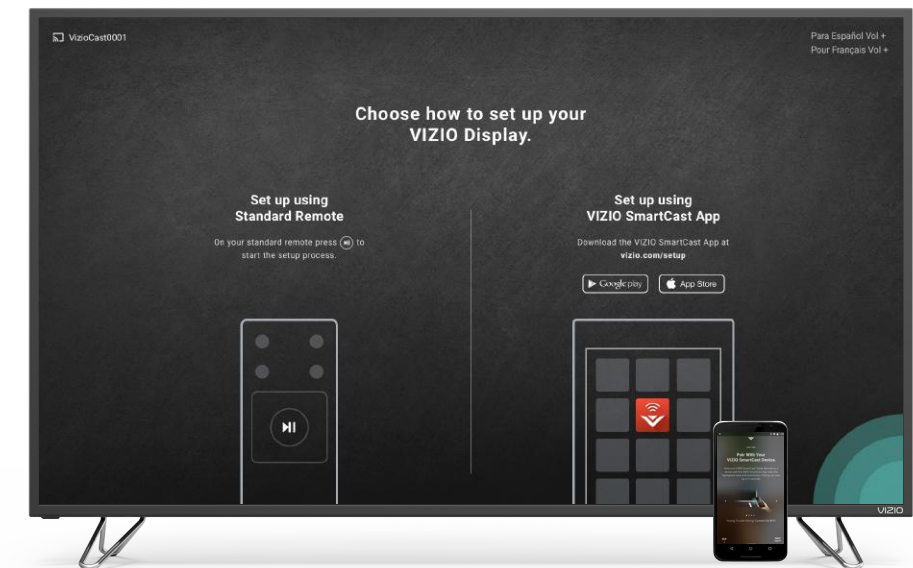

Setup with the IR Remote

1. Press the OK/Play key on your IR remote during the initial setup screen.
2. Use the Arrow Keys and the OK/Play button to select and confirm settings.
3. Follow the instruction on the screen to complete setup.



Your Display features an easy-to-use on-screen menu.

To open the on-screen menu, press the **MENU** button on the remote.

From this menu, you can:

- Adjust the Picture settings
- Adjust the Audio settings
- Adjust Network Settings
- Setting the Sleep Timers
- Name Inputs
- Adjust Display settings
- Access the user manual

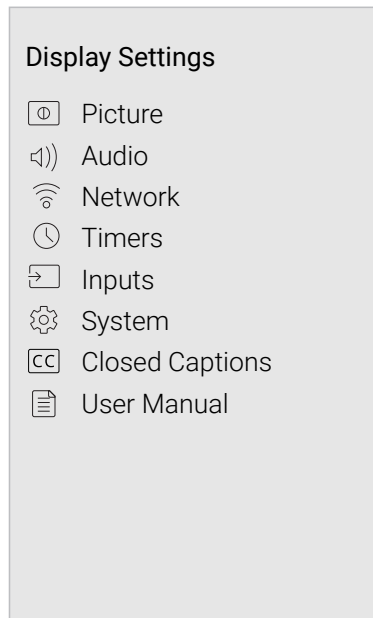

NAVIGATING THE ON-SCREEN MENU

To open the on-screen menu, press the **MENU** button on the remote.

Use the **Arrow** buttons to highlight a menu option, and press the **OK** button to select that option.

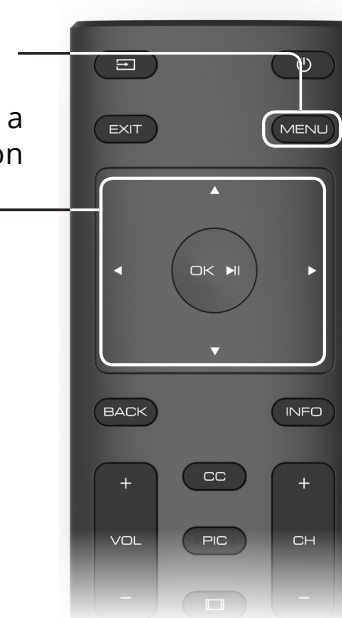

 While navigating the on-screen menu, you can press the **BACK** button at any time to return to the previous menu screen. The **EXIT** button will close the on-screen menu.

CHANGING THE INPUT SOURCE

External devices such as DVD players, Blu-ray Players, and video game consoles can be connected to your Display. To use one of these devices with your Display, you must first change the input source using the Input menu.

To change the input source:

1. Press the **INPUT** button on the remote. The Input menu is displayed.
2. Use the **Left/Right Arrow** buttons or the **INPUT** button on the remote to highlight the input you wish to view and press **OK**. The selected input is displayed.

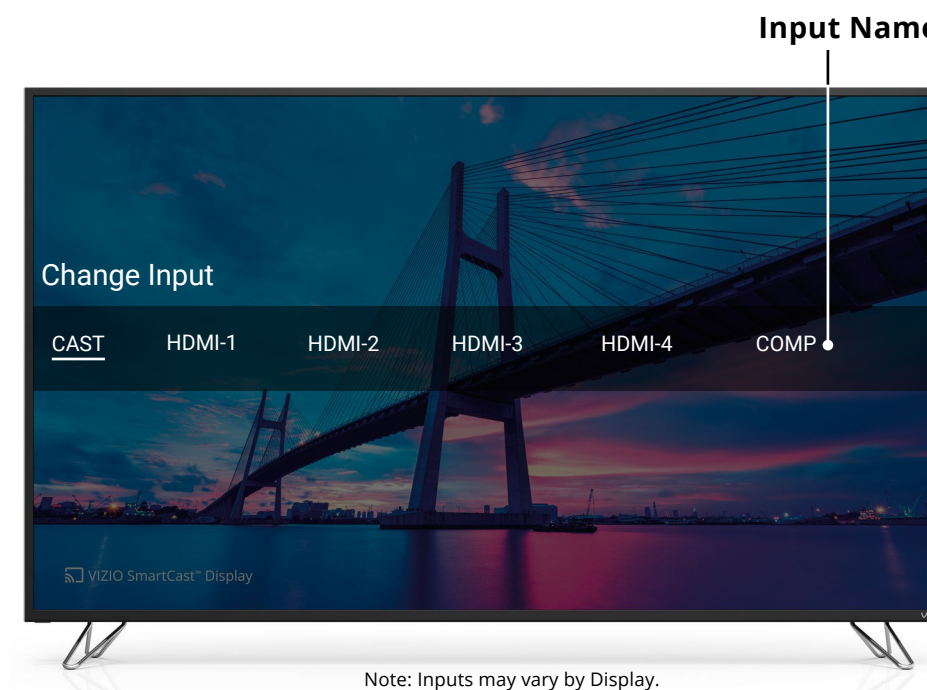

Note: Inputs may vary by Display.

 You can change the input names that appear on the Input menu to make your devices easy to recognize. See *Renaming Devices on the Input Menu* for more information.

CHANGING THE SCREEN ASPECT RATIO

The Display can display images in five different modes: Normal, Stretch, Panoramic, Wide, and Zoom. Each mode displays the picture differently.

Some programs have black bars on the top or sides of the picture so that the picture keeps its original shape. Examples include wide-screen movies and older television programs.

To change the screen aspect ratio:

1. Press the  **WIDE** button on the remote.
2. Use the **Arrow** buttons to highlight the aspect ratio you wish to view and press **OK**.
 - **Normal** preserves the content's original aspect ratio and size.
 - **Standard Definition** (480i and 480p—old Display programs) - Since the 4:3 aspect ratio is not large enough to fill the Display's screen, black bars are added to the left and right of the display image.
 - **720p** - Fills a 720p or 1080p screen.
 - **1080p and 1080i HD** - Fills a 720p or 1080p screen.
 - **Stretch** expands a widescreen image to fill the screen from top to bottom and stretches it half as much from right to left. Figures appear tall and thin.
 - **Standard Definition** - Not available.
 - **720p** - If you are watching widescreen 1.85:1 content, the image will fill the screen. With 2.35:1 widescreen content, one-sixth of the image is cut off by the left and right sides of the screen.
 - **1080p and 1080i** - Not available.
 - **Panoramic** stretches a 4:3 aspect ratio picture to the left and right edges of the screen. The center of the image is not stretched, but the sides of the image are extremely stretched. If you are watching widescreen (1.85:1 or 2.35:1) content with black bars on the top and bottom, the black bars will still appear on the top and bottom of the display

image.

- **Standard Definition** (480i and 480p) - Fills the screen from the left to right edges.
- **720p** - Not available.
- **1080p and 1080i** - Not available.
- **Wide** stretches a 4:3 aspect ratio picture to the edges of the screen. Since the picture is being stretched, the display image may appear distorted—figures appear short and fat. If the program is already formatted for widescreen viewing (1.85:1 or 2.35:1), then black bars will appear on the top and bottom of the display image.
- **Zoom** expands images evenly in all directions (33% taller and 33% wider) with black bars to fit the screen. A 720p image will fill a 1080p screen.
 - **Standard Definition** - Not available.
 - **720p** - Fills a 720p screen
 - **1080p and 1080i** - Not available.



Tip: The aspect ratio cannot be changed for Ultra HD, HDR content or for any video content on HDMI-4.

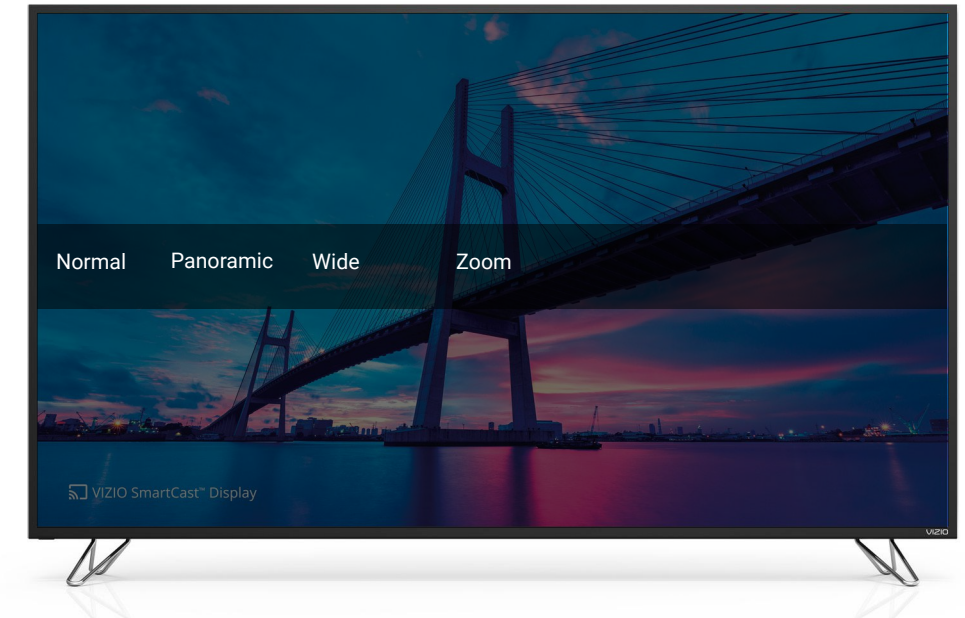

Note: Aspect ratio settings may vary by Input source.

ADJUSTING THE PICTURE SETTINGS

Your Display can be adjusted to suit your preferences and viewing conditions.



If you've changes to the settings for a picture mode, an asterisks appears after its name (see *Saving a Custom Picture Mode*).

To adjust the picture settings:

1. Press the **MENU** button on the remote. The on-screen menu is displayed.
2. Use the **Arrow** buttons on the remote to highlight **Picture** and press **OK**. The PICTURE menu is displayed.

3. Use the **Arrow** buttons on the remote to highlight **Picture Mode**, then use the **Left/Right Arrow** buttons to change the picture mode:

- **Standard mode** sets the picture settings to the default settings.
- **Calibrated mode** sets the picture settings to values ideal for watching Display in a brightly-lit room.
- **Calibrated Dark mode** sets the picture settings to values ideal for watching Display in a dark room.
- **Vivid mode** sets the picture settings to values that produce a brighter, more vivid picture.
- **Game mode** reduces throughput delays and optimizes the picture settings for displaying game console output.
- **Computer mode** optimizes the picture settings for displaying computer output.

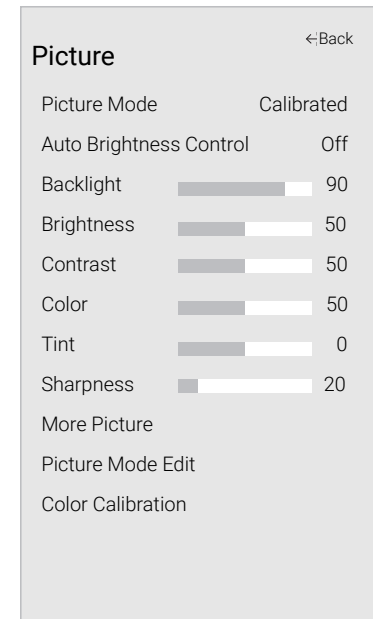

4. To manually change each of the picture settings, use the **Up/Down Arrow** buttons on the remote to highlight that picture setting, then use the **Left/Right Arrow** buttons to adjust the setting:

- **Auto Brightness Control** - The auto brightness control detects the light levels in the room and automatically adjusts the backlight for the best picture. Select **Off, Low, Medium, or High**.
- **Backlight** - Adjusts the LED brightness to affect the overall brilliance of the picture. Backlight cannot be adjusted when starting from some picture modes.
- **Brightness** - Adjusts the black level of the picture. When this setting is too low, the picture may be too dark to distinguish details. When this setting is too high, the picture may appear faded or washed out.
- **Contrast** - Adjusts the white level of the picture. When this setting is too low, the picture may appear dark. When this setting is too high, the picture may appear faded or washed out. If the setting is too high or too low, detail may be difficult to distinguish in dark or bright areas of the picture.
- **Color** - Adjusts the intensity of the picture colors.
- **Tint** - Adjusts the hue of the picture. This setting is useful in adjusting the flesh tones in the picture. If flesh appears too orange, reduce the level of color before adjusting tint.
- **Sharpness** - Adjusts the edge sharpness of picture elements. It can be used to sharpen non-HD (high definition) content; however, it will not produce detail that does not otherwise exist.

5. When you have finished adjusting the picture settings, press the **EXIT** button on the remote.

Adjusting More Picture Settings

To adjust more picture settings:

1. From the PICTURE menu, use the **Arrow** buttons to highlight **More Picture**, and then press **OK**.

2. Use the **Arrow** buttons to highlight the setting you wish to adjust, then press the **Left/Right Arrow** buttons to change the setting:

- **Color Temperature** - See *Adjusting the Color Temperature on this page*.

- **Black Detail** - Adjusts the average brightness of the picture to compensate for large areas of brightness. Select **Off**, **Low**, **Medium**, or **High**.

- **Active LED Zones** - Dynamically improves the contrast ratio of the picture by adjusting the backlight. The adjustment is controlled by the content on the screen. Select **On** or **Off**.

- **Clear Action** - Reduces blur in scenes with fast action. Some sensitive viewers may notice flickering. Select **On** or **Off**.

- **Reduce Noise** - Opens a sub-menu with two settings:

- Reduce Signal Noise - Diminishes artifacts in the image caused by the digitizing of image motion content. Select **Off**, **Low**, **Medium**, or **High**.

- Reduce Block Noise - Reduces pixelation and distortion for mpeg files. Select **Off**, **Low**, **Medium**, or **High**.

- **Game Low Latency** - Select **On** to reduce video delay (lag) when gaming.

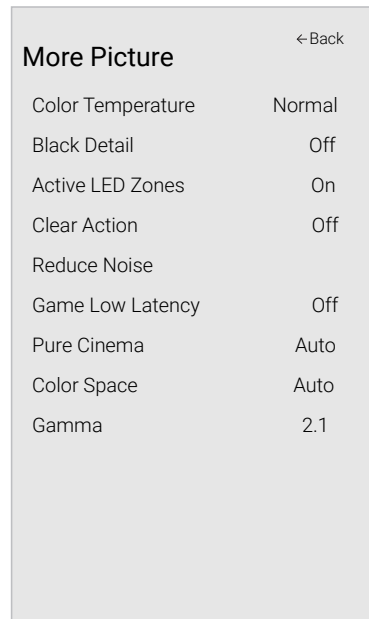

More Picture		← Back
Color Temperature	Normal	
Black Detail	Off	
Active LED Zones	On	
Clear Action	Off	
Reduce Noise		
Game Low Latency	Off	
Pure Cinema	Auto	
Color Space	Auto	
Gamma	2.1	

- **Pure Cinema Mode** - Optimizes the picture for watching film. Select **Auto** or **Off**.
 - **Color Space** - Select Color Space for the source. Video sources uses YCbCr, but PC uses RGB.
 - **Gamma** - Set the shape of the Gamma curve. Use lower Gamma values for bright room conditions, and higher values when it's dark.
3. When you have finished adjusting More Picture Settings, press the **EXIT** button on the remote.

Adjusting the Color Temperature

Adjusting the color temperature changes the white balance of the picture.

To adjust the color temperature:

1. From the MORE PICTURE menu, use the **Arrow** buttons to highlight **Color Temperature**, and then press **OK**.

2. Use the **Arrow** buttons on the remote to highlight a color temperature preset and then press **OK**.

- **Normal** is optimized for television viewing.
- **Cool** produces a blue-hued picture.
- **Computer** optimizes the picture for use as a PC monitor.

3. When you have finished adjusting the color temperature, press the **EXIT** button on the remote.

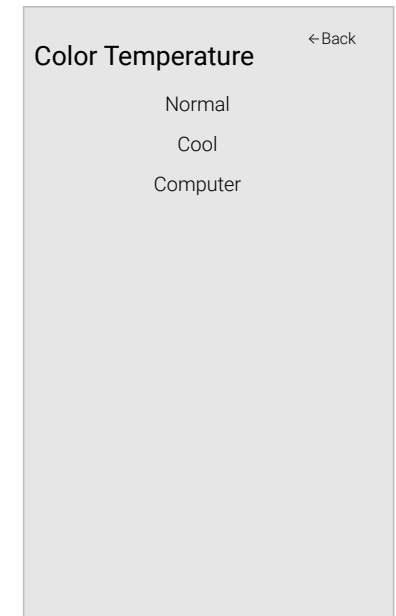

Color Temperature		← Back
Normal		
Cool		
Computer		

Adjusting the Picture Mode Edit Settings

Picture Mode Edit Settings allow you to make precise adjustments to the picture and to create picture modes to save groups of picture settings.

To adjust the Picture Mode Edit settings:

1. From the PICTURE menu, use the **Arrow** buttons to highlight **Picture Mode Edit**, and then press **OK**. The PICTURE MODE EDIT menu is displayed.
2. Use the **Arrow** buttons to highlight the setting you wish to adjust, then press **OK** to change the setting:
 - **Save Picture Mode** - Save a custom picture mode.
 - **Lock Picture Mode** - Prevent changes to custom picture modes. Choose between **On** or **Off**
 - **Reset Picture Mode[†]** - Reset the picture mode settings to factory default values.

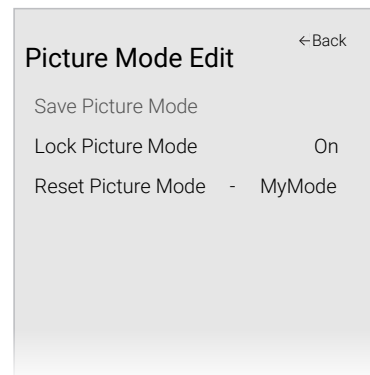
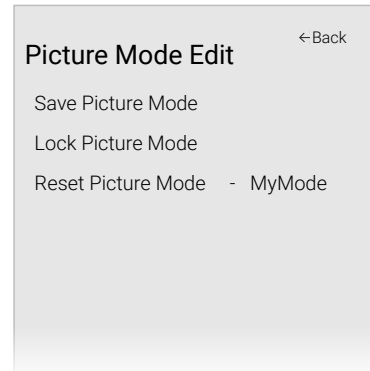

Saving a Custom Picture Mode

Custom picture modes allow you to save a group of custom settings for various viewing conditions and video sources.

- Changes made while on any preset picture mode will add an asterisk on the top right corner of the preset mode.
- The custom picture mode is not automatically saved.

To save a custom picture mode:

1. From the PICTURE MODE EDIT menu, use the **Arrow** buttons to highlight **Save Picture Mode**, and then press **OK**. The SAVE PICTURE MODE menu is displayed.
2. Use the on-screen keyboard to enter a name for your custom picture mode.
3. Highlight **Save** and press **OK**.
4. Press the **EXIT** button to exit the menu screens.

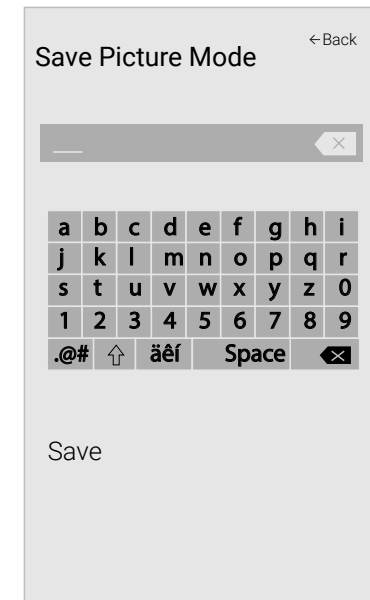

Locking/Unlocking a Custom Picture Mode

Custom picture modes can be locked/unlocked with a systemn PIN to prevent accidental changes to their settings.

To lock all custom picture modes:

1. From the PICTURE MODE EDIT menu, use the **Arrow** buttons to highlight **Lock Picture Mode**, and then press **OK**. The LOCK PICTURE MODE menu is displayed.
2. Use the **Arrow** buttons to select **On**.
3. Use the **Number Pad** on your remote to enter a unique 4-digit PIN.

—or—

If a system pin code was previously created, use the **Number Pad** on your remote to enter your pin code.

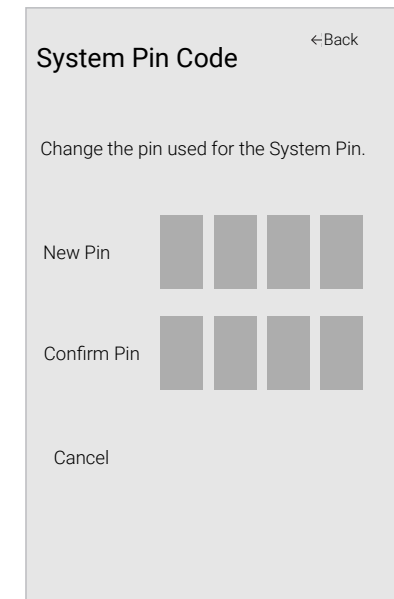

To unlock all custom picture modes:

1. From the PICTURE MODE EDIT menu, use the **Arrow** buttons to highlight **Lock Picture Mode**, and then press **OK**. The UNLOCK PICTURE MODE menu is displayed.
2. Use the **Arrow** buttons to select **Off**.
3. Use the **Number Pad** on your remote to enter your 4-digit PIN.
4. Make any desired changes to the picture modes.
5. Relock the picture modes, if desired.
6. Press the **EXIT** button to exit the menu screens.

[†] Only available on customized preset modes.

Deleting a Custom Picture Mode

Custom picture modes that are no longer needed can be deleted.

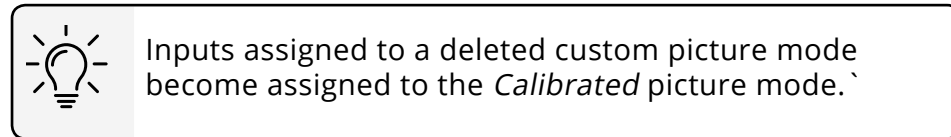

To delete a custom picture mode:

1. From the PICTURE MODE EDIT menu, use the **Arrow** buttons to highlight **Delete Picture Mode**, and then press **OK**. The DELETE PICTURE MODE window is displayed.

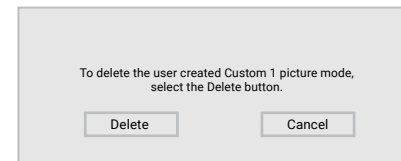

2. Use the **Left/Right** Arrow buttons to highlight **Delete** and press **OK**.
3. Press the **EXIT** button to exit the menu screens.

Resetting a Picture Mode

A preset picture mode that has been edited can be reset to factory default settings.

To reset a customized preset picture mode:

1. From the PICTURE MODE EDIT menu, use the **Arrow** buttons to highlight **Reset Picture Mode**, and then press **OK**. The RESET PICTURE MODE window is displayed.

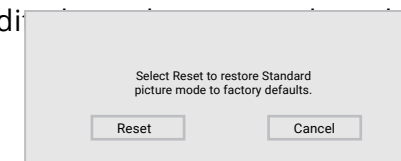

2. Use the **Left/Right** Arrow buttons to highlight **Reset** and press **OK**.
3. Press the **EXIT** button to exit the menu screens.

Adjusting the Color Tuner Settings

The Color Tuner settings allow you to adjust the HSB color and 11 point white balance, turn color channels off for testing, and display color bar, flat, and ramp test patterns.



The Color Tuner, 11 Point White Balance, and test patterns allow technicians to manually calibrate the Display. Calibration requires specialized training, an input with precisely set colors, and a specialized light meter.

To adjust the HSB color settings:

1. From the COLOR CALIBRATION menu, use the **Arrow** buttons to highlight **Color Tuner**, and then press **OK**. The Color Tuner menu is displayed.

Color Tuner						
	Red	Green	Blue	Cyan	Magenta	Yellow
Hue	0	0	0	0	25	-14
Saturation	-1	5	-4	0	-2	0
Brightness	-24	0	-22	0	0	0
Offset	0	0	0			
Gain	0	0	0			

2. Use the **Arrow** buttons on the remote to highlight the **Hue, Saturation, Brightness, Offset, or Gain** of the color you wish to adjust. Press the **OK** button.
3. Use the **Left/Right Arrow** buttons to adjust the value. When you are finished press the **OK** button to save the setting.
4. When you are finished adjusting the color tuner settings, press the **EXIT** button.

To turn color channels off and on:

1. From the COLOR CALIBRATION menu, use the **Arrow** buttons to highlight **Color Tuner**, and then press **OK**. The Color Tuner menu is displayed.

Color Tuner						
	Red	Green	Blue	Cyan	Magenta	Yellow
Hue	0	0	0	0	25	-14
Saturation	-1	5	-4	0	-2	0
Brightness	-24	0	-22	0	0	0
Offset	0	0	0			
Gain	0	0	0			

2. Use the **Arrow** buttons on the remote to highlight **Red, Green, or Blue**.
3. Press the **OK** button to turn the color channel off or on. An X appears over a color channel that has been turned off.
4. Use the **Arrow** buttons to highlight another color channel to turn off or on. Only two color channels can be turned off at the same time.
5. When you are finished with the color channels, press the **EXIT** button.

To adjust the 11 Point White Balance settings:

1. From the Color Tuner menu, use the **Arrow** buttons to highlight **Color Tuner**, and then press the **Left/Right Arrow** buttons until the 11 Point White Balance menu is displayed.

11 Point White Balance				
	Gain	Red	Green	Blue
	5%	0	0	0

2. Use the **Arrow** buttons on the remote to highlight the **Gain** and **Color values** you wish to adjust. Press the **OK** button and use the **Left/Right Arrow** buttons to adjust the value. When you are finished, press the **OK** button to save the setting.
3. When you are finished, press the **EXIT** button.

To show or hide the SMPTE Test Pattern:

1. From the Color Calibration menu, use the **Arrow** buttons to highlight **Calibration Test**, and then press the **Left/Right Arrow** buttons until the SMPTE Test Pattern menu is displayed.

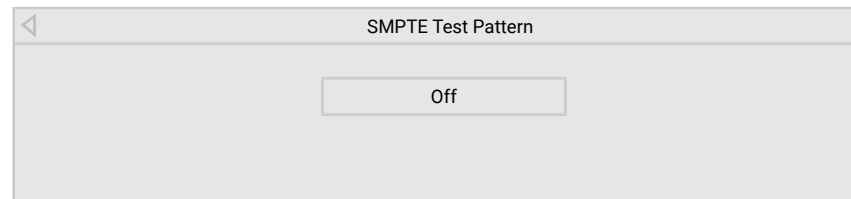

2. Use the **Arrow** buttons on the remote to highlight **Off**. Use the **Left/Right Arrow** buttons to highlight **On** to show the SMPTE Pattern.

—or—

To hide the SMPTE Test Pattern, use the **Left/Right Arrow** buttons to highlight **Off**.

3. When you are finished, press the **EXIT** button.

To show or hide the Flat Test Pattern:

1. From the Color Calibration menu, use the **Arrow** buttons to highlight **Calibration Test**, and then press the **Left/Right Arrow** buttons until the Flat Test Pattern menu is displayed.

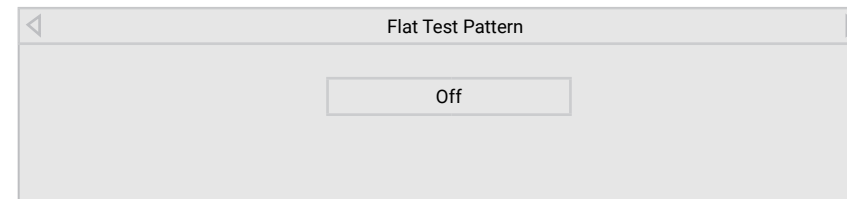

2. Use the **Arrow** buttons on the remote to highlight **Off**. Use the **Left/Right Arrow** buttons to select the percentage brightness for the flat test pattern. Selecting a percentage immediately shows the flat pattern at that brightness.

—or—

To disable the Flat Test Pattern, use the **Left/Right Arrow** buttons to highlight **Off**.

3. When you are finished, press the **EXIT** button.

To show or hide the Ramp Test Pattern:

1. From the Color Calibration menu, use the **Arrow** buttons to highlight **Calibration Test**, and then press the **Left/Right Arrow** buttons until the Ramp Test Pattern menu is displayed.

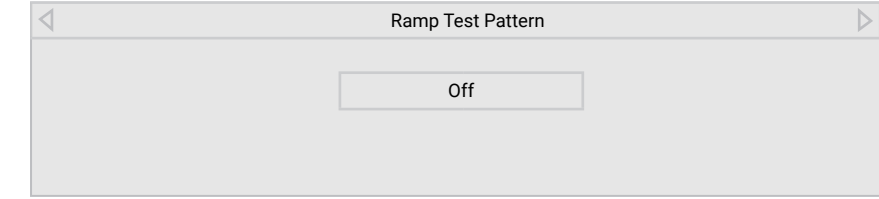

2. Use the **Arrow** buttons on the remote to highlight **Off**. Use the **Left/Right Arrow** buttons to select the color for the ramp test pattern. Selecting a color immediately shows that color ramp.

—or—

To hide the Ramp Test Pattern, use the **Left/Right Arrow** buttons to highlight **Off**.

3. When you are finished, press the **EXIT** button.

To show or hide the Uniformity Analyzer Test Pattern:

1. From the Color Calibration menu, use the **Arrow** buttons to highlight **Calibration Tests**, and then press the **Left/Right Arrow** buttons until the Uniformity Analyzer Test Pattern menu is displayed.

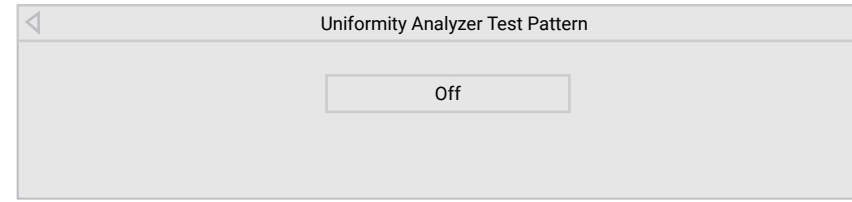

2. Use the **Arrow** buttons on the remote to highlight **Off**. Use the **Left/Right Arrow** buttons to highlight **On** to show the Uniformity Analyzer Test Pattern.

—or—

To hide the Uniformity Analyzer Test Pattern, use the **Left/Right Arrow** buttons to highlight **Off**.

3. When you are finished, press the **EXIT** button.

ADJUSTING THE AUDIO SETTINGS

To adjust the audio settings:

1. Press the **MENU** button on the remote. The on-screen menu is displayed.
2. Use the **Arrow** buttons on the remote to highlight **Audio** and press **OK**. The AUDIO menu is displayed.
3. Use the **Arrow** buttons to highlight the setting you wish to adjust, then press **Left/Right Arrow** buttons to change the setting:
 - **Speakers** - Turns the built-in speakers On or Off.

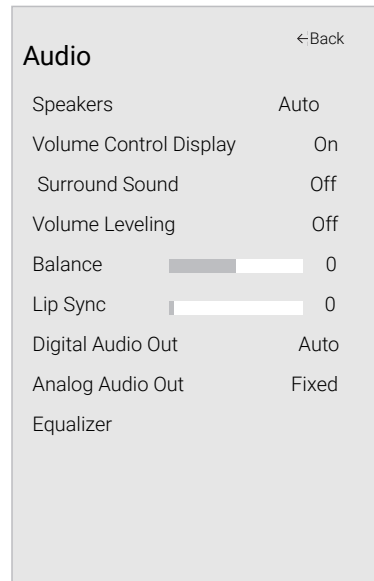

When the Display speakers are set to **On**, DTS signals cannot be passed through digital audio outputs.

- **Volume Control Display** - Toggle between **On** or **Off** to hide or display the on-screen volume slider that appears when volume is adjusted.
- **Surround Sound** - Surround sound uses DTS TruSurround™ to deliver an immersive surround sound experience from the Display's internal speakers. TruSurround completes the entertainment experience by providing deep, rich bass and by delivering crisp details and clear, intelligible dialog. Select **On** or **Off**.
- **Volume Leveling** - Volume leveling uses DTS TruVolume™ to maintain consistent volume levels during transitions between program content, AV formats, and input sources. Select **On** or **Off**. In a few cases, volume leveling may artificially suppress volume increases, making it difficult to hear dialog or flattening sudden noises. If this occurs, turn

volume leveling off.

- **Balance** - Adjusts the loudness of the audio output from the left and right speakers.
- **Lip Sync** - Adjusts the synchronization between the display image and the accompanying audio track.
- **Digital Audio Out** - Changes the type of processing for digital audio out and HDMI ARC output when connected to a home theater audio system. Select **Auto**, **PCM**, **Dolby D** or **Bitstream**.



You must select **Bitstream** for audio with more than two channels (3.0, 5.0, or 5.1, for example).

- **Analog Audio Out** - Sets the volume control properties for the RCA connector when connected to a home theater audio system. Select **Variable** if you are controlling the volume with the Display's volume controls, or select **Fixed** if an external audio device (sound bar or AV receiver) will control the volume.
 - **Equalizer** - Adjusts the boost or attenuation of different frequencies using either preset or custom settings. See *Changing the Equalizer Settings on this page*.
4. When you have finished adjusting the audio settings, press the **EXIT** button on the remote.

Changing the Equalizer Settings

The graphic equalizer has several pre-set modes and allows you to create one custom mode.

To select a pre-set audio mode:

1. Press the **MENU** button on the remote. The on-screen menu is displayed.
2. Use the **Arrow** buttons on the remote to highlight **Audio** and press **OK**. The AUDIO menu is displayed.
3. Use the **Arrow** buttons to highlight **Equalizer** and press **OK**. The Audio Mode and equalizer settings screen appears.
4. Use the **Left** and **Right Arrow** buttons to select an audio mode. The equalizer bars change to reflect the mode.
5. Press the **EXIT** button on the remote.

To create, modify, or replace the single custom equalizer setting:

1. Press the **MENU** button on the remote. The on-screen menu is displayed.
2. Use the **Arrow** buttons on the remote to highlight **Audio** and press **OK**. The AUDIO menu is displayed.
3. Use the **Arrow** buttons to highlight **Equalizer** and press **OK**. The Audio Mode and equalizer settings screen appears.
4. Use the **Left** and **Right Arrow** buttons to select any audio mode as a starting point.
5. Use the **Arrow** buttons to highlight a frequency and then press **OK**.
6. Use the **Up** and **Down Arrow** buttons to adjust the boost (up) and attenuation (down) for the frequency.
7. Use the **Left** and **Right Arrow** buttons to select another frequency, if desired, and adjust it.
8. Press the **EXIT** button on the remote.

USING THE NETWORK CONNECTION MENU

Your Display is Internet-ready, featuring both an Ethernet port and built-in high-speed Wireless-N.

Connecting to a Wireless Network

To connect to a wireless network whose network name (SSID) is being broadcast:



If your Display is connected to a network with an Ethernet cable, you will not see the wireless network connection menu. You must disconnect the Ethernet cable to set up a wireless network connection.

1. Press the **MENU** button on the remote. The on-screen menu is displayed.
2. Use the **Arrow** buttons on the remote to highlight **Network** and press **OK**. The NETWORK menu is displayed.
3. If you do not see your wireless network displayed, highlight **More Access Points** and press **OK**. The WIRELESS ACCESS POINTS menu, which is a list of available wireless networks, is displayed.
4. Highlight the name of your wireless network (this is the network's SSID) and press **OK**.
5. Using the on-screen keyboard, enter your network's password, then highlight **Connect** and press **OK**.
6. Press the **EXIT** button on the remote.

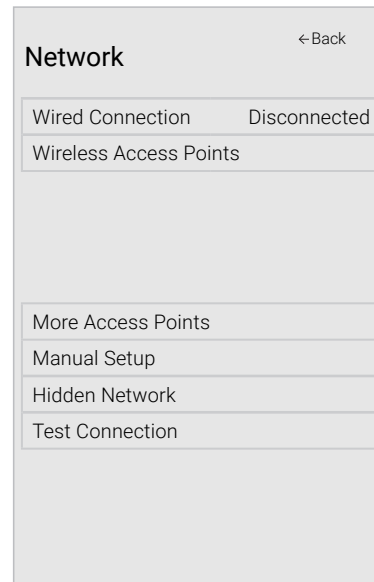

Changing the Manual Setup Settings

Advanced users can fine-tune the network settings using the Manual Setup feature.

To change advanced network settings:

1. From the NETWORK menu, highlight **Manual Setup** and press **OK**. The MANUAL SETUP menu is displayed.
2. To change the settings manually, use the **Arrow** buttons on the remote to highlight **DHCP** and then use the **Left/Right Arrow** buttons to change the setting to **Off**.
3. Use the **Arrow** and **OK** buttons to adjust each setting:
 - **IP Address** - The IP address assigned to the TV.
 - **Subnet Mask** - The subnet mask.
 - **Default Gateway** - Your network's default gateway address.
 - **Pref. DNS Server** - Your preferred domain name server address.
 - **Alt. DNS Server** - Your alternate domain name server address.
4. Use the **Arrow** buttons on the remote to highlight **Save** and press **OK**.
5. Press the **EXIT** button on the remote.

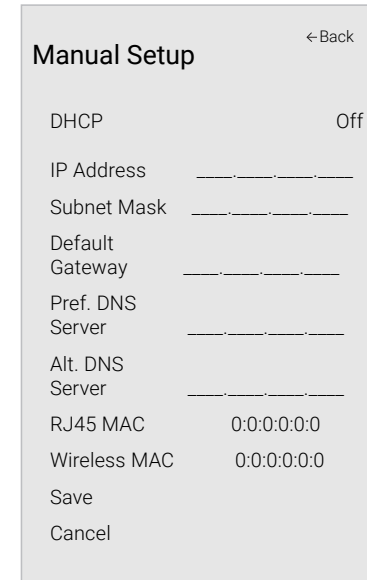

Finding MAC Addresses for Network Setup

The security settings on your router may require you to enter the Display's MAC address in the router's settings.

To find the Display's MAC address:

1. From the NETWORK menu, highlight **Manual Setup** and press **OK**. The MANUAL SETUP menu is displayed.
2. Find the MAC address for the TV at the bottom of the list. The MAC addresses for the connections in use are displayed:
 - **RJ45 MAC** - The Ethernet or RJ45 MAC address may be needed to set up your network when you have connected the TV to your network with an Ethernet (Cat 5) cable.
 - **Wireless MAC** - The Wireless (WiFi) MAC address may be needed to connect your TV to your network with WiFi.

Connecting to a Hidden Network

To connect to a wireless network whose network name (SSID) is not being broadcast:

1. From the NETWORK menu, highlight **Hidden Network** and press **OK**. The ENTER ACCESS POINT NAME screen is displayed.
2. Using the on-screen keyboard, enter your network's name (SSID), then highlight Connect and press **OK**
3. Using the on-screen keyboard, enter your network's password, then highlight Connect and press **OK**.
4. Press the **EXIT** button on the remote.

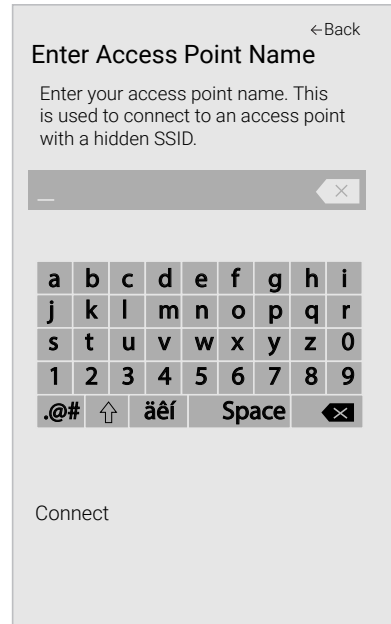

Testing Your Network Connection

To test your network connection:

1. From the NETWORK menu, highlight **Test Connection** and press **OK**.
2. The TEST CONNECTION screen displays the connection method, network name, signal strength, and download speed of your network connection.
3. Press the EXIT button on the remote.

SETTING TIMERS

Setting the Sleep Timer

When activated, the Display's sleep timer will turn the Display off after a set period of time.

1. Press the **MENU** button on the remote. The on-screen menu is displayed.
2. Use the **Arrow** buttons on the remote to highlight **Timers** and press **OK**. The TIMERS menu is displayed.
3. Use the **Left/Right Arrow** buttons on the remote to highlight the period of time after which you want the Display to go to sleep: **30, 60, 90, 120, or 180 minutes**. If you don't want the sleep timer to activate, change the setting to **Off**.
4. When you have finished setting the sleep timer, press the **EXIT** button on the remote.

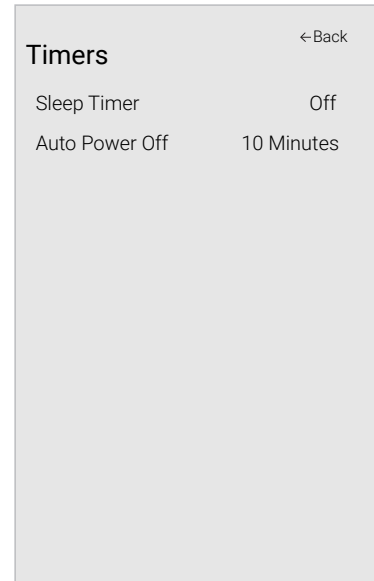

Setting the Auto Power Off Feature

To help save energy, your Display is set by default to turn off after 10 minutes without a video or audio signal. This feature can be deactivated.

To set the Auto Power Off feature:

1. From the TIMERS menu, use the **Up/Down Arrow** buttons on the remote to highlight **Auto Power Off**.
2. Use the **Left/Right Arrow** buttons on the remote to change whether the Display will turn off. If you don't want the Display to turn off when there is no signal, change the setting to **Off**. Otherwise, select **10 minutes**.
3. When you have finished setting the auto power off time, press the **EXIT** button on the remote.

RENAMING DEVICES ON THE INPUT MENU

You can rename the inputs to make them easier to recognize on the Input menu. For example, if you have a DVD player connected to the Component input, you can rename that input to display "DVD Player." See *Changing the Input Source*.

To change the name of an input:

1. Press the **MENU** button on the remote. The on-screen menu is displayed.
2. Use the **Arrow** buttons on the remote to highlight **Input** and press **OK**. The INPUT menu is displayed.
3. Highlight the input device that you want to rename and press **OK**.
4. To use a preset input name:
 - a. Highlight the **Input Port** row and press **Left/Right** arrow keys to scroll across the list of preset names.—or—
 - a. Enter your custom label using the on-screen keyboard.
 - b. Highlight **OK** and press **OK**.
 - c. The Input Name changes to show the custom name that you created.
5. When you have finished naming your input, press the **EXIT** button on the remote.

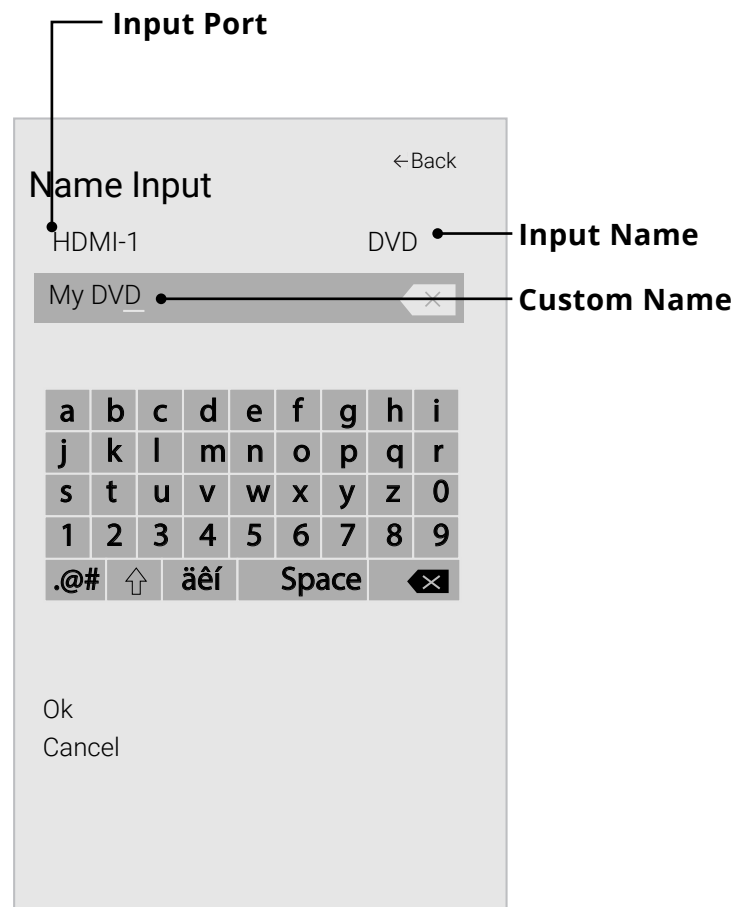

CHANGING THE DISPLAY SETTINGS

Using the System menu, you can:

- Check for system updates
- View system information
- Change the on-screen menu language
- Set time zone and local settings
- Adjust the CEC settings
- Adjust when the power indicator is illuminated
- Change your Display's name
- Review and maintain the list of paired devices.
- Reset the Display settings & set up administrative controls

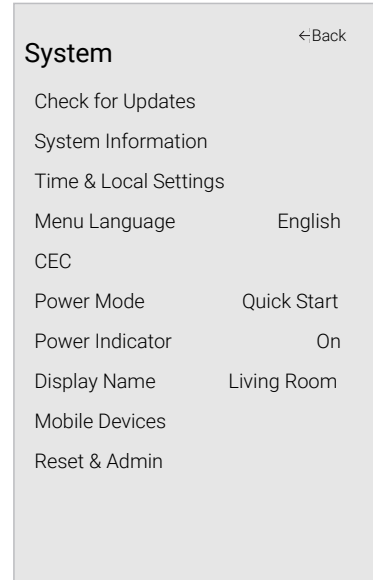

Checking for System Updates

To view technical data and status information about your Display and network connection:

1. Press the **MENU** button on the remote. The on-screen menu is displayed.
2. Use the **Arrow** buttons on the remote to highlight **Check for Updates** and press **OK**. The Display will begin to check for updates
3. If an update is found, the Display will ask to confirm the update.

If no update is found the display will note **No Update Available**.

Viewing System Information

To view technical data and status information about your Display and network connection:

1. Press the **MENU** button on the remote. The on-screen menu is displayed.
2. Use the **Arrow** buttons on the remote to highlight **System Information** and press **OK**. The SYSTEM menu is displayed.
3. Highlight **System Information** and press **OK**.
4. Use the **Up/Down Arrow** buttons to scroll through the system information.
5. When you are finished reviewing the system information, press the **EXIT** button on the remote.

Setting the Time and Local Settings

To ensure the correct time is displayed when you press the **INFO** button, set the Display's time zone:

1. Press the **MENU** button on the remote. The on-screen menu is displayed.
2. Use the **Arrow** buttons on the remote to highlight **System** and press **OK**. The SYSTEM menu is displayed.
3. Use the **Arrow** buttons on the remote to highlight **Time & Local Settings** and press **OK**. The menu headed by the local date and time is displayed.
4. Highlight **Time Zone** and press **OK**. The TIME ZONE menu is displayed.
5. Highlight your time zone and press **OK**.
6. Highlight **Daylight Saving Time** and press **OK**. The DAYLIGHT SAVING TIME menu is displayed. Choose **On** if it is currently Daylight Savings Time, **Off** if it is Standard Time, or **Auto** to have the system automatically detect Daylight Savings Settings.
7. Press the **EXIT** button on the remote.



Changing the On-Screen Menu Language

Your Display can display the on-screen menu in different languages.

To change the on-screen menu language:

1. Press the **MENU** button on the remote. The on-screen menu is displayed.
2. Use the **Arrow** buttons on the remote to highlight **System** and press **OK**. The SYSTEM menu is displayed.
3. Use the **Arrow** buttons on the remote to highlight **Menu Language** and press **OK**. The MENU LANGUAGE menu is displayed.
4. Highlight your preferred language (**English**, **Español**, or **Français**) and press **OK**.
5. Press the **EXIT** button on the remote.

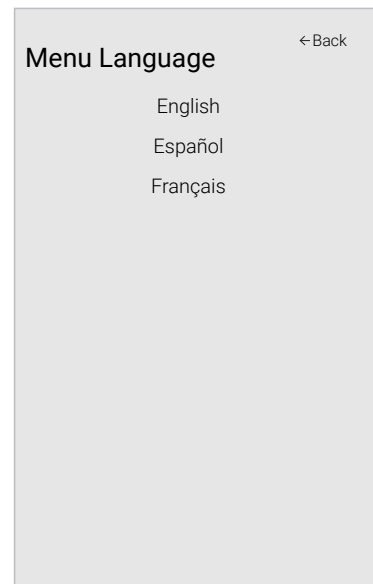

Adjusting the CEC Settings

The CEC function on your Display enables you to control HDMI-connected devices with the included remote without any additional programming.



Not all HDMI devices support CEC. See your device's user manual for details.

To enable, disable, or adjust CEC settings:

1. Press the **MENU** button on the remote. The on-screen menu is displayed.
2. Use the **Arrow** buttons on the remote to highlight **System** and press **OK**. The SYSTEM menu is displayed.
3. Use the **Arrow** buttons on the remote to highlight **CEC** and press **OK**. The CEC menu is displayed.
4. Use the **Arrow** and **OK** buttons to adjust each setting:
 - CEC - Select Enable to use the Display remote to control CEC devices connected to HDMI. Select ARC Only for plug and play of an audio device connected to the HDMI ARC input. The ARC setting does not support video devices connected to the audio device (Select Enable to enable support for these devices). Select Disable to turn CEC off.
 - Device Discovery - Use this function to determine if your device is connected and supports CEC. (Required for Enable option only)
5. Press the **EXIT** button on the remote.

Adjusting the Power Mode

Your Display is set to Eco Mode by default. When the Display is powered off, Eco Mode setting uses less than 0.5W of power. Quick Start Mode enables your Display to power on faster as well as automatically power on when casting content.



Please note that by changing this setting the energy consumption required to operate this device will change.

To switch between Eco Mode and Quick Start Mode:

1. Press the **MENU** button on the remote. The on-screen menu is displayed.
2. Use the **Arrow** buttons on the remote to highlight **System** and press **OK**. The SYSTEM menu is displayed.
3. Use the **Arrow** buttons on the remote to highlight **Power Mode** and press **OK**. The Power Mode menu is displayed.
4. Highlight either Eco Mode or Quick Start Mode and press **OK** to select.

Turning the Power Indicator On or Off

The Power Indicator on the front of your Display normally does not glow when the Display is on. You can change this setting if you prefer the light to be on.

To turn the Power Indicator Light On or Off:

1. Press the **MENU** button on the remote. The on-screen menu is displayed.
2. Use the **Arrow** buttons on the remote to highlight **System** and press **OK**. The SYSTEM menu is displayed.
3. Highlight **Power Indicator** and press **OK**.
4. Use the **Up/Down Arrow** buttons to select **On** or **Off**, then press **OK**.

Changing the Display Name

Naming your display helps to differentiate it from other cast devices you may have in your home.

To view or edit your Display name:

1. Press the **MENU** button on the remote. The on-screen menu is displayed.
2. Use the **Arrow** buttons on the remote to highlight **System** and press **OK**. The SYSTEM menu is displayed.
3. Use the **Arrow** buttons on the remote to highlight **Display Name** and press **OK**. The Display Name menu is displayed.
4. Enter your custom name using the on-screen keyboard.
5. Press the **EXIT** button on the remote.

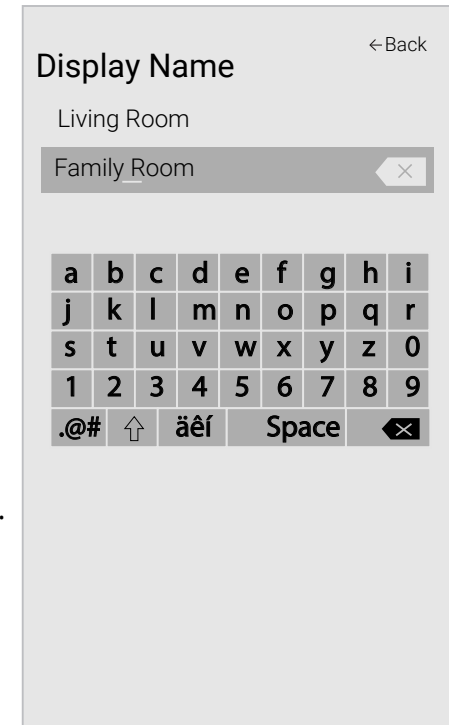

It's recommended to name the display based on the room it is in or the location.

Managing Mobile Devices

Your Display can be paired with multiple mobile devices so you can easily control your Display across multiple devices.

To see a list of paired devices or unpair a device:

1. Press the **MENU** button on the remote. The on-screen menu is displayed.
2. Use the **Arrow** buttons on the remote to highlight **System** and press **OK**. The SYSTEM menu is displayed.
3. Use the **Arrow** buttons on the remote to highlight **Mobile Devices** and press **OK**. The list of paired devices appears.
4. Highlight a device name to delete it and press OK.
5. Use the **Left/Right Arrows** to select YES or NO when asked to confirm.

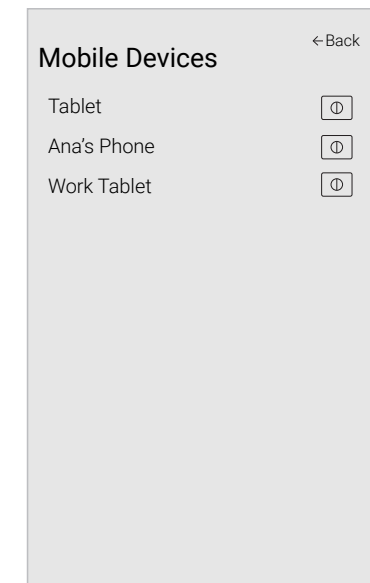

USING THE RESET & ADMIN MENU

You can use the Display's Reset & Admin menu to restore the Display to its factory default settings as well as access other system settings.

Using the Reset & Admin, you can:

- Reset the display to factory settings
- Force the system to power off and on
- Create a system pin code to lock content and picture settings
- Turn Viewing Data **On** or **Off**
- Start or stop the Store Demo Mode

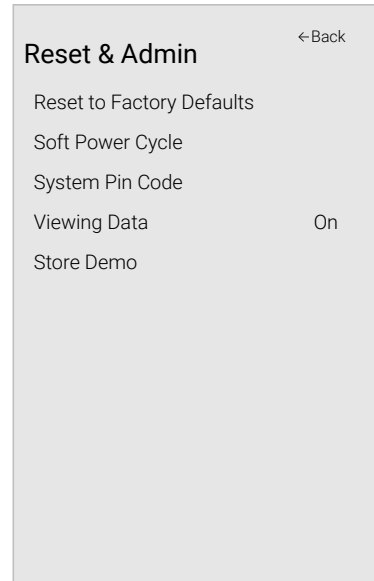

Restoring the Display to Factory Default Settings

All of the on-screen menu settings can be reset to the factory defaults.



If you restore the Display to the factory default settings, all changes you have made to the settings will be lost!

This includes any wireless or picture settings.

To restore the Display to its factory default settings:

1. Press the **MENU** button on the remote. The on-screen menu is displayed.
2. Use the **Arrow** buttons on the remote to highlight **System** and press **OK**. The SYSTEM menu is displayed.
3. Highlight **Reset & Admin** and press **OK**. The RESET & ADMIN menu is displayed.
4. Highlight **Reset Display to Factory Defaults** and press **OK**. If you have changed the default parental control PIN, enter it now.

The Display displays, "Select Reset to restore all Display settings to factory defaults and clear all account information."

5. Highlight **Reset** and press **OK**.
6. Wait for the Display to turn off. The Display will turn back on shortly afterward and the Setup App will begin.

About Viewing Data

Video ACR collects data related to publicly available content displayed on your television/display, such as the identity of your broadcast, cable, or satellite television provider, and the television programs and commercials viewed (including time, date, channel, and whether you view them live or at a later time). We also collect unique identifiers about this TV, including the IP address. This data is collectively referred to as "Viewing Data." For more information about Viewing Data and how VIZIO protects its customers' privacy, please consult our privacy policy at www.vizio.com/privacy.

When ACR collection is turned on, we may share Viewing Data with authorized data partners including analytics companies, media companies and advertisers. VIZIO and its authorized data partners use Viewing Data to generate summary analysis and reports of how users engage with content on their TVs and other devices. VIZIO Viewing Data is sometimes enhanced with household demographic data and data about digital actions (e.g. digital purchases and other consumer behavior taken by devices associated with the IP Address we collect). Viewing Data also enables our authorized data partners to deliver advertising relevant to your profile that you might find useful, both on the VIZIO TV/display and other devices sharing your IP Address. Viewing Data is also used to help content publishers, broadcasters or content distribution services create or recommend more relevant entertainment based on summary insights, as well as helps us improve the design of our products, software and services.

You can easily turn this feature On or Off in the RESET & ADMIN menu. If you have trouble enabling or disabling Viewing Data, please contact VIZIO customer service by emailing techsupport@vizio.com or calling (855) 472-8817.

For more information, see <https://www.vizio.com/viewingdata> and review VIZIO's privacy policy at <https://www.vizio.com/privacy>

USING THE INFO WINDOW

The Info Window can be displayed by pressing the **INFO** or **GUIDE** button on the remote:

- Press the **INFO** button one time to display input, display name, picture mode, time, and network information.

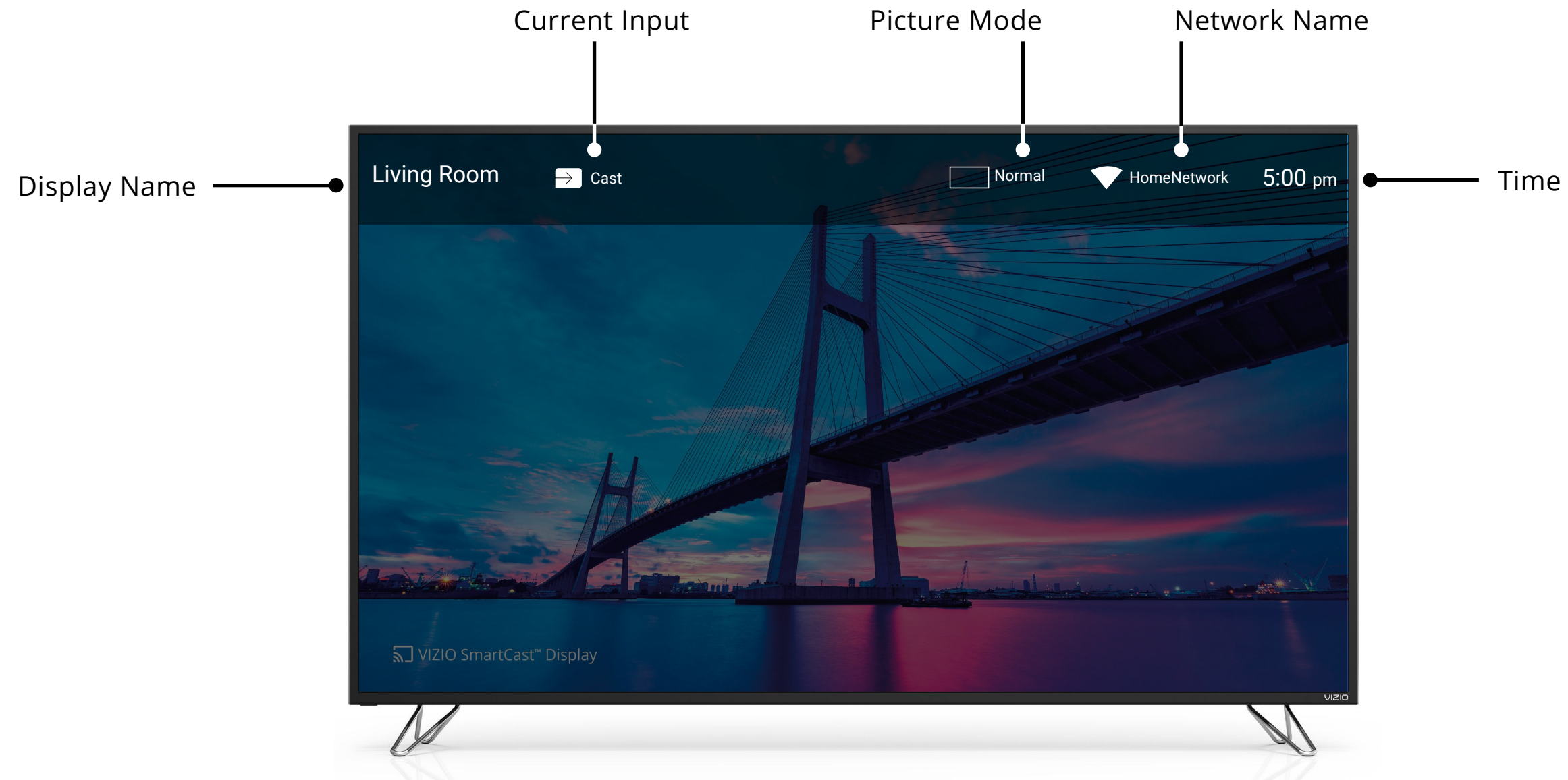

Playing USB Media

You to connect a USB thumb drive to your Display to play videos.

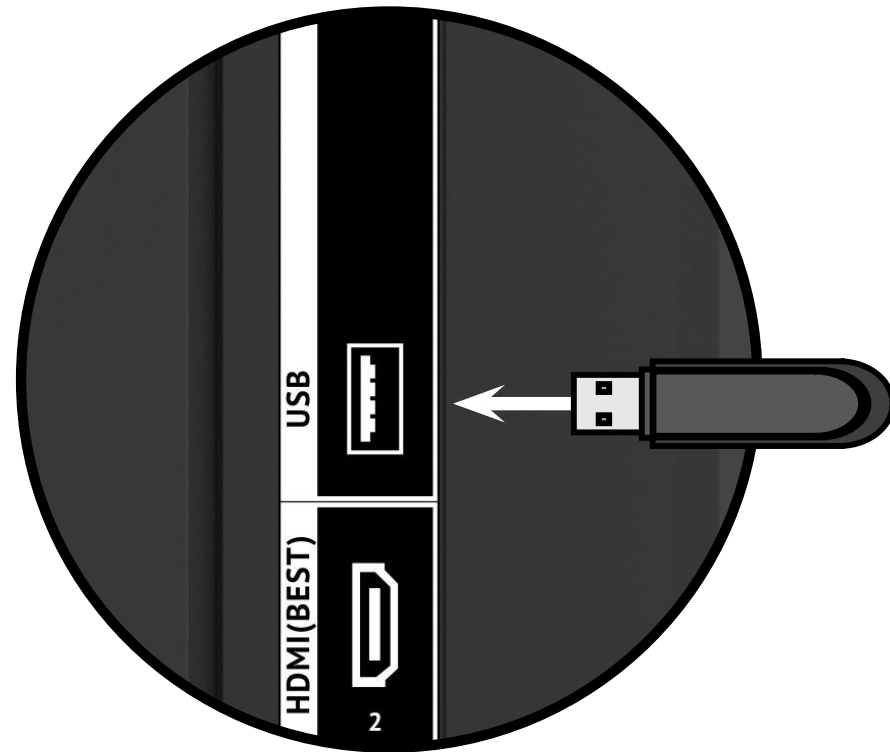

Preparing Your USB Drive to Play USB Media

To display USB media, you must first save your videos onto a USB thumb drive:

- The USB thumb drive must be formatted as FAT32.
- Files on the USB thumb drive must end in a supported file extension (.mp4 only).
- The player is not designed to play media from external hard drives, MP3 players, cameras, or smartphones.

Displaying USB Media

To display your USB media:

1. Connect your USB thumb drive to the USB port on the side of the Display.
2. The Display will recognize the USB stick and begin playing content on its own.

Removing the USB Drive from the Display

To safely remove your USB drive from the Display:

1. Turn off the Display.
2. Disconnect your USB thumb drive from the USB port on the side of the Display.



Do not remove the USB thumb drive while the Display is on. Doing so may damage the drive.

Do You Have Questions? Find Answers At

SUPPORT.VIZIO.COM

Find help with:

- New Product Setup
- Connecting Your Devices
- Technical Problems
- Product Updates
- And More



**Live Chat
Support Available**

**You can also contact our
award-winning support team at:**

Phone: (877) 698-4946 (TOLL-FREE)

Hours Of Operation:

Monday - Friday: 7 AM TO 11 PM (CST)

Saturday - Sunday: 8 AM TO 9 PM (CST)



Take A Moment To Register Your Product At

VIZIO.COM/PRODUCT-REGISTRATION

Why Register?



Customized Support

Get assistance quickly with your information on-hand.



News & Offers

Take advantage of the latest news and special offers from VIZIO.



Safety & Satisfaction

Stay up to date with important product updates and notifications.

REGISTER YOUR VIZIO PRODUCT NOW

How do I download the VIZIO SmartCast™ App?

- Make sure your phone or tablet is connected to a Wi-Fi network. Open a browser on your phone or tablet. Navigate to vizio.com/smartcastapp and follow the on-screen instructions to download the VIZIO SmartCast™ App.

How do I change the inputs?

- Make sure the VIZIO SmartCast™ App is installed on your phone or tablet. Open the VIZIO SmartCast™ App. Tap on the Device list and select your Display. Tap on the **Input Icon**  and select the input of your choice.
- Press the **INPUT** button on the back of the Display to cycle through the inputs.
- Press the **INPUT** button on the basic remote to cycle through the inputs.

How do I connect to my Wi-Fi network?

- On your IR remote, press the Menu button then go to Network → Select your Wi-Fi name → Enter password.
- Press the **Setup / Link** button twice on the IR remote. Open the VIZIO SmartCast™ App on your phone or tablet. Tap on the Device list and select **Setup a New Device** and follow the on-screen instructions.
- Open the VIZIO SmartCast™ App on your phone or tablet. Tap on the device list and select your Display. Tap on the **Settings** icon → **Network** → **Wireless Access Points**. Select your Wi-Fi network from the list, enter the Wi-Fi password, and tap **Connect**.
- Press the **Setup / Link** button twice on the IR remote. Press **Play / Pause** button to enter manual setup. Follow the on-screen instructions to complete setup and connect to a wireless network.

How do I stream apps like Netflix and Youtube to my VIZIO SmartCast™ Display?

- Download and open a Chromecast-enabled apps on your mobile device, such as like Netflix or Youtube. Then tap the Cast button.

How do I exit Demo Mode

- **Press and hold** the **INPUT** button on the back of the Display to exit the demo mode.

How do I watch Cable/Antenna TV channels?

- If you subscribe to cable or satellite, simply connect an HDMI cable (not included) to the receiver.
- If you use external antennas to watch local broadcast channels, a TV tuner is required and is sold separately by third parties.

The remote is not responding.

- Make sure the batteries are properly inserted matching the - and + symbols.
- Replace the batteries with fresh ones.

The Display displays “No Signal.”

- Press the **INPUT** button on the remote control to select a different input source.

There is no power.

- Ensure the Display is plugged into a working electrical outlet.
- Ensure the power cable is securely attached to the Display.
- Press the **Power/Standby** button on the remote or on the back of the Display to turn the Display on.

The power is on, but there is no image on the screen.

- Ensure all cables are securely attached to the Display.
- Ensure all devices are connected correctly. Devices differ; see your device’s user manual for details.
- Adjust Brightness, Contrast, or Backlight. See *Adjusting the Picture Settings*.
- Press the **INPUT** button on the remote to select a different input source.

There is no sound.

- Press Volume Up on the remote control.
- Press the **MUTE** button on the remote to ensure mute is off.
- Check the audio settings. See *Adjusting the Audio Settings*.
- Check the audio connections of external devices (Blu-ray player, game console, cable/satellite box) that are connected to the TV.

The sound is flat or dialog is not audible.

- Turn off Volume Leveling. See *Adjusting the Audio Settings*.

The colors on the TV don’t look right.

- Adjust the Color and Tint settings in the Picture menu. See *Adjusting the Picture Settings*.
- Select a pre-set picture mode. See *Adjusting the Picture Settings*. VIZIO recommends selecting Calibrated.
- Check all cables to ensure they are securely attached.

The buttons on the remote aren’t working.

- Ensure you are only pressing one button at a time.
- Point the remote directly at the Display when pressing a button.
- Replace the remote batteries with new ones. See *Replacing the Batteries*.

The image quality is not good.

- For the best image quality, view high-definition programs using digital sources. Connect your devices with HDMI cables.

The picture is distorted.

- Move the Display away from electrical appliances, cars, and fluorescent lights.
- Ensure all cables are securely attached.

The display image does not cover the entire screen.

- If you are using Display, AV, or Component with 480i input, press the  button on the remote to change the screen mode.

The Display has pixels (dots) that are always dark.

- Your HD Display is precision-manufactured using an extremely high level of technology. However, sometimes pixels may not display correctly. These types of occurrences are inherent to this type of product and do not constitute a defective product.

When I change input source, the display image changes size.

- The TV remembers the viewing mode on each input source. If the viewing mode on the new input source differs from the one on the input source you switch from, the difference may be noticeable.

M50-E1	
Screen Size:	50"
Viewable Area:	49.50"
Dimensions w/ Stand:	44.40" x 27.98" x 8.70"
w/o Stand:	44.40" x 25.61" x 2.68"
Weight w/ Stand:	30.86 lbs
w/o Stand:	29.32 lbs
LCD Backlight:	Full Array LED
Active LED Zones:	32
Refresh Rate:	120 Hz Effective Refresh Rate
Maximum Resolution:	3840 x 2160 (UHD)
Dynamic Contrast Ratio:	20M:1
Pixel Pitch:	0.315 mm (H) X 0.315 mm (V)
Viewing Angle:	178° (H) / 178° (V)
HDMI Inputs:	4
Component Video Inputs:	1
USB Port:	1
Audio Outputs:	Analog Stereo, Optical Digital, HDMI ARC
OSD Language:	English, French, Spanish
Ambient Light Sensor:	Yes

M50-E1	
Remote Control Model:	XRT135
Certifications:	UL, cUL, FCC Class B, BET7/ICES-003 Class B, IC, HDMI (CEC, ARC), Dolby Audio™
Voltage Range:	120 V @ 60 Hz
Power Consumption:	43.66W
Standby Power:	<0.5W
Zero Bright Pixel Guarantee:	Yes
Screw Size	M6
Wallmount Hole Pattern	200 mm (V) x 200 mm (H)

M55-E0	
Screen Size:	55"
Viewable Area:	54.64"
Dimensions w/ Stand:	48.97" x 30.58" x 9.13"
w/o Stand:	48.97" x 28.31" x 2.51"
Weight w/ Stand:	36.15 lbs
w/o Stand:	34.17 lbs
LCD Backlight:	Full Array LED
Active LED Zones:	32
Refresh Rate:	120 Hz Effective Refresh Rate
Maximum Resolution:	3840 x 2160 (UHD)
Dynamic Contrast Ratio:	20M : 1
Pixel Pitch:	0.315 mm (H) X 0.315 mm (V)
Viewing Angle:	178° (H) / 178° (V)
HDMI Inputs:	4
Component Video Inputs:	1
USB Port:	1
Audio Outputs:	Analog Stereo, Optical Digital, HDMI ARC
OSD Language:	English, French, Spanish
Ambient Light Sensor:	Yes

M55-E0	
Remote Control Model:	XRT135
Certifications:	C-US , CSA , FCC Class B, ICES-003 Class B, IC, HDMI (CEC, ARC), Dolby Audio™
Voltage Range:	120 V @ 60 Hz
Power Consumption:	165W
Standby Power:	<0.5W
Zero Bright Pixel Guarantee:	Yes
Screw Size	M6
Wallmount Hole Pattern	400 mm (V) x 400 mm (H)

M65-E0

Screen Size:	65"
Viewable Area:	64.50"
Dimensions w/ Stand:	57.59" x 35.78" x 10.87"
w/o Stand:	57.59" x 33.14" x 2.51"
Weight w/ Stand:	57.32 lbs
w/o Stand:	55.33 lbs
LCD Backlight:	Full Array LED
Active LED Zones:	32
Refresh Rate:	120 Hz Effective Refresh Rate
Maximum Resolution:	3840 x 2160 (UHD)
Dynamic Contrast Ratio:	20M:1
Pixel Pitch:	0.315 mm (H) X 0.315 mm (V)
Viewing Angle:	178° (H) / 178° (V)
HDMI Inputs:	4
Component Video Inputs:	1
USB Port:	2
Audio Outputs:	Analog Stereo, Optical Digital, HDMI ARC
OSD Language:	English, French, Spanish
Ambient Light Sensor:	Yes

M65-E0

Remote Control Model:	XRT135
Certifications:	C-US , CSA , FCC Class B, ICES-003 Class B, IC, HDMI (CEC, ARC), Dolby Audio™
Voltage Range:	120 V @ 60 Hz
Power Consumption:	200W
Standby Power:	<0.5W
Zero Bright Pixel Guarantee:	Yes
Screw Size	M6
Wallmount Hole Pattern	400 mm (V) x 400 mm (H)

M70-E3

Screen Size:	70"
Viewable Area:	69.50"
Dimensions w/ Stand:	61.70" x 38.36" x 11.17"
w/o Stand:	61.70" x 35.53" x 2.72"
Weight w/ Stand:	60.41 lbs
w/o Stand:	58.64 lbs
LCD Backlight:	Full Array LED
Active LED Zones:	32
Refresh Rate:	120 Hz Effective Refresh Rate
Maximum Resolution:	3840 x 2160 (UHD)
Dynamic Contrast Ratio:	50M:1
Pixel Pitch:	0.4008 mm (H) X 0.4008 mm (V)
Viewing Angle:	178° (H) / 178° (V)
HDMI Inputs:	4
Component Video Inputs:	1
Composite Inputs:	1 (Shared with Component)
Audio Outputs:	Analog Stereo, Optical Digital, HDMI ARC
OSD Language:	English, French, Spanish
Ambient Light Sensor:	Yes

M70-E3

Remote Control Model:	XRT135
Certifications:	UL, cUL, FCC Class B, BET7/ICES-003 Class B, IC, HDMI (CEC, ARC), Dolby Audio™
Voltage Range:	120 V @ 60 Hz
Power Consumption:	280W
Standby Power:	<0.5W
Zero Bright Pixel Guarantee:	Yes
Screw Size	M6
Wallmount Hole Pattern	400 mm (V) x 400 mm (H)

M75-E1	
Screen Size:	75"
Viewable Area:	74.50"
Dimensions w/ Stand:	66.58" x 40.99" x 13.78"
w/o Stand:	66.58" x 38.24" x 3.11"
Weight w/ Stand:	77.91 lbs
w/o Stand:	77.16 lbs
LCD Backlight:	Full Array LED
Active LED Zones:	32
Refresh Rate:	120 Hz Effective Refresh Rate
Maximum Resolution:	3840 x 2160 (UHD)
Dynamic Contrast Ratio:	20M:1
Pixel Pitch:	0.4298 mm (H) X 0.4298 mm (V)
Viewing Angle:	178° (H) / 178° (V)
HDMI Inputs:	2
Component Video Inputs:	1
USB Port:	1
Audio Outputs:	Analog Stereo, Optical Digital, HDMI ARC
OSD Language:	English, French, Spanish
Ambient Light Sensor:	Yes

M75-E1	
Remote Control Model:	XRT135
Certifications:	UL, cUL, FCC Class B, BET7/ICES-003 Class B, IC, HDMI (CEC, ARC), Dolby Audio™
Voltage Range:	120 V @ 60 Hz
Power Consumption:	178.25W
Standby Power:	<0.5W
Zero Bright Pixel Guarantee:	Yes
Screw Size	M8
Wallmount Hole Pattern	400 mm (V) x 400 mm (H)

FCC Class B Radio Interference Statement

NOTE: This equipment has been tested and found to comply with the limits for a Class B digital device, pursuant to Part 15 of the FCC Rules. These limits are designed to provide reasonable protection against harmful interference in a residential installation. This equipment generates, uses and can radiate radio frequency energy, and if not installed and used in accordance with the instructions, may cause harmful interference to radio communications. However, there is no guarantee that interference will not occur in a particular installation. If this equipment does cause harmful interference to radio or television reception, which can be determined by turning the equipment off and on, the user is encouraged to try to correct the interference by one or more of the following measures:

- Reorient or relocate the receiving antenna.
- Increase the separation between the equipment and receiver.
- Connect the equipment into an outlet on a circuit different from that to which the receiver is connected.
- Consult the dealer or an experienced radio/Display technician for help.

This device complies with Part 15 of the FCC Rules. Operation is subject to the following two conditions: (1) this device may not cause harmful interference, and (2) this device must accept any interference received, including interference that may cause undesired operation.

Notice

The changes or modifications not expressly approved by the party responsible for compliance could void the user's authority to operate the equipment.

Shielded interface cables and AC power cord, if any, must be used in order to comply with the emission limits.

The manufacturer is not responsible for any radio or Display interference caused by unauthorized modification to this equipment. It is the responsibilities of the user to correct such interference.

FCC Warning

Changes or modifications not expressly approved by the party responsible for compliance with the FCC Rules could void the user's authority to operate this equipment.

Caution

Always use an AC/DC power adapter that is properly grounded. Use the AC cords listed below for each area.

For USA / Canada

This equipment Should be installed and operated with a minimum distance 20 cm between the antenna and your body .Users must follow the specific operating instructions for satisfying RF exposure compliance.

For Canada

The device for the band 5150-5250 MHz is only for indoor use to reduce the potential for harmful interference to co-channel mobile satellite systems. The maximum antenna gain permitted (for devices in the 5725-5825 MHz band) to comply with the E.I.R.P. limits specified for point-to-point and non point-to-point operation as appropriate .

Canada Notice for License-Exempt Radio Apparatus

This device complies with Industry Canada's license-exempt RSSs. Operation is subject to the following two conditions: (1) This device may not cause harmful interference, and (2) this device must accept any interference received, including interference that may cause undesired operation.

This device operates on a no-protection no-interference basis. Should the user seek to obtain protection from other radio services operating in the same TV bands, a radio license is required. Please consult Industry Canada's document CPC-2-1-28, Optional Licensing for Low-Power Radio Apparatus in the TV Bands, for details.

Cet appareil est conforme aux CNR exempts de licence d'Industrie Canada. Son fonctionnement est sujet aux deux conditions suivantes:

1. le dispositif ne doit pas produire de brouillage préjudiciable, et
2. ce dispositif doit accepter tout brouillage reçu, y compris un brouillage susceptible de provoquer un fonctionnement indésirable.

Cet appareil fonctionne sur une base sans protection et sans interférence. Dans le cas où l'utilisateur cherche à obtenir de la protection des autres services de radio fonctionnant sur les mêmes bandes TV, aucune licence est requise. Veuillez consulter le document CPC-2-1-28 d'Industrie Canada, License optionnelle pour les appareils radio de faible puissance, pour plus de détails.

Industry Canada Class B emission compliance statement

This Class B digital apparatus complies with Canadian ICES-003. Cet appareil numérique de la classe B est conforme à la norme NMB-003 du Canada.

Declaración de México:

La operación de este equipo está sujeta a las siguientes dos condiciones: (1) es posible que este equipo o dispositivo no cause interferencia perjudicial y (2) este equipo o dispositivo debe aceptar cualquier interferencia, incluyendo la que pueda causar su operación no deseada.

UNITED STATES AND CANADA

BY USING YOUR VIZIO PRODUCT YOU AGREE TO BE BOUND BY ALL THE TERMS OF THIS WARRANTY. BEFORE USING YOUR VIZIO PRODUCT, PLEASE READ THIS WARRANTY CAREFULLY. IF YOU DO NOT AGREE TO THE TERMS OF THIS WARRANTY, DO NOT USE THE VIZIO PRODUCT AND, WITHIN THIRTY (30) DAYS OF THE DATE OF PURCHASE, RETURN IT FOR A REFUND TO THE AUTHORIZED RETAILER WHERE YOU PURCHASED IT. This warranty contains a binding arbitration agreement and a class action waiver for United States residents. If you live in the United States, the binding arbitration agreement and class action waiver affect your rights under this warranty. Please read the text under the section titled "Binding Arbitration Agreement; Class Action Waiver (U.S. Residents Only)" carefully.

How Long This Warranty Lasts

For non-commercial use, VIZIO warrants the product on the terms set forth below for one (1) year from the date of original purchase. For commercial use, VIZIO warrants this product on the terms set forth below for ninety (90) days from the date of original purchase.

What This Warranty Covers

VIZIO warrants the product against defects in materials and workmanship when the product is used normally in accordance with VIZIO's user guides and manuals.

Except where restricted by law, this warranty applies only to the original purchaser of a new product. The purchase must have been made from an authorized retailer in the United States (including Puerto Rico) or Canada. The product must also be located in the country where it was purchased at the time of warranty service.

Zero Bright Pixel Defect Guarantee (Displays Only)

Your product may qualify for a warranty against "zero bright pixel" defects for the duration of the warranty on select new product purchases. To determine if this guarantee applies to your product, refer to the model's product information page at www.vizio.com, look for the "zero bright pixel" guarantee on the box, or contact VIZIO Technical Support at the email address or telephone number below.

How to Get Service

Before obtaining warranty service, you may visit www.vizio.com for additional help and troubleshooting. To obtain warranty service, contact

VIZIO Technical Support via email at TechSupport@VIZIO.com or via phone at 877 MY VIZIO (877-698-4946). The VIZIO Technical Support hours are 6:00AM to 9:00PM Monday through Friday and 7:00AM to 4:00PM Saturday and Sunday, Pacific Time.

Your Obligations Before Service

You must obtain pre-authorization before sending your product to a VIZIO service center. You may be required to supply a purchase receipt (or copy) to show that the product is within the warranty period.

When you return a product to a VIZIO service center, you must ship the product in its original packaging or in packaging that affords an equal degree of protection. VIZIO Technical Support will provide instructions for packing and shipping the product to the VIZIO service center.

ALL USER DATA AND DOWNLOADED APPLICATIONS STORED ON A PRODUCT WILL BE DELETED IN THE COURSE OF SOME IN-HOME AND ALL SHIP-IN WARRANTY SERVICE. If this occurs, your product will be restored to its original state. You will be responsible for restoring all applicable user data and downloaded applications. Recovery and reinstallation of user data and downloaded applications is not covered under this warranty. In order to protect your personal information, VIZIO recommends that you always clear all personal information from the product before it is serviced, regardless of the servicer.

VIZIO's Responsibilities

If VIZIO determines that a product is covered by this warranty, VIZIO will (at its option) repair or replace it, or refund the purchase price to you. There will be no charge for parts or labor during the warranty period. Replacement parts may be new or recertified at VIZIO's option and sole discretion. Replacement parts and VIZIO's labor are warranted for the remaining portion of the original warranty or for ninety (90) days from warranty service, whichever is longer.

Types of Service

Displays that are 32 inches or larger will usually be serviced in-home. In-home service requires complete and easy access to the product and does not include de-installation or re-installation of the product. In-home service is subject to availability. VIZIO will provide other service options when in-home service is not available.

All other VIZIO products must be sent to a VIZIO service center to obtain warranty service. VIZIO is not responsible for transportation costs to the service center, but VIZIO will cover return shipping to the customer.

What This Warranty Does Not Cover

This warranty does not cover: (a) cosmetic damage; (b) normal wear and tear; (c) improper operation; (d) improper voltage supply or power surges; (e) signal issues; (f) damage from shipping; (g) acts of God; (h) customer misuse, modifications or adjustments; (i) installation, set-up, or repairs attempted by anyone other than by a VIZIO authorized service center; (j) products with unreadable or removed serial numbers; (k) products requiring routine maintenance; or (l) products sold "AS IS", "CLEARANCE", "FACTORY RECERTIFIED", or by a non-authorized reseller.

What to Do If You Are Not Satisfied With Service

If you feel VIZIO has not met its obligations under this warranty, you may attempt to resolve the issue informally with VIZIO. If you are unable to resolve the issue informally and wish to file a formal claim against VIZIO, and if you are a resident of the United States, you must submit your claim to binding arbitration according to the procedures described below, unless an exception applies. Submitting a claim to binding arbitration means that you do not have the right to have your claim heard by a judge or jury. Instead your claim will be heard by a neutral arbitrator.

Binding Arbitration Agreement; Class Action Waiver (U.S. Residents Only)

UNLESS YOU HAVE BROUGHT AN ELIGIBLE CLAIM IN SMALL CLAIMS COURT OR HAVE OPTED OUT AS DESCRIBED BELOW, ANY CONTROVERSY OR CLAIM RELATING IN ANY WAY TO YOUR VIZIO PRODUCT, INCLUDING ANY CONTROVERSY OR CLAIM ARISING OUT OF OR RELATING TO THIS WARRANTY, A BREACH OF THIS WARRANTY, OR THE VIZIO PRODUCT'S SALE, CONDITION OR PERFORMANCE, WILL BE SETTLED BY BINDING ARBITRATION ADMINISTERED BY THE AMERICAN ARBITRATION ASSOCIATION AND CONDUCTED BY A SINGLE ARBITRATOR APPOINTED BY THE AMERICAN ARBITRATION ASSOCIATION, IN ACCORDANCE WITH ITS COMMERCIAL ARBITRATION RULES AND ITS SUPPLEMENTARY PROCEDURES FOR CONSUMER-RELATED DISPUTES. You may learn more about the American Arbitration Association and its rules for arbitration by visiting www.adr.org or by calling 800-778-7879. Since this warranty concerns a transaction in interstate or international commerce, the Federal Arbitration Act will apply.

The filing fees to begin and carry out arbitration will be shared between you and VIZIO, but in no event will your fees ever exceed the amount allowable by the American Arbitration Association, at which point VIZIO will cover all additional administrative fees and expenses. VIZIO waives its

right to recover attorneys' fees in connection with any arbitration under this warranty. If you are the prevailing party in an arbitration to which the Supplementary Procedures for Consumer-Related Disputes applies, then you are entitled to recover attorneys' fees as the arbitrator may determine.

The dispute will be governed by the laws of the state or territory in which you resided at the time of your purchase (if in the United States). The place of arbitration will be Irvine, California, or your county of residence (if in the United States). The arbitrator will have no authority to award punitive or other damages not measured by the prevailing party's actual damages, except as may be required by statute. The arbitrator will not award consequential damages, and any award will be limited to monetary damages and will include no equitable relief, injunction, or direction to any party other than the direction to pay a monetary amount. Judgment on the award rendered by the arbitrator will be binding and final, except for any right of appeal provided by the Federal Arbitration Act, and may be entered in any court having jurisdiction. Except as may be required by law, neither you nor VIZIO nor an arbitrator may disclose the existence, content, or results of any arbitration under this warranty without the prior written consent of you and VIZIO.

ANY DISPUTE, WHETHER IN ARBITRATION, IN COURT, OR OTHERWISE, WILL BE CONDUCTED SOLELY ON AN INDIVIDUAL BASIS. VIZIO AND YOU AGREE THAT NO PARTY WILL HAVE THE RIGHT OR AUTHORITY FOR ANY DISPUTE TO BE ARBITRATED AS A CLASS ACTION, A PRIVATE ATTORNEY GENERAL ACTION, OR IN ANY OTHER PROCEEDING IN WHICH EITHER PARTY ACTS OR PROPOSES TO ACT IN A REPRESENTATIVE CAPACITY.

NO ARBITRATION OR PROCEEDING WILL BE JOINED, CONSOLIDATED, OR COMBINED WITH ANOTHER ARBITRATION OR PROCEEDING WITHOUT THE PRIOR WRITTEN CONSENT OF ALL PARTIES TO ANY SUCH ARBITRATION OR PROCEEDING.

Exceptions to Binding Arbitration Agreement and Class Action Waiver

IF YOU DO NOT WISH TO BE BOUND BY THE BINDING ARBITRATION AGREEMENT AND CLASS ACTION WAIVER, THEN: (1) you must notify VIZIO in writing within sixty (60) days of the date that you purchased the product; (2) your written notification must be mailed to VIZIO at 39 Tesla, Irvine, CA 92618, Attn: Legal Department; and (3) your written notification must include (a) your name, (b) your address, (c) the date you purchased the product, and (d) a clear statement that you wish to opt out of the binding arbitration agreement and class action waiver.

In addition, you may pursue a claim in small claims court in your county of residence (if in the United States) or in Orange County, California. In such

case the provisions of the section titled "Binding Arbitration Agreement; Class Action Waiver (U.S. Residents)" will not apply.

Exclusions and Limitations

TO THE GREATEST EXTENT PERMITTED BY APPLICABLE LAW, THERE ARE NO EXPRESS WARRANTIES OTHER THAN THOSE DESCRIBED ABOVE. ANY IMPLIED WARRANTIES, INCLUDING ANY IMPLIED WARRANTY OF MERCHANTABILITY AND FITNESS FOR A PARTICULAR PURPOSE, WILL BE LIMITED IN DURATION TO THE WARRANTY PERIOD SET FORTH ABOVE. SOME STATES AND PROVINCES DO NOT ALLOW LIMITATIONS ON HOW LONG AN IMPLIED WARRANTY LASTS, SO THE ABOVE LIMITATION MAY NOT APPLY TO YOU.

VIZIO WILL NOT BE RESPONSIBLE FOR LOSS OF USE, LOSS OF INFORMATION OR DATA, COMMERCIAL LOSS, LOST REVENUE OR LOST PROFITS, OR OTHER INDIRECT, SPECIAL, INCIDENTAL OR CONSEQUENTIAL DAMAGES, EVEN IF VIZIO HAS BEEN ADVISED OF THE POSSIBILITY OF SUCH DAMAGES, AND EVEN IF THE REMEDY FAILS OF ITS ESSENTIAL PURPOSE. SOME STATES AND PROVINCES DO NOT ALLOW THE EXCLUSION OR LIMITATION OF INCIDENTAL OR CONSEQUENTIAL DAMAGES, SO THE ABOVE LIMITATION OR EXCLUSION MAY NOT APPLY TO YOU.

IN LIEU OF ANY OTHER REMEDY FOR ANY AND ALL LOSSES AND DAMAGES RESULTING FROM ANY CAUSE WHATSOEVER (INCLUDING VIZIO'S NEGLIGENCE, ALLEGED DAMAGE, OR DEFECTIVE GOODS, NO MATTER WHETHER SUCH DEFECTS ARE DISCOVERABLE OR LATENT), VIZIO MAY, AT ITS SOLE AND EXCLUSIVE OPTION AND IN ITS DISCRETION, REPAIR OR REPLACE YOUR PRODUCT, OR REFUND ITS PURCHASE PRICE. AS NOTED, SOME STATES AND PROVINCES DO NOT ALLOW THE EXCLUSION OR LIMITATION OF INCIDENTAL OR CONSEQUENTIAL DAMAGES, SO THE ABOVE LIMITATION OR EXCLUSION MAY NOT APPLY TO YOU.

How the Law Applies

This warranty gives you specific legal rights, and you may also have other rights, which vary from state to state and province to province. This warranty applies to the greatest extent permitted by applicable law.

General

No employee or agent of VIZIO may modify this warranty. If any term of this warranty, other than the class action waiver, is found to be unenforceable, that term will be severed from this warranty and all other terms will remain in effect. If the class action waiver is found to be unenforceable,

then the entire section titled "Binding Arbitration Agreement; Class Action Waiver (U.S. Residents Only)" will not apply. This warranty applies to the maximum extent not prohibited by law.

Changes to Warranty

This warranty may change without notice, but any change will not affect your original warranty. Check www.vizio.com for the most current version.

MEXICO

BY USING YOUR VIZIO PRODUCT YOU AGREE TO BE BOUND BY ALL THE TERMS OF THIS WARRANTY. BEFORE USING YOUR VIZIO PRODUCT, PLEASE READ THIS WARRANTY CAREFULLY. IF YOU DO NOT AGREE TO THE TERMS OF THIS WARRANTY, DO NOT USE THE VIZIO PRODUCT AND, WITHIN THIRTY (30) DAYS OF THE DATE OF PURCHASE, RETURN IT FOR A REFUND TO THE AUTHORIZED RETAILER WHERE YOU PURCHASED IT.

Warrantor

The warrantor under this warranty is VIZIO Sales & Marketing Mexico S. de R.L. de C.V.

How Long This Warranty Lasts

For non-commercial use, VIZIO warrants the product on the terms set forth below for one (1) year from the date of original purchase. For commercial use, VIZIO warrants this product on the terms set forth below for ninety (90) days from the date of original purchase.

What This Warranty Covers

VIZIO warrants the product against defects in materials and workmanship when the product is used normally in accordance with VIZIO's user guides and manuals.

Except where restricted by law, this warranty applies only to the original purchaser of a new product. The purchase must have been made from an authorized retailer in Mexico. The product must also be located in Mexico at the time of warranty service.

Zero Bright Pixel Defect Guarantee (Displays Only)

Your product may qualify for a warranty against "zero bright pixel" defects for the duration of the warranty on select new product purchases. To determine if this guarantee applies to your product, refer to the model's product information page at www.vizio.mx, look for the "zero bright pixel" guarantee on the box, or contact VIZIO Technical Support at the email address or telephone number below.

How to Get Service

Before obtaining warranty service, you may visit www.vizio.com for additional help and troubleshooting. To obtain warranty service, contact VIZIO Technical Support via email at TechSupport@VIZIO.com or via phone at 877 MY VIZIO (877-698-4946). The VIZIO Technical Support hours are 9:00AM to 6:00PM Monday through Friday, Central Standard Time.

Your Obligations Before Service

You must obtain pre-authorization before sending your product to a VIZIO service center. You may be required to supply a purchase receipt (or copy) to show that the product is within the warranty period.

When you return a product to a VIZIO service center, you must ship the product in its original packaging or in packaging that affords an equal degree of protection. VIZIO Technical Support will provide instructions for packing and shipping the product to the VIZIO service center.

ALL USER DATA AND DOWNLOADED APPLICATIONS STORED ON A PRODUCT WILL BE DELETED IN THE COURSE OF SOME IN-HOME AND ALL SHIP-IN WARRANTY SERVICE. If this occurs, your product will be restored to its original state. You will be responsible for restoring all applicable user data and downloaded applications. Recovery and reinstallation of user data and downloaded applications is not covered under this warranty. In order to protect your personal information, VIZIO recommends that you always clear all personal information from the product before it is serviced, regardless of the service.

VIZIO's Responsibilities

If VIZIO determines that a product is covered by this warranty, VIZIO will (at its option) repair or replace it, or refund the purchase price to you. There will be no charge for parts or labor during the warranty period. Replacement parts may be new or recertified at VIZIO's option and sole discretion. Replacement parts and VIZIO's labor are warranted for the remaining portion of the original warranty or for ninety (90) days from warranty service, whichever is longer.

Types of Service

Displays that are 32 inches or larger will usually be serviced in-home. In-home service requires complete and easy access to the product and does not include de-installation or re-installation of the product. In-home service is subject to availability. VIZIO will provide other service options when in-home service is not available. All other VIZIO products must be sent to a VIZIO service center to obtain warranty service. VIZIO is not responsible for transportation costs to the service center, but VIZIO will cover return shipping to the customer.

What This Warranty Does Not Cover

This warranty does not cover: (a) cosmetic damage; (b) normal wear and tear; (c) improper operation; (d) improper voltage supply or power surges; (e) signal issues; (f) damage from shipping; (g) acts of God; (h) customer misuse, modifications or adjustments; (i) installation, set-up, or repairs attempted by anyone other than by a VIZIO authorized service center; (j) products with unreadable or removed serial numbers; (k) products requiring routine maintenance; or (l) products sold "AS IS", "CLEARANCE", "FACTORY RECERTIFIED", or by a non-authorized reseller.

What to Do If You Are Not Satisfied With Service

If you feel VIZIO has not met its obligations under this warranty, you may attempt to resolve the issue informally with VIZIO. If you are unable to resolve the issue informally and wish to file a formal claim against VIZIO, you may do so.

Exclusions and Limitations

TO THE GREATEST EXTENT PERMITTED BY APPLICABLE LAW, THERE ARE NO EXPRESS WARRANTIES OTHER THAN THOSE DESCRIBED ABOVE. ANY IMPLIED WARRANTIES, INCLUDING ANY IMPLIED WARRANTY OF MERCHANTABILITY AND FITNESS FOR A PARTICULAR PURPOSE, WILL BE LIMITED IN DURATION TO THE WARRANTY PERIOD SET FORTH ABOVE. SOME STATES AND PROVINCES DO NOT ALLOW LIMITATIONS ON HOW LONG AN IMPLIED WARRANTY LASTS, SO THE ABOVE LIMITATION MAY NOT APPLY TO YOU.

VIZIO WILL NOT BE RESPONSIBLE FOR LOSS OF USE, LOSS OF INFORMATION OR DATA, COMMERCIAL LOSS, LOST REVENUE OR LOST PROFITS, OR OTHER INDIRECT, SPECIAL, INCIDENTAL OR CONSEQUENTIAL DAMAGES, EVEN IF VIZIO HAS BEEN ADVISED OF THE POSSIBILITY OF SUCH DAMAGES, AND EVEN IF THE REMEDY FAILS OF ITS ESSENTIAL PURPOSE. SOME STATES AND PROVINCES DO NOT ALLOW THE EXCLUSION OR LIMITATION OF INCIDENTAL OR CONSEQUENTIAL DAMAGES, SO THE ABOVE LIMITATION OR EXCLUSION MAY NOT APPLY TO YOU.

IN LIEU OF ANY OTHER REMEDY FOR ANY AND ALL LOSSES AND DAMAGES RESULTING FROM ANY CAUSE WHATSOEVER (INCLUDING VIZIO'S NEGLIGENCE, ALLEGED DAMAGE, OR DEFECTIVE GOODS, NO MATTER WHETHER SUCH DEFECTS ARE DISCOVERABLE OR LATENT), VIZIO MAY, AT ITS SOLE AND EXCLUSIVE OPTION AND IN ITS DISCRETION, REPAIR OR REPLACE YOUR PRODUCT, OR REFUND ITS PURCHASE PRICE. AS NOTED, SOME STATES AND PROVINCES DO NOT ALLOW THE EXCLUSION OR LIMITATION OF INCIDENTAL OR CONSEQUENTIAL DAMAGES, SO THE ABOVE LIMITATION OR EXCLUSION MAY NOT APPLY TO YOU.

How the Law Applies

This warranty gives you specific legal rights, and you may also have other rights, which vary from state to state and province to province. This warranty applies to the greatest extent permitted by applicable law.

General

No employee or agent of VIZIO may modify this warranty. If any term of this warranty is found to be unenforceable, that term will be severed from this warranty and all other terms will remain in effect. This warranty applies to the maximum extent not prohibited by law.

Changes to Warranty

This warranty may change without notice, but any change will not affect your original warranty. Check www.vizio.mx for the most current version.

INFORMATION EXCLUSIVELY FOR MEXICO

To make a warranty claim, or to obtain parts, components, supplies and accessories, you may contact the importer of record, the warranty service provider, or the establishment from whom you purchased the VIZIO product.

Importer of Record
VIZIO Sales & Marketing México S. de R.L. de C.V.
PRESIDENTE MASARYK 111, Of 152 - Of 111
COL. POLANCO V SECCIÓN
DELEGACIÓN MIGUEL HIDALGO,
CIUDAD DE MÉXICO D.F. 11560

Warranty Service Provider
VIZIO Sales & Marketing México S de RL de CV
Presidente Masaryk 111, Of 152 - Of 111
Col. Polanco V Sección
Delegación Miguel Hidalgo
Ciudad de México, México
C.P. 11560
01-800-801-0096 or 001-855-472-7444

Date of purchase:
Model:
Brand:

To make a warranty claim, present your product and either this warranty, duly stamped by the establishment from whom you purchased the VIZIO product, or a valid invoice or receipt showing the date of purchase.

Under the terms of this warranty, VIZIO or its representative must exchange parts and components of the product and include labor and shipping expenses of the product on which this warranty is valid, within the service network, at no cost to the consumer.

VIZIO is not obligated to honor the warranty in the following cases.

(a) When the product has been used under other than normal conditions.

(b) When the product has not been operated according to the accompanying instructions for use.

(c) When the product has been altered or repaired by persons not authorized by VIZIO or the respective seller.

Software Licenses

All software is provided subject to a software license agreement(s) and you agree that you will be bound by such license agreement(s) in addition to these terms. Your use of this product is subject to VIZIO's privacy policy, which may be updated from time to time, and is available to view at <http://www.vizio.com/privacy>.

Export Regulations

Customer acknowledges that the VIZIO products, which include technology and software, are subject to customs and export control laws in the United States ("US"). The products may also be subject to the customs and export control laws and regulations of the country in which the products are manufactured and/or received.

Internet Connectivity

Network conditions, environmental and other factors may negatively affect connectivity and the resulting video quality, if any.

The applications and content of the applications pictured herein or described in accompanying documentation may only be available in certain countries or languages, may require additional fees or subscription charges, and may be subject to future updates, modifications or discontinuation without notice. VIZIO has no control over third party applications or content and assumes no responsibility for the availability or interruption of such applications or content. Additional third party terms, conditions and restrictions apply. A Google account is required to download applications from the Google Play store. A MyVIZIO account is required to access certain features of the VIZIO SmartCast™ App.

Information in this User Manual is subject to change without notice. To review the most updated version of this User Manual and the associated Quick Start Guide, go to <http://www.vizio.com>.

© 2017 VIZIO, Inc. All Right Reserved.

This User Manual may not be copied in whole or in part without the written permission of VIZIO, Inc. VIZIO, Inc. has made reasonable efforts to ensure the accuracy of the information provided herein. All product specifications, functionality, features, configurations, performance, design and other product information described herein are subject to change without notice. VIZIO, Inc. is not responsible for typographical, technical, or descriptive errors.

VIZIO, the VIZIO logo, the V logo, and other terms and phrases are trademarks or registered trademarks of VIZIO, Inc.

HDMI, HDMI High-Definition Multimedia Interface, and the HDMI Logo are trademarks or registered trademarks of HDMI Licensing LLC.

The Bluetooth® word mark and logos are registered trademarks owned by Bluetooth SIG, Inc. Used under license.

For DTS patents, see <http://patents.dts.com>. Manufactured under license from DTS Licensing Limited. DTS, the Symbol, & DTS and the Symbol together are registered trademarks, and DTS Studio Sound is a trademark of DTS, Inc. © DTS, Inc. All Rights Reserved.

Dolby and the double-D symbol are registered trademarks of Dolby Laboratories.

© 2017 Google Inc. All rights reserved. Google Cast is a trademark of Google Inc.

Other names of companies, products, and services used in this User Manual may be trademarks, trade names or service marks of others and VIZIO, Inc. disclaims any interest in trademarks, trade names or service marks other than its own. Mention of non-VIZIO products is for informational purposes only.



Caution: Avoid exposing a drive to magnetic fields. Security devices with magnetic fields may include airport walk-through devices and security wands. Airport conveyor belts or similar security devices that check carry-on luggage generally use X-rays and should not cause magnetic damage to drives.

If you are traveling internationally, check the customs regulations for device use for each country you will visit, and check the power cord and adapter requirements for each location in which you plan to use the display as voltage, frequency and plug configurations may vary.



Warning: To reduce risk of electric shock, fire or damage to your device or other property, do not attempt to power the device with a voltage converter kit sold for appliances.

Battery Disposal



Caution: Battery cells may explode. Do not dispose of the battery in a fire or with ordinary household waste. Dispose of batteries promptly. Replace the battery only with the same or equivalent type of battery recommended by VIZIO.

Always properly dispose of your VIZIO electronic products. For information on how to properly dispose of or recycle your VIZIO products please go to www.vizio.com/environment.



© 2017 VIZIO INC. ALL RIGHTS RESERVED.
170407AD-US