



Dear VIZIO Customer,

Congratulations on your new VIZIO VL260M television purchase. Thank you for your support. For maximum benefit of your HDTV, please read these instructions before making any adjustments, and retain them for future reference. We hope you will experience many years of enjoyment from your new VIZIO HDTV High Definition Television.

For assistance, please call (877) 668-8462 or e-mail us at www.vizio.com.

To purchase or inquire about accessories and installation services for your VIZIO HDTV, please visit our website at www.vizio.com or call toll free at (888) 849-4623.

We recommend you register your VIZIO HDTV either at our website www.VIZIO.com or fill out and mail your registration card. For peace of mind and to protect your investment beyond the standard warranty, VIZIO offers on-site extended warranty service plans. These plans give additional coverage during the standard warranty period. Visit our website or call us to purchase a plan.

Write down the serial number located on the back of your HDTV.

-----

Purchase Date \_\_\_\_\_



VIZIO is a registered trademark of VIZIO, Inc. dba V, Inc.  
HDMI logo and "High Definition Multimedia Interface" are registered trademarks of HDMI Licensing LLC.  
Manufactured under license from Dolby Laboratories.  
Dolby and the double-D symbol are trademarks of Dolby Laboratories.



TruSurround HD is a trademark of SRS Labs, Inc.  
TruSurround HD technology is incorporated under license from SRS Labs, Inc.

THE TRADEMARKS SHOWN HEREIN ARE THE PROPERTY OF THEIR RESPECTIVE OWNERS; IMAGES USED ARE FOR ILLUSTRATION PURPOSES ONLY. BRAVO, VIZIO AND THE V LOGO AND WHERE VISION MEETS VALUE AND OTHER VIZIO TRADEMARKS ARE THE INTELLECTUAL PROPERTY OF VIZIO INC. PRODUCT SPECIFICATIONS ARE SUBJECT TO CHANGE WITHOUT NOTICE OR OBLIGATION. © 2009 VIZIO INC. ALL RIGHTS RESERVED.



## Important Safety Instructions

Your HDTV is designed and manufactured to operate within defined design limits, and misuse may result in electric shock or fire. To prevent your HDTV from being damaged, the following rules should be observed for the installation, use, and maintenance of your HDTV. Read the following safety instructions before operating your HDTV. Keep these instructions in a safe place for future reference.

- To reduce the risk of electric shock or component damage, switch off the power before connecting other components to your HDTV.
- Unplug the power cord before cleaning your HDTV. A damp cloth is sufficient for cleaning your HDTV. Do not use a liquid or a spray cleaner for cleaning your HDTV. Do not use abrasive cleaners.
- Always use the accessories recommended by the manufacturer to insure compatibility.
- When moving your HDTV from an area of low temperature to an area of high temperature, condensation may form in the housing. Wait before turning on your HDTV to avoid causing fire, electric shock, or component damage.
- Use only with the cart, stand, tripod, bracket, or table specified by manufacturer or sold with your HDTV. When a cart is used, use caution when moving the cart/HDTV combination to avoid injury from tip-over. Do not place your HDTV on an unstable cart, stand, or table. If your HDTV falls, it can injure a person and cause serious damage to your HDTV. Use only a cart or stand recommended by the manufacturer or sold with your HDTV.
- A distance of at least 3 feet should be maintained between your HDTV and any heat source, such as a radiator, heater, oven, amplifier etc. Do not install your HDTV close to smoke. Operating your HDTV close to smoke or moisture may cause fire or electric shock.
- Slots and openings in the back and bottom of the cabinet are provided for ventilation. To ensure reliable operation of your HDTV and to protect it from overheating, be sure these openings are not blocked or covered. Do not place your HDTV in a bookcase or cabinet unless proper ventilation is provided.
- Never push any object into the slots and openings on your HDTV cabinet. Do not place any objects on the top of your HDTV. Doing so could short circuit parts causing a fire or electric shock. Never spill liquids on your HDTV.
- Your HDTV should be operated only from the type of power source indicated on the label. If you are not sure of the type of power supplied to your home, consult your dealer or local power company.
- Do not apply pressure or throw objects at your HDTV. This may compromise the integrity of the display. The manufacturer's warranty does not cover user abuse or improper installations.
- The power cord must be replaced when using different voltage than the voltage specified. For more information, contact your dealer.
- Your HDTV is equipped with a **three-pronged grounded plug (a plug with a third grounding pin)**. This plug will fit only into a grounded power outlet. This is a safety feature. If your outlet does not accommodate the three-pronged, have an electrician install the correct outlet, or use an adapter to ground your HDTV safely. **Do not defeat the safety purpose of the grounded plug.**
- When connected to a power outlet, power is always flowing into your HDTV. To totally disconnect power, unplug the power cord.



- The lightning flash with arrowhead symbol within an equilateral triangle is intended to alert the user to the presence of un-isolated, dangerous voltage within the inside of your HDTV that may be of sufficient magnitude to constitute a risk of electric shock to persons.



- The exclamation point within an equilateral triangle is intended to alert the user to the presence of important operating and servicing instructions in the literature



accompanying your HDTV.

- Do not overload power strips and extension cords. Overloading can result in fire or electric shock.
- The wall socket should be installed near your HDTV and easily accessible.
- Only power of the marked voltage can be used for your HDTV. Any other voltage than the specified voltage may cause fire or electric shock
- Do not touch the power cord during lightning. To avoid electric shock, avoid handling the power cord during electrical storms.
- Unplug your HDTV during a lightning storm or when it will not be used for long period of time. This will protect your HDTV from damage due to power surges.
- Do not attempt to repair or service your HDTV yourself. Opening or removing the back cover may expose you to high voltages, electric shock, and other hazards. If repair is required, contact your dealer and refer all servicing to qualified service personnel.
- Keep your HDTV away from moisture. Do not expose your HDTV to rain or moisture. If water penetrates into your HDTV, unplug the power cord and contact your dealer. Continuous use in this case may result in fire or electric shock.
- Do not use your HDTV if any abnormality occurs. If any smoke or odor becomes apparent, unplug the power cord and contact your dealer immediately. Do not try to repair your HDTV yourself.
- Avoid using dropped or damaged appliances. If your HDTV is dropped and the housing is damaged, the internal components may function abnormally. Unplug the power cord immediately and contact your dealer for repair. Continued use of your HDTV may cause fire or electric shock.
- Do not install your HDTV in an area with heavy dust or high humidity. Operating your HDTV in environments with heavy dust or high humidity may cause fire or electric shock.
- Follow instructions for moving your HDTV. Ensure that the power cord and any other cables are unplugged before moving your HDTV.
- When unplugging your HDTV, hold the power plug, not the cord. Pulling on the power cord may damage the wires inside the cord and cause fire or electric shock. When your HDTV will not be used for an extended period of time, unplug the power cord.
- To reduce risk of electric shock, do not touch the connector with wet hands.
- Insert batteries in accordance with instructions. Incorrect polarities may cause the batteries to leak which can damage the remote control or injure the operator.
- If any of the following occurs, contact the dealer:
  - The power cord fails or frays.
  - Liquid sprays or any object drops into your HDTV.
  - Your HDTV is exposed to rain or other moisture.
  - Your HDTV is dropped or damaged in any way.
  - The performance of your HDTV changes substantially.



## Television Antenna Connection Protection

### External Television Antenna Grounding

If an outside antenna/satellite dish or cable system is to be connected to the TV, make sure that the antenna or cable system is electrically grounded to provide some protection against voltage surges and static charges.

Article 810 of the National Electrical Code, ANSI/NFPA 70, provides information with regard to proper grounding of the mast and supporting structure, grounding of the lead-in wire to an antenna discharge unit, size of the grounding conductors, location of antenna discharge unit, connection to grounding electrodes, and requirements of the grounding electrode.

#### Lightning Protection

For added protection of the TV during a lightning storm or when it is left unattended or unused for long periods of time, unplug the TV from the wall outlet and disconnect the antenna or cable system.

#### Power Lines

Do not locate the antenna near overhead light or power circuits, or where it could fall into such power lines or circuits.

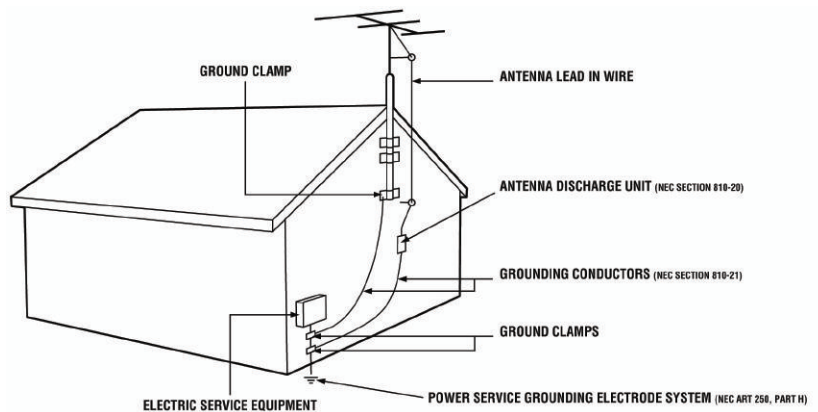

**Remember, the screen of the coaxial cable is intended to be connected to earth in the building installation.**



## Advisory of the DTV Transition

The nationwide switch to digital television broadcasting will be complete on June 12, 2009, but your local television stations may switch sooner. After the switch, analog-only television sets that receive TV programming through an antenna will need a converter box to continue to receive over-the-air TV. Watch your local stations to find out when they will turn off their analog signal and switch to digital-only broadcasting. Analog-only TVs should continue to work as before to receive low power, Class A or translator television stations and with cable and satellite TV services, gaming consoles, VCRs, DVD players, and similar products.

For additional information, please contact the parties listed below, as appropriate:

FCC (US Federal Communications Commission)

<http://www.fcc.gov/>

Phone: 1-888-CALL-FCC (1-888-225-5322)

TTY: 1-888-TELL-FCC (1-888-835-5322)

Fax: 1-866-418-0232

E-mail: [fccinfo@fcc.gov](mailto:fccinfo@fcc.gov)

NTIA (National Telecommunications and Information Administration)

<http://www.ntia.doc.gov/>

1-888-DTV-2009

Listings of US Television Stations

<http://www.high-techproductions.com/usTVstations.htm>

**Note:** Your VIZIO HDTV is capable of receiving Digital Broadcasts, and no Digital Converter Box is required.

**Note:** The Federal Communications Commission (FCC), the Consumer Electronics Association (CEA) and the Consumer Electronics Retailers Coalition (CERC) have made a new tip sheet available for digital television (DTV) retailers to reproduce and distribute to consumers on the sales floor. The file may be downloaded online at [www.dtv.gov](http://www.dtv.gov). While you're there, check out the other useful information in the FCC is making available to consumers interested in learning more about the analog to digital transition.



## Table of Contents

Important Safety Instructions.....	2
Television Antenna Connection Protection .....	4
Advisory of the DTV Transition.....	5
Opening the Package .....	8
TV Setup and Stand Assembly .....	9
Setting Up Your HDTV .....	10
Wall Mounting your HDTV.....	10
<b>CHAPTER 1 BASIC CONTROLS AND CONNECTIONS .....</b>	<b>11</b>
Front Panel.....	11
Side Panel Controls.....	11
Rear Panel Connections.....	12
VIZIO Remote Control.....	13
Insertion of Batteries in the Remote Control .....	14
Remote Control Range .....	14
VIZIO Remote Control Precautions .....	14
<b>CHAPTER 2 CONNECTING EQUIPMENT .....</b>	<b>15</b>
Which Video Connection Should I Use? .....	15
Connecting Your Cable or Satellite Box .....	16
Using HDMI (Best).....	16
HDMI Connections for Cable or Satellite Boxes with DVI .....	17
Using Component Video (Better).....	17
Using S-Video (Better).....	18
Using Composite Video (Good).....	18
Using Coaxial (Antenna) (Good).....	18
Connecting Coaxial (RF).....	19
Using Your Antenna or Digital Cable for Standard TV or Digital TV) .....	19
Using the Antenna or Cable through Your VCR.....	19
Connecting Your DVD Player.....	20
Using HDMI (Best).....	20
HDMI Connections for DVD Players with DVI .....	20
Using Component Video (Better).....	21
Using S-Video (Better).....	21
Using Composite (AV) Video (Good).....	22
Connecting Your VCR or Video Camera.....	22
Optical Output of audio received with HD Programs.....	23
Connecting a Computer.....	23
Preset PC Resolutions.....	24
Resolution through RGB Input.....	24
<b>CHAPTER 3 USING YOUR HDTV THE FIRST TIME.....</b>	<b>25</b>
Setup Wizard.....	25
Select Input Source .....	27
Fine Tuning the picture.....	27
Setting the Time Zone .....	27
Watching a TV Program.....	27
Adjusting Basic HDTV Settings.....	27
Program Information.....	27
<b>CHAPTER 4 ADVANCED ADJUSTMENT OF HDTV .....</b>	<b>27</b>
Using the On Screen Display (OSD).....	27
Picture Menu .....	27
Picture Mode.....	27



Backlight ..... 27

Brightness ..... 27

Contrast ..... 27

Color..... 27

Tint ..... 27

Sharpness ..... 27

Advanced Video ..... 27

Reset Picture Mode ..... 27

Audio Menu ..... 27

    Equalizer ..... 27

    Balance ..... 27

    SRS TSHD ..... 27

    Digital Audio Out ..... 27

    Speakers ..... 27

    Lip Sync ..... 27

    Reset Audio Mode ..... 27

TV Menu ..... 27

    Tuner Mode ..... 27

    Auto Search ..... 27

    Partial Channel Search ..... 27

    Skip Channel ..... 27

    MTS ..... 27

    Time Zone ..... 27

    Daylight Saving ..... 27

    Channel Info ..... 27

Setup Menu ..... 27

    Language ..... 27

    Sleep Timer ..... 27

    Wide ..... 27

    Input Naming ..... 27

    CC (Closed Caption) ..... 27

    H/V Position ..... 27

    Parental ..... 27

    System Info ..... 27

    System Reset ..... 27

**CHAPTER 5 UNDERSTANDING VIEWING FEATURES ..... 27**

    Viewing Modes ..... 27

**CHAPTER 6 MAINTENANCE AND TROUBLESHOOTING ..... 27**

    Maintenance ..... 27

    Troubleshooting Guide ..... 27

    Telephone & Technical Support ..... 27

    Compliance ..... 27

    FCC Class B Radio Interference Statement ..... 27

**SPECIFICATIONS ..... 27**

**LIMITED PRODUCT WARRANTY ..... 27**

**VIZIO RETURN POLICY ..... 27**

**INDEX ..... 27**



## Opening the Package

Your HDTV and its accompanying accessories are carefully packed in a cardboard carton that has been designed to protect it from transportation damage. Once you have opened the carton, check that your HDTV is in good condition and that all of the contents are included.

The glass surface can easily be scratched or broken, so handle your HDTV gently and never place your HDTV with the glass facing downwards on a surface without protective padding.

**IMPORTANT:** Save the carton and packing material for future shipping.

## Package Contents

- VIZIO VL260M
- Stand and thumb screw
- VIZIO remote control VR2
- AA batteries for the remote control (2)
- Power cord
- Quick Setup Guide
- Registration Card



## Additional certified accessories for your HDTV are sold separately:

- Wall mounts
- High Definition cables
- Extra or replacement remote control

VIZIO also offers installation services and extended warranty services for your HDTV.

To purchase or inquire about additional accessories and services for your VIZIO HDTV, visit our web site at [www.VIZIO.com](http://www.VIZIO.com) or call us toll free at 888-VIZIOCE (888-849-4623)

**Caution:** Do not apply pressure or throw objects at your HDTV. This may compromise the integrity of the display. The manufacturer's warranty does not cover user abuse or improper installations.





## TV Setup and Stand Assembly

**Note:** We strongly recommend that two people perform the setup and assembly due to the weight and size of the TV.

### To unpack the TV and stand base:

1. Remove the remote control, batteries, and power cord from the foam end caps.
2. Remove the top foam end cap.
3. Remove the stand from the bottom foam end cap.
4. Remove the TV from the box and lay it face down on a clean, flat surface.

**Note:** Make sure that the surface is free of debris to prevent the TV screen from getting scratched.

### To attach the TV stand base:

1. Slide the stand base onto the stand neck (already connected to TV).
2. On the bottom of the base, insert the thumb screw and tighten. Move the TV into an upright position.

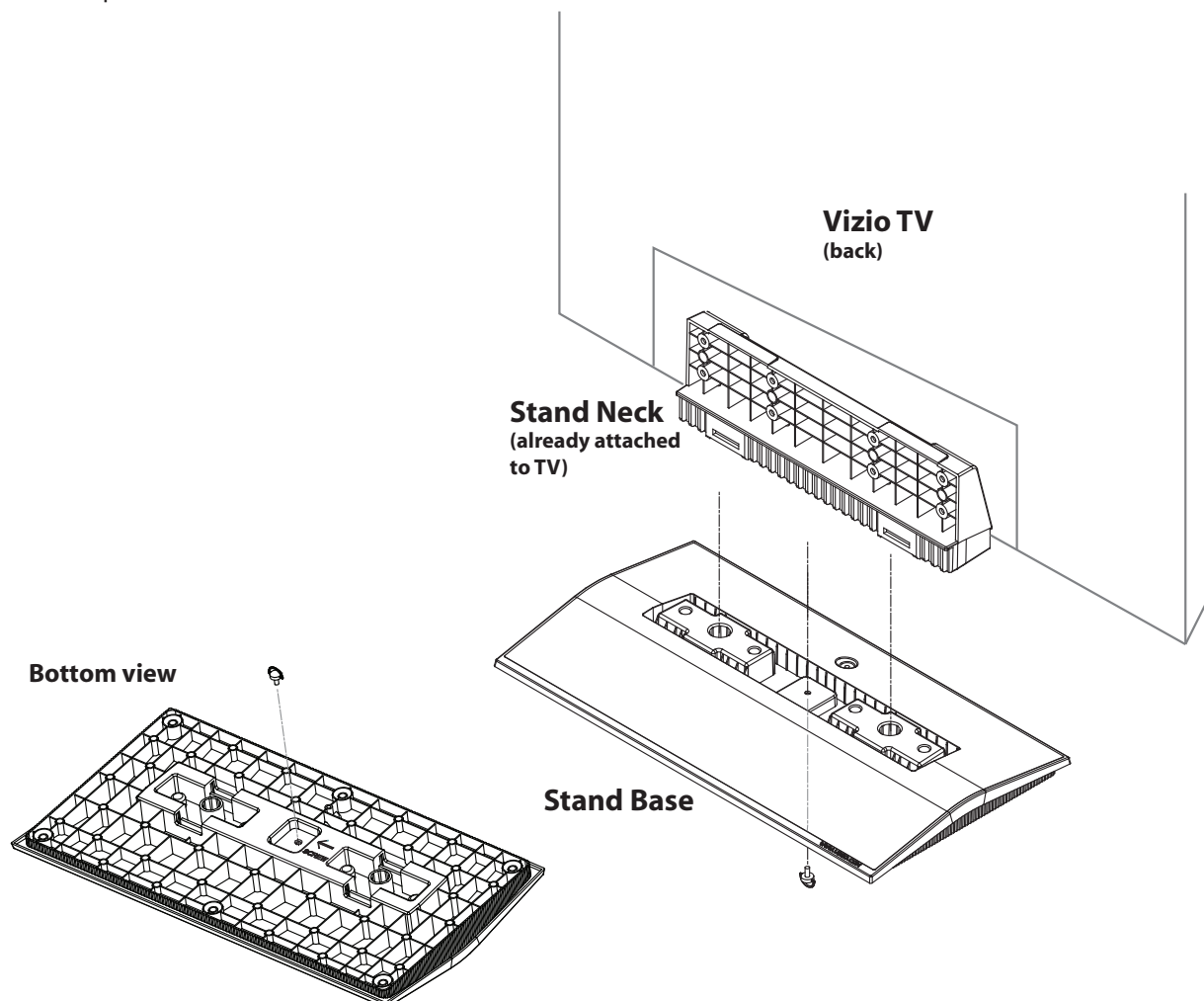

## Setting Up Your HDTV

- Read this user manual carefully before installing your HDTV.
- The power consumption of your HDTV is about 73W (AVG). Use the included power cord. When an extension cord is required, use one with the correct power rating. The cord must be grounded and the grounding feature must not be compromised.
- Your HDTV should be installed on a flat surface to avoid tipping.
- For proper ventilation, you must allow space between the back of your HDTV and the wall.
- If you want to mount your HDTV on the wall, see below for additional information.
- Avoid installing your HDTV in places with high humidity, dust, or smoke so you do not shorten the service life of the electronic components.
- Install your HDTV in a level, landscape orientation, with the VIZIO logo at the bottom to prevent poor ventilation and excessive component damage.

VIZIO offers professional installation services. Contact VIZIO for more information on these services at 888-VIZIOCE (888-849-4623) or [www.VIZIO.com](http://www.VIZIO.com).

## Wall Mounting your HDTV

Your HDTV can be mounted on the wall for viewing. If you choose to mount your HDTV on the wall, follow the instructions below.

1. Remove the stand base and neck:
  - a. Disconnect the cables from your HDTV.
  - b. Place your HDTV face down on a soft, flat surface to prevent damage to the screen.
  - c. Remove the six (6) screws holding the stand neck, and then remove the neck and base.

**Note:** To remove the base from the neck, unscrew thumbscrew on bottom.

2. Mount your HDTV on the wall:
  - a. Attach your HDTV to a wall mount (sold separately) using the mounting holes in the back panel of your HDTV.
  - b. Read the instructions that came with your specific wall mount to properly hang your HDTV.



## Chapter 1 Basic Controls and Connections

### Front Panel

**POWER 'VIZIO' LIGHT**– The VIZIO name lights white when powered on and orange when powered off.

**REMOTE CONTROL SENSOR** – Point the remote control directly at this window for the best response to the remote signal.



### Side Panel Controls



**HEADPHONE** – Connect your headphones here for personalized listening without disturbing others.

**POWER ( )** – Switch the HDTV on by pressing the button once. Press the button again to turn the HDTV off.

**MENU** – This button activates the On Screen Display (OSD). If a sub-menu is active, pressing this button will proceed to the next level.

**CH ▲/▼** – Use these buttons to step up or down the TV channels. While the OSD is active, these buttons function as up and down controls in the OSD menus.

**VOL + / -** – Use these buttons to increase or decrease the speaker volume. While the OSD is active, these buttons function as left and right controls in the OSD menus.

**INPUT (ENTER) –**

- Repeated pressing of this button steps through the input sources in the following sequence: TV, AV, Component, RGB, HDMI1 and HDMI2. Once you have stepped through the entire

sequence, you will return to the beginning.

- If a sub-menu is active, pressing this button will return to the previous menu level.
- Additionally, when the OSD is active, this button confirms the menu function to be adjusted.

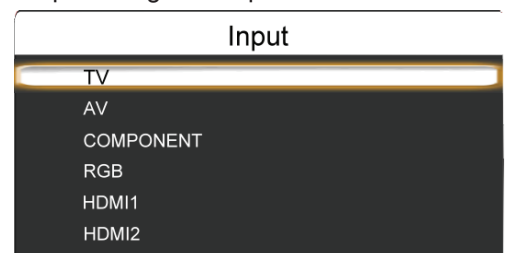

## Rear Panel Connections

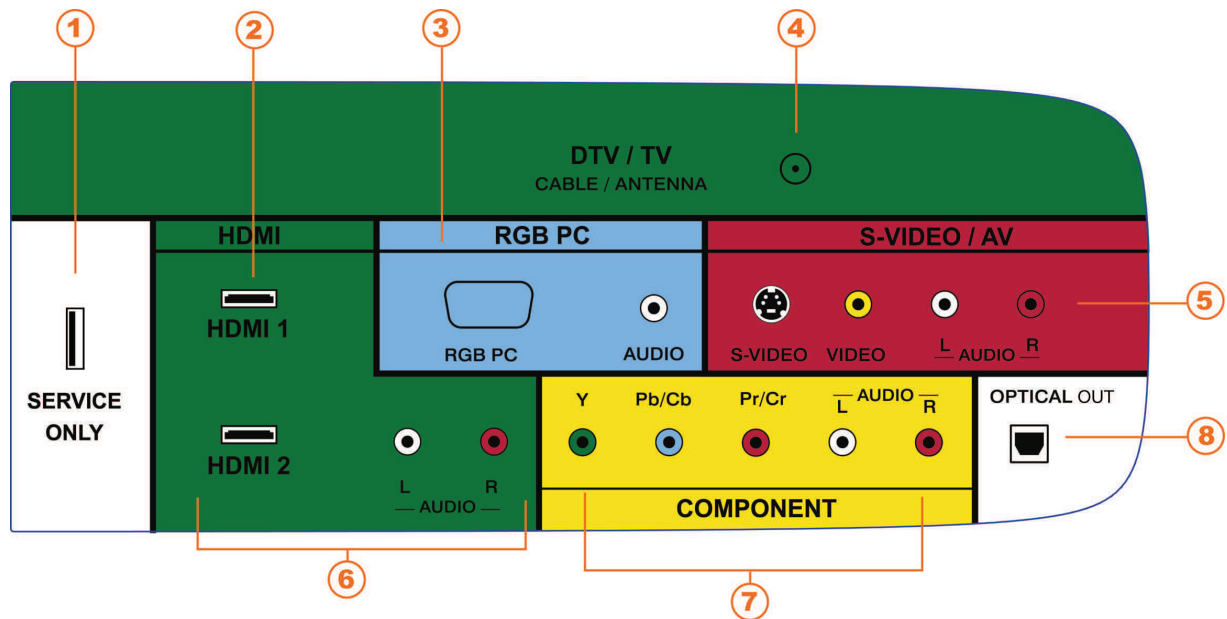

1. **SERVICE ONLY** – Do not use. For service technician use only.
2. **HDMI 1** – Connect digital video devices such as DVD multimedia players or set top box through this all digital connector.
3. **RGB PC** – Connect the video and audio from a computer here. A cable with a 1/8" mini plug stereo connector at the end connecting to the TV is needed if sound is also transmitted with this signal.
4. **DTV/TV** – Connect to an antenna or digital cable (not a cable box) for Digital TV. For digital TV stations in your area visit [www.antennaweb.org](http://www.antennaweb.org).
5. **S-VIDEO/AV** – Connect composite or S-Video video devices, such as a VCR or video game. Use the white and red connectors to connect the external audio from the same source.
6. **HDMI 2** - Connect another digital video device such as a DVD multimedia player or set top box through this all digital connector. For users who want to connect to a DVI enabled device, use a DVI-HDMI cable and connect the analog audio output of the device to the L+R AUDIO here. Your VIZIO Certified HDMI and HDMI-DVI cables are available for purchase from [www.VIZIO.com](http://www.VIZIO.com) or by calling 888-VIZIOCE (888-849-4623).
7. **COMPONENT (YPb/CbPr/Cr with Audio L/R)** – Connect component video devices such as a DVD Player or set top box here.
8. **OPTICAL OUT** – When digital TV is selected for viewing, the audio associated with the programming will be available on the SPDIF Optical connector for connection to your home theater system.



## VIZIO Remote Control

**GUIDE** – This button displays program information.

**POWER** (  ) – Press this button to turn the TV on from the Standby mode. Press it again to return to the Standby mode.

**TV** – Press this button to select TV.

**AV** – Press this button to select the AV (either Composite or S-Video) input.

**COMP** – Press the button to select the Component input.

**HDMI** – Press this button to select the HDMI input. By pressing it repeatedly you will go through all HDMI inputs in sequence.

**MENU** – Use this button for the On-Screen Display (OSD) menu. Press the button to select a feature after it has been highlighted.

**▲▼◀▶** -These buttons are used to navigate the OSD menu. They are used as value settings when the slide bar is shown on the screen and option settings to turn a feature off or on.

**MUTE** – This button turns the sound on and off.

**LAST** – This button recalls the previously viewed channel. If the On-Screen Display (OSD) menu is being used, this button will allow you to get back to previous menu screen or out to your program when you press it repeatedly.

**VOL ▲/▼** – This button turns the volume up or down.

**CH ▲/▼** – This button turns the channels up or down.

**NUMBER BUTTON PAD** – Use these buttons to select a channel or enter a password.

**INPUT** –Repeatedly pressing this button will step you through the input sources in the following sequence: TV, AV, Component, RGB, HDMI1, and HDMI2. The sequence will then be repeated.

- (**DASH**) – When selecting a digital channel directly, use this button for the separation of main and sub-channels. For example, channel 28-2 would be selected by the button sequence 2 8 DASH 2.



## Insertion of Batteries in the Remote Control

Insert two AA batteries into the remote control. Make sure that you match the (+) and (-) symbols on the batteries with the (+) and (-) symbols inside the battery compartment. Re-attach the battery cover.

### Precautionary Tips for Inserting the Batteries:

- Only use the specified AA batteries.
- Do not mix new and old batteries. This may result in cracking or leakage that may pose a fire risk or lead to personal injury.
- Inserting the batteries incorrectly may also result in cracking or leakage that may pose a fire risk or lead to personal injury.
- Dispose of the batteries in accordance with local laws and regulations.
- Keep the batteries away from children and pets.



### Remote Control Range

Point the remote control at the remote control sensor to transmit the commands.

Do not place any obstacles between the remote control and the receiver window.

The effective range of the remote control is approximately 30 feet (10 meters) from the front of the receiver window, 30° to the left and right, 20° up and down.

### VIZIO Remote Control Precautions

The remote control should be kept dry and away from heat sources. Avoid humidity.

If the TV responds erratically to the remote control or does not respond at all, check the batteries. If the batteries are low or exhausted, replace them with fresh batteries.

When not using the remote control for a long period of time, remove the batteries.

Do not take the batteries apart, heat them, or throw them into a fire.

Do not subject the remote control to undue physical stress, such as striking or dropping it.

Do not attempt to clean the remote control with a volatile solvent. Wipe it with a clean, damp cloth.











## Chapter 2 Connecting Equipment

### Which Video Connection Should I Use?

The VIZIO HDTV has six different ways to connect your video equipment from a basic connection to the most advanced for digital displays.

Connection Quality (type)	Connector	Description
Best (digital)		HDMI provides an interface between any audio/video source, such as a set-top box, DVD player, or A/V receiver and a digital television (DTV), over a single cable.
Best (digital) ----- Good (analog)		Connect a digital or analog antenna cable or coaxial cable to watch TV programming.
Best (analog)		RGB PC (VGA) – This is most commonly used for PC input.
Better (analog)		Component - Component video provides a sharper image than composite video and S-video because the three video signals are transmitted via three separate channels.
Good (analog)	 	<p>S-Video (AV) - Combining the three video signals into two channels, S-Video provides a sharper image than Composite video, but is not as good as Component video.</p> <p>Composite (AV) - All three video signals are combined into one channel, thus making the image less sharp than Component or S-Video.</p>

**Note:** For more info refer to the Quick Start Guide



## Connecting Your Cable or Satellite Box

You have four options for connecting your cable or satellite box to your HDTV: HDMI, Component, Composite, or Coax (RF). Based on your home theater configuration, you can decide which option is the right one for you. Refer to your set-top box user manual for more information about the video output requirements or consult your cable or satellite operator.

### Using HDMI (Best)

Cable and Satellite Boxes that have an HDMI digital interface should be connected to the HDMI input of the HDTV for optimal results.

**Note:** To maintain the display quality, use a VIZIO certified HDMI cable. This cable is available in 6, 15, and 30 foot lengths. See [www.vizio.com](http://www.vizio.com) or call 1-888-VIZIOCE (1-888-849-4623) for details.

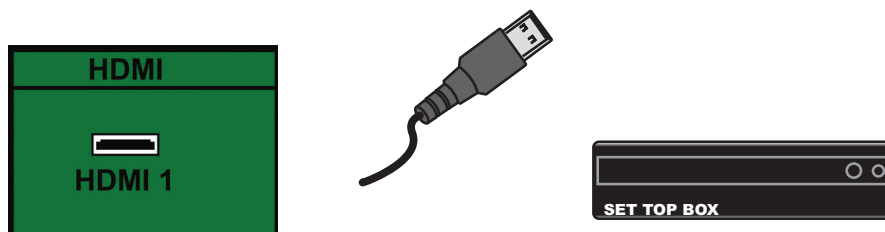

1. Turn off the power to the HDTV and HDTV Set-Top Box.
2. Connect an HDMI cable to the HDMI output of your HDTV Set-Top Box and the other end to an **HDMI** input on the back of the HDTV.
3. Turn on the power to the HDTV and HDTV Set-Top Box.
4. Select **HDMI 1** or **HDMI 2** using the **INPUT** button on the remote control, or directly by pressing the **HDMI** button on the remote control.

**Note:**

- The HDMI input on the HDTV supports High-bandwidth Digital Content Protection (HDCP). HDCP encrypts the transmission between the video source and the digital display for added security and protection.
- If you are already using the HDMI1 input for another device, or you do not want to use the HDMI1 input for the Set-Top Box, you can connect the Set-Top Box to another HDMI connection.
- Refer to your HDTV Set-Top Box user manual for more information about the video output requirements of the product or consult your cable or satellite operator.





## HDMI Connections for Cable or Satellite Boxes with DVI

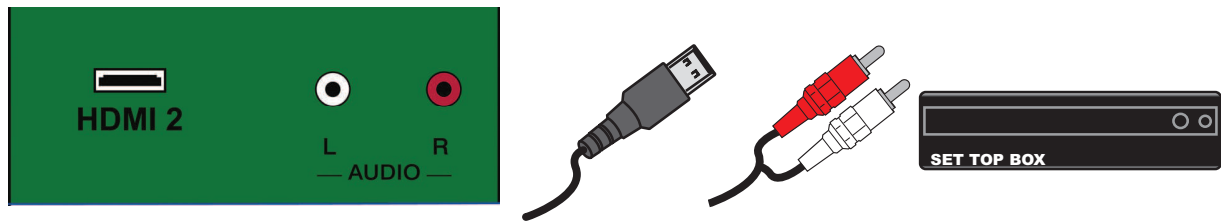

1. Turn off the power to the HDTV and HDTV Set-Top Box.
2. Using a HDMI-DVI cable, connect the DVI end to your HDTV Set-Top Box and the HDMI end to the **HDMI 2** input on the back of the HDTV.
3. Using an audio cable, connect the cable to the audio output connectors associated with the DVI output on your HDTV Set-Top Box and connect the other end to the audio connectors associated with the HDMI input on the back of the HDTV.
4. Turn on the power to the HDTV and HDTV Set-Top Box.
5. Select **HDMI 2** using the **INPUT** button on the remote control, or directly by pressing the **HDMI** button on the remote control.

### Note:

- The HDMI input on the HDTV supports High-bandwidth Digital Content Protection (HDCP). HDCP encrypts the transmission between the video source and the digital display for added security and protection.
- Refer to your HDTV Set-Top Box user manual for more information about the video output requirements of the product or consult your cable or satellite operator.

## Using Component Video (Better)

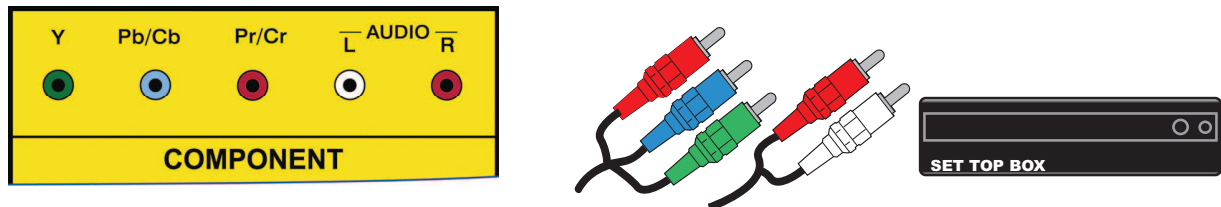

1. Turn off your HDTV and set-top box.
2. Connect the component cables (green, blue, and red) from your set-top box to the **COMPONENT** jacks on the back of your HDTV.
3. Connect the audio cables (white and red) from your set-top box to the adjacent **COMPONENT L** and **R Audio** jacks on the back of your HDTV.
4. Turn on your HDTV and set-top box.
5. Select **COMPONENT** using the **INPUT** button on the remote control, or directly by pressing the **COMP** button on the remote control.



### Using S-Video (Better)

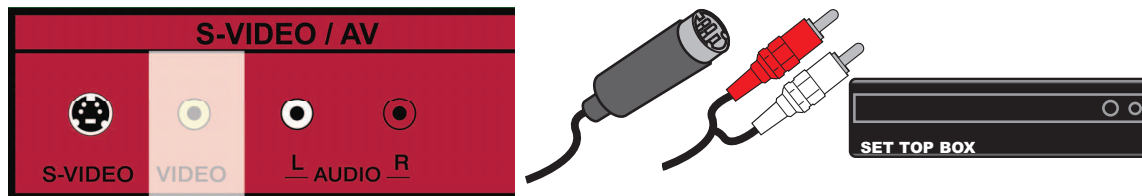

1. Turn off your HDTV and set-top box.
2. Connect the S-VIDEO cable from your set-top box to the **S-VIDEO** jack on the back of your HDTV.
3. Connect the audio cables (white and red) on your set-top box to the corresponding **L** and **R AUDIO** jacks on the back of your HDTV.
4. Turn on your HDTV and set-top box.
5. Press **AV** on the remote control to view the content.

### Using Composite Video (Good)

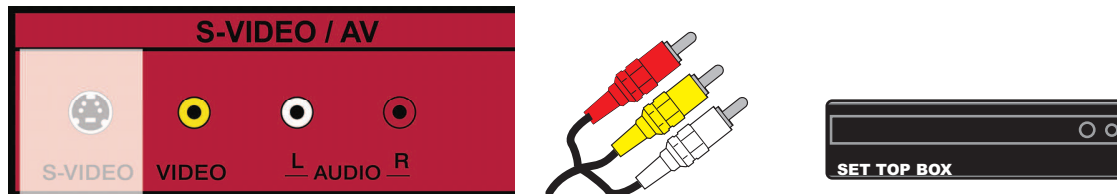

1. Turn off your HDTV and set-top box.
2. Connect the video cable (yellow) from your set-top box to the **AV** jack on the back of your HDTV.
3. Connect the audio cables (white and red) on your set-top box to the corresponding **L** and **R AUDIO** jacks on the back of your HDTV.
4. Turn on your HDTV and set-top box.
5. Select **AV** using the **INPUT** button on the remote control, or directly by pressing the **AV** button on the remote control.

### Using Coaxial (Antenna) (Good)

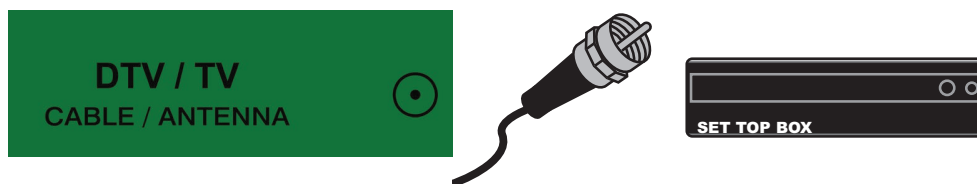

1. Turn off the power to the HDTV.
2. Connect the coaxial (RF) connector from your antenna or digital cable to the **DTV/TV CABLE/ANTENNA** connector on the back of the HDTV.
3. Turn on the power to the HDTV.
4. Select **TV** using the **INPUT** button on the remote control, or directly by pressing the **TV** button on the remote control.



## Connecting Coaxial (RF)

### Using Your Antenna or Digital Cable for Standard TV or Digital TV)

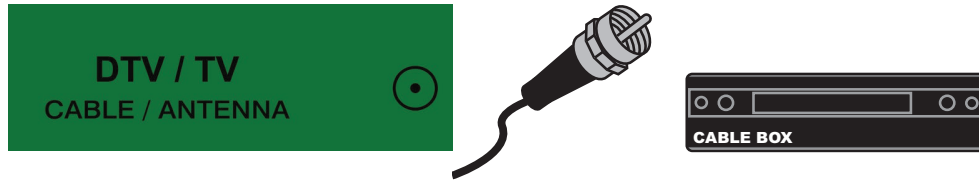

1. Turn off the power to the HDTV.
2. Connect the coaxial (RF) connector from your antenna or cable to the **DTV/TV CABLE/ANTENNA** connector on the back of the HDTV
3. Turn on the power to the HDTV.
4. Select TV using the **INPUT** button on the remote control, or directly by pressing the **TV** button on the remote control.

### Using the Antenna or Cable through Your VCR

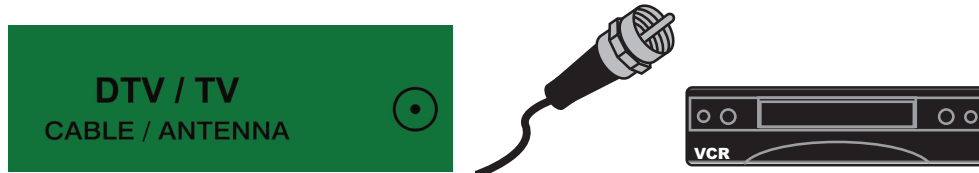

1. Turn off the power to the HDTV and VCR.
2. Connect the "Output to TV", "RF Out" or "Antenna Out" connector on the rear of your VCR to the **DTV/TV CABLE/ANTENNA** connector on the back of the HDTV.
3. Turn on the power to the HDTV and VCR.
4. Select TV using the **INPUT** button on the remote control, or directly by pressing the **TV** button on the remote control.

**Note:** If you have an off-air antenna or cable TV, connect it to the "Antenna In" connector on the rear of your VCR.



## Connecting Your DVD Player

You have several options for connecting your DVD player to your HDTV: HDMI, Component, S-Video and Composite (AV) inputs. Based on your home theater configuration, you can decide which option is the right one for you.

### Using HDMI (Best)

For optimal results, DVD players that have a digital interface such as HDMI should be connected to the HDMI input on your HDTV.



1. Turn off your HDTV and DVD player.
2. Connect a HDMI cable to the HDMI output of your DVD player and the other end to an **HDMI** input on the back of the HDTV.
3. Turn on the power to the HDTV and your DVD player.
4. Select **HDMI 1** or **HDMI 2** using the **INPUT** button on the remote control, or directly by pressing the **HDMI** button on the remote control.

### HDMI Connections for DVD Players with DVI

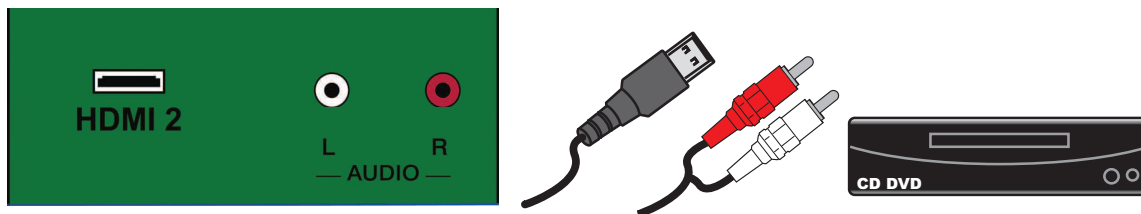

1. Turn off your HDTV and DVD player.
2. Using a HDMI-DVI cable, connect the DVI end to your DVD player and the HDMI end to the **HDMI 2** Input on the back of the HDTV.
3. Connect the audio cables (white and red) from the DVI audio output jacks on the DVD player to the adjacent **HDMI 2 L** and **R AUDIO** jacks on the back of the HDTV.
4. Turn on the power to the HDTV and your DVD player.
5. Select **HDMI 2** using the **INPUT** button on the remote control, or directly by pressing the **HDMI** button on the remote control.

**Note:** To maintain the display quality, use a VIZIO certified HDMI cable. This cable is available in 6, 15, and 30 foot lengths. See [www.vizio.com](http://www.vizio.com) or call 1-888-VIZIOCE (1-888-849-4623) for details.



### Using Component Video (Better)

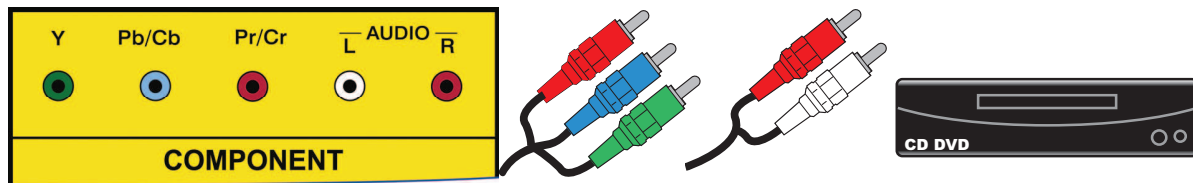

1. Turn off the power to the HDTV and DVD player.
2. Connect the component cable (green, blue, and red) from your DVD player to an available set of **COMPONENT** jacks on the back of the HDTV.
3. Connect the audio cables (white and red) from your DVD player to the **COMPONENT L** and **R AUDIO** jacks on the back of the HDTV.
4. Turn on the power to the HDTV and DVD player.
5. Select **COMPONENT** using the **INPUT** button on the remote control, or directly by pressing the **COMP** button on the remote control.

### Using S-Video (Better)

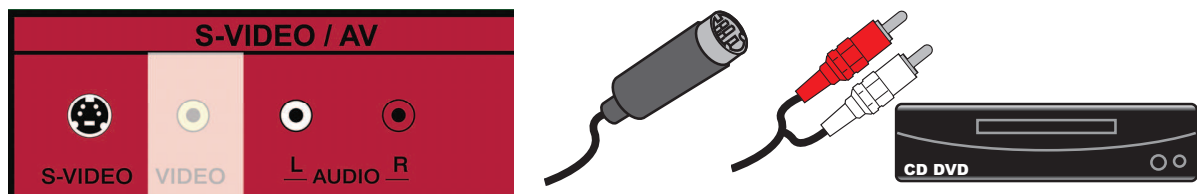

1. Turn off the power to the HDTV and DVD player.
2. Connect the S-VIDEO cable from your DVD player to the **S-VIDEO** jack on the back of the HDTV.
3. Connect the audio cables (white and red) on your DVD player to the corresponding **L** and **R AUDIO** jacks on the back of your HDTV.
4. Turn on the power to the HDTV and DVD player.
5. Select **AV** using the **INPUT** button on the remote control, or directly by pressing the **AV** button on the remote control.



### Using Composite (AV) Video (Good)

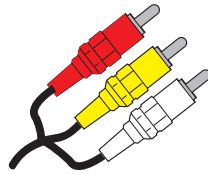
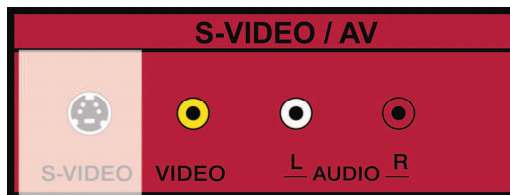

1. Turn off the power to the HDTV and DVD player.
2. Connect the video cable (yellow) from your DVD player to the **S-VIDEO/AV** jack on the back of your HDTV.
3. Connect the audio cables (white and red) on your DVD player to the **S-VIDEO/AV L** and **R AUDIO** jacks on the back of your HDTV.
4. Turn on the power to the HDTV and DVD Player.
5. Select **AV** using the **INPUT** button on the remote control, or directly by pressing the **AV** button on the remote control.

### Connecting Your VCR or Video Camera

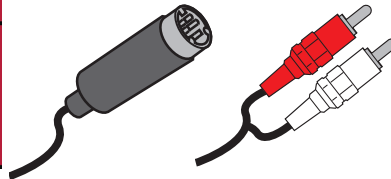
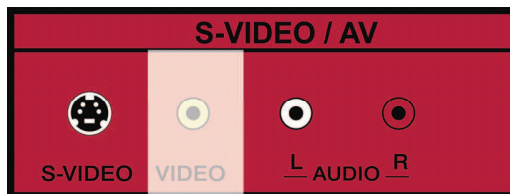

1. Turn off the power to the HDTV and VCR or Video Camera.
2. Connect the S-VIDEO cable from your VCR or video camera to the **S-VIDEO** jack on the back of your HDTV.
3. Connect the audio cables on your set-top box to the corresponding **L** and **R AUDIO** jacks on the back of your HDTV.
4. Turn on the power to the HDTV and VCR or Video Camera.
5. Select **AV** using the **INPUT** button on the remote control, or directly by pressing the **AV** button on the remote control.

**Note:** Refer to your VCR or Video Camera user manual for more information about the video output requirements of the product.



## Optical Output of audio received with HD Programs

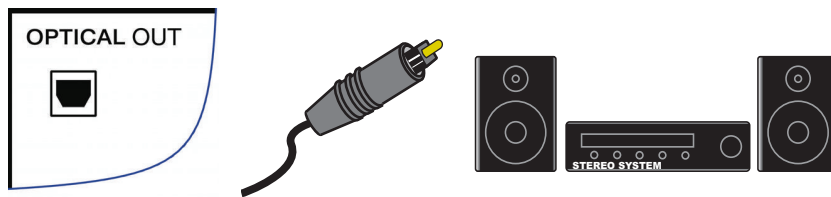

If your sound system has a SPDIF (optical) digital audio input you can connect it from your sound system to the **OPTICAL** digital audio out on the back of the HDTV. This is active when receiving audio with the programs being viewed no matter what input is being used.

## Connecting a Computer

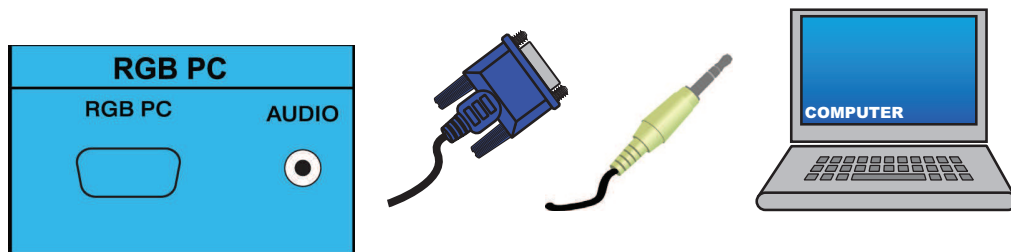

1. Turn off the power to the HDTV and Computer.
2. Connect the VGA cable from your computer to the **RGB PC** jack on the back of the HDTV.
3. Connect the 1/8-inch audio cable from your computer to the RGB PC **AUDIO** jack on the back of the HDTV. This step is optional and only needed if you want to transmit audio from the computer through the TV.
4. Turn on the power to the HDTV and Computer.
5. Select **RGB** using the **INPUT** button on the remote control.

### Note:

- For a better picture quality when connecting a PC computer through RGB PC, set your PC computer timing mode to VESA 1920 x 1080 at 60Hz.
- Refer to your PC computer user manual for more information about the video output requirements of the product.
- A RGB (VGA) cable and stereo mini jack cable are not included and can be purchased at an electronics store.

### Preset PC Resolutions

If connecting to a PC through the RGB PC input, set the TV timing mode to VESA 1920x1080 for better picture quality (refer to the graphic card's user guide for questions on how to set this timing mode). See the table below for the factory preset resolutions. Also see Resolution through RGB Input chart below for the best resolution available through RGB PC input when video card supports 1920x1080.

Mode No.	Resolution	Refresh Rate (Hz)	Horiz. Freq (KHz)	Vert Freq (Hz)	Horiz Sync Polarity (TTL)	Vert Sync Polarity (TTL)	Pixel Rate (MHz)	Remark
1	640 x 480	60	31.469	59.941	N	N	25.175	Windows
2	640 x 480	75	37.500	75.000	N	N	31.500	Windows
3	800 x 600	60	37.879	60.317	P	P	40.000	Windows
4	800 x 600	72	48.077	72.188	P	P	50.000	Windows
5	800 x 600	75	46.875	75.000	P	P	49.500	Windows
6	1024 x 768	60	48.363	60.004	N	N	65.000	Windows
7	1024 x 768	70	56.476	70.069	N	N	75.000	Windows
8	1024 x 768	75	60.023	75.029	P	P	78.750	Windows
9	720 x 400	70	31.469	70.087	N	P	28.322	DOS
10	Ⓢ1920 x 1080	60	66.587	59.934	P	N	138.50	Windows

**Note:** P: positive, N: negative, Ⓢ: Primary mode

### Resolution through RGB Input

If your PC supports VESA Reduce Blanking timing via the VGA card drive program (usually offered by the VGA Card Manufacturer), your TV set is equipped to have the 1920x1080 resolution display through this connection using the following timing: 138.5. The following parameters are often the values required by the software or programs to set up the display:

Parameters	Horizontal Values (Pixels)	Vertical Values (Lines)
Address	1920	1080
Front Porch	48	3
Sync Width	32	5
Back Porch	80	23
Total	2080	1111
Frequency	66.587 KHz	58.934 Hz
Sync Polarity	P	N
Pixel Rate (MHz)	138.5	
Refresh Rate (Hz)	60	





## Chapter 3 Using your HDTV the first time

### Setup Wizard

1. **Connecting the Power Cable**  
Connect the power cord to the power cord connector on the back of the HDTV, and then plug the power cord into an AC wall socket.
2. **Connect Audio and Video Cables to the HDTV**  
(see Chapter 2 for detailed steps)
3. **Turning Power On**  
Once all the components are connected, press the Power ON button on the side of the HDTV, or press the Power ON (Red) button on the remote control.
4. **Initial Setup**
  - a. After powering on the TV set, the *Initial Setup Welcome* screen will come up. Press **MENU** on the remote control.
  - b. The *Language* choice screen will be displayed; the default English option is highlighted. If you wish to change the OSD language to Español or Français, press ▼ on the remote control to select the language you want.
  - c. Press **MENU** on the remote to go to the next screen.
  - d. The next screen will display the options **Home Mode** and **Retail Mode**. Selecting Home Mode will give you an opportunity to save energy.
  - e. Press **MENU** on the remote to go to the next screen.
  - f. If **Retail Mode** is selected by mistake; the next option will allow you to switch your selection back to **Home Mode**.
  - g. Press **MENU** on the remote to go to the next screen.

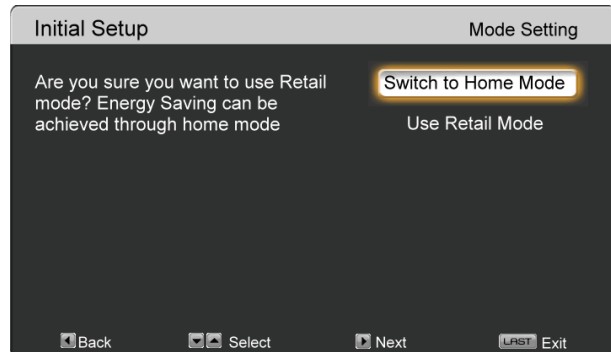
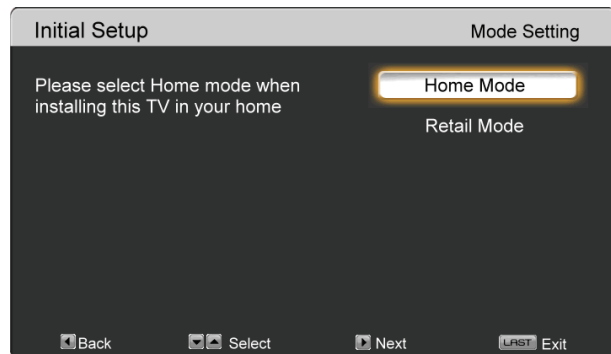
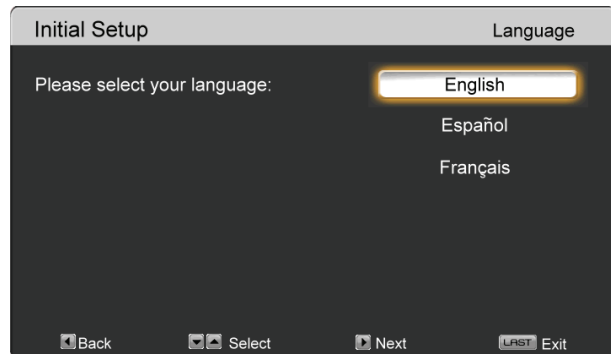
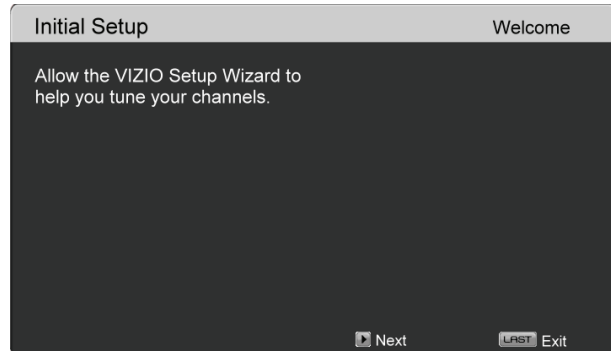

**Note:** At this point, if a set-top box from your cable or satellite service company is being used; please press the **LAST** button on the remote control and skip this section. Otherwise continue with next step:

- h. The *Tuner* screen will be displayed. If you are using Cable Service (with no box), press ▼ on the remote control to choose **CABLE**.
- i. Press **MENU** on the remote to go to the next screen. The *Channel Scan* screen will be displayed; default choice is Scan.
- j. Press **MENU** on the remote control to commence the search for available channels to be stored into memory.
- k. If you do not want to scan for channels at this time, press ▼ on the remote to highlight *Skip Scan* and then press **MENU**. The screen will now change to show the progress of the search for Analog (NTSC) and Digital (ATSC) channels.

**Note:** If you select *Skip Scan*, you can scan channels at a later time by selecting the TV input, then going to the Menu and selecting the Auto Search option in the TV menu.

Note: DTV digital broadcast is not available in all areas. Refer to [www.antennaweb.org](http://www.antennaweb.org) to get information about availability in your area, type of antenna and in which direction to point your antenna. The channel availability through cable depends upon which channels your cable operator supplies in Clear QAM; consult your cable operator for more information.

- i. When finished, the *Complete* screen will be displayed to inform you that the HDTV has completed the Initial Setup. Press ► on the remote control to exit and begin watching TV.

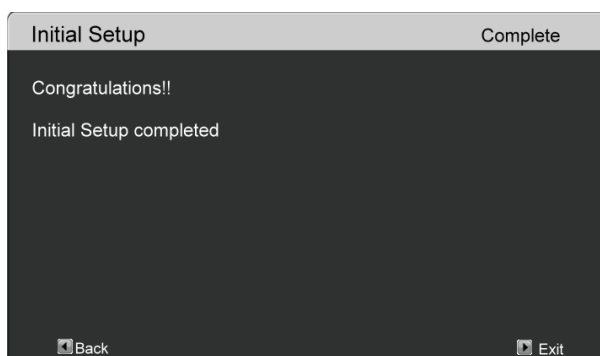
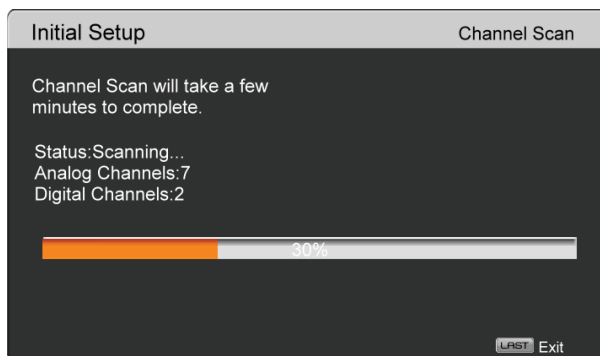
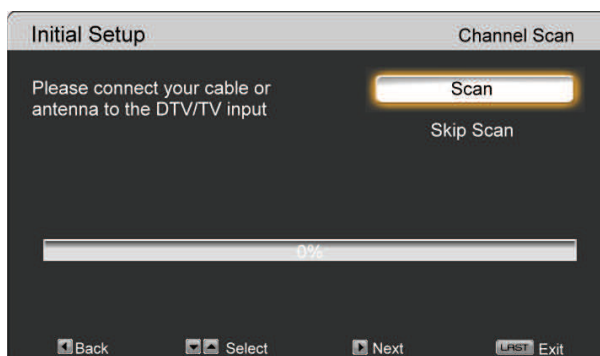
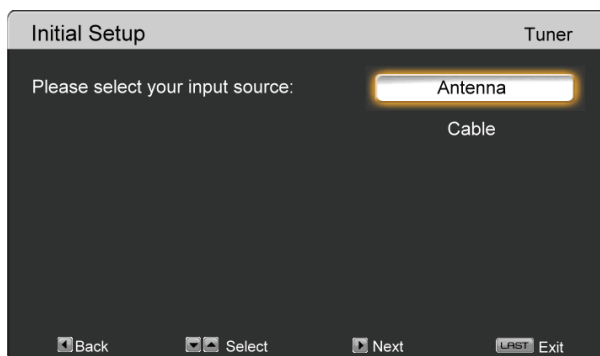

## Select Input Source

Select the Input Source for the HDTV by pressing the **INPUT** button on the remote control. Pressing this button will cycle you through the following options: TV, AV, Component, RGB, HDMI1, and HDMI2.

Turn on your Cable Box, VCR, External TV Tuner or Satellite Receiver and you will see a picture on your HDTV. If there is no picture, make sure you have selected the correct input on the HDTV.

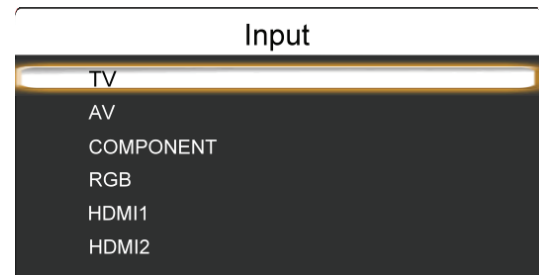

If the selected input is RF, you should be aware that the HDTV needs to be on either channel 3 or channel 4 matching the channel which has been selected on the back of the VCR, Cable Box, External TV Tuner or Satellite Receiver; please refer to Owner or User's Manual of such equipment for details.

**Note:** Your HDTV will display the television station or program selected by the cable box, VCR, external tuner, or satellite receiver. Use the remote control that came with that component to change programs or channels. If the service being used is the one which setup includes a box with two outputs for two different (distant) rooms, then scanning channels will help you to find the signal. Be aware that the channel to be selected varies from provider to provider. You may have to call your provider to get the specific channel when using your HDTV. Some examples of these channels are 105, 106, 115, and 116.



## Fine Tuning the picture

1. Press the **MENU** button to bring up the Menu display. The Picture Menu is highlighted. Press **MENU** to select it. Use the ▲ or ▼ buttons to scroll to the Advanced Video option.
2. Press the ► button to select it.
3. Use either ▲ or ▼ to scroll to the Color Temperature option.
4. Press the ► button to select it.
5. Press either ◀ or ▶ to change setting to **Normal**, and then press the **LAST** button repeatedly to go back to the previous screen.
6. Press either ▲ or ▼ button to select the Picture mode option.
7. Press either ◀ or ▶ button to change the Reset Picture Mode option to Standard.
8. Press the **LAST** key to exit the on screen display menu.

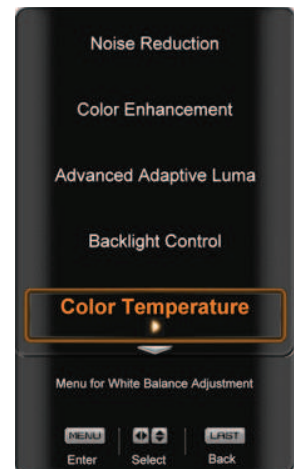
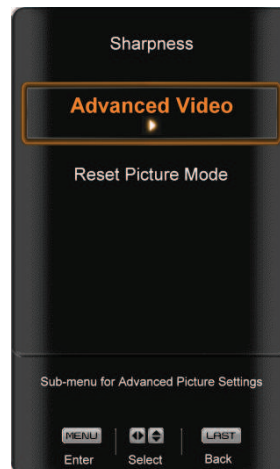

**Note:** To ensure that the correct program times are shown when pressing the Guide key:

## Setting the Time Zone

1. Press the Menu key, this will bring up the Picture Mode menu.
2. Press ▲ or ▼ on the remote control to highlight the TV menu, and then press **MENU** to select it.
3. Press ▲ or ▼ to highlight Time Zone. Press **MENU** to select it.
4. Press either ◀ or ▶ button to choose the proper Time Zone of your area.
5. Press the **LAST** key once to return to the previous screen or repeatedly to return to your program if task has been completed.
6. Your new TV set is now ready to automatically reproduce the best picture quality out of the input signal which is been fed into it.



## Watching a TV Program

Before you start watching TV, please make sure that any cable, satellite or off-air antenna connections are secure. Also, verify that the power cord is plugged into a correctly grounded electrical outlet or surge protector.

1. Press the power button on the remote control. The VIZIO logo on the front will change from orange to white.
2. There are 3 options for selecting your programming:
  - a. If you are using an antenna or cable connected through the DTV/TV CABLE/ANTENNA input, you can select TV directly by pressing the **TV** button on the remote control or by selecting TV from the Input menu after pressing **INPUT** on the remote control.
  - b. If you are watching broadcasts through a cable or satellite set-top box connected by an HDMI cable, select HDMI directly by pressing the HDMI button on the remote control, or by selecting HDMI from the Input menu after pressing **INPUT** on the remote control.
  - c. If you are watching broadcasts through a cable or satellite set-top box connected by a Component (YPbPr) cable, select Component directly by pressing the **COMP** button on the remote control or by selecting COMPONENT from the Input menu after pressing **INPUT** on the remote control.

**Note:** You should be able to see a picture. If you do not, make sure that all of the HDTV connections are secure and you have selected the correct video input source. Each press of the **HDMI** button on the remote control will cycle through the available inputs. Press the button until the input associated with the device you wish to view is shown in the Info box at the upper right corner of the screen.

3. When using option 2a, press the Channel buttons on the remote control or the CH **▲** or **▼** buttons to change the channel. The Channel buttons and on the remote control, control will not work if you are watching a program using HDMI, Component, or AV (S-Video or Composite) inputs.



## Adjusting Basic HDTV Settings



### Volume

To adjust the volume, press and hold the VOL▲ or VOL▼ button on the remote control until the desired level is reached.

### TV Channels

To step up or down through the available TV channels, press the CH ▲ or ▼ button on the remote control once for the next or previous channel, or hold it depressed until the desired channel is reached.

**Note:** Channel up and down will only operate in TV mode.

### Wide

Using this feature, you can watch video content in different size modes.

1. Press the **MENU** button on the remote control to bring up the OSD screen.
2. Press either the ▲ or ▼ button to select Setup.
3. Press **MENU** to go to the next level.
4. Press the ▼ button scroll down to Wide and select it.
5. Press either the ◀ or ▶ button to select among the modes.
6. For more information see *Viewing Modes*.

## Program Information

When watching a digital TV program, the On Screen Display will function as follows:

- When a channel is selected, an information header is shown over the picture for a few seconds.

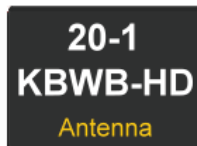

- When you press the **GUIDE** button on the remote control, the information header and a short summary of the program content, when available from the broadcaster, is displayed.

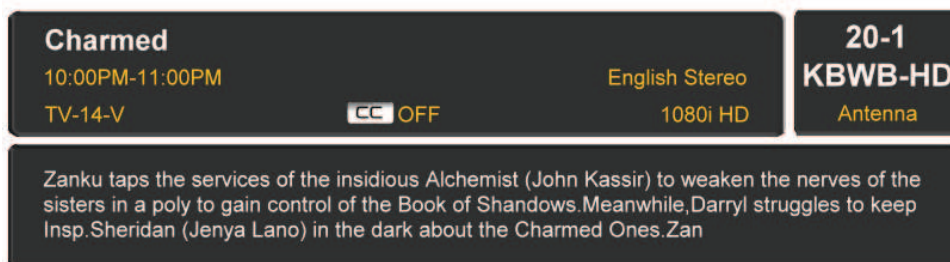

This information consists of the channel number and name, the format in which the program is broadcast (480i SD, 480P SD, 720P HD, 1080i HD), audio channel 1/2 or 2/2 (omitted if alternate channel is not broadcast), language, program title, program start and end time, program rating and if CC is available.

- Press the **GUIDE** button one more time to close the display



## Chapter 4 Advanced Adjustment of HDTV

### Using the On Screen Display (OSD)

The remote control or the control buttons on the left hand side of the TV can control all the function settings. The On Screen Display (OSD) allows you to adjust contrast, brightness and other settings. The TV will save changes made to the settings, even if the TV is turned off.

The OSD consists of several menu options: Picture, Audio Mode, TV, and Setup. The main menu options may vary depending on your selected input source.

**Note:** Some of the main menu options may have additional submenus, for example, the TV Rating submenu for Parental Controls.

1. Press the **MENU** button on the remote control and the Picture menu will be shown on the screen.
2. Press either **▲** or **▼** on the remote control or **CH ▲** or **CH ▼** on the side of the HDTV to select one of the other menu options:
  - Picture (Picture Adjust)
  - Audio Mode (Audio Adjust)
  - TV (TV Tuner Setup)
  - Setup (Global Settings)
3. Press **MENU** to select the option or feature you want to adjust.
4. Once the menu option is displayed, press the **▲** or **▼** button on the remote control to select one of the items to adjust.

Press **MENU** when finished.

5. Press the **LAST** key once to return to the previous screen or repeatedly to return to your program if task has been completed.

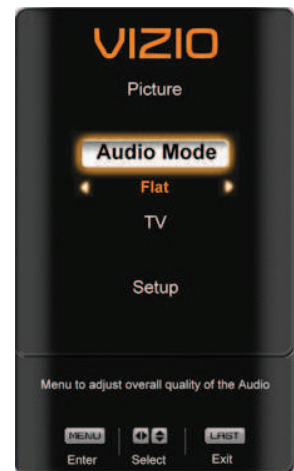

## Picture Menu

1. Press the **MENU** button on the remote control.
2. Press **▲** or **▼** on the remote control to highlight the Picture menu, and then press **MENU** to select it.
3. Press **▲** or **▼** on the remote control to select a Picture menu option.
4. Once the menu option is highlighted, press **◀** or **▶** on the remote control to adjust the setting.
5. Press the **LAST** button once to return to the previous screen or repeatedly to return to your program if the task has been completed.

### Picture Mode

When Picture is highlighted, press **◀** or **▶** to choose from Custom, Standard, Movie, Game, Vivid, Football, Golf, Basketball and Baseball.

### Backlight

The Backlight level adjusts the lamp current and this affects the overall brilliance of the picture but does not affect the Brightness (black level) or Contrast (white level) of the picture.

### Brightness

The Brightness adjusts the black levels in the picture. If the brightness is too low you will not be able to see the detail in darker parts of the picture and if the brightness is too high the picture will look washed out.

### Contrast

The Contrast adjusts the white levels in the picture. If the contrast is too low the picture will look washed out and if the contrast is too high you will not be able to see any detail in the bright parts of a picture.

### Color

Color adjusts the amount of color in the picture.

### Tint

The Tint adjusts the hue of the picture. The easiest way to set tint is to look at flesh tones and adjust for a realistic appearance. In most cases, the default middle position is correct. If people's faces look too orange try reducing the level of color first.

### Sharpness

The Sharpness adjustment adjusts the sharpness of the edges of elements in the picture. It does not produce detail that otherwise does not exist. This adjustment is helpful when viewing (Standard Definition) sources.

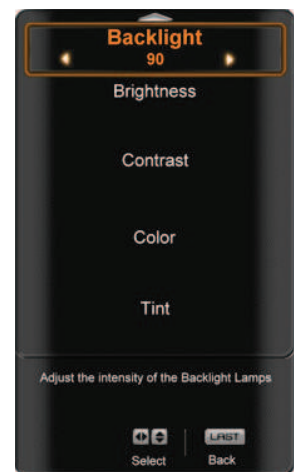



## Advanced Video

Press the ▼ button to highlight the option for Advanced Video selection and press either the ► button to select it. A new menu will be displayed showing the advanced functions available for fine tuning of the picture.

### Noise Reduction

This feature diminishes picture artifacts caused by the digitizing of image motion content that may be present in the picture. Choose from the Off, Low, Medium, or Strong setting.

### Color Enhancement

This feature increases the picture reproduction performance of the picture by reducing oversaturation of certain colors and improving flesh tones. Choose from Off, Normal, Rich Color, Green/Flesh, and Green/Blue setting.

### Advanced Adaptive Luma

Large areas of brightness in the picture will result in a higher Average Picture Level (APL) and the overall picture will look too light. This feature will lower the APL to counteract this effect. Choose from Off, Low, Medium, Strong, or Extend.

### Backlight Control

Set this feature to OFF, DCR, or OPC. DCR (Dynamic Contrast Ratio) improves the black level performance and increases contrast ratio. OPC (Optimum Power Control) Reduces power consumption while maintaining the same picture brightness.

### Color Temperature

Color Temperature is the “warmness” or “coolness” of the white areas of the picture. Choose from Normal, Custom, Cool, or Computer. Normal is the setting for television broadcasting. Custom allows you to set a preset calibrated for a white point to suit individual preferences. Cool produces a blue-hued image. The Computer setting sets the white point at the established setting for a PC display (9300K). Each preset may also be adjusted for a customized setting.

### Film Mode

Choose from Auto or Off. When set to Auto, the TV will detect the cadence (for example at 24 frames/second for film, or normal video at 60 fps). When set to Off it will stay at 60 fps.

## Reset Picture Mode

Press the ▼ button to highlight the option for Reset Picture Mode selection

Press ► button to return on Picture settings to factory default.

A screen will come up to confirm your selection or to cancel it.

Press either ◀ or ▶ to make the selection.

Press **MENU** to accept it.

Once the adjustments are completed press the **LAST** button repeatedly to exit the OSD completely.

**Note:** Only settings under the pictures adjustment will be reset.



## Audio Menu

1. Press the **MENU** button on the remote control and the Picture menu will be shown on the screen.
2. Press **▲** or **▼** on the remote control to highlight the Audio menu, and then press **MENU** to select it.
3. Press **▲** or **▼** on the remote control to select an Audio menu option.
4. Once the menu option is highlighted, press **◀** or **▶** on the remote control to adjust the setting.
5. Once the adjustments are completed press the **LAST** button repeatedly to exit the OSD completely.

**Note:** Equalizer adjustments are available for you to set them to your preferred settings. Equalizer will not be available if SRS is on.

### Equalizer

To select the options in the Equalizer sub-menu, press the **MENU** button. A new menu will be displayed showing the volumes of different frequencies.

Starting from lowest to the highest, they are 120 Hz, 500Hz, 1.5 kHz, 5 kHz and 10 kHz.

1. Press **◀** or **▶** to select the frequency to be adjusted.
2. Use **▲** or **▼** to adjust the selected frequency to your preference. Values above 0 will boost the frequency and values below 0 will attenuate the frequency.



**Note:** The Equalizer adjustment will only be available when SRS TSHD is set to Off.

### Balance

Adjust the sound to the left or the right.

### SRS TSHD

This option sets the SRS TruSurround HD surround sound process. Choose from On or Off.

**Note:** When SRS TSHD is ON, Equalizer adjustments are not available.

### Digital Audio Out

This option allows selection of the type of processing for the SPDIF (Optical connector) when used with a Receiver/Amplifier/Home Theater system. Select to choose from OFF, Dolby Digital or PCM.

### Speakers

Turn the internal speakers On or Off. You may want to turn the internal speakers off when listening to the audio through your Home Theater System.

### Lip Sync

Lip Sync is designed to adjust the audio of the program being viewed so that it matches the movement of the lips of someone talking on the screen.

### Reset Audio Mode

Return all Audio settings to factory default. A screen will come up to confirm your selection or to cancel it. Press **◀** or **▶** to make the selection, and then press **MENU** to accept it.



**Note:** Only settings under the Audio menu will be reset.

## TV Menu

When you first turned on your HDTV you set up your TV for DTV / TV channels using the Initial Setup screens. If you did not do this or if your setup has changed, you can do this from the TV menu.

1. Press the **MENU** button on the remote control and the Picture menu will be shown on the screen.
2. Press **▲** or **▼** on the remote control to highlight the TV menu, and then press **MENU** to select it.
3. Press **▲** or **▼** on the remote control to select a TV menu option.
4. Once the menu option is highlighted, press **◀** or **▶** on the remote control to adjust the setting.
5. Once the adjustments are completed press the **LAST** button repeatedly to exit the OSD completely.

### Tuner Mode

Select Cable or Antenna depending upon which equipment you have attached to the DTV / TV Input.

### Auto Search

Automatically search for TV channels that are available in your area. The TV will search for analog and digital channels.

### Partial Channel Search

If you believe channels are missed from the auto search, you can do a partial channel search to look for channel in a certain channel range again. Select to scan for Analog, Digital, or both Analog/Digital channels, then press the **▼** button to highlight the "From" and "To" selection. Press the **▶** button to select the range of channel numbers you want to start searching in. Press **MENU** to start channel search.

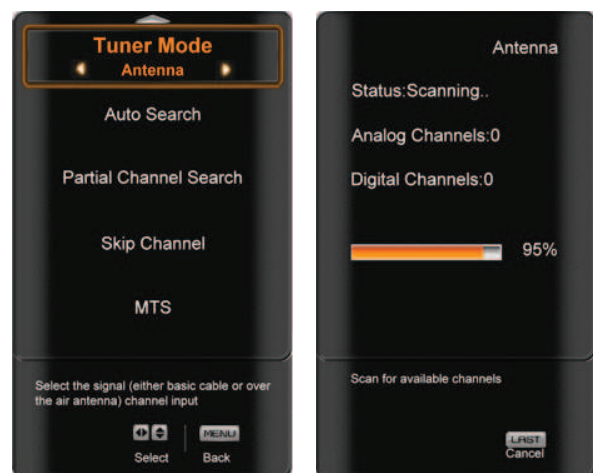

### Skip Channel

After the TV has stored all of the available digital channels in memory you will find that some channels are too weak to watch comfortably or they may be channels you do not want to see when using the CH▲ or CH▼ buttons. You will still be able to select this channel using the number buttons on the remote control. Scroll through the channels listed using ▲ or ▼ or scroll a page at a time by pressing ◀ or ▶. Press the **MENU** button to select the channel to be skipped.

### MTS

This feature allows you to select the different languages the broadcaster is transmitting the audio with the program you are watching. This signal is usually Spanish.

### Time Zone

Setting the correct Time Zone for your area will ensure that the correct program times are shown after pressing the **GUIDE** button on the remote control.

### Daylight Saving

Setting the daylight saving time for your area will ensure that the correct program times are shown after pressing the **GUIDE** button on the remote control.

### Channel Info

Channel Info displays the technical information of the channel including channel number, frequency, modulation type, status, SNR (signal noise ratio), and signal strength.

## Setup Menu

1. Press the **MENU** button on the remote control and the Picture menu will be shown on the screen.
2. Press ▲ or ▼ on the remote control to highlight the Setup menu, and then press **MENU** to select it.
3. Press ▲ or ▼ on the remote control to select **Setup** menu option.
4. Once the menu option is highlighted, press ◀ or ▶ on the remote control to adjust the setting.
5. Once the adjustments are completed press the **LAST** button repeatedly to exit the OSD completely.

### Language

Select to change the Language of the OSD. The default is English. You can also select Español or Français.

### Sleep Timer

Select the timer to turn off the TV in 30, 60, 90 or 120 minutes.

### Wide

Select how the picture displays on the screen. As you select an option, you will see the screen adjusting to the different sizes.

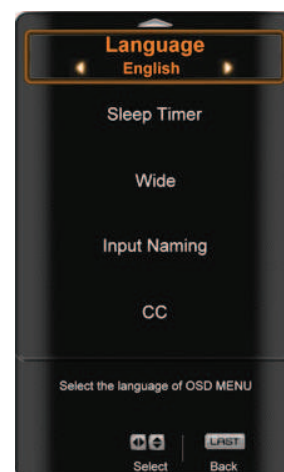

## Input Naming

This feature helps you identify the input being watched. You can use up to 8 characters; either letters or numbers or combinations of both, to add a name that will make it easier for you to recognize the input.

1. Press the ► button to go to the next screen that shows the different inputs.
2. Press the ▼ button to select the desired input which you want to label.
3. Press the **MENU** button to go to the first space in the bracket.
4. Press either the ▲ or ▼ button and select a desired letter or number.
5. Press the ► button to go to the next space and select a second character.
6. Repeat the steps 4 and 5 until the name of the input is complete.
7. Press the **MENU** button to accept the name of the input or the **LAST** key to cancel the setting.

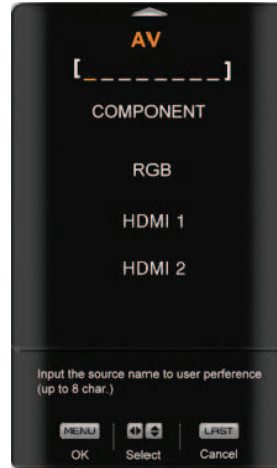

## CC (Closed Caption)

To select the options in the CC sub-menu, press the **MENU** button or the ► button. A new menu will be displayed showing the following CC settings:

### CC

The CC feature is available when watching regular analog (NTSC) TV. Select from CC1, CC2, CC3, CC4. Closed Caption for regular TV is usually CC1 or CC2.

### Digital CC Style

The Digital CC Style feature is available when watching digital TV.

Select either As Broadcaster or Custom. If Custom is selected then you can customize the way Closed Caption is displayed. The options available are:

- **Caption Style**
- **Font Size** (letter size)
- **Font Color** (letter color)
- **Font Opacity** (letter transparency)
- **Background Color** (color of the background where Closed Caption is displayed)
- **Background Opacity** (sets the transparency of the background)
- **Window Color** (color of the area where characters are displayed)
- **Window Opacity** (transparency of the area where characters are displayed)

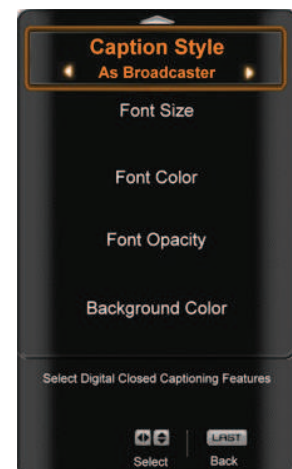

## H/V Position

To select the options in the H/V Position sub-menu, press the **MENU** button or the ► button. A new menu will be displayed showing the following H/V Position settings:

### H-Position

Adjust the horizontal position of the picture.

### V-Position

Adjust the vertical position of the picture.

### H-SIZE

Adjust the horizontal size of the picture.

### V-SIZE

Adjust the vertical size of the picture.

### Auto Phase (for Component input only)

The TV will automatically look for the phase of the signal to fine tune the picture.



**Note:** The H/V Position function is only available in HDMI, Component, or RGB modes.

## Parental

If you want to restrict certain channel and program viewing, you can do this by turning on the Parental Control. Selected programs, movies and channels can then be made available only after an authorized password has been entered and accepted by the TV.

To select the options in the Parental sub-menu, press **MENU**. Enter a password to access the Parental menu. The default password set in the factory is **0 0 0 0**.

**Note:** The Parental menu does not appear when the input mode is set to HDMI.

A new menu will be displayed showing the following Parental settings:

### Rating Enable

Select from ON or OFF. If set to OFF, you will not be able to set the US TV, US Movie, Canadian English, or Canadian French Ratings.

### Channel Block

Block individual channels from being displayed.

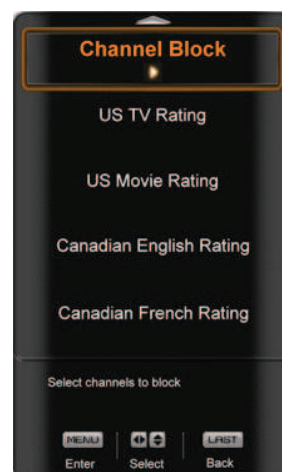

### US TV Rating

**Note:** When Rating Enable is OFF, US TV Rating adjustments are not available.

Press the **MENU** button to block (locked) or allow (unlocked) channels by the following US TV ratings:

- Y – All children
- Y7 – Older children
- G – General audience
- PG – Guidance suggested
- 14 – Strongly cautioned
- MA – Mature audience

You can also customize the TV ratings for the following content:

- A – All sub-ratings
- D – Sexual dialog
- L – Adult language
- S – Sexual situations
- V - Violence
- FV – Fantasy violence



### US Movie Rating

**Note:** When Rating Enable is OFF, US Movie Rating adjustments are not available.

Press the **MENU** button to block (locked) or allow (unlocked) channels by the following US Movie ratings:

- G – General audience
- PG – Parental guidance suggested
- PG-13 – Recommended for children 13 years of age or older
- R – Mature audience
- NC-17 – No one under 17 years of age
- X – No one under 17 years of age



### Canadian English Rating

**Note:** When Rating Enable is OFF, Canadian English Rating adjustments are not available.

Press the **MENU** button to block (locked) or allow (unlocked) channels by the following Canadian English ratings:

- C – Children
- C8+ – Children 8 years or older
- G – General Programming, suitable for all audiences
- PG – Parental guidance
- 14+ – Viewers 14 years or older
- 18+ – Adult programming





### Canadian French Rating

**Note:** When Rating Enable is OFF, Canadian French Rating adjustments are not available.

Press the **MENU** button to block (locked) or allow (unlocked) channels by the following Canadian French ratings:

- G – General audience
- 8 ans+ – General – not recommended for young children
- 13 ans+ – Not suitable for children under 13 years of age
- 16 ans+ – Not suitable for under 16 years of age
- 18 ans+ – Adults only

### DTV Rating

This option updates the TV or Movie rating table for digital programs in your local or regional area. It will allow the parental guidance control feature in your TV to have the most current parental control database for a digital signal. If *Not Available* appears at the bottom of the menu, then no update is available (the option is not activated in your area). This option may be available in the future for activation.

### Block Unrated TV

Block programming that does not have a rating.

### Change the Password

Select Access Code Edit to enter a new, 4-digit password using the number buttons on the remote control. Enter it a second time to confirm you entered it correctly.

**Note:** Make sure you write down and store the new password in a secure place. The System Reset feature (below) does NOT reset the password.



### System Info

Display the technical information including model name, version and revision of firmware, source type, and resolution.

### System Reset

To select the options in the System Reset sub-menu, press the **MENU** button or the ► button. A new menu will be displayed showing the following System Reset settings:

#### Setup Wizard

Use this function to return to the Initial Setup menu. Use this function if you want to have a guided setup when you move your TV. Please refer to Chapter 3 for more information.

**Note:** Previously scanned channels will be removed.

#### Reset All Settings

Use this function to reset the TV to the default factory settings.

The screen will display a message to confirm that you want to reset the values to factory settings.

**Note:** This does **NOT** reset the Parental Control Password.





## Chapter 5 Understanding Viewing Features

Your HDTV features the following viewing modes. You can switch viewing modes using the remote control, please follow the instructions on page 27.

### Viewing Modes

#### Normal Mode

The original 4:3 aspect ratio (1.33:1 source) is preserved, so black bars are added to the left and right of the display image. Standard TV broadcasts are displayed with a 4:3 Aspect Ratio. Movies in 4:3 Aspect Ratio may be referred to as pan-and-scan or full frame. These movies were originally filmed in 16:9 (widescreen), and then modified to fit a traditional TV screen (4:3).

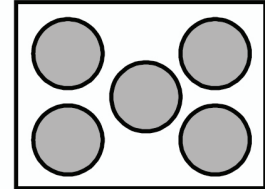

#### Full

Full mode allows you to view the entire picture. Recommended for HDMI and RGB / Computer viewing so you can see the complete picture without the image overstretching beyond the viewing area. If you experience "noise" along the border switch to Zoom 1. For 720p, 1080i, 1080p only.

#### Zoom 1

When watching a standard broadcast or full-frame movie in this mode, the display image is stretched proportionately to fill the TV screen. When watching a widescreen (1.78:1 source) program or movie, the display image fills the TV screen. If you are watching a widescreen (1.85:1 or 2.35:1 source) program or movie, there will still be black bars at the top and bottom.

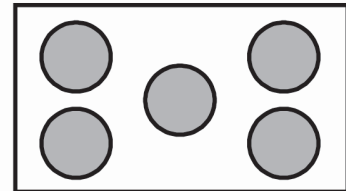

#### Zoom 2

Zooms in by 14% to crop the top and bottom bars for 2.35:1 film resolutions. For 480i/p, 4:3 only.

#### Stretch Mode

When watching a widescreen program (1.78:1 source) with black bars on the sides, the display image will stretch to fill the TV screen. People will appear wider than they really are. If you are watching a widescreen (1.85:1 or 2.35:1 source) program or movie, there will still be black bars at the top and bottom. This mode is available only when watching a widescreen program.

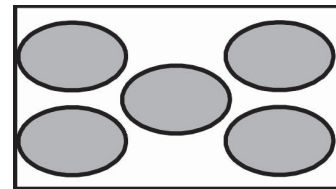

#### Panoramic Mode

When watching a standard broadcast or full frame movie in this mode, the 4:3 Aspect Ratio (1.33:1 source) display image is stretched horizontally on the left and right sides to fill the TV screen. The center of the image is not stretched.

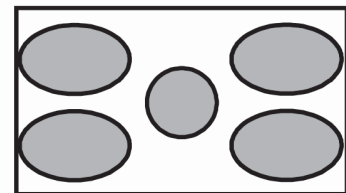

## Chapter 6 Maintenance and Troubleshooting

### Maintenance

#### Important

1. Make sure that the power cable is removed from the socket before cleaning the TV.
2. Do not use volatile solvent (such as toluene, rosin and alcohol) to clean the TV. Such chemicals may damage the housing, screen and remote control, and cause paint to peel.

#### Cleaning the Housing and Remote Control

1. Use a soft cloth for cleaning.
2. If the housing or remote control is seriously contaminated, use a soft cloth moistened with diluted neutral cleaner to clean the display. Wring water out of the cloth before cleaning to prevent water from penetrating into the housing. Wipe the display with a dry cloth after cleaning.

#### Cleaning the Screen

1. Use a soft cloth to gently clean the screen.
2. The screen is very fragile. Do not scrape it with any sharp object. Do not press or tap the screen to avoid cracking. When the screen is seriously contaminated, use a soft cloth moistened with diluted neutral cleaner to clean the display. Wring water out of the cloth before cleaning to prevent water from penetrating into the housing. Wipe the display with a dry cloth after cleaning.



## Troubleshooting Guide

If the TV fails or the performance changes dramatically, check following troubleshooting guide for possible solutions. Remember to check the peripherals to pinpoint the source of the failure. If the display still fails to perform as expected, contact the VIZIO for assistance by calling 1-877-MYVIZIO (698-4946) or e-mail us at [techsupport@vizio.com](mailto:techsupport@vizio.com).

General TV Problems	Solution
Receive the error message "No Signal."	<ul style="list-style-type: none"> <li>• Press the INPUT button on the remote control to select a different input source.</li> <li>• If you are using cable connected directly to the TV or an antenna, scan for channels from the Tuner menu in the OSD.</li> <li>• Press the TV button on the top of the remote to return to the TV mode.</li> </ul>
No power.	<ul style="list-style-type: none"> <li>• Make sure the power button is ON (VIZIO logo glows white).</li> <li>• Make sure AC power cord is securely connected to the AC socket.</li> <li>• Plug another electrical device to the power outlet to verify that the outlet is working.</li> </ul>
No sound.	<ul style="list-style-type: none"> <li>• Press Volume + (Up) on the remote control.</li> <li>• Press MUTE on the remote control to make sure that MUTE is not ON.</li> <li>• Check your audio settings. The audio may be set to SAP, or the speakers are set to off.</li> <li>• Check the audio connections of external devices that may be connected to the HDTV.</li> <li>• If you are using an antenna, the signal strength of the channel may be low. Make sure your antenna is connected securely to the TV and move the antenna around the room or close to a window.</li> </ul>
If the screen is black.	<ul style="list-style-type: none"> <li>• Make sure the power button is ON (VIZIO Logo glows white).</li> <li>• Press the INPUT button on the remote control to select a different input source.</li> <li>• Check the connections of external devices that may be connected to the HDTV.</li> <li>• Press the TV button on the top of the remote to return to the TV mode.</li> </ul>
Power is ON but there is no image on the screen.	<ul style="list-style-type: none"> <li>• Make sure all cables attached to the HDTV are connected to the correct output on the external device.</li> <li>• Adjust brightness, contrast or backlight.</li> <li>• Press the INPUT button on the remote control to select a different input source.</li> <li>• Press the TV button on the top of the remote to return to the TV mode.</li> </ul>
Wrong or abnormal colors appear.	<ul style="list-style-type: none"> <li>• Check Color and Tint settings in Picture Menu.</li> <li>• Reset Picture settings.</li> <li>• Check the video cables to make sure they are securely connected.</li> <li>• If you are using an antenna, the signal strength of the channel may be low. Make sure your antenna is connected securely to the TV and move the antenna around the room or close to a window.</li> </ul>
Control buttons do not work.	<ul style="list-style-type: none"> <li>• Press only one button at a time.</li> <li>• Press the TV button on the top of the remote to return to the TV mode.</li> </ul>
Remote control does not work.	<ul style="list-style-type: none"> <li>• Point the remote control directly at the remote sensor on your TV.</li> <li>• Remove any obstacles between the remote control and the remote sensor.</li> <li>• Replace dead batteries with new ones.</li> <li>• Press the TV button on the top of the remote to return to the TV mode.</li> </ul>
There appear to be image quality issues.	<ul style="list-style-type: none"> <li>• If you are using an antenna, the signal strength of the channel may be low. Make sure your antenna is connected securely to the TV and move the antenna</li> </ul>



General TV Problems	Solution
	<p>around the room or close to a window.</p> <ul style="list-style-type: none"> <li>For best image quality, view HD wide-screen programs where possible.</li> <li>If HD content is not available view "Standard Definition" from a digital source.</li> <li>Standard, analog TV will always be noticeably inferior to HD because your digital flat panel TV has video that is many times better than old TV so you will see interference and deficiencies you did not know you had.</li> </ul>
<p>You cannot see a picture.</p>	<ul style="list-style-type: none"> <li>Make sure the power button is ON (VIZIO logo glows white).</li> <li>Make sure AC power cord is securely connected to the AC socket.</li> <li>Press the INPUT button on the remote control to select a different input source.</li> <li>Press the TV button on the top of the remote to return to the TV mode.</li> <li>Check the connections of external devices that may be connected to the HDTV.</li> <li>If your HDTV is connected to a computer, press any button on your keyboard to "wake" your computer.</li> <li>If you are using an antenna, the signal strength of the channel may be low. Make sure your antenna is connected securely to the TV and move the antenna around the room or close to a window.</li> </ul>
<p>You see a distorted picture or hear unusual sound.</p>	<ul style="list-style-type: none"> <li>You may be getting interference from electrical appliances, cars, motorcycles, or fluorescent lights. If you have not mounted it on the wall, try moving your HDTV to another location to see if this is the cause of the problem.</li> </ul>
<p>The picture has abnormal patterns.</p>	<ul style="list-style-type: none"> <li>Check the connections of external devices that may be connected to the HDTV.</li> <li>Make sure the specifications of external devices meet the specifications of your HDTV (i.e. resolution).</li> <li>If you are using an antenna, the signal strength of the channel may be low. Make sure your antenna is connected securely to the TV and move the antenna around the room or close to a window.</li> </ul>
<p>The display image does not cover the entire screen.</p>	<ul style="list-style-type: none"> <li>If you are in RGB mode (Computer), make sure that H-Size and V-Position in the On Screen Display (OSD) are set correctly.</li> <li>If you are using TV, AV or Component with 480i input, press WIDE button on the remote control to scroll through various screen modes.</li> </ul>
<p>You can see a picture but you cannot hear sound.</p>	<ul style="list-style-type: none"> <li>Press Volume + (Up) on the remote control.</li> <li>Press MUTE on the remote control to make sure that MUTE is not ON.</li> <li>Check your audio settings. The audio may be set to SAP, or the speakers are set to off.</li> <li>Check the audio connections of external devices that may be connected to the HDTV.</li> </ul>
<p>The TV has pixels (dots) that are always dark or colored.</p>	<ul style="list-style-type: none"> <li>Your HDTV is manufactured using an extremely high level of precision technology, however, sometimes some pixels of your HDTV may not display. Pixel defects within industry specifications are inherent to this type of product and do not constitute a defective product.</li> </ul>
<p>You see "noise" or "trash" on the screen.</p>	<ul style="list-style-type: none"> <li>When your HDTV's digital capabilities exceed a digital broadcast signal, the signal is up-converted (increased) to match your TV's display capabilities. Up-converting can cause noise or trash.</li> <li>If you are using an antenna, the signal strength of the channel may be low. Make sure your antenna is connected securely to the TV and move the antenna around the room or close to a window.</li> </ul>
<p>You switch to a different input and the volume changes.</p>	<ul style="list-style-type: none"> <li>The TV remembers the volume level from the last time you adjusted it. If the sound level is higher or lower from another source, then the volume will change.</li> </ul>



General TV Problems	Solution
You switch to a different input and the screen size changes.	<ul style="list-style-type: none"> <li>The TV remembers the viewing mode from the last time you used a particular input (AV, Component, HDMI and TV).</li> </ul>
Tips for High-Definition Users.	<ul style="list-style-type: none"> <li>Your HDTV is an ideal platform for viewing High Definition Content.</li> <li>Best image quality will be achieved by HDMI. The next best is Component, followed by Composite.</li> <li>Due to variances in broadcast practices, it is possible some image distortions can occur.</li> </ul>
Tips for Letterbox Content Users.	<ul style="list-style-type: none"> <li>Some Letterboxed (or "Widescreen") versions of DVD movies are formatted for standard 4:3 Televisions. Your HDTV has the ability to expand this content so the entire screen is filled at the expense of image accuracy. To use this function, press ZOOM on the remote control to cycle among the options.</li> </ul>

### Telephone & Technical Support

Products are often returned due to a technical problem rather than a defective product that may result in unnecessary shipping charges billed to you. Our trained support personnel can often resolve the problem over the phone. For more information on warranty service or repair, after the warranty period, please contact our Support Department at the number below.

Customer support and quality service are integral parts of VIZIO's commitment to service excellence. For technical assistance contact our VIZIO Technical Support Department via email or phone.

Email: [techsupport@vizio.com](mailto:techsupport@vizio.com)  
 (877) 698-4946 Fax: (949) 585-9563  
 Hours of operation: Monday - Friday: 6 am to 9 pm  
 Saturday – Sunday: 8 am to 4 pm

Please have your VIZIO model number, serial number, and date of purchase available before you call.

**VIZIO**  
 Address:  
 39 Tesla  
 Irvine, CA 92618, USA  
 Telephone: (949) 428-2525 Fax: 949-585-9514  
 Web: [www.vizio.com](http://www.vizio.com)



## Compliance

Caution: Always use a power cable that is properly grounded. Please use the AC cords listed below for each area.

USA	UL
Canada	CSA
Germany	VDE
UK	BASE/BS
Japan	Electric Appliance Control Act

## FCC Class B Radio Interference Statement

NOTE: This equipment has been tested and found to comply with the limits for a Class B digital device, pursuant to Part 15 of the FCC Rules. These limits are designed to provide reasonable protection against harmful interference in a residential installation. This equipment generates, uses and can radiate radio frequency energy, and if not installed and used in accordance with the instructions, may cause harmful interference to radio communications. However, there is no guarantee that interference will not occur in a particular installation. If this equipment does cause harmful interference to radio or television reception, which can be determined by turning the equipment off and on, the user is encouraged to try to correct the interference by one or more of the following measures:

1. Reorient or relocate the receiving antenna.
2. Increase the separation between the equipment and receiver.
3. Connect the equipment into an outlet on a circuit different from that to which the receiver is connected.
4. Consult the dealer or an experienced radio/TV technician for help.

Notice:

1. The changes or modifications not expressly approved by the party responsible for compliance could void the user's authority to operate the equipment.
2. Shielded interface cables and AC power cord, if any, must be used in order to comply with the emission limits.
3. The manufacturer is not responsible for any radio or TV interference caused by unauthorized modification to this equipment. It is the responsibilities of the user to correct such interference.



## Specifications

Specifications		
Panel	26.02" Diagonal, 16:9 Aspect Ratio	
Resolution	1920 x 1080 pixels	
Pixel (Dot) Pitch	0.3mm (H) x 0.3mm (V)	
Display Compatibility	FHDTV (1080P)	
Colors	1.06 Billion	
Brightness cd/m <sup>2</sup> (typical)	400nits	
Contrast	1000:1 DCR: 5,000:1	
Response Time	8ms (typical)	
Viewing Angle	178° (horizontal/vertical); 178° (up/down)	
Inputs	2x HDMI 1x Composite Video and stereo audio 1x S-Video	1x Component Video and stereo audio 1x RGB 1x RF
Outputs	1x SPDIF Optical Digital Audio, 1x Headphone (side)	
VL260M Features	1080P FHDTV, HDMI v1.3, 3D Comb Filter, Dynamic Contrast Ratio, Dolby Digital for ATSC/QAM, Signal Compatibility, 480I(SDTV), 480P(EDTV), 720P(HDTV), 1080I(HDTV), 1080P(FHDTV), Channel Skip/Add, Favorite Channel, Video/Input Naming Capability, Closed Caption, Parental Control/V-CHIP 2.0, Programmable Timer, SRS TSHD.	
Special Features	Detachable Base	
Speakers	2x Built-in, 5W Speakers	
Panel Life	50,000 hours to half the original brightness	
<b>Power</b>		
Input	IEC Connector for direct power line connection	
Voltage Range	100~240Vac at 50/60 Hz	
Power Consumption	73W (AVG), 0.33W Standby	
<b>Environmental Conditions</b>		
Operating	Temperature: 5°C~35°C, Relative Humidity: 20~80%, Altitude: 0~14,000 ft	
Non-Operating	Temperature: -20°C~50°C, Relative Humidity: 10~70%, Altitude: 0~40,000 ft	
Dimensions	26.13" W x 18.74" H x 7.23" D with stand; 26.13" W x 17.16" H x 3.5" D without stand	
Net Weight	18.19 lbs with stand, 17.2 lbs without stand	
Gross Weight	22.18 lbs	
Certifications	CSA, CSA-US, FCC Class B	
Compliances	Energy Star 3.0. ATSC Spec A/65, EIA/CEA-766-A	

\*Product specifications may change without notice or obligation.



## Limited Product Warranty

VIZIO provides a “ONE-YEAR LIMITED WARRANTY” against manufacturing defects in materials and workmanship to the original purchaser of a new VIZIO display purchased from an authorized VIZIO U.S. reseller and used in the fifty (50) United States or Puerto Rico.

### VIZIO's Responsibility

VIZIO displays purchased new from an authorized VIZIO U.S. reseller and that are used in the fifty (50) United States or Puerto Rico are warranted to be free from manufacturing defects in materials and workmanship for one (1) year from the date of the original retail purchase. If the display fails to conform to this limited warranty, VIZIO will, at its option and sole discretion, repair or replace the display.

### Labor

During the one-year limited warranty period, VIZIO will provide, when needed, service labor to repair a manufacturing defect. Repairs required on displays which are thirty (30) inches and larger generally will be made “on-site” where the display is installed. The determination for performing the on-site repair is dependent upon the manufacturing defect and is at VIZIO's option and sole discretion. Repairs required on displays which are less than thirty (30) inches generally will be performed at a VIZIO service center.

### Parts

Repairs may be made with new or recertified parts, or the entire unit may be replaced with a new or recertified unit, at VIZIO's option and sole discretion. Replacement parts or replacement units provided under this limited warranty are warranted for the remaining portion of the original warranty period, or for ninety (90) days from warranty service or replacement, whichever is later.

### How to Obtain Warranty Service

To obtain warranty service, contact VIZIO Technical Support via email at [TechSupport@VIZIO.com](mailto:TechSupport@VIZIO.com), via phone at 877-MYVIZIO (877-698-4946), or via postal mail at VIZIO Technical Support, 39 Tesla, Irvine, CA 92618. You must provide the model, serial number, and date of purchase. VIZIO Technical Support is available from 6:00AM to 9:00PM Pacific Time, Monday through Friday, and 10:00AM to 2:00PM Pacific Time, Saturday and Sunday. Please note that holiday hours may vary. For up to date information, please visit [www.VIZIO.com](http://www.VIZIO.com).

VIZIO reserves the right to assess all warranty claims and to determine if defects or damages are covered by this limited warranty. In case of a claim that is not covered by this warranty, you will be contacted to determine whether VIZIO should repair the damage for a fee or whether the product should be returned to you as received by the service technician or service center.

Parts and service labor that are VIZIO's responsibility under this limited warranty will be provided without charge. All other service is at the customer's expense. VIZIO reserves the right to charge the customer for any service call for anything not covered by this limited warranty. Before you ask for warranty service, please review your User Manual. You may avoid a service call and a service charge.

Please refer to the reverse side of this page for additional information regarding how to obtain warranty service.

**PLEASE DO NOT RETURN YOUR UNIT TO VIZIO WITHOUT PRIOR AUTHORIZATION.**

### Not Covered

This limited warranty does not cover the following: cosmetic defects; damage, malfunctions or failures resulting from shipping or transit, improper or faulty installation, abuse, operation contrary to furnished instructions, operation on incorrect power supplies, products not supplied by VIZIO, modification, alteration, improper servicing or tampering; damage from fire, water, lightning, power surges, abnormal environmental conditions or other acts of nature; normal wear and tear; unsatisfactory visual or audio performance not caused by a manufacturing defect; or displays with a missing or unreadable serial number. Operation of the display for commercial purposes or in applications or uses for which the display





is not intended is not covered by this limited warranty. "Image Sticking", caused by static images on the screen for extended periods and or excessive brightness and contrast levels, is not covered by this limited warranty. Installation, removal, transportation and reinstallation of a display, and routine maintenance and cleaning, are not covered by this limited warranty.

THERE ARE NO EXPRESS WARRANTIES OTHER THAN THOSE LISTED OR DESCRIBED ABOVE. ANY IMPLIED WARRANTIES, INCLUDING ANY IMPLIED WARRANTY OF MERCHANTABILITY AND FITNESS FOR A PARTICULAR PURPOSE, SHALL BE LIMITED IN DURATION TO THE PERIOD OF TIME SET FORTH ABOVE. VIZIO'S TOTAL LIABILITY FOR ANY AND ALL LOSSES AND DAMAGES RESULTING FROM ANY CAUSE WHATSOEVER, INCLUDING VIZIO'S NEGLIGENCE, ALLEGED DAMAGE, OR DEFECTIVE GOODS, WHETHER SUCH DEFECTS ARE DISCOVERABLE OR LATENT, SHALL IN NO EVENT EXCEED THE PURCHASE PRICE OF THE DISPLAY. VIZIO SHALL NOT BE RESPONSIBLE FOR LOSS OF USE, COMMERCIAL LOSS, LOST REVENUE OR LOST PROFITS, OR OTHER INCIDENTAL OR CONSEQUENTIAL DAMAGES. SOME STATES DO NOT ALLOW LIMITATIONS ON HOW LONG AN IMPLIED WARRANTY MENUS OR THE EXCLUSION OR LIMITATION OF INCIDENTAL OR CONSEQUENTIAL DAMAGES, SO THE ABOVE LIMITATIONS OR EXCLUSIONS MAY NOT APPLY TO YOU.

This warranty gives you specific legal rights, and you may also have other rights, which vary from state to state. This is the only warranty applicable; no one is authorized to extend or modify it or to grant any other warranty on VIZIO's behalf.

### Owner's Responsibility

To ensure warranty service, keep the dated bill or sales receipt as evidence of the purchase date and location. This limited warranty applies only to original purchaser and is non-transferable.

**Note:** Warranty service conditions are subject to change. For the latest Warranty Terms and Conditions and additional information regarding VIZIO's Limited Product Warranty, please see complete details online at [www.VIZIO.com](http://www.VIZIO.com).

## VIZIO Return Policy

VIZIO's return policy allows for products purchased directly from VIZIO to be returned by the original purchaser during the initial thirty (30) day period following the date of purchase. A VIZIO return authorization number must first be obtained as provided below. The refund will be the purchase price actually paid by the purchaser less a ten percent (10%) restocking fee per each item returned. Shipping and handling are not refundable.

The return authorization number must first be obtained from VIZIO's Customer Service by emailing [CustomerSupport@VIZIO.com](mailto:CustomerSupport@VIZIO.com) or by calling 949-428-2525, 6:00AM to 9:00PM Pacific Time, Monday through Friday, and 10:00AM to 2:00PM Pacific Time, Saturday and Sunday. Please note that holiday hours may vary. For up to date information, please visit [www.VIZIO.com](http://www.VIZIO.com).

Products must be returned to the address specified by VIZIO Customer Service and must be shipped in the original packaging, with freight prepaid to VIZIO, and must be received in new and unused condition. The return authorization number must be included in the packaging. VIZIO reserves the right to assess fees for any damaged or missing parts in addition to the ten percent (10%) restocking fee.

Return authorization numbers are valid for only fifteen (15) days from issuance. The customer is responsible for and must prepay all shipping charges and shall assume all risk of loss or damage to the product while in transit to VIZIO. If the product is returned to VIZIO (i) without a VIZIO return authorization number, and/or (ii) beyond the fifteen (15) day period, and/or (iii) without proper packaging, VIZIO retains the right to refuse delivery of such return or may return the unit to the customer at the customer's expense and with no refund issued. This return policy does not apply to defective products. Please read VIZIO's Limited Product Warranty for warranty terms and conditions.



## **On-Site Warranty Repair Procedure**

**On-Site Warranty Repair generally is performed on repairable displays which are 30 inches and larger.**

If VIZIO Technical Support determines that a problem with a display unit may be within the terms and conditions of the VIZIO Limited Product Warranty and that an on-site repair may be performed, the customer will be provided with an on-site repair authorization number and on-site repair instructions. The determination for performing the on-site repair may be dependent upon the manufacturing defect and is at VIZIO's option and sole discretion. Proof of purchase is required to confirm the product is within the one-year limited warranty period and meets the terms and conditions of the VIZIO Limited Product Warranty.

On-site repair service is requested through VIZIO's third-party service provider. After VIZIO provides the customer with the on-site repair (OSR) authorization number, the third-party service provider will contact the customer and will schedule the repair at the customer's location. The total approximate time for the repair process, which includes the repair diagnosis, dispatching the technician, shipping the replacement part(s), and arranging the appointment with the customer, is completed within approximately 3 to 5 business days, pending availability of these factors.

If it is determined the product can not be repaired on-site, the customer will be required to ship the unit to VIZIO's service center, per the below warranty replacement procedure.

VIZIO is not responsible for the de-installation or re-installation of the product. However, some standard installation may be performed during the on-site repair, at VIZIO's option and sole discretion. Please read VIZIO's Limited Product Warranty for warranty terms and conditions.

## **Warranty Replacement Procedure**

**Warranty Replacement generally is performed on displays which are determined to be economically unreparable.**

If VIZIO Technical Support determines that a problem with a display unit may be within the terms and conditions of the VIZIO Limited Product Warranty and that a repair is not economically possible, based on certain manufacturing defects in materials and/or workmanship, and/or at VIZIO's option and sole discretion, the customer will be provided with a return authorization number and replacement instructions. Proof of purchase is required to confirm the product is within the one-year limited warranty period and meets the terms and conditions of the VIZIO Limited Product Warranty.

For displays forty-two inches (42") and larger, VIZIO will generally cover the transportation charges to perform an on-site swap of the original unit with the replacement unit. For displays under forty-two inches (42"), the customer is responsible for the transportation charges to VIZIO's service center. VIZIO will be responsible for the return transportation charges from the service center to the customer. Please read VIZIO's Limited Product Warranty for warranty terms and conditions.

## **Mail-In Warranty Repair Procedure**

**Mail-In Warranty Repair generally is performed on displays which are smaller than 30 inches.**

If VIZIO Technical Support determines that a problem with a display unit may be within the terms and conditions of the VIZIO Limited Product Warranty and that a mail-in repair may be performed, the customer will be provided with a return authorization number and mail-in repair instructions. Proof of purchase is required to confirm the product is within the one-year limited warranty period and meets the terms and conditions of the VIZIO Limited Product Warranty.

The customer will be provided with instructions for packing and shipping the unit to the VIZIO service center. The original carton box and packing material, or an equivalent as designated by VIZIO, must be utilized. The cost of shipping to VIZIO's service center is at the customer's expense. After the product is repaired and tested, the VIZIO service center will ship the unit back to the customer at VIZIO's expense. VIZIO is not responsible for the de-installation or re-installation of the product. Please read VIZIO's Limited Product Warranty for warranty terms and conditions.

**PLEASE DO NOT RETURN YOUR UNIT TO VIZIO WITHOUT PRIOR AUTHORIZATION.**



## Index

- Accessories, 8
- Adjustments
  - Advanced, 31
  - Channel, 11
  - Volume, 11
- Antenna, 15
- Audio Menu, 34
  - Balance adjustments, 34
  - Digital Audio Out, 34
  - Equalizer adjustments, 34
  - Lip Sync adjustments, 34
  - Reset Audio Mode, 34
  - Speaker adjustments, 34
  - SRS TSXD (surround sound) adjustments, 34
- Black bars, 41
- Blocking Channels, 38
- Brightness, 32
- Cable Box
  - Connecting, 16
- Camcorder
  - Connecting, 22
- CC Closed Caption, 37
- Changing Channels, 30
- Channel information, 36
- Cleaning your VIZIO TV, 42
- Coaxial connection
  - Satellite box, 19
- Coaxial Connection
  - cable TV, 19
- Color, 32
- Component Connector, 15
- Composite Connector, 15
- Computer
  - Connecting, 23
- Connecting Equipment
  - Cable, 16
  - Computer, 23
  - DVD, 20
  - Satellite Box, 16
  - Sound system, 23
  - VCR, 22
  - Video Camera, 22
- Connections
  - Rear Panel, 12
- Contents, 8
- Contrast, 32
- Controls
  - Front Panel, 11
  - Side Panel, 11
- Daylight Savings, 36
- DTV Transition, 5
- DVD Player
  - Connecting, 20
- DVI
  - Cable Box, 17
  - DVD Player, 20
  - Satellite Box, 17
- Film Mode, 33
- Fine Tuning the picture, 28
- GUIDE Button, 30
- HDMI, 15
- Horizontal/Vertical Position adjustments, 38
- INFO Button, 30
- Input Source
  - Choosing, 27
- Inputs
  - Antenna, 4
  - Connectors, 15
- Installation services, 8
- Maintenance of TV, 42
- Naming Inputs, 37
- On Screen Display, 31
- Parental Controls, 38
  - Block Unrated Programming, 40
  - Canadian English Rating, 39
  - Canadian French Rating, 40
  - Change the Password, 40
  - Channel Block, 38
  - DTV Rating, 40
  - Rating Enable, 38
  - US Movie Rating, 39
  - US TV Rating, 39
- Picture Menu, 32
  - Adaptive Luma, 33
  - Advanced Video, 33
  - Backlight, 32
  - Backlight Control, 33
  - Brightness, 32
  - Color, 32
  - Color Enhancement, 33
  - Color Temperature, 33
  - Contrast, 32
  - Noise Reduction, 33
  - Picture Mode, 32
  - Reset Picture Mode, 33
  - Sharpness, 32
  - Tint, 32
- Remote, 13
  - Batteries, 14
  - Range, 14
- Reset All Settings, 40
- RGB, 15
  - Connecting your PC, 23
- Safety Instructions, 2
- Satellite Box
  - Connecting, 16
- Screen Size explanation, 41
- Search for channels, 35



## VIZIO VL260M User Manual

- Select Language (MTS), 36
- Setting up, 10
- Setup Menu, 36
  - CC, 37
  - Language setup, 36
  - Parental Controls, 38
  - Setup Wizard, 40
  - System Menu, 40
  - Wide, 36
- Sharpness, 32
- Skip Channel, 36
- Sleep timer, 36
- Specifications
  - TV, 47
- Stand Assembly, 9
- S-Video, 15
- Technical Support, 45
- Time Zone, 36
- Time Zone, 28
- Tint, 32
- Troubleshooting, 43
- TV
  - Audio Adjustment, 34
  - TV Menu, 35
    - Auto Search adjustments, 35
    - Partial Channel Search, 35
    - Skip Channel, 36
    - Tuner Mode adjustments, 35
  - VCR
    - Connecting, 22
  - Viewing Modes, 41
  - Volume, 30
  - Wall mounting, 10
  - Warranty, 48
  - Warranty services, 8
  - Watching TV
    - Basic Adjustments, 30
    - Basic connections, 25
    - First Startup, 25
    - Getting your programs, 29
    - Program Information, 30
  - Wide, 36
  - Wizard, 40

