



# REFRIGERATOR USER INSTRUCTIONS

THANK YOU for purchasing this high-quality product. If you should experience a problem not covered in TROUBLESHOOTING or PROBLEM SOLVER, please visit our website at [www.whirlpool.com](http://www.whirlpool.com) for additional information. If you still need assistance, call us at 1-800-253-1301. In Canada, visit our website at [www.whirlpool.ca](http://www.whirlpool.ca) or call us at 1-800-807-6777.

You will need your model and serial number, located on the inside wall of the refrigerator compartment.

## Table of Contents

<b>REFRIGERATOR SAFETY</b> .....	<b>2</b>	<b>SMART REFRIGERATOR FEATURES</b> .....	<b>16</b>
Proper Disposal of Your Old Refrigerator.....	3	Getting the Most from Your Smart Refrigerator.....	16
<b>INSTALLATION INSTRUCTIONS</b> .....	<b>3</b>	Using Smart Grid.....	16
Unpack the Refrigerator.....	3	Using Smart Features.....	16
Door Removal, Leveling and Alignment.....	4	<b>REFRIGERATOR CARE</b> .....	<b>17</b>
Handle Installation and Removal.....	7	Cleaning.....	17
Location Requirements.....	7	Lights.....	17
Electrical Requirements.....	8	Vacation and Moving Care.....	17
Water Supply Requirements.....	8	<b>PROBLEM SOLVER</b> .....	<b>18</b>
Connect Water Supply.....	8	<b>ACCESSORIES</b> .....	<b>23</b>
Install Air Filter.....	10	<b>WATER FILTER CERTIFICATIONS</b> .....	<b>24</b>
<b>REFRIGERATOR USE</b> .....	<b>11</b>	<b>PERFORMANCE DATA SHEET</b> .....	<b>25</b>
Using the Controls.....	11	<b>WARRANTY</b> .....	<b>26</b>
Convertible Drawer Temperature Control.....	12		
Crisper Humidity Control.....	12		
Chilled Door Bin.....	13		
Water and Ice Dispensers.....	13		
Ice Maker and Storage Bin.....	14		
Water Filtration System.....	15		

# REFRIGERATOR SAFETY

## Your safety and the safety of others are very important.

We have provided many important safety messages in this manual and on your appliance. Always read and obey all safety messages.



This is the safety alert symbol.

This symbol alerts you to potential hazards that can kill or hurt you and others.

All safety messages will follow the safety alert symbol and either the word "DANGER" or "WARNING."

These words mean:

**⚠ DANGER**

You can be killed or seriously injured if you don't immediately follow instructions.

**⚠ WARNING**

You can be killed or seriously injured if you don't follow instructions.

All safety messages will tell you what the potential hazard is, tell you how to reduce the chance of injury, and tell you what can happen if the instructions are not followed.

## IMPORTANT SAFETY INSTRUCTIONS

**WARNING:** To reduce the risk of fire, electric shock, or injury when using your refrigerator, follow these basic precautions:

- Plug into a grounded 3 prong outlet.
- Do not remove ground prong.
- Do not use an adapter.
- Do not use an extension cord.
- Disconnect power before servicing.
- Replace all parts and panels before operating.
- Remove doors from your old refrigerator.
- Use nonflammable cleaner.
- Keep flammable materials and vapors, such as gasoline, away from refrigerator.
- Use two or more people to move and install refrigerator.
- Disconnect power before installing ice maker (on ice maker kit ready models only).
- Use a sturdy glass when dispensing ice (on some models).
- Do not hit the refrigerator glass doors (on some models).

**SAVE THESE INSTRUCTIONS**

State of California Proposition 65 Warnings:

WARNING: This product contains one or more chemicals known to the State of California to cause cancer.

WARNING: This product contains one or more chemicals known to the State of California to cause birth defects or other reproductive harm.

## Proper Disposal of Your Old Refrigerator

### **⚠️ WARNING**

#### **Suffocation Hazard**

Remove doors from your old refrigerator.

Failure to do so can result in death or brain damage.

**IMPORTANT:** Child entrapment and suffocation are not problems of the past. Junked or abandoned refrigerators are still dangerous, even if they will sit for “just a few days.” If you are getting rid of your old refrigerator, please follow these instructions to help prevent accidents.

### **Before You Throw Away Your Old Refrigerator or Freezer:**

- Take off the doors.
- Leave the shelves in place so that children may not easily climb inside.

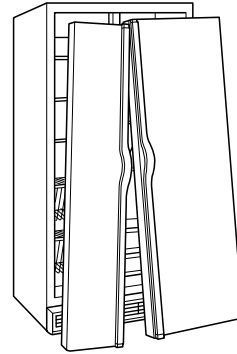

### **Important information to know about disposal of refrigerants:**

Dispose of refrigerator in accordance with Federal and Local regulations. Refrigerants must be evacuated by a licensed, EPA certified refrigerant technician in accordance with established procedures.

---

# INSTALLATION INSTRUCTIONS

---

## Unpack the Refrigerator

### **⚠️ WARNING**

#### **Excessive Weight Hazard**

Use two or more people to move and install refrigerator.

Failure to do so can result in back or other injury.

Remove packaging materials. Do not use sharp instruments, rubbing alcohol, flammable fluids, or abrasive cleaners to remove tape or glue. These products can damage the surface of your refrigerator. For more information, see “Refrigerator Safety.”

### **When Moving Your Refrigerator:**

Your refrigerator is heavy. When moving the refrigerator for cleaning or service, be sure to cover the floor with cardboard or hardboard to avoid floor damage. Always pull the refrigerator straight out when moving it. Do not wiggle or “walk” the refrigerator when trying to move it, as floor damage could occur.

### **Important information to know about glass shelves and covers:**

Do not clean glass shelves or covers with warm water when they are cold. Shelves and covers may break if exposed to sudden temperature changes or impact, such as bumping. Tempered glass is designed to shatter into many small, pebble-size pieces. This is normal. Glass shelves and covers are heavy. Use both hands when removing them to avoid dropping.

## Door Removal, Leveling and Alignment

Gather the required tools and parts and read all instructions before starting installation. Save these instructions for future reference.

**NOTE:** Before moving your product into your home, measure the doorway of your home to see whether you need to remove the refrigerator and freezer doors. If door removal is necessary, see the instructions below.

**IMPORTANT:** Before you begin, turn the refrigerator control OFF or turn cooling off. Unplug refrigerator or disconnect power. Remove food, the ice storage bin (on some models), and any adjustable door or utility bins from doors.

**TOOLS NEEDED:**

Bubble level, Phillips screwdriver, 3/16" hex key, 1/4" hex-head socket wrench, 1/4" and 5/16" open-ended wrenches or adjustable wrench, internal star drive or 3/8" hex-head socket wrench



### ⚠ WARNING

#### Electrical Shock Hazard

**Disconnect power before removing doors.**  
Failure to do so can result in death or electrical shock.

### 3 Wiring Connection

A. P-clamp  
B. Routing Plate  
C. Electrical Housing

D. Wiring Clip  
E. Grommets  
F. Wiring Plugs

### 4 Top Left Hinge

A. Do Not Remove Screws.

### 5 Door Removal

### 6 Top Right Hinge

A. Do Not Remove Screws.

### 7 Bottom Hinges (Left and Right)

A. Bottom Hinge  
B. Leveler Bracket  
C. Leveling Foot

### 8 Leveling

A. Bottom Hinge  
B. Leveler Bracket  
C. Leveling Foot

### 9 Door Alignment (Bottom Right Hinge)

A. Alignment Screw

### 1 Base Grille

Doors must be open to 90°

### 2A Water Dispenser Tubing Connection (Style 1)

A. Face of Fitting

### 2B Water Dispenser Tubing Connection (Style 2)

## Remove the Doors

### **⚠ WARNING**



#### Electrical Shock Hazard

Disconnect power before removing doors.

Failure to do so can result in death or electrical shock.

1. Unplug refrigerator or disconnect power.
2. Open both doors to 90°. Remove the base grille by removing the two screws, then pulling out on the outside corners. See *Graphic 1*.

**NOTE:** The doors must only be opened to 90°. If they are opened all the way, the base grille will not come off.

**IMPORTANT:** The Smart Grid antenna housing is mounted on the metal frame behind the base grille. Do not remove, open, crush, pull, kick or step on the antenna housing. Doing so can damage the antenna.

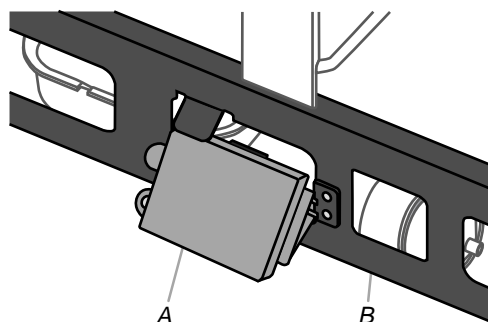

A. Antenna housing  
B. Metal frame

3. Disconnect the water tubing, located behind the base grille on the freezer door side. The dispenser tubing runs through the door hinge, and must be disconnected in order to remove the door.
  - **Style 1:** Press the colored outer ring against the face of fitting and pull the water tubing free. See *Graphic 2A*.

**NOTE:** Keep the water tubing connector attached to the tube that runs underneath the freezer. The door cannot be removed if the connector is still attached to the tube that runs through the door hinge.
  - **Style 2:** Firmly pull on the clasp to release the tube, then pull the water tubing free. See *Graphic 2B*.

**NOTE:** Keep the clasp attached to the tube that runs underneath the freezer.
4. Disconnect the wiring, located behind the base grille on the freezer door side. See *Graphic 3*.
  - Remove the P-clamp using a 1/4" hex-head socket wrench. Remove the small wiring bundle from the P-clamp.
  - Remove the wiring clip using a 1/4" hex-head socket wrench.
  - Pull the electrical housing out from under the refrigerator. Disconnect the wiring plugs from the housing.
  - Gently pull the large wiring bundle (with two white plugs) through the routing plate.

5. Close both doors and keep them closed until you are ready to lift them free from the cabinet.
6. Use a 3/16" hex key to remove the top left hinge screws as shown. See *Graphic 4*.

**IMPORTANT:** Do not remove either screw A.

### **⚠ WARNING**

#### Excessive Weight Hazard

Use two or more people to lift the freezer door.

Failure to do so can result in back or other injury.

7. Lift freezer door straight up off bottom hinge. See *Graphic 5*. The water tubing and wiring remain attached to the freezer door and pull through the bottom left hinge.

**NOTE:** This may require two people - one to lift the door and another to feed the water tubing and wiring through the hinge. Be sure the hole in the hinge is clear of obstructions, then gently pull one water tube through the hinge. (Avoid kinking the tube.) Next, gently pull the other water tube through the hinge, again avoiding kinks. Finally, gently pull the wiring bundle (including the grommet and wiring plugs) through the hinge.

**IMPORTANT:** Rest the door on its side on a soft, clean surface, such as a towel, blanket or piece of cardboard. This will help avoid damaging the door, water tubing and wiring.

8. Use a 3/16" hex key to remove the top right hinge screws as shown. See *Graphic 6*.

**IMPORTANT:** Do not remove either screw A.
9. Lift the refrigerator door straight up off bottom hinge.

**IMPORTANT:** Rest the door on its side on a soft, clean surface, such as a towel, blanket or piece of cardboard. This will help avoid damaging the door.
10. It may not be necessary to remove the bottom hinges to move the refrigerator through a doorway. Both bottom hinges have similar construction.

■ If necessary, use an internal star drive or a 3/8" hex-head socket wrench to remove the bottom hinges. See *Graphic 7*.

**IMPORTANT:** The leveler brackets are mounted behind the hinges. If you remove the hinges, make sure that the leveler brackets are replaced when reinstalling the hinges.

## Replace the Doors and Hinges

1. Replace both bottom hinges, if removed. Make sure that the leveler brackets are assembled behind the hinges. Tighten screws.

**IMPORTANT:** When the screws are tightened properly, there should not be any gaps between the refrigerator, leveler bracket and hinge.

**NOTE:** There are two wiring bundles that run underneath the freezer - a large bundle with a large grommet and two white plugs at the end, and a small bundle with a small grommet and one yellow plug at the end.

## **⚠ WARNING**

### **Excessive Weight Hazard**

**Use two or more people to lift the freezer door.**

**Failure to do so can result in back or other injury.**

2. Before replacing the freezer door on the bottom left hinge, feed the small wiring bundle through the hinge. Assistance may be needed.

**IMPORTANT:** Do not feed the large wiring bundle through the hinge. This bundle is intended to run directly from the door to the connections beneath the freezer. Forcing the large bundle through the hinge may damage the door and/or the wiring, and will keep the door from closing properly.

3. Feed both water tubes through the bottom left hinge, then replace the freezer door on the hinge. Assistance may be needed.

**NOTE:** Provide additional support for the doors while the top hinges are being replaced. Do not depend on the door magnets to hold the doors in place while you are working.

4. Align and replace the top left hinge as shown. See *Graphic 4*. Tighten screws.

5. Reconnect water tubing and wiring.

**IMPORTANT:** Do not intertwine the water tubing and wiring bundles when reconnecting them.

- **Water Connection Style 1:** Push the larger  $\frac{5}{16}$ " (7.94 mm) water tube into the blue fitting until it stops, then push the smaller  $\frac{1}{4}$ " (6.35 mm) water tube into the green fitting until it stops. See *Graphic 2A*.

**Water Connection Style 2:** Push the black water tube with the blue tip into the blue fitting until it stops. Close the clasp around the tubing, making sure it snaps into place. Repeat this process to connect the red-tipped black water tube and the red fitting. See *Graphic 2B*.

- Reinstall the P-clamp around the small wiring bundle (with one yellow plug), then replace the P-clamp on the top screw hole of the routing plate. See *Graphic 3*.
- Gently route the large wiring bundle (with two white plugs) through the hole in the routing plate, so that the wiring runs behind the right side of the routing plate. See *Graphic 3*.

**NOTE:** The large wiring bundle should always remain below the small wiring bundle.

- Reconnect the wiring plugs to the electrical housing, then push the housing back under the refrigerator. Align the left hole in the front lip of the housing with the right hole in the refrigerator's base crossbar. See *Graphic 3*.
- Reinstall the wiring clip over the grommets. First install the smaller grommet into the top of the clip, then install the larger grommet into the bottom of the clip (closest to the screw hole). See *Graphic 3*.
- Align the clip's screw hole with the left hole in the electrical housing and the right hole in the crossbar, and screw in the clip using a single screw. Tighten screw. See *Graphic 3*.

**IMPORTANT:** Once connected, the wiring bundles should not be taut. Some flexibility is needed to allow the freezer door to open properly.

6. Replace the refrigerator door by lifting the door onto the bottom right hinge.
7. Align and replace the top right hinge as shown. See *Graphic 6*. Tighten screws.
8. Replace the ice storage bin (on some models) and any adjustable door or utility bins.
9. Plug refrigerator into a grounded 3 prong outlet.

## **Leveling and Door Closing**

Your refrigerator has two adjustable front feet — one on the right and one on the left. In most cases, the refrigerator should be steady when both feet are touching the floor. If your refrigerator seems unsteady or if you want the doors to close more easily, adjust the refrigerator's tilt using the instructions below:

1. Move the refrigerator into its final location. If necessary, open both doors to 90° and remove the base grille. See *Graphic 1*.
2. The two leveling feet are located on the brackets on each side of the product. See *Graphic 8*.

**NOTE:** Having someone push against the top of the refrigerator takes some weight off the leveling feet. This makes it easier to make adjustments.

3. Use a  $\frac{1}{4}$ " open-ended or adjustable wrench to adjust the leveling feet. Turn the leveling foot to the left to raise that side of the product, or turn it to the right to lower that side of the product.
4. Open both doors again and check that they close as easily as you like. If not, tilt the refrigerator slightly more to the rear by turning the leveling feet to the left. It may take several more turns, and you should turn both leveling feet the same amount.

5. Use a bubble level to check the leveling of the refrigerator.

**NOTE:** Whenever you need to move the refrigerator, turn the leveling feet to the right until they are no longer touching the ground. This will allow the refrigerator to roll more easily.

## **Door Alignment**

A refrigerator that is not level from side-to-side may appear to have doors that are not properly aligned. If the doors appear this way, use the instructions in the previous section to check the leveling.

The doors are designed to be slightly different heights when the refrigerator is empty, in order to account for the weight of food that will be placed on the doors. If the doors are still not aligned after checking the leveling and loading the refrigerator with food, follow the steps below to adjust the door alignment.

1. If necessary, open both doors to 90° and remove the base grille. See *Graphic 1*.
2. Locate the alignment screw on the bottom hinge of the refrigerator door. See *Graphic 9*.
3. Use a  $\frac{5}{16}$ " open-ended or adjustable wrench to turn the screw. To raise the refrigerator door, turn the screw to the right. To lower the door, turn the screw to the left.
4. Check that the doors are even at the top. If necessary, continue to turn the alignment screw until the doors are aligned.
5. Open both doors to 90°. Replace the base grille. See *Graphic 1*.

## Handle Installation and Removal

**PARTS INCLUDED:** Door handles (2), 1/8" hex key, spare setscrew(s)

### To Install the Handles:

**NOTE:** The handle mounting setscrews are preinstalled in the handle.

1. Remove the handles, which are packed inside the refrigerator.

**NOTE:** To avoid scratching the finish, place the handles on a towel or other soft surface.

2. Open the freezer door. On the refrigerator door, place the handle on the shoulder screws with the setscrews facing the freezer.

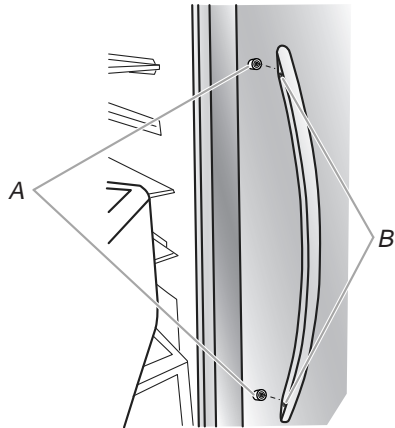

A. Shoulder screws  
B. Setscrews inside the handle

3. Firmly push the handle toward the door until the handle base is flush against the door.
4. While holding the handle, insert the short end of the hex key into the upper hole and slightly rotate the hex key until it is engaged in the setscrew.

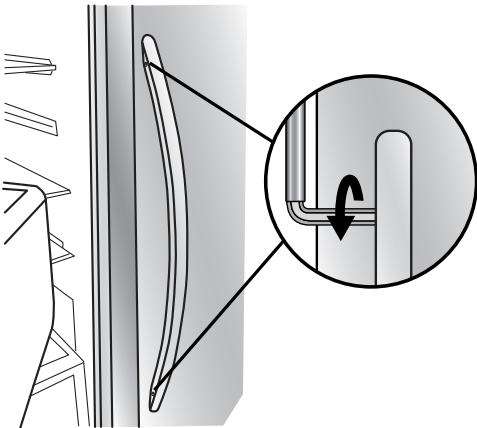

5. Using a clockwise motion, tighten the setscrew until it begins to contact the shoulder screw.
6. Repeat steps 4 and 5 to begin fastening the lower setscrew.
7. Once both setscrews have been partially tightened as outlined in the previous steps, fully tighten both the upper and lower setscrews.  
**IMPORTANT:** When the screws feel tight, tighten them an additional quarter-turn. The handle is not properly installed without this extra tightening.
8. Open the refrigerator door and close the freezer door. Repeat steps 2 through 7 to install the other handle onto the freezer door with the setscrews facing the refrigerator.
9. Save the hex key and all instructions.

### To Remove the Handles:

1. While holding the handle, insert the short end of the hex key into the lower setscrew hole and slightly rotate the hex key until it is engaged in the setscrew.
2. Using a counterclockwise motion, loosen the setscrew a quarter-turn at a time.
3. Repeat steps 1 and 2 for the upper setscrew. Gently pull the handle away from the door.
4. If necessary, use a Phillips screwdriver to remove the shoulder screws from the door.

## Location Requirements

### ! WARNING



#### Explosion Hazard

Keep flammable materials and vapors, such as gasoline, away from refrigerator.

Failure to do so can result in death, explosion, or fire.

**IMPORTANT:** This refrigerator is designed for indoor household use only.

To ensure proper ventilation for your refrigerator, allow for 1/2" (1.27 cm) of space on each side and at the top. Allow for 1" (2.54 cm) of space behind the refrigerator. If your refrigerator has an ice maker, allow extra space at the back for the water line connections. When installing your refrigerator next to a fixed wall, leave a 2" (5.08 cm) minimum space on each side (depending on your model) to allow the doors to swing open.

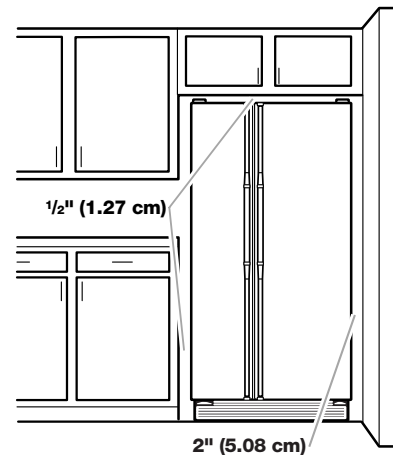

### NOTES:

- This refrigerator is intended for use in a location where the temperature ranges from a minimum of 55°F (13°C) to a maximum of 110°F (43°C). The preferred room temperature range for optimum performance, which reduces electricity usage and provides superior cooling, is between 60°F (15°C) and 90°F (32°C). It is recommended that you do not install the refrigerator near a heat source, such as an oven or radiator.
- Normal minimum cabinet cut-out width required for product installation is 36" (91.44 cm). However, if the product is placed against an extended wall and the ability to remove the crisper pans is desired, an additional 18" (45.72 cm) of cabinet width is required, so a total cabinet opening width of 54" (137.16 cm) is recommended.

## Electrical Requirements

### **⚠ WARNING**



#### Electrical Shock Hazard

Plug into a grounded 3 prong outlet.

Do not remove ground prong.

Do not use an adapter.

Do not use an extension cord.

Failure to follow these instructions can result in death, fire, or electrical shock.

Before you move your refrigerator into its final location, it is important to make sure you have the proper electrical connection.

#### Recommended Grounding Method

A 115 volt, 60 Hz, AC only, 15- or 20-amp fused, grounded electrical supply is required. It is recommended that a separate circuit serving only your refrigerator be provided. Use an outlet that cannot be turned off by a switch. Do not use an extension cord.

**NOTE:** Before performing any type of installation or cleaning, or removing a light bulb, turn cooling off or turn the control (Thermostat, Refrigerator or Freezer Control depending on the model) to OFF, and then disconnect the refrigerator from the electrical source. When you are finished, reconnect the refrigerator to the electrical source and turn cooling on or reset the control (Thermostat, Refrigerator or Freezer Control depending on the model) to the desired setting. See “Using the Controls” in the User Instructions, User Guide, or Use & Care Guide.

## Water Supply Requirements

Gather the required tools and parts before starting installation. Read and follow the instructions provided with any tools listed here.

#### TOOLS NEEDED:

- Flat-blade screwdriver
- 1/4" Nut driver
- 7/16" and 1/2" Open-end or two adjustable wrenches
- 1/4" Drill bit
- Cordless drill

**NOTE:** Your refrigerator dealer has a kit available with a 1/4" (6.35 mm) saddle-type shutoff valve, a union, and copper tubing. Before purchasing, make sure a saddle-type valve complies with your local plumbing codes. Do not use a piercing-type or 3/16" (4.76 mm) saddle valve which reduces water flow and clogs more easily.

#### IMPORTANT:

- All installations must meet local plumbing code requirements.
- Use copper tubing and check for leaks. Install copper tubing only in areas where the household temperatures will remain above freezing.

## Water Pressure

A cold water supply with water pressure of between 30 and 120 psi (207 and 827 kPa) is required to operate the water dispenser and ice maker. If you have questions about your water pressure, call a licensed, qualified plumber.

- If your refrigerator has a water dispenser: After installation is complete, use the water dispenser to check the water pressure.
  - With the water filter removed, dispense 1 cup (237 mL) of water. If 1 cup of water is dispensed in 8 seconds or less, the water pressure to the refrigerator meets the minimum requirement.
  - If it takes longer than 8 seconds to dispense 1 cup of water, the water pressure to the refrigerator is lower than recommended. See “Problem Solver” for suggestions.

#### Reverse Osmosis Water Supply

**IMPORTANT:** The pressure of the water supply coming out of a reverse osmosis system going to the water inlet valve of the refrigerator needs to be between 30 and 120 psi (207 and 827 kPa).

If a reverse osmosis water filtration system is connected to your cold water supply, the water pressure to the reverse osmosis system needs to be a minimum of 40 to 60 psi (276 to 414 kPa). If the water pressure to the reverse osmosis system is less than 40 to 60 psi (276 to 414 kPa):

- Check to see whether the sediment filter in the reverse osmosis system is blocked. Replace the filter if necessary.
- Allow the storage tank on the reverse osmosis system to refill after heavy usage.
- If your refrigerator has a water filter, it may further reduce the water pressure when used in conjunction with a reverse osmosis system. Remove the water filter. See “Water Filtration System” in the User Instructions, User Guide, or Use & Care Guide.

If you have questions about your water pressure, call a licensed, qualified plumber.

## Connect Water Supply

Read all directions before you begin.

#### IMPORTANT:

- Plumbing shall be installed in accordance with the International Plumbing Code and any local codes and ordinances.
- The gray water tubing on the back of the refrigerator (which is used to connect to the household water line) is a PEX (cross-linked polyethylene) tube. Copper and PEX tubing connections from the household water line to the refrigerator are acceptable, and will help avoid off-taste or odor in your ice or water. Check for leaks.

If PEX tubing is used instead of copper, we recommend the following Whirlpool Part Numbers:  
W10505928RP (7 ft [2.14 m] jacketed PEX),  
8212547RP (5 ft [1.52 m] PEX), or  
W10267701RP (25 ft [7.62 m] PEX).

- Install tubing only in areas where temperatures will remain above freezing.

#### TOOLS NEEDED:

Gather the required tools and parts before starting installation.

- Flat-blade screwdriver
- 7/16" and 1/2" open-end wrenches or two adjustable wrenches
- 1/4" nut driver



## Connect to Water Line

**IMPORTANT:** If you turn the refrigerator on before the water line is connected, turn the ice maker OFF.

### Style 1 (Recommended)

1. Unplug refrigerator or disconnect power.
2. Turn OFF main water supply. Turn ON nearest faucet long enough to clear line of water.
3. Use a quarter-turn shutoff valve or the equivalent, served by a ½" copper household supply line.

**NOTE:** To allow sufficient water flow to the refrigerator, a minimum ½" size copper household supply line is recommended.

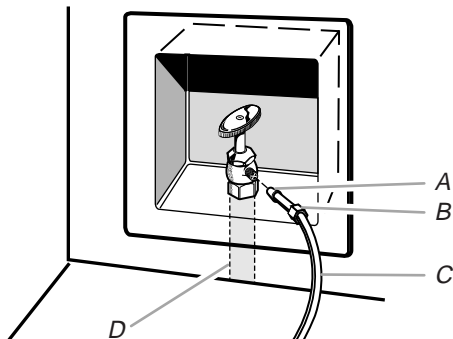

A. Bulb  
B. Nut  
C. Copper tubing (to refrigerator)  
D. Household supply line (½" minimum)

4. Now you are ready to connect the copper tubing to the shutoff valve. Use ¼" (6.35 mm) OD soft copper tubing to connect the shutoff valve and the refrigerator.
  - Ensure that you have the proper length needed for the job. Be sure both ends of the copper tubing are cut square.
  - Slip compression sleeve and compression nut onto copper tubing as shown. Insert end of tubing into outlet end squarely as far as it will go. Screw compression nut onto outlet end with adjustable wrench. Do not overtighten.

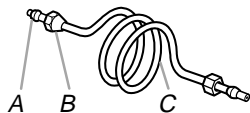

A. Compression sleeve  
B. Compression nut  
C. Copper tubing

5. Place the free end of the tubing into a container or sink, and turn on main water supply to flush out tubing until water is clear. Turn off shutoff valve on the water pipe.

**NOTE:** Always drain the water line before making the final connection to the inlet of the water valve, to avoid possible water valve malfunction.

6. Bend the copper tubing to meet the water line inlet, which is located on the back of the refrigerator cabinet as shown. Leave a coil of copper tubing to allow the refrigerator to be pulled out of the cabinet or away from the wall for service.

### Style 2

1. Unplug refrigerator or disconnect power.
2. Turn OFF main water supply. Turn ON nearest faucet long enough to clear line of water.
3. Locate a ½" (1.27 cm) to 1¼" (3.18 cm) vertical cold water pipe near the refrigerator.

### IMPORTANT:

- Make sure it is a cold water pipe.
  - Horizontal pipe will work, but drill on the top side of the pipe, not the bottom. This will help keep water away from the drill and normal sediment from collecting in the valve.
4. Determine the length of copper tubing you need. Measure from the connection on the lower rear corner of refrigerator to the water pipe. Add 7 ft (2.1 m) to allow for cleaning. Use ¼" (6.35 mm) O.D. (outside diameter) copper tubing. Be sure both ends of copper tubing are cut square.
  5. Using a cordless drill, drill a ¼" (6.35 mm) hole in the cold water pipe you have selected.

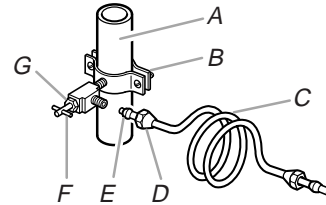

A. Cold water pipe  
B. Pipe clamp  
C. Copper tubing  
D. Compression nut  
E. Compression sleeve  
F. Shutoff valve  
G. Packing nut

6. Fasten the shutoff valve to the cold water pipe with the pipe clamp. Be sure the outlet end is solidly in the ¼" (6.35 mm) drilled hole in the water pipe and that the washer is under the pipe clamp. Tighten the packing nut. Tighten the pipe clamp screws slowly and evenly so the washer makes a watertight seal. Do not overtighten, or you may crush the copper tubing.
7. Slip the compression sleeve and compression nut on the copper tubing as shown. Insert the end of the tubing into the outlet end squarely as far as it will go. Screw the compression nut onto outlet end with adjustable wrench. Do not overtighten.
8. Place the free end of the tubing in a container or sink, and turn ON the main water supply. Flush the tubing until water is clear. Turn OFF the shutoff valve on the water pipe. Coil the copper tubing.

## Connect to Refrigerator

### Style 1

1. Unplug refrigerator or disconnect power.
2. Remove and discard the short, black plastic part from the end of the water line inlet.
3. Thread the nut onto the end of the tubing. Tighten the nut by hand. Then tighten it with a wrench two more turns. Do not overtighten.

**NOTE:** To avoid rattling, be sure the copper tubing does not touch the cabinet's side wall or other parts inside the cabinet.

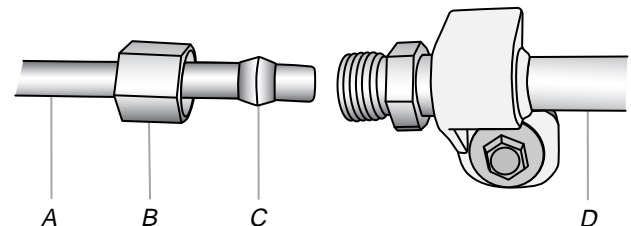

A. Household water line  
B. Nut (purchased)  
C. Ferrule (purchased)  
D. Refrigerator water tubing

4. Install the water supply tube clamp around the water supply line to reduce strain on the coupling.
5. Turn shutoff valve ON.
6. Check for leaks. Tighten any connections (including connections at the valve) or nuts that leak.

## Style 2

1. Unplug refrigerator or disconnect power.
2. Remove and discard the plastic part that is attached to the inlet of the water valve.
3. Attach the copper tube to the valve inlet using a compression nut and sleeve as shown. Tighten the compression nut. Do not overtighten.
4. Use the tube clamp on the back of the refrigerator to secure the tubing to the refrigerator as shown. This will help avoid damage to the tubing when the refrigerator is pushed back against the wall.
5. Turn shutoff valve ON.
6. Check for leaks. Tighten any connections (including connections at the valve) or nuts that leak.

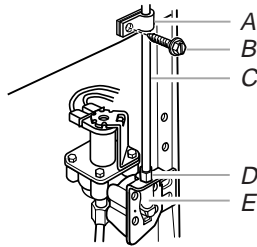

A. Tube clamp  
B. Tube clamp screw  
C. Copper tubing  
D. Compression nut  
E. Valve inlet

7. On some models, the ice maker is equipped with a built-in water strainer. If your water conditions require a second water strainer, install it in the  $\frac{1}{4}$ " (6.35 mm) water line at either tube connection. Obtain a water strainer from your nearest appliance dealer.

## Style 3

1. Unplug refrigerator or disconnect power.
2. Remove and discard the black nylon plug from the gray water tube on the rear of the refrigerator.
3. If the gray water tube supplied with the refrigerator is not long enough, a  $\frac{1}{4}$ " x  $\frac{1}{4}$ " (6.35 mm x 6.35 mm) coupling is needed in order to connect the water tubing to an existing household water line. Thread the provided nut onto the coupling on the end of the copper tubing.

**NOTE:** Tighten the nut by hand. Then tighten it with a wrench two more turns. Do not overtighten.

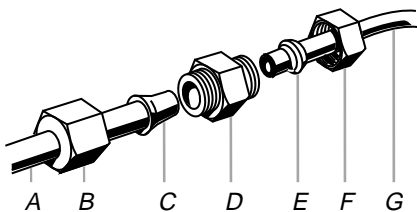

A. Refrigerator water tubing  
B. Nut (provided)  
C. Bulb  
D. Coupling (purchased)  
E. Ferrule (purchased)  
F. Nut (purchased)  
G. Household water line

4. Turn shutoff valve ON.
5. Check for leaks. Tighten any nuts or connections (including connections at the valve) that leak.

## Complete the Installation

### ⚠ WARNING



#### Electrical Shock Hazard

Plug into a grounded 3 prong outlet.

Do not remove ground prong.

Do not use an adapter.

Do not use an extension cord.

Failure to follow these instructions can result in death, fire, or electrical shock.

1. Plug into a grounded 3 prong outlet.
2. Flush the water system. See "Water and Ice Dispensers" in the User Instructions or User Guide.

**NOTE:** Allow 24 hours to produce the first batch of ice. Allow 72 hours to completely fill ice container.

## Install Air Filter (on some models)

On some models, your refrigerator's accessory packet includes an air filter, which must be installed prior to use. On some models, the air filter is already installed at the factory.

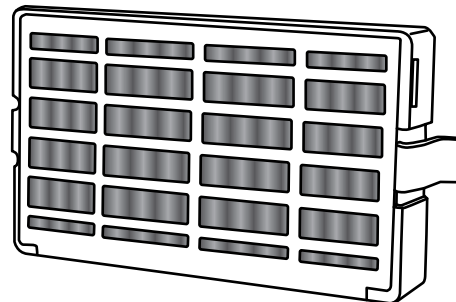

The air filter reduces the buildup of odors. This helps to maintain a cleaner environment inside the refrigerator.

### Installing the Air Filter (on some models)

The filter should be installed behind the vented door, which is located (depending on your model) along either the rear or left interior wall near the top of the refrigerator compartment.

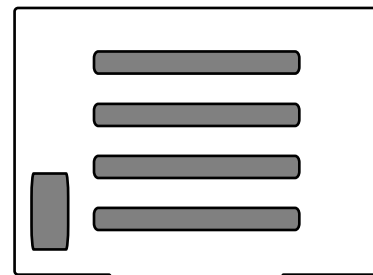

1. Remove the air filter from its packaging.
2. Lift open the vented door.

- Snap the filter into place.

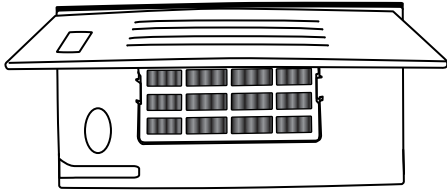

- Close the vented door.

### Installing the Filter Status Indicator (on some models)

The filter comes with a status indicator, which should be activated and installed at the same time the air filter is installed.

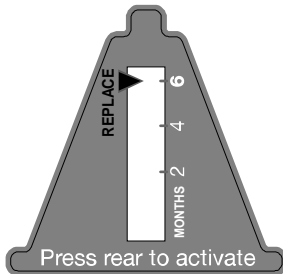

- Place the indicator face-down on a firm, flat surface.
- Apply pressure to the bubble on the back of the indicator, until the bubble pops to activate the indicator.
- Lift open the vented air filter door. On some models, there are notches behind the door.
- On models with notches:**
  - Slide the indicator down into the notches, facing outward.
 

**NOTE:** The indicator will not easily slide into the notches if the rear bubble has not been popped.
  - Close the air filter door, and check that the indicator is visible through the rectangular hole in the door.

#### On models without notches:

- Store the indicator in a visible place you will easily remember - either inside the refrigerator, or elsewhere in your kitchen or home.

### Replacing the Air Filter

The disposable air filter should be replaced every 6 months, when the status indicator has completely changed from white to red.

To order a replacement air filter, see “Accessories.”

- Remove the old air filter by squeezing in on the side tabs.
- Remove the old status indicator.
- Install the new air filter and status indicator using the instructions in the previous sections.

# REFRIGERATOR USE

## Using the Controls

The refrigerator and freezer controls are located on the dispenser panel.

**IMPORTANT:** The display screen on the dispenser control panel will turn off automatically and enter “sleep” mode when the control buttons and dispenser pads have not been used for 2 minutes or more. While in “sleep” mode, the first press of a control button will only reactivate the display screen, without changing any settings.

- Touch any control button on the dispenser panel to activate the display screen. The home screen will appear as shown.

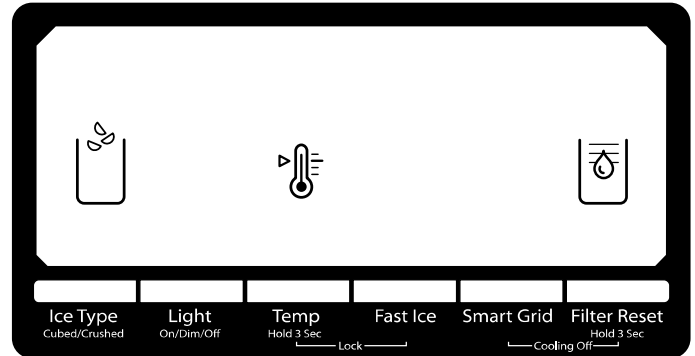

## Adjusting the Controls

For your convenience, your refrigerator and freezer controls are preset at the factory. When you first install your refrigerator, make sure that the controls are still set to the “mid-settings.” The factory recommended set points are 37°F (3°C) for the refrigerator and 0°F (-18°C) for the freezer.

### IMPORTANT:

- Wait 24 hours before you put food into the refrigerator. If you add food before the refrigerator has cooled completely, your food may spoil.
 

**NOTE:** Adjusting the set points to a colder than recommended setting will not cool the compartments any faster.
- If the temperature is too warm or too cold in the refrigerator or freezer, first check the air vents to be sure they are not blocked before adjusting the controls.
- The preset settings should be correct for normal household usage. The controls are set correctly when milk or juice is as cold as you like and when ice cream is firm.
- Wait at least 24 hours between adjustments. Recheck the temperatures before other adjustments are made.

To view and adjust the set points, press and hold the TEMP button for 3 seconds. When adjust mode is activated, adjusting information will appear on the display screen.

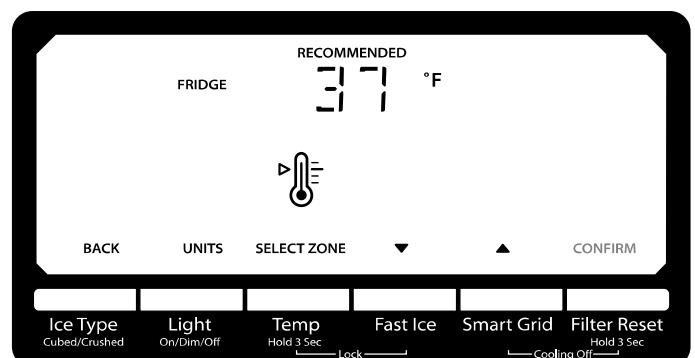

**NOTE:** To view Celsius temperatures, press the LIGHT button when adjust mode is activated. To return the display setting to Fahrenheit, press LIGHT again.

- When adjust mode is activated, the display screen shows the refrigerator set point and “FRIDGE” appears.
- Press SMART GRID to raise the set point, or press FAST ICE to lower the set point.
- When you have finished viewing (and adjusting if desired) the refrigerator set point, press TEMP to change the display to show the freezer set point. When the zone has been changed, “FREEZER” appears on the display screen.
- Press SMART GRID to raise the set point, or press FAST ICE to lower the set point.
- When you have finished viewing (and adjusting if desired) both the refrigerator and freezer set points, press FILTER to save the settings.

**NOTE:** To exit without saving changes, press ICE TYPE at any time while in adjust mode, or allow about 60 seconds of inactivity and adjust mode will turn off automatically.

When adjusting temperature set points, use the following chart as a guide.

CONDITION:	TEMPERATURE ADJUSTMENT:
REFRIGERATOR too cold	REFRIGERATOR Setting 1° higher
REFRIGERATOR too warm	REFRIGERATOR Setting 1° lower
FREEZER too cold	FREEZER Setting 1° higher
FREEZER too warm / Too little ice	FREEZER Setting 1° lower

The set point range for the refrigerator is 33°F to 45°F (0°C to 7°C). The set point range for the freezer is -5°F to 5°F (-21°C to -15°C).

### Cooling On/Off

Your refrigerator and freezer will not cool when cooling is turned off.

- To turn cooling off, press and hold the SMART GRID and FILTER buttons at the same time for 3 seconds.

**IMPORTANT:** To avoid unintentionally locking the dispenser or changing other settings, be sure to press both buttons at exactly the same time.

When cooling is off, “COOLING OFF” will appear on the display screen.

- Press and hold SMART GRID and FILTER for 3 seconds again to turn cooling back on.

### Smart Grid

See “Smart Refrigerator Features” for information about setting up Smart Grid functionality, turning it on and off, receiving important notifications, and taking advantage of available features.

### Delay Ice

For information about the Delay Ice feature that is associated with Smart Grid functionality, see “Smart Refrigerator Features.”



## Additional Features

### Fast Ice

The Fast Ice feature assists with temporary periods of heavy ice use by increasing ice production over a 24-hour period.

**IMPORTANT:** This feature only works if the ice maker is turned on. See “Ice Maker and Storage Bin.”

- Press FAST ICE to turn on the Fast Ice feature. When the feature is on, the Fast Ice icon will appear on the dispenser display screen. The Fast Ice setting will remain on for 24 hours unless manually turned off.



- To manually turn off the Fast Ice feature, press FAST ICE again or adjust the freezer temperature set point. The Fast Ice icon will disappear when the feature is off.

**NOTE:** If increased ice production is desired at all times, change the freezer set point to a lower setting. Setting the freezer to a colder temperature may make some foods, such as ice cream, harder.

### Door Ajar Alarm

The Door Ajar Alarm feature sounds an alarm when the refrigerator or freezer door is open for 5 minutes and the product cooling is turned on. The alarm will repeat every 2 minutes. Close both doors to turn it off. The feature then resets and will reactivate when either door is left open again for 5 minutes.

**NOTE:** To mute the audible alarm while keeping the doors open, such as while cleaning the inside of the refrigerator, press any button on the control panel. The alarm sound will be temporarily turned off, but the Door Ajar icon will still be displayed on the dispenser control panel.



## Convertible Drawer Temperature Control (on some models)

The control can be adjusted to properly chill meats or vegetables. The air inside the pan is cooled to avoid “spot” freezing and can be set to keep meats at the National Livestock and Meat Board recommended storage temperatures of 28° to 32°F (-2° to 0°C).

### To store meat:

Set the control to one of the three MEAT settings to store meat at its optimal storage temperature.

### To store vegetables:

Set the control to VEG to store vegetables at their optimal storage temperatures.

**NOTE:** If food starts to freeze, move the control to the right (less cold), toward the VEG setting. Remember to wait 24 hours between adjustments.

## Crisper Humidity Control (on some models)

You can control the amount of humidity in the moisture-sealed crisper. Adjust the control to any setting between LOW and HIGH.

**LOW** (open) for best storage of fruits and vegetables with skins.

**HIGH** (closed) for best storage of fresh, leafy vegetables.

---

## Chilled Door Bin

(on some models)

Cool air from the freezer is directed to the refrigerator door bin directly beneath the vents.

**NOTE:** The dairy compartment and can rack are not associated with the Chilled Door Bin feature.

---

### Chilled Door Bin Control

The chilled door bin control is located on the left-hand side of the refrigerator compartment.

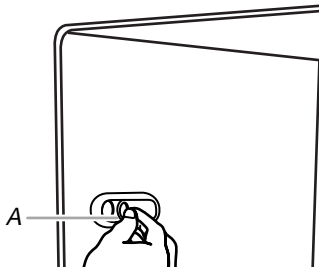

A. Chilled door bin control

- Slide the door chill control to the left to reduce the flow of cold air to the bin and make it less cold.
- Slide the door chill control to the right to increase the flow of cold air to the bin and make it colder.

---

## Water and Ice Dispensers

### NOTES:

- The dispensing system will not operate when either door (refrigerator or freezer) is open.
- Allow 24 hours for the refrigerator to cool down and chill water.
- Allow 24 hours to produce the first batch of ice. Discard the first three batches of ice produced. Wait 72 hours for full ice production.
- The display screen on the dispenser control panel will turn off automatically and enter “sleep” mode when the control buttons and dispenser pads have not been used for 2 minutes or more. While in “sleep” mode, the first press of a control button will only reactivate the display screen, without changing any settings.

---

### Flush the Water System

Air in the water dispensing system can cause the water dispenser to drip. After connecting the refrigerator to a water source or replacing the water filter, flush the water system. Flushing the water dispensing system forces air from the water line and filter, and prepares the water filter for use.

**NOTE:** As air is cleared from the system, water may spurt out of the dispenser.

1. Using a sturdy container, depress and hold the water dispenser pad for 5 seconds, then release it for 5 seconds.
2. Repeat Step 1 until water begins to flow.
3. Once water begins to flow, continue depressing and releasing the dispenser pad (5 seconds on, 5 seconds off) until a total of 3 gal. (12 L) has been dispensed.

Additional flushing may be required in some households.

---

## The Water Dispenser

### IMPORTANT:

- Dispense at least 1 qt (1 L) of water every week to maintain a fresh supply.
- If the flow of water from the dispenser decreases, it could be caused by low water pressure.
  - With the water filter removed, dispense 1 cup (237 mL) of water. If 1 cup of water is dispensed in 8 seconds or less, the water pressure to the refrigerator meets the minimum requirement.
  - If it takes longer than 8 seconds to dispense 1 cup of water, the water pressure to the refrigerator is lower than recommended. See “Water Supply Requirements” or “Problem Solver” for suggestions.

### To Dispense Water:

1. Press a sturdy glass against the water dispenser pad. Hold the glass close to the water dispenser spout to ensure that the water dispenses into the glass.

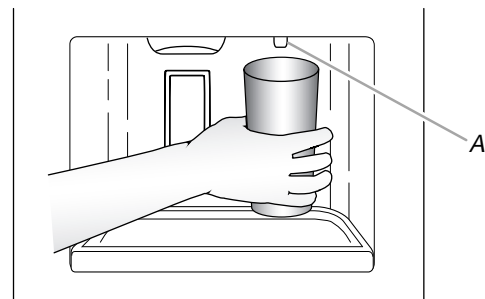

A. Water dispenser spout

2. Remove the glass to stop dispensing.

---

## The Ice Dispenser

Ice dispenses from the ice maker storage bin in the freezer when the dispenser pad is pressed. To turn off the ice maker, see “Ice Maker and Storage Bin.”

Your ice maker can produce both crushed and cubed ice. Before dispensing ice, select which type of ice you prefer by pressing the ICE TYPE button.

The display screen indicates which type of ice is selected.

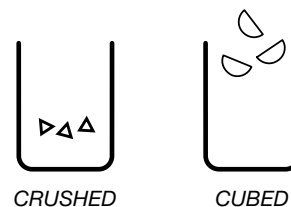

For crushed ice, cubes are crushed before being dispensed. This may cause a slight delay when dispensing crushed ice. Noise from the ice crusher is normal, and pieces of ice may vary in size. When changing from crushed to cubed, a few ounces of crushed ice will be dispensed along with the first cubes.

## To Dispense Ice:

1. Make sure the desired type of ice is selected. To switch between cubed and crushed, press ICE TYPE.

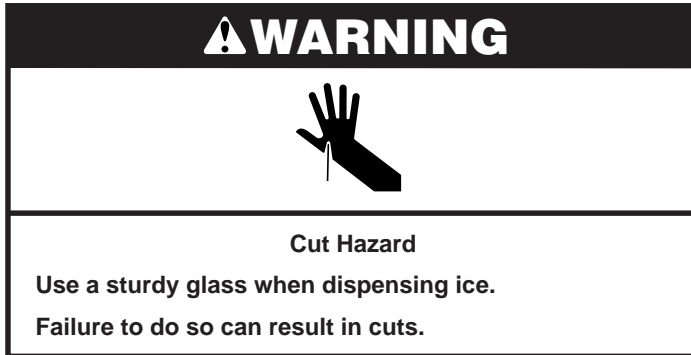

2. Press a sturdy glass against the ice dispenser pad. Hold the glass close to the ice guide to ensure that the ice dispenses into the glass.

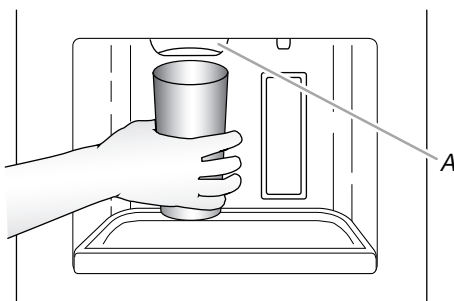

A. Ice guide

**IMPORTANT:** You do not need to apply a lot of pressure to the pad in order to activate the ice dispenser. Pressing hard will not make the ice dispense faster or in greater quantities.

3. Remove the glass to stop dispensing.

**NOTE:** Ice may continue to dispense for several seconds after removing the glass from the pad. The dispenser may continue to make noise for a few seconds after dispensing.

## The Dispenser Light

When you use the dispenser, the light will automatically turn on. If you want the light to be on continuously, you may choose either ON or DIM. The display screen indicates which mode is selected.

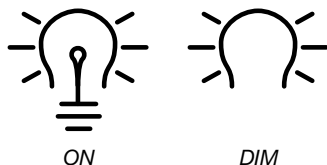

**ON:** Press LIGHT to turn the dispenser light on.

**DIM:** Press LIGHT a second time to select DIM mode. The dispenser light will remain on, but at a lower intensity.

**OFF:** Press LIGHT a third time to turn the dispenser light off.

The dispenser lights are LEDs that cannot be changed. If it appears that your dispenser lights are not working, see “Problem Solver” for more information.

## The Dispenser Lock

The dispenser can be turned off for easy cleaning or to avoid unintentional dispensing by small children and pets.

**NOTE:** The lock feature does not shut off power to the refrigerator, to the ice maker, or to the dispenser light. It simply deactivates the controls and dispenser pads. To turn off the ice maker, see “Ice Maker and Storage Bin.”

- Press and hold the TEMP and FAST ICE buttons at the same time for 3 seconds to lock the dispenser.

**IMPORTANT:** To avoid unintentionally locking the dispenser or changing other settings, be sure to press both buttons at exactly the same time.

- Press and hold the TEMP and FAST ICE buttons at the same time again to unlock the dispenser.

The display screen indicates when the dispenser is locked.



## Ice Maker and Storage Bin

- Allow 24 hours to produce the first batch of ice. Discard the first three batches of ice produced.
- The quality of your ice will be only as good as the quality of the water supplied to your ice maker. Avoid connecting the ice maker to a softened water supply. Water softener chemicals (such as salt) can damage parts of the ice maker and lead to poor quality ice. If a softened water supply cannot be avoided, make sure the water softener is operating properly and is well maintained.
- Do not use anything sharp to break up the ice in the storage bin. This can cause damage to the ice container and the dispenser mechanism.
- Do not store anything on top of or in the ice maker or storage bin.

## Turning the Ice Maker On/Off

The On/Off switch can only be accessed when the ice storage bin has been removed. The switch is located on the freezer door, on the left side of the wall that surrounds the ice storage bin. See the following section for bin removal instructions.

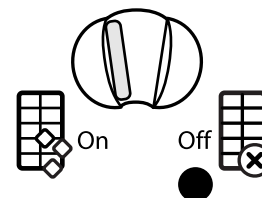

## Ice Maker Control

- To turn on the ice maker, slide the control to the ON (left) position.
- To manually turn off the ice maker, slide the control to the OFF (right) position.

**NOTE:** The ice maker has an automatic shutoff to keep the storage bin from overflowing during normal operation. The ice maker sensors will automatically stop ice production, but the control will remain in the ON (left) position.

## Removing and Replacing the Ice Storage Bin

1. Press down the release lever and tilt the bucket outward. Use both hands to hold the base of the storage bin, then lift it up and out.

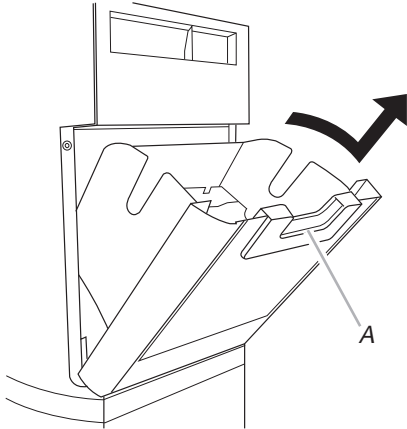

A. Release lever

**NOTE:** It is not necessary to turn the ice maker control to the OFF (right) position when removing the storage bin. The sensor cover (“flipper door”), located on the right wall of the freezer door, stops the ice maker from producing ice if the door is open or the storage bin is removed.

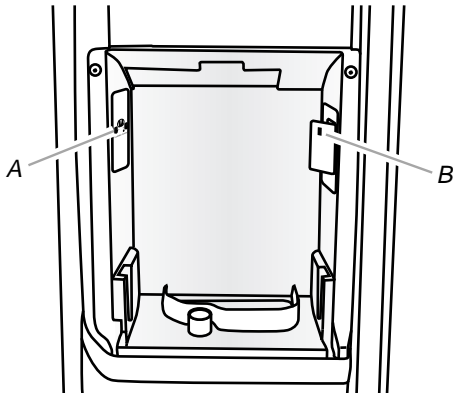

A. On/Off switch  
B. Sensor cover

2. Replace the bin by sliding it onto the door, then tilting it back into an upright position. The release lever will click when the bin is securely in place.

## Delay Ice

Smart Grid Event notifications can affect ice production. For information about the Delay Ice feature that is associated with Smart Grid functionality, see “Smart Refrigerator Features.”



## Water Filtration System

Do not use with water that is microbiologically unsafe or of unknown quality without adequate disinfection before or after the system. Systems certified for cyst reduction may be used on disinfected waters that may contain filterable cysts.

### Water Filter Status Light

The water filter status light will help you know when to change your water filter.

- When the dispenser control panel’s water filter status display changes to “ORDER,” this tells you that it is almost time to change the water filter cartridge.
- Replace the water filter cartridge when the water filter status display changes to “REPLACE.”

**NOTE:** If water flow to your water dispenser or ice maker decreases noticeably, change the filter sooner. The filter should be replaced at least every 6 months, depending on your water quality and usage.

### Resetting the Filter Status

- After changing the water filter, reset the status light by pressing and holding the FILTER button for 3 seconds.

When the system is reset, the “ORDER” and “REPLACE” icons will disappear from the display screen.

### Changing the Water Filter

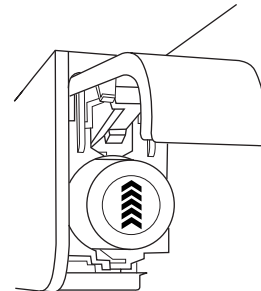

1. Locate the water filter in the top-right corner of the refrigerator compartment.
2. Lift open the filter cover door. The filter will be released and then be ejected as the door is opened.
3. When the door is completely open, pull the filter straight out.  
**NOTE:** There may be some water in the filter. Some spilling may occur. Use a towel to wipe up any spills.
4. Take the new filter out of its packaging and remove the covers from the O-rings. Be sure the O-rings are still in place after the covers are removed.
5. With the arrow pointing up, align the new filter with the filter housing and slide it into place. The filter cover door will automatically begin to close as the new filter is inserted.
6. Close the filter cover door completely in order to snap the filter into place. You may need to press hard.
7. Flush the water system. See “Water and Ice Dispensers.”

---

# SMART REFRIGERATOR FEATURES

---

## Getting the Most from Your Smart Refrigerator

---

### Smart Functionality

---

Your refrigerator offers two types of smart functionality:

#### Smart Grid

The Smart Grid feature allows your Smart Refrigerator to adjust or delay certain functions during times when energy prices or demand are the highest, which could save you money. Your Smart Refrigerator will go into a Smart Delay until energy rates go down. You can disable the Smart Delay and other Smart Grid Events at any time.

#### Smart Features

Many features of your Smart Refrigerator can be remotely accessed by devices such as computers, smartphones, tablets, etc. These Smart Features allow you to remotely monitor, manage and maintain your refrigerator.

---

### Getting Connected

---

This Whirlpool® Smart Refrigerator has built-in Wi-Fi connectivity and must be connected to the Internet through your home wireless network. Refer to the Quick Set-Up Guide included with your refrigerator to complete the installation.

You will also need to create an account and register the refrigerator to your online account. Your refrigerator's Smart Appliance ID number ("SAID") can be found on a label inside the refrigerator compartment, just above the crisper on the right-hand interior wall.

To create an online account, go to <http://smart.whirlpool.com>.

---

## Using Smart Grid

This feature monitors energy price and demand information from your utility company and sends notifications to the refrigerator to run high energy-consuming tasks during off-peak times when electricity costs and demand are lower. The Smart Grid icon will appear on the dispenser display screen when the feature is active.



If the refrigerator receives a Smart Grid notification, it will implement Smart Delay and/or Delay Ice.

**Smart Delay:** The Smart Delay feature adjusts cooling system operations, the defrost cycle, and high energy-consuming features such as Fast Ice.

**Delay Ice:** The Delay Ice feature temporarily stops ice production for up to 4 hours, depending on the type of notification received. The Delay Ice icon appears on the dispenser display screen.



- To manually turn off the Smart Delay and Delay Ice features and resume normal operation and ice production, press the SMART GRID button on the dispenser control panel.

Smart Grid functionality and the Smart Delay and Delay Ice features will turn off for 4 hours, and the Smart Grid and Delay Ice icons will both disappear from the display screen.

**NOTE:** After 4 hours have passed, the Smart Grid feature will automatically reactivate. To manually reactivate before 4 hours have passed, press the SMART GRID button.

---

## Using Smart Features

Following is a summary of the additional Smart Features that make it more convenient to use your Smart Refrigerator. Some features include the ability to receive notifications through text (SMS) and e-mail, and require you to configure your notification settings in your online account.

**Temperature Setting Adjustment:** This Smart feature allows you to remotely adjust the temperature set point(s) of your refrigerator and freezer.

**Power Outage Notification:** In the event your refrigerator loses power, you will be notified when power is restored. This will allow you to react appropriately in order to avoid or minimize loss of food.

**Door Ajar Notification:** You will receive a notification if either door (refrigerator or freezer) is left open for longer than 10 minutes.

**Water Filter Status Notification:** You will be notified when it is time to change your water filter. The notification will provide you with filter replacement information and the opportunity to place the order. You can also remotely reset the status of the filter.

**Energy Monitor:** The Energy Monitor tracks current power usage and also provides an overview of previous power consumption.

---



# REFRIGERATOR CARE

## Cleaning

### **WARNING**



#### Explosion Hazard

Use nonflammable cleaner.

Failure to do so can result in death, explosion, or fire.

Both the refrigerator and freezer sections defrost automatically. However, clean both sections about once a month to avoid buildup of odors. Wipe up spills immediately.

**IMPORTANT:** Because air circulates between both sections, any odors formed in one section will transfer to the other. You must thoroughly clean both sections to eliminate odors. To avoid odor transfer and drying out of food, wrap or cover foods tightly.

#### To Clean Your Refrigerator:

**NOTE:** Do not use abrasive or harsh cleaners such as window sprays, scouring cleansers, flammable fluids, cleaning waxes, concentrated detergents, bleaches or cleansers containing petroleum products on plastic parts, interior and door liners or gaskets. Do not use paper towels, scouring pads, or other harsh cleaning tools.

1. Unplug refrigerator or disconnect power.
2. Hand wash, rinse, and dry removable parts and interior surfaces thoroughly. Use a clean sponge or soft cloth and a mild detergent in warm water.
3. Wash stainless steel and painted metal exteriors with a clean sponge or soft cloth and a mild detergent in warm water.
4. There is no need for routine condenser cleaning in normal home operating environments. If the environment is particularly greasy or dusty, or there is significant pet traffic in the home, the condenser should be cleaned every 2 to 3 months to ensure maximum efficiency.

If you need to clean the condenser:

- Remove the base grille. See the “Door Removal” instructions, either in the User Instructions or the Installation Instructions and Owner’s Manual, or in the separate instruction sheet provided with your refrigerator.
  - Use a vacuum cleaner with a soft brush to clean the grille, the open areas behind the grille and the front surface area of the condenser.
  - Replace the base grille when finished.
5. Plug in refrigerator or reconnect power.

## Lights

The interior and dispenser lights are LEDs that cannot be changed.

- If the dispenser lights do not appear to be working as described in “Water and Ice Dispensers” (in the User Instructions, User Guide, or Use & Care Guide) or if the interior lights do not illuminate when either door is opened, call for assistance or service. See either the front cover or the Warranty for contact information.

## Vacation and Moving Care

### Vacations

#### If You Choose to Leave Refrigerator On While You Are Away:

1. Use up any perishables and freeze other items.
2. If your refrigerator has an automatic ice maker and is connected to the household water supply, turn off the water supply to the refrigerator. Property damage can occur if the water supply is not turned off.
3. If you have an automatic ice maker, turn off the ice maker.  
**NOTE:** Depending on your model, raise the wire shutoff arm to OFF (up) position or press the switch to OFF (right).
4. Empty the ice bin.

#### If You Choose to Turn Refrigerator Off Before You Leave:

1. Remove all food from the refrigerator.
2. If your refrigerator has an automatic ice maker:
  - Turn off the water supply to the ice maker at least one day ahead of time.
  - When the last load of ice drops, raise the wire shutoff arm to the OFF (up) position or move the switch to the OFF (right) setting.
3. Depending on the model, turn the Refrigerator Control to OFF or turn cooling off. See “Using the Controls” in the User Instructions, User Guide, or Use & Care Guide.
4. Clean, wipe, and dry thoroughly.
5. Tape rubber or wood blocks to the tops of both doors to prop them open far enough for air to get in. This stops odor and mold from building up.

### Moving

When you are moving your refrigerator to a new home, follow these steps to prepare it for the move.

1. If your refrigerator has an automatic ice maker:
  - Turn off the water supply to the ice maker at least one day ahead of time.
  - Disconnect the water line from the back of the refrigerator.
  - When the last load of ice drops, raise the wire shutoff arm to the OFF (up) position or move the switch to the OFF (right) setting.
2. Remove all food from the refrigerator and pack all frozen food in dry ice.
3. Empty the ice bin.
4. Depending on the model, turn the Refrigerator Control to OFF or turn cooling off. See “Using the Controls” in the User Instructions, User Guide, or Use & Care Guide.
5. Unplug refrigerator.
6. Clean, wipe, and dry thoroughly.
7. Take out all removable parts, wrap them well, and tape them together so they don’t shift and rattle during the move.
8. Depending on the model, raise the front of the refrigerator so it rolls more easily OR screw in the leveling legs so they don’t scrape the floor. See “Adjust the Doors” or “Door Removal, Leveling and Alignment.”
9. Tape the doors closed and tape the power cord to the back of the refrigerator.

When you get to your new home, put everything back and refer to the Installation Instructions for preparation instructions. Also, if your refrigerator has an automatic ice maker, remember to reconnect the water supply to the refrigerator.

# PROBLEM SOLVER

First try the solutions suggested here or visit our website and reference FAQs (Frequently Asked Questions) to possibly avoid the cost of a service call.  
In the U.S.A., [www.whirlpool.com](http://www.whirlpool.com) In Canada, [www.whirlpool.ca](http://www.whirlpool.ca)

**⚠ WARNING**



**Electrical Shock Hazard**

Plug into a grounded 3 prong outlet.

Do not remove ground prong.

Do not use an adapter.

Do not use an extension cord.

Failure to follow these instructions can result in death, fire, or electrical shock.

## GENERAL OPERATION

## Possible Causes and/or Recommended Solutions

### Refrigerator will not operate

- **Not connected to an electrical supply** - Plug the power cord into a grounded 3 prong outlet. Do not use an extension cord.
- **No power to the electrical outlet** - Plug in a lamp to see if the outlet is working.
- **Household fuse has blown or circuit breaker has tripped** - Replace the fuse or reset the circuit breaker. If the problem continues, contact a licensed electrician.
- **Control or cooling is not turned on** - Turn on the refrigerator control, or turn cooling on. See "Using the Controls."
- **New installation** - Following installation, allow 24 hours for the refrigerator and freezer to cool completely.  
**NOTE:** Adjusting the temperature control(s) to the coldest setting will not cool either compartment (refrigerator or freezer) more quickly.

### Motor seems to run too much

- **Your new refrigerator has an energy-efficient motor** - The refrigerator may run longer than you're used to, because the compressor and fans operate at lower speeds that are more energy-efficient. This is normal.  
**NOTE:** Your refrigerator may run even longer if the room is warm, a large load of food is added, the doors are opened often, or if a door has been left open.

### Refrigerator seems noisy

The compressor in your new refrigerator regulates temperature more efficiently and uses less energy than older models. During various stages of operation, you may hear normal operating sounds that are unfamiliar.

#### The following noises are normal:

- **Buzzing/Clicking** - Heard when the water valve opens and closes to dispense water or fill the ice maker. If the refrigerator is connected to a water line, this is normal. If the refrigerator is not connected to a water line, turn off the ice maker.
- **Cracking/Crashing** - Heard when ice is ejected from the ice maker mold.
- **Popping** - Heard when the inside walls contract/expand, especially during initial cooldown.
- **Pulsating/Whirring** - Heard when the fans/compressor adjust to optimize performance during normal operation.
- **Rattling** - Heard when water passes through the water line, or due to the flow of refrigerant. Rattling may also come from items placed on top of the refrigerator.
- **Water running or gurgling** - Heard when ice melts during the defrost cycle and water runs into the drain pan.
- **Sizzling** - Heard when water drips onto the heater during the defrost cycle.

GENERAL OPERATION	Possible Causes and/or Recommended Solutions
Temperature is too warm	<ul style="list-style-type: none"> <li>■ <b>New installation</b> - Following installation, allow 24 hours for the refrigerator and freezer to cool completely. <b>NOTE:</b> Adjusting the temperature control(s) to the coldest setting will not cool either compartment (refrigerator or freezer) more quickly.</li> <li>■ <b>Doors are opened often or not closed completely</b> - This allows warm air to enter the refrigerator. Minimize door openings, keep the doors fully closed, and make sure both doors are properly sealed.</li> <li>■ <b>Air vents are blocked</b> - Remove items that are immediately in front of the vents.</li> <li>■ <b>Large amount of warm food recently added</b> - Allow several hours for the refrigerator to return to its normal temperature.</li> <li>■ <b>Controls are not set correctly for the surrounding conditions</b> - Adjust the controls to a colder setting. Check the temperature again in 24 hours.</li> </ul>
Temperature is too cold	<ul style="list-style-type: none"> <li>■ <b>Controls are not set correctly for the surrounding conditions</b> - Adjust the controls to a warmer setting. Check the temperature again in 24 hours.</li> <li>■ <b>Top refrigerator shelf is colder than lower shelves</b> - On some models, air from the freezer enters the refrigerator compartment through vents near the top refrigerator shelf. As a result, the top shelf can be slightly colder than lower shelves.</li> <li>■ <b>Air vents are blocked</b> - Remove items that are immediately in front of the vents.</li> </ul>
Interior moisture buildup	<p><b>NOTE:</b> Some moisture buildup is normal. Clean with a soft dry cloth.</p> <ul style="list-style-type: none"> <li>■ <b>Room is humid</b> - A humid environment contributes to moisture buildup. Use the refrigerator only in an indoor location, with as little humidity as possible.</li> <li>■ <b>Doors are opened often or not closed completely</b> - This allows humid air to enter the refrigerator. Minimize door openings, keep the doors fully closed, and make sure both doors are properly sealed.</li> </ul>
Interior lights do not work	<ul style="list-style-type: none"> <li>■ <b>Doors have been open for an extended period of time</b> - Close the doors to reset the lights.</li> <li>■ <b>Light bulb is loose in the socket or has burned out</b> - On models with incandescent interior light bulbs, tighten or replace the bulb. See “Lights.”</li> </ul> <p><b>NOTE:</b> On models with LED lights, call for assistance or service if the interior lights do not illuminate when either door is opened. See either the front cover or the Warranty for contact information.</p>
Dispenser lights do not work (on some models)	<ul style="list-style-type: none"> <li>■ <b>Dispenser light is turned off</b> - On some models, if the dispenser light is set to OFF, the light will turn on only when a dispenser pad/lever is pressed. If you want the dispenser light to stay on continuously, select a different setting. See “Water and Ice Dispensers.”</li> <li>■ <b>Dispenser light is set to AUTO or NIGHT LIGHT</b> - On some models, if the dispenser light is set to AUTO or NIGHT LIGHT, make sure the dispenser light sensor is not blocked. See “Water and Ice Dispensers.”</li> </ul> <p><b>NOTE:</b> On models with LED lights, call for assistance or service if the dispenser lights do not operate correctly. See either the front cover or the Warranty for contact information.</p>

**⚠ WARNING**



**Explosion Hazard**

Use nonflammable cleaner.  
Failure to do so can result in death, explosion, or fire.

DOORS AND LEVELING	Possible Causes and/or Recommended Solutions
Doors are difficult to open	<ul style="list-style-type: none"> <li>■ <b>Gaskets are dirty or sticky</b> - Clean the gaskets and contact surfaces with mild soap and warm water. Rinse and dry with a soft cloth.</li> </ul>
Doors will not close completely	<ul style="list-style-type: none"> <li>■ <b>Door is blocked open</b> - Move food packages away from the door. Make sure all bins and shelves are in their correct positions. Make sure all packaging materials have been removed.</li> </ul>
Doors appear to be uneven	<ul style="list-style-type: none"> <li>■ <b>Doors need to be aligned, or refrigerator needs to be leveled</b> - See the leveling and door alignment instructions.</li> </ul>
Refrigerator rocks and is not stable	<ul style="list-style-type: none"> <li>■ <b>Refrigerator is not level</b> - To stabilize the refrigerator, remove the base grille and lower the leveling feet until they touch the floor. See the leveling and door alignment instructions.</li> </ul>

**⚠ WARNING**



**Cut Hazard**

Use a sturdy glass when dispensing ice.  
Failure to do so can result in cuts.

ICE AND WATER	Possible Causes and/or Recommended Solutions
Ice maker is not producing ice, not producing enough ice, or producing small/hollow ice	<ul style="list-style-type: none"> <li>■ <b>Refrigerator is not connected to a water supply, or the water supply shutoff valve is not fully turned on</b> - Connect the refrigerator to a water supply and make sure the water shutoff valve is fully open.</li> <li>■ <b>Kink in the water source line</b> - A kink in the water line can reduce water flow, resulting in decreased ice production, small ice cubes, and/or hollow or irregularly-shaped ice. Straighten the water line.</li> <li>■ <b>Ice maker is not turned on</b> - Turn on the ice maker. See “Ice Maker and Storage Bin.”</li> <li>■ <b>New installation</b> - After connecting the refrigerator to a water source, flush the water system. (See “Water and Ice Dispensers.”) Wait 24 hours for ice production to begin. Wait 72 hours for full ice production. Discard the first three batches of ice produced.</li> <li>■ <b>Large amount of ice was recently removed</b> - Allow sufficient time for the ice maker to produce more ice.</li> <li>■ <b>Ice is jammed in the ice maker ejector arm</b> - Remove ice from the ejector arm using a plastic utensil.</li> <li>■ <b>Inadequate water pressure</b> - Verify that the household has adequate water pressure. See “Water Supply Requirements.”</li> <li>■ <b>Water filter is installed incorrectly</b> - Make sure the filter is properly installed. See “Water Filtration System.”</li> <li>■ <b>A reverse osmosis water filtration system is connected to your cold water supply</b> - This can decrease water pressure. See “Water Supply Requirements.”</li> </ul> <p><b>NOTE:</b> If questions remain regarding water pressure, contact a licensed, qualified plumber.</p>

---

**ICE AND WATER****Possible Causes and/or Recommended Solutions**

---

**Ice dispenser will not operate properly**

- **Doors not closed completely** - Make sure both doors are firmly closed. (On some models, only the freezer door must be closed in order to operate the dispenser.)
- **New installation** - After connecting the refrigerator to a water source, flush the water system. (See “Water and Ice Dispensers.”) Wait 24 hours for ice production to begin. Wait 72 hours for full ice production. Discard the first three batches of ice produced.
- **Ice maker is not turned on, or ice bin is not installed correctly** - Turn on the ice maker and make sure the ice storage bin is firmly in position. See “Ice Maker and Storage Bin.”
- **Ice is clogged or frozen together in the ice storage bin, or ice is blocking the ice delivery chute** - Remove or separate the clogged ice, using a plastic utensil if necessary. Clean the ice delivery chute and the bottom of the ice storage bin using a warm damp cloth, then dry both thoroughly. To avoid clogging and to maintain a fresh supply of ice, empty the storage bin and clean both the storage bin and the delivery chute every 2 weeks.
- **Wrong ice has been added to the storage bin** - Use only ice cubes produced by the current ice maker.
- **Dispenser is locked** - Unlock the dispenser. See “Water and Ice Dispensers.”
- **Ice dispenser jams while dispensing crushed ice** - For models with the ice storage bin on the door, temporarily switch from crushed ice to cubed ice to clear the jam.
- **Dispenser pad/lever has been pressed too long** - Ice will automatically stop dispensing. Wait a few minutes for the dispenser to reset, then resume dispensing. Take large amounts of ice directly from the ice bin, not through the dispenser.
- **Water pressure to the home is not at or above 30 psi (207 kPa)** - The water pressure to the home affects the flow from the dispenser. See “Water Supply Requirements.”
- **Water filter is clogged or incorrectly installed** - Replace filter or reinstall it correctly. See “Water Filtration System.”

---

**Ice or water has an off-taste, odor, or gray color**

- **New plumbing connections** - New plumbing connections can result in off-flavored or discolored ice or water. This problem should go away over time.
- **Ice has been stored too long** - Discard the ice and wash the ice bin. Allow 24 hours for the ice maker to produce new ice.
- **Odor has transferred from food** - Use airtight moisture-proof packaging to store food.
- **Use of non-recommended water supply line** - Odors and tastes can transfer from certain materials used in non-recommended water supply lines. Use only a recommended water supply line. See “Water Supply Requirements.”
- **There are minerals (such as sulfur) in the water** - A water filter may need to be installed in order to remove the minerals.
- **Water filter was recently installed or replaced** - Gray or dark discoloration in ice or water indicates that the water filtration system needs additional flushing. See “Water and Ice Dispensers.”

---

**Water dispenser will not operate properly**

- **Doors not closed completely** - Make sure both doors are firmly closed. (On some models, only the freezer door must be closed in order to operate the dispenser.)
- **Refrigerator is not connected to a water supply, or the water supply shutoff valve is not turned on** - Connect the refrigerator to a water supply and make sure the water shutoff valve is fully open.
- **Kink in the water source line** - A kink in the water line can reduce water flow to the dispenser. Straighten the water line.
- **Water pressure to the home is not at or above 30 psi (207 kPa)** - The water pressure to the home affects the flow from the dispenser. See “Water Supply Requirements.”
- **New installation** - After connecting the refrigerator to a water source, flush the water system. See “Water and Ice Dispensers.”
- **Dispenser is locked** - Unlock the dispenser. See “Water and Ice Dispensers.”
- **Water filter is clogged or incorrectly installed** - Replace filter or reinstall it correctly. See “Water Filtration System.”
- **A reverse osmosis water filtration system is connected to your cold water supply** - This can decrease water pressure. See “Water Supply Requirements.”

**NOTE:** If questions remain regarding water pressure, contact a licensed, qualified plumber.

---

**ICE AND WATER****Possible Causes and/or Recommended Solutions**

---

**Water is leaking or dripping from the dispenser**

**NOTE:** After dispensing, a few additional drops of water are normal.

- **Glass was not held under the dispenser long enough** - Hold the glass under the dispenser for 2 to 3 seconds after releasing the dispenser pad/lever.
- **New installation, or water filter was recently installed or replaced** - Air in the water lines causes the water dispenser to drip. Flush the water system to remove the air in the water lines. See “Water and Ice Dispensers.”
- **Residual ice in the dispenser chute is melting** - Make sure the ice chute is free of ice shavings or pieces.

---

**Water is leaking from the back of the refrigerator**

- **Water line connections are not fully tightened** - Make sure all connections are firmly tightened. See “Connect Water Supply.”

---

**Water from the dispenser is not cool enough (on some models)**

**NOTE:** Water from the dispenser is chilled to 50°F (10°C).

- **New installation** - Allow 24 hours after installation for the water supply to cool completely.
  - **Recently dispensed a large amount of water** - Allow 24 hours for the new water supply to cool completely.
  - **Water has not been recently dispensed** - The first glass of water may not be cool. Discard the first glass of water dispensed.
  - **Refrigerator is not connected to a cold water pipe** - Make sure the refrigerator is connected to a cold water pipe. See “Water Supply Requirements.”
- 

---

**SMART FEATURES****Possible Causes and/or Recommended Solutions**

---

**Low/no ice production**

- **Smart Delay and/or Delay Ice activated** - The Smart Grid feature allows the refrigerator to detect when the electric grid is in a period of peak usage or peak rates. When Smart Grid functionality is activated, ice production may be delayed for up to 4 hours, depending on the type of Smart Grid notification received. To return to normal ice production, press the SMART GRID button on the dispenser control panel. Both the Smart Grid and Delay Ice icons will disappear from the display screen.
-

---

# ACCESSORIES

The following accessories are available for your refrigerator.  
To order an accessory, call **1-800-442-9991** and ask for the part number listed below or contact your authorized Whirlpool dealer.  
In Canada, call **1-800-807-6777**.

**affresh® Stainless Steel Cleaner:**

Order Part #W10355016  
In Canada, order Part #W10355016B

**affresh® Stainless Steel Wipes:**

Order Part #W10355049  
In Canada, order Part #W10355049B

**affresh® Kitchen & Appliance Cleaner:**

Order Part #W10355010  
In Canada, order Part #W10355010B

**Water Filter:**

Order Part #W10295370A (P4RFWB)

**Air Filter:**

Order Part #W10311524

# WATER FILTER CERTIFICATIONS

State of California  
Department of Public Health  
Water Treatment Device  
Certificate Number  
10 - 2030  
Date Issued: February 26, 2010

---

<u>Trademark/Model Designation</u> P5WB2L	<u>Replacement Elements</u> P4RFBW
----------------------------------------------	---------------------------------------

---

Manufacturer: Whirlpool Corporation

---

The water treatment device(s) listed on this certificate have met the testing requirements pursuant to Section 116830 of the Health and Safety Code for the following health related contaminants:

<u>Microbiological Contaminants and Turbidity</u> Cysts	<u>Inorganic/Radiological Contaminants</u> Asbestos Lead
------------------------------------------------------------	----------------------------------------------------------------

---

<u>Organic Contaminants</u> Atrazine Lindane Toxaphene 2, 4 - D	<u>Rated Service Capacity:</u> 200 gal	<u>Rated Service Flow:</u> 0.5 gpm
-----------------------------------------------------------------------------	----------------------------------------	------------------------------------

---

Conditions of Certification:  
Do not use where water is microbiologically unsafe or with water of unknown quality, except that systems certified for cyst reduction may be used on disinfected waters that may contain filterable cysts.



# PERFORMANCE DATA SHEET

## Water Filtration System Model P5WB2L/P4RFBW Capacity 200 Gallons (757 Liters)



System tested and certified by NSF International against NSF/ANSI Standard 42 for the reduction of Chlorine Taste and Odor, and Particulate Class I\*; and against NSF/ANSI Standard 53 for the reduction of Live Cysts, Asbestos, Lead, Lindane, Toxaphene, Atrazine, and 2,4 - D.

This system has been tested according to NSF/ANSI Standards 42 and 53 for the reduction of the substances listed below. The concentration of the indicated substances in water entering the system was reduced to a concentration less than or equal to the permissible limit for water leaving the system, as specified in NSF/ANSI Standards 42 and 53.

Substance Reduction Aesthetic Effects	NSF Reduction Requirements	Average Influent	Influent Challenge Concentration	Maximum Effluent	Minimum % Reduction	Average % Reduction
Chlorine Taste/Odor Particulate Class I*	50% reduction 85% reduction	2.0 mg/L 7,300,000 #/mL	2.0 mg/L ± 10% At least 10,000 particles/mL	0.20 mg/L 75,000 #/mL**	97 99	97.2 99.4
Contaminant Reduction	NSF Reduction Requirements	Average Influent	Influent Challenge Concentration	Maximum Effluent	Minimum % Reduction	Average % Reduction
Live Cysts <sup>†</sup>	99.95%	160,000/L	50,000/L min.	54/L <sup>†</sup>	99.97	99.99
Asbestos	99%	87 MFL	10 <sup>7</sup> to 10 <sup>8</sup> fibers/L <sup>††</sup>	0.17 MFL	99	99
Lead: @ pH 6.5 Lead: @ pH 8.5	0.010 mg/L 0.010 mg/L	0.160 mg/L 0.140 mg/L	0.15 mg/L ± 10% 0.15 mg/L ± 10%	0.001 mg/L 0.005 mg/L	99.4 98.6	99.4 98.6
Lindane	0.0002 mg/L	0.0019 mg/L	0.002 mg/L ± 10%	0.00002 mg/L	98.9	99
Toxaphene	0.003 mg/L	0.014 mg/L	0.015 mg/L ± 10%	0.001 mg/L	93	93
Atrazine	0.003 mg/L	0.0094 mg/L	0.009 mg/L ± 10%	0.0005 mg/L	94.5	94.7
2,4 - D	0.07 mg/L	0.220 mg/L	0.210 mg/L ± 10%	0.028 mg/L	87.5	96.1

Test Parameters: pH = 7.5 ± 0.5 unless otherwise noted. Flow = 0.5 gpm (1.9 Lpm). Pressure = 60 psig (413.7 kPa). Temp. = 68°F to 71.6°F (20°C to 22°C). Rated service capacity = 200 gallons (757 liters).

- It is important that operational, maintenance, and filter replacement requirements be carried out for the product to perform as advertised. Property damage can occur if all instructions are not followed.
- Use replacement filter P4RFBW, part #W10295370A. 2013 suggested retail price of \$39.99 U.S.A./\$49.99 Canada. Prices are subject to change without notice.
  - Style 1** – When the water filter status display changes from “GOOD” to “ORDER,” order a new filter. When the filter indicator reads “REPLACE,” it is recommended that you replace the filter.
  - Style 2** – When the filter indicator changes from green to yellow, order a new filter. When the indicator changes from yellow to red, it is recommended that you replace the filter.
  - Style 3** – When the filter indicator reads 10%, order a new filter. When the indicator reads 0%, it is recommended that you replace the filter.
  - Style 4** – Press FILTER to check the status of your water filter. If the filter indicator light is yellow, order a new filter. If the filter indicator light is red, it is recommended that you replace the filter.
- After changing the water filter, flush the water system. See “Water and Ice Dispensers” or “Water Dispenser” in the User Instructions or User Guide.
- These contaminants are not necessarily in your water supply. While testing was performed under standard laboratory conditions, actual performance may vary.
- The product is for cold water use only.
- The water system must be installed in compliance with state and local laws and regulations.
- Do not use with water that is microbiologically unsafe or of unknown quality without adequate disinfection before or after the system. Systems certified for cyst reduction may be used on disinfected waters that may contain filterable cysts.
- Refer to the “Warranty” section (in the User Instructions or User Guide) for the Manufacturer’s name, address and telephone number.
- Refer to the “Warranty” section (in the User Instructions or User Guide) for the Manufacturer’s limited warranty.

### Application Guidelines/Water Supply Parameters

Water Supply	City or Well
Water Pressure	30 - 120 psi (207 - 827 kPa)
Water Temperature	33° - 100°F (0.6° - 37.8°C)
Service Flow Rate	0.5 gpm (1.9 Lpm) @ 60 psi

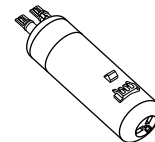

\*Class I particle size: >0.5 to <1 um

\*\*Test requirement is at least 100,000 particles/mL of AC Fine Test Dust.

<sup>†</sup>Based on the use of *Cryptosporidium parvum* oocysts

<sup>††</sup>Fibers greater than 10 um in length

---

# WHIRLPOOL CORPORATION MAJOR APPLIANCE WARRANTY

---

## LIMITED WARRANTY

For one year from the date of purchase, when this major appliance is operated and maintained according to instructions attached to or furnished with the product, Whirlpool Corporation or Whirlpool Canada LP (hereafter "Whirlpool") will pay for Factory Specified Parts and repair labor to correct defects in materials or workmanship that existed when this major appliance was purchased. Service must be provided by a Whirlpool designated service company. YOUR SOLE AND EXCLUSIVE REMEDY UNDER THIS LIMITED WARRANTY SHALL BE PRODUCT REPAIR AS PROVIDED HEREIN. This limited warranty is valid only in the United States or Canada and applies only when the major appliance is used in the country in which it was purchased. Proof of original purchase date is required to obtain service under this limited warranty.

---

## ITEMS EXCLUDED FROM WARRANTY

### This limited warranty does not cover:

1. Replacement parts or repair labor if this major appliance is used for other than normal, single-family household use or when it is used in a manner that is inconsistent to published user or operator instructions and/or installation instructions.
2. Service calls to correct the installation of your major appliance, to instruct you on how to use your major appliance, to replace or repair house fuses, or to correct house wiring or plumbing.
3. Service calls to repair or replace appliance light bulbs, air filters or water filters. Consumable parts are excluded from warranty coverage.
4. Damage resulting from accident, alteration, misuse, abuse, fire, flood, acts of God, improper installation, installation not in accordance with electrical or plumbing codes, or use of products not approved by Whirlpool.
5. Cosmetic damage, including scratches, dents, chips or other damage to the finish of your major appliance, unless such damage results from defects in materials or workmanship and is reported to Whirlpool within 30 days from the date of purchase.
6. Any food or medicine loss due to refrigerator or freezer product failures.
7. Pickup and delivery. This major appliance is intended to be repaired in your home.
8. Repairs to parts or systems resulting from unauthorized modifications made to the appliance.
9. Expenses for travel and transportation for product service if your major appliance is located in a remote area where service by an authorized Whirlpool servicer is not available.
10. The removal and reinstallation of your major appliance if it is installed in an inaccessible location or is not installed in accordance with Whirlpool's published installation instructions.
11. Replacement parts or repair labor on major appliances with original model/serial numbers that have been removed, altered or cannot be easily determined.
12. Discoloration, rust, or oxidation of stainless steel surfaces.

**The cost of repair or replacement under these excluded circumstances shall be borne by the customer.**

---

## DISCLAIMER OF IMPLIED WARRANTIES

IMPLIED WARRANTIES, INCLUDING ANY IMPLIED WARRANTY OF MERCHANTABILITY OR IMPLIED WARRANTY OF FITNESS FOR A PARTICULAR PURPOSE, ARE LIMITED TO ONE YEAR OR THE SHORTEST PERIOD ALLOWED BY LAW. Some states and provinces do not allow limitations on the duration of implied warranties of merchantability or fitness, so this limitation may not apply to you. This warranty gives you specific legal rights, and you also may have other rights that vary from state to state or province to province.

---

## LIMITATION OF REMEDIES; EXCLUSION OF INCIDENTAL AND CONSEQUENTIAL DAMAGES

YOUR SOLE AND EXCLUSIVE REMEDY UNDER THIS LIMITED WARRANTY SHALL BE PRODUCT REPAIR AS PROVIDED HEREIN. WHIRLPOOL SHALL NOT BE LIABLE FOR INCIDENTAL OR CONSEQUENTIAL DAMAGES. Some states and provinces do not allow the exclusion or limitation of incidental or consequential damages, so these limitations and exclusions may not apply to you. This warranty gives you specific legal rights, and you also may have other rights that vary from state to state or province to province.

---

If outside the 50 United States and Canada, contact your authorized Whirlpool dealer to determine if another warranty applies.

7/12

---

For additional product information, in the U.S.A., visit [www.whirlpool.com](http://www.whirlpool.com).  
In Canada, visit [www.whirlpool.ca](http://www.whirlpool.ca).

If you do not have access to the Internet and you need assistance using your product or you would like to schedule service, you may contact Whirlpool at the number below.

*Have your complete model number ready. You can find your model number and serial number on the label, located on the inside wall of the refrigerator compartment.*

For assistance or service in the U.S.A., call 1-800-253-1301. In Canada, call 1-800-807-6777.

If you need further assistance, you can write to Whirlpool with any questions or concerns at the address below:

In the U.S.A.:

Whirlpool Brand Home Appliances  
Customer eXperience Center  
553 Benson Road  
Benton Harbor, MI 49022-2692

In Canada:

Whirlpool Brand Home Appliances  
Customer eXperience Centre  
200 – 6750 Century Ave.  
Mississauga, Ontario L5N 0B7

Please include a daytime phone number in your correspondence.

Please keep all provided instructions and your model number information for future reference.

