



cabrio[®]

Use & Care Guide

Guide d'utilisation et d'entretien

**Top-Loading High Efficiency Low-Water Washer
Laveuse haute efficacité à faible consommation
d'eau avec chargement par le dessus**

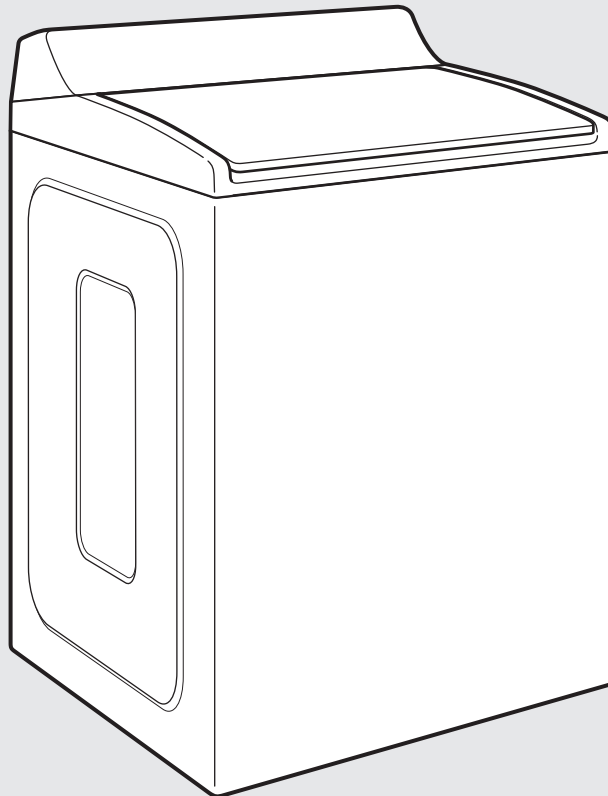

Para obtener acceso al Manual de uso y cuidado en español, o para obtener información adicional acerca de su producto, visite: www.whirlpool.com.

If you have any problems or questions, visit us at www.whirlpool.com
Pour tout problème ou toute question, consulter www.whirlpool.ca



Designed to use only HE High Efficiency detergents.
Conçue pour l'utilisation d'un détergent haute efficacité seulement.

**W10607424B
W10607425B - SP**

Table of Contents

WASHER SAFETY	2
WHAT'S NEW UNDER THE LID?	4
CONTROL PANEL AND FEATURES.....	5
Dispensers	7
CYCLE GUIDE.....	8
USING YOUR WASHER.....	9
WASHER MAINTENANCE	13
TROUBLESHOOTING	15
WARRANTY	20
ASSISTANCE OR SERVICE.....	Back Cover

Table des matières

SÉCURITÉ DE LA LAVEUSE	21
QUOI DE NEUF SOUS LE COUVERCLE?	22
TABLEAU DE COMMANDE ET CARACTÉRISTIQUES	23
Distributeurs	25
GUIDE DES PROGRAMMES	26
UTILISATION DE LA LAVEUSE.....	28
ENTRETIEN DE LA LAVEUSE.....	32
DÉPANNAGE	34
GARANTIE	42
ASSISTANCE OU SERVICE.....	Couverture arrière

Washer Safety

Your safety and the safety of others are very important.

We have provided many important safety messages in this manual and on your appliance. Always read and obey all safety messages.



This is the safety alert symbol.

This symbol alerts you to potential hazards that can kill or hurt you and others.

All safety messages will follow the safety alert symbol and either the word "DANGER" or "WARNING." These words mean:

! DANGER

You can be killed or seriously injured if you don't immediately follow instructions.

! WARNING

You can be killed or seriously injured if you don't follow instructions.

All safety messages will tell you what the potential hazard is, tell you how to reduce the chance of injury, and tell you what can happen if the instructions are not followed.

IMPORTANT SAFETY INSTRUCTIONS

WARNING: To reduce the risk of fire, electric shock, or injury to persons when using the washer, follow basic precautions, including the following:

- Read all instructions before using the washer.
- Do not wash articles that have been previously cleaned in, washed in, soaked in, or spotted with gasoline, dry-cleaning solvents, other flammable, or explosive substances as they give off vapors that could ignite or explode.
- Do not add gasoline, dry-cleaning solvents, or other flammable, or explosive substances to the wash water. These substances give off vapors that could ignite or explode.
- Under certain conditions, hydrogen gas may be produced in a hot water system that has not been used for 2 weeks or more. **HYDROGEN GAS IS EXPLOSIVE.** If the hot water system has not been used for such a period, before using the washing machine, turn on all hot water faucets and let the water flow from each for several minutes. This will release any accumulated hydrogen gas. As the gas is flammable, do not smoke or use an open flame during this time.
- Do not allow children to play on or in the washer. Close supervision of children is necessary when the washer is used near children.
- Before the washer is removed from service or discarded, remove the door or lid.
- Do not reach into the washer if the drum, tub or agitator is moving.
- Do not install or store the washer where it will be exposed to the weather.
- Do not tamper with controls.
- Do not repair or replace any part of the washer or attempt any servicing unless specifically recommended in this manual or in published user-repair instructions that you understand and have the skills to carry out.
- See "Electrical Requirements" located in the installation instructions for grounding instructions.

SAVE THESE INSTRUCTIONS

State of California Proposition 65 Warnings:

WARNING: This product contains one or more chemicals known to the State of California to cause cancer.

WARNING: This product contains one or more chemicals known to the State of California to cause birth defects or other reproductive harm.

What's New Under the Lid?

Cleaning with Less Water

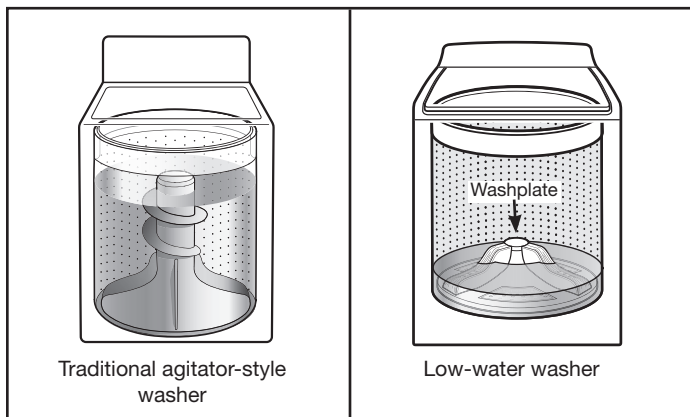

The most striking difference in your new washer is the low-water washplate wash system. The washer automatically adjusts the water level to the load size—no water level selector is needed.



For best performance, it is recommended to load items in loose heaps evenly around the washplate.

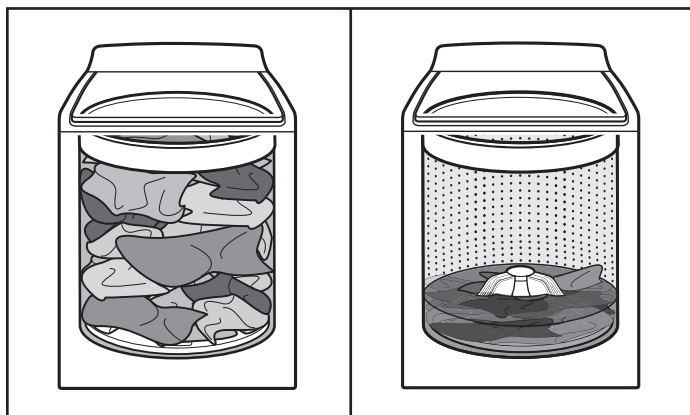

As the washer dampens and moves the load, the level of the items will settle in the basket. This is normal and does not indicate that more items should be added.

IMPORTANT: You will not see a washer basket full of water as with your past agitator-style washer. It is normal for some of the load to be above the water line.

Automatic Load Size Sensing

Once you start the cycle, the lid will lock, and the washer will begin the sensing process to determine the correct water level for the load.

Initially the basket will start to spin prior to adding water, this is part of the sensing process and is normal. This low-water wash method uses less water and energy compared to a traditional agitator-style washer.

Choosing the Right Detergent

Use only High Efficiency detergents. The package will be marked "HE" or "High Efficiency." Low-water washing creates excessive sudsing with a regular non-HE detergent. Using regular detergent will likely result in longer cycle times and reduced rinsing performance. It may also result in component failures and noticeable mold or mildew. HE detergents are made to produce the right amount of suds for the best performance. Follow the manufacturer's instructions to determine the amount of detergent to use, and do not go over the Max line. See "Using Laundry Product Dispensers" for more information.



Use only High Efficiency (HE) detergent.

Improved Cleaning

Low-water cleaning means concentrated cleaning. Rather than diluting detergent as done in an agitator-style washer, this washer delivers the detergent directly to the soils. This low water wash also allows the clothing to move in a more effective way to remove soils.

Normal Sounds You Can Expect

At different stages of the wash cycle, you may hear sounds and noises that are different from those of your previous washer. For example, you may hear a clicking and hum at the beginning of the cycle as the lid lock goes through a self-test. There will be different kinds of humming and whirring sounds as the washplate moves the load and as basket is slowing down to stop. And sometimes, you may hear nothing at all as the washer determines the correct water level for your load or allows time for clothes to soak.

Control Panel and Features

Not all features and cycles are available on all models.

STEAM MODEL

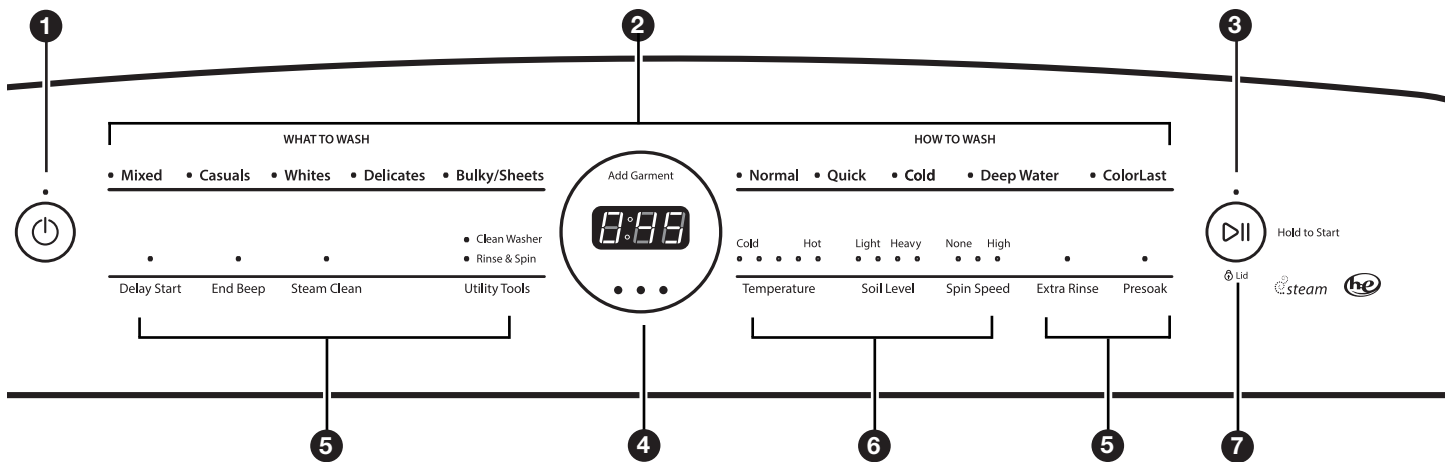

NON-STEAM MODEL

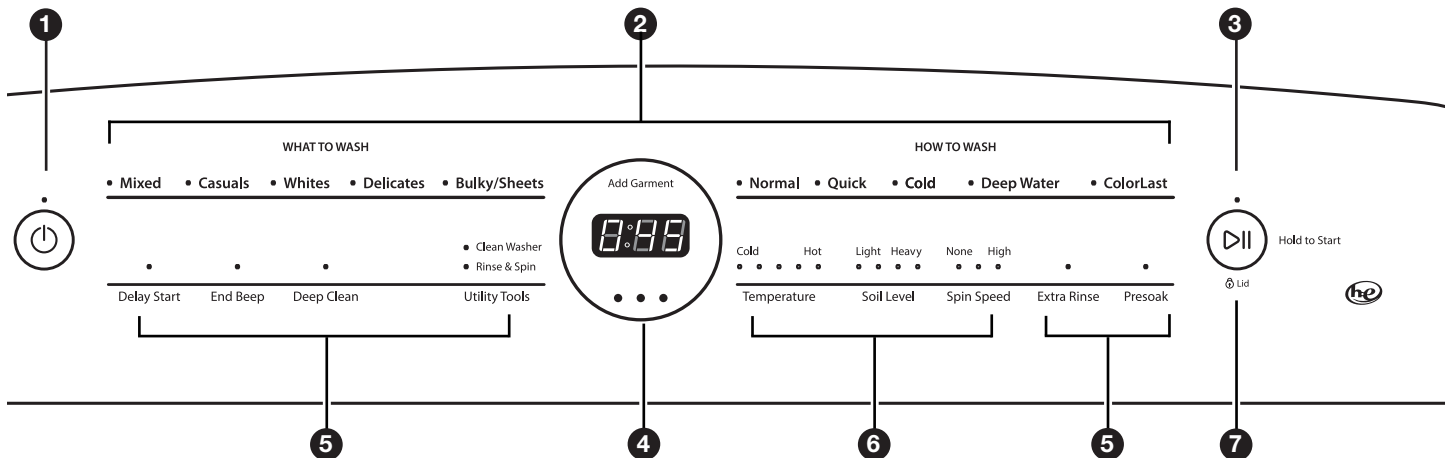

NOTE: The control panel features a sensitive surface that responds to a light touch of your finger. To ensure your selections are registered, touch the control panel with your finger tip, not your fingernail. When selecting a setting or option, simply touch its name until the desired section is illuminated.

1 POWER BUTTON

Touch to turn the washer On. Touching once while the washer is on will cancel the current cycle, touching twice will turn the washer Off.

2 WHAT TO WASH/HOW TO WASH

First select a cycle from the “What to Wash” and then select the “How to Wash” to get the best combination cycle available for the type of items you are going to wash. See “Cycle Guide” for cycle details.

3 START/PAUSE BUTTON

Touch and hold START/PAUSE to begin the selected cycle; touch again to pause a cycle.

4 LED TIME/STATUS DISPLAY

The Estimated Time Remaining display shows the time required for the cycle to complete. Factors such as load size and water pressure may affect the time shown in the display. Tightly packed loads, unbalanced loads, or excessive suds may cause the washer to adjust the cycle time, as well.

If you have set a delay start to the cycle, the Estimated Time Remaining display will show the delay time adjusted. When the cycle is complete, the Done indicator will light until the lid is opened.

ADD GARMENT

When Add Garment is lit, you may pause the washer, open the lid, and add items. Touch and hold START to start the washer again.

5 OPTIONS

You may add or remove options for each cycle. Not all options can be used with all cycles, and some are preset to work with certain cycles.

DELAY START

Touch Delay Start to delay the start of the wash cycle up to 12 hours “12H”. Touch Delay Start until a “0H” appears in the status display to turn off, or touch POWER.

END BEEP

Use this to turn the signal indicating the end of a wash cycle to low, medium, high, or off.

NOTE: You may also adjust the tones that sound when a feature, setting, or option is touched. Touch and hold End Beep for about 3 seconds to turn key activation sounds to low, medium, high or off.

STEAM CLEAN (depending on model)

The Steam Clean option adds additional soak and wash time to many cycles to help remove tough stains, as well as a steam boost for added cleaning power. Steam Clean uses a heater within the washer to maintain the selected temperature setting throughout the wash period. Steam Clean may be selected as an option with other cycles.

DEEP CLEAN (depending on model)

This option provides enhanced cleaning action for tough stains. It will add additional agitation and soak time to the cycle.

CLEAN BOOST (depending on model)

This option provides enhanced cleaning action for tough stains. It will add additional agitation and soak time to the cycle.

UTILITY TOOLS

Clean Washer

Use this every 30 washes to keep the inside of your washer fresh and clean. This cycle uses a higher water level. Use with affresh® Washer Cleaner tablet or liquid chlorine bleach to thoroughly clean the inside of your washer. This cycle should not be interrupted. See “Washer Care.”

IMPORTANT: Do not place garments or other items in the washer during the Clean Washer cycle. Use this cycle with an empty wash tub.

Rinse & Spin

Combines a rinse and high speed spin for loads requiring an additional rinse cycle or to complete a load after power interruption. Also use for loads that require rinsing only.

EXTRA RINSE

This option can be used to automatically add a second rinse to most cycles.

PRESOAK

Use this option to add an extra soak period to any cycle to help loosen tough stains. The washer will fill and then pause to soak, and then begin the selected cycle.

6 CYCLE MODIFIERS

When you select a cycle, its default settings or the previous cycle selection used will light up.

TEMPERATURE

Temperature Control senses and maintains uniform water temperatures by regulating incoming hot and cold water.

Select a wash temperature based on the type of fabric and soils being washed. For best results and following the garment label instructions, use the warmest wash water safe for your fabric.

- On some models and cycles, warm and hot water will be cooler than what your previous washer provided.
- Even for cold wash settings, some warm water may be added to the washer to maintain a minimum temperature.

SOIL LEVEL

Soil Level (wash time) is preset for each wash cycle. As you touch the Soil Level pad, the cycle time (minutes) will increase or decrease in the Estimated Time Remaining display and a different wash time will appear.

Select the most suitable setting for your load. For heavily soiled items, select Heavy Soil Level for more wash time. For lightly soiled items, select Light Soil Level for less wash time. Lighter soil level setting will help reduce tangling and wrinkling.

SPIN SPEED

This washer automatically selects the spin speed based on the cycle selected. The preset speeds can be changed. Not all spin speeds are available with all cycles.

- Faster spin speeds mean shorter dry times, but may increase wrinkling in your load.
- Slower spin speeds mean less wrinkling, but will leave your load more damp.

7 LID

The Lid Lock (🔒 Lid) indicator lights up when the lid is locked and cannot be opened. If you need to open the lid, touch and hold START/PAUSE. The lid will unlock once the washer movement has stopped. This may take several minutes if the load was spinning at high speed. Touch and hold START/PAUSE button again to restart the cycle.



Dispensers

A Liquid fabric softener dispenser

Pour measured liquid fabric softener into the liquid fabric softener dispenser if desired. It will dispense automatically at the optimum time.

- Use only liquid fabric softener in this dispenser.

B High Efficiency “HE” detergent dispenser

Add liquid or powdered HE detergent product to this dispenser for your main wash cycle. Remove tray if using powder detergent.

IMPORTANT: Make sure tray is in drawer when using liquid detergent and removed when using powder detergent and do not go over the Max line.



Use only High Efficiency (HE) detergent.

NOTE: Follow the manufacturer’s instructions to determine the amount of detergent to use.

C Liquid chlorine bleach dispenser

This dispenser holds up to 3/4 cup (180 mL) liquid chlorine bleach. The bleach will be automatically diluted and dispensed at the optimum time during the wash cycle. This dispenser cannot dilute powdered bleach.

NOTE: Fill dispenser with only liquid bleach.

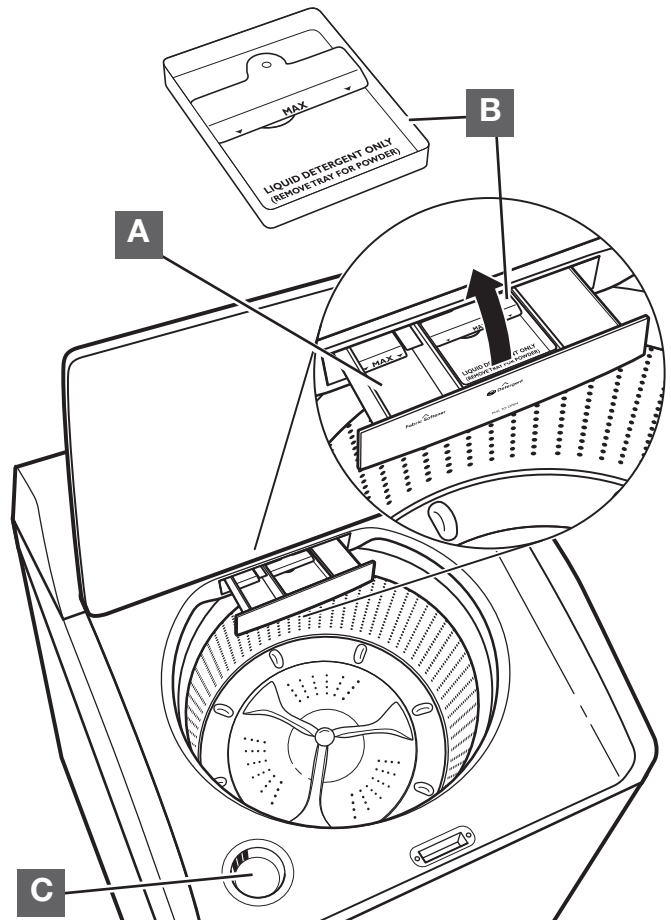

Cycle Guide

The Whirlpool® Cabrio® washer, has a unique user interface to help you select the best cycle you need for your load. The “What to Wash” “How to Wash” layout guides you to the optimal cycle in two easy steps:

First determine what items are in the load that you are trying to wash. Use that to guide your “What to Wash” selection. Then determine how you want the washer to wash them and select the appropriate “How to Wash” selection. See chart below for more details.

For best fabric care, choose the cycle that best fits the load being washed.

R - Recommended Cycle

a - Alternate Cycle

Blank – Cycle is available but not optimal.

		How do you want to wash?				
		“How to Wash” Cycle Selection				
		Normal	Quick	Cold	Deep Water	ColorLast
		• Powerful Soil Removal • Regular	• Fast	• Saving Water & Energy • Cold Wash	• with Extra Water • “Conventional Style” More Water	• Protecting my colors • Protecting my fabrics • Gentle cleaning
What do you want to wash?	“What to Wash” Cycle Selection					
Athletic/High Performance Wear	Mixed	R	a	a	a	a
Bright Colors				a		R
Cottons/Linens		R				
Dark Colors				a		R
Jeans		R	a	a	a	
Pajamas		R	a	a	a	a
Sweatshirts		R	a	a	a	a
Terry Cloth		R	a		a	
Towels		R	a		a	
T-Shirts		R	a	a	a	a
Business Casual	Casuals	R	a	a	a	a
Dress Shirts/Pants		R	a	a	a	a
Linens		R	a	a	a	a
No-Iron Fabrics		R	a	a	a	a
Baby Clothes	Whites	R			a	NA
Dish Cloths		R	a		a	
Handkerchiefs		R	a		a	
Napkins		R	a		a	
Socks		R	a		a	
Tablecloth		R	a	a	a	
Undergarments		R	a		a	
White Clothing		R	a	a	a	
White Shirts		R	a	a	a	
White Towels		R	a		a	
White T-Shirts	R	a	a	a		
Bras	Delicates	R	a	a	a	a
Handwash Fabrics		R	a	a	a	a
Lingerie		R	a	a	a	a
Machine Wash Silks		R	a	a	a	a
Wool		R	a	a	a	a
Blankets	Bulky/Sheets	a	a	a	R	
Coats & Jackets		R	a	a	a	a
Comforters		a	a	a	R	
Machine Wash Curtains		R	a	a	a	a
Machine Wash Slip Covers		R	a	a	a	
Non-Rubber Lined Rugs & Mats		R	a	a	a	
Sheets		R	a		a	a
Sleeping Bags		a	a	a	R	

Using Your Washer

⚠️ WARNING



Fire Hazard

Never place items in the washer that are dampened with gasoline or other flammable fluids.

No washer can completely remove oil.

Do not dry anything that has ever had any type of oil on it (including cooking oils).

Doing so can result in death, explosion, or fire.

⚠️ WARNING



Electrical Shock Hazard

Plug into a grounded 3 prong outlet.

Do not remove ground prong.

Do not use an adapter.

Do not use an extension cord.

Failure to follow these instructions can result in death, fire, or electrical shock.

1. Sort and prepare your laundry

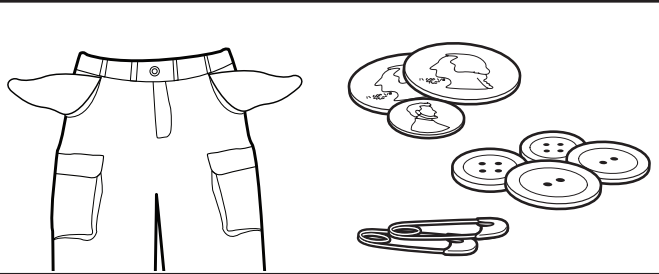

- Empty pockets. Loose change, buttons, or any small object can pass under the washplate and become trapped, causing unexpected sounds.
- Sort items by recommended cycle, water temperature, and colorfastness.
- Separate heavily soiled items from lightly soiled.
- Separate delicate items from sturdy fabrics.
- Do not dry items if stains remain after washing; heat can set stains into fabric.
- Treat stains promptly.
- Close zippers, fasten hooks, tie strings and sashes. Remove non-washable trim and ornaments.
- Mend rips and tears to avoid further damage to items during washing.

Helpful Tips:

- For best performance, use HE liquid detergent when washing bulky items.
- When washing water-proof or water-resistant items, load evenly.
- Use mesh bags to help avoid tangling when washing delicate or small items.
- Turn knits inside out to avoid pilling. Separate lint-takers from lint-givers. Synthetics, knits, and corduroy fabrics will pick up lint from towels, rugs, and chenille fabrics.

NOTE: Always read and follow fabric care labels instructions to avoid damage to your items.

2. Add laundry products

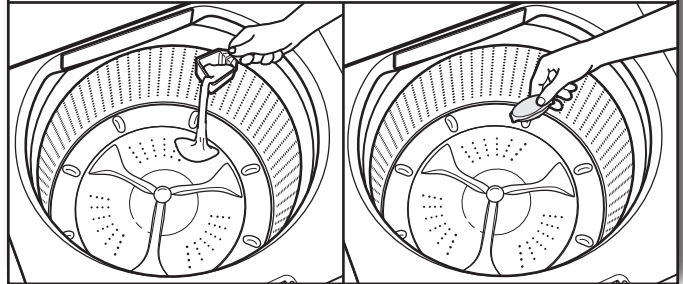

Single-dose laundry packet, color-safe bleach, Oxi-type boosters, or fabric softener crystals can be added to the basket prior to adding laundry.

NOTE: Always follow manufacturer's instructions.

3. Load laundry into washer

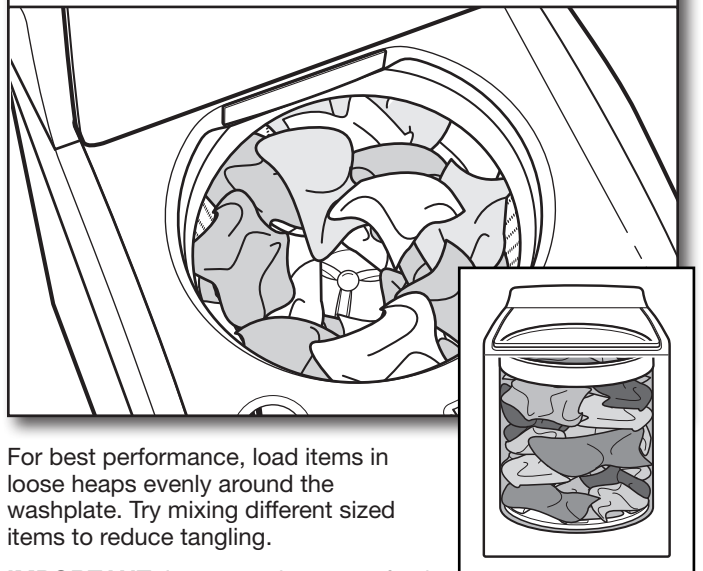

For best performance, load items in loose heaps evenly around the washplate. Try mixing different sized items to reduce tangling.

IMPORTANT: Items need to move freely for best cleaning and to reduce wrinkling and tangling.

Using Laundry Product Dispensers

NOTE: Do not add single-dose laundry packets, color-safe bleach, Oxi-type boosters, or fabric softener crystals to dispensers. They will not dispense correctly. Add to the basket prior to adding laundry.

4. Add HE detergent

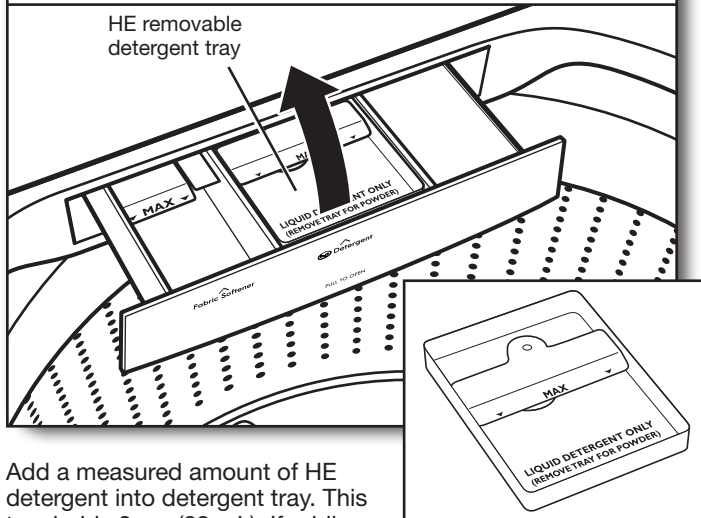

Add a measured amount of HE detergent into detergent tray. This tray holds 3 oz. (89 mL). If adding powder HE detergent remove inside tray. Do not overfill tray – adding too much detergent may cause detergent to be dispensed into the washer too early.

NOTE: Make sure tray is in drawer when using liquid detergent and removed when using powder detergent. Do not go over the Max line.

IMPORTANT: Use only High Efficiency detergents. The package will be marked “HE” or “High Efficiency.” Low-water washing creates excessive sudsing with a regular non-HE detergent. Using regular detergent will likely result in longer cycle times and reduced rinsing performance. It may also result in component failures and noticeable mold or mildew. HE detergents are made to produce the right amount of suds for the best performance. Follow the manufacturer’s instructions to determine the amount of detergent to use.

HELPFUL TIP: See “Washer Maintenance” for information on recommended method of cleaning washer dispenser trays.

5. Add liquid chlorine bleach to dispenser

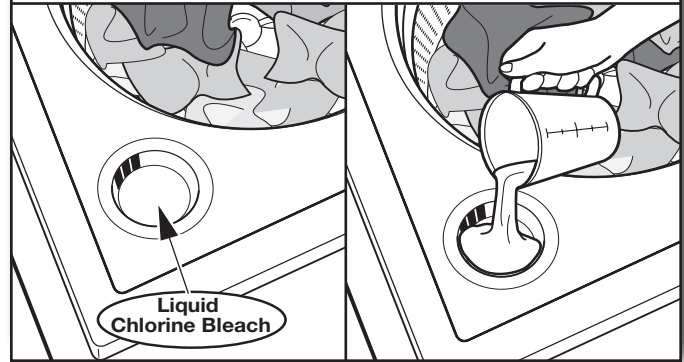

Do not overfill, dilute, or use more than 1 cup (250 mL). Do not use color-safe bleach or Oxi products in the same cycle with liquid chlorine bleach.

6. Add liquid fabric softener

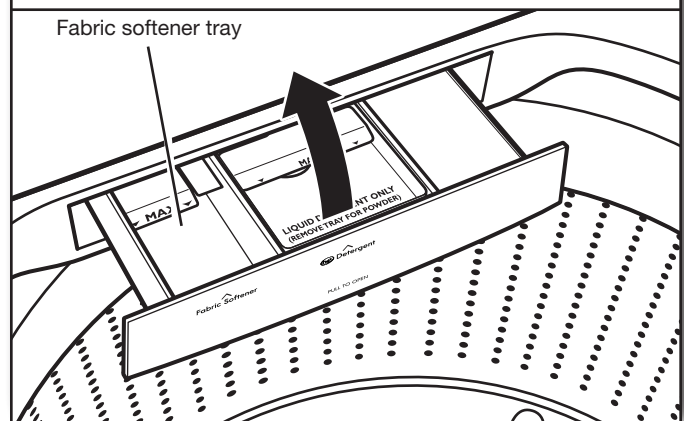

Pour a measured amount of liquid fabric softener into tray; always follow manufacturer’s directions for correct amount of fabric softener based on your load size. Close dispenser drawer. Fabric Softener is added during rinse.

IMPORTANT: Do not overfill or dilute. Overfilling dispenser will cause fabric softener to immediately dispense into washer.

If Extra Rinse option is selected, fabric softener will be dispensed into the last rinse.

It is normal for a small amount of water to remain in the dispenser at the end of a cycle.

7. Touch POWER to turn on washer



Make sure the dispenser drawer is closed completely, then touch POWER to turn on the washer.

8. Select type of load to wash

WHAT TO WASH

- Mixed
- Casuals
- Whites
- Delicates
- Bulky/Sheets

HOW TO WASH

- Normal
- Quick
- Cold
- Deep Water
- ColorLast

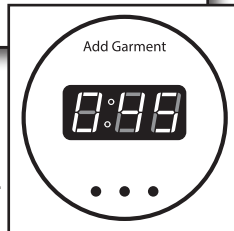

First touch a cycle from the “What to Wash” and then select the “How to Wash” to get the best combination cycle available for the type of items you are going to wash. See “Cycle Guide” for cycle details. Red, green, and blue LED lights come on below the time/status display when the “How to Wash” ColorLast cycle is selected. Not all cycles are available on all models.

Estimated Time Remaining will light up with a cycle time. You may notice time adjusting during the cycle. This is normal.

If you do not want to begin a cycle immediately, you may choose DELAY START option.

To choose a delay time:

1. Touch DELAY START button to select desired delay time. Time will increase in hour increments up to 12 hours.
2. Touch and hold START/PAUSE button to start delay start time.

IMPORTANT: When delaying a cycle, use liquid HE detergent only in the dispenser. Powdered detergents may absorb moisture from a previous cycle and clump before the wash cycle begins.

To cancel delay start:

1. Touch POWER to cancel Delay Start.

To pause delay start:

1. Touch START/PAUSE button to pause delay start.
2. Touch and hold START/PAUSE button again to start Delay Start time. If the delay start time is not started after 10 minutes the washer will power off.

9. Select cycle modifiers

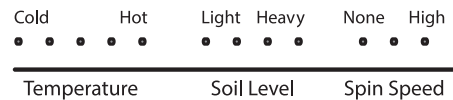

Once you select a cycle, the default modifiers or the previous set modifiers for that cycle will be lit. Touch the cycle settings buttons to change the Soil Level, Spin Speed, and Temperature, if desired. Not all settings are available with all cycles.

NOTE: Always read and follow fabric care labels instructions to avoid damage to your items.

Temperature	Suggested Fabrics
Hot Some cold water is added to save energy. This will be cooler than your hot water heater setting.	Whites and pastels Durable items Heavy soils
Warm Some cold water will be added, so this may be cooler than what your previous washer provided.	Bright colors Moderate to light soils
Cool Warm water is added to assist in soil removal and to help dissolve detergents.	Colors that bleed or fade Light soils
Cold Warm water may be added to assist in soil removal and to help dissolve detergents.	Dark colors that bleed or fade Light soils

10. Select cycle options

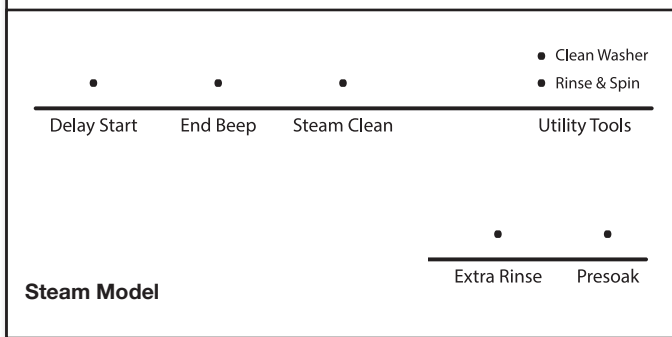

Select any other cycle options you may wish to add, if not previously set. Some cycles will automatically add certain options such as Extra Rinse. These may be turned off if desired.

NOTE: Not all options are available with all cycles. Touch control panel to select any other options.

11. Touch and hold START/PAUSE button to begin wash cycle

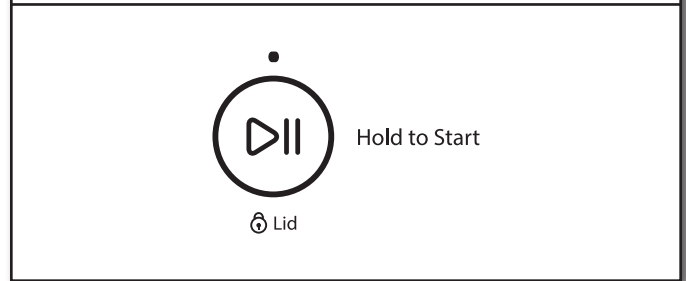

Touch and hold START/PAUSE button to start the wash cycle. When the cycle has finished, the end of cycle signal will sound (if set). Promptly remove items when cycle is done to avoid odor, reduce wrinkling, and rusting of metal hooks, zippers, and snaps.

Unlocking the lid to add items

If you need to open the lid to add 1 or 2 missed items:

Touch START/PAUSE button to pause washer; the lid will unlock once the washer movement has stopped. This may take several minutes if the load was spinning at a high speed. Then close lid and touch and hold START/PAUSE button again to restart the cycle.

IMPORTANT: If lid is left open for more than 10 minutes the water will pump out and F8E6 error code will appear on the display.

Washer Maintenance

WATER INLET HOSES

Replace inlet hoses after 5 years of use to reduce the risk of hose failure. Periodically inspect and replace inlet hoses if bulges, kinks, cuts, wear, or leaks are found.

When replacing your inlet hoses, mark the date of replacement on the label with a permanent marker.

NOTE: This washer does not include inlet hoses. See the Installation Instructions for more information.

WASHER CARE

Recommendations to Help Keep Your Washer Clean and Performing at its Best

1. Always use High Efficiency (HE) detergents and follow the HE detergent manufacturer's instructions regarding the amount of HE detergent to use. Never use more than the recommended amount because that may increase the rate at which detergent and soil residue accumulate inside your washer, which in turn may result in undesirable odor.
2. Use warm and hot wash water settings sometimes (not exclusively cold water washes), because they do a better job of controlling the rate at which soils and detergent accumulate.
3. Always leave the washer lid open between uses to help dry out the washer and prevent the buildup of odor-causing residue.

Cleaning Your Top Loading Washer

Read these instructions completely before beginning the routine cleaning processes recommended below. This Washer Maintenance Procedure should be performed, at a minimum, once per month or every 30 wash cycles, whichever occurs sooner, to control the rate at which soils and detergent may otherwise accumulate in your washer.

Cleaning the Inside of the Washer

To keep your washer odor-free, follow the usage instructions provided above, and use this recommended monthly cleaning procedure:

Clean Washer Cycle

This washer has a special cycle that uses higher water volumes in combination with affresh® Washer Cleaner or liquid chlorine bleach to clean the inside of the washer.

Begin procedure

1. **affresh® Washer Cleaner Cycle Procedure (Recommended for Best Performance):**
 - a. Open the washer lid and remove any clothing or items.
 - b. Place an affresh® Washer Cleaner tablet in the bottom of the washer basket.
 - c. Do not place an affresh® Washer Cleaner tablet in the detergent dispenser.
 - d. Do not add any detergent or other chemical to the washer when following this procedure.
 - e. Close the washer lid.
 - f. Select the CLEAN WASHER cycle.
 - g. Touch and hold the START/PAUSE button to begin the cycle. The Clean Washer Cycle Operation is described below.

NOTE: For best results, do not interrupt cycle. If cycle must be interrupted, touch POWER. After the Clean Washer cycle has stopped, run a Rinse & Spin cycle to rinse cleaner from washer.

WASHER CARE (cont.)

2. Chlorine Bleach Procedure (Alternative):

- a. Open the washer lid and remove any clothing or items.
 - b. Add 1 cup (236 mL) of liquid chlorine bleach to the bleach compartment.
- NOTE:** Use of more liquid chlorine bleach than is recommended above could cause washer damage over time.
- c. Close the washer lid.
 - d. Do not add any detergent or other chemical to the washer when following this procedure.
 - e. Select the CLEAN WASHER cycle.
 - f. Touch and hold the START/PAUSE button to begin the cycle. The Clean Washer Cycle Operation is described below.

NOTE: For best results, do not interrupt cycle. If cycle must be interrupted, touch POWER. After the Clean Washer cycle has stopped, run a Rinse & Spin cycle to rinse cleaner from washer.

Description of Clean Washer Cycle Operation:

1. This cycle will fill to a water level higher than in normal wash cycles to provide rinsing at a level above the water line for normal wash cycle.
2. During this cycle, there will be some agitation and spinning to increase the removal of soils.

After this cycle is complete, leave the lid open to allow for better ventilation and drying of the washer interior.

Cleaning the Outside of the Washer

Use a soft, damp cloth or sponge to wipe away any spills. Use only mild soaps or cleaners when cleaning external washer surfaces.

IMPORTANT: To avoid damaging the washer's finish, do not use abrasive products.

NON-USE AND VACATION CARE

Operate your washer only when you are home. If moving, or not using your washer for a period of time, follow these steps:

1. Unplug or disconnect power to washer.
2. Turn off water supply to washer, to avoid flooding due to water pressure surge.

CLEANING YOUR DISPENSER

You may find laundry product residue leftover in your dispenser drawer. To remove residue, follow this recommended cleaning procedure:

1. Pull drawer out until you feel resistance.
2. Push 1 tab downward, and then continue pulling out.
3. Wash in warm, soapy water, using a mild detergent.
4. Rinse with warm water.
5. Air dry, or dry with a towel, then place back into slot.

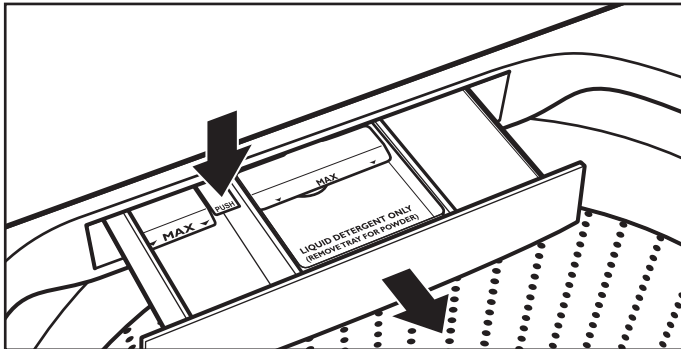

IMPORTANT: Dispenser drawer and tray are not dishwasher safe.

WINTER STORAGE CARE

IMPORTANT: To avoid damage, install and store washer where it will not freeze. Because some water may stay in hoses, freezing can damage washer. If storing or moving during freezing weather, winterize your washer.

To winterize washer:

1. Shut off both water faucets; disconnect and drain water inlet hoses.
2. Put 1 qt. (1 L) of R.V.-type antifreeze in basket and run washer on RINSE & SPIN cycle for about 30 seconds to mix antifreeze and remaining water.
3. Unplug washer or disconnect power.

TRANSPORTING YOUR WASHER

1. Shut off both water faucets. Disconnect and drain water inlet hoses.
2. If washer will be moved during freezing weather, follow WINTER STORAGE CARE directions before moving.
3. Disconnect drain from drain system.
4. Unplug power cord.
5. Place inlet hoses inside washer basket.
6. Drape power cord and drain hose over the console and secure with masking tape.
7. Place foam packing ring from original shipping materials back inside washer. If you do not have packing ring, place heavy blankets or towels into basket opening. Close lid and place tape over lid and down front of washer. Keep lid taped until washer is placed in new location. Transport Washer in the upright position.

⚠ WARNING



Electrical Shock Hazard

Plug into a grounded 3 prong outlet.

Do not remove ground prong.

Do not use an adapter.

Do not use an extension cord.

Failure to follow these instructions can result in death, fire, or electrical shock.

REINSTALLING/USING WASHER AGAIN

To reinstall washer after non-use, vacation, winter storage or moving:

1. Refer to Installation Instructions to locate, level, and connect washer.
2. Before using again, run washer through the following recommended procedure:

To use washer again:

1. Flush water pipes and hoses. Reconnect water inlet hoses. Turn on both water faucets.
2. Plug in washer or reconnect power.
3. Run washer through Bulky/Sheets and Deep Water Wash cycle to clean washer and remove antifreeze, if used. Use only HE High Efficiency detergent. Use half the manufacturer's recommended amount for a medium-size load.

Troubleshooting

First try the solutions suggested here or visit our website at www.whirlpool.com/product_help -
In Canada www.whirlpool.ca for assistance and to possibly avoid a service call.

If you experience	Possible Causes	Solution
Vibration or Off-Balance		
Vibration, rocking, or "walking"	Feet may not be in contact with the floor and locked.	Front and rear feet must be in firm contact with floor, and washer must be level to operate properly.
	Washer may not be level.	Check floor for flexing or sagging. If flooring is uneven, a ¾" (19 mm) piece of plywood under your washer will reduce sound. See "Level the Washer" in the Installation Instructions.
Vibration during spinning or washer stopped	Load could be unbalanced.	Load items in loose heaps evenly around the washplate. Adding wet items to washer or adding more water to basket could unbalance washer.
		Avoid washing single items. Balance a single item such as a rug or jeans jacket with a few extra items. If the dial is flashing, redistribute the load, close the lid, and touch and hold START/ PAUSE.
		Use Bulky/Sheets and Deep Water cycle for oversized, non-absorbent items such as comforters or poly-filled jackets. Other items are not appropriate for Bulky/Sheets Deep Water cycle. See "Cycle Guide."
		Item or load not suitable for selected cycle. See "Cycle Guide" and "Using Your Washer."
Noises – For normal operating sounds, go to www.whirlpool.com/product_help.		
Clicking or metallic noises	Objects may be caught in washer drain system.	Empty pockets before washing. Loose items such as coins could fall between basket and tub or may block pump. It may be necessary to call for service to remove items.
		It is normal to hear metal items on clothing such as metal snaps, buckles, or zippers touch against the stainless steel basket.
Gurgling or humming	Washer may be draining water.	It is normal to hear the pump making a continuous humming sound with periodic gurgling or surging as final amounts of water are removed during the spin/drain cycles.
Humming	Load sensing may be occurring.	You may hear the hum of the sensing spins after you have started the washer. This is normal.
Whirring	Basket may be slowing down.	You may hear the whirring sound of the basket slowing down. This is normal.
Water Leaks		
Check the following for proper installation:	Washer not level.	Water may splash off basket if washer is not level.
	Fill hoses not attached tightly.	Tighten fill-hose connection.
	Fill hose washers	Make sure all four fill hose flat washers are properly seated.
	Drain hose connection	Pull drain hose from washer cabinet and properly secure it to drainpipe or laundry tub.
		Do not place tape over drain opening.
	Check household plumbing for leaks or clogged sink or drain.	Water can back up out of a clogged sink or drainpipe. Check all household plumbing for leaks (laundry tubs, drain pipe, water pipes, and faucets.)
Washer not loaded as recommended.	An unbalanced load can cause basket to be out of alignment and cause water to splash off tub. See "Using Your Washer" for loading instructions.	
Washer not performing as expected		
Not enough water in washer	Load not completely covered in water.	This is normal operation for an HE low-water washer. The load will not be completely underwater. The washer senses load sizes and adds correct amount of water for optimal cleaning. See "What's New under the Lid."
		IMPORTANT: Do not add more water to washer. Adding water lifts the items off the washplate, resulting in less effective cleaning. Run clean washer cycle to optimize the water level and wash performance.

Troubleshooting

First try the solutions suggested here or visit our website at www.whirlpool.com/product_help -
In Canada www.whirlpool.ca for assistance and to possibly avoid a service call.

If you experience	Possible Causes	Solution
Washer not performing as expected (cont.)		
Washer won't run or fill, washer stops working	Check for proper water supply.	Both hoses must be attached and have water flowing to inlet valve.
		Both hot and cold water faucets must be turned on.
		Check that inlet valve screens have not become clogged.
		Check for any kinks in inlet hoses, which can restrict water flow.

⚠ WARNING



Electrical Shock Hazard

Plug into a grounded 3 prong outlet.

Do not remove ground prong.

Do not use an adapter.

Do not use an extension cord.

Failure to follow these instructions can result in death, fire, or electrical shock.

Washer won't run or fill, washer stops working (cont.)	Check proper electrical supply.	Plug power cord into a grounded 3-prong outlet.
		Do not use an extension cord.
		Ensure there is power to outlet.
		Reset a tripped circuit breaker. Replace any blown fuses. NOTE: If problems continue, contact an electrician.
	Normal washer operation.	Lid must be closed for washer to run.
		Washer will pause during certain phases of cycle. Do not interrupt cycle.
		Washer may be stopped to reduce suds.
	Washer may be tightly packed.	Remove several items, rearrange load evenly around the washplate. Close lid, touch and hold START/PAUSE button.
		Add only 1 or 2 additional items after washer has started.
		Do not add more water to the washer.
Not using HE detergent or using too much HE detergent.	Only use HE detergent. Suds from regular detergents can slow or stop the washer. Always measure detergent and following detergent directions based on your load requirements.	
	To remove suds, cancel cycle. Select RINSE & SPIN. Select your cycle. Touch and hold START/PAUSE. Do not add more detergent.	
Washer not draining/spinning, loads are still wet	Small items may have been caught in pump or between basket and tub, which can slow draining.	Empty pockets and use garment bags for small items.
	Using cycles with a lower spin speed.	Cycles with lower spin speeds remove less water than cycles with high spin speeds. Use the recommended cycle/speed spin for your item.
	Washer may be tightly packed or unbalanced.	Tightly packed loads may not allow the washer to spin correctly, leaving the load wetter than normal. Evenly arrange the wet load for balanced spinning. Select RINSE & SPIN to remove excess water. See "Using Your Washer" for loading recommendations.

Troubleshooting

First try the solutions suggested here or visit our website at www.whirlpool.com/product_help -
In Canada www.whirlpool.ca for assistance and to possibly avoid a service call.

If you experience	Possible Causes	Solution
Washer not performing as expected (cont.)		
Washer not draining/ spinning, loads are still wet (cont.)	Load off balanced.	See "Vibration or Off-Balance" in Troubleshooting section for more information.
	Check plumbing for correct drain hose installation. Drain hose extends into standpipe farther than 4.5" (114 mm).	Check drain hose for proper installation. Use drain hose form and securely attach to drainpipe or tub. Do not tape over drain opening. Lower drain hose if the end is higher than 96" (2.4 m) above the floor. Remove any clogs from drain hose.
	Not using HE detergent or using too much HE detergent.	Suds from regular detergent or using too much detergent can slow or stop draining or spinning. Use only HE detergent. Always measure and follow detergent directions for your load. To remove extra suds, select RINSE & SPIN. Do not add detergent.
Incorrect or wrong wash or rinse temperatures	Check for proper water supply.	Make sure hot and cold inlet hoses are not reversed.
		Both hoses must be attached to both washer and faucet, and have both hot and cold water flowing to inlet valve.
		Check that inlet valve screens are not clogged.
	Remove any kinks in hoses.	
Energy-saving controlled wash temperatures.	ENERGY STAR® qualified washers use cooler wash and rinse water temperatures than traditional top-load washers. This includes cooler hot and warm washes.	
Load not rinsed	Check for proper water supply.	Make sure hot and cold inlet hoses are not reversed.
		Both hoses must be attached and have water flowing to the inlet valve.
		Both hot and cold water faucets must be on.
		Inlet valve screens on washer may be clogged.
	Remove any kinks in the inlet hose.	
	Not using HE detergent or using too much HE detergent.	The suds from regular detergent can cause the washer to operate incorrectly.
		Use only HE detergent. Be sure to measure correctly.
		Always measure detergent and follow detergent directions based on load size and soil level.
	Washer may be tightly packed.	The washer is less efficient at rinsing when load is tightly packed.
		Load items in loose heaps evenly around the washplate.
Use cycle designed for the fabrics being washed.		
Add only 1 or 2 additional items after washer has started.		
Sand, pet hair, lint, etc. on load after washing	Heavy sand, pet hair, lint, and detergent or bleach residues may require additional rinsing.	Add an Extra Rinse to the selected cycle.
Load is tangling	Washer not loaded as recommended.	Load items in loose heaps evenly around the washplate.
		Reduce tangling by mixing types of load items. Use the recommended cycle for the type of items being washed.
	Wash action and/or spin speed too fast for load.	Select a cycle with a slower wash action and slower spin speed. Note that items will be wetter than when using a higher speed spin.
Not cleaning or removing stains	Wash load not completely covered in water.	Washer senses load size and adds correct amount of water. This is normal and necessary for clothes to move.
	Added more water to washer.	Do not add more water to washer. Adding water lifts the items off the washplate, resulting in less effective cleaning.
	Washer not loaded as recommended.	Load items in loose heaps evenly around the washplate.
		Add only 1 or 2 additional items after washer has started.

Troubleshooting

First try the solutions suggested here or visit our website at www.whirlpool.com/product_help -
In Canada www.whirlpool.ca for assistance and to possibly avoid a service call.

If you experience	Possible Causes	Solution
Washer not performing as expected (cont.)		
Not cleaning or removing stains (cont.)	Not using HE detergent or using too much HE detergent.	The suds from regular detergent can keep washer from operating correctly.
		Use only HE detergent. Be sure to measure correctly.
		Always measure detergent and follow detergent directions based on load size and soil level.
	Not using correct cycle for fabric type.	Use a higher soil level cycle option and warmer wash temperature to improve cleaning.
		If using Quick cycle (on some models), wash only a few items.
		Use Whites Normal cycle for tough cleaning.
		See the "Cycle Guide" to match your load with the best cycle.
	Not using dispensers.	Use dispensers to avoid chlorine bleach and fabric softener staining.
		Load dispensers before starting a cycle.
		Avoid overfilling.
Do not add products directly onto load.		
Not washing like colors together.	Wash like colors together and remove promptly after the cycle is complete to avoid dye transfer.	
Odors	Monthly maintenance not done as recommended.	Run the Clean Washer cycle after every 30 washes. See "Washer Care" in "Washer Maintenance."
		Unload washer as soon as cycle is complete.
	Not using HE detergent or using too much HE detergent.	Use only HE detergent. Be sure to measure correctly.
		Always follow the detergent directions.
		See "Washer Care" section.
Fabric Damage	Sharp items were in pockets during wash cycle.	Empty pockets, zip zippers, and snap or hook fasteners before washing to avoid snags and tears.
	Strings and straps could have tangled.	Tie all strings and straps before starting wash load.
	Items may have been damaged before washing.	Mend rips and broken threads in seams before washing.
	Fabric damage can occur if the load is tightly packed.	Load items in loose heaps evenly around washplate.
		Load items should move freely during wash to avoid damage.
		Use cycle designed for the fabrics being washed.
		Add only 1 or 2 additional items after washer has started.
	Garment care instructions may not have been followed.	Always read and follow garment manufacturer's care label instructions. See the "Cycle Guide" to match your load with the best cycle.
	Liquid chlorine bleach may have been added incorrectly.	Do not pour liquid chlorine bleach directly onto load. Wipe up bleach spills.
		Undiluted bleach will damage fabrics. Do not use more than recommended by manufacturer.
		Do not place load items on top of bleach dispenser when loading and unloading washer.

Troubleshooting

First try the solutions suggested here or visit our website at www.whirlpool.com/product_help -
In Canada www.whirlpool.ca for assistance and to possibly avoid a service call.

If you experience	Possible Causes	Solution
Washer not performing as expected (cont.)		
Incorrect dispenser operation	Clogged dispensers or laundry products dispensing too soon.	Do not overfill dispenser. Overfilling causes immediate dispensing.
		Load dispensers before starting a cycle.
		It is normal for small amounts of water to remain in dispenser at the end of the cycle.
		Fabric softener thickens as it gets older. If there becomes an increase of fabric softener in the dispenser after a cycle, then check the age of the fabric softener and replace if needed.
	Homes with low water pressure may result in residual powder in the dispenser. To avoid, select a warmer wash temperature if possible, depending on your load.	
	Liquid chlorine bleach not used in dispenser.	Use only liquid chlorine bleach in the bleach dispenser.
Powdered detergent not dissolving completely in load	Using too much HE detergent.	Follow the manufacturer's instructions to determine the amount of detergent to use.
	Water temperature is very cold.	Select a warmer wash temperature.
		Try adding the detergent to the basket prior to adding laundry, rather than using the detergent dispenser.
Single-dose laundry packet not dissolving	Adding laundry packet incorrectly.	Be sure laundry packet is added to washer basket before adding clothes. Follow the manufacturer's instructions to avoid damage to your items.
Error Code Appears in Display		
F#E# code (F-type error code) appears in display	System error code.	Touch POWER to clear the code and exit cycle. Then touch POWER, select cycle, and then touch and hold START/PAUSE to start washer. If code appears again, call for service.
F8E1 or LF (too long to fill) appears in display	Washer taking too long to fill. Drain extends more than 4.5" (114 mm) into standpipe.	Check plumbing for correct drain hose installation. Use drain hose form and attach securely to drainpipe or tub. Do not tape over drain opening. See Installation Instructions.
		Make sure water supply line is turned on.
F9E1, drn, dr (drain pump system problem - long drain) appears in display	Washer taking too long to drain water. Drain extends more than 4.5" (114 mm) into standpipe.	Check plumbing for correct drain hose installation. Use drain hose form and attach securely to drainpipe or tub. Do not tape over drain opening.
		Lower drain hose if the end is higher than 96" (2.4 m) above the floor. Remove any clogs from drain hose. See Installation Instructions.
F8E6 (Lid opened) appears in display	Washer lid left open.	Close the lid and touch Power to clear the display. If the lid is left open for more than 10 minutes, the cycle will reset and water in the washer will drain.
F1E1 ACU (Appliance control fault)	Internal ACU failure.	Call for service.
F2E5 UI/ACU mismatch	Wrong ACU or UI has been installed.	Call for service.
F3E1 Water level sensing failure	Pressure sensor on ACU failure.	Call for service.
F5E2 Lid lock will not lock or lid lock failure	An item in the load maybe keeping the lid from locking.	Check for items directly under the lid.
F5E3 Lid cannot unlock	Objects on washer lid keep it from unlocking.	Remove objects, such as baskets of laundry, from top of washer.
F6E2 or F6E3 Communication Error: UI cannot communicate	ACU or UI synchronization error.	Remove power from the washer. Let washer set for 5 minutes for the washer to completely power down. Apply power to washer and check for error codes. If the error code persists call for service.

WHIRLPOOL® LAUNDRY LIMITED WARRANTY

ATTACH YOUR RECEIPT HERE. PROOF OF PURCHASE IS REQUIRED TO OBTAIN WARRANTY SERVICE. Please have the following information available when you call the Customer eXperience Center:

- Name, address, and telephone number
- Model number and serial number
- A clear, detailed description of the problem
- Proof of purchase including dealer or retailer name and address

IF YOU NEED SERVICE:

1. Before contacting us to arrange service, please determine whether your product requires repair. Some questions can be addressed without service. Please take a few minutes to review the Troubleshooting or Problem Solver section of the Use and Care Guide, scan the QR code on the right to access additional resources, or visit https://www.whirlpool.com/product_help.
2. All warranty service is provided exclusively by our authorized Whirlpool Service Providers. In the U.S. and Canada, direct all requests for warranty service to:



https://www.whirlpool.com/product_help

Whirlpool Customer eXperience Center

In the U.S.A. call 1-800-253-1301. In Canada call 1-800-807-6777.

If outside the 50 United States and Canada, contact your authorized Whirlpool dealer to determine if another warranty applies.

ONE YEAR LIMITED WARRANTY

WHAT IS COVERED

For one year from the date of purchase, when this major appliance is installed, operated, and maintained according to instructions attached to or furnished with the product, Whirlpool Corporation or Whirlpool Canada LP (hereafter "Whirlpool") will pay for Factory Specified Replacement Parts and repair labor to correct defects in materials or workmanship that existed when this major appliance was purchased, or at its sole discretion replace the product. In the event of product replacement, your appliance will be warranted by the remaining term of the original unit's warranty period.

YOUR SOLE AND EXCLUSIVE REMEDY UNDER THIS LIMITED WARRANTY SHALL BE PRODUCT REPAIR AS PROVIDED HEREIN. Service must be provided by a Whirlpool designated service company. This limited warranty is valid only in the United States or Canada and applies only when the major appliance is used in the country in which it was purchased. This limited warranty is effective from the date of original consumer purchase. Proof of original purchase date is required to obtain service under this limited warranty.

WHAT IS NOT COVERED

1. Commercial, non-residential, multiple-family use, or use inconsistent with published user, operator, or installation instructions.
2. In-home instruction on how to use your product.
3. Service to correct improper product maintenance or installation, installation not in accordance with electrical or plumbing codes, or correction of household electrical or plumbing (i.e. house wiring, fuses, or water inlet hoses).
4. Consumable parts (i.e. light bulbs, batteries, air or water filters, preservation solutions, etc.).
5. Defects or damage caused by the use of non-genuine Whirlpool parts or accessories.
6. Conversion of your product from natural gas or L.P. gas or reversal of appliance doors.
7. Damage from accident, misuse, abuse, fire, floods, acts of God, or use with products not approved by Whirlpool.
8. Repairs to parts or systems to correct product damage or defects caused by unauthorized service, alteration, or modification of the appliance.
9. Cosmetic damage including scratches, dents, chips, and other damage to appliance finishes unless such damage results from defects in materials and workmanship and is reported to Whirlpool within 30 days.
10. Discoloration, rust, or oxidation of surfaces resulting from caustic or corrosive environments, including but not limited to, high salt concentrations, high moisture or humidity, or exposure to chemicals.
11. Pick-up or delivery. This product is intended for in-home repair.
12. Travel or transportation expenses for service in remote locations where an authorized Whirlpool servicer is not available.
13. Removal or reinstallation of inaccessible appliances or built-in fixtures (i.e. trim, decorative panels, flooring, cabinetry, islands, countertops, drywall, etc.) that interfere with servicing, removal, or replacement of the product.
14. Service or parts for appliances with original model/serial numbers removed, altered, or not easily determined.

The cost of repair or replacement under these excluded circumstances shall be borne by the customer.

DISCLAIMER OF IMPLIED WARRANTIES

IMPLIED WARRANTIES, INCLUDING ANY IMPLIED WARRANTY OF MERCHANTABILITY OR IMPLIED WARRANTY OF FITNESS FOR A PARTICULAR PURPOSE, ARE LIMITED TO ONE YEAR OR THE SHORTEST PERIOD ALLOWED BY LAW. Some states and provinces do not allow limitations on the duration of implied warranties of merchantability or fitness, so this limitation may not apply to you. This warranty gives you specific legal rights, and you also may have other rights that vary from state to state or province to province.

DISCLAIMER OF REPRESENTATIONS OUTSIDE OF WARRANTY

Whirlpool makes no representations about the quality, durability, or need for service or repair of this major appliance other than the representations contained in this Warranty. If you want a longer or more comprehensive warranty than the limited warranty that comes with this major appliance, you should ask Whirlpool or your retailer about buying an extended warranty.

LIMITATION OF REMEDIES; EXCLUSION OF INCIDENTAL AND CONSEQUENTIAL DAMAGES

YOUR SOLE AND EXCLUSIVE REMEDY UNDER THIS LIMITED WARRANTY SHALL BE PRODUCT REPAIR AS PROVIDED HEREIN. WHIRLPOOL SHALL NOT BE LIABLE FOR INCIDENTAL OR CONSEQUENTIAL DAMAGES. Some states and provinces do not allow the exclusion or limitation of incidental or consequential damages, so these limitations and exclusions may not apply to you. This warranty gives you specific legal rights, and you also may have other rights that vary from state to state or province to province.

Assistance or Service

Before calling for assistance or service, please check "Troubleshooting" or visit www.whirlpool.com/help. It may save you the cost of a service call. If you still need help, follow the instructions below.

When calling, please know the purchase date and the complete model and serial number of your appliance. This information will help us to better respond to your request.

If you need replacement parts or to order accessories

We recommend that you use only FSP® Factory Specified Parts.

These parts will fit right and work right because they are made with the same precision used to build every new WHIRLPOOL® appliance.

To locate FSP® replacement parts, assistance in your area, or accessories:

Whirlpool Corporation Customer eXperience Center

1-800-253-1301 www.whirlpool.com

1-800-442-9991 (Accessories)

www.whirlpool.com/accessories

Whirlpool Canada LP
Customer eXperience Centre

1-800-807-6777

www.whirlpool.ca

or call your nearest designated service center or refer to your Yellow Pages telephone directory.

Our consultants provide assistance with

In the U.S.A.

- Features and specifications on our full line of appliances.
- Installation information.
- Specialized customer assistance (Spanish speaking, hearing impaired, limited vision, etc.).

In the U.S.A. and Canada

- Use and maintenance procedures.
- Accessory and repair parts sales.
- Referrals to local dealers, repair parts distributors, and service companies. Whirlpool designated service technicians are trained to fulfill the product warranty and provide after-warranty service, anywhere in the United States and Canada.

You can write with any questions or concerns at:

Whirlpool Corporation
Customer eXperience Center
553 Benson Road
Benton Harbor, MI 49022-2692

Customer eXperience Centre
Whirlpool Canada LP
Unit 200-6750 Century Ave
Mississauga, Ontario L5N 0B7

Please include a daytime phone number in your correspondence.

Assistance ou Service

Avant de faire un appel pour assistance ou service, veuillez vérifier la section "Dépannage" ou consulter www.whirlpool.com/help. Cette vérification peut vous faire économiser le coût d'une visite de réparation.

Si vous avez encore besoin d'aide, suivre les instructions ci-dessous.

Lors d'un appel, veuillez connaître la date d'achat et les numéros au complet de modèle et de série de votre appareil. Ces renseignements nous aideront à mieux répondre à votre demande.

Si vous avez besoin de pièces de rechange ou pour commander des accessoires

Si vous avez besoin de commander des pièces de rechange, nous vous recommandons d'utiliser seulement des pièces spécifiées par l'usine FSP®. Ces pièces conviendront et fonctionneront bien parce qu'elles sont fabriquées selon les mêmes spécifications précises utilisées pour construire chaque nouvel appareil WHIRLPOOL®.

Pour trouver des pièces de rechange FSP®, de l'aide ou des accessoires dans votre région :

Whirlpool Canada LP Centre pour l'eXpérience de la clientèle
1-800-807-6777 www.whirlpool.ca

ou contacter votre centre de réparation désigné le plus proche, ou encore consulter les Pages Jaunes.

Nos consultants fournissent l'assistance pour :

- Procédés d'utilisation et d'entretien.
- Vente d'accessoires et de pièces de rechange.
- Les références aux concessionnaires, compagnies de service de réparation et distributeurs de pièces de rechange locaux. Les techniciens de service désignés par Whirlpool sont formés pour remplir la garantie des produits et fournir un service après la garantie, partout au Canada.

Pour plus d'assistance

Vous pouvez nous soumettre toute question ou problème en écrivant à l'adresse ci-dessous :

Centre pour l'eXpérience de la clientèle
Whirlpool Canada LP
Unit 200-6750 Century Ave
Mississauga, Ontario L5N 0B7

Dans votre correspondance, veuillez indiquer un numéro de téléphone où on peut vous joindre dans la journée.