



®

WORX



Line Trimmer

ENG

Pag 02

Débroussailleuse

F

Pag 12

Desmalezadora

ES

Pag 20

WG150

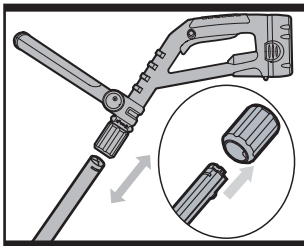
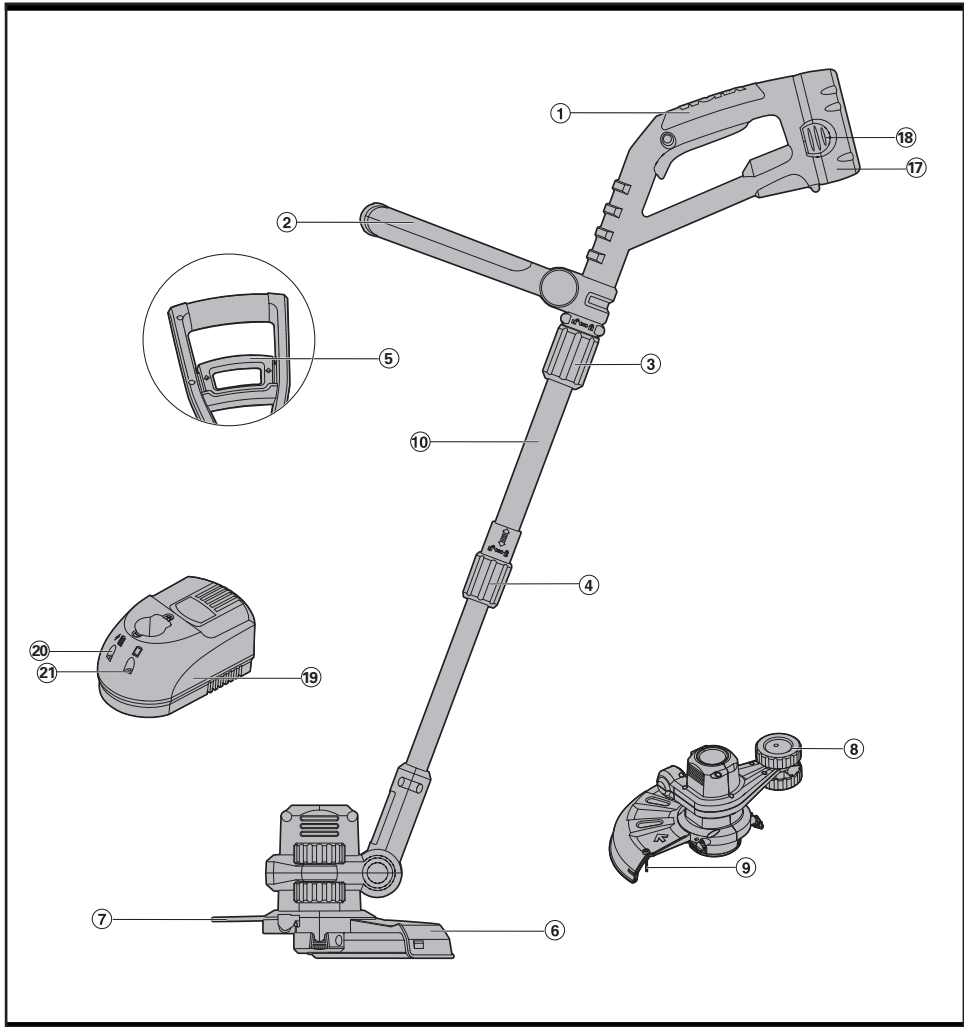

A

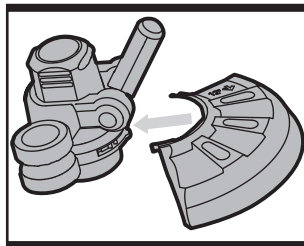

B

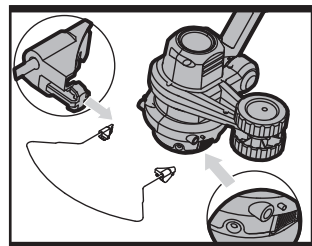

C

Grass Trimmer

ENG

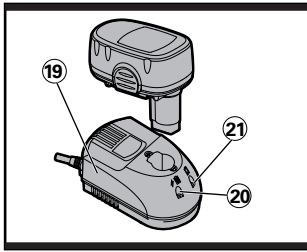

D

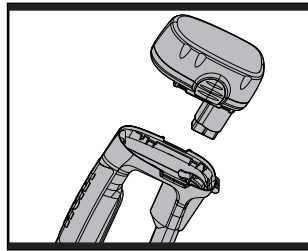

E

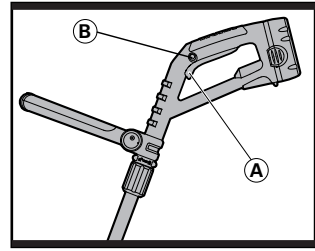

F

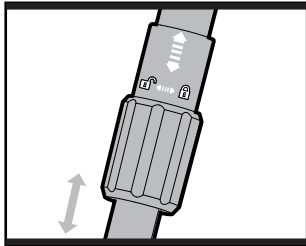

G

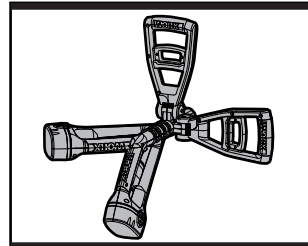

H

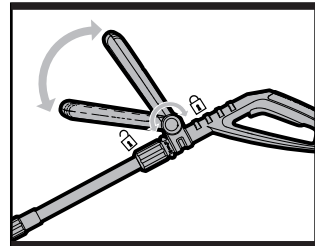

I

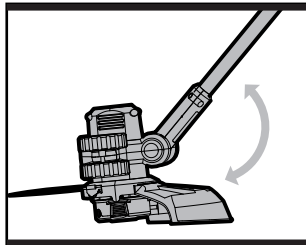

J

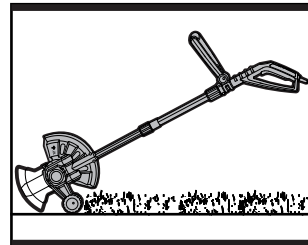

K

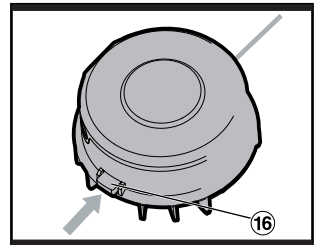

L

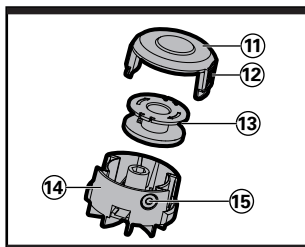

M

Grass Trimmer

ENG



- 1. MAIN HANDLE**
- 2. AUXILIARY HANDLE**
- 3. UPPER LOCKING KNOB**
- 4. LOWER LOCKING KNOB**
- 5. AUXILIARY HANDLE LOCKING LEVER**
- 6. SAFETY GUARD**
- 7. SPACER GUARD**
- 8. EDGER WHEEL**
- 9. LINE CUTTER**
- 10. TELESCOPIC SHAFT**
- 11. CUTTING HEAD COVER (See M)**
- 12. CAP RELEASE LATCH (See M)**
- 13. SPOOL (See M)**
- 14. CUTTING HEAD (See M)**
- 15. EYELET (See M)**
- 16. LINE FEED BUTTON (See L)**
- 17. BATTERY PACK**
- 18. BATTERY PACK RELEASE LATCH**
- 19. CHARGER**
- 20. CHARGED INDICATOR LIGHT(GREEN)**
- 21. CHARGING INDICATOR LIGHT(RED)**

05

TECHNICAL DATA

Model No.	WG150
Rated Voltage	18V \equiv
Rated No-Load Speed	8200min ⁻¹
Cutting Diameter	10"
Line Diameter	0.065"
Machine Weight	6.8lbs

ACCESSORIES

Battery:

1 hour charger:

18V - 1.7Ah Ni-Cd 1pc
Voltage 120V-60Hz 1pc

We recommend that you buy all your accessories from the store where you purchased the tool. Use good quality accessories marked with a well known brand name. Choose the bits according to the work you intend to undertake. Refer to the accessory packaging for further details. Store personnel can also help and advise.

Grass Trimmer

ENG

SAFETY INSTRUCTIONS

WARNING! When using electric gardening appliances, basic safety precautions must always be followed to reduce the risk of fire, electric shock, and serious injury, including the following:

READ ALL INSTRUCTIONS

1. FOR ALL DOUBLE-INSULATED APPLIANCES

- a) **Replacement parts.** When servicing use only identical replacement parts.
- b) **Polarized appliance connections.** To reduce the risk of electric shock, this appliance has a polarized plug (one blade is wider than the other) and will require the use of a polarized extension cord. The appliance plug will fit into a polarized extension cord only one way. If the plug does not fit fully into the extension cord, reverse the plug. If the plug still does not fit, obtain a correct polarized extension cord. A polarized extension cord will require the use of a polarized wall outlet. This plug will fit into the polarized wall outlet only one way. If the plug does not fit fully into the wall outlet, reverse the plug. If the plug still does not fit, contact a qualified electrician to install the proper wall outlet. Do not change the equipment plug, extension cord receptacle, or extension cord plug in any way.

2. FOR ALL APPLIANCES

- a) **Avoid dangerous environment.** Don't use appliances in damp or wet locations.
- b) **Don't use in rain.**
- c) **Keep children away.** All visitors should be kept at a distance from work area.
- d) **Dress properly.** Do not wear loose clothing or jewelry. They can be caught in moving parts. Use of protective gloves and substantial footwear is recommended when working outdoors. Wear protective hair covering to contain long hair.
- e) **Use safety glasses.** Always use face or dust mask if operation is dusty.
- f) **Use right appliance.** Do not use appliance for any job except that for which it is intended.
- g) **Ground Fault Circuit Interrupter (GFCI) protection should be provided on the circuit(s) or outlet(s) to be used for the gardening appliance.** Receptacles are available having built-in GFCI protection and may be used for an added measure of safety.

h) **WARNING!** To reduce the risk of electric shock, use only with an extension cord intended for outdoor use, such as an extension cord of cord type SW-A, SOW-A, STW-A, STOW-A, SJW-A, SJOW-A, SJTW-A, or SJTOW-A.

i) **Extension cord!** Make sure your extension cord is in good condition. When using an extension cord, be sure to use one heavy enough to carry the current your product will draw. An undersized extension cord will cause a drop in line voltage resulting in loss of power and overheating. Table 1 shows the correct size to use depending on cord length and nameplate ampere rating. If in doubt, use the next heavier gage. The smaller the gage number, the heavier the cord. To reduce the risk of disconnection of appliance cord from the extension cord during operating:

- i) Make a knot as shown in Figure 2; or
- ii) Use one of the plug-receptacle retaining straps or connectors described in this manual.

Table 1 Minimum gauge for extension cords

Volts	Total length of cord in feet			
	120V	25	50	100
240V	50	100	200	300
Ampere Rating More than Not more than	AWG			
0-6	18	16	16	12
6-10	18	16	14	12
10-12	16	16	16	12
12-16	14	12	Not recommended	

NOTE-Only the applicable parts of the Table need to be included. For instance, a 120-volt product need not include the 240-volt heading.

Figure 2 Method of securing extension cord

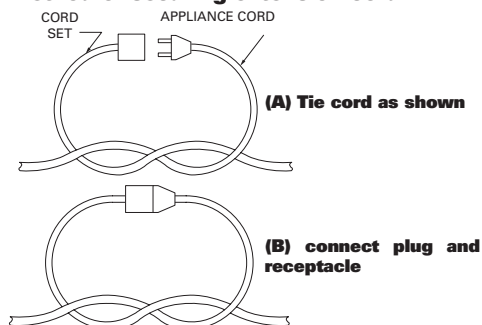



- j) Avoid unintentional starting.** Don't carry plugged-in appliance with finger on switch. Be sure switch is off when plugging in.
- k) Don't abuse cord. Never carry appliance by cord or yank it to disconnect from receptacle.** Keep cord from heat, oil, and sharp edges.
- l) Don't grasp the exposed cutting blades or cutting edges when picking up or holding the appliance.**
- m) Don't force appliance.** It will do the job better and with less risk of injury at the rate for which it was designed.
- n) Don't overreach.** Keep proper footing and balance at all times.
- o) Stay alert. Watch what you are doing.** Use common sense. Do not operate appliance when you are tired.
- p) Disconnect appliance.** Disconnect the appliance from the power supply when not in use, before servicing, when changing accessories such as blades, and the like.
- q) Store idle appliances indoors.** When not in use, appliances should be stored indoors in dry, and high or locked-up place, out of reach of children.
- r) Maintain appliance with care.** Keep cutting edge sharp and clean for best performance and to reduce the risk of injury. Follow instructions for lubricating and changing accessories. Inspect appliance cord periodically, and if damaged, have it repaired by an authorized service facility. Inspect extension cords periodically and replace if damaged. Keep handles dry, clean, and free from oil and grease.
- s) Check damaged parts.** Before further use of the appliance, a guard or other part that is damaged should be carefully checked to determine that it will operate properly and perform its intended function. Check for alignment of moving parts, binding of moving parts, breakage of parts, mounting, and any other condition that may affect its operation. A guard or other part that is damaged should be properly repaired or replaced by an authorized service center unless indicated elsewhere in this manual.

3. EDGER-TRIMMERS

- a) Keep guards in place and in working order.**
- b) Keep hands and feet away from cutting area.**

ADDITIONAL SAFETY INSTRUCTION FOR THE BATTERY GRASS TRIMMER

- a) Don't charge appliances in damp or wet locations.
- b) Don't use battery-operated appliance in rain.
- c) Remove or disconnect battery before servicing, cleaning or removing material from the gardening appliance.
- d) Use only following type battery: BYD 1.2V.
- e) Do not dispose of the battery in a fire. The cell may explode. Check with local codes for possible special disposal instructions.
- f) Do not open or mutilate the battery. Released electrolyte is corrosive and may cause damage to the eyes or skin. It may be toxic if swallowed.
- g) Exercise care in handling batteries in order not to short the battery with conducting materials such as rings, bracelets, and keys. The battery or conductor may overheat and cause burns.
- h) When replacing batteries, all batteries should be replaced at the same time. Mixing fresh and discharged batteries could increase internal cell pressure and rupture the discharge battery. (Applies to products employing more than one separately replaceable primary battery.)

Save these instructions.



SYMBOLS



Read the manual



Warning



Do not expose to rain or water



Do not burn



Ni-Cd

Do not dispose of batteries. Return exhausted batteries to your local collection or recycling point.



Wear eye protection



Wear ear protection



To avoid possibility of electric shock, do not use in damp or wet conditions.

08



Keep all other people, including children, pets and bystanders outside the 50 ft hazard zone, stop the trimmer immediately if you are approached.

ASSEMBLY INSTRUCTIONS

1. ASSEMBLY OF THE MAIN HANDLE AND SHAFT (See A)

Loosen the upper locking knob (3) clockwise. Insert the telescopic shaft into the main handle, until a click sound is heard (See A). Tighten the upper locking knob anti-clockwise.

2. ASSEMBLY OF THE SAFETY GUARD

Fix the safety guard to the trimmer head making sure the sides are located into the grooves on the trimmer head (See B). Secure the safety guard onto the trimmer head

with the screw provided (on the inside of the guard).

3. ASSEMBLY OF THE SPACER GUARD

Locate and snap fit the pivot bracket of spacer guard into the hole of trimmer head (See C). When not required, rotate the spacer guard to the underside opposite side of the safety guard and clip into the two locations.

OPERATION INSTRUCTIONS



NOTE: Before using the tool, read the instruction book carefully.

1. CHARGING YOUR BATTERY PACK



Warning: The charger and battery pack are specifically designed to work together so do not attempt to use any other devices. Never insert or allow metallic objects into your charger or battery pack connections because an electrical failure and hazard will occur.

2. BEFORE USING YOUR CORDLESS GRASS TRIMMER

Your battery pack is UNCHARGED and you must charge once before use. Your battery pack will not be fully charged until you have performed several charge and discharge operations by charging & working with your grass trimmer. After this your battery pack performance will improve.

3. HOW TO CHARGE YOUR BATTERY PACK

Connect the battery charger to the power supply and the green light (20) will illuminate. Then, fully insert the battery pack into the charger to make the connections and the red light (21) will illuminate to show charging has started. A discharged battery at normal ambient temperature will take approximately 1 hour to reach full charge. Charging time may vary due to variable ambient temperatures and battery conditions. When charging is completed the green light (20) will illuminate to indicate end of charge. (See D)

Note: green = power on, red = charging, Battery pack inserted +green = charging completed

Grass Trimmer

ENG



The battery pack can then be removed for use in your trimmer. The charger timer circuit and battery pack temperature safety cut-out device prevent overcharge of your battery pack.



Warning:

After long usage the battery will become hot, let the hot battery cool down for 1 hour before recharging.

4. TO REMOVE OR INSTALL BATTERY PACK

Locate latches on side of battery pack and depress both sides to release battery pack from your grass trimmer. Remove battery pack from your grass trimmer (See E). After recharge insert the battery pack into grass trimmer's battery port. A simple push and slight pressure will be sufficient.

5 SAFETY ON/OFF SWITCH

Your switch is locked off to prevent accidental starting. Depress lock off button (B) then on/off switch (A) and release lock off button (B). Your switch is now on. To switch off just release the on/off switch (See F).



Warning: The cutting head continues to rotate after the trimmer has been switched off, wait until it has stopped then lay down the tool.

6. ADJUSTMENT OF THE TELESCOPIC SHAFT (See G)

Unscrew the lower locking knob (4) in the direction indicated to unlock.

Adjust the length of the telescopic shaft to the most comfortable length.

Tighten the lower locking knob.

7. MAIN HANDLE ROTATION (See H)

Unscrew the upper locking knob (3) in the direction indicated to unlock.

Adjust the angle of the main handle clockwise 90 degree max.

Turn the upper locking knob in the opposite direction to lock.

8. ADJUSTMENT OF AUXILIARY HANDLE

Pull up the auxiliary handle locking lever (5).

Hold the lever and rotate the auxiliary handle to the most comfortable and balanced position (See I).

Release the lever, your auxiliary handle has been locked.

9. ADJUSTMENT OF THE TRIMMER HEAD ANGLE TO THE SHAFT

Use both of your hands, one grips the shaft, another on the head, then apply adequate force to adjust the trimmer head to the most comfortable position. The ratchet mechanism will make a heavy clicking sound which is normal and not a defect (See J).

OPERATION



Warning: Always wear eye protection. Never lean over the trimmer head. Rocks or debris can ricochet or be thrown into eyes and face and cause blindness or other serious injury. When opening unit, check for the following:

Wear eye protection and heavy clothing. Hold front handle with one hand and auxiliary handle with another hand. Keep unit below waist level. Work only from your right to your left to ensure debris is thrown away from you. Without bending over, keep line near and parallel to the ground (perpendicular when edging) and not crowded into material being cut.



Warning: Make sure that line is fed out before operation. Make sure motor is up to full speed before trimming.



Warning: Use only 0.065" diameter cutting line. Other sizes of line will not feed properly and will result in improper cutting head function or can cause serious injury. Do not use other material such as wire, string, rope, etc. Wire can break off during cutting and become a dangerous missile that can cause serious injury.

TRIMMING

Hold the bottom of the trimmer head about 3.25" (8 cm) above the ground and at an angle. Allow only the tip of line to make contact. Do not force trimmer line into work area.

EDGING (See K)

Unscrew the upper locking knob (3) and rotate the main and auxiliary handle to 90° with cutting head (See H).

Retighten the upper locking knob.

Adjust trimmer head angle to be the lowest horizontal setting. Then position the wheel on the ground for edge mode. The guard has two



white line guides to indicate the cutting line position. Align these marks with the edge of your lawn.

While edging allow the tip of the line to make contact. Do not force the line. The rotation wheel helps protect the unit and keeps the unit from contacting the ground. Take extra caution while edging as objects can be thrown from the trimmer line.

AUTOMATIC LINE FEED SYSTEM

When initially switching on the trimmer, a small length of line is fed out.

A 'clattering' noise will be heard when the lines hit the line cutter. **DO NOT BE ALARMED** this is quit normal. After about 5 seconds the line will be cut to the correct length and the noise will reduce as the motor achieves full speed.

If the noise of the line being cut can't be heard, more line will be fed out.

To feed more line, it is first necessary to allow the trimmer to stop completely, then restart, allowing the motor to reach full speed.

Repeat above 4 times until you hear the lines hitting against the line cutter. (Do not repeat this procedure more than 6 times)

10

TO MANUALLY FEED THE LINE (See L)

If required, line can be feed out manually.

To operate, press and release manual line feed button (16), whilst gently pull out the line until the line reaches the line cutter.

If the line extends past the line cutter, too much line has been fed out.

If too much line is fed out, remove the spool cap. With one hand, rotate the spool anti-clockwise until it is stopped. Hold the spool in place. With the other hand, press the line feed button(16) fully. Continue to rotate the spool a little, then release the line feed button. The line will then be shorter. Repeat these steps until the line is at the desired length.

TO REMOVE THE CAP

Press and hold in the two latches (12) (See M). Pull cap away from the spool holder.

When refitting the spool cap.

Keep all areas of the cap and spool holder clean. Press firmly down towards the spool holder to ensure cap is fully located.

Check that the cap is correctly fitted by trying to remove it without depressing the two latches.

TO REPLACE CUT LINE

For your convenience it is recommended you buy spool and line complete.

TO FIT SPOOL AND LINE COMPLETE:

Remove old spool.

Place new spool into cap with **cut out areas of the spool in line with eyelets.**

Release line from cleat and feed line through eyelet .

Refit the cap.

TO FIT NYLON LINE ONLY:

Warning! Take approximately 16ft of line. Insert 5/8" of line into the spool holes and wind line in the direction of the arrows on the top of the spool.

Your Trimmer is designed to use only line with a maximum diameter of 0.065".

IMPORTANT :Leave approximately 4" of line unwound and place into cleat.

Care should be taken to ensure that the line is neatly coiled on the spool. Failure to do so will impair the efficiency of the automatic line feed. Then fit spool as described in **"To fit spool and line complete"**.

MAINTENANCE

After use, disconnect the machine from the battery and check for damage. Your power tool requires no additional lubrication or maintenance. There are no user serviceable parts in your power tool. Battery powered trimmers should only be repaired by an authorised repairer. Use only manufacturers recommended replacement parts and accessories.

Never use water or chemical cleaners to clean your power tool. Wipe clean with a dry cloth. Always store your power tool in a dry place out of the reach of children. Keep the motor ventilation slots clean. Keep all working controls free of dust. If you see some sparks flashing in the ventilation slots, this is normal and will not damage your power tool.

Grass Trimmer

ENG



WARRANTY STATEMENT

30 DAY Satisfaction Guarantee

If for any reason you are dissatisfied with any WORX product, you can return the product, along with proof of purchase, within 30 days for a full refund.

If your WORX product becomes defective due to faulty materials or workmanship within the specified warranty period of;

- 24 months for DIY and light trade use, from the date of purchase.

We guarantee to repair or replace all defective parts free of charge, repair products subject to fair wear and tear, free of charge, or at our discretion, replace the unit free of charge to ensure minimum inconvenience to the customer. Your warranty is subject to the following conditions:

- Proof of purchase date and a valid receipt is produced.
- The product has not been misused.
- The product has not been used for Professional purposes.
- Unauthorized persons have not attempted repairs.
- The product has not been used for hire purposes.
- The product has not sustained damage through foreign objects, substances or accidents.
- Damage is not a result of fitting non-approved accessories.

To claim the guarantee, you will need to submit proof of purchase to the seller or an authorized repair agent.

You can check the location of your nearest authorized repair agent by contacting us at:

Positec USA, Inc.
Charlotte, NC 28216
PHONE: 1-866-354-WORX (9679)

This warranty does not apply to accessories.

This warranty applies only to the original purchaser and may not be transferred.

All repairs and replacement tools will be covered by the limited warranty for the balance

of the warranty period from the date of the original purchase.

All repairs must use genuine spare parts.



WORX
you've got the power

Designed in Italy. Made in China
Conçu en Italie. Fabriqué en Chine
Diseñado en Italia. Fabricado en China

