

DIGITAL pad

# **DRUM**

## **Pro**

**DD-55 DD-55c**  
*Digital Percussion, Digital Percussion*

## **Owner's Manual**



# SPECIAL MESSAGE SECTION

This product utilizes batteries or an external power supply (adapter). DO NOT connect this product to any power supply or adapter other than one described in the manual, on the name plate, or specifically recommended by Yamaha.

This product should be used only with the components supplied or; a cart, rack, or stand that is recommended by Yamaha. If a cart, etc., is used, please observe all safety markings and instructions that accompany the accessory product.

## SPECIFICATIONS SUBJECT TO CHANGE:

The information contained in this manual is believed to be correct at the time of printing. However, Yamaha reserves the right to change or modify any of the specifications without notice or obligation to update existing units.

This product, either alone or in combination with an amplifier and headphones or speaker/s, may be capable of producing sound levels that could cause permanent hearing loss. DO NOT operate for long periods of time at a high volume level or at a level that is uncomfortable. If you experience any hearing loss or ringing in the ears, you should consult an audiologist.

**IMPORTANT:** The louder the sound, the shorter the time period before damage occurs.

## NOTICE:

Service charges incurred due to a lack of knowledge relating to how a function or effect works (when the unit is operating as designed) are not covered by the manufacturer's warranty, and are therefore the owners responsibility. Please study this manual carefully and consult your dealer before requesting service.

## ENVIRONMENTAL ISSUES:

Yamaha strives to produce products that are both user safe and environmentally friendly. We sincerely believe that our products and the production methods used to produce them, meet these goals. In keeping with both the letter and the spirit of the law, we want you to be aware of the following:

### Battery Notice:

This product MAY contain a small non-rechargeable battery which (if applicable) is soldered in place. The average life span of this type of battery is approximately five years. When replacement becomes necessary, contact a qualified service representative to perform the replacement.

This product may also use "household" type batteries. Some of these may be rechargeable. Make sure that the battery being charged is a rechargeable type and that the charger is intended for the battery being charged.

When installing batteries, do not mix batteries with new, or with batteries of a different type. Batteries MUST be installed correctly. Mismatches or incorrect installation may result in overheating and battery case rupture.

### Warning:

Do not attempt to disassemble, or incinerate any battery. Keep all batteries away from children. Dispose of used batteries promptly and as regulated by the laws in your area. Note: Check with any retailer of household type batteries in your area for battery disposal information.

### Disposal Notice:

Should this product become damaged beyond repair, or for some reason its useful life is considered to be at an end, please observe all local, state, and federal regulations that relate to the disposal of products that contain lead, batteries, plastics, etc. If your dealer is unable to assist you, please contact Yamaha directly.

### NAME PLATE LOCATION:

The name plate is located on the bottom of the product. The model number, serial number, power requirements, etc., are located on this plate. You should record the model number, serial number, and the date of purchase in the spaces provided below and retain this manual as a permanent record of your purchase.

Model \_\_\_\_\_

Serial No. \_\_\_\_\_

Purchase Date \_\_\_\_\_

# PLEASE KEEP THIS MANUAL

92-BP (bottom)

# FCC INFORMATION (U.S.A.)

## 1. IMPORTANT NOTICE: DO NOT MODIFY THIS UNIT!

This product, when installed as indicated in the instructions contained in this manual, meets FCC requirements. Modifications not expressly approved by Yamaha may void your authority, granted by the FCC, to use the product.

**2. IMPORTANT:** When connecting this product to accessories and/or another product use only high quality shielded cables. Cable/s supplied with this product MUST be used. Follow all installation instructions. Failure to follow instructions could void your FCC authorization to use this product in the USA.

**3. NOTE:** This product has been tested and found to comply with the requirements listed in FCC Regulations, Part 15 for Class "B" digital devices. Compliance with these requirements provides a reasonable level of assurance that your use of this product in a residential environment will not result in harmful interference with other electronic devices. This equipment generates/uses radio frequencies and, if not installed and used according to the instructions found in the users manual, may cause interference harmful to the operation of other electronic devices. Compliance

with FCC regulations does not guarantee that interference will not occur in all installations. If this product is found to be the source of interference, which can be determined by turning the unit "OFF" and "ON", please try to eliminate the problem by using one of the following measures:

Relocate either this product or the device that is being affected by the interference.

Utilize power outlets that are on different branch (circuit breaker or fuse) circuits or install AC line filter/s.

In the case of radio or TV interference, relocate/reorient the antenna. If the antenna lead-in is 300 ohm ribbon lead, change the lead-in to co-axial type cable.

If these corrective measures do not produce satisfactory results, please contact the local retailer authorized to distribute this type of product. If you can not locate the appropriate retailer, please contact Yamaha Corporation of America, Electronic Service Division, 6600 Orangethorpe Ave, Buena Park, CA90620

The above statements apply ONLY to those products distributed by Yamaha Corporation of America or its subsidiaries.

\* This applies only to products distributed by YAMAHA CORPORATION OF AMERICA.

(class B)

## OBSERVERA!

Apparatens kopplingsinte och växelströmskällan (nätet) så länge som den är ansluten till vägguttaget, även om själva apparaten har stängts av.

**ADVARSSEL:** Netspændingen til dette apparat er IKKE afbrudt, så længe netledningen sidder i en stikkontakt, som er tændt — også selvom der er slukket på apparatets afbryder.

**VAROITUS:** Laitteen toisiopiiriin kytketty käyttökytin ei irroita koko laitetta verkosta.

(standby)

## Entsorgung leerer Batterien (nur innerhalb Deutschlands)

Leisten Sie einen Beitrag zum Umweltschutz. Verbrauchte Batterien oder Akkumulatoren dürfen nicht in den Hausmüll. Sie können bei einer Sammelstelle für Altbatterien bzw. Sondermüll abgegeben werden. Informieren Sie sich bei Ihrer Kommune.

(battery)

# PRECAUTIONS

## PLEASE READ CAREFULLY BEFORE PROCEEDING

\* Please keep these precautions in a safe place for future reference.



### WARNING

**Always follow the basic precautions listed below to avoid the possibility of serious injury or even death from electrical shock, short-circuiting, damages, fire or other hazards. These precautions include, but are not limited to, the following:**

- Do not open the instrument or attempt to disassemble the internal parts or modify them in any way. The instrument contains no user-serviceable parts. If it should appear to be malfunctioning, discontinue use immediately and have it inspected by qualified Yamaha service personnel.
- Do not expose the instrument to rain, use it near water or in damp or wet conditions, or place containers on it containing liquids which might spill into any openings.
- If the AC adaptor cord or plug becomes frayed or damaged, or if there is a sudden loss of sound during use of the instrument, or if any unusual smells or smoke should appear to be caused by it, immediately turn off the power switch, disconnect the adaptor plug from the outlet, and have the instrument inspected by qualified Yamaha service personnel.
- Use the specified adaptor (PA-5D, PA-5C or an equivalent recommended by Yamaha) only. Using the wrong adaptor can result in damage to the instrument or overheating.
- Before cleaning the instrument, always remove the electric plug from the outlet. Never insert or remove an electric plug with wet hands.
- Check the electric plug periodically and remove any dirt or dust which may have accumulated on it.
- Do not put burning items, such as candles, on the unit. A burning item may fall over and cause a fire.



### CAUTION

**Always follow the basic precautions listed below to avoid the possibility of physical injury to you or others, or damage to the instrument or other property. These precautions include, but are not limited to, the following:**

- Do not place the AC adaptor cord near heat sources such as heaters or radiators, and do not excessively bend or otherwise damage the cord, place heavy objects on it, or place it in a position where anyone could walk on, trip over, or roll anything over it.
- When removing the electric plug from the instrument or an outlet, always hold the plug itself and not the cord.
- Do not connect the instrument to an electrical outlet using a multiple-connector. Doing so can result in lower sound quality, or possibly cause overheating in the outlet.
- Unplug the AC power adaptor when not using the instrument, or during electrical storms.
- Always make sure all batteries are inserted in conformity with the +/- polarity markings. Failure to do so might result in overheating, fire, or battery fluid leakage.
- Always replace all batteries at the same time. Do not use new batteries together with old ones. Also, do not mix battery types, such as alkaline batteries with manganese batteries, or batteries from different makers, or different types of batteries from the same maker, since this can cause overheating, fire, or battery fluid leakage.
- Do not dispose of batteries in fire.
- Do not attempt to recharge batteries that are not intended to be charged.
- When the batteries run out, or if the instrument is not to be used for a long time, remove the batteries from the instrument to prevent possible leakage of the battery fluid.
- Keep batteries away from children.
- If the batteries do leak, avoid contact with the leaked fluid. If the battery fluid should come in contact with your eyes, mouth, or skin, wash immediately with water and consult a doctor. Battery fluid is corrosive and may possibly cause loss of sight or chemical burns.
- Before connecting the instrument to other electronic components, turn off the power for all components. Before turning the power on or off for all components, set all volume levels to minimum. Also, be sure to set the volumes of all components at their minimum levels and gradually raise the volume controls while playing the instrument to set the desired listening level.
- Do not expose the instrument to excessive dust or vibrations, or extreme cold or heat (such as in direct sunlight, near a heater, or in a car during the day) to prevent the possibility of panel disfiguration or damage to the internal components.
- Do not use the instrument near other electrical products such as televisions, radios, or speakers, since this might cause interference which can affect proper operation of the other products.
- Do not place the instrument in an unstable position where it might accidentally fall over.
- Before moving the instrument, remove all connected adaptor and other cables.
- When cleaning the instrument, use a soft, dry cloth. Do not use paint thinners, solvents, cleaning fluids, or chemical-impregnated wiping cloths. Also, do not place vinyl, plastic or rubber objects on the instrument, since this might discolor the panel or keyboard.
- Do not rest your weight on, or place heavy objects on the instrument, and do not use excessive force on the buttons, switches or connectors.
- Do not operate the instrument for a long period of time at a high or uncomfortable volume level, since this can cause permanent hearing loss. If you experience any hearing loss or ringing in the ears, consult a physician.

#### ■ DATA BACK-UP AND STORAGE

- Yamaha recommends that you regularly save data using an external device such as the floppy disk-based Yamaha MIDI data filer MDF3, and storing the floppy disks in a safe, cool, dry place. **YAMAHA CANNOT BE HELD RESPONSIBLE FOR THE ACCIDENTAL LOSS OF IMPORTANT MUSIC DATA!** Regarding the data you have created, as long as fresh batteries are inserted in (or an AC power adaptor is connected to) the instrument, the data will be retained, even when the power is turned off. It will also be retained long enough to exchange an old set of batteries for a new set. If you have important data in the instrument which you don't want to lose, please take care to keep fresh batteries inserted in (or keep an AC power adaptor connected to) the instrument, and to regularly save data.

Yamaha cannot be held responsible for damage caused by improper use or modifications to the instrument, or data that is lost or destroyed.

Always turn the power off when the instrument is not in use.

Make sure to discard used batteries according to local regulations.

\* The illustrations and LED displays as shown in this owner's manual are for instructional purposes only, and may be different from the ones on your instrument.

\* Any mention or reference to the DD-55 in this manual also applies to the model DD-55C.

## ***Congratulations!***

*Thank you for purchasing the Yamaha DD-55. The DD-55 has been developed to respond and play like a drum set - but with greater ease, flexibility and sophisticated functions. Before you use the instrument, we recommend that you carefully read through this manual.*

# Contents

<b>Setting Up</b>	<b>5</b>	<b>Recording a Song</b>	<b>20</b>
Power Requirements .....	5	Recording.....	20
<b>Panel Controls</b>	<b>6</b>	Playback.....	20
<b>Playing the Demo Song</b>	<b>8</b>	<b>MIDI Functions</b>	<b>21</b>
<b>Play the Pads/Pedals</b>	<b>9</b>	What's MIDI?.....	21
Pad Names .....	9	What You Can Do With MIDI .....	23
Hand Percussion ON/OFF .....	10	Connecting to a Computer .....	24
Assigning a Drum Kit to the Pads and Pedals .....	10	Enter/Exit the MIDI/Utility Mode .....	25
Assigning a Voice to Individual Pads and Pedals ("E U" Custom Kit).....	11	Setting the Clock.....	25
Reverb ON/OFF.....	12	Local ON/OFF .....	26
Setting the Pad Sensitivity .....	13	Setting the MIDI Transmit Channel .....	27
Adjusting the Pad Volume.....	14	Setting the MIDI Note Number .....	28
Click ON/OFF.....	14	Saving and Loading Song Data .....	29
<b>Playing a Song</b>	<b>15</b>	<b>Appendix</b>	<b>31</b>
Select the Song and Play.....	15	Initialize .....	31
Tap Start .....	16	Troubleshooting .....	32
Auto Kit Select ON/OFF Setting.....	16	Drum Voice List.....	33
Adjusting the Tempo .....	17	Song List .....	35
<b>Play along with a Song</b>	<b>18</b>	Drum Kit List.....	36
Track ON/OFF .....	18	Drum Map .....	38
Break.....	18	GM Voice List.....	40
A-B Repeat .....	19	MIDI Implementation Chart .....	41
		Specifications .....	44

### ● Trademarks

- Apple and Macintosh are trademarks of Apple Computer, Inc., registered in the U.S. and other countries.
- Windows is the registered trademark of Microsoft® Corporation.

All other trademarks are the property of their respective holders.

### ● Supplied Accessories

- Drum Stick (x2)
- Foot Pedal 1 & 2
- Owner's Manual

This section contains information about setting up your DD-55 for playing. Make sure to read this section carefully before using the instrument.

## Power Requirements

Although the DD-55 will run either from an optional AC adaptor or batteries, Yamaha recommends use of an AC adaptor whenever possible. An AC adaptor is more environmentally friendly than batteries and does not deplete resources.

### Using an AC Power Adaptor

- ① Make sure that the [STANDBY/ON] switch of the DD-55 is set to STANDBY.
- ② Connect the AC adaptor (PA-5D, PA-5C or other adaptor specifically recommended by Yamaha) to the power supply jack.
- ③ Plug the AC adaptor into an AC outlet.

#### **⚠ CAUTION**

- Never interrupt the power supply (e.g. remove the batteries or unplug the AC adaptor) during any DD-55 record operation! Doing so can result in a loss of data.

#### **⚠ WARNING**

- Use ONLY a Yamaha PA-5D or PA-5C AC Power Adaptor (or other adaptor specifically recommended by Yamaha) to power your instrument from the AC mains. The use of other adaptors may result in irreparable damage to both the adaptor and the DD-55.
- Unplug the AC Power Adaptor when not using the DD-55, or during electrical storms.

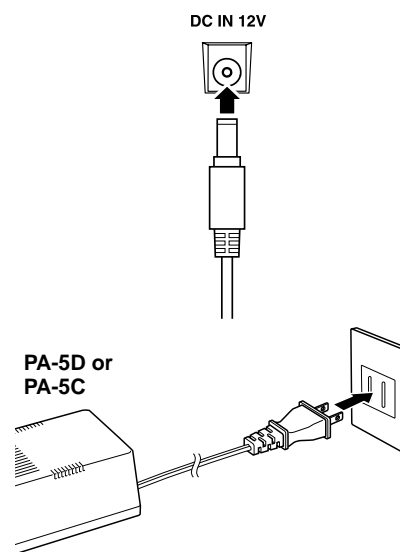

### Using Batteries

For battery operation the DD-55 requires six 1.5V “C” size, R14P (LR14) or equivalent batteries. (Alkaline batteries are recommended.) When the batteries need to be replaced, the volume may be reduced, the sound may be distorted, and other problems may occur. When this happens, turn the power off and replace the batteries, as described below.

- ① Open the battery compartment cover located on the instrument’s bottom panel.
- ② Insert the six new batteries, being careful to follow the polarity markings on the inside of the compartment.
- ③ Replace the compartment cover, making sure that it locks firmly in place.

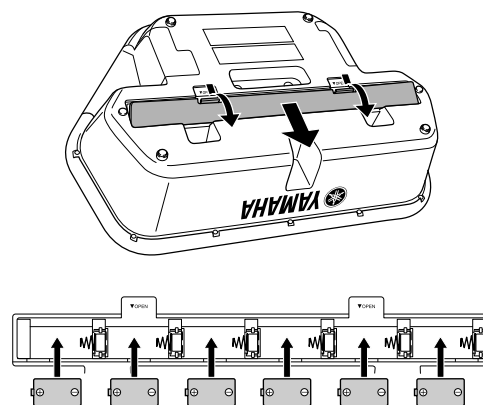

#### **⚠ CAUTION**

- When the batteries run down, replace them with a complete set of six new batteries. NEVER mix old and new batteries.
- Do not use different kinds of batteries (e.g. alkaline and manganese) at the same time.
- If the instrument is not to be in use for a long time, remove the batteries from it, in order to prevent possible fluid leakage from the battery.
- Plugging or unplugging the AC power adaptor while the batteries are installed will reset the DD-55 to the defaults.

## Front Panel

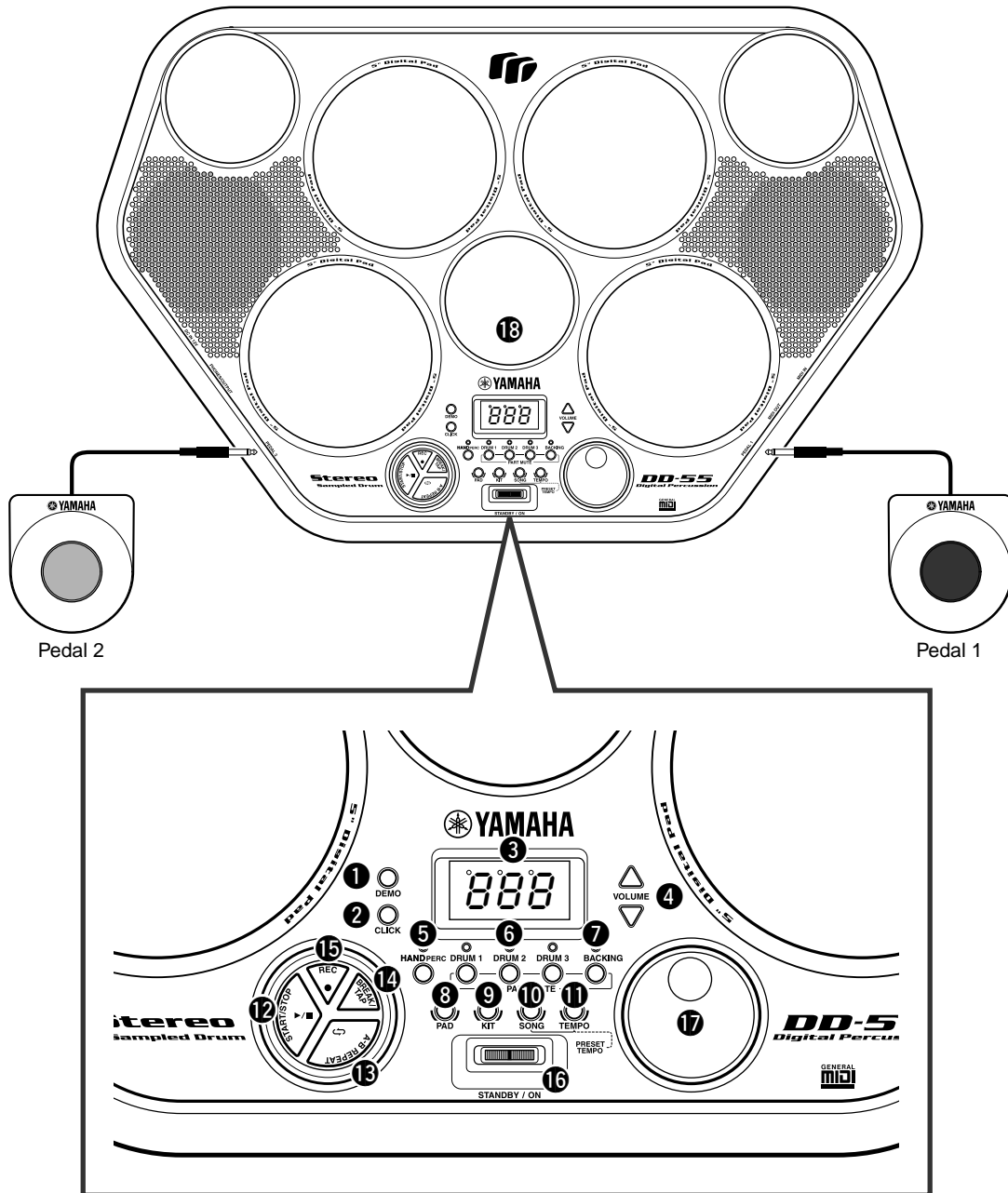

## Front Panel

① DEMO button .....	8, 25	⑩ SONG button .....	8, 15, 16, 17
② CLICK button .....	14	⑪ TEMPO button .....	17
③ DISPLAY .....	10	⑫ START/STOP button.....	8, 15, 25
④ VOLUME [▲], [▼] buttons.....	8	⑬ A-B REPEAT button .....	19
⑤ HAND PERC button.....	10	⑭ BREAK/TAP button .....	16, 18
⑥ DRUM 1 - 3 buttons .....	18	⑮ REC button .....	20
⑦ BACKING button.....	18	⑯ STANDBY/ON Switch .....	8, 31
⑧ PAD button.....	11, 14, 27	⑰ DIAL.....	10
⑨ KIT button .....	10, 28	⑱ Drum Pads (x7).....	9



**Using a pair of headphones**

A standard pair of stereo headphones can be plugged in here for private practice or late-night playing. The internal stereo speaker system is automatically shut off when a pair of headphones is plugged into the PHONES/OUTPUT jack.

Do not listen with the headphones at high volume for long periods of time. Doing so may cause hearing loss.

**CAUTION**

- Connect the DD-55 to external equipment only after turning off power for all devices. To prevent damage to the speakers, set the volume of the external devices at the minimum setting before connecting them. Failure to observe these cautions may result in electric shock or equipment damage.

Side Panel (Left)

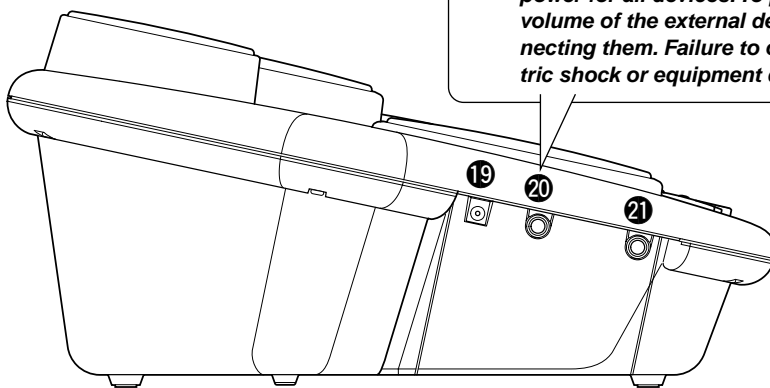

Side Panel (Right)

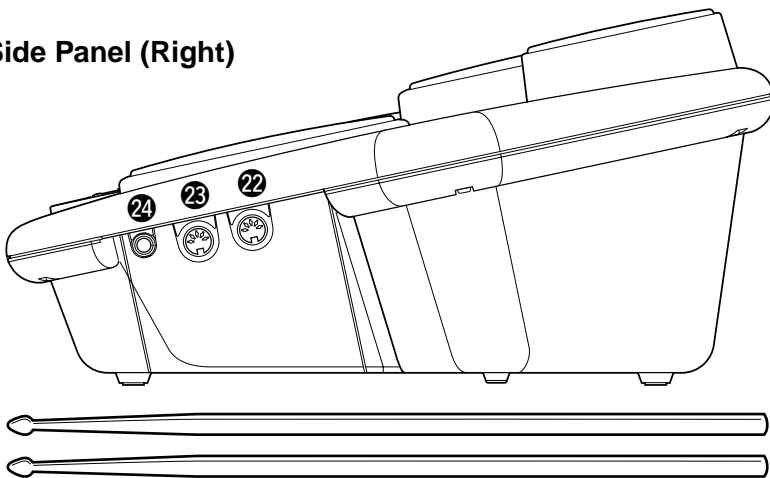

**CAUTION**

- Since speakers are built into the DD-55, you should be careful to never leave any video tapes, cassette tapes, floppy disks or any kind of magnetic storage media on the panel — doing so may result in data loss or damage to the items. Also avoid using the DD-55 near a television or computer monitor, since interference may result.
- Use the sticks with caution. Do not use them for anything other than playing the instrument. Also, to avoid damage or injury, refrain from waving them recklessly or throwing them.

Side Panel (Left)

19 DC IN 12V (AC Adaptor) Jack.....	5
20 PHONES/OUTPUT Jack .....	7
21 PEDAL 2 Jack .....	7

Side Panel (Right)

22 MIDI IN Terminal.....	22
23 MIDI OUT Terminal.....	22
24 PEDAL 1 Jack .....	7

**Using the Foot Pedals (1/2)**

When connected, these pedals can be used simultaneously play the drum set's hi-hat pedal or bass drum voices — or they can also be assigned to play other voices as well. Connect the supplied Pedal 1 to the PEDAL 1 jack 24 and Pedal 2 to the PEDAL 2 jack 21.

**CAUTION**

- Make sure that the pedal plugs are properly connected to the PEDAL jacks before turning on the power.
- Do not press Pedal 2 while turning the power on. Doing this changes the recognized polarity of the pedal, resulting in reversed pedal operation.
- Avoid using the pedals directly on a soft floor, since they may scratch the surface of the floor.
- Avoid getting caught in or tripping over the pedal cords; this may cause the instrument to fall and result in damage or injury.

# Playing the Demo Song

The DD-55 features a demonstration song, specially created to show you the dynamic possibilities of the instrument.

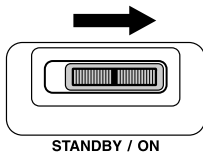

STANDBY / ON

## 1 Turn on the power.

Turn the [STANDBY/ON] switch ON.

### ⚠ CAUTION

- Even when the switch is in the "STANDBY" position, electricity is still flowing to the instrument at the minimum level. When you are not using the DD-55 for a long time, make sure you unplug the AC power adaptor from the wall AC outlet, and/or remove the batteries from the instrument.

## 2 Start the Demo Song.

Press the [DEMO] button and the demo song starts playing.

### ● MASTER VOLUME

The overall volume level of the DD-55 is controlled by two **VOLUME** [▲], [▼] buttons (10 volume levels L0 - L9).

Press the **VOLUME** [▲] button to increase the overall volume by one level. Press the **VOLUME** [▼] button to decrease the overall volume by one level. Holding down either of the buttons increases or decreases the volume level rapidly.

L0	← L5 →	L9
Small	← Volume Level →	Large

\* When the VOLUME is set to L0, no sound is produced.

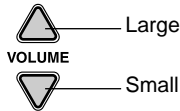

## 3 Stop the Demo Song.

To stop playback, press the [DEMO] button again or press the [START/STOP] button.

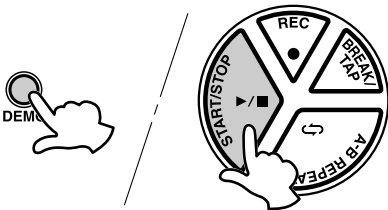

### ● SONG VOLUME

To control the volume level of the song, press the [SONG] button and the song starts playing, simultaneously hold down the [SONG] button and use the **VOLUME** [▲], [▼] buttons (levels L0 - L9). (For more information on songs, see page 15.)

The SONG VOLUME can be used to adjust the balance between the song accompaniment and your own performance on the pads.

Simultaneously hold down the [SONG] button and press the **VOLUME** [▲] button to increase the song volume by one level. Hold down the [SONG] button and press the **VOLUME** [▼] button to decrease the song volume by one level. Holding either of the buttons (while holding down the [SONG] button) increases or decreases the song volume level rapidly.

L0	← L5 →	L9
Small	← Volume Level →	Large

\* When the VOLUME is set to L0, no sound is produced by the song.

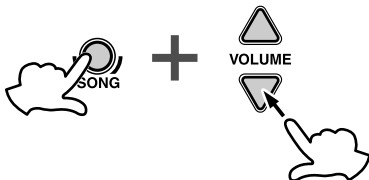



# Play the Pads/Pedals

Strike the pad with the supplied drum sticks or your hands to play the drum voices. When playing the pads with your hands, turn the Hand Percussion feature on by pressing the [HAND PERC] button (the lamp lights).

The volume of the pads' sounds responds to your playing; when you play soft the volume is soft, and when you play strongly the volume is loud.

The actual loudness of the sound may vary according to which part of the pad is struck.

## Pad Names

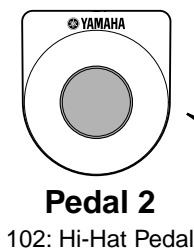
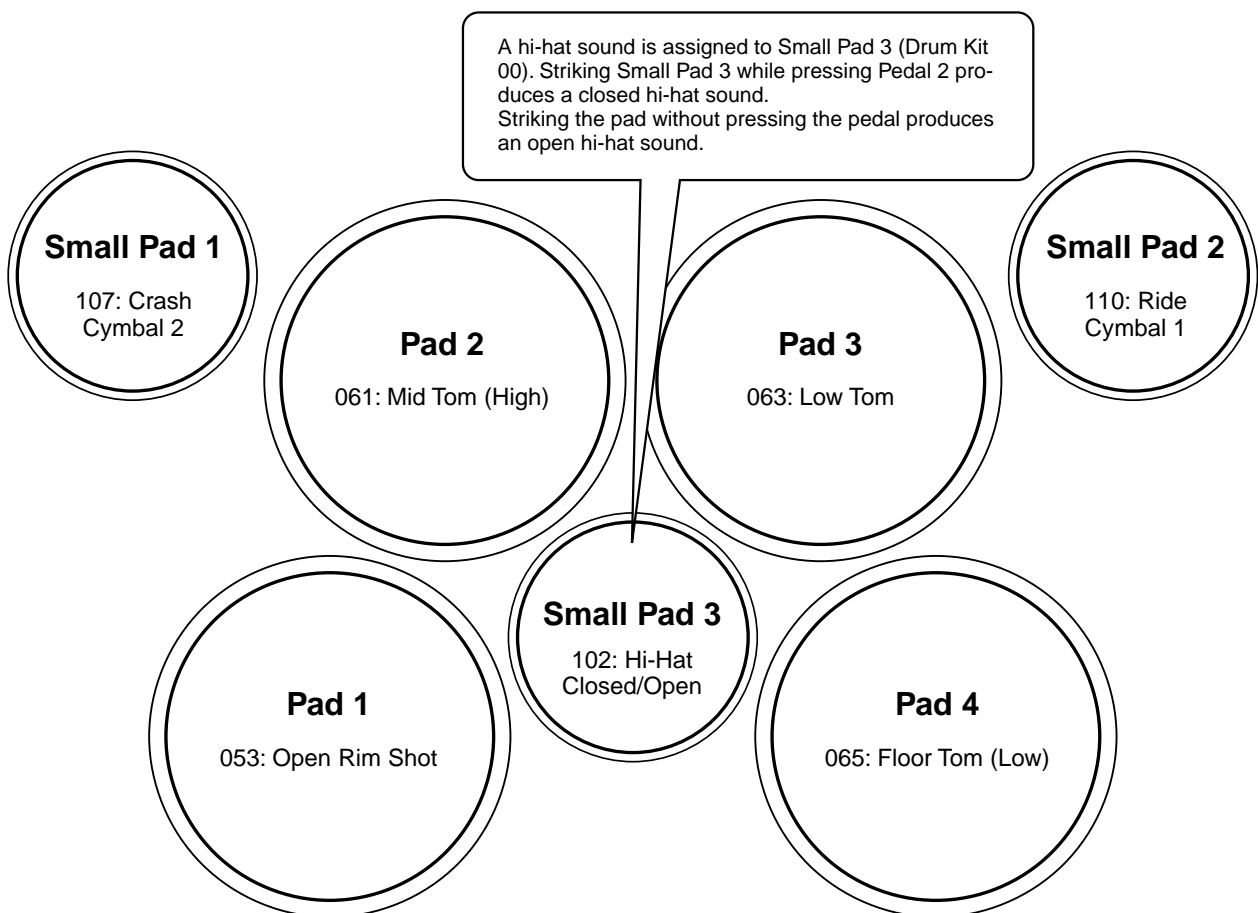

Ex. shown, Drum Kit 00

The bass drum voice is controlled by pressing Foot Pedal 1. Pedal 1 features touch response; the volume responds to how hard you press the pedal. Use Foot Pedal 2 to control the Hi-hat. (This is in the case of Drum Kit 00.)

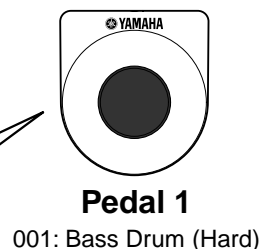
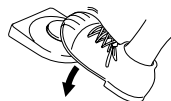

## Hand Percussion ON/OFF

You can play the pads of the DD-55 either with the supplied sticks or with your hands.

Hand Percussion on



### 1 Press the [HAND PERC] button.

When you press the [HAND PERC] button, the button's lamp lights, and the pad sensitivity is automatically adjusted for optimum playing by hand.



- When HAND PERCUSSION is on, the DD-55 automatically selects an appropriate song (#94) and kit (#29), ideal for playing by hand and using with the Hand Percussion feature.

#### **CAUTION**

- When Hand Percussion is on, do not strike the pads with drumsticks or anything other than your hands.

## Assigning a Drum Kit to the Pads and Pedals

The DD-55 allows you to choose from 45 different Drum Kits (00 - 44 : see the “Drum Kit List” page 36) quickly and easily. 45 of the kits have preset voice combinations that will be set to the pads and pedals when the kit is selected.

Select some different kits and try playing them.

The DD-55 also has one Custom Drum Kit allowing you to assign the desired voices to the seven pads or two pedals (see “Assigning a Voice to Individual Pads and Pedals” page 11).

For some drum kits (35 - 44), the sound changes each time you strike the pad.



### 1 Press the [KIT] button.

When you press the [KIT] button, the currently selected Drum Kit number appears on the display.

### 2 Select a Drum Kit Number.

Turn the **DIAL** to select a Drum Kit number. Drum Kit numbers will increase as the **DIAL** is turned to the right (clockwise), and decrease as the **DIAL** is turned to the left (counter-clockwise).

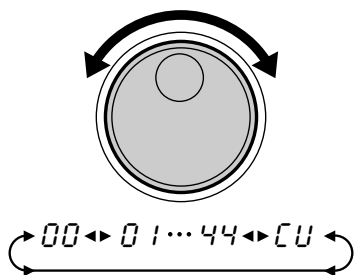

- Drum Kit number 00 is normally selected when the power is turned on. However, if Auto Kit Select is set to OFF, the last Drum Kit selected before turning the power OFF, is automatically selected when the power is turned on. (See “Auto Kit Select ON/OFF Setting” on page 16.)
- The “CU” Drum Kit is the Custom Kit. Changes made to any one of the preset drum kits will be saved here. (See “Assigning a Voice to Individual Pads and Pedals” page 11.)

## Assigning a Voice to Individual Pads and Pedals ("CU" Custom Kit)

The DD-55 contains a total of 212 high quality drum sounds (see the "Drum Voice List" page 33) — and you can assign these freely to each of the 7 drum pads and 2 foot pedals. Try assigning some different voices and create your own "CU" Custom Drum Kit.



- Any changes made to one of the preset drum kits will automatically be saved in the "CU" Custom Drum Kit.
- Both the Custom and "00" drum kit contents are the same until modified (see the "Drum Kit List" page 36).



### 1 Press the [PAD] button.

When you press the [PAD] button, Pad 1's currently assigned voice number is shown in the display.

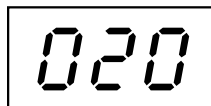
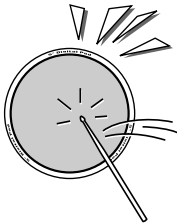

### 2 Select the pad or pedal to be assigned.

Strike any pad one time (or press a pedal), and the currently assigned voice number for that pad/pedal is shown in the display.

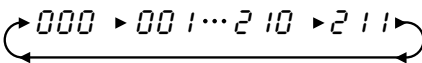
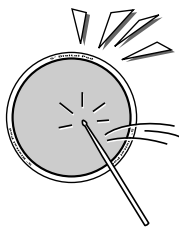

### 3 Select a Voice Number.

You can select the voice by repeatedly striking the pad or repeatedly pressing the pedal (while listening to the voice), or by turning the **DIAL**.

- **Striking the pad or pressing the pedal to select a voice.**  
Every time the pad is struck or a pedal is pressed, voice numbers will increase by a value of one (1).

- **Using the DIAL to select a voice.**

Turn the **DIAL** to the right (clockwise), and voice numbers will increase. Turn the **DIAL** to the left (counter-clockwise), and voice numbers will decrease.

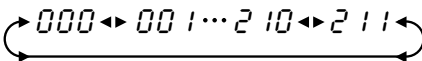
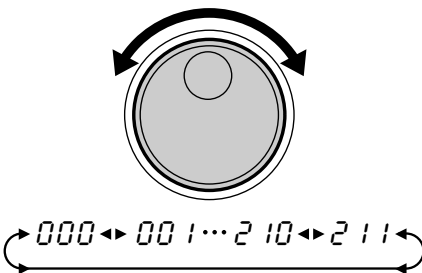

Repeat the previous steps 2 and 3 for any or all of the DD-55's pads and pedals.

### 4 Play the Pads and Pedals.

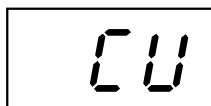

After assigning a voice to the desired pad/pedal, press the [KIT] button. You can now play the voice you have assigned to the pad/pedal. After you've assigned the voice, the DD-55 will automatically be set to the custom kit.

## Reverb ON/OFF

Different depths of the DD-55's reverb effect can be added to the DD-55's overall sound.

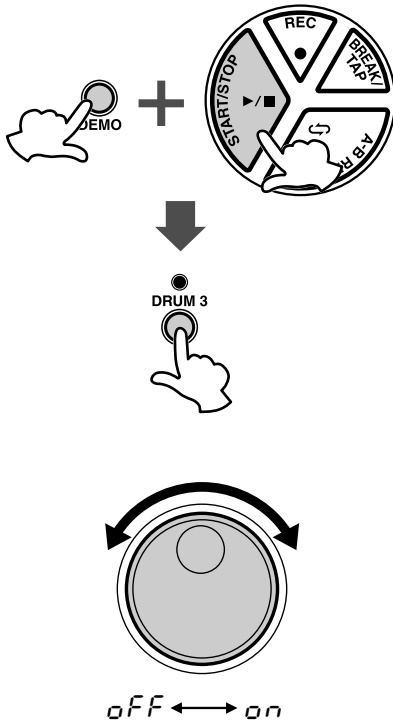

### 1 Display the Reverb On/Off Setting.

Simultaneously press the [DEMO] and [START/STOP] button to enter the MIDI/Utility mode, then press the [DRUM3] button. The current Reverb setting appears in the display.

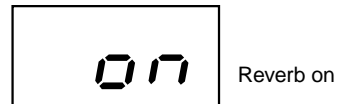

### 2 Set the Reverb On/Off.

To set to “on” (Reverb ON), turn the **DIAL** to the right (clockwise), to set to “off” (Reverb OFF), turn the **DIAL** to the left (counter-clockwise).

### 3 Exit the Reverb On/Off Setting.

After setting the Reverb ON/OFF, simultaneously press the [DEMO] and [START/STOP] button to exit the MIDI/Utility mode.

## Setting the Pad Sensitivity

The DD-55 allows you to custom-set the sensitivity of the pads (range 0 - 2).

When set to a value of 2, the pad sensitivity is the highest, providing the most dynamic range for your playing (softest to loudest volume).

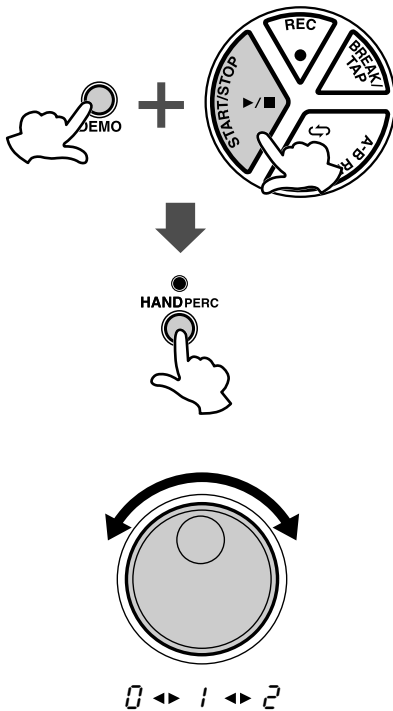

### 1 Display the current pad sensitivity setting.

Simultaneously press the [DEMO] and [START/STOP] button to enter the MIDI/Utility mode, then press the [HAND PERC] button. The current pad sensitivity setting appears in the display.

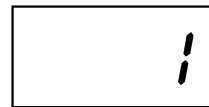

### 2 Set the sensitivity value.

To raise the value, turn the **DIAL** to the right (clockwise), and to lower it, turn the **DIAL** to the left (counter-clockwise).



• Default setting is “1.”

### 3 Exit the sensitivity setting.

After setting the sensitivity, simultaneously press the [DEMO] and [START/STOP] button to exit the MIDI/Utility mode.

### DD-55 Sound Triggering

The DD-55 is fitted with sensors underneath each pad. When struck, each pad/sensor produces velocity data. However, striking one pad very strongly may inadvertently trigger the sounds of other pads, because the sensors of those pads pick up the vibrations of the struck pad. To prevent this from happening, the DD-55 is set to ignore hits of low velocity. (It assumes the low velocity is “noise.”) However, some noise may get through and trigger the sensors.

Here is another related problem: When you strike two pads simultaneously and hit one with less force than the other, the pad struck weakly may not sound because the DD-55 assumes the hit to be noise.

These problems may be solved by changing the DD-55 settings or altering your playing technique (as described below).

- **Striking two pads simultaneously results in one of the pads not sounding.**
  - Set the pad sensitivity level to 2. This may solve the problem if you strike one of the pads weakly. Better yet, try striking both pads with the same force.
- **Striking one pad results in other pads also sounding, even though they were not struck.**
  - Set the pad sensitivity level to 0. With this setting, any pads that are not struck may not respond to the vibrations of your playing.

## Adjusting the Pad Volume

The DD-55 lets you adjust the volume of each pad (range: L0 - L9), allowing you to set the overall balance of the kit.

### 1 Press and hold the [PAD] button and strike the pad whose volume you want to adjust.

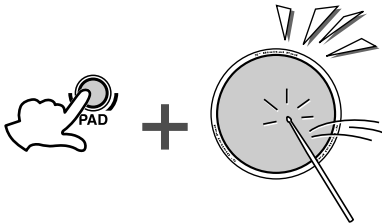

The corresponding pad is selected for changing volume.

### 2 Press and hold down the [PAD] button and simultaneously press VOLUME [▲] or [▼] to adjust the designated pad's volume.

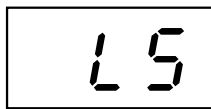

Pad Volume



• The default Pad volume is "L 9."

## Click ON/OFF



Press the [CLICK] button.

The click sounds in rhythm at the current tempo. (See "Adjusting the Tempo" on page 17.)

To turn the click off, press the button once again.

# Playing a Song

The DD-55 features 100 different songs that can be used to provide accompaniment. (See the “Song List” on page 35.)

Select one of the songs and have listen.

## Select the Song and Play

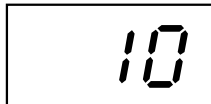

### 1 Press the [SONG] button.

When you press the [SONG] button, the current song number appears in the display.

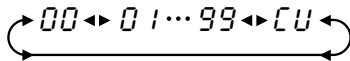
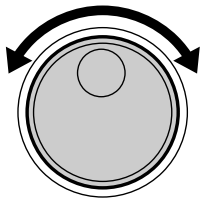

### 2 Select a Song Number.

Use the **DIAL** to select a song number. Song numbers will increase as the **DIAL** is turned to the right (clockwise), and decrease as the **DIAL** is turned to the left (counter-clockwise). (See the “Song List” on page 35.)



- Song number “00” is automatically selected whenever the power is turned ON.
- With the Auto Kit Select feature turned on, selecting a song will also automatically select the best suited Drum Kit for that song. (See “Auto Kit Select ON/OFF Setting” on page 16.)
- Song numbers are arranged in each category according to their complexity. Smaller numbers are easier to play than larger numbers.



### 3 Press the [START/STOP] button.

When you press the [START/STOP] button, a one- or two-measure count-in plays, and the song starts playing.

As the song is playing, the Song’s current measure will be shown in the display. Try playing the pads and pedals along with the song.

To stop playback of the song, press the [START/STOP] button once again.



- You can also use the TAP START function to start songs (see page 16).

## Tap Start

The Tap Start function allows you to set the song's overall tempo as well as start the accompaniment — simply by tapping out the rhythm.

The accompaniment will playback at the tempo with which the pads are struck or the pedals are pressed.

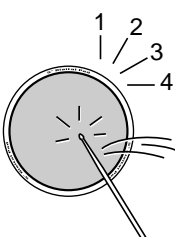
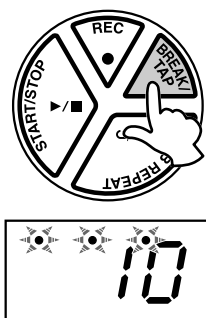

### 1 Press the [BREAK/TAP] button.

While song playback is stopped, press the [BREAK/TAP] button. All three of the beat lamps flash, indicating the DD-55 is set to Tap Start standby.

To cancel the Tap Start mode, simply press the [BREAK/TAP] button once again (the beat lamps will turn off).

### 2 Play the Tap Start.

In the case of a song in 4/4, strike any pad or press any pedal four times, and the accompaniment will start at the desired tempo.



- The number of times needed to strike the pad will change according to the following time signatures; 5/4, 5 times; 4/4, 4 times; 3/4, 3 times; 6/8, 2 times.

### 3 Stop the Song Playback.

Press the [START/STOP] button and the song accompaniment will stop.

## Auto Kit Select ON/OFF Setting

The Auto Kit Select function automatically selects the best matching drum kit for the selected song. You can deactivate this feature by setting the Auto Kit Select to OFF.

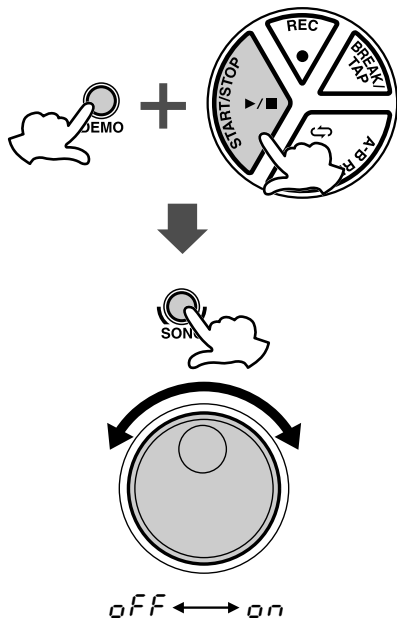

### 1 Setting the Auto Kit Select to ON/OFF.

Simultaneously press the [DEMO] and [START/STOP] button to enter the MIDI/Utility mode. An “*nn*” appears in the display indicating the MIDI/Utility mode.

Next, press the [SONG] button. The current ON/OFF setting appears in the display.

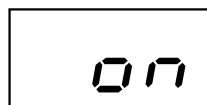

Auto Kit Select is turned on.

### 2 Select ON/OFF.

Turn the **DIAL** to the right (clockwise) to activate the Auto Kit Select (*on*). Turn to the left (counter-clockwise) to deactivate the Auto Kit Select (*off*).



### 3 Exit the Auto Kit Select.

Press the [DEMO] and [START/STOP] buttons simultaneously once again to exit the MIDI/Utility mode.



- The Auto Kit Select is automatically set to "OFF" when the MIDI Transmit Channel setting is changed (see "Setting the MIDI Note Number" on page 28).

## Adjusting the Tempo

The song tempo can be set anywhere from 32 to 280 beats per minute. The higher the tempo value, the faster the tempo.

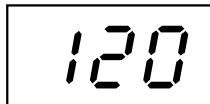

### 1 Press the [TEMPO] button.

When you press the [TEMPO] button, the current tempo value (32 - 280) appears in the display.

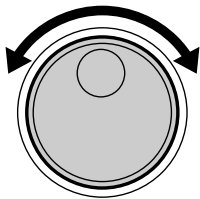

032 ◀▶ 033 ... 279 ◀▶ 280

### 2 Set the Tempo.

Use the **DIAL** to select the TEMPO. Turn the **DIAL** to the right (clockwise) to increase the Tempo value, and turn it to the left (counter-clockwise) to decrease the value. (The Tempo range is 32 - 280.) Press the [SONG] button to exit from the Tempo setting mode.



- When both the [SONG] and [TEMPO] buttons are pressed simultaneously, the preset tempo of the currently selected song is automatically applied.

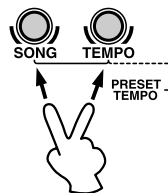

#### ● About the Beat Indicator

During song playback, the three beat lamps in the display will flash in a specific pattern to help you in keeping the beat.

For a song in 4/4 time at a tempo of 120 bpm:

1st beat	2nd beat	3rd beat	4th beat
· 120	· 120	° 120	° 120

# Play along with a Song

Use the pads and pedals to play along with the song accompaniment.



- The DD-55 can play a total of 32 notes simultaneously. That includes notes produced by song accompaniment, pads, foot pedals, and note data received through the MIDI IN jack.

## Track ON/OFF

The DD-55's song accompaniment consists of 4 tracks: Drum tracks 1, 2, and 3, and the Backing track.

DRUM 1	Bass Drum
DRUM 2	Snare Drum
DRUM 3	Cymbal
BACKING	Backing

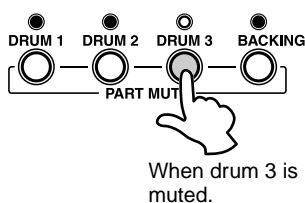

Pressing a Track button ([DRUM 1], [DRUM 2], [DRUM 3], [BACKING]) will mute (turn off the sound) the corresponding track and its indicator lamp will turn off.

Muting DRUM 1, DRUM 2 and DRUM 3 tracks allows you to play along with the song and practice the missing part.

## Break

With the Break function, you can liven up songs by adding your own solos or fills, whenever you want.

Striking a pad while in the Break mode, the song's accompaniment will be muted until the end of the measure you have finished your fill or solo in.

### 1 During song playback, press the [BREAK/TAP] button.



During song playback, press the [BREAK/TAP] button. The three beat lamps in the display flash, indicating the DD-55 is in Break standby mode.

To cancel the Break mode, simply press the [BREAK/TAP] button once again. (The beat lamps flash in tempo.)

### 2 Play the Break.

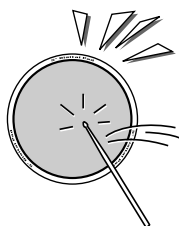

Strike any pad or pedal, and the accompaniment will mute until the end of the measure you played in. You can play a drum fill or drum solo during this break.

The DD-55 returns to the Break standby mode when the Break measure is completed.

### 3 Exit the Break mode.



To exit the Break mode, press the [BREAK/TAP] button. The Break mode is also exited when the song is stopped.

## A-B Repeat

If you want to practice a particular section of a song, you can specify that section's "A" (start repeat) and "B" (end repeat) points. The accompaniment will continuously repeat between points "A" and "B" allowing you to practice between those points for as long as you like.



A03

### 1 Set the "A" (start repeat) point.

When the song playback has reached the start of the section you want to practice, press the [A-B REPEAT] button and the "A" repeat point is set. An "A" will appear in the display.



b05

### 2 Set the "B" (end repeat) point.

When the song playback has reached the end point of the section you want to practice, press the [A-B REPEAT] button once again to set the "B" point ("b" appears in the display). A one-measure count-in plays ("A-b" appears in the display), then the specified section plays back repeatedly. The current measure number will appear in the display during repeat playback.



• The A-B Repeat start and end points can only be set in measure steps.



A-b

### 3 Stop the A-B REPEAT.

Press the [START/STOP] button and the song accompaniment will stop.

"A-b" will appear in the display indicating the A-B REPEAT mode is still engaged.

Press the [START/STOP] button once again and the accompaniment will again repeat between the set points.



• Repeat is canceled when a different song is selected.



#### ● Exit the Repeat

To exit the A-B Repeat function, press the [A-B REPEAT] button during playback ("A-b" is indicated), and the A-B Repeat mode will be canceled (the A-B Repeat points will also be canceled) and normal playback of the accompaniment will continue.

# Recording a Song

The DD-55's Custom Song feature (song number "CU") allows you to record and playback one original song (20000 notes approximately).

## Data that can be recorded in the Custom Song Mode

- Drum pad and pedal data
- Song data (the number cannot be changed while in the RECORD Mode)
- Track ON/OFF settings
- Tempo setting (The tempo cannot be changed while in the RECORD mode)
- Song Volume setting

## Recording

### 1 Prepare to Record.

Select the desired song, drum kit, tempo and track on/off setting.



- Any song from 00 - 99 can be selected. After recording, the data is automatically saved to the "CU" song. (Recording cannot be done if the "CU" song is selected.)



### 2 Start Recording.

Press the [REC] button to start recording. A count-in sound plays, guiding you into the start of the recording.

The following indication appears (for a time signature of 4/4):

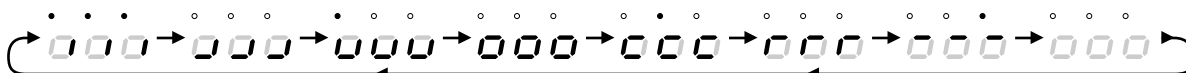

- Press the [CLICK] button to turn the click sound on or off during recording.



### 3 Stop Recording.

To stop recording, press the [START/STOP] button.



- Any previously recorded data will be replaced with new data.
- If the memory becomes full while recording is in progress, "FL" will appear in the display and recording will automatically stop.

## Playback

The recorded Custom Song (CU) can be played back in the same manner as any song (song numbers 00 - 99).

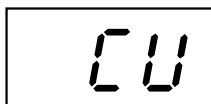

Song number "CU" follows Song number "99" (or prior to "00").



- The A-B Repeat function (see page 19) cannot be used in the Custom Song Mode.

The MIDI IN and MIDI OUT terminals, located on the DD-55's right side panel, offer broadened musical possibilities through use of MIDI. What is MIDI? What can you do with MIDI? And how can you use MIDI with the DD-55? Here are some answers to those questions...

## What's MIDI?

No doubt you have heard the terms "acoustic instrument" and "digital instrument." In the world today, these are the two main categories of instruments.

Let's consider an acoustic piano and a classical guitar as representative acoustic instruments. With the piano, you strike a key, and a hammer inside hits some strings and plays a note. With the guitar, you directly pluck a string and the note sounds.

But how does a digital instrument go about playing a note?

### ● Acoustic guitar note production

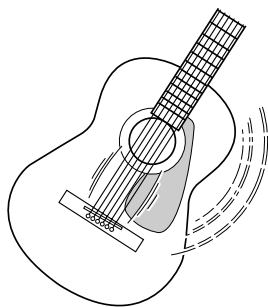

Pluck a string and the body resonates the sound.

### ● Digital instrument note production

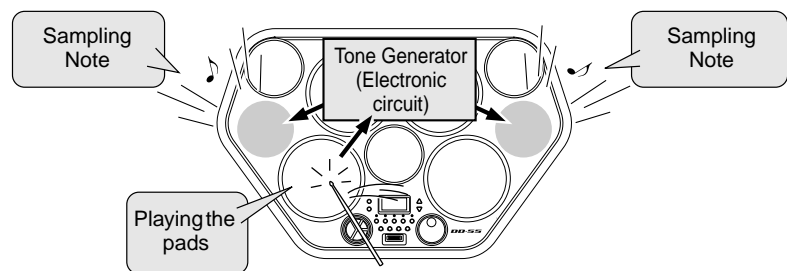

Based on playing information from the pads and pedals, a sampling note stored in the tone generator is played through the speakers.

As shown in the illustration above, in an electronic instrument the sampling note (previously recorded note) stored in the tone generator section (electronic circuit) is played based on information received from the pads and pedals. So then what is the information from the pads and pedals that becomes the basis for note production?

For example, let's say you play a "C" quarter note using the grand piano sound on the keyboard. Unlike an acoustic instrument that puts out a resonated note, the electronic instrument puts out information from the keyboard such as with what voice, with which key, about how strong, when was it pressed and when was it released. Then each piece of information is changed into a number value and sent to the tone generator. Using these numbers as a basis, the tone generator plays the stored sampling note.

### ● Example of Keyboard Information

Voice number (with what voice)	01 (grand piano)
Note number (with which key)	60 (C3)
Note on (when was it pressed) and note off (when was it released)	Timing expressed numerically (quarter note)
Velocity (about how strong)	120 (strong)

MIDI is an acronym that stands for Musical Instrument Digital Interface, which allows electronic musical instruments to communicate with each other, by sending and receiving compatible Note, Control Change, Program Change and various other types of MIDI data, or messages. The DD-55 can control a MIDI device by transmitting note related data and various types of controller data.

The DD-55 can be controlled by the incoming MIDI messages which automatically determine tone generator mode, select MIDI channels, voices and effects, change parameter values and of course play the voices specified for the various parts.

MIDI messages can be divided into two groups: Channel messages and System messages.

● **Channel Messages**

The DD-55 is an electronic instrument that can handle 16 channels. This is usually expressed as “it can play 16 instruments at the same time.” Channel messages transmit information such as Note ON/OFF, Program Change, for each of the 16 channels.

Message Name	DD-55 Operation/Panel Setting
Note ON/OFF	Messages which are generated when the pad or pedal is played. Each message includes a specific note number which corresponds to the pad which is struck, plus a velocity value based on how hard the pad is struck.
Program Change	Voice setting (control change bank select MSB/LSB setting; only receive is available)
Control Change	Voice setting (volume, pan pot, etc.; only receive is available)

● **System Messages**

This is data that is used in common by the entire MIDI system. System messages include messages like Exclusive Messages that transmit data unique to each instrument manufacturer and Realtime Messages that control the MIDI device.

Message Name	DD-55 Operation/Panel Setting
Exclusive Message	Reverb/Chorus/DSP settings, etc.
Realtime Messages	Clock setting Start/stop operation

The messages transmitted/received by the DD-55 are shown in the MIDI Implementation Chart on page 41.

**About MIDI terminals**

In order to exchange MIDI data between multiple devices, each device must be connected by a MIDI cable. The DD-55 is equipped with two types of MIDI terminals, both of which are located on the right side panel.

**MIDI IN** ..... Data transmitted from other MIDI instruments via MIDI, is received at this terminal.

**MIDI OUT** ..... Data produced by the DD-55, is transmitted to other MIDI instruments via MIDI from this terminal.

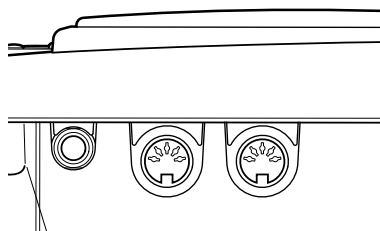

- Never use MIDI cables longer than about 15 meters. Cables longer than this can pick up noise which can cause data errors.

## What You Can Do With MIDI

The DD-55 also features side panel MIDI terminals (MIDI IN and MIDI OUT) as well as a comprehensive set of MIDI functions, that let you use the instrument in a variety of recording and performance applications.

In all cases, make sure to properly set the MIDI Transmit Channels on the DD-55. Also make appropriate settings on the connected instruments. (Refer to the relevant owner's manuals for details.)

### ● You can play the voices and sounds of the DD-55 from another MIDI instrument

This setup allows you to control the DD-55 from a MIDI keyboard controller — especially one not having a tone generator. Connect the MIDI IN terminal on the DD-55 to the MIDI OUT terminal on the other instrument.



### ● You can play the voices and sounds of another MIDI instrument from the DD-55

In this setup, you can play another MIDI instrument or tone generator from the DD-55. For example, this lets you mix two different sounds together when you play a pad on the DD-55. Connect the MIDI OUT terminal on the DD-55 to the MIDI IN terminal on the other instrument.

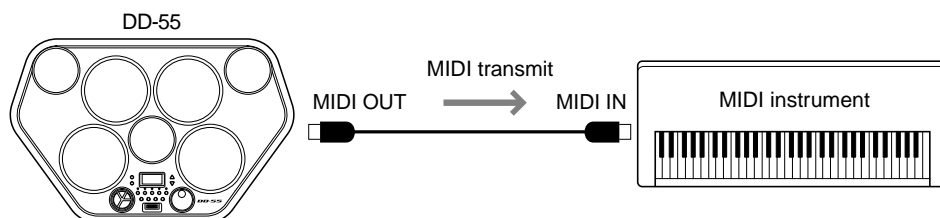

### ● You can record your performance on the DD-55 to a connected sequencer or computer

Here, you can record all your playing, along with the DD-55's auto accompaniment, to a connected computer or sequencer. Naturally, you can use the sophisticated functions of the computer or sequencer to edit your data, and play it back using the sounds of the DD-55. The DD-55 also lets you play back up to 16 different channels — letting you create complex recordings and compositions.

To set up, connect the MIDI OUT terminal on the DD-55 to the MIDI IN terminal on the sequencer or computer (allowing you to record). Also, connect the MIDI IN terminal on the DD-55 to the MIDI OUT terminal on the sequencer or computer (allowing playback). You may need to set Local On/Off (page 26) to off, for best results.

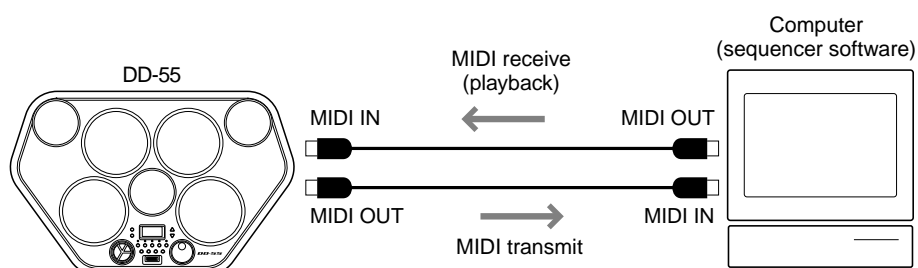

• When using a computer, special software (sequencer software) is needed.

## Connecting to a Computer

You can enjoy using personal computer music software when you connect your DD-55's MIDI terminals to a personal computer. Make sure to use only special MIDI cables.

- Connect the MIDI terminals of the DD-55 to the MIDI terminals of the MIDI interface installed to your computer.

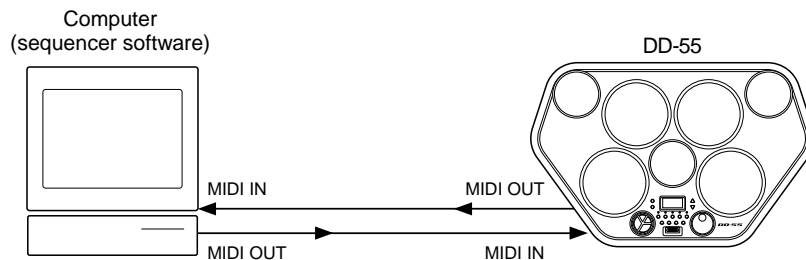

- When using a MIDI interface with a Macintosh series computer, connect the RS-422 terminal of the computer (modem or printer terminal) to the MIDI interface, as shown in the diagram below.

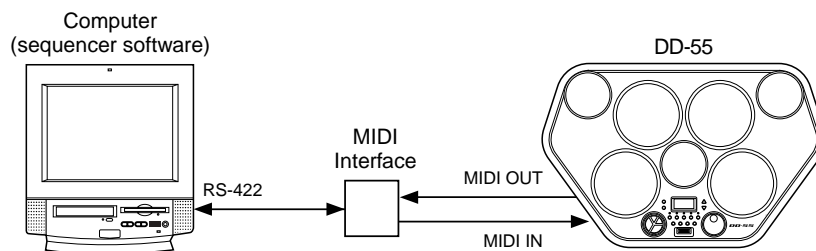

- When connecting to a computer with a USB interface, use the Yamaha UX16 USB/MIDI Interface. Connect the UX16 and the computer with a standard USB cable, then make the proper MIDI connections between the DD-55 and the UX16.

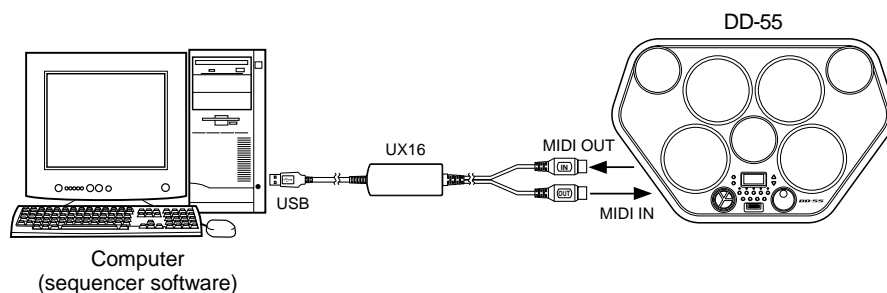

- If you use the Yamaha UX16, be sure to install the supplied driver on your computer.



## Enter/Exit the MIDI/Utility Mode

Simultaneously press the [DEMO] and [START/STOP] button to enter the MIDI/Utility mode. An “*nn*” appears in the display indicating the MIDI/Utility mode.

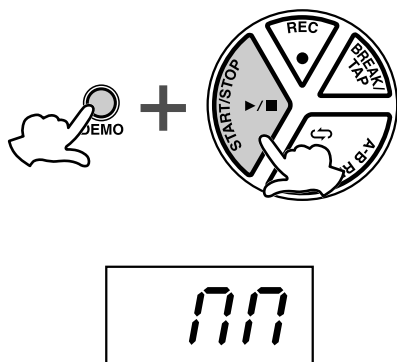

• Pads and pedals do not sound while in the MIDI/Utility mode.

To exit the MIDI mode, once again simultaneously press the [DEMO] and [START/STOP] buttons. The DD-55 exits from the MIDI mode and returns to the normal play mode.

## Setting the Clock

When the DD-55 is connected via MIDI to another MIDI device — such as a sequencer or rhythm machine — you can have the two devices play back in perfect synchronization. To do this properly, you have to make sure that the time based functions (song playback, etc.) on each device are properly set, as to whether they are controlled by internal clock or external clock. When the internal clock ( *I* ) is enabled on the DD-55, timing will be controlled by the DD-55’s internal clock. When external clock ( *E* ) selected, the DD-55 will synchronize to the external sequencer’s or computer’s clock.

*I* (Internal) .....The DD-55’s clock is used as the timing clock.

*E* (External).....The external clock is used as the timing clock (If the clock is set to external without being connected to another MIDI device, the DD-55’s Song Play or Demo functions will not operate.)

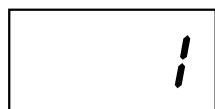

### 1 Display the clock setting.

After entering the MIDI/Utility mode, press the [DRUM 1] button to see the current setting for the MIDI clock.

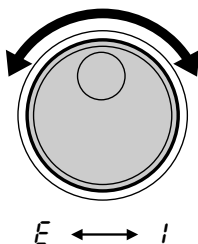

### 2 Set the Clock to External/Internal.

To set the clock to “*I*” (external), turn the **DIAL** to the right (clock-wise). To set the clock to “*E*” (internal), turn the **DIAL** to the left (counter-clockwise).

### 3 Exit the MIDI/Utility mode.

After the clock is set, exit the MIDI/Utility mode.



• The default MIDI clock setting is “*I*” (internal).

## Local ON/OFF

The Local ON/OFF setting determines whether or not the internal voices respond to the notes you play on the DD-55's pads. Setting this to OFF disconnects the DD-55's pads from the voices. However, data produced by the DD-55 is transmitted via the MIDI OUT terminal.

- ON (Local ON)** ..... *The internal voices will be played and controlled by the DD-55 and its pads. Data received via MIDI will also be played by the DD-55.*
- OFF (Local OFF)** ..... *Striking the pads will not produce any sound from the voices. However, the data will be transmitted through the MIDI OUT. However, data received via MIDI will be played by the DD-55.*



- Normally, this should be set to "ON" — since you'll want to hear the sound of the DD-55 as you play it. However, for external sequencer applications, you may need to set this to "OFF" to avoid getting "double" notes, in which the sounds of the DD-55 are played twice — once from the pads and once again by the pad data routed through the sequencer.

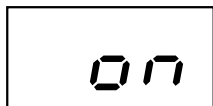

### 1 Display the Local On/Off Setting.

After entering the MIDI/Utility mode, press the **[DRUM 2]** button and the current Local ON /OFF setting will appear in the display.

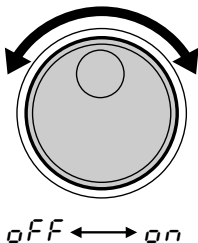

### 2 Set the Local On/Off.

To set to "ON" (Local ON), turn the **DIAL** to the right (clockwise), to set to "OFF" (Local OFF), turn the **DIAL** to the left (counter-clockwise).

### 3 Exit the MIDI/Utility mode.

After setting the Local ON/OFF, exit the MIDI/Utility mode.



- Regardless of the Local ON/OFF setting, the DD-55's performance data (including demo song data) is always sent to the MIDI OUT terminals for transmission to external MIDI devices.
- The default Local ON/OFF setting is ON (Local ON).

## Setting the MIDI Transmit Channel

Each of the pads/pedals (a total of 9) can be assigned to transmit on any of the 16 MIDI channels, or turned off (indicated as “OFF” in the display). Also, song transmit channels are as shown below:

	Transmit Channel	Default
Pad/Pedal	1 - 16	10
Drum (Song)	10 (Fixed)	10
Backing (Song)	11 - 16 (Fixed)	11 - 16
Pad/Pedal (Custom )	10 (Fixed)	10

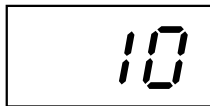

### 1 Display the MIDI Transmit Channel Number.

After entering the MIDI/Utility mode, press the [PAD] button and the current Pad 1 transmit channel will be displayed.

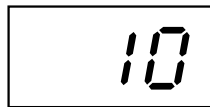
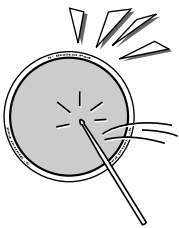

### 2 Select a pad to be assigned a MIDI Transmit Number.

To select the pad you want to assign a MIDI transmit channel, strike the appropriate pad. That pad's currently selected MIDI transmit channel will appear in the display.

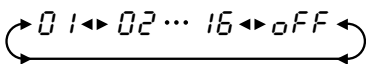
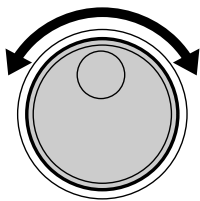

### 3 Set the MIDI Transmit Channel Number.

Turn the **DIAL** to the right (clockwise) to increase the MIDI transmit channel value, or turn it to the left (counter-clockwise) to decrease the value.



- You can also select the MIDI transmit channel by striking the pad repeatedly. Every time the pad is struck the MIDI transmit channel number will increase by 1.

### 4 Exit the MIDI/Utility mode.

After you've assigned each pad to a MIDI transmit channel as desired, exit the MIDI/Utility mode.



- For further information on what type of data is transmitted via MIDI, see the “MIDI Implementation Chart” (page 41).

## Setting the MIDI Note Number

Each pad and pedal (9 total) can be assigned a specific MIDI note number anywhere from C-2 to G8.

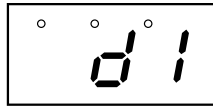

### 1 Display the MIDI Note Number.

After entering the MIDI/Utility mode, press the [KIT] button, the MIDI note number currently assigned to Pad 1 will appear in the display.

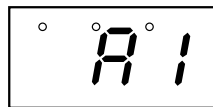
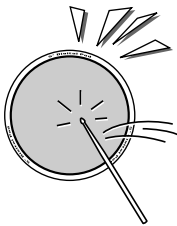

### 2 Select the pad to be assigned a MIDI Note Number.

Strike any pad to see the currently assigned MIDI note number for the pad in the display.

Sharp notes are indicated by a beat lamp on the right side of the display.

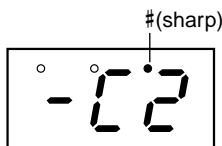

### 3 Assign a MIDI Note Number.

To select the desired MIDI note number, turn the **DIAL** to the right (clockwise) and the MIDI note numbers will increase. Turn the **DIAL** to the left (counter-clockwise) and MIDI note numbers will decrease.

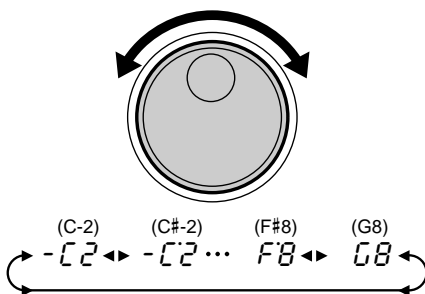

- You can also select the MIDI note number by striking the pad repeatedly. Every time the pad is struck, the value will increase by semitone steps.

### 4 Exit the MIDI/Utility mode.

After you've assigned each pad to a MIDI note number as desired, exit the MIDI/Utility mode.



- For information on transmit notes and voices, refer to the DD-55 "Drum Map" on page 38.
- When the Pad Assign or Kit Assign is set, the MIDI Note Number will be applied to the preset value. If the Auto Kit Select is set to ON and another Song is selected, the MIDI Note Number will be applied to the preset value.
- Auto Kit Select is automatically turned off when a MIDI Note Number is changed.

## Saving and Loading Song Data

The DD-55 lets you save and load song data to/from a connected computer. Once the song is loaded, you can play or practice them in the same way as with the preset songs.

To transfer song data between the DD-55 and the connected computer, you must first install the special Song Filer software to the computer.

DD-55 song data that can be loaded and saved:

- Number of songs: 1 song (song number "CU")
- Available memory: 100 Kbytes
- Data format: SMF Format 0

### ■ Installing Song Filer.....

You can download the Song Filer software from the following Yamaha PK CLUB website. Make sure that your computer has an Internet connection.

**Yamaha PK CLUB (Portable Keyboard Home Page)**  
<http://www.yamahaPKclub.com/>

System requirements for Song Filer

#### [Windows]

OS:	Windows 95/98/Me/2000/XP
CPU:	Pentium/100MHz or faster
Available Memory:	8MB or more
Free space in Hard Disk:	2MB or more
Display:	800 x 600, 256 colors or more

#### [Macintosh]

OS:	Mac OS 7.5 - 9.2.2 (OS X is not supported)
CPU:	Power PC or higher
Available Memory:	8MB or more
Free space in Hard Disk:	2MB or more
Display:	800 x 600, 256 colors or more



- Visit the Yamaha PK CLUB website for more information on the latest version of Song Filer and how to install it.

## ■ Song Filer Functions .....

After you install Song Filer on the computer and connect the DD-55 to the computer, you can use the two functions described below.

Refer to page 24 for information on connecting the DD-55 to a computer.

For more information on using Song Filer, refer to the PDF manual included with the Song Filer application download.

### ● Managing Data on DD-55

The DD-55's custom song data can be deleted by using your computer. You should delete this custom song data before sending data from the computer to the DD-55.

### ● Transmitting and Receiving Files

You can transfer a song file between the DD-55 and your computer.

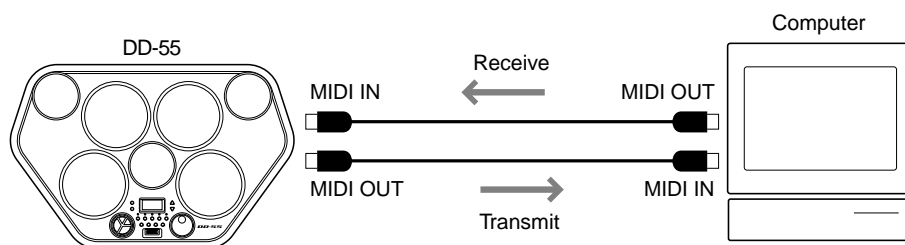

## Initialize.....

The DD-55's Custom Song, Custom Kit, and Panel Setting data are backed up so long as power is supplied to the DD-55 by means of batteries or an AC adaptor.

Initialize is the term which refers to this data being restored to its original factory settings. To initialize the DD-55, follow the procedure below.

### **⚠ CAUTION**

- *Keep in mind that initializing the data erases any and all of the original data you saved to the instrument.*

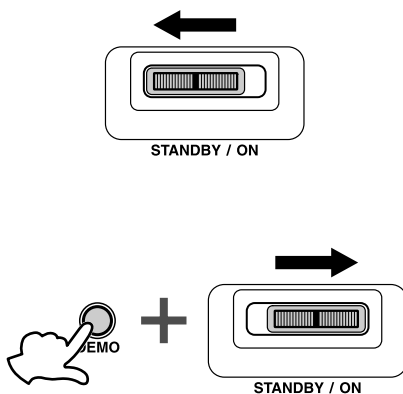

- ① Turn the power off. (Move the [STANDBY/ON] switch to the STANDBY position.)
- ② While holding down the [DEMO] button, turn the power on again. (Move the [STANDBY/ON] switch to the ON position.) The DD-55 will be initialized to its factory settings. "C1 r" will appear in the display when the initialization process is complete.

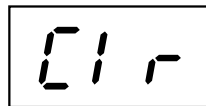

The following data will remain in memory, as long as batteries are installed or an AC adaptor is connected, even if the power is turned off.

- Custom Song
- Custom Kit
- Auto Kit Selection
- MIDI Transmit Channel for the PAD
- MIDI Transmit Note for the PAD
- Pad Sensitivity

## Troubleshooting .....

**In many cases, problems or malfunctions that occur during use can be remedied easily. Please check the following list before deciding that your DD-55 is damaged. If the suggested remedy is ineffective, take the DD-55 to an authorized Yamaha dealer for proper diagnosis and repair. Do not attempt to repair this digital instrument by yourself as serious damage may occur.**

Problem	Cause/Solution
A buzz or click occurs momentarily when the DD-55 is turned ON or OFF	This is a normal power surge noise that occurs when the POWER switch is operated.
The LED display is completely dark. When the pads are struck, the display is dark and returns to "000".	The batteries are low and should be replaced with a complete set of six new batteries immediately. Ideally, an optional AC adaptor PA-5D or PA-5C should be used to power the DD-55 (see page 5).
The custom pad voice assignments have disappeared or defaulted.	
No sound comes from the speakers.	<ul style="list-style-type: none"> <li>• The volume is set too low. Adjust the volume (see page 8).</li> <li>• A plug is inserted into the PHONES/OUTPUT jack and should be taken out (see page 7).</li> <li>• The LOCAL ON/OFF is set to OFF. Set the LOCAL ON/OFF to ON (see page 26).</li> <li>• You are in the MIDI/Utility mode. Exit the MIDI/Utility mode (see page 25).</li> </ul>
Striking two pads simultaneously results in one of the pads not sounding.	Refer to "DD-55 Sound Triggering" to resolve the problem (see page 13).
Striking a pad results in other pads also sounding, though they were not struck.	
The selected voice does not sound when the pad is struck.	The desired voice has not been assigned to the pad. Use the PAD ASSIGN function to program the desired voice to the appropriate pad (see page 11).
The song or Demo does not start playback.	The MIDI clock has been set to "E" (external). Change the MIDI clock setting to "I" (internal) (see page 25).
"E I r" appears in the display when the POWER switch is turned ON, and backed up data has been erased.	Backed up data is initialized if batteries are not installed or AC adaptor is disconnected while the power is turned off (see page 31).



# Drum Voice List .....

## ● Panel Voice List

Voice No.	Voice Name
000	Bass Drum Soft
001	Bass Drum Hard
002	Bass Drum
003	Bass Drum Soft
004	Bass Drum Hard
005	Bass Drum
006	Bass Drum 2
007	Room Bass Drum
008	Rock Bass Drum Soft
009	Rock Bass Drum Hard
010	Rock Bass Drum
011	Elec. Bass Drum Hard
012	Elec. Bass Drum
013	Dance Bass Drum Soft
014	Dance Bass Drum Hard
015	Dance Bass Drum
016	Jazz Bass Drum Soft
017	Jazz Bass Drum Hard
018	Jazz Bass Drum
019	Snare H Soft
020	Snare M
021	Snare H Hard
022	Snare H Soft
023	Snare M
024	Snare H Hard
025	Snare H Soft 2
026	Snare M 2
027	Snare H Hard 2
028	Room Snare H Soft
029	Room Snare M
030	Room Snare H Hard
031	Rock Snare H Soft
032	Rock Snare M
033	Rock Snare H Hard
034	Snare L
035	Elec. Snare M
036	Elec. Snare H
037	Dance Snare Snappy

Voice No.	Voice Name
038	Dance Snare M
039	Dance Snare H Hard
040	Jazz Snare H Soft
041	Jazz Snare M
042	Jazz Snare H Hard
043	Brush Tap
044	Brush Slap
045	Brush Tap
046	Brush Slap
047	Side Sticks
048	Side Sticks
049	Side Sticks 2
050	Room Side Sticks
051	Dance Side Sticks
052	Jazz Side Sticks
053	Open Rim Shot
054	Open Rim Shot
055	Open Rim Shot 2
056	Room Open Rim Shot
057	Dance Open Rim Shot
058	Jazz Open Rim Shot
059	Sticks
060	High Tom
061	Mid Tom H
062	Mid Tom L
063	Low Tom
064	Floor Tom H
065	Floor Tom L
066	High Tom
067	Mid Tom H
068	Mid Tom L
069	Low Tom
070	Floor Tom H
071	Floor Tom L
072	Room High Tom
073	Room Mid Tom H
074	Room Mid Tom L
075	Room Low Tom

Voice No.	Voice Name
076	Room Floor Tom H
077	Room Floor Tom L
078	Rock High Tom
079	Rock Mid Tom H
080	Rock Mid Tom L
081	Rock Low Tom
082	Rock Floor Tom H
083	Rock Floor Tom L
084	Elec. High Tom
085	Elec. Mid Tom H
086	Elec. Mid Tom L
087	Elec. Low Tom
088	Elec. Floor Tom H
089	Elec. Floor Tom L
090	Dance High Tom
091	Dance Mid Tom H
092	Dance Mid Tom L
093	Dance Low Tom
094	Dance Floor Tom H
095	Dance Floor Tom L
096	Jazz High Tom
097	Jazz Mid Tom H
098	Jazz Mid Tom L
099	Jazz Low Tom
100	Jazz Floor Tom H
101	Jazz Floor Tom L
102	Hi-Hat Closed/Open *
103	Hi-Hat Open
104	Hi-Hat Closed/Open *
105	Hi-Hat Open
106	Crash Cymbal 1
107	Crash Cymbal 2
108	Crash Cymbal 1
109	Crash Cymbal 2
110	Dance Cymbal
111	Ride Cymbal 1
112	Ride Cymbal 2
113	Ride Cymbal 1

\* By assigning Closed and Open Hi-Hat voices to both the Pad and Pedal, those voices can be controlled with the foot pedal as follows:

- Strike the pad while pressing the Foot Pedal, the “Closed” Hi-Hat voice will sound.
- Strike the pad without pressing the Foot Pedal, the “Open” Hi-Hat voice will sound.
- Press the Foot Pedal without striking the pad, the Hi-Hat “Pedal” voice will sound.
- If these voices have been assigned to more than one pad, only the left-most pad can be used with the Pedal function (Closed/Open).

Voice No.	Voice Name
114	Ride Cymbal 2
115	Ride Cymbal Cup
116	Ride Cymbal Cup
117	Chinese Cymbal
118	Chinese Cymbal
119	Splash Cymbal
120	Splash Cymbal
121	Hand Clap
122	Finger Snap
123	Tambourine
124	Tambourine
125	Cowbell
126	Cowbell
127	Dance Cowbell
128	Jazz Cowbell
129	Conga H Close
130	Conga H Open
131	Conga L
132	Conga H Close
133	Conga H Open
134	Conga L
135	Dance Conga H Mute
136	Dance Conga H Open
137	Dance Conga L
138	Jazz Conga H Close
139	Jazz Conga H Open
140	Jazz Conga L
141	Bongo H
142	Bongo L
143	Bongo H
144	Bongo L
145	Timbale H
146	Timbale L
147	Timbale H
148	Timbale L
149	Agogo H
150	Agogo L
151	Cabasa
152	Cabasa

Voice No.	Voice Name
153	Maracas
154	Maracas
155	Shaker
156	Shaker
157	Claves
158	Triangle Mute
159	Triangle Open
160	Guiro Short
161	Guiro Short
162	Guiro Long
163	Cuica Mute
164	Cuica Open
165	Castanet
166	Jazz Castanet
167	Vibraslap
168	Wood Block H
169	Wood Block L
170	Jingle Bell
171	Bell Tree
172	Pandiero Keto
173	Pandiero Solto
174	Pandiero Ponta
175	Pandiero Calcanhar
176	Tamborim Solto
177	Tamborim Ponta
178	Tamborim Nylon Volta
179	Conga Muff
180	Surdo Mute
181	Surdo Open
182	Hi Q
183	Hi Q Low
184	Whip Slap
185	Scratch Push
186	Scratch Pull
187	Click Noise
188	Metronome Click
189	Metronome Bell
190	Seq Click L
191	Seq Click H

Voice Number	Phrase Name
192	Simple Rock
193	Pop Rock
194	Rock'n' Roll
195	Groove Rock
196	Hard Rock
197	Contemporary R&B
198	Hard Shuffle
199	Blues Shuffle
200	A.O.R
201	Soul
202	Club Mix
203	House
204	Jazz Funk
205	Ballad
206	R & B
207	Motor Town
208	Swing Jazz
209	Urban Funk
210	Fusion
211	Fusion Samba

**NOTE:**

- Phrase data cannot be transmitted.
- The pan data for each voice is fixed and cannot be changed, regardless of the pad assignments. For example, if a voice containing a "left" pan setting is assigned to a right pad, the actual sound will come from the left.

# Song List .....

Song No.	Song Name	Difficulty
<b>Demo</b>		
00	Technical Funk	—
01	Heavy Metal	
02	Hyper Dance Mix	
03	Latin Fusion	
04	Straight Ahead	
<b>Pattern</b>		
05	Simple Rock	Easy
06	Pop Rock	
07	R&R 1	
08	R&R 2	Nomal
09	Groove Rock	
10	Hard Rock 1	Easy
11	Hard Rock 2	Nomal
12	Contemporary R&B	
13	Hard Shuffle	
14	Blues Shuffle	
15	A.O.R 1	
16	A.O.R 2	
17	Soul 1	
18	Soul 2	
19	Club Mix	
20	House	
21	Jazz Funk 1	Difficult
22	Jazz Funk 2	
23	Ballad	Easy
24	R&B	Nomal
25	Motor Town	
26	Urban Funk	Difficult
27	Fusion 1	
28	Fusion 2	
29	Fusion Samba	Nomal
30	Swing Jazz 1	
31	Swing Jazz 2	
<b>Fill in</b>		
32	Simple Rock	Easy

Song No.	Song Name	Difficulty
33	Pop Rock 1	Easy
34	Pop Rock 2	
35	R&R 1	
36	R&R 2	Nomal
37	Groove Rock 1	
38	Groove Rock 2	Easy
39	Hard Rock 1	Nomal
40	Hard Rock 2	
41	Contemporary R&B	
42	Hard Shuffle 1	
43	Hard Shuffle 2	
44	Blues Shuffle 1	
45	Blues Shuffle 2	
46	A.O.R 1	
47	A.O.R 2	
48	Soul 1	
49	Soul 2	
50	Club Mix 2	Difficult
51	Club Mix 2	
52	House 1	
53	House 2	Easy
54	Jazz Funk 1	
55	Jazz Funk 2	Difficult
56	Ballad 1	Nomal
57	Ballad 2	
58	R&B 1	Difficult
59	R&B 2	
60	Motor Town 1	Nomal
61	Motor Town 2	
62	Urban Funk 1	Difficult
63	Urban Funk 2	
64	Fusion 1	
65	Fusion 2	Nomal
66	Fusion Samba 1	
67	Fusion Samba 2	
68	Swing Jazz 1	Nomal

Song No.	Song Name	Difficulty
69	Swing Jazz 2	Nomal
<b>Song</b>		
70	Simple Rock	Easy
71	Pop Rock	
72	R&R	Nomal
73	Groove Rock	
74	Hard Rock	Difficult
75	Contemporary R&B	Nomal
76	Hard Shuffle	
77	Blues Shuffle	Difficult
78	A.O.R	Nomal
79	Soul	
80	Club Mix	Difficult
81	House	
82	Jazz Funk	Easy
83	Ballad	Difficult
84	R&B	
85	Motor Town	Difficult
86	Urban Funk	
87	Fusion	Nomal
88	Fusion Samba	
89	Swing Jazz	Difficult
<b>Latin</b>		
90	Mambo	Difficult
91	Rhumba Guaguanco	
92	Bossa-Nova	Nomal
93	Samba Batucada	
94	Cha-Cha	Difficult
95	Compatsa	
96	Songo	Nomal
97	Mozañbique	
98	Reggae	Difficult
99	Bemde(African 6/8)	

**Demo:** These songs demonstrate the drum sounds and rhythms.

**Pattern:** These are special loop-repeating patterns for drum practice. A variety of basic patterns are included in this type.

**Fill in:** These are special fill patterns appropriate for use with many rhythms.

**Song:** These include drum and fill-in patterns, and are ideal for general practice purposes.

**Latin:** These are special loop-repeating Latin rhythm patterns.

# Drum Kit List .....

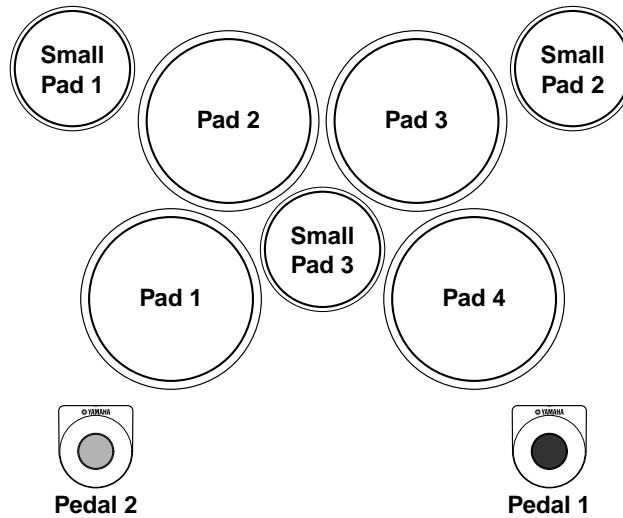

Category	Kit No.	Kit Name	Pad 1	Pad 2	Pad 3	Pad 4
Demo	00	Stereo Kit 1	053 Open Rim Shot	061 Mid Tom H	063 Low Tom	065 Floor Tom L
	01	Heavy Metal Kit	032 Rock Snare M	080 Rock Mid Tom L	081 Rock Low Tom	083 Rock Floor Tom L
	02	Dance Kit	057 Dance Open Rim Shot	147 Timbale H	148 Timbale L	015 Dance Bass Drum
	03	Latin Kit	130 Conga H Open	145 Timbale H	146 Timbale L	134 Conga L
	04	Stereo Kit 2	053 Open Rim Shot	060 High Tom	062 Mid Tom L	064 Floor Tom H
Song	05	Standard Kit 1	024 Snare H Hard	067 Mid Tom H	068 Mid Tom L	070 Floor Tom H
	06	Rock Kit 1	033 Rock Snare H Hard	078 Rock High Tom	080 Rock Mid Tom L	081 Rock Low Tom
	07	R & R Kit	023 Snare M	067 Mid Tom H	069 Low Tom	071 Floor Tom L
	08	Rock Kit 2	032 Rock Snare M	080 Rock Mid Tom L	081 Rock Low Tom	083 Rock Floor Tom L
	09	Hard Rock Kit	024 Snare H Hard	067 Mid Tom H	068 Mid Tom L	070 Floor Tom H
	10	R & B Kit 1	032 Rock Snare M	048 Side Sticks	081 Rock Low Tom	083 Rock Floor Tom L
	11	Shuffle Kit	053 Open Rim Shot	061 Mid Tom H	063 Low Tom	065 Floor Tom L
	12	Blues Kit	053 Open Rim Shot	060 High Tom	062 Mid Tom L	064 Floor Tom H
	13	A.O.R. Kit	053 Open Rim Shot	061 Mid Tom H	063 Low Tom	064 Floor Tom H
	14	Soul Kit	033 Rock Snare H Hard	079 Rock Mid Tom H	081 Rock Low Tom	083 Rock Floor Tom L
	15	Club Kit	030 Room Snare H Hard	074 Room Mid Tom L	075 Room Low Tom	077 Room Floor Tom L
	16	House Kit	057 Dance Open Rim Shot	092 Dance Mid Tom L	093 Dance Low Tom	094 Dance Floor Tom H
	17	Jazz Funk Kit	024 Snare H Hard	067 Mid Tom H	069 Low Tom	070 Floor Tom H
	18	Ballad Kit	030 Room Snare H Hard	072 Room High Tom	074 Room Mid Tom L	076 Room Floor Tom H
	19	R & B Kit 2	023 Snare M	068 Mid Tom L	069 Low Tom	070 Floor Tom H
	20	R & B Kit 3	024 Snare H Hard	067 Mid Tom H	069 Low Tom	071 Floor Tom L
	21	Funk Kit	054 Open Rim Shot	081 Rock Low Tom	120 Splash Cymbal	083 Rock Floor Tom L
	22	Fusion Kit 1	053 Open Rim Shot	061 Mid Tom H	063 Low Tom	064 Floor Tom H
	23	Fusion Kit 2	024 Snare H Hard	066 High Tom	068 Mid Tom L	069 Low Tom
	24	Jazz Kit	055 Open Rim Shot 2	096 Jazz High Tom	098 Jazz Mid Tom L	100 Jazz Floor Tom H
Latin	25	Mambo Kit	048 Side Sticks	066 High Tom	068 Mid Tom L	069 Low Tom
	26	Rumba Kit	048 Side Sticks	066 High Tom	069 Low Tom	070 Floor Tom H
	27	Bossa Nova Kit	048 Side Sticks	066 High Tom	068 Mid Tom L	069 Low Tom
	28	Samba Kit	176 Tamborim Solto	164 Cuica Open	163 Cuica Mute	178 Tamborim Nylon Volta
	29	Cha Cha Cha Kit	130 Conga H Open	141 Bongo H	142 Bongo L	131 Conga L
	30	Comparsa Kit	054 Open Rim Shot	066 High Tom	068 Mid Tom L	069 Low Tom
	31	Songo Kit	054 Open Rim Shot	066 High Tom	069 Low Tom	070 Floor Tom H
	32	Conga Kit	130 Conga H Open	141 Bongo H	142 Bongo L	131 Conga L
	33	Reggae Kit	048 Side Sticks	024 Snare H Hard	067 Mid Tom H	069 Low Tom
	34	Bembe Kit	024 Snare H Hard	067 Mid Tom H	069 Low Tom	070 Floor Tom H
Sequential Kit	35	Sequence Kit 1	The Sequential Kit features complete rhythm pattern phrases that you can play simply by hitting a pad on the DD-55. No need to worry if you hit a pad repeatedly or hit more than one pad — the DD-55 plays the phrase through once and stops, until you hit a pad again.			
	36	Sequence Kit 2				
	37	Sequence Kit 3				
	38	Sequence Kit 4				
	39	Sequence Kit 5				
	40	Sequence Kit 6				
	41	Sequence Kit 7				
	42	Sequence Kit 8				
	43	Sequence Kit 9				
	44	Sequence Kit 10				

Small Pad 1		Small Pad 2		Small Pad 3		Pedal 1		Pedal 2	
106	Crash Cymbal 1	111	Ride Cymbal 1	102	Hi-Hat Closed/Open *	001	Bass Drum Hard	102	Hi-Hat Closed/Open *
108	Crash Cymbal 1	116	Ride Cymbal Cup	105	Hi-Hat Open	010	Rock Bass Drum	010	Rock Bass Drum
120	Splash Cymbal	182	Hi Q	104	Hi-Hat Closed/Open *	014	Dance Bass Drum Hard	104	Hi-Hat Closed/Open *
106	Crash Cymbal 1	125	Cowbell	129	Conga H Close	000	Bass Drum Soft	157	Claves
106	Crash Cymbal 1	111	Ride Cymbal 1	102	Hi-Hat Closed/Open *	001	Bass Drum Hard	102	Hi-Hat Closed/Open *
108	Crash Cymbal 1	113	Ride Cymbal 1	104	Hi-Hat Closed/Open *	003	Bass Drum Soft	104	Hi-Hat Closed/Open *
108	Crash Cymbal 1	113	Ride Cymbal 1	104	Hi-Hat Closed/Open *	008	Rock Bass Drum Soft	104	Hi-Hat Closed/Open *
108	Crash Cymbal 1	113	Ride Cymbal 1	104	Hi-Hat Closed/Open *	003	Bass Drum Soft	104	Hi-Hat Closed/Open *
108	Crash Cymbal 1	116	Ride Cymbal Cup	104	Hi-Hat Closed/Open *	010	Rock Bass Drum	104	Hi-Hat Closed/Open *
108	Crash Cymbal 1	116	Ride Cymbal Cup	104	Hi-Hat Closed/Open *	005	Bass Drum	104	Hi-Hat Closed/Open *
108	Crash Cymbal 1	113	Ride Cymbal 1	104	Hi-Hat Closed/Open *	009	Rock Bass Drum Hard	104	Hi-Hat Closed/Open *
106	Crash Cymbal 1	115	Ride Cymbal Cup	102	Hi-Hat Closed/Open *	001	Bass Drum Hard	102	Hi-Hat Closed/Open *
106	Crash Cymbal 1	111	Ride Cymbal 1	102	Hi-Hat Closed/Open *	001	Bass Drum Hard	102	Hi-Hat Closed/Open *
106	Crash Cymbal 1	111	Ride Cymbal 1	102	Hi-Hat Closed/Open *	002	Bass Drum	102	Hi-Hat Closed/Open *
108	Crash Cymbal 1	121	Hand Clap	104	Hi-Hat Closed/Open *	008	Rock Bass Drum Soft	104	Hi-Hat Closed/Open *
108	Crash Cymbal 1	120	Splash Cymbal	104	Hi-Hat Closed/Open *	007	Room Bass Drum	104	Hi-Hat Closed/Open *
013	Dance Bass Drum Soft	109	Crash Cymbal 2	121	Hand Clap	015	Dance Bass Drum	104	Hi-Hat Closed/Open *
108	Crash Cymbal 1	116	Ride Cymbal Cup	104	Hi-Hat Closed/Open *	005	Bass Drum	104	Hi-Hat Closed/Open *
108	Crash Cymbal 1	113	Ride Cymbal 1	104	Hi-Hat Closed/Open *	003	Bass Drum Soft	104	Hi-Hat Closed/Open *
108	Crash Cymbal 1	114	Ride Cymbal 2	104	Hi-Hat Closed/Open *	005	Bass Drum	104	Hi-Hat Closed/Open *
108	Crash Cymbal 1	113	Ride Cymbal 1	104	Hi-Hat Closed/Open *	003	Bass Drum Soft	104	Hi-Hat Closed/Open *
108	Crash Cymbal 1	116	Ride Cymbal Cup	104	Hi-Hat Closed/Open *	003	Bass Drum Soft	104	Hi-Hat Closed/Open *
106	Crash Cymbal 1	111	Ride Cymbal 1	102	Hi-Hat Closed/Open *	002	Bass Drum	102	Hi-Hat Closed/Open *
108	Crash Cymbal 1	114	Ride Cymbal 2	104	Hi-Hat Closed/Open *	003	Bass Drum Soft	104	Hi-Hat Closed/Open *
108	Crash Cymbal 1	114	Ride Cymbal 2	052	Jazz Side Sticks	016	Jazz Bass Drum Soft	104	Hi-Hat Closed/Open *
108	Crash Cymbal 1	116	Ride Cymbal Cup	126	Cowbell	003	Bass Drum Soft	104	Hi-Hat Closed/Open *
108	Crash Cymbal 1	104	Hi-Hat Closed/Open *	157	Claves	003	Bass Drum Soft	104	Hi-Hat Closed/Open *
120	Splash Cymbal	114	Ride Cymbal 2	104	Hi-Hat Closed/Open *	003	Bass Drum Soft	104	Hi-Hat Closed/Open *
149	Agogo H	150	Agogo L	177	Tamborim Ponta	180	Surdo Mute	181	Surdo Open
162	Guiro Long	161	Guiro Short	129	Conga H Close	157	Claves	153	Maracas
157	Claves	114	Ride Cymbal 2	126	Cowbell	004	Bass Drum Hard	104	Hi-Hat Closed/Open *
108	Crash Cymbal 1	116	Ride Cymbal Cup	120	Splash Cymbal	005	Bass Drum	104	Hi-Hat Closed/Open *
157	Claves	125	Cowbell	129	Conga H Close	161	Guiro Short	162	Guiro Long
108	Crash Cymbal 1	114	Ride Cymbal 2	104	Hi-Hat Closed/Open *	004	Bass Drum Hard	104	Hi-Hat Closed/Open *
108	Crash Cymbal 1	116	Ride Cymbal Cup	048	Side Sticks	005	Bass Drum	104	Hi-Hat Closed/Open *



# Drum Map

- “<—” indicates that in the column on the immediate left.
- Each percussion voice uses one note.
- The MIDI Note # and Note are actually one octave lower than listed. For example, in “GM Standard 1”, the “Seq Click H” (Note# 36/Note C1) corresponds to (Note# 24/Note C0).

(MSB=127, LSB=000)

Program Change No.	000	001	008	016	024	027	032	119
Keyboard	GM Standard 1	Standard 2	Room	Rock	Electronic Kit	Dance	Jazz	Stereo & Latin
25	C# 0 13	C# -1	Surdo Mute	<—	<—	<—	<—	<—
26	D 0 14	D -1	Surdo Open	<—	<—	<—	<—	<—
27	D# 0 15	D# -1	Hi Q	<—	<—	<—	<—	<—
28	E 0 16	E -1	Whip Slap	<—	<—	<—	<—	<—
29	F 0 17	F -1	Scratch Push	<—	<—	<—	<—	<—
30	F# 0 18	F# -1	Scratch Pull	<—	<—	<—	<—	<—
31	G 0 19	G -1	Finger Snap	<—	<—	<—	<—	<—
32	G# 0 20	G# -1	Click Noise	<—	<—	<—	<—	<—
33	A 0 21	A -1	Metronome Click	<—	<—	<—	<—	<—
34	A# 0 22	A# -1	Metronome Bell	<—	<—	<—	<—	<—
35	B 0 23	B -1	Seq Click L	<—	<—	<—	<—	<—
36	C 1 24	C 0	Seq Click H	<—	<—	<—	<—	<—
37	C# 1 25	C# 0	Brush Tap	<—	<—	<—	<—	Brush Tap
38	D 1 26	D 0	Brush Swirl	<—	<—	<—	<—	Brush Swirl
39	D# 1 27	D# 0	Brush Slap	<—	<—	<—	<—	Brush Slap
40	E 1 28	E 0	Brush Tap Swirl	<—	<—	Reverse Cymbal	Brush Tap Swirl	Brush Tap Swirl
41	F 1 29	F 0	Snare Roll	<—	<—	<—	<—	Snare Roll
42	F# 1 30	F# 0	Castanet	<—	<—	Hi Q Low	Jazz Castanet	<—
43	G 1 31	G 0	Snare H Soft	Snare H Soft 2	Snare H Soft	Snare Rock H	AnSD Snappy	Jazz Snare H Soft
44	G# 1 32	G# 0	Sticks	<—	<—	<—	<—	<—
45	A 1 33	A 0	Bass Drum Soft	<—	<—	Rock Bass Drum Soft	Dance Bass Drum Soft	Jazz Bass Drum Soft
46	A# 1 34	A# 0	Open Rim Shot	Open Rim Shot 2	Open Rim Shot	<—	Dance Open Rim Shot	Jazz Open Rim Shot 2
47	B 1 35	B 0	Bass Drum Hard	<—	<—	Rock Bass Drum Hard	Dance Bass Drum Hard	Jazz Bass Drum Hard
48	C 2 36	C 1	Bass Drum	Bass Drum 2	Room Bass Drum	Rock Bass Drum	Elec. Bass Drum	Dance Bass Drum
49	C# 2 37	C# 1	Side Sticks	Side Sticks 2	Side Sticks	<—	Dance Side Sticks	Jazz Side Sticks 2
50	D 2 38	D 1	Snare M	Snare M 2	Room Snare M	Rock Snare M	Elec. Snare Drum M	Dance Snare M
51	D# 2 39	D# 1	Hand Clap	<—	<—	<—	<—	<—
52	E 2 40	E 1	Snare H Hard	Snare H Hard 2	Room Snare H Hard	Rock Snare H Hard	Elec. Snare Drum H	Dance Snare H Hard
53	F 2 41	F 1	Floor Tom L	<—	Room Floor Tom L	Rock Floor Tom L	Elec. Floor Tom L	Dance Floor Tom L
54	F# 2 42	F# 1	Hi-Hat Closed	<—	<—	<—	<—	Jazz Floor Tom L
55	G 2 43	G 1	Floor Tom H	<—	Room Floor Tom H	Rock Floor Tom H	Elec. Floor Tom H	Dance Floor Tom H
56	G# 2 44	G# 1	Hi-Hat Pedal	<—	<—	<—	<—	Jazz Floor Tom H
57	A 2 45	A 1	Low Tom	<—	Room Low Tom	Rock Low Tom	Elec. Low Tom	Dance Low Tom
58	A# 2 46	A# 1	Hi-Hat Open	<—	<—	<—	<—	Jazz Low Tom
59	B 2 47	B 1	Mid Tom L	<—	Room Mid Tom L	Rock Mid Tom L	Elec. Mid Tom L	Dance Mid Tom L
60	C 3 48	C 2	Mid Tom H	<—	Room Mid Tom H	Rock Mid Tom H	Elec. Mid Tom H	Dance Mid Tom H
61	C# 3 49	C# 2	Crash Cymbal 1	<—	<—	<—	<—	Jazz Mid Tom H
62	D 3 50	D 2	High Tom	<—	Room High Tom	Rock High Tom	Elec. High Tom	Dance Cymbal
63	D# 3 51	D# 2	Ride Cymbal 1	<—	<—	<—	<—	Jazz Cymbal 1
64	E 3 52	E 2	Chinese Cymbal	<—	<—	<—	<—	Crash Cymbal 1
65	F 3 53	F 2	Ride Cymbal Cup	<—	<—	<—	<—	Chinese Cymbal
66	F# 3 54	F# 2	Tambourine	<—	<—	<—	<—	Ride Cymbal Cup
67	G 3 55	G 2	Splash Cymbal	<—	<—	<—	<—	Tambourine
68	G# 3 56	G# 2	Cowbell	<—	<—	<—	<—	Splash Cymbal
69	A 3 57	A 2	Crash Cymbal 2	<—	<—	<—	<—	Cowbell
70	A# 3 58	A# 2	Vibraslap	<—	<—	<—	<—	Dance Cowbell
71	B 3 59	B 2	Ride Cymbal 2	<—	<—	<—	<—	Jazz Cowbell
72	C 4 60	C 3	Bongo H	<—	<—	<—	<—	Crash Cymbal 2
73	C# 4 61	C# 3	Bongo L	<—	<—	<—	<—	Ride Cymbal 2
74	D 4 62	D 3	Conga H Mute	<—	<—	<—	<—	Bongo H
75	D# 4 63	D# 3	Conga H Open	<—	<—	<—	<—	Bongo L
76	E 4 64	E 3	Conga L	<—	<—	<—	<—	Dance Conga H Mute
77	F 4 65	F 3	Timbale H	<—	<—	<—	<—	Dance Conga H Open
78	F# 4 66	F# 3	Timbale L	<—	<—	<—	<—	Jazz Conga H Open
79	G 4 67	G 3	Agogo H	<—	<—	<—	<—	Dance Conga L
80	G# 4 68	G# 3	Agogo L	<—	<—	<—	<—	Jazz Conga L
81	A 4 69	A 3	Cabasa	<—	<—	<—	<—	Timbale H
82	A# 4 70	A# 3	Maracas	<—	<—	<—	<—	Timbale L
83	B 4 71	B 3	Samba Whistle H	<—	<—	<—	<—	Agogo H
84	C 5 72	C 4	Samba Whistle L	<—	<—	<—	<—	Agogo L
85	C# 5 73	C# 4	Guiro Short	<—	<—	<—	<—	Cabasa
86	D 5 74	D 4	Guiro Long	<—	<—	<—	<—	Maracas
87	D# 5 75	D# 4	Claves	<—	<—	<—	<—	Samba Whistle H
88	E 5 76	E 4	Wood Block H	<—	<—	<—	<—	Samba Whistle L
89	F 5 77	F 4	Wood Block L	<—	<—	<—	<—	Guiro Short
90	F# 5 78	F# 4	Cuica Mute	<—	<—	<—	<—	Guiro Long
91	G 5 79	G 4	Cuica Open	<—	<—	<—	<—	Claves
92	G# 5 80	G# 4	Triangle Mute	<—	<—	<—	<—	Wood Block H
93	A 5 81	A 4	Triangle Open	<—	<—	<—	<—	Wood Block L
94	A# 5 82	A# 4	Shaker	<—	<—	<—	<—	Cuica Mute
95	B 5 83	B 4	Jingle Bell	<—	<—	<—	<—	Cuica Open
96	C 6 84	C 5	Bell Tree	<—	<—	<—	<—	Triangle Mute
97	C# 6 85	C# 5						Triangle Open
98	D 6 86	D 5						Shaker
99	D# 6 87	D# 5						Jingle Bell
100	E 6 88	E 5						Bell Tree
101	F 6 89	F 5						Cuica Mute
102	F# 6 90	F# 5						Cuica Open
103	G 6 91	G 5						Triangle Mute
104	G# 6 92	G# 5						Triangle Open

Program Change No.	120	121	122	123	124	125	126	127
Keyboard	Pad Standard 1	Pad Standard 2	Pad Room	Pad Rock	Pad Electronic	Pad Dance	Pad Jazz	Pad Stereo & Latin
MIDI								
25	C# 0 13	C# -1	<=>	<=>	<=>	<=>	<=>	<=>
26	D 0 14	D -1	<=>	<=>	<=>	<=>	<=>	<=>
27	D# 0 15	D# -1	<=>	<=>	<=>	<=>	<=>	<=>
28	E 0 16	E -1	<=>	<=>	<=>	<=>	<=>	<=>
29	F 0 17	F -1	<=>	<=>	<=>	<=>	<=>	<=>
30	F# 0 18	F# -1	<=>	<=>	<=>	<=>	<=>	<=>
31	G 0 19	G -1	<=>	<=>	<=>	<=>	<=>	<=>
32	G# 0 20	G# -1	<=>	<=>	<=>	<=>	<=>	<=>
33	A 0 21	A -1	<=>	<=>	<=>	<=>	<=>	<=>
34	A# 0 22	A# -1	<=>	<=>	<=>	<=>	<=>	<=>
35	B 0 23	B -1	<=>	<=>	<=>	<=>	<=>	<=>
36	C 1 24	C 0	<=>	<=>	<=>	<=>	<=>	<=>
37	C# 1 25	C# 0	Brush Tap	<=>	<=>	<=>	<=>	Brush Tap
38	D 1 26	D 0	(Brush Swirl)	<=>	<=>	<=>	<=>	(Brush Swirl)
39	D# 1 27	D# 0	Brush Slap	<=>	<=>	<=>	<=>	Brush Slap
40	E 1 28	E 0	(Brush Tap Swirl)	<=>	<=>	<=>	<=>	(Brush Tap Swirl)
41	F 1 29	F 0	(Snare Roll)	<=>	<=>	<=>	<=>	(Snare Roll)
42	F# 1 30	F# 0	<=>	<=>	<=>	<=>	<=>	<=>
43	G 1 31	G 0	Snare H Soft	Snare H Soft 2	Room Snare H Soft	Rock Snare H	Snare L	Dance Snare Snappy
44	G# 1 32	G# 0	<=>	<=>	<=>	<=>	<=>	<=>
45	A 1 33	A 0	Bass Drum Soft	<=>	<=>	Rock Bass Drum Soft	<=>	Dance Bass Drum Soft
46	A# 1 34	A# 0	Open Rim Shot	Open Rim Shot 2	Room Open Rim Shot	<=>	<=>	Dance Open Rim Shot
47	B 1 35	B 0	Bass Drum Hard	<=>	<=>	Rock Bass Drum Hard	Elec. Bass Drum Hard	Dance Bass Drum Hard
48	C 2 36	C 1	Bass Drum	Bass Drum 2	Room Bass Drum	Rock Bass Drum	Elec. Bass Drum	Dance Bass Drum
49	C# 2 37	C# 1	Side Sticks	Side Sticks 2	Room Side Sticks	<=>	<=>	Dance Side Sticks
50	D 2 38	D 1	Snare M	Snare M 2	Room Snare M	Rock Snare M	Elec. Snare Drum M	Dance Snare M
51	D# 2 39	D# 1	<=>	<=>	<=>	<=>	<=>	<=>
52	E 2 40	E 1	Snare H Hard	Snare H Hard 2	Room Snare H Hard	Rock Snare H Hard	Elec. Snare Drum H	Dance Snare H Hard
53	F 2 41	F 1	Floor Tom L	<=>	Room Floor Tom L	Rock Floor Tom L	Elec. Floor Tom L	Dance Floor Tom L
54	F# 2 42	F# 1	Hi-Hat Closed	<=>	<=>	<=>	<=>	Dance Hi-Hat Closed
55	G 2 43	G 1	Floor Tom H	<=>	Room Floor Tom H	Rock Floor Tom H	Elec. Floor Tom H	Dance Floor Tom H
56	G# 2 44	G# 1	Hi-Hat Pedal	<=>	<=>	<=>	<=>	Dance Hi-Hat Pedal
57	A 2 45	A 1	Low Tom	<=>	Room Low Tom	Rock Low Tom	Elec. Low Tom	Dance Low Tom
58	A# 2 46	A# 1	Hi-Hat Open	<=>	<=>	<=>	<=>	Dance Hi-Hat Open
59	B 2 47	B 1	Mid Tom L	<=>	Room Mid Tom L	Rock Mid Tom L	Elec. Mid Tom L	Dance Mid Tom L
60	C 3 48	C 2	Mid Tom H	<=>	Room Mid Tom H	Rock Mid Tom H	Elec. Mid Tom H	Dance Mid Tom H
61	C# 3 49	C# 2	Crash Cymbal 1	<=>	<=>	<=>	<=>	Dance Cymbal
62	D 3 50	D 2	High Tom	<=>	Room High Tom	Rock High Tom	Elec. High Tom	Dance High Tom
63	D# 3 51	D# 2	Ride Cymbal 1	<=>	<=>	<=>	<=>	<=>
64	E 3 52	E 2	Chinese Cymbal	<=>	<=>	<=>	<=>	<=>
65	F 3 53	F 2	Ride Cymbal Cup	<=>	<=>	<=>	<=>	<=>
66	F# 3 54	F# 2	Tambourine	<=>	<=>	<=>	<=>	<=>
67	G 3 55	G 2	Splash Cymbal	<=>	<=>	<=>	<=>	<=>
68	G# 3 56	G# 2	Cowbell	<=>	<=>	<=>	<=>	Dance Cowbell
69	A 3 57	A 2	Crash Cymbal 2	<=>	<=>	<=>	<=>	<=>
70	A# 3 58	A# 2	<=>	<=>	<=>	<=>	<=>	<=>
71	B 3 59	B 2	Ride Cymbal 2	<=>	<=>	<=>	<=>	<=>
72	C 4 60	C 3	Bongo H	<=>	<=>	<=>	<=>	<=>
73	C# 4 61	C# 3	Bongo L	<=>	<=>	<=>	<=>	<=>
74	D 4 62	D 3	Conga H Close	<=>	<=>	<=>	<=>	Dance Conga H Mute
75	D# 4 63	D# 3	Conga H Open	<=>	<=>	<=>	<=>	Jazz Conga H Open
76	E 4 64	E 3	Conga L	<=>	<=>	<=>	<=>	Dance Conga L
77	F 4 65	F 3	Timbale H	<=>	<=>	<=>	<=>	<=>
78	F# 4 66	F# 3	Timbale L	<=>	<=>	<=>	<=>	<=>
79	G 4 67	G 3	<=>	<=>	<=>	<=>	<=>	<=>
80	G# 4 68	G# 3	<=>	<=>	<=>	<=>	<=>	<=>
81	A 4 69	A 3	Cabasa	<=>	<=>	<=>	<=>	<=>
82	A# 4 70	A# 3	Maracas	<=>	<=>	<=>	<=>	<=>
83	B 4 71	B 3	(Samba Whistle H)	<=>	<=>	<=>	<=>	<=>
84	C 5 72	C 4	(Samba Whistle L)	<=>	<=>	<=>	<=>	<=>
85	C# 5 73	C# 4	Guiro Short	<=>	<=>	<=>	<=>	<=>
86	D 5 74	D 4	<=>	<=>	<=>	<=>	<=>	<=>
87	D# 5 75	D# 4	<=>	<=>	<=>	<=>	<=>	<=>
88	E 5 76	E 4	<=>	<=>	<=>	<=>	<=>	<=>
89	F 5 77	F 4	<=>	<=>	<=>	<=>	<=>	<=>
90	F# 5 78	F# 4	<=>	<=>	<=>	<=>	<=>	<=>
91	G 5 79	G 4	<=>	<=>	<=>	<=>	<=>	<=>
92	G# 5 80	G# 4	<=>	<=>	<=>	<=>	<=>	<=>
93	A 5 81	A 4	<=>	<=>	<=>	<=>	<=>	<=>
94	A# 5 82	A# 4	Shaker	<=>	<=>	<=>	<=>	<=>
95	B 5 83	B 4	<=>	<=>	<=>	<=>	<=>	<=>
96	C 6 84	C 5	<=>	<=>	<=>	<=>	<=>	<=>
97	C# 6 85	C# 5	<=>	<=>	<=>	<=>	<=>	<=>
98	D 6 86	D 5	<=>	<=>	<=>	<=>	<=>	<=>
99	D# 6 87	D# 5	<=>	<=>	<=>	<=>	<=>	<=>
100	E 6 88	E 5	<=>	<=>	<=>	<=>	<=>	<=>
101	F 6 89	F 5	<=>	<=>	<=>	<=>	<=>	<=>
102	F# 6 90	F# 5	<=>	<=>	<=>	<=>	<=>	<=>
103	G 6 91	G 5	<=>	<=>	<=>	<=>	<=>	<=>
104	G# 6 92	G# 5	<=>	<=>	<=>	<=>	<=>	<=>



# GM Voice List.....

(MSB=000, LSB=000)

Program Change No.	Voice Name
000	Grand Piano
001	Bright Piano
002	ElecGrandPno
003	Honkytonk
004	El.Piano 1
005	El.Piano 2
006	Harpichord
007	Clavi.
008	Celesta
009	Glockenspiel
010	Music Box
011	Vibraphone
012	Marimba
013	Xylophone
014	TubularBells
015	Dulcimer
016	DrawbarOrgan
017	Perc.Organ
018	Rock Organ
019	Church Organ
020	Reed Organ
021	Accordion
022	Harmonica
023	Tango Accord
024	Nylon Guitar
025	Steel Guitar
026	Jazz Guitar
027	Clean Guitar
028	Muted Guitar
029	Overdriven
030	Distortion
031	GtrHarmonics
032	AcousticBass
033	Finger Bass
034	Pick Bass
035	FretlessBass
036	Slap Bass 1
037	Slap Bass 2
038	Synth Bass 1
039	Synth Bass 2
040	Violin
041	Viola
042	Cello
043	Contrabass
044	Trem.Strings
045	PizzicatoStr
046	Orch.Harp
047	Timpani

Program Change No.	Voice Name
048	Strings 1
049	Strings 2
050	SynStrings1
051	SynStrings2
052	Choir Aahs
053	Voice Oohs
054	Synth Voice
055	OrchestraHit
056	Trumpet
057	Trombone
058	Tuba
059	MutedTrumpet
060	French Horn
061	BrassSection
062	SynthBrass1
063	SynthBrass2
064	Soprano Sax
065	Alto Sax
066	Tenor Sax
067	Baritone Sax
068	Oboe
069	English Horn
070	Bassoon
071	Clarinet
072	Piccolo
073	Flute
074	Recorder
075	Pan Flute
076	Blown Bottle
077	Shakuhachi
078	Whistle
079	Ocarina
080	Square Lead
081	SawtoothLead
082	CalliopeLead
083	Chiff Lead
084	Charang Lead
085	Voice Lead
086	Fifths Lead
087	Bass & Lead
088	New Age Pad
089	Warm Pad
090	PolySynthPad
091	Choir Pad
092	Bowed Pad
093	Metallic Pad
094	Halo Pad
095	Sweep Pad

Program Change No.	Voice Name
096	Rain
097	Sound Track
098	Crystal
099	Atmosphere
100	Brightness
101	Goblins
102	Echoes
103	Sci-Fi
104	Sitar
105	Banjo
106	Shamisen
107	Koto
108	Kalimba
109	Bagpipe
110	Fiddle
111	Shanai
112	Tinkle Bell
113	Agogo
114	Steel Drums
115	Woodblock
116	Taiko Drum
117	Melodic Tom
118	Synth Drum
119	Rev.Cymbal
120	GtrFretNoise
121	Breath Noise
122	Seashore
123	Bird Tweet
124	TelephonRing
125	Helicopter
126	Applause
127	Gunshot



YAMAHA [ DIGITAL PERCUSSION ]  
 Model DD-55 MIDI Implementation Chart

Date:07-FEB-2001  
 Version : 1.0

Function...	Transmitted	Recognized	Remarks
Basic Default Channel Changed	10 - 16 1 - 16	1 - 16 1 - 16	
Mode Default Messages Altered	3 x *****	3 x x	
Note Number : True voice	0 - 127 *****	13 - 96 13 - 96	
Velocity Note ON Note OFF	o 9nH,v=1-127 o 9nH,v=0	o 9nH,v=1-127 o 9nH,v=0	
After Key's Touch Ch's	x x	x x	
Pitch Bend	o *3	o	
Control Change	0,32 o 1 o *3 6,38 o *3 7 o 10 o *1 11 o 64 o *3 71 o *3 72 o *3 73 o *3 84 o *3 91 o 93 o *3 94 o *3 96,97 o *3 100,101 o *3	o o o o o o o o o o o o o o o o o o o o	Bank Select Modulation Data Entry Volume Pan Expression Sustain Harmonic Content Release Time Brightness Portament Cntrl Reverb Depth Chorus Depth Variation Depth Data Inc,Dec RPN LSB,MSB
Prog Change : True #	o *****	o 0 - 127	
System Exclusive	o *4	o *4	
: Song Pos. Common : Song Sel. : Tune	x x x	x x x	
System : Clock Real Time: Commands	o o	o o *2	
Aux :All Sound OFF :Reset All Cntrls :Local ON/OFF :All Notes OFF Mes- :Active Sense sages:Reset	x x x x o x	o(120) o(121) x x o x	

Mode 1 : OMNI ON , POLY      Mode 2 : OMNI ON , MONO      o : Yes  
 Mode 3 : OMNI OFF, POLY      Mode 4 : OMNI OFF, MONO      x : No

**NOTE:**

- \*1 Value of Pan for each drum pad and foot pedal is not transmitted via MIDI.
- \*2 The DD-55 can accept Start/Stop signals, received via MIDI, by setting the MIDI clock to "External".
- \*3 This data is transmitted only when it is contained in the song data.
- \*4 Exclusive
- <GM System ON> F0H, 7EH, 7FH, 09H, 01H, F7H
- This message automatically restores all default settings for the instrument, with the exception of MIDI Master Tuning.
- <MIDI Master Volume> F0H, 7FH, 7FH, 04H, 01H, II, mm, F7H
- This message allows the volume of all channels to be changed simultaneously (Universal System Exclusive).
  - The values of "mm" is used for MIDI Master Tuning. (Values for "II" are ignored.)
- <Reverb Type> F0H, 43H, 1nH, 4CH, 02H, 01H, 00H, mmH, IIH, F7H
- mm : Reverb Type MSB
  - II : Reverb Type LSB
- Refer to the Effect Map (page 43) for details.
- <Chorus Type> F0H, 43H, 1nH, 4CH, 02H, 01H, 20H, mmH, IIH, F7H
- mm : Chorus Type MSB
  - II : Chorus Type LSB
- Refer to the Effect Map (page 43) for details.
- <DSP Type> F0H, 43H, 1nH, 4CH, 02H, 01H, 40H, mmH, IIH, F7H
- mm : DSP Type MSB
  - II : DSP Type LSB
- Refer to the Effect Map (page 43) for details.
- <DRY Level> F0H, 43H, 1nH, 4CH, 08H, 0mH, 11H, IIH, F7H
- II : Dry Level
  - 0m : Channel Number
- \*5 Recording to an external sequencer from the DD-55 and playing back the data may result in selection of a different Reverb effect or a different kit.
- Sending MIDI data from the DD-55 to an external tone generator may result in an unexpected voice, particularly if the tone generator doesn't have the same kind of voice as the DD-55.

## ■ Effect map

- \* If the received value does not contain an effect type in the TYPE LSB, the LSB will be directed to TYPE 0.
- \* The numbers in parentheses in front of the Effect Type names correspond to the number indicated in the display.
- \* By using an external sequencer, which is capable of editing and transmitting the system exclusive messages and parameter changes, you can select the Reverb, Chorus and DSP effect types which are not accessible from the DD-55 panel itself.

### ● REVERB

TYPE MSB	TYPE LSB								
	00	01	02	08	16	17	18	19	20
000	No Effect								
001	(1)Hall1					(2)Hall2			
002	Room					(3)Room1		(4)Room2	
003	Stage				(5)Stage1	(6)Stage2			
004	Plate				(7)Plate1	(8)Plate2			
005...127	No Effect								

### ● CHORUS

TYPE MSB	TYPE LSB								
	00	01	02	08	16	17	18	19	20
000...064	No Effect								
065	Chorus		Chorus2						
066	Celeste					Chorus1			
067	Flanger			Flanger1		Flanger2			
068...127	No Effect								

### ● DSP

TYPE MSB	TYPE LSB								
	00	01	02	08	16	17	18	19	20
000	No Effect								
001	(1)Hall1					(2)Hall2			
002	Room					(3)Room1		(4)Room2	
003	Stage				(5)Stage1	(6)Stage2			
004	Plate				(7)Plate1	(8)Plate2			
005	Delay L,C,R				(26)Delay L,C,R				
006	(27)Delay L,R								
007	(28)Echo								
008	(29)Cross Delay								
009	(9)Early Reflection1	(10)Early Reflection2							
010	(11)Gate Reverb								
011	(12)Reverse Gate								
012...019	No Effect								
020	(30)Karaoke								
021...064	No Effect								
065	Chorus		(14)Chorus2						
066	Celeste					(13)Chorus1			
067	Flanger			(15)Flanger1		(16)Flanger2			
068	Symphonic				(17)Symphonic				
069	Rotary Speaker				(19)Rotary Speaker1				
070	Tremolo				(21)Tremolo1				
071	Auto Pan				(24)Auto Pan		(20)Rotary Speaker2	(22)Tremolo2	(23)Guitar Tremolo
072	(18)Phaser								
073	Distortion								
074	(33)Overdrive								
075	(34)Amp Simulation				(31)Distortion Hard	(32)Distortion Soft			
076	(36)3Band EQ					(35)EQ Telephone			
077	(37)2Band EQ								
078	Auto Wah				(25)Auto Wah				
079...127	No Effect								

## Specifications .....

### Drum Pads

7 pads (125mm x 4, 88mm x 3), Touch Sensitive

### Maximum Polyphony

32

### Drum Kits

45 Preset +1 Custom

### Songs

100

### Tracks

4 (DRUM 1/DRUM 2/DRUM 3/BACKING)

### Custom Song

1 Song (approximately 20,000 notes)

### Voices

Drum Voices 192 + GM Voices 128 + Drum Kits 8

### Functions

Track ON/OFF, TAP START, BREAK, A-B REPEAT, DEMO

### Panel Controls

[STANDBY/ON] switch, [PAD] button, [KIT] button, [SONG] button, [TEMPO] button, VOLUME [▲], [▼] buttons, [HAND PERC] button, TRACK (DRUM 1/DRUM 2/DRUM 3/BACKING) button, [DEMO] button, [CLICK] button, [START/STOP] button, [A-B REPEAT] button, [BREAK/TAP] button, [REC] button, DIAL

### LED Display

Song/Drum Kit/Tempo etc.

### Auxiliary jacks

DC IN12 V, PHONES/OUTPUT, MIDI IN/OUT, PEDAL 1/2

### Main Amplifier

5W + 5W

### Speaker

8 cm x 2

### Power Consumption

16 W

### Power Supply

Adaptor : DC12V (Yamaha PA-5D or PA-5C sold separately)

Batteries: Six "C" size, R14P (LR14), or equivalent batteries (sold separately)

### Dimensions (WxDxH)

558 x 355 x 174 mm (22" x 14" x 6" 7/8)

### Weight

3.9 kg (8 lbs. 10 oz)

### Supplied Accessories

Drum Stick x 2, Foot Pedal 1 & 2, Owner's Manual

### Optional Accessories

Headphones HPE-150

USB-MIDI Interface UX16

\* Specifications and descriptions in this owner's manual are for information purposes only. Yamaha Corp. reserves the right to change or modify products or specifications at any time without prior notice. Since specifications, equipment or options may not be the same in every locale, please check with your Yamaha dealer.

# Limited Warranty

**90 DAYS LABOR**

**1 YEAR PARTS**

Yamaha Corporation of America, hereafter referred to as Yamaha, warrants to the original consumer of a product included in the categories listed below, that the product will be free of defects in materials and/or workmanship for the periods indicated. This warranty is applicable to all models included in the following series of products:

## **DD SERIES OF DIGITAL PERCUSSION**

If during the first 90 days that immediately follows the purchase date, your new Yamaha product covered by this warranty is found to have a defect in material and/or workmanship, Yamaha and/or its authorized representative will repair such defect without charge for parts or labor.

If parts should be required after this 90 day period but within the one year period that immediately follows the purchase date, Yamaha will, subject to the terms of this warranty, supply these parts without charge. However, charges for labor, and/or any miscellaneous expenses incurred are the consumers responsibility. Yamaha reserves the right to utilize reconditioned parts in repairing these products and/or to use reconditioned units as warranty replacements.

**THIS WARRANTY IS THE ONLY EXPRESS WARRANTY WHICH YAMAHA MAKES IN CONNECTION WITH THESE PRODUCTS. ANY IMPLIED WARRANTY APPLICABLE TO THE PRODUCT, INCLUDING THE WARRANTY OF MERCHANT ABILITY IS LIMITED TO THE DURATION OF THE EXPRESS WARRANTY. YAMAHA EXCLUDES AND SHALL NOT BE LIABLE IN ANY EVENT FOR INCIDENTAL OR CONSEQUENTIAL DAMAGES.**

Some states do not allow limitations that relate to implied warranties and/or the exclusion of incidental or consequential damages. Therefore, these limitations and exclusions may not apply to you.

This warranty gives you specific legal rights. You may also have other rights which vary from state to state.

## **CONSUMERS RESPONSIBILITIES**

If warranty service should be required, it is necessary that the consumer assume certain responsibilities:

1. Contact the Customer Service Department of the retailer selling the product, or any retail outlet authorized by Yamaha to sell the product for assistance. You may also contact Yamaha directly at the address provided below.
2. Deliver the unit to be serviced under warranty to: the retailer selling the product, an authorized service center, or to Yamaha with an explanation of the problem. Please be prepared to provide proof purchase date (sales receipt, credit card copy, etc.) when requesting service and/or parts under warranty.
3. Shipping and/or insurance costs are the consumers responsibility.\* Units shipped for service should be packed securely.

\*Repaired units will be returned PREPAID if warranty service is required within the first 90 days.

**IMPORTANT:** Do NOT ship anything to ANY location without prior authorization. A Return Authorization (RA) will be issued that has a tracking number assigned that will expedite the servicing of your unit and provide a tracking system if needed.

4. Your owners manual contains important safety and operating instructions. It is your responsibility to be aware of the contents of this manual and to follow all safety precautions.

## **EXCLUSIONS**

This warranty does not apply to units whose trade name, trademark, and/or ID numbers have been altered, defaced, exchanged removed, or to failures and/or damages that may occur as a result of:

1. Neglect, abuse, abnormal strain, modification or exposure to extremes in temperature or humidity.
2. Improper repair or maintenance by any person who is not a service representative of a retail outlet authorized by Yamaha to sell the product, an authorized service center, or an authorized service representative of Yamaha.
3. This warranty is applicable only to units sold by retailers authorized by Yamaha to sell these products in the U.S.A., the District of Columbia, and Puerto Rico. This warranty is not applicable in other possessions or territories of the U.S.A. or in any other country.

Please record the model and serial number of the product you have purchased in the spaces provided below.

Model \_\_\_\_\_ Serial # \_\_\_\_\_ Sales Slip # \_\_\_\_\_

Purchased from \_\_\_\_\_ Date \_\_\_\_\_  
(Retailer)

**YAMAHA CORPORATION OF AMERICA**  
**Electronic Service Division**  
**6600 Orangethorpe Avenue**  
**Buena Park, CA 90620**

**KEEP THIS DOCUMENT FOR YOUR RECORDS. DO NOT MAIL!**

For details of products, please contact your nearest Yamaha representative or the authorized distributor listed below.

Pour plus de détails sur les produits, veuillez-vous adresser à Yamaha ou au distributeur le plus proche de vous figurant dans la liste suivante.

Die Einzelheiten zu Produkten sind bei Ihrer unten aufgeführten Niederlassung und bei Yamaha Vertragshändlern in den jeweiligen Bestimmungsländern erhältlich.

Para detalles sobre productos, contacte su tienda Yamaha más cercana o el distribuidor autorizado que se lista debajo.

## NORTH AMERICA

### CANADA

**Yamaha Canada Music Ltd.**  
135 Milner Avenue, Scarborough, Ontario,  
M1S 3R1, Canada  
Tel: 416-298-1311

### U.S.A.

**Yamaha Corporation of America**  
6600 Orangethorpe Ave., Buena Park, Calif. 90620,  
U.S.A.  
Tel: 714-522-9011

## CENTRAL & SOUTH AMERICA

### MEXICO

**Yamaha de México S.A. de C.V.**  
Calz. Javier Rojo Gómez #1149,  
Col. Guadalupe del Moral  
C.P. 09300, México, D.F., México  
Tel: 55-5804-0600

### BRAZIL

**Yamaha Musical do Brasil Ltda.**  
Av. Reboucas 2636-Pinheiros CEP: 05402-400  
Sao Paulo-SP, Brasil  
Tel: 011-3085-1377

### ARGENTINA

**Yamaha Music Latin America, S.A.**  
**Sucursal de Argentina**  
Viamonte 1145 Piso2-B 1053,  
Buenos Aires, Argentina  
Tel: 1-4371-7021

### PANAMA AND OTHER LATIN AMERICAN COUNTRIES/ CARIBBEAN COUNTRIES

**Yamaha Music Latin America, S.A.**  
Torre Banco General, Piso 7, Urbanización Marbella,  
Calle 47 y Aquilino de la Guardia,  
Ciudad de Panamá, Panamá  
Tel: +507-269-5311

## EUROPE

### THE UNITED KINGDOM

**Yamaha-Kemble Music (U.K.) Ltd.**  
Sherbourne Drive, Tilbrook, Milton Keynes,  
MK7 8BL, England  
Tel: 01908-366700

### IRELAND

**Danfay Ltd.**  
61D, Sallynoggin Road, Dun Laoghaire, Co. Dublin  
Tel: 01-2859177

### GERMANY

**Yamaha Music Central Europe GmbH**  
Siemensstraße 22-34, 25462 Rellingen, Germany  
Tel: 04101-3030

### SWITZERLAND/LIECHTENSTEIN

**Yamaha Music Central Europe GmbH,**  
**Branch Switzerland**  
Seefeldstrasse 94, 8008 Zürich, Switzerland  
Tel: 01-383 3990

### AUSTRIA

**Yamaha Music Central Europe GmbH,**  
**Branch Austria**  
Schleiergasse 20, A-1100 Wien, Austria  
Tel: 01-60203900

### THE NETHERLANDS

**Yamaha Music Central Europe,**  
**Branch Nederland**  
Clarissenhof 5-b, 4133 AB Vianen, The Netherlands  
Tel: 0347-358 040

## BELGIUM/LUXEMBOURG

**Yamaha Music Central Europe GmbH,**  
**Branch Belgium**  
Rue de Geneve (Genevastraat) 10, 1140 - Brussels,  
Belgium  
Tel: 02-726 6032

## FRANCE

**Yamaha Musique France**  
BP 70-77312 Marne-la-Vallée Cedex 2, France  
Tel: 01-64-61-4000

## ITALY

**Yamaha Musica Italia S.P.A.**  
Viale Italia 88, 20020 Lainate (Milano), Italy  
Tel: 02-935-771

## SPAIN/PORTUGAL

**Yamaha-Hazen Música, S.A.**  
Ctra. de la Coruna km. 17, 200, 28230  
Las Rozas (Madrid), Spain  
Tel: 91-639-8888

## GREECE

**Philippou Nakas S.A. The Music House**  
147 Skiathou Street, 112-55 Athens, Greece  
Tel: 01-228 2160

## SWEDEN

**Yamaha Scandinavia AB**  
J. A. Wettergrens Gata 1  
Box 30053  
S-400 43 Göteborg, Sweden  
Tel: 031 89 34 00

## DENMARK

**YS Copenhagen Liaison Office**  
Generatorvej 8B  
DK-2730 Herlev, Denmark  
Tel: 44 92 49 00

## FINLAND

**F-Musiikki Oy**  
Kluuvikatu 6, P.O. Box 260,  
SF-00101 Helsinki, Finland  
Tel: 09 618511

## NORWAY

**Norsk filial av Yamaha Scandinavia AB**  
Grini Næringspark 1  
N-1345 Østerås, Norway  
Tel: 67 16 77 70

## ICELAND

**Skifan HF**  
Skeifan 17 P.O. Box 8120  
IS-128 Reykjavik, Iceland  
Tel: 525 5000

## OTHER EUROPEAN COUNTRIES

**Yamaha Music Central Europe GmbH**  
Siemensstraße 22-34, 25462 Rellingen, Germany  
Tel: +49-4101-3030

## AFRICA

**Yamaha Corporation,**  
**Asia-Pacific Music Marketing Group**  
Nakazawa-cho 10-1, Hamamatsu, Japan 430-8650  
Tel: +81-53-460-2312

## MIDDLE EAST

### TURKEY/CYPRUS

**Yamaha Music Central Europe GmbH**  
Siemensstraße 22-34, 25462 Rellingen, Germany  
Tel: 04101-3030

### OTHER COUNTRIES

**Yamaha Music Gulf FZE**  
LB21-128 Jebel Ali Freezone  
P.O.Box 17328, Dubai, U.A.E.  
Tel: +971-4-881-5868

## ASIA

### THE PEOPLE'S REPUBLIC OF CHINA

**Yamaha Music & Electronics (China) Co.,Ltd.**  
25/F., United Plaza, 1468 Nanjing Road (West),  
Jingan, Shanghai, China  
Tel: 021-6247-2211

### HONG KONG

**Tom Lee Music Co., Ltd.**  
11/F., Silvercord Tower 1, 30 Canton Road,  
Tsimshatsui, Kowloon, Hong Kong  
Tel: 2737-7688

### INDONESIA

**PT. Yamaha Music Indonesia (Distributor)**  
**PT. Nusantik**  
Gedung Yamaha Music Center, Jalan Jend. Gatot  
Subroto Kav. 4, Jakarta 12930, Indonesia  
Tel: 21-520-2577

### KOREA

**Yamaha Music Korea Ltd.**  
Tong-Yang Securities Bldg. 16F 23-8 Yoido-dong,  
Yongdungpo-ku, Seoul, Korea  
Tel: 02-3770-0660

### MALAYSIA

**Yamaha Music Malaysia, Sdn., Bhd.**  
Lot 8, Jalan Perbandaran, 47301 Kelana Jaya,  
Petaling Jaya, Selangor, Malaysia  
Tel: 3-78030900

### PHILIPPINES

**Yupango Music Corporation**  
339 Gil J. Puyat Avenue, P.O. Box 885 MCPO,  
Makati, Metro Manila, Philippines  
Tel: 819-7551

### SINGAPORE

**Yamaha Music Asia Pte., Ltd.**  
#03-11 A-Z Building  
140 Paya Lebar Road, Singapore 409015  
Tel: 747-4374

### TAIWAN

**Yamaha KHS Music Co., Ltd.**  
3F, #6, Sec.2, Nan Jing E. Rd. Taipei.  
Taiwan 104, R.O.C.  
Tel: 02-2511-8688

### THAILAND

**Siam Music Yamaha Co., Ltd.**  
891/1 Siam Motors Building, 15-16 floor  
Rama 1 road, Wangmai, Pathumwan  
Bangkok 10330, Thailand  
Tel: 02-215-2626

### OTHER ASIAN COUNTRIES

**Yamaha Corporation,**  
**Asia-Pacific Music Marketing Group**  
Nakazawa-cho 10-1, Hamamatsu, Japan 430-8650  
Tel: +81-53-460-2317

## OCEANIA

### AUSTRALIA

**Yamaha Music Australia Pty. Ltd.**  
Level 1, 99 Queensbridge Street, Southbank,  
Victoria 3006, Australia  
Tel: 3-9693-5111

### NEW ZEALAND

**Music Houses of N.Z. Ltd.**  
146/148 Captain Springs Road, Te Papapa,  
Auckland, New Zealand  
Tel: 9-634-0099

### COUNTRIES AND TRUST TERRITORIES IN PACIFIC OCEAN

**Yamaha Corporation,**  
**Asia-Pacific Music Marketing Group**  
Nakazawa-cho 10-1, Hamamatsu, Japan 430-8650  
Tel: +81-53-460-2312

**HEAD OFFICE** Yamaha Corporation, Pro Audio & Digital Musical Instrument Division  
Nakazawa-cho 10-1, Hamamatsu, Japan 430-8650  
Tel: +81-53-460-3273



Yamaha PK CLUB (Portable Keyboard Home Page, English only)  
<http://www.yamahaPKclub.com/>

Yamaha Manual Library  
<http://www2.yamaha.co.jp/manual/english/>

U.R.G., Pro Audio & Digital Musical Instrument Division, Yamaha Corporation  
© 2004 Yamaha Corporation

WD47990 ???PO???.?-01A0 Printed in Malaysia