



**DTX**  
drums

ELECTRONIC DRUM KIT

**DTX400K**  
**DTX430K**  
**DTX450K**

**Owner's Manual**

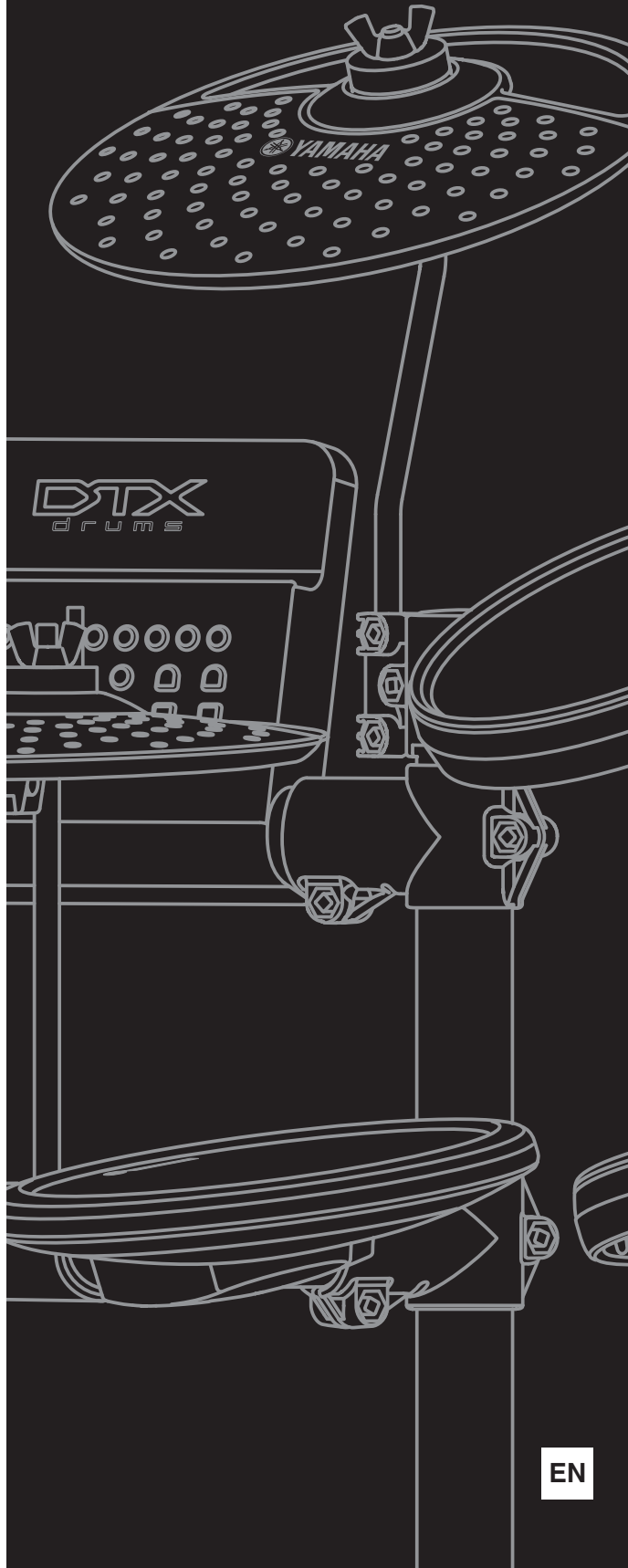

# Contents

<b>PRECAUTIONS</b> .....	<b>4</b>
<b>Welcome</b> .....	<b>6</b>
<b>Product Manuals</b> .....	<b>6</b>

## Setup

<b>First Steps</b> .....	<b>7</b>
<b>Package Contents</b> .....	<b>8</b>
<b>Assembly Guide</b> .....	<b>11</b>
<b>Setting Up for Sound</b> .....	<b>19</b>
Connecting the Power.....	19
Connecting Headphones or Speakers .....	19
Connecting a Music Player .....	19
Turning On the Drum Module.....	20
Turning Off the Drum Module.....	20
Auto Power-Off .....	20
Restoring the Default Settings (Factory Set) ...	20
<b>Component Names &amp; Functions</b> .....	<b>21</b>
Control Panel .....	21
Left Side.....	22
Right Side .....	22

## Basic Techniques

<b>Selecting &amp; Playing a Kit</b> .....	<b>23</b>
Selecting a Kit.....	23
Adjusting Kit Sensitivity.....	23
<b>Playing Techniques</b> .....	<b>24</b>
Snare Pad .....	24
Hi-hat Cymbal .....	24
<b>Performing with a Song</b> .....	<b>25</b>
Selecting a Song.....	25
Adjusting the Song Volume.....	25
Adjusting the Volume of Muted Drum Parts ...	26
Looping Part of a Song .....	26
<b>Using the Metronome</b> .....	<b>27</b>
Starting and Stopping the Metronome .....	27
Adjusting the Metronome Volume .....	27
Confirming Tempo via Number Buttons .....	27
Confirming Tempo via Voice Guidance .....	27
Adjusting the Tempo .....	28
Other Settings .....	28

<b>Practicing in Training Mode</b> .....	<b>29</b>
Basic Training Mode Procedure.....	29
1. Groove Check.....	30
2. Rhythm Gate .....	31
3. Measure Break.....	32
4. Tempo Up/Down.....	33
5. Change Up .....	34
6. Easy Session .....	35
7. Groove Tracker.....	36
8. Pad Gate .....	37
9. Part Mute.....	38
10. Fast Blast.....	39

## Advanced Techniques

<b>Setting Parameters using Menu Mode</b> .....	<b>40</b>
Basic Menu Mode Procedure .....	40
<b>1</b> Metronome Settings.....	41
<b>2</b> Kit Settings.....	42
<b>3</b> MIDI Settings .....	44
<b>4</b> Hi-hat Settings .....	45
<b>5</b> Trigger Settings.....	46
<b>6</b> Training Settings .....	49
<b>7</b> Other Settings.....	53
<b>Integrating Separately Sold Accessories</b> ..	<b>56</b>
For DTX400K Owners .....	56
For DTX430K & DTX450K Owners .....	56
<b>Connecting to a Computer</b> .....	<b>57</b>
Making Connections.....	57
MIDI Reference Manual .....	57

## Reference

<b>Troubleshooting</b> .....	<b>58</b>
<b>Data List</b> .....	<b>60</b>
<b>Specifications</b> .....	<b>64</b>
<b>Index</b> .....	<b>65</b>

# SPECIAL MESSAGE SECTION

This product utilizes batteries or an external power supply (adapter). DO NOT connect this product to any power supply or adapter other than one described in the manual, on the name plate, or specifically recommended by Yamaha.

This product should be used only with the components supplied or; a cart, rack, or stand that is recommended by Yamaha. If a cart, etc., is used, please observe all safety markings and instructions that accompany the accessory product.

## SPECIFICATIONS SUBJECT TO CHANGE:

The information contained in this manual is believed to be correct at the time of printing. However, Yamaha reserves the right to change or modify any of the specifications without notice or obligation to update existing units.

This product, either alone or in combination with an amplifier and headphones or speaker/s, may be capable of producing sound levels that could cause permanent hearing loss. DO NOT operate for long periods of time at a high volume level or at a level that is uncomfortable. If you experience any hearing loss or ringing in the ears, you should consult an audiologist. **IMPORTANT:** The louder the sound, the shorter the time period before damage occurs.

## NOTICE:

Service charges incurred due to a lack of knowledge relating to how a function or effect works (when the unit is operating as designed) are not covered by the manufacturer's warranty, and are therefore the owners responsibility. Please study this manual carefully and consult your dealer before requesting service.

## ENVIRONMENTAL ISSUES:

Yamaha strives to produce products that are both user safe and environmentally friendly. We sincerely believe that our products and the production methods used to produce them, meet these goals. In keeping with both the letter and the spirit of the law, we want you to be aware of the following:

### Battery Notice:

This product MAY contain a small non-rechargeable battery which (if applicable) is soldered in place. The average life span of this type of battery is approximately five years. When replacement becomes necessary, contact a qualified service representative to perform the replacement.

This product may also use "household" type batteries. Some of these may be rechargeable. Make sure that the battery being charged is a rechargeable type and that the charger is intended for the battery being charged.

When installing batteries, never mix old batteries with new ones, and never mix different types of batteries. Batteries MUST be installed correctly. Mismatches or incorrect installation may result in overheating and battery case rupture.

### Warning:

Do not attempt to disassemble, or incinerate any battery. Keep all batteries away from children. Dispose of used batteries promptly and as regulated by the laws in your area. Note: Check with any retailer of household type batteries in your area for battery disposal information.

### Disposal Notice:

Should this product become damaged beyond repair, or for some reason its useful life is considered to be at an end, please observe all local, state, and federal regulations that relate to the disposal of products that contain lead, batteries, plastics, etc. If your dealer is unable to assist you, please contact Yamaha directly.

## NAME PLATE LOCATION:

The name plate is located on the bottom of the product. The model number, serial number, power requirements, etc., are located on this plate. You should record the model number, serial number, and the date of purchase in the spaces provided below and retain this manual as a permanent record of your purchase.

Model

---

Serial No.

---

Purchase Date

---

92-BP (bottom)

# PLEASE KEEP THIS MANUAL

## FCC INFORMATION (U.S.A.)

### 1. IMPORTANT NOTICE: DO NOT MODIFY THIS UNIT!

This product, when installed as indicated in the instructions contained in this manual, meets FCC requirements. Modifications not expressly approved by Yamaha may void your authority, granted by the FCC, to use the product.

### 2. IMPORTANT:

When connecting this product to accessories and/or another product use only high quality shielded cables. Cable/s supplied with this product MUST be used. Follow all installation instructions. Failure to follow instructions could void your FCC authorization to use this product in the USA.

### 3. NOTE:

This product has been tested and found to comply with the requirements listed in FCC Regulations, Part 15 for Class "B" digital devices. Compliance with these requirements provides a reasonable level of assurance that your use of this product in a residential environment will not result in harmful interference with other electronic devices. This equipment generates/uses radio frequencies and, if not installed and used according to the instructions found in the users manual, may cause interference harmful to the operation of other electronic devices. Compliance with FCC regulations does not guar-

antee that interference will not occur in all installations. If this product is found to be the source of interference, which can be determined by turning the unit "OFF" and "ON", please try to eliminate the problem by using one of the following measures:

Relocate either this product or the device that is being affected by the interference.

Utilize power outlets that are on different branch (circuit breaker or fuse) circuits or install AC line filter/s.

In the case of radio or TV interference, relocate/reorient the antenna. If the antenna lead-in is 300 ohm ribbon lead, change the lead-in to co-axial type cable.

If these corrective measures do not produce satisfactory results, please contact the local retailer authorized to distribute this type of product. If you can not locate the appropriate retailer, please contact Yamaha Corporation of America, Electronic Service Division, 6600 Orangethorpe Ave, Buena Park, CA90620

The above statements apply ONLY to those products distributed by Yamaha Corporation of America or its subsidiaries.

\* This applies only to products distributed by YAMAHA CORPORATION OF AMERICA.

(class B)

## COMPLIANCE INFORMATION STATEMENT (DECLARATION OF CONFORMITY PROCEDURE)

Responsible Party : Yamaha Corporation of America  
Address : 6600 Orangethorpe Ave., Buena Park, Calif. 90620  
Telephone : 714-522-9011  
Type of Equipment : ELECTRONIC DRUM KIT  
Model Name : DTX400K/DTX430K/DTX450K

This device complies with Part 15 of the FCC Rules.  
Operation is subject to the following two conditions:  
1) this device may not cause harmful interference, and  
2) this device must accept any interference received including interference that may cause undesired operation.  
See user manual instructions if interference to radio reception is suspected.

\* This applies only to products distributed by YAMAHA CORPORATION OF AMERICA.

(FCC DoC)

# PRECAUTIONS

## PLEASE READ CAREFULLY BEFORE PROCEEDING

Please keep this manual in a safe and handy place for future reference.



### WARNING

Always follow the basic precautions listed below to avoid the possibility of serious injury or even death from electrical shock, short-circuiting, damages, fire or other hazards. These precautions include, but are not limited to, the following:

#### Power supply/AC power adaptor

- Do not place the power cord near heat sources such as heaters or radiators. Also, do not excessively bend or otherwise damage the cord, or place heavy objects on it.
- Only use the voltage specified as correct for the instrument. The required voltage is printed on the name plate of the instrument.
- Use the specified adaptor (page 64) only. Using the wrong adaptor can result in damage to the instrument or overheating.
- Check the electric plug periodically and remove any dirt or dust which may have accumulated on it.

#### Assembly

- Under no circumstances should any of the components of this product be taken apart or customized. Doing so could result in electric shock, fire, injury, or malfunction.
- Do not sit or stand on the rack. Doing so could cause it to fall over or break, possibly causing injury.
- Be careful with the holders for cymbal and tom pads as they have sharp tips. In order to avoid injury, therefore, you should take special care whenever handling these components.
- Be careful with the anti-slip stoppers on kick pads and foot pedals as they have sharp tips. In order to avoid injury, therefore, you should take special care whenever handling these components.
- Securely tighten fixing nuts and other fasteners. In addition, be sure to immediately tighten any nuts that have come loose. If this precaution is not observed, pads may fall off or the rack may collapse or fall over, possibly causing injury.
- Take care when setting up cables. If anyone were to trip on a cable, the instrument could topple over and cause injury.

#### Water warning

- Do not expose the instrument to rain, use it near water or in damp or wet conditions, place on it any containers (such as vases, bottles or glasses) containing liquids which might spill into any openings. If any liquid such as water seeps into the instrument, turn off the power immediately and unplug the power cord from the AC outlet. Then have the instrument inspected by qualified Yamaha service personnel.
- Never insert or remove an electric plug with wet hands.

#### Fire warning

- Do not put burning items, such as candles, on the unit. A burning item may fall over and cause a fire.

#### If you notice any abnormality

- When one of the following problems occur, immediately turn off the power switch and disconnect the electric plug from the outlet. Then have the device inspected by Yamaha service personnel.
  - The power cord or plug becomes frayed or damaged.
  - It emits unusual smells or smoke.
  - Some object has been dropped into the instrument.
  - There is a sudden loss of sound during use of the instrument.



### CAUTION

Always follow the basic precautions listed below to avoid the possibility of physical injury to you or others, or damage to the instrument or other property. These precautions include, but are not limited to, the following:

#### Power supply/AC power adaptor

- Do not connect the instrument to an electrical outlet using a multiple-connector. Doing so can result in lower sound quality, or possibly cause overheating in the outlet.
- When removing the electric plug from the instrument or an outlet, always hold the plug itself and not the cord. Pulling by the cord can damage it.
- Remove the electric plug from the outlet when the instrument is not to be used for extended periods of time, or during electrical storms.

#### Assembly

- Read carefully the attached documentation explaining the assembly process. Failure to assemble the instrument in the proper sequence might result in damage to the instrument or even injury.
- Do not place hands or feet under a foot switch or foot pedal. Doing so could result in injury.

- Do not use the electronic drum kit's rack to hold acoustic drums. Doing so could cause clamps to break and the drums to fall off, which in turn could lead to injury.
- Mind your fingers when adjusting clamps. Fingers can easily be caught and crushed if care is not taken during this operation.
- Be careful with the tips of supports, arms, screws, and the like. Fingers can easily be injured by sharp tips if these components are not handled carefully.

#### Location

- Do not place the instrument in an unstable position where it might accidentally fall over.
- Before moving the instrument, remove all connected cables, to prevent damage to the cables or injury to anyone who might trip over them.

- When setting up the product, make sure that the AC outlet you are using is easily accessible. If some trouble or malfunction occurs, immediately turn off the power switch and disconnect the plug from the outlet. Even when the power switch is turned off, electricity is still flowing to the product at the minimum level. When you are not using the product for a long time, make sure to unplug the power cord from the wall AC outlet.
- Use only the stand/rack specified for the instrument. When attaching the stand or rack, use the provided screws only. Failure to do so could cause damage to the internal components or result in the instrument falling over.

## Connections

- Before connecting the instrument to other electronic components, turn off the power for all components. Before turning the power on or off for all components, set all volume levels to minimum.
- Be sure to set the volumes of all components at their minimum levels and gradually raise the volume controls while playing the instrument to set the desired listening level.

Yamaha cannot be held responsible for damage caused by improper use or modifications to the instrument, or data that is lost or destroyed.

Always turn the power off when the instrument is not in use.

Even when the [  ] (Standby/On) switch is in standby status (power lamp is off), electricity is still flowing to the instrument at the minimum level.

When you are not using the instrument for a long time, make sure you unplug the power cord from the wall AC outlet.

## NOTICE

To avoid the possibility of malfunction/damage to the product, damage to data, or damage to other property, follow the notices below.

### ■ Handling and Maintenance

- Do not use the instrument in the vicinity of a TV, radio, stereo equipment, mobile phone, or other electric devices. Otherwise, the instrument, TV, or radio may generate noise.
- Do not expose the instrument to excessive dust or vibrations, or extreme cold or heat (such as in direct sunlight, near a heater, or in a car during the day) to prevent the possibility of panel disfiguration, damage to the internal components or unstable operation. (Verified operating temperature range: 5° – 40°C, or 41° – 104°F.)
- Do not place vinyl, plastic or rubber objects on the instrument, since this might discolor the panel or keyboard.
- When cleaning the drum module, be sure to use a clean, dry cloth. Cleaning products that contain organic solvents, paint thinner, detergents, and chemically-treated cleaning cloths can cause discoloration and/or warping and should not be used.
- When cleaning the pads, avoid cleaning products that contain organic solvents, paint thinner, and alcohol as they can cause discoloration and/or warping. Instead, we recommend that you remove dust using a soft dry cloth or wipe clean with a moist, tightly-wrung-out cloth. If a pad is very dirty, wipe the dirt away using a cloth moistened with a neutral detergent solution and tightly wrung out. Following this, wipe away the detergent solution using a cloth soaked in water and tightly wrung out.

## Handling caution

- Do not insert a finger or hand in any gaps on the instrument.
- Never insert or drop paper, metallic, or other objects into the gaps on the panel. This could cause physical injury to you or others, damage to the instrument or other property, or operational failure.
- Do not rest your weight on, or place heavy objects on the instrument, and do not use excessive force on the buttons, switches or connectors.
- Do not use the instrument/device or headphones for a long period of time at a high or uncomfortable volume level, since this can cause permanent hearing loss. If you experience any hearing loss or ringing in the ears, consult a physician.

## Information

### ■ About copyrights

- Copying of the commercially available musical data including but not limited to MIDI data and/or audio data is strictly prohibited except for your personal use.
- This product incorporates and bundles computer programs and contents in which Yamaha owns copyrights or with respect to which it has license to use others' copyrights. Such copyrighted materials include, without limitation, all computer software, style files, MIDI files, WAVE data, musical scores and sound recordings. Any unauthorized use of such programs and contents outside of personal use is not permitted under relevant laws. Any violation of copyright has legal consequences. DON'T MAKE, DISTRIBUTE OR USE ILLEGAL COPIES.

### ■ About this manual

- The illustrations as shown in this manual are for instructional purposes only, and may appear somewhat different from those on your instrument.
- The company names and product names in this manual are the trademarks or registered trademarks of their respective companies.

### ■ Optional Pads

Within this Owner's Manual, the optional external pads that may be connected to the drum module are referred to by model name. Please note that these model names were up-to-date as of printing of this manual. Details regarding any subsequently released models will be made available via the following web site.

<http://www.yamaha.com/>

## Welcome

*First of all, thank you for purchasing a Yamaha DTX400K, DTX430K, or DTX450K Electronic Drum Kit. In order to get the most out of your new instrument, please be sure to read this owner's manual carefully. And after doing so, be sure to store it in a safe place so that you can refer back to it again as needed.*

## Product Manuals

---

The DTX400K, DTX430K, and DTX450K are described in the following two manuals.

### ■ **Owner's Manual (this booklet)—Setup, Basic Techniques, Advanced Techniques, and Reference sections.**

#### **Setup**

Describes how to assemble your electronic drum kit and get it set up for playing.

#### **Basic Techniques**

Describes the basic techniques used when operating and playing the electronic drum kit.

#### **Advanced Techniques**

Describes the setting of parameters and other more advanced modes of use.

#### **Reference**

Describes troubleshooting techniques and contains other reference materials.

### ■ **MIDI Reference Manual (pdf)**

**\* Not bundled with this product.**

The drum module's MIDI Reference Manual contains the following. See page 57 for more details.

- MIDI-related reference information
- Reference material that will prove useful when making music using the drum module and a computer
- Instructions on how to transfer songs from your computer to the drum module

### ● **Using PDF Manuals**

The Reference Manual for your DTX400K, DTX430K, or DTX450K is made available in digital format as a PDF document. As such, a computer and suitable software will be required in order to read it. We recommend that Adobe® Reader® be used for this purpose as it allows you to quickly and easily search for keywords, to print out specific sections, and to conveniently jump from page to page by clicking embedded links. Keyword searching and link-based navigation in particular are extremely useful functions available only with digital-type documents.

The most-recent version of Adobe® Reader® can be downloaded from the following web page.

<http://www.adobe.com/products/reader/>

# First Steps

1



Open the box and confirm that all parts are present and correct.

2



Assemble the parts.

- The assembly process is described in detail on pages 8 through 18.

3

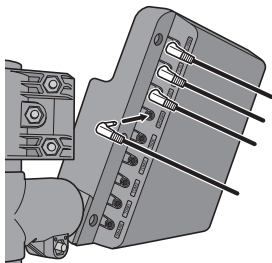

Make the necessary connections.

- Connect the pads to the drum module using the cables provided.  
→ See page 18.
- Connect the power adaptor to the drum module and turn on the module.  
→ See page 19.

4



Play your electronic drum kit.

- Basic techniques used when operating and playing the electronic drum kit are described in the Basic Techniques section (pages 23 to 39).
- More complex methods are described in the Advanced Techniques section (pages 40 to 55).

# Package Contents

After opening up the package containing your electronic drum kit, please verify that all of the following parts are present.

## For DTX400K Owners

- Parts ⑬, ⑰, and ⑱ are contained in Box 1.
- Parts ⑩ and ⑪ are contained in Box 2.
- The DTX400K does not have any parts numbered ⑦, ⑨, or ⑬.
- Parts ⑭ and ⑮ are almost identical in appearance but are actually different. They can be told apart by the sticker on the base section.
- Parts ③ and ⑧ are almost identical in appearance but are actually different. Part ⑧ has a wing bolt, but part ③ does not. In addition, the polystyrene foam packaging used for part ③ is marked "T" (tom); while the packaging for part ⑧ is marked "S" (snare).

### ① Base supports (x2)



### ② Vertical supports (x2)



### ③ Third tom part (x1)



### ④ Left arm (x1)



### ⑤ Drum module (x1)



### ⑥ First/second tom part (x1)

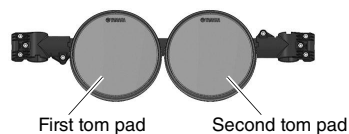

### ⑧ Snare pad (x1)

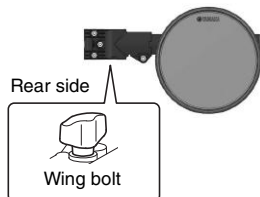

### ⑩ Cymbal holders (x2)



### ⑪ Hi-hat holder (x1)



### ⑫ Cymbal/hi-hat pads (x3)



### ⑭ Hi-hat controller (x1)



### ⑮ KU100 Kick Unit (x1)



### ⑯ Nine-channel snake cable (x1)

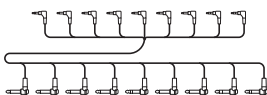

### ⑰ Tuning key (x1)

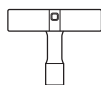

### ⑱ Cable bands (x3)



### ⑲ Power adaptor (x1)

\* May not be included depending on your particular area. Please check with your Yamaha dealer.

### ⑳ Owner's Manual (this booklet)



## For DTX430K Owners

- Parts 16, 17, and 18 are contained in Box 1.
- Parts 10 and 11 are contained in Box 2.
- The DTX430K does not have any parts numbered 7 or 9.

1 Base supports (x2)



2 Vertical supports (x2)



3 Third tom part (x1)

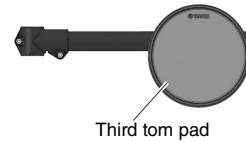

4 Left arm (x1)



5 Drum module (x1)



6 First/second tom part (x1)

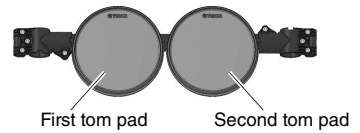

8 Snare pad (x1)



10 Cymbal holders (x2)



11 Hi-hat holder (x1)



12 Cymbal/hi-hat pads (x3)



13 KP65 Kick Pad (x1)



14 HH65 Hi-hat Controller (x1)



15 FP6110A Foot Pedal (x1)



16 Nine-channel snake cable (x1)

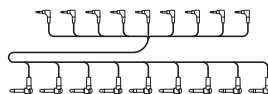

17 Tuning key (x1)

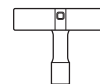

18 Cable bands (x3)



19 Power adaptor (x1)

\* May not be included depending on your particular area. Please check with your Yamaha dealer.

20 Owner's Manual (this booklet)

## For DTX450K Owners

- Parts ⑨, ⑯, ⑰, and ⑱ are contained in Box 1.
- Parts ⑦, ⑩, and ⑪ are contained in Box 2.

① Base supports (x2)



② Vertical supports (x2)



③ Third tom part (x1)

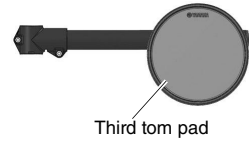

④ Left arm (x1)



⑤ Drum module (x1)



⑥ First/second tom part (x1)

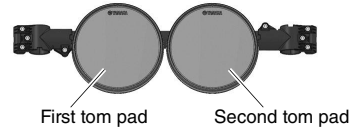

⑦ Hexagonal rod (x1)



⑧ TP70S Snare Pad (x1)



⑨ S wing bolt (x1)



⑩ Cymbal holders (x2)



⑪ Hi-hat holder (x1)



⑫ Cymbal/hi-hat pads (x3)



⑬ KP65 Kick Pad (x1)



⑭ HH65 Hi-hat Controller (x1)



⑮ FP6110A Foot Pedal (x1)



⑯ Nine-channel snake cable (x1)

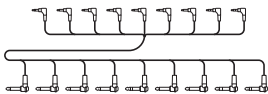

⑰ Tuning key (x1)



⑱ Cable bands (x3)



⑲ Power adaptor (x1)

\* May not be included depending on your particular area. Please check with your Yamaha dealer.

⑳ Owner's Manual (this booklet)

# Assembly Guide

Fully assembled drum kit (DTX450K shown)

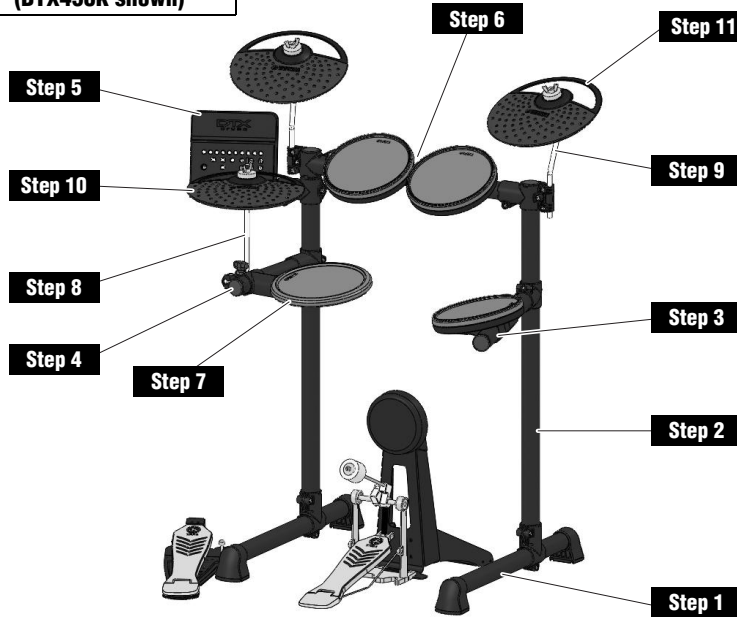

### CAUTION

- Choose a flat, hard surface on which to assemble your electronic drum kit.
- Take care to avoid mixing up parts or assembling them in the wrong direction. In addition, the assembly steps should be completed one at a time in the order described.
- The assistance of at least one other person will be required when assembling the electronic drum kit.
- Once a piece has been assembled, be sure to tighten the corresponding nuts or bolts.
- To disassemble your electronic drum kit, carry out the assembly sequence in reverse.

## Step 1 Preparing the base supports

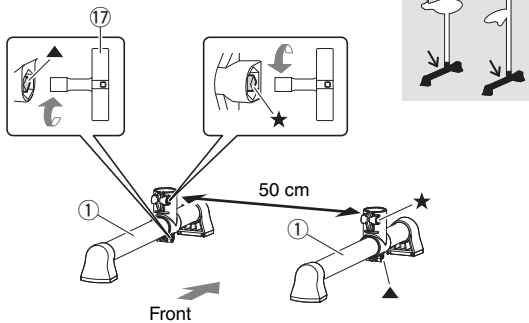

1. Take the two base supports (①) and the tuning key (⑰) from the package, and using the tuning key, securely tighten the ▲ key bolts (i.e., the key bolts labeled ▲ in the figure).

### NOTE

The two base supports are identical.

2. Using the tuning key, loosen the ★ key bolt on each of the two base supports (①).
3. Viewing from the front as shown in the figure, place the base supports (①) at the left and right approximately 50 cm apart.

## Step 2 Attaching the vertical supports

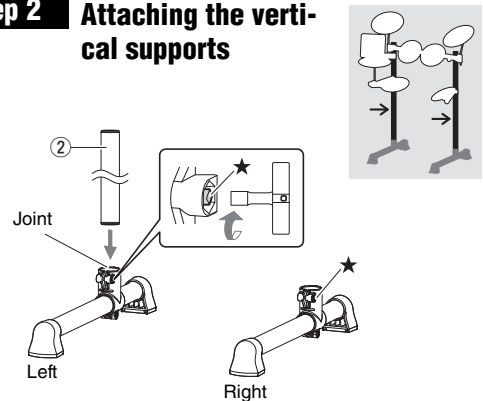

1. Take a vertical support (②) from the package, and insert it fully into the joint on the left base support.

### NOTE

The two vertical supports are identical.

2. Using the tuning key, tighten the ★ key bolt that you loosened in **Step 1** in order to secure the vertical support (②) in place.

### CAUTION

After completing this step, lay the assembly down safely to prevent it from falling over.

3. Repeat **1.** and **2.** to assemble the right upright bar.

### Step 3 Attaching the third tom part

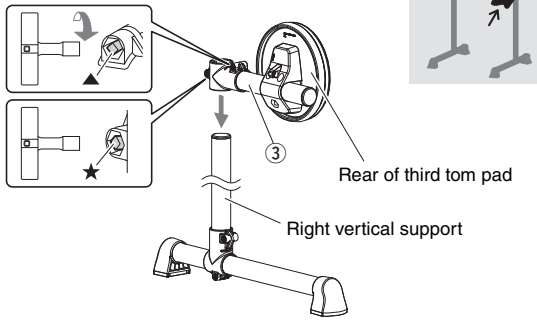

#### IMPORTANT

The third tom part (3) and the snare part (8) from the DTX400K are almost identical in appearance, and special care should be taken to avoid mixing them up during the assembly process. To tell them apart, look for the wing bolt, which is only found on part 8. See the figure on page 8 for more details.

1. Take the third tom part (3) from the package, and using the tuning key, securely tighten the ▲ key bolt.
2. Loosen the ★ key bolt.
3. Slide the third tom part (3) onto the right vertical support and lower it to the center of the support or thereabouts. Ensure that the third tom pad is oriented as shown in the above figure at this time.

#### NOTE

Care should be taken to avoid assembling the third tom pad upside-down or back-to-front.

4. Tighten the ★ key bolt to secure the third tom part (3) in place.

#### CAUTION

After completing this step, lay the assembly down safely to prevent it from falling over.

#### NOTE

The third tom pad will be rotated into place in **Step 12**.

### Step 4 Attaching the left arm

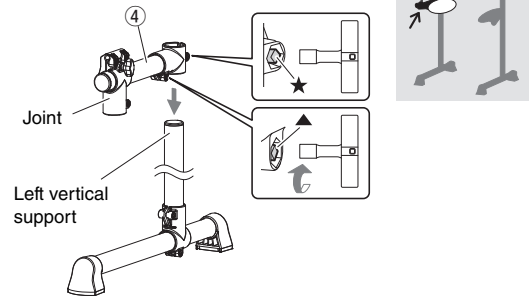

The joint shown in the figure is not part of the DTX400K.

1. Take the left arm (4) from the package, and using the tuning key, securely tighten the ▲ key bolt.
2. Loosen the ★ key bolt.
3. Slide the left arm (4) onto the left vertical support and lower it to the center of the support or thereabouts. Ensure that the left arm is oriented as shown in the above figure at this time.
4. Tighten the ★ key bolt to secure the left arm (4) in place.

#### CAUTION

After completing this step, lay the assembly down safely to prevent it from falling over.

### Step 5 Attaching the drum module

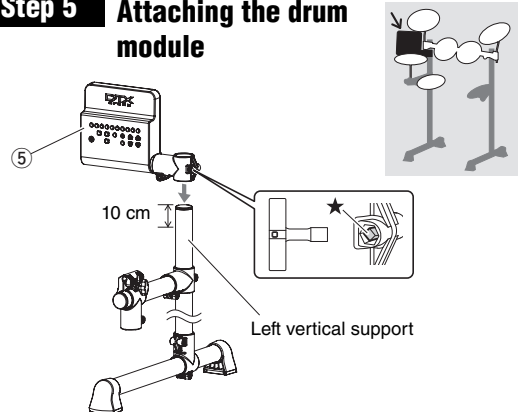

1. Take the drum module (5) from the package and loosen the ★ key bolt.
2. Slide the drum module (5) onto the left vertical support and lower it to a position about 10 cm from the top. The angle at which the module should be assembled is shown in the figure.
3. Tighten the ★ key bolt to secure the drum module (5) in place.

#### CAUTION

After completing this step, lay the assembly down safely to prevent it from falling over.

## Step 6 Attaching the first/second tom part

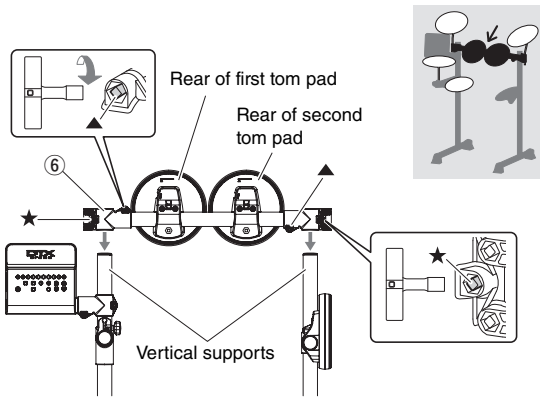

1. Take the first/second tom part (6) from the package, and using the tuning key, securely tighten the ▲ key bolts.

**NOTE**

This part has two ▲ key bolts, one each on the left and right.

2. Loosen the ★ key bolts.

**NOTE**

This part has two ★ key bolts, one each on the left and right.

3. Slide the first/second tom part (6) onto the vertical supports and move it down until the tops of the supports are flush with the tops of the holes. Ensure that the tom part is oriented as shown in the above figure at this time.

**NOTE**

Care should be taken to avoid assembling the first and second tom pads upside-down or back-to-front.

4. Tighten the ★ key bolts to secure the first/second tom part (6) in place.

**NOTE**

The tom pads will be rotated into place in **Step 12**.

The details of **Step 7** are different for the DTX400K, DTX430K, and DTX450K.

### For DTX400K Owners

## Step 7 Attaching the snare pad

1. Take the snare part (8) from the package and lightly tighten the wing bolt.

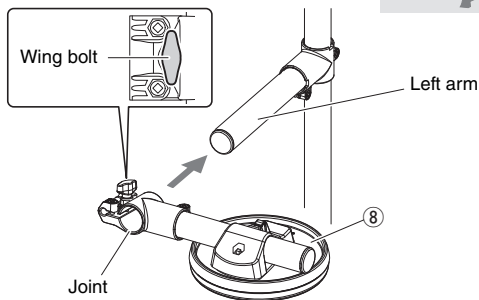

2. Place the snare part (8) on the left arm, which was assembled in **Step 4**, and slide it back until the front end of the arm is flush with the joint.
3. Securely tighten the wing bolt.

4. Loosen the ◆ key bolt located on the back of the snare pad (8), and rotate the pad 180°, turning it over.

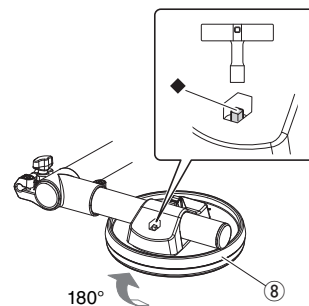

5. Tighten the ◆ key bolt to secure the snare pad (8) in place.

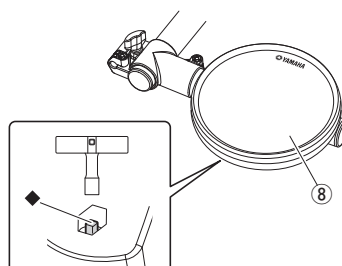

The details of **Step 7** are different for the DTX400K, DTX430K, and DTX450K.

**For DTX430K Owners**

**Step 7 Attaching the snare pad**

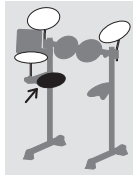

1. Loosen the wing bolt on the joint on the left arm, which was attached in **Step 4**.

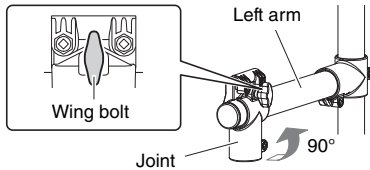

2. Rotate the joint 90° counter-clockwise, making the joint section horizontal.
3. Securely tighten the wing bolt.
4. Loosen the **◆** key bolt on the joint.

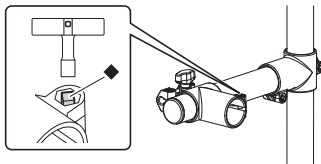

5. Take the snare pad (8) from the package and slide it fully into the joint.

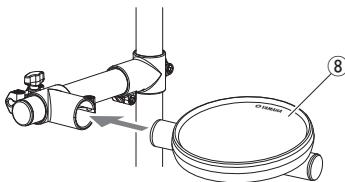

6. Tighten the **◆** key bolt to secure the snare pad (8) in place.

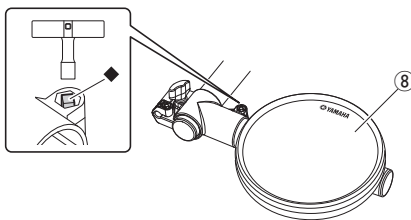

**For DTX450K Owners**

**Step 7 Attaching the snare pad**

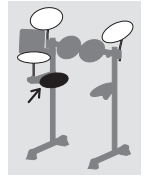

1. Loosen the wing bolt on the joint on the left arm, which was attached in **Step 4**.

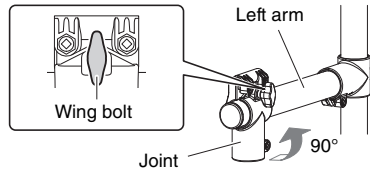

2. Rotate the joint 90° counter-clockwise, making the joint section horizontal.
3. Securely tighten the wing bolt.
4. Loosen the **◆** key bolt on the joint.

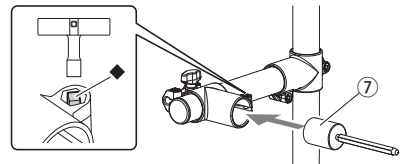

5. Take the hexagonal rod (7) from the package and slide it fully into the joint.
6. Tighten the **◆** key bolt to secure the hexagonal rod (7) in place.
7. Take the snare pad (8) and the S wing bolt (9) from the package and lightly tighten the S wing bolt (9). (Five or six turns is sufficient.)

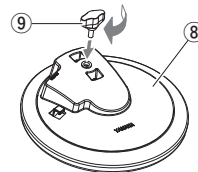

8. Place the snare pad (8) on the hexagonal rod (7), which was attached in 6. above, and slide it fully back. Then tighten the S wing bolt (9) to secure the snare pad (8) in place.

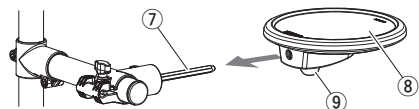

9. Loosen the **◆** key bolt and adjust the angle of the snare pad. When finished, retighten the **◆** key bolt to secure the snare pad in place.

The details of **Step 8** are different for the DTX400K, DTX430K, and DTX450K.

**For DTX400K and DTX430K Owners**

**Step 8 Attaching the hi-hat holder**

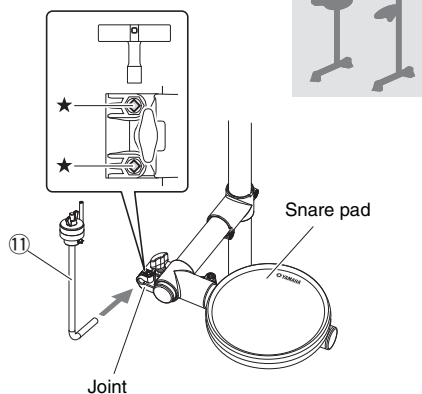

1. Loosen the two ★ key bolts on the joint on the snare-pad part, which was attached in **Step 7**.
2. Take the hi-hat holder (11) from the package and slide it into the joint from the front as shown in the figure. Then adjust the angle of the hi-hat holder.
  - When correctly inserted, the tip of the hi-hat holder (11) will protrude slightly from the rear of the joint.
  - When correctly oriented, the metal rod section at the top of the hi-hat holder (11) will be vertical.
3. Tighten the two ★ key bolts to secure the hi-hat holder (11) in place.

**For DTX450K Owners**

**Step 8 Attaching the hi-hat holder**

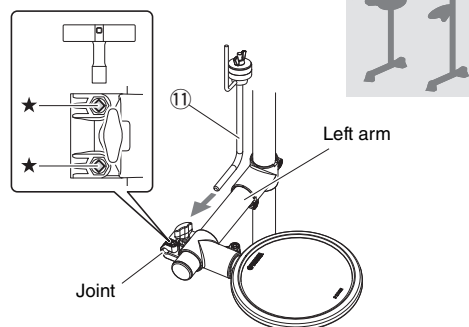

1. Loosen the two ★ key bolts on the joint on the left arm, which was attached in **Step 4**.
2. Take the hi-hat holder (11) from the package and slide it into the joint from the rear as shown in the figure. Then adjust the angle of the hi-hat holder.
  - When correctly inserted, the tip of the hi-hat holder (11) will protrude slightly from the front of the joint.
  - When correctly oriented, the metal rod section at the top of the hi-hat holder (11) will be vertical.
3. Tighten the two ★ key bolts to secure the hi-hat holder (11) in place.

**Step 9 Attaching the cymbal holders**

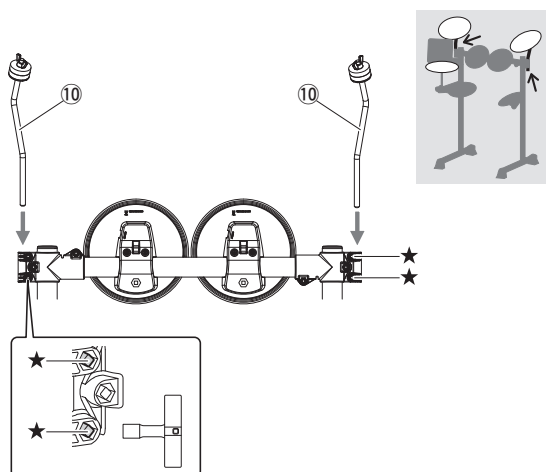

1. Loosen the four ★ key bolts at the ends of the first/second tom part, which was attached in **Step 6**.
2. Take the cymbal holders (10) from the package and insert them into the ends of the first/second tom part. Then adjust the angles of the cymbal holders until they are oriented as shown in the figure.

**NOTE**

The two cymbal holders are identical.

- When correctly inserted, the tips of the cymbal holders (10) will protrude slightly from the bottom of the tom part.
  - When correctly oriented, the cymbal holders (10) will be as shown in the figure.
3. Tighten the four ★ key bolts to secure the cymbal holders (10) in place.

## Step 10 Attaching the hi-hat

### ● Adjusting the position of the hi-hat stopper pin

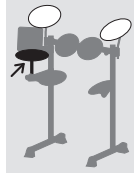
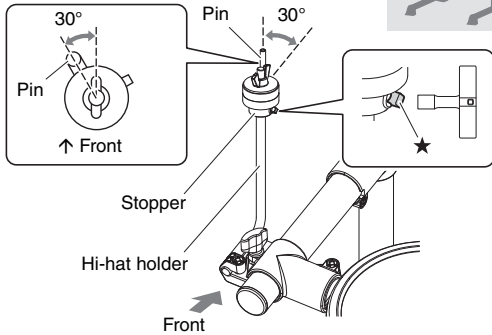

This figure shows the hi-hat holder correctly inserted in the DTX450K. It is inserted from the front in the DTX400K and DTX430K, and therefore, faces in the opposite direction.

1. Using the tuning key, loosen the ★ key bolt on the stopper, which is located at the top of the hi-hat holder.
2. Adjust the position of the pin until, as shown in the figure, it is approximately 30° counter-clockwise from the front-rear direction of the kit when viewed from above.
3. Tighten the ★ key bolt to secure the stopper pin.

### ● Assembling the hi-hat pad

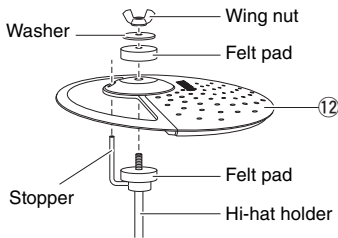

All three of the cymbal/hi-hat pads (12) are identical. One of these is to be used as the hi-hat pad.

1. Remove the wing nut, the washer, and the upper felt pad from the hi-hat holder. (Do not remove the lower felt pad.)
2. Take the hi-hat pad (12); one of three) from the package and place it on the hi-hat holder with the stopper pin also passing through the hole provided.
3. Replace the felt pad removed in 1. above the hi-hat pad (12).
4. Replace the washer removed in 1. above the felt pad.
5. Tighten the wing nut to secure the hi-hat pad (12) in place. Ensure that the wing nut is firmly tightened.

## Step 11 Assembling the cymbal pads

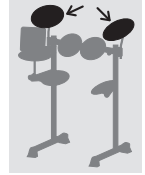
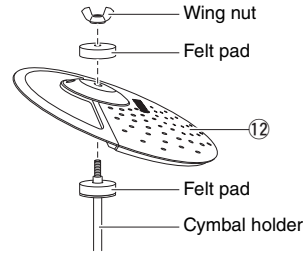

In this step, the two remaining cymbal/hi-hat pads (12) are assembled. Accordingly, 1. to 4. must be performed twice.

#### NOTE

The two cymbal pads (12) are identical.

1. Remove the wing nut and the upper felt pad from the cymbal holder. (Do not remove the lower felt pad.)
2. Place the cymbal pad (12) on the cymbal holder, with the holder passing through the central hole.
3. Replace the felt pad removed in 1. above the cymbal pad (12).
4. Tighten the wing nut to secure the cymbal pad (12) in place.

## Step 12 Rotating the tom pads into place

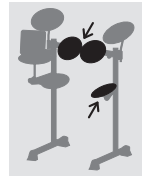
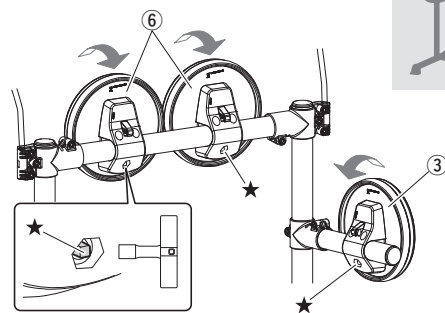

Step 12 applies to each of the three tom pads. Accordingly, 1. to 3. must be performed three times.

1. Loosen the ★ key bolt on the tom pad (3) or (6).
2. Rotate the tom pad to a position where it will be easy to play. (If necessary, refer to the picture of the properly assembled kit on page 11.)
3. Tighten the ★ key bolt to secure the tom pad in place.



**Step 13** is only required for the DTX430K and DTX450K. Owners of the DTX400K should skip to **Step 14**.

### Step 13 Assembling the kick pad

1. Take the kick pad (13) from the package, remove the four wing bolts, spring washers, and flat washers from the kick pad holder, and arrange each set nearby in the disassembled condition.
2. Assemble the base to the holder as shown below, and then from the base side, assemble the wing bolts, spring washers, and flat washers removed in 1. in order to secure it in place.

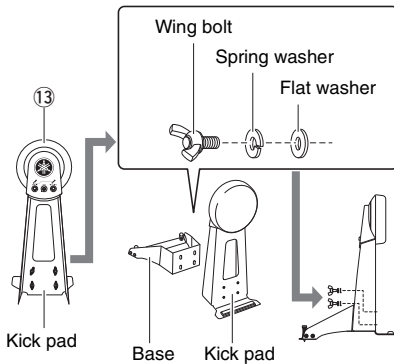

3. Take the foot pedal (15) from the package and insert the beater into the hole in the holder as shown below.
4. Slide the beater rod into the hole until the tip protrudes approximately 15 mm from the rear, and then tighten the beater bolt using the tuning key.

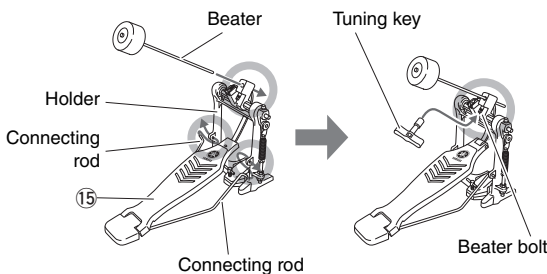

5. Turn the foot pedal's T-bolt counter-clockwise to loosen it.

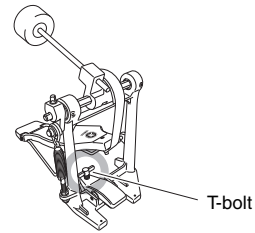

6. Fit the raised section at the front of the kick pad holder into the foot-pedal's assembly bracket.
7. Turn the foot pedal's T-bolt clockwise to secure the parts together.
8. Operate the pedal and confirm whether the beater head strikes the kick pad near the center. If not, adjust the length of the beater or move it left or right as required.

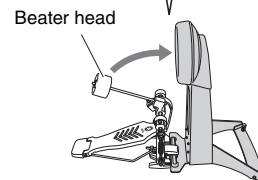
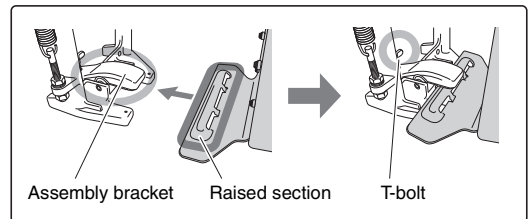

### Step 14 Positioning the hi-hat controller and kick drum

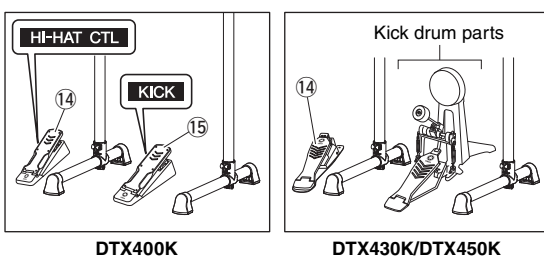

Arrange the hi-hat controller (14) and the kick drum parts or kick unit (15) as shown in the figure on the left.

**IMPORTANT**

The hi-hat controller (14) and the kick unit (15) from the DTX400K are almost identical in appearance. They can be told apart by the sticker on the base section.

## Step 15 Fine-tuning the positions of the pads and the drum module

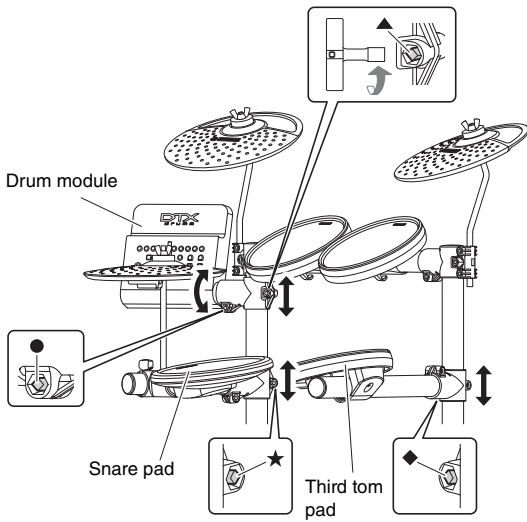

Sit on your stool and adjust the positions of the pads and the drum module to your liking.

- To adjust the height of the snare pad, loosen the ★ key bolt.
- To adjust the height of the third tom pad, loosen the ◆ key bolt.
- To adjust the height of the drum module, loosen the ▲ key bolt.
- To tilt the drum module forwards or backwards, loosen the ● key bolt.

### CAUTION

- Be sure to always retighten any key bolt after you have finished adjusting the corresponding part.
- Before moving on to the next step, ensure that all key bolts have been tightened.

### NOTE

- Refer back to **Step 7** if you wish to readjust the angle of the snare pad.
- Refer back to **Step 12** if you wish to readjust the angles of the tom pads.

## Step 16 Connecting the pads to the drum module

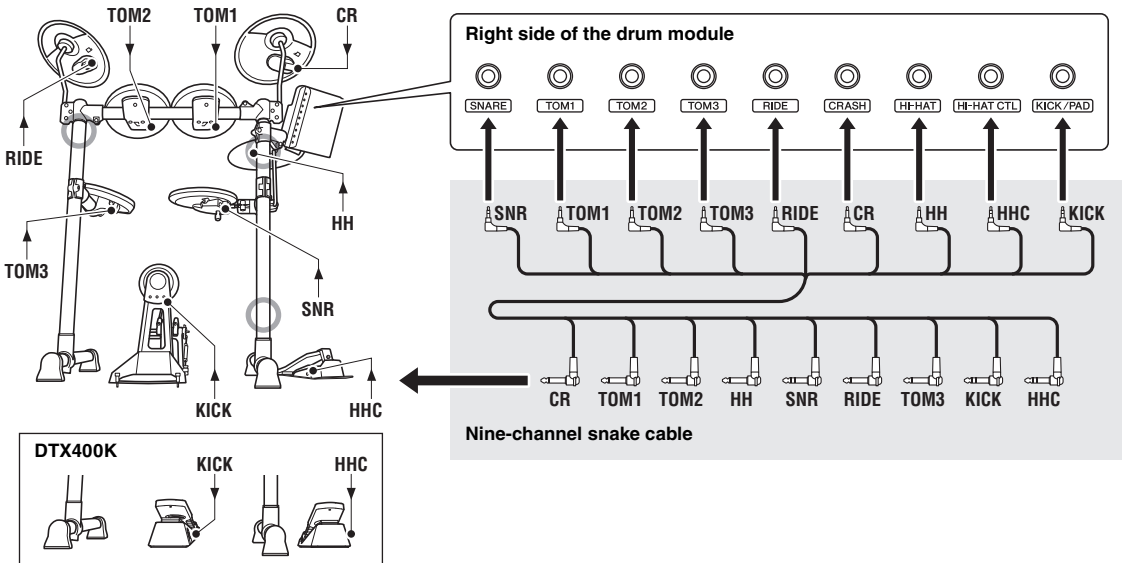

1. Insert the mini plugs\* at one end of the nine-channel snake cable (16) into the correct trigger input jacks (SNARE to KICK/PAD) on the right side of the drum module. (\*: The smaller set of plugs.)

### NOTE

The sticker on each of the snake cable's plugs indicates the name of the corresponding pad.

2. Insert the nine-channel snake cable's standard plugs\* into the jacks in the corresponding pads. (\*: The larger set of plugs.)

3. Wrap the cables for the snare pad, the tom pads, and the cymbal/hi-hat pads around the cable clips to prevent them from being pulled out.

### NOTICE

Excessive bending can damage the cables. Ensure, therefore, that they are not bent at an extreme angle when wrapped around the clips.

4. Using the cable bands (18), secure the cables to the kit rack at the ○ positions in the figure above.

*Congratulations—You have finished assembling your electronic drum kit!*

# Setting Up for Sound

## Connecting the Power

1. Ensure that your drum module is turned off (i.e., none of the buttons are lit).
2. Insert the power adaptor's DC plug into the [ 12V  $\equiv$  +  $\ominus$  - ] connector on the left side of the module.
3. Hook the power adaptor's cord around the cord clip to prevent it from being accidentally pulled out.

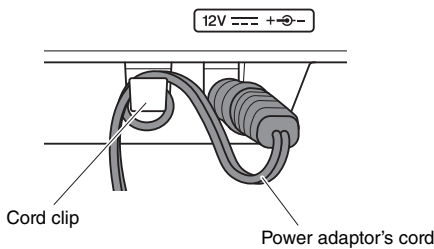

### ⚠ CAUTION

Excessive bending can damage the power adaptor cord and create a fire hazard. Ensure, therefore, that the power cord is not bent at an extreme angle when wrapped around the clip.

4. Plug the power adaptor's AC power cord into an AC wall socket or another electrical outlet.

### ⚠ WARNING

Use only the power adaptor that came with your drum module.

## Connecting Headphones or Speakers

Your drum module does not have built-in speakers. In order to hear it, therefore, you will need to connect headphones or monitor speakers via the [PHONES/OUTPUT] standard stereo-audio jack. You can adjust the output volume using the [VOLUME] buttons on the control panel.

### NOTE

The [PHONES/OUTPUT] jack is a stereo connector. You can connect a 1/4" mono-audio jack to it, but in such a case, please be sure to set the output to mono using the Stereo/Mono parameter from Menu Mode (page 53).

### ⚠ CAUTION

To prevent hearing loss, avoid using headphones at a high volume for extended periods of time.

## Connecting a Music Player

You can connect a portable music player or another similar source of audio to your drum module via the [AUX IN] (auxiliary input) stereo mini-jack. This makes it possible to play along with your favorite tunes.

### NOTICE

- Whenever connecting other devices, ensure that the cables you use have plugs that match the input or output connectors on those devices.
- Before making connections, furthermore, you should also turn the volume on the other devices fully down.
- When all connections have been made, use each device's volume controller to balance its output with that of the drum module.

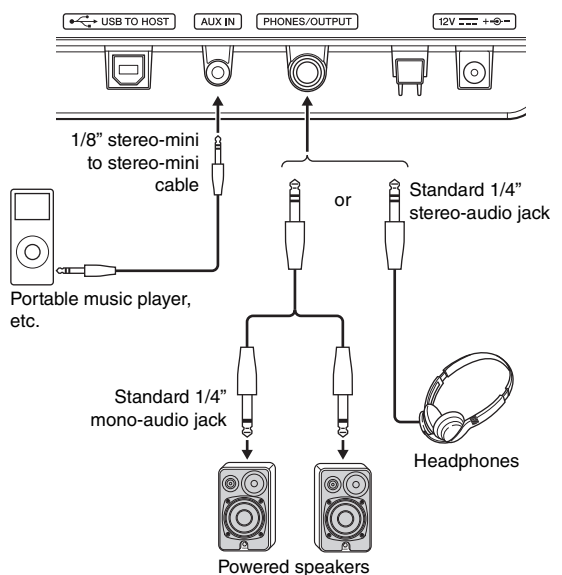

## Turning On the Drum Module

1. If you have connected your drum module to other audio devices such as powered speakers, ensure that the volume on all other devices is turned down fully.
2. Press the [  ] (Standby/On) button.  
The drum module will turn on and its buttons will light up.



**NOTE**

Connect the hi-hat controller before turning on the drum module. Please do not turn the drum module on with the hi-hat controller depressed. The drum module can not identify the type of pedal properly and it causes that the kick may produce much smaller sound than expected.

## Turning Off the Drum Module

1. If you have connected your drum module to other audio equipment, ensure that the volume on all other devices is turned down fully.
2. Press the [  ] (Standby/On) button.  
The drum module will turn off and all button lights will go out.



**CAUTION**

When setting up the product, make sure that the AC outlet you are using is easily accessible. If some trouble or malfunction occurs, immediately turn off the power switch and disconnect the plug from the outlet. Even when the power switch is turned off, electricity is still flowing to the product at the minimum level. When you are not using the product for a long time, make sure to unplug the power cord from the wall AC outlet.

**NOTICE**

The drum module automatically stores all current settings before it turns off. For this reason, please do not unplug the power adaptor until all button lights have gone out.

## Auto Power-Off

The Auto Power-Off function automatically turns off the drum module after a certain period of inactivity. This helps to save energy should you forget to turn it off yourself.

**NOTE**

The drum module automatically stores all current settings before it turns off.

### ● Setting the Auto Power-Off Function

You can set the amount of time that the Auto Power-Off function will wait before turning off the drum module. For details, see the description of the Auto Power-Off Time parameter from Menu Mode (page 53).

**NOTICE**

- In certain modes of operation, the Auto Power-Off function will not turn off the drum module when the set time has elapsed. We recommend, therefore, that you always turn off the drum module manually when you are finished using it.
- If you expect the drum module to be inactive for a certain length of time while connected to other audio equipment, we recommend that you turn the volume on the other equipment fully down. Alternatively, you can disable the Auto Power-Off function to ensure that the drum module stays on.

**NOTE**

- Settings for the Auto Power-Off function do not represent exact times and there may be some variation.
- By default, the Auto Power-Off time is set to 30 minutes.

### ● Quickly disabling Auto Power-Off

To quickly disable the Auto Power-Off function, turn on the drum module while holding down the [TRAINING] button. The function will remain off until you set a new Auto Power-Off time.

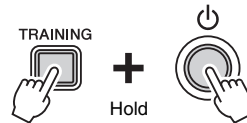

## Restoring the Default Settings (Factory Set)

Straight out of the box, your drum module already contains a wide range of pre-programmed drum kits and songs. These default settings—collectively known as the Factory Set—can be conveniently restored at any time if you have accidentally overwritten them or wish to delete all of your own settings. To do so, use the Factory Set function as follows.

**NOTICE**

When you restore the Factory Set as described below, any changes you have made to parameters will be lost. Before proceeding, therefore, you should ensure that they contain no irreplaceable settings.

1. Press the [  ] (Standby/On) button and verify that the drum module turns off.
2. Turn on the drum module while holding down the [VOLUME+] button and the [VOLUME-] button.

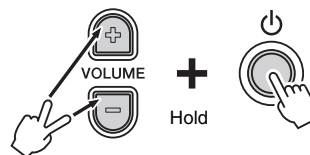

The drum module's lights will flash and the Factory Set will be restored.

# Component Names & Functions

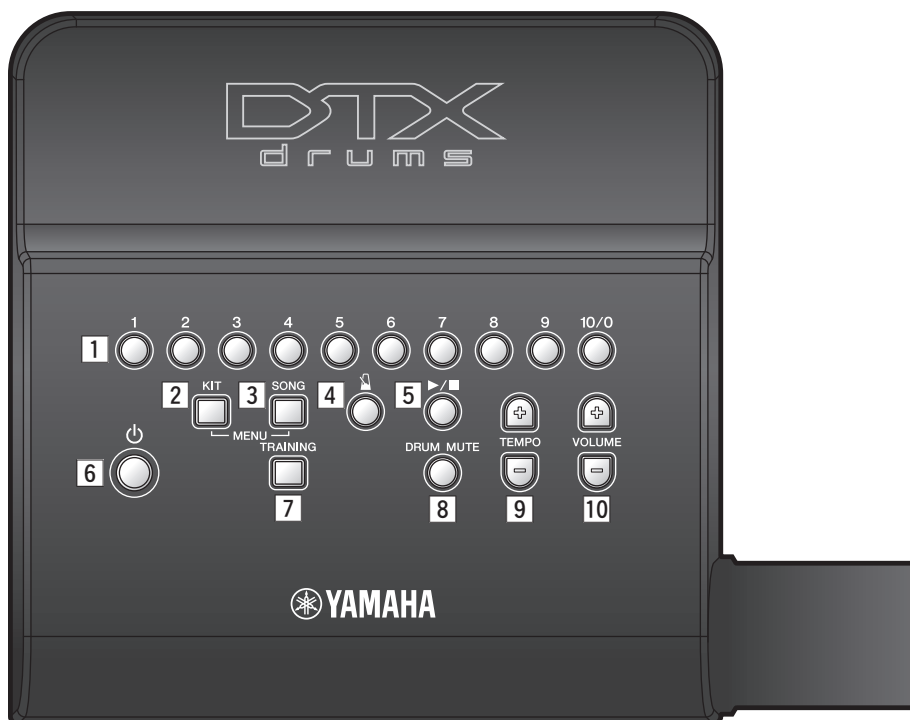

## Control Panel

### 1 Number buttons

- These buttons are used to select drum kits, songs, and training types. (pages 23, 25, 29)
- You can use them to enter a tempo directly. (page 28)
- In Menu Mode, they are used to select settings. (page 40)
- Also in Menu Mode, you can use them to enter setting values directly. (page 40)

### 2 [KIT] button (page 23)

Use this button when you want to select a different drum kit.

### 3 [SONG] button (page 25)

Use this button when you want to select a different song.

### 4 [ ] (metronome) button (page 27)

- This button is used to start and stop the built-in metronome.
- In Training Mode, it is also used to start and stop training sessions.

### 5 [▶/■] button

- Using this button, you can start and stop songs. (page 25)
- In Training Mode, it is also used to start and stop training sessions. (page 29)

### 6 [ ] (Standby/On) button (page 20)

Use this button to turn the drum module on and off.

### 7 [TRAINING] button (page 29)

This button is used to access Training Mode.

### 8 [DRUM MUTE] button (page 25)

Using this button, you can mute and unmute drum parts from a practice drum pattern.

### 9 [TEMPO] buttons (page 28)

Use these buttons to increase or decrease the tempo in steps of one BPM.

\*: In Menu Mode, the [TEMPO] buttons can also be used to increase or decrease settings.

### 10 [VOLUME] buttons (page 19)

These buttons are used to adjust the overall volume of the drum module. Press the [VOLUME+] button to increase it and the [VOLUME-] button to decrease it.

■ Left side

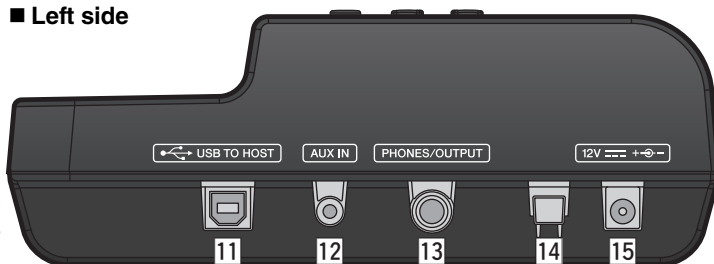

■ Right side

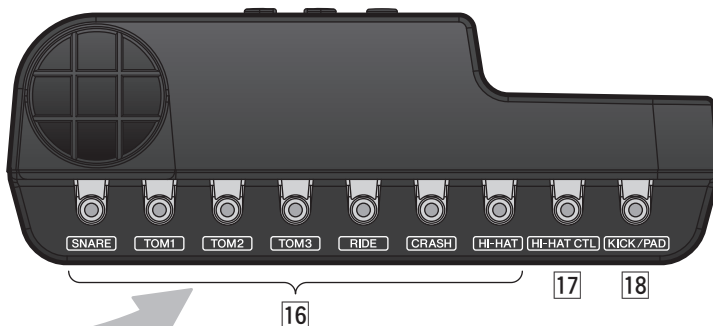

Control panel



**Left Side**

**11 [USB TO HOST] terminal (page 57)**

This terminal is used to connect the drum module to a computer via a USB cable.

**12 [AUX IN] jack (page 19)**



The Auxiliary Input stereo mini-jack is used to input audio from an external source. For example, you can use this jack to connect a portable music player, a CD player, or another similar device and play along with your favorite tunes.

**13 [PHONES/OUTPUT] jack (page 19)**

Use this standard stereo-audio jack to connect headphones, an amplifier, a mixer, or other similar equipment.

**14 Cord clip (page 19)**

Wrap the power adaptor cord around this clip to prevent accidental unplugging during use.

**15 [ 12V  +  ] connector (page 19)**

Use this connector for the power adaptor that came with your drum module.

**Right Side**

**16 Trigger input jacks (page 18)**

These jacks are used to connect the snare, tom, and cymbal pads.

**17 [HI-HAT CTL] jack (page 18)**

The Hi-hat Control jack is used to connect a hi-hat controller.

**18 [KICK/PAD] jack (page 18)**

Use this jack to connect a kick pad or pedal. When using a KP65 Kick Pad, an additional pad can be connected via the kick pad itself.

# Selecting & Playing a Kit

For the purpose of this manual, the term “kit” refers to a full set of drum-sound assignments for all of the pads. The drum module comes with ten different drum and percussion kits already set up.

## Selecting a Kit

1. Press the [KIT] button to activate Kit Mode.
2. Select a kit by pressing the corresponding number button ([1] to [10/0]).

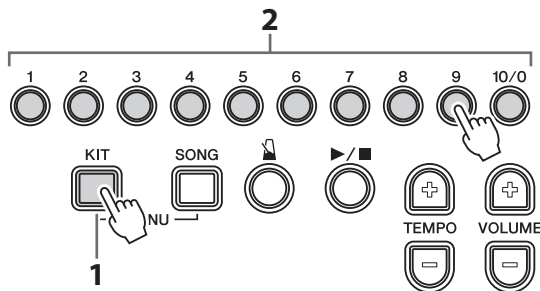

3. Play the pads and see how the kit sounds.

**NOTE**

For detailed information on the ten preset kits, see the Data List section (page 60).

### Quick select from Song Mode or Training Mode

In order to select a kit quickly without having to leave Song Mode or Training Mode, press and hold the [KIT] button, and then press the number button ([1] to [10/0]) for the desired kit.

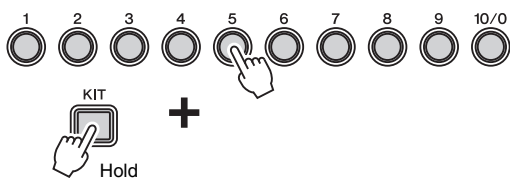

## Adjusting Kit Sensitivity

Using the following procedure, you can change the sensitivity of a kit—that is, how the drum sounds change depending on how hard you strike the pads. Sensitivity can be adjusted to ten different levels.

While holding the [KIT] button, press either the [VOLUME+] or [VOLUME-] button.

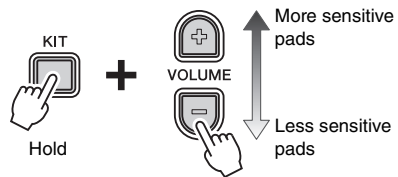

- Each time you press the [VOLUME+] button, you increase the sensitivity by one level. This means that louder sounds can be more easily produced with softer drumming.
- Each time you press the [VOLUME-] button, you decrease the sensitivity by one level. This means that louder sounds can only be produced by drumming hard.

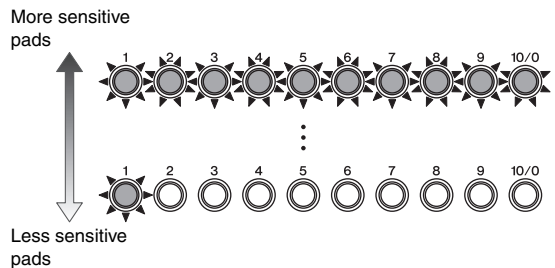

**NOTE**

- You can set a different sensitivity for each of the drum module's ten kits.
- If you wish to set sensitivities on an individual pad basis, see the descriptions of the Trigger Settings parameters from Menu Mode (page 46).

## Playing Techniques

### Snare Pad

If using a TP70S Snare Pad, you will be able to produce three distinct sounds (i.e., head, open rim, and closed rim) depending on where you strike it, much the same as if you were playing an acoustic snare.

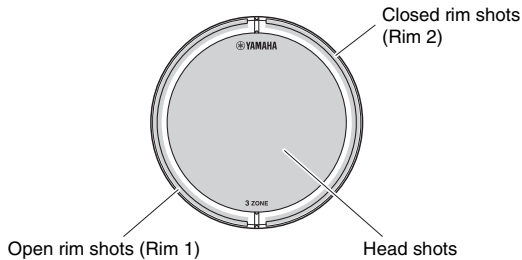

#### ● Head shots

Hitting the main surface of the pad produces a head shot sound.

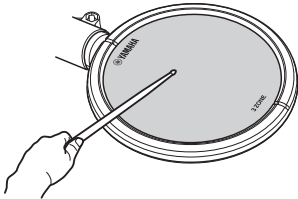

#### ● Open rim shots

Hitting the open-rim zone produces an open rim-shot sound.

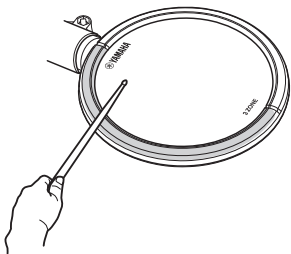

#### ● Closed rim shots (cross sticking)

Hitting the closed-rim zone produces a closed rim-shot sound.

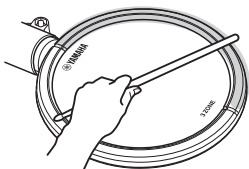

### Hi-hat Cymbal

#### ● Open/close

- You can produce an open hi-hat sound by striking the hi-hat pad with the hi-hat controller's pedal not depressed.
- You can produce a closed hi-hat sound by striking the hi-hat pad with the hi-hat controller's pedal depressed.
- If using an HH65 Hi-hat Controller, you can operate the pedal to recreate the sound of a closing hi-hat.

#### ● Foot closed

You can depress the hi-hat controller's pedal to create a foot-close sound without having to strike the hi-hat pad.

#### ● Hi-hat splash

Depressing the hi-hat controller's pedal and then immediately releasing it produces a hi-hat splash sound.



# Performing with a Song

The drum module comes complete with ten practice songs. Covering a wide range of genres, they provide a convenient, enjoyable way to practice drumming.

## Selecting a Song

1. Press the [SONG] button.
2. Press the [▶/■] button to start the current song.
3. If you wish press one of the number buttons ([1] to [10/0]) to select a different one.

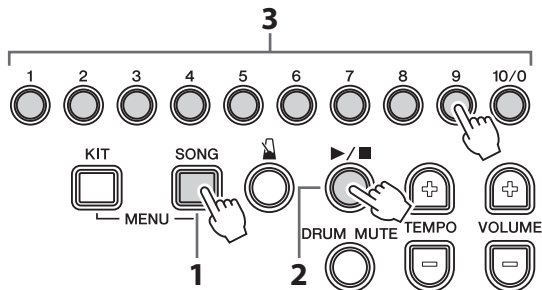

- You can stop song playback by pressing the [▶/■] button once again.
- If you wish to mute the programmed drum parts and hear only the song parts, press the [DRUM MUTE] button. To unmute the drum parts, press the [DRUM MUTE] button once again.
- The most appropriate drum kit is pre-assigned to each of the drum module's songs, so whenever you select a new song, the current kit will also change. If you wish to use a different kit to play a certain song, please select that kit after changing the song. For more details, see Quick select from Song Mode or Training Mode (page 23).

**NOTE**

For detailed information on the ten built-in songs, see the Data List section (page 60).

### Quick select from Kit Mode or Training Mode

In order to select a song quickly without having to leave Kit Mode or Training Mode, press and hold the [SONG] button, and then press the number button ([1] to [10/0]) for the desired song.

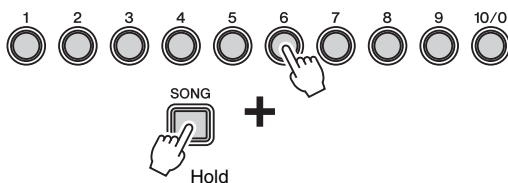

## Adjusting the Song Volume

Using the following procedure, you can set the volume of the current song to your preferred level.

1. Press the [▶/■] button to start the song.



2. While holding the [SONG] button, press either the [VOLUME+] or [VOLUME-] button.

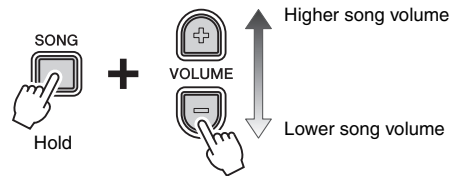

- Each time you press the [VOLUME+] button, you increase the song volume by one.
- Each time you press the [VOLUME-] button, you decrease the song volume by one.

## Adjusting the Volume of Muted Drum Parts

If you press the [DRUM MUTE] button while playing a song, the drum parts from the song will be muted—that is, their volume will be reduced to zero. If, however, you would like the drum parts to be slightly audible in this type of situation, you can adjust the muted volume as described below.

1. Press the [▶/■] button to start the song.
2. Press the [DRUM MUTE] button to mute the drum parts.

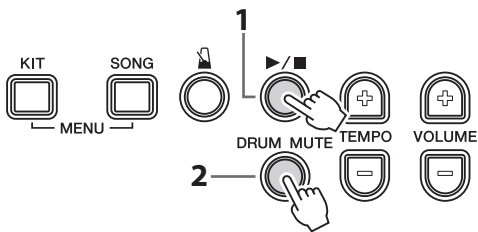

3. While holding the [DRUM MUTE] button, press either the [VOLUME+] or [VOLUME-] button.

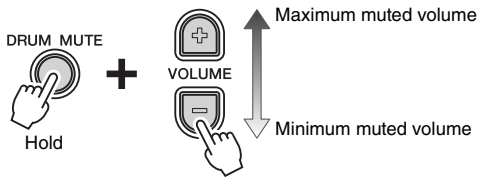

- Each time you press the [VOLUME+] button, you increase the volume of the muted drums by one.
- Each time you press the [VOLUME-] button, you decrease the volume of the muted drums by one.

By pressing the [DRUM MUTE] button once again, you can unmute the drum parts and restore their normal volumes.

## Looping Part of a Song

As described below, you can have a song playback between two points set in units of one measure. To do so, you simply need to set a loop start point (A) and a loop end point (B) while the song is playing.

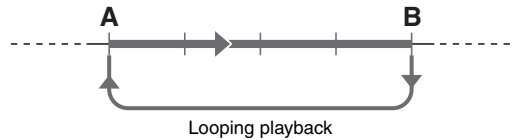

1. Press the [▶/■] button to start the song.



2. At point A, press and hold the [SONG] button and press the [▶/■] button.

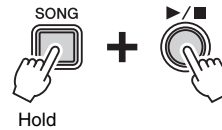

3. At point B, again press and hold the [SONG] button and press the [▶/■] button.

To stop looped playback, press and hold the [SONG] button and press the [▶/■] button.

### NOTE

- When you select a different song, looped playback will be cancelled automatically and points A and B will be reset.
- After an automatic lead-in (to help guide you into the phrase), the range from Point A to Point B is played back repeatedly.

# Using the Metronome

Playing your electronic drum kit along with the built-in metronome is a great way to perfect your rhythm.

## Starting and Stopping the Metronome



- Press the [M] button to turn on the metronome.
- Press the [M] button once again to turn it off.

## Adjusting the Metronome Volume

To adjust the volume of the metronome, press and hold the [M] button, and then press either the [VOLUME+] or [VOLUME-] button.

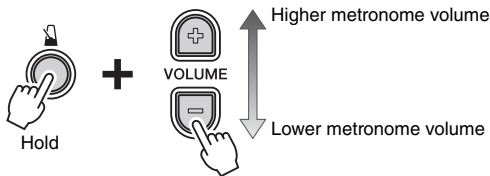

- Each time you press the [VOLUME+] button, you increase the metronome volume by one.
- Each time you press the [VOLUME-] button, you decrease the metronome volume by one.

## Confirming Tempo via Number Buttons

Whenever necessary, you can confirm the drum module's current tempo from the flashing pattern of the number button lights.

Press either the [TEMPO+] or [TEMPO-] button once.



Each digit of the tempo will be flashed in sequence.

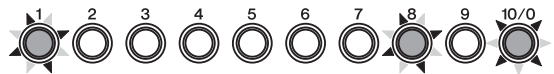

### Example:

When the tempo is 108 BPM, the number button lights will flash [1]→[0]→[8].

## Confirming Tempo via Voice Guidance

Whenever necessary, you can have the drum module speak the current tempo to you as a BPM value.

Press and hold the [M] button. You will hear the current tempo spoken (in English), and the number button lights will flash as described above.



## Adjusting the Tempo

The following three methods are available when you want to change the tempo.

- Increase or decrease using the [TEMPO+] or [TEMPO-] button
- Direct input of a BPM using the number buttons
- Setting a new tempo using pads (tap tempo)

### NOTE

- The drum module supports tempos between 30 and 300 BPM.
- If you select a different song (page 25) after adjusting the tempo, the selected song's tempo will be used for the metronome.

### ■ Increasing or decreasing using the [TEMPO+] or [TEMPO-] button



- Each time you press the [TEMPO+] button, you increase the metronome BPM by one.
- Each time you press the [TEMPO-] button, you decrease the metronome BPM by one.

### ■ Directly inputting a BPM using the number buttons

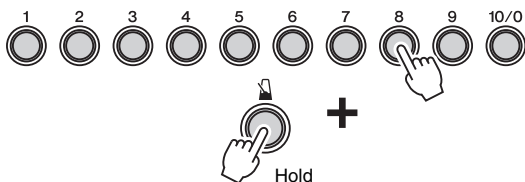

1. While holding the [TEMPO+] button, enter the BPM using the number buttons.

#### Example: Setting a tempo of 138 BPM

Press the number buttons in the sequence [1]→[3]→[8].

2. After entering all necessary digits, remove your finger from the [TEMPO+] button.

The drum module will speak the new tempo to you (in English).

### NOTE

- Number button [10/0] is used to enter the value zero. You cannot use it to enter the number ten.

#### Example: Setting a tempo of 110 BPM

Press the number buttons in the sequence

[1]→[1]→[10/0].

You cannot do this by pressing [1]→[10/0].

- There is no need to enter a zero first in order to set a two-digit tempo.

#### Example:

To set a tempo of 72 BPM, simply press the number buttons in the sequence [7]→[2]. You do not need to press [0]→[7]→[2].

- Whenever the drum module is speaking the tempo, you can enter a new tempo directly using the number buttons but without having to hold down the [TEMPO+] button.

### ■ Tapping the tempo on the pads

1. While holding the [TEMPO+] button, strike a pad at least three times at the desired tempo.

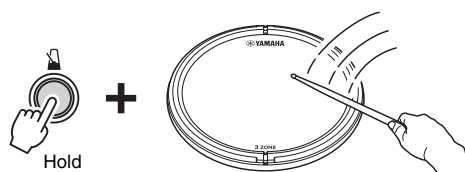

2. Remove your finger from the [TEMPO+] button.

### NOTE

Instead of using a pad, you can also tap the tempo by pressing the [TEMPO+] or [TEMPO-] button at least three times.

## Other Settings

The following metronome-related settings can be made in Menu Mode. For details, see the description of the Metronome Settings parameter group from Menu Mode (page 41).

- Metronome pattern
- Metronome length in beats
- Metronome sound
- Number-button lighting pattern when using the metronome

# Practicing in Training Mode



The drum module's Training Mode provides many different ways in which to practice playing the drums. With ten different types of training available, you can finely hone your sense of rhythm, master drum patterns from a range of different musical genres, or if you are a beginner, learn easy patterns in an enjoyable way.



## Training Mode

<b>Work on your rhythm</b>	
1. Groove Check .....	Page 30
2. Rhythm Gate.....	Page 31
3. Measure Break .....	Page 32
4. Tempo Up/Down .....	Page 33
5. Change Up .....	Page 34
<b>Have fun with drum patterns</b>	
6. Easy Session.....	Page 35
7. Groove Tracker .....	Page 36
<b>Learn new drum patterns</b>	
8. Pad Gate.....	Page 37
9. Part Mute.....	Page 38
<b>Play as wildly as you can</b>	
10. Fast Blast.....	Page 39

## Basic Training Mode Procedure



The basic procedure common to all ten types of training is as follows.

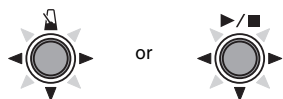

1. Press the [TRAINING] button to activate Training Mode. 
2. Select your desired training type by pressing the corresponding number button ([1] to [10/0]). 

The [] and/or [/■] button will flash, indicating that the drum module is on standby to start training.



**NOTE**

- The buttons that flash at this time depend on the type of training selected.
- Both the [] and [/■] buttons will flash with certain types of training.

3. Press the flashing [] or [/■] button to start training.

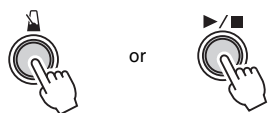

4. To end training, press the button used to start it in Step 3. above.

- To select a different kit from Training Mode, press and hold the [KIT] button, and then press the number button ([1] to [10/0]) for the desired kit. (See Quick select from Song Mode or Training Mode on page 23.)
- To select a different song from Training Mode, press and hold the [SONG] button, and then press the number button ([1] to [10/0]) for the desired song. (See Quick select from Kit Mode or Training Mode on page 25.)

**NOTE**

- If you wish to adjust the duration of training, see the description of the Timer parameter from Menu Mode (page 49).
- If you wish to adjust the duration of Fast Blast training, see the description of the Fast Blast Timer parameter from Menu Mode (page 52).

## ■ Scoring function

The drum module's scoring function, which is used with certain types of training, evaluates your ability on a scale of one to ten and displays the result using the number buttons ([1] to [10/0]). Number button [10/0] represents the highest score; number button [1], the lowest.

In addition, the Voice Guidance function announces the results of scoring using the five levels shown below.

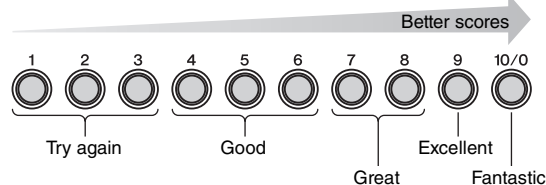

**NOTE**

Fast Blast training uses its own unique form of scoring. See page 39 for more details.

TRAINING → 1 **Groove Check**

As an aid to improving your timing, Groove Check uses the number button lights to show how early or late you are drumming. Two different training styles are available—the first uses the metronome; the second lets you play along with a song. At the end of training, the drum module will display your score using number buttons [1] to [10/0] and will also speak it to you.

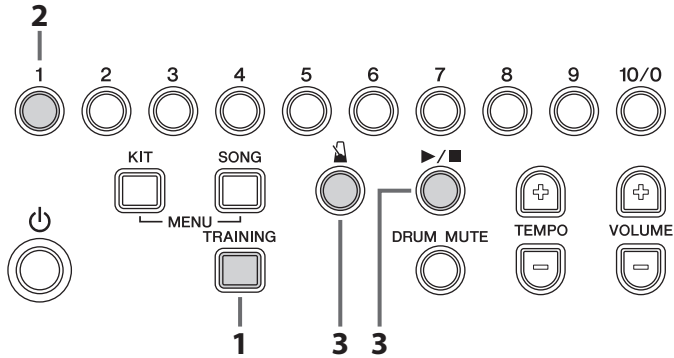

1. Press the [TRAINING] button to activate Training Mode.
2. Press number button [1].  
The [MUTE] and [▶/■] buttons will flash, indicating that the drum module is on standby to start training.
3. Press either the [MUTE] or [▶/■] button when you are ready to go.  
If you press the [MUTE] button, the metronome will be used for training. Alternatively, if you press the [▶/■] button, the current song will be used.
4. Play the pads as tightly as you can along with the metronome or song.

● **Display of individual strikes**

- The number buttons ([1] to [10/0]) will flash to indicate the accuracy of the timing of individual strikes.
- If number buttons [5] and [6] flash together, your timing for the current strike was perfect.
- Number buttons [6] to [10/0] indicate that the current strike was late. The further from the [5] and [6] number buttons, the later the strike.
- Number buttons [5] to [1] indicate that the current strike was early. The further from the [5] and [6] number buttons, the earlier the strike.

● **Display of current timing variation**

- Half-lit number buttons ([1] to [10/0]) indicate how tightly you are currently playing.
- The wider the band of half-lit number buttons, the greater the degree of variation in your timing.

5. To end training, press the button used to start it in Step 3. above.

The drum module will display your score using number buttons [1] to [10/0] and will also speak it to you (in English). For more details regarding scoring, see Scoring function (page 29).

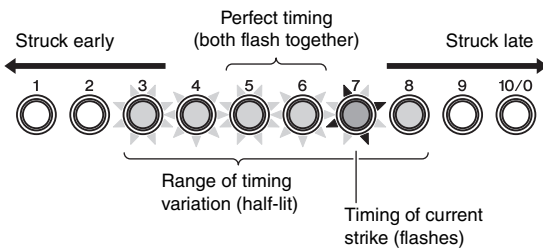

TRAINING  →  **Rhythm Gate**

Rhythm Gate training allows you to confirm by ear whether or not your timing is accurate. If you do not strike a pad in time, it will not produce any sound. Two different training styles are available—the first uses the metronome; the second lets you play along with a song. At the end of training, the drum module will display your score using number buttons [1] to [10/0] and will also speak it to you.

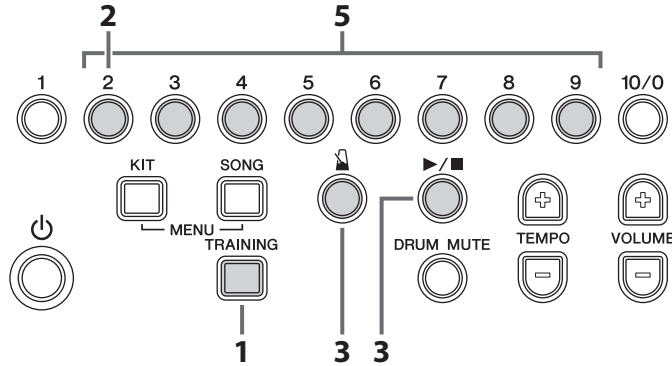

1. Press the [TRAINING] button to activate Training Mode.
2. Press number button [2].  
The [ ] and [▶/■] buttons will flash, indicating that the drum module is on standby to start training.
3. Press either the [ ] or [▶/■] button when you are ready to go.  
If you press the [ ] button, the metronome will be used for training. Alternatively, if you press the [▶/■] button, the current song will be used.
4. Play the pads as tightly as you can along with the metronome or song.  
The pads will only produce a sound when struck in time. In addition, the number buttons will light up as shown below during this training.

5. Press number buttons [2] to [9] to adjust the difficulty level (i.e., the width of the gate). Four different levels are available as shown below. The higher the difficulty level, the more accurate your timing will have to be in order to produce a sound.

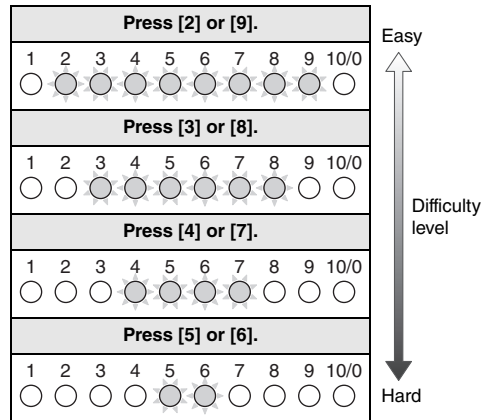

**NOTE**  
Number buttons [1] and [10/0] are not used with this type of training.

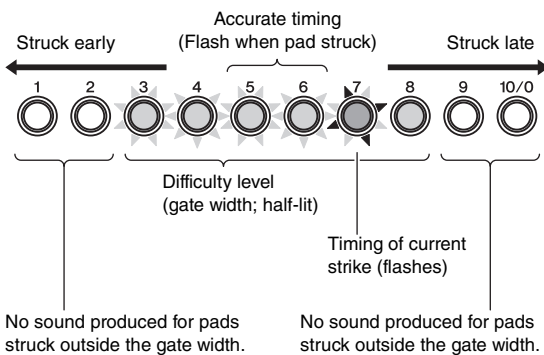

6. To end training, press the button used to start it in Step 3. above.  
Your score will be displayed using number buttons [1] to [10/0] and will also be spoken to you (in English). For more details regarding scoring, see Scoring function (page 29).

TRAINING

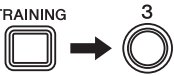

## Measure Break

With Measure Break training, the metronome will be muted for certain measures in a sequence. For example, by setting the measures during which you play fills to be muted in this way, you can check for any deviation in your timing when the metronome returns. This will help you to play at a constant tempo throughout your performances. Please note that this type of training is not scored.

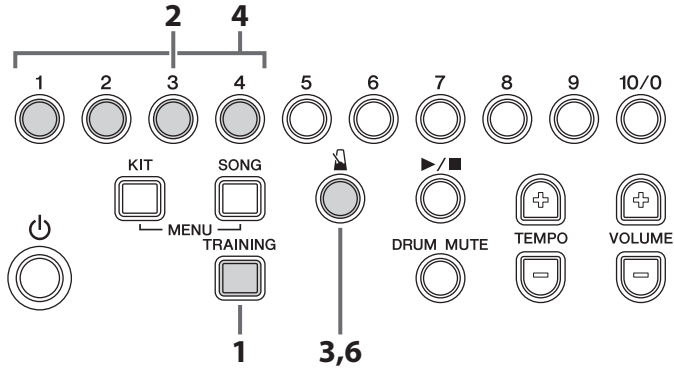

1. Press the [TRAINING] button to activate Training Mode.
2. Press number button [3].  
The [ ] button will flash, indicating that the drum module is on standby to start training.
3. Press the [ ] button.  
The metronome will start to play a sequence of four measures in length.

4. If necessary, press the number buttons corresponding to the measures in the sequence to toggle the metronome on (fully-lit) or off (half-lit) for them.

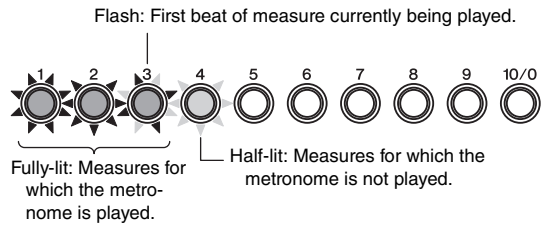

- Each of the number buttons represents a measure in the sequence.
  - On the first beat of each measure, the corresponding number button will flash.
5. Practice playing the pads along with the song.
  6. To end training, press the [ ] button once again.

**NOTE**

You can also change the number of measures in the metronome sequence. To do so, press and hold the corresponding number button ([2] to [10/0]) until the displayed sequence length changes. For example, to set the sequence length to eight measures, press and hold number button [8].



TRAINING → **4** **Tempo Up/Down**

Use Tempo Up/Down training to see how fast you can go and still maintain accurate timing. As you play along with a metronome, the drum module will automatically increase the tempo if your timing is good and decrease it if not. Please note that this type of training is not scored.

**If you would like to check or adjust the current tempo before you start training, see Using the Metronome (page 27).**

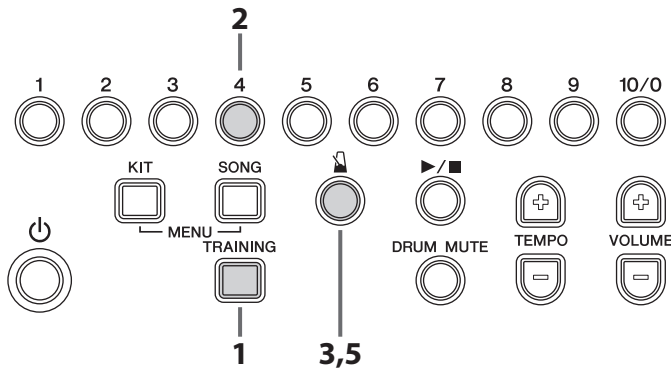

1. Press the [TRAINING] button to activate Training Mode.
2. Press number button [4].  
The [4] button will flash, indicating that the drum module is on standby to start training.
3. Press the [4] button.  
The metronome will start playing.
4. Focusing on accurate timing, play the pads along with the metronome. The half-lit number buttons indicate how much time remains before the end of the current four measures.  
The drum module will evaluate your timing after every four measures.  
  - If your timing was accurate during the four measures, the drum module will automatically increase the metronome's tempo and the number-button lights will scan quickly once from left to right.



- If your timing was not accurate during the four measures, the drum module will automatically decrease the metronome's tempo and the number-button lights will scan quickly once from right to left.

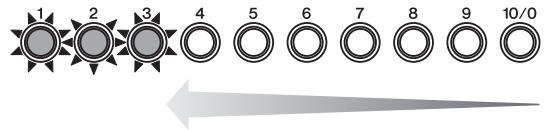

- Continue to play along with the metronome as the tempo changes each four measures.
5. To end training, press the [4] button once again.

**NOTE**

- If you wish to adjust the difficulty level for this training, see the description of the Difficulty Level parameter from Menu Mode (page 50).
- This training can be set either to mute pads when they are not played in time or to play pads whenever they are struck. For details, see the description of the Ignore Timing parameter from Menu Mode (page 50).

TRAINING → **5** **Change Up**

In Change Up training, your aim is to maintain good timing as you play along with up to seven different practice rhythms that change every two measures. The rhythms are assigned to number buttons [1] to [7], allowing you to freely choose which ones you want to practice with. At the end of training, the drum module will display your score using number buttons [1] to [10/0] and will also speak it to you.

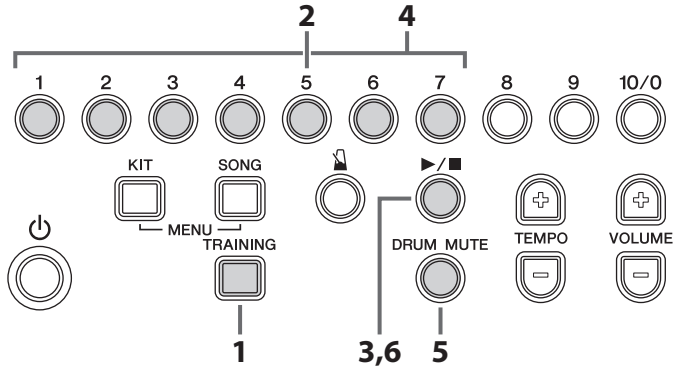

1. Press the [TRAINING] button to activate Training Mode.
2. Press number button [5].  
The [▶/■] button will flash, indicating that the drum module is on standby to start training.
3. Press the [▶/■] button when you are ready to go.
  - A practice rhythm and the metronome will start to play, and the practice rhythm will change after every two measures.
4. Press number buttons [1] to [7] to select the rhythms to practice with.
  - When a number button is fully lit, the corresponding rhythm will be included in the practice session.
  - When a number button is half lit, the corresponding rhythm will be skipped as you practice.
  - The number buttons will flash to indicate which rhythm you should be playing.

5. Focusing on accurate timing, play the practice rhythm on the pads.
  - To adjust the volume of the practice rhythm, press and hold the [SONG] button, and then press either the [VOLUME+] or [VOLUME-] button.
  - To mute the practice rhythm and play along with only the metronome, press the [DRUM MUTE] button.
  - To unmute the practice rhythm, press the [DRUM MUTE] button once again.
6. To end training, press the [▶/■] button once again. The drum module will display your score using number buttons [1] to [10/0] and will also speak it to you (in English). For more details regarding scoring, see Scoring function (page 29).

**NOTE**

- You can also press the [■] button to end training.
- If you wish to adjust the difficulty level for this training, see the description of the Difficulty Level parameter from Menu Mode (page 50).
- This training can be set either to mute pads when they are not played in time or to play pads whenever they are struck. For details, see the description of the Ignore Timing parameter from Menu Mode (page 50).
- You can also change the number of measures for which each practice rhythm is repeated by pressing number button [10/0]. When this button is half lit, each rhythm will be played for four measures before changing; when fully lit, the rhythm will be played for one measure; and when not lit, it will be played for two measures.

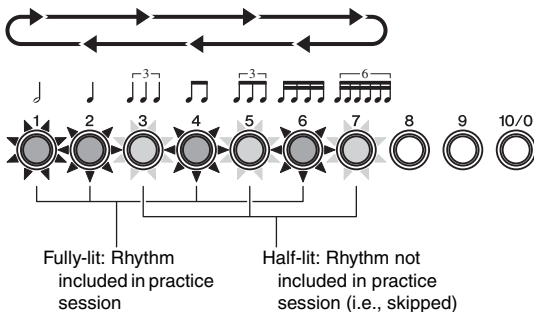

TRAINING → **Easy Session**

Easy Session training lets you play a drum pattern along with an accompanying song simply by striking any pad(s) in time. As such, it is not unlike a basic form of jamming with other band members. Please note that this type of training is not scored.

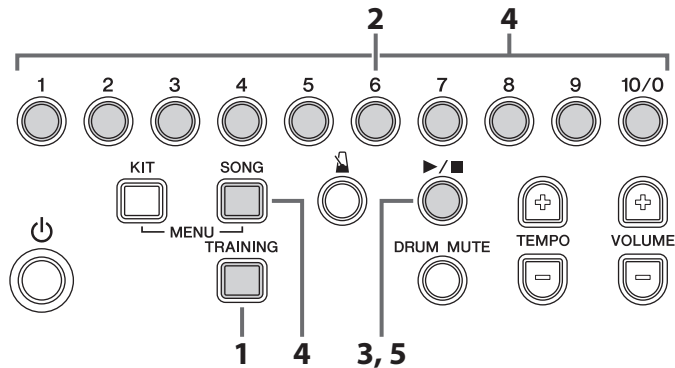

1. Press the [TRAINING] button to activate Training Mode.
2. Press number button [6].  
The [▶/■] button will flash, indicating that the drum module is on standby to start training.
3. Press the [▶/■] button to start the accompaniment.
4. Play the pads along with the accompaniment.
  - Regardless of which pad(s) you strike, the drum module will play the correct sounds for the drum pattern. For this reason, you will not necessarily hear the pad you strike.
  - If you stop playing the pads, the drum module will stop playing the drum pattern.
  - The half-lit number buttons provide a guide to variations in the drum pattern.

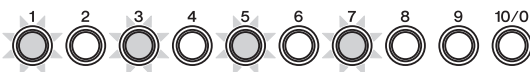

Half lit = When to strike the pad(s)

- In order to play the drum pattern correctly, the pads must be struck at precisely the timing indicated by the half-lit number buttons.
  - To select a different song while training, hold down the [SONG] button and press the corresponding number button ([1] to [10/0]).
5. To end training, press the [▶/■] button once again.

**NOTE**

The [DRUM MUTE] button is not used with this type of training.

TRAINING → **7** **Groove Tracker**

Groove Tracker makes it simple to play a number of different practice drum patterns, which will automatically reflect the speed and strength of your drumming. In addition, you can also freely add your own fills to the basic pattern. Please note that this type of training is not scored.

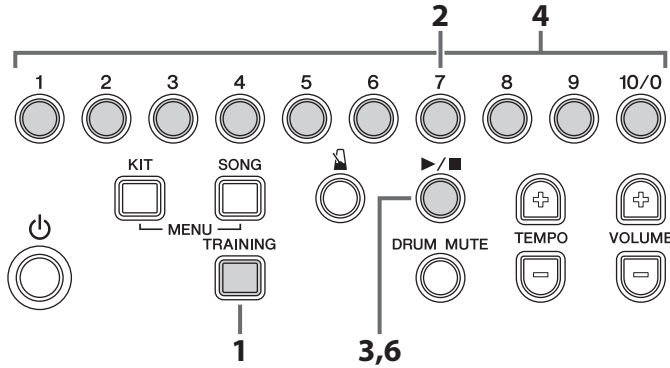

1. Press the [TRAINING] button to activate Training Mode.
2. Press number button [7].  
The [▶/■] button will flash, indicating that the drum module is on standby to start training.
3. Press the [▶/■] button when you are ready to go.  
The drum module will play the practice drum pattern once. In addition, the number buttons ([1] to [10/0]) will light up as the pattern plays.
4. To select a different practice drum pattern, press the corresponding number button ([1] to [10/0]).
5. Play the hi-hat or kick pad. Each time you do so, the next part of the drum pattern will be played.
  - Refer to the drum scores in the Data List section (page 62) for details on the pads to be played to advance each drum pattern and how much the patterns advance with each strike.
  - The tempo of the drum pattern will change to reflect the speed of your drumming.
  - The volume of the drum pattern will change to reflect the strength of your drumming.

**NOTE**

- You can select which pad(s) you would like to use to advance the drum pattern. For details, see the description of the Groove Tracker Control Pad(s) parameter from Menu Mode (page 51).
- You can set how much the practice drum pattern should advance for each strike of the selected pad(s). For details, see the description of the Groove Tracker Advance Step parameter from Menu Mode (page 51).

- If you briefly stop drumming and then begin again, the drum pattern will play from the start.

**NOTE**

You can set the period of time after which the drum pattern will return to the start when you stop drumming. For details, see the description of the Groove Tracker Return Time parameter from Menu Mode (page 50).

6. To end training, press the [▶/■] button once again.

**Muting specific parts from the practice drum pattern**

You can mute any of the individual drum parts (i.e., snare, kick, tom, hi-hat, and/or cymbal) that make up the practice drum pattern. If, for example, you were to mute the snare part, you could play whatever snare pattern you like along with the rest of the drum parts.

1. Press the [DRUM MUTE] button and verify that it lights up.



2. Strike the pad corresponding to the part from the practice drum pattern you wish to mute.
  - The selected drum part will now be muted.
  - If the pad corresponding to the muted drum part is not struck for certain period of time, it will be automatically unmuted.
3. To manually unmute all drum parts, press the [DRUM MUTE] button once again and verify that it turns off.

**NOTE**

The [▶/■] button is not used with this type of training.

TRAINING → **8** **Pad Gate**

In Pad Gate training, the pads will only produce a sound when your drumming precisely matches a practice drum pattern. At the end of training, the drum module will display your score using number buttons [1] to [10/0] and will also speak it to you.

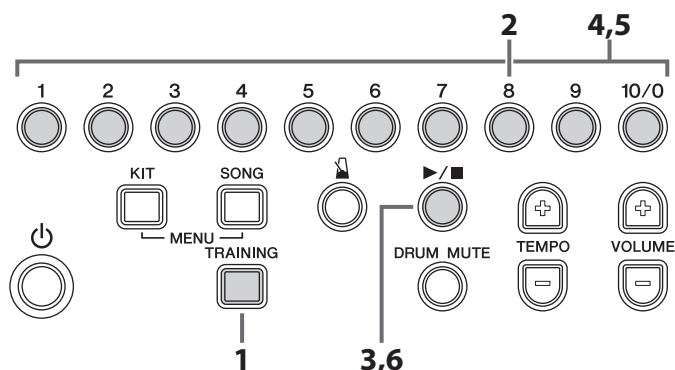

1. Press the [TRAINING] button to activate Training Mode.
2. Press number button [8].  
The [▶/■] button will flash, indicating that the drum module is on standby to start training.
3. Press the [▶/■] button when you are ready to go.
  - The drum module will start to play the practice drum pattern.
  - The number buttons ([1] to [10/0]) will light up to display the progression of the practice drum pattern.
4. If necessary, select a different practice drum pattern using number buttons [1] to [10/0].  
Drum scores for the various practice drum patterns can be found in the Data List section (page 62).
5. Play the practice drum pattern on the pads.
  - The pads will not produce a sound if they are struck out of time.
  - If you play any phrase other than the practice drum pattern, the pads will not produce a sound.
  - To select a different practice drum pattern, press the corresponding number button ([1] to [10/0]).
6. To end training, press the [▶/■] button once again.  
The drum module will display your score using number buttons [1] to [10/0] and will also speak it to you (in English). For more details regarding scoring, see Scoring function (page 29).

#### Muting specific parts from the practice drum pattern

You can mute any of the individual drum parts (i.e., snare, kick, tom, hi-hat, and/or cymbal) that make up the practice drum pattern. If, for example, you were to mute the snare part, you could focus your training on just the snare pad.

1. Press the [DRUM MUTE] button and verify that it lights up.



2. Strike the pad corresponding to the part from the practice drum pattern you wish to mute.
  - The selected drum part will now be muted.
  - If the pad corresponding to the muted drum part is not struck for certain period of time, it will be automatically unmuted.
3. To manually unmute all drum parts, press the [DRUM MUTE] button once again and verify that it turns off.

#### NOTE

- If you wish to adjust the difficulty level for this training, see the description of the Difficulty Level parameter from Menu Mode (page 50).
- You can choose either to mute pads when they are not played in time or to play all pads regardless of when they are struck. For details, see the description of the Ignore Timing parameter from Menu Mode (page 50).
- You can set which groups of pads the drum module should consider when deciding whether or not you are playing the correct pattern. For details, see the description of the Pad Gate Group parameter from Menu Mode (page 52).

TRAINING  →  **Part Mute**

Part Mute training lets you mute any or all of the drum parts (i.e., hi-hat, snare, kick, tom, and/or cymbal) and also the instrument parts from an accompanying song. Please note that this type of training is not scored.

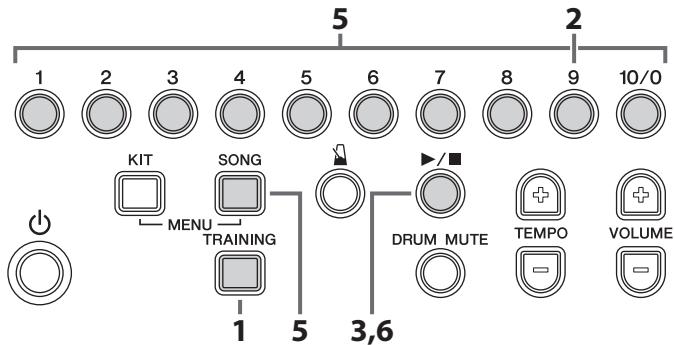

1. Press the [TRAINING] button to activate Training Mode.
2. Press number button [9].  
The [▶/■] button will flash, indicating that the drum module is on standby to start training.
3. Press the [▶/■] button to start the current song.  
Each of the drum parts and the non-drum parts are assigned to different number buttons as shown in the diagram, allowing you to mute and unmute them by pressing the corresponding button. (see the description below)
4. Practice playing the pads along with the song.
5. To select a different song while training, hold down the [SONG] button and press the corresponding number button ([1] to [10/0]).
6. To end training, press the [▶/■] button once again.

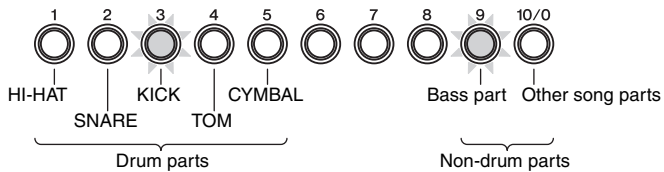

■ **Muting drum parts**

● **Muting with number buttons [1] to [5]**

1. To mute a drum part, press the corresponding number button.  
The part will be muted and the number button will light up.
2. To unmute a drum part, again press the corresponding number button, which will be lit.  
The part will be unmuted and the number button's light will go out.

**NOTE**

When you play the pads, the number buttons will flash to indicate the corresponding drum parts.

● **Muting with the pads**

1. Press the [DRUM MUTE] button and verify that it lights up.
2. Strike the pad corresponding to the drum part you wish to mute.  
The selected part will be muted and the corresponding number button will light up.
3. To manually unmute all drum parts, press the [DRUM MUTE] button once again and verify that its light goes out.

**NOTE**

If the pad(s) corresponding to a muted drum part are not struck for certain period of time, the part will be automatically unmuted and the number button's light will go out.

■ **Muting non-drum parts**

1. Press number button [9] to mute the accompanying song's bass part; press number button [10/0] to mute the other instrument parts.  
The number button(s) corresponding to the muted song part(s) will light up.
2. To unmute song parts, again press the corresponding number button(s), which will be lit.  
The number button light(s) will go out.

TRAINING 10/0 **Fast Blast**

In a Fast Blast training session, you just play the drums as wildly as you can over a set period of time. More a game than a form of practice, your aim is to get the highest possible score. At the end of training, the drum module will display your score using number buttons [1] to [10/0] and will also speak it to you.

**NOTE**  
Fast Blast uses a different scoring system than the other types of training.

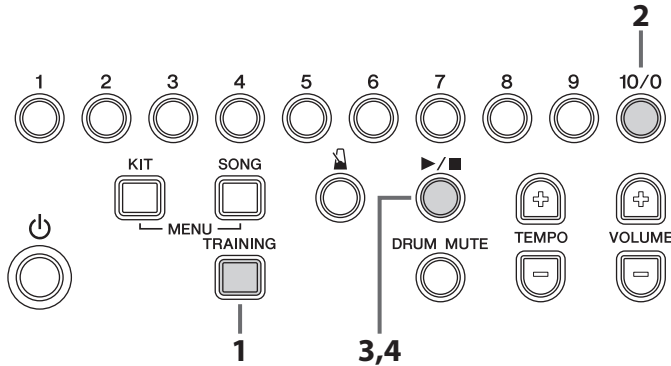

1. Press the [TRAINING] button to activate Training Mode.
2. Press number button [10/0].  
The [▶/■] button will flash, indicating that the drum module is on standby to start training.
3. Press the [▶/■] button.
4. Within the training time (10 seconds), play as many of the pads as often as you can.
  - The timer will start when you strike the first pad.
  - Each time you strike a pad and increase your score, the position of the fully-lit number button moves from left to right.

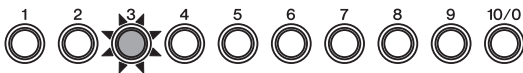

- The half-lit number buttons indicate how much time is left before the end of the training session. Specifically, the half-lit number button lights will successively go out from right to left, and the training session will end when they are all turned off.

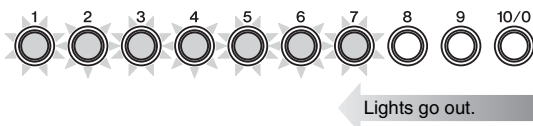

- When the training session has ended, the drum module will display your score using number buttons [1] to [10/0] and will also speak it to you (in English).

**Example:**  
If you scored 980, the number buttons would flash [9]→[8]→[0].

- To end a training session before the timer runs out, press the [▶/■] button once again.

- NOTE**
- If you would like to check your score once again, press any of the number buttons [1] to [10/0].
  - If you wish to adjust the training time, see the description of the Fast Blast Timer parameter from Menu Mode (page 52).

# Setting Parameters using Menu Mode

Menu Mode is used to set drum-module parameters and functions, which are arranged into the following seven groups.

<b>1</b>	<b>Metronome Settings</b>	
1-1.	Pattern .....	Page 41
1-2.	Beats .....	Page 41
1-3.	Sound .....	Page 41
1-4.	Number Button Lighting Pattern .....	Page 42
<b>2</b>	<b>Kit Settings</b>	
2-1.	Pad Sound .....	Page 42
2-2.	Pad Volume .....	Page 42
2-3.	Pad Panning .....	Page 43
2-4.	Double Bass Drum .....	Page 43
2-5.	Reverb .....	Page 43
<b>3</b>	<b>MIDI Settings</b>	
3-1.	Local Control .....	Page 44
3-2.	Note Number .....	Page 44
<b>4</b>	<b>Hi-hat Settings</b>	
4-1.	Clutch Position .....	Page 45
4-2.	Splash Sensitivity .....	Page 45
4-3.	Foot Close Position .....	Page 45
4-4.	Foot Close Velocity .....	Page 45
4-5.	Kick Velocity .....	Page 46
<b>5</b>	<b>Trigger Settings</b>	
5-1.	Pad Velocity Curve .....	Page 46
5-2.	Crosstalk .....	Page 47
5-3.	Snare Pad Type .....	Page 48
5-4.	Pedal Types .....	Page 48
5-5.	Gain .....	Page 49
5-6.	Minimum Level .....	Page 49
<b>6</b>	<b>Training Settings</b>	
6-1.	Timer .....	Page 49
6-2.	Difficulty Level .....	Page 50
6-3.	Ignore Timing .....	Page 50
6-4.	Groove Tracker Return Time .....	Page 50
6-5.	Groove Tracker Control Pad(s) .....	Page 51
6-6.	Groove Tracker Advance Step .....	Page 51
6-7.	Pad Gate Group .....	Page 52
6-8.	Fast Blast Timer .....	Page 52
<b>7</b>	<b>Other Settings</b>	
7-1.	Kit Lock .....	Page 53
7-2.	Voice Guidance Volume .....	Page 53
7-3.	Auto Power-Off Time .....	Page 53
7-4.	Stereo/Mono .....	Page 53
7-5.	Initialize Kit .....	Page 54
7-6.	Initialize Song .....	Page 54
7-7.	Revert to Last Power On .....	Page 55
7-8.	Factory Set .....	Page 55

## Basic Menu Mode Procedure

The basic procedure used to activate Menu Mode and select the parameter to be set is as follows. For details of the individual parameters, please see the corresponding sections below.

- While holding the **[KIT]** button, press the **[SONG]** button to activate Menu Mode. Number buttons **[1]** to **[7]** will start to flash.

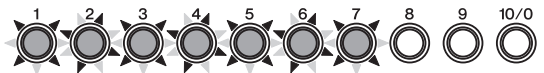
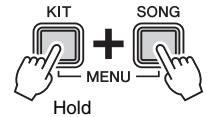

- Press the number button corresponding to the group containing the parameter you wish to set. (Parameter groups are shown in the hierarchical list on the left.)

Number button	Group	Number button	Group
[1]	Metronome Settings	[4]	Hi-hat Settings
[2]	Kit Settings	[5]	Trigger Settings
[3]	MIDI Settings	[6]	Training Settings
		[7]	Other Settings

- Press the number button corresponding to the parameter you wish to set. (Parameters are shown in the hierarchical list on the left.) The number buttons flash continuously to indicate the current setting.
- Enter the new setting.

You can use the number buttons to directly set parameters with numerical values, such as a velocity. To enter the value 105, for example, press the number buttons in the order **[1]**→**[10/0]**→**[5]**.

- Number button **[10/0]** is used to enter the value zero. You cannot use it to enter the number ten.
- If you take no action for awhile, the setting is automatically stored.
- When you have entered a value, the number buttons will flash continuously to indicate the new setting.

**NOTE**

You can also use the **[TEMPO+]** and **[TEMPO-]** buttons to increase and decrease setting values. Specifically, the **[TEMPO+]** button increases the current setting by one each time it is pressed; the **[TEMPO-]** button decreases it by one.



# 1 Metronome Settings

## 1-1. Pattern

**Steps:**  
MENU ([KIT] + [SONG]) → [1] → [1] → Setting

Using the following procedure, you can set one of eight patterns for the drum module's metronome.

1. While holding the **[KIT]** button, press the **[SONG]** button to activate Menu Mode.
2. Press number button **[1]** to select the Metronome Settings parameter group.
3. Press number button **[1]** to select the Pattern parameter.
4. Select a new metronome pattern using the corresponding number button (**[1]** to **[8]**). The available settings are as follows.

Number button	Setting
[1]	
[2]	
[3]	
[4]	
[5]	
[6]	
[7]	
[8]	

**NOTE**  
With settings [2], [4], [6], and [8], the first beat is accented.

## 1-2. Beats

**Steps:**  
MENU ([KIT] + [SONG]) → [1] → [2] → Setting

Using the following procedure, you can set the metronome to between 1 and 9 beats in length.

1. While holding the **[KIT]** button, press the **[SONG]** button to activate Menu Mode.
2. Press number button **[1]** to select the Metronome Settings parameter group.
3. Press number button **[2]** to select the Beats parameter.
4. Select a new metronome length in beats using the corresponding number button (**[1]** to **[9]**). The available settings are as follows.

Number button	Setting
[1]	1 beat
[2]	2 beats
[3]	3 beats
[4]	4 beats
[5]	5 beats
[6]	6 beats
[7]	7 beats
[8]	8 beats
[9]	9 beats

## 1-3. Sound

**Steps:**  
MENU ([KIT] + [SONG]) → [1] → [3] → Setting

Using the following procedure, you can set the sound played by the metronome to, for example, a standard click sound, a cowbell, a drumsticks sound, or a spoken count.

1. While holding the **[KIT]** button, press the **[SONG]** button to activate Menu Mode.
2. Press number button **[1]** to select the Metronome Settings parameter group.
3. Press number button **[3]** to select the Sound parameter.
4. Select a new metronome sound using the corresponding number button (**[1]** to **[6]**). The available settings are as follows.

Number button	Setting
[1]	Metronome click 1
[2]	Metronome click 2
[3]	Cowbell
[4]	Drumsticks
[5]	Spoken count 1
[6]	Spoken count 2

## 1-4. Number Button Lighting Pattern

**Steps:**

MENU ([KIT] + [SONG]) → [1] → [4] → Setting

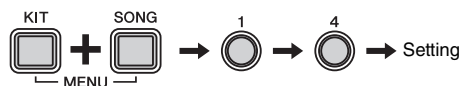

You can have number buttons [1] to [10/0] light up when playing the metronome in Kit Mode or Song Mode. Use the following procedure to set the buttons' lighting pattern.

1. While holding the [KIT] button, press the [SONG] button to activate Menu Mode.
2. Press number button [1] to select the Metronome Settings parameter group.
3. Press number button [4] to select the Number Button Lighting Pattern parameter.
4. Select a new lighting pattern using the corresponding number button ([1] to [3]). The available settings are as follows.

Number button	Setting
[1]	Off (no lighting)
[2]	Pattern 1
[3]	Pattern 2

## 2 Kit Settings

### 2-1. Pad Sound

**Steps:**

MENU ([KIT] + [SONG]) → [2] → [1] → Setting

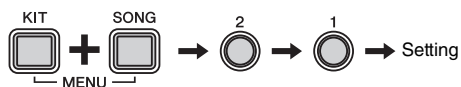

Using the following procedure, you can change the sounds assigned to the current kit's pads. This makes it very easy to create your own unique kits.

1. While holding the [KIT] button, press the [SONG] button to activate Menu Mode.
2. Press number button [2] to select the Kit Settings parameter group.
3. Press number button [1] to select the Pad Sound parameter.
4. Strike a pad to select it.
5. Enter a new drum-sound number using number buttons [1] to [10/0]. For a list of sounds and numbers, see the Voice List (page 61).

Setting
1 to 169

### 2-2. Pad Volume

**Steps:**

MENU ([KIT] + [SONG]) → [2] → [2] → Setting

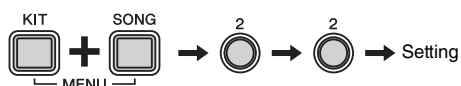

Using the following procedure, you can adjust the volume of the current kit's pads.

1. While holding the [KIT] button, press the [SONG] button to activate Menu Mode.
2. Press number button [2] to select the Kit Settings parameter group.
3. Press number button [2] to select the Pad Volume parameter.
4. Strike a pad to select it.
5. Enter a new volume using number buttons [1] to [10/0].

Setting
0 to 127

### 2-3. Pad Panning

**Steps:**  
MENU ([KIT] + [SONG]) → [2] → [3] → Setting

Using the following procedure, you can adjust the panning of the current kit's pads.

1. While holding the [KIT] button, press the [SONG] button to activate Menu Mode.
2. Press number button [2] to select the Kit Settings parameter group.
3. Press number button [3] to select the Pad Panning parameter.
4. Strike a pad to select it.
5. Enter a new panning position using number buttons [1] to [10/0]. A value of 64 corresponds to the center position. Smaller values than this move the pad increasingly towards the left; larger values move it towards the right.

Setting
0 to 127

### 2-4. Double Bass Drum

**Steps:**  
MENU ([KIT] + [SONG]) → [2] → [4] → Setting

Using the following procedure, you can easily configure the drum module to produce a kick drum sound when you operate the pedal connected to the [HI-HAT CONTROL] trigger input jack. This convenient function provides support for double bass drumming techniques.

1. While holding the [KIT] button, press the [SONG] button to activate Menu Mode.
2. Press number button [2] to select the Kit Settings parameter group.
3. Press number button [4] to select the Double Bass Drum parameter.
4. Set the parameter using number button [1] or [2]. The available settings are as follows.

Number button	Setting
[1]	Off
[2]	On

**NOTE**

While the Double Bass Drum function is enabled, you will be unable to use the hi-hat controller plugged into the [HI-HAT CONTROL] trigger input jack to simulate opening and closing of the hi-hat.

### 2-5. Reverb

**Steps:**  
MENU ([KIT] + [SONG]) → [2] → [5] → Setting

Reverb effects add a warm ambience to sounds, simulating the complex reflections of actual performance spaces, such as a concert hall or a small club. Use the following procedure to select a reverb effect for the current kit.

1. While holding the [KIT] button, press the [SONG] button to activate Menu Mode.
2. Press number button [2] to select the Kit Settings parameter group.
3. Press number button [5] to select the Reverb parameter.
4. Select a reverb effect using the corresponding number button ([1] to [10/0]). The available settings are as follows.

Number button	Setting
[1]	Off
[2]	Hall 1
[3]	Hall 2
[4]	Hall 3
[5]	Room 1
[6]	Room 2
[7]	Room 3
[8]	Stage 1
[9]	Stage 2
[10/0]	Plate

## 3 MIDI Settings

### 3-1. Local Control

**Steps:**

MENU ([KIT] + [SONG]) → [3] → [1] → Setting

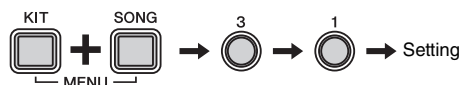

The Local Control parameter determines whether or not the drum module's internal tone generator will produce sounds in response to playing of the pads or of songs. Normally, this parameter is set to "On", meaning that pads and songs will generate sounds. When "Off" is selected, the tone generator is essentially disconnected from the pads and songs, which will be unable to generate any sound. An "Off" setting can prove highly useful when you wish to record your drum performances as MIDI data on a sequencer or using DAW software.

1. While holding the [KIT] button, press the [SONG] button to activate Menu Mode.
2. Press number button [3] to select the MIDI Settings parameter group.
3. Press number button [1] to select the Local Control parameter.
4. Set the parameter using number button [1] or [2]. The available settings are as follows.

Number button	Setting	Description
[1]	Off	The internal tone generator does not respond to pads and songs.
[2]	On	The internal tone generator responds to pads and songs.

**NOTE**

- The drum module's internal tone generator will continue to respond to received MIDI data when Local Control is turned off.
- The drum module will continue to output drum performances as MIDI data when Local Control is turned off.

### 3-2. Note Number

**Steps:**

MENU ([KIT] + [SONG]) → [3] → [2] → Setting

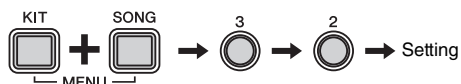

Using the following procedure, you can set the MIDI note number that is output when each of the pads is played.

1. While holding the [KIT] button, press the [SONG] button to activate Menu Mode.
2. Press number button [3] to select the MIDI Settings parameter group.
3. Press number button [2] to select the Note Number parameter.
4. Strike a pad to select it.
5. Enter a new note number using number buttons [1] to [10/0].

Setting
0 to 127

**NOTE**

Note number settings are relevant only when you have connected your drum module to a computer. For more details, refer to the MIDI Reference Manual (PDF).

## 4 Hi-hat Settings

### 4-1. Clutch Position

**Steps:**

MENU ([KIT] + [SONG]) → [4] → [1] → Setting

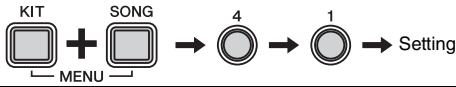

Using the following procedure, you can simulate the effect of changing the hi-hat's clutch position. The smaller the setting, the quicker an open hi-hat sound will decay.

1. While holding the **[KIT]** button, press the **[SONG]** button to activate Menu Mode.
2. Press number button **[4]** to select the Hi-hat Settings parameter group.
3. Press number button **[1]** to select the Clutch Position parameter.
4. Enter a new clutch position using number buttons **[1]** to **[10/0]**.

Setting
0 to 64

### 4-2. Splash Sensitivity

**Steps:**

MENU ([KIT] + [SONG]) → [4] → [2] → Setting

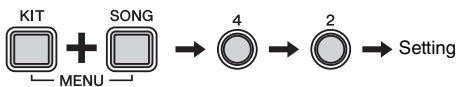

Using the following procedure, you can set the degree of sensitivity for detecting hi-hat foot splashes. The higher the value, the easier it will be to produce a foot-splash sound with the hi-hat controller. High values may, however, result in splash sounds being unintentionally produced when, for example, you operate the hi-hat controller lightly as you keep time. It is a good idea, therefore, to set this parameter to "Off" if you do not want to play foot splashes.

1. While holding the **[KIT]** button, press the **[SONG]** button to activate Menu Mode.
2. Press number button **[4]** to select the Hi-hat Settings parameter group.
3. Press number button **[2]** to select the Splash Sensitivity parameter.
4. Enter a new splash sensitivity using number buttons **[1]** to **[10/0]**.

Setting
0 to 127

**NOTE**

Set this parameter to [0] in order to turn off foot splashes.

### 4-3. Foot Close Position

**Steps:**

MENU ([KIT] + [SONG]) → [4] → [3] → Setting

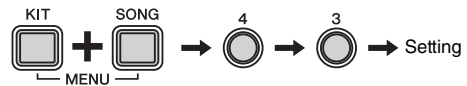

Using the following procedure, you can adjust the position at which the hi-hat switches from open to closed when you operate the hi-hat controller. The lower the value, the smaller the virtual opening between the top and bottom hi-hats. Larger values increase the size of the gap between the top and bottom cymbals, and this can prevent foot close or foot splash sounds from being produced when you operate the pedal.

This parameter only has an effect when you are using an HH65 Hi-hat Controller.

1. While holding the **[KIT]** button, press the **[SONG]** button to activate Menu Mode.
2. Press number button **[4]** to select the Hi-hat Settings parameter group.
3. Press number button **[3]** to select the Foot Close Position parameter.
4. Enter a new foot close position using number buttons **[1]** to **[10/0]**.

Setting
0 to 32

### 4-4. Foot Close Velocity

**Steps:**

MENU ([KIT] + [SONG]) → [4] → [4] → Setting

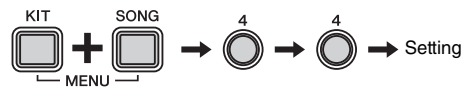

Using the following procedure, you can adjust the velocity (or power) of foot-close sounds produced using the hi-hat controller.

This parameter only has an effect when you are using the hi-hat controller that comes with the DTX400K.

1. While holding the **[KIT]** button, press the **[SONG]** button to activate Menu Mode.
2. Press number button **[4]** to select the Hi-hat Settings parameter group.
3. Press number button **[4]** to select the Foot Close Velocity parameter.
4. Enter a new velocity using number buttons **[1]** to **[10/0]**.

Setting
1 to 127

## 4-5. Kick Velocity

**Steps:**

MENU ([KIT] + [SONG]) → [4] → [5] → Setting

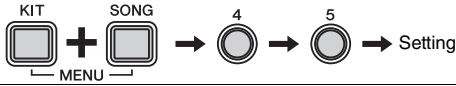

Using the following procedure, you can adjust the velocity (or power) of kick sounds produced using the hi-hat controller. In order for the Kick Velocity parameter to have an effect, Double Bass Drum must be set to “On” for the current kit (page 43).

This parameter only has an effect when you are using the hi-hat controller that comes with the DTX400K.

1. While holding the [KIT] button, press the [SONG] button to activate Menu Mode.
2. Press number button [4] to select the Hi-hat Settings parameter group.
3. Press number button [5] to select the Kick Velocity parameter.
4. Enter a new velocity using number buttons [1] to [10/0].

Setting
1 to 127

## 5 Trigger Settings

### 5-1. Pad Velocity Curve

**Steps:**

MENU ([KIT] + [SONG]) → [5] → [1] → Setting

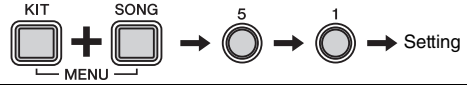

Using the following procedure, you can select a velocity curve for individual pads. A velocity curve determines how the velocity (or power) of a sound is affected by how hard you strike the pad.

1. While holding the [KIT] button, press the [SONG] button to activate Menu Mode.
2. Press number button [5] to select the Trigger Settings parameter group.
3. Press number button [1] to select the Pad Velocity Curve parameter.
4. Strike a pad to select it.
5. Enter a new velocity curve setting using number buttons [1] to [10/0]. The available settings are as follows.

Setting
1 to 25

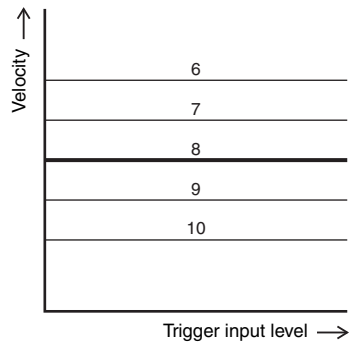
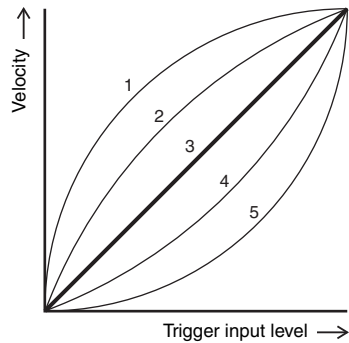

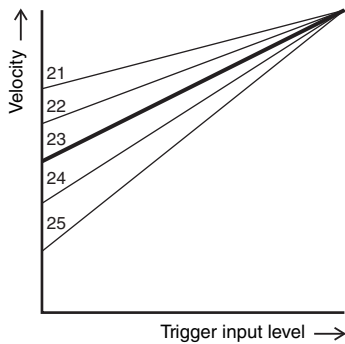
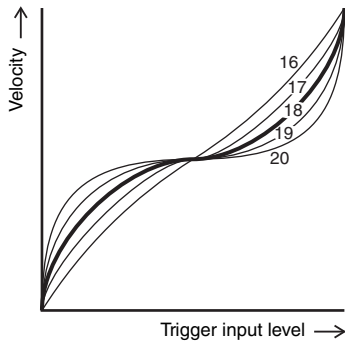
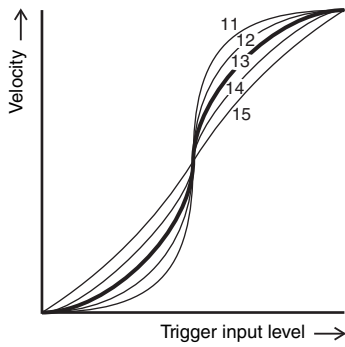

## 5-2. Crosstalk

### Steps:

MENU ([KIT] + [SONG]) → [5] → [2] → Setting

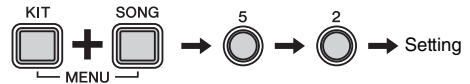

The term “crosstalk” refers to the output of spurious trigger signals from a pad other than the one that was struck as a result of vibration or interference between pads. Using the following procedure, you can adjust the Crosstalk parameter for individual pads to prevent this phenomenon from occurring.

1. While holding the **[KIT]** button, press the **[SONG]** button to activate Menu Mode.
2. Press number button **[5]** to select the Trigger Settings parameter group.
3. Press number button **[2]** to select the Crosstalk parameter.
4. Strike a pad to select it.
5. Enter a new setting (%) using number buttons **[1]** to **[10/0]**. Larger values are more effective in preventing crosstalk; however, they can also make it difficult to play pads simultaneously during light drumming.

Setting
0 to 99

### 5-3. Snare Pad Type

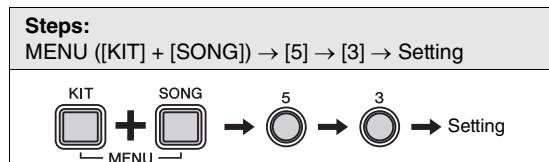

Using the following procedure, you can specify the type of snare pad connected to your drum module.

1. While holding the **[KIT]** button, press the **[SONG]** button to activate Menu Mode.
2. Press number button **[5]** to select the Trigger Settings parameter group.
3. Press number button **[3]** to select the Snare Pad Type parameter.
4. Select a new snare pad type using the corresponding number button (**[1]** to **[6]**). The available settings are as follows.

Number button	Setting
[1]	Automatic identification (only for [2] and [3])
[2]	TP70S
[3]	Snare pad that comes with DTX400K
[4]	XP-series pad
[5]	TP70S reversed
[6]	XP-series pad reversed

**NOTE**

- When set to [1], the drum module will automatically identify the type of snare pad that came with your electronic drum kit when it is turned on. If you then press and hold number button [1], the drum module will flash number button [2] or [3] to indicate the result of automatic identification.
- Whenever you change the type of snare connected to the drum module, please update this setting using the corresponding number button ([2] to [4]). For example, when you use the XP-series pad, select [4].
- You can use setting [5] or [6] to switch (or reverse) the drum sounds assigned to Rim 1 and Rim 2. This makes it easier for left-handed drummers to configure their electronic drum kit.

### 5-4. Pedal Types

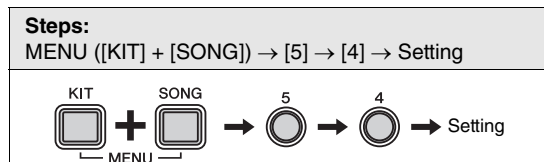

Use the following parameter to specify the types of pedals (i.e., hi-hat controller and kick) connected to your drum module.

1. While holding the **[KIT]** button, press the **[SONG]** button to activate Menu Mode.
2. Press number button **[5]** to select the Trigger Settings parameter group.
3. Press number button **[4]** to select the Pedal Types parameter.
4. Select a new pedal type combination using the corresponding number button (**[1]** to **[5]**). The available settings are as follows.

Number button	Setting	
	Hi-hat controller	Kick pedal
[1]	Automatic identification (only for [2] and [3])	
[2]	HH65	KP65
[3]	Hi-hat controller pedal that comes with DTX400K	KU100
[4]	Hi-hat controller pedal that comes with DTX400K	KP65
[5]	HH65	KU100

**NOTE**

- This parameter can normally be set to [1] (automatic identification).
- When set to [1], the drum module will automatically identify the type of pedal that came with your electronic drum kit when it is turned on. If you then press and hold number button [1], the drum module will flash number button [2] or [3] to indicate the result of automatic identification.
- Connect the hi-hat controller before turning on the drum module. Please do not turn the drum module on with the hi-hat controller depressed. The drum module can not identify the type of pedal properly and it causes that the kick may produce much smaller sound than expected.
- Whenever you change the type of hi-hat controller or kick pedal connected to the drum module, please update this setting using the corresponding number button ([2] to [5]).



### 5-5. Gain

**Steps:**  
MENU ([KIT] + [SONG]) → [5] → [5] → Setting

Using the following procedure, you can set the gain level for trigger signals output from individual pads. The higher the gain setting, the louder the sounds produced by light drumming.

1. While holding the **[KIT]** button, press the **[SONG]** button to activate Menu Mode.
2. Press number button **[5]** to select the Trigger Settings parameter group.
3. Press number button **[5]** to select the Gain parameter.
4. Strike a pad to select it.
5. Enter a new gain level using number buttons **[1]** to **[10/0]**.

Setting
1 to 127

### 5-6. Minimum Level

**Steps:**  
MENU ([KIT] + [SONG]) → [5] → [6] → Setting

When the strength with which you strike a pad is no more than this level, the pad will not output a trigger signal in response and no sound will be produced.

1. While holding the **[KIT]** button, press the **[SONG]** button to activate Menu Mode.
2. Press number button **[5]** to select the Trigger Settings parameter group.
3. Press number button **[6]** to select the Minimum Level parameter.
4. Strike a pad to select it.
5. Enter a new setting (%) using number buttons **[1]** to **[10/0]**.

Setting
0 to 99 (%)

## 6 Training Settings

### 6-1. Timer

**Steps:**  
MENU ([KIT] + [SONG]) → [6] → [1] → Setting

Using the following procedure, you can set the practice timer used in the drum module's Training Mode. The timer begins counting at the start of a training session, and when the set time is reached, it automatically ends the session.

1. While holding the **[KIT]** button, press the **[SONG]** button to activate Menu Mode.
2. Press number button **[6]** to select the Training Settings parameter group.
3. Press number button **[1]** to select the Timer parameter.
4. Select your preferred practice time using the corresponding number button (**[1]** to **[10/0]**). The available settings are as follows.

Number button	Setting
[1]	Off
[2]	30 seconds
[3]	60 seconds
[4]	90 seconds
[5]	120 seconds
[6]	150 seconds
[7]	180 seconds
[8]	300 seconds
[9]	480 seconds
[10/0]	600 seconds

**NOTE**

The practice time set using this parameter applies to the following types of training only.

- Groove Check
- Rhythm Gate
- Measure Break
- Tempo Up/Down
- Change Up
- Pad Gate

Other types of training are not affected.

## 6-2. Difficulty Level

**Steps:**  
MENU ([KIT] + [SONG]) → [6] → [2] → Setting

Using the following procedure, you can set the level of training difficulty for Tempo Up/Down (page 33), Change Up (page 34), and Pad Gate (page 37).

1. While holding the [KIT] button, press the [SONG] button to activate Menu Mode.
2. Press number button [6] to select the Training Settings parameter group.
3. Press number button [2] to select the Difficulty Level parameter.
4. Select a new difficulty level using the corresponding number button ([1] to [5]). The higher the level, the more difficult the training.

Setting
1 to 5

**NOTE**

The level of difficulty set using this parameter applies only to the Tempo Up/Down, Change Up, and Pad Gate training types. Other types of training are not affected.

## 6-3. Ignore Timing

**Steps:**  
MENU ([KIT] + [SONG]) → [6] → [3] → Setting

Using the following procedure, you can set the Ignore Timing parameter for Tempo Up/Down (page 33), Change Up (page 34), and Pad Gate (page 37) training. When set to “On”, the pads will produce a sound whenever they are struck; when “Off”, only pads played exactly in time will produce a sound.

1. While holding the [KIT] button, press the [SONG] button to activate Menu Mode.
2. Press number button [6] to select the Training Settings parameter group.
3. Press number button [3] to select the Ignore Timing parameter.

4. Set the parameter using number button [1] or [2]. The available settings are as follows.

Number button	Setting	Description
[1]	Off	Pads played out of time will not produce a sound.
[2]	On	Pads will produce a sound whenever they are played.

**NOTE**

This parameter applies only to the Tempo Up/Down, Change Up, and Pad Gate training types. Other types of training are not affected.

## 6-4. Groove Tracker Return Time

**Steps:**  
MENU ([KIT] + [SONG]) → [6] → [4] → Setting

Using the following procedure, you can set the period of time after which the practice drum pattern in Groove Tracker training (page 36) will return to the start when you stop drumming.

1. While holding the [KIT] button, press the [SONG] button to activate Menu Mode.
2. Press number button [6] to select the Training Settings parameter group.
3. Press number button [4] to select the Groove Tracker Return Time parameter.
4. Enter a new return time setting using number buttons [1] to [10/0]. The bigger the setting, the longer the return time.

Setting
1 to 10

**NOTE**

- When set to [1], the practice drum pattern will not return to the start.
- The time set using this parameter only applies to Groove Tracker training. Other types of training are not affected.

### 6-5. Groove Tracker Control Pad(s)

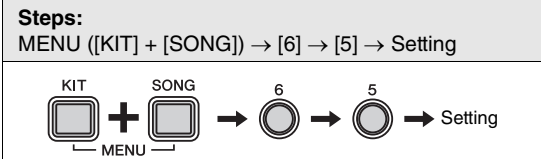

Using the following procedure, you can select which pad(s) you would like to use to advance the practice drum pattern in Groove Tracker training (page 36).

1. While holding the [KIT] button, press the [SONG] button to activate Menu Mode.
2. Press number button [6] to select the Training Settings parameter group.
3. Press number button [5] to select the Groove Tracker Control Pad(s) parameter.
4. Select a new setting using the corresponding number button ([1] to [6]). The available settings are as follows.

Number button	Setting	Description
[1]	Auto	The drum module will automatically select the best setting for the practice drum pattern.
[2]	Cymbal + hi-hat 1	The cymbal and hi-hat pads will advance the pattern and will also produce their own sounds.
[3]	Cymbal + hi-hat 2	The cymbal and hi-hat pads will advance the pattern.
[4]	Kick	The kick pad or pedal will advance the pattern.
[5]	Snare + hi-hat	The snare and hi-hat pads will advance the pattern.
[6]	All	All pads and pedals will advance the pattern.

**NOTE**

- With a setting of [3] to [6], the corresponding pad(s) will not produce a drum sound of their own.
- When this parameter is set to [6], the [DRUM MUTE] button cannot be used to mute the practice drum pattern.

### 6-6. Groove Tracker Advance Step

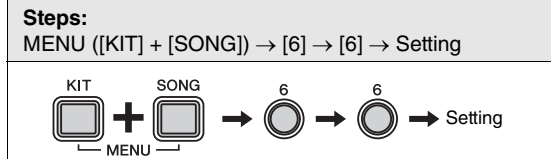

Using the following procedure, you can set how much the practice drum pattern in Groove Tracker training (page 36) should advance for each strike of the set pad(s).

1. While holding the [KIT] button, press the [SONG] button to activate Menu Mode.
2. Press number button [6] to select the Training Settings parameter group.
3. Press number button [6] to select the Groove Tracker Advance Step parameter.
4. Select a new advancement step using the corresponding number button ([1] to [5]). The available settings are as follows.

Number button	Setting	Description
[1]	Auto	The drum module will automatically identify the best advancement step for the practice drum pattern.
[2]		The practice drum pattern will advance in quarter-note steps.
[3]		The practice drum pattern will advance in eighth-note steps.
[4]		The practice drum pattern will advance in sixteenth-note steps.
[5]		The practice drum pattern will advance in eighth-note triplet steps.

**NOTE**

- The advancement step set using this parameter only applies to Groove Tracker training. Other types of training are not affected.
- If, when set to [1], you press and hold number button [1], the drum module will flash a number button between [2] and [5] to indicate the result of automatic identification.

## 6-7. Pad Gate Group

**Steps:**  
MENU ([KIT] + [SONG]) → [6] → [7] → Setting

Using the following procedure, you can set which groups of pads the drum module should consider when deciding whether or not you are playing the correct pattern in Pad Gate training (page 37).

1. While holding the **[KIT]** button, press the **[SONG]** button to activate Menu Mode.
2. Press number button **[6]** to select the Training Settings parameter group.
3. Press number button **[7]** to select the Pad Gate Group parameter.
4. Select a new setting using the corresponding number button (**[1]** to **[4]**). The available settings are as follows.

Number button	Setting	Description
[1]	All pads	Any pad will produce a sound and be scored, as long as the timing of your drumming is correct.
[2]	Group type 1	The kit will be separated into five groups—Kick, Snare, Toms, Cymbals, and Hi-hat. In order for your drumming to produce sounds and be scored, you must strike pads from the same group as those from the practice drum pattern and do so in time.
[3]	Group type 2	More difficult than Group type 1, this setting splits each of the toms and each of the cymbals into individual groups. In addition, the hi-hat pad and the hi-hat controller are also treated separately.
[4]	All notes	With this setting, you must play the exact same practice drum pattern as the drum module.

**NOTE**

- The evaluation method set using this parameter applies only to Pad Gate training. Other types of training are not affected.
- The higher the setting, the more difficult the training.

## 6-8. Fast Blast Timer

**Steps:**  
MENU ([KIT] + [SONG]) → [6] → [8] → Setting

Using the following procedure, you can set the timer for Fast Blast training sessions (page 39). When the timer counts down to zero after the start of a training session, it will automatically end the training.

1. While holding the **[KIT]** button, press the **[SONG]** button to activate Menu Mode.
2. Press number button **[6]** to select the Training Settings parameter group.
3. Press number button **[8]** to select the Fast Blast Timer parameter.
4. Select your preferred practice time using the corresponding number button (**[1]** to **[10/0]**). The available settings are as follows.

Number button	Setting
[1]	10 seconds
[2]	30 seconds
[3]	60 seconds
[4]	90 seconds
[5]	120 seconds
[6]	150 seconds
[7]	180 seconds
[8]	300 seconds
[9]	480 seconds
[10/0]	600 seconds

**NOTE**

The timer set using this parameter applies only to Fast Blast training. Other types of training are not affected.

## 7 Other Settings

### 7-1. Kit Lock

**Steps:**

MENU ([KIT] + [SONG]) → [7] → [1] → Setting

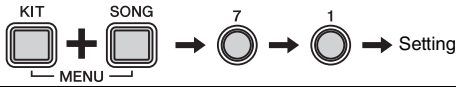

Normally, when you select a song, the drum module automatically chooses the most appropriate kit. You can, however, use the Kit Lock function to prevent this if you wish to keep the current kit when practicing with different songs.

1. While holding the **[KIT]** button, press the **[SONG]** button to activate Menu Mode.
2. Press number button **[7]** to select the Other Settings parameter group.
3. Press number button **[1]** to select the Kit Lock parameter.
4. Set the parameter using number button **[1]** or **[2]**. The available settings are as follows.

Number button	Setting
[1]	Off
[2]	On

**NOTE**

Regardless of this parameter's setting, you can always select a new kit using the drum module's control panel.

### 7-2. Voice Guidance Volume

**Steps:**

MENU ([KIT] + [SONG]) → [7] → [2] → Setting

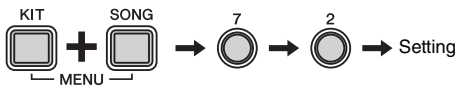

1. While holding the **[KIT]** button, press the **[SONG]** button to activate Menu Mode.
2. Press number button **[7]** to select the Other Settings parameter group.
3. Press number button **[2]** to select the Voice Guidance Volume parameter.
4. Enter a new voice guidance volume using number buttons **[1]** to **[10/0]**. Larger setting values represent higher volumes and vice-versa.

Setting
1 to 10

**NOTE**

Setting this parameter to **[1]** turns off the Voice Guidance function.

### 7-3. Auto Power-Off Time

**Steps:**

MENU ([KIT] + [SONG]) → [7] → [3] → Setting

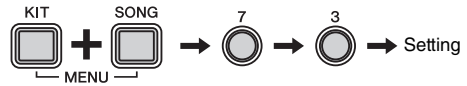

Using the following procedure, you can set the time until the Auto Power-Off function (page 20) activates or you can disable this function.

1. While holding the **[KIT]** button, press the **[SONG]** button to activate Menu Mode.
2. Press number button **[7]** to select the Other Settings parameter group.
3. Press number button **[3]** to select the Auto Power-Off Time parameter.
4. Set a time or disable this function using the corresponding number button (**[1]** to **[7]**). The available settings are as follows.

Number button	Setting
[1]	Auto Power-Off disabled
[2]	5 minutes
[3]	10 minutes
[4]	15 minutes
[5]	30 minutes
[6]	60 minutes
[7]	120 minutes

### 7-4. Stereo/Mono

**Steps:**

MENU ([KIT] + [SONG]) → [7] → [4] → Setting

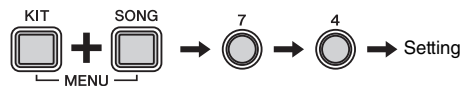

Using the following procedure, you can set the **[PHONES/OUTPUT]** jack to output either mono or stereo sound. We recommend that you select the Mono setting if connecting a standard mono-audio cable to this jack in order to use your drum module with external speakers, a mixer, or other similar equipment.

1. While holding the **[KIT]** button, press the **[SONG]** button to activate Menu Mode.
2. Press number button **[7]** to select the Other Settings parameter group.
3. Press number button **[4]** to select the Stereo/Mono parameter.
4. Set the parameter using number button **[1]** or **[2]**. The available settings are as follows.

Number button	Setting
[1]	Stereo
[2]	Mono

## 7-5. Initialize Kit

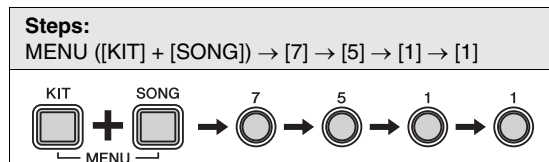

Using the following procedure, you can restore a kit's default settings.

### NOTICE

When you initialize a kit, all of the changes you have made to it will be lost. Before proceeding, therefore, you should ensure that the kit contains no irreplaceable settings.

1. Press the **[KIT]** button.
2. Select the kit to initialize using the corresponding number button (**[1]** to **[10/0]**).
3. While holding the **[KIT]** button, press the **[SONG]** button to activate Menu Mode.
4. Press number button **[7]** to select the Other Settings parameter group.
5. Press number button **[5]** to select the Initialize Kit function.
  - Number button **[1]** will light up.
6. Press number button **[1]**.
  - Number button **[1]** will start to flash.
  - If you do not wish to proceed with initialization, press the **[KIT]** button now to exit Menu Mode.
7. Press number button **[1]**.
  - The kit will be initialized.

## 7-6. Initialize Song

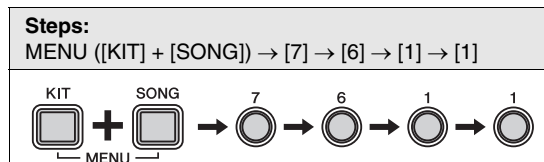

Using the following procedure, you can restore a song's default settings.

### NOTICE

When you initialize a song, all of the changes you have made to it will be lost. Before proceeding, therefore, you should ensure that the song contains no irreplaceable data.

1. Press the **[SONG]** button.
2. Select the song to initialize using the corresponding number button (**[1]** to **[10/0]**).
3. While holding the **[KIT]** button, press the **[SONG]** button to activate Menu Mode.
4. Press number button **[7]** to select the Other Settings parameter group.
5. Press number button **[6]** to select the Initialize Song function.
  - Number button **[1]** will light up.
6. Press number button **[1]**.
  - Number button **[1]** will start to flash.
  - If you do not wish to proceed with initialization, press the **[KIT]** button now to exit Menu Mode.
7. Press number button **[1]**.
  - The song will be initialized.

## 7-7. Revert to Last Power On

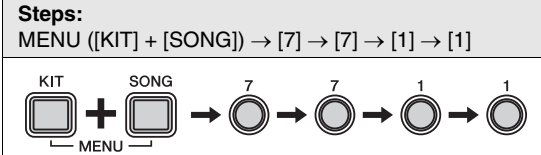

Using the following procedure, you can return all of the parameters from Kit Mode, Song Mode, and Menu Mode to the settings they had when you last turned on the drum module.

### NOTICE

When you reset parameters as described below, any changes you have made to them since last turning on the drum module will be lost. Before proceeding, therefore, you should ensure that they contain no irreplaceable settings.

1. While holding the [KIT] button, press the [SONG] button to activate Menu Mode.
2. Press number button [7] to select the Other Settings parameter group.
3. Press number button [7] to select the Revert to Last Power On function.
  - Number button [1] will light up.
4. Press number button [1].
  - Number button [1] will start to flash.
  - If you do not wish to proceed with initialization, press the [KIT] button now to exit Menu Mode.
5. Press number button [1].
  - The parameters will be initialized.

## 7-8. Factory Set

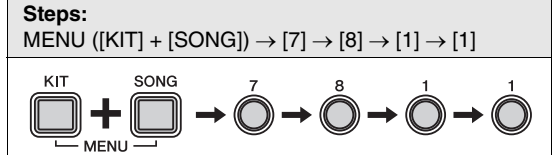

Using the following procedure, you can return all of the parameters from Kit Mode, Song Mode, and Menu Mode to their default settings.

### NOTICE

When you reset parameters as described below, any changes you have made to them will be lost. Before proceeding, therefore, you should ensure that they contain no irreplaceable settings.

1. While holding the [KIT] button, press the [SONG] button to activate Menu Mode.
2. Press number button [7] to select the Other Settings parameter group.
3. Press number button [8] to select the Factory Set function.
  - Number button [1] will light up.
4. Press number button [1].
  - Number button [1] will start to flash.
  - If you do not wish to proceed with initialization, press the [KIT] button now to exit Menu Mode.
5. Press number button [1].
  - The parameters will be initialized.

### NOTE

You can also restore the Factory Set by turning on the drum module with the [VOLUME+] button and the [VOLUME-] button held down. See page 20 for more details.

# Integrating Separately Sold Accessories

As described below, you can add various accessories\* to your electronic drum kit for an even more enjoyable drumming experience. (\*: Sold separately)

## For DTX400K Owners

By upgrading the KU100 Kick Unit and/or the hi-hat controller included as part of the DTX400K, you can make your electronic drum kit feel much closer to the real thing.

### ■ Replacing the KU100 Kick Unit with a KP65 Kick Pad

1. Assemble the KP65 Kick Pad. For details, see Step 13 on page 17.
2. Turn off the drum module.  
The KP65 Kick Pad must be connected with the drum module turned off.
3. Disconnect the cable from the KU100 and plug it into the [OUT ▶ DTX] jack on the back on the KP65.

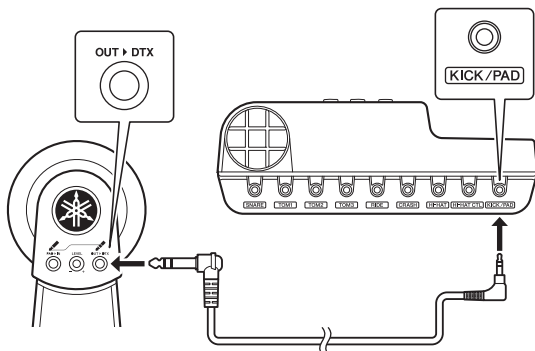

4. Turn on the drum module.
5. Set the kick type to “KP65”. For more details, see the description of the Pedal Types parameter from Menu Mode (page 48).
6. Play the KP65 Kick Pad.

When you upgrade your KU100 to a KP65, you will need a foot pedal to play the new kick pad.

### ■ Replacing the bundled hi-hat controller with an HH65 Hi-hat Controller

1. Turn off the drum module.  
The HH65 Hi-hat Controller must be connected with the drum module turned off.
2. Disconnect the cable from the bundled hi-hat controller and plug it into the [OUTPUT] jack on the HH65.
3. Turn on the drum module.
4. Set the hi-hat controller type to “HH65”. For more details, see the description of the Pedal Types parameter from Menu Mode (page 48).
5. Play the HH65 Hi-hat Controller.

## For DTX430K & DTX450K Owners

### ■ Adding a PCY90AT Cymbal Pad

1. Turn off the drum module.  
The PCY90AT Cymbal Pad must be connected with the drum module turned off.
2. Using the cable that came with the cymbal pad, connect it to the [PAD ▶ IN] jack on the KP65 Kick Pad.

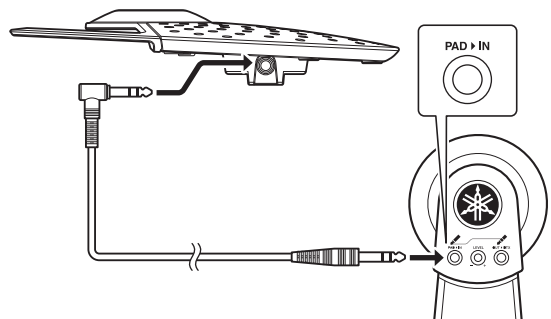

3. Turn on the drum module.
4. Play the newly added cymbal pad.



# Connecting to a Computer

## Making Connections

While the drum module is highly powerful and versatile all by itself, you can connect it to a computer via USB for even greater convenience and flexibility. When connected in this way, MIDI data can be freely exchanged with the computer, allowing the drum module to be used as an input device for music production applications. In this section, you'll learn how to make the necessary connections.

### NOTE

- As the drum module has no built-in speakers, you will need to connect headphones or an amplifier and speakers in order to hear it. For details, see page 19.
- A USB cable is not included. In order to connect your drum module to a computer, choose a USB A-B cable of less than 3 meters in length.

### Supported operating systems:

- Windows XP, Service Pack 3 (32-bit); Windows Vista (32-bit), and Windows 7 (32- or 64-bit)
- Mac OS X 10.5 to 10.7

### NOTICE

You may damage a computer not running one of the above operating systems by connecting the drum module to it. In addition, there is no need to install the Yamaha USB-MIDI driver when using one of the above operating systems.

1. Turn off the drum module.
2. Start up your computer.  
Shut down all applications before proceeding to the next step.
3. Connect the USB cable first to the drum module's [USB TO HOST] terminal and then to the computer.

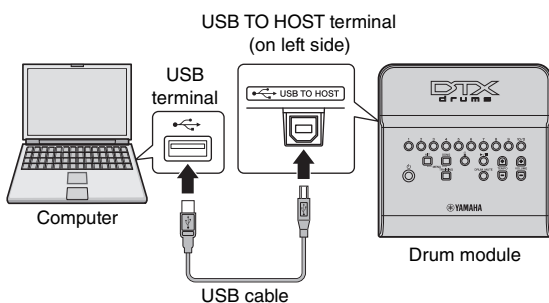

4. Turn on the drum module.  
You will now be able to exchange MIDI data between the drum module and computer.

## Yamaha USB-MIDI driver

In most situations, there is no need to install the Yamaha USB-MIDI driver and the above setup procedure will suffice. If, however, your computer is having difficulty communicating with the drum module, please download the standard Yamaha USB-MIDI driver from the following web page and install it on your computer.

<http://download.yamaha.com/>

### NOTE

- Information on system requirements is also provided on the above web page.
- The USB-MIDI driver may be revised and updated without prior notice. Before installing, please visit the above web page to confirm that you have the most up-to-date version.

## Precautions when using the [USB TO HOST] terminal

If proper care is not taken when connecting your drum module to a computer via the [USB TO HOST] terminal, either or both of the devices may freeze or data may become corrupted or be permanently lost. Be sure, therefore, to observe the following precautions at this time.

If the drum module or computer should freeze, restart the application being used, reboot the computer, or turn the drum module off once and then back on.

### NOTICE

- Use a USB A-B cable of less than 3 meters in length.
- Before connecting to a computer via the [USB TO HOST] terminal, restore it from any power-saving mode (such as Suspend, Sleep, or Standby).
- Connect your computer via the [USB TO HOST] terminal before turning on the drum module.
- Be sure to always perform the following steps before turning the drum module on or off and either plugging in or unplugging the USB cable.
  - \* Shut down all applications.
  - \* Ensure that no data is being sent from the drum module. (Data is transmitted by striking the pads and by playing songs and drum patterns.)
  - \* When connected to a computer, allow at least 6 seconds to pass between turning the drum module on and off and plugging in or unplugging the USB cable.

## MIDI Reference Manual

The drum module's MIDI Reference Manual contains the following.

- MIDI-related reference information
- Reference material that will prove useful when making music using the drum module and a computer
- Instructions on how to transfer songs from your computer to the drum module.

The MIDI Reference Manual is available for download as a PDF file from the following web page below.

<http://download.yamaha.com/>

\*: Yamaha Corporation reserves the right to modify this URL at any time without prior notice.

# Troubleshooting

In addition to the following, you can also find troubleshooting tips in the MIDI Reference Manual (PDF). See page 57 for details on downloading this manual.

## No sound is produced when a pad is struck, or the volume is lower than expected.

### ■ Check connections as follows.

- Ensure that the pads are properly connected to the drum module's trigger input jacks.
- Ensure that the drum module is properly connected to headphones or other audio equipment, such as an amplifier and/or speakers.
- Ensure that the amplifier and/or speakers connected to the drum module are turned on and are not set to the lowest possible volume.
- Ensure that the cables for the hi-hat controller and the kick unit are not connected to each other's jacks. (DTX400K only; see page 17.)
- If you are using a KP65 Kick Pad, try adjusting its Level dial.
- If you are using a KU100 Kick Unit, connect the hi-hat controller before turning on the drum module. Please do not turn the drum module on with the hi-hat controller depressed. The drum module can not identify the type of pedal properly and it causes that the kick may produce much smaller sound than expected.

### ■ Check the drum module's settings as follows.

- Ensure that the drum module's volume is not turned fully down. (See page 19)
- Try adjusting the Pad Volume parameter from Menu Mode. (See page 42)
- Try adjusting the Gain parameter from Menu Mode. (See page 49)
- Try adjusting the Pad Velocity Curve parameter from Menu Mode. (See page 46)
- Try adjusting the Crosstalk parameter from Menu Mode. (See page 47)
- Ensure that the Snare Pad Type parameter from Menu Mode is set correctly. (See page 48)
- Ensure that the Pedal Types parameter from Menu Mode is set correctly. (See page 48)
- Ensure that the Local Control parameter from Menu Mode is set correctly. (See page 44)

### ■ If you cannot play foot closed hi-hat sounds, try the following.

- Ensure that you are operating the hi-hat controller in a firm and full manner.
- Ensure that the Double Bass Drum parameter from Menu Mode is set to "Off". (See page 43)
- If you are using an HH65 Hi-hat Controller, set the Foot Close Position parameter from Menu Mode to a small value. (See page 45)

## Sounds or volumes are not as expected.

### ■ If hi-hat splash sounds are not produced as expected, try the following.

- Adjust the Splash Sensitivity parameter from Menu Mode. (See page 45)

### ■ If it is difficult to produce closed hi-hat sounds with an HH65 Hi-hat Controller, try the following.

- Adjust the Foot Close Position parameter from Menu Mode. (See page 45)

### ■ If it is difficult to produce louder and quieter foot-closed hi-hat sounds, try the following.

- Ensure that the Pedal Types parameter from Menu Mode is set correctly. (See page 48)
- If using the hi-hat controller that comes with the DTX400K, adjust the Foot Close Velocity parameter from Menu Mode to an appropriate fixed level: This pedal does not support playing of louder and quieter foot-closed hi-hat sounds. (See page 45)

### ■ If pads are producing only sounds at very high volumes (i.e., high velocities), try the following.

- Adjust the sensitivity of the drum kit. (See page 23)
- Adjust the Gain parameter from Menu Mode. High settings will result in loud drum sounds. (See page 49)
- Adjust the Pad Velocity Curve parameter from Menu Mode. (See page 46)
- Ensure that you are using only the recommended Yamaha pads. (Products from other manufacturers can output excessively large signals.)

### ■ If the volumes of drum sounds produced by the various pads are poorly balanced, proceed as follows.

- Adjust the Pad Volume parameter from Menu Mode for each pad. (See page 42)
- Ensure that the Stereo/Mono parameter from Menu Mode is set correctly. (See page 53)

### ■ If the drum module's volume is not well balanced with that of the device connected to the [AUX IN] jack (such as a portable music player), proceed as follows.

- Ensure that the volume of the connected device is set to a suitable level. (See page 19)

### ■ If the volume of your drumming is not well balanced with that of a drum-module song, proceed as follows.

- Adjust the song volume. (See page 25)

**If you notice double triggering, crosstalk, or skipped sounds (as described below), proceed as follows.**

- **Double triggering—i.e., multiple sounds are produced in response to a single strike:**
  - If the pad or drum trigger in question features a controller for adjusting output or sensitivity, turn it down.
  - Ensure that the Gain parameter from Menu Mode is not set too high. (See page 49)
- **Crosstalk—i.e., a sound is produced by a pad other than the one that was struck:**
  - Adjust the Crosstalk parameter from Menu Mode to a suitable level for each affected pad. (See page 47)
- **Skipped sounds—i.e., a pad does not produce a sound (usually during rolls or fills):**
  - Adjust the Crosstalk parameter from Menu Mode to a suitable level for each affected pad. (See page 47)

#### **Other common questions**

- **How do I make the drum module store its settings?**
  - The drum module automatically stores its settings whenever you turn it off using the [] (Standby/On) button. (See page 20)
- **How do I reset all of the drum module's parameters to their default settings?**
  - You can restore default settings using the Factory Set function. (See page 20)
- **How do I reset all of the drum module's parameters to the settings they had when I last turned it on?**
  - You can do this using the Revert to Last Power On function. (See page 55)
- **How do I reset only a desired drum kit to the default setting?**
  - Initialize the kit from Menu Mode. (See page 54)
- **How do I stop the drum module turning off while I'm using it?**
  - Disable the Auto Power-Off function. (See page 20)
- **How do I stop the drum module changing the current drum kit when I select a different song?**
  - By default, your drum module always chooses the best kit for each song. To prevent it from doing so, enable the Kit Lock function. (See page 53)
- **How do I have the drum module choose the best drum kit for each song?**
  - Disable the Kit Lock function. (See page 53)
- **What should I do if I can't hear the voice guidance?**
  - Adjust the Voice Guidance Volume parameter from Menu Mode. (See page 53)

# Data List

## ■ Kit List

### 1. Maple Custom

Kit with a Maple Custom Absolute sound.

PAD	No.	Name
SNARE	22	MapleCustom
TOM1	45	Maple 1 H
TOM2	46	Maple 1 M
TOM3	47	Maple 1 L
RIDE	82	Warm Rd 20-1
CRASH	93	DarkCrash 18
HI-HAT	113	Bright 14
KICK	1	MapleCustom
PAD	89	WarmCrash 16

### 2. Oak Custom

Kit with an Oak Custom sound.

PAD	No.	Name
SNARE	23	OakCustom
TOM1	51	Oak H
TOM2	52	Oak M
TOM3	53	Oak L
RIDE	81	Bright Rd 20
CRASH	88	BrightCr 18
HI-HAT	115	Dark 13
KICK	2	OakCustom
PAD	89	WarmCrash 16

### 3. Hard Rock

Rock kit with a double bass drum.

PAD	No.	Name
SNARE	25	HardRock
TOM1	57	HardRock H
TOM2	58	HardRock M
TOM3	59	HardRock L
RIDE	84	Warm Ride 22
CRASH	102	China 19
HI-HAT	116	Dark 14
KICK	5	HardRock
PAD	94	VividCrash 18

### 4. Vintage

A seventies sounding kit.

PAD	No.	Name
SNARE	27	Vintage
TOM1	60	Vintage H
TOM2	61	Vintage M
TOM3	62	Vintage L
RIDE	86	Vintage Rd 22
CRASH	97	VintageCr 16
HI-HAT	118	Vintage 14
KICK	6	Vintage 24
PAD	98	VintageCr 18

### 5. Funk

Kit with a high-pitched snare.

PAD	No.	Name
SNARE	26	Funk
TOM1	54	Birch H
TOM2	55	Birch M
TOM3	56	Birch L
RIDE	83	Warm Rd 20-2
CRASH	91	DarkCrash 16
HI-HAT	117	Vivid 13
KICK	4	Birch 22
PAD	96	ThinCrash 16

### 6. Session

Dry sounding kit with a deep snare.

PAD	No.	Name
SNARE	24	DeepOak
TOM1	48	Maple 2 H
TOM2	49	Maple 2 M
TOM3	50	Maple 2 L
RIDE	83	Warm Rd 20-2
CRASH	92	DarkCrash 17
HI-HAT	112	Bright 13
KICK	3	Oak 22
PAD	90	WarmCrash 18

### 7. Jazz

Ideal kit for jazz drumming.

PAD	No.	Name
SNARE	28	Jazz
TOM1	63	Jazz H
TOM2	64	Jazz M
TOM3	65	Jazz L
RIDE	82	Warm Rd 20-1
CRASH	85	Mellow Rd 18
HI-HAT	114	Bright 15
KICK	8	Jazz
PAD	87	Sizzle Ride

### 8. R&B

Electronic sounding kit.

PAD	No.	Name
SNARE	39	HipHop 1
TOM1	69	T8-1 H
TOM2	70	T8-1 M
TOM3	11	T8-3
RIDE	109	R&B Ride
CRASH	100	Splash 12
HI-HAT	126	R&B
KICK	18	HipHop 1
PAD	99	Splash 10

### 9. Marching

Ideal kit for marching music.

PAD	No.	Name
SNARE	29	FieldSnare
TOM1	67	Marching M
TOM2	66	Marching H
TOM3	68	Marching L
RIDE	105	Hand Mute
CRASH	104	Hand Open
HI-HAT	119	Percussion 1
KICK	160	GranCasaOpen
PAD	95	HeavyCrash 18

### 10. Percussion

Kit containing a range of percussion sounds.

PAD	No.	Name
SNARE	151	Cajon
TOM1	130	Bongo H
TOM2	139	Cowbell 1 SW
TOM3	129	Conga L
RIDE	149	Shaker 2
CRASH	99	Splash 10
HI-HAT	120	Percussion 2
KICK	7	Vintage 18
PAD	103	Trash

## ■ Song List

No.	Name	Description
1	8beat Basic	Suitable for practicing standard eight-beat songs.
2	Hard Rock	Slightly up-tempo hard rock from the 70s.
3	Electro Pop	Electronic pop with a kick on every beat.
4	Rock Shuffle	Rock tune with a swung rhythm.
5	Heavy Metal	A metal-type song using a double-bass drum.
6	16beat Rock	A rock song perfect for practicing 16-beat rhythms.
7	Funk Rock	Funky sounding rock song with a mid-tempo beat.
8	8beat Funk	Funk tune based on an eight-beat rhythm.
9	Slow Blues	Bluesy song with a laid back tempo.
10	4beat Jazz	Mid-tempo jazz tune with a four-beat rhythm.

## ■ Voice List

### Kick

- 1 MapleCustom
- 2 OakCustom
- 3 Oak 22
- 4 Birch 22
- 5 HardRock
- 6 Vintage 24
- 7 Vintage 18
- 8 Jazz
- 9 T8-1
- 10 T8-2
- 11 T8-3
- 12 T9-1
- 13 T9-2
- 14 T9 Hard
- 15 Electric
- 16 ElectricComp
- 17 ElectricClick
- 18 HipHop 1
- 19 HipHop 2
- 20 Break
- 21 DnB

### Snare

- 22 MapleCustom
- 23 OakCustom
- 24 DeepOak
- 25 HardRock
- 26 Funk
- 27 Vintage
- 28 Jazz
- 29 FieldSnare
- 30 T8-1
- 31 T8-1 Clap
- 32 T8-2
- 33 T8-2 Clap
- 34 T9-1
- 35 T9-1 Clap
- 36 T9-2
- 37 T9-2 Clap
- 38 Analog
- 39 HipHop 1
- 40 HipHop 2
- 41 HipHop 3
- 42 R&B
- 43 Break
- 44 DnB

### Tom

- 45 Maple 1 H
- 46 Maple 1 M
- 47 Maple 1 L
- 48 Maple 2 H
- 49 Maple 2 M
- 50 Maple 2 L
- 51 Oak H
- 52 Oak M
- 53 Oak L
- 54 Birch H
- 55 Birch M
- 56 Birch L
- 57 HardRock H
- 58 HardRock M
- 59 HardRock L
- 60 Vintage H
- 61 Vintage M
- 62 Vintage L
- 63 Jazz H
- 64 Jazz M
- 65 Jazz L
- 66 Marching H
- 67 Marching M
- 68 Marching L
- 69 T8-1 H
- 70 T8-1 M
- 71 T8-1 L
- 72 T8-2 H
- 73 T8-2 M
- 74 T8-2 L
- 75 T9-1 H
- 76 T9-1 M
- 77 T9-1 L
- 78 SynthTom H
- 79 SynthTom M
- 80 SynthTom L

### Cymbal

- 81 Bright Rd 20
- 82 Warm Rd 20-1
- 83 Warm Rd 20-2
- 84 Warm Ride 22
- 85 Mellow Rd 18
- 86 Vintage Rd 22
- 87 Sizzle Ride
- 88 BrightCr 18
- 89 WarmCrash 16
- 90 WarmCrash 18
- 91 DarkCrash 16
- 92 DarkCrash 17
- 93 DarkCrash 18
- 94 VividCrash 18
- 95 HeavyCrash 18
- 96 ThinCrash 16
- 97 VintageCr 16
- 98 VintageCr 18
- 99 Splash 10
- 100 Splash 12
- 101 China 17
- 102 China 19
- 103 Trash
- 104 Hand Open
- 105 Hand Mute
- 106 Hand SW
- 107 T8 Ride
- 108 T9 Ride
- 109 R&B Ride
- 110 T8 Crash
- 111 SynthCrash

### Hi-Hat

- 112 Bright 13
- 113 Bright 14
- 114 Bright 15
- 115 Dark 13
- 116 Dark 14
- 117 Vivid 13
- 118 Vintage 14
- 119 Percussion 1
- 120 Percussion 2
- 121 T8-1
- 122 T8-2
- 123 T9-1
- 124 T9-2
- 125 Analog
- 126 R&B
- 127 DnB

### Percussion

- 128 Conga H
- 129 Conga L
- 130 Bongo H
- 131 Bongo L
- 132 Timbales H
- 133 Timbales L
- 134 PandeiroShake
- 135 Pandeiro Tap
- 136 PandeiroSlide
- 137 Tambourine 1
- 138 Tambourine 2
- 139 Cowbell 1 SW
- 140 Cowbell 2
- 141 Cowbell 3
- 142 Claves
- 143 Maracas
- 144 Triangle Open
- 145 Triangle Mute
- 146 WoodBlock H
- 147 WoodBlock L
- 148 Shaker 1
- 149 Shaker 2
- 150 Djembe
- 151 Cajon
- 152 Tabla Na 1
- 153 Tabla Na 2
- 154 Bayan Ge
- 155 Taiko Don
- 156 Taiko Ka
- 157 WindChime
- 158 Whistle S
- 159 Whistle L
- 160 GranCasaOpen
- 161 Metronome 1
- 162 Metronome 2
- 163 Clap
- 164 T9 Clap
- 165 Analog Clap 1
- 166 Analog Clap 2
- 167 HipHop Clap
- 168 AnalogCowbell
- 169 AnalogClaves

## ■ Drum Score

There are many different types of drum score commercially available, but we've chosen the following common format for the examples below.

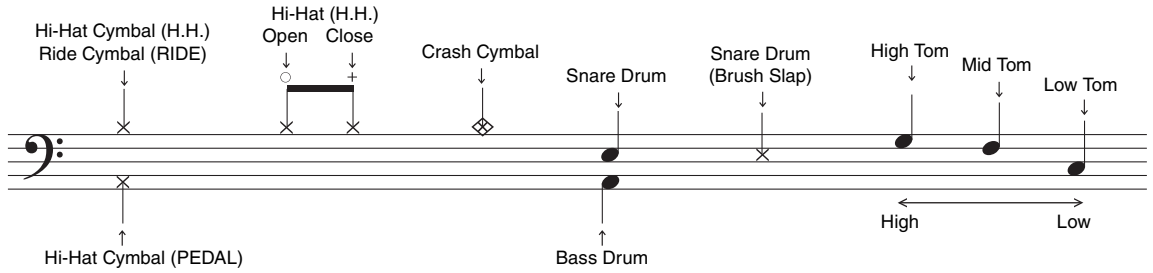

## ■ Scores for Groove Tracker and Pad Gate Training

### ① 8beat Basic

Control Pads : Cymbal + hi-hat 1  
Advance Step : ♪

♩ = 102

### ② Hard Rock

Control Pads : Cymbal + hi-hat 1  
Advance Step : ♩

♩ = 170

### ③ Electro Pop

Control Pad : Kick  
Advance Step : ♩

♩ = 125

### ④ Rock Shuffle

Control Pads : Cymbal + hi-hat 1  
Advance Step : ♩

♩ = 146

⑤ Heavy Metal

Control Pad : Kick  
Advance Step : ♩

♩ = 256

Musical notation for Heavy Metal pattern. It features a bass clef and a common time signature (C). The melody consists of quarter notes on a single pitch. The drum part consists of a steady eighth-note pattern. Above the staff, there are seven circles with 'x' marks, each aligned with a quarter note in the melody.

⑥ 16beat Rock

Control Pads : Snare + hi-hat  
Advance Step : ♩

♩ = 148

Musical notation for 16beat Rock pattern. It features a bass clef and a common time signature (C). The melody consists of quarter notes on a single pitch. The drum part features a complex pattern with snare and hi-hat sounds. Above the staff, there are several groups of 'x' marks representing snare and hi-hat hits.

⑦ Funk Rock

Control Pad : Kick  
Advance Step : ♩

♩ = 107

Musical notation for Funk Rock pattern. It features a bass clef and a common time signature (C). The melody consists of quarter notes on a single pitch. The drum part features a complex pattern with snare and hi-hat sounds. Above the staff, there are several groups of 'x' marks representing snare and hi-hat hits.

⑧ 8beat Funk

Control Pads : Cymbal + hi-hat 1  
Advance Step : ♩

♩ = 116

Musical notation for 8beat Funk pattern. It features a bass clef and a common time signature (C). The melody consists of quarter notes on a single pitch. The drum part features a complex pattern with cymbal and hi-hat sounds. Above the staff, there are several groups of 'x' marks representing cymbal and hi-hat hits. The word "(RIDE)" is written above the first group of hits.

⑨ Slow Blues

Control Pads : Cymbal + hi-hat 1  
Advance Step : ♩

♩ = 56

Musical notation for Slow Blues pattern. It features a bass clef and a common time signature (C). The melody consists of quarter notes on a single pitch. The drum part features a complex pattern with cymbal and hi-hat sounds. Above the staff, there are several groups of 'x' marks representing cymbal and hi-hat hits. The word "(RIDE)" is written above the first group of hits. Below the staff, there are brackets with the number "3" indicating triplets.

⑩ 4beat Jazz

Control Pad : Kick  
Advance Step : ♩

♩ = 132

Musical notation for 4beat Jazz pattern. It features a bass clef and a common time signature (C). The melody consists of quarter notes on a single pitch. The drum part features a complex pattern with snare and hi-hat sounds. Above the staff, there are several groups of 'x' marks representing snare and hi-hat hits. The word "(RIDE)" is written above the first group of hits.

# Specifications

## ■ Drum module





<b>Tone generator</b>	Type	AWM2
	Maximum polyphony	32 notes
	Voices	Drum and percussion: 169 Keyboard: 128
	Drum kits	10 (all of which may be edited and overwritten)
	Songs	10
	Reverb	9 types
<b>Click-track</b>	Tempo	30 to 300 BPM (Tap Tempo and Voice Guidance functions)
	Beats	1/4 to 9/4
<b>Other</b>	Jacks and terminals	SNARE (mini stereo audio) TOM1 (mini mono audio) TOM2 (mini mono audio) TOM3 (mini mono audio) RIDE (mini mono audio) CRASH (mini mono audio) HI-HAT (mini mono audio) HI-HAT CTL (mini stereo audio) KICK/PAD (mini stereo audio) [USB TO HOST] ports [AUX IN] jack (mini stereo audio) PHONES/OUTPUT (standard stereo audio) DC IN
	Power consumption	5 W
	Power adaptor	PA-130 or equivalent
	Dimensions and weight	240 x 188 x 68 mm, 0.5kg

\* Specifications and descriptions in this owner's manual are for information purposes only. Yamaha Corporation reserves the right to modify products or specifications at any time without prior notice. Since specifications, equipment, and options may not be the same in every locale, please check with your Yamaha dealer.



## Index

## Symbols

[12V  -] connector.....	22
[  ] (metronome) button.....	21
[  ] button.....	21
[  ] (Standby/On) button.....	21
[AUX IN] jack.....	22
[DRUM MUTE] button.....	21
[HI-HAT CTL] jack.....	22
[KICK/PAD] jack.....	22
[KIT] button.....	21
[PHONES/OUTPUT] jack.....	22
[SONG] button.....	21
[TEMPO] buttons.....	21
[TRAINING] button.....	21
[USB TO HOST] terminal.....	22, 57
[VOLUME] buttons.....	21

## A

Assembly.....	11
Auto Power-Off.....	20
Auto Power-Off Time.....	53

## B

Base support.....	8, 9, 10
Beats.....	41

## C

Cable band.....	8, 9, 10
Change Up.....	34
Close.....	24
Closed rim shots.....	24
Clutch Position.....	45
Computer.....	57
Control Panel.....	21
Cord clip.....	19, 22
Cross sticking.....	24
Crosstalk.....	47
Cymbal holder.....	8, 9, 10
Cymbal pad.....	8, 9, 10
Cymbal/hi-hat pad.....	8, 9, 10

## D

Data List.....	60
Difficulty Level.....	31, 50
Double Bass Drum.....	43
Drum module.....	8, 9, 10
Drum Score.....	62

## E

Easy Session.....	35
External source.....	22

## F

Factory Set.....	20, 55
Fast Blast.....	39
Fast Blast Timer.....	52
First tom pad.....	8, 9, 10
First/second tom part.....	8, 9, 10
Foot Close Position.....	45
Foot Close Velocity.....	45
Foot closed.....	24
FP6110A.....	9, 10

## G

Gain.....	49
Groove Check.....	30

Groove Tracker.....	36
Groove Tracker Advance Step.....	51
Groove Tracker Control Pad(s).....	51
Groove Tracker Return Time.....	50

## H

Have fun with drum patterns.....	29
Head shots.....	24
Headphone.....	19
Hexagonal rod.....	10
HH65.....	9, 10, 24, 56
Hi-hat Controller.....	8, 9, 10
Hi-hat Cymbal.....	24
Hi-hat holder.....	8, 9, 10
Hi-hat pad.....	8, 9, 10
Hi-hat Settings.....	45
Hi-hat splash.....	24

## I

Ignore Timing.....	50
Initialize Kit.....	54
Initialize Song.....	54

## K

Kick Unit.....	8, 56
Kick Velocity.....	46
Kit.....	23
Kit List.....	60
Kit Lock.....	53
Kit Settings.....	42
KP65.....	9, 10, 56
KU100.....	8, 56

## L

Learn new drum patterns.....	29
Left arm.....	8, 9, 10
Left side.....	22
Local Control.....	44
Looping Part.....	26

## M

Measure Break.....	32
Menu Mode.....	40
Metronome.....	27
Metronome Settings.....	41
MIDI Reference Manual.....	6, 57
MIDI Settings.....	44
Minimum Level.....	49
Music Player.....	19
Mute.....	26

## N

Nine-channel snake cable.....	8, 9, 10
Note Number.....	44
Number Button Lighting Pattern.....	42
Number buttons.....	21

## O

Open.....	24
Open rim shots.....	24
Other Settings.....	53

## P

Package Contents.....	8, 9, 10
Pad Gate.....	37
Pad Gate Group.....	52
Pad Panning.....	43

Pad Sound.....	42
Pad Velocity Curve.....	46
Pad Volume.....	42
Part Mute.....	38
Pattern.....	41
PCY90AT.....	56
Pedal Types.....	48
Play as wildly as you can.....	29
Power adaptor.....	8, 9, 10, 19
Practice song.....	25

## R

Reverb.....	43
Revert to Last Power On.....	55
Rhythm Gate.....	31
Right side.....	22
Rim 1.....	24
Rim 2.....	24

## S

S wing bolt.....	10
Score.....	62
Scoring function.....	29
Second tom pad.....	8, 9, 10
Sensitivity.....	23
Separately Sold Accessories.....	56
Snare pad.....	8, 9, 10, 24
Snare Pad Type.....	48
Song.....	25
Song List.....	60
Song parts.....	25
Sound.....	41
Speaker.....	19
Splash Sensitivity.....	45
Stereo/Mono.....	53
Store.....	20

## T

Tapping the tempo.....	28
Tempo.....	27
Tempo Up/Down.....	33
Third tom part.....	8, 9, 10
Timer.....	49
TP70S.....	10, 24
Training Mode.....	29
Training Settings.....	49
Trigger input jacks.....	22
Trigger Settings.....	46
Tuning key.....	8, 9, 10

## U

USB-MIDI driver.....	57
----------------------	----

## V

Vertical support.....	8, 9, 10
Voice Guidance.....	27, 29
Voice Guidance Volume.....	53
Voice List.....	61
Volume.....	19

## W

Wing bolt.....	8
Work on your rhythm.....	29

# Important Notice: Guarantee Information for customers in European Economic Area (EEA) and Switzerland

<b>English</b>	<b>Important Notice: Guarantee Information for customers in EEA* and Switzerland</b> For detailed guarantee information about this Yamaha product, and Pan-EEA* and Switzerland warranty service, please either visit the website address below (Printable file is available at our website) or contact the Yamaha representative office for your country. * EEA: European Economic Area
<b>Deutsch</b>	<b>Wichtiger Hinweis: Garantie-Information für Kunden in der EWR* und der Schweiz</b> Für nähere Garantie-Information über dieses Produkt von Yamaha, sowie über den Pan-EWR*- und Schweizer Garantieservice, besuchen Sie bitte entweder die folgende angegebene Internetadresse (eine druckfähige Version befindet sich auch auf unserer Webseite), oder wenden Sie sich an den für Ihr Land zuständigen Yamaha-Vertrieb. *EWR: Europäischer Wirtschaftsraum
<b>Français</b>	<b>Remarque importante: Informations de garantie pour les clients de l'EEE* et de la Suisse</b> Pour des informations plus détaillées sur la garantie de ce produit Yamaha et sur le service de garantie applicable dans l'ensemble de l'EEE ainsi qu'en Suisse, consultez notre site Web à l'adresse ci-dessous (le fichier imprimable est disponible sur notre site Web) ou contactez directement l'Yamaha dans votre pays de résidence. * EEE: Espace Economique Européen
<b>Nederlands</b>	<b>Belangrijke informatie: Garantie-informatie voor klanten in de EER* en Zwitserland</b> Voor gedetailleerde garantie-informatie over dit Yamaha-product en de garantie van de EER* en Zwitserland, gaat u naar de onderstaande website (u vindt een afdrukbaar bestand op onze website) of neemt u contact op met de vertegenwoordiging van Yamaha in uw land. * EER: Europese Economische Ruimte
<b>Español</b>	<b>Aviso importante: Información sobre la garantía para los clientes del EEE* y Suiza</b> Para una información detallada sobre este producto Yamaha y sobre el soporte de garantía en la zona EEE* y Suiza, visite la dirección web que se incluye más abajo (la versión del archivo para imprimir está disponible en nuestro sitio web) o póngase en contacto con el representante de Yamaha en su país. * EEE: Espacio Económico Europeo
<b>Italiano</b>	<b>Avviso importante: informazioni sulla garanzia per i clienti residenti nell'EEA* e in Svizzera</b> Per informazioni dettagliate sulla garanzia relativa a questo prodotto Yamaha e l'assistenza in garanzia nei paesi EEA* e in Svizzera, potete consultare il sito Web all'indirizzo riportato di seguito (è disponibile il file in formato stampabile) oppure contattate l'ufficio di rappresentanza locale della Yamaha. * EEA: Area Economica Europea
<b>Português</b>	<b>Aviso importante: informações sobre as garantias para clientes da AEE* e da Suíça</b> Para obter uma informação pormenorizada sobre este produto da Yamaha e sobre o serviço de garantia na AEE* e na Suíça, visite o site a seguir (o arquivo para impressão está disponível no nosso site) ou entre em contato com o escritório de representação da Yamaha no seu país. * AEE: Área Económica Europeia
<b>Ελληνικά</b>	<b>Σημαντική σημείωση: Πληροφορίες εγγύησης για τους πελάτες στον ΕΟΧ* και Ελλάδα</b> Για λεπτομερείς πληροφορίες εγγύησης σχετικά με το παρόν προϊόν της Yamaha και την κάλυψη εγγύησης σε όλο το εύρος του ΕΟΧ και την Ελλάδα, επισκεφτείτε την παρακάτω ιστοσελίδα (εΚτυσιμότητα μπορεί είναι διαθέσιμη στην ιστοσελίδα μας) ή απευθυνθείτε στην αντιπροσωπεία της Yamaha στη χώρα σας. * ΕΟΧ: Ευρωπαϊκός Οικονομικός Χώρος
<b>Svenska</b>	<b>Viktigt: Garantierinformation för kunder i EES-området* och Schweiz</b> För detaljerad information om denna Yamaha-produkt och garantiering i hela EES-området* och Schweiz kan du antingen besöka nedanstående webbadress (en utskriftsvänlig fil finns på webbplatsen) eller kontakta Yamahas officiella representant i ditt land. * EES: Europeiska Ekonomiska Samarbetsområdet
<b>Norsk</b>	<b>Viktig merknad: Garantierinformasjon for kunder i EØS* og Sveits</b> Detaljert informasjon om dette Yamaha-produktet og garantiering for hele EØS-området* og Sveits kan fås enten ved å besøke nettstedens nederste (utskriftsversjon finnes på våre nettsider) eller kontakte kontaktpunktet i landet der du bor. *EØS: Det europeiske økonomiske samarbeidsområdet
<b>Dansk</b>	<b>Vigtig oplysning: Garantiplysninger til kunder i EØO* og Schweiz</b> De kan finde detaljerede garantiplysninger om dette Yamaha-produkt og den fælles garantieringsordning for EØO* (og Schweiz) ved at besøge det websted, der er angivet nedenfor (der findes en fil, som kan udskrives, på vores websted), eller ved at kontakte Yamahas nationale repræsentationskontor i det land, hvor de bor. * EØO: Det Europæiske Økonomiske Samarbejdsområde

<b>Suomi</b>	<b>Tärkeä ilmoitus: Takuutiedot Euroopan talousalueen (ETA)* ja Sveitsin asiakkaille</b> Tämän Yamaha-tuotteen sekä ETA-alueen ja Sveitsin takuuta koskevat yksityiskohtaiset tiedot saatte alla olevasta nettiosoitteesta. (Tulostettava tiedosto saatavissa sivustollamme.) Voitte myös ottaa yhteyttä paikalliseen Yamaha-edustajaan. *ETA: Euroopan talousalue
<b>Polski</b>	<b>Ważne: Warunki gwarancyjne obowiązujące w EOG* i Szwajcarii</b> Aby dowiedzieć się więcej na temat warunków gwarancyjnych tego produktu firmy Yamaha i serwisu gwarancyjnego w całym EOG* i Szwajcarii, należy odwiedzić wskazaną poniżej stronę internetową (plik gotowy do wydruku znajduje się na naszej stronie internetowej) lub skontaktować się z przedstawicielstwem firmy Yamaha w swoim kraju. * EOG — Europejski Obszar Gospodarczy
<b>Česky</b>	<b>Důležité oznámení: Zásuní informací o zárukách v EHS* a ve Švýcarsku</b> Podrobné zprávy o informacích o tomto produktu Yamaha a zárukách v rámci EHS* a ve Švýcarsku naleznete na níže uvedené webové adrese (soubor k tisku je dostupný na našich webových stránkách) nebo se můžete obrátit na zastoupení firmy Yamaha ve své zemi. * EHS: Evropský hospodářský prostor
<b>Magyar</b>	<b>Fontos figyelmeztetés: Garancia-információk az EGT* területén és Svájcban élő vásárlók számára</b> A jelen Yamaha termék részletes garancia-információk, valamint az EGT*-re és Svájcra kiterjedő garanciális szolgáltatás tekintetében keressék fel webhelyünket az alábbi címen (a webhelyen nyomtatható fájl is található), vagy pedig lépjen kapcsolatba az országában működő Yamaha képviselői roddal. * EGT: Európai Gazdasági Térség
<b>Eesti keel</b>	<b>Ouline märkus: Garantiteave Euroopa Majanduspiirkonna (EMP)* ja Šveitsi klientidele</b> Täpsemat teabe saamiseks selle Yamaha toote garantii ning kogu Euroopa Majanduspiirkonna ja Šveitsi garantiteeninduse kohta, külastage palun veebisaiti alljärgneval aadressil (meie saitil on saadaval printitav fail) või pöörduge Teie riigioni Yamaha esinduse poole. * EMP: Euroopa Majanduspiirkond
<b>Latviešu</b>	<b>Svarīgs paziņojums: garantijas informācija klientiem EEZ* un Šveicē</b> Lai saņemtu detalizētu garantijas informāciju par šo Yamaha produktu, kā arī garantijas apakpošanu EEZ* un Šveicē, lūdzam apmeklēt zemāk norādīto tīmekļa vietnes adresi (tīmekļa vietnē ir pieejams drukājams fails) vai sazināties ar Jūsu valstī apkalpojošo Yamaha pārstāvniecību. * EEZ: Eiropas Ekonomikas zona
<b>Lietuvių kalba</b>	<b>Dėmesio: informacija dėl garantijos pirkėjams EEE* ir Šveicarijoje</b> Jei reikia išsamios informacijos apie šį „Yamaha“ produktą ir jo techninę priežiūrą visoje EEE* ir Šveicarijoje, apsilankykite mūsų svetainėje toliau nurodytu adresu (svetainėje yra spausdinamas failas) arba kreipkitės į „Yamaha“ atstovybę savo šalyje. *EEE – Europos ekonominė erdvė
<b>Slovenčina</b>	<b>Dôležité upozornenie: Informácie o záruke pre zákazníkov v EHP* a Švajčiarsku</b> Podrobnejšie informácie o záruke týkajúcej sa tohto produktu od spoločnosti Yamaha a garancijnom servise v EHP* a Švajčiarsku nájdete na webovej stránke uvedenej nižšie (na našej webovej stránke je k dispozícii súbor na tlač) alebo sa obráťte na zástupcu spoločnosti Yamaha vo svojej krajine. * EHP: Európsky hospodársky priestor
<b>Slovensščina</b>	<b>Pomembno obvestilo: Informacije o garanciji za kupce v EGP* in Švici</b> Za podrobnejše informacije o tem Yamahinem izdelku ter garancijskem servisu v celotnem EGP in Švici, obiščite spletno mesto, ki je navedeno spodaj (našljiva datoteka je na voljo na našem spletnem mestu), ali se obrnite na Yamahinega predstavnik v svoji državi. * EGP: Evropski gospodarski prostor
<b>Български език</b>	<b>Важно съобщение: Информация за гаранцията за клиенти в ЕИП* и Швейцария</b> За подробна информация за гаранцията за този продукт на Yamaha и гаранционното обслужване в паневропейската зона на ЕИП* и Швейцария или посетете посочения по-долу уеб сайт (на нашия уеб сайт има файл за печат), или се свържете с представителния офис на Yamaha във вашата страна. * ЕИП: Европейско икономическо пространство
<b>Limba română</b>	<b>Notificare importantă: Informații despre garanție pentru clienții din SEE* și Elveția</b> Pentru informații detaliate privind acest produs Yamaha și serviciul de garanție Pan-SEE* și Elveția, vizitați site-ul la adresa de mai jos (fișierul imprimabil este disponibil pe site-ul nostru) sau contactați biroul reprezentanții Yamaha din țara dumneavoastră. * SEE: Spațiul Economic European

<http://europe.yamaha.com/warranty/>

### Information for Users on Collection and Disposal of Old Equipment



This symbol on the products, packaging, and/or accompanying documents means that used electrical and electronic products should not be mixed with general household waste.

For proper treatment, recovery and recycling of old products, please take them to applicable collection points, in accordance with your national legislation and the Directives 2002/96/EC.

By disposing of these products correctly, you will help to save valuable resources and prevent any potential negative effects on human health and the environment which could otherwise arise from inappropriate waste handling.

For more information about collection and recycling of old products, please contact your local municipality, your waste disposal service or the point of sale where you purchased the items.

#### [For business users in the European Union]

If you wish to discard electrical and electronic equipment, please contact your dealer or supplier for further information.

#### [Information on Disposal in other Countries outside the European Union]

This symbol is only valid in the European Union. If you wish to discard these items, please contact your local authorities or dealer and ask for the correct method of disposal.

(weee\_eu)

### OBSERVERA!

Apparaten kopplas inte ur växelströmskällan (nätet) så länge som den är ansluten till vägguttaget, även om själva apparaten har stängts av.

**ADVARSEL:** Netspændingen til dette apparat er IKKE afbrudt, så længe netledningen sidder i en stikkontakt, som er tændt — også selvom der er slukket på apparatets afbryder.

**VAROITUS:** Laitteen toisiopiiriin kytketty käyttökytin ei irroita koko laitetta verkosta.

(standby)

The model number, serial number, power requirements, etc., may be found on or near the name plate, which is at the bottom of the unit. You should note this serial number in the space provided below and retain this manual as a permanent record of your purchase to aid identification in the event of theft.

**Model No.**

---

**Serial No.**

---

(bottom)

For details of products, please contact your nearest Yamaha representative or the authorized distributor listed below.

Pour plus de détails sur les produits, veuillez-vous adresser à Yamaha ou au distributeur le plus proche de vous figurant dans la liste suivante.

Die Einzelheiten zu Produkten sind bei Ihrer unten aufgeführten Niederlassung und bei Yamaha Vertragshändlern in den jeweiligen Bestimmungsländern erhältlich.

Para detalles sobre productos, contacte su tienda Yamaha más cercana o el distribuidor autorizado que se lista debajo.

## NORTH AMERICA

### CANADA

**Yamaha Canada Music Ltd.**  
135 Milner Avenue, Toronto, Ontario M1S 3R1, Canada  
Tel: +1-416-298-1311

### U.S.A.

**Yamaha Corporation of America**  
6600 Orangethorpe Avenue, Buena Park, CA 90620, U.S.A.  
Tel: +1-714-522-9011

## CENTRAL & SOUTH AMERICA

### MEXICO

**Yamaha de México, S.A. de C.V.**  
Av. Insurgentes Sur 1647 Piso 9, Col. San José Insurgentes,  
Delegación Benito Juárez, México, D.F., C.P. 03900  
Tel: +52-55-5804-0600

### BRAZIL

**Yamaha Musical do Brasil Ltda.**  
Rua Fidêncio Ramos, 302 – Cj 52 e 54 – Torre B – Vila  
Olímpia – CEP 04551-010 – São Paulo/SP, Brazil  
Tel: +55-11-3704-1377

### ARGENTINA

**Yamaha Music Latin America, S.A., Sucursal Argentina**  
Olga Cossetini 1553, Piso 4 Norte,  
Madero Este-C1107CEK, Buenos Aires, Argentina  
Tel: +54-11-4119-7000

### VENEZUELA

**Yamaha Musical de Venezuela, C.A.**  
AV. Manzanares, C.C. Manzanares Plaza,  
Piso 4, Oficina 0401, Baruta, Caracas, Venezuela  
Tel: +58-212-943-1877

### PANAMA AND OTHER LATIN

### AMERICAN COUNTRIES/

### CARIBBEAN COUNTRIES

**Yamaha Music Latin America, S.A.**  
Edif. Torre Banco General, F7, Urb. Marbella,  
Calle 47 y Aquilino de la Guardia, Panama,  
P.O.Box 0823-05863, Panama, Rep.de Panama  
Tel: +507-269-5311

## EUROPE

### THE UNITED KINGDOM/IRELAND

**Yamaha Music Europe GmbH (UK)**  
Sherbourne Drive, Tilbrook, Milton Keynes, MK7 8BL, U.K.  
Tel: +44-1908-366700

### GERMANY

**Yamaha Music Europe GmbH**  
Siemensstrasse 22-34, 25462 Rellingen, Germany  
Tel: +49-4101-303-0

### SWITZERLAND/LIECHTENSTEIN

**Yamaha Music Europe GmbH, Rellingen,  
Branch Switzerland in Zürich**  
Seefeldstrasse 94, 8008 Zürich, Switzerland  
Tel: +41-44-3878080

### AUSTRIA

**Yamaha Music Europe GmbH, Branch Austria**  
Schleiergasse 20, 1100 Wien, Austria  
Tel: +43-1-60203900

### CZECH REPUBLIC/HUNGARY/

### ROMANIA/SLOVAKIA/SLOVENIA

**Yamaha Music Europe GmbH, Branch Austria**  
Schleiergasse 20, 1100 Wien, Austria  
Tel: +43-1-60203900

### POLAND/LITHUANIA/LATVIA/ESTONIA

**Yamaha Music Europe GmbH**  
Sp.z o.o. Oddział w Polsce  
ul. Wrotkowa 14, 02-553 Warsaw, Poland  
Tel: +48-22-880-08-88

### BULGARIA

**Dinacord Bulgaria LTD.**  
Bul.Iskarsko Schose 7 Targowski Zentar Ewropa  
1528 Sofia, Bulgaria  
Tel: +359-2-978-20-25

### MALTA

**Olimpus Music Ltd.**  
Valletta Road, Mosta MST9010, Malta  
Tel: +356-2133-2093

## NETHERLANDS/BELGIUM/LUXEMBOURG

**Yamaha Music Europe, Branch Benelux**  
Clarissenhof 5b, 4133 AB Vianen, The Netherlands  
Tel: +31-347-358040

## FRANCE

**Yamaha Music Europe**  
7 rue Ambroise Croizat, Zone d'activités de Pariest,  
77183 Croissy-Beaubourg, France  
Tel: +33-1-6461-4000

## ITALY

**Yamaha Music Europe GmbH, Branch Italy**  
Viale Italia 88, 20020, Lainate (Milano), Italy  
Tel: +39-02-93577-1

## SPAIN/PORTUGAL

**Yamaha Music Europe GmbH Ibérica, Sucursal en España**  
Ctra. de la Coruna km. 17,200, 28231  
Las Rozas de Madrid, Spain  
Tel: +34-91-639-88-88

## GREECE

**Philippos Nakas S.A. The Music House**  
19th klm. Leof. Lavriou 190 02 Peania – Attiki, Greece  
Tel: +30-210-6686260

## SWEDEN

**Yamaha Music Europe GmbH Germany filial  
Scandinavia**  
JA Wettergrensgata 1, 400 43 Göteborg, Sweden  
Tel: +46-31-89-34-00

## DENMARK

**Yamaha Music Denmark,  
Fillial of Yamaha Music Europe GmbH, Tyskland**  
Generatorvej 8C, ST. TH., 2860 Søborg, Denmark  
Tel: +45-44-92-49-00

## FINLAND

**F-Musiikki Oy**  
Antaksentie 4  
FI-01510 Vantaa, Finland  
Tel: +358 (0)96185111

## NORWAY

**Yamaha Music Europe GmbH Germany -  
Norwegian Branch**  
Grini Næringspark 1, 1361 Østerås, Norway  
Tel: +47-6716-7800

## ICELAND

**Hljodfaerhusid Ehf.**  
Sidumula 20  
IS-108 Reykjavik, Iceland  
Tel: +354-525-5050

## CROATIA

**Euro Unit D.O.O.**  
Slakovce 73  
40305 Nedelisce  
Tel: +38540829400

## RUSSIA

**Yamaha Music (Russia) LLC.**  
Room 37, entrance 7, bld. 7, Kievskaya street, Moscow,  
121059, Russia  
Tel: +7-495-626-5005

## OTHER EUROPEAN COUNTRIES

**Yamaha Music Europe GmbH**  
Siemensstrasse 22-34, 25462 Rellingen, Germany  
Tel: +49-4101-303-0

## AFRICA

**Yamaha Music Gulf FZE**  
JAFZA-16, Office 512, P.O.Box 17328,  
Jebel Ali FZE, Dubai, UAE  
Tel: +971-4-801-1500

## MIDDLE EAST

## TURKEY

**Yamaha Music Europe GmbH  
Merkezi Almanya Türkiye İstanbul Şubesi**  
Maslak Meydanı Sokak, Spring Giz Plaza Bagimsiz Böl.  
No:3, Sanyer İstanbul, Turkey  
Tel: +90-212-999-8010

## CYPRUS

**Nakas Music Cyprus Ltd.**  
Nikis Ave 2k  
1086 Nicosia  
Tel: +357-22-511080

## Major Music Center

21 Ali Riza Ave. Ortakoy  
P.O.Box 475 Nicosia, Cyprus  
Tel: (392) 227 9213

## OTHER COUNTRIES

**Yamaha Music Gulf FZE**  
JAFZA-16, Office 512, P.O.Box 17328,  
Jebel Ali FZE, Dubai, UAE  
Tel: +971-4-801-1500

## ASIA

## THE PEOPLE'S REPUBLIC OF CHINA

**Yamaha Music & Electronics (China) Co., Ltd.**  
2F, Yunhedasha, 1818 Xinzha-lu, Jingan-qu, Shanghai, China  
Tel: +86-400-051-7700

## HONG KONG

**Tom Lee Music Co., Ltd.**  
11/F., Silvercord Tower 1, 30 Canton Road,  
Tsimshatsui, Kowloon, Hong Kong  
Tel: +852-2737-7688

## INDIA

**Yamaha Music India Private Limited**  
Spazedge Building, Ground Floor, Tower A, Sector-47,  
Gurgaon- Sohna Road, Gurgaon-122002, Haryana, India  
Tel: +91-124-485-3300

## INDONESIA

**PT. Yamaha Musik Indonesia (Distributor)**  
Yamaha Music Center Bldg. Jalan Jend. Gatot Subroto Kav.  
4, Jakarta 12930, Indonesia  
Tel: +62-21-520-2577

## KOREA

**Yamaha Music Korea Ltd.**  
8F, Dongsung Bldg. 21, Teheran-ro 87-gil, Gangnam-gu,  
Seoul, 135-880, Korea  
Tel: +82-2-3467-3300

## MALAYSIA

**Yamaha Music (Malaysia) Sdn. Bhd.**  
No.8, Jalan Perbandaran, Kelana Jaya, 47301  
Petaling Jaya, Selangor, Malaysia  
Tel: +60-3-78030900

## SINGAPORE

**Yamaha Music (Asia) Private Limited**  
Block 202 Hougang Street 21, #02-00,  
Singapore 530202, Singapore  
Tel: +65-6740-9200

## TAIWAN

**Yamaha Music & Electronics Taiwan Co., Ltd.**  
2F., No.1, Yuanfong Rd. Banqiao Dist.  
New Taipei City 22063, Taiwan  
Tel: +886-2-7741-8888

## THAILAND

**Siam Music Yamaha Co., Ltd.**  
3, 4, 15, 16th Fl., Siam Motors Building, 891/1 Rama 1  
Road, Wangmai, Pathummai, Bangkok 10330, Thailand  
Tel: +66-2215-2622

## VIETNAM

**Yamaha Music Vietnam Company Limited**  
15th Floor, Nam A Bank Tower, 201-203 Cach Mang Thang  
Tam St., Ward 4, Dist.3, Ho Chi Minh City, Vietnam  
Tel: +84-8-3818-1122

## OTHER ASIAN COUNTRIES

<http://asia.yamaha.com>

## OCEANIA

## AUSTRALIA

**Yamaha Music Australia Pty. Ltd.**  
Level 1, 99 Queensbridge Street, Southbank,  
Vic. 3006, Australia  
Tel: +61-3-9693-5111

## NEW ZEALAND

**Music Works LTD**  
P.O.BOX 6246 Wellesley, Auckland 4680, New Zealand  
Tel: +64-9-634-0099

## COUNTRIES AND TRUST

## TERRITORIES IN PACIFIC OCEAN

<http://asia.yamaha.com>

DM112

HEAD OFFICE: Yamaha Corporation 10-1, Nakazawa-cho, Naka-ku, Hamamatsu, Japan 430-8650

Yamaha web site  
<http://www.yamaha.com/>

Yamaha Downloads  
<http://download.yamaha.com/>



WZ87640

Manual Development Department  
© 2012 Yamaha Corporation

Published 12/2015 POAP\*.\*\*.D0  
Printed in Vietnam

WZ87640