

YAMAHA



**DIGITAL PROGRAMMABLE ALGORITHM SYNTHESIZER
SYNTHÉTISEUR NUMÉRIQUE À ALGORITHMES
PROGRAMMABLES**

**DIGITAL PROGRAMMIERBARER ALGORITHMUS
SYNTHESIZER**

**OWNER'S MANUAL
MANUEL D'UTILISATION
BEDIENUNGSANLEITUNG**

CONGRATULATIONS!

Your Yamaha DX21 Digital Programmable Algorithm Synthesizer incorporates the state-of-the-art in digital FM tone generation technology, providing extraordinarily vibrant, rich voices and outstanding playability. The DX21 actually has two FM tone generators, permitting two voices to be combined and played simultaneously, or in a split keyboard configuration. The DX21 has a 32-voice programmable RAM memory from which any voice can be selected at the touch of a button, a built-in 128-voice preset ROM memory from which voices can be called into the RAM memory as desired, 32 special "performance" memories which can be programmed with combinations of voices and some function parameters, and a cassette interface that permits unlimited storage of FM voices. Of course, the DX21 is fully programmable, allowing you to create your own FM voices or sound effects. Broad MIDI compatibility is also provided so the DX21 can control or be controlled via other MIDI compatible music equipment. To ensure that you gain maximum benefit from all the performance and flexibility provided by the DX21, we urge you to read this owner's manual thoroughly while actually trying out all of the available functions.

CONTENTS

PRECAUTIONS	2	CHAPTER IV: THE PERFORMANCE MEMORY	27
CHAPTER I: SETTING UP	3	1. Performance Memory Organization.....	27
1. Audio Outputs.....	3	2. Accessing the Performance Memory.....	27
2. Optional Foot Controllers & Foot Switches.....	3	3. Programming the Performance Memory.....	27
3. Optional BC1 Breath Controller.....	3	4. The Performance Name.....	28
4. Headphones.....	3	CHAPTER V: VOICE PROGRAMMING	29
5. MIDI Terminals.....	3	1. The Basics of FM Synthesis.....	29
6. Cassette.....	3	2. The EDIT and COMPARE modes.....	34
7. AC Power.....	4	3. The Voice Parameters.....	34
8. Music Rack Installation.....	4	4. STORING Voice Data.....	43
CHAPTER II: PLAYING THE DX21	5	5. Two Approaches to Creating Your Own Voices.....	43
1. The 32 Voice RAM Memory.....	5	GENERAL SPECIFICATIONS	45
2. The SINGLE Play Mode.....	5	MIDI DATA FORMAT	46
3. The DUAL Play Mode.....	6	1. Transmission Conditions.....	46
4. The SPLIT Play Mode.....	6	2. Transmission Data.....	46
5. The 128 Voice ROM Memory.....	7	3. Reception Conditions.....	49
CHAPTER III: THE FUNCTION MODE	9	4. Reception Data.....	50
1. Accessing the FUNCTION Mode.....	9	5. System Exclusive Data.....	53
2. Entering Function Data.....	9	DATA CHART	57
3. The Performance Parameters.....	10		
4. Tuning Functions.....	16		
5. Memory Management Functions.....	17		
6. MIDI Functions.....	24		

PRECAUTIONS

1. Location

Choose the installation location for the DX21 with caution. Avoid locations exposed to direct sunlight or other sources of heat. Also avoid locations subject to vibration, excessive dust, cold or moisture.

2. Cleaning

Do not attempt to clean the exterior with chemical solvents, as this may damage the finish. Clean with a soft, dry cloth.

3. Service and Modifications

Do not open the cabinet or attempt to make your own repairs or modifications to any part of the instrument. Such actions may not only result in electrical shock or damage, but will also void the product warranty. Refer all servicing to a qualified Yamaha service center.

4. Relocation

When moving the instrument be sure to unplug the AC mains cord as well as all other connecting cables.

5. Handling

Avoid applying excessive force to switches and slide controls, dropping or rough handling. The DX21 is ruggedly constructed using reliable solid-state circuitry, nonetheless it is a fine instrument that should be treated with care.

6. Electrical Storms (Lightning)

Digital circuitry such as that used in the DX21 is sensitive to voltage spikes and surges. Because of this, the DX21 should be turned off and unplugged from the AC power outlet in the event of an electrical storm.

7. Electromagnetic Fields

Digital circuitry is also sensitive to electromagnetic fields such as those produced by television sets, radio receivers, transmitters, transceivers, etc. The DX21 should be kept at least several feet from such sources in order to prevent possible random malfunctions.

CHAPTER I: SETTING UP

1. Audio Outputs

The DX21 has two audio outputs, one for each tone generator channel. These are labelled MIX/A and B. When a plug is plugged into the MIX/A output only, the sound from both the A and B tone generator channels will be mixed and delivered via the MIX/A output. When plugs are inserted into both MIX/A and B jacks, however, the channel A signal will be delivered via the MIX/A output and the channel B signal will be delivered via the B output. This permits sending a stereo signal to a stereo sound system giving you the full impact of the DX21's dual and split play mode capability.

2. Optional Foot Controllers & Foot Switches

The remaining three phone jacks are for optional foot controllers and footswitches. The VOLUME jack accepts a Yamaha FC-7 or equivalent foot controller for volume or "swell" control. The SUSTAIN jack accepts a Yamaha FC-4 or FC-5 footswitch or equivalent for sustain control—press for sustain, release to damp. And the PORTAMENTO jack also accepts a Yamaha FC-4 or FC-5 footswitch or equivalent permitting ON/OFF switching of the programmed portamento effect.

3. Optional BC1 Breath Controller

Yamaha's unique BC1 breath controller is plugged into the mini-jack on the rear panel.

4. Headphones

The PHONES jack accepts any standard pair of stereo headphones. When a plug is inserted into the B audio output the channel A and B signals are delivered to the headphones in stereo. When the B audio output is not connected the channel A and B signals are mixed and delivered to the headphones in mono. Headphone volume is controlled via the VOLUME control on the top panel.

5. MIDI Terminals

These terminals are used when connecting the DX21 to other MIDI (Musical Instrument Digital Interface) compatible equipment such as digital sequence recorders, modular FM voice generators, drum machines, etc. The MIDI OUT terminal transmits MIDI data from the DX21 to other MIDI equipment. The MIDI OUT terminal will normally be connected to the MIDI IN terminal of the receiving equipment. The MIDI IN terminal accepts MIDI data from external MIDI equipment such as a digital sequence recorder, music computer or modular FM voice generator. The DX21's MIDI IN terminal will normally be connected to the MIDI OUT terminal of the transmitting equipment. The MIDI THRU terminal re-transmits the data received at the MIDI IN terminal. Thus, data received via the DX21 MIDI IN terminal can be simultaneously sent to other MIDI equipment.

6. Cassette

The DIN connector end of the supplied cassette cable is plugged into the DX21 CASSETTE connector. The three plugs on the other end of the cable should be connected to a cassette data recorder (the kind normally used with personal computers, etc.) as follows:

- RED → cassette deck microphone input.
- WHITE → cassette deck earphone output.
- BLACK → cassette deck remote input (The DX21 does not output cassette remote control signals, so this jack may be left unconnected).

7. AC Power

Plug the DX21 AC power cord into an AC wall socket. Be sure that your local line voltage matches that specified on the DX21 rear panel. The POWER switch is located next to the AC cord on the rear panel. **NOTE:** When setting up your system, be sure to turn the DX21 and any effects units used on **BEFORE** turning the main amplifier system on. This will prevent the initial power-on shock surge from possible damaging your amplifier and speaker system.

8. Music Rack Installation

The music rack supplied with the DX21 fits into the two sockets on the rear panel (see diagram).

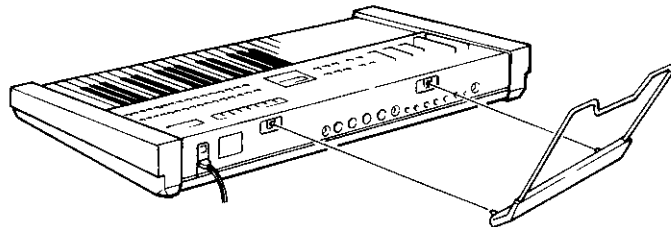

DX21 CONNECTIONS

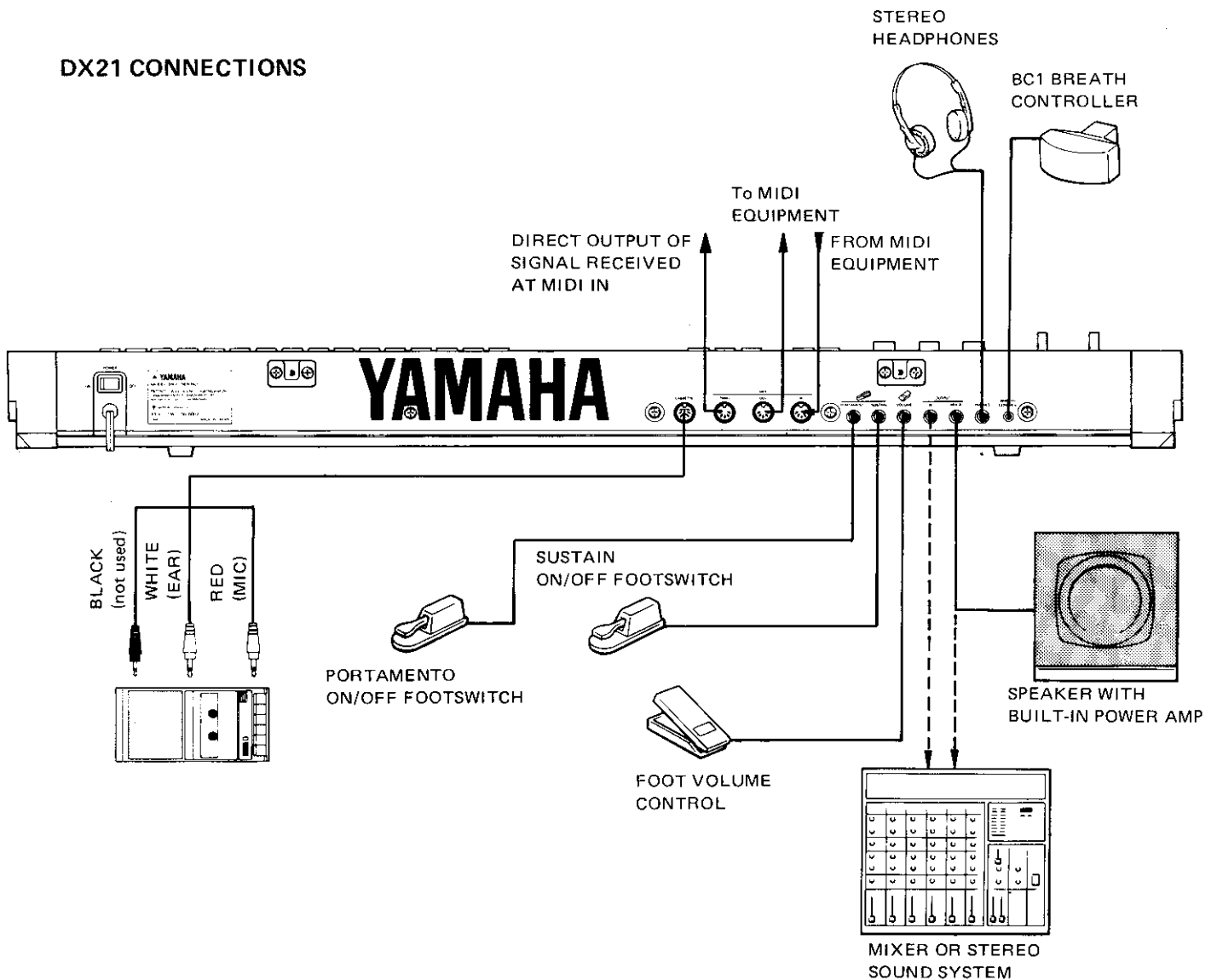

CHAPTER II: PLAYING THE DX21

1. The 32 Voice RAM Memory

The DX21 has 32 RAM (Random Access Memory) locations which contain voices which may be immediately selected by pressing the appropriate memory button while the DX21 is in one of the three normal play modes described below. The two rows of 16 buttons— row A and row B—are the voice memory selectors. The row A and B selectors correspond to DX21 tone generator channels A and B.

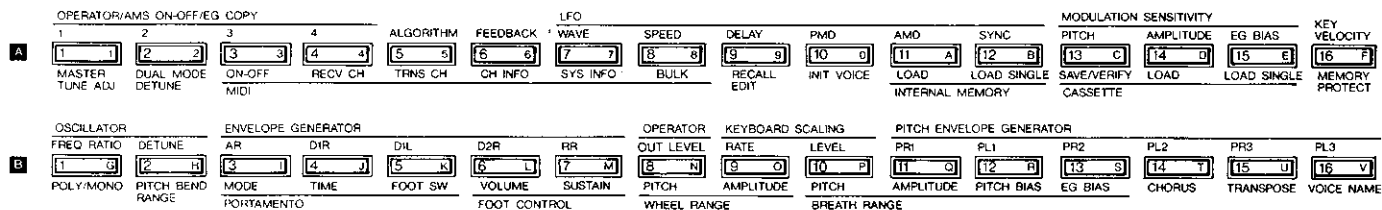

These same buttons actually serve a number of functions. In the FUNCTION and EDIT modes--which are covered in later sections of this manual--they serve to select the function or edit parameter to be programmed.

Since RAM memory can be written to as well as read from, it is possible to load new voice data into the 32 available RAM memory locations. This can be done by loading new voices from the DX21's internal 128-voice ROM (Read Only Memory) into the RAM memory (see "5. The 128 Voice ROM Memory", below), or by loading a new set of 32 voices from data stored on an external cassette tape (see *CHAPTER III: THE FUNCTION MODE*, Memory Management Functions).

If you're just starting out, you'll want to try out the voices that are pre-programmed into the RAM memory. You can do this in any of the three play modes discussed below. Make sure your DX21 is properly connected to a sound system--or you could simply plug a pair of headphones into the PHONES jack (see *CHAPTER I: SETTING UP*), set the VOLUME control to about its center position, and set the A/B BALANCE control to its center position (you'll feel a "click" stop at dead center). Now you can start experimenting with the DX21 voices in the SINGLE play mode.

2. The SINGLE Play Mode

Enter the SINGLE play mode by pressing the PLAY SINGLE button to the left of the LCD (Liquid Crystal Display) panel. When you do this the LCD will look something like this.



The top line of the LCD reads "PLAY SINGLE", indicating that you are in the SINGLE play mode, and the bottom display line will indicate the selected memory location number (A1 through A16, or B1 through B16) followed by the name of the selected voice.

In this mode you can play any of the voices currently in the DX21's RAM memory individually.

3. The DUAL Play Mode

Enter the DUAL mode by pressing the PLAY DUAL button.

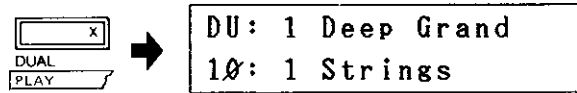

"DU" in the upper left display corner indicates that the DUAL mode has been selected. The upper display line now shows the number and name of any voice selected from the "A" row of memory selectors, while the lower display line shows the number and name of any voice selected from the "B" row of voice selectors. The number followed by a colon in the lower left display corner indicates the current DUAL MODE DETUNE function value (see *CHAPTER III: THE FUNCTION MODE*).

In this mode any of the 16 voices from tone generator "A" can be selected and combined with any voice from tone generator "B". As you try out various combinations of voices you'll notice that some voices are louder than others, resulting in one voice overpowering the other when two are combined. This can be adjusted by using the A/B BALANCE control. Moving this control more towards the "A" end of the scale increases the volume of the "A" voice while decreasing the volume of the "B" voice. Moved in the opposite direction—towards "B"—it has the opposite effect. Use this control to achieve the best balance between the two selected voices in the DUAL play mode.

4. The SPLIT Play Mode

Enter the SPLIT mode by pressing the PLAY SPLIT button.

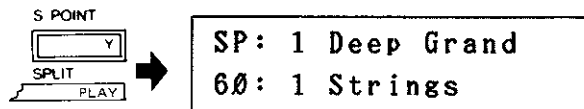

"SP" in the upper left display corner indicates that the SPLIT mode has been selected. As in the DUAL mode the number and name of one voice selected from the "A" row will be shown on the upper display line, and the number and name of a voice selected from the "B" row will be shown on the lower display line. Unlike the DUAL mode, however, the two selected voices do not sound together. The "A" voice will be assigned to all keys to the left of and including the programmed "split" key, while the "B" voice will be assigned to all keys to the right of the split key. This type of arrangement lets you assign a bass voice, for example, to the left side of the keyboard and a piano voice to the right side of the keyboard so you can play bass and piano lines simultaneously.

The next step is to decide on and program the desired split point. Note that at the extreme left of the lower display line there is a number followed by a colon. This is the number of the selected split point. To program the split point, simply press the S POINT button (notice that this is the same as the PLAY SPLIT button you used to enter the SPLIT mode) and while holding it down press the key on the DX21 keyboard at which you want the split point to be programmed (C3=60).

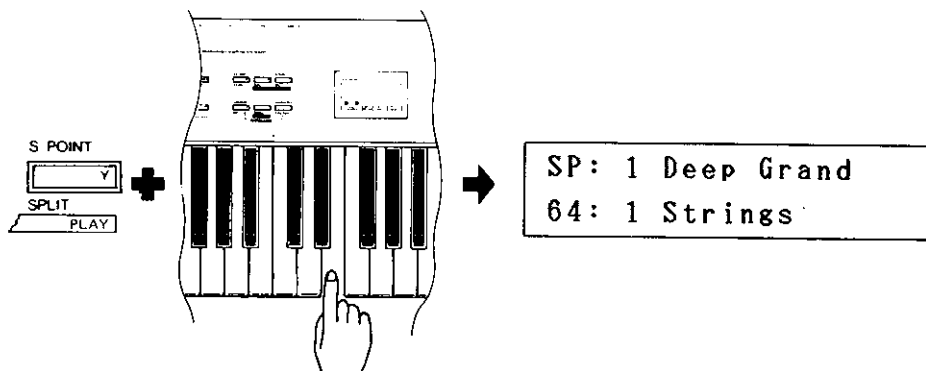

SPLIT POINT set at 60

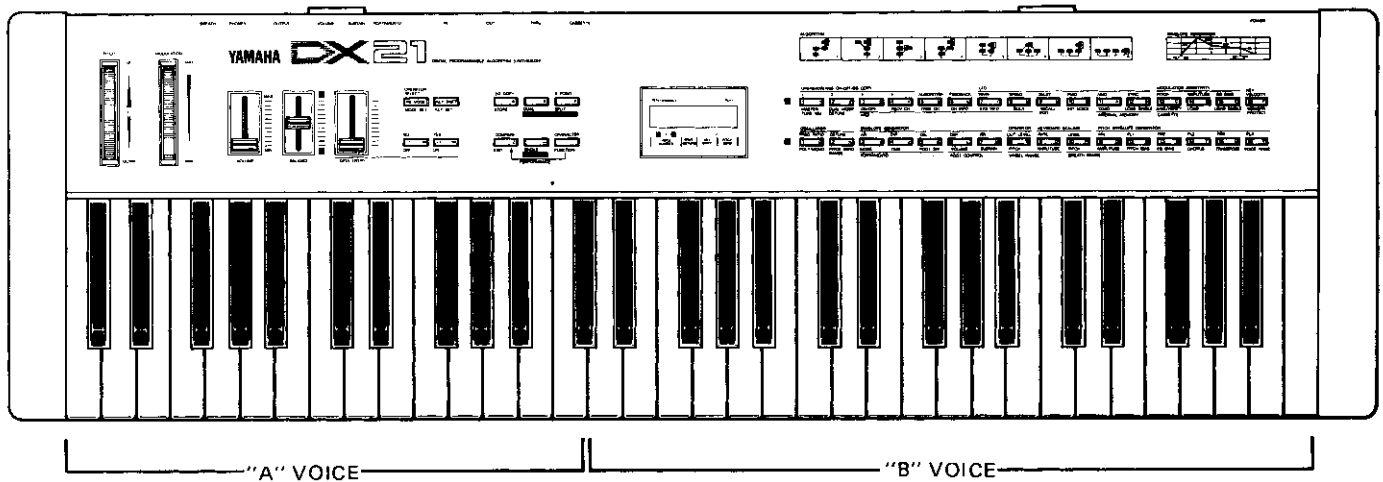

The split point number on the LCD will change to the number of the pressed key, the "A" voice will be playable on all keys to its left (Including the split key), and the "B" voice will be playable on all keys to the right of the split key. This process can be repeated as many times as necessary, but you must press and hold the S POINT key again every time you re-program the split point.

As in the DUAL mode, the A/B BALANCE control can be used to balance the volume levels of the "A" and "B" voices.

5. The 128 Voice ROM Memory

The DX21 comes with 128 different pre-programmed voices in an internal ROM (Read Only Memory). These voices can be loaded in groups of 8, or singly, into the DX21's selectable 32-voice RAM memory. The ROM voices are organized into 16 different categories, each containing 8 voices (see next page).

To load these voices into the DX21's RAM voice memory for selection and use, see A11: LOAD INTERNAL MEMORY and A12: LOAD SINGLE INTERNAL MEMORY in the following chapter.

THE 128 VOICES PROVIDED IN THE INTERNAL ROM

GROUP 1 : PIANO		GROUP 5 : BRASS		GROUP 9 : PERCUSSION 2		GROUP 13 : BASS	
1	Deep Grand	1	Horns	1	Electro Tom	1	Solid Bass
2	Uprrt Piano	2	Brite Brass	2	Timpani	2	Pluck Bass
3	Honkey Tonk	3	Flugel horn	3	Breakin	3	Synthe Bass
4	Ivory Ebony	4	Trombone	4	Xylo snare	4	Mono Bass
5	Phase Grand	5	Hard Brass	5	Synballs	5	Flap Bass
6	Elec Grand	6	Power Brass	6	Hand Drum	6	Elec Bass
7	Piano bells	7	BC1 Horns	7	Clock werks	7	Uprrt Bass
8	Acous Elec	8	BC1 Trumpet	8	Heifer Bell	8	Fretless
GROUP 2 : ELECTRIC PIANO		GROUP 6 : PLUCKED		GROUP 10 : LEAD SYNTH		GROUP 14 : SOUND EFFECT 1	
1	Old Electro	1	Pluk guitar	1	Heavy synth	1	Racing Car
2	New Electro	2	Brtr Guitar	2	Harmo solo	2	Helicopter
3	High Tines	3	Soft Harp	3	Feed Lead	3	Alarm Call
4	Hard Tines	4	Sitar	4	Mono Lead	4	Ghosties
5	Perco Piano	5	Jazz Guit	5	Hollow lead	5	Dopplar FX
6	Wood Piano	6	Old Banjo	6	Lyrisyn	6	Storm Wind
7	Vibra belle	7	Kotokoto	7	Schmooh	7	Space Talk
8	Piano brass	8	Folk Guit	8	Huff Talk	8	Birds
GROUP 3 : ORGAN		GROUP 7 : COMPING		GROUP 11 : OTHER KEYBOARD		GROUP 15 : SOUND EFFECT 2	
1	Click organ	1	Easy Synth	1	Harpsi low	1	Diesel
2	Jazz Organ	2	Easy Clav	2	Harpsi Hi	2	Hole in 1
3	Ham <n> Eggs	3	>> WOW <<	3	Fuzz Clav	3	<< Smash >>
4	Drawbars	4	Metal Keys	4	Clear Clav	4	FM SQUARE
5	Club Organ	5	Cheeky	5	Mute Clav	5	FM PULSE
6	<6 Tease>	6	Rubber Band	6	Squeeze box	6	FM SAW TOOTH
7	Gentle Pipe	7	Pick Pluck	7	Celeste	7	LFO NOISE
8	Full Ranks	8	S/H Synth	8	Circus time	8	PINK NOISE
GROUP 4 : STRINGS		GROUP 8 : PERCUSSION 1		GROUP 12 : WIND REED		GROUP 16 : SOUND EFFECT 3	
1	Strings	1	Glocken	1	Claranette	1	Wind-bells
2	Silk Cello	2	Hamarimba	2	Bassoon	2	Synvox
3	Orchestra	3	Steel Drums	3	Pan Floot	3	Punk funk
4	Solo Violin	4	Tube Bells	4	Lead Reed	4	Whistling
5	Box Cello	5	Temple gong	5	Mono Sax	5	Voices
6	Rich string	6	Mamarimbs	6	Flute wood	6	Zing Plop
7	5th String	7	Good Vibes	7	<BC1> Sax	7	Valve Plop
8	Pizzicato	8	Bells Bells	8	BC1 Hrmnca	8	Mars to ??

CHAPTER III: THE FUNCTION MODE

The FUNCTION mode permits access to four groups of functions: tuning functions, MIDI functions, memory management functions, and performance functions. In this chapter we'll describe each of these functions; what they do and how they are programmed.

1. Accessing the FUNCTION Mode

The FUNCTION mode is accessed by pressing the FUNCTION button to the left of the LCD display. Individual parameters to be programmed are then called by pressing the appropriate voice selector button. Note that when the FUNCTION mode is active pressing a voice selector button calls the corresponding FUNCTION parameter—these are the functions printed in brown below each voice selector. Note that there are two exceptions: the PB (Pitch Bend) MODE SET and KEY SHIFT KEY SET buttons are NOT included among the voice selectors. These function selectors are located immediately above the DATA ENTRY -1 and +1 switches. When the FUNCTION mode is called, the LCD should look something like this.

```
FUNCTION CONTROL
Master Tune = 0
```

The top line of the display will read "FUNCTION CONTROL", indicating that the FUNCTION mode is active, and the lower display line will show the name of the selected function and its current data. In the example above, the MASTER TUNE function is called (press the A1 button) and the data is currently set at 0.

2. Entering Function Data

Once the desired function has been selected, its value can be altered using either the linear DATA ENTRY control located to the left of the panel, or the adjacent -1/NO/OFF and +1/YES/ON switches.

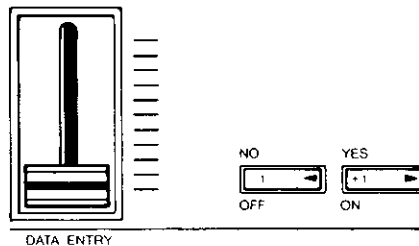

Moving the DATA ENTRY control away from you increases the value of the selected parameter, and moving the control towards you decreases the data value. Pressing the -1 switch decreases the value of the selected parameter by one (decrements), and pressing the +1 switch increases the value by one (increments). While the DATA ENTRY control is valuable for quickly approaching the desired value with parameters that have a large data range, the +1 and -1 switches permit precise step-wise location of a specific value. The switches are also easier to use with parameters that only have two values—e.g. ON (1) or OFF (0). In some cases you will be required to answer YES or NO to prompts which will appear on the LCD display. The -1/NO/OFF and +1/YES/ON switches are used for this.

3. The Performance Parameters

“Performance parameters” are programmable parameters which pertain mainly to real-time performance effects such as how the pitch bend and modulation wheels affect the sound. [Note that performance parameters B1 through B15 are memorized individually for each voice. Parameters B1 — B15 must therefore be stored in the appropriate voice after editing using the STORE function (see *CHAPTER V: VOICE PROGRAMMING*, “4. Storing Voice Data”).]

B1: POLY/MONO



This function selects either the POLY or MONO note output mode.

There are two possible settings: POLY and MONO. In the POLY mode the note output configuration depends on the currently selected play mode. When the play mode is set to SINGLE up to 8 notes can be played simultaneously. When set to SPLIT up to 4 notes may be simultaneously played on each side of the split point (4 + 4). When set to DUAL up to 4 notes may be played simultaneously. In the MONO mode, which can only be selected when the DX21 is in the SINGLE play mode, the DX21 acts as a last-note-priority monophonic keyboard. In the SPLIT mode it is possible to select one POLY voice and one MONO voice. In this case up to seven notes can be played simultaneously on the POLY voice and one on the MONO voice.

Once the POLY/MONO function is selected, subsequent presses on the B1 button alternate between the POLY and MONO modes. The DATA ENTRY switches can also be used: the -1 switch selects POLY and the +1 switch selects MONO.

The POLY/MONO function can not be selected in the DUAL or SPLIT play mode (only the display changes). Set to SINGLE play mode to select POLY/MONO function.

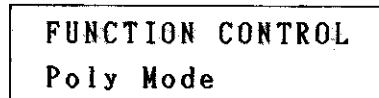

B2: PITCH BEND RANGE



This function sets the pitch range of the pitch bend wheel located to the left of the DX21 panel. The pitch bend wheel automatically centers at normal pitch. It then may be moved upward (away from the player to raise the pitch, or moved downward (toward the player) to lower the pitch by the specified amount.

The data range is from 0 to 12. At 0 the pitch bend wheel is off. Each increment between 1 and 12 represents a semitone. Thus if this function is set to 12, maximum travel of the pitch bend wheel produces a one-octave pitch variation, both above and below center position—i.e. plus or minus one octave.

The DATA ENTRY control and -1/+1 switches can be used to enter data. Once the PITCH BEND RANGE function is called, subsequent presses on the B2 button increment the data value.



PB MODE: MODE SET



This function selector, located immediately above the DATA ENTRY -1 button, offers a choice of three pitch bend wheel modes: Low, High and K-on. In the Low mode, the pitch bend wheel affects only the lowest note played on the keyboard. In other words, if a chord is played, the pitch bend wheel affects only the pitch of the lowest note in the chord—this makes it possible to produce some interesting effects. The High mode is just the opposite—only the highest note played will be affected by the pitch bend wheel. In the K-on (Key on) mode, all notes played are affected simultaneously by the pitch bend wheel, while notes sustained using the sustain footswitch will not be affected.

The DATA ENTRY control and -1/+1 switches can be used to select the desired mode.

The PB MODE (MODE SET) does not function in the SPLIT play mode.

FUNCTION CONTROL Bend Mode = Low
--

B3: PORTAMENTO MODE

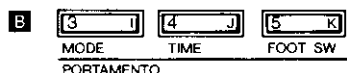

Two different portamento modes are available: Full Time Portamento and Fingered Portamento. When the POLY/MONO function is set to POLY (button B1), only the Full Time Portamento mode is accessible. In the MONO mode, you have a choice between the Full Time and Fingered portamento modes.

- (1) "Full Time Porta" (MONO and POLY modes): A conventional portamento effect in which portamento occurs whenever a new note is played.
- (2) "Fingered Porta" (MONO mode only): Portamento only occurs if the previously played note is held while the next note is played. This mode is useful in re-creating the effect of guitar string bending techniques, wood bass slide effects, etc. If you lift your hand off the DX21 keyboard between notes, there will be no portamento effect.

Once the PORTAMENTO MODE function is called, subsequent presses on the B3 button alternate between the two available portamento modes only if the MONO note output mode is selected. The DATA ENTRY switches can also be used to select the desired portamento mode.

FUNCTION CONTROL Full Time Porta
--

B4: PORTAMENTO TIME

This function sets the speed of the portamento effect.

The data range is from 0 to 99. At 0 portamento is off. A setting of 99 produces the longest portamento effect.

Data can be entered using the DATA ENTRY control and -1/+1 switches. Once the PORTAMENTO TIME function has been called, subsequent presses on the B4 button increment the data value.

FUNCTION CONTROL Porta Time = 0

B5: PORTAMENTO FOOT SWITCH

This function turns the rear-panel PORTAMENTO footswitch jack ON or OFF. When OFF the PORTAMENTO footswitch will NOT function. When ON the PORTAMENTO footswitch connected to the PORTAMENTO jack can be used to turn the portamento effect ON or OFF. (accepts Yamaha FC-4 or FC-5 foot switches)

Once the PORTAMENTO FOOT SW function has been called, subsequent presses on the B5 button alternate between the ON and OFF settings. The DATA ENTRY switches can also be used to turn this function ON and OFF.

FUNCTION CONTROL Foot Porta : OFF
--

B6: FOOT CONTROL VOLUME

B	<input type="text" value="6"/> L	<input type="text" value="7"/> M
	VOLUME	SUSTAIN
	FOOT CONTROL	

This function sets the control range of a foot volume controller (Yamaha FC-7, optional) connected to the rear-panel VOLUME jack.

The data range is from 0 to 99. At 0 the foot controller is OFF and will have no effect on the sound. At 99 the foot controller can be used to adjust output volume over the full range from maximum volume to zero volume. Intermediate settings permit corresponding degrees of "expression" or "swell" control.

The DATA ENTRY control and -1/+1 switches can be used to enter the data for this function. Once the FOOT CONTROL VOLUME function is called, subsequent presses on the B6 button increment the data value.

FUNCTION CONTROL Foot Volume =99

B7: FOOT CONTROL SUSTAIN

This function turns the sustain footswitch (Yamaha FC-4 or FC-5, optional) connected to the rear-panel SUSTAIN jack ON or OFF. When ON the sustain pedal can be used to control the sustain effect. When OFF the sustain pedal will not function.

Once this function is called subsequent presses on the B7 button alternate between the ON and OFF states. The DATA ENTRY switches can also be used to select the desired mode.

FUNCTION CONTROL Foot Sustain: ON
--

B8: WHEEL RANGE (MODULATION WHEEL), PITCH

B	<input type="text" value="8"/> N	<input type="text" value="9"/> O
	PITCH	AMPLITUDE
	WHEEL RANGE	

As you move the DX21 modulation wheel away from you an increasing amount of LFO (Low Frequency Oscillator) modulation is applied to the selected voice.

LFO modulation can be made to modulate the pitch of the voice producing a range of vibrato type effects. This function is used to set the maximum depth of pitch modulation which can be applied using the modulation wheel. The actual effect produced depends on the settings of the LFO parameters—these will be discussed in *CHAPTER V: VOICE PROGRAMMING*. Note, however, that the appropriate voice PITCH MODULATION SENSITIVITY parameter must be set to a value higher than 0 for pitch modulation to be effective. The voice PITCH MODULATION SENSITIVITY parameter will also be discussed in *CHAPTER V*. The data range is from 0 to 99. At 0 pitch modulation is OFF, and rotating the modulation wheel will cause no pitch modulation to be applied to the voice. A setting of 99 produces the greatest possible pitch modulation depth.

Data is entered using the DATA ENTRY controls or switches. Once this function is called, subsequent presses on the B8 button increment the data value.

FUNCTION CONTROL	
MW Pitch	=50

B9: WHEEL RANGE (MODULATION WHEEL), AMPLITUDE

As you move the DX21 modulation wheel away from you an increasing amount of LFO modulation is applied to the selected voice. LFO modulation can be made to modulate the amplitude (level) of specified voice elements (operators), producing a range of tremolo or timbre modulation (wow-wow) type effects. This function is used to set the maximum depth of amplitude modulation which can be applied using the modulation wheel. The actual effect produced depends on the settings of the LFO parameters—these will be discussed in *CHAPTER V: VOICE PROGRAMMING*. Note, however, that the appropriate voice AMPLITUDE MODULATION SENSITIVITY parameter must be set to a value higher than 0 for amplitude modulation to be effective. The voice AMPLITUDE MODULATION SENSITIVITY parameter will also be discussed in *CHAPTER V*.

The data range is from 0 to 99. At 0 amplitude modulation is OFF, and rotating the modulation wheel will cause no amplitude modulation to be applied to the voice. A setting of 99 produces the greatest possible amplitude modulation depth.

Data is entered using the DATA ENTRY controls or switches. Once this function is called, subsequent presses on the B9 button increment the data value.

FUNCTION CONTROL	
MW Amplitude	= 0

The Yamaha Breath Controller

B	10 P	11 G	12 R	13 S
	PITCH	AMPLITUDE	PITCH BIAS	EG BIAS
BREATH RANGE				

The optional Yamaha BC1 Breath Controller is a unique way of adding expression to the sound as you play the DX21 keyboard. The BC1 is held in the mouth just like the mouthpiece of a wind instrument. Blowing harder or softer into the BC1 mouthpiece then produces a corresponding effect. The Breath Controller can be used to apply varying amounts of pitch or amplitude LFO modulation, just like the modulation wheel. In addition it can be set up to directly affect pitch, amplitude or timbre in response to breath pressure. Set to directly affect amplitude (EG BIAS), for example, the Breath Controller can be used to apply realistic tonguing effects to brass and other wind instrument sounds.

The four BREATH parameters listed below determine just how the Breath Controller will affect the DX21 sound. These parameters may be set individually, or combined for more complex effects.

B10: BREATH RANGE, PITCH

This function is used to set the maximum depth of LFO pitch modulation which can be applied using the Breath Controller. The actual effect produced depends on the settings of the LFO parameters—these will be discussed in *CHAPTER V: VOICE PROGRAMMING*. Note, however, that the appropriate voice PITCH MODULATION SENSITIVITY parameter must be set to a value higher than 0 for pitch modulation to be effective. The voice PITCH MODULATION SENSITIVITY parameter will be discussed in *CHAPTER V: VOICE PROGRAMMING*.

The data range is from 0 to 99. At 0 pitch modulation is OFF, and applying breath pressure to the Breath Controller will cause no pitch modulation to be applied to the voice. A setting of 99 produces the greatest possible pitch modulation depth. Data is entered using the DATA ENTRY controls and -1/+1 switches. Once this function is called, subsequent presses on the B10 button increment the data value.

FUNCTION CONTROL	
BC Pitch	= 0

B11: BREATH RANGE, AMPLITUDE

This function is used to set the maximum depth of LFO amplitude modulation which can be applied using the Breath Controller. The actual effect produced depends on the settings of the LFO parameters—these will be discussed in *CHAPTER V: VOICE PROGRAMMING*. Note, however, that the appropriate voice AMPLITUDE MODULATION SENSITIVITY parameter must be set to a value higher than 0 for amplitude modulation to be effective. The voice AMPLITUDE MODULATION SENSITIVITY parameter will be discussed in *CHAPTER V: VOICE PROGRAMMING*.

The data range is from 0 to 99. At 0 amplitude modulation is OFF, and applying breath pressure to the Breath Controller will cause no amplitude modulation to be applied to the voice. A setting of 99 produces the greatest possible amplitude modulation depth.

Data is entered using the DATA ENTRY controls or switches. Once this function is called, subsequent presses on the B11 button increment the data value.

FUNCTION CONTROL	
BC Amplitude	= 0

B12: BREATH RANGE, PITCH BIAS

This function permits breath pressure applied to the BC1 Breath Controller to directly control the pitch of the voice. In other words the LFO has no effect—only your breath pressure directly affects the pitch of the voice.

The data range is from 0 to 99. At 50 pitch bias is OFF. A setting of 99 permits the greatest pitch increase to be produced through the Breath Controller, while a setting of 0 permits the greatest pitch decrease.

Data is entered using the DATA ENTRY controls and -1/+1 switches. Once this function is called, subsequent presses on the B12 button increment the data value.

FUNCTION CONTROL	
BC Pitch Bias	= 50

B13: BREATH RANGE, EG BIAS

This function permits breath pressure applied to the BC1 Breath Controller to directly control the amplitude or timbre of the voice, according to settings of the corresponding voice parameters which will be covered in *CHAPTER V*. The LFO has no effect—only your breath pressure directly affects the amplitude or timbre of the voice.

The data range is from 0 to 99. At 0 EG bias is OFF. A setting of 99 permits the greatest amplitude or timbre variation to be produced through the Breath Controller. Data is entered using the DATA ENTRY controls and -1/+1 switches. Once this function is called, subsequent presses on the B13 button increment the data value.

FUNCTION CONTROL	
BC EG Bias	= 0

B14: CHORUS

B	<table border="1"><tr><td>14</td><td>T</td></tr></table>	14	T
14	T		
CHORUS			

The DX21 has a built-in chorus effect which can be used to add a pleasant stereo chorus effect to any voice. Chorus is only effective, however, when both the DX21's A and B audio outputs are connected to a sound system in a stereo configuration. The full impact of the chorus effect will not be heard if the A/MIX output only is used, or if the A and B outputs are externally mixed to a mono signal.

This function turns the chorus effect ON or OFF. Once the CHORUS function is called, subsequent presses on the B14 button alternate between the ON and OFF states. The DATA ENTRY buttons can also be used to select the desired mode.

FUNCTION CONTROL	
Chorus	: OFF

B15: TRANSPOSE

B	<table border="1"><tr><td>15</td><td>U</td></tr></table>	15	U
15	U		
TRANSPOSE			

This function permits transposing the pitch of the entire DX21 keyboard up or down two octaves in semitone steps.

The data range is from C1 to C5 (C3 is middle C, C2 is one octave lower than middle C, C4 is one octave higher than middle C, etc.). Immediately after this function is called the desired new key can be selected simply by pressing any note on the keyboard between C1 and C5 (within a plus or minus two octave range of middle C). The keyboard's C3 key then assumes the pitch of the key played, and all other keys are adjusted automatically. Pressing any key higher than C5 on the keyboard results in a transposition to C5. This method of data entry can only be used once, immediately after the TRANSPOSE function is called. Further alterations may be made using the DATA ENTRY control or switches.

FUNCTION CONTROL	
Middle C	= C 3

KEY SHIFT: KEY SET



During any of the normal DX21 play modes, pressing the KEY SHIFT button instantly transposes the pitch of the entire DX21 keyboard up or down to a key programmed using this function. When KEY SHIFT is engaged the letter "K" will appear at the upper left corner of the LCD display until the KEY SHIFT button is pressed again, returning the keyboard to normal pitch.

Pressing this button in the FUNCTION mode permits programming the desired pitch to be shifted to when the KEY SHIFT button is pressed during any of the play modes.

The transpose range for the KEY SHIFT function is plus or minus two octaves. The data range is from -24 to +24, with 0 corresponding to standard keyboard pitch. Each increment corresponds to a shift in pitch of one semitone—a setting of 2 would therefore raise the pitch of the entire keyboard a whole tone.

Immediately after calling the KEY SET function, data can be entered simply by pressing a key on the keyboard within a plus/minus two octave range of C3 (middle C). The pressed key then assumes the pitch of C3 and all other keys are adjusted accordingly. Pressing the A2 key, for example, produces a setting of -3. Pressing a key higher than C5 results in a +24 setting, and pressing a key lower than C1 results in a -24 setting. This method of data entry, however, can only be used once after this function is called. Subsequent changes can be made using the DATA ENTRY control and -1/+1 switches.

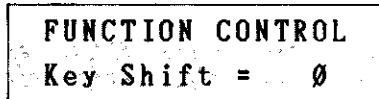

4. Tuning Functions

This group includes just two functions: MASTER TUNE and DUAL MODE DETUNE.

A1: MASTER TUNE



This is the DX21 MASTER TUNE function. All voices are affected simultaneously. The programmable data range is from -63 to +63. When set to +0 the pitch of the A3 key is the standard 440 Hz. At the lowest setting of -64 the overall pitch of the keyboard is 100 cents (1 semitone) lower than standard pitch, and at the highest setting of +63 the overall pitch of the keyboard is 100 cents higher than standard pitch.

Use the DATA ENTRY control or -1/+1 switches to enter the data for this parameter. Once the MASTER TUNE function is called, subsequent presses on the A1 button increment the data value.



A2: DUAL MODE DETUNE

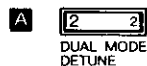

This function makes it possible to detune the pitches of channels A and B to create chorus-type effects. DUAL MODE DETUNE only functions when the DUAL play mode is selected.

The data range is from 0 to 99. At 0 no detune effect is produced. The greatest (deepest) detune effect—a pitch difference between channels A and B of approximately 1/4 semitone—is achieved with a setting of 99. The detune effect is produced by simultaneously increasing the pitch of channel A while decreasing the pitch of channel B.

Use the DATA ENTRY control or -1/+1 switches to enter the data for this parameter. Once the DUAL MODE DETUNE function is called, subsequent presses on the A2 button increment the data value.

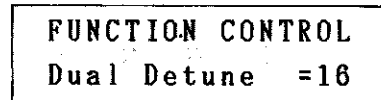

5. Memory Management Functions

The memory management functions include functions for loading voices from the DX21's internal ROM voice memory, for storing and loading RAM memory voices to and from cassette tape, initializing the voice memory, recalling voice data from a special "safety" buffer memory, and turning the DX21 memory write protect function ON and OFF.

A9: EDIT RECALL



In addition to the voice edit buffer, the DX21 has a special edit recall buffer memory which maintains the last edited voice data. If, after editing or creating a new voice, you inadvertently call new data into the voice edit buffer by pressing one of the voice selector buttons before storing the edited voice data, the voice you had spent so much time editing will be erased from the edit buffer. If only one error of this type has been made, the edited data still resides in the edit recall buffer and can be recalled into the voice edit buffer using this function.

When this function is initially called the LCD will read "Recall Edit?". Confirm your intention to recall the data into the voice edit buffer by pressing the DATA ENTRY YES button. The DX21 will then reconfirm with "Are You Sure?". Press the DATA ENTRY YES button again to actually execute the edit recall function. The EDIT mode will then be automatically entered, and the voice edit buffer will contain the data called from the edit recall buffer. Pressing another function button, a PLAY mode button or the EDIT mode button during the above process will abort the edit recall function.

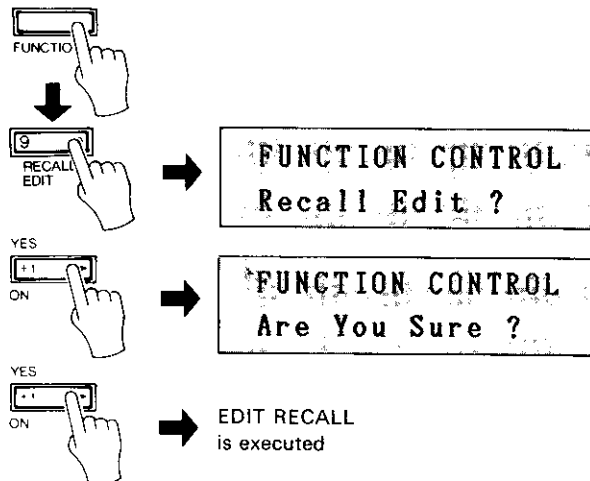

A11: LOAD INTERNAL MEMORY

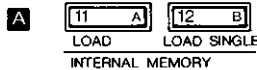

To load a ROM voice group, first make sure that the MEMORY PROTECT function is OFF (A16). Then enter the FUNCTION mode and press the A11 voice selector button to call the LOAD INTERNAL MEMORY function. The LCD should now look like this.

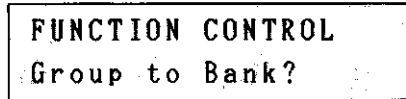

Confirm your intention to load a group of 8 ROM voices into RAM memory by pressing the DATA ENTRY YES button. The top line of the LCD will now ask you to select the group you wish to load—"Group (1-16) ?"—and the lower display line will show the currently selected group. The 16 different ROM voice groups are selected by pressing the A1 through A16 voice memory selectors.

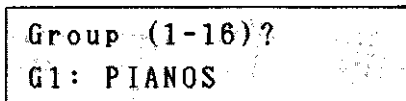

Once you have selected the desired ROM memory group, press the DATA ENTRY YES button to go on to the next step. If you press the NO button at this point the display will revert to the "Group to Bank?" stage. If you do press the YES button, the display will prompt you to select the group of 8 memory locations to which you will load the selected ROM voice group—A1 through A8, A9 through A16, B1 through B8, or B9 through B16. The desired memory location group is selected by pressing the A1 through A4 buttons. The selected group will be displayed on the lower line of the LCD.

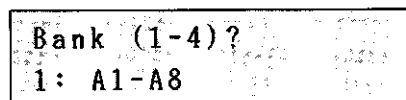

Now the selection of the source voices and the destination memory locations is complete, all you have to do to actually load the selected voices is press the DATA ENTRY YES button. If you press the NO button at this point the display will revert to the "Group to Bank?" stage. If you do press YES, the display will announce that the load job has been accomplished with the "COMPLETED !" display. You can now press any play mode selector to try out the newly loaded voices.

** Be sure to turn the MEMORY PROTECT function back ON after the load operation.

A12: LOAD SINGLE INTERNAL MEMORY

This function lets you load one ROM voice into the DX21 voice edit buffer, from which it can be stored in any of the 32 RAM memory locations using the STORE function. Make sure the MEMORY PROTECT function (A16) is OFF before attempting to use the LOAD SINGLE INTERNAL MEMORY function.

When this function is first called the LCD will look like this.

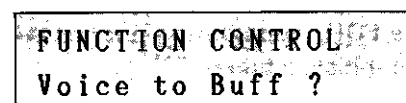

Confirm your intention to load a single ROM voice into the voice edit buffer by pressing the DATA ENTRY YES button. The upper line of the display will now show the currently selected ROM voice group, and the lower line will show the voice currently selected from that group.

```

G1: PIANOS
1: Deep Grand
  
```

The various voice groups can be selected by using the A1 through A16 buttons, and the 8 voices within each group are individually selected using the B1 through B8 buttons. When the desired voice has been selected in this way, simply hold down the STORE button and press the memory selector button to which you want to store the selected voice.

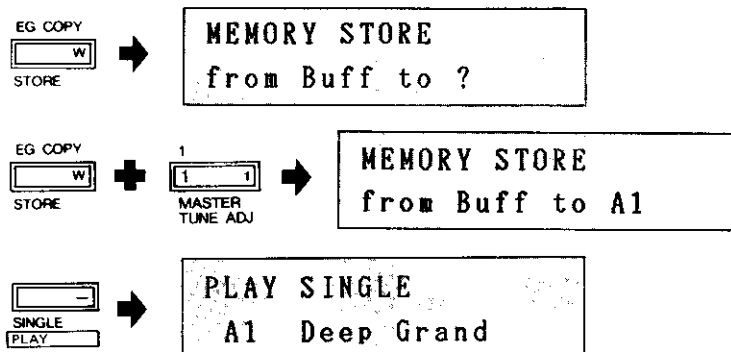

You can now try out the newly loaded voice.

** Be sure to turn the MEMORY PROTECT function back ON after the load operation.

A13: CASSETTE SAVE/VERIFY

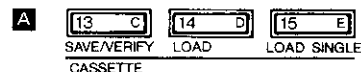

This function actually incorporates two "sub-functions"—SAVE and VERIFY. After calling this function, subsequent presses on the B13 button alternate between the SAVE and VERIFY sub- functions. Normally, however, you will start with the SAVE function which saves the entire contents of the DX21 RAM voice memory onto cassette tape. The VERIFY function is then used to check the saved data against the data still in RAM memory, to ensure that no errors occurred in the SAVE process. Before using this function, make sure that an appropriate data cassette recorder is properly connected to the DX21 as described in *CHAPTER 1: SETTING UP*.

When this function is initially called the LCD will read "Save to Tape?". Confirm your intention to save the contents of the 32 voice memory locations to cassette tape by pressing the DATA ENTRY YES button. The display will then read "from Mem to Tape, all ready?". At this point reconfirm that the cassette recorder is set up properly, make sure a suitable blank tape is loaded into the cassette recorder, and start the recorder running in the RECORD mode. To begin the actual save operation press the DATA ENTRY YES button. Pressing another function button, a PLAY mode button or the EDIT mode button prior to the final step in the above process will abort the CASSETTE SAVE function. As the DX21 saves each voice to tape, the upper line of the display will indicate the voice number being saved. When all 32 voices have been saved the DX21 will automatically go into the tape verify mode, permitting you to check that the data was recorded properly.

Stop the cassette recorder. The LCD will now read "Verify Tape ?". To verify, first rewind the tape to the beginning of the file just saved, then press the DATA ENTRY YES button in response to the "Verify Tape ?" display which should be showing. the display will now read "Verify Tape, ready ?". Press the DATA ENTRY YES button then start the cassette recorder running in the PLAY mode. The DX21 will now read each voice from the cassette tape, and compare it with the corresponding voice data in the RAM voice memory. If the cassette and RAM data matches, the display will read "VERIFY COMPLETED". Any PLAY mode can then be entered simply by pressing the corresponding mode selector button.

If an error is encountered this fact will be displayed on the LCD. If this happens, go back and try the SAVE process—followed by the VERIFY process—one more time. If the error persists then you may have to carefully adjust the record and/or playback level of the cassette recorder, or use a higher quality recorder or tape. Be sure to check that all cassette connections are made properly.

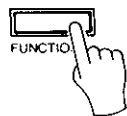

FUNCTION CONTROL
Save to Tape ?

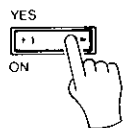

from Mem to Tape
all ready ?

Start cassette recorder in RECORD mode

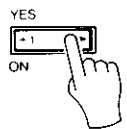

INT A 1 to Tape

counts down from A1 to B16

Press to stop SAVE during execution

FUNCTION CONTROL
Verify Tape ?

appears when SAVE completed

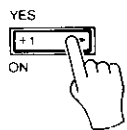

Verify Tape
ready ?

Rewind cassette to beginning of file and enter PLAY mode

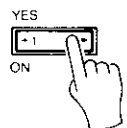

Verify Tape A 1

counts down from A1 to B16

VERIFY COMPLETED

appears if tape is verified with no errors

A14: CASSETTE LOAD

This function loads a complete set of 32 voices from cassette tape into the DX21 RAM voice memory. Before using this function make sure that all cassette connections have been properly made, as described in *CHAPTER 1: SETTING UP*. Also make sure that the DX21 MEMORY PROTECT function (A16) is OFF.

When this function is initially called the LCD will read "Load from Tape?". Confirm your intention to load a complete set of 32 voices from cassette tape into the RAM voice memory (remember, this will erase any voices previously in the RAM memory) by pressing the DATA ENTRY YES button. The LCD will now read "from Tape to Mem, all ready?". At this point make sure the appropriate cassette tape is loaded into the recorder and is rewound to the beginning of the desired voice file. To execute the load operation press the DATA ENTRY YES button again and start the cassette recorder running in the PLAY mode. Pressing another function button, a PLAY mode button or the EDIT mode button prior to the final step in the above process will abort the CASSETTE LOAD function. The DX21 will indicate each voice on the LCD as it is loaded. When the load function is completed the LCD will read "LOAD COMPLETED".

Stop the cassette recorder and turn the DX21 MEMORY PROTECT function back ON. The LOAD function can be interrupted at any time by pressing the DATA ENTRY NO button. This can, however, result in incomplete data loading, possibly causing "garbled" voice data to appear in one memory location.

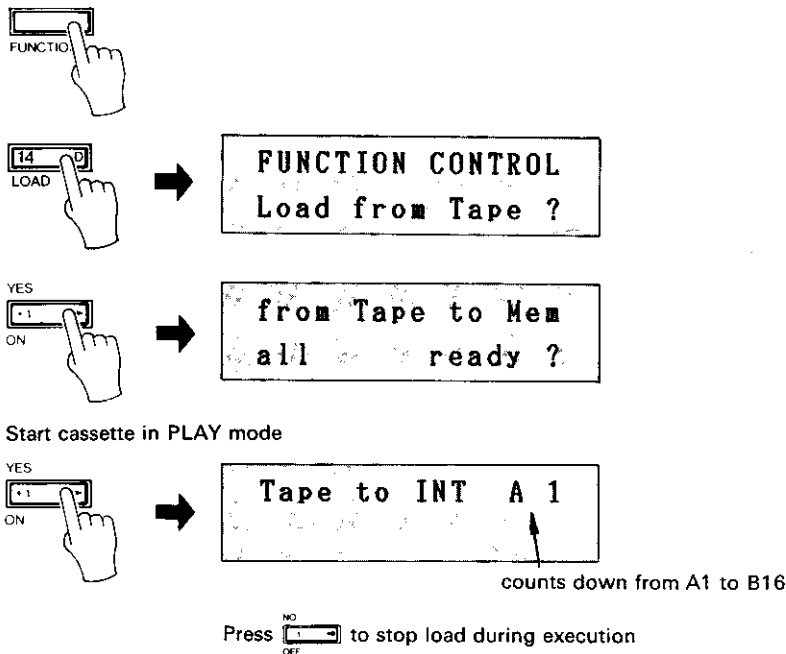

The following display will appear when all voices have been loaded

Tape to INT B16
Load Completed

** Be sure to turn the MEMORY PROTECT function back ON after a successful LOAD operation.

A15: CASSETTE LOAD SINGLE

This function allows you to load a single voice from a previously saved 32-voice cassette file into the DX21 voice edit buffer, from which it can be stored in any voice memory using the STORE function. Make sure the MEMORY PROTECT function (A16) is OFF before using the LOAD SINGLE function.

When this function is initially called the LCD will read "Load Single?". Press the DATA ENTRY YES button to go on to the next step. The LCD will now read "Tape # ? to Buff, (A1-A16, B1-B16)". You must now enter the voice number of the voice you wish to load from cassette—do this by pressing the corresponding voice memory selector button. The selected voice number will appear in place of the "# ?" portion of the upper display line. Then, make sure the appropriate cassette is loaded in the cassette recorder and is rewound to the beginning of the voice file containing the desired voice, press the DATA ENTRY YES button, and start the cassette recorder running in the PLAY mode. The DX21 will automatically locate the selected voice and load it into the voice edit buffer. When finished, the display will read "LOAD COMPLETED". The LOAD SINGLE function can be interrupted by pressing the DATA ENTRY NO button. Doing this may, however, result in garbled voice data in the DX21 voice edit buffer.

The loaded voice may now be stored into any voice memory location by holding down the STORE button while pressing the voice selector of the destination voice memory location. This must be done before another voice selector button is pressed if you desire to keep the loaded voice in memory, otherwise the loaded voice data in the voice edit buffer will be erased and replaced by the voice data called by the pressed voice selector button.

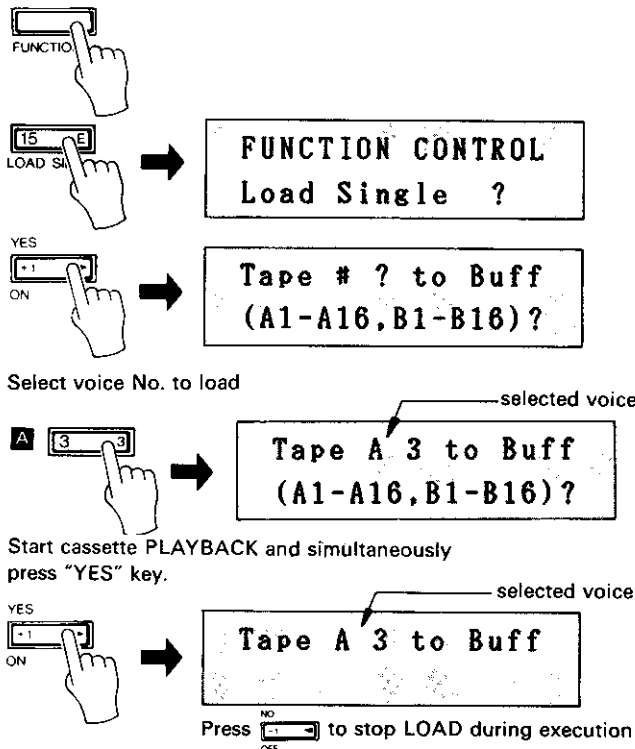

The following display appears when the specified voice has been loaded.

Tape A 3 to Buff
Load Completed

** Be sure to turn the MEMORY PROTECT function (A16) back ON after a successful LOAD operation.

A16: MEMORY PROTECT



This function turns the DX21 MEMORY PROTECT function ON or OFF. When ON, the internal RAM voice memory cannot be altered using the STORE, INTERNAL MEMORY LOAD, or CASSETTE LOAD functions. The MEMORY PROTECT function does not affect the voice edit buffer, so the INIT VOICE, EDIT RECALL, INTERNAL MEMORY LOAD SINGLE, and CASSETTE LOAD SINGLE functions will operate whether MEMORY protect is ON or OFF.

When this function is called the LCD will read either "Mem Protect:ON" or "Mem Protect:OFF", according to the current state of the MEMORY PROTECT function (MEMORY PROTECT is automatically turned ON each time mains power to the DX21 is turned ON). The DATA ENTRY ON and OFF buttons are used to turn MEMORY PROTECT ON or OFF.

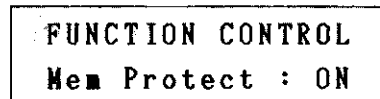

6. MIDI Functions

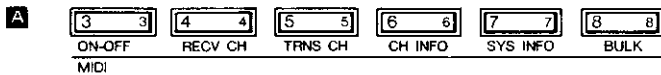

This group of functions deals with parameters which control the transmission and reception of MIDI data via the DX21 MIDI OUT and MIDI IN terminals. This section will describe how each parameter is programmed, while actual operational details will depend entirely on the type of MIDI equipment with which the DX21 will be used.

A3: MIDI ON-OFF

This function turns transmission and reception via the DX21's MIDI terminals ON or OFF. When ON the DX21 can transmit or receive MIDI data to or from external MIDI equipment. When OFF, no MIDI data interchange is possible.

This function is turned ON or OFF using the DATA ENTRY buttons.



ON, OFF

A4: RECEIVE CHANNEL

The DX21 is capable of receiving data on any of the 16 available MIDI channels, or in the OMNI mode which enables reception on all channels simultaneously. This function is used to set the desired MIDI receive channel or activate the OMNI mode. The receive channel is normally set to match the transmission channel of the MIDI equipment from which the DX21 will be receiving MIDI data.

Data is entered using the DATA ENTRY control or buttons, and the data range is from "Midi Omni: ON" (in this state the OMNI mode is ON) to "Midi Recv Ch = 1" through "Midi Recv Ch = 16".

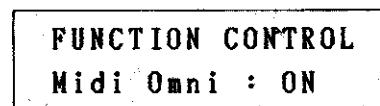

1 ~ 16

A5: TRANSMIT CHANNEL

The DX21 can transmit MIDI data on any of the 16 available MIDI channels. This function is used to set the desired transmission channel. The transmission channels will normally be set to match the receive channel of the MIDI equipment to which the DX21 will be transmitting data.

Data is entered using the DATA ENTRY control or buttons, and the data range is from 1 to 16.

FUNCTION CONTROL
Midi Trns Ch = 1

1 ~ 16

A6: CHANNEL INFORMATION

This is the MIDI channel information "switch". It turns transmission and reception of all MIDI BASIC EVENT DATA and OTHER EVENT DATA (except for key event data, which is always transmitted when the MIDI ON-OFF function is ON) ON or OFF. This function is turned ON or OFF using the DATA ENTRY ON and OFF buttons.

FUNCTION CONTROL
Midi Ch Info:ON

The data turned ON or OFF by this function consists of the following:

- (a) KEY VELOCITY: Initial touch response data. Although the DX21 does not have key velocity sensitivity (keyboard touch response), its tone generator is capable of receiving key velocity information from an external keyboard which has this capability.
- (b) MODULATION WHEEL: Modulation wheel position.
- (c) BREATH CONTROLLER: Breath controller pressure.
- (d) PORTAMENTO FOOT SW: Portamento footswitch on/off status.
- (e) PROGRAM CHANGE: Voice memory selection.
- (f) DATA ENTRY CONTROL: DATA ENTRY control position. Transmission only.
- (g) DATA ENTRY SW: DATA ENTRY +1 and -1 switch status. Transmission only.

Pitch bend, sustain switch and "all keys off" status data are transmitted whether this function is ON or OFF.

NOTE:

The above MIDI data is generally common to all keyboards and equipment compatible with the MIDI system. Due to differences in the features provided by some manufacturers, however, complete compatibility can not be guaranteed.

A7: SYSTEM INFORMATION

This function turns transmission and reception of MIDI SYSTEM EXCLUSIVE INFORMATION data ON or OFF. The DATA ENTRY ON and OFF buttons are used to turn this function ON or OFF. MIDI SYSTEM EXCLUSIVE INFORMATION consists of voice parameters and related data which is transmitted by the BULK TRANSMIT function (A8) described below. When this function is ON voice parameter changes made in the DX21 EDIT mode are transmitted in real time.

FUNCTION CONTROL
Midi SY Info:OFF

OFF, ON

A8: BULK TRANSMIT

This function permits transmission of "32 Bulk Data". That is, the data pertaining to the 32 voices contained in the DX21 RAM voice memory. This data could be transmitted, for example, to the RAM voice memory of another DX21.

When this function is called the LCD will read "Midi Transmit?". Pressing the DATA ENTRY YES button then begins actual transmission of the data. During transmission the LCD will go blank. Transmission takes about two seconds.

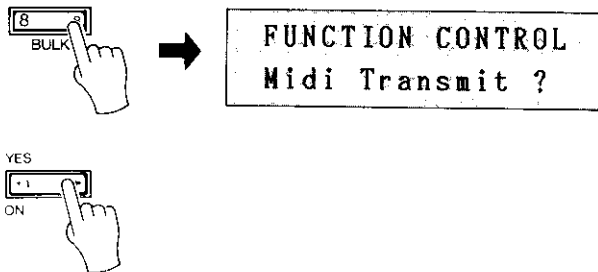

NOTE:

System exclusive communication data is only useable with compatible Yamaha MIDI equipment.

CHAPTER IV: THE PERFORMANCE MEMORY

1. Performance Memory Organization

In addition to the DX21's 32 voice RAM memories and 128-voice ROM memory, the DX21 also features a special 32 performance memory system. This performance memory can be programmed with a voice number or pair of voice numbers (one from each channel), play mode, split mode split key number or dual mode detune data, key shift data, and pitch bend mode data. Thus, when one performance memory is called a voice or combination of voices in any play mode is automatically called along with the most important real-time performance parameters programmed for that voice or voice combination.

2. Accessing the Performance Memory

To access the performance memory, hold down the FUNCTION key and press the EDIT/COMPARE key. The LCD will look something like this:

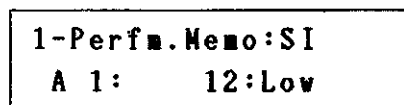

The 32 performance memories are then selected by pressing the voice selector buttons (A1 through A16 = 1 through 16, B1 through B16 = 17 through 32). The first data on the top LCD line is the selected performance memory and its performance name. This is followed by the programmed play mode: SI = SINGLE play mode, DU = DUAL play mode, SP = SPLIT play mode. From left to right on the lower display line we have the number of the voice or voices selected by this performance memory, the split or detune data (this depends on whether the SPLIT or DUAL play mode is selected), the key shift data, and the pitch bend mode.

3. Programming the Performance Memory

The performance memory is programmed quite simply by setting up the desired voice or voices in the desired play mode, with the desired performance parameters. Then, after making sure the MEMORY PROTECT function (A16) is OFF, access the performance memory by holding down the FUNCTION button and pressing the EDIT/COMPARE button. Now you can store the currently set up performance combination in any memory location by holding down the STORE button and pressing the performance memory selector button to which you wish to save the performance data. Before you do this, however, you might want to give your performance combination a name.

Turn MEMORY PROTECT off

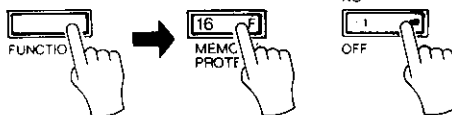

Call PERFORMANCE mode



Enter PERFORMANCE NAME while holding down

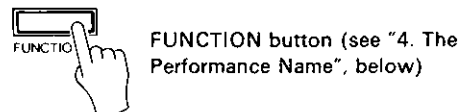

Store DATA IN PERFORMANCE MEMORY



Select PERFORMANCE number to STORE to while holding STORE button

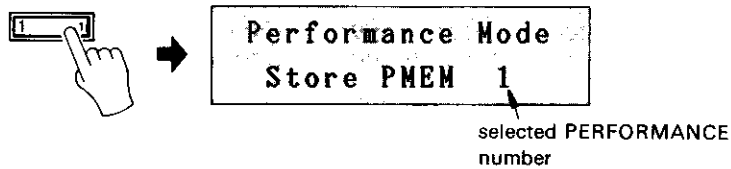

Release the key

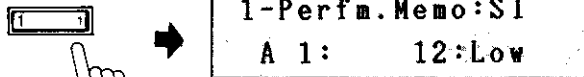

Check this display to determine that the programmed parameters have been properly stored

** Be sure to turn the MEMORY PROTECT function (A16) back ON after a successful storage operation.

4. The Performance Name

The performance name can be programmed at any time while in the performance mode as follows. Hold down the FUNCTION/CHARACTER button. You'll notice that a cursor begins flashing over the first letter of the current performance name. While holding down the CHARACTER button you can enter characters by pressing the appropriate character buttons (see *CHAPTER V: VOICE PROGRAMMING, B16: VOICE NAME*). The available characters are printed in white on the right of the voice selector buttons and the buttons to the left of the LCD. Pressing the PLAY SINGLE button inputs a space. The cursor can be moved backwards or forwards by pressing the DATA ENTRY +1 and -1 buttons. Once a performance name has been entered the entire performance combination must be stored using the STORE function, as described in "3. Programming the Performance Memory", above.

CHAPTER V: VOICE PROGRAMMING

1. The Basics of FM Synthesis

Before you begin actually programming or editing your own voices, a basic understanding of how digital FM synthesis works will be necessary. In the following explanation we will discover how the DX21's FM voice generator produces complex voices. This information will help you to understand the process and make it easier for you to create and edit your own voices.

OPERATORS

The Yamaha DX series FM digital synthesizers use pure sine waves that interact to create the full harmonic spectrum for any voice. Each digital sine wave oscillator is combined with its own envelope generator to form an "operator".

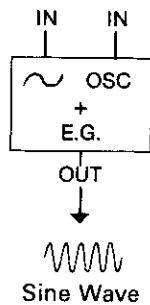

Note that the operator's oscillator has two inputs: one for the oscillator pitch data, and one for modulation data.

CARRIERS AND MODULATORS

The DX21 voice generator has 4 operators. When the output of one operator is fed to the modulation input of a second operator—i.e. the first operator modulates the second—a whole spectrum of harmonics is created that can form an incredibly diverse range of complex waveforms (including the more conventional triangle, sawtooth, and square waveforms). All this from just two operators!

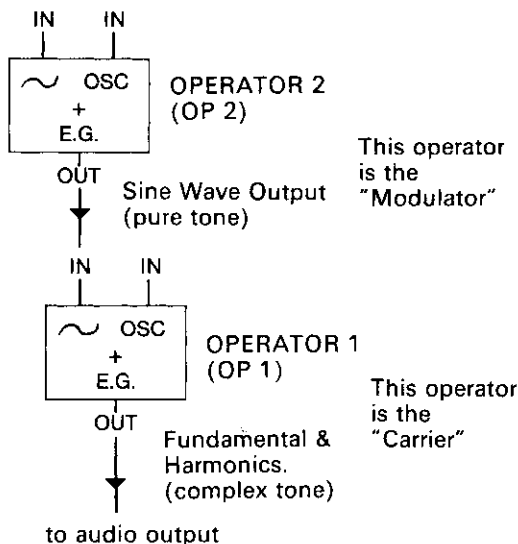

Operators do not have to be connected “vertically” in a modulator-carrier relationship, as shown above. The outputs of two operators can also be mixed—just as the stops in an organ are mixed. In this case the sounds are simply added together with no modulation effect.

ALGORITHMS

We have seen two different ways that two operators may be combined. The DX21 uses four operators, offering a lot of potential connection possibilities. These different configurations of operator relationships are called “algorithms”, and the DX21 offers 8 algorithm choices. These are all printed right on the DX21 panel. In the algorithm diagrams on the panel the small boxes numbered 1 through 4 are the operators.

ALGORITHM #1

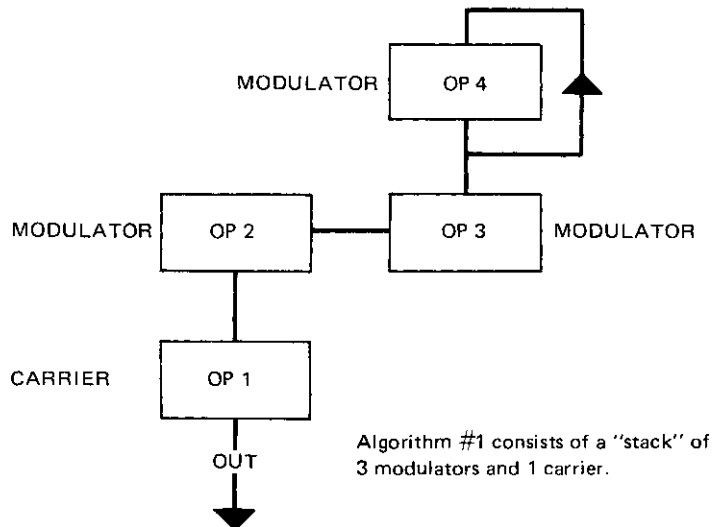

HOW ALGORITHMS AFFECT THE SOUND

By changing the relative frequencies between operators in a modulator-carrier relationship, you change not only the fundamental pitch of the note, but also the frequencies present in the harmonic structure. Thus, the timbre of the voice can be precisely controlled. In addition, since each operator has its own envelope generator (and a sophisticated one, too!), the harmonic structure of a note can be programmed to vary over time, just as a plucked string changes its overtones as the note decays.

Depending on the selected algorithm, operators can be stacked vertically, connected horizontally, or both. In the vertical arrangement, when the output of one operator is connected to the input of another the result is modulation. By convention, the operator at the bottom—or “output”—of a stack of operators is known as a “carrier”. All operators in the same stack above the carrier are “modulators”. By increasing the output level of one or more modulators feeding a carrier, the number of harmonics in the resultant sound is increased (its “bandwidth” is increased), making it more brilliant.

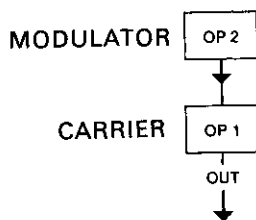

The bottom operator of a stack is called a CARRIER. Any operators which are connected to the carrier's inputs are called MODULATORS. YOU CAN'T HEAR A MODULATOR DIRECTLY, but you hear its effect by listening to the carrier's altered (modulated) output. A given operator can be either a carrier or a modulator: the only difference is how it is "connected" in a given algorithm.

Most algorithms have multiple modulators and carriers. In one algorithm a given operator may be a carrier, while in the next it might function as a modulator—the only difference being how it is connected. In algorithm number 5, for example, there are two vertical stacks of two operators, and the outputs of the carriers in these stacks are connected in parallel (horizontally). Algorithm 5 has an equal number of modulators and carriers—two modulators and two carriers.

ALGORITHM #5

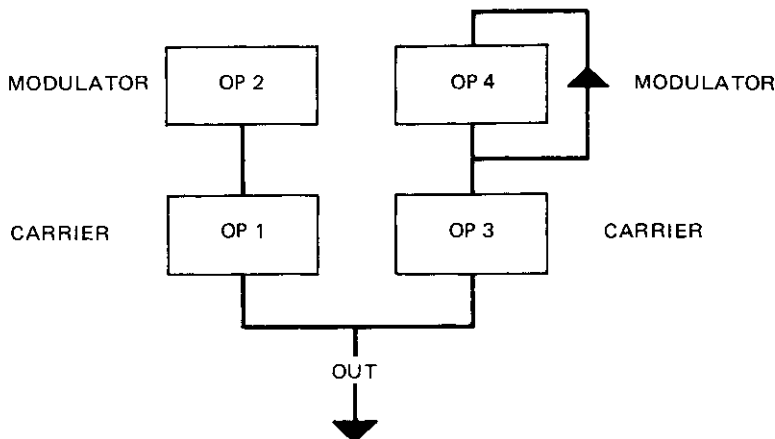

On the other hand, all operators in algorithm 8 function as carriers. Note that no modulation can occur in this algorithm (except for the feedback loop on operator 4—we'll discuss that later). But algorithm 8 is ideal for creating rich organ voices—think of each operator as different organ "stops", which can be mixed together as desired.

The algorithm alone, however, does not determine the actual sound of the voice. The vital characteristics of the voice you create depend mostly on the frequencies and levels you program into each operator. The 8 algorithms provided in the DX21 were specially selected because they offer the broadest range of voice programming possibilities.

The results of using different frequency ratios, as well as different algorithms, are shown graphically in the accompanying illustration. In the left column you see the waveforms created by 1:1, 2:1 and 3:1 ratios between one modulator and one carrier. In the right column you see the waveforms which result from the same three ratios, but when the two operators used are both carriers (connected horizontally, this is known as additive synthesis).

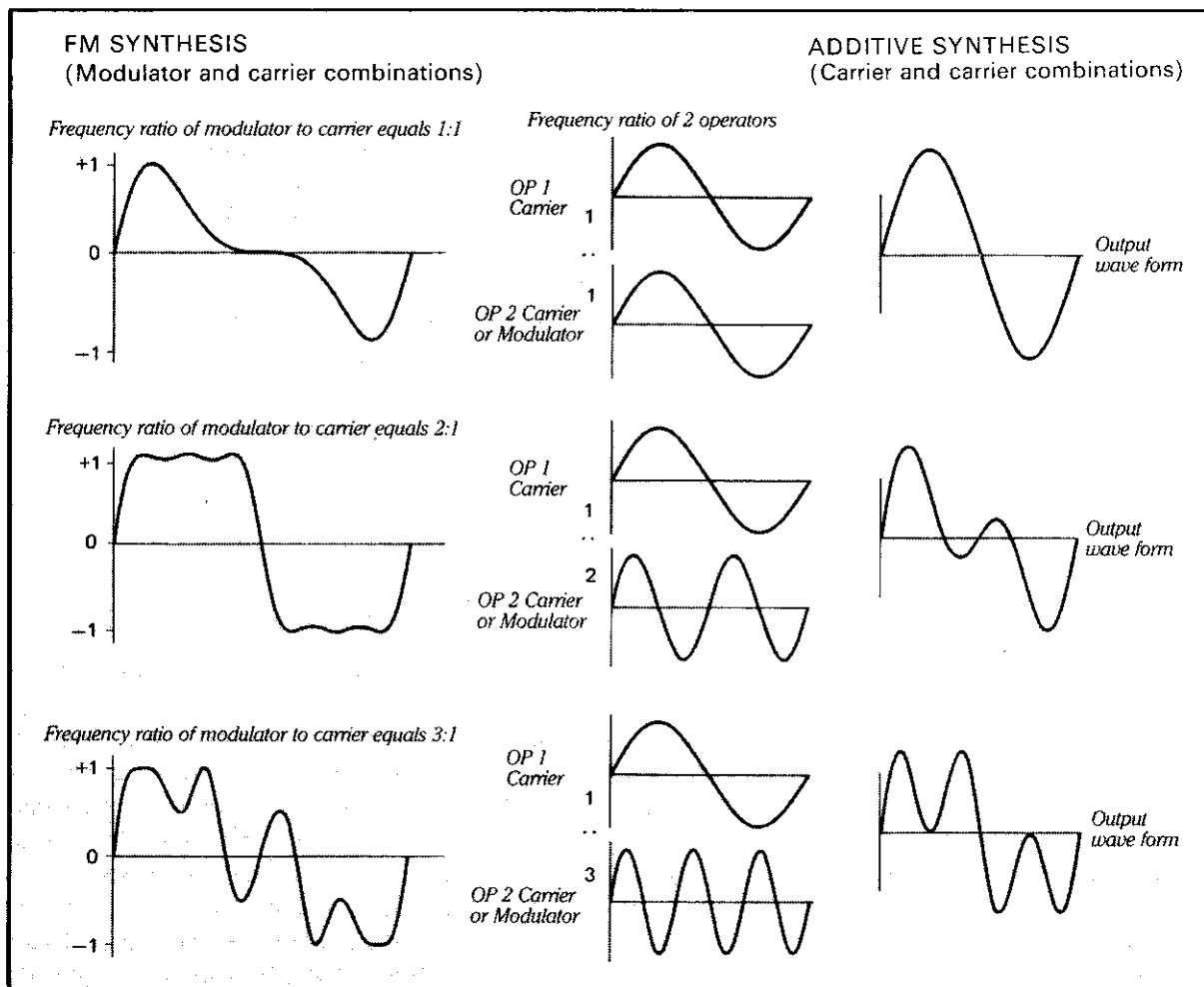

Still more variations can be achieved by changing the relative output levels between operators; the greater the level of the modulating operator, the more harmonics are present.

FEEDBACK

Note that every algorithm has one operator with a "feedback loop"—represented by a line from the output of the operator which feeds back to the input of the same operator. In effect, a feedback loop means that the operator is modulating itself. While every algorithm has one feedback loop, feedback is not necessarily used in every voice. One of the DX21 editing functions permits the feedback level to be set between 0 (no feedback) and 7 (maximum feedback).

ENVELOPE GENERATORS

Consider what happens when you play a note on, say, an acoustic instrument. The level of the sound initially goes up to some value, then eventually falls to nothing, following some sort of pattern that is characteristic of the particular instrument played. For example, a low note on a pipe organ starts slowly when you press a key, because it takes a while for the large column of air within the pipe to build up to maximum oscillation level, and takes a while to die down once the key is released. A note played on a wood block, on the other hand, starts quickly as the mallet strikes the block, and stops quickly as the block stops resonating. The characteristic volume pattern of any note played on any instrument is known as its "volume envelope". Most acoustic instruments also have a "timbre envelope", in which the harmonic content of the note changes (the timbre changes) from the time the note is initiated to the time it decays.

Each of the 4 operators available in DX21 can be programmed with its own envelope. The envelope applied to a carrier will, generally, contribute to the overall volume envelope of the note, while an envelope applied to a modulator will contribute to the timbre envelope of the note.

Here is a copy of the envelope diagram printed above the LCD on the DX21 panel.

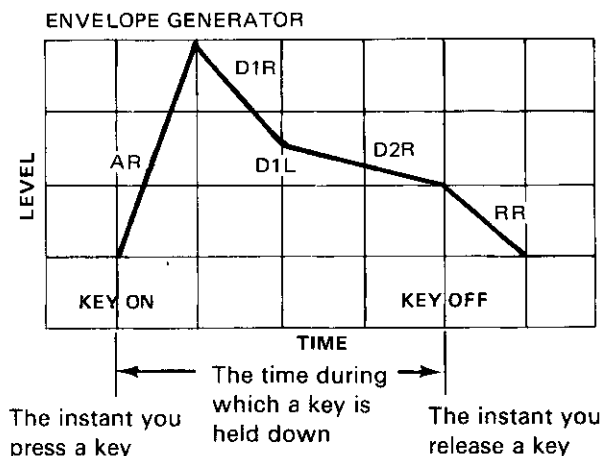

This envelope diagram can be used as a guide in visualizing DX21 envelope settings while you program or edit a voice.

Each envelope generator can be programmed with five different parameters: ATTACK RATE (AR), DECAY 1 RATE (D1R), DECAY 1 LEVEL (D1L), DECAY 2 RATE (D2R), and RELEASE RATE (RR). The RATE parameters determine how fast the envelope moves from one level to the next. The term LEVEL is used rather than "volume" because the envelope of the operator you're working on could affect volume or timbre, depending on whether it is a carrier or a modulator.

Any note begins at zero level when you press a key, then begins to approach maximum EG level at a rate determined by the setting of AR (Attack Rate). The envelope may reach maximum level instantly, or it may take over 30 seconds depending on the setting of AR.

When the envelope reaches maximum level it immediately begins moving towards the next level in the envelope—D1L (Decay 1 Level)—at a speed determined by the setting of D1R (Decay 1 Rate).

The change from maximum EG level to D1R can be either a decrease in level or a sustain at maximum level, depending on the values you choose for D1L.

After reaching D1L, the envelope then begins to decay toward zero level at a speed determined by the setting of the D2R (Decay 2 Rate) parameter. If D2R is set to 0 (no decay), however, the note will be sustained at D1L for as long as you hold the key. Now, when you release the key you have been holding the envelope will immediately begin to decay towards 0 level at a speed determined by RR (Release Rate). In fact, at whatever point in the envelope you release the key the envelope will immediately begin moving toward 0 level at the set Release Rate. Thus ends the note envelope "history".

THE PITCH EG

In addition to the EG functions just described, the DX21 also has a "PITCH EG". This pitch envelope generator is programmed in a similar way to the individual operator EGs, but it affects the overall pitch of the voice rather than level and timbre. This is useful for creating certain types of voices—whistling, for example, in which the pitch of the note usually starts out a bit low and then sweeps up to the proper pitch.

2. The EDIT and COMPARE Modes

To actually program or edit a voice you need to enter the EDIT mode. This is done by pressing the EDIT/COMPARE switch in the group of switches to the left of the LCD panel.

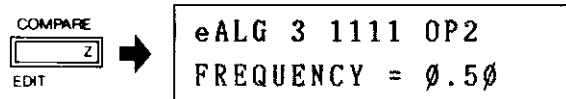

When the EDIT mode is activated the upper line of the LCD will indicate the currently selected algorithm, the operator ON/OFF status (the group of four 1s or 0s) and the currently selected operator. The lower display line will indicate the currently selected voice parameter. The last voice selected in the PLAY mode will be selected for editing. The individual voice parameters are then selected by pressing the corresponding voice selector switches—all voice parameters are printed in violet above the voice selector switches. The selected parameter is then programmed using the DATA ENTRY control and/or switches. The individual parameters will be described in detail below.

Once the EDIT mode has been called and any parameter change has been made, a small letter "e" will appear in the top left corner of the LCD, indicating that editing is in progress. You can play the DX21 keys and listen to how parameter changes are affecting the voice as you edit. In many cases you will be editing an existing voice and will want to compare the sound of the edited voice with the original voice. This is done simply by pressing the EDIT/COMPARE switch again. The small letter "e" in the top left corner of the LCD will change to a "c" indicating that the COMPARE mode has been activated, and that the voice you will now hear is the original voice before editing (the parameters displayed on the LCD will also revert to those of the original voice). You can then return to the voice being edited by pressing the EDIT/COMPARE switch again. This can be repeated as many times as needed during the editing process. The COMPARE mode can only be entered from the EDIT mode, however, after at least one data change has been made to the original voice.

The EDIT/COMPARE mode can be exited by entering any PLAY mode or the FUNCTION mode. Please note, however, that if you exit the EDIT/COMPARE mode and then select a new voice ANY DATA YOU HAVE EDITED WILL BE ERASED!!! This is because all editing is performed in a special edit buffer memory which is the same memory to which a voice is called when its selector button is pressed. To save edited data you must use the STORE function to save the new data in one of the DX21's 32 RAM voice memories. The STORE function will be discussed in *CHAPTER III: MEMORY MANAGEMENT*. If you do make a mistake and lose the edited data, the DX21 has been provided with a special temporary buffer memory from which the lost data can be recalled (assuming only one error has been made) using the EDIT RECALL function. The EDIT RECALL function will also be discussed in *CHAPTER III: MEMORY MANAGEMENT*.

3. The Voice Parameters

The following is a brief description of each available voice parameter, how it is programmed, and its effect. These parameters are selected by pressing the appropriately labelled (violet labels indicate voice parameters) panel switch while the DX21 is in the EDIT mode.

PB MODE: OPERATOR SELECT



This switch (located immediately above the -1 DATA ENTRY button) selects the operator to be worked on. Only one operator can be selected at a time. Only the parameters for the selected operator will be displayed on the LCD panel.

In the EDIT mode the currently selected operator number is generally displayed at the top right corner of the LCD: for example, "OP 3". This only applies to parameters which can be individually programmed for each operator, however, when parameters that affect all operators simultaneously are called (the LFO WAVE, SPEED and DELAY parameters, for example) the current operator display will disappear from the LCD and individual operators cannot be selected.

A1-A4: OPERATOR/AMS ON-OFF/EG COPY, 1-4

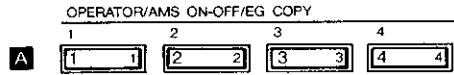

Individually turns operators 1 through 4 ON or OFF. In many cases a voice will not require all operators in an algorithm. Operators that are not needed should be turned OFF while editing. Also, during the voice creation process, it is a good idea to start with all operators OFF and then turn them ON one at a time as you program and add them to the algorithm. The four digits immediately following the algorithm number on the upper display line represent the four operators, 1 through 4, in order from left to right. When an operator is ON a "1" appears in the corresponding position, and when an operator is OFF a "0" appears in the corresponding position. Each press on the A1 through A4 buttons alternately turns the corresponding operator ON and OFF.

When the AMPLITUDE MODULATION SENSITIVITY parameter is selected (A14), these switches are used to determine to which operators the sensitivity setting will apply.

When the EG COPY function is in use these switches are used to select the operator to which the data from the currently selected operator will be copied.

The EG COPY function copies the ENVELOPE GENERATOR and KEYBOARD SCALING data from one specified operator to another. This can save a lot of programming time when operators are to be programmed with the same or similar data. The EG COPY procedure is described in the illustration below.

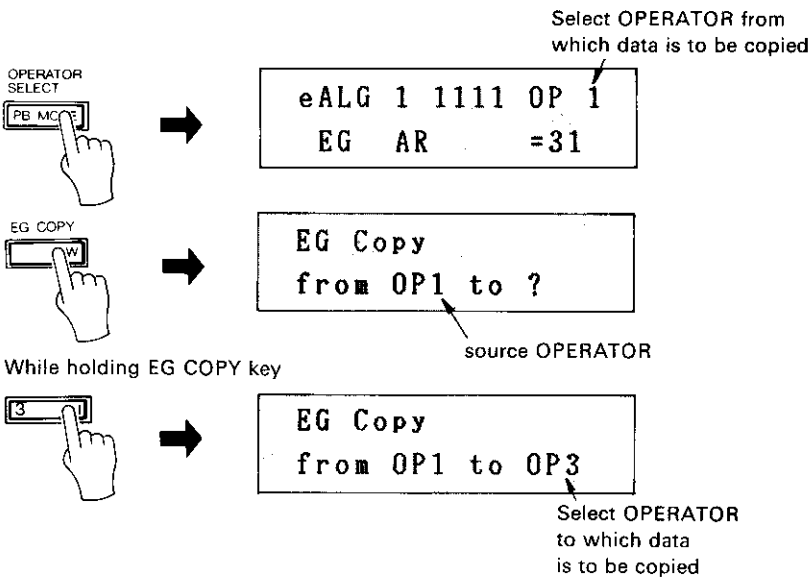

A5: ALGORITHM

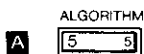

Permits selection of any of the 8 available algorithms. The desired algorithm number is selected using either the DATA ENTRY control or switches.

eALG 3 1111
ALGORITHM SELECT

A6: FEEDBACK

FEEDBACK
A [6]

Feedback can be applied to one operator in each algorithm. Pressing this switch permits setting the amount (level) of feedback which will be applied. The feedback level range is from 0 to 7. At 0 feedback is OFF, and at 7 maximum feedback is applied. Data is entered via the DATA ENTRY control or switches.

eALG 3 1111
FEEDBACK = 7

The LFO

LFO
WAVE SPEED DELAY PMD AMD SYNC
A [7] [8] [9] [10] [11] [12]

"LFO" stands for Low Frequency Oscillator. It is this oscillator that is used to apply modulation effects such as tremolo or vibrato to the DX21 voices. By setting the LFO WAVE, SPEED and SYNC parameters you determine the effect that will be applied to the currently selected voice when the modulation wheel or breath controller is operated. The LFO parameters work together with the A13 and A14 MODULATION SENSITIVITY parameters, and these must be set properly to achieve the desired effect.

NOTE:
When the DX21 is set to the DUAL or SPLIT play mode, the LFO data set for the A voice simultaneously affects the B voice.

A7: LFO WAVE

Permits selection of the low frequency oscillator waveform. The available waveforms are SAW UP (a rising sawtooth waveform), SQUARE, TRIANGLE, and S/HOLD (sample and hold).

These waveforms are selected using the DATA ENTRY control or switches.

eALG 3 1111
LFO WAVE: S/HOLD

A8: LFO SPEED

Permits setting the speed of the low frequency oscillator. The data range is from 0 to 99. 0 corresponds to the slowest LFO speed (0.06 Hz), and 99 corresponds to the fastest LFO speed (50 Hz).

eALG 3 1111
LFO SPEED = 35

A9: LFO DELAY

Permits setting a delay of between 0 and approximately 3 seconds before the LFO modulation effect begins after a key is played. This is particularly useful for simulating brass instruments, human voice, etc., in which the a vibrato effect is gradually applied after the note has been initiated.

The data range is from 0 to 99. At 0 there is no delay, and a setting of 99 produces a delay of approximately 15 seconds. With longer delay settings the modulation effect begins gradually for a remarkably natural sound.

```
eALG 3 1111
LFO DELAY = 3
```

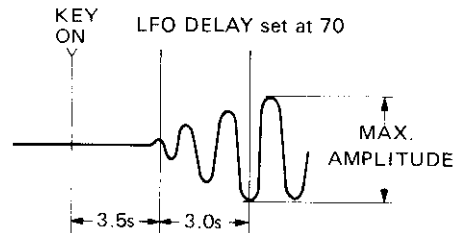

A10: LFO PMD

This parameter sets the depth of pitch variation produced by LFO modulation for all operators simultaneously. This function is independent from pitch modulation produced by the modulation wheel and breath controller, and is always ON once set.

The data range is from 0 to 99. At 0 pitch modulation is OFF, and a setting of 99 produces the greatest pitch variation, dependent on the PITCH MODULATION SENSITIVITY setting, described below (A13). When the PITCH MODULATION SENSITIVITY parameter is set to maximum (7), the maximum pitch variation (PM DEPTH = 99) will be plus and minus 1 octave.

Even if this parameter is set to 0, pitch modulation can still be applied via the modulation wheel or breath controller.

```
eALG 3 1111
LFO PMD = 2
```

A11: LFO AMD

This parameter sets the depth of amplitude variation (tremolo or wow) produced by LFO modulation for all operators simultaneously. This function is independent from amplitude modulation produced by the modulation wheel or breath controller, and is always ON once set.

The data range is from 0 to 99. At 0 amplitude modulation is OFF, and a setting of 99 produces the greatest variation, dependent on the AMPLITUDE MODULATION SENSITIVITY setting (A14). When the AMPLITUDE MODULATION SENSITIVITY parameter is set to maximum (3), the maximum amplitude variation (AM DEPTH = 99) will be plus and minus 42 dB peak-to-peak.

Even if this parameter is set to 0, amplitude modulation can still be applied via the modulation wheel and breath controller.

```
eALD 3 1111
LFO AMD = 44
```

A12: LFO SYNC

The beginning of the LFO cycle is normally synchronized with key-on timing. This parameter permits turning this synchronization ON or OFF. All operators are affected simultaneously.

```
eALG 3 1111
LFO SYNC: ON
```

When this parameter is ON, the LFO cycle always begins from the peak of a positive half-cycle (90 degrees phase angle) when a key is played. This produces a clear, consistent attack on all notes.

When LFO KEY SYNC is OFF, the LFO cycle starts from a random point when a key is played. This is the ideal setting when the LFO is being used to create natural-sounding chorus or phasing type effects.

NOTE:

When in DUAL or SPLIT mode, the "B" voice is affected by the LFO data of the "A" voice."

A13: PITCH MODULATION SENSITIVITY

MODULATION SENSITIVITY		
PITCH	AMPLITUDE	EG BIAS
A 13 C	14 D	15 E

This parameter sets the sensitivity of all operators to pitch modulation applied either via the LFO PMD parameter, above, or via the modulation wheel of breath controller. The data range is from 0 to 7. At 0 no pitch modulation can be applied, and at 7 the maximum pitch modulation can be achieved. When LFO PMD, above, is set to 99 a setting of 7 produces a plus and minus one-octave pitch variation.

eALG 3 1111
P MOD SENS. = 5

A14: AMPLITUDE MODULATION SENSITIVITY

This sets the operator's sensitivity to LFO and EG BIAS effects applied via the LFO PMD or AMD functions, or via the modulation wheel or breath controller.

The application of LFO modulation to a carrier results in tremolo, and applied to a modulator the result is a periodic variation in timbre which is similar to wow effects. When EG BIAS is applied to a carrier via the breath controller the result is volume (expression) control, and applied to a modulator the result is brilliance control.

The data range is from 0 to 3. At 0 amplitude modulation sensitivity is OFF and no LFO or EG BIAS effects can be applied to the selected operators. A setting of 3 produces maximum sensitivity and therefore maximum effect depth.

The operators to which modulation sensitivity is to be applied are selected using buttons A1 through A4. The four digits—1 or 0—at the top right corner of the LCD correspond to operators 1 through 4. When an operator is turned ON—i.e. able to receive amplitude modulation—the corresponding digit will be a "1". When OFF the corresponding digit will be a "0". The operators are turned ON and OFF alternately each time the corresponding OPERATOR/AMS ON-OFF/EG COPY button is pressed.

eALG 3 AME 1000
A MOD SENS. = 3

A15: EG BIAS

This sets the operator's sensitivity to EG BIAS effects applied via the breath controller. EG bias changes the overall output level from the operator. The harder you blow into the breath controller, the higher the maximum envelope level. When EG BIAS is applied to a carrier via the breath controller the result is volume (expression) control, and applied to a modulator the result is brilliance control.

The data range is from 0 to 7. At 0 EG BIAS sensitivity is OFF and no EG BIAS effects can be applied to the selected operators. A setting of 7 produces maximum sensitivity and therefore maximum effect depth.

```
eALG 3 1111 OP 2
E BIAS SENS. = 5
```

A16: KEY VELOCITY

```
KEY
VELOCITY
A 16 F
```

While the DX21 has no key velocity sensitivity of its own, its voice generators will accept key velocity data from an external MIDI controller keyboard which does have this feature. This function determines the sensitivity of each operator to keyboard velocity sensitivity data from an external keyboard connected to the DX21 MIDI IN terminal (key velocity sensitivity = the harder you play a key, the louder the note. Timbre variations are produced when keyboard sensitivity is applied to a modulator).

The data range is from 0 to 7. At 0 key velocity sensitivity for the selected operator is OFF. A setting of 7 produces the highest sensitivity, and therefore the greatest effect.

```
eALG 3 1111 OP 2
KEY VELOCITY = 4
```

B1: FREQUENCY RATIO

```
OSCILLATOR
FREQ RATIO DETUNE
B 1 G 2 H
```

These parameters determine the actual frequency of each operator. For operators which function as carriers this determines the actual pitch of the sound produced. For operators functioning as modulators this determines the harmonic spectrum of the sound produced.

Each operator can be set to any of 64 different frequency ratios as follows:

DX21 OPERATOR FREQUENCY RATIOS

0.50	0.71	0.78	0.87	1.00	1.41
1.57	1.73	2.00	2.82	3.00	3.14
3.46	4.00	4.24	4.71	5.00	5.19
5.65	6.00	6.28	6.92	7.00	7.07
7.85	8.00	8.48	8.65	9.00	9.42
9.89	10.00	10.38	10.99	11.00	11.30
12.00	12.11	12.56	12.72	13.00	13.84
14.00	14.10	14.13	15.00	15.55	15.57
15.70	16.96	17.27	17.30	18.37	18.84
19.03	19.78	20.41	20.76	21.20	21.98
22.49	23.55	24.22	25.95		

These frequency ratios have been carefully chosen as the most useful for voice programming. A ratio of 1.00 sets the selected operator to standard pitch—a pitch of 440 Hz will be produced when the A3 (A above middle C) key is pressed. A ratio of 0.50 produces a pitch one octave lower, and a ratio of 2.00 produces a pitch one octave higher than standard pitch, and so on. The fractional ratios—1.73, for example—produce extremely complex waveforms when combined with operators set to other ratios, permitting the creation of an unlimited variety of sound effects

including extremely realistic bells, explosions, etc. More even ratios are more useful for creating musical instrument sounds. It is possible to combine a modulator set to a fractional ratio at a low operator level with even-ratio operators to add bite to a string sound and many other effects.

The standard DX21 keyboard pitch is 8', therefore in terms of footage: 0.50 = 16', 1.00 = 8', and 2.00 = 4'

```
eALG 3 1111 OP 2
FREQUENCY      = 0.78
```

B2: DETUNE

This parameter permits slight detuning of the selected operator in relation to the others, making it possible to create richer, fuller voice effects. If detune is applied to carriers, the result is a thick, multi-instrument effect. Applied to modulators the result is a slight periodic variation in timbre— sometimes similar to a phase shift effect.

The data range is from -7 to +7, for a maximum detuning range of plus or minus 2 cents (1/600th of an octave). At +0 no detune effect is produced.

```
eALG 3 1111 OP 2
DETUNE         = +3
```

B3-B7: ENVELOPE GENERATOR, AR, D1R, D1L, D2R, RR

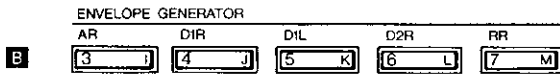

These switches select the specific envelope generator parameters to be worked on: ATTACK RATE, DELAY 1 RATE, DELAY 1 LEVEL, DELAY 2 RATE and RELEASE RATE.

The data range for AR, D1R, and D2R is 0 to 31, with 31 being the fastest rate (instantaneous) and 0 the slowest. RR and D1L have a data range of from 0 to 15, with 15 being maximum level and 0 being zero level for D1L.

```
eALG 3 1111 OP 2
EG AR         = 22
```

The following EG curve shows the relationship between the RATE and LEVEL parameters.

BASIC EG CURVE

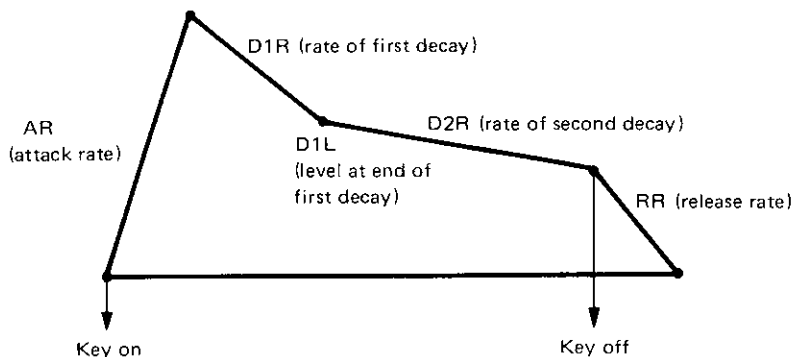

The following EG curves show the parameters for some common instruments. When creating voices on the DX21 you should apply these EG curves to the carrier operator.

PIANO E.G. CURVE

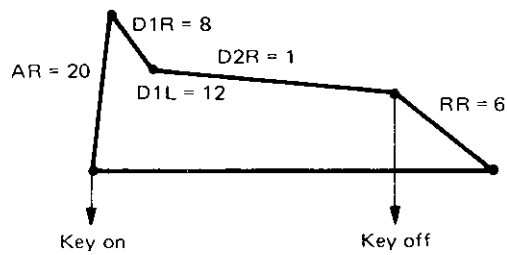

ORGAN E.G. CURVE

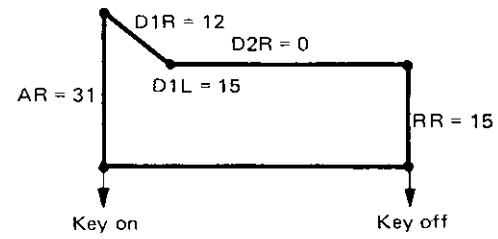

BRASS E.G. CURVE

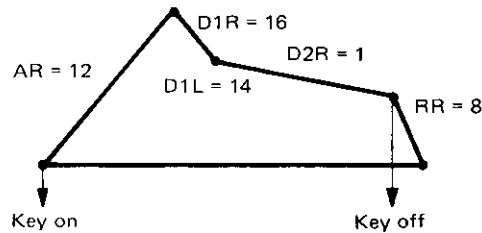

B8: OPERATOR OUTPUT LEVEL

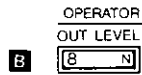

Permits setting the output level of the selected operator. The data range is from 0 to 99. At 0 the operator is OFF, and a setting of 99 produces maximum output level from the selected operator.

Varying the output level of an operator which is functioning as a carrier results in a change in the overall level of the sound contributed to the voice by that operator, while varying the output level of an operator which is functioning as a modulator results in a change in the harmonic spectrum produced by the carrier, thereby changing the timbre of the sound.

Data is entered using the DATA ENTRY control or switches.

```
eALG 3 1111 OP 2
OUTPUT LEVEL = 99
```

B9: RATE SCALING

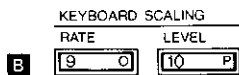

This parameter makes it possible to gradually shorten the overall envelope length (increase EG rate) as higher notes on the keyboard are played. This is particularly useful for simulating the sound of stringed instruments such as piano or guitar, in which the envelope of the higher notes is noticeably shorter than the lower notes.

```
eALG 3 1111 OP 2
RATE SCALE = 1
```

The data range is from 0 to 3. At 0 RATE SCALING is minimum and at 3 the greatest variation in envelope length is produced.

B10: LEVEL SCALING

This parameter produces a gradual decrease in note output level towards the right (high) end of the keyboard. Many acoustic instruments exhibit a gradual falloff in level towards the higher notes, and this function can be used to create the most natural overall keyboard response for any particular voice.

The data range is from 0 to 99. At 0 no level scaling is applied. At 99 the deepest keyboard level scaling effect is produced, and highest note on the keyboard may be almost inaudible. Set this parameter for the most natural overall balance for the particular voice.

```
eALG 3 1111 OP 2
LEVEL SCALE = 25
```

B11-16: PITCH ENVELOPE GENERATOR, PR1, PL1, PR2, PL2, PR3, PL3

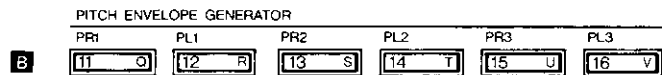

These switches select the specific pitch envelope generator parameters to be worked on: PITCH RATE 1, PITCH LEVEL 1, PITCH RATE 2, PITCH LEVEL 2, PITCH RATE 3 and PITCH LEVEL 3. Note that the parameters are slightly different from those of the volume envelope generator, and that there are six parameters instead of five. The data range for all pitch envelope generator RATE and LEVEL parameters is 0 to 99. For the RATE parameters 99 is the fastest rate (instantaneous) and 0 the slowest. The LEVEL parameters actually correspond to pitch. 50 is standard pitch, 99 is the highest pitch and 0 is the lowest pitch reachable with the pitch EG. The following chart shows the relationship between the pitch EG rate and level parameters.

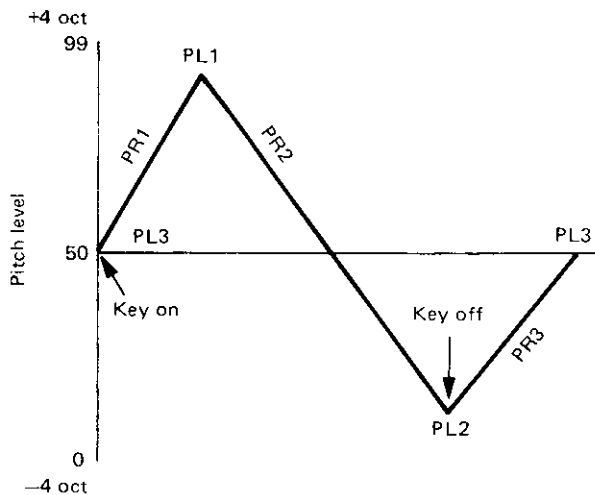

PL3 (Pitch Level 3) is the level (pitch) at which the note begins and finishes. PR1 (Pitch Rate 1) is the speed at which the pitch moves from PL3 to PL1 when a key is pressed. PR2 is the speed at which the EG curve moves from PL1 to PL2. The EG begins moving towards PL2 immediately after PL1 is reached. PL2 is the "sustain" pitch. The pitch determined by PL2 will be maintained as long as a key is held. Once the key is released the EG will begin moving back towards PL3 at a rate determined by the setting of PR3. PR3 can be thought of as the "release" rate. If all level parameters are set at 50 (standard pitch), the pitch envelope generator will have no effect.

B16 (FUNCTION MODE): VOICE NAME



This function is accessed in the FUNCTION mode—press the FUNCTION button and then the B16 (VOICE NAME) button.

The VOICE NAME function can be used to give voices in the voice memory an identifying name. Voice names can be up to 10 characters in length.

When this function is called the flashing cursor will appear at the beginning of the voice name entry space on the lower display line, ready for you to enter the first character. The available characters are printed in white on the right side of the voice selector buttons and the group of six buttons to the left of the LCD. To enter a character in the FUNCTION: VOICE NAME mode, hold down the CHARACTER button (this is the same as the FUNCTION button) and press the corresponding character button. As each character is entered the flashing cursor moves one space to the right, ready for the next character. A character entered over an existing character will replace the original character. The PLAY SINGLE button can be used to enter a space. To correct errors, the cursor may be moved to the left and right using the - 1/NO/OFF and +1/YES/ON switches, respectively.

4. STORING Voice Data

If you have edited any of the above voice parameters and wish to keep the edited data, you must use the STORE function BEFORE PRESSING ANY VOICE SELECTOR AFTER EXITING THE EDIT OR FUNCTION MODES, and store the new data in one of the 32 RAM voice memories. Of course, this means it is a good idea to have a free memory location ready before you begin editing. If you are editing voices that were originally called from the internal ROM memory, don't worry, you can recall the ROM memory voices any time you need to. If the RAM is full of original voices, however, make sure any voices you want to keep have been saved to cassette tape from which they can later be recalled.

To STORE a newly edited voice, first exit the EDIT mode by pressing the PLAY SINGLE mode selector. Then, hold down the STORE button (this is the same as the EG COPY button) and press the voice selector to which you want to save the edited voice data. The MEMORY PROTECT function must be OFF before attempting to use the STORE function.

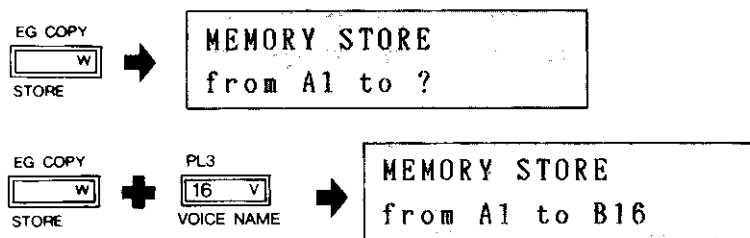

5. Two Approaches to Creating Your Own Voices

There are two basic approaches which can be taken when programming voices on the DX21. First, you can run through all the existing voices, choose one that is close to the sound you wish to create, and then edit that voice to create your own. Second, you can "initialize" the the voice edit buffer (see *CHAPTER III: MEMORY MANAGEMENT*, 1. The Initialize Voice Function) setting all parameters to their initial values and begin programming your voice from scratch.

The first method, editing a preset voice, is generally a much more efficient approach, provided the sound you want is close to something that already exists. If, however, you are looking for a unique voice that is totally unlike any of the available presets, it is probably best to initialize and start from scratch.

If you choose to program a voice from scratch, you'll need to have a clear memory location (or one containing a voice that you either don't want or have already backed up on cassette tape), so that when you've completed programming the voice, you can save it. Since all editing is done in the separate voice edit buffer, nothing is erased while you are actually programming the voice. But when you save the new voice whatever was in that memory location will be erased and replaced by the new data.

GENERAL SPECIFICATIONS

Keyboard	61 keys, C ₁ ~ C ₆
Sound Source	FM Tone Generator: 4 operators x 2 (A,B), 8 Algorithms
Simultaneous Note Output	Polyphonic: 8 notes (SINGLE), 4 notes (DUAL), 4 + 4 notes (SPLIT) Monophonic: 1 note (SINGLE, DUAL), 1 + 1 note (SPLIT)
Internal Memory	128 ROM voice memory 32 RAM voice memory 32 RAM performance memory
Controls	PITCH BEND WHEEL, MODULATION WHEEL, VOLUME, BALANCE, DATA ENTRY
Display	LCD (16 characters x 2 lines)
Connecting Terminals	OUTPUT MIX/A, OUTPUT B, PHONES, CASSETTE
Control Terminals	FOOTSWITCH (SUSTAIN, PORTAMENTO), FOOT CONTROLLER (VOLUME), MIDI (IN, OUT, THRU)
Dimensions/Weight	909 (W) x 82 (H) x 270 (D) mm (35.8" x 3.2" x 10.6") 8 kg (17.6 lbs)
Power Requirements	U.S. & Canadian Models: 120 V, 50/60 Hz General Models: 220 ~ 240 V, 50 Hz
Power Consumption	7 W
Standard Accessories	Music Stand, Cassette Cable
Optional Accessories	FC7 Foot Controller, FC4 or FC5 Footswitch, BC1 Breath Controller, LC-21S or SC-21 Carrying Case, LG-21 Stand, MIDI-03 or MIDI-15 MIDI Cable

MIDI DATA FORMAT

1. Transmission Conditions

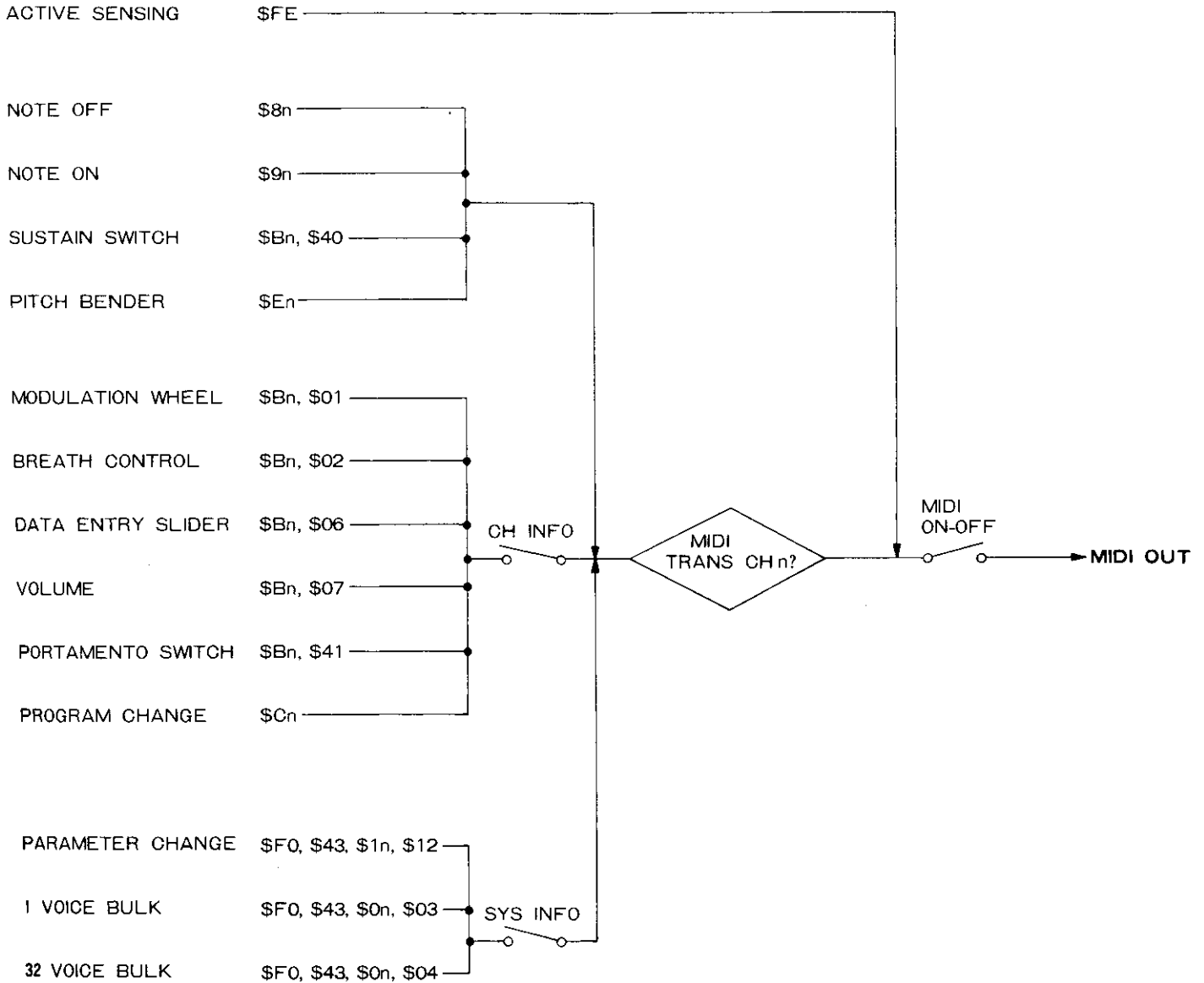

2. Transmission Data

All MIDI data is transmitted when the MIDI ON/OFF function is ON. The MIDI transmission channel is determined by the setting of the MIDI TRNS CH function.

2-1. CHANNEL INFORMATION

2-1-1. Channel Voice Message

(1) Key Off

Status	1000nnnn	n=channel no.
Note no.	0kkkkkkk	k=36(C1) ~ 96(C6)
Velocity	01000000	

(2) Key On

Status	1000nnnn	n=channel no.
Note no.	0kkkkkkk	k=36(C1) ~ 96(C6)
Velocity	01000000	

(3) Control Change

Status	1011nnnn	n=channel no.
Control no.	0ccccccc	
Control code	0vvvvvvv	

a) Transmitted whether MIDI CH INFO is ON or OFF

Control no.	Control code.
C=64: Sustain sw.	V=0:OFF, 127:ON

b) Transmitted when MIDI CH INFO is ON

Control No.	Control code
C=1: modulation wheel	V=0~127
C=2: breath control	V=0~127
C=6: data entry slider	V=0~127
C=7: foot volume	V=0~127
C=65: portamento sw.	V=0:OFF, 127:ON

(4) Program Change

Status	1100nnnn	n=channel no.
Program no.	0ppppppp	p=0~31

This data is transmitted when a voice selector is pressed during the play mode, when MIDI CH INFO is ON and MIDI SYS INFO is OFF. Also transmitted when a performance selector is pressed in the performance mode.

(5) Pitch Bend

Status	1110nnnn	n=channel no.
Code (LSB)	0uuuuuuu	
Code (MSB)	0vvvvvvv	

The transmitted data is as follows:

MSB	LSB	
00000000	00000000	Lowest value
01000000	00000000	Center value
01111111	01111110	Highest value

2-2. SYSTEM INFORMATION

2-2-1. System Real-time Message

Active sensing Status	11111110
--------------------------	----------

Transmitted once approximately every 200 milliseconds

2-2-2. System Exclusive Message

Transmitted only when MIDI SYS INFO is ON

(1) Parameter Change

Status	11110000	
ID no.	01000011	
Substatus/ch. no.	0001nnnn	n=channel no.
Parameter group no.	00010010	
Parameter no.	0ppppppp	
Data	0ddddddd	
EOX	11110111	

This data is transmitted when voice or function parameters are changed in the EDIT or FUNCTION modes. The voice parameters transmitted are those given in voice parameter table 5-2, and the function parameters transmitted are shown in function parameter table 5-3.

(2) 1 Voice Bulk Data

Status	11110000	
ID no.	01000011	
Substatus/ch. no.	0000nnnn	n=channel no.
Format no.	00000011	
Byte count	00000000	
Byte count	01011101	
Data	0ddddddd	} 93 bytes
	0ddddddd	
Checksum	0eeeeeee	
EOX	11110111	

The data for one voice is transmitted when a voice selector is pressed in the PLAY SINGLE mode. Data in the voice edit buffer is transmitted when a format no. f=3 dump request is received. The transmitted data is shown in voice parameter table 5-2. The checksum is the lowest 7 bits of the two's complement sum of all data bytes (the same applies below).

(3) 32 Voice Bulk Data

Status	11110000	
ID no.	01000011	
Substatus/ch. no.	0000nnnn	n=channel no.
Format no.	00000100	
Byte count	00100000	
Byte count	00000000	
Data	0ddddddd	} 4096 bytes
	0ddddddd	
Checksum	0eeeeeee	
EOX	11110111	

The data of all 32 voices in RAM memory will be transmitted if the YES (or BULK) key is pressed in response to the "MIDI Transmit?" display which appears when the BULK key is pressed in the FUNCTION mode. The data for all 32 voices will also be transmitted when a format no. f=4 dump request is received. The transmitted data is shown in voice data table 5-1. 55 bytes of 0's are added to the 73 bytes in this table, so 128 bytes are transmitted for each voice. 4096 bytes are therefore transmitted for all 32 voices.

3. Reception Conditions

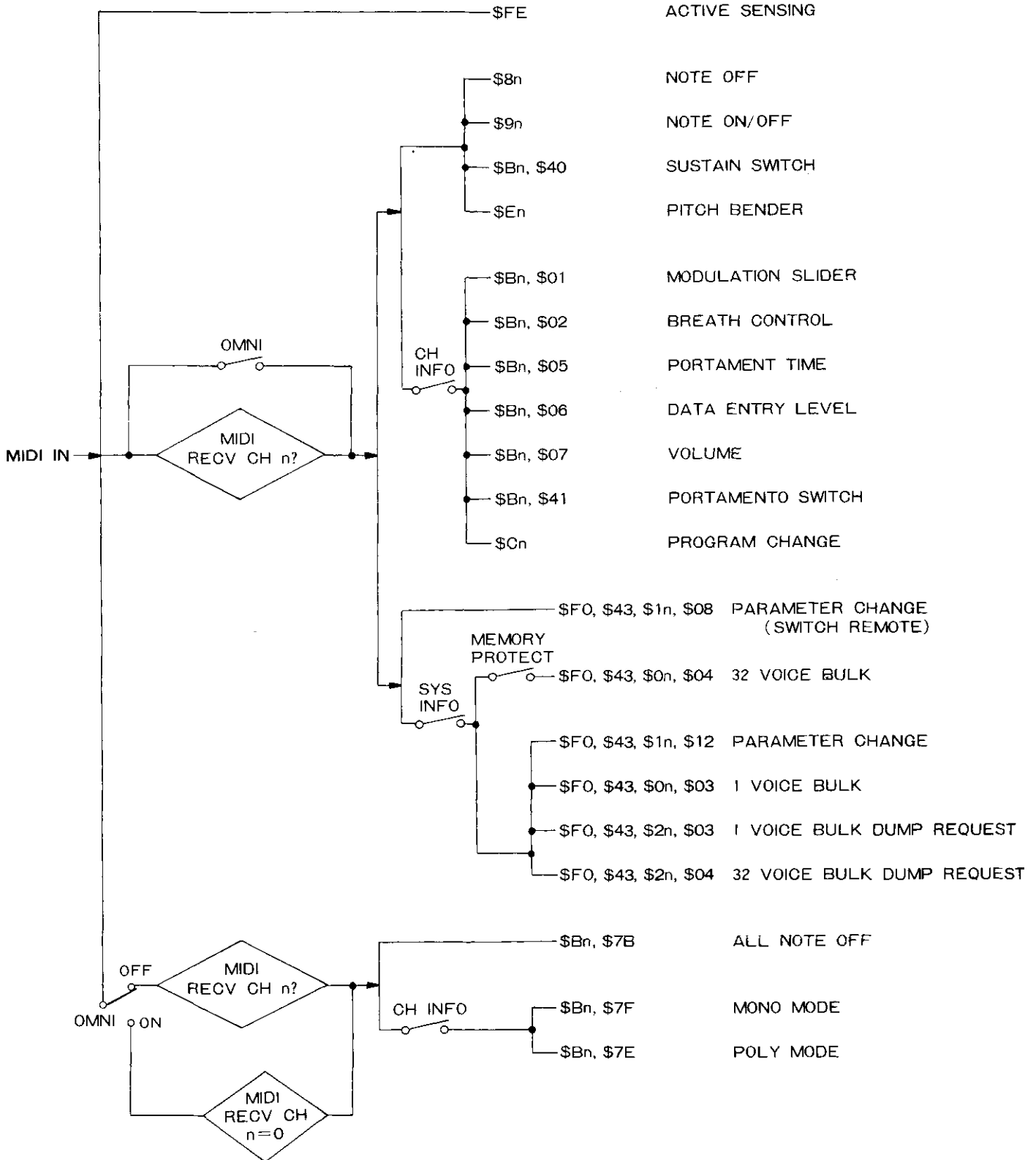

4. Reception Data

All MIDI data is received when the MIDI ON/OFF function is ON. When a specific MIDI receive channel has been selected using the MIDI RECV CH function, and the OMNI mode is OFF, MIDI data will be received only on the specified channel. MIDI data will be received on all channels when the OMNI mode is ON.

4-1. CHANNEL INFORMATION

4-1-1. Channel Voice Message

(1) Key off

Status	1000nnnn	n=channel no.
Note no.	0kkkkkkk	k=0(C-2) ~ 127 (G8)
Velocity	0vvvvvvv	v is ignored

(2) Key On/Off

Status	1001nnnn	n=channel no.
Note no.	0kkkkkkk	k=0(C-2) ~ 127 (G8)
Velocity	0vvvvvvv	v=0: key off v=1~127: key on

The key on note level will vary according to the received velocity value. The range of this instrument is C-1 to B6. If a higher or lower key number is received, it will be output within the range limits. For example, received C7 through B7 data will be output as notes in the C6 through B6 range.

(3) Control Change

Status	1011nnnn	n=channel no.
Control no.	0ccccccc	
Control code	0vvvvvvv	

a) Received whether MIDI CH INFO is ON or OFF

Control no.	Control code
C=64: Sustain sw.	V=0:OFF, 127:ON
Control no.	Control code
C=1: modulation wheel	V=0~127
C=2: breath control	V=0~127
C=5: portamento time	V=0~127
C=6: data entry slider	V=0~127
C=7: foot volume	V=0~127
C=65: portamento sw.	V=0:OFF, 127:ON

(4) Program Change

Status	1100nnnn	n=channel no.
Program no.	0ppppppp	

Received only when MIDI CH INFO is ON. If received during the PLAY or PERFORMANCE mode the voice or performance number will be changed accordingly. The lower five bits of the program no. contain the voice or performance number.

(5) Pitch Bend

Status	1110nnnn	n=channel no.
Code (LSB)	0uuuuuuu	
Code (MSB)	0vvvvvvv	

Function s only on MSB data:

MSB	
00000000	Lowest value
01000000	Center value
01111111	Highest value

4-1-2. Channel Mode Message

Status	1011nnnn	n=channel no.
	0ccccccc	
	0vvvvvvvv	

a) Received whether MIDI CH INFO is ON or OFF

C=123	V=0	All notes OFF
-------	-----	---------------

b) Received only when MIDI CH INFO is ON

C=126	V=1	MONO mode ON
C=127	V=0	POLY mode ON

4-2. SYSTEM INFORMATION

4-2-1. System Real-Time Message

Active sensing

Status	11111110
--------	----------

Sensing begins when this code is received once. If status and data are not received within 300 milliseconds the MIDI receive buffer will be cleared and the currently output note will be turned OFF.

4-2-2. System Exclusive Message

(1) parameter Change (switch mode)

Status	11110000	
ID no.	01000011	
Substatus/ch. no.	0001nnnn	n=channel no.
Parameter group no.	00001000	
Switch no.	0mmmmmmm	
Data	0ddddddd	d=0:OFF, 1~127:ON
EOX	11110111	

All panel switches are controlled. The switch numbers are arranged as shown in the illustration below. Received only when MIDI SYS INFO is ON.

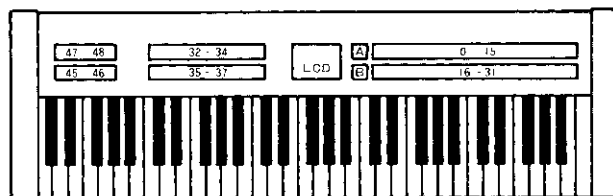

(2) Parameter Change

The format is the same as the transmitted parameter change data. Received only when MIDI SYS INFO is ON. Permits changing voice and function parameters while the EDIT mode is active. It is also possible to change modes: PLAY, EDIT, etc. The parameter no. and data received are shown in voice parameter table 5-2 and function parameter table 5-3.

(3) 1 Voice Bulk Data

Received only when MIDI SYS INFO is ON. The format is the same as for the transmitted 1 voice bulk data. The 93 voice data bytes are read into the voice edit buffer, replacing the current voice data. The 93 received data bytes are shown in voice parameter table 5-2.

(4) 32 Voice Bulk Data

Received only when MIDI SYS INFO is ON. The format is the same as for the transmitted 32 voice bulk data. This data can be received only when the MEMORY PROTECT function is OFF. The received voice data is stored in the 32 RAM voice memory locations. The "MIDI RECEIVED!!" display appears to confirm complete reception of 32 voice bulk data.

(5) Dump Request

Status	11110000	
ID no.	01000011	
Substatus/ch. no.	0010nnnn	n=channel no.
Format no.	0 f f f f f f	f=3,4
EOX	11110111	

Received only when MIDI SYS INFO is ON. When received the bulk data corresponding to the received format code will be dumped via MIDI OUT.

f=3: 1 voice bulk data
f=4: 32 voice bulk data

5. System Exclusive Data

5-1. VOICE DATA (VMEM format)

Parameter no.	Parameter		
P			
0	ATTACK RATE		
1	DECAY 1 RATE		
2	DECAY 2 RATE		
3	RELEASE RATE		
4	DECAY 1 LEVEL	} OP 4	
5	KEYBOARD SCALING LEVEL		
6	AMPLITUDE MODULATION ENABLE/EG BIAS SENSITIVITY/KEY VELOCITY		
7	OUTPUT LEVEL		
8	OSCILLATOR FREQUENCY		
9	KEYBOARD SCALING RATE/DETUNE 1		
10	} SAME AS FOR OP4		} OP 2
19			
20	} SAME AS FOR OP4		} OP 3
29			
30	} SAME AS FOR OP4	} OP 1	
31			
32			
39			
40	LFO SYNC/FEEDBACK LEVEL/ALGORITHM		
41	LFO SPEED		
42	LFO DELAY		
43	PITCH MODULATION DEPTH		
44	AMPLITUDE MODULATION DEPTH		
45	PITCH MODULATION SENSITIVITY/AMPLITUDE MODULATION SENSITIVITY/LFO WAVE		
46	TRANSPOSE		
47	PITCH BEND RANGE		
48	CHORUS SWITCH/PLAY MODE/SUSTAIN FOOT SWITCH/PORTAMENTO FOOT SWITCH/PORTAMENTO MODE		
49	PORTAMENTO TIME		
50	FOOT VOLUME		
51	MODULATION WHEEL PITCH MODULATION RANGE		
52	MODULATION WHEEL AMPLITUDE MODULATION RANGE		
53	BREATH CONTROL PITCH MODULATION RANGE		
54	BREATH CONTROL AMPLITUDE MODULATION RANGE		
55	BREATH CONTROL PITCH BIAS RANGE		
56	BREATH CONTROL EG BIAS RANGE		
57	VOICE NAME 1		
58			
66	VOICE NAME 10		
67	PITCH EG RATE 1		
68	PITCH EG RATE 2		
69	PITCH EG RATE 3		
70	PITCH EG LEVEL 1		
71	PITCH EG LEVEL 2		
72	PITCH EG LEVEL 3		

5-2. VOICE PARAMETERS (VCED format)

Parameter no. P	Parameter	LCD Display	Data	Note
0	ATTACK RATE	EG AR	0 ~ 31	
1	DECAY 1 RATE	EG D1R	0 ~ 31	
2	DECAY 2 RATE	EG D2R	0 ~ 31	
3	RELEASE RATE	EG RR	0 ~ 15	
4	DECAY 1 LEVEL	EG D1L	0 ~ 15	
5	KEYBOARD SCALING LEVEL	LEVEL SCALE	0 ~ 99	
6	KEYBOARD SCALING RATE	RATE SCALE	0 ~ 3	OP4
7	EG BIAS SENSITIVITY	E BIAS SENS.	0 ~ 7	
8	AMPLITUDE MODULATION ENABLE	A MOD SENS.	0, 1	
9	KEY VELOCITY	KEY VELOCITY	0 ~ 7	
10	OUTPUT LEVEL	OUTPUT LEVEL	0 ~ 99	
11	OSCILLATOR FREQUENCY	FREQUENCY	0 ~ 63	
12	DETUNE 1	DETUNE	0 ~ 7	
13 }	SAME AS FOR OP4			
25				
26 }	SAME AS FOR OP4			
38				
39 }	SAME AS FOR OP4			
51				
52	ALGORITHM	ALGORITHM SELECT	0 ~ 7	
53	FEEDBACK LEVEL	FEEDBACK	0 ~ 7	
54	LFO SPEED	LFO SPEED	0 ~ 99	
55	LFO DELAY	LFO DELAY	0 ~ 99	
56	PITCH MODULATION DEPTH	LFO PMD	0 ~ 99	
57	AMPLITUDE MODULATION DEPTH	LFO AMD	0 ~ 99	
58	LFO SYNC	LFO SYNC	0, 1	
59	LFO WAVE	LFO WAVE	0 ~ 3	
60	PITCH MODULATION SENSITIVITY	P MOD SENS.	0 ~ 7	
61	AMPLITUDE MODULATION SENSITIVITY	A MOD SENS.	0 ~ 7	
62	TRANSPOSE	Middle C	0 ~ 48	
63	PLAY MODE POLY/MONO	Poly Mode	0, 1	
64	PITCH BEND RANGE	P Bend Range	0 ~ 12	
65	PORTAMENTO MODE	Full Time Porta	0, 1	
66	PORTAMENTO TIME	Porta Time	0 ~ 99	
67	FOOT VOLUME	Foot Volume	0 ~ 99	
68	SUSTAIN FOOT SWITCH	Foot Sustain	0, 1	
69	PORTAMENT FOOT SWITCH	Foot Porta	0, 1	
70	CHORUS SWITCH	Chorus	0, 1	
71	MODULATION WHEEL PITCH MODULATION RANGE	MW Pitch	0 ~ 99	
72	MODULATION WHEEL AMPLITUDE MODULATION RANGE	MW Amplitude	0 ~ 99	
73	BREATH CONTROL PITCH MODULATION RANGE	BC Pitch	0 ~ 99	
74	BREATH CONTROL AMPLITUDE MODULATION RANGE	BC Amplitude	0 ~ 99	
75	BREATH CONTROL PITCH BIAS RANGE	BC Pitch Bias	0 ~ 99	
76	BREATH CONTROL EG BIAS RANGE	BC EG Bias	0 ~ 99	
77	VOICE NAME		1 ASCII	
86			10 ~ 99	
87	PITCH EG RATE 1	PEG RATE 1	0 ~ 99	
88	PITCH EG RATE 2	PEG RATE 2	0 ~ 99	
89	PITCH EG RATE 3	PEG RATE 3	0 ~ 99	
90	PITCH EG LEVEL 1	LEVEL 1	0 ~ 99	
91	PITCH EG LEVEL 2	LEVEL 2	0 ~ 99	
92	PITCH EG LEVEL 3	LEVEL 3	0 ~ 99	

5-3. FUNCTION PARAMETERS

Parameter no. P	Parameter	LCD Display	Data	Note
93	OPERATOR ENABLE/DISABLE		0 ~ 15	
94	OPETATOR SELECT		0 ~ 3	
95	EDIT MODE I=ON		0, 1	*
96	FUNCTION MODE I=ON	FUNCTION CONTROL	0, 1	*
97	STORE MODE I=ON	MEMORY STORE	0, 1	*
98	PLAY DUAL MODE I=ON		0, 1	*
99	PLAY SPLIT MODE I=ON		0, 1	*
100	PLAY SINGLE MODE I=ON	PLAY SINGLE	0, 1	*
101	DUAL MODE DETUNE	Dual Detune	0 ~ 99	
102	SPLIT POINT		0 ~ 127	*
103	MASTER TUNE \$40=CENTER .	Master Tune	0 ~ 127	
104	MIDI SWITCH I=ON	Midi Switch	0, 1	*
105	MIDI CH INFO	Midi is OFF!	0, 1	*
106	OMNI 0=OFF I=ON	Midi Omni	0, 1	*
107	MIDI TRANS CH	Midi Trns Ch	0 ~ 15	*
108	MIDI RECV CH 0=OMNI ON	Midi Recv Ch	0 ~ 16	*
109	MIDI SYS INFO	Midi Sy Info	0, 1	*
110	32 VOICE BULK DUMP	Midi Transmit?	1	*
111	EDIT RECALL	Recall Edit?	0, 1	*
112	INIT VOICE	Init. Voice?	0, 1	*
113				
114				
115				
116				
117				
118				
119	MEMORY PROTECT I=ON	Mem Protect	0, 1	*
120	KEY SHIFT 24=CENTER	Key Shift	0 ~ 48	
121	PITCH BEND MODE I=ON	Bend Mode	0, 1	*
122	KEY SHIFT		0, 1	*
123	COMPARE		0, 1	*
124	PITCH BEND MODE		0 ~ 2	
125				
126				
127				

* Receive only

Function ...	Transmitted	Recognized	Remarks
Basic Default	1 - 16	1 - 16	memorized
Channel Changed	1 - 16	1 - 16	
Mode Default	3	1, 2, 3, 4	memorized
Mode Messages	x	POLY, MONO(M=1)	
Mode Altered	XXXXXXXXXXXXXXXXXX	x	
Note Number : True voice	36 - 96 XXXXXXXXXXXXXXXXXX	0 - 127 0 - 127	
Velocity Note ON	x 9nH, v=64	o v=1-127	
Velocity Note OFF	x 8nH, v=64	x	
After Key's	x	x	
Touch Ch's	x	x	
Pitch Bender	o	o 0-12 semi	7 bit resolution
Control Change	1 : o 2 : o 5 : x 6 : o 7 : o 64 : o 65 : o 96 : o 97 : o	X1 : o X1 : o X1 : o X1 : x X1 : o X1 : o X1 : x X1 : x	X1 : Modulation wheel X1 : Breath control X1 : Portamento time Data entry knob X1 : Foot volume Sustain foot sw X1 : Portamento f sw Data entry +1 Data entry -1
Prog Change : True #	o 0 - 31 XXXXXXXXXXXXXXXXXX	o 0 - 127 0 - 31	
System Exclusive	o	X2 : o	X2 : Voice parameters
System : Song Pos	x	x	
System : Song Sel	x	x	
Common : Tune	x	x	
System : Clock	x	x	
Real Time : Commands	x	x	
Aux : Local ON/OFF	x	x	
Aux : All Notes OFF	x	o (123, 126, 127)	
Mes- : Active Sense	o	o	
sages: Reset	x	x	
Notes: All MIDI communications are enabled if MIDI switch is on. X1 = transmit/receive if CH information switch is on. X2 = transmit/receive if system information switch is on.			



VOICE/FUNCTION DATA

DATE/PRESET No. : _____

VOICE NAME : _____

PROGRAMMER : _____

OP	4	3	2	1	LFO										AME	OP
					ALGO-RITHM	FEED-BACK	WAVE	SPEED	DELAY	PMD	AMD	SYNC	PITCH	AMPLITUDE	EG BIAS	KEY VELOCITY
					5	6	7	8	9	10	11	12	13	14	15	16

OP	4	3	2	1	OPERATOR										PITCH ENVELOPE GENERATOR				TRAMS-POSE		VOICE NAME			
					FREQ RATIO	DETUNE	AR	DIR	DIL	D2R	RR	OUT LEVEL	RATE	LEVEL	PR1	PL1	PR2	PL2	PR3	PL3				
					ENVELOPE GENERATOR										PITCH ENVELOPE GENERATOR				CHORUS		VOICE NAME			
					17	18	19	20	21	22	23	24	25	26	27	28	29	30	31	32				
					OSCILLATOR				ENVELOPE GENERATOR				OPERATOR				PITCH ENVELOPE GENERATOR				TRAMS-POSE		VOICE NAME	
					PORTAMENTO		MODE		TIME		FOOT SW		VOLUME		FOOT CONTROL		WHEEL RANGE		BREATH RANGE		PITCH BIAS		EG BIAS	

YAMAHA 21 PERFORMANCE DATA

DATE : _____

PROGRAMMER : _____

A				B			
No.	PERFORMANCE NAME	VOICE NO./NAME	SETTINGS	No.	PERFORMANCE NAME	VOICE NO./NAME	SETTINGS
1				1			
2				2			
3				3			
4				4			
5				5			
6				6			
7				7			
8				8			
9				9			
10				10			
11				11			
12				12			
13				13			
14				14			
15				15			
16				16			

SINCE 1887  **YAMAHA**
NIPPON GAKKI CO., LTD. HAMAMATSU, JAPAN