

DIGITAL MIXING CONSOLE

# LS9

## LS9-16/LS9-32 Owner's Manual



# FCC INFORMATION (U.S.A.)

## 1. IMPORTANT NOTICE: DO NOT MODIFY THIS UNIT!

This product, when installed as indicated in the instructions contained in this manual, meets FCC requirements. Modifications not expressly approved by Yamaha may void your authority, granted by the FCC, to use the product.

## 2. IMPORTANT:

When connecting this product to accessories and/or another product use only high quality shielded cables. Cable/s supplied with this product MUST be used. Follow all installation instructions. Failure to follow instructions could void your FCC authorization to use this product in the USA.

## 3. NOTE:

This product has been tested and found to comply with the requirements listed in FCC Regulations, Part 15 for Class "B" digital devices. Compliance with these requirements provides a reasonable level of assurance that your use of this product in a residential environment will not result in harmful interference with other electronic devices. This equipment generates/uses radio frequencies and, if not installed and used according to the instructions found in the users manual, may cause interference harmful to the operation of other electronic devices. Compliance with FCC

regulations does not guarantee that interference will not occur in all installations. If this product is found to be the source of interference, which can be determined by turning the unit "OFF" and "ON", please try to eliminate the problem by using one of the following measures:

Relocate either this product or the device that is being affected by the interference.

Utilize power outlets that are on different branch (circuit breaker or fuse) circuits or install AC line filter/s.

In the case of radio or TV interference, relocate/reorient the antenna. If the antenna lead-in is 300 ohm ribbon lead, change the lead-in to co-axial type cable.

If these corrective measures do not produce satisfactory results, please contact the local retailer authorized to distribute this type of product. If you can not locate the appropriate retailer, please contact Yamaha Corporation of America, Electronic Service Division, 6600 Orangethorpe Ave, Buena Park, CA90620

The above statements apply ONLY to those products distributed by Yamaha Corporation of America or its subsidiaries.

\* This applies only to products distributed by YAMAHA CORPORATION OF AMERICA.

(class B)

## COMPLIANCE INFORMATION STATEMENT (DECLARATION OF CONFORMITY PROCEDURE)

Responsible Party : Yamaha Corporation of America  
Address : 6600 Orangethorpe Ave., Buena Park,  
Calif. 90620  
Telephone : 714-522-9011  
Type of Equipment : DIGITAL MIXING CONSOLE  
Model Name : LS9-16, LS9-32

This device complies with Part 15 of the FCC Rules.  
Operation is subject to the following two conditions:  
1) this device may not cause harmful interference, and  
2) this device must accept any interference received including interference that may cause undesired operation.  
See user manual instructions if interference to radio reception is suspected.

\* This applies only to products distributed by YAMAHA CORPORATION OF AMERICA. (FCC DoC)

## IMPORTANT NOTICE FOR THE UNITED KINGDOM Connecting the Plug and Cord

**WARNING: THIS APPARATUS MUST BE EARTHED**  
IMPORTANT. The wires in this mains lead are coloured in accordance with the following code:

GREEN-AND-YELLOW	: EARTH
BLUE	: NEUTRAL
BROWN	: LIVE

As the colours of the wires in the mains lead of this apparatus may not correspond with the coloured markings identifying the terminals in your plug proceed as follows:

The wire which is coloured GREEN-and-YELLOW must be connected to the terminal in the plug which is marked by the letter E or by the safety earth symbol  or colored GREEN or GREEN-and-YELLOW.

The wire which is coloured BLUE must be connected to the terminal which is marked with the letter N or coloured BLACK.

The wire which is coloured BROWN must be connected to the terminal which is marked with the letter L or coloured RED.

(3 wires)

This product contains a battery that contains perchlorate material.  
Perchlorate Material—special handling may apply,  
See [www.dtsc.ca.gov/hazardouswaste/perchlorate](http://www.dtsc.ca.gov/hazardouswaste/perchlorate).

\* This applies only to products distributed by YAMAHA CORPORATION OF AMERICA. (Perchlorate)

This product contains a high intensity lamp that contains a small amount of mercury. Disposal of this material may be regulated due to environmental considerations. For disposal information in the United States, refer to the Electronic Industries Alliance web site:  
[www.eiae.org](http://www.eiae.org)

\* This applies only to products distributed by YAMAHA CORPORATION OF AMERICA. (mercury)



## Explanation of Graphical Symbols

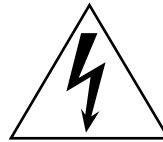

The lightning flash with arrowhead symbol within an equilateral triangle is intended to alert the user to the presence of uninsulated “dangerous voltage” within the product’s enclosure that may be of sufficient magnitude to constitute a risk of electric shock to persons.



The exclamation point within an equilateral triangle is intended to alert the user to the presence of important operating and maintenance (servicing) instructions in the literature accompanying the product.

The above warning is located on the rear or side of the unit.

# IMPORTANT SAFETY INSTRUCTIONS

- 1 Read these instructions.
- 2 Keep these instructions.
- 3 Heed all warnings.
- 4 Follow all instructions.
- 5 Do not use this apparatus near water.
- 6 Clean only with dry cloth.
- 7 Do not block any ventilation openings. Install in accordance with the manufacturer’s instructions.
- 8 Do not install near any heat sources such as radiators, heat registers, stoves, or other apparatus (including amplifiers) that produce heat.
- 9 Do not defeat the safety purpose of the polarized or grounding-type plug. A polarized plug has two blades with one wider than the other. A grounding type plug has two blades and a third grounding prong. The wide blade or the third prong are provided for your safety. If the provided plug does not fit into your outlet, consult an electrician for replacement of the obsolete outlet.
- 10 Protect the power cord from being walked on or pinched particularly at plugs, convenience receptacles, and the point where they exit from the apparatus.
- 11 Only use attachments/accessories specified by the manufacturer.
- 12 Use only with the cart, stand, tripod, bracket, or table specified by the manufacturer, or sold with the apparatus. When a cart is used, use caution when moving the cart/apparatus combination to avoid injury from tip-over.
- 13 Unplug this apparatus during lightning storms or when unused for long periods of time.
- 14 Refer all servicing to qualified service personnel. Servicing is required when the apparatus has been damaged in any way, such as power-supply cord or plug is damaged, liquid has been spilled or objects have fallen into the apparatus, the apparatus has been exposed to rain or moisture, does not operate normally, or has been dropped.



### WARNING

TO REDUCE THE RISK OF FIRE OR ELECTRIC SHOCK, DO NOT EXPOSE THIS APPARATUS TO RAIN OR MOISTURE.

(98-6500)

### ADVARSEL!

Lithiumbatteri—Eksplodingsfare ved fejlagtig håndtering. Udskiftning må kun ske med batteri af samme fabrikat og type. Levér det brugte batteri tilbage til leverandoren.

### VARNING

Explosionsfara vid felaktigt batteribyte. Använd samma batterityp eller en ekvivalent typ som rekommenderas av apparattillverkaren. Kassera använt batteri enligt fabrikantens instruktion.

### VAROITUS

Paristo voi räjähtää, jos se on virheellisesti asennettu. Vaihda paristo ainoastaan laitevalmistajan suosittelemaan tyyppiin. Hävitä käytetty paristo valmistajan ohjeiden mukaisesti.

(lithium caution)

### NEDERLAND / THE NETHERLANDS

- Dit apparaat bevat een lithium batterij voor geheugen back-up.
- This apparatus contains a lithium battery for memory back-up.
- Raadpleeg uw leverancier over de verwijdering van de batterij op het moment dat u het apparaat aan het einde van de levensduur of gelieve dan contact op te nemen met de vertegenwoordiging van Yamaha in uw land.
- For the removal of the battery at the moment of the disposal at the end of life please consult your retailer or Yamaha representative office in your country.
- Gooi de batterij niet weg, maar lever hem in als KCA.
- Do not throw away the battery. Instead, hand it in as small chemical waste.

(lithium disposal)



# PRECAUTIONS

## PLEASE READ CAREFULLY BEFORE PROCEEDING

\* Please keep this manual in a safe place for future reference.

### **WARNING**

Always follow the basic precautions listed below to avoid the possibility of serious injury or even death from electrical shock, short-circuiting, damages, fire or other hazards. These precautions include, but are not limited to, the following:

#### **Power supply/Power cord**

- Only use the voltage specified as correct for the device. The required voltage is printed on the name plate of the device.
- Use only the included power cord.  
If you intend to use the device in an area other than in the one you purchased, the included power cord may not be compatible. Please check with your Yamaha dealer.
- Do not place the power cord near heat sources such as heaters or radiators, and do not excessively bend or otherwise damage the cord, place heavy objects on it, or place it in a position where anyone could walk on, trip over, or roll anything over it.
- Be sure to connect to an appropriate outlet with a protective grounding connection. Improper grounding can result in electrical shock.

#### **Do not open**

- Do not open the device or attempt to disassemble the internal parts or modify them in any way. The device contains no user-serviceable parts. If it should appear to be malfunctioning, discontinue use immediately and have it inspected by qualified Yamaha service personnel.

#### **Water warning**

- Do not expose the device to rain, use it near water or in damp or wet conditions, or place containers on it containing liquids which might spill into any openings.
- Never insert or remove an electric plug with wet hands.

#### **Fire warning**

- Do not put burning items, such as candles, on the unit. A burning item may fall over and cause a fire.

#### **If you notice any abnormality**

- When one of the following problems occur, immediately turn off the power switch and disconnect the electric plug from the outlet. Then have the device inspected by Yamaha service personnel.
  - The power cord or plug becomes frayed or damaged.
  - It emits unusual smells or smoke.
  - Some object has been dropped into the instrument.
  - There is a sudden loss of sound during use of the device.
- If this device should be dropped or damaged, immediately turn off the power switch, disconnect the electric plug from the outlet, and have the device inspected by qualified Yamaha service personnel.

### **CAUTION**

Always follow the basic precautions listed below to avoid the possibility of physical injury to you or others, or damage to the device or other property. These precautions include, but are not limited to, the following:

#### **Power supply/Power cord**

- Remove the electric plug from the outlet when the device is not to be used for extended periods of time, or during electrical storms.
- When removing the electric plug from the device or an outlet, always hold the plug itself and not the cord. Pulling by the cord can damage it.

#### **Location**

- When transporting or moving the device, do not hold the display. Improper transportation can result in injury or damage to the device itself.
- Before moving the device, remove all connected cables.
- When setting up the product, make sure that the AC outlet you are using is easily accessible. If some trouble or malfunction occurs, immediately turn off the power switch and disconnect the plug from the outlet. Even when the power switch is turned off, electricity is still flowing to the product at the minimum level. When you are not using the product for a long time, make sure to unplug the power cord from the wall AC outlet.

- Do not place the device in a location where it may come into contact with corrosive gases or salt air. Doing so may result in malfunction.
- Avoid setting all equalizer controls and faders to their maximum. Depending on the condition of the connected devices, doing so may cause feedback and may damage the speakers.
- Do not expose the device to excessive dust or vibrations, or extreme cold or heat (such as in direct sunlight, near a heater, or in a car during the day) to prevent the possibility of panel disfiguration or damage to the internal components.
- Do not place the device in an unstable position where it might accidentally fall over.
- Do not block the vents. This device has ventilation holes at the top and rear to prevent the internal temperature from becoming too high. In particular, do not place the device on its side or upside down. Inadequate ventilation can result in overheating, possibly causing damage to the device(s), or even fire.
- Do not use the device in the vicinity of a TV, radio, stereo equipment, mobile phone, or other electric devices. Doing so may result in noise, both in the device itself and in the TV or radio next to it.

### Connections

- Before connecting the device to other devices, turn off the power for all devices. Before turning the power on or off for all devices, set all volume levels to minimum.
- Be sure to connect to a properly grounded power source. A ground screw is provided on the rear panel of this device for maximum safety and shock prevention. If the mains outlet is not grounded, be sure to connect the ground screw to a confirmed ground point before plugging the device into the mains. Improper grounding can result in electrical shock.

XLR-type connectors are wired as follows (IEC60268 standard): pin 1: ground, pin 2: hot (+), and pin 3: cold (-).

Yamaha cannot be held responsible for damage caused by improper use or modifications to the device, or data that is lost or destroyed.

Always turn the power off when the device is not in use.

The performance of components with moving contacts, such as switches, volume controls, and connectors, deteriorates over time. Consult qualified Yamaha service personnel about replacing defective components.

### Handling caution

- When turning on the AC power in your audio system, always turn on the power amplifier LAST, to avoid speaker damage. When turning the power off, the power amplifier should be turned off FIRST for the same reason.
- Do not insert your fingers or hands in any gaps or openings on the device (vents, etc.).
- Avoid inserting or dropping foreign objects (paper, plastic, metal, etc.) into any gaps or openings on the device (vents, etc.) If this happens, turn off the power immediately and unplug the power cord from the AC outlet. Then have the device inspected by qualified Yamaha service personnel.
- Do not apply oil, grease, or contact cleaner to the faders. Doing so may cause problems with electrical contact or fader motion.
- Do not use the device or headphones for a long period of time at a high or uncomfortable volume level, since this can cause permanent hearing loss. If you experience any hearing loss or ringing in the ears, consult a physician.
- Do not rest your weight on the device or place heavy objects on it, and avoid use excessive force on the buttons, switches or connectors.

### Backup battery

- This device has a built-in backup battery. When you unplug the power cord from the AC outlet, the current scene data and library data is retained. However, if the backup battery fully discharges, this data will be lost. When the backup battery is running low, the LCD display indicates "Low Battery!" when you starting up the system (the Battery field also indicates "LOW" or "NO" in the MISC SETUP screen.) In this case, immediately save the data to a USB memory, then have qualified Yamaha service personnel replace the backup battery.

# Contents

<b>1. Introduction</b>	<b>9</b>	<b>5. Input channel operations</b>	<b>53</b>
Thank you .....	9	Signal flow for input channels.....	53
An overview of the LS9 .....	9	Specifying the channel name / icon.....	55
Differences between the LS9-16 and LS9-32 .....	11	HA (head amp) settings.....	57
Number of INPUT channels.....	11	Sending the signal from	
Rear panel .....	11	an input channel to the STEREO/MONO bus.....	58
Top panel.....	12	Sending the signal from	
Other.....	13	an input channel to a MIX bus.....	62
The LS9's channel structure .....	13	Using the SELECTED CHANNEL section .....	62
About the MIX bus types (VARI / FIXED).....	14	Using a popup window.....	64
About word clock .....	14	Using the faders (SENDS ON FADER mode) .....	65
Conventions in this manual.....	14		
About the firmware version.....	14	<b>6. Output channel operations</b>	<b>67</b>
		Signal flow for output channels .....	67
<b>2. Parts and their function</b>	<b>15</b>	Specifying the channel name / icon.....	69
Top panel.....	15	Sending signals from MIX channels	
Rear panel .....	23	to the STEREO/MONO bus .....	71
Front panel.....	26	Sending signals from MIX channels	
		and STEREO/MONO channels	
<b>3. Basic operations on the LS9</b>	<b>27</b>	to MATRIX buses.....	75
Basic operations in the top panel.....	27	Using the SELECTED CHANNEL section .....	75
About the [HOME] key.....	27	Using a popup window.....	77
Selecting the fader layer.....	27	Using the faders (SENDS ON FADER mode) .....	78
Using the SELECTED CHANNEL section.....	29		
Selecting functions .....	29	<b>7. Operations in</b>	
Viewing the display .....	30	<b>the SELECTED CHANNEL section</b>	<b>81</b>
Constant display area.....	30	About the SELECTED CHANNEL section.....	81
Main area.....	31	About the SELECTED CH VIEW screen .....	82
The on-screen user interface.....	32	Operations in the SELECTED CHANNEL section..	83
Assigning a name.....	34		
Using the tool buttons .....	35	<b>8. Custom fader layer</b>	<b>91</b>
About the tool buttons.....	35	About the custom fader layer .....	91
Using libraries.....	35	Assigning channels to the custom fader layer .....	92
Initializing settings .....	38		
Copying and pasting settings .....	39	<b>9. Input/output patching</b>	<b>95</b>
Comparing two sets of settings .....	39	Changing the output patching.....	95
		Changing the input patching .....	99
<b>4. Connections and setup</b>	<b>41</b>	Inserting an external device into a channel .....	101
Connections.....	41	Directly outputting an INPUT channel .....	103
Installing an option card.....	44		
Setup required when starting up .....	45	<b>10. USB memory recorder</b>	<b>105</b>
Returning the current scene to the initial state ....	45	About the USB memory recorder.....	105
Word clock connection and settings .....	46	Assigning channels to	
HA (head amp) settings.....	47	the input/output of the recorder.....	106
Sending an input channel signal		Recording to USB memory .....	108
to the STEREO bus.....	50	Playing back audio files from USB memory .....	110
		Editing the title list.....	112
		Linking scene recall with audio file playback .....	113

<b>11. EQ and Dynamics</b>	<b>115</b>	<b>15. Talkback / Oscillator</b>	<b>151</b>
About EQ and dynamics .....	115	About talkback and oscillator .....	151
Using EQ .....	115	Using talkback .....	151
Using dynamics .....	117	Using the oscillator .....	153
Using the EQ/Dynamics libraries .....	120		
EQ library .....	120	<b>16. Meters</b>	<b>155</b>
Dynamics library .....	120	Using the METER screen .....	155
<b>12. Grouping and linking</b>	<b>121</b>	<b>17. Graphic EQ and effects</b>	<b>157</b>
About mute groups .....	121	About the virtual rack .....	157
Using mute groups .....	121	Mounting a GEQ or effect in the virtual rack .....	158
Using the MUTE GROUP screen		<b>Graphic EQ operations</b> .....	<b>161</b>
to operate mute groups .....	121	About the graphic EQ .....	161
Using the SELECTED CH VIEW screen		Inserting a GEQ in a channel .....	161
to specify mute groups .....	122	Using the 31 Band GEQ .....	163
Using the Mute Safe function .....	123	Using the Flex15GEQ .....	164
<b>The Channel Link function</b> .....	<b>124</b>	<b>About the internal effects</b> .....	<b>166</b>
Linking the desired input channels .....	124	Using an internal effect via send/return .....	167
<b>Copying, moving, or initializing a channel</b> .....	<b>126</b>	Inserting an internal effect into a channel .....	168
Copying the parameters of a channel .....	126	Editing the internal effect parameters .....	170
Moving the parameters of a channel .....	127	Using the Tap Tempo function .....	172
Initializing the parameters of a channel .....	128	Using the Freeze effect .....	173
		<b>Using the graphic EQ and effect libraries</b> .....	<b>174</b>
		GEQ library .....	174
		Effect library .....	174
<b>13. Scene memory</b>	<b>129</b>	<b>Using an external head amp</b> .....	<b>175</b>
About scene memories .....	129	Remotely controlling an external head amp .....	175
Using scene memories .....	129		
Storing a scene .....	129	<b>18. MIDI</b>	<b>177</b>
Recalling a scene .....	131	MIDI functionality on the LS9 .....	177
Using user-defined keys to recall .....	132	Basic MIDI settings .....	178
<b>Editing scene memories</b> .....	<b>134</b>	Using program changes	
Sorting and renaming scene memories .....	134	to recall scenes and library items .....	180
Scene memory editing .....	136	Using control changes to control parameters .....	183
Copying/pasting a scene .....	136	Using parameter changes	
Clearing a scene .....	137	to control parameters .....	185
Cutting a scene .....	138	Using MMC (MIDI Machine Control)	
Inserting a scene .....	138	to operate the USB memory recorder .....	186
<b>Using the Focus function</b> .....	<b>139</b>		
<b>Using the Recall Safe function</b> .....	<b>140</b>	<b>19. User settings (Security)</b>	<b>187</b>
<b>Using the Fade function</b> .....	<b>143</b>	User Level settings .....	187
		User types and user authentication keys .....	187
		Setting the Administrator password .....	188
		Creating a user authentication key .....	188
		Logging-in .....	189
		Changing the password .....	191
		Editing a user authentication key .....	192
		Changing the user level .....	192
<b>14. Monitor/Cue</b>	<b>145</b>		
About the monitor/cue functions .....	145		
Using the Monitor function .....	146		
Using the Cue function .....	148		
About cue groups .....	148		
Operating the Cue function .....	149		

**Preferences** ..... 194  
**User-defined keys** ..... 196  
**Console lock** ..... 197  
     Locking the console ..... 197  
     Unlocking the console ..... 198  
     Specifying the CONSOLE LOCK  
     screen image ..... 198  
**Using USB memory to save/load data** ..... 199  
     Saving the LS9's internal data  
     on USB memory ..... 199  
     Loading a file from USB memory ..... 200  
     Editing the files saved on USB memory ..... 201  
     Formatting USB memory media ..... 204  
  
**20. Other functions** ..... **205**  



---

**About the SETUP screen** ..... 205  
**Word clock settings** ..... 206  
**Switching a digital I/O card's SRC on/off** ..... 208  
**Using cascade connections** ..... 209  
     Operations on the cascade slave LS9 ..... 210  
     Operations on the cascade master LS9 ..... 212  
**Basic settings for MIX buses and  
 MATRIX buses** ..... 213  
**Setting the date and time of the internal clock** ..... 215  
**Setting the network address** ..... 216  
**Specifying the brightness or  
 contrast of the display, LEDs, and lamps** ..... 217  
**Using the Help function** ..... 218  
     Loading a Help file from a USB memory ..... 218  
     Loading a text file from a USB memory ..... 219  
     Assigning the Help function to  
     a user-defined key ..... 219  
     Viewing Help ..... 220  
**Initializing the LS9's internal memory** ..... 222  
**Adjusting the faders (Calibration function)** ..... 223  
**Adjusting the input/output gain  
 (Calibration function)** ..... 224

**Appendices** ..... **225**  

---

**EQ Library List** ..... 225  
**DYNAMICS Library List** ..... 227  
**Dynamics Parameters** ..... 229  
**Effect Type List** ..... 232  
**Effects Parameters** ..... 233  
**Effects and tempo synchronization** ..... 244  
**Scene Memory/Effect Library  
 to Program Change Table** ..... 245  
**Parameters that can be assigned  
 to control changes** ..... 249  
**Control change parameter assignments** ..... 251  
**NRPN parameter assignments** ..... 253  
**Mixing parameter operation applicability** ..... 256  
**Functions that can be assigned  
 to user-defined keys** ..... 257  
**MIDI Data Format** ..... 260  
**Warning/Error Messages** ..... 268  
**Troubleshooting** ..... 270  
**General Specifications** ..... 272  
**Input/output characteristics** ..... 273  
     Electrical characteristics ..... 275  
     Mixer Basic Parameters ..... 277  
     Pin Assignment ..... 278  
     Dimensions ..... 279  
**Attaching the RK1 rackmount kit  
 (sold separately)** ..... 280  
**MIDI Implementation Chart** ..... 281  
**Index** ..... 282  
**Block Diagram** ..... End of Manual  
**Level Diagram** ..... End of Manual

- The illustrations and screen displays as shown in this Owner's manual are for instructional purposes only, and may be different from the ones on your device.
- The bitmap fonts used in this device have been provided by and are the property of Ricoh Co., Ltd.
- The company names and product names in this Owner's Manual are the trademarks or registered trademarks of their respective companies.
- MPEG Layer-3 audio coding technology licensed from Fraunhofer IIS and Thomson. 



## Thank you

Thank you for purchasing the Yamaha LS9 digital mixing console. In order to take full advantage of the LS9's superior functionality and enjoy years of trouble-free use, please read this manual before you begin using the product. After you have read the manual, keep it in a safe place.

## An overview of the LS9

The LS9 is a digital mixing console with the following features.

### ■ Mixing system that packs top-class functionality into a compact size.....

The LS9 is a full-digital mixing console designed for installed systems or SR applications, and in spite of its compact size, provides functionality and a channel count comparable to large-format consoles. 24-bit linear AD/DA converters are used to deliver up to 108 dB of dynamic range and amazing sound quality.

As input channels, it provides 32 (LS9-16 model) or 64 (LS9-32 model) monaural INPUT channels, and four stereo ST IN channels.

As output channels, it provides 16 MIX channels, eight MATRIX channels, a STEREO channel, and a MONO channel. L/C/R three-channel output using the STEREO/MONO channels is also supported.

### ■ Analog-feeling operability.....

Simply by pressing a key, you can select the combination of channels ("fader layer") to be operated from the top panel faders. You can operate the console while quickly switching between input channels and output channels. In addition, you can also use a custom fader layer that lets you specify any desired combination of channels. Since fader/cue operations and on/off switching for all channels can be performed from the panel, even customers using digital consoles for the first time will find operation familiar and comfortable.

The SELECTED CHANNEL section located at the right of the display lets you use the knobs to control the main parameters (gain, EQ, dynamics threshold, bus send levels, etc.) for the particular channel on which you're focusing. This section can be operated just like a module on an analog mixer.

Mix parameter settings, including head amp gain and phantom power for input channels, can be stored and recalled as "scenes."

All faders on the panel are motorized moving faders, so that when you recall a scene, the previous fader locations are reproduced immediately.

■ **Effects and graphic EQ that can be patched into a desired signal path . . . . .**

There are eight virtual racks, in which you can mount effects or graphic EQ and then patch them into the desired signal route. Graphic EQ can be mounted in racks 1–4, and effects or graphic EQ can be mounted in racks 5–8. You can simultaneously use up to four high-quality multi-effects, which include reverb, delay, multi-band compressor, and various modulation-type effects. These can be used via an internal bus, or inserted into a desired channel. For the graphic EQ you can select either 31-band graphic EQ or Flex 15 GEQ. These can be inserted into the desired channel or output. The Flex 15 GEQ allows you to adjust the gain for any fifteen of the thirty-one bands. Since two Flex 15 GEQ units can be mounted in a single virtual rack, a total of up to sixteen graphic EQ units can be used simultaneously.

■ **A recorder function that's useful for sound checks or recording mixes . . . . .**

A recorder function is provided, allowing you to use USB memory to record the output of the STEREO bus or a MIX bus, or assign an audio file in USB memory to a desired input channel or monitor output and play it back. Supported file formats are MP3 (MPEG-1 Audio Layer-3) for recording, and MP3, WMA (Windows Media Audio), and MPEG-4 AAC (Advanced Audio Coding) for playback. However, DRM (Digital Rights Management) is not supported. This function is convenient when you want to record the mix output of a specific bus, or if you want to play back a song from the speakers during the sound check.

■ **Cascade connections in the digital domain . . . . .**

A second LS9 console or a digital mixer such as the Yamaha M7CL or PM5D connected via a digital I/O card installed in a slot can be cascade-connected in the digital domain.

Of the MIX buses, MATRIX buses, STEREO (L/R) bus, MONO buses, and CUE (L/R) bus, the desired buses can be merged, and all mixed bus signals can be cascaded individually.

■ **Security functions that can be specified at user-level or system-level . . . . .**

User levels can be distinguished into three levels (administrator, guest, user), and the functionality available to each non-administrator user can be restricted. Passwords can be specified for the administrator and users, preventing important settings from being changed accidentally. Information specific to each user (user level, system settings, and user-defined key settings) can be stored on USB memory as a “user authentication key.” By loading your own user authentication key from USB memory, you can instantly set up the ideal operating environment for yourself.

■ **I/O card expansion . . . . .**

The rear panel provides one slot (LS9-16) or two slots (LS9-32) in which separately sold mini-YGDAI cards can be installed. AD cards, DA cards, or digital I/O cards can be installed in these slots to add inputs and outputs port.

## Differences between the LS9-16 and LS9-32

The LS9 is available in two models; the LS9-16 and the LS9-32. These models differ as follows.

### Number of INPUT channels

The LS9-16 has up to 32 operable INPUT channels, while the LS9-32 has up to 64. The number and structure of other channels (ST IN channels, MIX channels, MATRIX channels, STEREO/MONO channels) are identical.

### Rear panel

The LS9-16 and LS9-32 differ in the number of rear panel INPUT jacks, OMNI OUT jacks, and slots they provide. The rear panel of the LS9-16 provides sixteen INPUT jacks, eight OMNI OUT jacks, and one slot.

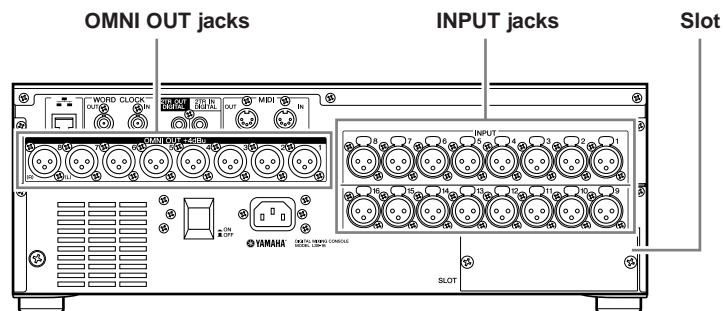

In contrast, the rear panel of the LS9-32 provides thirty-two INPUT jacks, sixteen OMNI OUT jacks, two slots, and one LAMP connector.

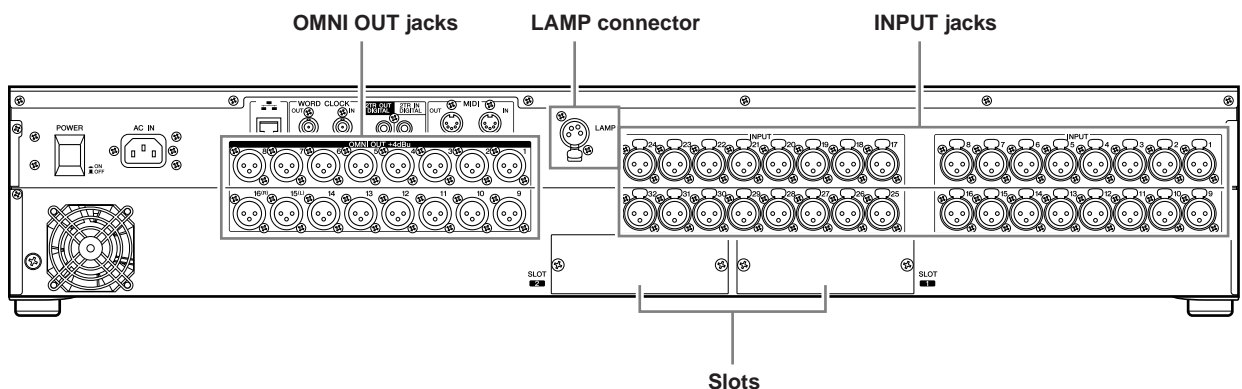

## Top panel

The LS9-16 and LS9-32 differ in the number of top panel channel modules and ST IN channels they provide. The LS9-16 provides sixteen channel modules and two ST IN channels, and by switching fader layers you can operate up to 32 INPUT channels (monaural) and four ST IN channels (stereo).

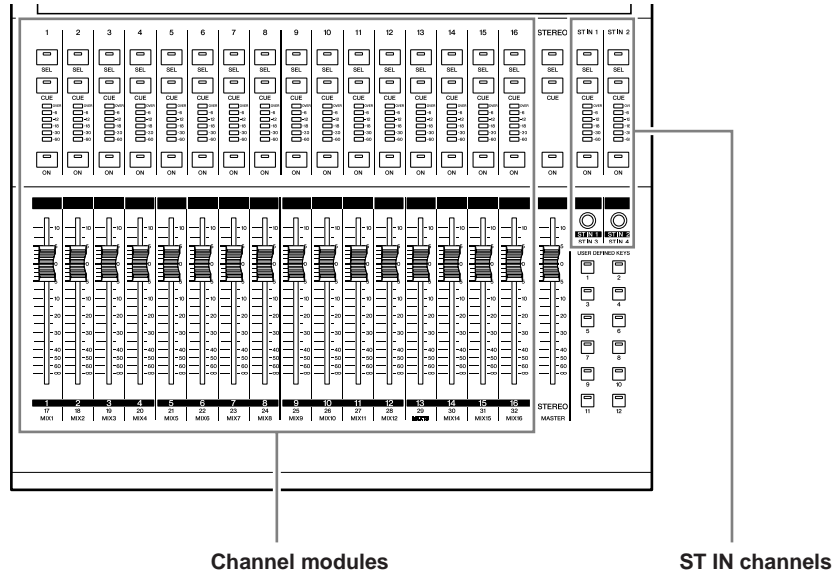

The LS9-16 provides thirty-two channel modules and four ST IN channels. By switching fader layers you can operate up to sixty-four INPUT channels (monaural). The four ST IN channels (stereo) can be operated from either layer (1-32 or 33-64).

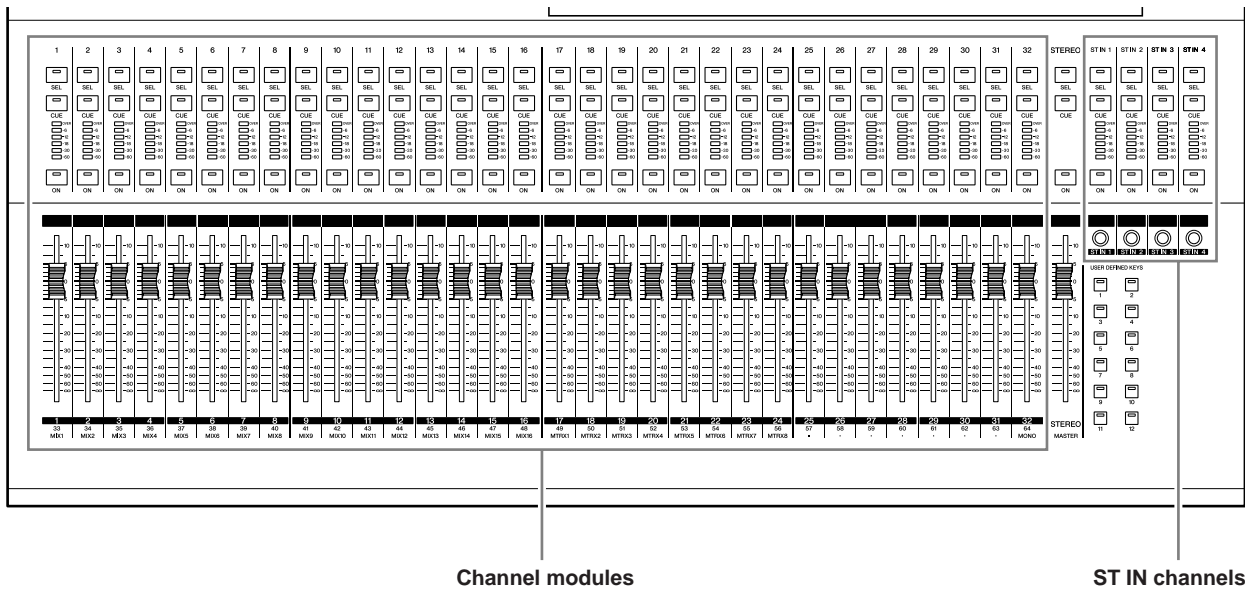



## Other

The names of the LAYER section keys differ between the LS9-16 and LS9-32.

● **LS9-16**

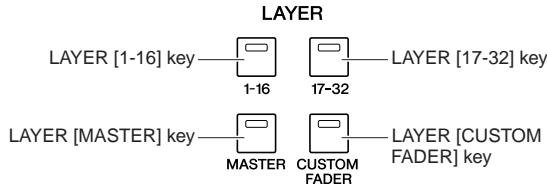

● **LS9-32**

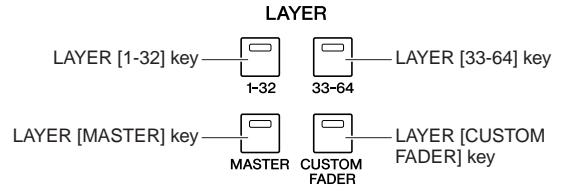

In conjunction with this difference, there are also differences in the numbering of the channel modules on the panel and the channels that are assigned to each fader layer.



- In this owner's manual, whenever there is a difference between the LS9-16 model and the LS9-32 model, specifications that apply only to the LS9-32 model are enclosed in curly brackets { } (e.g., INPUT jacks 1–16 {1–32}).
- When the specifications are common to both models, the manual refers simply to the LS9.

## The LS9's channel structure

The LS9 provides the following input channels and output channels.

■ **Input channels** .....

This section processes input signals and sends them to various buses (STEREO, MONO, MIX). The LS9 has the following two types of input channel.

● **INPUT channels 1–32 {1–64}**

These channels process monaural signals. In the initial state, the input signals from the rear panel INPUT jacks and the input channels of the slot(s) are assigned to these channels.

● **ST IN channels 1–4**

These channels process stereo signals. In the initial state, the outputs of virtual racks 5–8 are assigned to these channels.

Signal assignments to the input channels (input patching) can be changed as desired.

■ **Output channels** .....

This section mixes the signals sent from input channels etc., and sends them to the corresponding output ports or output buses.

There are three types of output channel, as follows.

● **MIX channels 1–16**

These channels process the signals sent from input channels to the MIX buses, and send them from the output ports. These are used mainly to send signals to the monitor system or to external effects.

The signals of MIX channels 1–16 can also be sent to the STEREO bus, MONO bus, or MATRIX buses. When the LS9 is in the initial state, these are assigned to the OMNI OUT jacks or the output channels of the slot(s).

● **MATRIX channels 1–8**

These channels process the signals that are sent from MIX channels, STEREO channels, and MONO channel to the MATRIX buses, and send them from the output ports. Using the STEREO and MONO buses, different combinations of signals and mix balances can be sent out from the console.

● **STEREO channel / MONO channel**

These channels process the signals that are sent from the input channels or MIX channels, and send them to the corresponding output port. These channels are used as the main stereo output and monaural output.

The STEREO channel and MONO channel can be used either to output independent signals, or for three-channel L/C/R playback.

When the LS9 is in the initial state, the STEREO channel is assigned to OMNI OUT jacks 15/16 {31/32} and to the 2TR OUT DIGITAL jack.

Signal assignments to the output channels (output patching) can be changed as desired.

## About the MIX bus types (VARI / FIXED)

The sixteen MIX buses provided on the LS9 can be assigned either as VARI or FIXED types in pairs of adjacent odd-numbered/even-numbered buses (→ p. 213). They can also be switched between monaural/stereo for the same pairs of buses. VARI type and FIXED type buses differ as follows.

### ● VARI

This type allows the send level of the signal sent from the input channels to the MIX bus to be varied. The point at which the signal is sent from the input channel to a VARI type MIX bus can be chosen from before the EQ (attenuator), before the fader, or after the channel on/off. This type is used mainly for sending the signal to a monitor system or external effect.

### ● FIXED

With this type, the send level of the signal sent from the input channels to the MIX bus is fixed. The signal from an input channel is sent to a FIXED type MIX bus from before Pan (if the MIX bus is monaural) or after Pan (if the MIX bus is stereo). This type is used mainly when you want to distribute signals to an external device with the same mix as the STEREO/MONO buses.

## About word clock

“Word clock” refers to the clock that provides the basis of timing for digital audio signal processing.

Normally, one device transmits a reference word clock signal, and the other devices receive this word clock signal and synchronize to it.

In order to transmit or receive digital audio signals to or from an external device via the LS9’s 2TR IN DIGITAL/2TR OUT DIGITAL jacks or via a digital I/O card installed in a slot, the word clock must be synchronized between the devices. Be aware that if the word clock is not synchronized, the signal will not be sent correctly, or there may be unpleasant noise. (For details on synchronizing the LS9’s word clock with an external device → p. 46)

## Conventions in this manual

In this manual, switch-type controllers on the panel are called “keys.” Of the control knobs on the panel, those that turn from a minimum value to a maximum value are called “controls,” while those that turn endlessly are called “encoders.”

Controllers located on the panel are enclosed in square brackets [ ] (e.g., [CUE] key) in order to distinguish them from the virtual buttons and knobs displayed in the screen. For some controllers, the name of the section is given before the [ ] (e.g., LAYER [MASTER] key).

Whenever there is a difference between the LS9-16 model and the LS9-32 model, specifications that apply only to the LS9-32 model are enclosed in curly brackets { } (e.g., INPUT jacks 1–16 {1–32}).

## About the firmware version

You can view the firmware version number in the MISC SETUP screen (→ p. 206). You can also download the most recent firmware version from the website.

<http://www.yamahaproaudio.com/>

# Parts and their function

This chapter explains the LS9's parts and their functions.

## Top panel

The LS9's top panel is organized into the following sections.

### LS9-16

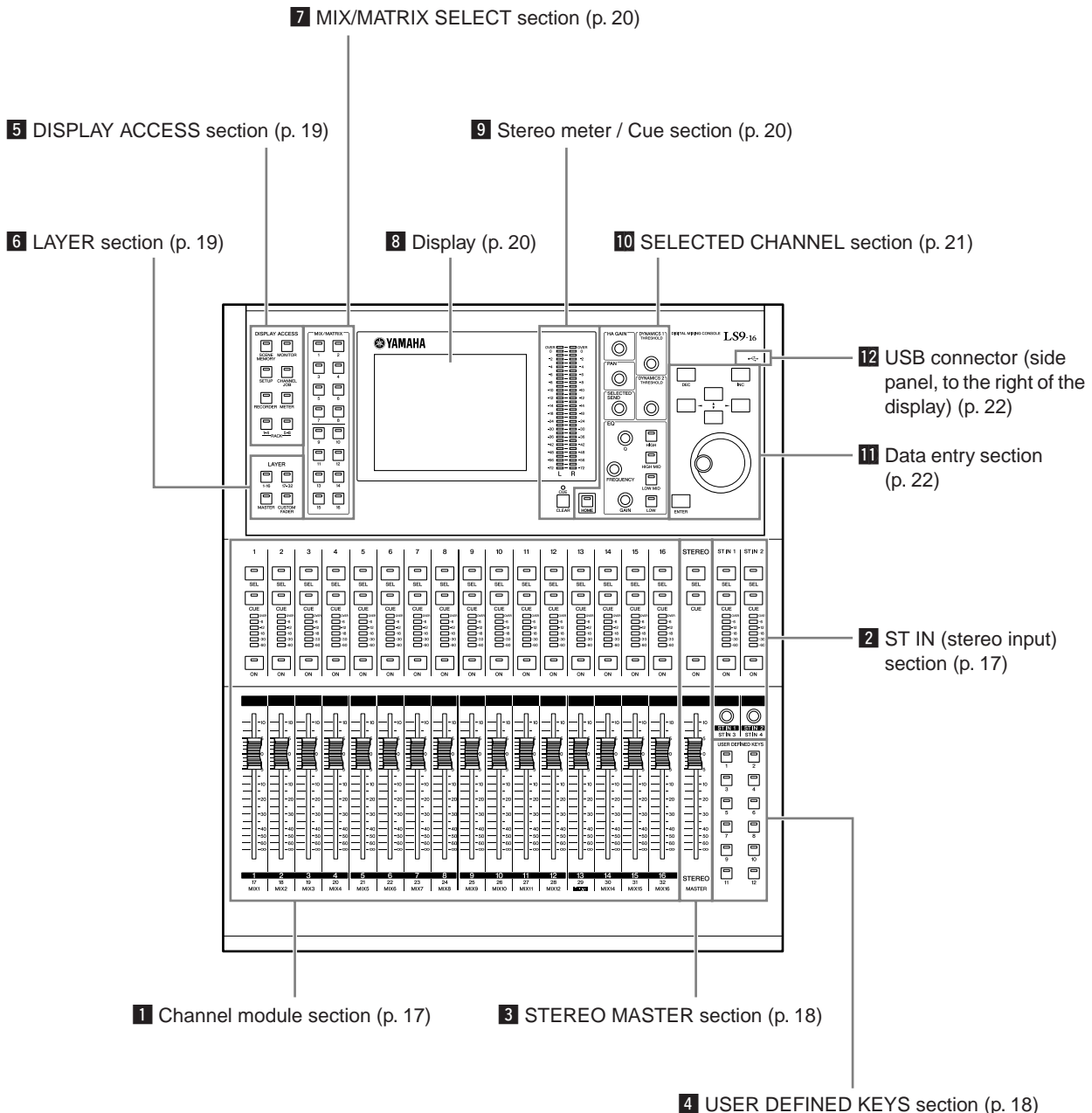

**LS9-32**

**7** MIX/MATRIX SELECT section (p. 20)

**10** SELECTED CHANNEL section (p. 21)

**9** Stereo meter / Cue section (p. 20)

**11** Data entry section (p. 22)

**5** DISPLAY ACCESS section (p. 19)

**12** USB connector (side panel, to the right of the display) (p. 22)

**6** LAYER section (p. 19)

**8** Display (p. 20)

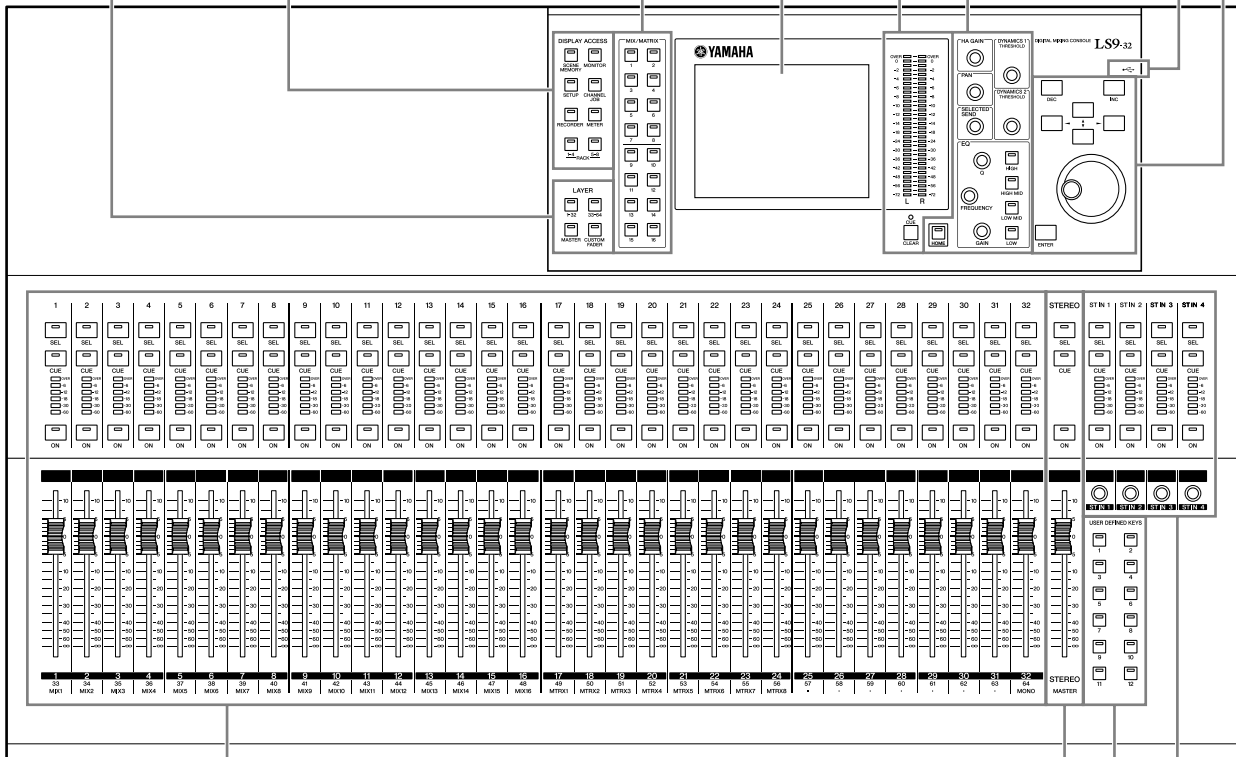

**1** Channel module section (p. 17)

**3** STEREO MASTER section (p. 18)

**4** USER DEFINED KEYS section (p. 18)

**2** ST IN (stereo input) section (p. 17)



## 1 Channel module section . . . . .

In this section you can operate the main parameters of the input channels and output channels, as well as the monitor output. Use the LAYER section (→ p. 19) to select the channels that are mapped to this section.

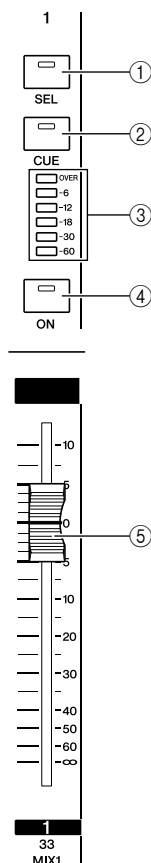

## 2 ST IN (stereo input) section . . . . .

In this section you can operate the main parameters of the stereo ST IN channels 1–4. The function of each controller is the same as in the Channel Module section, with the exception that the L-channel or R-channel will be alternately selected as the target of operations each time you press the [SEL] key, and the fact that the encoder rather than the fader is used to adjust the level.

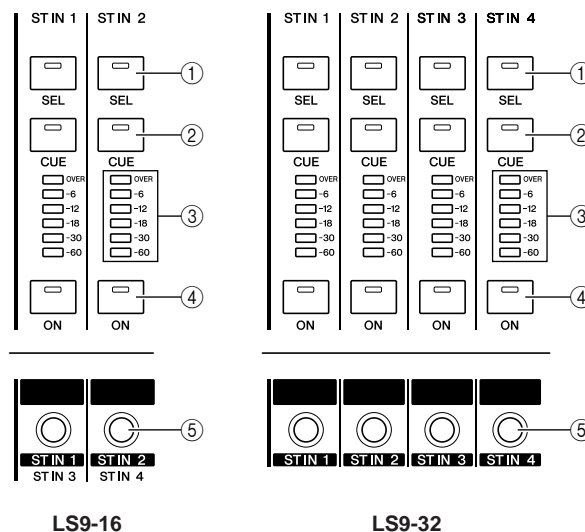

### ① [SEL] key

This key selects the channel to be operated. When you press this key to make the LED light, the corresponding channel will be selected for operations in the SELECTED CHANNEL section or in the display. In the ST IN section, the L-channel and R-channel will be alternately selected as the target of operations each time you press the [SEL] key.

### ② [CUE] key

This key selects the channel to be cue-monitored. When cue is on, the LED will be lit.

### ③ Meter LEDs

These LEDs indicate the audio signal level of the input channel or output channel.

### ④ [ON] key

This switches the channel on/off. The key LED will light for channels that are on. In SENDS ON FADER mode, this key is an on/off switch for the signal that is sent from that channel to the currently selected MIX bus (or from a MIX channel, to the MATRIX bus).

### ⑤ Fader/Encoder

This adjusts the signal level or monitor level of the input channel or output channel. In SENDS ON FADER mode, this adjusts the send level from that channel to the currently selected MIX bus (or from a MIX channel, to the MATRIX bus).

### 3 STEREO MASTER section .....

In this section you can operate the main parameters of the STEREO channel.

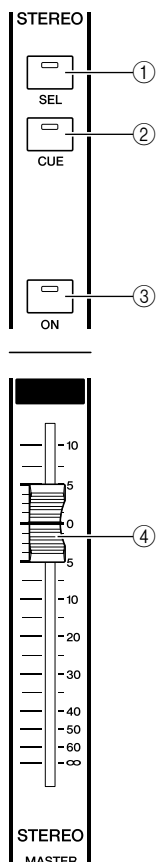

#### ① [SEL] key

This key selects the STEREO channel as the target of operations. The L-channel and R-channel will be alternately selected as the target of operations each time you press the [SEL] key.

#### ② [CUE] key

This key cue-monitors the STEREO channel. When cue is on, the LED will be lit.

#### ③ [ON] key

This switches the STEREO channel on/off. When on, the key LED will light. In SENDS ON FADER mode, you can use this as an on/off switch for MIX/MATRIX channels or as an on/off switch for the signal sent from the STEREO channel to the MATRIX buses, depending on the LAYER.

#### ④ Fader

This adjusts the output level of the STEREO channel. In SENDS ON FADER mode, this adjusts the level of the MIX/MATRIX channels or the send level from the STEREO channel to the MATRIX buses, depending on the LAYER.



- If you turn on MONITOR ON MASTER FADER in the USER DEFINED KEY SETUP screen, the [ON] key and fader will respectively turn MONITOR on/off and control its level.

### 4 USER DEFINED KEYS section .....

Here you can execute the functions that are programmed for the user-defined keys.

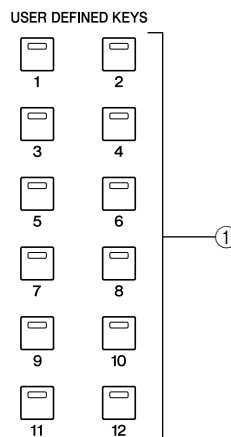

#### ① User-defined keys [1]–[12]

These keys execute the functions that have been programmed for each key (e.g., switching scenes, turning talkback or the internal oscillator on/off).

## 5 DISPLAY ACCESS section

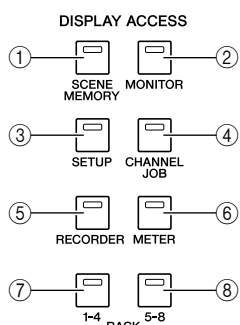

### ① [SCENE MEMORY] key

This key accesses a screen where you can store, recall, and edit scene memories, and make settings for the Focus function and Fade Time function.

### ② [MONITOR] key

This key accesses a screen where you can make settings for cue, monitor, oscillator, and talkback.

### ③ [SETUP] key

This key accesses a screen where you can set and verify the user level, and make basic system settings.

### ④ [CHANNEL JOB] key

This key accesses a screen where you can make settings for Channel Link, Mute Group, and Recall Safe functions, and copy or move settings between channels.

### ⑤ [RECORDER] key

This key accesses a screen where you can operate and make settings for the Recorder function which records and plays audio files.

### ⑥ [METER] key

This key accesses a meter screen where you can view the input/output levels of all channels in a single view.

### ⑦ [RACK 1-4] key

This key accesses a screen where you can edit the graphic EQ assigned to virtual racks 1–4. By pressing the [RACK 1-4] key and [RACK 5-8] key simultaneously you can access the VIRTUAL RACK screen, where you can assign a graphic EQ (31 Band GEQ or Flex 15 GEQ) to each virtual rack.

### ⑧ [RACK 5-8] key

This key accesses a screen where you can edit the graphic EQ or internal effect that is assigned to virtual racks 5–8, and make settings for external head amps. By pressing the [RACK 1-4] key and [RACK 5-8] key simultaneously you can access the VIRTUAL RACK screen, where you can assign a graphic EQ (31 Band GEQ or Flex 15 GEQ) or internal effect to each virtual rack.

## 6 LAYER section

Here you can select the type of channels that will be operated from the channel module section (→ p. 17) and ST IN section (→ p. 17).

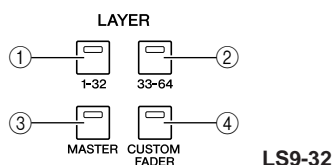
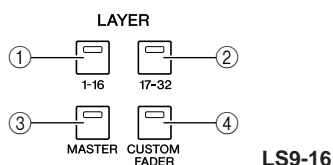

### ① LAYER [1-16] {LAYER [1-32]} key

### ② LAYER [17-32] {LAYER [33-64]} key

### ③ LAYER [MASTER] key

These keys assign fixed preset combinations of channels to the channel module section and the ST IN section. The combination of channels corresponding to each key is as follows.

#### For the LS9-16

LAYER key / module	1–16	ST IN 1–2
LAYER [1-16] key	CH 1–16	ST IN 1–2
LAYER [17-32] key	CH 17–32	ST IN 3–4
LAYER [MASTER] key	MIX 1–16	—

#### For the LS9-32

LAYER key / module	1–16	17–24	25–31	32	ST IN 1–4
LAYER [1-32] key	CH 1–16	CH 17–24	CH 25–31	CH 32	ST IN 1–4
LAYER [33-64] key	CH 33–48	CH 49–56	CH 57–63	CH 64	ST IN 1–4
LAYER [MASTER] key	MIX 1–16	MATRIX 1–8	—	MONO	—

### ④ LAYER [CUSTOM FADER] key

This key assigns the channels selected by you (the user) to the channel module section and the ST IN section. (For the channel assignment procedure → p. 91)

## 7 MIX/MATRIX SELECT section .....

In this section you can select the MIX channel or MATRIX channel that will be the object of operations.

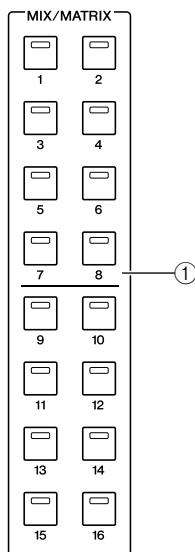

### ① MIX/MATRIX [1]–[16] keys

These keys select the MIX channel (or if the selected channel is a MIX/STEREO/MONO channel, the MATRIX channel) whose send level will be adjusted by the SELECTED CHANNEL section. The LED of the key corresponding to the currently selected channel will light (or blink, in the case of a MATRIX channel). In SENDS ON FADER mode, these keys select a MIX bus or MATRIX button as the send-destination. In this case, the LED of the key corresponding to the currently selected bus will blink, and the LED of keys corresponding to selectable buses will light. For MATRIX buses, the [9]–[16] keys will be dark and cannot be selected.

## 8 Display .....

In this display you can view and edit all mix parameters, as well as various settings.



Use the DISPLAY ACCESS section (→ p. 19) to select the screen that you want to view. Then use the cursor keys of the data entry section (→ p. 22) to move the cursor to the desired parameter, and use the dial or the [INC][DEC] keys to edit the value.

## 9 Stereo meter / Cue section .....

In this section you can view the level of the STEREO channel or cue monitor.

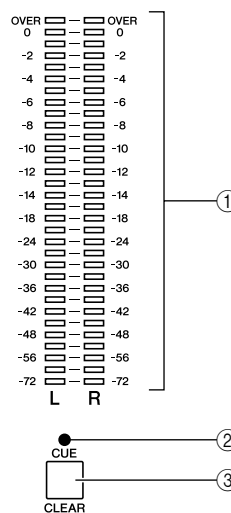

### ① Stereo meter

This is a 32-segment LED meter that indicates the L/R channel levels of the STEREO channel. While the [CUE] key of any channel is on, this meter will indicate the cue monitor level.

### ② CUE LED

This LED will blink while the [CUE] key of any channel is on.

### ③ [CUE CLEAR] key

This key clears all cue monitoring that is currently active.



## 10 SELECTED CHANNEL section.....

In this section you can operate the most important mix parameters for the currently selected input channel or output channel.

The function of the controllers in this section will depend on the type of channel that is selected.

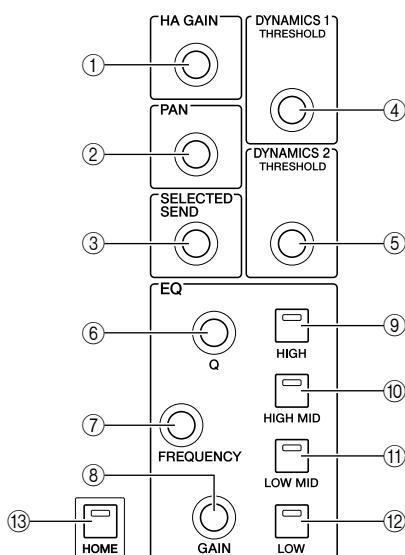

### ① [HA GAIN] encoder

● **When an INPUT/ST IN channel is selected**

The encoder will adjust the gain of the internal head amp or an external head amp device (AD8HR) connected to a rear panel slot.

**NOTE**

• The PAD will be internally switched on or off when the HA gain is adjusted between -14 dB and -13 dB. Keep in mind that noise may be generated if there is a difference between the Hot and Cold output impedance of the external device connected to the INPUT connector when using phantom power.

● **When any other channel is selected**

The encoder will not do anything.

### ② [PAN] encoder

● **When an INPUT/ST IN channel is selected**

● **When a MIX channel is selected**

The encoder will adjust the panning of the signal sent to the L/R channels (or the L/C/R channels in the case of LCR mode) of the STEREO bus. If a MIX channel set to stereo is selected, the encoder will adjust the output balance of the left and right channels.

● **When a MATRIX channel is selected**

If a monaural MATRIX channel is selected, the encoder will not do anything. If a stereo MATRIX channel is selected, the encoder will adjust the output balance of the left and right channels.

● **When a STEREO/MONO (C) channel is selected**

The encoder will not do anything for MONO (C) channel. For a STEREO channel, the encoder will adjust the output balance of the left and right channels.

### ③ [SELECTED SEND] encoder

● **When an INPUT/ST IN channel is selected**

The encoder will adjust the send level from that channel to the currently selected bus. (For a FIXED type bus, the encoder will switch the send on/off.)

If the send-destination bus is stereo, this encoder will specify the panning of the signal sent to the two buses if an odd-numbered bus is selected, or will specify the send level if an even-numbered bus is selected.

● **When a MIX channel is selected**

The encoder will adjust the send level from that MIX channel to the currently selected MATRIX bus.

● **When a MATRIX channel is selected**

The encoder will adjust the send level from the MIX channels to the currently selected MATRIX bus.

**NOTE**

• In SENDS ON FADER mode, this encoder will not do anything regardless of which channel is selected.

### ④ [DYNAMICS 1] encoder

● **When an INPUT/ST IN channel is selected**

The encoder will adjust the threshold of Dynamics 1 (e.g., gate).

● **When any other channel is selected**

The encoder will adjust the threshold of the compressor, etc.

### ⑤ [DYNAMICS 2] encoder

● **When an INPUT/ST IN channel is selected**

The encoder will adjust the threshold of Dynamics 2 (e.g., compressor).

● **When any other channel is selected**

The encoder will not do anything.

### ⑥ EQ [Q] encoder

### ⑦ EQ [FREQUENCY] encoder

### ⑧ EQ [GAIN] encoder

These encoders adjust the Q, frequency, and gain of the band selected by keys ⑨–⑫.

**HINT**

• By simultaneously pressing the EQ [Q] encoder and the EQ [GAIN] encoder, you can reset the gain to 0 dB for the band selected by the keys below (⑨–⑫).

• If you have selected a LOW band or HIGH band whose type can be changed, you can switch the type by turning the EQ [Q] encoder while pressing it when Q is set to the maximum or minimum value.

**LOW band :**

- Switches to LOW shelving if you turn the encoder toward the right while pressing it when Q is at the minimum value
- Switches to high pass filter if you turn the encoder toward the left while pressing it when Q is at the maximum value (MIX, MATRIX, STEREO, and MONO channels only)

**HIGH band :**

- Switches to HIGH shelving if you turn the encoder toward the right while pressing it when Q is at the minimum value
- Switches to low pass filter if you turn the encoder toward the left while pressing it when Q is at the maximum value

For shelving, high pass filter, and low pass filter as well, you can switch the type by turning the encoder while pressing it.

- ⑨ EQ [HIGH] key
- ⑩ EQ [HIGH MID] key
- ⑪ EQ [LOW MID] key
- ⑫ EQ [LOW] key

These keys select the band controlled by encoders ⑥–⑧. By simultaneously pressing the EQ [HIGH] key and EQ [LOW] key, you can reset the gain of all four bands to 0 dB.

⑬ [HOME] key

This key returns the state of the LS9's panel to home position. When you press this key, the panel will change as follows.

- The display will show the SELECTED CH VIEW screen for the currently selected channel.
- The channel level function will be assigned to the faders (SENDS ON FADER mode will be defeated).

**11 Data entry section** .....

This section lets you edit specific parameters in the screen.

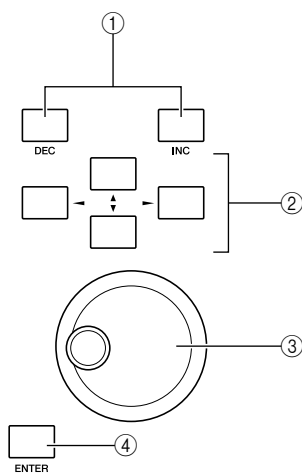

① [DEC]/[INC] keys

These keys increment or decrement the value of the parameter at which the cursor is located in the screen, in steps of -1/+1.

② Cursor keys

These keys move the cursor up/down/left/right in the screen.

③ Dial

This dial continuously increments or decrements the value of the parameter at which the cursor is located in the screen.

④ [ENTER] key

This key is used to switch a button in the screen on/off, or to confirm a change you make.

**12 USB connector (side panel, to the right of the display)** .....

This connector lets you connect USB memory.

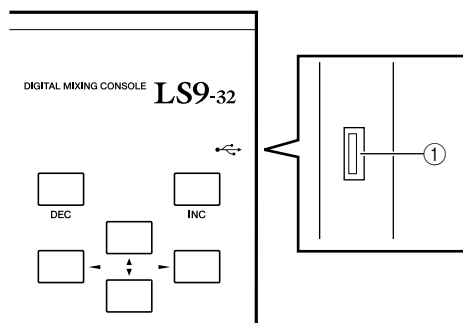

① USB connector

USB memory can be connected here, and used to save or load internal data. User authentication key data to define the user level can also be saved on USB memory and used to restrict the functionality that is available to each user.



- Operation is guaranteed only for USB flash memory.

■ USB memory format

Only USB memory that is 2 GB or less in capacity and is formatted in FAT12, FAT16, or FAT32 is supported. If the USB memory is formatted in any other way, you must reformat it in the USER SETUP screen.

■ Write protection

Some USB memory has write protection that prevents data from being erased inadvertently. If your USB memory contains important data, we suggest that you use its write protect feature to prevent accidental erasure. Conversely, you must make sure that your USB memory's write protect feature is disabled before you attempt to save data to it.

**CAUTION**

- The ACCESS indicator will appear in the upper part of the screen while data is being accessed, such as during saving, loading, or deleting. During this time, you must not disconnect the USB memory from the USB connector or power-off the LS9. Doing so may damage your USB memory, or damage the data in the LS9 or in the USB memory.

# Rear panel

**LS9-16**

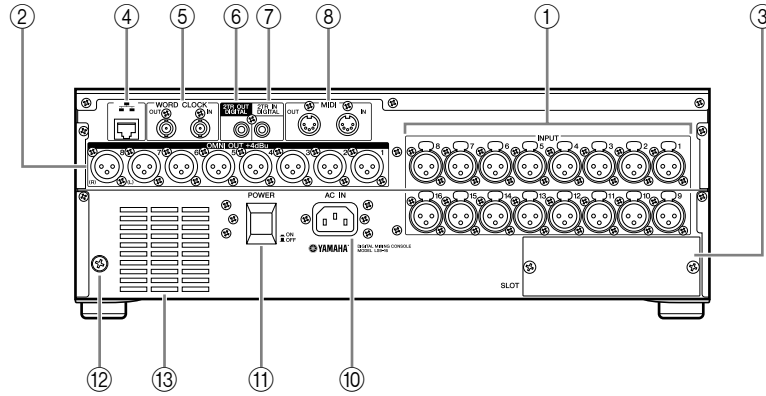

**LS9-32**

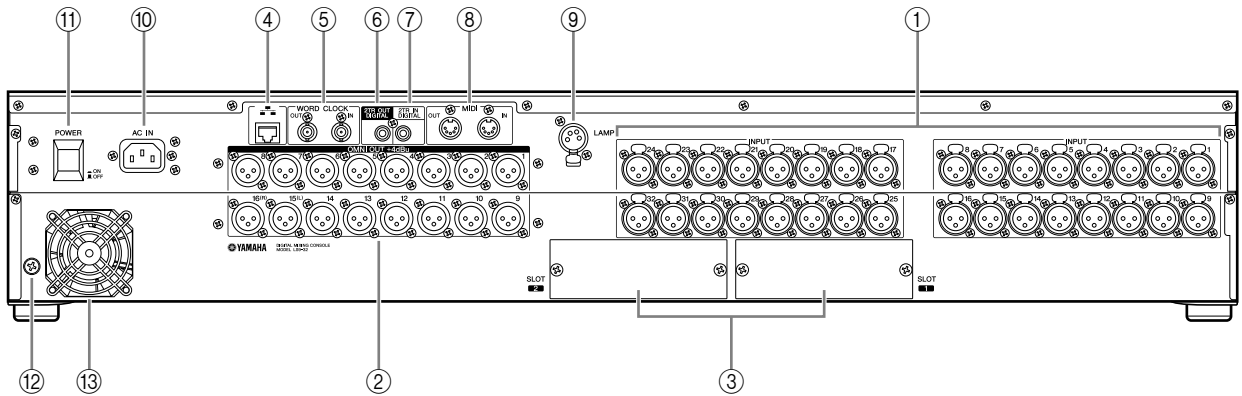

① INPUT jacks 1–16 {1–32}

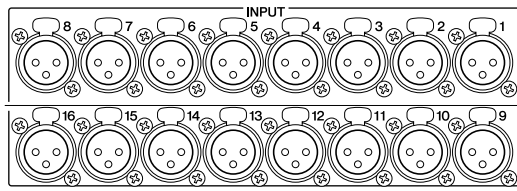

LS9-16

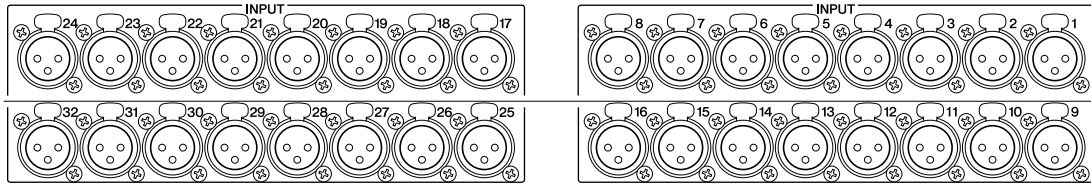

LS9-32

These are balanced XLR-3-31 female input jacks for inputting analog audio signals from line level devices or microphones. The nominal input level is  $-62 \text{ dBu} - +10 \text{ dBu}$ . Resettable head amps are provided on all jacks, and head amp settings can be stored in scene memory.

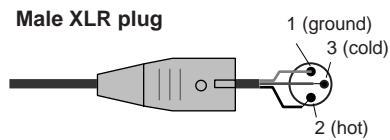

② OMNI OUT jacks 1–8 {1–16}

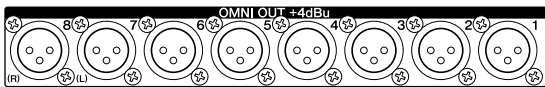

LS9-16

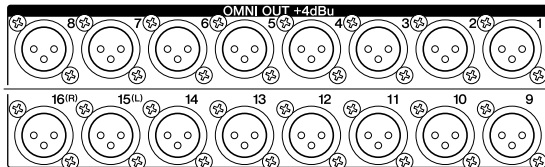

LS9-32

These are XLR-3-32 male output jacks for outputting analog audio signals. These are used mainly to output MIX/MATRIX channel signals. The nominal output level is  $+4 \text{ dBu}$ .

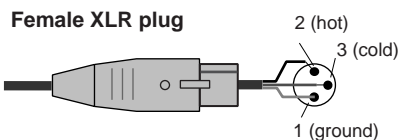

NOTE

• The nominal output level of OMNI OUT jacks 1–8 {1–16} is  $+4 \text{ dBu}$  (maximum level is  $+24 \text{ dBu}$ ), but if necessary this can be changed by an internal switch to  $-2 \text{ dBu}$  (maximum level is  $+18 \text{ dBu}$ ). (A fee will be charged for this change.) For details, contact to your Yamaha dealer listed at the end of this manual.

③ Slots {1–2}



LS9-16

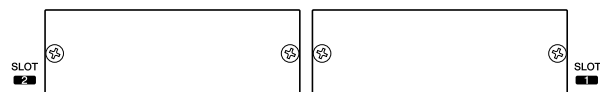

LS9-32

Separately sold mini-YGDAI I/O cards can be installed in these slots to provide additional input/output ports. The LS9-16 has one slot, and the LS9-32 has two slots. Each slot can input/output a maximum of 16 channels of signals.

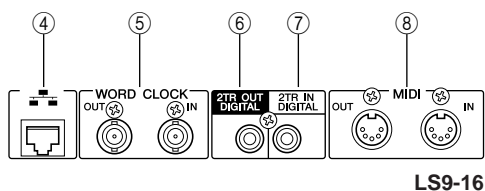

LS9-16

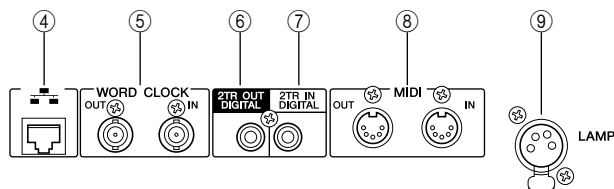

LS9-32

#### ④ NETWORK connector

This connector allows the LS9 to be connected to a Windows computer via a CAT3 (transfer rate: maximum 10 Mbps) or CAT5 (transfer rate: maximum 100 Mbps) compatible Ethernet cable. This is used mainly for controlling mix parameters or editing scene memories and libraries from the dedicated “LS9 Editor” application program.

#### NOTE

- The DME-N Network Driver required for connection to the NETWORK connector, the Studio Manager required for running LS9 Editor, and the LS9 Editor itself can be downloaded from the Yamaha website listed below.

<http://www.yamahaproaudio.com/>

#### ⑤ WORD CLOCK IN/OUT connectors

These are BNC connectors used to transmit and receive word clock signals to and from an external device. The WORD CLOCK IN connector is internally terminated by a 75 ohm resistor.

#### ⑥ 2TR OUT DIGITAL jack

This is a coaxial jack that outputs the digital audio signal of a specified channel in consumer format (IEC-60958). This is used mainly to output STEREO/MONO channel signals.

#### ⑦ 2TR IN DIGITAL jack

This is a coaxial jack that inputs a stereo digital audio signal in consumer format (IEC-60958). The signal input from this jack can be patched to any input channel.

#### ⑧ MIDI IN/OUT connectors

These connectors are used to transmit and receive MIDI messages to and from external MIDI devices. The MIDI IN connector receives messages from an external device, and the MIDI OUT connector transmits messages from the LS9. These are used mainly for recording LS9 parameter operations or scene/library changes on an external device, or for remotely operating LS9 parameters.

#### ⑨ LAMP connector (LS9-32 only)

This is an XLR-4-31 connector that supplies power to a separately sold gooseneck lamp (e.g., Yamaha LA1L). The brightness of the lamp can be adjusted in the screen.

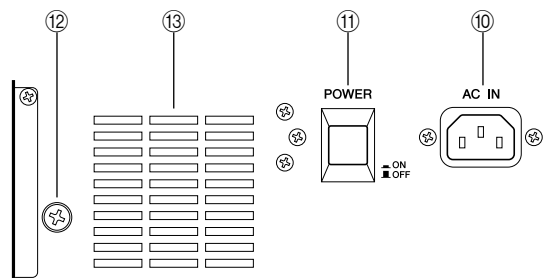

LS9-16

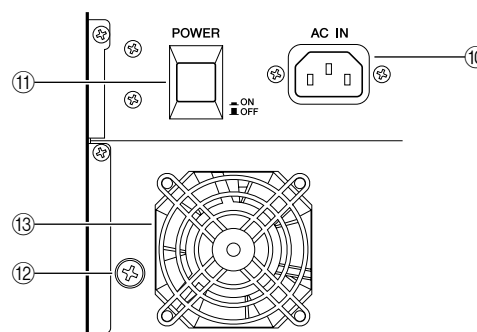

LS9-32

#### ⑩ AC IN connector

Connect the included power cable to this connector to supply power to the unit.

#### ⑪ POWER switch

This switch turns the power on/off.

#### ⑫ Grounding screw

To ensure safe operation, be sure to ground the LS9 securely. The included power cable has a three-conductor plug, so if the AC outlet is grounded the LS9 will be grounded appropriately. If the AC outlet is not grounded, establish a secure ground connection from this screw. Correctly grounding the unit is an effective way to eliminate hum and interference noise.

#### ⑬ Cooling fan vent

This is the vent for the cooling fan inside the console. When placing the console, be careful not to block this vent.

## Front panel

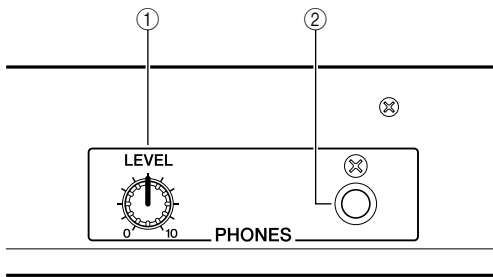

① **PHONES LEVEL control**

This adjusts the level of the signal that is output from the PHONES OUT jack ②.

② **PHONES OUT (headphone output) jack**

This is a headphone jack for monitoring the MONITOR OUT or CUE signal.



# Basic operations on the LS9

This chapter explains the various user interfaces you'll use to operate the LS9, and basic operations.

## Basic operations in the top panel

Here we explain basic operations you'll perform in the LS9's top panel.

### About the [HOME] key

The [HOME] key in the SELECTED CHANNEL section restores the LS9's panel to its basic state (home position).



When you press the [HOME] key, the panel will change as follows.

- The display will show the SELECTED CH VIEW screen, where you can view all parameters of the selected channel.



- The channel level function will be assigned to the faders (SENDS ON FADER mode will be defeated).

The [HOME] key will blink if the display is showing any screen other than the SELECTED CH VIEW screen, or if SENDS ON FADER mode is active. In such cases, you will find it convenient to press the [HOME] key to restore the panel to home position (the [HOME] key will change to steadily lit), and then proceed with operations.

### Selecting the fader layer

The channel module section of the top panel lets you switch between combinations of channels to be controlled ("fader layers") so that you can control input channels, output channels, or monitor levels.

Press the keys of the LAYER section to switch the combination of channels you want to control.

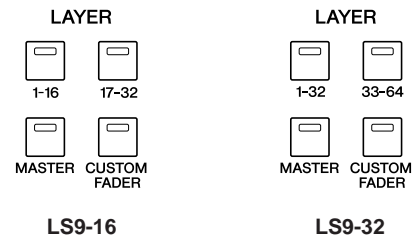

The combination of channels corresponding to each key is as follows.

### LS9-16

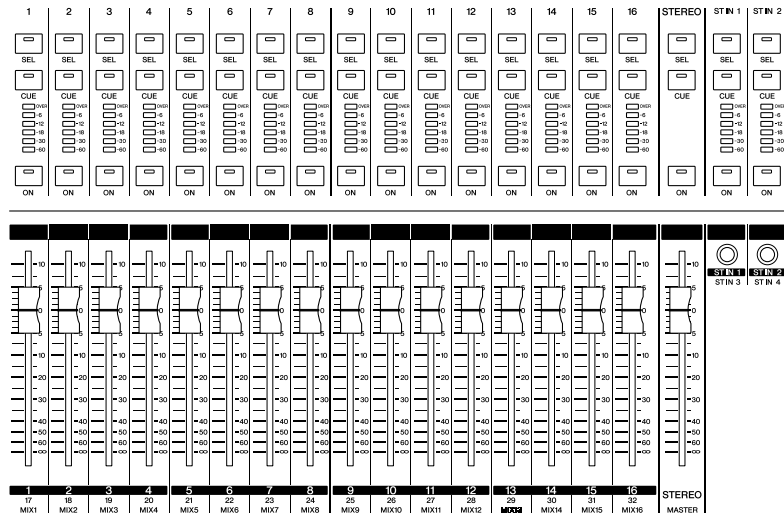

LAYER section key				
LAYER [1-16]	INPUT CH 1-16		STEREO	ST IN 1-2
LAYER [17-32]	INPUT CH 17-32		STEREO	ST IN 3-4
LAYER [MASTER]	MIX 1-16		STEREO	—
LAYER [CUSTOM FADER]	Any desired channels		STEREO	Any desired channels

### LS9-32

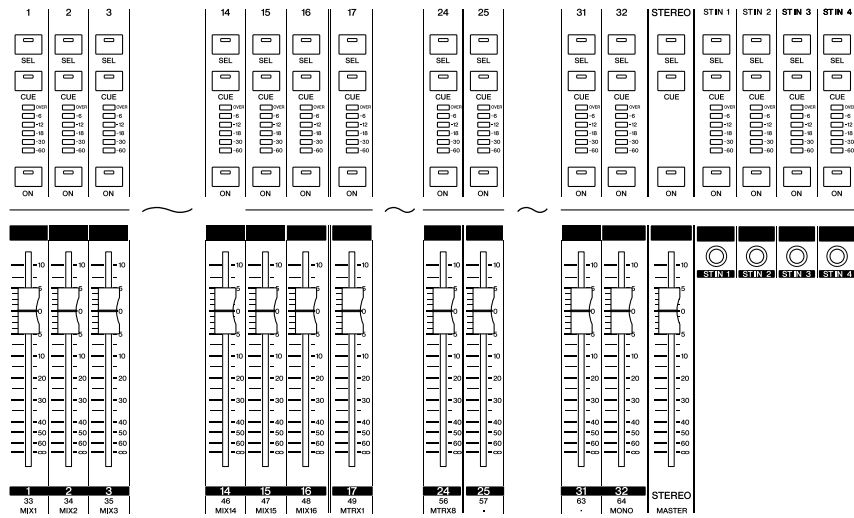

LAYER section key							
LAYER [1-32]	INPUT CH 1-16		INPUT CH 17-32		STEREO	ST IN 1-4	
LAYER [33-64]	INPUT CH 33-48		INPUT CH 49-64		STEREO	ST IN 1-4	
LAYER [MASTER]	MIX 1-16		MATRIX 1-8	—	MONO	STEREO	—
LAYER [CUSTOM FADER]	Any desired channels		Any desired channels		STEREO	Any desired channels	

**HINT**

- On the LS9-16, MATRIX channels and MONO channels are not assigned to the fader layers that are preset. If you want to use the top panel faders and [ON] keys to control the MATRIX channels or MONO channel, you can assign them to the custom fader layer (→ p. 91).

## Using the SELECTED CHANNEL section

You can use the encoders and keys of the SELECTED CHANNEL section to directly operate the mix parameters (EQ, pan, dynamics, etc.) of the currently selected channel from the top panel.

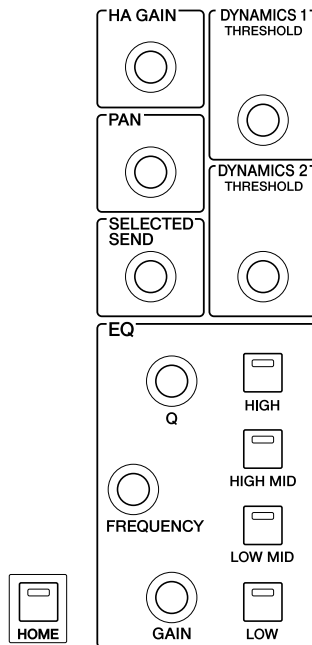

- 1 Make sure that the desired fader layer is selected in the LAYER section.
- 2 Use the [SEL] keys of the channel module STEREO section, and ST IN section to select the channel that you want to operate.

The currently selected channel is indicated in the upper left of the screen.

For stereo channels (STEREO channels, ST IN channels), you will alternate between the L-channel and R-channel each time you press the [SEL] key.



- If AUTO CHANNEL SELECT is turned on in the PREFERENCE popup window (→ p. 194), you can select a channel simply by operating its [ON] key or fader, without having to press its [SEL] key.

- 3 Turn the encoders of the SELECTED CHANNEL section to edit the desired parameters.

The parameter assigned to each encoder will change. Before operating the EQ encoders, you'll need to use the EQ [HIGH], EQ [HIGH MID], EQ [LOW MID], and EQ [LOW] keys to select the band you want to control.



- By pressing one of the SELECTED CHANNEL section's encoders inward, you can also access a popup window where you can edit detailed settings for the parameter (→ p. 194).

## Selecting functions

Use the keys of the DISPLAY ACCESS section when you want to use functions other than mix parameters, or when you want to change various settings.

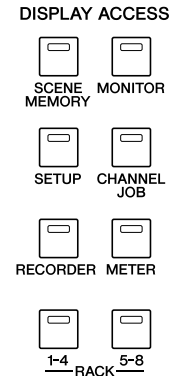

When you press one of the keys in the DISPLAY ACCESS section, the corresponding screen will appear in the display. If the screen consists of more than one page, you can switch between pages by pressing the same key repeatedly. For example if you press the [SCENE MEMORY] key, the SCENE MEMORY screen will appear, where you can store or recall scene memories.

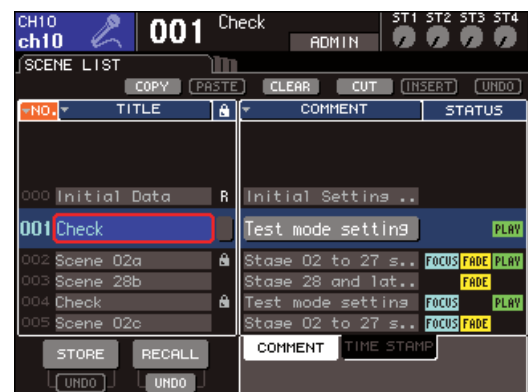

- If you press the lit DISPLAY ACCESS key while a popup screen is displayed, the popup screen will close.
- If you press and hold down the DISPLAY ACCESS section key, the previously displayed screen will appear.

## Viewing the display

Here we explain the various types of information shown in the display.

### Constant display area



#### ① Selected channel

This shows the number, name, and icon of the channel currently selected by its [SEL] key for operations. (For details on assigning a name → p. 34, For details on selecting an icon → p. 55, 69) You can also move the cursor to this area and use the dial or the [DEC]/[INC] keys to change the selected channel.

#### ② Scene memory

This shows the number and name of the scene that is currently selected for store/recall operations. An “R” (Read Only) indication is shown for read-only scenes or write-protected scenes. If you have modified the parameters from their most recently stored or recalled state, an “E” (Edited) indication is shown. Move the cursor to the scene number, use the dial or the [DEC]/[INC] keys to change the scene number, and press the [ENTER] key to recall the scene.

#### NOTE

- Simply changing the scene that is shown here will not execute a store/recall operation.
- To execute a store or recall operation, access the SCENE MEMORY screen and use the STORE/RECALL buttons in the screen (→ p. 129), or press a user-defined key to which you've assigned the scene store/recall operation (→ p. 132).
- You can also move the cursor to the scene number in the constant display area and use the dial or the [DEC]/[INC] keys to change the scene number. This scene number will blink if the most recently stored or recalled scene is different than the currently selected scene.

#### ③ MIDI

The MIDI indicator will appear when MIDI messages are received.

#### ④ User name / status

This shows the name of the user who is currently logged-in (authenticated and permitted to operate the console). Other indicators are shown here if oscillator or talkback is on, or if internal memory or USB memory is being accessed.

##### When oscillator is on



##### When talkback is on



##### While recording to USB memory



##### While playing from USB memory



##### While accessing internal memory when storing USB memory or a scene



#### ⑤ ST IN level

This indicates the on/off status and input level of ST IN channels 1–4. This shows a gray knob and black index when on, or a dark gray knob and black index when off.



In SENDS ON FADER mode, this shows the on/off status and send level of the signal sent from ST IN channels 1–4 to the MIX bus. When on, the knob will be a color corresponding to the send-destination (the same type of color as the keys of the MIX/MATRIX SELECT section), and the indices will be white. When off, the knob will be gray and the indices will be black.



#### HINT

- In SENDS ON FADER mode, the send-destination bus is shown blinking at the right of the scene number.

## Main area

The contents of the main area will depend on the currently selected function.

### SELECTED CH VIEW screen

This screen shows all mix parameters of the currently selected channel. To access this screen, press the [HOME] key of the SELECTED CHANNEL section.



### Various function screens

These screens allow you to access functions and settings other than channel mix parameters. To access each of these screens, press the appropriate key of the DISPLAY ACCESS section.



### Popup windows

Some windows show lists or details of specific parameters in the screen. These are called “popup windows.”

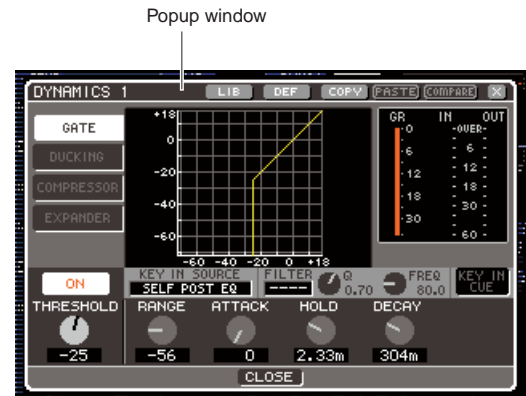

By operating the knobs and buttons in a popup window, you can edit more detailed parameters. In some popup windows, there are several buttons called “tool buttons” in the upper part of the window. You can use these tool buttons to recall or copy/paste library data.

To close the popup window and return to the previous screen, move the cursor to the “x” symbol or the CLOSE button, and press the [ENTER] key. (You can also close the popup window and return to the SELECTED CHANNEL VIEW screen by pressing the [HOME] key.)

## The on-screen user interface

The interface shown in the screen of the LS9 includes the following items.

### ■ Cursor

The blinking red and yellow frame displayed in the screen is called the “cursor.”

The cursor is used to specify the object of your operations. Use the cursor keys of the data entry section to move the cursor up/down/left/right.

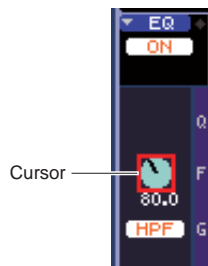

### ■ Buttons

Buttons in the screen are used to execute specific functions, to switch parameters on/off, or to select one of several choices.

To execute a button’s function, to switch it on/off, or to select a desired item, move the cursor to the desired button and press the [ENTER] key of the data entry section.

By moving the cursor to a button that shows the ▼ symbol and then pressing the [Enter] key, you can open another popup window where you can specify details.



### ■ Knobs and faders

Knobs in the screen are used to view or edit the values of the corresponding parameters. Normally, you will move the cursor to a knob and use the dial or [DEC]/[INC] keys of the data entry section to edit the value. The current value is shown in numerical form immediately below the knob. Some knobs will move in tandem with the encoders of the SELECTED CHANNEL section.

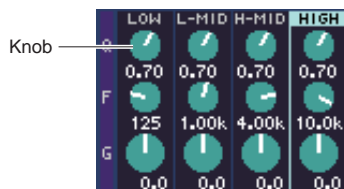

Faders in the screen are mainly used to view or edit the level of the corresponding channels. They will move in tandem with the faders of the top panel. You can also move the cursor to a fader and use the dial or [DEC]/[INC] keys of the data entry section to edit the value. The current value is shown in numerical form immediately below the fader.

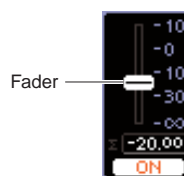

### ■ List window

A window like the following will appear when you are selecting an item from a list, such as when selecting a function for a user-defined key.

Within the list, the constantly-highlighted item in the center is the selected item. To scroll the list up or down, use the dial or the [DEC]/[INC] keys.





### ■ Keyboard window

The keyboard window shown below will appear when you assign a name or comment to a scene or library, or when you assign a name to a channel. To enter characters, move the cursor to the desired character in the window and press the [ENTER] key. (For the procedure → p. 34)



### ■ Dialog box

When you need to confirm the operation you just performed or when a problem has occurred, a dialog box will appear, asking you to confirm the operation or displaying a warning.

#### ● CONFIRMATION dialog box

This dialog box will appear when confirmation is required. Move the cursor to the OK button to execute the operation (or to the CANCEL button to cancel it), and press the [ENTER] key.

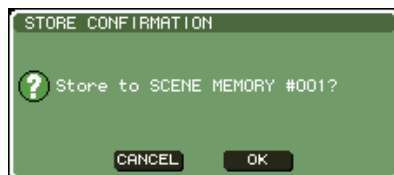

#### ● ATTENTION dialog box

This dialog box will display a warning when a problem has occurred with the operation you are attempting to execute.

If you move the cursor to the OK button and press the [ENTER] key, the operation will be executed in a way that circumvents the problem. If you move the cursor to the CANCEL button and press the [ENTER] key, the operation will be cancelled.

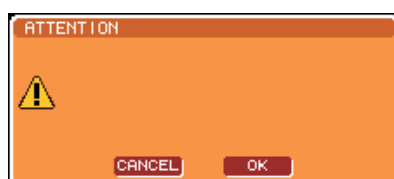

#### ● CAUTION dialog box

This dialog box will display a warning if a fatal error has occurred in the operation you attempted to execute. When you move the cursor to the CLOSE button and press the [ENTER] key, the operation will be forcibly cancelled, and the dialog box will disappear.

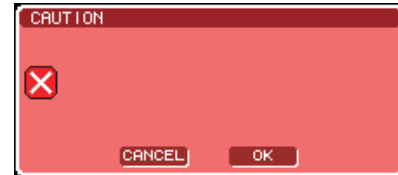

## Assigning a name

On the LS9, you can assign a name to each input channel and output channel, and assign a title to each scene or library data item when you save it.

To assign a name, you will use the keyboard window that is shown in the main area.

### 1 Access the window where you can assign a name.

The illustration below shows the SCENE STORE popup window that is used when assigning a name to a scene.

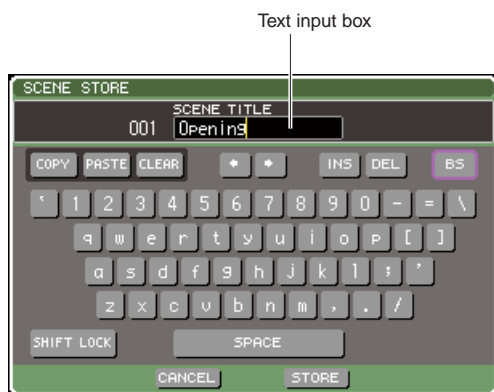

A yellow vertical line called the “text cursor” is shown to indicate the current location in the box that displays the characters that have been input.

### 2 Use the on-screen keyboard to enter text.

Move the cursor (the red frame) to the desired character in the keyboard window and press the [ENTER] key; the character will be entered in the text input box, and the text cursor (yellow vertical line) in the box will move to the right.

### 3 Enter the subsequent characters in the same way.

While entering characters, you can use the following buttons in the keyboard window.

#### ● COPY button

Copies the entire text string from the text box into buffer memory.

#### ● PASTE button

Inserts the text string copied using the COPY button at the location of the text cursor.

#### ● CLEAR button

Erases all characters that were entered in the text input box.

#### ● ← / → buttons

Moves the text cursor forward or backward in the text input box.

#### ● INS button

Inserts a space (blank) at the text cursor.

#### ● DEL button

Deletes the character to the right of the text cursor.

#### ● BS button

Deletes the character to the left of the text cursor.

#### ● SHIFT LOCK button

Switches between uppercase and lowercase alphabetical characters. You’ll be able to enter uppercase characters and symbols if this button is on, and lowercase characters and numerals if this button is off.

#### ● ENTER button

Finalizes the name you entered. In the SCENE STORE popup window, you can obtain the same result by moving the cursor to the STORE button and pressing the [ENTER] key.

### 4 When you’ve entered the name, move the cursor to the STORE button or the ENTER button and press the [ENTER] key.

The name you entered will be applied.



- The basic procedure is the same in the windows that let you assign names to channels or other types of library data. If you’re entering a channel name, the name will be updated immediately, without your having to use the ENTER button.

## Using the tool buttons

The title bar at the top of some popup windows and screens contains tool buttons that provide additional functions. You can use these buttons to recall related libraries, or to copy the parameters of a channel to a different channel. Here we will explain how to use the tool buttons.

### About the tool buttons

Tool buttons like the following are shown in the ATT/HPF/EQ, DYNAMICS 1/2, GEQ, and EFFECT popup windows and screens.

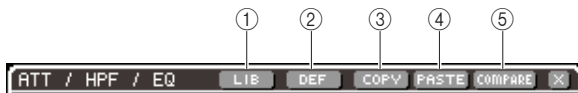

#### ① LIB (library) button

This button recalls the library that is related to the current popup window or screen (EQ, dynamics, GEQ, or effect library).

#### ② DEF (default) button

This button restores the currently selected channel (EQ/dynamics) or rack (effect) to the default state.

#### ③ COPY button

This button copies the settings of the currently selected channel (EQ/dynamics) or rack (GEQ/effect). The copied settings are held in buffer memory (a memory area for temporary storage).

#### ④ PASTE button

This button pastes the settings held in buffer memory into the currently selected channel (EQ/dynamics) or rack (GEQ/effect).

#### ⑤ COMPARE button

This button exchanges the settings held in buffer memory with the settings of the currently selected channel (EQ/dynamics) or rack (GEQ/effect).

#### NOTE

- You cannot press the PASTE button or COMPARE button if no settings have been copied into buffer memory.

In addition, some screens have the following tool buttons.

- SET ALL** ..... Turns on all of the parameters in the screen.
- CLEAR ALL**..... Turns off all of the parameters in the screen.

### Using libraries

Here we will explain the basic procedure for using libraries. You can use libraries to store (save) or recall (load) the settings of the currently selected channel (EQ/dynamics) or rack (GEQ/effect).

The following libraries are provided.

- Input EQ library
- Output EQ library
- Dynamics library
- GEQ library
- Effect library

The operating procedure is essentially the same for all libraries.

#### ● Recalling data from a library

#### 1 Access a popup window or screen that contains tool buttons.

To access each popup window or screen, proceed as follows.

[ ATT/HPF/EQ popup window ]  
[ DYNAMICS 1/2 popup window ]



In the SELECTED CH VIEW screen, move the cursor to the knob corresponding to EQ or dynamics 1/2, or to a button that has a ▼ symbol, and press the [ENTER] key.



- If POPUP APPEARS WHEN PRESSING KNOBS is turned on in the PREFERENCE popup window (→ p. 194), you can access the popup window by pressing the SELECTED CHANNEL section encoder that corresponds to EQ or dynamics 1/2.

### [ RACK screen ]

In the DISPLAY ACCESS section, press the [RACK 1-4] or [RACK 5-8] key.

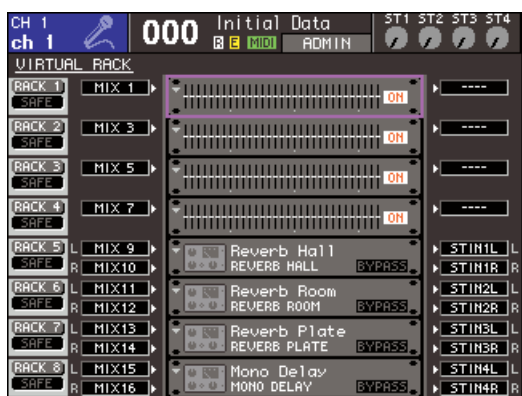

## 2 Select the channel (EQ/dynamics) or rack (GEQ/effect) whose settings you want to recall.

The method of selecting a channel/rack will depend on the type of popup window or screen that is currently displayed.

### [ ATT/HPF/EQ popup window ]

### [ DYNAMICS 1/2 popup window ]

Press a [SEL] key on the panel, or move the cursor to the selected channel in the constant display area of the screen, and use the dial or the [DEC]/[INC] keys.

Selected channel



### [ RACK screen ]

In the DISPLAY ACCESS section, repeatedly press the [RACK 1-4] or [RACK 5-8] key.



- If you want to change the assignment (31BandGEQ, Flex15GEQ, or effect) to each rack, simultaneously press the [RACK 1-4] key and [RACK 5-8] to access the VIRTUAL RACK screen (→ p. 158).

## 3 Move the cursor to the LIB button in the toolbar and press the [ENTER] key to access the popup window of the corresponding library.

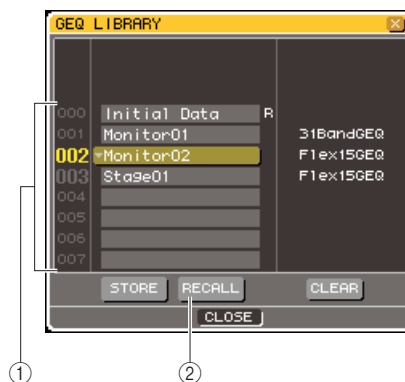

### ① List

This shows the settings that are saved in the library. The highlighted line indicates the data that is selected for operations. Read-only data is indicated by an “R” symbol.

### ② RECALL button

This button recalls the settings selected in the list into the currently selected channel (EQ/dynamics) or rack (GEQ/effect).



- The right side of the list shows information about the corresponding data (the dynamics type or effect type used, etc.). For the dynamics library, a symbol is shown to indicate whether the data can be recalled by dynamics 1 or 2.

## 4 Move the cursor to the list, and select the recall-source library number by using the dial or the [DEC]/[INC] keys to move the highlighted line in the list.

In some cases, the data selected as the recall-source cannot be recalled into the currently selected channel/rack. Each library has the following limitations.

### ● Dynamics library

The dynamics library holds three types of data; Dynamics 1 and Dynamics 2 for input channels, and Dynamics 1 for output channels. Recall is not possible if you've selected a type that is not supported by the corresponding dynamics processor.

### ● GEQ library

The GEQ library holds two types of data; 31BandGEQ or Flex15GEQ. Recall is not possible if you've selected a type that is different than the recall-destination GEQ.

### ● Effect library

Effect settings whose effect type is "HQ.Pitch" or "Freeze" can be recalled only to racks 5 or 7. They cannot be recalled if any other rack is selected.

If you select a library item number that cannot be recalled, the RECALL button will be disabled.

## 5 Move the cursor to the RECALL button and press the [ENTER] key.

The selected data will be loaded into the channel (EQ/dynamics) or rack (GEQ/effect) you selected in step 2.



- You also have the option of displaying a dialog box that asks you to confirm the recall operation (→ p. 194).

## ● Storing data in a library

### 1 Access a popup window or screen that contains tool buttons.

### 2 Select the channel (EQ/dynamics) whose settings you want to store, or the rack in which the GEQ/effect whose settings you want to store is already mounted.

### 3 Move the cursor to the LIB button in the toolbar and press the [ENTER] key to access the popup window or screen of the corresponding library.

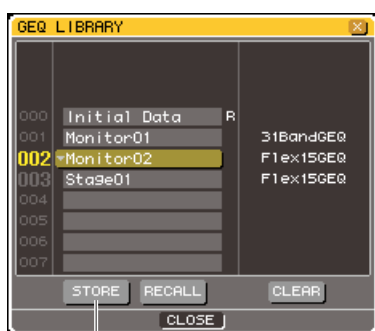

STORE button

## 4 Move the cursor to the list, and use the dial or the [DEC]/[INC] keys to select the store-destination library number.

## 5 After you've selected the store-destination, move the cursor to the STORE button and press the [ENTER] key.

The LIBRARY STORE popup window will appear, allowing you to assign a name to the data. For details on entering text, refer to "Assigning a name" (→ p. 34).

## 6 When you've assigned a name to the data, move the cursor to the STORE button in the LIBRARY STORE popup window and press the [ENTER] key.

A dialog box will ask you to confirm the Store operation.

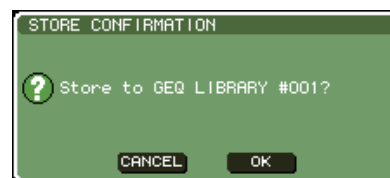

## 7 To execute the Store operation, move the cursor to the OK button and press the [ENTER] key.

The current settings will be stored in the library number you selected in step 4. If you decide to cancel the Store operation, move the cursor to the CANCEL button instead of the OK button, and press the [ENTER] key.



- Even after you've stored the settings, you can edit the title of the data by moving the cursor to the data name in the list and pressing the [ENTER] key to access the LIBRARY TITLE EDIT popup window. However, you can't rename read-only data (indicated by the "R" symbol).



- Please be aware that if you store to a location that already contains data, the existing data will be overwritten. (However, you can't overwrite read-only data.)
- Don't turn off the power while the Store operation is in progress. The data will not be stored correctly if you do so.

## ● Erasing data from a library

- 1 Access a popup window or screen that contains tool buttons.
- 2 Move the cursor to the LIB button in the toolbar and press the [ENTER] key to access the popup window of the corresponding library.

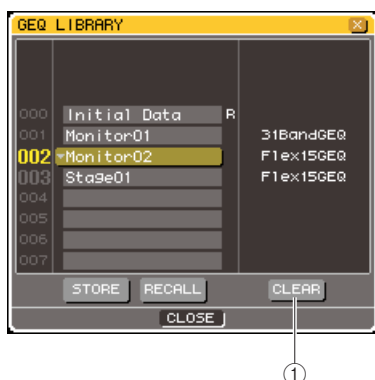

### ① CLEAR button

Clears (erases) the data that is selected in the list.

- 3 Move the cursor to the list, and use the dial or the [DEC]/[INC] keys to select the library item number that you want to clear.
- 4 Move the cursor to the CLEAR button and press the [ENTER] key.  
A dialog box will ask you to confirm the Clear operation.
- 5 To execute the Clear operation, move the cursor to the OK button and press the [ENTER] key.

The data you selected in step 3 will be cleared. If you decide to cancel the Clear operation, move the cursor to the CANCEL button instead of the OK button, and press the [ENTER] key.

#### NOTE

- You can't clear read-only data (data indicated by an "R" symbol).

## Initializing settings

Here's how you can return the EQ/dynamics settings of the currently selected channel or the effect settings of a rack to their initial state.

#### HINT

- GEQ settings can be initialized using the FLAT button in the screen.

- 1 Access a popup window or screen that contains tool buttons.
- 2 Select the channel (EQ/dynamics) or rack (effect) whose settings you want to initialize.
- 3 Move the cursor to the DEF button and press the [ENTER] key.

A dialog box will ask you to confirm the Initialize operation.

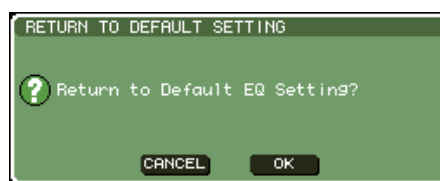

- 4 To execute the Initialize operation, move the cursor to the OK button and press the [ENTER] key.

The EQ/dynamics settings of the channel you selected in step 2 or the effect settings of the rack will be initialized. If you decide to cancel the Initialize operation, move the cursor to the CANCEL button instead of the OK button, and press the [ENTER] key.



## Copying and pasting settings

Here's how you can copy the EQ/dynamics settings of the currently selected channel or the GEQ/effect settings of the currently selected rack to buffer memory, and then paste them to a different channel or rack.

Copy/paste is limited to the following combinations.

- Between EQ of input channels
- Between EQ of output channels
- Between dynamics for which the same type (GATE, DUCKING, COMPRESSOR, EXPANDER, COMPANDER-H, COMPANDER-S, DE-ESSER) is selected
- Between effects mounted in a rack

**1** Access a popup window or screen that contains tool buttons.

**2** Select the channel (EQ/dynamics) or rack (GEQ/effect) whose settings you want to copy.

**3** Move the cursor to the COPY button and press the [ENTER] key.

The current settings will be held in buffer memory.

**4** Select the paste-destination channel or rack.

**5** Move the cursor to the PASTE button and press the [ENTER] key.

The settings of the channel (EQ/dynamics) or the rack (GEQ/effect) you selected in step 2 will be pasted.

## Comparing two sets of settings

By using the compare button in the toolbar, you can exchange the settings held in the buffer memory with the settings of the currently selected channel (EQ/dynamics) or rack (GEQ/effect). This is convenient when you want to temporarily save an interim result of your editing, and then compare it with subsequent edits.

**1** Access a popup window or screen that contains tool buttons.

**2** Select a channel (EQ/dynamics) or rack (GEQ/effect).

**3** Move the cursor to the COPY button and press the [ENTER] key to save the current settings in the buffer memory.

This will be the first version of your settings.

**4** Edit the settings of the currently selected channel (EQ/dynamics) or rack (GEQ/effect).

This will be the second version of your settings.

### NOTE

- Please note that if you copy other settings before you execute the Compare operation, the buffer memory will be overwritten.
- After saving the first version of your settings in buffer memory, you can also initialize the channel/rack and create the second version of your settings from scratch.

## 5 When you want to compare the first and second versions of your settings, move the cursor to the COMPARE button and press the [ENTER] key.

You will return to the first version of your settings. At this time, the second version of your settings will be saved in buffer memory.

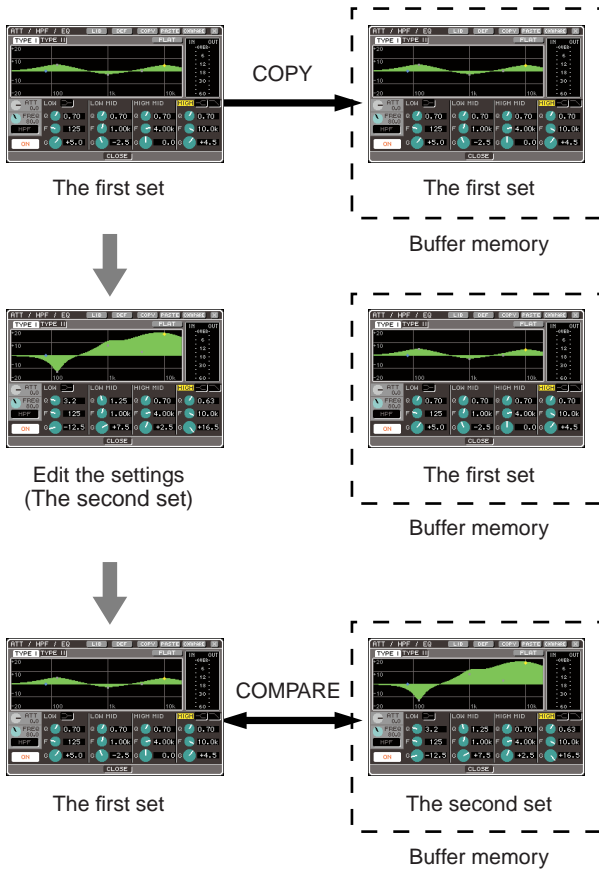

## 6 With the cursor left at the COMPARE button, repeatedly press the [ENTER] key to compare the first and second versions of settings.

Each time you press the [ENTER] key, the current settings will be exchanged with the settings saved in buffer memory. Unlike the Paste operation, this operation lets you return to the previous settings at any time as long as the buffer memory has not been overwritten.

### HINT

- The settings held in buffer memory can also be used by the Paste operation.
- If you operate the tool buttons for a rack in which Flex15GEQ (of the two types of GEQ) is selected, A and B will be individually exchanged with the buffer memory.

# Connections and setup

This chapter explains how to connect the audio inputs and outputs, how to perform the setup necessary when starting the LS9 for the first time, and how to check the operation.

## Connections

### ■ Analog input connections .....

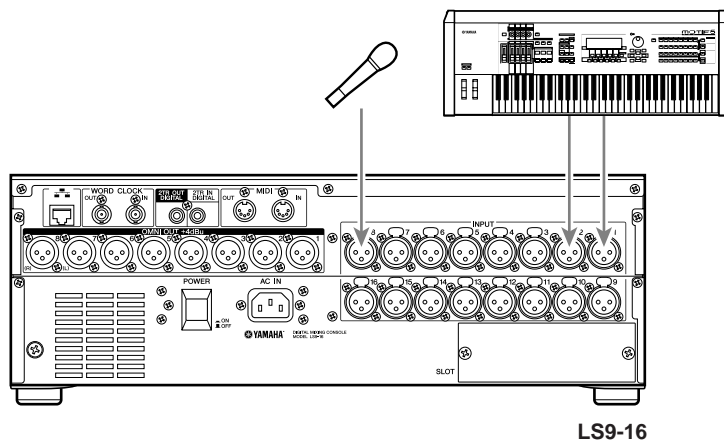

LS9-16

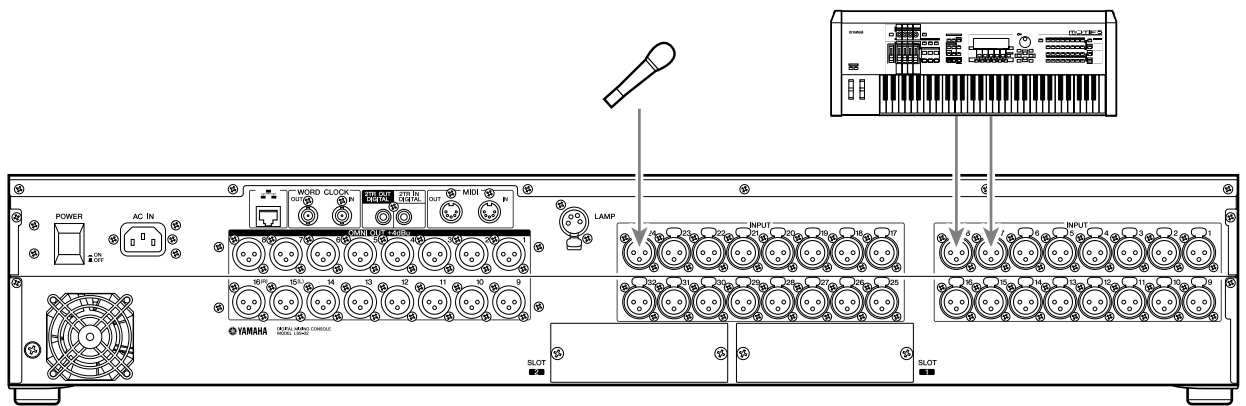

LS9-32

Connect microphones or line level devices to INPUT jacks 1–16 {1–32}. When the LS9 is in its initial state, the signal from each INPUT jack is patched to the following channels.

**For the LS9-16**

Analog input jacks	Input channels
INPUT jacks 1–16	INPUT channels 1–16

**For the LS9-32**

Analog input jacks	Input channels
INPUT jacks 1–32	INPUT channels 1–32

**NOTE**

- This patching can be changed as necessary (→ p. 99). For example if you want to connect a stereo line-level device, you can assign two INPUT jacks to a ST IN channel so that the left and right channels can be operated in tandem for convenience.

■ Analog output connections.....

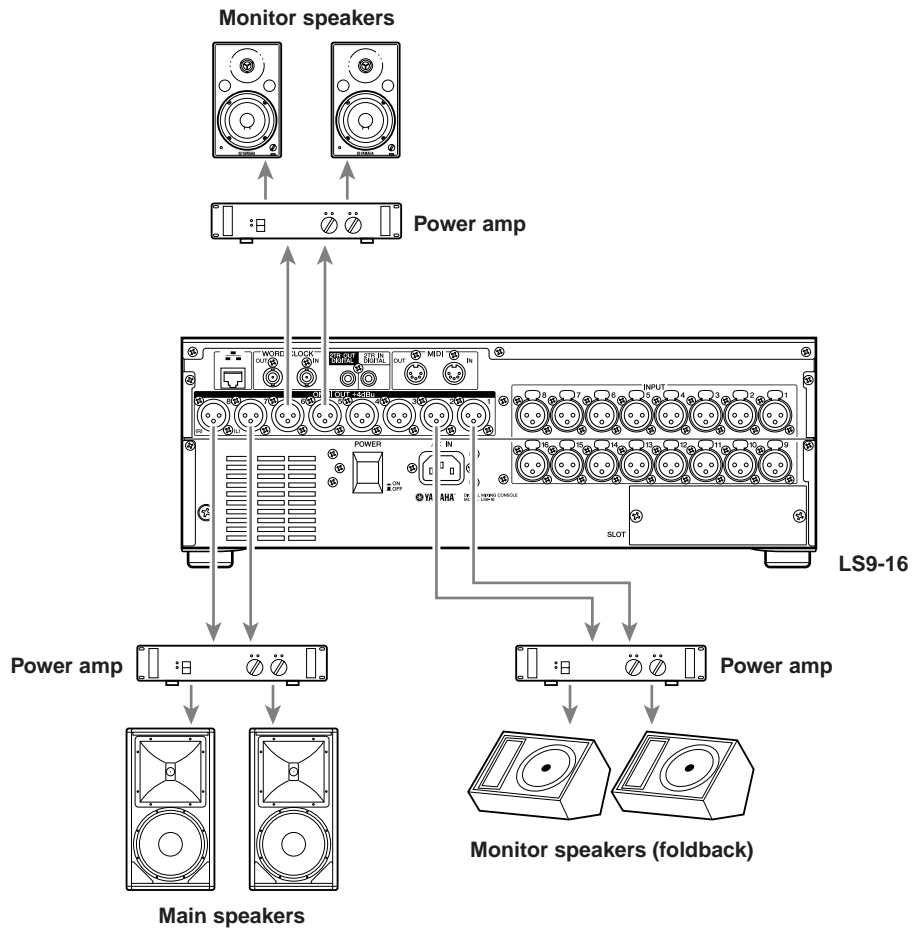

OMNI OUT jacks 1–8 {1–16} can be connected to your main speakers, monitor speakers (foldback), or monitor speakers for the engineer.  
 When the LS9 is in its initial state, the signal from the following channels is patched to each OMNI OUT jack.  
 This patching can be changed as necessary (→ p. 95).

**For the LS9-16**

Analog output jacks	Output channels
OMNI OUT jacks 1–6	MIX channels 1–6
OMNI OUT jacks 7–8	STEREO L/R channel

**For the LS9-32**

Analog output jacks	Output channels
OMNI OUT jacks 1–14	MIX channels 1–14
OMNI OUT jacks 15–16	STEREO L/R channel

## Digital input/output connections

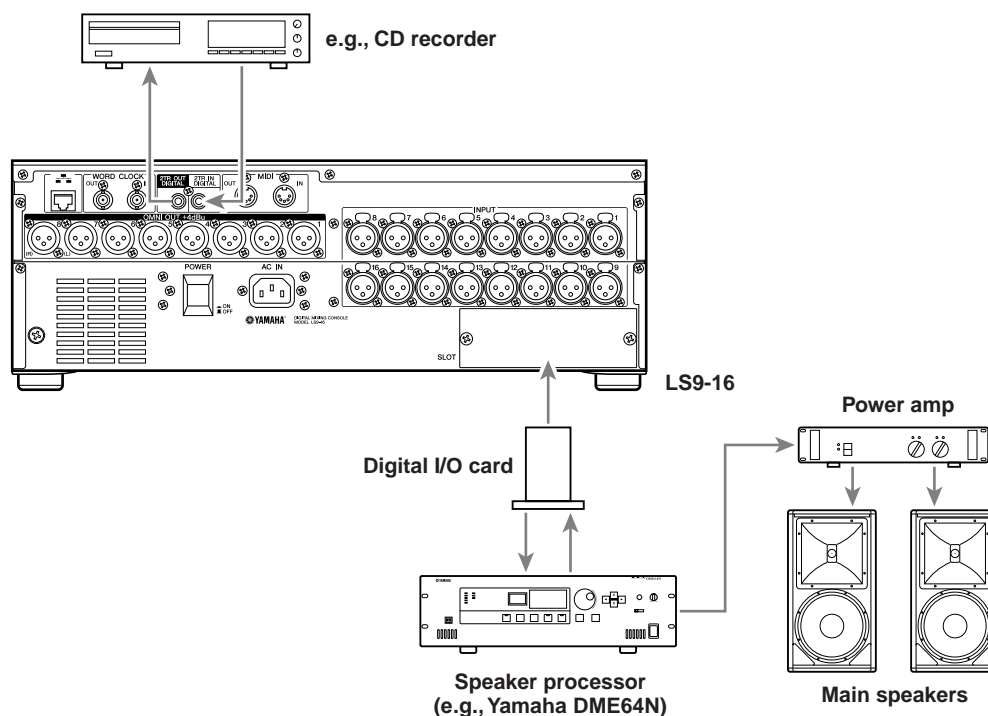

Use the 2TR IN DIGITAL/2TR OUT DIGITAL jacks or the mini-YGDAI slot to send or receive digital audio signals between the LS9 and external equipment. When the LS9 is in the default state, the signals of the following channels are patched to the 2TR IN DIGITAL/2TR OUT DIGITAL jacks and slots. This patching can be changed as necessary (→ p. 95, 99).

### For the LS9-16

Digital input/output jacks	Input/output channels
2TR IN DIGITAL jack (L/R)	No assignment
2TR OUT DIGITAL jack (L/R)	STEREO L/R channel
Slot input channels 1–8	INPUT channels 17–24
Slot input channels 9–16	INPUT channels 25–32
Slot output channels 1–8	MIX channels 1–8
Slot output channels 9–16	MIX channels 9–16

### For the LS9-32

Digital input/output jacks	Input/output channels
2TR IN DIGITAL jack (L/R)	No assignment
2TR OUT DIGITAL jack (L/R)	STEREO L/R channel
Slot 1 input channels 1–8	INPUT channels 33–40
Slot 1 input channels 9–16	INPUT channels 41–48
Slot 2 input channels 1–8	INPUT channels 49–56
Slot 2 input channels 9–16	INPUT channels 57–64
Slot 1 output channels 1–8	MIX channels 1–8
Slot 1 output channels 9–16	MIX channels 9–16
Slot 2 output channels 1–8	MIX channels 1–8
Slot 2 output channels 9–16	MIX channels 9–16

The LS9's 2TR IN DIGITAL/2TR OUT DIGITAL jacks are used to transfer two-channel digital audio signals to or from an external device (e.g., CD player or CD/MD recorder).

By installing a separately sold digital I/O card in a slot, you can add more input/output jacks to the LS9, or connect a DAW system or speaker processor.

For details on the types of I/O cards that can be used, refer to the appendix at the end of this manual (→ p. 274). Check the Yamaha website for the most recent information on I/O cards.

<http://www.yamahaproaudio.com/>

**NOTE**

- In order for digital audio signal to be transmitted or received via the 2TR IN DIGITAL/2TR OUT DIGITAL jacks or slots, the word clock of both devices must be synchronized (→ p. 46).

## Installing an option card

Before you install an I/O card in a slot, you must check the Yamaha website to verify whether the LS9 supports that card and to verify the number of other Yamaha cards or third-party cards that can be used in conjunction with it.

<http://www.yamahaproaudio.com/>

To install an option I/O card, proceed as follows.

- 1 Make sure that the power is turned off.**
- 2 Loosen the screws that fasten the slot, and remove the slot cover.**

Keep the removed slot cover in a safe place.

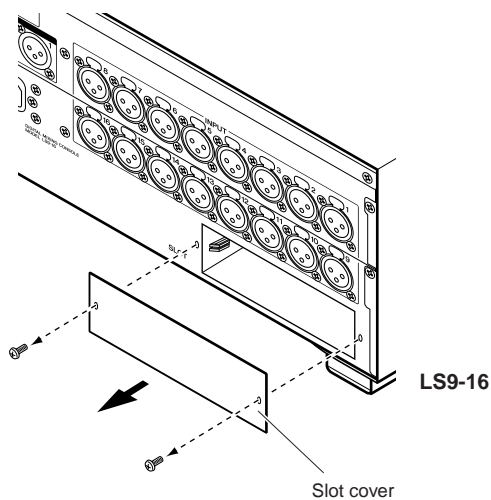

- 3 Align both edges of the card with the guide rails inside the slot, and insert the card into the slot.**

Push the card all the way into the slot to ensure that the contacts of the card are correctly inserted into the connector inside the slot.

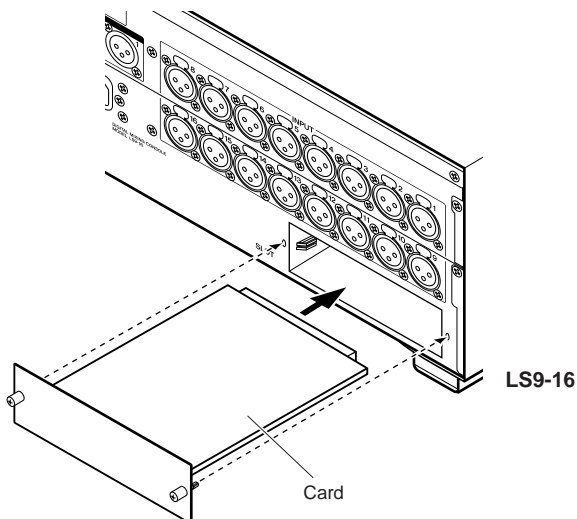

- 4 Fasten the card using the screws attached to the card.**

Be aware that damage or malfunctions may occur if the card is not fastened.

### **CAUTION**

- Before installing separately sold I/O cards into the console, you must make sure that the console's power switch is turned off. Otherwise, malfunctions or electrical shock may occur.



## Setup required when starting up

Here we explain the setup that is required when starting the LS9 for the first time. So that you can check whether the connections are correct, we also describe the basic procedure for getting the input signal from an INPUT channel to be output from the STEREO bus.

### Returning the current scene to the initial state

We will power-on the LS9 and recall (load) the initial setting scene (scene number 000).

#### NOTE

- We are recalling the default setting scene here so that the remaining operations in this chapter can be performed appropriately. In actual operation, there's no need to recall the default setting scene each time you start up.

### 1 Power-on the LS9.

When you power-on the LS9, you must turn on your equipment in the order of the LS9 → power amp or monitor system. (Use the opposite order when powering-off.)

### 2 In the DISPLAY ACCESS section, press the [SCENE MEMORY] key to access the SCENE LIST screen.

In this screen you can recall or store scene memories.



- 1 Scene list
- 2 RECALL button

### 3 Move the cursor to the scene list, and use the dial or the [DEC]/[INC] keys to make "000 Initial Data" appear in the highlighted line in the center of the list.



### 4 Move the cursor to the RECALL button and press the [ENTER] key.

Scene number "000" will be loaded, and the mix parameters will return to their initial state.

#### NOTE

- Be aware that when scene number "000" is loaded, the input patch, output patch, internal effect/GEQ, and HA (head amp) settings will also return to their initial state. (However, the word clock source selection will not be affected.)

## Word clock connection and settings

“Word clock” is the clock data that provides the timing basis for audio signals to be processed digitally. If a digital I/O card installed in a slot is digitally connected to an external device such as a DAW system, CD player, or HDR (hard disk recorder), and you want digital audio signals to be transmitted or received between the LS9 and the external device, you must synchronize the word clock of the respective devices. In order for this to occur, one device must be the word clock master (transmitting device) and the other device must be the slave (receiving device), and the slave device must synchronize to the master device. If you want to set the LS9 as the word clock slave so that it will synchronize to the word clock supplied from an external device, you can either use the clock data included in the digital audio signal received from a digital I/O card, or provide dedicated word clock to the WORD CLOCK IN jack located on the rear panel.

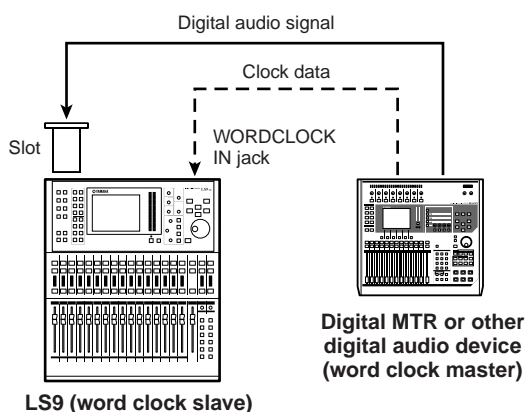
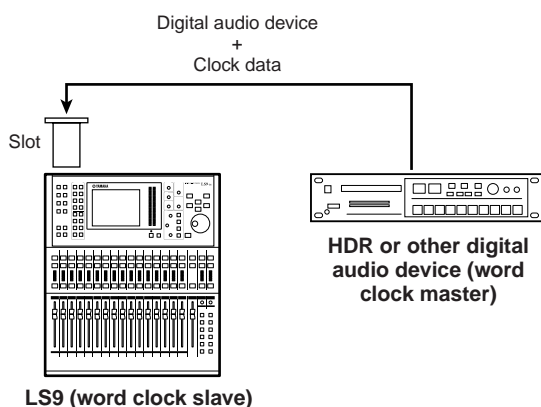

In either case, you must use the following procedure to specify the word clock source that the LS9 will use for operation.



- The following procedure is not necessary if you are using the LS9 as the word clock master, or if no external devices are digitally connected to the LS9.

- 1 In the **DISPLAY ACCESS** section, press the **[SETUP]** key repeatedly to access the **SYSTEM SETUP** screen.

In this screen you can make various settings that affect the entire LS9.



LS9-32

- 1 **WORD CLOCK** button

- 2 Move the cursor to the **WORD CLOCK** button in the **MIXER SETUP** field, and press the **[ENTER]** key.

The **WORD CLOCK** popup window will appear, allowing you to select the clock source on which the LS9 will operate.



LS9-32

### 3 Use the buttons in the window to select the clock source to which the LS9 will synchronize.

- If you want the clock source to be the clock data included in a digital audio signal from a slot

Turn on a valid 2-channel button for the corresponding slot.

- If you want the clock source to be the clock data included in the digital audio signal from the 2TR IN DIGITAL jack

Turn on the 2TR IN button.

#### NOTE

- If a conventional CD player or similar device is connected to the 2TR IN DIGITAL jack, use that device as the clock master. In some cases, noise may occur when synchronization is lost.

- If you want the word clock data from the WORD CLOCK IN jack to be the clock source

Turn on the WC IN button.

- If you want the LS9's internal clock to be the clock source

Turn on the INT48k (sampling frequency: 48 kHz) or INT44.1k (sampling frequency: 44.1 kHz) button.

If the LS9 is correctly operating with the new clock, the symbol located immediately above the corresponding button will turn light blue. Also, the frequency of the selected clock source is shown in the upper left of the window.

### 4 To close the WORD CLOCK popup window, move the cursor to the CLOSE button (or the × symbol in the upper right of the window) and press the [ENTER] key.

#### NOTE

- The word clock setting is maintained even if you turn off the power. If you've set the LS9 to synchronize to the word clock of an external device, be aware that an error message will appear and the system will not operate correctly if the external device is powered-off when you power-cycle the LS9 or if the connection is disconnected.

## HA (head amp) settings

Here we explain how to adjust the HA (head amp) gain, switch phantom power on/off, and switch the phase for each input channel to which you've connected a mic or instrument.

When setting HA-related parameters on the LS9, you can either use the SELECTED CHANNEL section or the SELECTED CH VIEW screen in the display to make settings for a single channel at a time, or use the popup window to make settings for eight channels at a time.

### ● Making HA settings for one channel at a time

Select the channel that you want to set, and use the SELECTED CHANNEL section or the SELECTED CH VIEW screen of the display to make HA settings.

- 1 Make sure that a mic or instrument is connected to the INPUT jack (→ p. 41).
- 2 Make sure that the fader layer that contains the desired channel is selected in the LAYER section.

If necessary, use the keys of the LAYER section to switch fader layers.

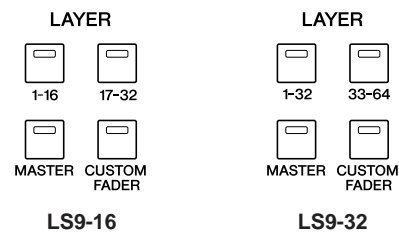

### 3 Press the [SEL] key of the channel for the INPUT jack you want to operate, so that the LED is lit.

That channel is now selected for operations in the SELECTED CHANNEL section.

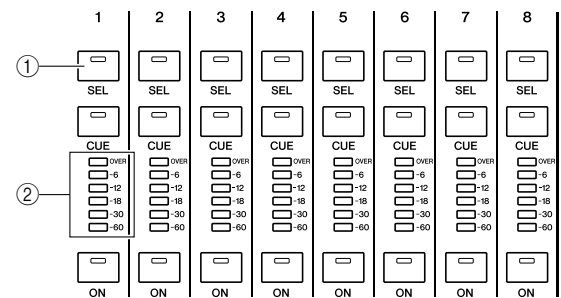

- ① [SEL] key
- ② Meter LEDs

#### 4 Press the SELECTED CHANNEL section [HOME] key.

The [HOME] key restores the LS9's panel to its basic state (home position). When you press this key, the SELECTED CH VIEW screen will appear in the display, showing all the parameters of the channel that is selected by its [SEL] key. Also, SENDS ON FADER mode will be defeated, and the channel level function will be assigned to the faders.

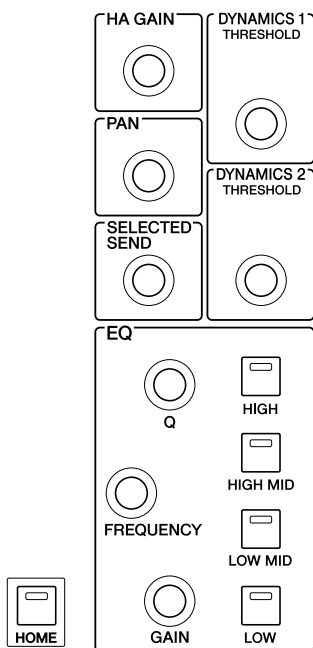

#### 5 Use either of the following methods to adjust the HA gain of the selected channel.

- **Using the SELECTED CHANNEL section**  
Operate the SELECTED CHANNEL section [HA GAIN] encoder. When you do so, the GAIN knob in the SELECTED CH VIEW screen will move in tandem. (If any other screen is displayed, a small popup window will show the value.)
- **Using the SELECTED CH VIEW screen**  
Use the cursor keys of the DATA ENTRY section to move the cursor to the GAIN knob in the screen, and use the dial or the [DEC]/[INC] keys to adjust the HA gain.

In either case, the level of that channel is shown by the meter LEDs in the channel module section. If the meter does not move even though a signal is being input, check whether the INPUT jack is connected appropriately, and whether the meter detection point might have been set to POST ON (immediately after the channel on/off) (→ p. 155).

**NOTE**

- The PAD will be internally switched on or off when the HA gain is adjusted between -14 dB and -13 dB. Keep in mind that noise may be generated if there is a difference between the Hot and Cold output impedance of the external device connected to the INPUT connector when using phantom power.

#### 6 To make HA settings for another channel, use the [SEL] keys to select another channel and make settings in the same way.



① GAIN knob

## ● Making HA settings for a group of eight channels

Here's how to access a popup window where you can make HA settings for a group of eight channels.

**1** Make sure that a mic or instrument is connected to the INPUT jack (→ p. 41).

**2** Press the **SELECTED CHANNEL** section [HOME] key.

The **SELECTED CH VIEW** screen will appear in the display.



- ① HA popup button
- ② GAIN knob

**3** Use the keys of the **LAYER** section and the [SEL] keys of the channel module section to select the channel for the INPUT jack you want to control.

**4** Move the cursor to the HA popup button or GAIN knob in the **SELECTED CH VIEW** screen, and press the [ENTER] key.

The HA/PATCH popup window will appear, allowing you to adjust the HA gain, switch phantom power on/off, and switch the phase in groups of eight channels. This popup window shows the parameters for the eight channels that include the channel you selected in step 2.



- ① +48V button
- ② GAIN knob
- ③ Ø (phase) button



• If you've turned on **POPUP APPEARS WHEN PRESSING KNOBS** in the **PREFERENCE** popup window (→ p. 194), you can also access this popup window by pressing the **SELECTED CHANNEL** section [HA GAIN] encoder.

**5** To adjust the HA gain, move the cursor to the **GAIN** knob of the desired channel in the window, and use the dial or the [DEC]/[INC] keys.

The input level of the channel is shown by the level meter located immediately to the right of the GAIN knob in the screen.



• The **PAD** will be internally switched on or off when the HA gain is adjusted between -14 dB and -13 dB. Keep in mind that noise may be generated if there is a difference between the Hot and Cold output impedance of the external device connected to the **INPUT** connector when using phantom power.

**6** To turn on phantom power for each channel, move the cursor to the **+48V** button in the HA field of the screen, and press the [ENTER] key.

The +48V button will turn on (red), and phantom power will be supplied to the corresponding INPUT jack.



• If you want to use phantom power, you must first turn ON the +48V MASTER ON/OFF button located in the **SYSTEM SETUP** screen.

**7** To switch the phase of each channel between normal and reverse phase, move the cursor to the Ø button in the HA field and press the [ENTER] key.

The Ø button will change from black to red, and the phase of the corresponding channel will be reversed.

**8** If you want to operate the HA of a channel that is not currently shown in the popup window, use the [SEL] key to select that channel, and then make settings for it.

For example if INPUT channels 1–8 are shown in the popup window, pressing the INPUT channel 9 [SEL] key will change the popup window to INPUT channels 9–16.

## Sending an input channel signal to the STEREO bus

Here we explain how to adjust the level of a signal sent from a gain-adjusted input channel to the STEREO bus, adjust its pan (INPUT channel) or balance (ST IN channel), and monitor it from external speakers connected to the STEREO channel. The following procedure will let you check whether the mic, instrument, and main speakers are connected appropriately.

When setting the level or pan/balance of a signal being sent to the STEREO bus, you can either use the SELECTED CHANNEL section or the SELECTED CH VIEW screen in the display to make settings for a single channel at a time, or use the popup window to make settings for eight channels at a time.

### ● Controlling the signal sent to the STEREO bus, one channel at a time

Here's how to select the input channel that you want to control, and use the top panel faders/encoders, the SELECTED CHANNEL section, and the SELECTED CH VIEW screen of the display to control the level and pan/balance.

#### 1 Press the SELECTED CHANNEL section [HOME] key.

The SELECTED CH VIEW screen will appear in the display.

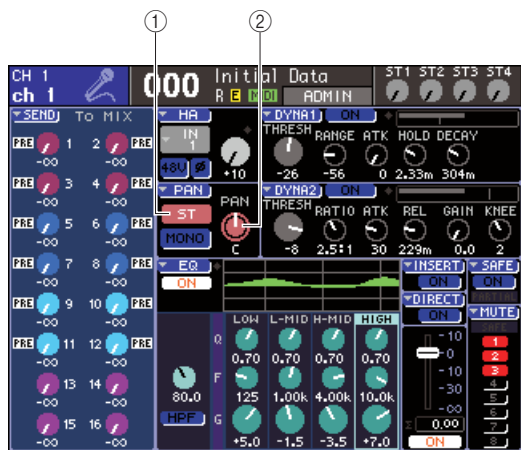

- ① ST button
- ② PAN/BAL knob

#### 2 Use the keys of the LAYER section and the [SEL] keys of the channel module section to select the channel for the INPUT jack you want to control.

#### 3 Make sure that the ST button in the screen is on (white characters on a pink background).

The ST button is an on/off switch for the signal sent from that channel to the STEREO bus. If this is off (gray characters on a black background), move the cursor to ST button and press the [ENTER] key.

#### 4 In the STEREO MASTER section of the top panel, make sure that the STEREO channel [ON] key is on, and raise the STEREO channel fader to 0 dB.

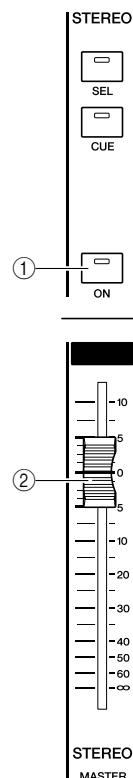

- ① STEREO channel [ON] key
- ② STEREO channel fader

#### 5 In the channel module section or the ST IN section, make sure that the [ON] key of the currently selected channel is turned on.



## 6 Raise the fader of the currently selected channel (or the encoder for a ST IN channel) to obtain an appropriate volume.

In this state, you should hear sound from the speaker system patched to the STEREO channel. If you don't hear sound, watch the stereo meter located at the right of the display to see whether the LR meter is moving.

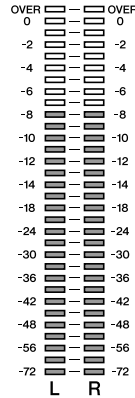

### ● If the LR meter is moving

It is possible that the output jack connected to your speaker system is not correctly patched to the STEREO channel. Check the output port patching (→ p. 95).

### ● If the LR meter is not moving

It is possible that the channel's [ON] key is off, or that the ST button is turned off in the SELECTED CH VIEW screen. Check the setting of the [ON] key or ST button.

#### HINT

- You can also use headphones connected to the front panel PHONES OUT jack to monitor the signal that is being output from the STEREO channel (→ p. 146).

## 7 To adjust the pan/balance of the signal that is sent from the input channel to the STEREO bus, turn the SELECTED CHANNEL section [PAN] encoder.

When you turn the [PAN] encoder, the PAN/BAL knob in the SELECTED CH VIEW screen will also move in tandem with it. You can obtain the same result by moving the cursor to the PAN/BAL knob and operating the dial or the [DEC]/[INC] keys.

## 8 To control another channel, use the [SEL] keys to select another channel and make settings in the same way.

## ● Controlling the signal sent to the STEREO bus, eight channels at a time

Here's how to access a popup window in which the level and pan/balance of the signal sent to the STEREO bus can be adjusted for eight channels at a time.

### 1 Press the SELECTED CHANNEL section [HOME] key.

The SELECTED CH VIEW screen will appear in the display.



- PAN popup button
- PAN/BAL knob

### 2 Use the keys of the LAYER section and the [SEL] keys of the channel module section to select the channel for the INPUT jack you want to control.

### 3 Move the cursor to the PAN popup button or PAN/BAL knob in the SELECTED CH VIEW screen, and press the [ENTER] key.

The TO STEREO/MONO popup window will appear, allowing you to adjust the level and pan/balance of the signal sent to the STEREO bus, eight channels at a time. This popup window shows the parameters for the eight channels that include the channel you selected in step 2.



- [ST] button
- [PAN] knob



HINT

- If you've turned on *POPUP APPEARS WHEN PRESSING KNOBS* in the *PREFERENCE* popup window (→ p. 194), you can also access this popup window by pressing the *SELECTED CHANNEL* section [PAN] encoder.

**4** In the **STEREO MASTER** section of the top panel, make sure that the **STEREO channel [ON]** key is on, and raise the **STEREO channel fader** to 0 dB.

**5** Make sure that the **ST** button for each channel in the window is on (white characters on a pink background).

The ST button is an on/off switch for the signal sent from each channel to the STEREO bus. This is the same function as the ST button in the *SELECTED CHANNEL VIEW* screen.

**6** To adjust the pan (**INPUT channel**) or balance (**ST IN channel**) of the signal sent from the input channel to the STEREO bus, move the cursor to the **PAN/BAL** knob of the desired channel in the window, and operate the dial or the **[DEC]/[INC]** keys.

**7** In the channel module section or the **ST IN** section, make sure that the **[ON]** key of the channel you want to operate is turned on.

**8** Raise the fader/encoder of each channel to obtain an appropriate volume.

**9** If you want to operate a channel that is not currently shown in the popup window, use the **[SEL]** key to select that channel, and then make settings for it.

For example if **INPUT** channels 1–8 are shown in the popup window, pressing the **INPUT** channel 9 **[SEL]** key will change the popup window to **INPUT** channels 9–16. If you press a **[SEL]** key of the **ST IN** section, the L/R channels of **ST IN** channels 1–4 will be displayed together.

# Input channel operations

This chapter explains operations for input channels (INPUT channels and ST IN channels).

## Signal flow for input channels

The input channel are the section that processes the signals received from the rear panel input jacks or slot, and sends them to the STEREO bus, MONO bus, and MIX buses. There are two types of input channel, as follows.

### ■ INPUT channels 1-32 {1-64}

These channels are used to process monaural signals. When the LS9 is in the default state, the input signals from the rear panel INPUT jacks and the input channels of the slot(s) are assigned to these channels. For details, refer to p.99.

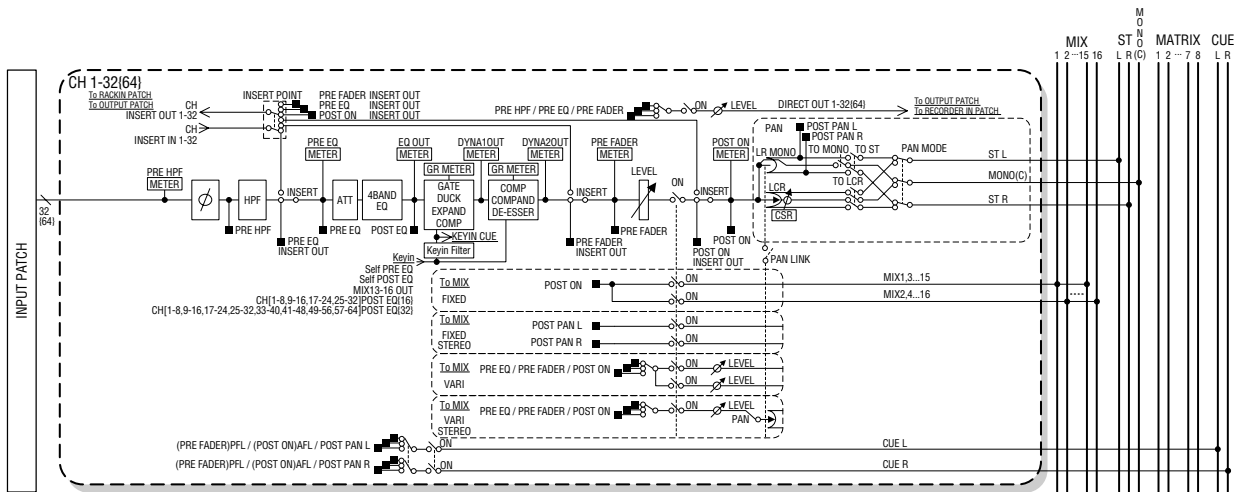

### ■ ST IN channels 1-4

These channels are used to process stereo signals. When the LS9 is in the default state, the outputs of virtual racks 5-8 are assigned to these channels.

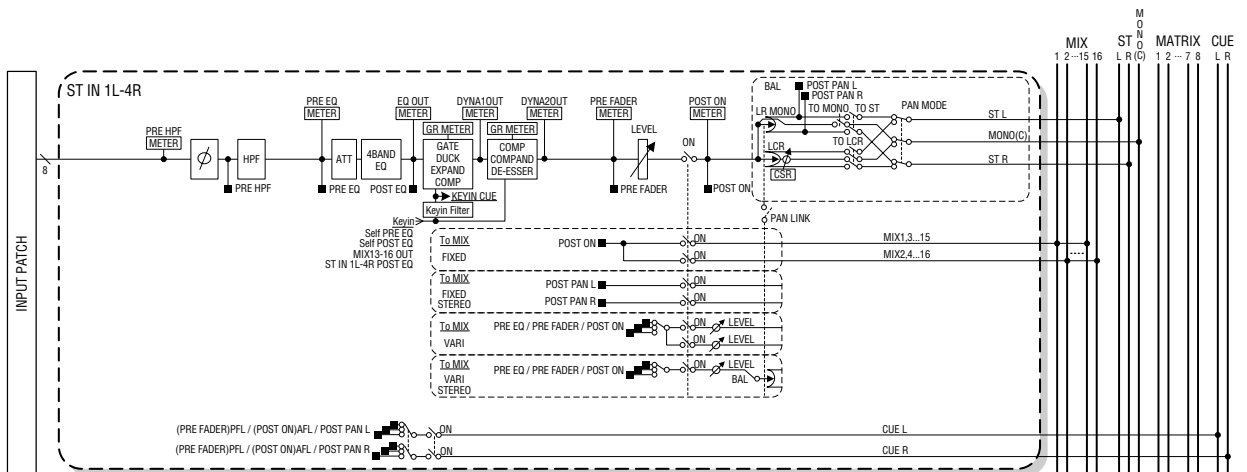

● **INPUT PATCH**

This assigns input signals to the input channels.

● **∅ (phase)**

Switches the phase of the input signal.

● **HPF (High Pass Filter)**

This is a high pass filter that cuts the region below the specified frequency.

● **ATT (attenuator)**

Attenuates/boosts the level of the input signal.

● **4 BAND EQ (4 band equalizer)**

A parametric EQ with four bands; HIGH, HIGH MID, LOW MID, and LOW.

● **DYNAMICS 1**

This is a dynamics processor that can be used as a gating, ducking, expander, or compressor.

● **DYNAMICS 2**

This is a dynamics processor that can be used as a compressor, compander, or de-esser.

● **LEVEL**

Adjusts the input level of the input channel.

● **ON (on/off)**

Turns the input channel on/off. If this is off, the corresponding channel is muted.

● **PAN**

This adjusts the panning of the signal sent from the INPUT channel to the STEREO bus. If necessary, this pan setting can also be applied to signals sent to two MIX buses that are assigned as stereo.

● **BALANCE**

On ST IN channels, the BALANCE is used instead of PAN. The BALANCE adjusts the volume balance of the left/right signals sent from the ST IN channel to the STEREO bus. If necessary, you can also apply this balance setting to the signal sent to two MIX buses that are assigned as stereo.

● **LCR (Left/Center/Right)**

This sends the signal of the input channel to the STEREO bus / MONO bus as a three-channel signal that adds a C (Center) channel to the L/R channels.

● **TO MIX ON/OFF MIX (MIX send on/off)**

This is an on/off switch for the signal sent from the input channel to MIX buses 1–16.

There are two types of MIX buses; FIXED types whose send level is fixed, and VARI types whose send level can be adjusted. You can switch between FIXED type and VARI type in sets of two adjacent odd-numbered/even-numbered MIX buses. (For details, refer to → p. 213)

● **TO MIX LEVEL 1-16 (MIX send level 1–16)**

This adjusts the send level of the signal sent from the input channel to VARI type MIX buses 1–16. The signal sent to VARI type MIX buses can be taken from pre-EQ, pre-fader, or post-channel on/off as desired. The signal sent to FIXED type MIX buses is taken pre-pan if the MIX bus is monaural, or post-pan if the MIX bus is stereo.

● **INSERT (INPUT channels 1–32 only)**

This lets you patch the desired output/input ports in order to insert an effect processor or other external device (→ p. 101). The insert-out/insert-in position can be switched pre-EQ, pre-fader, or post-channel on/off.

● **DIRECT OUT (INPUT channels only)**

This lets you patch the desired output port in order to output the input signal directly (→ p. 103). The direct out signal can be taken from pre-HPF, pre-EQ, or pre-fader.

● **METER**

This meters the level of the input channel. You can switch the position at which the level is detected.

## Specifying the channel name / icon

On the LS9, the name and icon shown in the screen can be specified for each input channel. Here we will explain how to specify the channel name and icon.

- 1 Press the SELECTED CHANNEL section [HOME] key.**  
The SELECTED CH VIEW screen will appear in the display.
- 2 Use the LAYER section to select the desired fader layer.**
- 3 Press a [SEL] key in the channel module section or ST IN section to select the input channel that you want to operate.**



① Input port select popup button

- 4 Move the cursor to the input port select popup button in the HA field of the screen, and press the [ENTER] key.**

The PATCH/NAME popup window will appear, allowing you to select an input port and icon for the input channel, and to assign a name.

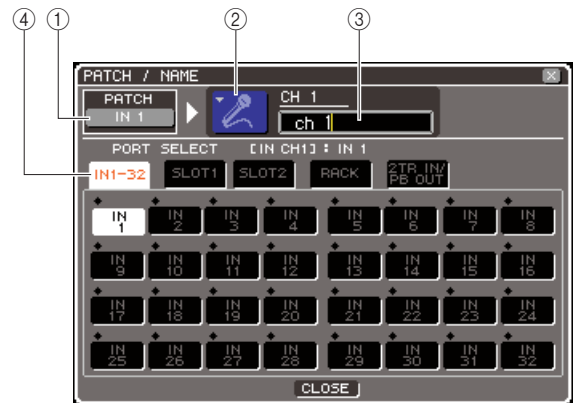

LS9-32

This popup window contains the following items.

### ① Input port button

This indicates the currently selected input port. When you're selecting the icon or editing the channel name, moving the cursor to this button and pressing the [ENTER] key will take you back to the input port selection screen.

### ② Icon button

This indicates the icon selected for that channel. When you move the cursor to this button and press the [ENTER] key, a screen where you can select an icon and a sample name will appear.

### ③ Channel name input box

This indicates the name assigned to that channel. When you move the cursor to this field and press the [ENTER] key, a keyboard window will appear, allowing you to enter a name.

### ④ Tabs

These tabs switch the items that are shown in the window.

**5** To select an icon for this channel, move the cursor to the icon button and press the [ENTER] key.

The window display will change as follows.



**① Icon select buttons**

These buttons select the icon that is used for this channel.

**② Sample name select buttons**

These buttons select sample names that are related to the currently selected icon. When you press a button, its sample name will be entered in the channel name field.

**③ Icon background color select buttons**

These buttons let you choose one of eight colors as the background color for the icon.

**6** Use the icon select buttons and the icon background color select buttons to select the icon and icon color you want to use for that channel.

The selected icon is shown in the icon button in the upper part of the window.

**7** If desired, use the sample name select buttons to select a sample name. The selected sample name will be entered in the channel name field in the upper part of the window.



- You can add or edit the text after entering the sample name in the channel name field. If you want to assign channel names that consist of a common name plus a number, such as "Vocal 1" and "Vocal 2," you can simply enter a sample name and then add a number.

**8** If you want to enter a channel name directly (or edit the previously-entered sample name), move the cursor to the channel name field in the upper part of the window and press the [ENTER] key.

The keyboard window will appear in the lower part of the window, allowing you to enter or edit the text. For details on using the keyboard window, refer to p.34.

**9** Use the [SEL] keys to select another input channel, and specify its icon and channel name in the same way.

While the PATCH/NAME popup window is displayed, you can use the [SEL] keys to switch the channel that you're operating.

**10** When you've finished entering information, move the cursor to the CLOSE button (or the × symbol in the upper right of the window) and press the [ENTER] key.

You will return to the SELECTED CH VIEW screen.

# HA (head amp) settings

Here's how to make HA (Head Amp) settings such as phantom power on/off, gain, and phase for each input channel.

## 1 Press the SELECTED CHANNEL section [HOME] key.

The SELECTED CH VIEW screen will appear in the display.



- ① HA popup button
- ② GAIN knob

## 2 Use the LAYER section to select the desired fader layer.

## 3 Press a [SEL] key in the channel module section or ST IN section to select the input channel that you want to operate.

## 4 If you only want to adjust the HA gain for that channel, operate the SELECTED CHANNEL section [HA GAIN] encoder.

You can obtain the same result by moving the cursor to the GAIN knob in the SELECTED CH VIEW screen and operating the dial or the [DEC]/[INC] keys.

## 5 If you want to edit detailed parameters such as phantom power on/off and phase, move the cursor to the HA popup button or GAIN knob in the HA field of the SELECTED CH VIEW screen, and press the [ENTER] key to access the HA/PATCH popup window.

In the HA/PATCH popup window you can adjust the HA gain, switch phantom power on/off, and switch the phase for sets of eight channels. This popup window shows the parameters for the eight channels that include the channel you selected in step 3.



- ① +48V button
- ② GAIN knob
- ③ Ø (phase) button



If you've turned on POPUP APPEARS WHEN PRESSING KNOBS in the PREFERENCE popup window (→ p. 194), you can also access the above popup window by pressing the SELECTED CHANNEL section [HA GAIN] encoder.

### CAUTION

- If you don't need phantom power, be sure to turn this button off.
- Before you turn phantom power on, make sure that no devices other than phantom-powered devices, such as a condenser microphone, are connected. Otherwise, you risk damaging the devices.
- Do not connect or disconnect a device while phantom power is applied. Doing so can damage the connected device and/or the unit itself.
- To protect your speaker system, leave the power amps (powered speakers) turned off when switching the phantom power on/off. We also recommend that you set all output level faders to the minimum position. Otherwise, high-volume output may damage your hearing or equipment.

## 6 To adjust the HA gain, move the cursor to the GAIN knob of the desired channel in the window, and use the dial or the [DEC]/[INC] keys.

The input level of the channel is shown by the level meter located immediately to the right of the GAIN knob in the screen.



The PAD will be internally switched on or off when the HA gain is adjusted between -14 dB and -13 dB. Keep in mind that noise may be generated if there is a difference between the Hot and Cold output impedance of the external device connected to the INPUT connector when using phantom power.

## 7 To turn on phantom power, move the cursor to the +48V button of the desired channel in the window, and press the [ENTER] key.

The +48V button will turn on (red), and phantom power will be supplied to the corresponding INPUT jack.



If you want to use phantom power, you must first turn ON the +48V MASTER ON/OFF button located in the SYSTEM SETUP screen.

**8 To switch the phase of each channel between normal and reverse phase, move the cursor to the Ø button of the desired channel in the window, and press the [ENTER] key.**

The Ø button will change from black to red, and the phase of the corresponding channel will be reversed.

**9 If you want to operate the HA of a channel that is not currently shown in the popup window, use the [SEL] key to select that channel, and then make settings for it.**

For example if INPUT channels 1–8 are shown in the popup window, pressing the INPUT channel 9 [SEL] key will change the popup window to INPUT channels 9–16.

**10 When you've finished making settings, move the cursor to the CLOSE button (or the × symbol in the upper right of the window) and press the [ENTER] key.**

## Sending the signal from an input channel to the STEREO/MONO bus

Here we will explain how to send the signal of an input channel to the STEREO bus or MONO bus.

The STEREO bus / MONO bus are used to output signals to the main speakers. Signals can be sent to the STEREO bus or MONO bus in either ST/MONO mode or LCR mode, and you can choose either of these two modes for each channel. These two modes differ as follows.

### ■ ST/MONO mode .....

In this mode, signals are sent independently from the input channel to the STEREO bus and to the MONO bus.

- The signals sent from the same input channel to the STEREO bus and to the MONO bus can be switched on/off independently.
- The panning of the signal sent from an INPUT channel to the STEREO bus L/R can be operated by the SELECTED CHANNEL section [PAN] encoder, or by the TO ST PAN knob in the screen. (The signal sent to the MONO bus is not affected by this encoder or knob.)
- The volume balance of the signal sent from a ST IN channel to the STEREO bus left and right can be operated by the SELECTED CHANNEL section [PAN] encoder, or by the TO ST BALANCE knob in the screen. (The signal sent to the MONO bus is not affected by this knob.)

### ■ LCR mode .....

In this mode, the signal from the input channel is sent to three buses at once; STEREO (L/R) and MONO (C).

- The signals sent from the same input channel to the STEREO bus and to the MONO bus can be switched on/off together.
- The CSR (Center Side Ratio) knob in the screen adjusts the proportion of the signal level sent from the input channel to the STEREO (L/R) bus and the level sent to the MONO (C) bus.
- The level of the signal sent from the input channel to the STEREO (L/R) bus and the MONO (C) bus will change according to the settings of the SELECTED CHANNEL section [PAN] encoder or the TO ST PAN knob / TO ST BALANCE knob in the screen.



• If you want to use headphones etc. to monitor the signal of the STEREO bus or MONO bus, you should press the DISPLAY ACCESS section [MONITOR] key several times to access the MONITOR screen, and select "LCR" as the monitor source (→ p. 146).



**1** Make sure that an input source is connected to the input channel you're operating, and make head amp settings for phantom power, gain, and phase to obtain the optimal input signal (→ p. 57).

**2** Press the **SELECTED CHANNEL** section [HOME] key.

The **SELECTED CH VIEW** screen will appear in the display.



- ① TO ST field
- ② TO ST PAN knob (for a ST IN channel, the TO ST BAL knob)

**3** Use the **LAYER** section to select the desired fader layer.

**4** Press a [SEL] key in the channel module section or **ST IN** section to select the input channel for the desired source.

**5** If you only want to adjust the pan or balance for that channel, operate the **SELECTED CHANNEL** section [PAN] encoder (→ p. 86).

You can obtain the same result by moving the cursor to the PAN/BAL knob in the **SELECTED CH VIEW** screen and operating the dial or the [DEC]/[INC] keys.

**6** If you want to switch the on/off setting of the signal sent from the input channel to the **STEREO/MONO** bus, or if you want to switch between **ST/MONO** mode and **LCR** mode, move the cursor to the **TO ST PAN** knob or the **PAN** popup button located in the **TO ST** field of the **SELECTED CH VIEW** screen, and press the [ENTER] key to access the **TO STEREO/MONO** popup window.

In the **TO STEREO/MONO** popup window you can switch between **ST/MONO** mode and **LCR** mode in sets of eight channels, and change the on/off status and pan/balance settings of the signals sent from those channels to the **STEREO/MONO** bus. This popup window shows the parameters for the eight channels that include the channel you selected in step 4.



**HINT**

- If you've turned on **POPUP APPEARS WHEN PRESSING KNOBS** in the **PREFERENCE** popup window (→ p. 194), you can also access the above popup window by pressing the **SELECTED CHANNEL** section [PAN] encoder.

This popup window contains the following items.

**① Channel number / Channel name**

This indicates the number and name of the channel you're operating.

**② MODE button**

This button selects either **ST/MONO** mode or **LCR** mode to as the way in which the signal will be sent to the **STEREO** bus and **MONO** bus. This mode can be specified individually for each channel. The setting will alternate between the two modes each time you press the button.

The currently selected mode is shown by the position of the indicator (the green ♦ symbol) located immediately above the button.

**③ ST button**

**④ MONO button**

When the **MODE** button is set to **ST/MONO** mode, these buttons act as individual on/off switches for the signal sent from that channel to the **STEREO** bus and **MONO** bus.

**⑤ TO ST PAN/TO ST BALANCE knob**

For an **INPUT** channel, this acts as a **PAN** knob that adjusts the left/right panning of the signal sent to the **STEREO** bus.

For a **ST IN** channel, this acts as a **BALANCE** knob that adjusts the volume balance of the left/right signals sent to the **STEREO** bus.

Move the cursor to the knob and use the dial or the [DEC]/[INC] keys to adjust the setting.

For channels whose MODE button is set to LCR mode, the following button and knob are shown instead of the ST button ③ and MONO button ④.

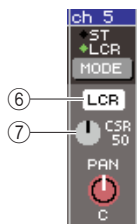

⑥ **LCR button**

This button is an on/off switch for all signals sent from that channel to the STEREO bus and MONO bus. If you turn off the button, no signals will be sent from that input channel to the STEREO bus or MONO bus.

⑦ **CSR knob**

This knob adjusts the relative level of the signals sent from that channel to the STEREO (L/R) bus and to the MONO (C) bus, in a range of 0–100%. Move the cursor to the knob and use the dial or the [DEC]/[INC] keys to adjust the setting.

- 7 Use the **MODE** button to select either **ST/MONO** mode or **LCR** mode for each channel.
- 8 The **ST** button and **MONO** button are on/off switches for the signal sent from each channel to the **STEREO** bus and **MONO** bus.
- 9 If you want to use the **STEREO** bus, make sure that the **[ON]** key of the **STEREO** channel is turned on in the top panel **STEREO MASTER** section, and raise the fader of the **STEREO** channel to an appropriate position.
- 10 If you want to use the **MONO** bus, make sure that the **[ON]** key of the **MONO** channel is turned on, and raise the fader of the **MONO** channel to an appropriate position.

This operation will differ between the LS9-16 and LS9-32.

● **For the LS9-16**

Assign the MONO channel to the custom fader layer, press the **LAYER [CUSTOM FADER]** key to access the custom fader layer, and then operate the **[ON]** key and fader of the corresponding channel module.

● **For the LS9-32**

Press the **LAYER [MASTER]** key to access the master fader layer, and operate the **[ON]** key and fader of channel module 32.

- 11 In the top panel channel module section or **ST IN** section, make sure that the **[ON]** key is turned on for the input channel you want to operate, and raise the fader/encoder to an appropriate position.

The following steps will differ depending on whether you selected a ST/MONO mode channel or an LCR mode channel in step 7.

- **For a channel set to ST/MONO mode**
  - 12 Use the **ST** button and **MONO** button in the **TO STEREO/MONO** popup window as on/off switches for the signal sent from the input channel to the **STEREO** bus and **MONO** bus.
  - 13 Use the **SELECTED CHANNEL** section **[PAN]** encoder to adjust the pan/balance of the signal sent from the input channel to the **STEREO** bus.
 

You can obtain the same result by using the **TO ST PAN/TO ST BAL** knob in the **TO STEREO/MONO** popup window.
- **For a channel set to LCR mode**
  - 12 Use the **LCR** button in the **TO STEREO/MONO** popup window as an on/off switch for the signal sent from the input channel to the **STEREO** bus and **MONO** bus.
 

For a channel that is set to LCR mode, the signal sent to the **STEREO** bus and **MONO** bus can be switched on/off in a single operation.
  - 13 Use the **CSR** knob in the **TO STEREO/MONO** popup window to adjust the proportion between the signal level sent from that channel to the **STEREO (L/R)** bus and the signal level sent to the **MONO (C)** bus.
  - 14 Use the **TO ST PAN** knob in the **TO STEREO/MONO** popup window to set the panning of the signal sent from the input channel to the **STEREO (L/R)** bus and the **MONO (C)** bus.

If the CSR knob is set to 0%, operating the **TO ST PAN** knob of an **INPUT** channel will change the signal levels sent to the **STEREO (L/R)** bus and **MONO (C)** bus as shown in the following illustration. In this case, the **TO ST PAN** knob will operate as a conventional **PAN** knob, and no signal is sent to the **MONO (C)** bus.

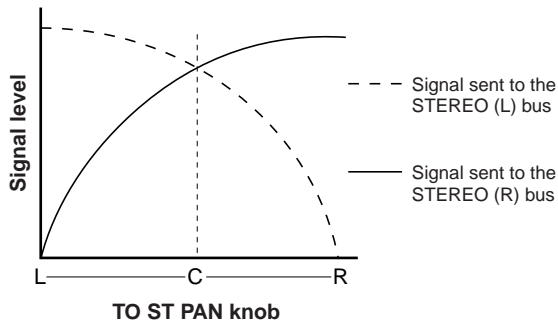

If a ST IN channel is selected, operating the TO ST BALANCE knob will change the signal levels sent from the ST IN L/R channels to the STEREO (L/R) bus and MONO (C) bus as shown in the following illustration. In this case, the [PAN] encoder will operate as a conventional BALANCE knob, and no signal is sent to the MONO (C) bus.

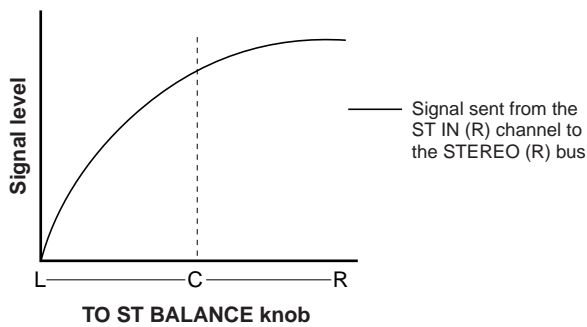
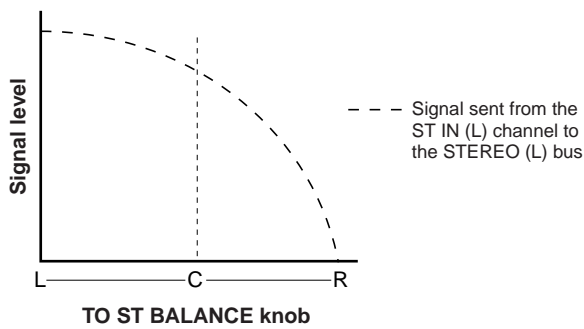

If the CSR knob is set to 100%, operating the TO ST PAN knob will change the signal levels sent to the STEREO (L/R) bus and MONO (C) bus as shown in the following illustration.

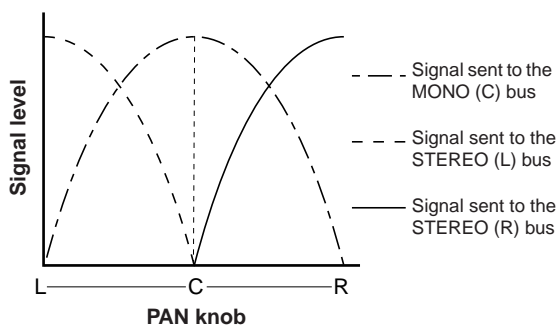

If a ST IN channel is selected, operating the TO ST BALANCE knob will change the signal levels sent from the ST IN L/R channels to the STEREO (L/R) bus and MONO (C) bus as shown in the following illustration.

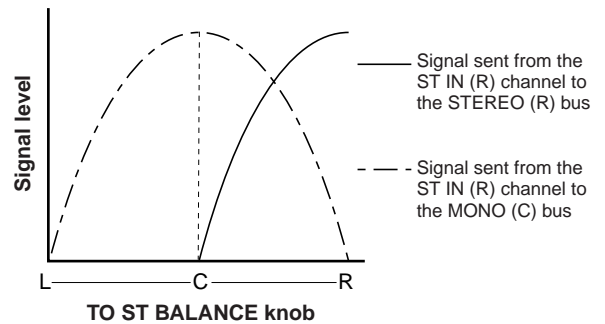
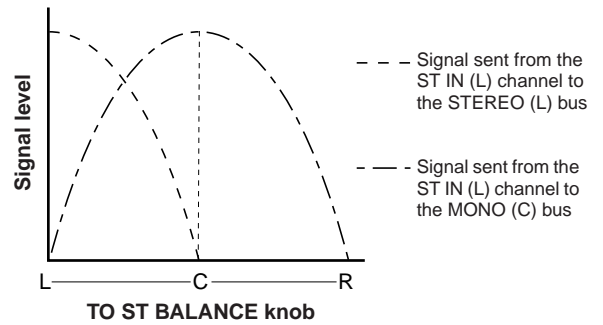

**15** If you want to operate a channel that is not currently shown in the popup window, use the [SEL] key to select that channel, and then make settings for it.

For example if INPUT channels 1–8 are shown in the popup window, pressing the INPUT channel 9 [SEL] key will change the popup window to INPUT channels 9–16.

**16** When you've finished making settings, move the cursor to the CLOSE button (or the × symbol in the upper right of the window) and press the [ENTER] key.

# Sending the signal from an input channel to a MIX bus

Here we will explain how to send the signal of an input channel to MIX buses 1–16. MIX buses are used mainly to send signals to on-stage foldback speakers or to external effect processors. Signals can be sent from an input channel to a MIX bus in the following three ways.

## ■ Using the SELECTED CHANNEL section.....

In this method, you use the SELECTED CHANNEL section [SELECTED SEND] encoder to adjust the level of the signal sent to the MIX bus.

This method lets you control the signals sent from a specific input channel to all MIX buses.

## ■ Using a popup window.....

In this method, you use the MIX SEND popup window to adjust the send levels from eight channels to a MIX bus.

This method lets you control the send level, on/off setting, and send point for the signals sent from a set of eight channels to a specific MIX bus.

## ■ Using the top panel faders.....

In this method, you switch the LS9 to SENDS ON FADER mode and use the top panel faders to adjust the send levels to the MIX bus. This method lets you simultaneously control the send levels and on/off switching for the signals sent from all input channels to a specific MIX bus.

### Using the SELECTED CHANNEL section

Here's how to use the SELECTED CHANNEL section [SELECTED SEND] encoder to adjust the level of the signals sent from a specific input channel to each MIX bus.

- 1** Make sure that an output port is assigned to the MIX bus to which you're sending the signal, and that a monitor system or external effect processor etc. is connected to the corresponding output port.

Refer to p.95 for details on assigning an output port to a MIX bus, or to p.42 for details on connecting external equipment.

- 2** Press the SELECTED CHANNEL section [HOME] key.

The SELECTED CH VIEW screen will appear in the display.



- ① TO MIX field**  
In this field you can switch the on/off status and adjust the send level of the signal sent from the input channel to the MIX bus.
- ② TO MIX LEVEL knob**  
This adjusts the send level of the signal sent from the input channel to a VARI type MIX bus. To adjust the send level in this field, move the cursor to the knob and use the dial or the [DEC]/[INC] keys.
- ③ TO MIX ON/OFF button**  
If the send-destination MIX bus is a FIXED type, this button is displayed instead of the knob ②. This button is an on/off switch for the signal sent from the input channel to a FIXED type MIX bus. To turn the signal on/off, move the cursor to the button and press the [ENTER] key.

④ **PRE/POST indicator**

This indicates the send position of the signal sent from the input channel to a VARI type MIX bus. The signal is being sent from the pre-EQ or pre-fader position if this indicates PRE, or from immediately after the channel on/off if the PRE indication is not shown. This indicator is only for display. You cannot use this field to change the send position of the signal.

**3 Use the LAYER section keys and the [SEL] keys of the channel module section or ST IN section to select the input channel that you want to operate.**

**4 Use the MIX/MATRIX SELECT section keys to select the send-destination MIX bus.**

The LED of the corresponding key will light, indicating that it is selected as the send-destination.

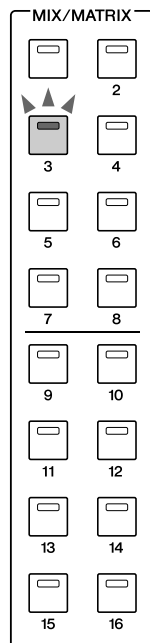

● **If the send-destination MIX bus is the VARI type**

The TO MIX field in the screen shows the knob in the same color as the corresponding key of the MIX/MATRIX SEND section.

● **If the send-destination MIX bus is the FIXED type**

The TO MIX field will show the TO MIX ON/OFF button instead of the TO MIX LEVEL knob. In this case, you can't adjust the send level.

**NOTE**

- If the LED of only a specific key in the MIX/MATRIX SELECT section is blinking and the LEDs of the remaining keys are lit, the LS9 is in SENDS ON FADER mode (the mode in which you can use the faders to control the send levels to the MIX buses or MATRIX buses). Press the desired key in the MIX/MATRIX SELECT section so that only the LED of that key is lit.

**5 If you selected a VARI type MIX bus in step 4, use the SELECTED CHANNEL section [SELECTED SEND] encoder to adjust the send level from that channel to the MIX bus you selected in step 4.**

If the send-destination MIX bus is set to stereo, the function of the [SELECTED SEND] encoder will change depending on which of the two adjacent keys of the MIX/MATRIX SELECT section are lit.

● **If the left key is lit**

Use the [SELECTED SEND] encoder to adjust the pan (or balance, for a ST IN channel) of the signal that is sent from the INPUT channel to the two MIX buses.

● **If the right key is lit**

Use the [SELECTED SEND] encoder to adjust the send level shared by the two MIX buses.

**6 To switch the on/off status of a signal sent to a VARI type MIX bus, move the cursor to the TO MIX LEVEL knob in the screen and press the [ENTER] key to access the MIX SEND popup window.**

If you switch this off, the knob will turn grey.

**7 To switch the on/off status of a signal sent to a FIXED type MIX bus, move the cursor to the TO MIX ON/OFF button in the screen and press the [ENTER] key.**

If you switch this off, the knob will change to black characters on a blue background. To turn it back on, press the [ENTER] key once again.

**8 Use the top panel [SEL] keys to select another input channel, and adjust the send level to the selected MIX bus in the same way.**

**9 Use the keys of the MIX/MATRIX SELECT section to select another MIX bus as the send-destination, and adjust the send level from the input channel in the same way.**

**HINT**

- If PRE is selected as the send position to the MIX bus, then you will also be able to select either PRE EQ (immediately before the attenuator) or PRE FADER (immediately before the fader) for each MIX bus (→ p. 213).
- If desired, the pan/balance setting of the signal sent to a stereo MIX bus can be linked with the TO ST PAN/TO ST BAL knob of the SELECTED CH VIEW screen (→ p. 213).
- If you want to monitor the signal that is being sent to a specific MIX bus, select the master fader layer and press the [CUE] key for that MIX channel.



## Using a popup window

In this method, you use the MIX SEND popup window to adjust the send levels from eight channels to a MIX bus.

**1** Make sure that an output port is assigned to the MIX bus to which you're sending the signal, and that a monitor system or external effect processor etc. is connected to the corresponding output port.

**2** Press the **SELECTED CHANNEL** section [HOME] key.

The **SELECTED CH VIEW** screen will appear in the display.



① SEND popup button

**3** Use the **LAYER** section keys and the [SEL] keys of the channel module section or **ST IN** section to select the send-source input channel.

**4** Use the **MIX/MATRIX SELECT** section keys to select the send-destination MIX bus.

**5** Move the cursor to the **SEND** popup button in the screen, and press the [ENTER] key to access the **MIX SEND** popup window.

In the **MIX SEND** popup window you can control the send level, on/off setting, and send point for the signals sent from a set of eight input channels to the currently selected MIX bus.

### HINT

- If you've turned on **POPUP APPEARS WHEN PRESSING KNOBS** in the **PREFERENCE** popup window (→ p. 194), you can also access the above popup window by pressing the **SELECTED CHANNEL** section [SELECTED SEND] encoder.
- If you want to switch the on/off status of the signal sent to a **VARI** type **MIX** bus, you can move the cursor to the **TO MIX LEVEL** knob in the screen and press the [ENTER] key to access the above popup window.

The **MIX SEND** popup window shows the parameters for the eight channels that include the channel you selected in step 3. The contents of the window will differ depending on whether the send-destination MIX bus is **VARI** type or **FIXED** type.

[ For a **VARI** type **MIX** bus ]



① **Channel number / Channel name**

This indicates the number and name of the send-source channel.

② **PRE** button

This switches the position from which the signal is sent from the send-source channel to the currently selected MIX bus. If this button is on, the pre-EQ or pre-fader signal will be sent; if this button is off, the signal from immediately after the channel on/off will be sent.

③ **TO MIX ON/OFF** button

This is an on/off switch for the signal that is sent from the send-source channel to the currently selected MIX bus.

④ **TO MIX LEVEL** knob

This adjusts the level of the signal that is sent from the send-source channel to the currently selected MIX bus.

⑤ **ALL PRE** button

This button selects **PRE** as the position from which the signals are sent from all input channels to the **VARI** type MIX bus.

⑥ **ALL POST** button

This button selects **POST** as the position from which the signals are sent from all input channels to the **VARI** type MIX bus.

If the send-destination MIX bus is set to stereo, the screen will change as follows.

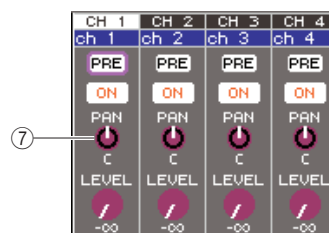

- ⑦ **TO MIX PAN/TO MIX BALANCE knob**  
 This knob adjusts the pan (or balance, for a ST IN channel) of the signal that is sent from the INPUT channel to the two MIX buses.



- If PRE is selected as the send position to the MIX bus, then you will also be able to select either PRE EQ (immediately before the attenuator) or PRE FADER (immediately before the fader) for each MIX bus (→ p. 213).
- If desired, the pan/balance setting of the signal sent to a stereo MIX bus can be linked with the TO ST PAN/TO ST BAL knob of the SELECTED CH VIEW screen (→ p. 213).

[ For a FIXED type MIX bus ]



- ① **Channel number / Channel name**  
 This indicates the number and name of the send-source channel.
- ② **TO MIX ON/OFF button**  
 This is an on/off switch for the signal that is sent from the send-source channel to the currently selected MIX bus.
- If the send-destination MIX bus is set to stereo, on/off operations are linked for adjacent odd-numbered/even-numbered MIX buses.

- ⑥ If you selected a VARI type MIX bus in step 4, move the cursor to the TO MIX LEVEL knob in the screen, and use the dial or the [DEC]/[INC] keys to adjust the send level from each channel to the selected MIX bus.
- If the send-destination MIX bus is set to stereo, move the cursor to the TO MIX PAN (TO MIX BALANCE) knob and adjust the pan (or balance, for a ST IN channel) of the signal sent from each channel to the two MIX buses.

- ⑦ To switch the send position of a signal sent to a VARI type MIX bus, move the cursor to the PRE button in the screen and press the [ENTER] key.
- If the PRE button is on, the pre-EQ or pre-fader signal will be sent; if this button is off, the signal from immediately after the channel on/off will be sent.



- If the PRE button is on, then you will be able to select either PRE EQ (immediately before the attenuator) or PRE FADER (immediately before the fader) for each MIX bus (→ p. 213).

- ⑧ To switch the on/off status of a signal sent to a VARI/FIXED type MIX bus, move the cursor to the TO MIX ON/OFF button in the screen and press the [ENTER] key.

If the send-destination MIX bus is set to stereo, operation of the adjacent left/right pair of buttons is linked.

- ⑨ If you want to operate a channel that is not currently shown in the popup window, use the [SEL] key to select that channel, and then make settings for it.

- ⑩ If you want to adjust the send level to another MIX bus, use the keys of the MIX/MATRIX SELECT section to select another MIX bus, and make settings in the same way.

- ⑪ When you've finished making settings, move the cursor to the CLOSE button (or the × symbol in the upper right of the window) and press the [ENTER] key.

### Using the faders (SENDS ON FADER mode)

Here's how to use the top panel faders/encoders to adjust the send level and turn the signal on/off for the signals sent from all input channels to a specific MIX bus.

- ① Make sure that an output port is assigned to the MIX bus to which you're sending the signal, and that a monitor system or external effect processor etc. is connected to the corresponding output port.
- ② Press the SELECTED CHANNEL section [HOME] key.  
 The SELECTED CH VIEW screen will appear in the display.



- ① **SEND popup button**



**3 Use the MIX/MATRIX SELECT section keys to select the send-destination MIX bus.**

The LED of the corresponding key will light, indicating that it is selected as the send-destination.

**4 Press the same key of the MIX/MATRIX SELECT section once again.**

The key will change from lit to blinking, and the LEDs of the remaining keys in the MIX/MATRIX SELECT section will light. This indicates that the LS9 is now in SENDS ON FADER mode (in which you can use the faders to control the send levels to the MIX bus / MATRIX bus).

In SENDS ON FADER mode, the function of the channel module section's faders and [ON] keys (the ST IN section's encoders and [ON] keys) will change as follows.

● **Faders/Encoders**

These will adjust the send level of the signal sent from the input channels to the currently selected MIX bus. When you switch from normal mode to SENDS ON FADER mode, the fader positions will move to the value of the send levels to the currently selected MIX bus.

● **[ON] keys**

These will operate as on/off switches for the signal sent from the input channels to the currently selected MIX bus. When you switch from normal mode to SENDS ON FADER mode, the [ON] keys will light or go dark according to the on/off status of the signals being sent to the currently selected MIX bus.

● **[SEL] keys**

The [SEL] key of the selected channel will blink, and the [SEL] keys of channels that are not selected will light. However, the [SEL] keys of unassigned modules will go dark.

**5 If you selected a VARI type MIX bus in step 3, use the faders of the channel module section and the encoders of the ST IN section to adjust the send level from the channels to the MIX bus you selected in step 3.**

As necessary, switch fader layers to the layer that contains the desired send-source input channels.

**6 To switch the on/off status of a signal sent to a VARI/FIXED type MIX bus, press the top panel [ON] key.**

If the send-destination MIX bus is set to stereo, on/off operations will be linked for the signal sent to the two adjacent odd-numbered/even-numbered MIX buses.

**7 Repeat steps 3–6 to adjust the send level and switch the on/off status for other MIX buses in the same way.**

**8 When you've finished setting the MIX send levels, press the key that is currently blinking in the MIX/MATRIX SELECT section.**

The LS9 will return to normal mode.



- You can assign the SENDS ON FADER function to a user-defined key. This allows you quickly switch to SENDS ON FADER mode for a specific MIX bus, or quickly return to the previous state.
- You can also use the [HOME] key to cancel SENDS ON FADER mode.

In SENDS ON FADER mode (when the send-destination is a MIX bus), the STEREO MASTER module will operate differently depending on the selected fader layer.

Fader layer	Function
1-16 {1-32}/17-32 {33-64}	Send-destination MIX channel module
MASTER/CUSTOM FADER	STEREO channel (however, the fader and [ON] key will do nothing)



- If you switch the fader layer from 1-16 {1-32}, 17-32 {33-64}, or CUSTOM FADER to MASTER while in SENDS ON FADER mode (when the send-destination is a MIX bus), SENDS ON FADER mode will be cancelled.
- You cannot operate the fader or [ON] key of a channel that is not a send-source (a channel that does not have a MIX SEND parameter) or of a channel that is not a send-destination bus master.

# Output channel operations

This chapter explains operations for output channels (MIX channels, MATRIX channels, STEREO channels, MONO channels).

## Signal flow for output channels

The output channel section takes the signals sent from the input channels to the various buses, processes them with EQ and dynamics, and sends them to output ports or other buses. The following types of output channel are provided.

### ■ MIX channels 1–16

These channels process the signals sent from input channels to MIX buses, and output them to the corresponding output port, MATRIX bus, STEREO bus, or MONO (C) bus. When the LS9 is in the initial state, these are assigned to the OMNI OUT jacks or the output channels of the slot(s).

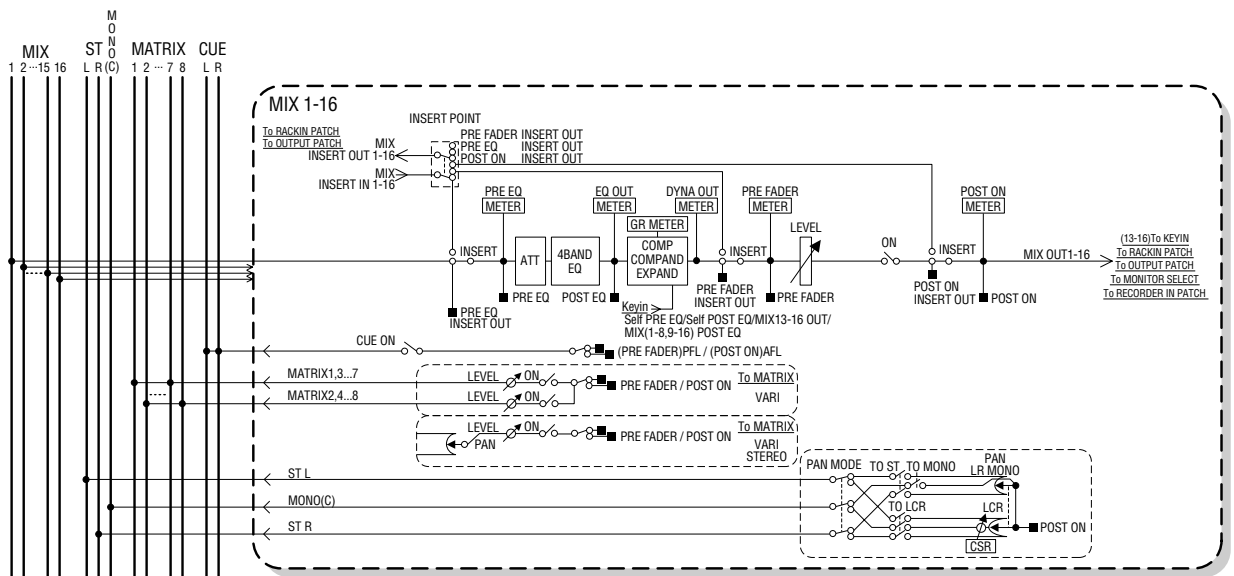

## ■ STEREO channel / MONO (C) channel

Each of these channels process the signal sent from the input channels to the STEREO bus or MONO (C) bus, and send it to an output port or MATRIX bus. If input channels are set to LCR mode, the STEREO (L/R) channels and the MONO (C) channel can be used together as a set of three output channels.

When the LS9 is in the initial state, the STEREO channel is assigned to the 2TR OUT DIGITAL jack.

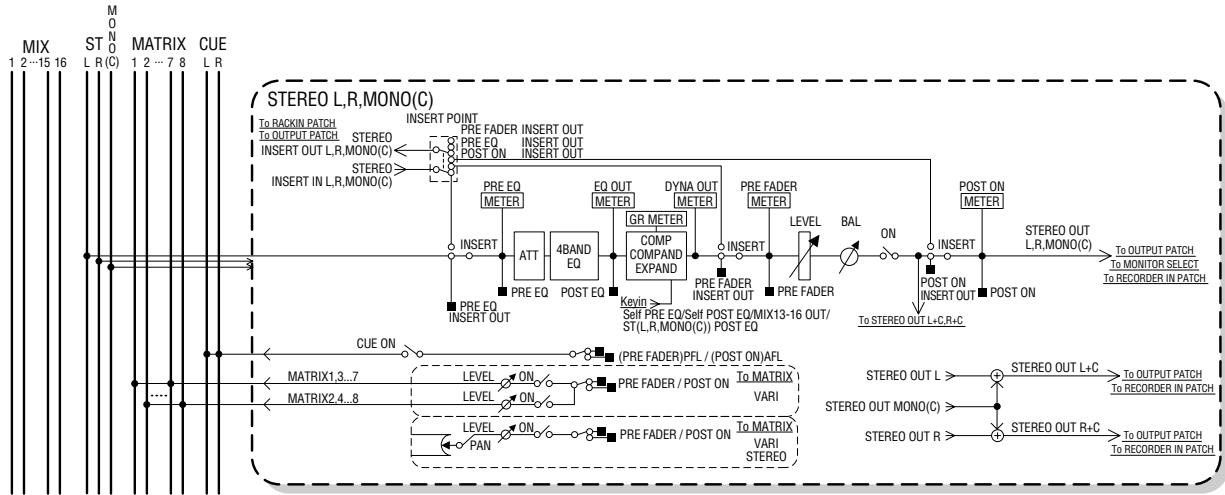

## ■ MATRIX channels 1-8

These channels process the signals sent from MIX channels and STEREO/MONO channels to MATRIX buses, and send them to the corresponding output ports.

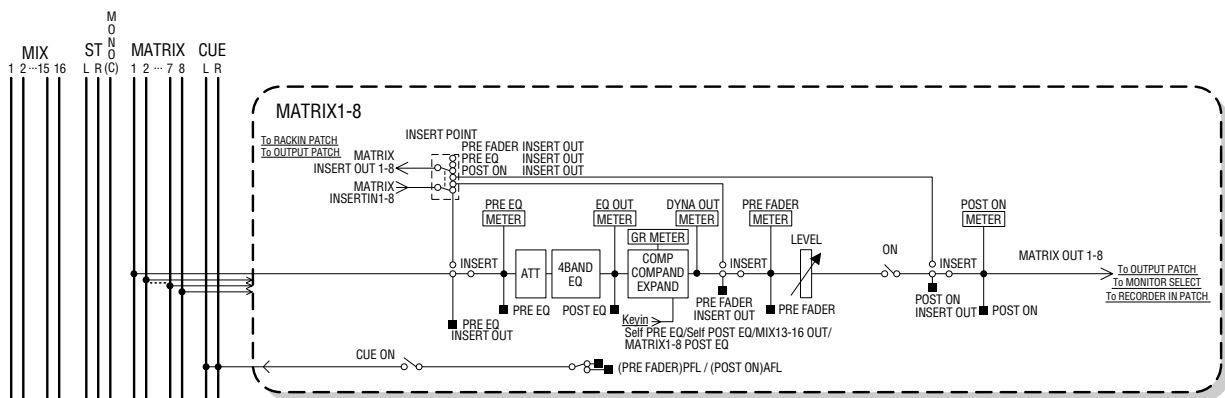

● **ATT (attenuator)**

Attenuates/boosts the level of the signal.

● **4 BAND EQ (4 band equalizer)**

This is a parametric EQ with four bands; HIGH, HIGH MID, LOW MID, and LOW.

● **COMP/COMPANDER/EXPAND (compressor/compannder/expander)**

This is a dynamics processor that can be used as a compressor, compannder, or expander.

● **LEVEL**

This adjusts the output level of the channel.

● **BALANCE (STEREO channel only)**

Adjusts the left/right volume balance of the STEREO (L/R) channel.

● **ON (on/off)**

Turns the output channel on/off. If this is off, the corresponding channel is muted.

● **TO MATRIX ON/OFF (MATRIX send on/off)**

This is an on/off switch for the signal sent from the MIX channels, STEREO (L/R) channel, or MONO (C) channel to each MATRIX bus 1-8.

● **TO MATRIX LEVEL 1-8 (MATRIX send levels 1-8)**

This adjusts the send level of the signal sent from the MIX channels, STEREO (L/R) channel, or MONO (C) channel to each MATRIX bus 1-8. As the position from which the signal is sent to the MATRIX bus, you can choose either pre-fader or after the channel on/off.

If the send-destination MATRIX bus is set to stereo, you can use the TO MATRIX PAN knob in the screen to adjust the panning between the two MATRIX buses. If the send-source is the STEREO channel or a stereo MIX channel, use the TO MATRIX BALANCE knob to adjust the volume balance of the left and right channels sent to the two MATRIX buses.

#### ● INSERT

You can patch the desired output/input ports to insert an external device such as an effect processor. You can switch the insert-out and insert-in locations.

#### ● METER

This meters the level of the output channel. You can switch the position at which the level is detected.

#### ● KEY IN (MIX channels 13–16 only)

You can send the output signals of MIX channels 13–16 to the dynamics processors of each channel, and use them as key-in signals to control the dynamics.

#### ● RACK IN PATCH

This patches the output signal of a MIX channel to an input of the rack.

#### ● OUTPUT PATCH

This assigns an output port to an output channel.

#### ● MONITOR SELECT

This selects the output signal of a rack of output channels as a monitor source.

## Specifying the channel name / icon

Here's how to specify the channel name and icon for each output channel.

### 1 Press the SELECTED CHANNEL section [HOME] key.

The SELECTED CH VIEW screen will appear in the display.

### 2 Use the LAYER section to select the fader layer that contains the desired output channel.



- In order to select a MATRIX channel or MONO channel on the LS9-16, you must assign the channel to the custom fader layer, and then select this layer.

### 3 Press a [SEL] key in the channel module section or ST IN section to select the output channel that you want to operate.

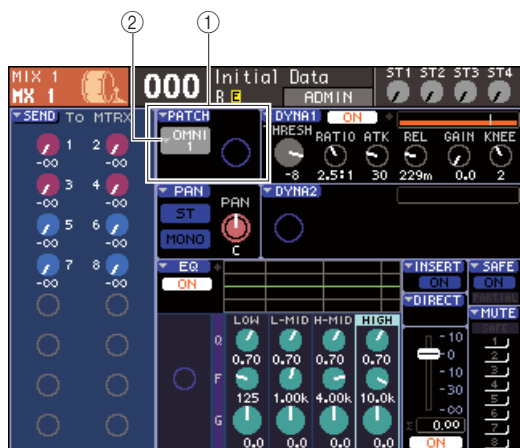

- 1 PATCH field
- 2 Output port select popup button

### 4 Move the cursor to the output port select popup button in the PATCH field of the screen, and press the [ENTER] key.

The PATCH/NAME popup window will appear, allowing you to select an output port and icon for the output channel, and to assign a name.

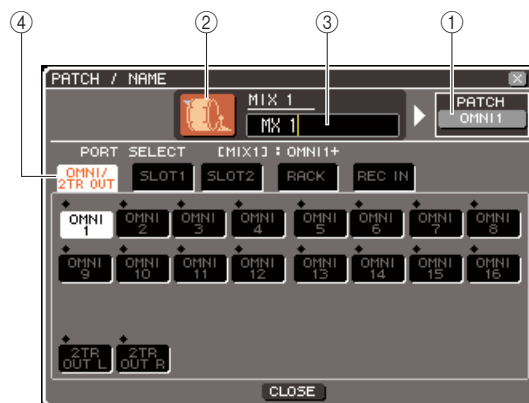

This popup window contains the following items.

#### ① Output port button

This indicates the output port that is assigned to the corresponding channel. If more than one output port is assigned, one port will be displayed to represent them. When you're selecting the icon or editing the channel name, moving the cursor to this button and pressing the [ENTER] key will take you back to the output port selection screen.

② **Icon button**

This shows the icon that is selected for the corresponding channel.

When you move the cursor to this button and press the [ENTER] key, a screen where you can select an icon and a sample name will appear.

③ **Channel name input box**

This indicates the name that is assigned to the corresponding channel. When you move the cursor to this field and press the [ENTER] key, a keyboard window will appear, allowing you to enter a name.

④ **Tabs**

These tabs switch the items that are shown in the window.

**5 To select an icon for this channel, move the cursor to the icon button and press the [ENTER] key.**

The window display will change as follows.



① **Icon select buttons**

These buttons select the icon that is used for this channel.

② **Sample name select buttons**

These buttons select sample names that are related to the currently selected icon. When you press a button, its sample name will be entered in the channel name field.

③ **Icon background color select buttons**

These buttons let you choose one of eight colors as the background color for the icon.

**6 Use the icon select buttons and the icon background color select buttons to select the icon you want to use for that channel.**

The selected icon is shown in the icon button in the upper part of the window.

**7 If desired, use the sample name select buttons to select a sample name. The selected sample name will be entered in the channel name field in the upper part of the window.**



- You can add or edit the text after entering the sample name in the channel name field. If you want to assign channel names that consist of a common name plus a number, such as "Vocal 1" and "Vocal 2," you can simply enter a sample name and then add a number.

**8 If you want to enter a channel name directly (or edit the previously-entered sample name), move the cursor to the channel name field in the upper part of the window and press the [ENTER] key.**

The keyboard window will appear in the lower part of the window, allowing you to enter or edit the text. For details on using the keyboard window, refer to p.34.

**9 Use the [SEL] keys to select another output channel, and specify its icon and channel name in the same way.**

While the PATCH/NAME popup window is displayed, you can use the [SEL] keys to switch the channel that you're operating.

**10 When you've finished entering information, move the cursor to the CLOSE button (or the × symbol in the upper right of the window) and press the [ENTER] key.**

You will return to the SELECTED CH VIEW screen.

# Sending signals from MIX channels to the STEREO/MONO bus

This section explains how to send the signal of a MIX channel to the STEREO bus or MONO bus.

Signals can be sent to the STEREO bus or MONO bus in either ST/MONO mode or LCR mode, and you can choose either of these two modes for each MIX channel. These two modes differ as follows.

## ■ ST/MONO mode

This mode sends the signal from the MIX channel to the STEREO bus and to the MONO bus independently.

- The signals sent from the same MIX channel to the STEREO bus and to the MONO bus can be switched on/off individually.
- The panning of the signal sent from a monaural MIX channel to the STEREO bus L/R can be operated by the SELECTED CHANNEL section [PAN] encoder, or by the TO ST PAN knob in the screen. (The signal sent to the MONO bus is not affected by this encoder or knob.)
- The volume balance of the signals sent from two stereo-assigned MIX channels to the STEREO bus left and right can be operated by the SELECTED CHANNEL section [PAN] encoder, or by the TO ST BAL knob in the screen. (The signal sent to the MONO bus is not affected by this knob.)

## ■ LCR mode

This mode sends the signal of the MIX channel to a total of three buses (STEREO (L/R) and MONO (C)) together.

- The signals sent from the same MIX channel to the STEREO bus and to the MONO bus can be switched on/off together.
- The CSR (Center Side Ratio) knob in the screen adjusts the proportion of the signal level sent from the MIX channel to the STEREO (L/R) bus and the level sent to the MONO (C) bus.
- The level of the signal sent from the MIX channel to the STEREO (L/R) bus and the MONO (C) bus will change according to the settings of the SELECTED CHANNEL section [PAN] encoder or the TO ST PAN knob / TO ST BAL knob in the screen.

**HINT** →

- If you want to use headphones etc. to monitor the signal of the STEREO bus or MONO bus, you should press the DISPLAY ACCESS section [MONITOR] key several times to access the MONITOR (2/4) screen, and select "LCR" as the monitor source (→ p. 146) before you continue with the following procedure.

### 1 Press the SELECTED CHANNEL section [HOME] key.

The SELECTED CH VIEW screen will appear in the display.

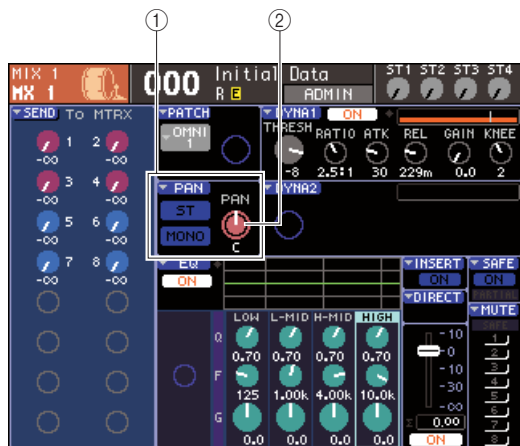

- ① TO ST field
- ② TO ST PAN knob (for a stereo MIX channel, the TO ST BAL knob)

### 2 In the LAYER section, press the LAYER [MASTER] key to select the master fader layer.

### 3 Press a [SEL] key in the channel module section to select the send-source MIX channel.

### 4 If you only want to adjust the pan or balance of the MIX channel, operate the SELECTED CHANNEL section [PAN] encoder (→ p. 86).

You can obtain the same result by moving the cursor to the PAN/BAL knob in the SELECTED CH VIEW screen and operating the dial or the [DEC]/[INC] keys.



**5** If you want to switch the on/off status of the signal sent from the MIX channel to the STEREO/MONO bus, or switch it between ST/MONO mode and LCR mode, use either of the following methods to access the TO STEREO/MONO popup window.

- Move the cursor to the PAN popup button located in the TO ST field of the SELECTED CH VIEW screen, and press the [ENTER] key.
- Move the cursor to the TO ST PAN knob located in the TO ST field of the SELECTED CH VIEW screen, and press the [ENTER] key.

In the TO STEREO/MONO popup window you can switch between ST/MONO mode and LCR mode in sets of eight MIX channels, and change the on/off status and pan/balance settings of the signals sent from those channels to the STEREO/MONO bus. This popup window shows the parameters for the eight channels that include the MIX channel you selected in step 3.



**HINT**

- If you've turned on POPUP APPEARS WHEN PRESSING KNOBS in the PREFERENCE popup window (→ p. 194), you can also access the above popup window by pressing the SELECTED CHANNEL section [PAN] encoder.

This popup window contains the following items.

- 1 Channel number / Channel name**  
This indicates the number and name of the channel you're operating.
- 2 MODE button**  
This button selects either ST/MONO mode or LCR mode to specify how the signal is sent to the STEREO bus and MONO bus. You can specify this mode individually for each MIX channel. The setting will alternate between the two modes each time you press the button.  
The currently selected mode is shown by the position of the indicator (the green ♦ symbol) located immediately above the button.

- 3 ST button**
- 4 MONO button**

When the MODE button is set to ST/MONO mode, these buttons act as individual on/off switches for the signal sent from that MIX channel to the STEREO bus and MONO bus.

**5 TO ST PAN/TO ST BALANCE knob**

For monaural MIX channels, this acts as the PAN knob that adjusts the left/right panning of the signal sent to the STEREO bus.

For stereo MIX channels, this acts as the BALANCE knob that adjusts the volume of the left and right signals sent to the STEREO bus.

Move the cursor to the knob and use the dial or the [DEC]/[INC] keys to adjust the setting.

For channels whose MODE button is set to LCR mode, the following button and knob are shown instead of the ST button (3) and MONO button (4).

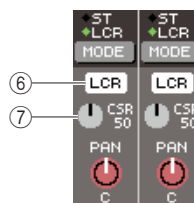

**6 LCR button**

This button is an on/off switch for all signals sent from that MIX channel to the STEREO bus and MONO bus. If you turn off the button, no signals will be sent from that output channel to the STEREO bus or MONO bus.

**7 CSR knob**

This knob adjusts the proportion between the signal level sent from that MIX channel to the STEREO (L/R) bus and the level sent to the MONO (C) bus, over a range of 0–100%. To adjust the setting, move the cursor to the knob, press the [ENTER] key, and use the dial or the [DEC]/[INC] keys.

**6 Use the MODE button to select either ST/MONO mode or LCR mode for each MIX channel.**

**7 The ST button and MONO button are on/off switches for the signal sent from the MIX channel to the STEREO bus and MONO bus.**

**8 If you want to use the STEREO bus, make sure that the [ON] key of the STEREO channel is turned on in the top panel STEREO MASTER section, and raise the fader of the STEREO channel to an appropriate position.**



- 9** If you want to use the MONO bus, make sure that the [ON] key of the MONO channel is turned on, and raise the fader of the MONO channel to an appropriate position.

This operation will differ between the LS9-16 and LS9-32.

● **For the LS9-16**

Assign the MONO channel to the custom fader layer, press the LAYER [CUSTOM] key to access the custom fader layer, and then operate the [ON] key and fader of the corresponding channel module.

● **For the LS9-32**

Press the LAYER [MASTER] key to access the master fader layer, and operate the [ON] key and fader of channel module 32.

- 10** Select the master fader layer, make sure that the [ON] key of the desired MIX channel is turned on, and raise the fader to an appropriate position.

The following steps will differ depending on whether you selected a ST/MONO mode MIX channel or an LCR mode MIX channel in step 6.

● **For a MIX channel set to ST/MONO mode**

- 11** Use the ST button and MONO button in the TO STEREO/MONO popup window as on/off switches for the signal sent from the MIX channel to the STEREO bus and MONO bus.

- 12** Use the SELECTED CHANNEL section [PAN] encoder to adjust the pan/balance of the signal sent from the MIX channel to the STEREO bus.

You can obtain the same result by using the TO ST PAN/TO ST BALANCE knob in the TO STEREO/MONO popup window.

● **For a MIX channel set to LCR mode**

- 11** Use the LCR button in the TO STEREO/MONO popup window as an on/off switch for the signal sent from the MIX channel to the STEREO bus and MONO bus.

For a MIX channel that is set to LCR mode, the signal sent to the STEREO bus and MONO bus can be switched on/off in a single operation.

- 12** Use the CSR knob in the TO STEREO/MONO popup window to adjust the proportion between the signal level sent from that MIX channel to the STEREO (L/R) bus and the signal level sent to the MONO (C) bus.

- 13** Use the TO ST PAN knob in the TO STEREO/MONO popup window to set the panning of the signal sent from the MIX channel to the STEREO (L/R) bus and the MONO (C) bus.

If the CSR knob is set to 0%, operating the TO ST PAN knob of a MIX channel will change the signal levels sent to the STEREO (L/R) bus and MONO (C) bus as shown in the following illustration. In this case, the TO ST PAN knob will operate as a conventional PAN knob, and no signal is sent to the MONO (C) bus.

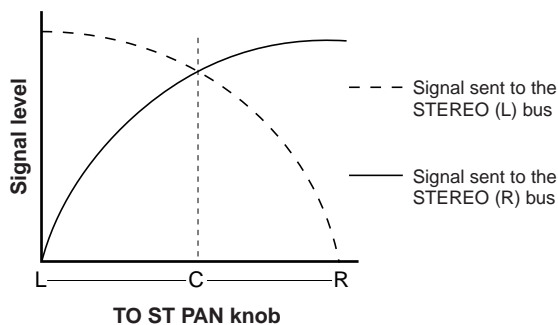

If a MIX channel set to stereo is selected, operating the TO ST BALANCE knob will change the signal levels sent from the MIX channel to the STEREO (L/R) bus and MONO (C) bus as shown in the following illustration. In this case, the [PAN] encoder will operate as a conventional BALANCE knob, and no signal is sent to the MONO (C) bus.

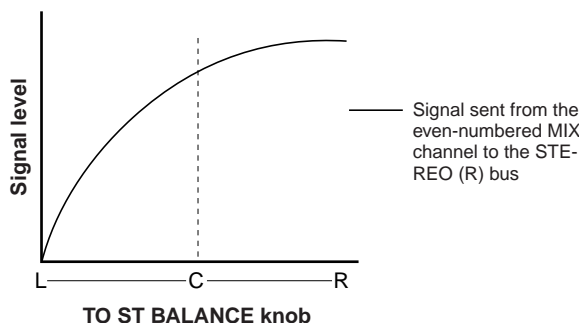
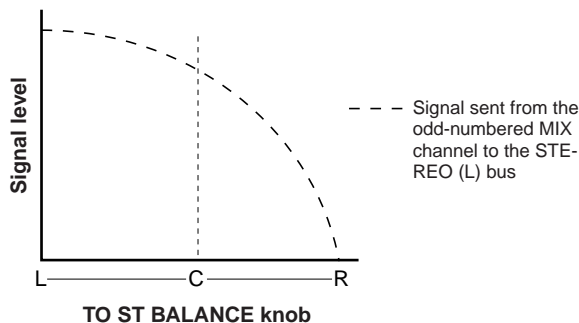

If the CSR knob is set to 100%, operating the TO ST PAN knob will change the signal levels sent to the STEREO (L/R) bus and MONO (C) bus as shown in the following illustration.

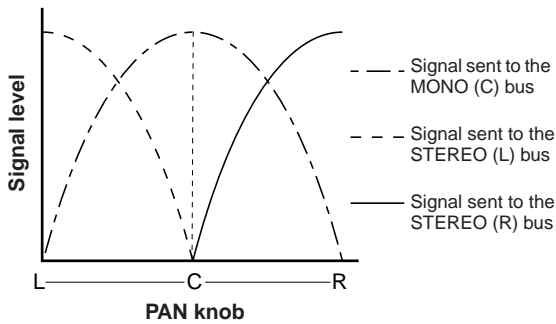

If a stereo MIX channel is selected, operating the TO ST BALANCE knob will change the signal levels sent from the MIX channel to the STEREO (L/R) bus and MONO (C) bus as shown in the following illustration.

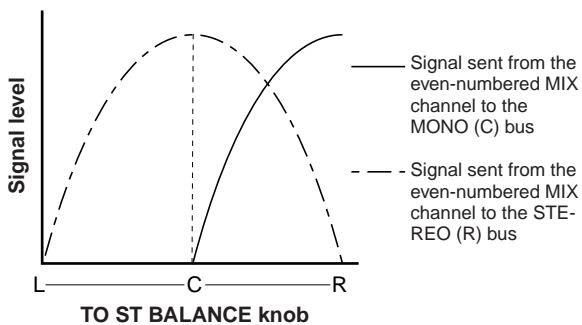
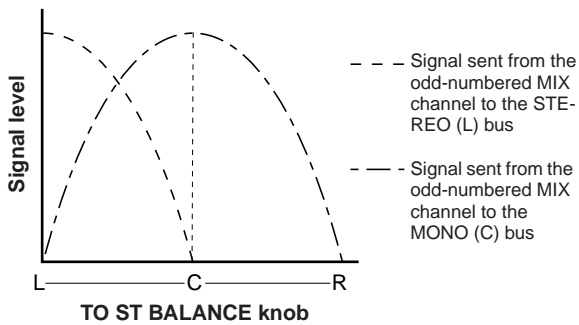

**14** If you want to operate a channel that is not currently shown in the popup window, use the [SEL] key to select that channel, and then make settings for it.

For example if MIX channels 1–8 are shown in the popup window, pressing the MIX channel 9 [SEL] key will change the popup window to MIX channels 9–16.

**15** When you've finished making settings, move the cursor to the CLOSE button (or the × symbol in the upper right of the window) and press the [ENTER] key.

# Sending signals from MIX channels and STEREO/MONO channels to MATRIX buses

This section explains how to send the signal from a MIX channel or STEREO/MONO channel to MATRIX buses 1–8. You can do this in any of the following three ways.

## ■ Using the SELECTED CHANNEL section .....

In this method, you use the SELECTED CHANNEL section [SELECTED SEND] encoder to adjust the level of the signal sent to the MATRIX bus.

## ■ Using a popup window .....

In this method, you use the MATRIX SEND popup window to adjust the send levels from eight channels to a MATRIX bus.

This method lets you control the send level, on/off setting, and send point for the signals sent from a set of eight channels to a specific MATRIX bus.

## ■ Using the top panel faders .....

In this method, you switch the LS9 to SENDS ON FADER mode and use the top panel faders to adjust the send levels to the MATRIX bus. This method lets you simultaneously control the send levels and on/off switching for the signals sent from MIX, STEREO (L/R), and MONO channels to a specific MATRIX bus.

### Using the SELECTED CHANNEL section

In this method, you use the SELECTED CHANNEL section [SELECTED SEND] encoder to adjust the level of the signal sent to the MATRIX bus.

You can either control the signals sent from a desired MIX, STEREO (L/R), or MONO channel to all MATRIX buses, or control the signals sent from all MIX channels to a specific MATRIX bus.

#### ■ Controlling the signals sent from a MIX, STEREO (L/R), or MONO channel to all MATRIX buses

##### 1 Press the SELECTED CHANNEL section [HOME] key.

The SELECTED CH VIEW screen will appear in the display.

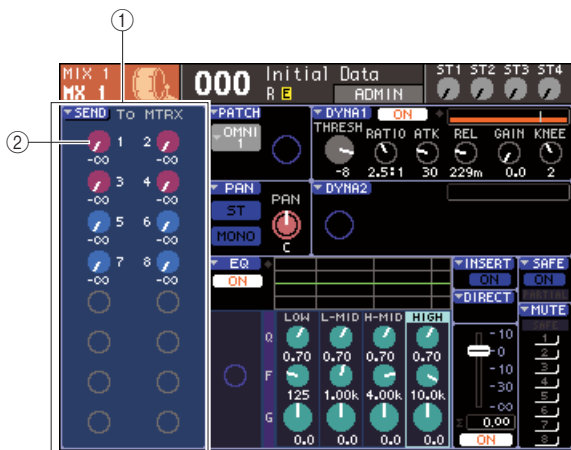

##### ① TO MATRIX field

If a MIX, STEREO (L/R), or MONO channel is selected, this area of the SELECTED CH VIEW screen will show the TO MATRIX field, allowing you to switch the on/off status and adjust the send level of the signals sent to the MATRIX buses.

##### ② TO MATRIX LEVEL knobs

These adjust the send level of the signals sent from the MIX, STEREO (L/R), or MONO channel to the MATRIX buses. These knobs are the same color as the corresponding keys of the MIX/MATRIX SEND section.

To adjust the send level in this field, move the cursor to the knob and use the dial or the [DEC]/[INC] keys. To switch the on/off status of a signal sent to a MATRIX bus, move the cursor to the corresponding knob and press the [ENTER] key.

##### 2 Use the LAYER section keys and the channel module section [SEL] keys to select the send-source MIX, STEREO (L/R), or MONO channel.

##### HINT

- In order to select a MONO channel on the LS9-16, you must first select the custom fader layer to which you've assigned that MONO channel, and then press the corresponding [SEL] key.

### 3 Use the MIX/MATRIX SELECT section keys to select the send-destination MATRIX bus.

When a MIX, STEREO (L/R), or MONO channel is selected, the keys of the MIX/MATRIX SELECT section are used to select the send-destination MATRIX bus.

When you press a key to select the send-destination MATRIX bus, only the LED of the corresponding key will blink, indicating that it is selected as the send-destination. The cursor will move to the corresponding TO MATRIX LEVEL knob in the TO MATRIX field of the screen.

**NOTE**

- If a MIX, STEREO (L/R), or MONO channel is selected, MIX/MATRIX SELECT section keys 9–16 are inactive.
- If the LED of only the specified key is blinking in the MIX/MATRIX SELECT section and the LEDs of the remaining keys are lit, the LS9 is in SENDS ON FADER mode. Press the desired key of the MIX/MATRIX SELECT section so that only the LED of that key is blinking.

### 4 Use the SELECTED CHANNEL section [SELECTED SEND] encoder to adjust the send level from that channel to the MATRIX bus you selected in step 3.

If the send-destination MATRIX bus is set to stereo, the function of the [SELECTED SEND] encoder will change depending on which of the two adjacent keys of the MIX/MATRIX SELECT section are lit.

● **If the left key is lit**

Use the [SELECTED SEND] encoder to adjust the pan (or balance, for a STEREO channel) of the signal that is sent from that channel to the two MATRIX buses.

● **If the right key is lit**

Use the [SELECTED SEND] encoder to adjust the send level shared by the two MATRIX buses.

### 5 To switch the on/off status of a signal sent to a MATRIX bus, move the cursor to the TO MATRIX LEVEL knob in the screen and press the [ENTER] key.

If you switch this off, the knob will turn grey. To turn it back on, press the [ENTER] key once again.

### 6 Use the top panel [SEL] keys to select another channel, and adjust the send level to the selected MATRIX bus in the same way.

### 7 Use the keys of the MIX/MATRIX SELECT section to select another MATRIX bus as the send-destination, and adjust the send level in the same way.

**HINT**

- If PRE is selected as the send position to the MATRIX bus, then you will also be able to select either PRE EQ (immediately before the attenuator) or PRE FADER (immediately before the fader) for each two adjacent odd-numbered/even-numbered MATRIX buses (→ p. 213).
- If desired, the pan/balance setting of the signal sent to a stereo MATRIX bus can be linked with the TO ST PAN/TO ST BAL knob of the SELECTED CH VIEW screen (→ p. 213).
- If you want to monitor the signal that is being sent to a specific MATRIX bus, select the fader layer that includes that MATRIX channel, and press the corresponding [CUE] key.

## ■ Controlling the signals sent from MIX, STEREO (L/R), or MONO channels to a specific MATRIX bus

### 1 Press the SELECTED CHANNEL section [HOME] key.

The SELECTED CH VIEW screen will appear in the display.

### 2 Use the LAYER section keys and the [SEL] keys of the channel module section to select the send-destination MATRIX channel.

The SELECTED CH VIEW screen will change as follows.

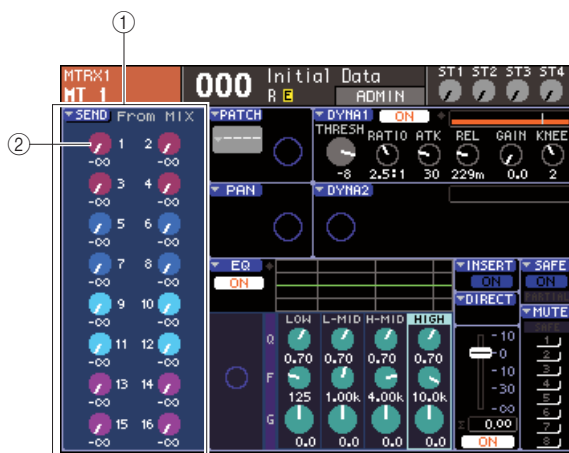

① **FROM MIX field**

If a MATRIX channel is selected, this area of the SELECTED CH VIEW screen will show the FROM MIX field, allowing you to switch the on/off status and adjust the send level of the signals sent from each MIX channel to the MATRIX bus.

② **FROM MIX LEVEL knobs**

These knobs indicate and control the send level of the signals sent from MIX channels 1–16 to the currently selected MATRIX bus.

**HINT**

- In order to select a MATRIX channel on the LS9-16, you must first select the custom fader layer to which you've assigned that MATRIX channel, and then press the corresponding [SEL] key.

- To adjust the send level from a MIX channel to the selected MATRIX bus, move the cursor to the selected MATRIX bus, move the cursor to the corresponding knob of the FROM MIX field, and operate the [SELECTED SEND] encoder.

You can obtain the same result by operating the dial or the [DEC]/[INC] keys.

If the send-destination MATRIX bus is set to stereo, the send level to the two adjacent odd-numbered/even-numbered MATRIX buses will be linked.

- To switch the on/off status of a signal sent from a MIX channel to the selected MATRIX bus, move the cursor to the corresponding knob of the FROM MIX field and press the [ENTER] key.

If you switch this off, the knob will turn grey. To turn it back on, press the [ENTER] key once again.

**NOTE**

- When the SELECTED CH VIEW screen for MATRIX channels is displayed, the keys of the MIX/MATRIX section will operate as keys that select the send-destination MIX bus for the input channels.

- Use the top panel [SEL] keys to switch the send-destination MATRIX channel and control the send level to a specific MATRIX bus in the same way.

### Using a popup window

Here's how you can use the MATRIX SEND popup window to adjust the send levels from up to eight channels to a MATRIX bus.

- Press the SELECTED CHANNEL section [HOME] key.

The SELECTED CH VIEW screen will appear in the display.

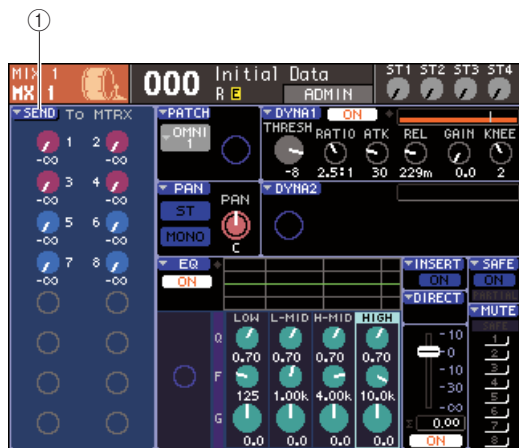

① SEND popup button

- Use the LAYER section keys and the channel module section [SEL] keys to select the send-source MIX, STEREO (L/R), or MONO channel.

- Use the MIX/MATRIX SELECT section keys to select the send-destination MATRIX bus.

Only the LED of the corresponding key will blink, indicating that it is selected as the send-destination.

- Move the cursor to the SEND popup button in the screen, and press the [ENTER] key to access the MATRIX SEND popup window.

In the MATRIX SEND popup window you can view eight MIX channels or the STEREO (L/R) and MONO channels at once, and control the send level, on/off status, and send point for the signals sent to the MATRIX bus.

The MATRIX SEND popup window shows the parameters for a maximum of eight channels that include the channel you selected in step 3.



- Channel number / Channel name

This indicates the number and name of the send-source channel.

- PRE button

This switches the position from which the signal is sent from the send-source channel to the currently selected MATRIX bus. If this button is on, the pre-EQ or pre-fader signal will be sent; if this button is off, the signal from immediately after the channel on/off will be sent.

- TO MATRIX ON/OFF button

This is an on/off switch for the signal that is sent from the send-source channel to the currently selected MATRIX bus.

- TO MATRIX LEVEL knob

This adjusts the level of the signal that is sent from the send-source channel to the currently selected MATRIX bus.



If the send-destination MATRIX bus is set to stereo, the screen will change as follows.

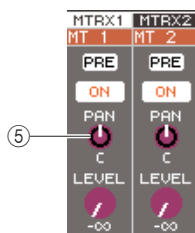

**5 TO MATRIX PAN/TO MATRIX BALANCE knob**

This knob adjusts the panning (or the balance, if the send-source is a STEREO channel or a MIX channel set to stereo) of the signal sent from this channel to the two MATRIX buses.

**HINT**

- If you've turned on POPUP APPEARS WHEN PRESSING KNOBS in the PREFERENCE popup window (→ p. 194), you can also access the above popup window by pressing the SELECTED CHANNEL section [SELECTED SEND] encoder.
- If PRE is selected as the send position to the MATRIX bus, then you will also be able to select either PRE EQ (immediately before the attenuator) or PRE FADER (immediately before the fader) for each two adjacent odd-numbered/even-numbered MATRIX buses (→ p. 213).
- If desired, the pan/balance setting of the signal sent to a stereo MATRIX bus can be linked with the TO ST PAN/TO ST BAL knob of the SELECTED CH VIEW screen (→ p. 213).

**5 To adjust the send level from each channel to the selected MATRIX bus, move the cursor to a TO MATRIX LEVEL knob in the screen, and operate the dial or the [DEC]/[INC] keys.**

If the send-destination MATRIX bus is set to stereo, move the cursor to the TO MATRIX PAN (TO MATRIX BAL) knob and adjust the pan (or balance, for a STEREO channel or MIX channels set to stereo) of the signal sent from each channel to the two MATRIX buses.

**6 To switch the send position of a signal sent to the MATRIX bus, move the cursor to the PRE button in the screen and press the [ENTER] key.**

If the PRE button is on, the pre-EQ or pre-fader signal will be sent; if this button is off, the signal from immediately after the channel on/off will be sent.

**HINT**

- If the PRE button is on, then you will be able to select either PRE EQ (immediately before the attenuator) or PRE FADER (immediately before the fader) for each two adjacent odd-numbered/even-numbered MATRIX buses (→ p. 213).

**7 To switch the on/off status of a signal sent to the MATRIX bus, move the cursor to the TO MATRIX ON/OFF button in the screen and press the [ENTER] key.**

If the send-destination MATRIX bus is set to stereo, operation of the adjacent left/right pair of buttons is linked.

**8 If you want to operate a channel that is not currently shown in the popup window, use the [SEL] key to select that channel, and then make settings for it.**

**9 If you want to adjust the send level to another MATRIX bus, use the keys of the MIX/MATRIX SELECT section to select another MATRIX bus, and make settings in the same way.**

**10 When you've finished making settings, move the cursor to the CLOSE button (or the × symbol in the upper right of the window) and press the [ENTER] key.**

**Using the faders (SENDS ON FADER mode)**

Here's how to use the top panel faders and [ON] keys to adjust the send level and turn the signal on/off for the signals sent from the MIX, STEREO (L/R), and MONO channels to a specific MATRIX bus.

**1 Press the SELECTED CHANNEL section [HOME] key.**

The SELECTED CH VIEW screen will appear in the display.



**1 SEND popup button**

**2 Use the LAYER section keys and the channel module section [SEL] keys to select a MIX, STEREO (L/R), or MONO channel.**



**3 Use the MIX/MATRIX SELECT section keys to select the send-destination MATRIX bus.**

Only the LED of the corresponding key will blink, indicating that it is selected as the send-destination.

**4 Press the same key of the MIX/MATRIX SELECT section once again.**

The key will change from lit to blinking, and the LEDs of the remaining keys in the MIX/MATRIX SELECT section will light. This indicates that the LS9 is now in SENDS ON FADER mode, allowing you to use the faders to control the send levels to the MIX bus / MATRIX bus.

In SENDS ON FADER mode, the faders and [ON] keys of the channel module section will change their operation as follows.

**● Faders**

The faders will adjust the send level of the signal sent from each channel to the currently selected MATRIX bus. When you switch from normal mode to SENDS ON FADER mode, the fader positions will move to the value of the send levels to the currently selected MATRIX bus.

**● [ON] keys**

These keys will function as on/off switches for the signal sent from each channel to the currently selected MATRIX bus. When you switch from normal mode to SENDS ON FADER mode, the [ON] keys will light or go dark according to the on/off status of the signals being sent to the currently selected MATRIX bus.

**● [SEL] keys**

The [SEL] key of the selected channel will blink, and the [SEL] keys of channels that are not selected will light. However, the [SEL] keys of unassigned modules will go dark.

**5 Use the channel module faders to adjust the send levels from the channels to the MATRIX bus you selected in step 3.**

As necessary, switch fader layers to access the layer that contains the desired send-source channel.

**6 To switch the on/off status of a signal sent to the MATRIX bus, press the top panel [ON] key.**

If the send-destination MATRIX bus is set to stereo, on/off operations will be linked for the signal sent to the two adjacent odd-numbered/even-numbered MATRIX buses.

**NOTE**

- While SENDS ON FADER mode is active with a MATRIX bus as the send-destination, the faders/encoders and [ON] keys of input channels will be disabled. If you want to operate an input channel, you must first disable the above SENDS ON FADER mode.

**7 Repeat steps 3–6 to adjust the send level and switch the on/off status for other MATRIX buses in the same way.**

**8 When you've finished setting the MATRIX send levels, press the key that is currently blinking in the MIX/MATRIX SELECT section.**

The LS9 will return to normal mode.

**HINT**

- You can assign the SENDS ON FADER function to a user-defined key. This allows you quickly switch to SENDS ON FADER mode for a specific MATRIX bus, or quickly return to the previous state.
- You can also use the [HOME] key to cancel SENDS ON FADER mode.

In SENDS ON FADER mode (when the send-destination is a MATRIX bus), the STEREO MASTER module will operate differently depending on the selected fader layer.

Fader layer	Function
1-16 {1-32}/17-32 {33-64}	Send-destination MATRIX channel module
MASTER/ CUSTOM FADER	[SEL] key, [CUE] key: STEREO channel  [ON] key, fader: Adjust the on/off status and send level of signals sent to MATRIX buses

**NOTE**

- If you switch the fader layer from 1-16 {1-32}, 17-32 {33-64}, or CUSTOM FADER to MASTER while in SENDS ON FADER mode (when the send-destination is a MATRIX bus), SENDS ON FADER mode will be cancelled.
- You cannot operate the fader or [ON] key of a channel that is not a send-source (a channel that does not have a MATRIX SEND parameter) or of a channel that is not a send-destination bus master.



## ◆ Chapter 7 ◆

# Operations in the SELECTED CHANNEL section

This chapter explains how you can use the SELECTED CHANNEL section and the SELECTED CH VIEW screen to control the parameters of a selected channel.

## About the SELECTED CHANNEL section

The SELECTED CHANNEL section located at the right of the display corresponds to a channel module of a conventional analog mixer, and allows you to manually adjust all the major parameters of the currently selected channel.

Operations in this section will affect the channel that is currently selected by its [SEL] key. You can use the encoders and keys on the panel to control mix parameters such as head amp gain, EQ settings, the threshold setting of the dynamics processors, pan/balance settings, and send levels to the MIX/MATRIX buses.

For a ST IN channel or STEREO channel, either the L or the R channel is selected, and the major parameters are linked.

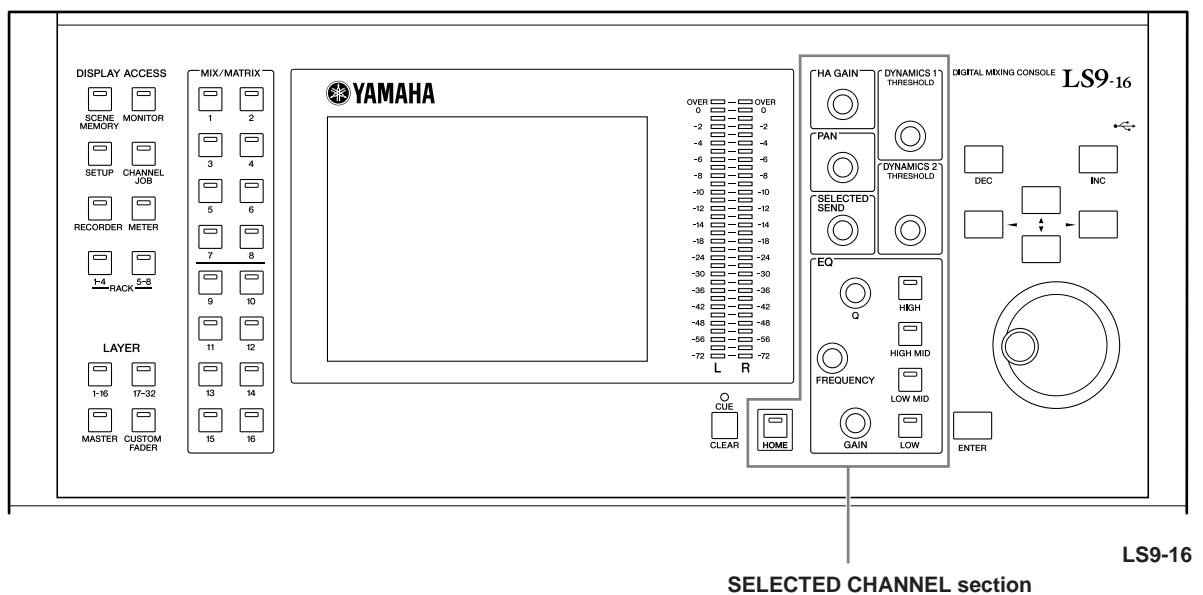

- If you want to use the SELECTED CHANNEL section to set the send levels to the MIX/MATRIX buses, use the keys of the MIX/MATRIX SELECT section located at the left of the display.

# About the SELECTED CH VIEW screen

When you press the [HOME] key, the SELECTED CH VIEW screen will appear in the display. This screen shows most of the parameters of the channel currently selected by its [SEL] key. You can use the SELECTED CH VIEW screen to check the values when operating the encoders of the SELECTED CHANNEL section, or when you need to edit more detailed parameters.

The SELECTED CH VIEW screen contains the following items.

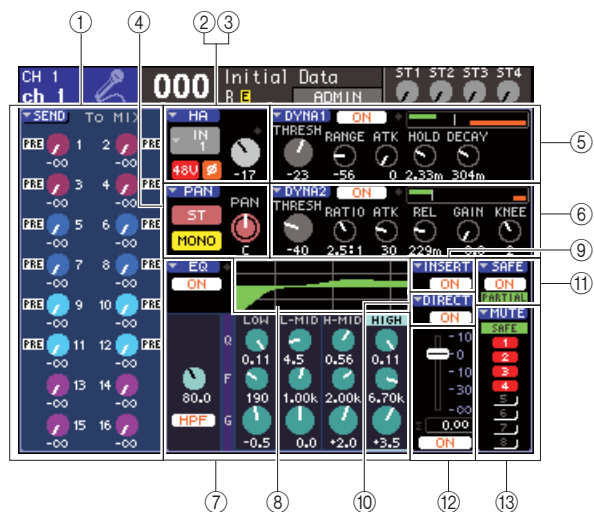

## ① SEND field

### ● When an input channel is selected

Here you can switch the on/off status of the signals sent from that channel to each MIX bus (if the MIX bus is set to the FIXED type), and view or edit the send levels.

### ● When a MIX, STEREO, or MONO channel is selected

Here you can switch the on/off status of the signals sent from that channel to each MATRIX bus, and view or edit the send levels.

### ● When a MATRIX channel is selected

Here you can switch the on/off status of the signals sent from each MIX channel to that MATRIX bus, and view or edit the send levels.

## ② HA field (input channels only)

In this field you can view or edit the input port patched to the input channel, the head amp gain, the phantom power on/off status, and the phase setting. The input level OVER indicator is also shown here.



## ③ PATCH field (output channels only)

For output channels, the PATCH field is shown in the ② area. In this field you can view and edit the output port that is patched to the output channel. For channels to which two or more output ports are patched, only one will be shown as a representative.

## ④ PAN field

### ● When an INPUT channel or monaural MIX channel is selected

This functions as an on/off switch for the signal sent from that channel to the STEREO/MONO bus. Here you can also view or edit the panning of the signal sent to the STEREO bus.

### ● When a ST IN channel or a stereo MIX channel is selected

This functions as an on/off switch for the signal sent from that channel to the STEREO/MONO bus. This also lets you view or edit the balance of the left/right signals sent from that channel to the STEREO bus.

### ● When a stereo MATRIX channel is selected

This shows the balance of the signals sent from the two MATRIX channels.

### ● When a STEREO channel is selected

This shows the balance of the left/right signals sent from the STEREO channel.

## ⑤ DYNA1 field

## ⑥ DYNA2 field (input channels only)

Here you can view or edit the Dynamics 1/2 parameters. This also accesses the DYNAMICS 1 / DYNAMICS 2 popup windows where you can edit detailed dynamics parameters that cannot be edited in the SELECTED CHANNEL section.

## ⑦ EQ field

Here you can switch the four-band EQ on/off, and view or edit its parameters. For input channels, you can also switch the HPF (high-pass filter) on/off, and view or adjust its cutoff frequency.

## ⑧ EQ graph field

This shows the response of the EQ/HPF.

## ⑨ INSERT field (INPUT channels 1–32 and MIX/MATRIX/STEREO/MONO channels only)

The signal route for insertion in the channel can be switched on/off here.

## ⑩ DIRECT field (INPUT channels only)

This is an on/off switch for the signal that is directly output from the channel. You can also view and edit the output level here.

## ⑪ SAFE field

Switches the Recall Safe status on/off for that channel. If only some of the channel parameters are set to Recall Safe, the PARTIAL indicator will light.

## ⑫ FADER field

Here you can view and edit the input/output level of the channel, and switch the channel on/off.

## ⑬ MUTE field

Here you can select the mute group to which that channel is assigned. SAFE indicator will light if the corresponding channel is set to Mute Safe.

# Operations in the SELECTED CHANNEL section

This section explains how you can use the SELECTED CHANNEL section to control all of the parameters for a specific channel.

## 1 Press the SELECTED CHANNEL section [HOME] key.

The SELECTED CH VIEW screen will appear in the display. If you leave this screen displayed, you will always be able to view the settings in the screen while operating an encoder of the SELECTED CHANNEL section.



- You can also access the SELECTED CH VIEW screen by pressing any one of the encoders in the SELECTED CHANNEL section.

## 2 Use the LAYER section to select the desired fader layer.

## 3 Press a [SEL] key in the channel module section, ST IN section, or STEREO MASTER section to select a channel.

Operations in the SELECTED CHANNEL section will affect the channel that is currently selected by its [SEL] key. The number and name of the currently selected channel is shown in the upper left of the display.



- Channel number
- Channel name



- In the case of ST IN channels or STEREO channels, you can switch between L and R by repeatedly pressing the same [SEL] key.
- In order to select a MATRIX/MONO channel on the LS9-16, you must first select the custom fader layer to which you've assigned that channel, and then press the corresponding [SEL] key.
- You can also move the cursor to the selected channel in the upper left of the display, and use the [DEC]/[INC] keys to change the selected channel.

Even if a screen other than the SELECTED CH VIEW screen is selected, the encoders of the SELECTED CHANNEL section always affect the currently selected channel. When you operate an encoder, a small popup window indicating the value of that parameter will appear in the screen.



## 4 Use the encoders of the SELECTED CHANNEL section and the buttons and knobs in the SELECTED CH VIEW screen to edit the parameters of the selected channel.

Subsequent operations will differ depending on the parameters you want to adjust.

### ● Adjusting the send levels from a specific channel to the MIX buses / MATRIX buses

Use the SEND field when you want to send the signal from an INPUT/ST IN channel to a MIX bus, or from a MIX, STEREO, or MONO channel to a MATRIX bus.



#### ① SEND popup button

This accesses a popup window where you can make send level settings for eight channels at a time.

#### ② TO MIX LEVEL (TO MATRIX LEVEL) knobs

These knobs indicate the send level of the signal sent from that input channel to each MIX bus or MATRIX bus. If the send-destination MIX bus / MATRIX bus is set to stereo, the left knob of the two adjacent knobs will operate as a PAN knob. (For a ST IN channel, a stereo MIX channel, or STEREO channel, it will operate as the BALANCE knob.)



#### ③ TO MIX ON/OFF button

If the send-destination MIX bus is a FIXED type, the TO MIX LEVEL knob will not appear; instead, the TO MIX ON/OFF button will be shown. By moving the cursor to the TO MIX ON/OFF button and pressing the [ENTER] key, you can turn the signal sent from that channel to the MIX button on/off.

To adjust the send level to a MIX bus / MATRIX bus, use the keys of the MIX/MATRIX SELECT section to select the send-destination bus, and use the SELECTED CHANNEL section [SELECTED SEND] encoder. (Alternatively, move the cursor to the TO MIX LEVEL/TO MATRIX LEVEL knob in the screen, and operate the dial or the [DEC]/[INC] keys.)

If desired, you can use the TO MIX ON/OFF buttons to switch the signal sent to each bus on/off (if the MIX bus is the FIXED type).

At the left side of these buttons is shown the position from which the signal is sent from the current channel. (For details on changing the send position → p. 213)

#### HINT

- If you want to make send level settings for eight channels at a time, use the SEND popup button in the screen to access the popup window (→ p. 64).
- If you've turned on POPUP APPEARS WHEN PRESSING KNOBS in the PREFERENCE popup window (→ p. 194), you can also access the above popup window by pressing the SELECTED CHANNEL section [SELECTED SEND] encoder.
- You can access the SEND popup window by moving the cursor to the To MIX SEND knob of a VARI type, and pressing the [ENTER] key.
- For MIX buses that are set to STEREO, the left knob indicates the PAN of the MIX SEND, and the right knob indicates the SEND LEVEL.



## ● Adjusting the send level from the MIX channels to a specific MATRIX bus

To adjust the send level from the MIX channels to a specific MATRIX bus, access the send-destination MATRIX channel in the SELECTED CH VIEW screen.

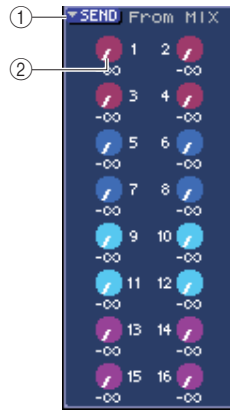

### ① SEND popup button

This button displays a popup window where you can make send level settings for eight channels at a time.

### ② TO MATRIX LEVEL knobs

These adjust the send level of the signal sent from each MIX channel to the currently selected MATRIX bus.

To adjust the send level to a MATRIX bus, use the keys of the MIX/MATRIX SELECT section to select the MIX channel you want to operate, and then operate the SELECTED CHANNEL section [SELECTED SEND] encoder. (Alternatively, move the cursor to the TO MATRIX LEVEL knob in the screen, and operate the dial or the [DEC]/[INC] keys.)

At the left side of each of these knobs is shown the position from which the signal is sent from the MIX channel. (For details on changing the send position → p. 213)

#### HINT

- If you want to make send level settings for eight channels at a time, use the SEND popup button in the screen to access the popup window (→ p. 77).
- If you've turned on POPUP APPEARS WHEN PRESSING KNOBS in the PREFERENCE popup window (→ p. 194), you can also access the above popup window by pressing the SELECTED CHANNEL section [SELECTED SEND] encoder.
- You can access the SEND popup window by moving the cursor to the To MATRIX SEND knob and pressing the [ENTER] key.
- For MATRIX buses that are set to STEREO, the left knob indicates the PAN of the MATRIX SEND, and the right knob indicates the SEND LEVEL.

## ● Making HA settings (input channels only)

To control the head amp (HA) assigned to an INPUT/ST IN channel, you will use the [HA GAIN] encoder of the SELECTED CHANNEL section and the HA field of the SELECTED CHANNEL VIEW screen. The HA field includes the following items.

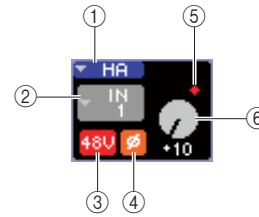

### ① HA popup button

This button displays the HA/PATCH popup window where you can make head amp settings for eight channels at a time (→ p. 57).

### ② Input port select popup button

This accesses the PATCH/NAME popup window, where you can select the input port and specify the channel name and icon. The input port assigned to that channel is shown inside this button.

### ③ +48V button

This button switches the phantom power on/off for the head amp assigned to that channel.

### ④ Ø (phase) button

This button switches the input assigned to that channel between normal phase and reverse phase. The phase is reversed when the button is on, and normal when the button is off.

### ⑤ OVER indicator

This will light when the input signal from the HA reaches the overload point.

### ⑥ GAIN knob

This indicates the amount of gain for the head amp assigned to that channel.

To adjust the gain value, use the SELECTED CHANNEL section [HA GAIN] encoder. (Alternatively, move the cursor to the GAIN knob and operate the dial or the [DEC]/[INC] keys.) The indicator above the GAIN knob in the screen shows whether the signal of the patched input port has overloaded.

When you move the cursor to the input port select popup button and press the [ENTER] key, the PATCH/NAME popup window will appear, allowing you to select the input port and specify the channel name and icon. (For details on the popup window → p. 55)

#### HINT

- If you want to make head amp settings for eight channels at a time, use the HA popup button in the screen to access the HA/PATCH popup window (→ p. 57).
- If you've turned on POPUP APPEARS WHEN PRESSING KNOBS in the PREFERENCE popup window (→ p. 194), you can also access the above popup window by pressing the SELECTED CHANNEL section [HA GAIN] encoder.

#### NOTE

- The PAD will be internally switched on or off when the HA gain is adjusted between -14 dB and -13 dB. Keep in mind that noise may be generated if there is a difference between the Hot and Cold output impedance of the external device connected to the INPUT connector when using phantom power.

## ● Changing the output patching (Output channels only)

To change the output patching of an output channel in the SELECTED CH VIEW screen, use the PATCH popup button.

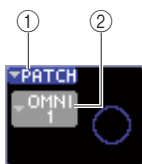

### ① PATCH popup button

This button displays the HA/PATCH popup window where you can make output port settings for eight channels at a time (→ p. 95).

### ② Output port select popup button

This accesses the PATCH/NAME popup window, where you can select the output port and specify the channel name and icon. The output port assigned to that channel is shown inside the button. For channels to which two or more output ports are patched, only one will be shown as a representative.

To select the output port and specify the channel name or icon, move the cursor to the output port select popup button and press the [ENTER] key to access the PATCH/NAME popup window (→ p. 69).



- If you want to make output port settings for eight channels at a time, use the PATCH popup button in the screen to access the HA/PATCH popup window (→ p. 95).
- If you've turned on POPUP APPEARS WHEN PRESSING KNOBS in the PREFERENCE popup window (→ p. 194), you can also access the above popup window by pressing the SELECTED CHANNEL section [HA GAIN] encoder.

## ● Setting the pan/balance

To adjust the pan/balance of the signal sent from that channel to the STEREO bus, use the [PAN] encoder of the SELECTED CHANNEL section and the PAN field of the SELECTED CH VIEW screen. The PAN field includes the following items.

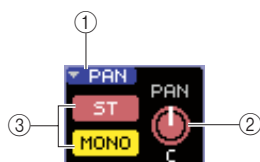

### ① PAN popup button

This button displays the TO STEREO/MONO popup window where you can make pan/balance settings for eight channels at a time.

### ② PAN/BAL knob

The following parameter will change, according to the channel that is selected.

INPUT channel	TO STEREO PAN
ST IN channel	TO STEREO BALANCE
MIX (MONO x 2) channel	TO STEREO PAN
MIX (STEREO) channel	MIX BALANCE
MATRIX (MONO x 2) channel	Not displayed
MATRIX (STEREO) channel	MATRIX BALANCE
STEREO channel	STEREO BALANCE
MONO channel	Not displayed



- You can also access the TO STEREO/MONO popup window by moving the cursor to the PAN/BAL knob and pressing the [ENTER] key.

### ③ ST/MONO button (INPUT, ST IN, MIX channels only)

This switches the on/off status of the signal sent from that channel to the STEREO (L/R) bus and MONO (C) bus.

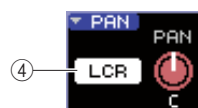

### ④ LCR button

If an INPUT, ST IN, or MIX channel is set to LCR mode, the LCR button is displayed in location ③. The LCR button is an overall on/off switch for the signals sent from the channel to the STEREO bus and MONO bus.

To adjust the pan/balance of each channel, use the ST/MONO button or the LCR button to select the send-destination bus, and operate the SELECTED CHANNEL section [PAN] encoder. (Alternatively, move the cursor to the PAN/BAL knob in the screen, and operate the dial or the [DEC]/[INC] keys.)



- If you want to make pan/balance settings for eight channels at a time, use the PAN popup button in the screen to access the TO STEREO/MONO popup window (→ p. 72). Alternatively, you can move the cursor to the PAN/BAL knob and press the [ENTER] key to access it.
- If you've turned on POPUP APPEARS WHEN PRESSING KNOBS in the PREFERENCE popup window (→ p. 194), you can also access the above popup window by pressing the SELECTED CHANNEL section [PAN] encoder.

## ● Making dynamics settings

To operate the dynamics of the currently selected channel, use the SELECTED CHANNEL section [DYNAMICS 1]/[DYNAMICS 2] encoder, and the DYNA1/DYNA2 field of the SELECTED CH VIEW screen.

### NOTE

- The DYNA 2 field of the SELECTED CH VIEW screen and the [DYNAMICS 2] encoder of the SELECTED CHANNEL section are valid only if an input channel is selected.

The DYNA1/DYNA2 field of the SELECTED CH VIEW screen contains the following items.



### ① DYNA1/DYNA2 popup buttons

These buttons access the DYNAMICS 1/DYNAMICS 2 popup window, where you can make detailed settings for dynamics.

### ② THRESH knob

This indicates the setting of the threshold parameter of a gate or compressor. To adjust the value, use the SELECTED CHANNEL section [DYNAMICS 1]/[DYNAMICS 2] encoder. (Alternatively, move the cursor to the knob and operate the dial or the [DEC]/[INC] keys.)

### ③ DYNAMICS ON/OFF button

These buttons turn dynamics processors 1/2 on/off.

### ④ OVER indicator

This will light if the output level of the dynamics reaches the overload point.

### ⑤ Level meter

This displays a bar graph indication of the signal level being input to the dynamics (on=green, off=gray) and the amount of gain reduction (orange). The threshold setting is shown as a vertical line.

### ⑥ Parameter knobs

These knobs indicate the values of parameters other than threshold.

To operate the dynamics, turn the DYNAMICS ON/OFF button on, and use the SELECTED CHANNEL section [DYNAMICS 1]/[DYNAMICS 2] encoders to adjust the threshold parameters. (Alternatively, move the cursor to the DYNA1/DYNA2 field, and operate the dial or the [DEC]/[INC] keys.)

To make detailed dynamics settings, move the cursor to the DYNA1/DYNA2 popup button or the DYNA1/DYNA2 field, and press the [ENTER] key to access the DYNAMICS 1/DYNAMICS 2 popup window. (For details on the popup window → p. 117)

### HINT

- If you've turned on POPUP APPEARS WHEN PRESSING KNOBS in the PREFERENCE popup window (→ p. 194), you can also access the above popup window by pressing the SELECTED CHANNEL section [DYNAMICS 1]/[DYNAMICS 2] encoder.

## ● Making HPF/EQ settings

To operate the HPF/EQ of the currently selected channel, use the SELECTED CHANNEL section EQ encoders, and the EQ field of the SELECTED CH VIEW screen. The EQ field of the SELECTED CH VIEW screen contains the following items.



### ① EQ popup button

This button accesses the ATT/HPF/EQ popup window, where you can make detailed HPF/EQ settings.

### ② EQ ON/OFF button

Switches the EQ on/off.

### ③ HPF ON/OFF button

Switches the HPF on/off.

### ④ HPF FREQ knob

Indicates the cutoff frequency of the HPF.

### ⑤ OVER indicator

This will light when the post-EQ signal reaches the overload point.

### ⑥ Q/F/G knobs

These knobs indicate the Q, F (center frequency), and G (amount of boost/cut) settings for each band (LOW, L-MID, H-MID, and HIGH).

To operate the EQ, switch the EQ ON/OFF button on, and use the EQ [Q], EQ [FREQUENCY], and EQ [GAIN] knobs of the SELECTED CHANNEL section to adjust the Q, center frequency, and the amount of boost/cut. (Use the EQ [HIGH], EQ [HIGH MID], EQ [LOW MID], and EQ [LOW] keys to select the band you want to operate.) Alternatively, move the cursor to the knobs of the EQ field in the screen, and use the dial or the [DEC]/[INC] keys.

To make detailed EQ settings, move the cursor to the EQ popup button or the knobs of the EQ field, and press the [ENTER] key to access the ATT/HPF/EQ popup window. (For details on the popup window → p. 115)

**HINT**

- You can also use the cursor keys to switch bands.
- If you've turned on POPUP APPEARS WHEN PRESSING KNOBS in the PREFERENCE popup window (→ p. 194), you can also access the above popup window by pressing an EQ encoder in the SELECTED CHANNEL section.

**NOTE**

- The type of the LOW band EQ or HIGH band EQ cannot be switched in the SELECTED CH VIEW screen. If necessary, you can access the ATT/HPF/EQ popup window and switch the EQ type.
- If the HIGH band EQ type is set to Low Pass Filter, the HIGH band Q knob will not be displayed, and the GAIN knob will function as an on/off switch for the Low Pass Filter.

**● Making insert settings (INPUT channels 1–32 and MIX/MATRIX/STEREO/MONO channels only)**

Use the INSERT field to make insert-related settings in the SELECTED CH VIEW screen. This field includes the following items.

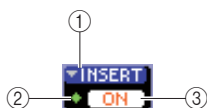

**① INSERT popup button**

This accesses the INSERT popup window, where you can assign input/output ports to insert-in/insert-out and specify the signal insertion points for eight channels at a time.

**② IN indicator**

This indicates the signal level of the input port that is patched to insert-in.

**③ INSERT ON/OFF button**

Switches the insert on/off.

To make insert settings, move the cursor to the INSERT popup button, and press the [ENTER] key to access the INSERT popup window. (For details on the popup window → p. 101)

When you've assigned input/output ports to insert-in/out in the popup window, turn on the INSERT ON/OFF button.

**● Making direct output settings (INPUT channels only)**

Use the DIRECT field to make direct-output related settings for an INPUT channel in the SELECTED CH VIEW screen. This field includes the following items.

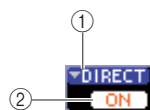

**① DIRECT popup button**

This button accesses the DIRECT OUT popup window, where you can assign an output port to the direct output and adjust the output level for eight channels at a time.

**② DIRECT OUT ON/OFF button**

Turns the direct output on/off.

To make direct output settings, move the cursor to the DIRECT popup button, and press the [ENTER] key to access the DIRECT OUT popup window. (For details on the popup window → p. 103)

When you've assigned an output port to direct output in the popup window, turn on the DIRECT OUT ON/OFF button.

**● Setting a channel to Recall Safe**

In the SELECTED CH VIEW screen, use the SAFE field to set the currently selected channel to the Recall Safe status (in which that channel will not be affected by Recall operations). This field includes the following items.

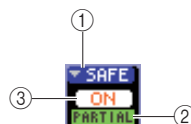

**① SAFE popup button**

This opens the RECALL SAFE screen, where you can make settings related to Recall Safe.

**② PARTIAL indicator**

This indicator will light if only some of the parameters of that channel are set to Recall Safe.

**③ RECALL SAFE ON/OFF button**

Switches the Recall Safe status on/off for the channel.

To set all parameters of the channel to Recall Safe mode, press the RECALL SAFE ON/OFF button to turn it on. If you want to set only specific parameters of the channel to Recall Safe mode, use the SAFE popup button to access the RECALL SAFE screen, and select the parameters that you want to be in Recall Safe mode. (For details on the RECALL SAFE screen → p. 140)

## ● Turning a channel on/off

Use the FADER field to switch the channel on/off in the SELECTED CH VIEW screen. This field includes the following items.

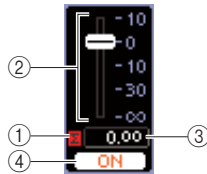

### ① $\Sigma$ CLIP indicator

This indicator will light if an overload occurs at even one of the level detection points in that channel.

### ② Fader

This indicates and adjusts the input/output level of the channel. This is linked with the fader on the top panel.

### ③ Input/output level

This indicates the current setting of the fader.

### ④ CH ON/OFF button

This button switches the channel on/off. This is linked with the [ON] button of the top panel.

When you press the CH ON/OFF button in the FADER field, that channel will be switched on/off. If you move the cursor to the fader and operate the dial or the [DEC]/[INC] keys, the level of that channel will change. If a fader layer that includes the corresponding channel is recalled to the top panel, the corresponding [ON] key and fader will be linked with these operations.

## ● Assigning a channel to a mute group

In the SELECTED CH VIEW screen, use the MUTE field to assign a channel to a mute group (a group that allows multiple channels to be muted/unmuted simultaneously). This field includes the following items.

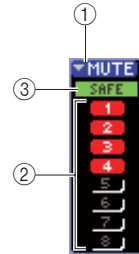

### ① MUTE popup button

This accesses the MUTE GROUP screen, where you can select the channels to be assigned to each mute group.

### ② MUTE buttons 1–8

These buttons select the mute group(s) to which this channel is assigned.

### ③ MUTE SAFE indicator

This will light if the corresponding channel is set to Mute Safe (the state in which it will not be affected by Mute operations). Mute Safe settings can be made in the MUTE GROUP screen.

To assign the channel to a mute group, turn on the desired mute button 1–8 (multiple selections are allowed). To check the channels that are assigned to each mute group, move the cursor to the MUTE popup button and press the [ENTER] key to access the MUTE GROUP screen. (For details on the MUTE GROUP screen → p. 121)





# ◆ Chapter 8 ◆

## Custom fader layer

This chapter explains how to assign the desired channels to the custom fader layer.

### About the custom fader layer

The channel module section and ST IN channel section on the top panel of the LS9 consists of four layers called “fader layers.”

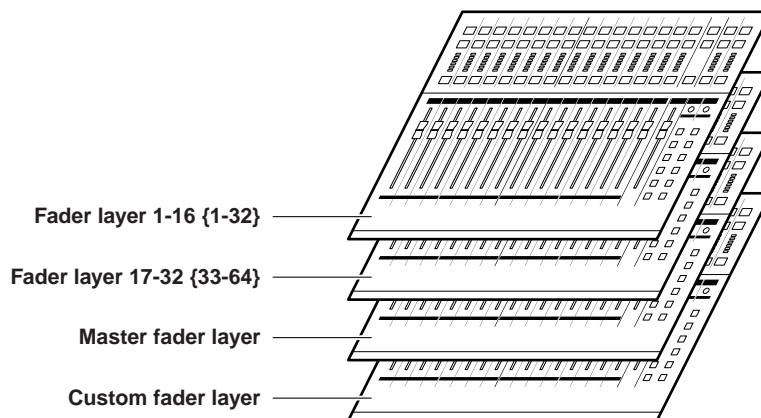

8  
Custom fader layer

When you switch between these fader layers, you are changing the channels that will be controlled by the faders, encoders, [ON] keys, and [SEL] keys of the channel module section and ST IN channel section. Use the keys of the LAYER section to switch fader layers.

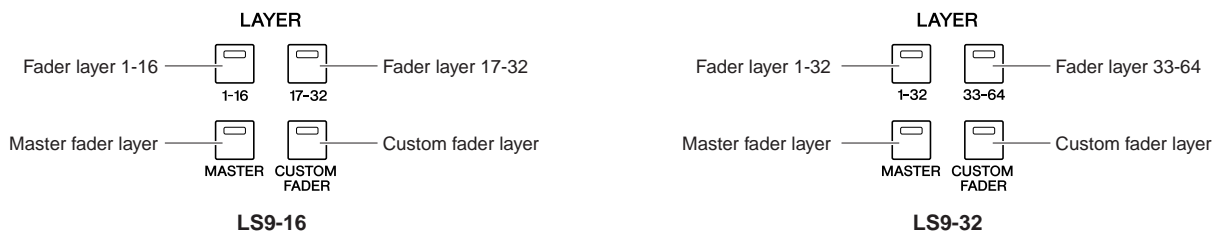

Of the above fader layers, channels are pre-assigned to fader layer 1-16 {1-32}, fader layer 17-32 {33-64}, and the master fader layer (→ p. 28).

However, you are free to assign desired channels to the custom fader layer that is recalled when you press the LAYER [CUSTOM FADER] key.

For example, INPUT channels belonging to different fader layers could be assigned to consecutive modules so that they can be operated together. Alternatively, input channels and output channels can both be assigned, so that you could simultaneously operate the send level from an INPUT channel to a specific MIX bus at the same time that you adjust the master level of that MIX bus itself.

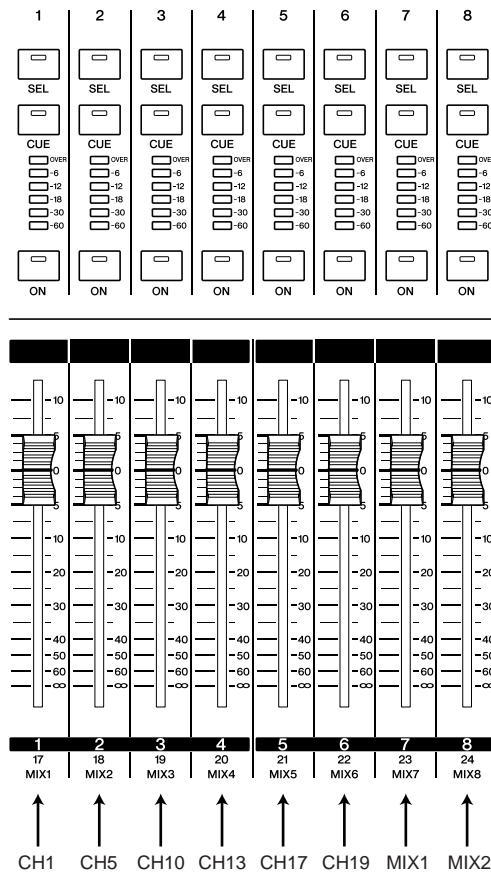

## Assigning channels to the custom fader layer

To assign the desired channels to the custom fader layer, proceed as follows.

- 1** In the DISPLAY ACCESS section, press the [SETUP] key repeatedly to access the USER SETUP screen.



① CUSTOM FADER LAYER popup button

- 2** Move the cursor to the CUSTOM FADER LAYER popup button in the screen, and press the [ENTER] key.

The CUSTOM FADER LAYER popup window will appear, allowing you to select the channel that will be assigned to each channel module or ST channel.



LS9-32

**① Channel module select field**

Select the channels that will be assigned to the top panel channel modules 1–16 {1–32}.

**② ST IN channel select field**

Select the channels that will be assigned to the top panel ST IN channels 1–2 {1–4}.

### 3 Move the cursor to the channel module select field or the ST IN channel select field, use the dial or the [DEC]/[INC] keys to select the channel that you want to assign to that field, and press the [ENTER] key.

The field will show the name of the selected channel.

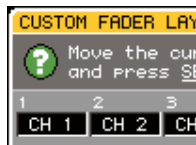

The following channels can be selected for each field.

- **Channels that can be selected in the channel module select field**

- INPUT channels 1–32 {1–64}
- ST IN channels 1–4
- STEREO channel
- MONO channels
- MIX channels 1–16
- MATRIX channels 1–8
- MONITOR LEVEL

If you select a ST IN channel 1–4 or the STEREO channel in the channel module select field, the L/R channels will be assigned together. In this case, the channel module will operate as follows.

- The fader and [ON] key will operate the L and R channels together.
- The L and R channels will be selected alternately each time you press the [SEL] key.
- The meter LEDs will indicate the signal level of the L or R channel, whichever level is greater.

If you select one of a pair of MIX/MATRIX channels set to stereo in the channel module select field, the channel module will operate as follows.

- The fader and [ON] key will operate the two MIX/MATRIX channels together.
- Pressing the [SEL] key will select only the MIX/MATRIX channel that you assigned.
- The meter LEDs will indicate the signal level of the L or R channel, whichever level is greater.

- **Channels that can be selected in the ST IN channel select field**

- ST IN channels 1–4



- As an alternative to using the dial or the [DEC]/[INC] keys, you can move the cursor to the field you want to edit and press a [SEL] key to select a channel.

### 4 Assign channels to other fields in the same way.

### 5 To recall the custom fader layer you've created, press the LAYER [CUSTOM FADER] key in the LAYER section.

The channels you selected in step 3 will be assigned to the channel module section and ST IN channel section of the panel.



- Custom fader layer settings are remembered for each user. When a user logs-in, their previous settings will be reproduced.



## Input/output patching

This chapter explains how to edit the input patching and output patching, how to connect inserts, and how to use direct outputs.

### Changing the output patching

When the LS9 is in the initial state, the output ports (jacks and internal ports) are patched to the following output channels.

#### For the LS9-16

Output port (jack / internal port)	Output channels
OMNI OUT jacks 1–6	MIX channels 1–6
OMNI OUT jacks 7–8	STEREO L/R channel
Slot output channels 1–8	MIX channels 1–8
Slot output channels 9–16	MIX channels 9–16
Rack inputs 5A (L), 6A (L), 7A (L), 8A (L)	MIX channels 13–16
2TR OUT DIGITAL jack (L/R)	STEREO L/R channel
USB memory recorder input (L/R)	STEREO L/R channel

#### For the LS9-32

Output port (jack / internal port)	Output channels
OMNI OUT jacks 1–12	MIX channels 1–12
OMNI OUT jacks 13–14	MATRIX channels 1–2
OMNI OUT jacks 15–16	STEREO L/R channel
Slot 1 output channels 1–8	MIX channels 1–8
Slot 1 output channels 9–16	MIX channels 9–16
Slot 2 output channels 1–8	MIX channels 1–8
Slot 2 output channels 9–16	MIX channels 9–16
Rack inputs 5A (L), 6A (L), 7A (L), 8A (L)	MIX channels 13–16
2TR OUT DIGITAL jack (L/R)	STEREO L/R channel
USB memory recorder input (L/R)	STEREO L/R channel

However, the above patching can be modified as needed. If you want to change the output patching, you can either select the output port that will be the output destination for each channel, or you can select the channel that will be the output source for each output port.

#### ● Selecting the output port for each output channel

Here's how to select the output port that will be the output destination for each output channel.

- 1 Press the [HOME] key to access the **SELECTED CH VIEW** screen, and use the [SEL] keys to select an output channel.

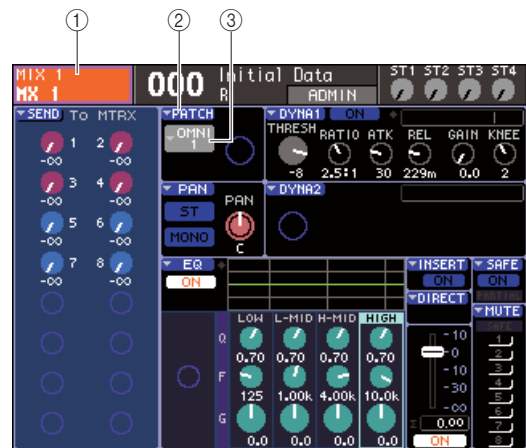

- ① Channel number / Channel name
- ② PATCH popup button
- ③ Port select popup button



- As an alternative to using the PATCH popup button, you can also select the output port in the PATCH/NAME popup window that appears when you move the cursor to the port select popup button and press the [ENTER] key (→ p. 69).

**2 Move the cursor to the PATCH popup button in the screen, and press the [ENTER] key.**

The HA/PATCH popup window will appear. This popup window shows the output port assigned to the output channels, in groups of eight channels.



**① Channel number**

This is the number of the output channel.

**② Channel name**

These are the names of each channel.

**③ Port select popup button**

This button selects the output port assigned to the channel. The currently selected output port is shown.



• Even if multiple output ports are assigned, only one output port is shown.

**3 Make sure that the cursor is located at the output port for the desired channel, and press the [ENTER] key.**

The OUTPUT PORT SELECT popup window will appear, allowing you to select the output port for the output channel.

This popup window contains the following items.



LS9-16

**① Category tab**

This selects the type of output ports that are shown in the lower part of the popup window. Each tab corresponds to the following output ports.

**● OMNI/2TR OUT**

Shows the OMNI OUT jacks 1–8 {1–16} and 2TR OUT DIGITAL jack.

**● SLOT {1/2}**

Shows output channels 1–16 of the slot(s) {1/2}.

**● RACK**

Shows the inputs of racks 1–8. Use this when you want to send the signal of an output channel to the input of a GEQ or effect.



• For details on GEQ and effects, refer to p.157.

**● REC IN**

Shows the input of the USB memory recorder. Use this when you want to send the signal of an output channel to the input of the USB memory recorder.

**② Port select button**

This selects the output port that is assigned to the corresponding channel.

**③ Level indicator**

This indicates the state of the port's signal using the following colors.

- -60 dB or below ..... black
- -60 dB to -18 dB ..... green
- -18 dB to 0 dB ..... yellow
- OVER ..... red'

**4 Move the cursor to the desired tab in the upper part of the window, and press the [ENTER] key.**

The type of ports shown in the lower part of the window will change according to the tab you selected.

**5 Move the cursor to the desired port select button, and press the [ENTER] key.**

That port will be selected as the output destination. You can select more than one output port.

**6 Move the cursor to the CLOSE button and press the [ENTER] key to return to the previous screen.**



• As an alternative to using the CLOSE button, you can return to the previous screen by pressing the SELECTED CHANNEL section [HOME] key once.

**7 If necessary, perform the same steps for other output channels.**



● **Selecting the output channel for each output port**

Here's how to select the output channel that will be the output source for each output port.

- 1 In the **DISPLAY ACCESS** section, press the **[SETUP]** key repeatedly to access the **SYSTEM SETUP** screen.

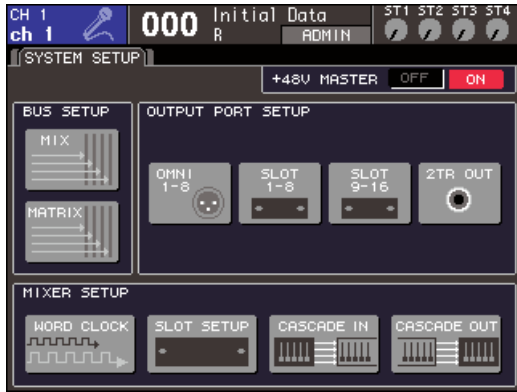

LS9-16



LS9-32

In the **OUTPUT PORT SETUP** field in the center of the screen, you can select the output port assigned to the output channel from the following choices.

- **OMNI 1-8 {1-8/9-16}**  
Select the output channels assigned to OMNI OUT jacks 1-8 {1-16}.
- **SLOT {1/2} 1-8/9-16**  
Select the output channels assigned to output channels 1-16 of the slot(s) {1/2}.
- **2TR OUT**  
Select the output channel assigned to the 2TR OUT DIGITAL jack.

- 2 In the **OUTPUT PORT SETUP** field, move the cursor to the button for the output ports that you want to set, and press the **[ENTER]** key.

The **OUTPUT PORT** popup window will appear, allowing you to make output port settings.

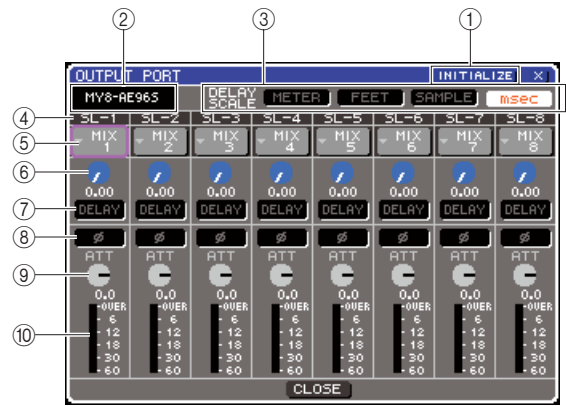

① **INITIALIZE button**

This initializes the settings for the displayed output ports. When you move the cursor to this button and press the **[ENTER]** key, a dialog box will ask you to confirm the Initialize operation.

② **I/O card type**

If the output channel of a slot is selected for operations, this area indicates the type of I/O card installed in that slot.

③ **DELAY SCALE field**

Use the following buttons to select the units for the delay time displayed below the delay time setting knob (⑥).

● **METER**

The delay time is displayed as a distance in meters, calculated as the speed of sound at an air temperature of 20°C (68°F) (343.59 m/s) × delay time (seconds).

● **FEET**

The delay time is displayed as a distance in feet, calculated as the speed of sound at an air temperature of 20°C (68°F) (1127.26 feet/s) × delay time (seconds).

● **SAMPLE**

The delay time is displayed in units of samples. If you change the sampling frequency on which the LS9 operates, the number of samples will change accordingly.

● **msec**

The delay time is displayed in units of milliseconds.

④ **Output port**

This is the type and number of the output port to which the channel is assigned.

⑤ **Channel select button**

This button selects the channel assigned to the output port. The number of the currently selected channel is shown.

⑥ **Delay time setting knob**

This knob sets the delay time of the output port. Move the cursor to this knob and use the dial or the [DEC]/[INC] keys to adjust the setting. The delay time value is shown below the knob, using the units selected in the DELAY SCALE field (③).

⑦ **DELAY button**

Switches the delay on/off for the output port.

⑧ **∅ (phase) button**

Switches the phase of the signal assigned to the output port between normal phase (black) and reverse phase (orange).

⑨ **ATT knob**

Adjusts the amount of attenuation/boost for the signal assigned to the output port. To change the setting, move the cursor to this knob in the screen, and use the dial or the [DEC]/[INC] keys. You can adjust the value in 1.0 dB steps in a range of -96 – +24 dB. The current value is shown immediately below the knob.

⑩ **Level meter**

This meter shows the signal level of the channel assigned to the output port.

**3 To assign a channel to an output port, move the cursor to the channel number field of that port, and press the [ENTER] key.**

The OUTPUT CH SELECT popup window will appear. This popup window contains the following items.



LS9-32

① **Category tab**

This selects the type of channel that will be shown in the lower part of the window. Each tab corresponds to the following channels.

● **OUT CH**

Output channels (MIX channels 1–16, MATRIX channels 1–8, STEREO L/R channel, and MONO (C) channel) will be shown.

● **MONITOR OUT**

The MONITOR OUT L/R/C channels will be shown.

● **CH 1-32 {1-32/33-64}**

INPUT channels 1–32 {1–64} will be shown.

② **Channel select button**

This selects the channel that is assigned to the output port.

**4 Use the category tabs and the channel select buttons to select the send-source channel.**

**5 Move the cursor to the CLOSE button and press the [ENTER] key to return to the previous screen.**

If PATCH is turned on in the CONFIRMATION field of the PREFERENCE popup window, a confirmation dialog box will appear when you attempt to modify the patching.

If STEAL PATCH is turned on, a confirmation dialog box will appear if you attempt to change a location that is already patched to another location. (For details, refer to → p. 194)



- If you assign CH 1-32 {1-32/33-64} to an output port, the selected INPUT channel will be output directly from the corresponding output port. In this case, the channel select button in the OUTPUT PORT popup window will indicate "DIR CH xx" (xx = channel number). (For details on direct output → p. 103)

**6 Make settings for delay, phase, and attenuator as necessary.**

**7 Repeat steps 3–6 to assign channels to other output ports.**

**8 When you've finished making settings, move the cursor to the CLOSE button (or to the × symbol in the upper right of the window), and press the [ENTER] key to return to the previous screen.**

# Changing the input patching

When the LS9 is in the initial state, the following input ports (jacks / internal ports) are patched to each input channel.

For the LS9-16

Input channels	Input port (jack / internal port)
INPUT channels 1–16	INPUT jacks 1–16
INPUT channels 17–32	Slot input channels 1–16
ST IN channels 1–4 (L/R)	Rack outputs 5–8 (L/R)

For the LS9-32

Input channels	Input port (jack / internal port)
INPUT channels 1–32	INPUT jacks 1–32
INPUT channels 33–48	Slot 1 input channels 1–16
INPUT channels 49–64	Slot 2 input channels 1–16
ST IN channels 1–4 (L/R)	Rack outputs 5–8 (L/R)

However, the above patching can be modified as needed. Here's how to change the patching of each input channel.

- 1 Press the [HOME] key to access the **SELECTED CH VIEW** screen, and use the [SEL] keys to select an input channel.



- 1 Channel number / Channel name
- 2 HA popup button
- 3 Port select popup button



As an alternative to using the HA popup button, you can also select the input port in the PATCH/NAME popup window that appears when you move the cursor to the port select popup button and press the [ENTER] key (→ p. 55).

- 2 Move the cursor to the HA popup button in the screen, and press the [ENTER] key.

The HA/PATCH popup window will appear. In this popup window, you can view the input port and name selected for each input channel, turn the phantom power on/off, adjust the gain, and switch between normal/reversed phase, in groups of eight channels.

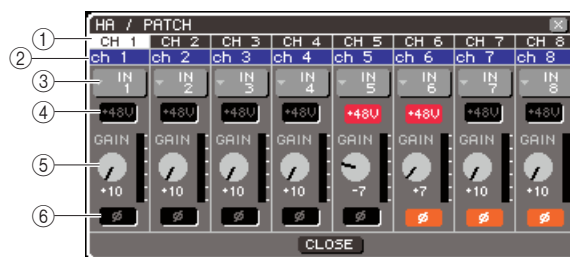

- 1 Channel number  
This is the number of the input channel.
  - 2 Channel name  
This is the name of the input channel.
  - 3 Port select popup button  
This button selects the input port assigned to the channel. The currently selected input port is shown.
  - 4 +48V button  
This button switches the phantom power on (red) or off (black) for the head amp assigned to that channel.
  - 5 GAIN knob  
This indicates the amount of gain for the head amp assigned to that channel. Move the cursor to the knob and use the dial or the [DEC]/[INC] keys to adjust the setting. The level meter located immediately to the right of the knob shows the input level of the corresponding port.
- NOTE**

  - The PAD will be internally switched on or off when the HA gain is adjusted between -14 dB and -13 dB. Keep in mind that noise may be generated if there is a difference between the Hot and Cold output impedance of the external device connected to the INPUT connector when using phantom power.
- 6 ∅ (phase) button  
This button switches the head amp assigned to that channel between normal phase (black) and reverse phase (orange).

**3 Move the cursor to the port select popup button for the desired channel, and press the [ENTER] key.**

The INPUT PORT SELECT popup window will appear, allowing you to select the input port for the input channel.

This popup window contains the following items.

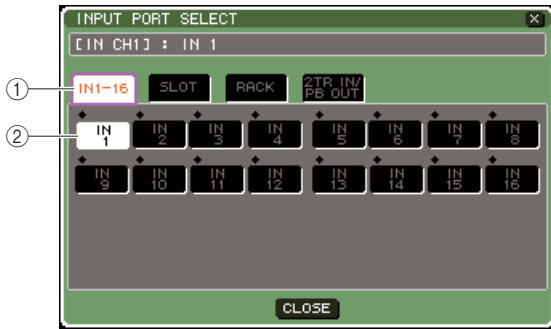

LS9-16

**① Category tab**

These tabs select the input ports that are shown in the popup window. Each tab corresponds to the following input ports.

● **IN 1-16 {1-32}**

Shows INPUT jacks 1–16 {1–32}.

● **SLOT {1/2}**

Shows input channels 1–16 of the slot(s) {1/2}.

● **RACK**

Shows the outputs of racks 1–8. Use this when you want to send the output of a GEQ or effect to an input channel.



• For details on GEQ and effects, refer to p.157.

● **2TR IN/PB OUT**

Shows the 2TR IN DIGITAL jack and the USB memory recorder's output. Use this when you want to send the input signal from the 2TR IN DIGITAL jack or the output signal of the USB memory recorder to an input channel.

**② Port select button**

This selects the input port that is assigned to the channel.

**4 Use the category tabs and the port select buttons to select the input-source port.**

**5 Move the cursor to the CLOSE button and press the [ENTER] key to return to the previous screen.**



• As an alternative to using the CLOSE button, you can return to the previous screen by pressing the SELECTED CHANNEL section [HOME] key once.

**6 If necessary, perform the same steps for other input channels.**

# Inserting an external device into a channel

If necessary, you can insert an internal effect/GEQ or an external device such as an effect processor into the signal path of INPUT channels 1–32 or any output channel (MIX, MATRIX, STEREO, MONO). When doing so, the type of input/output port used for the insertion and the signal patch location of the insertion can be specified individually for each channel.

Here we will explain how an external device connected to an I/O card in a slot can be inserted into the desired channel.

- 1 Connect your external device to the I/O card installed in a slot {1/2}.

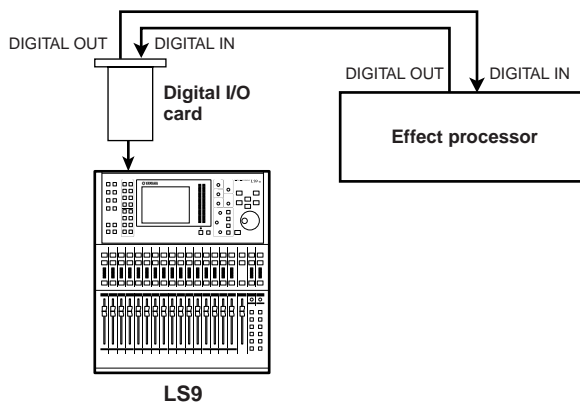

**NOTE**

- If you install a digital I/O card in a slot and digitally connect an external device, you must synchronize the word clock of the LS9 and the external device (→ p. 46).

- 2 Press the [HOME] key to access the SELECTED CH VIEW screen, and use the [SEL] keys to select the channel into which you want to insert an external device.



① INSERT popup button

- 3 Move the cursor to the INSERT popup button in the screen, and press the [ENTER] key.

**NOTE**

- For the INPUT channels, insert connections can be made only for channels 1–32. If an INPUT channel 33–64 is selected on the LS9-32, the INSERT popup button is not shown.

The INSERT popup window will appear. In this popup window, you can view the insert input/output port, change the insert position and switches the insert on/off, in groups of eight channels.



- ① Channel block diagram  
This shows the direct output position (only for INPUT channels) and the position of the insert connection for the selected channel.
- ② Channel number  
This is the channel number.
- ③ Channel name  
This is the channel name.
- ④ Insert point select box  
This selects the insert point for the signal. Move the cursor to this box and use the dial or the [DEC]/[INC] keys to switch between PRE EQ (immediately before the EQ), PRE FADER (immediately before the fader), or POST ON (immediately after the channel on/off).

⑤ **Output port select popup button**

⑥ **Input port select popup button**

These buttons select the output port and input port that are patched to insert-out and insert-in. The currently selected output port and input port are shown.

⑦ **INSERT ON/OFF button**

This button turns the insert on/off. To switch this on/off, move the cursor to this button and use the [DEC]/[INC] keys or the [ENTER] key.

**4 Move the cursor to the output port select popup button, and press the [ENTER] key.**

The OUTPUT PORT SELECT popup window will appear, allowing you to select the output port that will be patched to insert-out.

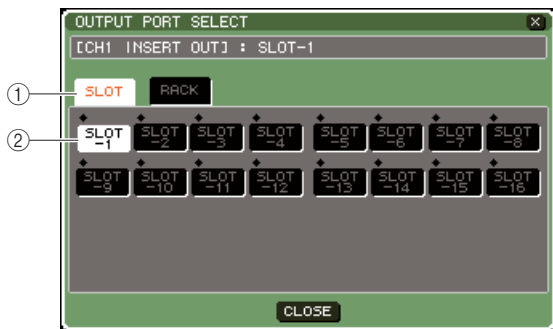

LS9-16

① **Category tab**

These tabs select the output ports that are shown in the popup window. Each tab corresponds to the following output ports.

● **SLOT {1/2}**

Shows output channels 1–16 of the slot(s) {1/2}.

● **RACK**

Shows the inputs of racks 1–8. Use these when you want to insert a GEQ or effect into that channel.

② **Port select button**

This selects the output port that is assigned to insert-out.

**5 Use the category tabs and the port select buttons to select the insert-out port.**

**6 Move the cursor to the CLOSE button and press the [ENTER] key to return to the previous screen.**



- After moving the cursor to the insert-out patch select box in step 4, you can also select the output port by using the dial or the [DEC]/[INC] keys instead of pressing the [ENTER] key.

**7 Move the cursor to the input port select popup button, and press the [ENTER] key.**

The INPUT PORT SELECT popup window will appear, allowing you to select the input port that will be patched to insert-in.

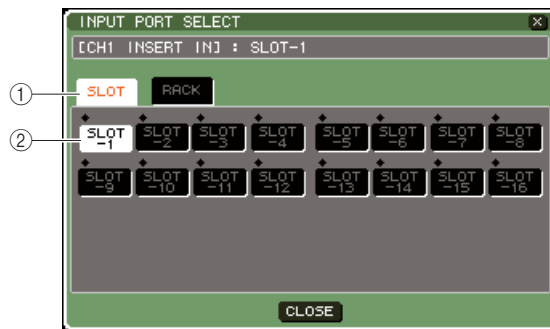

LS9-16

① **Category tab**

These tabs select the input ports that are shown in the popup window. Each tab corresponds to the following input ports.

● **SLOT {1/2}**

Shows input channels 1–16 of the slot(s) {1/2}.

● **RACK**

Shows the outputs of racks 1–8. Use these when you want to insert a GEQ or effect into the channel.

② **Port select button**

This selects the input port that is assigned to insert-in.

**8 Use the category tabs and the port select buttons to select the insert-in port.**

**9 Move the cursor to the CLOSE button and press the [ENTER] key to return to the previous screen.**

**10 Move the cursor to the insert point select box, and use the dial or the [DEC]/[INC] keys to select the insert point.**

You can select PRE EQ (immediately before the EQ), PRE FADER (immediately before the fader), or POST ON (immediately after the channel on/off).

**11 Move the cursor to the INSERT ON/OFF button, and press the [DEC]/[INC] keys or the [ENTER] key to turn it ON.**

This enables the insertion you specified.



# Directly outputting an INPUT channel

The signal of an INPUT channel can be output directly from the desired OMNI OUT jack or from the output channel of a desired slot. For example by sending signals to an external digital recorder via a digital I/O card installed in a slot, you can make a live recording without affecting the LS9's internal mixing.

- 1 Connect your external device to an OMNI OUT jack or to an I/O card installed in a slot {1/2}.

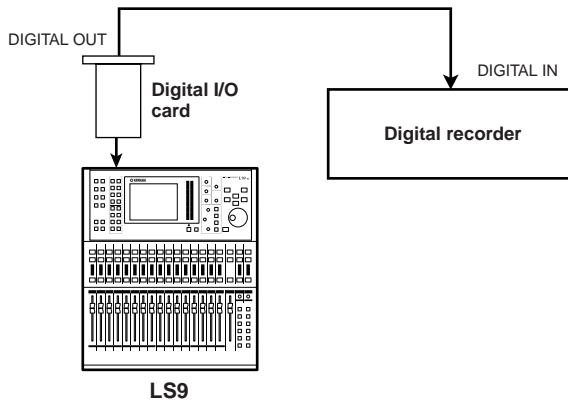

**NOTE**

If you install a digital I/O card in a slot and digitally connect an external device, you must synchronize the word clock of the LS9 and the external device (→ p. 46).

- 2 Press the [HOME] key to access the SELECTED CH VIEW screen, and use the [SEL] keys to select the INPUT channel from which you want to take a direct output.



- 1 DIRECT popup button

- 3 Move the cursor to the DIRECT popup button in the screen, and press the [ENTER] key.

The DIRECT OUT popup window will appear. In this popup window you can view the name of each channel, switch the direct output point, and adjust the output level, in groups of eight channels.



- 1 Channel block diagram

This shows the direct output point for the selected channel.

- 2 Channel number

This is the channel number.

- 3 Channel name

This is the channel name.

- 4 Direct out point select box

This selects the point from which the signal will be directly output. Move the cursor to this box and use the dial or the [DEC]/[INC] keys to switch between PRE HPF (immediately before the high pass filter), PRE EQ (immediately before the EQ), or PRE FADER (immediately before the fader).

- 5 DIRECT ON/OFF button

This button turns direct output on/off. To switch this on/off, move the cursor to this button and use the [DEC]/[INC] keys or the [ENTER] key.

- 6 Port select popup button

This button selects the output port that will be patched to direct output. The currently selected output port is shown.

- 7 DIRECT OUT LEVEL knob

This knob adjusts the level of the direct output.

**4 Move the cursor to the port select popup button, and press the [ENTER] key.**

The OUTPUT PORT SELECT popup window will appear, allowing you to select the output port that will be patched to direct output.

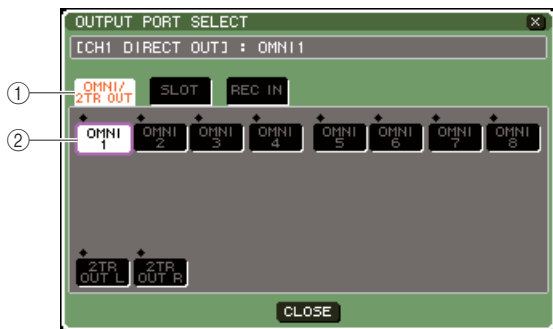

LS9-16

**① Category tab**

These tabs select the output ports that are shown in the popup window. Each tab corresponds to the following output ports.

● **OMNI / 2TR OUT**

Shows OMNI OUT jacks 1–8 {1–16} and 2TR OUT DIGITAL jack.

● **SLOT {1/2}**

Shows output channels 1–16 of the slot(s) {1/2}.

● **REC IN**

Shows USB memory recorder input channels.

**② Port select button**

This selects the output port that is assigned to direct output.

**5 Use the category tabs and the port select buttons to select the port that will be the direct output.**

**6 Move the cursor to the CLOSE button and press the [ENTER] key to return to the previous screen.**

**7 Move the cursor to the direct out point select box, and use the dial or the [DEC]/[INC] keys to select the direct out point.**

You can choose PRE HPF (immediately before the high-pass filter), PRE EQ (immediately before the EQ), or PRE FADER (immediately before the fader).

**8 Move the cursor to the DIRECT OUT ON/OFF button, and press the [DEC]/[INC] keys or the [ENTER] key to turn it ON.**

This enables the direct output you specified.

**9 As necessary, move the cursor to the DIRECT OUT LEVEL knob and use the dial or the [DEC]/[INC] keys to adjust the level of the direct output.**



• As an alternate method of specifying a direct output, you can select an INPUT channel as the output source of an output port (→ p. 98).

# ◆ Chapter 10 ◆

## USB memory recorder

This chapter explains how to use the USB memory recorder.

### About the USB memory recorder

The LS9 provides a USB memory recorder function that lets you easily record internal signals to USB memory, or play back audio files recorded on USB memory.

As the file format for recording, it uses MP3 (MPEG-1 Audio Layer-3). For playback, it supports MP3 as well as WMA (Windows Media Audio) and AAC (MPEG-4 AAC) files. However, DRM (Digital Rights Management) is not supported.

By using the USB memory recorder, the output from the STEREO bus or a MIX bus can be recorded to USB memory, or background music or sound effects saved in USB memory can be played back via an assigned input channel.

#### ■ Signal flow for the USB memory recorder

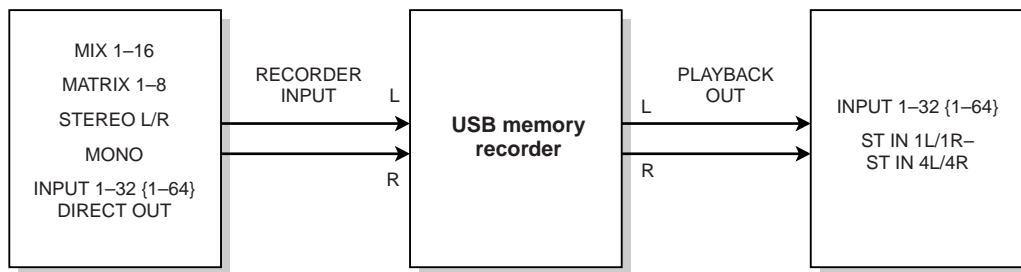

#### NOTE

- Recording and playback cannot be done simultaneously.
- The signal being recorded cannot be input to an INPUT channel.

## Assigning channels to the input/output of the recorder

Here's how to patch the desired channels to the input and output of the USB memory recorder. You can patch any desired output channel or the direct output of an INPUT channel to the recorder input, and you can patch the recorder output to any desired input channel.

### 1 In the DISPLAY ACCESS section, press the [RECORDER] key repeatedly to access the RECORDER screen.

In this screen you can assign signals to the input and output of the USB memory recorder, and perform recording and playback operations.

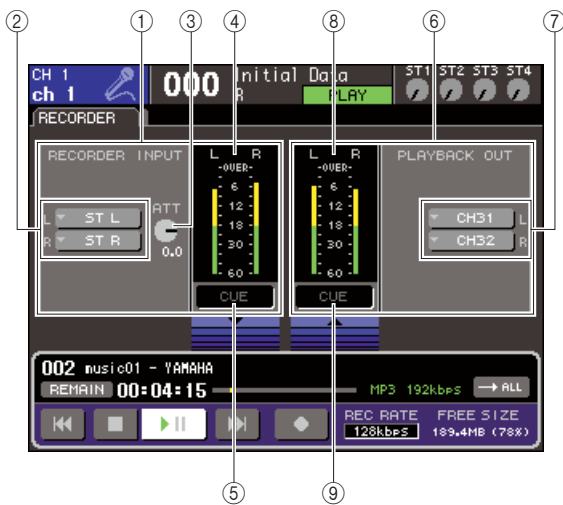

#### ① RECORDER INPUT field

Here you can make settings for the recorder inputs.

#### ② RECORDER INPUT popup buttons L/R

These buttons access the OUTPUT CH SELECT popup window, where you can patch channels to the L/R inputs of the recorder.

#### ③ ATT (attenuator) knob

This knob adjusts the amount of attenuation/boost for the signal that is input to the recorder. You can adjust the value in 0.1 dB steps in a range of -96 to +24 dB. The current value is shown immediately below the knob.

#### ④ Input level meter

This level meter indicates the level of the signal being input to the recorder.

#### ⑤ INPUT CUE button

This button cue-monitors the signal that is being input to the recorder. Move the cursor to the button and press the [ENTER] key to turn cue on/off.

#### ⑥ PLAYBACK OUT field

Here you can make settings for the recorder outputs.

#### ⑦ PLAYBACK OUT popup buttons L/R

These buttons access the INPUT CH SELECT popup window, where you can patch channels to the L/R outputs of the recorder.

#### ⑧ Output level meter

This level meter indicates the level of the signal being output from the recorder.

#### ⑨ OUTPUT CUE button

This button cue-monitors the signal that is being output from the recorder. Move the cursor to the button and press the [ENTER] key to turn cue on/off.

### 2 To assign channels to the recorder inputs, move the cursor to the RECORDER INPUT popup button L or R, and press the [ENTER] key.

The OUTPUT CH SELECT popup window will appear.



LS9-32

#### ① Category tabs

These tabs select the type of channels shown in the lower part of the window.

##### ● OUT CH

Output channels will be shown.

##### ● CH 1-32 {1-32/33-64}

Direct outputs of INPUT channels 1–32 {1–32/33–64} will be shown.

## ② Channel select buttons

Select the channels that will be assigned to the USB memory recorder's inputs, from the following choices.

- **MIX 1–16**

MIX channels 1–16

- **MTRX 1–8**

MATRIX channels 1–8

- **ST L/R**

STEREO channel L/R

- **ST L+C**

STEREO channel L mixed with the MONO (C) channel

- **ST R+C**

STEREO channel R mixed with the MONO (C) channel

- **MONO**

MONO channel

- **CH1–32 {1–64}**

Direct output of an INPUT channel 1–32 {1–64}

## 3 Use the category tabs and the port select buttons to select the channel that you want to patch to the USB memory recorder input.

If you select a channel to which another port is already patched, a dialog box will ask you to confirm the patch change. Move the cursor to the OK button of the dialog box and press the [ENTER] key.



- You cannot assign multiple channels to a single input.

## 4 When you've finished making the assignment, move the cursor to the CLOSE button and press the [ENTER] key.

You will return to the RECORDER screen.

## 5 Assign a channel to the other input in the same way.



- The USB memory recorder always records and plays back in stereo. If you want to record in monaural, with the same signal for left and right, you must assign both of the recorder inputs to the same channel.

## 6 To assign channels to the recorder outputs, move the cursor to the PLAYBACK OUT popup button L or R, and press the [ENTER] key.

The OUTPUT CH SELECT popup window will appear.

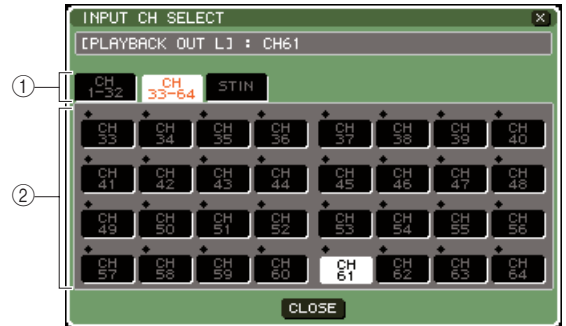

LS9-32

### ① Category tabs

These tabs select the type of channels shown in the lower part of the window.

- **CH 1-32 {1-32/33-64}**

INPUT channels 1–32 {1–32/33–64} will be shown

- **ST IN**

L/R channels of ST IN channels 1–4 will be shown.

### ② Channel select buttons

Select the channels that will be patched to the USB memory recorder's outputs, from the following choices.

- **CH 1–32 {1–64}**

INPUT channels 1–32 {1–64}

- **STIN 1L/1R–STIN 4L/4R**

L/R channels of ST IN channels 1–4

## 7 Use the category tabs and the channel select buttons to select the channel that you want to patch to the USB memory recorder input.

If you select a channel to which another signal is already patched, a dialog box will ask you to confirm the patch change. Move the cursor to the OK button of the dialog box and press the [ENTER] key.



- You can patch multiple channels to the recorder output.

## 8 When you've finished making the assignment, move the cursor to the CLOSE button and press the [ENTER] key.

You will return to the RECORDER screen.

## 9 Assign a channel to the other output in the same way.

# Recording to USB memory

Here's how to record the signal of the desired output channels as an audio file (MP3) onto the USB memory inserted in the USB connector located at the right of the display.

- 1** In the **DISPLAY ACCESS** section, press the **[RECORDER]** key repeatedly to access the **RECORDER** screen.



**① Audio file display field**

The track number, title, artist, format (MP3/WMA/AAC), and bit rate of during playback or the most recently played audio file are displayed.

**② REMAIN/ELAPSE button**

This button selects the content that is shown in the **TIME FIELD** (③). When you move the cursor to this button and press the **[ENTER]** key, the field will alternate between showing **REMAIN** (remaining time display) and **ELAPSE** (elapsed time display).

**③ TIME (remaining time / elapsed time) field**

According to the setting in (②), this shows either the remaining time that can be recorded to USB memory, or the elapsed time.

**④ Transport**

These buttons perform record/play/stop operations for the USB memory recorder.

**⑤ REC RATE (bit depth) button**

This selects the bit depth for recording.

**⑥ FREE SIZE field**

This indicates the amount of free capacity in USB memory, in terms of MB and as a percentage.

- 2** Connect USB memory with sufficient free capacity to the USB connector.

The **FREE SIZE** field indicates the amount of free capacity.

When you connect USB memory to the USB connector, a **YPE** folder and a **SONGS** folder within that **YPE** folder will be created automatically in the root directory of the USB memory.

The files created by recording operations will be saved in the above **SONGS** folder, or in the currently selected folder below that level.

For playback as well, you will only be able to play back audio files that are saved in the **SONGS** folder or in the currently selected folder below that level.

**■ USB memory folder structure**

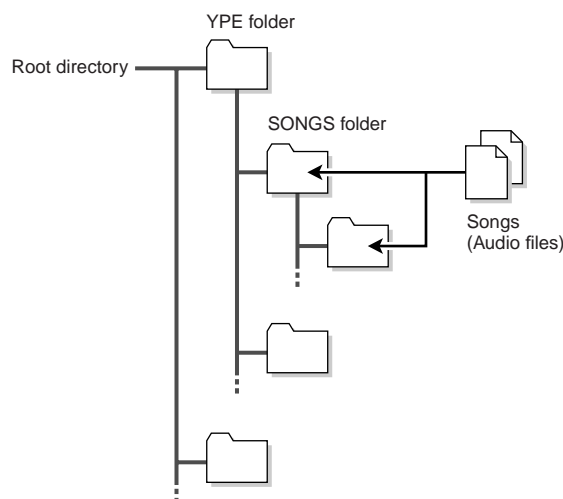

- 3** Assign the desired channels to the input and output of the USB memory recorder (→ p. 106).

- 4** So that you can monitor the signal being recorded on the recorder, raise the fader of the channel(s) that are patched to the input/output of the recorder.

The level meter in the **RECORDER** screen shows the signal level before and after the recorder. If necessary, use the **ATT** knob in the **RECORDER INPUT** field to adjust the input level to the recorder.

**NOTE**

- The signal being recorded will not be output from the recorder output jacks (**PLAYBACK OUT**).

**HINT**

- Operating the **ATT** knob will not affect the level of the signal being output to other ports from the corresponding output channel.

- 5** Move the cursor to the **REC RATE** field in the lower right of the screen, and use the dial or the **[DEC]/[INC]** keys to select the bit depth of the audio file that will be recorded.

You can choose 96 kbps, 128 kbps, or 192 kbps. Higher bit rates will improve the audio quality, but will increase the size of the data.

**HINT**

- The word clock rate at which the **LS9** is currently operating (44.1 kHz or 48 kHz) will automatically be selected as the sampling rate of the audio file.



## 6 Move the cursor to the REC button (●) at the bottom of the screen, and press the [ENTER] key.

You will use the transport at the bottom of the screen to perform record/play/stop operations for the recorder.

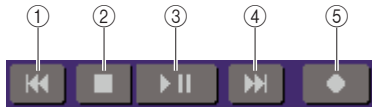

Each button has the following function.

### ① REW (⏮) button

- When you move the cursor to this button, and press and immediately release the [ENTER] key

You will return to the beginning of the song. If you were already at the beginning, you will return to the beginning of the preceding song in the title list (→ p. 110).

- When you move the cursor to this button, and press and hold the [ENTER] key for two seconds or longer

The song will rewind.

In either of the above cases, operating this button during playback will cause playback to resume from the current location when you release the [ENTER] key.

### ② STOP (■) button

- When you move the cursor to this button and press the [ENTER] key during playback

Playback will stop.

- When you move the cursor to this button and press the [ENTER] key during recording

Recording will stop, and the recorded content will be saved in a file (the file name and title will be assigned a default name).

- When you move the cursor to this button and press the [ENTER] key in record-ready mode

Record-ready mode will be defeated.

### ③ PLAY/PAUSE (▶||) button

- When you move the cursor to this button and press the [ENTER] key while stopped

Playback will start.

- When you move the cursor to this button and press the [ENTER] key during playback

Playback will pause.

- When you move the cursor to this button and press the [ENTER] key in record-ready mode

Recording will start.

- When you move the cursor to this button and press the [ENTER] key during recording

Recording will pause.

### ④ FF (▶▶) button

- When you move the cursor to this button, and press and immediately release the [ENTER] key

You will move to the beginning of the next song in the title list.

- When you move the cursor to this button, and press and hold the [ENTER] key for two seconds or longer

The song will be fast-forwarded.

In either of the above cases, operating this button during playback will cause playback to resume from the current location when you release the [ENTER] key.

### ⑤ REC (●) button

- When you move the cursor to this button and press the [ENTER] key while stopped

The recorder will be in record-ready mode, and the PLAY/PAUSE (▶||) button will blink.



- You can also assign the function of each button to a user-defined key (→ p. 196).

While stopped, move the cursor to the REC (●) button and press the [ENTER] key; the PLAY/PAUSE (▶||) button will blink, and the recorder will be in record-ready mode.

## 7 To begin recording, move the cursor to the PLAY/PAUSE (▶||) button in the lower part of the screen, and press the [ENTER] key.

During recording, the REC (●) button and the PLAY/PAUSE (▶||) button will light. The TIME field will indicate the elapsed time.

## 8 To stop recording, move the cursor to the STOP (■) button and press the [ENTER] key.

The audio file will be saved to USB memory.



- In the default state, the recorded audio file will be saved in the SONGS folder within the YPE folder. However, you may also specify a folder of a level below the SONGS folder.
- The recorded file will be given a default title and file name. You can change this later.

## 9 To audition the recorded content, proceed as follows.

- ① Move the cursor to the PLAY/PAUSE (▶||) button and press the [ENTER] key.

The recorded content will be played back via the input channel you specified in step 3.

- ② To stop playback, move the cursor to the STOP (■) button and press the [ENTER] key.

# Playing back audio files from USB memory

Here's how to play back audio files that have been saved on USB memory. In addition to files that were recorded on the LS9 console, you can also play files that were copied from your computer to USB memory.

Three types of audio file format can be played: MP3 (MPEG-1 Audio Layer-3), WMA (Windows Media Audio), and AAC (MPEG-4 AAC). The sampling rate can be either 44.1 kHz or 48 kHz, and the bit rate can be between 64 kbps and 320 kbps.

## 1 Connect the USB memory containing the audio files to the USB connector.

**NOTE**

- If you want to play back an audio file, you must save it in the SONGS folder within the YPE folder, or in a folder you've created below the SONGS folder. Files located in other folders and files of unsupported formats will not be recognized.

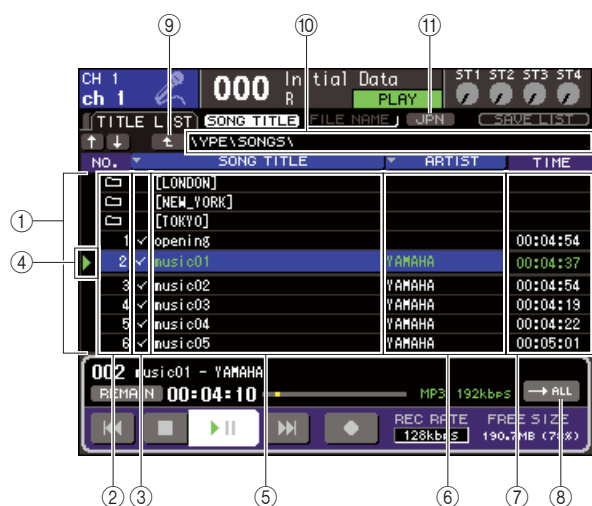

## 2 In the DISPLAY ACCESS section, press the [RECORDER] key repeatedly to access the TITLE LIST screen.



### ① Title list

This list shows the playable audio files and the folders that are saved in the selected folder of USB memory. The row with the blue background in the center of the list indicates the file/folder that is selected for operations.



### ② No. (track number)

This number indicates the order of each file for consecutive playback. If there is a lower-level folder, a folder icon (  ) is shown here. If an icon (  ) is shown here, it indicates that an upper level exists. Move the cursor to a displayed number and press the [ENTER] key to play back that audio file.

### ③ Playback selection check field

This field lets you select the files that will be played back during consecutive playback. When you move the cursor to this field and press the [ENTER] key, the check mark will alternately appear or disappear.

### ④ Status

This field shows a symbol to indicate whether the currently selected file is playing (  ) or paused (  ).

### ⑤ SONG TITLE/FILE NAME

This field shows the title or file name of the song. If the title is too long to be displayed, a “~” character is shown at the end.

### ⑥ ARTIST

This field shows the artist of the song. If the artist name is too long to be displayed, a “~” character is shown at the end.

### ⑦ TIME

This field shows the length of the song in hours : minutes : seconds.

### ⑧ MODE button

This button switches the playback mode. You can play back one song or all songs, and play them only once or repeatedly.

### ⑨ Change directory button

When you move the cursor to this button and press the [ENTER] key, the list will show the contents of the directory at the next higher level.

### ⑩ PATH (current path) field

This shows the full pathname of the folder (directory) that is currently selected as the recording destination and playback source.

### ⑪ JPN button

If this button is on, the titles or artist names in the list or of the currently-playing song will be displayed in Japanese characters compatible with Shift-JIS character encoding (double-byte code).

This setting will also be reflected in the RECORDER screen and in the TITLE/ARTIST EDIT popup window.

**3** You can use the change directory button in the screen and the folder icon in the No. field to view a content list of the folder that includes the desired file.

● **To move to a folder below**

Move the cursor to a folder icon shown in the No. field of the list, and press the [ENTER] key.



● **To move to the folder above**

Move the cursor to the change directory button and press the [ENTER] key.

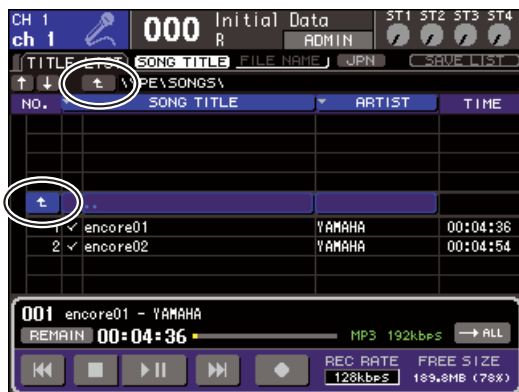

**HINT**

- When you move to a different folder in this way, that folder will automatically be selected as the recording-destination.

**NOTE**

- The folders that can be selected are restricted to the SONGS folder inside the YPE folder, and folders located below the SONGS folder.
- The LS9 can recognize a file name that is a maximum of 64 characters. If the file name is longer than this, the desired file may not play correctly.
- A maximum of 300 songs can be managed in a single directory. A maximum of 64 songs can be managed in a subdirectory.

**4** Operate the dial or the [DEC]/[INC] keys so that the desired file is shown in the center of the list.

**5** Move the cursor to the MODE button and press the [ENTER] key to select the playback mode.

The setting will alternate between the following four modes each time you press the [ENTER] key.



Starting with the currently selected song in the title list, songs will play back consecutively, and playback will stop at the last song in the list.



Starting with the currently selected song in the title list, songs will play back consecutively until the last song; then playback will return to the first song and will continue until you stop playback.



The currently selected song will play repeatedly until you stop playback.



The currently selected song will play once and then stop.

**6** If you selected a consecutive playback mode in step 5, move the cursor to the playback selection check field for each song you want to play, and press the [ENTER] key.

When performing consecutive playback, the files with a check mark will be played.

**7** Move the cursor to the PLAY/PAUSE (▶||) button and press the [ENTER] key.

The song you selected in step 4 will begin playing.

**HINT**

- The USB memory recorder can play back audio files whose sampling rate is 44.1 kHz or 48 kHz.
- Even if the sampling rate at which the LS9 is operating differs from the sampling rate of the audio file being played, the SRC (Sampling Rate Converter) function will automatically convert the rate so that the playback will be correct.

**NOTE**

- If or is selected as the playback mode, playback will continue until you stop playback.

**8** To stop playback, move the cursor to the STOP (■) button and press the [ENTER] key.

## Editing the title list

Here's how you can change the order of the audio files shown in the title list, and edit the titles or artist names.

- 1 Connect USB memory containing audio files to the USB connector.
- 2 In the DISPLAY ACCESS section, press the [RECORDER] key repeatedly to access the TITLE LIST screen.

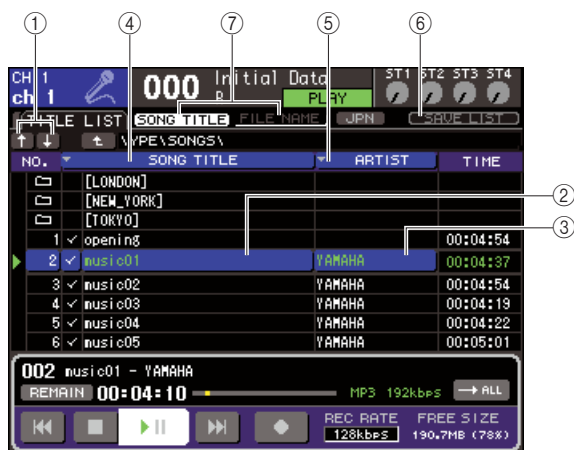

### ① ↑ / ↓ buttons

These buttons move the track number of the song selected in the list earlier (↑) or later (↓) in the list.

### ② SONG TITLE/FILE NAME EDIT button

This button lets you edit the title or file name of the song selected in the list.

### ③ ARTIST EDIT button

This button lets you edit the artist name of the song selected in the list.

### ④ TITLE SORT button

This button sorts the list in alphabetical order of the title.

### ⑤ ARTIST SORT button

This button sorts the list in alphabetical order of the artist name.

### ⑥ SAVE LIST button

This button saves the list sorting data to USB memory.

### ⑦ SONG TITLE/FILE NAME buttons

These buttons switch the items (title or file name) that are shown in the SONG TITLE/FILE NAME field.

- 3 Use the No. button and the change directory button in the screen to view a list of the contents of the folder that includes the desired file.

- 4 If you want to edit a title or file name in the title list, move the cursor to the SONG TITLE/FILE NAME EDIT button; if you want to edit the artist name, move the cursor to the ARTIST EDIT button; then press the [ENTER] key.

A popup window will appear, allowing you to edit the text.



### NOTE

- If the title or artist name contains characters that cannot be displayed, these characters will be converted into □ for display.
- The title and the artist name can be edited only for MP3 format audio files.

- 5 Edit the title or artist name.

A maximum of 128 single-byte characters (64 double-byte characters) can be input for both the title and for the artist name. (For details on entering characters → p. 34) If the text cannot be shown completely in the input field, the text will scroll horizontally.

- 6 Move the cursor to the OK button and press the [ENTER] key to close the popup window.

- 7 If necessary, use the SONG TITLE/FILE NAME SORT button, ARTIST SORT button, and ↑ / ↓ buttons in the screen to change the order of the title list.

Use the following buttons to change the order of the title list.

#### ● SONG TITLE/FILE NAME SORT button

When you move the cursor to this button and press the [ENTER] key, the title list will be sorted in numerical → alphabetical order by title. Each time you press the [ENTER] key, the list will alternate between ascending and descending order.

#### ● ARTIST SORT button

When you move the cursor to this button and press the [ENTER] key, the title list will be sorted in numerical → alphabetical order by artist name. Each time you press the [ENTER] key, the list will alternate between ascending and descending order.



• Two-byte code or Latin-1 (ISO-8859-1) code characters will not be sorted correctly.

● **↑ / ↓ buttons**

When you move the cursor to these buttons and press the [ENTER] key, the track number of the file currently selected in the title list will be moved upward or downward by one.

● **SAVE LIST button**

When you move the cursor to this button and press the [ENTER] key, the title list order and playback selections will be saved in USB memory. You should perform this operation if you want the title list to be preserved even after you disconnect the USB memory or turn off the power.

Since these settings are stored for each folder, a confirmation dialog box will ask you whether you want to save them if you move to a different folder.

## Linking scene recall with audio file playback

You can make link settings so that a specific audio file from USB memory is played back when you recall a certain scene. This is a convenient way to automatically play back a sound effect or background music at a certain point in the performance.

To link scene recall with audio file playback, proceed as follows.

- 1 **Connect the USB memory containing the audio file to the USB connector.**
- 2 **In the DISPLAY ACCESS section, press the [SCENE MEMORY] key repeatedly to access the SCENE PLAYBACK LINK screen.**

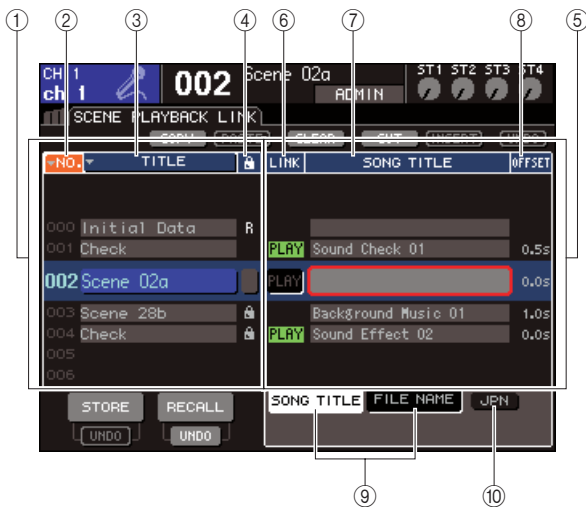

① **Scene list**

This is the list of scenes to which you can assign a song (audio file). The line with the blue background in the middle of the list is the scene that's selected for operation.

② **No. (scene number)**

③ **TITLE (scene title)**

④ **Protect**

These respectively indicate the scene number, title, and protect status.

⑤ **Song list**

This is the list of songs (audio files) that can be linked. The line with the blue background in the middle of the list is the file that's selected for operation.

⑥ **LINK**

This indicates whether linking from the scene to an audio file is enabled. The PLAY indicator is shown if linking is enabled. If the PLAY indicator is off even though a file is selected, the audio file will not play when scene recall occurs.

⑦ **SONG TITLE/FILE NAME field**

This shows the title or file name of the audio file.



• The audio file to be played must be saved in the SONGS folder within the YPE folder. Please note that you won't be able to specify a file that is in the root directory or another folder. When you execute playback, the path in the TITLE LIST screen will change to YPE\SONGS\.

• The file name is shown in black if the specified file no longer exists, and the song title or file name is shown in yellow if the file can no longer be recognized.

• The file specified for linking is distinguished by its eight-character file name + three-character extension. If you change the file name after specifying it for linking, or if you repeatedly delete and copy the file, there may be rare cases in which the linked file can no longer be recognized.

⑧ **OFFSET (Offset time)**

This shows the time from the recall operation until the corresponding audio file will begin playing.

⑨ **SONG TITLE/FILE NAME buttons**

These buttons select the item that is shown in the SONG TITLE/FILE NAME field.

⑩ **JPN button**

If this button is on, the song title will be displayed using Shift-JIS code (double-byte character code) to support Japanese.



• Other items in the SCENE PLAYBACK LINK screen are the same as in the SCENE LIST screen (→ p. 134).

- 3 **Operate the dial or the [DEC]/[INC] keys so that the scene to which you want to assign a song is displayed in the middle.**



**4** Move the cursor to the blue background area in the middle of the list SONG TITLE/ FILE NAME field, and press the [ENTER] key.

The SONG SELECT popup window will appear, allowing you to select an audio file.

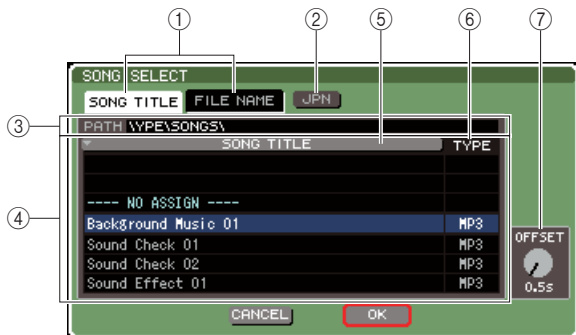

**1 SONG TITLE/FILE NAME buttons**  
These buttons select the item (song title or file name) that is shown in the song list.

**2 JPN button**  
If this button is on, the song title will be displayed using Shift-JIS code (double-byte character code) to support Japanese.

**3 PATH field**  
This indicates the path of the folder (\YPE\SONGS\ ) in which the audio files are saved. This cannot be changed.

**4 Song list**  
This shows the playable audio files in the SONGS folder.



- A maximum of 300 audio files can be displayed.
- Files other than playable audio files will not be displayed.

**5 SONG TITLE/FILE NAME button**  
When you move the cursor to this button and press the [ENTER] key, the song list will be sorted in alphanumeric order by song title or file name. Each time you press the [ENTER] key, the list will alternate between ascending and descending order.

**6 TYPE**  
This indicates the type of the audio file. The significance of this indication is as follows.

- **MP3** .....MPEG-1 Audio Layer-3
- **WMA** .....Windows Media Audio
- **AAC** .....MPEG4 AAC

**7 OFFSET (Offset time)**  
This specifies the time from the recall operation until the corresponding audio file begins to play.

**5** Operate the dial or the [DEC]/[INC] keys to scroll the song list so that the file you want to link to the scene is shown in the center with a blue background.

**6** If necessary, move the cursor to the OFFSET knob and use the dial or the [DEC]/[INC] keys to specify an offset time before the audio file will play back.

You can specify the offset time in a range of 0–99 seconds in 0.5 second units.

**7** Move the cursor to the OK button and press the [ENTER] key.

The popup window will close, and you will return to the SCENE PLAYBACK LINK screen. The title or file name of the file you selected will be displayed in the center of the song list.

Alternatively, if you select the CANCEL button instead of the OK button, the settings will be discarded and you will return to the SCENE PLAYBACK LINK screen.

**8** Move the cursor to the LINK field and press the [ENTER] key to turn on the link to the audio file.

The PLAY indicator will appear in the LINK field. The PLAY indicator will also appear in the STATUS field of the SCENE LIST screen.



**9** Repeat steps 3–8 to assign audio files to other scenes in the same way.



- As other ways to control audio file playback, you can use MIDI MMC commands for remote control from an external device (→ p. 186), or assign the DIRECT PLAY function to a user-defined key and play back the audio file directly (→ p. 196).

**10** Recall a scene to which you've linked an audio file.

After the offset time has elapsed, the audio file will play only once.



- When you recall the scene, the constant display area will show a count-down until the offset time has elapsed.
- You cannot play back during recording or in record-ready mode.
- If another song is playing when scene recall occurs, the currently-playing song will stop when recall occurs, regardless of the offset time setting.
- The linked audio file will be played only once, regardless of the playback mode setting.



# ◆ Chapter 11 ◆

## EQ and Dynamics

This chapter explains the EQ (equalizer) and dynamics that are provided on each channel of the LS9.

### About EQ and dynamics

Each input channel and output channel of the LS9 provides a four-band EQ and dynamics. EQ can be used on all input channels and all output channels. An attenuator is provided immediately before the EQ, allowing you to adjust the level of the input signal. In addition, input channels provide a high-pass filter that is independent of the EQ.

Input channels provide two dynamics processors. Dynamics 1 can be used as gate, ducking, compressor, or expander. Dynamics 2 can be used as compressor, compander hard, compander soft, or de-esser. Output channels provide one dynamics processor, which can be used as compressor, expander, compander hard, or compander soft.

### Using EQ

This section explains the four-band EQ that is provided on input channels and output channels.

- 1 Press the **SELECTED CHANNEL** section [HOME] key.  
The SELECTED CH VIEW screen will appear in the display.



① EQ popup button

- 2 Use the **LAYER** section to select the desired fader layer.
- 3 Press a [SEL] key in the channel module section, **STEREO MASTER** section, or **ST IN** section to select the channel that you want to operate.
- 4 In the screen, move the cursor to the **EQ popup button** or any knob in the EQ field, and press the [ENTER] key.

The ATT/HPF/EQ popup window will appear. In the ATT/HPF/EQ popup window you can view and edit all EQ parameters of the currently selected channel.



- If you've turned on **POPUP APPEARS WHEN PRESSING KNOBS** in the **PREFERENCE** popup window (→ p. 194), you can access the above popup window by pressing either of the EQ [Q], EQ [FREQUENCY], or EQ [GAIN] encoders while the **SELECTED CH VIEW** screen is shown.

The window contains the following items.

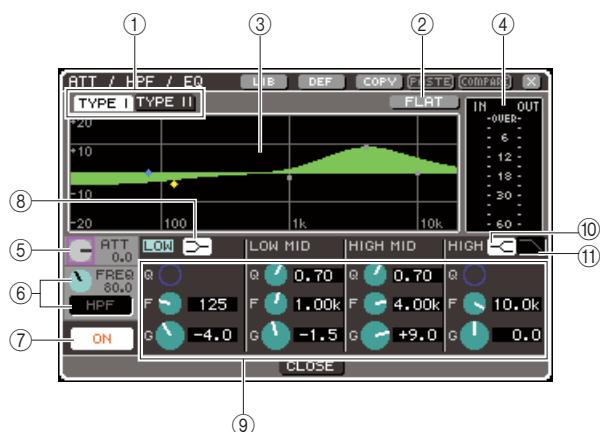

### ① TYPE I, II buttons

These buttons select the EQ type. If the TYPE I button is on, the EQ will use the same algorithm as previous Yamaha digital mixers; if the TYPE II button is on, a newly-developed algorithm will be used. Using TYPE II will reduce interference between bands.

### ② FLAT button

This button resets the GAIN parameter of all bands to the initial value (0.0 dB). When you move the cursor to this button and press the [ENTER] key, a dialog box will ask you to confirm the operation.

### ③ EQ graph

This graph shows the approximate response of the EQ parameters. A pointer is shown at the peak of each band. Operating the Q, FREQ, or GAIN knobs of each band will change the response curve accordingly. If EQ or high-pass filter is on, the response curve will be highlighted.

### ④ Level meter

This meter indicates the peak level before the EQ and after the EQ. If the signal has overloaded before or after the EQ, the OVER segment will light. If the corresponding channel is stereo (a ST IN channel, a MIX channel / MATRIX channel that is set to stereo, or the STEREO channel), level meters for two channels will be displayed.

### ⑤ ATT knob

This knob specifies the amount of attenuation/gain before entering the EQ, in a range of -96 dB—+24 dB. Use this to compensate for level changes caused by the EQ.

### ⑥ HPF FREQ knob, HPF ON/OFF button (input channels only)

This knob and button let you adjust the cutoff frequency of the high-pass filter placed immediately after the attenuation and before the EQ, and switch it on/off. The cutoff frequency can be adjusted in a range of 20–600 Hz.

### ⑦ EQ ON/OFF button

This switches the EQ on/off.

### ⑧ LOW shelving button

If this button is on, the LOW band EQ will switch to a shelving type. In this case, the LOW band Q knob will not be shown.

### ⑨ Q/FREQ/GAIN knobs

For each of the LOW, LOW MID, HIGH MID, and HIGH bands, these knobs adjust the Q (steepness), FREQ (center frequency), and GAIN (amount of boost/cut).



- You can move the cursor to one of the knobs in ⑨ and press the [ENTER] key to switch the EQ on/off.

### ⑩ HIGH shelving button

If this button is on, the HIGH band EQ will switch to a shelving type. In this case, the HIGH band Q knob will not be shown.

### ⑪ Low pass filter button

If this button is on, the HIGH band EQ will operate as a low-pass filter. In this case, the HIGH band Q knob will not be shown, and the GAIN knob will operate as a switch that turns the low-pass filter on/off.

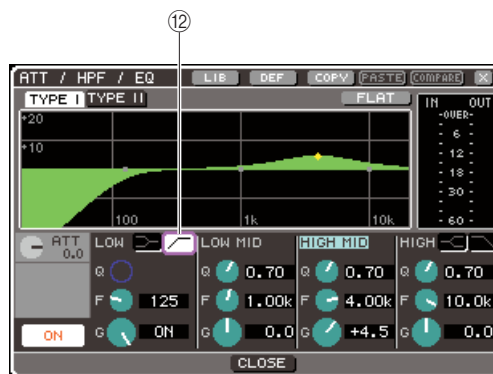

### ⑫ High-pass filter button (output channels only)

If this button is on, the LOW band EQ will operate as a high-pass filter. In this case, the LOW band Q knob will not be shown, and the GAIN knob will operate as a switch that turns the high-pass filter on/off.

## 5 To turn the EQ on/off, move the cursor to the EQ ON/OFF button and press the [ENTER] key.

If you want to make settings in the ATT/HPF/EQ popup window, move the cursor to the desired button/knob and use the [ENTER] key, the dial, or the [DEC]/[INC] keys.



- You can also adjust the Q, center frequency, and boost/cut amount using the EQ [Q], EQ [FREQUENCY], and EQ [GAIN] encoders of the SELECTED CHANNEL section. In this case, use the EQ [HIGH], EQ [HIGH MID], EQ [LOW MID], and EQ [LOW] keys to select the band that you want to adjust. You can also switch EQ bands for editing by moving the cursor onto a parameter of the desired band.

## 6 If you want to use the high-pass filter on an input channel, operate the HPF FREQ knob or HPF ON/OFF button in the ATT/HPF/EQ popup window.

Input channels provide a high-pass filter that is independent of the four-band EQ. Use the HPF ON/OFF button to switch the high-pass filter on/off, and use the HPF FREQ knob to specify the cutoff frequency.

### HINT

- Output channels do not provide a high-pass filter that is independent of the EQ. However by turning on the high-pass filter button in the popup window, you can use the LOW band EQ as a high-pass filter.
- For both input channels and output channels, you can turn on the low-pass filter button and use the HIGH band EQ as a low-pass filter.

## 7 If you want to initialize EQ settings or copy them to another channel, use the tool buttons in the ATT/HPF/EQ popup window.

For details on how to use these buttons, refer to “Using the tool buttons” (→ p. 35).

### HINT

- You can also use a dedicated library to save or load EQ settings at any time (→ p. 120). You can also take advantage of a wide variety of presets suitable for various instruments or situations.
- You can also use the encoders of the SELECTED CHANNEL section to adjust the EQ or high-pass filter (→ p. 87).

# Using dynamics

Input channels provide two dynamics processors, and output channels provide one dynamics processor.

## 1 Press the SELECTED CHANNEL section [HOME] key.

The SELECTED CH VIEW screen will appear in the display.

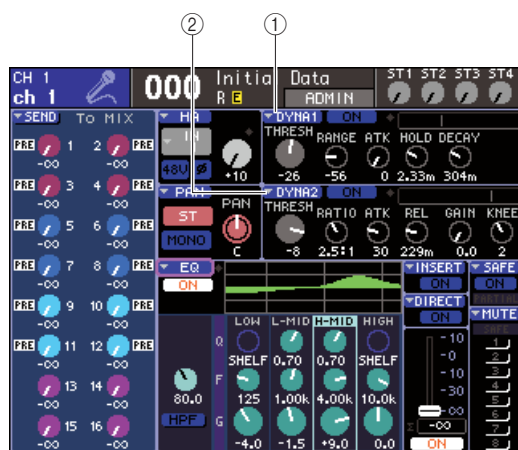

- ① DYN1 popup button
- ② DYN2 popup button (input channels only)

## 2 Use the LAYER section to select the desired fader layer.

## 3 Press a [SEL] key in the channel module section, STEREO MASTER section, or ST IN section to select the channel that you want to operate.

## 4 In the screen, move the cursor to the DYNA1/DYNA2 popup button or any knob in the DYNA1/DYNA2 field, and press the [ENTER] key.

The DYNAMICS 1/DYNAMICS 2 popup window will appear. In this popup window you can view and edit all dynamics parameters of the currently selected channel.

### HINT

- If you've turned on POPUP APPEARS WHEN PRESSING KNOBS in the PREFERENCE popup window (→ p. 194), you can also access the above popup window by pressing any of the [DYNAMICS 1]/[DYNAMICS 2] encoders while the SELECTED CH VIEW screen is shown.

The window contains the following items.

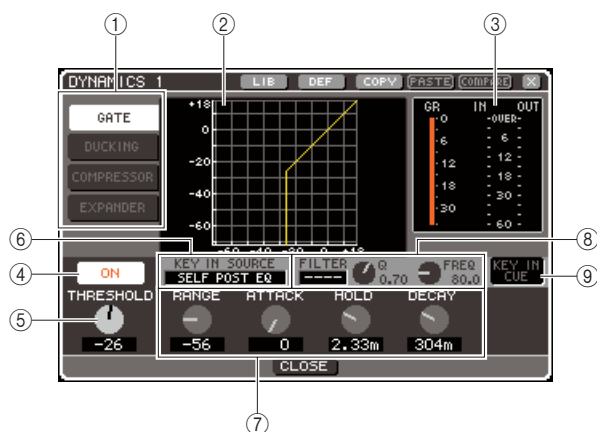

**① Dynamics type buttons**

Use these buttons to select one of the following four types of dynamics.

**Input channels**

DYNAMICS 1	GATE
	DUCKING
	COMPRESSOR
	EXPANDER
DYNAMICS 2	COMPRESSOR
	COMPANDER-H
	COMPANDER-S
	DE-ESSER

**Output channels**

DYNAMICS 1	COMPRESSOR
	EXPANDER
	COMPANDER-H
	COMPANDER-S



- For details on dynamics types, refer to the appendix at the end of this manual (→ p. 229).

**② Dynamics graph**

This graph shows the approximate response of dynamics processing.

**③ Level meters**

These meters show the amount of gain reduction (GR), and the peak levels before the gate (IN) and after the gate (OUT). If the signal has overloaded, the OVER segment will light. If the corresponding channel is stereo (a ST IN channel, a MIX channel / MATRIX channel that is set to stereo, or the STEREO channel), level meters for two channels will be displayed.

**④ DYNAMICS ON/OFF button**

This switches dynamics on/off.

**⑤ THRESHOLD knob**

This specifies the threshold level at which dynamics will operate.

**⑥ KEY IN SOURCE box**

You can select a key-in signal in this box. For details on the procedure, refer to step 6.

**⑦ Other parameters**

This area shows other dynamics parameters. The parameters shown will depend on the currently selected dynamics type.



- For details on parameters, refer to the appendix at the end of this manual (→ p. 229).
- You can switch dynamics on/off by moving the cursor to one of the knobs in ⑤ or ⑦ and pressing the [ENTER] key.

**⑧ KEY IN FILTER field (GATE and DUCKING only)**

This field lets you apply a filter to the key-in signal. This field provides a FILTER box that lets you select the filter type, a Q knob (which adjusts the Q of the filter), and a FREQ knob (which adjusts the cutoff frequency or center frequency).

To change the filter type, move the cursor to the FILTER BOX and use the dial or the [DEC]/[INC] keys to select either HPF (high-pass filter), BPF (band-pass filter), or LPF (low-pass filter); then press the [ENTER] key. If you select “----” in the FILTER box, no filter will be applied.



- After changing the type of filter in the FILTER box, be sure to press the [ENTER] key to apply the change.

**⑨ KEY IN CUE (GATE and DUCKING only)**

This button lets you cue-monitor the currently selected key-in signal.



- Even if you've selected MIX CUE mode (when all channels whose [CUE] key is on will be mixed for monitoring) as the cue mode, turning on the KEY IN CUE button will give priority to monitoring only the corresponding signal. All [CUE] keys that had been turned on at that time will be forcibly defeated.
- KEY IN CUE will automatically be cancelled when you exit the corresponding screen.

**5 To turn dynamics on/off, move the cursor to the DYNAMICS ON/OFF button and press the [ENTER] key.**

If you want to make settings in the DYNAMICS 1/ DYNAMICS 2 popup window, move the cursor to the desired button/knob and use the [ENTER] key, the dial, or the [DEC]/[INC] keys.



- You can also adjust the dynamics threshold by using the [DYNAMICS 1]/[DYNAMICS 2] encoders of the SELECTED CHANNEL section.

## 6 Select the key-in signal as necessary.

You can select one of the following as the key-in signal.

### For an input channel

<b>SELF PRE EQ</b>	The signal immediately before the EQ (attenuator) of the currently selected input channel
<b>SELF POST EQ</b>	The signal immediately after the EQ of the currently selected input channel
<b>CH 1–32 {64} POST EQ, STIN1L/1R–4L/4R POST EQ</b>	The signal immediately after the EQ of the corresponding input channel (*1)
<b>MIX OUT 13–16</b>	The signal immediately after the ON of the corresponding MIX channel

\*1: The signals that you can select are limited to the group to which that channel belongs, from the following five {nine} groups: CH 1–8, CH 9–16, CH17–24, CH25–32, {CH33–40, CH41–48, CH49–56, CH57–64}, and STIN1L1R–4L4R.

### For an output channel

<b>SELF PRE EQ</b>	The signal immediately before the EQ (attenuator) of the currently selected output channel
<b>SELF POST EQ</b>	The signal immediately after the EQ of the currently selected output channel
<b>MIX 1–16 POST EQ, MTRX1–8 POST EQ, ST L/R, MONO, POST EQ</b>	The signal immediately after the EQ of the corresponding output channel (*1)
<b>MIX OUT 13–16</b>	The signal immediately after the ON of the corresponding MIX channel

\*1: The signals that you can select are limited to the group to which that channel belongs, from the following four groups: MIX 1–8, MIX 9–16, MATRIX 1–8, and ST/MONO.



- If the dynamics type of DE-ESSER, the key-in signal is fixed at SELF POST EQ and cannot be changed.

To select the key-in signal, make your selection in the DYNAMICS 1/DYNAMICS 2 popup window.

- ① Move the cursor to the KEY IN SOURCE box, and use the dial or the [DEC]/[INC] keys to select the desired key-in signal. The newly selected key-in signal will blink.
- ② Press the [ENTER] key to confirm your selection of key-in signal.



- If you move the cursor out of the KEY IN SOURCE box while the key-in signal is blinking in the box, your change will be discarded, and the key-in signal setting will revert to the previous choice. To confirm your new choice of key-in signal, press the [ENTER] key without moving the cursor.

## 7 If you want to initialize dynamics settings or copy them to another channel, use the tool buttons in the DYNAMICS 1/DYNAMICS 2 popup window.

For details on how to use these buttons, refer to “Using the tool buttons” (→ p. 35).



- You can also use a dedicated library to save or load dynamics settings at any time (→ p. 120). You can also take advantage of a wide variety of presets suitable for various instruments or situations.

## Using the EQ/Dynamics libraries

EQ or dynamics settings can be stored in or recalled from dedicated libraries.

### EQ library

The EQ library consists of an input EQ library that lets you store and recall EQ settings for input channels, and an output EQ library that lets you store and recall EQ settings for output channels.

To access each library, move the cursor to the LIB tool button in the ATT/HPF/EQ popup window and press the [ENTER] key.



For details on library operations, refer to “Using libraries” (→ p. 35).

#### HINT

- For both the input EQ library and the output EQ library, you can recall 199 settings from each library. Input EQ provides 40 read-only presets, and output EQ provides 3 read-only presets.
- For details on how to access the ATT/HPF/EQ popup window, refer to “Using EQ” (→ p. 115).

### Dynamics library

You can use the dynamics library to store and recall dynamics settings.

All of the LS9’s dynamics processors use this library. However, the types that can be selected will differ between dynamics 1 and dynamics 2 for input channels, and dynamics 1 for output channels. You can’t recall a type that cannot be used.

To access the dynamics library, move the cursor to the LIB tool button in the DYNAMICS 1/DYNAMICS 2 popup window, and press the [ENTER] key.

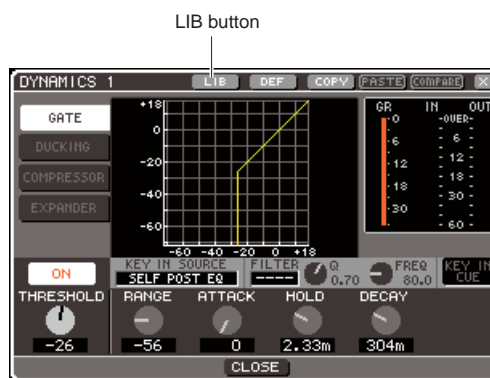

For details on library operations, refer to “Using libraries” (→ p. 35).

#### HINT

- You can recall 199 settings from this library. The library contains 41 read-only presets.
- For details on how to access the DYNAMICS 1/DYNAMICS 2 popup window, refer to “Using dynamics” (→ p. 117).



# ◆ Chapter 12 ◆

## Grouping and linking

This chapter explains the Mute Group function that lets you simultaneously control the muting of multiple channels, the Channel Link function that links the parameters of multiple channels, and the operations that let you copy or move parameters between channels.

### About mute groups

Mute groups allow you to switch muting on/off for multiple channels together. For example, you can use mute groups to cut out multiple non-adjacent channels simultaneously. The LS9 has eight mute groups, and they can be used with both input channels and output channels. Both types of channel can exist in the same group.

### Using mute groups

Here we will explain how to use mute groups. You will use the MUTE GROUP screen of the CHANNEL JOB screens to assign channels to each mute group or switch muting on/off. You can also use the SELECTED CH VIEW screen to specify the mute group(s) to which the currently selected channel belongs.



- Mute group 1–8 on/off functions can also be assigned to user-defined keys. For more about user-defined keys, refer to “User-defined keys” (→ p. 196).

#### Using the MUTE GROUP screen to operate mute groups

In the MUTE GROUP screen of the CHANNEL JOB screens, you can select a specific mute group and specify the channels that belong to that mute group. You can also switch each mute group on/off.

- 1** In the DISPLAY ACCESS section, press the [CHANNEL JOB] key repeatedly to access the MUTE GROUP screen of the CHANNEL JOB screens.

The [CHANNEL JOB] key accesses various CHANNEL JOB screens that allow you to perform operations on channels. The screen will change each time you press the key.

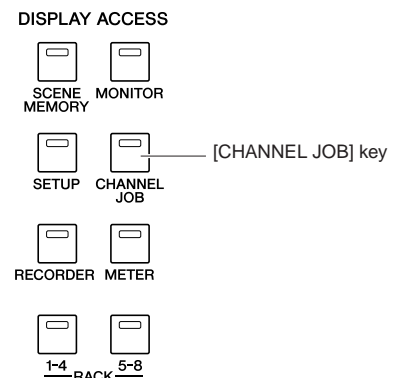

The MUTE GROUP screen of the CHANNEL JOB screen contains the following items.

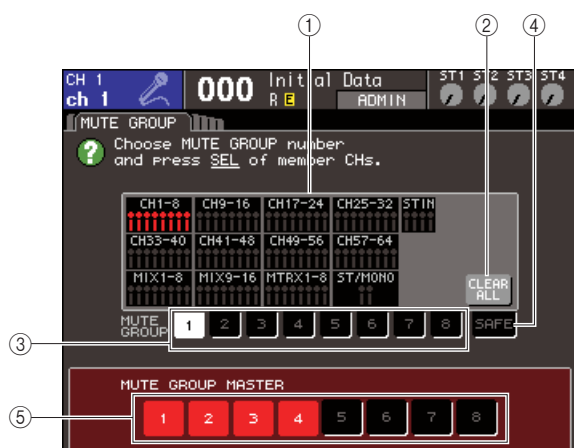

#### ① Channel display field

Channels assigned to the mute group selected by the 1–8 buttons are highlighted in red. If the SAFE button is selected, channels that are temporarily excluded from all mute groups are highlighted in green.

#### ② CLEAR ALL button

When you move the cursor to this button and press the [ENTER] key, all channels that are currently highlighted in the channel display field will be cleared.

#### ③ 1–8 buttons

These buttons select the mute group that is shown in the channel display field.

#### ④ SAFE button

Use this button when you want to temporarily exclude a specific channel from all mute groups. The channel display field shows the channels that are temporarily excluded from the mute groups. For more about mute safe, refer to “Using the Mute Safe function” (→ p. 123).

#### ⑤ MUTE GROUP MASTER buttons 1–8

These buttons switch muting on/off for mute groups 1–8.

**2 To select the mute group to which you want to assign channels, move the cursor to one of the 1–8 buttons and press the [ENTER] key.**

**3 Press the [SEL] key of the input channels / output channels (you may select more than one) that you want to assign.**

The [SEL] keys of the assigned channels will light. In the channel display field in the screen, the corresponding channels will also be highlighted in red. To cancel an assignment, press a lit [SEL] key once again to make it go dark.

**4 Assign channels to other mute groups in the same way.**



- You are free to assign the same channel to more than one mute group.

**5 To mute the channels assigned to a mute group, move the cursor to the MUTE GROUP MASTER 1–8 button for the desired mute group, and press the [ENTER] key (multiple selections are allowed).**

The selected MUTE GROUP MASTER button will light, and all channels belonging to that mute group will be muted. At this time, the [ON] key of the muted channels will blink.

**6 To defeat muting for a mute group, move the cursor to the MUTE GROUP MASTER button that you turned on in step 5, and press the [ENTER] key to make the button go dark.**



- Mute group assignments are saved as part of the scene. However, the mute on/off settings are not saved.



- If you assigned a mute group on/off function to a user-defined key, you can switch mute on/off by pressing the corresponding user-defined key to make it light or go dark.
- Even if a channel is assigned to a mute group, it will not be affected by mute on/off operations if its [ON] key was off to begin with.

## Using the SELECTED CH VIEW screen to specify mute groups

In the SELECTED CH VIEW screen you can select a specific channel and assign the mute group(s) to which that channel belongs (multiple assignments are allowed).



- In the SELECTED CH VIEW screen you can only assign mute groups. To switch muting on/off, you must either use the MUTE GROUP screen of the CHANNEL JOB screens (→ p. 121), or assign the mute on/off function to a user-defined key and operate that key (→ p. 196).

**1 Press the SELECTED CHANNEL section [HOME] key to access the SELECTED CH VIEW screen.**

## 2 Use the LAYER section keys and the [SEL] keys to select the channel whose mute group(s) you want to specify.

In the SELECTED CH VIEW screen you can use the MUTE field to specify the mute group(s) to which the currently selected channel belongs.



### ① MUTE field

This shows the mute groups to which the currently selected channel is assigned.

### ② MUTE popup button

When you move the cursor to this popup button and press the [ENTER] key, the MUTE GROUP screen of the CHANNEL JOB screen will appear. For details, refer to “Using the MUTE GROUP screen to operate mute groups” (→ p. 121).

### ③ Mute group select buttons 1–8

These select the mute group(s) to which the currently selected channel will be assigned.

### ④ SAFE indicator

This will light if the currently selected channel is set to Mute Safe. For more about mute safe, refer to “Using the Mute Safe function”.

## 3 To select the mute group(s) to which this channel will be assigned, move the cursor to a mute group select button and press the [ENTER] key (multiple selections are allowed).

## 4 Select the mute group(s) for other channels in the same way.

## Using the Mute Safe function

If necessary, specific channels registered to a mute group can be temporarily excluded from mute group operations (Mute Safe).

## 1 In the DISPLAY ACCESS section, press the [CHANNEL JOB] key repeatedly to access the MUTE GROUP screen of the CHANNEL JOB screens.

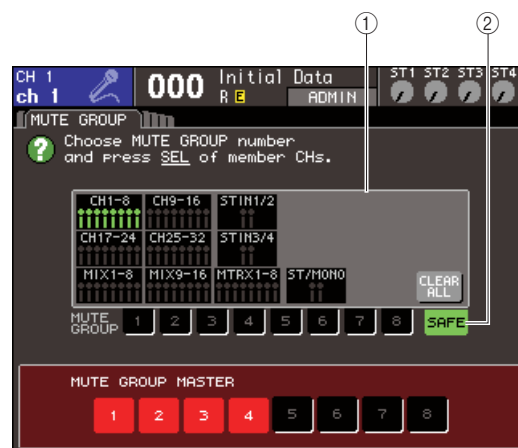

### ① Channel display field

When the SAFE button is on, channels that are temporarily excluded from the mute group are highlighted in this field.

### ② SAFE button

This lets you select the channels that will be set to Mute Safe status.

## 2 Move the cursor to the SAFE button and press the [ENTER] key.

## 3 Use the LAYER section keys and the channel module section [SEL] keys to select the channels you want to exclude from mute group operations (multiple selections are allowed).

The [SEL] key will light, and the corresponding channel in the channel display field of the screen will be highlighted in green. You can cancel the Mute Safe status by pressing a lit [SEL] key once again to make it go dark.

Channels that are set to Mute Safe will not be affected when you mute a mute group to which that channel belongs.



- Mute Safe settings are not saved in the scene. They will remain valid until you cancel the settings.

# The Channel Link function

Channel Link is a function that links the operation of parameters such as fader and EQ between input channels.

The parameters to be linked can be selected from the following choices.

- HA GAIN settings (linked while preserving the difference in level.)
- EQ settings
- Dynamics 1 and 2 settings
- On/off status of signals sent to MIX buses
- Send levels of signals sent to MIX buses
- Fader operations (linked while preserving the difference in level.)
- [ON] key operations

Two or more input channels that are linked are called a “link group.” The maximum number of link groups you can create, and the maximum number of input channels that can be included in each group, is 18 {34}. However, the selection of parameters for which operations of a channel are linked for multiple link groups is shared by all link groups.

## Linking the desired input channels

Here’s how to link specific parameters of input channels.



- Channel link settings are saved as part of the scene.
- Recall Safe does not affect channel link. When you recall a scene, the link status saved in that scene will always be reproduced.

**1** In the DISPLAY ACCESS section, press the [CHANNEL JOB] key repeatedly to access the CH LINK screen of the CHANNEL JOB screens.

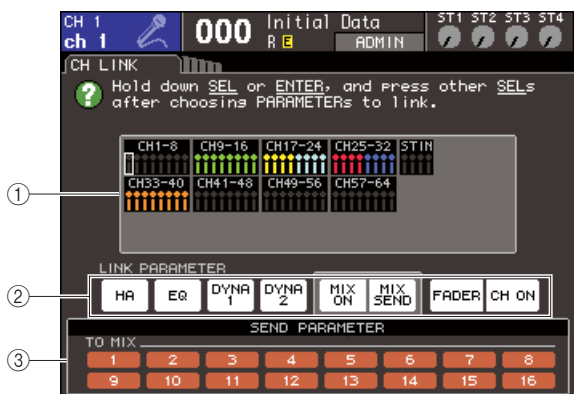

### ① Channel display field

When you create a link group, the corresponding channels will be highlighted. If there are two or more link groups, each group is shown in a different color.



- For ST IN channels, all parameters of L and R are always linked.

### ② LINK PARAMETER field

Use the buttons in this field to select the parameters that you want to be linked. These settings are shared by all link groups.

### ③ SEND PARAMETER field

If you have turned on the MIX ON or MIX SEND buttons in the LINK PARAMETER field, use the buttons of this field to specify the send-destination bus(es).

**2** Use the buttons of the LINK PARAMETER field to select the parameter(s) that will be linked (multiple selections are allowed).

The table below lists the parameters you can select in the LINK PARAMETER field.

<b>HA button</b>	Head amp settings
<b>EQ button</b>	EQ settings (including ATT/HPF)
<b>DYNA 1, 2 buttons</b>	Dynamics 1 and 2 settings
<b>MIX ON button</b>	On/off status of signals sent to MIX buses
<b>MIX SEND button</b>	Send levels of signals sent to MIX buses
<b>FADER button</b>	Fader operations
<b>CH ON button</b>	[ON] key operations



- If you link Dynamics 1 or 2 for two or more input channels, the parameter values will be linked, but the key-in signals are not linked. For more about dynamics, refer to “EQ and Dynamics” (→ p. 115).
- If you turn on the EQ button or DYNA 1/2 buttons, library recall operations will also be linked.

### 3 If you turned on the MIX ON or MIX SEND buttons in step 2, use the buttons of the SEND PARAMETER field to specify the bus(es) for which you want operations to be linked (multiple selections are allowed).

The table below lists the parameters you can select in the SEND PARAMETER field.

TO MIX 1-16 buttons	MIX buses 1-16
---------------------	----------------

**NOTE**

- If nothing is selected in the SEND PARAMETER field, send on/off and send level will not be linked.

### 4 To link channels, proceed as follows.

- ① Select the fader layer that contains the link-destination channel.
- ② Use one of the following methods to select the link-source channel.

● **If the link-source and link-destination channels are in the same fader layer**

Hold down the link-source [SEL] key and select the [SEL] key of the link-destination channel.

● **If the link-source and link-destination channels are in different fader layers**

Use the cursor keys to move the white frame of the channel display field to the link-source channel, then hold down the [ENTER] key and select the [SEL] key of the link-destination channel.

At this time, the values of the parameters you selected in steps 2 and 3 will be copied from the link-source to the link-destination channel. Subsequent operations of the parameters you selected in steps 2 and 3 will be linked between channels belonging to the same link group. The current link status is shown in the channel display field of the window.

**NOTE**

- HA GAIN and fader values, which are linked while preserving their level difference, will not be copied.

Link-source channel

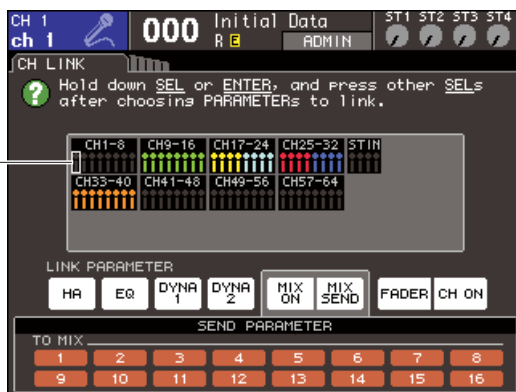

**HINT**

- When you press the [SEL] key of a channel belonging to a link group to make it light, the [SEL] keys of all channels belonging to the same link group will blink.
- If you link an INPUT channel to a ST IN channel, parameters that do not exist for a ST IN channel will be ignored.

### 5 If you want to add a new channel to an existing link group, do so as described in step 4.

**HINT**

- If the link-destination channel is already assigned to another link group, its assignment to the previous group will be cancelled, and it will be added to the newly assigned group.

### 6 To cancel a link, proceed as follows.

- ① Select the fader layer that contains the channel you want to un-link.
- ② Use one of the following methods to select any channel assigned to the link group.

● **If the channel that you want to un-link is in the same fader layer as another channel in that link group**

Hold down any [SEL] key registered in the link group, and select the [SEL] key of the channel that you want to un-link.

● **If no other channel in that link group is in the same fader layer as the channel you want to un-link**

Use the cursor keys to move the white frame of the channel display field to any channel registered in the link group, then hold down the [ENTER] key and select the [SEL] key of the channel you want to un-link.

**HINT**

- You can temporarily exclude a channel from link groups in order to adjust parameters that maintain their level balance while linked, such as when you want to adjust the level balance between channels in a link group. Hold down the [SEL] key of the channel whose balance you want to adjust, and edit the desired parameter. HA GAIN and fader will not be linked while you are holding down the [SEL] key. (However, this function will not work during the fade of a scene memory recall operation.)

# Copying, moving, or initializing a channel

This section explains how you can copy or move mix parameters between channels, or restore the parameters of a specific channel to their default settings.

## Copying the parameters of a channel

You can copy the mix parameter settings of a channel to another channel. When you execute the copy operation, the settings will overwrite the parameters of the copy-destination.

You can copy between the following combinations of channels.

- Between input channels
- Between the STEREO L/R channel and MONO channel
- Between MIX channels
- Between MATRIX channels

**1** In the DISPLAY ACCESS section, press the [CHANNEL JOB] key repeatedly to access the CH COPY screen of the CHANNEL JOB screens.

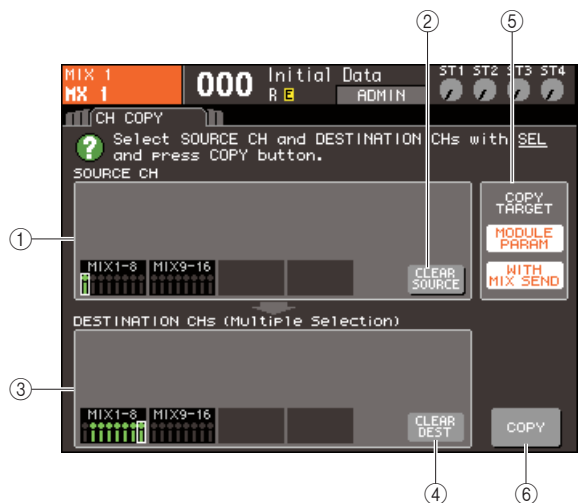

- 1 SOURCE CH field**  
Indicates the channel that is selected as the copy-source.
- 2 CLEAR SOURCE button**  
This button clears the channels shown in the SOURCE CH field and DESTINATION CHs field.
- 3 DESTINATION CHs field**  
Indicates the channels selected as the copy-destination.
- 4 CLEAR DEST button**  
This button clears the channels shown in the DESTINATION CHs field.

**5 COPY TARGET field**

If you've selected a MIX channel, MATRIX channel, or STEREO/MONO channel as the copy-source, use the buttons of this field to select the parameters that will be copied. You may turn both buttons on if desired.

If both buttons are on, the following parameters will be copied.

- **MODULE PARAM button**  
All parameters of the copy-source channel
- **WITH MIX SEND/WITH MATRIX SEND button**  
On/off status and send level settings of the send signals sent to the copy-source channel

**6 COPY button**

Executes the copy.

**2** To select the copy-source channel, press the corresponding [SEL] key to make it light.

The corresponding channel is highlighted in the SOURCE CH field of the window.

When you choose the copy-source channel, the DESTINATION CHs field is automatically emboldened, allowing you to select the copy-destination.

If you want to re-select the copy-source channel, move the cursor to the CLEAR SOURCE button and press the [ENTER] key.

**NOTE**

- Copy settings can be made only in the order of "copy-source" → "copy-destination."

**3** To select the copy-destination channel(s), press the corresponding [SEL] key to make it light (multiple selections are allowed).

The corresponding channel(s) is/are highlighted in the DESTINATION CHs field of the window. The channels that can be selected as the copy-destination will depend on the channel you selected in step 2.

If you want to re-select all of the copy-destination channels, move the cursor to the CLEAR DEST button and press the [ENTER] key.

**4** If you selected a MIX/MATRIX/STEREO/MONO channel as the copy-source, use the buttons of the COPY TARGET field to select the parameters you want to copy.

**5** To execute the Copy operation, move the cursor to the COPY button and press the [ENTER] key.

The copy will be executed, and the settings will overwrite the parameters of the copy-destination channel(s). After the copy has been executed, the SOURCE CH field and DESTINATION CHs field will return to an unset state.



## Moving the parameters of a channel

The settings of a specific input channel can be moved to a different input channel. When you execute a Move operation, the numbering of the channels between the move-source and move-destination will move forward or backward by one.

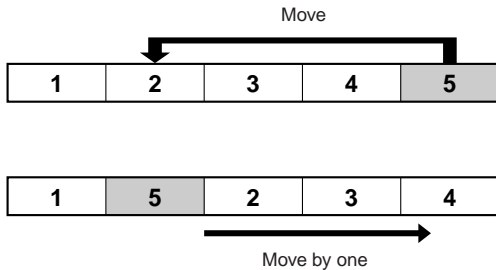

You can move settings between the following combinations of channels.

- Between INPUT channels
- Between ST IN channels

**1** In the DISPLAY ACCESS section, press the [CHANNEL JOB] key repeatedly to access the CH MOVE screen of the CHANNEL JOB screens.

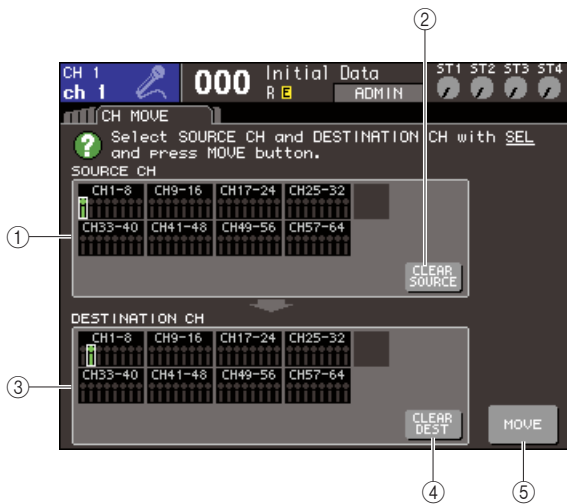

- ① **SOURCE CH field**  
This indicates the move-source channel.
- ② **CLEAR SOURCE button**  
This button clears the channels shown in the SOURCE CH field and DESTINATION CH field.
- ③ **DESTINATION CH field**  
This indicates the move-destination channel.
- ④ **CLEAR DEST button**  
This button clears all channels shown in the DESTINATION CH field.
- ⑤ **MOVE button**  
Executes the move.

**2** To select the move-source channel, press the corresponding [SEL] key to make it light.

The corresponding channel is highlighted in the SOURCE CH field of the window.

When you select the move-source channel, the DESTINATION CH field will automatically be emboldened, allowing you to select the move-destination.

If you want to re-select the move-source channel, move the cursor to the CLEAR SOURCE button and press the [ENTER] key.

**NOTE**

- Settings for the Move operation can be made only in the order of "move-source" → "move-destination."

**3** To select the move-destination channel, press the corresponding [SEL] key to make it light.

The corresponding channel is highlighted in the DESTINATION CH field of the window. The channels that can be selected will depend on the channel you selected in step 2.

If you want to re-select the move-destination channel, move the cursor to the CLEAR DEST button and press the [ENTER] key.

**4** To execute the Move operation, move the cursor to the MOVE button and press the [ENTER] key.

The settings of the move-source channel will be moved to the move-destination. The settings of all channels between the move-source and move-destination will be moved by one channel in the direction of the move-source. When the Move has been executed, the SOURCE CH field and DESTINATION CH field will return to an un-set state.

## Initializing the parameters of a channel

If desired, you can restore the parameters of any channel to an initialized state. This operation can be performed on any channel(s).

- 1** In the **DISPLAY ACCESS** section, press the **[CHANNEL JOB]** key repeatedly to access the **CH CLEAR** screen of the **CHANNEL JOB** screens.

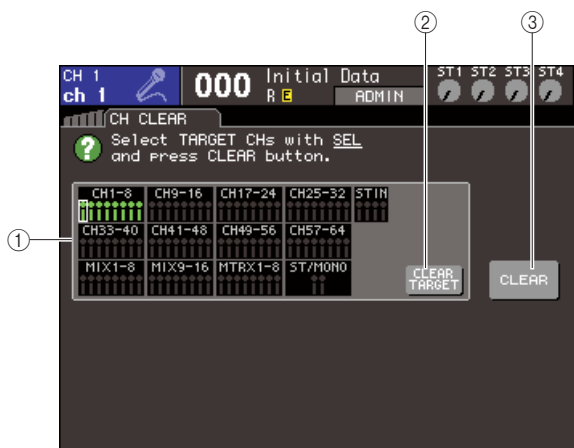

**① TARGET CHs field**

In this field, select the channel(s) that you want to initialize.

**② CLEAR TARGET button**

This button clears the channels shown in the TARGET CHs field.

**③ CLEAR button**

Executes the initialization.

- 2** To select the channel(s) to be initialized, press the corresponding **[SEL]** key to make it light (multiple selections are allowed).

The corresponding channel(s) is/are highlighted in the TARGET CHs field of the window.

If you want to de-select all channels, move the cursor to the **CLEAR TARGET** button and press the **[ENTER]** key.

- 3** To execute the Initialize operation, move the cursor to the **CLEAR** button and press the **[ENTER]** key.

The parameters of the selected channel(s) will be initialized. After initialization, the TARGET CHs field will return to a state in which nothing is selected.

# ◆ Chapter 13 ◆

## Scene memory

This chapter explains how to perform scene memory operations.

### About scene memories

On the LS9, settings such as the mix parameters and input/output port patching can be assigned a name and stored into memory (and later recalled from memory) as a “scene.”

Scenes are numbered with a scene number in the range of 000–300. Of these scenes, scene 000 is a read-only scene that restores the mix parameters to their default state, and scenes 001–300 are rewritable.

Each scene contains the position of the top panel faders and [ON] keys, as well as the following parameters.

- Input/output port patching
- Bus settings
- Head amp settings
- EQ settings
- Dynamics 1 and 2 settings
- Rack (GEQ/effect) settings
- Pan/balance settings
- Insert/direct out settings
- On/off status and send level of signals sent to MIX buses
- On/off status and send level of signals sent to MATRIX buses
- Mute group settings
- Channel link settings

### Using scene memories

This section explains how to store and recall the LS9’s mix parameters as “scenes.”

#### Storing a scene

To store the current mix settings as a scene memory, use the SCENE MEMORY screen.

- 1 Use the various controllers of the top panel or the buttons in the display to set the mix parameters as desired.

The number and title of the currently selected scene are shown in the center of the constant display area.

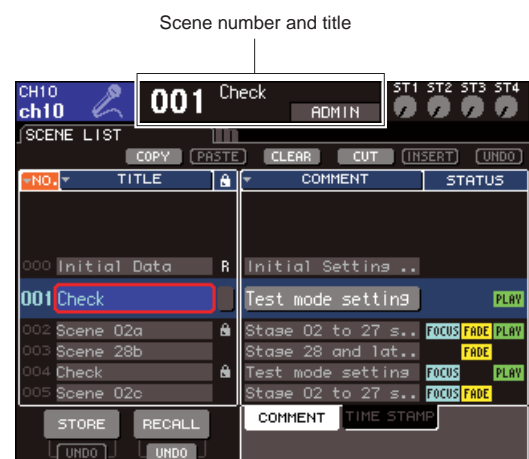

#### HINT

- You can also move the cursor to the scene number in the constant display area and use the dial or the [DEC]/[INC] keys to change the scene number. This scene number will blink if the most recently stored or recalled scene is different than the currently selected scene.

**NOTE**

- Simply changing the scene number does not actually execute the store or recall operation. To execute the store or recall operation, you must use the STORE/RECALL buttons in the SCENE MEMORY screen as explained in step 2 and following or in "Recalling a scene" (→ p. 131), or use a user-defined key (→ p. 132) to which you've assigned the scene store/recall function.

**2 In the DISPLAY ACCESS section, press the [SCENE MEMORY] key repeatedly to access the SCENE LIST screen.**

In this screen you can perform operations such as storing or recalling a scene.

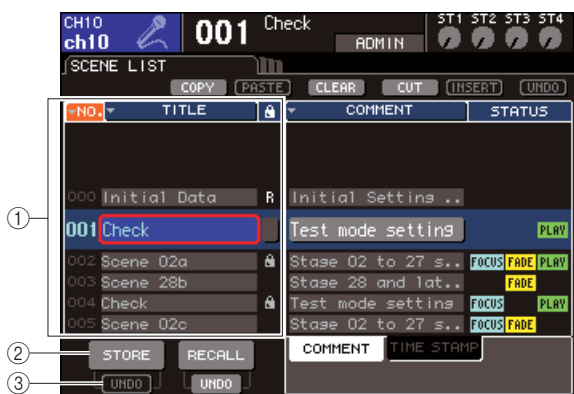
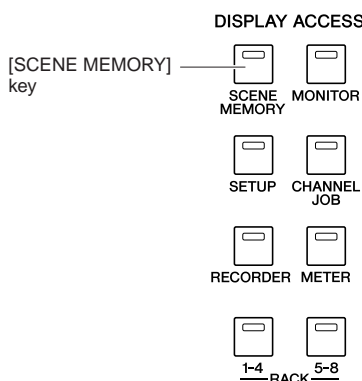

**1 Scene list**

This list shows the scenes that are stored in scene memory. The row highlighted in blue indicates that this scene number is selected for operations. A read-only scene is indicated by the R symbol, and a write-protected scene is indicated by the protect (lock) symbol.

**2 STORE button**

This stores the current mix settings into the location currently selected in the scene list.

**3 STORE UNDO button**

This button cancels (Undo) or re-executes (Redo) the most recently performed scene Store operation. This button is available from immediately after you overwrite (save) until the next time you store.

**3 Make sure that the cursor is located somewhere other than the constant display area, and use the dial or the [DEC]/[INC] keys to select the store-destination scene number.**

**NOTE**

- Note that the scene number, channel number, or ST IN channel input level will change if you operate the dial or the [DEC]/[INC] keys when the cursor is located in the constant display area.

**4 Move the cursor to the STORE button and press the [ENTER] key.**

The SCENE STORE popup window will appear, allowing you to assign a title to the scene.

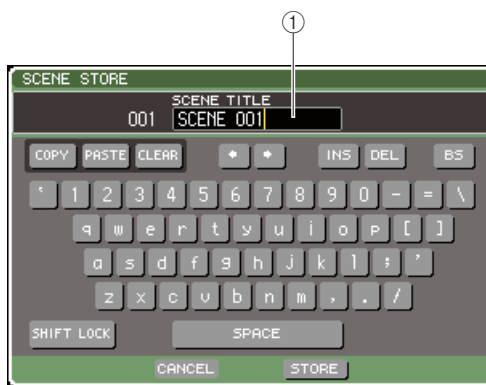

**1 SCENE TITLE field**

This field lets you enter a title for the scene (a maximum of sixteen characters).

**5 Assign a title to the scene as desired.**

For details on entering text, refer to "Assigning a name" (→ p. 34)

**6 Move the cursor to the STORE button located at the bottom of the SCENE STORE popup window, and press the [ENTER] key.**

The SCENE STORE popup window will close, and a dialog box will ask you to confirm the Store operation.



## 7 To execute the Store operation, move the cursor to the OK button and press the [ENTER] key.

The current mix settings will be stored to the scene number you selected in step 3.

If you decide to cancel the Store operation, move the cursor to the CANCEL button instead of the OK button, and press the [ENTER] key.

### NOTE

- If you store to a scene number in which a scene is already stored, the previous data will be overwritten.

### HINT

- You have the option of making settings so that the Store Confirmation dialog box does not appear (→ p. 194).

## 8 If you want to cancel the scene overwrite-store operation, move the cursor to the STORE UNDO button and press the [ENTER] key.

Immediately after overwrite-storing a scene, you can use the STORE UNDO button to undo (cancel) the most recently executed scene store operation. When you execute the STORE UNDO button, a dialog box will ask you to confirm the Undo operation. If you want to execute the Undo, move the cursor to the OK button and press the [ENTER] key. After executing the Undo, you can use the STORE UNDO button once again to Redo (re-execute) the store operation.

### NOTE

- The STORE UNDO button is available only immediately after overwrite-storing. Undo will no longer be possible if you subsequently perform a scene store/recall operation.

### HINT

- You can use the same procedure to store a scene in other SCENE MEMORY screens as well.
- The same function as the STORE button or STORE UNDO button can also be assigned to a user-defined key (→ p. 132).

## Recalling a scene

To recall a scene that was stored in scene memory, use the SCENE MEMORY screen.

### 1 In the DISPLAY ACCESS section, press the [SCENE MEMORY] key repeatedly to access the SCENE LIST screen.



#### ① Scene list

This list shows the scenes that are stored in scene memory. The row highlighted in blue indicates that this scene number is selected for operations.

#### ② RECALL button

This recalls the scene that is currently selected in the scene list.

#### ③ RECALL UNDO button

This button cancels (Undo) or re-executes (Redo) the most recently performed scene Recall operation.

### 2 Make sure that the cursor is located somewhere other than the constant display area, and use the dial or the [DEC]/[INC] keys to select the recall-source scene number.

### 3 Move the cursor to the RECALL button and press the [ENTER] key.

A dialog box will ask you to confirm the Recall operation.

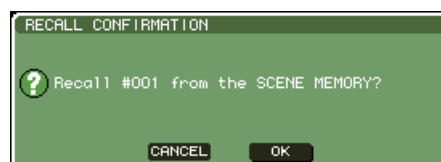

**4 To execute the Recall operation, move the cursor to the OK button and press the [ENTER] key.**

The scene you selected in step 2 will be recalled. If you decide not to execute the Recall operation, move the cursor to the CANCEL button instead of the OK button, and press the [ENTER] key.



- You have the option of making settings so that the Recall Confirmation dialog box does not appear (→ p. 194).

**5 If you decide to cancel the scene recall operation, move the cursor to the RECALL UNDO button and press the [ENTER] key.**

A dialog box will ask you to confirm the Undo operation. To execute the operation, move the cursor to the OK button and press the [ENTER] key. After executing the Undo, you can use the RECALL UNDO button once again to Redo (re-execute) the recall operation.



- You can use the same procedure to recall a scene in other SCENE MEMORY screens as well.
- Alternatively, you can recall a scene by moving the cursor to the scene number in the constant display area, using the dial or the [DEC]/[INC] keys to select a scene number, and pressing the [ENTER] key. A confirmation dialog box will appear if RECALL CONFIRMATION is turned ON in the PREFERENCE popup window.
- The same function as the RECALL button or RECALL UNDO button can also be assigned to a user-defined key.
- In addition, you can recall a scene by using MIDI messages (program changes) (→ p. 180).

**Using user-defined keys to recall**

You can use the user-defined keys to directly recall a selected scene with a single keystroke, or to step through the scenes. To do this, you must first assign a scene recall operation to a user-defined key.

The following recall operations can be assigned to a user-defined key.

● **INC RECALL**

Recalls the scene of the number that follows the currently loaded scene.

● **DEC RECALL**

Recalls the scene of the number that precedes the currently loaded scene.



- If no scene is stored in the number that precedes or follows the currently loaded scene, the closest scene number in which a scene is stored will be recalled.

● **DIRECT RECALL**

Allows you to directly specify a certain scene number and recall that scene.

To assign one of these functions to a user-defined key so that a scene can be recalled in a single keystroke, proceed as follows.

**1 In the DISPLAY ACCESS section, press the [SETUP] key repeatedly to access the USER SETUP screen.**

USER DEFINED KEYS button





- 2** Move the cursor to the **USER DEFINED KEYS** button and press the [ENTER] key to access the **USER DEFINED KEYS** popup window.

The **USER DEFINED KEYS** popup window lets you assign functions to user defined keys [1]–[12].

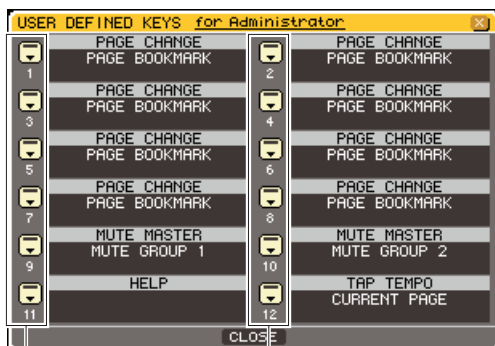

User defined keys popup buttons

- 3** Move the cursor to the popup button for the user-defined key to which you want to assign a function, and press the [ENTER] key.

The **USER DEFINED KEY SETUP** popup window will appear.

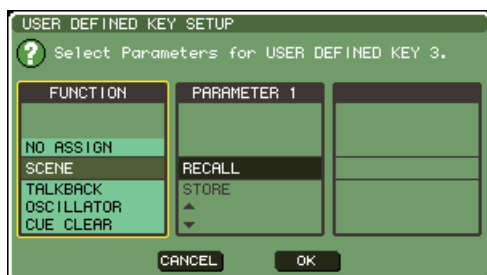

- 4** Move the cursor to the **FUNCTION** column, and use the dial or the [DEC]/[INC] keys to select “**SCENE.**”

In this popup window, you will proceed as follows depending on the function you want to assign.

● **To assign INC RECALL or DEC RECALL**

Move the cursor to the **PARAMETER 1** column, and use the dial or the [DEC]/[INC] keys to select “**INC RECALL**” or “**DEC RECALL.**”

● **To assign DIRECT RECALL**

Move the cursor to the **PARAMETER 1** column, use the dial or the [DEC]/[INC] keys to choose “**DIRECT RECALL,**” and then choose “**SCENE #xxx**” (xxx is the scene number) in the **PARAMETER 2** column.

- 5** When you’ve finished making settings, move the cursor to the **OK** button and press the [ENTER] key to close the popup window.

If desired, assign scene-recall functions to other user-defined keys in the same way.

- 6** Press the user-defined key to which you assigned a recall function.

The corresponding scene will be recalled.

# Editing scene memories

This section explains how to sort the scenes stored in scene memory, edit their titles, and copy/paste them.

## Sorting and renaming scene memories

You can use a dedicated window to sort the saved scene memories in alphabetical order of their titles or in order of the date on which they were created. You can also edit their titles.

**1** In the **DISPLAY ACCESS** section, press the **[SCENE MEMORY]** key repeatedly to access the **SCENE LIST** screen.



- The **SCENE MEMORY** screen consists of four screens, but the left half (scene list, store/recall buttons) and the tool buttons are the same in all screens.

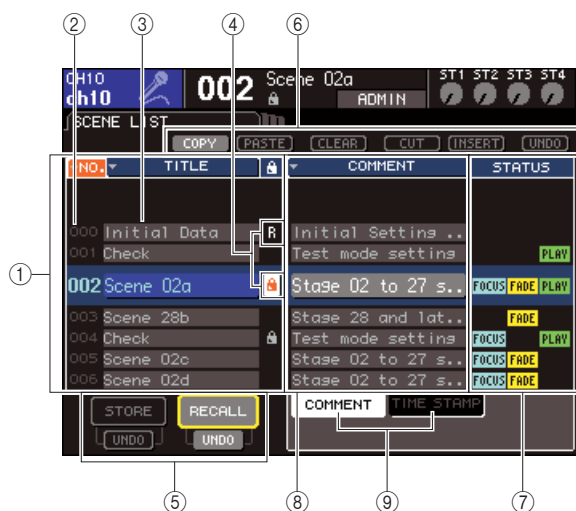

**1 Scene list**

This lists the scenes that are stored in scene memory. The line highlighted in blue indicates the scene currently selected for operations.



- You can also change the default order in which the list is sorted (ascending or descending scene number) (→ p. 194).

**2 Scene number**

This is the scene number 000–300.

**3 TITLE**

This is the name assigned to each scene (maximum 16 characters). You can move the cursor to this area and press the **[ENTER]** key to access the **SCENE TITLE EDIT** popup window, where you can assign a title or comment to the scene.

**4 R symbol (READ ONLY) / Protect symbol**

A read-only scene is indicated by the R symbol, and a write-protected scene is indicated by the protect (lock) symbol. For scenes 001–300, you can move the cursor to this area and press the **[ENTER]** key to switch between protected and un-protected settings.

**5 Store/Recall buttons**

These buttons are used to store/recall scenes. You can also undo (cancel) or redo (re-execute) store/recall operations. For details, refer to “Using scene memories” (→ p. 129).

**6 Tool buttons**

Use these buttons to perform operations such as Copy and Paste on the scenes stored in scene memory. For details, refer to “Scene memory editing” (→ p. 136).

**7 STATUS field**

This field indicates the status of each scene. For scenes for which something other than the ALL button is selected in the Focus function (→ p. 139), for scenes in which the Fade function is enabled (→ p. 143), and for scenes for which the link with an audio file is enabled (→ p. 113), the “FOCUS”, “FADING”, and “PLAY” indications will respectively be lit.

**8 COMMENT/TIME STAMP field**

This indicates the comment, or the date and time at which the scene was last stored, as the year/month/date and hours/minutes/seconds.

**9 COMMENT/TIME STAMP tabs**

These tabs switch the items (comment or time stamp) that are shown in the COMMENT/TIME STAMP field.

**2** To select a scene number, make sure that the cursor is located somewhere other than the constant display area, and use the dial or the **[DEC]/[INC]** keys.

The line highlighted in blue in the scene list indicates the scene currently selected for operations.



- You can also assign user-defined keys to execute functions such as incrementing or decrementing the scene number or scrolling the scene list up or down (→ p. 196).

**3** If you want the scenes to be listed in a different order, move the cursor to the “NO.” or “TITLE” buttons located above the scene list, or to “TIME STAMP” located above the STATUS/TIME STAMP field, and press the [ENTER] key.

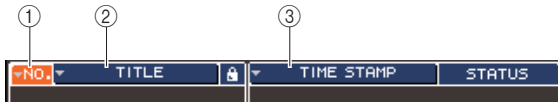

- ① **NO.**  
Sorted in order of scene number.
- ② **TITLE**  
Sorted in numeric/alphabetical order of title.
- ③ **COMMENT/TIME STAMP**  
Sorted in order of comment or date of creation.



• By leaving the cursor at the same button and pressing the [ENTER] key again, you can change the direction (ascending or descending) in which the list is sorted.

**4** If you want to edit the title of a scene, move the cursor to the TITLE field of the selected scene, and press the [ENTER] key to access the SCENE TITLE EDIT popup window.

For details on entering text, refer to “Assigning a name” (→ p. 34).

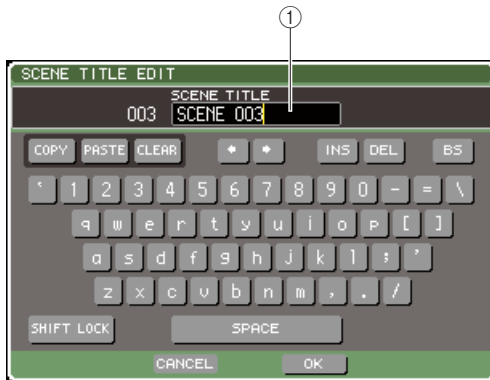

- ① **TITLE field**  
This field lets you enter a title for the scene. (The maximum is 16 characters.)



• You cannot edit the title of a read-only scene or a write-protected scene.  
• If you want to edit the comment of a scene, use the COMMENT/TIME STAMP tabs to display the comments in the scene list, move the cursor to the SCENE COMMENT field of the selected scene, and press the [ENTER] key to access the COMMENT EDIT popup window.

**5** To turn the protect setting on/off for a scene, move the cursor to the R symbol / protect symbol of the selected scene, and press the [ENTER] key.

Each time you press the [ENTER] key, the indication will alternate between the protect (lock) symbol, R (read only) symbol, and no symbol.

● **Protect (lock) symbol**

The scene cannot be overwritten.

● **R (read only) symbol**

In addition to the protection described above, it will also be impossible to overwrite the scene by loading a file from USB memory, etc.

This setting can be selected only for consecutive scene numbers from scene number 000.

● **No symbol**

The scene is not protected.



• The R symbol for scene number 000 cannot be disabled.

**6** Use the tool buttons to edit the scene memory.

For details, refer to the section “Scene memory editing” that follows.

## Scene memory editing

The scenes stored in scene memory can be copied/pasted to other scene numbers, or cleared (erased).

- 1 In the DISPLAY ACCESS section, press the [SCENE MEMORY] key to access any one of the SCENE MEMORY screens.**

Scene memories are edited using the buttons shown in the upper part of the SCENE MEMORY screen. Each button has the following function.

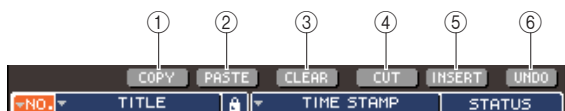

**1 COPY button**

Copies a scene into a memory buffer (a temporary storage area). For details on how to use this, refer to “Copying/pasting a scene” below.

**2 PASTE button**

This button pastes a scene (previously copied into the memory buffer) into another scene number. For details on how to use this, refer to “Copying/pasting a scene” below.

**3 CLEAR button**

This button clears (erases) the selected scene. For details on how to use this, refer to “Clearing a scene” (→ p. 137).

**4 CUT button**

Cuts a scene and places it in the memory buffer. Scenes following the scene number you cut will be moved forward. For details on how to use this, refer to “Cutting a scene” (→ p. 138).

**5 INSERT button**

Inserts a scene from the memory buffer at the location of a different scene number. Scene numbers following the inserted position will be moved backward. For details on how to use this, refer to “Inserting a scene” (→ p. 138).

**6 UNDO button**

This button cancels the most recently-executed scene editing operation. If you’ve accidentally cleared an important scene, you can press this key to return to the state prior to editing the scene.

- 2 Perform the desired editing operations.**

For details on the procedure, refer to the explanations that follow.

## Copying/pasting a scene

Here’s how to copy a scene into buffer memory, and then paste it to a different scene number.

- 1 In the DISPLAY ACCESS section, press the [SCENE MEMORY] key to access any one of the SCENE MEMORY screens.**

- 2 Make sure that the cursor is located somewhere other than the constant display area, and use the dial or the [DEC]/[INC] keys to select the copy-source scene number.**

- 3 Move the cursor to the COPY button and press the [ENTER] key.**

A dialog box will ask you to confirm the Copy operation.

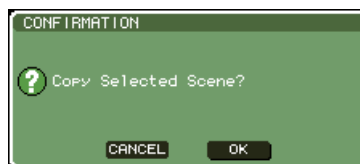

- 4 To execute the Copy operation, move the cursor to the OK button and press the [ENTER] key.**

The scene you selected in step 2 will be saved in the buffer memory.



- Be aware that if you copy/cut another scene before you paste, the other scene will be overwritten to the buffer memory.

- 5 Make sure that the cursor is located somewhere other than the constant display area, and use the dial or the [DEC]/[INC] keys to select the paste-destination scene number.**

- 6 Move the cursor to the PASTE button and press the [ENTER] key.**

A dialog box will ask you to confirm the Paste operation.

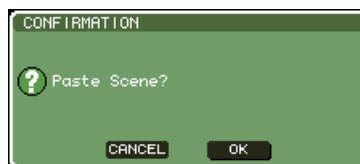

- A copied scene can also be inserted (→ p. 138).



- If nothing has been stored in the buffer memory, the PASTE button is not available.

## 7 To execute the Paste operation, move the cursor to the OK button and press the [ENTER] key.

The scene stored in the buffer memory will be pasted to the scene number you selected in step 5. If you decide to cancel the Paste operation, use the CANCEL button instead of the OK button.

### NOTE

- Be aware that when you paste to a scene number in which a scene has already been stored, the existing scene will be overwritten.
- Read-only scenes or write-protected scenes cannot be pasted.

## Clearing a scene

Here's how to clear a specified scene.

- 1 In the **DISPLAY ACCESS** section, press the **[SCENE MEMORY]** key to access any one of the **SCENE MEMORY** screens.
- 2 Make sure that the cursor is located somewhere other than the constant display area, and use the dial or the **[DEC]/[INC]** keys to select the scene number that you want to clear.
- 3 Move the cursor to the **CLEAR** button and press the **[ENTER]** key.

A dialog box will ask you to confirm the Clear operation.

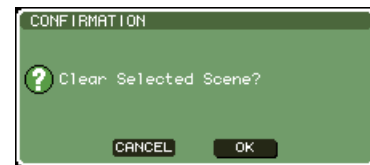

## 4 To execute the Clear operation, move the cursor to the OK button and press the [ENTER] key.

The scene number you selected in step 2 will be cleared. If you decide to cancel the Clear operation, use the CANCEL button instead of the OK button.

### NOTE

- Read-only scenes or write-protected scenes cannot be cleared.

## Cutting a scene

Here's how to cut a scene. When you cut a scene, the scenes of subsequent numbers will move forward. After you cut a scene, you'll be able to paste or insert it at the desired location.

- 1 In the **DISPLAY ACCESS** section, press the **[SCENE MEMORY]** key to access any one of the **SCENE MEMORY** screens.
- 2 Make sure that the cursor is located somewhere other than the constant display area, and use the dial or the **[DEC]/[INC]** keys to select the scene number that you want to cut.
- 3 Move the cursor to the **CUT** button and press the **[ENTER]** key.

A dialog box will ask you to confirm the Cut operation.

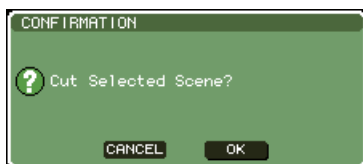

**NOTE**

- The **CUT** button cannot be used if the scene list is sorted in any other way than by the "NO." column.

- 4 To execute the Cut operation, move the cursor to the **OK** button and press the **[ENTER]** key.

The scene you selected in step 2 will be cut, and the scenes of subsequent numbers will be moved forward. At this time, the scene that was cut will be stored in buffer memory.

**NOTE**

- Read-only scenes or write-protected scenes cannot be cut.

- 5 If desired, you can paste (→ p. 136) or insert the cut scene (that was held in the buffer memory).

**NOTE**

- Be aware that if you copy or cut a different scene before you paste or insert, the newly copied or cut scene will overwrite the scene in the buffer memory.

## Inserting a scene

Here's how a scene held in the buffer memory can be inserted at the desired scene number location.

- 1 In the **DISPLAY ACCESS** section, press the **[SCENE MEMORY]** key to access any one of the **SCENE MEMORY** screens.
- 2 Perform the Copy operation (→ p. 136) or Cut operation so that the scene you want to insert is placed in the buffer memory.
- 3 Make sure that the cursor is located somewhere other than the constant display area, and use the dial or the **[DEC]/[INC]** keys to select the insert-destination scene number.
- 4 Move the cursor to the **INSERT** button and press the **[ENTER]** key.

A dialog box will ask you to confirm the Insert operation.

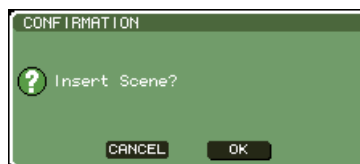

**NOTE**

- The **INSERT** button cannot be used if the scene list is sorted in any other way than by the "NO." column.
- If nothing has been stored in the buffer memory, the **INSERT** button is not available.
- The **INSERT** button cannot be used if the Insert operation would cause the number of stored scenes to exceed 300.
- You can't insert in front of a scene for which the **R** symbol (read only) is specified.

- 5 To execute the Insert operation, move the cursor to the **OK** button and press the **[ENTER]** key.

The scene stored in the buffer memory will be inserted at the scene number you selected in step 3. The numbers of scenes stored in locations preceding that scene will be moved back by one.



## Using the Focus function

“Focus” is a function that lets you select the parameters that will be updated when you recall each scene, so that only specific parameters will be updated when you recall that scene. For example, it is convenient to use this if you want to recall only the input channel settings of a certain scene.



- As a function that is the converse of Focus, there is also a “Recall Safe” function that lets you select channels and parameters to be excluded from recall operations (→ p. 140). However while the Focus function is specified for each scene, Recall Safe settings are common to all scenes.

### 1 In the DISPLAY ACCESS section, press the [SCENE MEMORY] key repeatedly to access the SCENE FOCUS screen.

In this screen you can make various settings for the Focus function. The screen contains the following items.

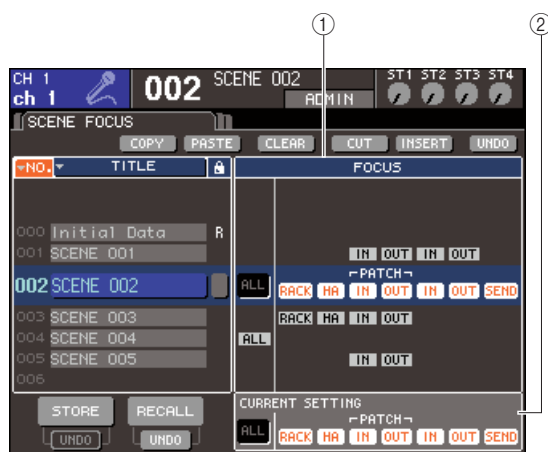

#### ① FOCUS field

This field lets you make Focus function settings for a scene saved in scene memory. Using the buttons arrayed in the center, select the parameters that will be updated when you recall the scene selected in the list in the left side of the screen. For other scenes, you can only check the on/off status of each parameter.

#### ② CURRENT field

This field lets you make Focus function settings for the scene you're currently operating. If you select a parameter in this field and then store the scene, your selections will be used the next time you recall that scene. When you recall a scene, the Focus function settings of that scene are shown in this field.

### 2 Make sure that the cursor is located somewhere other than the constant display area, and use the dial or the [DEC]/[INC] keys to select the scene for which you want to make Focus function settings.

### 3 Use the buttons other than “ALL” to select the parameters that will be subject to recall.

These buttons correspond to the following parameters (multiple selections are allowed).

Button name	Corresponding parameters
RACK	Rack settings
HA	Head amp settings
IN (PATCH)	Input port patching
OUT (PATCH)	Output port patching
IN	Input channel parameters
OUT	Output channel parameters
SEND	On/off status and send level settings for signals sent from input channels to MIX buses (shown only if the OUT button is on)



- The SEND button is shown only if the OUT button is on. However if both the IN button and OUT button are on, the parameters corresponding to SEND will automatically be subject to recall.

### 4 If you want to cancel the restrictions you specified in step 3, so that all parameters will be subject to recall, turn the ALL button on.

When you turn on the ALL button, all other buttons for that scene will be turned off. Turning on any other button will turn off the ALL button.

### 5 Make Focus function settings for other scenes as described in steps 2–4.

### 6 Recall a scene for which you've made Focus settings.

If buttons other than ALL are turned on for the scene, only the parameters whose buttons are on will be recalled. If the ALL button is turned on for the scene, all parameters will be updated.



- For scenes other than the scene number currently selected in the scene list, check marks show the state of the Focus function settings.
- Scenes for which Focus settings are made are indicated by a “FOCUS” indication in the STATUS field of the SCENE LIST screen.
- The Focus function can be used in conjunction with the Recall Safe function (→ p. 140). Channels or parameters that are excluded from Recall operations by either Focus or Recall Safe will not be recalled.

# Using the Recall Safe function

“Recall Safe” is a function that excludes only specific parameters/channels from Recall operations. This differs from the Focus settings (→ p. 139) made for individual scenes in that Recall Safe settings are common to all scenes.

**1** In the **DISPLAY ACCESS** section, press the **[CHANNEL JOB]** key repeatedly to access the **RECALL SAFE** screen.

In this screen you can make settings for the Recall Safe function. The window contains the following items.

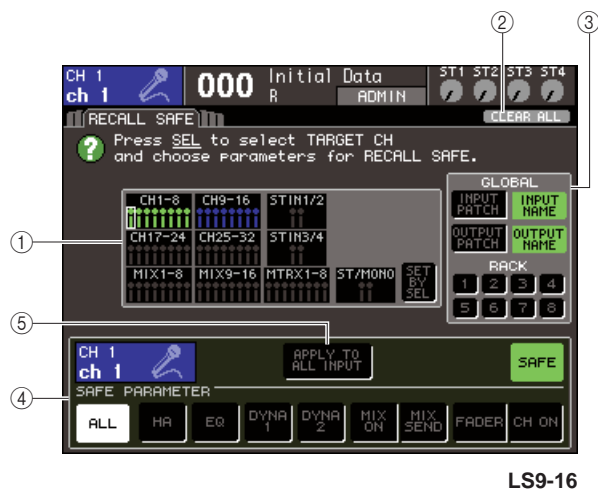
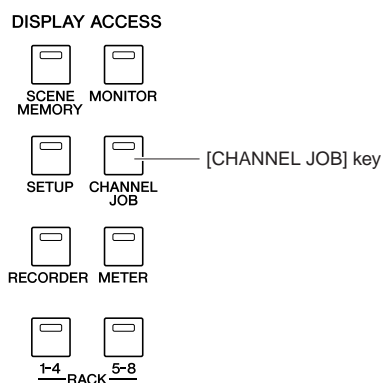

**① CH RECALL SAFE field**

The channels for which Recall Safe is turned on are highlighted in this field. If you turn on the SET BY SEL button, you can turn on Recall Safe for a channel simply by pressing the [SEL] key of that channel.

**② CLEAR ALL button**

This clears all Recall Safe settings for the channels that are highlighted in the CH RECALL SAFE field.

**③ GLOBAL field**

In this field, global parameters (parameters that affect the entire mix, and are not specific to individual channels) can be excluded from Recall operations.

**④ SAFE PARAMETER field**

Here you can switch Recall Safe on/off for each channel, and choose the parameters that will be excluded from Recall operations. If you select a channel by pressing its [SEL] key, the Recall Safe settings of that channel will be shown in this field.

**⑤ APPLY TO ALL INPUT button / APPLY TO ALL OUTPUT button**

If these buttons are on when you operate the SAFE PARAMETER buttons, the changes will apply to all input (or output) channels. This is convenient when you want to make settings for all channels in a single action.

**HINT**

- You can also access this screen from the SAFE field of the SELECTED CH VIEW screen (→ p. 88).

**2** To select the channel whose Recall Safe settings you want to edit, press the corresponding [SEL] key.

The corresponding channel in the CH RECALL SAFE field will be enclosed by a white border. (However, Recall Safe is not yet enabled at this point.) At this time, the SAFE PARAMETER field will show the Recall Safe settings of the selected channel.

**HINT**

- If the CH RECALL SAFE field's SET BY SEL button is on, Recall Safe will be enabled when you press the [SEL] key, and the corresponding channel will be highlighted in the CH RECALL SAFE field. You can select parameters as described in step 3 even after turning Recall Safe on.

### 3 If you want to enable Recall Safe for specific parameters of the selected channel, make the following settings in the SAFE PARAMETER field.

#### ● For an input channel

Use the buttons in the lower part of the SAFE PARAMETER field (except for the “ALL” button) to select the parameters that will be subject to Recall Safe (multiple selections are allowed). If you want all parameters to be subject to Recall Safe, turn on the ALL button (this is the default setting).



LS9-16



LS9-32

These buttons correspond to the following parameters.

Button name	Corresponding parameters
ALL	All parameters
HA	Head amp settings (including external HA)
EQ	EQ settings (including ATT/HPF)
DYNA 1	Dynamics 1 settings
DYNA 2	Dynamics 2 settings
MIX ON	On/off status of signals sent to MIX buses
MIX SEND	Send levels of signals sent to MIX buses
FADER	Fader positions
CH ON	On/off status of [ON] keys

#### NOTE

- If you turn on the ALL button, all other buttons of the SAFE PARAMETER field will be turned off.

#### ● If a STEREO/MONO channel is selected

With the exception of the types of button that are displayed, this is the same as for an input channel.



These buttons correspond to the following parameters.

Button name	Corresponding parameters
ALL	All parameters
EQ	EQ settings (including ATT)
DYNA 1	Dynamics 1 settings
MTRX ON	On/off status of signals sent to MATRIX buses
MTRX SEND	Send levels of signals sent to MATRIX buses
FADER	Fader positions
CH ON	On/off status of [ON] keys

#### ● If a MIX channel is selected

Use the buttons in the lower part of the SAFE PARAMETER field (except for the “ALL” button) to select the parameters that will be subject to Recall Safe (multiple selections are allowed).

In addition, you can use the WITH MIX SEND button to enable Recall Safe for the on/off status and send level of the signals sent from input channels to MIX buses.

If you want all parameters shown in the lower part of the field to be subject to Recall Safe, turn on the ALL button (this is the default setting).



These buttons correspond to the following parameters.

Button name	Corresponding parameters
ALL	All parameters (except for WITH MIX SEND)
EQ	EQ settings (including ATT)
DYNA 1	Dynamics 1 settings
MTRX ON	On/off status of signals sent to MATRIX buses
MTRX SEND	Send levels of signals sent to MATRIX buses
FADER	Fader positions
CH ON	On/off status of [ON] keys
WITH MIX SEND	On/off status and send level of signals sent from input channels to MIX buses

**NOTE**

- If the ALL button is on, all buttons will be turned off except for the WITH MIX SEND button located in the lower part of the SAFE PARAMETER field.
- You can switch the WITH MIX SEND button on/off while the ALL button is left on.

● If a MATRIX channel is selected

With the exception of the types of button that are displayed, this is the same as for a MIX channel. In addition, you can use the WITH MATRIX SEND button to enable Recall Safe for the on/off status and send level of the signals sent from output channels to MATRIX buses.

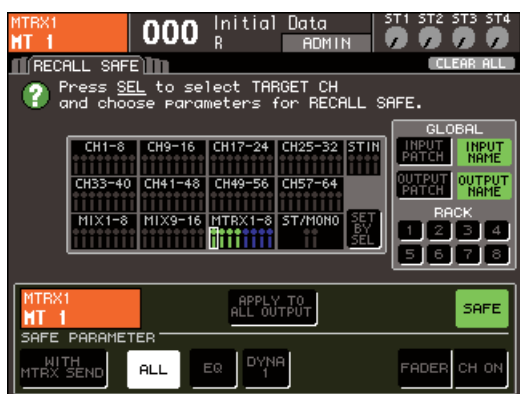

These buttons correspond to the following parameters.

Button name	Corresponding parameters
ALL	All parameters (except for WITH MATRIX SEND)
EQ	EQ settings (including ATT)
DYNA 1	Dynamics 1 settings
FADER	Fader positions
CH ON	On/off status of [ON] keys
WITH MATRIX SEND	On/off status and send level of signals sent from MIX channels / STEREO/MONO channels to MATRIX buses

**NOTE**

- If you turn on the ALL button, all buttons will be turned off except for the WITH MATRIX SEND button located in the SAFE PARAMETER field.
- You can switch the WITH MATRIX SEND button on/off while the ALL button is left on.

**4 To enable Recall Safe for the selected channel, turn on the SAFE button in the SAFE PARAMETER field.**

Channels for which Recall Safe is enabled will be highlighted in the CH RECALL SAFE field.

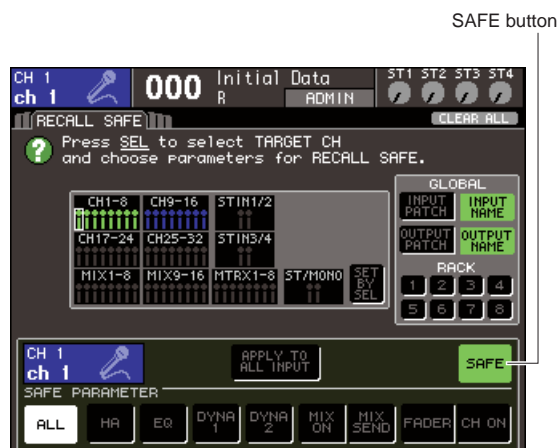

SAFE button

LS9-16



SAFE button

LS9-32

**NOTE**

- Simply selecting a parameter in step 3 does not enable Recall Safe. To turn Recall Safe on/off, you must also perform the operation of step 4.

**HINT**

- In the CH RECALL SAFE field, the color of the highlight will be green if the ALL button was selected in step 3, or blue if buttons other than ALL were selected.
- If you press the CLEAR ALL button, Recall Safe will be defeated for all channels for which it is enabled (i.e., the highlighted channels).
- You can also switch Recall Safe on/off in the SELECTED CH VIEW screen's SAFE field (-> p. 88).

## 5 If you want to enable Recall Safe for global parameters, turn on the desired buttons in the GLOBAL field.

These buttons correspond to the following parameters.

Button name	Corresponding parameters
INPUT PATCH	Input port patching
INPUT NAME	Input channel name
OUTPUT PATCH	Output port patching
OUTPUT NAME	Output channel name
1-8	Rack 1-8 settings

## 6 When you've finished making settings, execute a Recall operation.

Only the selected channel(s) and parameter(s) will be excluded from Recall operations.

Channel Link (→ p. 124) and the MIX/MATRIX bus settings in the SYSTEM SETUP screen (→ p. 213) are not subject to Recall Safe; the settings of the recalled scene will always be reproduced.

This means that if Recall Safe is enabled for one of several channels included in a link group or one of two MIX/MATRIX channels set to stereo, the parameter settings of that channel may differ from those of the other channel(s) when you recall a scene. In such cases, the applicable parameter will be automatically re-linked the next time it is operated.

### HINT

- The Recall Safe function can be used in conjunction with the Focus function (→ p. 139). Channels or parameters that are excluded from Recall operations by either Focus or Recall Safe will not be recalled.
- By performing the Recall operation while holding down the [SEL] key of a channel for which Recall Safe is disabled, you can temporarily enable the Recall Safe settings for that channel.

## Using the Fade function

“Fade” is a function that smoothly changes the faders of specified channels to their new values over a specified duration when you recall a scene. This is convenient when you want to obtain a fade-in/out effect, or when you want the levels to transition smoothly between two scenes. The settings of the Fade function are made independently for each scene.

### 1 In the DISPLAY ACCESS section, press the [SCENE MEMORY] key repeatedly to access the SCENE FADE screen.

In this screen you can make various settings for the Fade function. The screen contains the following items.

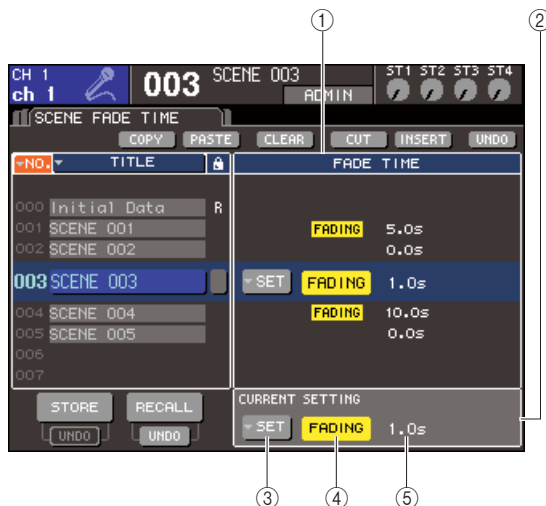

#### ① FADE TIME field

This field lets you make Fade function settings for a scene saved in scene memory. Use the buttons located in the center to make Fade function settings for the scene selected in the list shown in the left side of the screen. For other scenes, you can only view the settings.

#### ② CURRENT field

This field lets you make Fade function settings for the scene you're currently operating. When you recall a scene, the Fade function settings of that scene are shown in this field.

#### ③ SETUP popup button

This button displays the FADE TIME popup window.

#### ④ FADING button

This button switches the Fade function on/off for each scene.

#### ⑤ Fade time

This indicates the fade time (the time over which the fader will reach the new value).



**2** Make sure that the cursor is located somewhere other than the constant display area, and use the dial or the [DEC]/[INC] keys to select the scene for which you want to make Fade function settings.

**3** Move the cursor to the SET popup button, and press the [ENTER] key to access the FADE TIME popup window.

In this popup window you can select the channels to which Fade will be applied, and adjust the fade time.

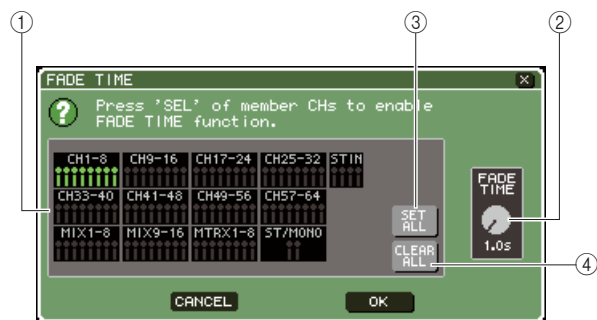

**① Channel display field**

The channels to which Fade is applied are highlighted.

**② FADE TIME knob**

This knob sets the fade time. Move the cursor to this knob and use the dial or the [DEC]/[INC] keys to adjust the setting.

**③ SET ALL button**

If you press this button, the Fade effect will be enabled for all faders/encoders of that scene.

**④ CLEAR ALL button**

If you press this button, the Fade effect will be disabled for all faders/encoders of that scene.

**4** Press the [SEL] keys of the desired channels to select the channels to which the Fade effect will be applied (multiple selections are allowed).

The [SEL] keys of the selected channels will light, and those channels will be highlighted in the channel display field of the popup window. You can cancel a selection by pressing a lit [SEL] key once again to make it go dark.

**5** Move the cursor to the FADE TIME knob, and use the dial or the [DEC]/[INC] keys to adjust the fade time.

The range is 0.0 sec–60.0 sec.

When you've finished making settings, move the cursor to the OK button and press the [ENTER] key to close the FADE TIME popup window.

**HINT**

- The fade time you specify here is used for all channels selected in step 4.

**6** To turn on the Fade function, move the cursor to the FADING button and press the [ENTER] key.

The Fade on/off setting is made individually for each scene. Save the scene if necessary.

**HINT**

- Scenes for which Fade settings are made are shown by a "FADING" indication in the STATUS field of the SCENE LIST screen.

**7** Make Fade function settings for other scenes as described in steps 2–6.

**8** Recall a scene for which the Fade function is turned on.

The faders will begin to move immediately after Recall occurs, and will reach the values of the recalled scene over the course of the specified fade time.

**NOTE**

- The Fade function settings can be applied individually even if faders are linked by Channel Link.

**HINT**

- If you stop a moving fader while you hold down the corresponding [SEL] key, the fade effect will stop at that point.
- If you recall the same scene while faders are moving, all channel faders will move immediately to their target positions.



# ◆ Chapter 14 ◆

## Monitor/Cue

This chapter explains the LS9's monitor/cue functions.

### About the monitor/cue functions

The Monitor function lets you audition various signals through your nearfield monitors or headphones. The LS9's front panel has a PHONES OUT jack for monitoring, and this jack always lets you monitor the signal that is selected as the monitoring source. By assigning the MONITOR OUT L/R/C channels to the desired output jacks, you can also monitor the same signal through external speakers. You can select the following signals as the monitor source.

- STEREO channel output signal
- MONO channel output signal
- STEREO + MONO channel output signal
- 2TR IN DIGITAL jack input signal
- INPUT channels 15/16 {31/32} input signal
- USB memory recorder output signal
- Any combination of up to eight signals from the STEREO, MONO, MIX, and MATRIX channels, the USB memory recorder output signal, INPUT channel 15/16 {31/32}, and the 2TR IN DIGITAL jack input signal

The Cue function lets you check an individual selected channel by temporarily sending it from the output jacks assigned to the MONITOR OUT channel or from the PHONES OUT jack. When you press the top panel [CUE] key, the cue signal of the corresponding channel is sent as the monitor output from the selected output port.

#### NOTE

- The cue signal is sent to the same output destination as the monitor signal. Be aware that for this reason, the cue signal will no longer be sent to the connected monitor speakers if you turn off the Monitor output. However, the cue signal will always be sent to the PHONES OUT jack.

The following diagram shows the monitor/cue signal flow.

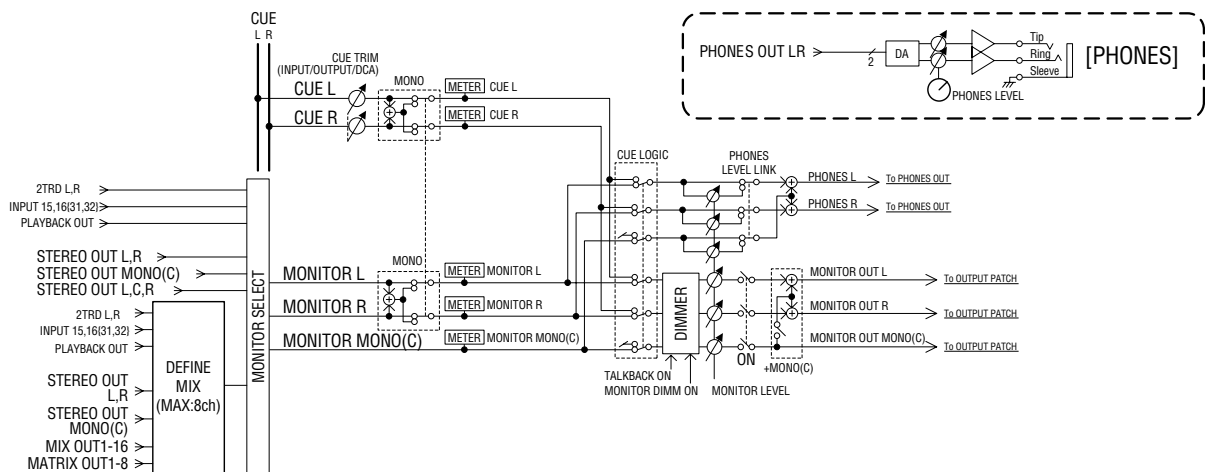

#### ● MONITOR SELECT

Selects the monitor source.

#### ● METER

Detects and indicates the level of the monitor signal or cue signal.

#### ● DIMMER

Attenuates the monitor/cue signal by a fixed amount.

#### ● MONITOR LEVEL

Adjusts the level of the monitor/cue signal. This affects the output jacks that are assigned to the MONITOR OUT L/R/C channels, and also the PHONES OUT jack.

#### ● ON (On/off)

Turns the monitor output on/off.

#### ● PHONES LEVEL (Headphone level)

Adjusts the output level of only the PHONES OUT jack.

## Using the Monitor function

This section explains how to select the desired monitor source, and monitor it from the PHONES OUT jack or external monitor speakers.

### 1 Connect your monitor system to the rear panel OMNI OUT jacks, 2TR OUT DIGITAL jack, or an I/O card installed in a slot.

The monitor signal can be sent to any desired output jack or output channel. If you're monitoring through headphones, make sure that your headphones are connected to the front panel PHONES OUT jack.

### 2 In the DISPLAY ACCESS section, press the [MONITOR] key repeatedly to access the MONITOR screen.

In the MONITOR screen you can check the current monitor settings, and turn monitoring on/off. The screen contains the following items.

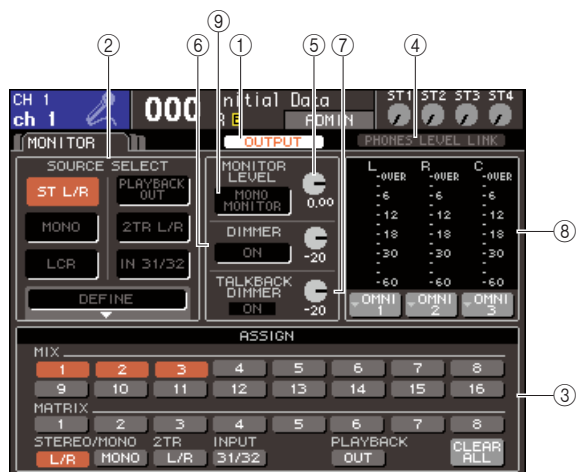

#### ① OUTPUT button

Turns the monitor output on/off.

#### ② SOURCE SELECT field

Use the buttons in this field to select the monitor source.

#### ③ ASSIGN field

If you selected DEFINE in the SOURCE SELECT field, use this field to specify the monitor source. You can select up to eight monitor sources simultaneously. If you want to clear all selections, move the cursor to the CLEAR ALL button and press the [ENTER] key.

#### ④ PHONES LEVEL LINK button

If this is on, the MONITOR LEVEL knob will adjust the level of the signal sent to the PHONES OUT jack.

#### ⑤ MONITOR LEVEL knob

Adjusts the output level of the monitor signal.

#### ⑥ DIMMER field

The Dimmer function which temporarily attenuates the monitor signal can be switched on/off here. Use the knob in this field to adjust the amount of attenuation.

#### ⑦ TALKBACK DIMMER field

If Talkback is enabled, this will indicate the on/off status of the Talkback Dimmer function which automatically attenuates the monitor signal. Here you can also specify the amount of attenuation applied by the talkback dimmer.

#### ⑧ Meter field

This indicates the level of the monitor signal. This meter shows the level immediately before the dimmer. If you move the cursor to the port select box located below the level meter and press the [ENTER] key, a popup window will appear, allowing you to select the port that will output the monitor signal.

#### ⑨ MONO MONITOR button

This button allows monaural monitoring. If this button is on, the signal sent from the PHONES OUT jack and the MONITOR OUT L/R channels will be monaural.

#### HINT

- If the normal dimmer and the talkback dimmer are both switched on simultaneously, the setting with the greatest amount of attenuation will be applied.

### 3 Use the buttons of the SOURCE SELECT field to select a monitor source.

In the SOURCE SELECT field you can select only one monitor source. However if you've selected DEFINE, you can use the ASSIGN field to specify multiple monitor sources.

The following table shows the monitor sources you can select in the SOURCE SELECT field.

ST L/R button	STEREO L/R channel output signal
MONO button	MONO channel output signal
2TR L/R button	2TR IN DIGITAL jack input signal
LCR button	STEREO L/R + MONO channel (LCR) output signal
IN 15/16 {31/32} button	INPUT channels 15/16 {31/32} input signal
PLAYBACK OUT button	USB memory recorder playback signal
DEFINE button	The signal(s) selected in the ASSIGN field

If you've selected DEFINE in the SOURCE SELECT field, you can use the ASSIGN field to select multiple sources. The following table shows the monitor sources you can select in the ASSIGN field.

<b>MIX 1–16 buttons</b>	MIX channels 1–16 output signals
<b>MATRIX 1–8 buttons</b>	MATRIX buses 1–8 output signals
<b>STEREO L/R button</b>	STEREO L/R channel output signal
<b>MONO button</b>	MONO channel output signal
<b>2TR L/R button</b>	2TR IN DIGITAL jack input signal
<b>INPUT 15/16 {31/32} button</b>	INPUT channels 15/16 {31/32} input signal
<b>PLAYBACK OUT button</b>	USB memory recorder playback signal

**NOTE**

- You can select a maximum of eight monitor sources in the ASSIGN field. If you select eight monitor sources, no further selections will be possible. Please turn off the buttons for unneeded sources.

#### 4 Move the cursor to one of the port select boxes (L/R/C) located below the level meter, and press the [ENTER] key.

The OUT PORT SELECT popup window will appear, allowing you to specify the port from which the L, R, and C monitor signals will be output.



LS9-16

#### 5 Move the cursor to the output destination port and press the [ENTER] key to select it; then move the cursor to the CLOSE button and press the [ENTER] key to close the popup window.

The following table lists the output ports you can select.

<b>OMNI 1–8 {1–16}</b>	OMNI OUT jacks 1–8 {1–16}
<b>2TR OUT L/R</b>	2TR OUT DIGITAL jack L, R
<b>SLOT {1/2} 1–16</b>	Output channels 1–16 of an I/O card installed in a slot {1/2}

**HINT**

- If desired, you can specify output ports only for MONITOR OUT L and R, and monitor through two speakers. If you have not specified an output port for MONITOR OUT C, selecting the MONO button or LCR button as the monitor source will automatically cause the MONO channel signal to be distributed to MONITOR OUT L/R.

#### 6 To output the monitor signal, move the cursor to the OUTPUT button of the MONITOR screen and press the [ENTER] key to turn it on.

The monitor source you selected in step 3 will be sent to the output destination you specified in step 5.

**HINT**

- The PHONES OUT jack will always output the monitor signal, regardless of whether the OUTPUT button is on or off.

#### 7 Move the cursor to the MONITOR LEVEL knob in the MONITOR screen, and use the dial or the [DEC]/[INC] keys to adjust the monitor level.

If PHONES LEVEL LINK is ON, you can use both the MONITOR LEVEL knob and the front panel PHONES LEVEL control to adjust the monitor level when monitoring through headphones.

**HINT**

- If PHONES LEVEL LINK is on, the MONITOR LEVEL knob will also affect the PHONES OUT jack.
- If you turn on MONITOR ON MASTER FADER that you've assigned to a user-defined key, you'll be able to use the master fader to control the monitor.

#### 8 Make settings for Dimmer and Monaural as desired.

**HINT**

- Monitor on/off operations, selection of the monitor source, and dimmer on/off operations can also be assigned to user-defined keys (→ p. 196).

# Using the Cue function

This section explains how to use the LS9's Cue function.

## About cue groups

The LS9's cue signals can be categorized into the following three groups.

### ① INPUT CUE group

The cue signals of input channels make up this group. To enable Cue for this group, press to turn on the [CUE] key of a channel module to which an INPUT channel is assigned or the [CUE] key of a ST IN channel.

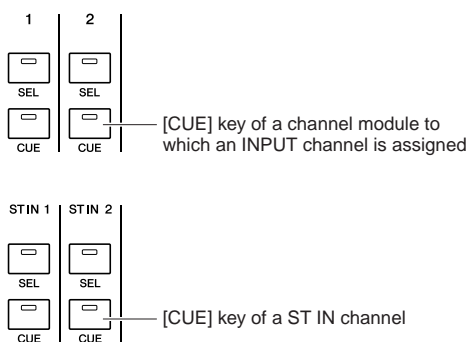

### ② OUTPUT CUE group

The cue signals of output channels make up this group. To switch to Cue for this group, press to turn on the [CUE] key of the STEREO MASTER section or the [CUE] key of a channel module to which a MIX/MATRIX/MONO channel is assigned.

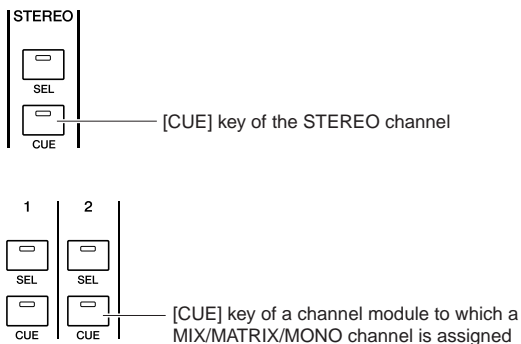

### ③ Other CUE group

These are the Cue signals operated using buttons displayed in the screen. This group is enabled if you turn on a CUE button in a RACK screen to which you've assigned an effect, the CUE button of the RECORDER screen, or the KEY IN CUE button of the DYNAMICS 1/2 popup window. This group will automatically be disabled when you exit the corresponding screen.

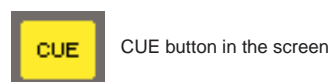

It is not possible to simultaneously turn on Cue between different groups. Normally, the group to which the most recently pressed [CUE] key (or a CUE/KEY IN CUE button in the screen) belongs will take priority, and the [CUE] keys of the previously selected group will be defeated. However if you switch the Cue signal group in a specific order, the state of the [CUE] keys of the previously-selected group will be restored when the current Cue signal is defeated.

The following illustration shows the priority order of the [CUE] keys. After you have switched groups from lower to upper levels, if you then defeat Cue for the upper group, the previous [CUE] key status of the group immediately below will be restored.

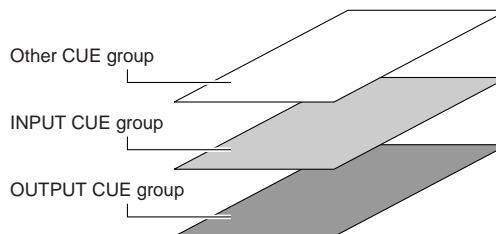

For example if you switch groups in the order of OUTPUT CUE group → INPUT CUE group → Other CUE group, you can then successively defeat the [CUE] keys (CUE/KEY IN CUE buttons) to successively restore the [CUE] key status of the previously selected group. However, if the CUE MODE is LAST CUE, the state of the [CUE] key is not reproduced.

## Operating the Cue function

This section explains how you can use the [CUE] key of a desired channel to monitor the Cue signal.

### NOTE

- The cue signal is sent to the same output destination as the monitor signal. Be aware that for this reason, the cue signal will not be sent to the connected monitor speakers if you turn off the Monitor output. However, the front panel PHONES OUT jack will always output the cue signal regardless of the Monitor on/off setting. For details on Monitor function settings, refer to "Using the Monitor function" (→ p. 146).

### 1 In the DISPLAY ACCESS section, press the [MONITOR] button repeatedly to access the CUE screen.

In the CUE screen you can check the Cue status, and turn Cue on/off.



#### ① CUE MODE field

This specifies the mode of operation when multiple [CUE] keys within the same group are turned on.

#### ② INPUT field

Here you can select one of the following positions from which input channels will be cued.

- **PFL (Pre-Fader Listen) button**  
The pre-fader signal will be output
- **AFL (After-Fader Listen) button**  
The signal immediately after the [ON] key will be output
- **POST PAN button**  
The post-pan signal will be output
- **PFL TRIM knob**  
If PFL is selected, you can adjust the output level of the cue signal in a range of -20 dB to +10 dB.

### NOTE

- Be aware that if you turn the POST PAN button on, you can no longer use input CUE to monitor the signal sent to the MONO bus from an input channel that is set to LCR mode.

#### ③ OUTPUT field

Here you can select one of the following choices as the position from which output channels will be cued.

- **PFL (Pre-Fader Listen) button**  
The pre-fader signal will be output
- **AFL (After-Fader Listen) button**  
The signal immediately after the [ON] key will be output
- **PFL TRIM knob**  
If PFL is selected, you can adjust the output level of the cue signal in a range of -20 dB to +10 dB.

#### ④ Meter field

- **CUE meter**  
This indicates the level of the cue signal.
- **ACTIVE CUE indicator**  
This indicates the currently-active CUE group.
- **CLEAR CUE button**  
Clears all Cue selections.

### 2 Use the buttons of the CUE MODE section to specify what will happen when multiple [CUE] keys within the same CUE group are turned on.

Use the following two buttons to choose the Cue mode.

- **MIX CUE button**  
All channels within the same CUE group whose [CUE] key is on will be mixed for monitoring (MIX CUE mode).
- **LAST CUE button**  
Only the channel whose [CUE] key was last turned on will be monitored (LAST CUE mode).

### HINT

- [CUE] keys belonging to different CUE groups cannot be turned on simultaneously. The CUE group to which the last-pressed [CUE] key belongs will be turned on, allowing only the signals of that group to be monitored.

### 3 Use the buttons and knobs of the INPUT field and OUTPUT field to specify the output position and output level for each CUE group.

#### 4 Press the [CUE] key of a desired channel to turn it on.

The Cue signal of the corresponding channel will be sent to the monitor signal output destination. You can also watch the Cue meter of the meter field to check the output level of the cue signal. The ACTIVE CUE indicator located below the Cue meter indicates the CUE group (INPUT or OUTPUT) that is currently turned on.

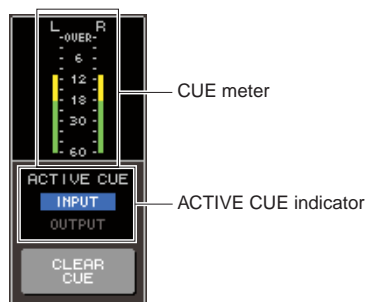

#### HINT

- If you want Cue operations and channel select operations to be linked, open the PREFERENCE popup window of the USER SETUP screen, and turn "[CUE]-[SEL] LINK" on (→ p. 194).

#### 5 Press the DISPLAY ACCESS section [MONITOR] button to access the MONITOR screen, and use the MONITOR LEVEL knob in the screen to adjust the level of the cue signal.

If PHONES LEVEL LINK is ON, you can use both the MONITOR LEVEL knob and the front panel PHONES LEVEL control to adjust the monitor level when monitoring through headphones.

#### 6 To defeat Cue, press the [CUE CLEAR] key or the currently-on [CUE] key once again.

If you want to clear all Cue selections, move the cursor to the CUE CLEAR button in the CUE screen, and press the [ENTER] key.

#### HINT

- All Cue selections will be cleared if you switch between MIX CUE mode and LAST CUE mode in the CUE MODE section.
- You can also assign the same function as the CLEAR CUE button to a user-defined key (→ p. 196).



# ◆ Chapter 15 ◆

## Talkback / Oscillator

This chapter explains how to use the talkback and oscillator functions.

### About talkback and oscillator

Talkback is a function that sends the signal of the selected INPUT jack to the desired bus. This is used mainly to convey directions from the operator to the performers and staff. The LS9 also contains an oscillator that allows a sine wave or pink noise to the desired bus, and this can be used to check external equipment or to test the response of the room.

The diagram below shows the signal flow of the talkback and oscillator.

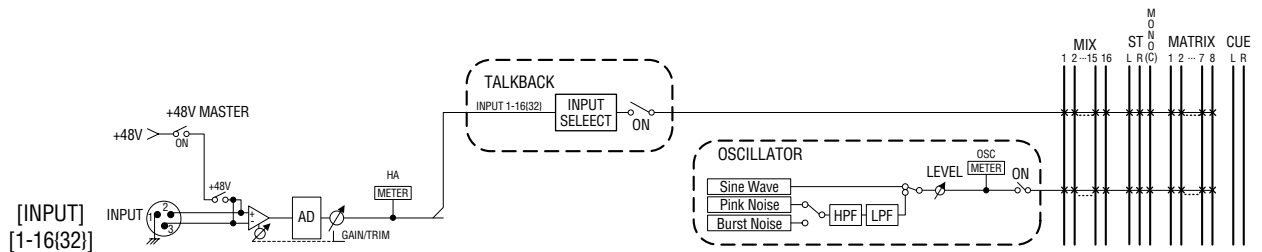

### Using talkback

Here's how a signal received at an INPUT jack 1–16 {1–32} can be output to the desired bus.

- 1 In the DISPLAY ACCESS section, press the [MONITOR] button repeatedly to access the TALKBACK screen.**

In the TALKBACK screen you can check the status of the talkback and turn it on/off.



- 1 TALKBACK ON button**  
This switches talkback on/off.

- 2 INPUT TO TALKBACK field**

Of the INPUT jacks 1–16 {1–32}, the input sensitivity, input level, and phantom power on/off status of the jack used for talkback is shown here. You can adjust the input sensitivity by selecting the GAIN knob in this field.

- **Input select popup button**

This displays the INPUT PORT SELECT popup window, where you can select the INPUT jack used for talkback.

- **+48V button**

This is an on/off switch for the phantom power (+48V) supplied to the INPUT jack used for talkback.

- **GAIN knob**

This adjusts the input sensitivity of the INPUT jack used for talkback.

- **Input level meter**

This indicates the input level of the mic connected to the INPUT jack used for talkback.

- 3 ASSIGN field**

This selects the buses to which the talkback signal will be sent. If you want to clear all selections, move the cursor to the CLEAR ALL button and press the [ENTER] key.

- 2** To assign the input from the INPUT jack to talkback, move the cursor to the input select popup window in the INPUT TO TALKBACK field, and press the [ENTER] key.

The INPUT PORT SELECT popup window will appear.



LS9-32

- 3** Of the IN1–16 {1–32} buttons, move the cursor to the port you want to use for talkback, and press the [ENTER] key. To cancel the selection, press the [ENTER] key once again on the selected port.

You can select only one port at a time.

- 4** When you've selected the port, move the cursor to the CLOSE button and press the [ENTER] key to close the popup window.

- 5** Connect your mic to the rear panel INPUT jack, move the cursor to the TALKBACK GAIN knob, and use the dial or the [DEC]/[INC] keys to adjust the input sensitivity of the mic.

The input level meter in the INPUT TO TALKBACK field shows the input level of the mic connected to the INPUT jack. If you want phantom power (+48V) to be supplied to the INPUT jack, turn on the +48V button in the INPUT TO TALKBACK field.

**NOTE**

- If you want to use phantom power, you must first turn ON the +48V MASTER ON/OFF button located in the SYSTEM SETUP screen.
- The PAD will be internally switched on or off when the HA gain is adjusted between -14 dB and -13 dB. Keep in mind that noise may be generated if there is a difference between the Hot and Cold output impedance of the external device connected to the INPUT connector when using phantom power.

- 6** Using the buttons in the ASSIGN field, select the bus(es) to which you want to send the talkback signal. (You may select more than one.)

The buttons correspond to the following buses.

MIX 1–16 buttons	MIX buses 1–16
MATRIX 1–8 buttons	MATRIX buses 1–8
ST L, ST R, MONO buttons	STEREO bus L/R, MONO bus

**HINT**

- If you want to clear all selections, move the cursor to the CLEAR ALL button and press the [ENTER] key.

- 7** To enable talkback, move the cursor to the TALKBACK ON button and press the [ENTER] key to turn it on.

The TALKBACK ON button will alternate between on and off each time you press the [ENTER] key (latched operation).

While talkback is on, the signal from the INPUT jack selected as the TALKBACK jack will be output to the send-destination bus.

**HINT**

- You can also assign the talkback on/off function to a user-defined key. In this case, you can choose either latched operation or unlatched operation (i.e., talkback will be On only while you hold down the key) (→ p. 196).
- You can also use Talkback Dimmer to lower the monitor level of the non-talkback signals when talkback is on (→ p. 146).

## Using the oscillator

Here's how you can send a sine wave or pink noise from the internal oscillator to the desired bus.

- 1** In the **DISPLAY ACCESS** section, press the **[MONITOR]** button repeatedly to access the **OSCILLATOR** screen.

In the **OSCILLATOR** screen you can check the settings of the oscillator and turn it on/off.



- 1 OUTPUT button**

This switches the oscillator on/off.

- 2 MODE field**

Move the cursor to a button in this field to select the desired type of oscillator.

- 3 Parameter field**

Here you can adjust the parameters of the oscillator you selected in the **MODE** field. Use the dial or the **[DEC]/[INC]** keys to operate the knobs shown in the field.

- 4 Oscillator level**

This indicates the output level of the oscillator.

- 5 ASSIGN field**

This selects the buses to which the oscillator signal will be sent. If you want to clear all selections, move the cursor to the **CLEAR ALL** button and press the **[ENTER]** key.

- 2** Use the buttons in the **MODE** field to select the type of signal you want to output.

You can choose from the following signals.

<b>SINE WAVE 1CH</b>	Sine wave, one channel
<b>PINK NOISE</b>	Pink noise
<b>BURST NOISE</b>	Burst noise (intermittently output pink noise)

- 3** If you want to adjust the oscillator parameters, use the dial or the **[DEC]/[INC]** keys to operate the knobs shown in the field.

The parameters shown in the parameter field will depend on the type of oscillator selected in the **MODE** field.

The following table lists the oscillator types and the parameters displayed for each type.

Oscillator type	Parameters
SINE WAVE 1CH	LEVEL, FREQ
PINK NOISE	LEVEL, HPF, LPF
BURST NOISE	LEVEL, HPF, LPF, WIDTH, INTERVAL

The following table describes each parameter in detail.

Parameter	Details
LEVEL	Oscillator output level
FREQ	Frequency of the sine wave produced by the oscillator
HPF	High-pass filter (on/off switch, cutoff frequency)
LPF	Low-pass filter (on/off switch, cutoff frequency)
WIDTH	Duration of the noise
INTERVAL	Length of silence between noise bursts

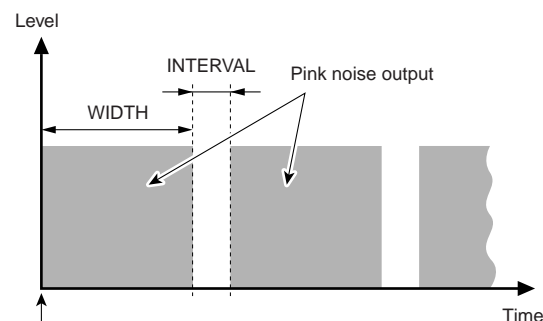

- 4** Using the buttons in the **ASSIGN** field, select the bus(es) to which you want to send the oscillator signal. (You may select more than one.)

The buttons correspond to the following buses.

<b>MIX 1–16 buttons</b>	MIX buses 1–16
<b>MATRIX 1–8 buttons</b>	MATRIX buses 1–8
<b>ST L, ST R, MONO buttons</b>	STEREO bus L/R, MONO bus

### HINT

- If you want to clear all selections, move the cursor to the **CLEAR ALL** button and press the **[ENTER]** key.

**5 To enable the oscillator, move the cursor to the OUTPUT button and press the [ENTER] key to turn it on.**

The oscillator signal will be sent to the bus(es) you selected in step 4. When you select the button and press the [ENTER] key once again, the oscillator will be turned off.



- *You can also assign the oscillator on/off function to a user-defined key (→ p. 196).*

# ◆ Chapter 16 ◆

## Meters

This chapter describes the meter screen which displays input/output level meters for all channels.

### Using the METER screen

By accessing the Meter screen you can view the input/output levels of all channels in the screen, and switch the metering point (the location at which the level is detected) of the level meters.

- 1 In the **DISPLAY ACCESS** section, press the **[METER]** key to access the Meter screen.

The Meter screen is divided into the **METER CH1-32** screen, {**METER CH 33-64** screen}, **OUTPUT METER** screen, and **CUSTOM FADER** screen.

#### [ METER CH1-32 screen ]

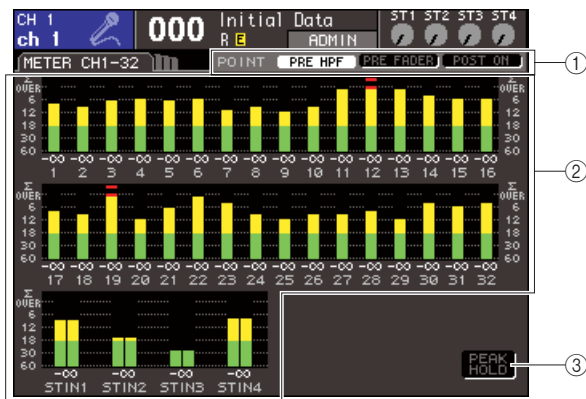

#### [ OUTPUT METER screen ]

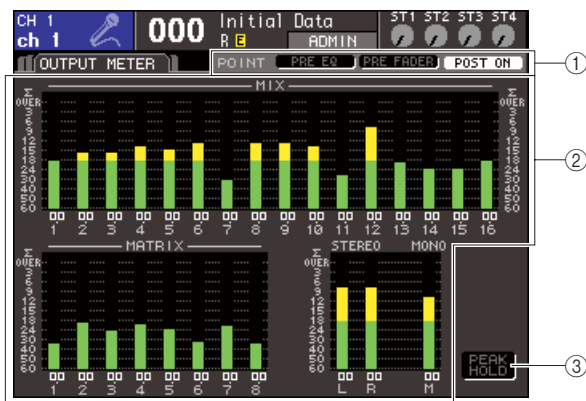

#### [ CUSTOM FADER screen ]

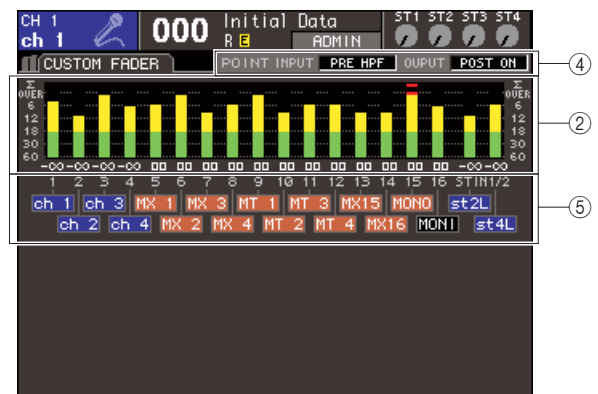

LS9-16

#### ① Metering point select buttons

Use these three buttons to select the metering point for the input/output channels.

#### ② Level meters

These show the input/output levels or fader values. The current fader value is shown in a range of  $-\infty$ –10. When you operate the corresponding fader, the value will change in realtime.

The  $\Sigma$  segment will light if even one of the level detection points within each channel is overloaded.

The  $\Sigma$  segment level detection points are as follows.

- **Input channels**  
..... PRE HPF, PRE FADER, POST ON
- **Output channels**  
..... PRE EQ, PRE FADER, POST ON

#### ③ PEAK HOLD button

If you turn this button on, the peak levels of the meters will be held. When you turn this button off, the peak level indications that had been held will be cleared.

④ **Metering point select box**

Use the dial or the [DEC]/[INC] keys to select the metering point for the input/output channels.

⑤ **Channel name**

This shows the first four characters of the channel name for the channels assigned to the [CUSTOM FADER] layer. Channels that are not assigned are shown as “----”.

**2 If desired, you can move the cursor to the metering point select buttons and press the [ENTER] key to switch the metering point. In the CUSTOM FADER screen, move the cursor to the metering point select box, use the dial or the [DEC]/[INC] keys to make your selection, and then press the [ENTER] key.**

The metering point for the level meters can be set independently for input channels and output channels.

You can choose from the following metering points.

● **Input channels**

- **PRE HPF** .....Immediately before the high-pass filter
- **PRE FADER** .....Immediately before the fader
- **POST ON** .....Immediately after the channel on/off.

● **Output channels**

- **PRE EQ** .....Immediately before the attenuator
- **PRE FADER** .....Immediately before the fader
- **POST ON** .....Immediately after the channel on/off.

For details on the metering points, refer to the block diagram at the end of this manual.

**3 If you want to hold the peak levels of the level meters, move the cursor to the PEAK HOLD button and press the [ENTER] key to turn it on.**

On/off operations of the PEAK HOLD button will apply to both input channels and output channels. When you turn this button off, the peak level indications that had been held will be cleared.



- You can also assign the PEAK HOLD button on/off function to a user-defined key (→ p. 196).
- If you turn on METER FOLLOW LAYER in the PREFERENCE screen, the same meter screen as the selected layer will be displayed when you press a LAYER key.



# ◆ Chapter 17 ◆

## Graphic EQ and effects

This chapter explains how to use the built-in graphic EQ and effects, and how to perform remote control operations via the dedicated protocol to control an external head amp (Yamaha AD8HR) from the LS9.

### About the virtual rack

The LS9 lets you insert the built-in graphic EQ (subsequently abbreviated as “GEQ”) and effects into the desired signal route to process the signals.

You can use two types of GEQ; 31 Band GEQ which lets you freely adjust thirty-one bands (frequency regions), and Flex15GEQ which lets you adjust any fifteen of thirty-one bands. You can also use 48 different effect types.

In order to use a GEQ or effect, you must mount the GEQ or effect in one of the eight virtual racks provided in the screen, and patch the input and output of that rack to the desired signal route. In other words, the operation is just as though you had installed a signal processor or effect device in an actual rack, and used patch cords to connect it. Only GEQ can be mounted in racks 1–4, and either GEQ or effects can be mounted in racks 5–8. [Figure 1]

Up to two channels of input and output can be used for each rack. (However if the “31 Band GEQ” is mounted in a rack, there will be only one channel each for input and output.) [Figure 2] shows the signal flow for the virtual racks.

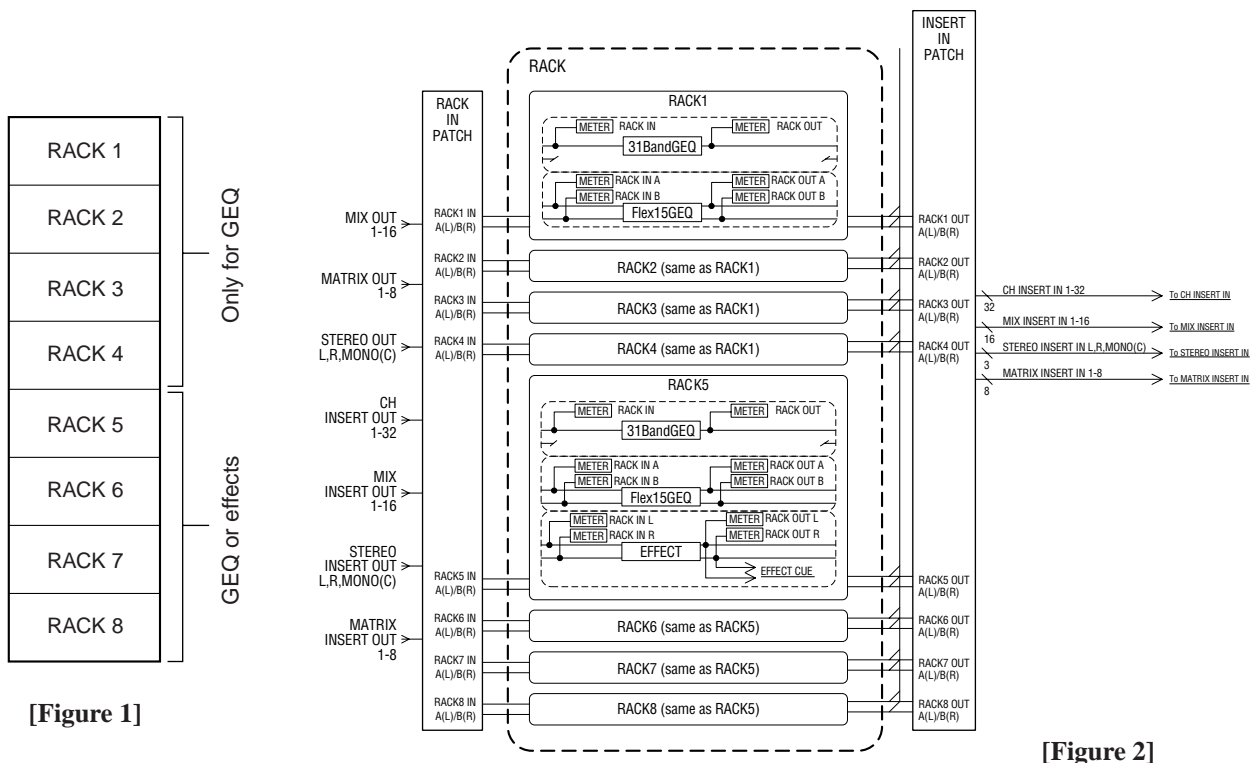

[Figure 1]

[Figure 2]



- In addition to the virtual rack for GEQ and effects, there is also a rack for mounting external head amps (Yamaha AD8HR). For details, refer to “Using an external head amp” (→ p. 175).

## Mounting a GEQ or effect in the virtual rack

This section explains how to mount a GEQ or effect in the virtual rack, and patch the input/output of the rack.

### 1 In the DISPLAY ACCESS section, press the [RACK 1-4] key and [RACK 5-8] key simultaneously to access the VIRTUAL RACK screen.

In the VIRTUAL RACK screen you can mount GEQ or effects, and make input/output settings.



- If you press only the [RACK 1-4] key or the [RACK 5-8] key, the setting screen (RACK 1–RACK 8 screens) for the rack you operated most recently will appear. To ensure that you access the desired screen, hold down one of the keys and then press the other key.

The screen contains the following items.

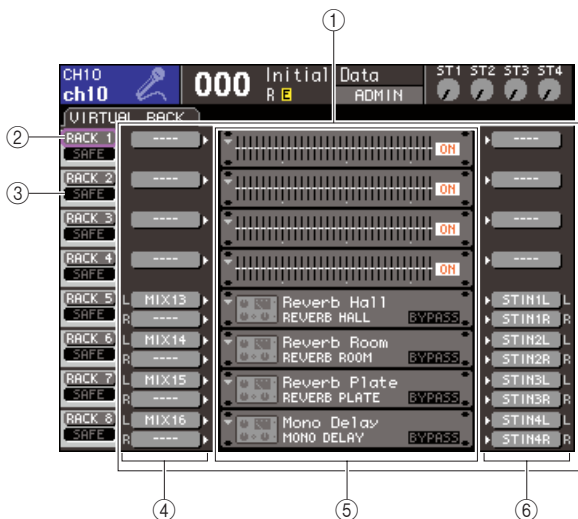

#### 1 GEQ/EFFECT field

In this field you can mount GEQ or effects in racks 1–8, and edit the input/output patching for each rack.

#### 2 RACK button

This displays the RACK MOUNT popup window, where you can select an item to mount in the rack. Each of these buttons corresponds to the rack shown at the immediate right.

#### 3 SAFE button

This button switches Recall Safe on/off for the rack. Each of these buttons corresponds to the rack shown at the immediate right.

#### 4 INPUT button

This button displays the OUTPUT CH SELECT popup window, where you can select the input source for the rack.

#### 5 Virtual rack

This area shows eight virtual racks in which GEQ or effects can be mounted. Racks 1–4 are only for GEQ, and either GEQ or effects can be mounted in racks 5–8. (However depending on the type of internal effect, some can be mounted only in rack 5 or 7.)

When you move the cursor to a virtual rack and press the [ENTER] key, the result will depend on whether a GEQ or effect is already mounted.

##### ● If a GEQ/effect is already mounted in that rack

The RACK 1–RACK 8 screen will appear, allowing you to edit the parameters of the GEQ or effect.

##### ● If the rack is vacant

The RACK MOUNTER popup window will appear, allowing you to select the GEQ or effect that will be mounted in the rack.

#### 6 OUTPUT button

This button displays the INPUT CH SELECT popup window, where you can select the output destination of the rack.

### 2 To mount a GEQ or effect in the rack, move the cursor to the RACK button for that rack and press the [ENTER] key.

The RACK MOUNTER popup window will appear.

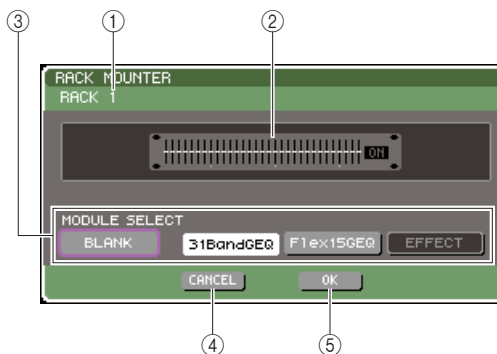

#### 1 Rack number

This indicates the number of the selected rack.

#### 2 Virtual rack

This is the virtual rack in which you can mount a GEQ or effect.

③ **MODULE SELECT buttons**

Use these buttons to select the GEQ or effect that will be mounted in the rack. Each button has the following function.

● **BLANK button**

Removes the GEQ or effect currently mounted in the rack; the rack will be empty.

● **31 Band GEQ button**

Mounts a 31 Band GEQ in the rack.

● **Flex15GEQ button**

Mounts a Flex15GEQ in the rack.

● **EFFECT button**

Mounts an effect in the rack. This button will not operate for racks 1–4.



- Input/output patching will be cleared if you change the item that is mounted or remove the mounted item.

④ **CANCEL button**

Cancels the changes you made in the RACK MOUNTER popup window, and closes the window.

⑤ **OK button**

Applies the changes you made in the RACK MOUNTER popup window, and closes the window.



- Be aware that if you remove a GEQ or effect that was mounted in a rack and close the window, all parameter settings for that GEQ or effect will be discarded. If you have not yet closed the window, you can recover the settings by mounting the same GEQ or effect once again.



- You can also display the RACK MOUNTER popup window by moving the cursor to a vacant rack in the GEQ/EFFECT field and pressing the [ENTER] key.

**3 Use the MODULE SELECT buttons to select the item you want to mount, move the cursor to the OK button, and press the [ENTER] key.**

**4 To select the input source for a rack, move the cursor to the INPUT button for that rack and press the [ENTER] key.**

The OUTPUT CH SELECT popup window will appear, allowing you to select the input source for the rack.

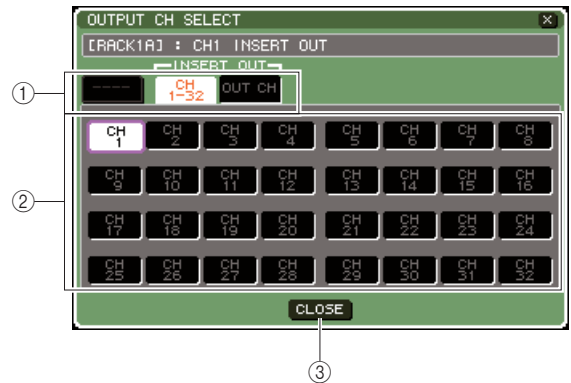

① **Channel select tabs**

These tabs switch the type of channels that are shown in the lower part of the window.

② **Channel select buttons**

Use these buttons to select the input source. Use the three tabs to switch between groups of input sources shown in the window.

③ **CLOSE button**

Closes the popup window.

The following input sources can be selected in this popup window.

Tab name	Button name	Input source
OUT CH (*1)	MIX 1–16	MIX channel 1–16 outputs
	MTRX 1–8	MATRIX channel 1–8 outputs
	ST L, ST R, MONO	STEREO (L/R) channel output, MONO (C) channel output
CH 1-32 (INSERT OUT)	CH 1–32	INPUT channel 1–32 Insert Outs
OUT CH (INSERT OUT)	MIX 1–16	MIX channel 1–16 Insert Outs
	MTRX 1–8	MATRIX channel 1–8 Insert Outs
	ST L, ST R, MONO	STEREO (L/R) channel Insert Out, MONO (C) channel Insert Out

\*1: This cannot be selected for 31 Band GEQ or Flex15GEQ.



- If you select Insert Out of a channel as the input source for 31 Band GEQ or Flex15GEQ, the Insert In of that same channel will automatically be selected as the output destination for that rack. When you defeat an Insert Out, the Insert In will also be defeated automatically. For details on Insert Out/In, refer to "Inserting an external device into a channel" (→ p. 101).

### 5 Switch the tabs as necessary, and select the input source that you want to use.

When you select an input source in the OUTPUT CH SELECT popup window, a dialog box will ask you to confirm the change in patching. To confirm the operation, move the cursor to the OK button and press the [ENTER] key.



- You have the option of making settings so that the patch change confirmation dialog box does not appear (→ p. 194).
- If you selected 31 Band GEQ, you'll be able to select one channel of input; otherwise you'll be able to select two channels of input.

### 6 Move the cursor to the OUTPUT button for that rack, and press the [ENTER] key.

The INPUT CH SELECT popup window will appear, allowing you to select the output destination for the rack.

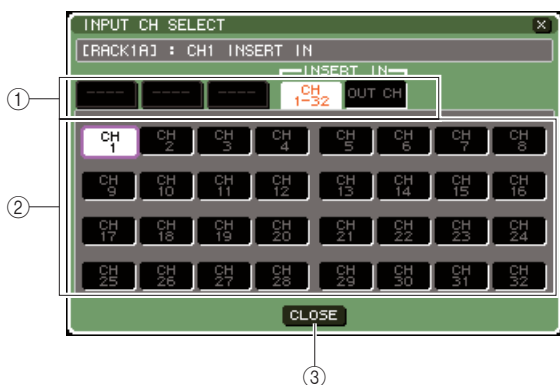

① **Channel select tabs**

These tabs switch the type of channels that are shown in the lower part of the window.

② **Channel select buttons**

Use these buttons to select the output destination.

③ **CLOSE button**

Closes the popup window.

The following output destinations can be selected in this popup window (multiple selections are allowed).

Tab name	Button name	Output destination
CH 1-32 (*1)	CH 1-32	INPUT channel 1-32 inputs
CH33-64 (*1) (LS9-32 only)	CH 33-64	INPUT channel 33-64 inputs
STIN (*1)	STIN1L/1R-4L/4R	ST IN channel 1-4 inputs
CH 1-32 (INSERT OUT)	CH 1-32	INPUT channel 1-32 Insert In
OUT CH (INSERT OUT)	MIX 1-16	MIX channel 1-16 Insert In
	MTRX 1-8	MATRIX channel 1-8 Insert In
	ST L, ST R, MONO	STEREO (L/R) channel Insert In, MONO (C) channel Insert In

\*1: This cannot be selected for 31 Band GEQ or Flex15GEQ.



- If you selected the Insert In of a certain channel as the output destination for 31 Band GEQ or Flex15GEQ, the Insert Out of the same channel will automatically be selected as the input source of that rack. When you defeat an Insert In, the Insert Out will also be defeated automatically.

### 7 Switch the tabs as necessary, and select the output destination that you want to use.

When you select an output destination in the INPUT CH SELECT popup window, a dialog box will ask you to confirm the patching change. To confirm the operation, move the cursor to the OK button and press the [ENTER] key.



- You have the option of making settings so that the patch change confirmation dialog box does not appear (→ p. 194).
- You can specify multiple output destinations for a rack.
- If you selected 31 Band GEQ, you'll be able to select one channel of output; otherwise you'll be able to select two channels of output.

### 8 To turn Recall Safe on/off, move the cursor to the SAFE button for that rack and press the [ENTER] key.

If Recall Safe is turned on for a rack, the contents and parameters of that rack will not change when a scene is recalled. For more about Recall Safe, refer to “Using the Recall Safe function” (→ p. 140).



- The type of GEQ or effect mounted in each rack, its parameter settings, and the input-source/output-destination settings are saved as part of the scene.

# Graphic EQ operations

## About the graphic EQ

The LS9 lets you mount a GEQ in racks 1–8 and patch it to the insert-out/in of a channel. You can use the top panel faders and [ON] keys to operate the amount of boost/cut for each band.

The following two types of GEQ are provided.

### ● 31 Band GEQ

This is a monaural 31-band GEQ. Each band is 1/3 octave wide, the adjustable boost/cut range is  $\pm 15$  dB, and the amount of boost/cut for each of the thirty-one bands can be adjusted. If a 31 Band GEQ is mounted in a rack, one channel of input and output can be used for that rack.

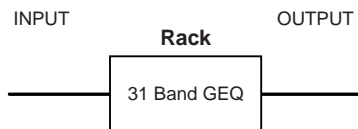

### ● Flex15GEQ

This is a monaural 15-band GEQ. Each band is 1/3 octave wide, and the adjustable boost/cut range is  $\pm 15$  dB. The Flex 15GEQ lets you adjust the boost/cut amount for any fifteen of the same bands as the thirty-one bands of the 31 Band GEQ. (Once you've used up fifteen bands of adjustment, you won't be able to adjust the boost/cut amount of another band until you reset a previously-adjusted band to the flat setting.)

A rack for which the Flex15GEQ is selected will have two Flex15GEQ units (shown as "A" and "B" respectively) mounted in that rack, and will allow two channels of input and output. If you mount a Flex15GEQ in each rack, you'll be able to use up to sixteen GEQ units simultaneously.

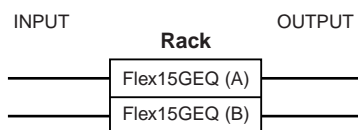

## Inserting a GEQ in a channel

The LS9's GEQ units can be patched to the insert-in/out of any channel except the ST IN channels. Here's how to insert a GEQ into the selected channel for use.

### 1 As described in steps 1–3 of "Mounting a GEQ or effect in the virtual rack" (→ p. 158), mount a GEQ in a rack.

The GEQ/EFFECT field shows the approximate settings and input/output levels of the GEQ. A rack in which a Flex15GEQ is mounted will show information for two GEQ units (A and B).

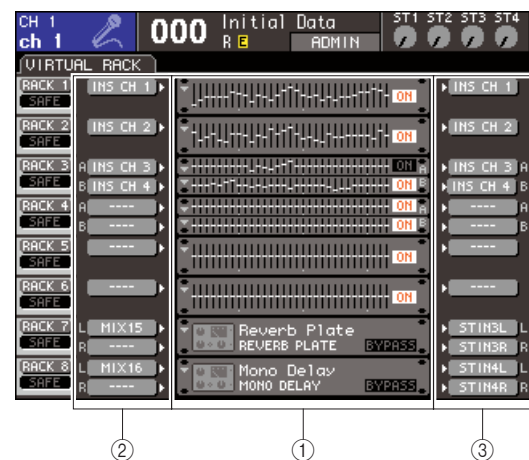

- ① Racks
- ② INPUT buttons
- ③ OUTPUT buttons



- If you're using a stereo source, you can mount a Flex15GEQ in one rack, or mount two 31 Band GEQ units in adjacent odd-numbered/even-numbered racks. This will let you link the two GEQ units later.

### 2 Use the INPUT button to open the OUTPUT CH SELECT popup window where you can select the input-source for the rack, and choose the insert-out of the desired channel.

The insert-out will be assigned to the input of the GEQ. (For details on the OUTPUT CH SELECT popup window → p. 159)



- If you select the Insert Out of a certain channel as the input source, the Insert In of that same channel will automatically be selected as the output destination for that rack. For details on Insert Out/In, refer to "Inserting an external device into a channel" (→ p. 101).

**3 Use the OUTPUT button to open the INPUT CH SELECT popup window where you can select the output-destination for the rack, and choose the insert-in to which you want to assign the output of the GEQ (multiple selections are allowed).**

The insert-in will be assigned to the output of the GEQ. (For details on the INPUT CH SELECT popup window → p. 160)



- If you select the Insert In of a certain channel as the output source, the Insert Out of that same channel will automatically be selected as the input source for that rack.

**4 In the GEQ/EFFECT field, move the cursor to the rack in which you mounted the GEQ and press the [ENTER] key.**

The RACK screen will appear, allowing you to edit the parameters of the GEQ or effect.



- You can also access the RACK screen by pressing the [RACK 1-4] key or [RACK 5-8] key. By repeatedly pressing the [RACK 1-4] key you can access the RACK 1-4 screens, and by repeatedly pressing the [RACK 5-8] key you can access the RACK 5-8 screens and EXTERNAL HA screen.
- The RACK screens for the 31 Band GEQ and the Flex15GEQ are nearly identical. However, the Flex15GEQ individually displays two GEQ units (A and B) mounted in a single rack.



**① GEQ ON/OFF button**

Switches the currently selected GEQ on/off.

**② FLAT button**

This returns all bands of the currently selected GEQ to 0 dB.

**③ INPUT button**

This button displays the OUTPUT CH SELECT popup window, where you can select the input source of the rack. The operating procedure is the same as for the INPUT button in the GEQ/EFFECT field.

**④ OUTPUT button**

This button displays the INPUT CH SELECT popup window, where you can select the output destination of the rack. The operating procedure is the same as for the OUTPUT button in the GEQ/EFFECT field.

**⑤ GEQ LINK button**

This button links adjacent GEQ units. In the case of a 31 band GEQ, the GEQ units in adjacent odd-numbered/even-numbered racks will be linked. In the case of a Flex15GEQ, the GEQ(A) and GEQ(B) within the same rack will be linked.



- The GEQ LINK button is shown only if linking is possible.

**5 If you want to link two GEQ units, turn on the GEQ LINK button.**

If you've selected 31 Band GEQ for two adjacent odd-numbered/even-numbered racks, or if you've selected a Flex15GEQ, you can use the GEQ LINK button to link the two GEQ units. This is convenient when you want to process a stereo source through GEQ units with identical settings.

When you turn the GEQ LINK button on, a popup window like the following will appear. The popup window contains the following items.

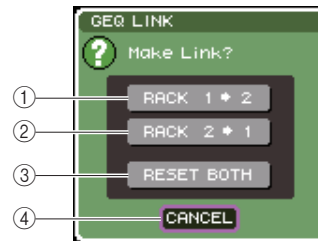

**① RACK x→y button ("x" and "y" are the rack number, or the rack number and the alphabetical characters A or B)**

The parameters of "x" will be copied to "y," and then linked.

**② RACK y→x button**

The parameters of "y" will be copied to "x," and then linked.

**③ RESET BOTH button**

The parameters of both will be initialized, and then linked.

**④ CANCEL button**

Cancels the link and closes the popup window.

To confirm the link, move the cursor to a button other than CANCEL, and press the [ENTER] key. When you link GEQ units, a symbol will appear in the GEQ/EFFECT field to indicate the linked status.

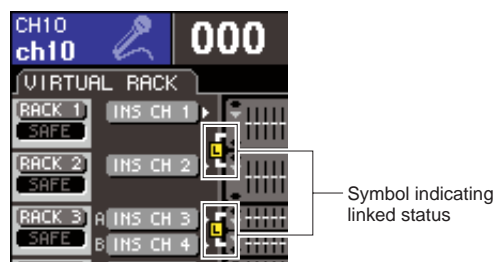



## 6 To turn on the GEQ, move the cursor to the GEQ ON/OFF button and press the [ENTER] key.

After you've turned the GEQ on, adjust the bands of the GEQ. For details on operating the GEQ, refer to "Using the 31 Band GEQ" (below) or "Using the Flex15GEQ" (→ p. 164).

## 7 Check whether INSERT is turned on for the patched channel.

For details, refer to "Inserting an external device into a channel" (→ p. 101).

### Using the 31 Band GEQ

Here we will explain how to use the 31 Band GEQ.

## 1 As described in steps 1–3 of "Mounting a GEQ or effect in the virtual rack" (→ p. 158), mount a GEQ in a rack.

A rack in which a 31 Band GEQ is mounted will show the approximate settings.



Rack image display

## 2 In the GEQ/EFFECT field, move the cursor to the rack in which you mounted the GEQ and press the [ENTER] key.

The RACK screen will appear, allowing you to edit the parameters of the GEQ.

You can also access the RACK screen by pressing the [RACK 1-4] key or [RACK 5-8] key. By repeatedly pressing the [RACK 1-4] key you can access the RACK 1–4 screens, and by repeatedly pressing the [RACK 5-8] key you can access the RACK 5–8 screens and EXTERNAL HA screen.

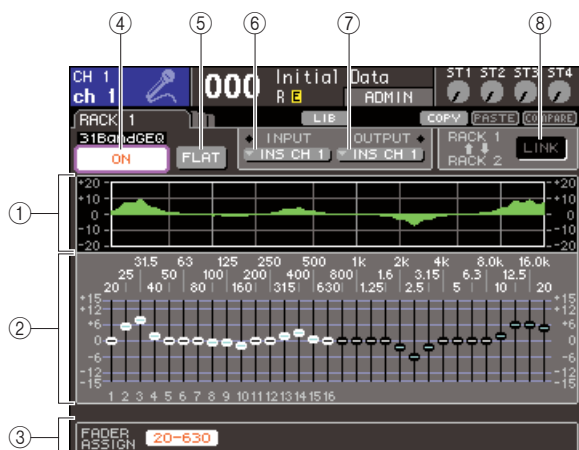

LS9-32

## ① EQ graph

This indicates the approximate response of the current 31 Band GEQ settings.

## ② Faders

These faders indicate the amount of boost/cut for each band of the 31 Band GEQ. The frequency and value for the fader currently selected by the cursor are shown below the fader.

## ③ FADER ASSIGN field

Use this field when you want to operate the boost/cut amount for each band using the top panel faders.

## ④ GEQ ON/OFF button

Switches the currently selected GEQ on/off.

## ⑤ FLAT button

This returns all bands of the currently selected GEQ to 0 dB.

## ⑥ INPUT button

This button displays the OUTPUT CH SELECT popup window, where you can select the input source of the rack.

## ⑦ OUTPUT button

This button displays the INPUT CH SELECT popup window, where you can select the output destination of the rack.

## ⑧ GEQ LINK button

This button links adjacent GEQ units.



### NOTE

- The GEQ LINK button is shown only if linking is possible. For a 31 Band GEQ, this button is displayed if a 31 Band GEQ is mounted in two adjacent odd-numbered/even-numbered racks.

## 3 After you've set the input-source and output-destination correctly, use the GEQ ON/OFF button to turn on the 31-band GEQ.

## 4 To adjust the boost/cut of each band, move the cursor to the desired fader and operate the dial or the [DEC]/[INC] keys.

## 5 If you want to use the top panel faders to adjust the boost/cut of each band, proceed as follows.

### ① Move the cursor to the button in the FADER ASSIGN field and press the [ENTER] key.

When this button is turned on, the faders in the screen will turn white, and you will be able to use the top panel faders to adjust the GEQ bands.

● For the LS9-16

On the LS9-16, the bands that can be controlled will depend on the button you selected. In order to adjust all of the bands, you'll need to switch these buttons as you work.

Button name	Bands
[20-630] button	16 bands from 20 Hz–630 Hz
[125-4k] button	16 bands from 125 Hz–4 KHz
[630-20k] button	16 bands from 630 Hz–20 KHz

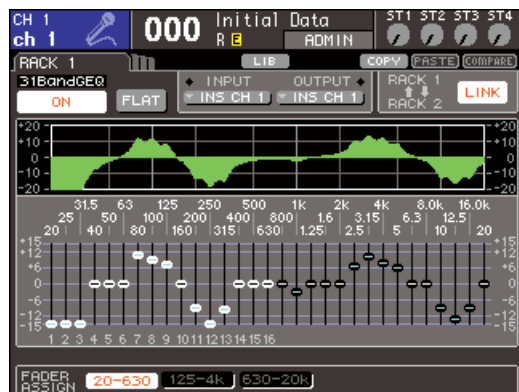

● For the LS9-32

Only the [20-20k] button can be selected. When this button is on, you can use the top panel faders 1–31 to operate all 31 bands.

② Operate the faders.

The corresponding frequency region will be boosted or cut.



- When a top panel fader is in the center (flat) position, the corresponding [ON] key will go dark. This indicates that the corresponding band is not being modified. If you raise or lower the fader even lightly, the [ON] key will light, indicating that this band is being modified. If you press a lit [ON] key to make it go dark, the corresponding band will immediately return to the flat state.

③ When you've finished making settings, turn off the button(s) of the FADER ASSIGN field.

The top panel faders and [ON] keys will return to their previous function.



- If a button in the FADER ASSIGN field is on, switching the display to another screen or rack will forcibly defeat the top panel fader assignments.
- However if you once again display the same rack, the group of bands you had previously been controlling will automatically be assigned to the faders.
- FADER ASSIGN on/off settings apply to all GEQ units together.

6 If you want to copy the currently-displayed 31 Band GEQ settings to the GEQ of another rack, or to initialize the settings, you can do so using the tool buttons at the top of the screen.

For details on how to use these buttons, refer to “Using the tool buttons” (→ p. 35).



- If a 31 Band GEQ is using 15 or fewer bands, its settings can also be copied to a Flex15GEQ.



- GEQ settings can be saved/loaded at any time using the dedicated library (→ p. 174).

## Using the Flex15GEQ

Here we will explain how to use the Flex15GEQ.

1 As described in “Mounting a GEQ or effect in the virtual rack” (→ p. 158) steps 1–3, mount a GEQ in a rack.

A rack in which a Flex15GEQ is mounted will show information for two GEQ units (A and B).

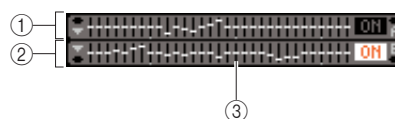

- ① GEQ (A)
- ② GEQ (B)
- ③ Rack graphic display area



- When you mount a Flex15GEQ, two monaural 31 Band GEQ units (A and B) are placed in a single rack. However, only up to fifteen bands can be adjusted for each unit.

2 Move the cursor to a rack in which a Flex15GEQ is mounted, and press the [ENTER] key.

The RACK screen will appear, allowing you to edit the parameters of GEQ (A) or GEQ (B).

To switch the RACK screen, repeatedly press the [RACK 1-4] keys (RACK 1–4 screens) or [RACK 5-8] key (RACK 5–8 screens / EXTERNAL HA screens). For a rack in which a Flex15GEQ is mounted, the RACK screen is shown separately as xA and xB (x is the rack number).

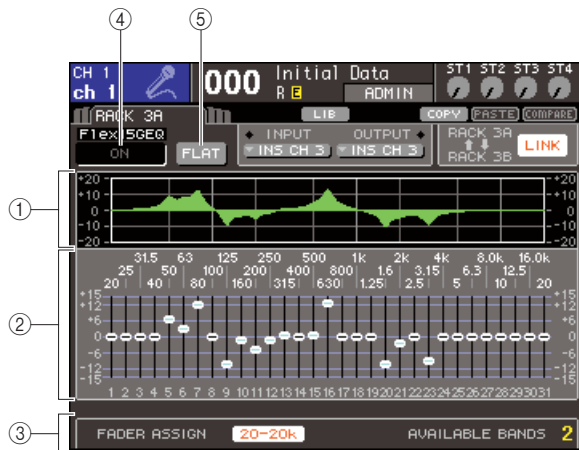

### ① EQ graph

This indicates the approximate response of the current Flex15GEQ settings.

### ② Faders

These faders indicate the amount of boost/cut for each band of the Flex15GEQ. The frequency and value for the fader currently selected by the cursor are shown below the fader.

### ③ FADER ASSIGN field

Use this field when you want to operate the boost/cut amount for each band using the faders. At the right side of “AVAILABLE BANDS,” there is always an indication of the remaining number of bands (maximum 15) that can be controlled for the current Flex15GEQ.

### ④ GEQ ON/OFF button

Switches the currently selected GEQ on/off.

### ⑤ FLAT button

This returns all bands of the currently selected GEQ to 0 dB.

- 3** Use the [RACK 1-4] key (for RACK 1–4 screens) or the [RACK 5-8] key (for RACK 5–8 screens) to select either GEQ unit A or B, make the correct input-source and output-destination settings, and then turn on the Flex15GEQ.

- 4** To adjust the boost/cut of each band, move the cursor to the desired fader and operate the dial or the [DEC]/[INC] keys.

For each of a Flex15GEQ’s two GEQ units (A and B), a maximum of fifteen bands can be controlled.

The remaining number of bands that can be controlled is shown at the right of “AVAILABLE BANDS” in the FADER ASSIGN field. If you have used all fifteen bands, you will have to return one of the used bands (i.e., a band for which a fader was raised or lowered) to the flat position before you can operate any other band.

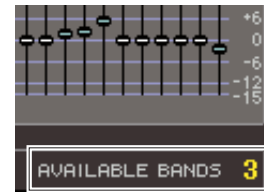

- 5** If you want to use the top panel faders to adjust the boost/cut of each band, proceed as follows.

- ① Move the cursor to the button in the FADER ASSIGN field and press the [ENTER] key.

For details on how operation and the buttons differ between models, refer to step 5 of “Using the 31 Band GEQ” (→ p. 163).

When this button is turned on, the faders in the screen will turn white, and you will be able to use the top panel faders to adjust the GEQ bands.

- ② Operate the faders.

The corresponding frequency region will be boosted or cut. A maximum of 15 bands can be controlled.



- The [ON] key will light if you raise or lower a fader even the slightest amount. This indicates that the corresponding band is being modified.
- To quickly return a boosted or cut band to the flat position, press the corresponding [ON] key to make it go dark.

- ③ When you’ve finished making settings, turn off the button(s) of the FADER ASSIGN field.

The top panel faders and [ON] keys will return to their previous function.



- If a button in the FADER ASSIGN field is on, switching the display to another screen or rack will forcibly defeat the top panel fader assignments. However if you once again display the same rack, the group of bands you had previously been controlling will automatically be assigned to the faders.

- 6** If you want to copy the currently-displayed Flex15GEQ settings to the GEQ of another rack, or to initialize the settings, you can do so using the tool buttons at the top of the screen.

For details on how to use these buttons, refer to “Using the tool buttons” (→ p. 35).



- GEQ settings can be saved/loaded at any time using the dedicated library (→ p. 174).

# About the internal effects

The internal effects of the LS9 can be mounted in racks 5–8. For each mounted effect you can choose one of 48 effect types, and patch the effect to the output of an output channel or the input of an input channel, or insert it into a channel.

With the default settings, the signals from MIX channels 13–16 are input to racks 5–8, and output to ST IN 1–4 (L/R).

**NOTE**

- The internal effects cannot be mounted in racks 1–4.
- Some effect types can be mounted only in rack 5 or 7.

To use an internal effect via send/return, assign the output of a MIX channel etc. to the input of the effect, and assign the output of the effect to an input channel.

In this case, the corresponding MIX bus is used as a master channel for the effect send, and the input channel is used as an effect return channel.

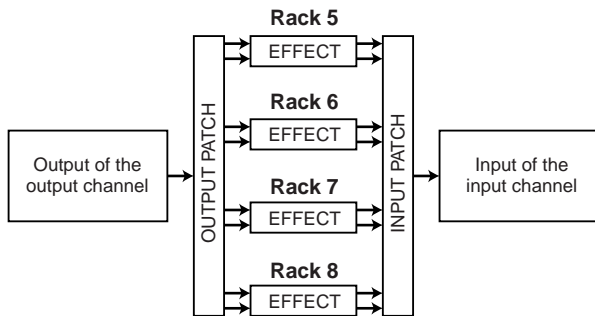

Alternatively, you can assign the input and output of the internal effect to the insert-out/in of a desired channel (except for a ST IN channel), so that the effect is inserted into that channel.



\* Except for a ST IN channel

The internal effects fall into two categories; “STEREO type” (2-in/2-out) effects that process the L/R channel input signals independently, and “MIX type” (1-in/2-out) effects that mix the two channels to monaural before processing them.

If signals are assigned to both the L and R inputs of an effect, the way in which the L/R channels are processed will depend on whether a Stereo effect type or a Mix effect type is selected, as follows.

● **STEREO type effects**

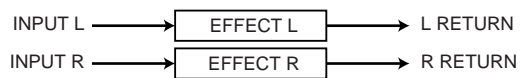

● **MIX type effects**



If a signal is assigned to only one input of a two-input effect, it will be processed as mono-in/stereo-out regardless of whether a Stereo effect type or Mix effect type is selected.



## Using an internal effect via send/return

Here we will explain how to use a MIX bus as an effect send bus and a ST IN channel as an effect return channel, so that the effect can be used in a send/return configuration.



- If you want to use a MIX bus as an effect send bus, select “VARI” as the bus type (→ p. 213). This will allow you to adjust the send level separately for each input channel.
- If you want to use the input to an effect in stereo, it is convenient to assign the send-source MIX bus to stereo (→ p. 213).

### 1 As described in “Mounting a GEQ or effect in the virtual rack” (→ p. 158) steps 1–3, mount an effect in a rack.

A rack in which an effect is mounted will indicate the effect type used by that effect, and the bypass on/off status.

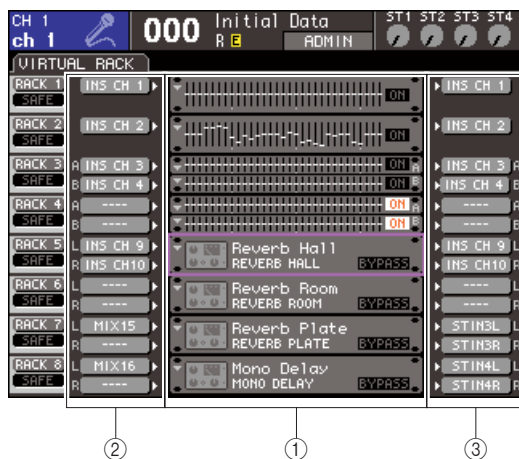

- ① Racks
- ② INPUT buttons
- ③ OUTPUT buttons

### 2 Use the INPUT L button to open the OUTPUT CH SELECT popup window, and select a MIX channel as the input source for the rack.

The output of the MIX channel you’re using as the effect send will be assigned to the L input of the effect. For details on the OUTPUT CH SELECT popup window, refer to step 4 of “Mounting a GEQ or effect in the virtual rack” (→ p. 158).

If you’re using a stereo source, assign the L/R signals of the stereo MIX channels to the L/R inputs of the rack.

### 3 Use the OUTPUT L button to open the INPUT CH SELECT popup window, and select the L input of the desired ST IN channel as the output-destination for the rack.

The L input of the ST IN channel used as the effect return channel will be assigned to the L output of the effect. For details on the INPUT CH SELECT popup window, refer to step 6 of “Mounting a GEQ or effect in the virtual rack” (→ p. 158).

If you’re using the output of the effect in stereo, assign the R input of the same ST IN channel to the R output of the rack in the same way.



- You can select more than one output destination for the effect.

### 4 Move the cursor to a rack in which an effect is mounted in the GEQ/EFFECT field, and press the [ENTER] key.

The RACK screen will appear, allowing you to edit the parameters of the effect.

You can also access the RACK 5–8 screens by repeatedly pressing the [RACK 5-8] key.



- The EXTERNAL HA screen that appears when you operate the [RACK 5-8] key is used when you’re using an external head amp (→ p. 175).



#### ① MIX BAL. knob

This knob adjusts the balance between the original sound and effect sound included in the output signal from the effect.

#### ② Input/output meters

These indicate the level of the signals before and after the effect.

#### ③ INPUT L/R buttons

These buttons display the OUTPUT CH SELECT popup window. The operating procedure is the same as for the INPUT button in the GEQ/EFFECT field.

#### ④ OUTPUT L/R buttons

These buttons display the INPUT CH SELECT popup window. The operating procedure is the same as for the OUTPUT button in the GEQ/EFFECT field.



- To change the mix balance of the original sound and effect sound, move the cursor to the **MIX BAL.** knob and use the dial or the **[DEC]/[INC]** keys.

The **MIX BAL.** knob adjusts the balance between the original sound and effect sound included in the output signal from the effect. This parameter is provided for all effect types.

If you're using the effect via send/return, set this to 100% (effect sound only).



- For details on editing the effect parameters, refer to "Editing the internal effect parameters" (→ p. 170).

- To adjust the effect send level of an input channel, press the **[HOME]** key to access the **SELECTED CH VIEW** screen, and access the input channel that you want to control.



- SEND field
- TO MIX SEND LEVEL knob

- Move the cursor to the **TO MIX SEND LEVEL** knob for the desired **MIX bus**, and use the dial or the **[DEC]/[INC]** keys to adjust the send level.

With these settings, the signal will be sent from the input channel to the internal effect. Adjust the send level of other input channels in the same way.

By moving the cursor to the knob and pressing the **[ENTER]** key, you can switch the signal sent from each channel to the corresponding bus on/off, and access a popup window where you can choose the send point (**PRE/POST**) (→ p. 64).



- Make sure that the send level from the **ST IN** channel you selected in step 3 to the corresponding **MIX bus** is set to 0. If you raise this send level, the output of the effect will be returned to the input of the same effect, possibly causing oscillation.

- To adjust the master level of the effect send, call up the fader layer that includes the **MIX channel** you specified as the input-source of the rack in step 2, and adjust the corresponding fader.

Set the level as high as possible without allowing the post-effect signal to reach the overload point.

- To adjust the effect return level, operate the encoder of the **ST IN** channel you selected as the output-destination of the rack in step 3.

### Inserting an internal effect into a channel

Here we will explain how to insert an effect into a channel by assigning the input/output of the internal effect to the input/output of the desired channel (except for a **ST IN** channel).

- As described in "Mounting a **GEQ** or effect in the virtual rack" (→ p. 158) steps 1–3, mount an effect in a rack.

A rack in which an effect is mounted will indicate the effect type used by that effect, and the bypass on/off status.

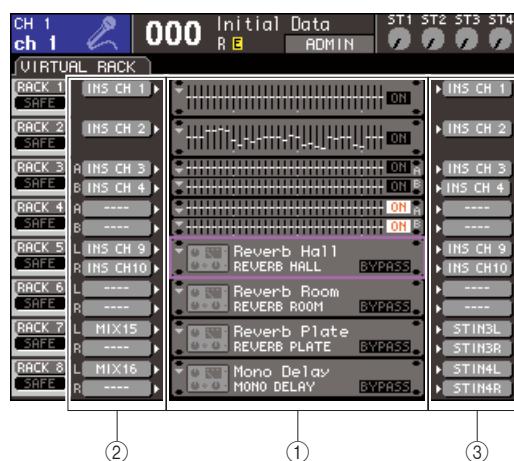

- Racks
- INPUT buttons
- OUTPUT buttons

- Use the **INPUT L** button to open the **OUTPUT CH SELECT** popup window, and select the insert-out of a channel as the input-source.

Insert-out will be assigned to the **L** input of the effect. For details on the **OUTPUT CH SELECT** popup window, refer to step 4 of "Mounting a **GEQ** or effect in the virtual rack" (→ p. 158).



**3 Use the INPUT L button to open the INPUT CH SELECT popup window, and select the insert-in of the same channel as the output-destination.**

Insert-in will be assigned to the L output of the effect. If you are inserting in a channel that handles a stereo source, use the same procedure to assign the insert-out/insert-in of the other channel to the R input and R output of the effect.

**4 Press the [HOME] key to access the SELECTED CH VIEW screen, and access the channel into which you want to insert the effect.**

**5 Move the cursor to the INSERT popup button, and press the [ENTER] key to access the INSERT popup window.**

Make sure that the desired rack is selected for the input/output ports you're using for the insertion. For details on Insert Out/In, refer to "Inserting an external device into a channel" (→ p. 101).



**1 INSERT ON/OFF button**



• The INSERT popup window also lets you change the insert-out/in position within the channel.

**6 Make sure that the INSERT ON/OFF button is turned on for the channel into which you inserted the effect.**

If this is off, turn it on. In this state, effect insertion is enabled for the corresponding channel.

**7 Repeatedly press the [RACK 5-8] key to access the RACK screen for the rack you inserted into the channel.**

In this screen you can edit the parameters of the effect. The screen contains the following items.



**1 Input/output meters**

These indicate the level of the signals before and after the effect.

**2 INPUT L/R buttons**

These buttons display the OUTPUT CH SELECT popup window. The operating procedure is the same as for the INPUT button in the GEQ/EFFECT field.

**3 OUTPUT L/R buttons**

These buttons display the INPUT CH SELECT popup window. The operating procedure is the same as for the OUTPUT button in the GEQ/EFFECT field.

**8 Select the effect type and edit the effect parameters.**

For details on editing the effect parameters, refer to "Editing the internal effect parameters."



• The levels before and after the effect are shown by the input/output meters at the upper right of the RACK screen.



• Adjust the insert out signal level and the effect parameters so that the signal does not reach the overload point at the input or output stage of the effect.

**9 Select the fader layer that includes the channel you selected in step 3 as the output destination of the rack, and operate the corresponding fader to adjust the level appropriately.**

## Editing the internal effect parameters

This section explains how to change the effect type and edit the parameters.

### 1 As described in “Mounting a GEQ or effect in the virtual rack” (→ p. 158) steps 1–3, mount an effect in a rack.

A rack in which an effect is mounted will indicate the effect type used by that effect, and the bypass on/off status.

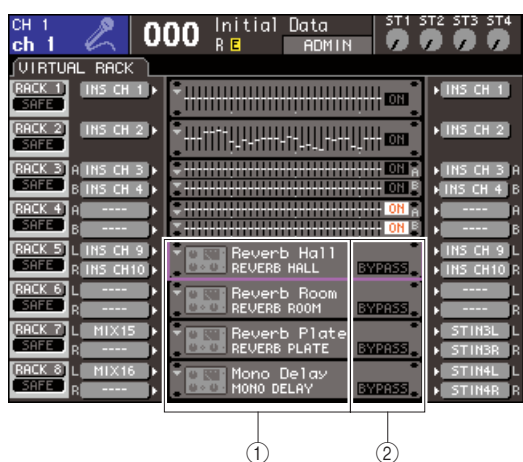

- ① Effect title/type
- ② Bypass on/off status

### 2 Move the cursor to the rack in which the effect you want to edit is mounted, and press the [ENTER] key.

The RACK screen will appear, allowing you to edit the parameters of the effect.

You can also access the RACK 5–8 screens by repeatedly pressing the [RACK 5-8] key.



- The EXTERNAL HA screen that appears when you operate the [RACK 5-8] key is used when you're using an external head amp (→ p. 175).



#### ① Effect type field

This shows the effect title, the name of the type that is used, and a graphic. The number of input/output channels (1 IN/2 OUT or 2 IN/2 OUT) of this effect is also shown. If you move the cursor to the effect type graphic and press the [ENTER] key, the EFFECT TYPE popup window will appear, allowing you to select the effect type.

#### ② BYPASS button

This button temporarily bypasses the effect.

#### ③ EFFECT CUE button

This button cue-monitors the output of the currently displayed effect. This cue function is valid only while this screen is displayed. The cue will be cancelled automatically when you switch to a different screen.

#### ④ Special parameter field

This shows special parameters that are specific to some effect types.

#### ⑤ Input/output meters

These indicate the level of the signals before and after the effect.

#### ⑥ INPUT L/R buttons

These buttons display the OUTPUT CH SELECT popup window.

#### ⑦ OUTPUT L/R buttons

These buttons display the INPUT CH SELECT popup window.

#### ⑧ Effect parameter field

This area shows parameters for the currently selected effect type.

### 3 If you want to change the effect type, proceed as follows.

#### ① Move the cursor to the effect type graphic, and press the [ENTER] key.

The EFFECT TYPE popup window will appear.

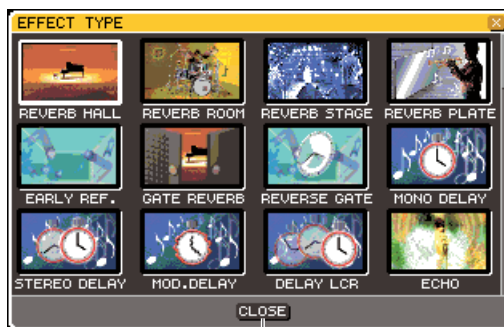

CLOSE button

② Use the dial or the cursor keys to move the cursor, and select the new effect type.

You can move the cursor up or down to select a new type in steps of twelve. If you decide not to change the effect type, use the cursor keys to move the cursor to the CLOSE button, and press the [ENTER] key.

③ When you've selected a new effect type, press the [ENTER] key.

The EFFECT TYPE popup window will close automatically, and the new effect is now available for use.

**HINT**

- You can also switch the effect type by recalling a library setting.

**NOTE**

- Effect types "HQ.PITCH" and FREEZE" can be used only in rack 5 or 7. Also, even if you copy these two effect types, you will not be able to paste them to rack 6 or 8.

4 To edit the effect parameters, move the cursor to the knobs in the effect parameter field, and use the dial or the [DEC]/[INC] keys.

**HINT**

- For details on the parameters of each effect type, refer to the supplementary material at the end of this manual (→ p. 233).

5 Edit the settings in the special parameter field as necessary.

For some effect types, parameters such as the following will appear in the special parameter field.

● TEMPO

This is shown if a tempo-type or modulation-type effect is selected.



① MIDI CLK button

If you turn this button on, the BPM parameter of that effect will be set to match the tempo of the MIDI timing clock being input from the currently-enabled MIDI port.

② BPM knob

This knob sets the BPM parameter manually. You can also assign the Tap Tempo function to a user-defined key, and set the BPM using it (→ p. 172).

● PLAY/REC

This is shown if FREEZE is selected as the effect type.

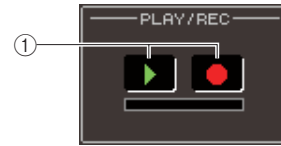

① PLAY button / REC button

These buttons are used to record (sample) and play back when using the freeze effect. For details on how to use this, refer to "Using the Freeze effect" (→ p. 173).

● SOLO

This is shown if M.BAND DYNA. or M.BAND COMP. is selected as the effect type.

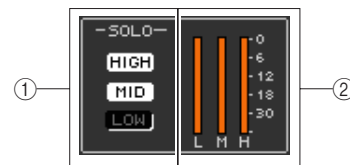

① HIGH/MID/LOW buttons

These buttons pass only the selected frequency band (multiple selections are allowed).

② Gain reduction meters

These show the amount of gain reduction for each band.

6 If you want to monitor only the output signal of the currently displayed effect, press the EFFECT CUE button to turn it on.

**HINT**

- If the Cue mode is set to MIX CUE mode (in which all channels whose [CUE] keys are on will be mixed for monitoring), only the output signal of the effect will be monitored when you turn on the EFFECT CUE button. (The [CUE] keys that had been turned on until then will be temporarily defeated.)

7 If you want to bypass the currently displayed effect, turn the BYPASS button on.

8 If you want to copy the currently-displayed effect settings to the effect of another rack, or to initialize the settings, you can do so using the tool buttons at the top of the screen.

For details on how to use these buttons, refer to "Using the tool buttons" (→ p. 35).

**HINT**

- Effect settings can be stored and recalled at any time using the effect library (→ p. 174).

## Using the Tap Tempo function

“Tap tempo” is a function that lets you specify the delay time of a delay effect or the modulation speed of a modulation effect by striking a key at the desired interval. To use the Tap function, you must first assign Tap Tempo to a user-defined key, and then operate that user-defined key.

- 1 In the **DISPLAY ACCESS** section, press the **[SETUP]** key repeatedly to access the **USER SETUP** screen within the **SETUP** screens.



① **USER DEFINED KEYS** popup button

- 2 Move the cursor to the **USER DEFINED KEYS** popup button and press the **[ENTER]** key to access the **USER DEFINED KEYS** popup window.

The **USER DEFINED KEYS** popup window lets you assign functions to user defined keys [1]–[12].

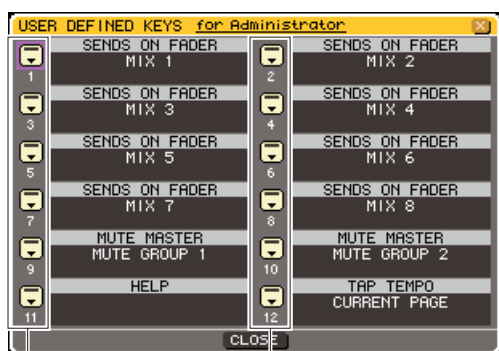

① **User defined keys** popup buttons

- 3 Move the cursor to the popup button for the user-defined key to which you want to assign the Tap Tempo function, and press the **[ENTER]** key.

The **USER DEFINED KEY SETUP** popup window will appear.

- 4 Select “**TAP TEMPO**” in the **FUNCTION** column, select “**CURRENT PAGE**” in the **PARAMETER 1** column, move the cursor to the **OK** button, and press the **[ENTER]** key.

To select an item in each column, move the cursor to the desired column and use the dial or the **[DEC]/[INC]** keys. Move the cursor to the **OK** button and press the **[ENTER]** key; the Tap Tempo function will be assigned to the user-defined key you selected in step 3, and you will return to the **USER DEFINED KEY SETUP** page.

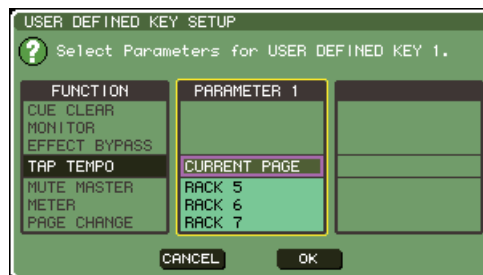

- If you specify “**CURRENT PAGE**” in the **PARAMETER 1** column, the Tap Tempo function can be used for the currently-shown effect (rack).
- If you specify “**RACK x**” ( $x=5-8$ ) in the **PARAMETER 1** column, the Tap Tempo function can be used only for a specific effect (rack).
- For more about user-defined keys, refer to “**User-defined keys**” (→ p. 196).

- 5 Repeatedly press the **[RACK 5-8]** key to access the **RACK** screen for the rack in which the effect you want to control is mounted.

- 6 Select an effect type that includes a **BPM** parameter.

For details on selecting the effect type, refer to step 3 of “**Editing the internal effect parameters**” (→ p. 170). The **BPM** parameter is shown in the special parameter field. It is included in delay-type and modulation-type effects, and can be used to specify the delay time or modulation speed.



① **BPM** parameter



• For details on the parameters of each effect type, refer to the supplementary material at the end of this manual (→ p. 233).

**7 At the desired tempo, repeatedly press the user-defined key to which you assigned the Tap Tempo function.**

The average interval (BPM) at which you press the key will be calculated, and that value will be reflected by the BPM parameter.

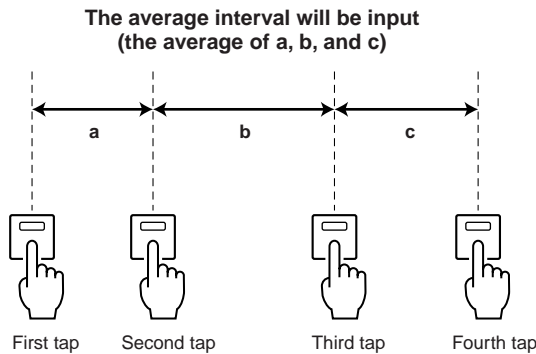

- If the average value is outside the range of 20–300 BPM, it will be ignored.
- If you turn on the MIDI CLK button in the special parameter field, the BPM parameter value will change according to the tempo of the MIDI timing clock received from the currently-enabled MIDI port.

### Using the Freeze effect

Here's how to use the "FREEZE" effect type, which provides the functionality of a simple sampler. When this effect type is selected, you can perform operations in the screen to record (sample) and play back a sound.

**1 In the DISPLAY ACCESS section, press the [RACK 1-4] key and [RACK 5-8] key simultaneously to access the VIRTUAL RACK screen.**

**2 Mount an effect in rack 5 or rack 7.**



• Effect types "FREEZE" and "HQ.PITCH" can be used only in rack 5 or 7.

**3 Move the cursor to the rack in which the effect you want to edit is mounted, and press the [ENTER] key.**

The RACK screen will appear, allowing you to edit the parameters of the effect. You can also access the RACK 5–8 screens by repeatedly pressing the [RACK 5-8] key.

**4 Select "FREEZE" as the effect type.**

For details on selecting the effect type, refer to step 3 of "Editing the internal effect parameters" (→ p. 170). If the "FREEZE" effect type is selected, a PLAY button, REC button, and progress bar are shown in the special parameter field.



- ① PLAY button
- ② REC button
- ③ Progress bar



• As an alternative to switching the effect type, you can also recall settings that use the "FREEZE" effect type from the effect library.

**5 To begin recording (sampling), turn on the REC button to make it light, and then turn on the PLAY button.**

The signal being input to the effect will be recorded. The progress bar shows the current recording location. When a fixed time has elapsed, the buttons will automatically turn off.



• You can adjust the parameters in the window to make detailed settings for recording time, the way in which recording will begin, and the way in which the sample will play back. For details on the parameters, refer to the supplementary material at the end of this manual (→ p. 233).

**6 To play back the recorded sample, move the cursor to the PLAY button and press the [ENTER] key.**



• If, after recording, you turn on the REC button again to enter record-ready mode, the sampled content will be erased.

## Using the graphic EQ and effect libraries

You can use dedicated libraries to store and recall graphic EQ and effect settings.

### GEQ library

Use the “GEQ library” to store and recall GEQ settings. This GEQ library can be referenced by all GEQ units used in the LS9. (However, the 31 Band GEQ and Flex15GEQ are different types. You cannot recall a GEQ library item of a different type.)

200 items can be recalled from the library. Number 000 is read-only, and the remaining library numbers can be freely read or written.

To access the GEQ library, move the cursor to the LIB toolbutton in the upper part of the screen when a GEQ is shown in the RACK screen, and press the [ENTER] key.



#### ① LIB button

For details on using the library, refer to “Using libraries” (→ p. 35).

#### NOTE

- Store/recall operations are performed on individual racks. You can't individually store/recall two Flex15GEQ units that are mounted in the same rack.

### Effect library

Use the “Effect library” to store and recall effect settings. 199 items can be recalled from the effect library. Library items 1–48 are read-only presets, and correspond to effect types 1–48 respectively. Library items 49–57 are reserved for use by the system. Other library item numbers can be freely read and written.

To access the effect library, move the cursor to the LIB toolbutton in the upper part of the screen when an effect is shown in a RACK 5–8 screen, and press the [ENTER] key.



#### ① LIB button

For details on using the library, refer to “Using libraries” (→ p. 35).

#### NOTE

- Library items using the “HQ.PITCH” or “FREEZE” effect types can be recalled only into rack 5 or 7. They cannot be recalled into rack 6 or 8.

#### HINT

- You can also use MIDI messages (program changes) to recall effect settings from the library (→ p. 180).



# Using an external head amp

If an I/O card (expected to go on sale in the future) that supports the external head amp (Yamaha AD8HR) remote protocol is installed in an LS9 slot, you'll be able to remotely control parameters such as the external head amp's phantom power (+48V) on/off, gain, and HPF from the LS9. For an example of actual connections, refer to the owner's manual of the I/O card.

## Remotely controlling an external head amp

Here's how to control the external head amp (subsequently called "external HA") from the LS9 via an I/O card installed in a slot.

### 1 Connect the LS9 and external HA.

Refer to the owner's manual for the I/O card and for the external head amp.

### 2 Repeatedly press the [RACK 5-8] key to access the EXTERNAL HA screen.

The EXTERNAL HA screen includes the following items.

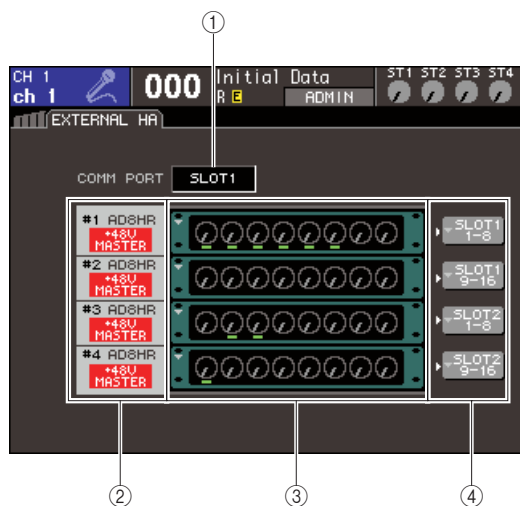

#### ① COMM PORT box

This box lets you select the communication port for the currently-installed I/O card(s).

#### NOTE

- When installing an MY16-ES64 or similar EtherSound interface card in an LS9-32, be sure to install it in SLOT 1.

#### ● SLOT {SLOT1}

Select the communication port for the I/O card installed in the slot {slot 1}.

#### ● SLOT2 (LS9-32 only)

Select the communication port for the I/O card installed in slot 2.

#### ② ID / Model name / +48V master

This displays information for the external HA mounted in the rack. The ID number is assigned automatically as 1 to 2 {1 to 4} in the order in which devices are connected to the I/O card. This area also shows the on/off status of the master phantom power.

#### ③ Virtual racks

These are two {four} racks in which remotely controllable external HA units can be mounted. If an external HA is mounted, its settings (gain setting, phantom power on/off, HPF on/off) are shown. When you move the cursor to a rack and press the [ENTER] key, the EXTERNAL HA popup window for that rack will appear.

#### ④ EXTERNAL HA PORT SELECT popup button

This button accesses the EXTERNAL HA PORT SELECT popup window, where you can specify the input ports to which the external HA mounted in the rack will be connected.

### 3 To select the communication port for the I/O card, move the cursor to the COMM PORT box, use the dial or the [DEC]/[INC] keys to select a port, and press the [ENTER] key.

### 4 To specify the input ports for an external HA, move the cursor to the EXTERNAL HA PORT SELECT popup button for that rack, and press the [ENTER] key.

The EXTERNAL HA PORT SELECT popup window will appear. The popup window includes the following items.

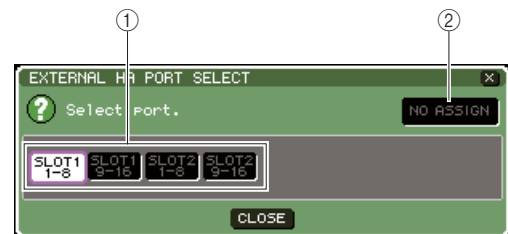

#### ① PORT SELECT buttons

These buttons specify the input ports to which the external HA is connected.

#### ② NO ASSIGN button

This button defeats the port selection.

**5 Use the PORT SELECT buttons to specify the input ports to which the audio output of the external HA is connected.**

When you've finished making settings, move the cursor to the CLOSE button and press the [ENTER] key to close the popup window.

**NOTE**

- If an external HA is connected to one of the LS9's slots, you must specify the appropriate input port manually. If this is set incorrectly, the external HA will not be detected correctly when you patch input ports to input channels.

**6 To remotely control an external HA, move the cursor to the rack in which the external HA you want to control is mounted, and press the [ENTER] key.**

The EXTERNAL HA popup window will appear. Here you can remotely control the external HA by using the knobs and buttons in the LS9's display or the dial etc. of the top panel.



**1 Rack select buttons**

These switch the rack that is displayed in the EXTERNAL HA popup window.

**2 +48V MASTER**

If an external HA is connected to the REMOTE connector, the on/off status of the master phantom power is shown here. (Switching this on/off is performed on the external HA itself.)

**3 +48V buttons**

These switch phantom power on/off for each channel.

**4 GAIN knobs**

These indicate the gain of the external HA. Move the cursor to the knob and use the dial or the [DEC]/[INC] keys to adjust the setting.

**5 HPF knobs / ON buttons**

These controls switch the external HA's built-in high-pass filter on/off, and adjust its cutoff frequency.

**HINT**

- When you newly connect an AD8HR, the above screen will reflect the state of the AD8HR's settings.
- Since the above knobs and buttons will be shown even if an AD8HR is not connected, you can use them to make settings even without the AD8HR, and store these settings in a scene.

**7 To remotely control the external HA in an LS9 input channel, press the [HOME] key to access the SELECTED CH VIEW screen, and access the channel that you want to control.**



**1 HA popup button**

**8 Move the cursor to the HA popup button, and press the [ENTER] key to access the HA/PATCH popup window.**



**1 Input port popup button**

**9 Press the input port popup button, and select the input port assigned to the external HA.**

With these settings, the external HA can be used in the same way as the LS9's own HA. For details on the HA/PATCH popup window, refer to "HA (head amp) settings" (→ p. 57).

**HINT**

- Settings for the external HA are saved as part of the scene (However, master phantom on/off, HPF on/off, and cutoff frequency settings are excepted).
- When you adjust the brightness of the LS9's panel LEDs, this will also affect the LEDs of the external HA.

# ◆ Chapter 18 ◆

## MIDI

This chapter explains how MIDI messages can be transmitted from an external device to control the LS9's parameters, and conversely how operations on the LS9 can be transmitted as MIDI messages.

### MIDI functionality on the LS9

The LS9 can use MIDI to perform the following operations.

#### ● Program Change transmission and reception

When you execute a specific event (scene/effect library recall) on the LS9, a program change message of the corresponding number can be transmitted to an external device. Conversely, the corresponding event can be executed when a program change message is received from an external device.

#### ● Control Change transmission and reception

When you execute a specific event (fader/encoder or key operation) on the LS9, the corresponding control change message can be transmitted to an external device. Conversely, events can be executed when control change messages are received from an external device. This allows you to record fader and key operations on a MIDI sequencer or other external device, and play them back later.

#### ● Parameter change (SysEx) transmission and reception

When specific events (fader/encoder or key operations, changes in system settings or user settings) are executed on the LS9, "parameter change" system exclusive messages can be transmitted to an external device. Conversely, events can be executed when parameter changes are received from an external device.

Using this capability, LS9 operations can be recorded and played back on a MIDI sequencer or other external device, or changes in system settings and user settings can be reflected on another LS9 console.

#### NOTE

- As the MIDI port used for transmitting and receiving MIDI messages, you can select either the rear panel MIDI IN/OUT connectors or an I/O card installed in the slot {1, 2}. (If you select an I/O card, you can also select a port number.) All of the above functionality will be common to the selected port.
- MMC (MIDI Machine Control) messages can be received to control the transport of the USB memory recorder.

## Basic MIDI settings

Here's how to select the type of MIDI messages the LS9 will transmit and receive, the MIDI port that will be used, and the MIDI channel.

- 1 In the **DISPLAY ACCESS** section, press the **[SETUP]** key repeatedly to access the **MISC SETUP** screen within the **SETUP** screens.

MIDI SETUP popup button



- 2 Move the cursor to the **MIDI SETUP** popup button, and press the **[ENTER]** key to access the **MIDI SETUP** popup window.

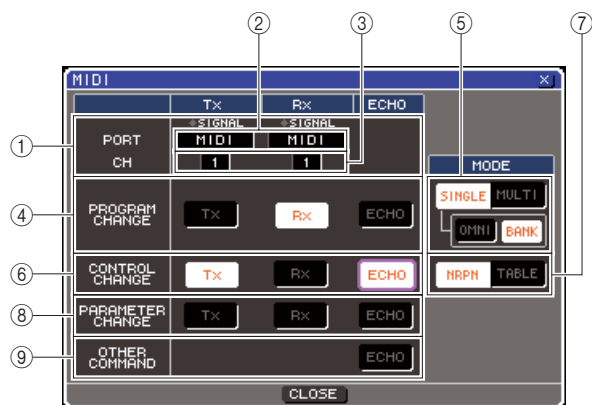

In the **MIDI SETUP** page you can select the type of MIDI messages that will be transmitted and received, and choose the port that will be used. This page includes the following items.

### ① PORT/CH field

Here you can select the port and MIDI channel that will be used to transmit and receive MIDI messages. If MIDI messages are being transmitted or received, the **SIGNAL** indicators at the top of this field will light.

### ② Port select box

Use the dial or the **[DEC]/[INC]** keys to select the MIDI message transmit (Tx) port and receive (Rx) port. If you select the same port as used by another function such as cascade link or HA remote, a confirmation dialog box will appear. If you select **OK**, the port setting for the other function will be disabled.

### ③ Channel select box

Use the dial or the **[DEC]/[INC]** keys to select the MIDI message transmit (Tx) channel and receive (Rx) channel.

### ④ PROGRAM CHANGE field

Here you can make settings for program change transmission and reception.

#### ● Tx button

Switches program change transmission on/off.

#### ● Rx button

Switches program change reception on/off.

#### ● ECHO button

This selects whether incoming program changes are echoed-out from the transmission port.



• For details on how to assign the scene or effect for each program number, refer to "Using program changes to recall scenes and library items" (→ p. 180).

### ⑤ PROGRAM CHANGE MODE field

Here you can select the program change transmit/receive mode.

#### ● SINGLE button

If this button is on, program changes will be transmitted and received on a single MIDI channel.

#### ● OMNI button

If this button is on, program changes of all MIDI channels will be received in Single mode. (Multi mode transmission/reception and Single mode transmission are disabled.)

#### ● BANK button

If this button is on, bank select messages can be transmitted and received in Single mode. (This is disabled for Multi mode transmission/reception.)

#### ● MULTI button

If this button is on, program changes will be transmitted/received on multiple MIDI channels (Multi mode).

### ⑥ CONTROL CHANGE field

Here you can make settings for control change transmission/reception.

#### ● Tx button

Switches control change transmission on/off.

#### ● Rx button

Switches control change reception on/off.

#### ● ECHO button

This selects whether incoming control changes are echoed-out from the transmission port.

⑦ **CONTROL CHANGE MODE field**

Here you can select the control change transmission/reception mode.

● **NRPN button**

If this button is on, the LS9's mix parameters will be transmitted/received as NRPN messages on one MIDI channel (NRPN mode).

● **TABLE button**

If this button is on, the LS9's mix parameters will be transmitted/received as control change messages on one MIDI channel (TABLE mode).

⑧ **PARAMETER CHANGE field**

Here you can make settings for transmission/reception of "parameter change" system exclusive messages.

● **Tx button**

Switches parameter change transmission on/off.

● **Rx button**

Switches parameter change reception on/off.

● **ECHO button**

This selects whether incoming parameter changes are echoed-out from the transmission port.

⑨ **OTHER COMMAND field**

Here you can specify how MIDI messages other than program changes, control changes, and parameter changes (i.e., messages such as note-on/off and MIDI timing clock) will be received.

● **ECHO button**

Selects whether other MIDI messages that are received will be echoed out from the transmit port.

**3 To specify the port that will transmit or receive each type of MIDI message, move the cursor to the transmit (Tx) or receive (Rx) port selection box, use the dial or the [DEC]/[INC] keys to specify the setting, and then press the [ENTER] key.**



You can choose from the following items.

Item	Description
----	No port will be used.
MIDI	Rear panel MIDI IN (Rx) / OUT (Tx) connector
SLOT {1/2} -1-8 (The number of available ports will depend on the card that is installed.)	A card that supports serial transmission, installed in a rear panel slot {1/2} (MY16-CII is valid in SLOT {1-2})

**4 To specify the channel (CH1-CH16) on which MIDI messages will be transmitted or received, move the cursor to the channel selection box, use the dial or the [DEC]/[INC] keys to specify the setting, and press the [ENTER] key.**



• When transmitting or receiving parameter changes, the channel number you specify here is used as the device number (a number that identifies the transmitting or receiving unit).

**5 Turn transmission/reception on or off for each MIDI message.**



• For details on using program changes, refer to "Using program changes to recall scenes and library items," below.  
 • For details on using control changes, refer to "Using control changes to control parameters" (→ p. 183).

## Using program changes to recall scenes and library items

The LS9 lets you assign a specific event (scene recall or effect library recall) to each program change number, so that when this event is executed on the LS9, a program change message of the corresponding number will be transmitted to an external device. Conversely, the corresponding event can be executed when a program change message is received from an external device.

### 1 Connect the LS9 to your external device.

The following illustration shows an example of using the MIDI IN/OUT connectors to transmit and receive MIDI messages.

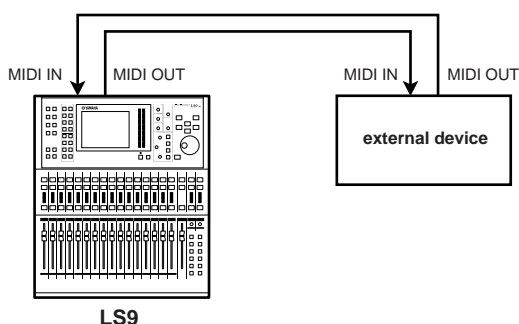

### 2 In the DISPLAY ACCESS section, press the [SETUP] key repeatedly to access the MISC SETUP screen.



### 3 Move the cursor to the MIDI SETUP popup button, and press the [ENTER] key to access the MIDI SETUP popup window.

### 4 As described in “Basic MIDI settings” (→ p. 178), select the ports and MIDI channels that will be used to transmit/receive program changes.

### 5 When you’ve finished making settings, move the cursor to the CLOSE button and press the [ENTER] key to close the popup window.

You will return to the MISC SETUP screen.

### 6 Move the cursor to the PROGRAM CHANGE popup button, and press the [ENTER] key to access the PROGRAM CHANGE popup window.

In the PROGRAM CHANGE popup window you can specify how program changes will be transmitted and received, and choose the event (scene recall or effect library recall) that will be assigned to each program number.

This page includes the following items.

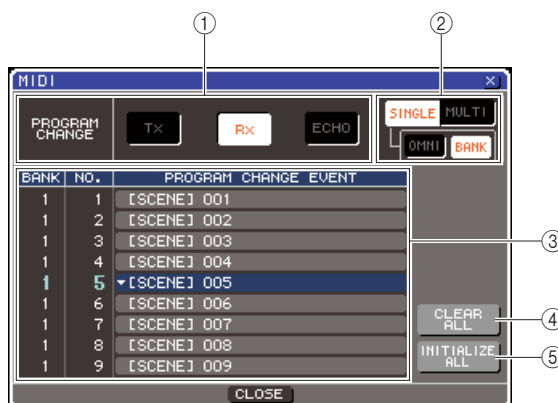

#### ① PROGRAM CHANGE field

Here you can switch program change transmission/reception on/off, and specify whether program changes will be echoed out. This setting is linked with the PROGRAM CHANGE field of the MIDI SETUP popup window.

#### ② PROGRAM CHANGE MODE field

Here you can select the program change transmit/receive mode. This setting is linked with the PROGRAM CHANGE MODE field of the MIDI SETUP page popup window.

#### ③ List

This list shows the event (scene recall / effect library recall) assigned to each program number. The list shows the following items.

##### ● CH/BANK

Indicates the MIDI channel 1–16 on which program changes are transmitted/received. In Single mode if the BANK button is on, this will be labeled BANK, and the numerical value in this column will correspond to the bank number.

##### ● NO.

Indicates the program number 1–128.



### ● PROGRAM CHANGE EVENT

Indicates the type/number/title of the event assigned to the program number for each MIDI channel (bank number). By pressing the popup button for an individual event, you can access the PROGRAM CHANGE EVENT popup window, where you can change the assignment for each program number.

#### ④ CLEAR ALL button

Pressing this button will clear all event assignments in the list.

#### ⑤ INITIALIZE ALL button

Pressing this button will restore all event assignments in the list to their default state.

## 7 Use the buttons of the PROGRAM CHANGE MODE field to select the program change transmission/reception mode.

You can select one of the following two program change transmission/reception modes.

### ● Multi mode (when the MULTI button is on)

Program changes of all MIDI channels will be transmitted and received. (The transmit/receive channel specified in the MIDI SETUP popup window will be ignored.)

When a program change is received, the event assigned to the corresponding MIDI channel and program number in the list will be executed.

When you execute the specified event on the LS9, the program change of the corresponding MIDI channel and program number in the list will be transmitted.

### ● Single mode (when the SINGLE button is on)

Only program changes of the transmit (Tx) and receive (Rx) channels specified in the MIDI SETUP popup window will be transmitted and received.

When a program change on the Rx channel is received, the event assigned to that program number of the corresponding channel in the list will be executed.

When you execute a specific event on the LS9, the program change of the corresponding program number will be transmitted on the Tx channel shown in the list. (If an event is assigned to more than one program number on the same channel, the lowest-numbered program number will be transmitted.)

If you turn on the OMNI button / BANK button in Single mode, operation will change as follows.

### ● When the OMNI button is on

Program changes of all MIDI channels will be received. However, regardless of the MIDI channel that is received, the event assigned to the corresponding program number of the Rx channel will be executed.

Turning on the OMNI button will not change the operation for program change transmission.

### ● When the BANK button is on

The CH indication in the list will change to BANK (bank number), and bank select (control change #0, #32) + program change messages can be transmitted and received. This is convenient when you want to control more than 128 events on a single MIDI channel.

When bank select and then program change messages (in that order) are received on the Rx channel, the event assigned to that bank number and program number in the list will be executed.

When you execute a specific event on the LS9, bank select + program change messages for the bank number and program number assigned to that event will be transmitted on the Tx channel. (If the same event is assigned more than once in the list, the lowest-numbered bank number and program number will be transmitted.)

#### NOTE

- The settings of the OMNI and BANK buttons are ignored in Multi mode.
- If the BANK button is on and only a program change on an applicable MIDI channel is received, the last-selected bank number will be used.

#### HINT

- If the BANK button is on, the OMNI button can also be turned on at the same time. In this case, bank select + program change messages of all MIDI channels will be received.

## 8 Use the buttons of the PROGRAM CHANGE field to turn transmission and reception on/off, and make settings for echo output.

This field includes the following items.

### ● Tx button

Switches program change transmission on/off.

### ● Rx button

Switches program change reception on/off.

### ● ECHO button

This selects whether incoming program changes are echoed-out from the transmission port.

**9 To change the event assignment for each program number, move the cursor to the popup button for the corresponding event in the list, and press the [ENTER] key.**

The PROGRAM CHANGE EVENT popup window will appear. In this window you can specify the event assigned to each program number. This popup window contains the following items.

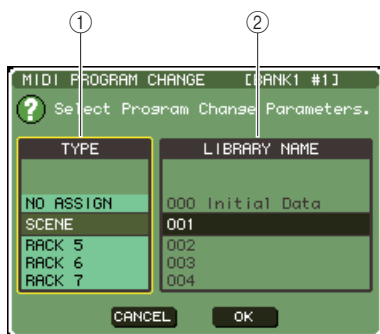

**① TYPE field**

Select the type of event.

The following table lists the events you can select.

Item	Content
NO ASSIGN	No assignment
SCENE	Scene memory recall operations
RACK 5-8	Effect library recall operations for racks 5-8 (only if an effect is mounted)

**② LIBRARY NAME field**

Select the number and title of the scene or library item to recall. If you selected SCENE in the TYPE field, this shows the scene number and its title. If you selected RACK 5-8, this shows the library number and its title.

**10 Use the TYPE field to select the type of event you want to assign, and use the LIBRARY NAME field to select the scene/library number that will be recalled.**

To select an item, use the dial or the [DEC]/[INC] keys. Move the cursor to the OK button and press the [ENTER] key to finalize the changes and close the PROGRAM CHANGE EVENT popup window.

**11 Assign events to other program numbers in the same way.**

With these settings, executing the specified event on the LS9 will cause the corresponding program change (or bank select + program change) message to be transmitted to the external device.

When an external device transmits a program change (or bank select + program change) message on the appropriate channel, the event assigned to that program number of the corresponding MIDI channel (or bank number) will be executed.

**HINT**

- You can use the CLEAR ALL button to erase all assignments to program numbers. The INITIALIZE ALL button will return all program number assignments to their default state.
- Assignments to program numbers are maintained as settings for the entire system, rather than for individual scenes.

**NOTE**

- In Single mode, if the same event is assigned to more than one program number on a Tx channel, only the lowest program number will be transmitted. (If the BANK button is on, only the program number of the lowest bank number will be transmitted.)
- In Multi mode, if the same event is assigned to more than one MIDI channel and more than one program number, only the lowest program number on each MIDI channel will be transmitted.

## Using control changes to control parameters

You can use MIDI control change messages to control specified events (fader/encoder operations, [ON] key on/off operations etc.) on the LS9. This capability can be used to record fader and key operations on a MIDI sequencer or other external device, and play back this data later.

You can use control changes to control events in either of the following two ways.

### ● Using control changes

This method uses typical control changes (control numbers 1–31, 33–95, 102–119). You can freely assign an event to each control number.

### ● Using NRPN (Non Registered Parameter Number)

This method uses a special type of control change messages called NRPN.

NRPN uses control change numbers 62 and 63 to specify the MSB (Most Significant Byte) and LSB (Least Significant Byte) of the parameter number, and subsequently-transmitted control change messages of control change number 6 (or 6 and 26) to specify the value of that parameter.

The event assigned to each combination of MSB and LSB is pre-defined, and cannot be changed.



- For details on the events assigned to NRPN messages, refer to the appendix (→ p. 253).

- 1 Connect the LS9 to your external device.
- 2 In the DISPLAY ACCESS section, press the [SETUP] key repeatedly to access the MISC SETUP screen.
- 3 Move the cursor to the MIDI SETUP popup button, and press the [ENTER] key to access the MIDI SETUP popup window.
- 4 As described in “Basic MIDI settings” (→ p. 178), select the ports and MIDI channels that will be used to transmit/receive control changes.
- 5 When you’ve finished making settings, move the cursor to the CLOSE button and press the [ENTER] key to close the popup window.

You will return to the MISC SETUP screen.

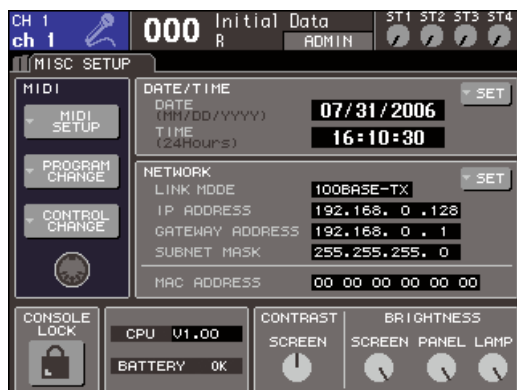

- 6 Move the cursor to the CONTROL CHANGE popup button, and press the [ENTER] key to access the CONTROL CHANGE popup window.

In the CONTROL CHANGE popup window you can specify how control changes will be transmitted and received, and assign the event (fader/encoder operation, [ON] key on/off operation, etc.) assigned to each control number. This page includes the following items.

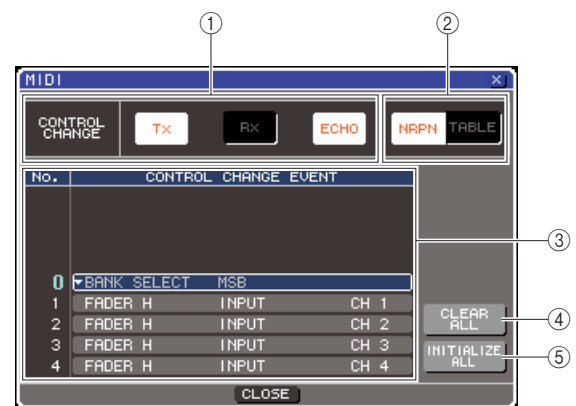

#### ① CONTROL CHANGE field

Here you can switch control change transmission/reception on/off, and specify whether control changes will be echoed out. This setting is linked with the CONTROL CHANGE field of the MIDI SETUP popup window.

## ② CONTROL CHANGE MODE field

Here you can select the control change transmission/reception mode. This setting is linked with the CONTROL CHANGE MODE field of the MIDI SETUP popup window.

## ③ List

This list shows the event (fader/encoder pattern, [ON] key on/off operation, etc.) assigned to each control number.

### ● NO.

This indicates the control number. You can use control numbers 1–31, 33–95, and 102–119.

### ● CONTROL CHANGE EVENT

Indicates/selects the type of event assigned to each control number. When you press the popup button for an event, the CONTROL CHANGE EVENT popup window will appear, allowing you to change the control number assignment.

## ④ CLEAR ALL button

Pressing this button will clear all event assignments in the list.

## ⑤ INITIALIZE ALL button

Pressing this button will restore all event assignments in the list to their default state.

## 7 Use the buttons of the CONTROL CHANGE MODE field to select the control change transmission/reception mode.

You can choose one of the following two modes for control change transmission/reception.

### ● NRPN mode (when the NRPN button is on)

The LS9's various mix parameters will be transmitted and received on a single MIDI channel as NRPN messages. If you select this mode, the assignments in the list will be ignored.

### ● TABLE mode (when the TABLE button is on)

The LS9's various mix parameters will be transmitted and received on a single MIDI channel as control change messages.

### HINT

- The channel on which control changes are transmitted and received is specified by the MIDI SETUP popup window PORT/CH field (→ p. 178).

## 8 Use the buttons of the CONTROL CHANGE field to turn transmission and reception on/off, and make settings for echo output.

Each button has the following function.

### ● Tx button

Switches control change transmission on/off.

### ● Rx button

Switches control change reception on/off.

### ● ECHO button

This selects whether incoming control changes are echoed-out from the transmission port.

## 9 To change the event assignment for each control number, move the cursor to the popup button for the corresponding event in the list, and press the [ENTER] key.

The CONTROL CHANGE EVENT popup window will appear. In this window you can specify the event assigned to each control number. The window contains the following items.

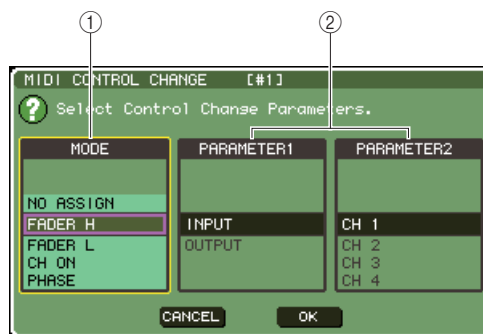

### ① MODE field

Select the type of event.

### ② PARAMETER 1/2 field

In conjunction with the MODE field, this specifies the type of event.

### NOTE

- If NRPN mode is selected as the control change transmission/reception mode, the settings in this window are ignored.

### HINT

- For details on the events that can be assigned to control changes, refer to the appendix (→ p. 249).

## 10 In the order of the MODE field → PARAMETER 1 field → PARAMETER 2 field, specify the type of event you want to assign.

To select an item, use the dial or the [DEC]/[INC] keys. Move the cursor to the OK button and press the [ENTER] key to finalize the changes and close the CONTROL CHANGE EVENT popup window.

## 11 Assign events to other control numbers in the same way.

When you operate the parameters you assigned on the LS9, control change messages will be transmitted to external devices. Similarly, if the corresponding control change messages are sent from an external device on the appropriate channel, the parameters assigned to those control numbers will change.

### HINT

- You can use the CLEAR ALL button to erase all assignments to control numbers. The INITIALIZE ALL button will return all control number assignments to their default state.
- Assignments to control numbers are maintained as settings for the entire system, rather than for individual scenes.

## Using parameter changes to control parameters

On the LS9, you can use a type of system exclusive messages called “parameter changes” to control specific events (fader/encoder operations, [ON] key on/off operations, etc.) as an alternative to using control changes or NRPN messages.

For details on the parameter changes that can be transmitted and received, refer to “MIDI Data Format” in the appendix.

- 1** Connect the LS9 to your external device.
- 2** In the **DISPLAY ACCESS** section, press the **[SETUP]** key repeatedly to access the **MISC SETUP** screen.
- 3** Move the cursor to the **MIDI SETUP** popup button, and press the **[ENTER]** key to access the **MIDI SETUP** popup window.
- 4** As described in “Basic MIDI settings” (→ p. 178), select the ports and MIDI channels (device numbers) that will be used to transmit/receive parameter changes.

### NOTE

- Parameter changes include a “device number” that specifies the transmitting or receiving device. The transmit (Tx) channel and receive (Rx) channel specified in the **MIDI SETUP** page are used as the device number.
- Please be aware that if the device number included in the transmitted parameter change does not match the device number of the receiving LS9 console, the message will be ignored.
- If parameter change and control change transmission/reception are turned on at the same time, a large amount of data will flood the MIDI port and cause overflows or other problems, so you should avoid this.

- 5** Use the **Tx** button and **Rx** button of the **PARAMETER CHANGE** field to turn on parameter change transmission/reception.

In this state when you operate specific parameters on the LS9, the corresponding parameter change messages will be transmitted. If valid parameter change messages are transmitted from an external device, the parameters assigned to those parameter changes will be controlled.

## Using MMC (MIDI Machine Control) to operate the USB memory recorder

You can use MMC (MIDI Machine Control) messages to operate the LS9's USB memory recorder from an external device.

MMC is only received (not transmitted). For details on the MMC messages that can be received, refer to "MIDI Data Format" in the appendix.

- 1** Connect the LS9 to your external device.
- 2** In the **DISPLAY ACCESS** section, press the **[SETUP]** key repeatedly to access the **MISC SETUP** screen within the **SETUP** screens.
- 3** Move the cursor to the **MIDI SETUP** popup button, and press the **[ENTER]** key to access the **MIDI SETUP** popup window.
- 4** As described in "Basic MIDI settings" (→ p. 178), select the port and MIDI channel (device number) that will be used to receive MMC messages.

### NOTE

- MMC messages include a "device number" that specifies the receiving device. The receive (Rx) channel specified in the MIDI SETUP page is used as the device number.
- Please be aware that if the device number included in the transmitted MMC message does not match the device number of the receiving LS9 console, the message will be ignored.

- 5** Prepare the USB memory recorder for use. For details on using the USB memory recorder, see p.105.

In this state, an external device will be able to control operations such as play, record, stop, and pause on the LS9's USB memory recorder.

The following MMC commands are supported.

Command	MMC#	Content
Stop	01	Stop playback or recording.
Play	02	Begins playback of the selected file. The file to be played can be selected beforehand in the TITLE LIST screen, or the desired track number can be selected using a MIDI Song Select message (F3).
Play	03	Begins playback of the selected file. The file to be played can be selected beforehand in the TITLE LIST screen, or the desired track number can be selected using a MIDI Song Select message (F3).
Record	06	Begins recording.
Pause	09	Pauses playback or recording.



# ◆ Chapter 19 ◆

## User settings (Security)

This chapter explains the User Level settings that allow restrictions on the parameters that can be operated by each user, the Console Lock function that temporarily disables operation of the console, the Preferences settings that allow the operating environment to be customized, and Save/Load operations using USB memory.

### User Level settings

User Level settings allow you to restrict the parameters that be operated by each user, or to change the settings of the custom fader layer, user-defined keys, and preference settings for each user. Settings for each user can be stored as a “user authentication key” on USB memory, allowing users to be switched easily, simply by connecting the memory device to a USB connector. This is convenient in the following situations.

- Unintended or mistaken operation can be prevented.
- The range of functionality operable by an outside engineer (guest engineer) can be limited.
- In situations in which multiple operators alternate with each other, output settings etc. can be locked to prevent unintended operations.
- Preferences of each operator can easily be switched.

### User types and user authentication keys

There are three types of user, as follows. In order to operate the LS9, you must log-in as some type of user.

#### ● Administrator

This is the administrator of the LS9, and can use all of its functionality. Only one set of Administrator settings is internally maintained in the console. The Administrator can create user authentication keys for other users.

#### ● Guest

A User can use only the range of functionality permitted by the Administrator. Only one set of Guest settings is internally maintained in the console.

#### ● User

A User can use only the range of functionality permitted by the Administrator. User settings are saved on USB memory as a user authentication key. Multiple sets of User settings can be saved with different user names. Custom fader layer, user-defined key, and preference settings can be edited, and these settings stored in the user authentication key.

In addition, a User who has Power User privileges can create or edit user authentication keys with a specified user level.

When a user logs on, the user settings for that user are applied. User settings include the following information.

- Password (except for Guest)
- User level (except for Administrator)
- Preferences
- User-defined keys

Privileges for each user are as follows.

Logged-in user	Custom fader layer / user-defined keys / preference setting editing	User Level setting	Password setting	Comment editing	User authentication key (USB memory)	
					Create new	Overwrite-save
Administrator	Available (Can edit the settings for Administrator and for Guest.)	Available (Cannot edit the user level, since the administrator can always perform all operations. Can edit the user level for Guest.)	Available	—	Available	—
User	Power user	Available	Available	Available	Available	Available
	Normal user (a user without Power User privileges)	Available	N/A (View only)	Available	Available	—
Guest	Available	N/A (View only)	—	Available	—	—

## Setting the Administrator password

With the factory settings, the Administrator password is not set, meaning that anyone can log in with Administrator privileges and perform all operations. If you want to restrict the operations of other users, you must specify an Administrator password.

- 1 In the DISPLAY ACCESS section, press the [SETUP] key repeatedly to access the USER SETUP screen.

PASSWORD CHANGE popup button



- 2 Move the cursor to the PASSWORD CHANGE popup button, and press the [ENTER] key.

A keyboard window will appear, allowing you to enter a password.



- 3 Enter the password in the NEW PASSWORD field; then move the cursor to the OK button and press the [ENTER] key.

The password can be up to eight characters. For details on entering a password, refer to “Assigning a name” (→ p. 34)

## Creating a user authentication key

Here’s how to create a user authentication key and save it on USB memory. A user authentication key can be created only by an Administrator or Power User. The user level can be specified when the authentication key is created, but the custom fader layer, user-defined key settings, and preference settings will be carried over from the user who is currently logged-in.

- 1 Connect USB memory to the USB connector.
- 2 In the DISPLAY ACCESS section, press the [SETUP] key repeatedly to access the USER SETUP screen.

CREATE USER KEY button



**3 Move the cursor to the CREATE USER KEY button and press the [ENTER] key.**

The CREATE USER KEY popup window will appear.

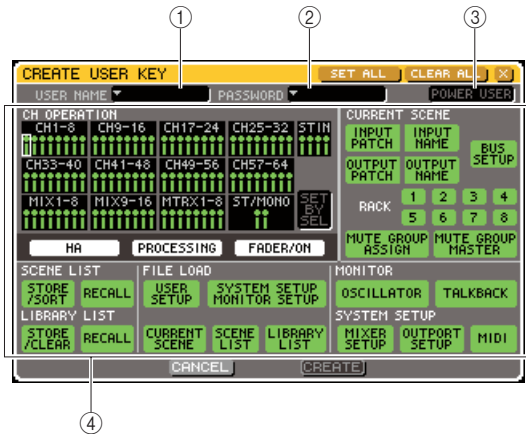

**1 USER NAME**

The user name of up to eight characters is shown (and can be edited) here. When you move the cursor to this field and press the [ENTER] key, a keyboard window will appear, allowing you to enter a user name (→ p. 34).

**2 PASSWORD**

Specify a password of up to eight characters. Press this to access a keyboard window where you can enter the password (→ p. 34).

**3 POWER USER**

Specifies whether Power User privileges will be granted to this user.

**4 Access permission settings**

These settings specify the range of operations that the user can perform. For details on each item, refer to p.193.

**4 When you have specified the user name, password, power user privileges on/off, and user rights, move the cursor to the CREATE button and press the [ENTER] key.**

If you are logged-in as the Administrator, the user authentication key will be saved on USB memory. If you are logged-in as a Power User, a dialog box will ask you to confirm the store-destination USB memory. If you want to save the user authentication key on different USB memory, connect the desired USB memory and then press [OK].

**Logging-in**

In order to operate the LS9, you must log in as the Administrator, Guest, or a User.

User settings for the Administrator and Guest are saved in the console itself, but in order to log in as a User you must connect USB memory on which a user authentication key has been saved. If you disconnect the USB memory after logging-in, your access privileges will forcibly revert to Guest.

**NOTE**

- If the power is turned off and then on again, the console will generally start up in the log-in state in which the power was turned off. If a user password has been assigned, you will need to enter the password. However if you cancel the input, you will be forcibly logged-in as Guest. Similarly, you will also be forcibly logged-in as Guest if you had been logged-in as a user requiring a user authentication key, but USB memory is no longer connected.

**● Logging-in as Administrator**

**1 In the DISPLAY ACCESS section, press the [SETUP] key repeatedly to access the USER SETUP screen.**

Log-in popup button



**2 Move the cursor to the log-in popup button and press the [ENTER] key.**

The LOGIN popup window will appear.

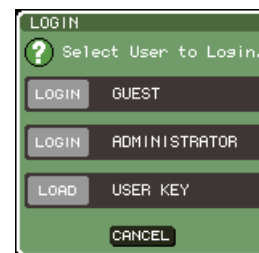

**3 Move the cursor to the ADMINISTRATOR LOGIN button and press the [ENTER] key.**

If no Administrator password has been set, you will simply be logged-in. If a password has been set, a keyboard window will appear, allowing you to enter the password.



**4 Enter the password, move the cursor to the OK button, and press the [ENTER] key.**

For details on entering a password, refer to “Assigning a name” (→ p. 34).  
If the password was incorrect, a message of “WRONG PASSWORD” will appear in the bottom of the screen.

**● Logging-in as Guest**

**1 In the DISPLAY ACCESS section, press the [SETUP] key repeatedly to access the USER SETUP screen.**

**2 Move the cursor to the log-in popup button and press the [ENTER] key.**

The LOGIN popup window will appear.

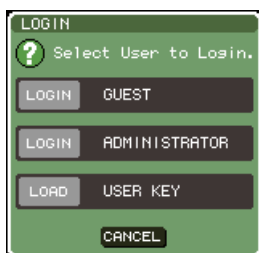

**3 Move the cursor to the GUEST LOGIN button and press the [ENTER] key.**

**● Logging-in as a User**

To log-in as a User, you will use a user authentication key saved on USB memory. You may also log-in using a user authentication key that was created on a different LS9 console.

**1 Connect the USB memory to the USB connector.**

**2 In the DISPLAY ACCESS section, press the [SETUP] key repeatedly to access the USER SETUP screen.**

**3 Move the cursor to the log-in popup button and press the [ENTER] key.**

The LOGIN popup window will appear.

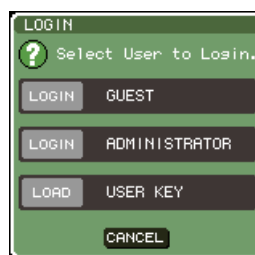

**4 Move the cursor to the LOAD USER KEY button and press the [ENTER] key.**

The SAVE/LOAD popup window will appear, and the files and folders saved on the USB memory will be displayed. User authentication keys have a file name of “User name.L9U”.



File list

LOAD button

**5 Move the cursor to the file list, and turn the dial to select the user authentication key of the user as whom you want to log-in.**

The highlighted line in the file list indicates the file that is selected for operations.  
For details on loading from USB memory, refer to “Loading a file from USB memory” (→ p. 200).

## 6 Move the cursor to the LOAD button and press the [ENTER] key.

If no password has been set, you will simply be logged-in. If a password has been set, a keyboard window will appear, allowing you to enter the password.

### NOTE

- If you select a user authentication key that was created on a different LS9 console, a keyboard window will appear, allowing you to enter the Administrator password of the LS9 console that you will be using. (If the Administrator passwords are identical, this window will not appear.) When you enter the correct Administrator password, another keyboard window will appear, allowing you to enter the password for the selected user.
- If you re-save the user authentication key, you will not be asked for the Administrator password the next time. (→ p. 192 Editing a user authentication key)



## 7 Enter the password, move the cursor to the OK button, and press the [ENTER] key.

For details on entering a password, refer to “Assigning a name” (→ p. 34).

If the password was incorrect, a message of “WRONG PASSWORD” will appear in the bottom of the screen.

## Changing the password

Here’s how to change the password of the logged-in user. A change in the Administrator password is updated immediately. A change in a User password will be discarded if the user simply logs-out; it must be applied to the user authentication key before the user logs-out. The Guest account does not have a password.

### 1 In the DISPLAY ACCESS section, press the [SETUP] key repeatedly to access the USER SETUP screen.

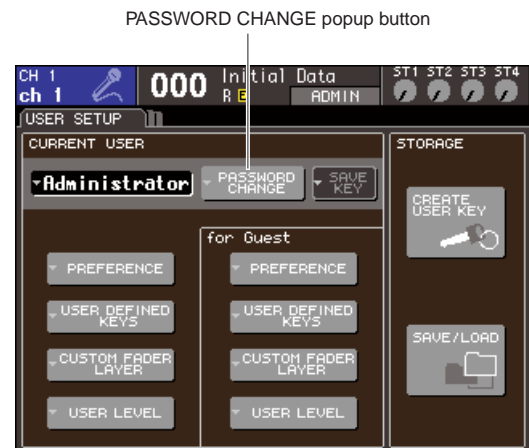

### 2 Move the cursor to the PASSWORD CHANGE popup button, and press the [ENTER] key.

A keyboard window will appear, allowing you to enter the password.



- 3 Enter the current password, move the cursor to the OK button, and press the [ENTER] key.

For details on entering a password, refer to “Assigning a name” (→ p. 34).

When you enter the correct password, a keyboard window will appear, allowing you to enter the new password.



- 4 Enter the password in the NEW PASSWORD field; then move the cursor to the OK button and press the [ENTER] key.

### Editing a user authentication key

If you are logged-in as a user, you can edit your custom fader layer, user-defined keys, and preference settings, and overwrite (save) them onto your user authentication key. If you are logged-in as a Power User, you can also change the user level.

- 1 Log-in as a user, and edit the custom fader layer (→ p. 91), user-defined keys (→ p. 196) and preference settings (→ p. 194).

If you are logged-in as a Power User, you can also change the user level.

- 2 In the DISPLAY ACCESS section, press the [SETUP] key repeatedly to access the USER SETUP screen.



- 3 Move the cursor to the SAVE KEY popup button, and press the [ENTER] key.

A dialog box will ask whether you really want to overwrite (save) the user authentication key.

- 4 To overwrite (save), move the cursor to the OK button and press the [ENTER] key.



• If you attempt to log-in as a different user after changing the settings but not saving them, a message will ask you whether you want to save the user authentication key. In this case, you can also save the user authentication key by moving the cursor to the OK button and pressing the [ENTER] key.

### Changing the user level

Here's how to view/change the user level of the logged-in user.

- For the Administrator ..... There is no such setting for the Administrator himself, but the setting for the Guest account can be changed.
- For the Guest ..... The setting of the Guest account can be viewed. It cannot be changed.
- For a normal User... The setting of that User account can be viewed. It cannot be changed.
- For a Power User .... The setting of that User account can be changed.

- 1 In the DISPLAY ACCESS section, press the [SETUP] key repeatedly to access the USER SETUP screen.



- 2 Move the cursor to the USER LEVEL popup button and press the [ENTER] key to access the USER LEVEL popup window.



• If you are logged in as Administrator, you can move the cursor to the “for Guest” USER LEVEL popup button and press the [ENTER] key to access the USER LEVEL popup window, where you can view or change the guest's user level.



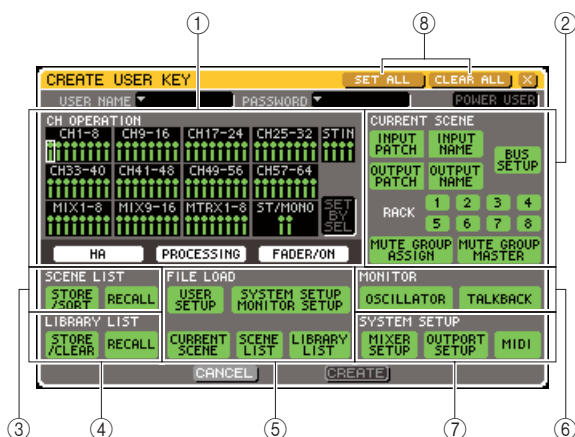

This page includes the following items.

### ① CH OPERATION field

Here you can specify (for each channel) the operations that will be permitted for input channels and output channels. The settings will apply to the currently selected channel. Use the panel [SEL] keys to select the channel for which you want to make settings. Channels that have the same settings are shown with the same color in the channel display field. The selected channel is shown with a frame around it.

#### ● HA

Restricts operation of the HA (Head Amp) patched to that channel.

#### ● PROCESSING

Restricts operation of all signal processing parameters for that channel (except for fader and [ON] key).



- For the channel parameters included in PROCESSING, refer to the appendix (→ p. 256).

#### ● FADER / ON

Restricts operation of that channel's fader and [ON] key.

#### ● SET BY SEL

If this button is on, you can use the [SEL] keys of the panel to turn all settings of the corresponding channel on or off.

### ② CURRENT SCENE field

This specifies the operations that can be performed on the current scene memory.

#### ● INPUT PATCH / NAME

Restricts operations for input channel patching and names.

#### ● OUTPUT PATCH / NAME

Restricts operations for output channel patching and names.

### ● BUS SETUP

Restricts operations for bus setup.

### ● RACK 1-8

Restricts operations for the racks (1-8).

### ● MUTE GROUP ASSIGN / MASTER

Restricts operations for mute group assignment and mute group master.

### ③ SCENE LIST field

This specifies the operations that can be performed on scene memories.

#### ● STORE / SORT operations

#### ● RECALL operations

### ④ LIBRARY LIST field

This specifies the operations that can be performed on libraries.

#### ● STORE / CLEAR operations

#### ● RECALL operations

### ⑤ FILE LOAD field

This specifies the types of file that can be loaded from USB memory.

#### ● USER SETUP (user-defined keys and preference settings)

#### ● SYSTEM SETUP / MONITOR SETUP

#### ● CURRENT SCENE

#### ● SCENE LIST

#### ● LIBRARY LIST

### ⑥ MONITOR field

This specifies the monitor setup operations that can be performed.

#### ● OSCILLATOR

#### ● TALKBACK

### ⑦ SYSTEM SETUP field

This specifies the system setup operations that can be performed.

#### ● MIXER SETUP

#### ● OUTPUT SETUP

#### ● MIDI

### ⑧ SET ALL/CLEAR ALL buttons

These buttons set or clear all items in the window.

## 3 Specify the user level by turning-on the button for each item that will be permitted.

## 4 When you've finished making settings, move the cursor to the CLOSE button and press the [ENTER] key to close the popup window.

# Preferences

Settings related to the operating environment (such as whether or not certain messages are displayed, or whether key operations are linked) can be made according to the preferences of each user. These settings are changed for the user who is logged-in, but if you are logged-in as the Administrator, you will also be able to change the Guest settings.

**1** In the **DISPLAY ACCESS** section, press the **[SETUP]** key repeatedly to access the **USER SETUP** screen.

PREFERENCE popup button



**2** Move the cursor to the **PREFERENCE** popup button, and press the **[ENTER]** key to access the **PREFERENCE** popup window.

**NOTE**

- If you are logged in as Administrator, you can move the cursor to the "for Guest" PREFERENCE popup button and press the [ENTER] key to access the PREFERENCE popup window, where you can view or change the guest's preference settings.

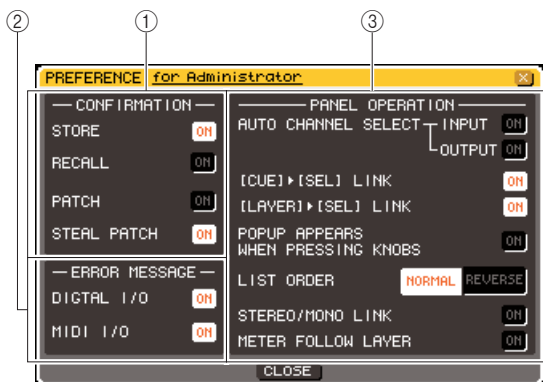

This page includes the following items.

① **CONFIRMATION** field

Here you can select whether confirmation messages will appear when you perform scene or patch operations.

- **STORE**
- **RECALL**

If these buttons are on, a confirmation message will appear when you perform a scene Store or Recall operation respectively.

- **PATCH**

If this button is on, a confirmation message will appear when you edit an input patch or output patch.

- **STEAL PATCH**

If this button is on, a confirmation message will appear when you edit an input patch or output patch item that is already patched.

② **ERROR MESSAGE** field

Here you can select whether an error message will be displayed when the following problems occur.

- **DIGITAL I/O**

When an error is detected in the digital input/output.

- **MIDI I/O**

When an error is detected in MIDI transmission/reception.

③ **PANEL OPERATION** field

Here you can make settings for options related to panel operation.

- **AUTO CHANNEL SELECT—INPUT**
- **AUTO CHANNEL SELECT—OUTPUT**

These specify whether the corresponding channel will be selected when you operate a channel's [ON] key or fader. This can be turned on/off separately for INPUT (input channels) and OUTPUT (output channels).

- **[CUE] → [SEL] LINK**

Specifies whether channel selection will be linked with cue operations. If this button is on, pressing the [CUE] key of a channel will simultaneously select that channel and light its [SEL] key.

- **[LAYER] → [SEL] LINK**

Specifies whether channel selection will be linked with fader layer selection. If this button is on, and you press a panel LAYER key to switch the fader layer, the last-selected channel of that fader layer will be selected, and its [SEL] key will light.

● **POPUP APPEARS WHEN PRESSING KNOBS**

Specifies whether pressing a knob of the **SELECTED CHANNEL** section when the **SELECTED CHANNEL VIEW** screen is shown will cause the popup window for that parameter to appear.

If this button is on, a popup window will appear (or close) whenever you press a knob.

● **LIST ORDER**

This specifies the order in which scene memories and library items will appear in the screen.

- **NORMAL**..... Show the list in ascending numerical order.
- **REVERSE** ..... Show the list in ascending numerical order.

● **STEREO / MONO LINK**

This specifies whether **STEREO** channel and **MONO** channel on/off and fader operations will be linked.

If you turn this button on, the **STEREO** channel on/off setting will be copied to the **MONO** channel, and subsequently on/off operations will be linked. Faders will be linked while preserving the difference in level.

● **METER FOLLOW LAYER**

Specifies whether the meter screen will be linked with fader layer selection. If this button is on, switching the fader layer will cause the meter screen to switch to the corresponding fader layer, regardless of which screen had been displayed.

- 3 Turn each button on or off to make the desired preference settings.**
- 4 When you've finished making settings, move the cursor to the **CLOSE** button and press the [ENTER] key to close the popup window.**

## User-defined keys

Here's how you can assign the desired functions to the user defined keys in the USER DEFINED section of the top panel, and press these keys to execute the defined function.

This assignment procedure will define the user-defined keys for the user who is currently logged-in, but if you are logged-in as the Administrator, you can also make user-defined key settings for the Guest account.

- 1 In the DISPLAY ACCESS section, press the [SETUP] key repeatedly to access the USER SETUP screen.

USER DEFINED KEYS popup button

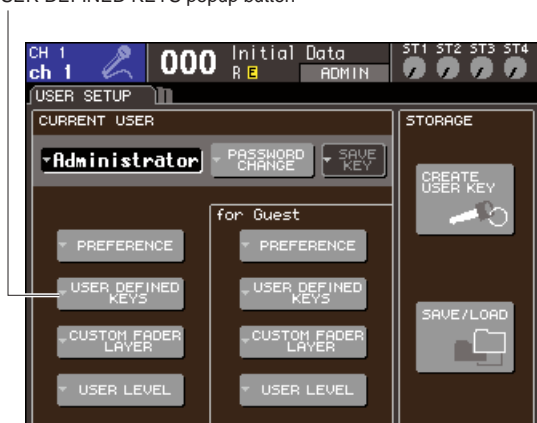

- 2 Move the cursor to the USER DEFINED KEYS popup button, and press the [ENTER] key.

The USER DEFINED KEYS popup window will appear.

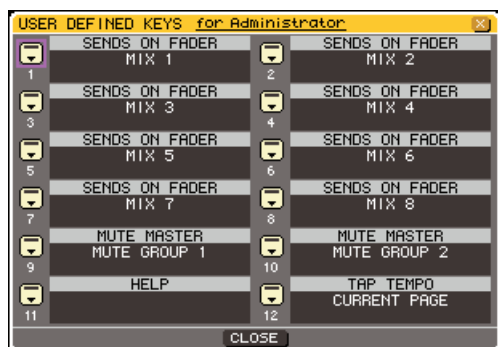

The twelve buttons in the screen correspond to user-defined keys [1]–[12] on the panel, and the function or parameter assigned to each one is shown at the right of the corresponding button. If nothing is assigned to the button, an indication of “----” is shown.

- 3 Move the cursor to the button for the user-defined key whose function you want to assign, and press the [ENTER] key.

The USER DEFINED KEY SETUP popup window will appear. In this window you can select a function to assign to the user defined key, and select option parameters.



- 4 Make sure that the FUNCTION field is enclosed by a yellow frame, and then use the dial or the [DEC]/[INC] keys of the panel to select the function you want to assign.

If the selected function has additional parameters, the parameters are shown in the PARAMETER 1/2 fields. For details on the assignable functions and their parameters, refer to “Functions that can be assigned to user-defined keys” (→ p. 257).

- 5 If the selected function has parameters, move the cursor to the PARAMETER 1 or 2 field and select parameters 1 and 2 in the same way.
- 6 Move the cursor to the OK button and press the [ENTER] key to close the USER DEFINED KEY SETUP popup window.
- 7 Assign the desired functions to other user-defined keys in the same way.
- 8 To execute an assigned function, press the corresponding USER DEFINED [1]–[12] key on the panel.

# Console lock

You can temporarily prohibit console operations in order to prevent unwanted operation. This setting completely disables operations of the panel and touch screen, so that controls cannot be operated by an accidental touch or by an unauthorized third party while the operator is taking a break.

If a password is set for the currently logged-in user, that password will be used for the Console Lock function. If you power-cycle the console while it is locked, you will be asked to enter the password if you had been logged-in as a user for whom a password is assigned. If you had been logged-in as the Guest, the console will start up normally.

**NOTE**

- If you have forgotten the password, refer to "Initializing the LS9's internal memory" (→ p. 222).
- The Guest cannot set a password.
- Even while the console is locked, control from an external device via MIDI or LS9 Editor will still operate as usual.

## Locking the console

**1** In the DISPLAY ACCESS section, press the [SETUP] key repeatedly to access the MISC SETUP screen.



CONSOLE LOCK button

**2** Move the cursor to the CONSOLE LOCK button and press the [ENTER] key.

If you are logged-in as a user for whom a password is set, a keyboard window will appear, allowing you to enter the password. For details on entering a password, refer to "Assigning a name" (→ p. 34).



**3** Enter the password of the logged-in user, move the cursor to the OK button, and press the [ENTER] key.

The CONSOLE LOCK screen will appear, the Console Lock function will be enabled, and all controls will become inoperable.

**HINT**

- If an image file is loaded from USB memory, the CONSOLE LOCK screen will show that image.

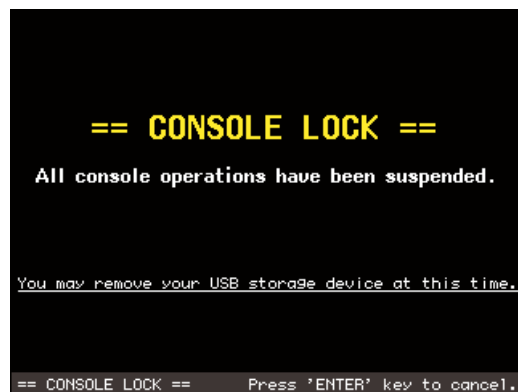

## Unlocking the console

### 1 When the CONSOLE LOCK screen is displayed, press the [ENTER] key.

If you are logged-in as a user for whom no password is set, the console will be unlocked. If you are logged-in as a user for whom a password is set, a keyboard window will appear, allowing you to enter the password.



### 2 Enter the password of the logged-in user, move the cursor to the OK button, and press the [ENTER] key.

The console will be unlocked, you will return to the MISC SETUP screen, and the controls will be operable once again.

#### HINT

- You may disconnect the USB memory device while the console is locked. Insert the USB memory device before you defeat Console Lock.

## Specifying the CONSOLE LOCK screen image

If an image file is saved in USB memory, the CONSOLE LOCK screen can display that image.

In the SAVE/LOAD popup window, specify the image file that you want to display and load it from USB memory. For the procedure of loading from USB memory, refer to “Loading a file from USB memory” (→ p. 200).

#### NOTE

- The image file is not backed-up in internal memory. Each time you turn on the power, you will need to reload it from USB memory.
- The image file will be converted into 320 x 240 pixels, 216 colors for display.
- The image file is limited to 8/16/24/32-bit color, un-compressed, and a maximum of 307,256 bytes.



## Using USB memory to save/load data

This section explains how you can connect commercially-available USB memory to the USB connector located at the right side of the display, and use it to save or load data such as internal settings for the LS9.

### NOTE

- Operation is guaranteed only with USB flash memory.
- The operation of storage media with capacities of up to 16GB has been verified. (However, this does not necessarily guarantee the operation of all USB storage media.) The FAT12, FAT16 and FAT32 formats are supported. On the LS9 V1.10 or higher, storage media with a capacity of 4GB or larger will be formatted in FAT32 and storage media with a capacity of 2GB or smaller will be formatted in FAT16. Long file names are not supported.

### CAUTION

- The ACCESS indicator will appear in the constant display area of the screen while data is being accessed, such as during saving, loading, or deleting. Do not disconnect the USB memory or power-off the LS9 while this indicator is shown. Doing so may damage the data in USB memory.

## Saving the LS9's internal data on USB memory

Here's how all of the LS9's internal data (except for the data included in a user authentication key) can be saved on USB memory as a file. The saved file will have an extension of ".L9A".

- 1 In the DISPLAY ACCESS section, press the [SETUP] key repeatedly to access the USER SETUP screen.



- 2 Move the cursor to the SAVE/LOAD button and press the [ENTER] key.

The SAVE/LOAD popup window will appear.



SAVE button

- 3 If you want to move to a different directory, move the cursor to the icon of the column of the desired directory, and press the [ENTER] key.

To move to the next higher level, move the cursor to the arrow button in the PATH field and press the [ENTER] key.

- 4 Move the cursor to the SAVE button and press the [ENTER] key.

A keyboard window will appear, allowing you to enter a file name and comment.



- 5 Enter a file name of up to eight characters and a comment of up to 32 characters; then move the cursor to the SAVE button and press the [ENTER] key.

When the file has finished being saved, the popup window showing the save progress indication and the type of data will close.

## Loading a file from USB memory

Here's how to load an LS9 settings file (extension .L9A) from USB memory into the LS9.

You can use the same procedure to load the following files other than the settings files.

Extension	Type	Contents of file
.L9A	ALL	LS9 internal settings file
.L9U	KEY	LS9 user authentication key
.XML	XML	XML file for displaying help
.TXT	TXT	Text file for displaying help
.BMP	BMP	Image file for display in the CONSOLE LOCK screen

### CAUTION

- Press the [HOME] key to access the SELECTED CH VIEW screen, and use the [SEL] keys to select the INPUT channel from which you want to take a direct output. Before you load, turn off the power of the equipment connected to the LS9 and/or lower the volume so that there will not be a problem even if a signal is output from the LS9.

- In the DISPLAY ACCESS section, press the [SETUP] key repeatedly to access the USER SETUP screen.



- Move the cursor to the SAVE/LOAD button and press the [ENTER] key.

The SAVE/LOAD popup window will appear. If an image file is saved in USB memory, the CONSOLE LOCK screen can display that image (→ p. 198).



File list

LOAD button

- Move the cursor to the file list, and use the dial on the panel to select the file you want to load.

The highlighted line in the file list indicates the file that is selected for operations.

- When you move the cursor to the LOAD button and press the [ENTER] key, a dialog box will ask you to confirm the operation.

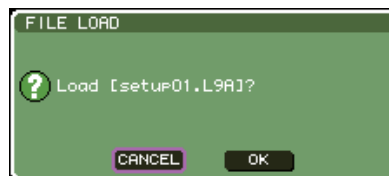

- Move the cursor to the OK button and press the [ENTER] key; loading will begin.

When the file has finished being loaded, the popup window showing the progress indication and the type of data will close.

Even if you cancel while the settings file is still being loaded, the data up to that point will have been loaded. The type of file that can be loaded will depend on the User Level setting at the time you load the file.

## Editing the files saved on USB memory

Here's how you can perform editing operations such as sorting the files and directories on USB memory, editing the file names or comments, copying, or pasting.

### ● File editing

- 1 In the **DISPLAY ACCESS** section, press the **[SETUP]** key repeatedly to access the **USER SETUP** screen.



- 2 Move the cursor to the **SAVE/LOAD** button and press the **[ENTER]** key.

The **SAVE/LOAD** popup window will appear, and the saved files and sub-directories will be shown in a list.

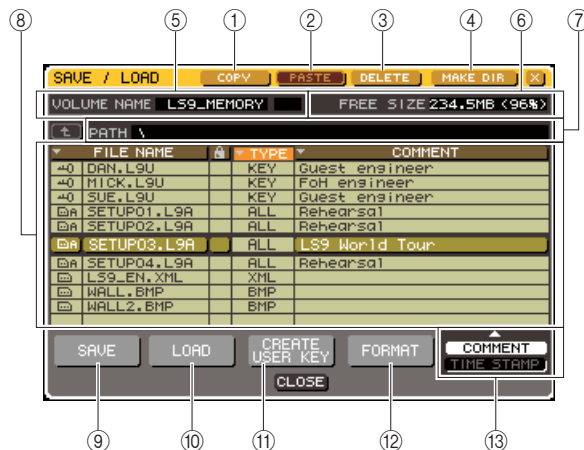

- ① **COPY button**  
This button copies a file into buffer memory (a temporary holding area) (→ p. 203).
- ② **PASTE button**  
This button pastes the file from buffer memory (→ p. 203).
- ③ **DELETE button**  
This button deletes the selected file (→ p. 203).

- ④ **MAKE DIR button**

This button creates a new directory (→ p. 203).

- ⑤ **VOLUME NAME**

This indicates the volume name of the USB memory. If the USB memory is write-protected, a protect symbol is shown in the **VOLUME NAME** field.

- ⑥ **FREE SIZE**

This indicates the amount of free space in the USB memory.

- ⑦ **PATH**

This shows the name of the current directory. You can move the cursor to the arrow button and press the **[ENTER]** key to move to the next upper level. If the current directory is the top level, the arrow button is dimmed.



- You cannot save if the directory name would exceed 237 characters.

- ⑧ **File list**

This area lists the files that are saved on USB memory. The highlighted line indicates the file selected for operations.

The file list contains the following items. If you move the cursor to the name of an item and press the **[ENTER]** key, that item name will turn orange, and the list will be sorted according to the character strings for those items. Each time you press the **[ENTER]** key, the sorting order will alternate between ascending and descending order.

#### ● FILE NAME

Indicates the file name or directory name, and shows an icon indicating its type.

#### ● READ ONLY

A lock symbol is shown to indicate protected files. You can press this area to enable or disable the protect setting.

#### ● FILE TYPE

ALL indicates a file containing LS9 internal settings, KEY indicates a user authentication key, XML indicates a help file, BMP indicates a bitmap image file, MP3 indicates an MP3 file, and [DIR] indicates a directory.

#### ● COMMENT

For LS9 files, the comment is displayed here. When you move the cursor to this area and press the **[ENTER]** key, a keyboard window will appear, allowing you to enter a comment for the file.

#### ● TIME STAMP

This shows the date and time at which the file was last modified.



- You can use the **COMMENT/TIME STAMP** button located at the lower right of the file list to toggle the display between **COMMENT** and **TIME STAMP**.

- ⑨ **SAVE button**  
Saves all of the LS9's internal settings together (→ p. 199).
- ⑩ **LOAD button**  
Loads the selected LS9 settings file (→ p. 200).
- ⑪ **CREATE USER KEY button**  
Creates a user authentication key (→ p. 192).
- ⑫ **FORMAT button**  
Formats the USB memory media (→ p. 204).
- ⑬ **COMMENT/TIME STAMP button**  
Toggles the item shown at the far right of the file list between COMMENT and TIME STAMP.

### 3 Perform the desired editing operation.

For details on the procedure, refer to the explanations that follow.

#### ● Sorting files and editing file names/ comments

- 1 In the **DISPLAY ACCESS** section, press the **[SETUP]** key repeatedly to access the **USER SETUP** screen.
- 2 Move the cursor to the **SAVE/LOAD** button, and press the **[ENTER]** key to access the **SAVE/LOAD** popup window.
- 3 To sort the files, move the cursor to the **"FILE NAME,"** lock symbol, **"FILE TYPE,"** **"COMMENT,"** or **"TIME STAMP"** field at the top of the file list, and press the **[ENTER]** key.

The list will be sorted as follows, according to the column title you selected.

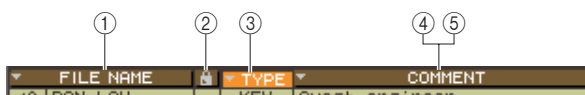

- ① **FILE NAME**  
Sort the list in alphanumerical order of file name.
- ② **Lock symbol**  
Sort the list according to Write Protect on/off status.
- ③ **FILE TYPE**  
Sort the list according to file type.
- ④ **COMMENT**  
Sort the list in alphanumeric order of the comment.
- ⑤ **TIME STAMP**  
Sort the list in order of date of creation.



• By pressing the **[ENTER]** key again, you can change the direction (ascending or descending) in which the list is sorted.

- 4 If you want to edit the file name or comment, move the cursor to the **FILE NAME** field or **COMMENT** field of each file and press the **[ENTER]** key to access the keyboard window.

For details on entering text, refer to “Assigning a name” (→ p. 34).

#### NOTE

- If the **COMMENT** field is not displayed, use the **COMMENT/TIME STAMP** button located at the lower right of the file list to turn **COMMENT** on.



- 5 Enter a file name / comment, move the cursor to the **RENAME** button or the **SET** button, and press the **[ENTER]** key.
- 6 To turn the **Protect** setting on/off, move the cursor to the lock symbol for that file and press the **[ENTER]** key.

A lock symbol is displayed for protected files; these files cannot be overwritten.

#### NOTE

- You cannot edit the file name or comment of a protected file.

## ● Copying/pasting a file

Here's how to copy a desired file into buffer memory, and then paste it with a different file name.

- 1 In the **DISPLAY ACCESS** section, press the **[SETUP]** key repeatedly to access the **USER SETUP** screen.
- 2 Move the cursor to the **SAVE/LOAD** button, and press the **[ENTER]** key to access the **SAVE/LOAD** popup window.
- 3 Move the cursor to the file list, use the panel dial to select the file that you want to copy, move the cursor to the **COPY** button, and press the **[ENTER]** key.

The highlighted line in the file list indicates the file that is selected for operations.

- 4 If you want to move to a different directory, move the cursor to the icon of the column of the desired directory, and press the **[ENTER]** key.

To move to the next higher level, move the cursor to the arrow button in the **PATH** field and press the **[ENTER]** key.

- 5 Move the cursor to the **PASTE** button and press the **[ENTER]** key.

A keyboard window will appear, allowing you to enter the paste-destination file name.

For details on entering text, refer to "Assigning a name" (→ p. 34).



- 6 Enter the paste-destination file name, move the cursor to the **PASTE** button, and press the **[ENTER]** key.

If you specified an existing file name, a confirmation message will appear.



- If you attempt to paste using the file name of an existing copy-protected file, the Paste operation will not be executed.

## ● Deleting a file

- 1 In the **DISPLAY ACCESS** section, press the **[SETUP]** key repeatedly to access the **USER SETUP** screen.
- 2 Move the cursor to the **SAVE/LOAD** button, and press the **[ENTER]** key to access the **SAVE/LOAD** popup window.
- 3 Move the cursor to the file list, use the panel dial to select the file that you want to delete, move the cursor to the **DELETE** button, and press the **[ENTER]** key.

A dialog box will ask you to confirm the Delete operation.

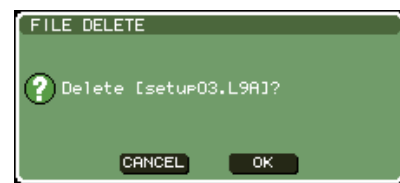

- 4 To execute the Delete operation, move the cursor to the **OK** button and press the **[ENTER]** key.



- You can't delete a protected file.

## ● Creating a directory

- 1 In the **DISPLAY ACCESS** section, press the **[SETUP]** key repeatedly to access the **USER SETUP** screen.
- 2 Move the cursor to the **SAVE/LOAD** button, and press the **[ENTER]** key to access the **SAVE/LOAD** popup window.
- 3 If you want to move to a different directory, move the cursor to the icon of the column of the desired directory, and press the **[ENTER]** key.

To move to the next higher level, move the cursor to the arrow button in the **PATH** field and press the **[ENTER]** key.

- 4 Move the cursor to the **MAKE DIR** button and press the **[ENTER]** key.

A keyboard window will appear, allowing you to enter a directory name.

For details on entering text, refer to “Assigning a name” (→ p. 34).



- 5 Enter a name for the directory you want to create, move the cursor to the **MAKE** button, and press the **[ENTER]** key.

If you specified an existing file name, a confirmation message will appear.

### Formatting USB memory media

Here’s how to format USB memory media using the FAT16 file system. USB memory up to 2 Gbytes in capacity is supported.

- 1 In the **DISPLAY ACCESS** section, press the **[SETUP]** key repeatedly to access the **USER SETUP** screen.



- 2 Move the cursor to the **SAVE/LOAD** button, and press the **[ENTER]** key to access the **SAVE/LOAD** popup window.



FORMAT button

- 3 Move the cursor to the **FORMAT** button and press the **[ENTER]** key.

A keyboard window will appear, allowing you to enter the volume name that will be applied after formatting.

For details on entering text, refer to “Assigning a name” (→ p. 34).



- 4 Enter the volume name, move the cursor to the **FORMAT** button, and press the **[ENTER]** key.

A dialog box will ask you to confirm the Format operation.



- 5 To execute the Format operation, move the cursor to the **OK** button and press the **[ENTER]** key.

Formatting will require several tens of seconds.



# ◆ Chapter 20 ◆

## Other functions

This chapter explains other functionality of the LS9 not covered elsewhere.

### About the SETUP screen

In the SETUP screen you can make various settings that apply to the entire LS9. The SETUP screen includes the following three screens. Repeatedly press the DISPLAY ACCESS section [SETUP] key to access the desired screen.

#### ● USER SETUP screen

In this screen you can restrict the functionality that is available to each user, and make settings that affect the operating environment. Here you can also save or load user settings to or from USB memory, and create user authentication keys.



• For details on functions and operation in the USER SETUP screen, refer to chapter 19 (→ p. 187).

#### ● SYSTEM SETUP screen

In this screen you can make settings related to buses and output ports, and settings related to word clock and cascade connections.



LS9-32

##### ① BUS SETUP field

Here you can make basic settings for MIX/MATRIX buses (→ p. 213).

##### ② OUTPUT PORT field

In this field you can assign an output channel to each output port. For details, refer to chapter 9 “Selecting the output channel for each output port” (→ p. 97).

##### ③ MIXER SETUP field

Here you can make word clock settings (→ p. 206), slot settings (→ p. 208), and cascade settings (→ p. 209).

### ● MISC SETUP screen

In this screen you can make various other settings.

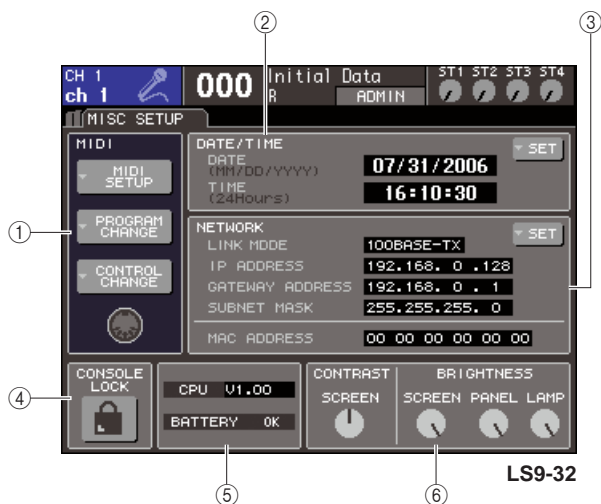

① **MIDI field**

Here you can make various MIDI-related settings. For details, refer to chapter 18 (→ p. 177).

② **DATE/TIME field**

Here you can specify the date and time (→ p. 215).

③ **NETWORK field**

Here you can make various network-related settings (→ p. 216).

④ **CONSOLE LOCK field**

This enables or disables Console Lock. For details, refer to chapter 19 “Console lock” (→ p. 197).

⑤ **CPU/BATTERY field**

The firmware version and the state of the internal memory backup battery are shown here. This will indicate OK if operation is normal, or LOW or NO if the voltage is low.

**NOTE**

- The LOW or NO indication will appear if the battery runs down. If this occurs, immediately save your data on a USB memory and contact your Yamaha dealer.

⑥ **CONTRAST/BRIGHTNESS field**

Here you can adjust the contrast and brightness of the display, the brightness of the top panel LEDs, and the brightness of the lamp connected to the LAMP connector (→ p. 217).

For details on the function and operations for each screen, refer to the second half of this chapter or to the corresponding other chapter.

## Word clock settings

“Word clock” refers to the clock that provides the basis of timing for digital audio signal processing. If you connect external equipment such as a DAW system or HDR (Hard Disk Recorder) to a digital I/O card installed in a rear panel slot, this equipment must be synchronized to the same word clock in order for digital audio signals to be sent and received. If digital audio signals are transferred in an unsynchronized state, the data will not be transmitted or received correctly, and noise may be present in the signal, even if the sampling rates are the same.

Specifically, you must first decide which device will transmit the reference word clock for the entire system (the word clock master), and then set the remaining devices (the word clock slaves) so that they synchronize to the word clock master. If you wish to use the LS9 as a word clock slave that is synchronized to the word clock supplied from an external device, you must specify the appropriate clock source (the port through which the word clock is obtained). The following steps show how to select the clock source that the LS9 will use.

**1** In the **DISPLAY ACCESS** section, press the **[SETUP]** key repeatedly to access the **SYSTEM SETUP** screen.



① **MIXER SETUP field**

② **WORD CLOCK button**

**2** Move the cursor to the **WORD CLOCK** button of the **MIXER SETUP** field in the lower part of the screen, and press the **[ENTER]** key.

The **WORD CLOCK** popup window will appear, allowing you to make word clock settings. This popup window contains the following items.

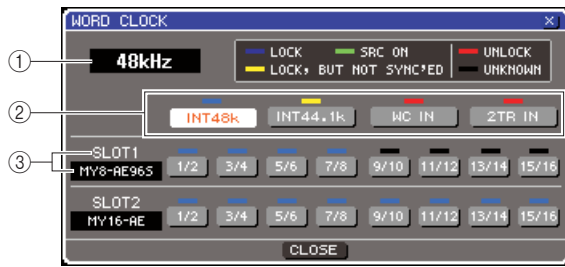

LS9-32

### ① Clock frequency

This indicates the frequency of the currently selected clock source. This field will indicate “UNLOCKED” while synchronization is lost, such as immediately after switching the master clock.

### ② Clock select buttons

These buttons select the master clock source. You can choose from the internal clock, the word clock signal supplied from the WORD CLOCK IN connector, or the word clock data included in the input signal from an I/O card in a slot.

### ③ Card type {Card type / Slot number}

This area shows the type of I/O card installed in the slot. {On the LS9-32, this area shows the slot number and the type of I/O card.}

## 3 Use the clock select buttons to select a clock source.

You can choose one of the following clock sources.

- INT 48 k
- INT 44.1 k

The LS9’s internal clock (sampling rate 48 kHz or 44.1 kHz, respectively) will be the clock source. Choose one of these if you want to use the LS9 as the word clock master.

### ● WORD CLOCK IN

The word clock signal supplied from the rear panel WORD CLOCK IN jack will be used as the clock source. In this case, the LS9 will operate as a word clock slave.

### ● SLOT {SLOT 1/2}

The clock data included in the digital audio input signal from a digital I/O card in the slot {slots 1/2} will be used as the clock source. (Select this in two-channel units.) In this case, the LS9 will operate as a word clock slave.

The status (operating state) of the clock data being received from each port is indicated by the color of the symbol displayed immediately above. Each color has the following significance.

### ● LOCK (light blue)

This indicates that a clock synchronized with the selected source is being input. If an external device is connected to the corresponding connector or slot, input/output is occurring normally between that device and the LS9. If the sampling frequency is close, this status may be displayed even if not synchronized.

### ● LOCK, BUT NOT SYNC’ED (yellow)

A valid clock is being input, but is not synchronized with the selected clock source. If an external device is connected to the corresponding connector, input/output cannot occur correctly between that device and the LS9.

### ● SRC ON (green)

This is a special status that is unique to a digital I/O card with SRC (Sampling Rate Converter) functionality installed in the slot {slots 1/2}; it indicates that SRC is enabled for the corresponding channel. If this status is displayed, normal input/output with the LS9 is occurring even if the signal is not synchronized.

### ● UNLOCK (red)

A valid clock is not being input. If an external device is connected to the corresponding connector, input/output cannot occur correctly between that device and the LS9.

### ● UNKNOWN (black)

This indicates that the clock status cannot be detected because no external device is connected or because there is no valid clock input. You will be able to select this connector/slot, but successful synchronization cannot occur until a valid connection is established.

If the symbol for the port selected in step 3 has turned light blue, and the clock frequency is shown in the upper left of the window, this indicates that the LS9 is operating correctly with the new clock.

#### HINT

- If you use a digital I/O card that contains a sampling rate converter (e.g., MY8-AE96S), input and output can occur normally with the LS9 even when unsynchronized. In this case, turn on the SRC button for the slot/channel that is receiving the signal (→ p. 208).

#### NOTE

- If the symbol for the selected clock does not turn light blue, make sure that the external device is correctly connected, and that the external device is set to transmit clock data.
- Noise may occur at the output jacks when the word clock setting is changed. In order to protect your speaker system, be sure to turn down the power amp volume before changing the word clock setting.
- If you attempt to select a channel whose SRC is on as the word clock source, a message will appear, warning you that the sampling rate converter will be disabled.

## 4 To close the WORD CLOCK popup window, move the cursor to the CLOSE button (or the × symbol in the upper right) and press the [ENTER] key.

You will return to the SYSTEM SETUP screen.

# Switching a digital I/O card's SRC on/off

If a digital I/O card with SRC (Sampling Rate Converter) functionality (such as the MY8-AE96S) is installed in the slot {slot 1/2}, you can use the SLOT SETUP popup window to turn the card's SRC on/off. In this window you can also check the operating status of the I/O card(s) installed in the slot(s).

- 1 In the DISPLAY ACCESS section, press the [SETUP] key repeatedly to access the SYSTEM SETUP screen.**



LS9-32

- 1 SLOT SETUP button**

- 2 Move the cursor to the SLOT SETUP button of the MIXER SETUP field in the lower part of the screen, and press the [ENTER] key.**

The SLOT SETUP popup window will appear, allowing you to make slot-related settings. This popup window contains the following items.

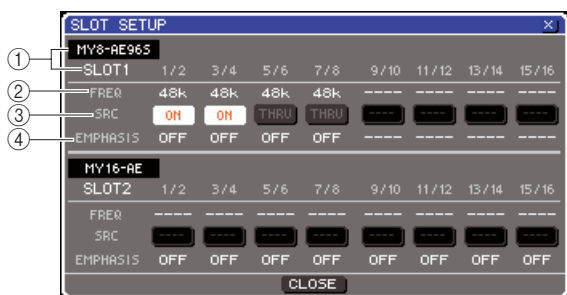

LS9-32

- 1 Card type {Card type / Slot number}**  
This area shows the type of I/O card installed in the slot. {On the LS9-32, this area shows the slot number and the type of I/O card in each slot.}
- 2 FREQ (Frequency)**  
This indicates the sampling frequency of the signal being input to each channel of an MY8-AE96 or MY8-AE96S digital I/O card, in sets of two channels.

- 3 SRC buttons**

For digital I/O cards that contain a built-in SRC (Sampling Rate Converter), the SRC can be switched on/off in groups of two channels.

- 4 EMPHASIS**

This area indicates whether emphasis processing is applied to the input signals of a slot in which an AES/EBU format digital I/O card is installed, in units of two channels.

This indication is displayed as follows.

Item	Description
---	No signal, or a signal without emphasis is being input
ON	A valid digital audio signal is being input, and emphasis is turned On for that signal
OFF	A valid digital audio signal is being input, and emphasis is turned Off for that signal

- 3 To turn on the SRC that is built-into the digital I/O card, move the cursor to the corresponding SRC button and press the [ENTER] key.**

The SRC can be turned on/off in units of two channels. For channels whose SRC is turned on, input/output can occur correctly even if the input signal is not synchronized with the LS9's clock source.

- 4 To close the WORD CLOCK popup window, move the cursor to the CLOSE button (or the × symbol in the upper right) and press the [ENTER] key.**

You will return to the SYSTEM SETUP screen.

## Using cascade connections

By cascade-connecting two or more LS9 consoles or an LS9 with an external mixer (such as the Yamaha M7CL) you can share the buses. For example this is convenient when you want to use an external mixer to increase the number of inputs.

If you are cascading two LS9 consoles, you can use the “Cascade Link” function to link cue operations, scene recall/store operations, and fader layer selections. In this case, you can operate the two LS9 consoles as if they were a single mixer.

Here we will explain cascade connections and operation, using an example in which two LS9 consoles are cascade-connected.

To cascade two LS9 consoles, you will install digital I/O cards in their respective slots, and connect the output ports of the sending unit (the cascade slave) to the input ports of the receiving unit (the cascade master).

The following illustration shows an example in which one sixteen-channel digital I/O card for each console are installed in the cascade slave LS9 and in the cascade master LS9, and the DIGITAL OUT jacks of the sending unit connected to the DIGITAL IN jacks of the receiving unit.

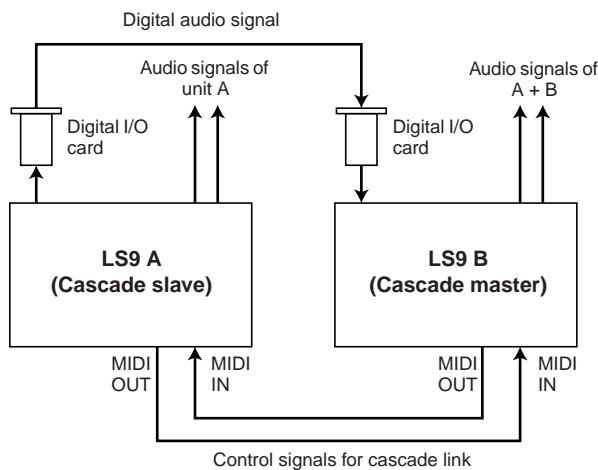

In this example, up to sixteen buses chosen from MIX buses 1–16, MATRIX buses 1–8, STEREO bus (L/R), MONO (C) bus, and CUE bus (L/R) can be shared, and the mixed signals transmitted from the cascade master LS9. {If you're cascade-connecting two LS9-32 consoles, you will be able to share all buses if you install two 16-channel digital I/O cards in each LS9-32 console.} Control signals for the Cascade Link function are transmitted and received via the MIDI IN/OUT connectors. In this type of setup, performing a cue operation, scene recall/store operation, or fader layer selection on either console will cause the same to occur on the other console.

When using a cascade connection, you must specify the slot(s)/channels on each LS9 console that will send and receive audio signals. Similarly, in order to use the Cascade Link function, you must specify the port that will transmit and receive control signals, and specify the parameters and events that will be linked. The following pages explain the required settings for cascade connection and the method of operation, separately for the cascade slave and the cascade master.

### HINT

- You can also cascade-connect the LS9 with digital mixers that have a Mini-YGDAI slot, such as the Yamaha M7CL or PM5D. However, this only allows you to cascade the audio signals; linking via control signals is not possible.
- You can also use an AD/DA card to make cascade connections with an analog mixer.
- There is no limit to the number of units that can be cascade-connected, but the signal delay from each cascade-slave will increase according to the number of units between it and the cascade-master.

## Operations on the cascade slave LS9

- 1 In the DISPLAY ACCESS section, press the [SETUP] key repeatedly to access the SYSTEM SETUP screen.



LS9-32

- 1 CASCADE OUT button

- 2 In the MIXER SETUP field located at the lower part of the SYSTEM SETUP screen, move the cursor to the CASCADE OUT button and press the [ENTER] key.

The CASCADE OUT PATCH popup window will appear. This window contains the following items.

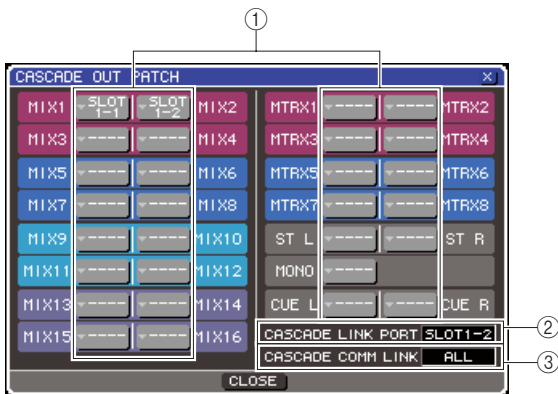

- 1 **Port select popup buttons**  
These buttons access an OUTPUT PORT SELECT popup window where you can select the output port for each bus.
- 2 **CASCAD LINK PORT field**  
When using the Cascade Link function, this specifies the port by which control signals will be transmitted and received between the two LS9 consoles.
- 3 **CASCAD COMM LINK field**  
Here you can select the parameters and events that will be linked by the Cascade Link function.

- 3 Move the cursor to the port select popup button for the bus whose port you want to assign, and press the [ENTER] key.

The OUTPUT PORT SELECT popup window will appear.

### [ OUTPUT PORT SELECT popup window for the LS9-32 ]

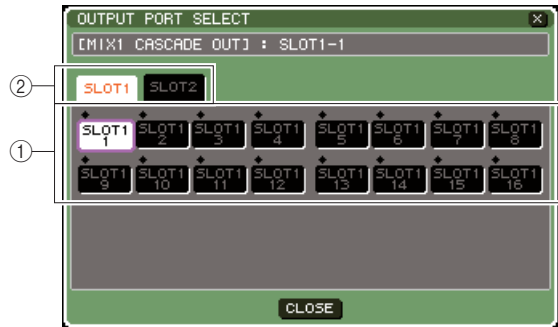

### [ OUTPUT PORT SELECT popup window for the LS9-16 ]



This popup window contains the following items.

- 1 **Port select buttons**  
These buttons select the output port for the selected bus.
- 2 **Slot select tabs (LS9-32 only)**  
These tabs select slots 1/2.
- 4 Use the port select buttons {slot select tabs and port select buttons} to select an output port, move the cursor to the CLOSE button and press the [ENTER] key.  
The port will be assigned to the bus you selected in step 3.
- 5 Repeat steps 3 and 4 to assign output ports to other buses.

**NOTE**

- You can't assign two or more buses to the same output port. If you select a bus to which a signal route has already been assigned, the previous assignment will be cancelled.



## 6 If you want to use the Cascade Link function to link parameters and events between two LS9 consoles, proceed as follows.

- ① Move the cursor to the **CASCADE LINK PORT** field, and use the dial or the [DEC]/[INC] keys to select the port that will transmit/receive control signals for cascade link.

You can choose from the following items.

### LS9-16

Item	Description
----	No port will be used.
MIDI	Rear panel MIDI IN/OUT connectors
SLOT1-1– SLOT1-8	Input/output channels 1–8 of a card supporting serial communication, installed in the rear panel slot 1

### LS9-32

Item	Description
----	No port will be used.
MIDI	Rear panel MIDI IN/OUT connectors
SLOT1-1– SLOT1-8	Input/output channels 1–8 of a card supporting serial communication, installed in rear panel slot 1
SLOT2-1– SLOT2-8	Input/output channels 1–8 of a card supporting serial communication, installed in rear panel slot 2

#### NOTE

- Control signals for cascade link and MIDI messages cannot share the same port. If you select a port that is already specified for transmission/reception of MIDI messages, a dialog box will ask whether it is OK to cancel the existing settings.

- ② Move the cursor to the **CASCADE COMM LINK** field, and use the dial or the [DEC]/[INC] keys to select the item you want to link.

You can choose from the following items.

#### ● OFF

Linking will not occur.

#### ● CUE

The following cue-related parameters and events will be linked.

- Cue enable/disable
- Cue mode (MIX CUE or LAST CUE)
- Cue point settings for input channels and output channels

#### ● ALL

All linkable parameters and events (including cue-related parameters) will be linked.

- Cue-related parameters and events (see above)
- Scene recall operations
- Scene store operations
- DIMMER (MONITOR screen) operations
- Switching the fader layer
- Panel LED and display brightness (MISC SETUP screen) operations
- Master mute group operations

## 7 To close the OUTPUT PORT SELECT popup window, move the cursor to the CLOSE button (or the × symbol in the upper right) and press the [ENTER] key.

## Operations on the cascade master LS9

- 1 In the DISPLAY ACCESS section, press the [SETUP] key repeatedly to access the SYSTEM SETUP screen.
- 2 In the MIXER SETUP field located at the lower part of the SYSTEM SETUP screen, move the cursor to the CASCADE IN button and press the [ENTER] key to access the CASCADE IN PATCH popup window.

The CASCADE IN PATCH popup window contains the following items.

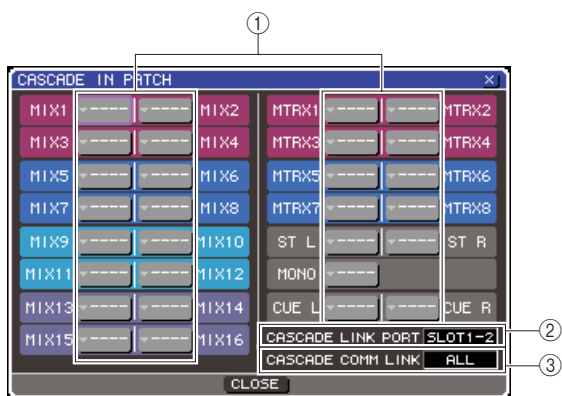

- 1 **Port select popup buttons**  
These buttons access the INPUT PORT SELECT popup window, where you can select the input port whose signal will be added to the bus.
  - 2 **CASCADE LINK PORT field**  
Here you can select the port that will transmit and receive control signals when using the Cascade Link function to link specific operations and parameter changes between two LS9 consoles.
  - 3 **CASCADE COMM LINK field**  
Here you can select the parameters and events that will be linked by the Cascade Link function.
- 3 **Move the cursor to the port select popup button for the bus whose port you want to assign, and press the [ENTER] key.**  
The INPUT PORT SELECT popup window will appear.  
This popup window contains the following items.

[ INPUT PORT SELECT popup window for the LS9-32 ]



[ INPUT PORT SELECT popup window for the LS9-16 ]

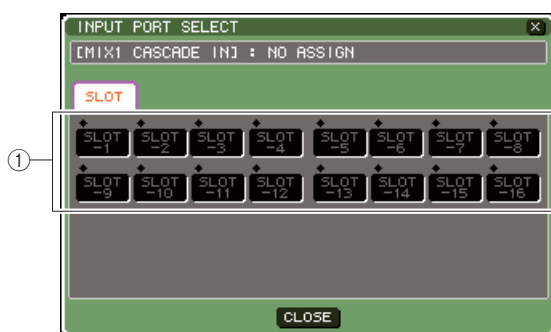

This popup window contains the following items.

- 1 **Port select buttons**  
Here you can select the input port whose signal will be added to the selected bus.
  - 2 **Slot select tabs (LS9-32 only)**  
These tabs select slots 1/2.
- 4 **Use the port select buttons {slot select tabs and port select buttons} to select an input port, move the cursor to the CLOSE button and press the [ENTER] key.**  
The input port will be assigned to the bus you selected in step 3. The signal input from this port will be mixed with the signal of the corresponding bus inside the cascade master.
  - 5 **Repeat steps 3 and 4 to assign input ports to other buses.**

**NOTE**

- You can't assign the same input port to two or more buses. If you select a bus to which a signal route has already been assigned, the previous assignment will be cancelled.

## 6 If you want to link specific parameters or events between two LS9 consoles, proceed as follows.

- 1 Move the cursor to the **CASCADE LINK PORT** field, and use the dial or the [DEC]/[INC] keys to specify the port that will transmit/receive control signals for cascade link.

The items you can select are the same as in the **CASCADE OUT PATCH** popup window (→ p. 211).

### NOTE

- Control signals for cascade link and MIDI messages cannot share the same port. If you select a port that is already specified for transmission/reception of MIDI messages, a dialog box will ask whether it is OK to cancel the existing settings.

- 2 Move the cursor to the **CASCADE COMM LINK** field, and use the dial or the [DEC]/[INC] keys to specify the item(s) you want to link, so that they match the settings of the cascade slave. The items you can select are the same as in the **CASCADE OUT PATCH** popup window (→ p. 211).

## 7 To close the **INPUT PORT SELECT** popup window, move the cursor to the **CLOSE** button (or the × symbol in the upper right) and press the [ENTER] key.

In this state, the bus signals of the cascade slave will be sent via the slot to the buses of the cascade master, and the combined signals of both buses will be output from the cascade master. If the Cascade Link function is enabled, the specified operations or parameter changes performed on either LS9 console will be followed by the other LS9 console.

## Basic settings for MIX buses and MATRIX buses

This section explains how to change the basic settings for MIX buses and MATRIX buses, such as switching between stereo and monaural, and selecting the position from which the signal is sent from an input channel.

The settings you make in the following procedure are saved as part of the scene.

### 1 In the **DISPLAY ACCESS** section, press the [SETUP] key repeatedly to access the **SYSTEM SETUP** screen.



LS9-32

- 1 **BUS SETUP** field
- 2 **MIX** button
- 3 **MATRIX** button

### 2 To make **MIX** bus settings, move the cursor to the **MIX** button of the **BUS SETUP** field and press the [ENTER] key.

The **MIX BUS SETUP** popup window will appear.



### 1 **SIGNAL TYPE (Signal processing method)**

This selects whether two adjacent odd-numbered/even-numbered MIX buses will be used as stereo channels whose main parameters are linked (STEREO) or as two monaural channels (MONO × 2).

② **BUS TYPE / PRE FADER SEND POINT**

For two adjacent odd-numbered/even-numbered buses, this selects the position from which the signal will be sent from the input channel. You can also switch the MIX bus type (VARI or FIXED) here.

③ **PAN LINK**

This specifies whether the panning at which the signal is sent from an input channel to the stereo bus will be linked with the TO ST PAN setting.

**3 Use the buttons in the SIGNAL TYPE field to specify for each two adjacent odd-numbered/even-numbered MIX buses whether they will function as STEREO (main parameters linked for the two MIX channels) or MONO × 2 (used as two monaural channels).**

**4 Use the buttons of the BUS TYPE / SEND POINT field to select the position from which the signal of the input channel will be sent.**

In this field you can switch the MIX bus type (VARI or FIXED). The following items can be selected for each bus.

● **VARI PRE EQ**

The MIX bus will be a VARI type (adjustable send level). Choose this if you want to use the MIX bus as an external effect send or as a foldback output. If the MIX send point of the input channel is set to PRE, the signal will be sent from immediately before the EQ (attenuator).

● **VARI PRE FADER**

The MIX bus will be a VARI type. Choose this if you want to use the MIX bus as an external effect send or as a foldback output. If the MIX send point of the input channel is set to PRE, the signal will be sent from immediately before the fader.

**NOTE**

• Even if you select VARI PRE EQ or VARI PRE FADER, input channels whose MIX send position is set to POST will send the post-fader signal to the MIX bus.

● **FIXED**

The MIX bus will be a FIXED type (send level is fixed at nominal level = 0.0 dB).

Choose this if you want to use the MIX bus as a group output or as a bus output for recording on a multitrack recorder. If the bus is set to MONO, the signal will be sent from immediately before the pan/balance of the input channel; if the bus is set to STEREO, the signal will be sent from immediately after the pan/balance.

**5 As desired, turn the buttons of the PAN LINK field on/off.**

For two MIX buses whose SIGNAL TYPE = STEREO and BUS TYPE = VARI, the PAN LINK button is displayed in this position.

This button specifies whether the panning at which the signal is sent from an input channel to the stereo MIX bus will be linked with the TO ST PAN setting.

● **If the PAN LINK button is on**

The PAN knob that appears in the location of the TO MIX SEND LEVEL knob of the input channel's SELECTED CH VIEW screen when the send-destination MIX bus is stereo will be linked with the TO ST PAN (BAL) knob.

● **If the PAN LINK button is off**

The PAN (BALANCE) knob displayed in the position of the TO MIX SEND LEVEL knob in the input channel SELECTED CH VIEW screen can be operated independently of the TO ST PAN (BAL) knob.

**NOTE**

• The PAN LINK button is not displayed for MIX buses whose SIGNAL TYPE is set to MONO × 2, or MIX buses whose BUS TYPE is set to FIXED.

**6 To close the popup window and return to the SYSTEM SETUP screen, move the cursor to the CLOSE button (or the × symbol in the upper right) and press the [ENTER] key.**

**7 To make basic settings for MATRIX buses, move the cursor to the MATRIX button of the BUS SETUP field and press the [ENTER] key.**

The MATRIX BUS SETUP popup window will appear.

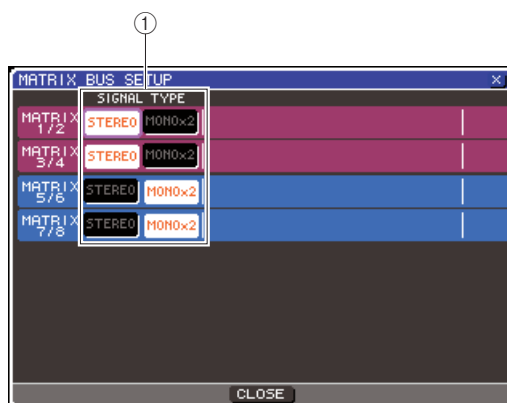

① **SIGNAL TYPE (Signal processing method)**

This selects whether two adjacent odd-numbered/even-numbered MATRIX buses will be used as stereo channels whose main parameters are linked (STEREO) or as two monaural channels (MONO × 2).

**8 Use the buttons in the SIGNAL TYPE field to specify for each two adjacent odd-numbered/even-numbered MATRIX buses whether they will function as STEREO (main parameters linked for the two MATRIX channels) or MONO × 2 (used as two monaural channels).**

**9 To close the popup window and return to the SYSTEM SETUP screen, move the cursor to the CLOSE button (or the × symbol in the upper right) and press the [ENTER] key.**

# Setting the date and time of the internal clock

This section explains how to set the date and time of the clock built into the LS9, and how to view the date and time. The date and time you specify here will affect the time stamp used when saving a scene.

- 1 In the **DISPLAY ACCESS** section, press the **[SETUP]** key to access the **MISC SETUP** screen.



LS9-32

- 1 **DATE/TIME field**  
This indicates the currently specified date and time.
- 2 **DATE/TIME SET popup button**  
This button accesses the DATE/TIME popup window, where you can set the date and time.

- 2 Move the cursor to the **DATE/TIME SET popup button** in the **DATE/TIME** field, and press the **[ENTER]** key.

The DATE/TIME popup window will appear.

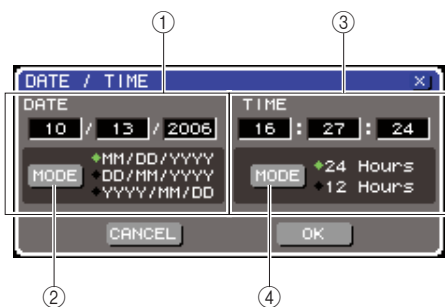

- 1 **DATE field**  
Specifies the date of the internal clock.
- 2 **DATE MODE button**  
Specifies the format in which the date will be displayed.
- 3 **TIME field**  
Specifies the time of the internal clock.
- 4 **TIME MODE button**  
Specifies the format in which the time will be displayed.

- 3 Move the cursor to the **DATE MODE** button and press the **[ENTER]** key to select the date format.

You can select from the following formats.

- MM/DD/YYYY (Month/Day/Year)
- DD/MM/YYYY (Day/Month/Year)
- YYYY/MM/DD (Year/Month/Day)

- 4 Move the cursor to each field of the **DATE** field, and use the dial or the **[DEC]/[INC]** keys to specify the date.

- 5 Move the cursor to the **TIME MODE** button and press the **[ENTER]** key to select the time format.

You can select from the following formats.

- 24Hours (hours shown in a range of 0–23)
- 12Hours (hours shown from AM 0–AM 11 and PM 0–PM 11)

- 6 Move the cursor to each field of the **TIME** field, and use the dial or the **[DEC]/[INC]** keys to specify the time.

- 7 When you have finished making settings, move the cursor to the **OK** button and press the **[ENTER]** key.

The date, time, and display format you specified will be finalized, and the popup window will close. If you select the **CANCEL** button or the **×** symbol instead of the **OK** button, your changes will be discarded and the popup window will close.

# Setting the network address

Here's how to set the network address that will be required when you use the LS9's NETWORK connector to connect it to a Windows computer.

**NOTE**

- The network address can be changed only by users who have administrative privileges.
- For details on network settings, refer to the LS9 Editor installation guide which can be downloaded from the following Yamaha website.  
<http://www.yamahaproaudio.com/>

**1** In the DISPLAY ACCESS section, press the [SETUP] key repeatedly to access the MISC SETUP screen.

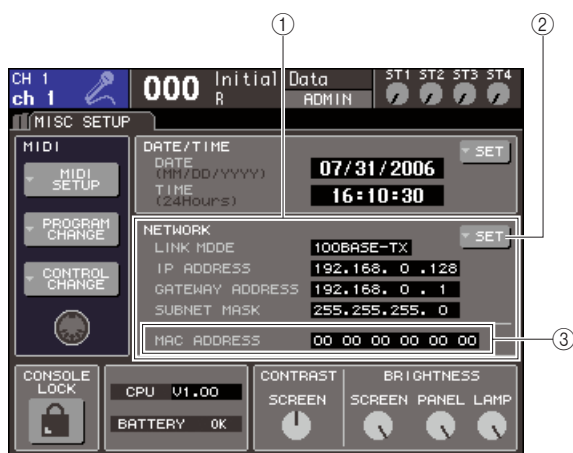

LS9-32

- 1 NETWORK field**  
This shows the values of network-related parameters.
- 2 NETWORK SET button**  
This accesses the NETWORK popup window, where you can make network-related settings.
- 3 MAC ADDRESS field**  
This is the MAC (Machine Access Control) address specified for identifying a host within a network. This field is only for display, and cannot be edited.

**2** Move the cursor to the NETWORK SET button in the NETWORK field, and press the [ENTER] key to access the NETWORK popup window.

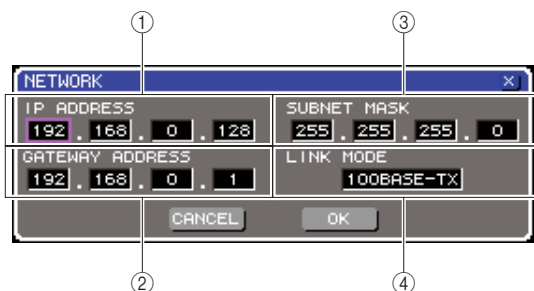

**1 IP ADDRESS field**

This is a number (IP address) assigned to identify each device on the Internet or within an LAN (Local Area Network).

**2 GATEWAY ADDRESS field**

This specifies the number (gateway address) that identifies a device (gateway) that allows data of differing media or protocol to be exchanged within a network to allow communication.

**3 SUBNET MASK field**

This defines the number of bits (of the IP address used within the network) that will be used as the network address that distinguishes the network.

**4 LINK MODE field**

Select either 100BASE-TX (transmission speed: maximum 100 Mbps) or 10BASE-T (transmission speed: max 10 Mbps) as the specification used for communication via the NETWORK connector.

**3** Move the cursor to the LINK MODE field, and use the dial or the [DEC]/[INC] keys to select a communication protocol for the NETWORK connector as appropriate for the network to which the LS9 is connected.

**NOTE**

- Be aware that if the specification does not match, communication will not occur correctly.

**4** Move the cursor to each remaining field in the screen, and use the dial or the [DEC]/[INC] keys to specify each address.

If you are connecting the LS9 to your computer in a one-to-one connection, we recommend that you make the following initial settings.

- **IP address**  
192.168.0.128 or similar (it must not conflict with the IP address of any other device on the network)
- **Gateway address**  
192.168.0.1 or similar (it must not conflict with the IP address of any other device on the network)
- **Subnet mask**  
255.255.255.0 or similar



- 5** When you have finished making settings, move the cursor to the OK button and press the [ENTER] key.

The changes will be finalized, and the popup window will close.

If you select the CANCEL button or the × symbol instead of the OK button, your changes will be discarded and the popup window will close.

## Specifying the brightness or contrast of the display, LEDs, and lamps

Here you can specify the contrast and brightness of the display, the brightness of the top panel LEDs, and the brightness of the lamp connected to the rear panel LAMP connector.

- 1** In the DISPLAY ACCESS section, press the [SETUP] key to access the MISC SETUP screen.

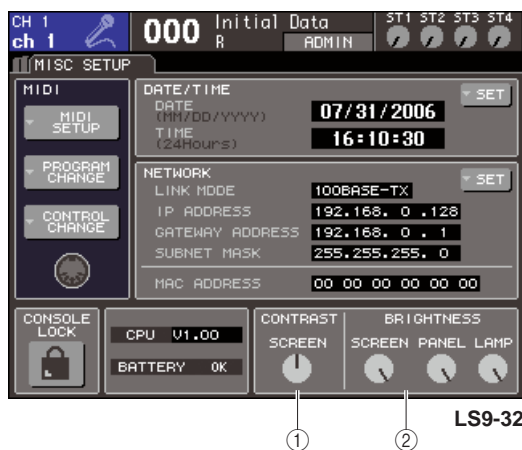

- ① CONTRAST field  
② BRIGHTNESS field

- 2** Move the cursor to a knob of the CONTRAST/BRIGHTNESS field, and use the dial or the [DEC]/[INC] keys to set the following parameters.

● **CONTRAST field**

- **SCREEN knob**

..... Specifies the contrast of the display backlight.



- You can also adjust the contrast by holding down the [HOME] key and turning the dial.

● **BRIGHTNESS field**

- **SCREEN knob**

..... Specifies the brightness of the display backlight.

- **PANEL knob**

..... Adjusts the brightness of the top panel LEDs. If a Yamaha AD8HR is connected to an I/O card that provides a REMOTE connector, the brightness of the AD8HR's LEDs will also change.

- **LAMP knob (LS9-32 only)**

..... Adjusts the brightness of the lamp connected to the rear panel LAMP jack.

## Using the Help function

You can view Help files provided by Yamaha, or display any desired text file created by the user.

\* We accept no responsibility for any damages that may result from the use of Help files created by a third party other than Yamaha.

### Loading a Help file from a USB memory

The help file is not backed up in internal memory. Each time you turn on the power, you must reload it from your USB memory. It is convenient to save your help file on the USB memory that contains your user authentication key.

- 1 Before you proceed, save the Help file (extension .xml) provided by Yamaha on your USB memory. You can download the most recent version of the Help file from the Yamaha website.

<http://www.yamahaproaudio.com/>

- 2 In the DISPLAY ACCESS section, press the [SETUP] key repeatedly to access the USER SETUP screen.



- 3 Move the cursor to the SAVE/LOAD button and press the [ENTER] key.

The SAVE/LOAD popup window will appear.



- 4 Move the cursor to the file list, and use the dial on the panel to select the help file you want to load.
- 5 Move the cursor to the LOAD button and press the [ENTER] key, and a confirmation dialog box will appear.
- 6 Move the cursor to the OK button and press the [ENTER] key to begin loading the file.

## Loading a text file from a USB memory

- 1 Using a commercially available text editor or the “Notepad” included with the Microsoft Windows series, create a text file (extension .txt) and save it on your USB memory.

By default, the character code set of the text file will be detected as UTF-8. However by adding a line consisting of [ISO-8859-1] or [Shift\_JIS] at the beginning of the file, you can force recognition of the file using that character code set. You can specify the desired character code set when using your text editor to save the text file. The Help function is able to display the following text files (character code sets / languages).

- Text files written in the ISO-8859-1 character code set (English, German, French, Spanish, etc.)
- Text files written in the Shift\_JIS character code set (Japanese)
- Text files of the above languages written in the UTF-8 character code set.

- 2 In the DISPLAY ACCESS section, press the [SETUP] key repeatedly to access the USER SETUP screen.

- 3 Move the cursor to the SAVE/LOAD button and press the [ENTER] key.

The SAVE/LOAD popup window will appear.

- 4 Move the cursor to the file list, and use the dial on the panel to select the text file you want to load.

- 5 Move the cursor to the LOAD button and press the [ENTER] key, and a confirmation dialog box will appear.

- 6 Move the cursor to the OK button and press the [ENTER] key to begin loading the file.

## Assigning the Help function to a user-defined key

- 1 Before you proceed, load the Help file from your USB memory.
- 2 In the DISPLAY ACCESS section, press the [SETUP] key repeatedly to access the USER SETUP screen.



USER DEFINED KEYS popup button

- 3 Move the cursor to the USER DEFINED KEYS popup button, and press the [ENTER] key.

The USER DEFINED KEYS popup window will appear.

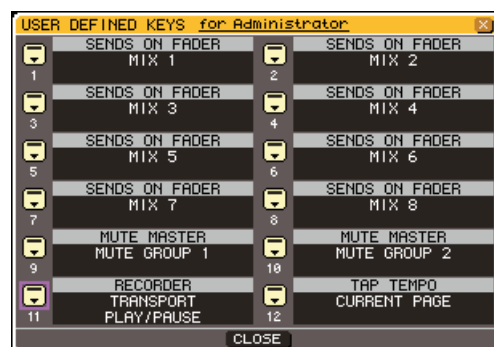

- 4 Move the cursor to the button for the user-defined key whose function you want to assign, and press the [ENTER] key.

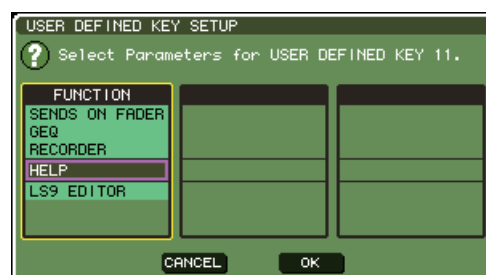

- 5 Use the panel dial or the [DEC]/[INC] keys to select "HELP." Move the cursor to the OK button and press the [ENTER] key to close the USER DEFINED KEY SETUP popup window.
- 6 Move the cursor to the CLOSE button and press the [ENTER] key to close the USER DEFINED KEY popup window.

## Viewing Help

- 1 Before you proceed, load the help file or text file from your USB memory.
- 2 Press the user-defined key to which the Help function is assigned; the HELP popup window will appear.

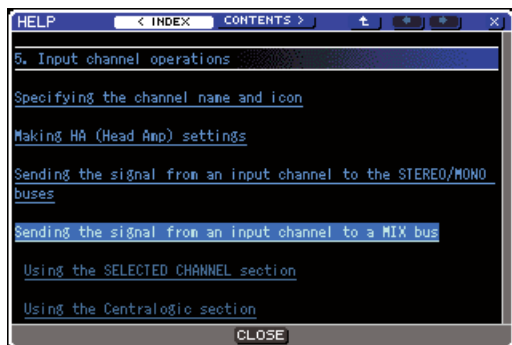

INDEX mode

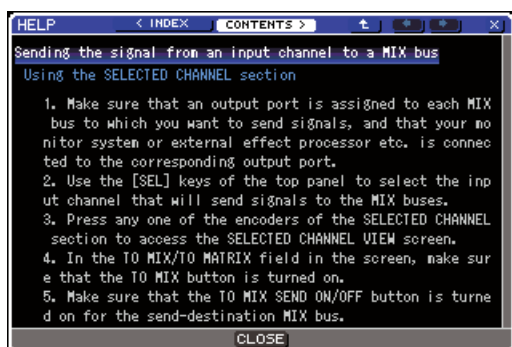

CONTENTS mode

- 3 Move the cursor to the desired section, and use the panel dial to scroll the contents. Links in the selected text will be highlighted.
- 4 Select a link (underlined portion) in the document, and press the [ENTER] key to jump to the link destination. By selecting a text link in INDEX mode and pressing the "ENTER" key, you can switch to CONTENTS mode and scroll to the corresponding section.  
Move the cursor a window link and press the [ENTER] key (a location with an → symbol and underlined text), you can close the HELP window and open the corresponding window.
- 5 To return from CONTENTS mode to INDEX mode, move the cursor to the INDEX button and press the [ENTER] key.
- 6 As necessary, you can also scroll by using the buttons in the tool bar.

- < INDEX button

Jumps to the table of contents.

If the cursor is at the table of contents, you can use the panel ► cursor key as an alternative.

- CONTENTS > button

Jumps to the content (article).

If the cursor is at the table of contents, you can use the panel ◀ cursor key as an alternative.

- ⬆ button

Scrolls to the chapter that precedes the currently-displayed location.

- ⬅ button

Returns to the previous link in the link history.

If the cursor is at the table of contents or within an article, you can use the panel [DEC] key as an alternative.

- ➔ button

Proceeds to the next link in the link history.

If the cursor is at the table of contents or within an article, you can use the panel [INC] key as an alternative.

- 7 To close the window, once again press the user-defined key to which the Help function is assigned.

## ■ Directly recalling the Help for a specific panel controller • • • • •

- 1 While holding down the user-defined key to which you've assigned the Help function, press (or turn) the panel controller whose function you want to learn about.

Panel controllers (other than the faders) will not function as long as you continue holding down the user-defined key to which the Help function is assigned.

- 2 If the corresponding controller has an explanation associated with it, the HELP popup window will appear, and you will automatically scroll to the corresponding item.

If there are multiple explanations for the same controller, you can repeat step 1 to successively display these explanations.

- 3 To close the window, once again press the user-defined key to which the Help function is assigned.

## ■ Directly recalling the Help for a specific controller in the LCD screen • • • • •

- 1 While holding down the user-defined key to which you've assigned the Help function, move the cursor to the on-screen controller whose function you want to read and press the [ENTER] key.

The on-screen buttons and tabs will not function as long as you continue holding down the user-defined key to which the Help function is assigned.

- 2 If there is a corresponding Help item, the HELP popup window will appear and you will automatically scroll to the corresponding item.

If there are multiple explanations for the same controller, close the HELP popup window and then repeat step 1 to successively view these explanations.

- 3 To close the window, once again press the user-defined key to which the Help function is assigned.

## Initializing the LS9's internal memory

If an error occurs in the LS9's internal memory, or if you have forgotten the password, you can use the following procedure to initialize the internal memory.

### **CAUTION**

- The entire contents of memory will be lost if you initialize the internal memory. Proceed with the following operation only if you are very sure you want to do this.

### 1 While holding down the [SCENE MEMORY] key of the DISPLAY ACCESS section, turn on the power.

After the opening screen, the following startup menu screen will appear.

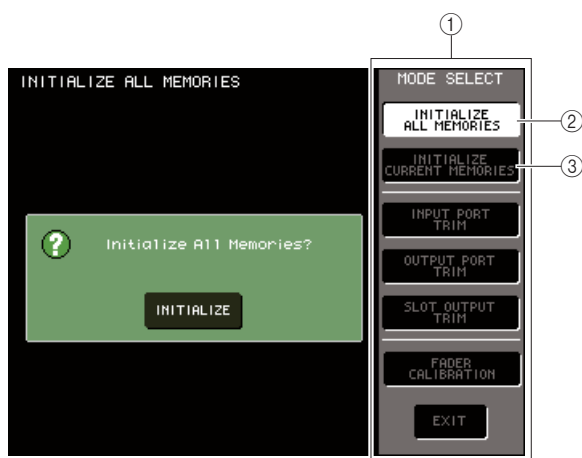

- ① MODE SELECT field
- ② INITIALIZE ALL MEMORIES button
- ③ INITIALIZE CURRENT MEMORIES button

### 2 According to the desired type of initialization, move the cursor to one of the buttons in the MODE SELECT field, and press the [ENTER] key.

#### ● INITIALIZE ALL MEMORIES button

The entire memory including scene memories and libraries will be returned to their factory-set condition.

#### ● INITIALIZE CURRENT MEMORIES button

The contents of memory except for scene memories and libraries will be returned to its factory-set condition.

### 3 To execute the Initialize operation, move the cursor to the INITIALIZE button located in the dialog box at the left side of the screen, and press the [ENTER] key.

A dialog box will ask you to confirm the operation.

### 4 Move the cursor to the OK button of the dialog box and press the [ENTER] key.

Initialization will begin.

#### NOTE

- Do not press any key until initialization has been completed.

### 5 When initialization has been completed, move the cursor to the EXIT button and press the [ENTER] key.

The console will start up in normal operating mode.

#### NOTE

- If the backup battery voltage is low, or if an error occurs in the internal memory, a warning dialog box will appear, and then the initialization menu will appear. If the warning dialog box appears, and you select the EXIT button to start up in normal operating mode, Yamaha cannot guarantee that the unit will operate correctly.

#### HINT

- Instead of using the EXIT button, you can also select a different button of the MODE SELECT field.



## Adjusting the faders (Calibration function)

Depending on the environment in which you use the console, discrepancies may occur in the motion of the motor faders. You can use the Calibration function to correct these discrepancies.

- 1 While holding down the [SCENE MEMORY] key of the DISPLAY ACCESS section, turn on the power.

After the opening screen, the following startup menu screen will appear.

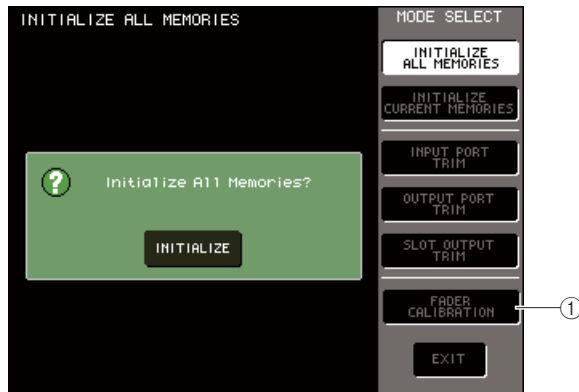

- 1 FADER CALIBRATION button

- 2 Move the cursor to the FADER CALIBRATION button and press the [ENTER] key.

The FADER CALIBRATION MODE popup window will appear, where you can adjust the faders.

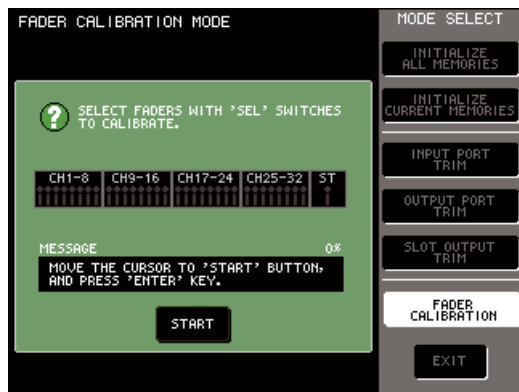

- This window will also appear if a problem is detected in the fader settings while the LS9 is started up.

- 3 Use the top panel [SEL] keys to select the fader for which you want to perform calibration.

Fader calibration is performed semi-automatically for the faders you specify using their [SEL] keys. Each fader selected by its [SEL] key is shown in red in the popup window.

- 4 Move the cursor to the START button and press the [ENTER] key.

A dialog box will ask you to confirm the operation.

- 5 Move the cursor to the OK button of the dialog box and press the [ENTER] key.

Each of the specified faders will move to the target positions in the following sequence.

- ①  $-\infty$  (push down to the minimum value)
- ② -20 dB
- ③ 0 dB
- ④ +10 dB (push up to the maximum value)

- 6 If there are any faders that are not in the positions shown in the screen, manually move them to the appropriate position.

- 7 When you have set all faders to the target location, move the cursor to the OK button and press the [ENTER] key.

The process will proceed to the next fader position.

- 8 Repeat steps 6–7 to adjust the faders for positions ① through ④.

- 9 When you have finished the calibration process and the APPLY button has appeared, move the cursor to the APPLY button and press the [ENTER] key.

The calibration settings will be saved in internal memory.



- If the RESTART button appears when calibration ends, calibration has failed. Move the cursor to the RESTART button and press the [ENTER] key to execute calibration once again.

- 10 Move the cursor to the EXIT button and press the [ENTER] key.

The console will start up in normal operating mode.



- Alternatively, you can continue by selecting a different menu instead of using the EXIT button.

## Adjusting the input/output gain (Calibration function)

If necessary, you can make fine adjustments to the input/output gain.

### 1 While holding down the [SCENE MEMORY] key of the DISPLAY ACCESS section, turn on the power.

After the opening screen, the following startup menu screen will appear.



- ① INPUT PORT TRIM button
- ② OUTPUT PORT TRIM button
- ③ SLOT OUTPUT TRIM button

### 2 In the MODE SELECT field, move the cursor to one of the following buttons to select the target you want to adjust, and press the [ENTER] key.

#### ● INPUT PORT TRIM (fine adjustment of the analog input gain) button

This makes fine adjustments in 0.1 dB steps to the gain of the specified analog input port. When you press this button, the screen will change as follows.



LS9-32

#### ● OUTPUT PORT TRIM (fine adjustment of the output ports) button

This makes fine adjustments in 0.01 dB steps to the gain of the specified output port. When you press this button, the screen will change as follows.

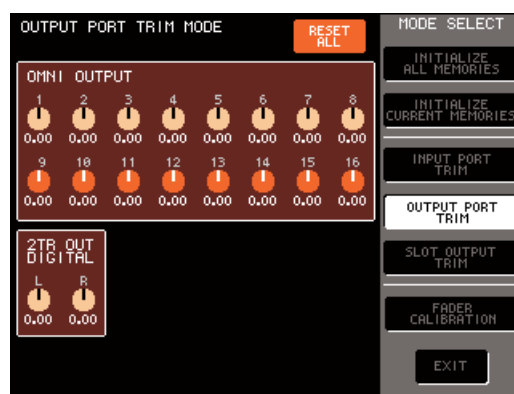

LS9-32

#### ● SLOT OUTPUT TRIM (fine adjustment of the output ports) button

This makes fine adjustments in 0.01 dB steps to the output port gain of the specified slot. When you press this button, the screen will change as follows.

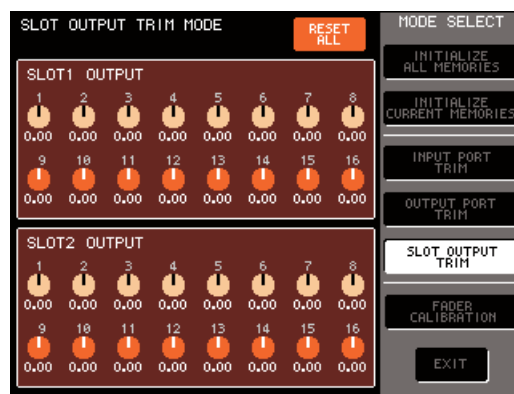

LS9-32

### 3 Move the cursor to the desired knob in the screen, and use the dial or the [DEC]/[INC] keys to adjust the value.

If you move the cursor to the RESET ALL button in the screen, and press the [ENTER] key, all knobs in that screen will be reset to 0 dB (the factory-set default value).

### 4 When you have finished making adjustments, move the cursor to the EXIT button and press the [ENTER] key.

The console will start up in normal operating mode.

#### HINT

- Alternatively, you can continue by selecting a different menu instead of using the EXIT button.

# Appendices

## EQ Library List

#	Title	Parameter				
		LOW	L-MID	H-MID	HIGH	
01	Bass Drum 1		PEAKING	PEAKING	PEAKING	H.SHELF
		G	+3.5 dB	-3.5 dB	0.0 dB	+4.0 dB
		F	100 Hz	265 Hz	1.06 kHz	5.30 kHz
		Q	1.25	10.0	0.90	—
02	Bass Drum 2		PEAKING	PEAKING	PEAKING	LPF
		G	+8.0 dB	-7.0 dB	+6.0 dB	ON
		F	80.0 Hz	400 Hz	2.50 kHz	12.5 kHz
		Q	1.4	4.5	2.2	—
03	Snare Drum 1		PEAKING	PEAKING	PEAKING	H.SHELF
		G	-0.5 dB	0.0 dB	+3.0 dB	+4.5 dB
		F	132 Hz	1.00 kHz	3.15 kHz	5.00 kHz
		Q	1.25	4.5	0.11	—
04	Snare Drum 2		L.SHELF	PEAKING	PEAKING	PEAKING
		G	+1.5 dB	-8.5 dB	+2.5 dB	+4.0 dB
		F	180 Hz	335 Hz	2.36 kHz	4.00 kHz
		Q	—	10.0	0.70	0.10
05	Tom-tom 1		PEAKING	PEAKING	PEAKING	PEAKING
		G	+2.0 dB	-7.5 dB	+2.0 dB	+1.0 dB
		F	212 Hz	670 Hz	4.50 kHz	6.30 kHz
		Q	1.4	10.0	1.25	0.28
06	Cymbal		L.SHELF	PEAKING	PEAKING	H.SHELF
		G	-2.0 dB	0.0 dB	0.0 dB	+3.0 dB
		F	106 Hz	425 Hz	1.06 kHz	13.2 kHz
		Q	—	8.0	0.90	—
07	High Hat		L.SHELF	PEAKING	PEAKING	H.SHELF
		G	-4.0 dB	-2.5 dB	+1.0 dB	+0.5 dB
		F	95.0 Hz	425 Hz	2.80 kHz	7.50 kHz
		Q	—	0.50	1.0	—
08	Percussion		L.SHELF	PEAKING	PEAKING	H.SHELF
		G	-4.5 dB	0.0 dB	+2.0 dB	0.0 dB
		F	100 Hz	400 Hz	2.80 kHz	17.0 kHz
		Q	—	4.5	0.56	—
09	E. Bass 1		L.SHELF	PEAKING	PEAKING	H.SHELF
		G	-7.5 dB	+4.5 dB	+2.5 dB	0.0 dB
		F	35.5 Hz	112 Hz	2.00 kHz	4.00 kHz
		Q	—	5.0	4.5	—
10	E. Bass 2		PEAKING	PEAKING	PEAKING	H.SHELF
		G	+3.0 dB	0.0 dB	+2.5 dB	+0.5 dB
		F	112 Hz	112 Hz	2.24 kHz	4.00 kHz
		Q	0.10	5.0	6.3	—
11	Syn. Bass 1		PEAKING	PEAKING	PEAKING	H.SHELF
		G	+3.5 dB	+8.5 dB	0.0 dB	0.0 dB
		F	85.0 Hz	950 Hz	4.00 kHz	12.5 kHz
		Q	0.10	8.0	4.5	—
12	Syn. Bass 2		PEAKING	PEAKING	PEAKING	H.SHELF
		G	+2.5 dB	0.0 dB	+1.5 dB	0.0 dB
		F	125 Hz	180 Hz	1.12 kHz	12.5 kHz
		Q	1.6	8.0	2.2	—
13	Piano 1		L.SHELF	PEAKING	PEAKING	H.SHELF
		G	-6.0 dB	0.0 dB	+2.0 dB	+4.0 dB
		F	95.0 Hz	950 Hz	3.15 kHz	7.50 kHz
		Q	—	8.0	0.90	—

#	Title	Parameter				
		LOW	L-MID	H-MID	HIGH	
14	Piano 2		PEAKING	PEAKING	PEAKING	H.SHELF
		G	+3.5 dB	-8.5 dB	+1.5 dB	+3.0 dB
		F	224 Hz	600 Hz	3.15 kHz	5.30 kHz
		Q	5.6	10.0	0.70	—
15	E. G. Clean		PEAKING	PEAKING	PEAKING	H.SHELF
		G	+2.0 dB	-5.5 dB	+0.5 dB	+2.5 dB
		F	265 Hz	400 Hz	1.32 kHz	4.50 kHz
		Q	0.18	10.0	6.3	—
16	E. G. Crunch 1		PEAKING	PEAKING	PEAKING	PEAKING
		G	+4.5 dB	0.0 dB	+4.0 dB	+2.0 dB
		F	140 Hz	1.00 kHz	1.90 kHz	5.60 kHz
		Q	8.0	4.5	0.63	9.0
17	E. G. Crunch 2		PEAKING	PEAKING	PEAKING	H.SHELF
		G	+2.5 dB	+1.5 dB	+2.5 dB	0.0 dB
		F	125 Hz	450 Hz	3.35 kHz	19.0 kHz
		Q	8.0	0.40	0.16	—
18	E. G. Dist. 1		L.SHELF	PEAKING	PEAKING	H.SHELF
		G	+5.0 dB	0.0 dB	+3.5 dB	0.0 dB
		F	355 Hz	950 Hz	3.35 kHz	12.5 kHz
		Q	—	9.0	10.0	—
19	E. G. Dist. 2		L.SHELF	PEAKING	PEAKING	H.SHELF
		G	+6.0 dB	-8.5 dB	+4.5 dB	+4.0 dB
		F	315 Hz	1.06 kHz	4.25 kHz	12.5 kHz
		Q	—	10.0	4.0	—
20	A. G. Stroke 1		PEAKING	PEAKING	PEAKING	H.SHELF
		G	-2.0 dB	0.0 dB	+1.0 dB	+4.0 dB
		F	106 Hz	1.00 kHz	1.90 kHz	5.30 kHz
		Q	0.90	4.5	3.5	—
21	A. G. Stroke 2		L.SHELF	PEAKING	PEAKING	H.SHELF
		G	-3.5 dB	-2.0 dB	0.0 dB	+2.0 dB
		F	300 Hz	750 Hz	2.00 kHz	3.55 kHz
		Q	—	9.0	4.5	—
22	A. G. Arpeg. 1		L.SHELF	PEAKING	PEAKING	PEAKING
		G	-0.5 dB	0.0 dB	0.0 dB	+2.0 dB
		F	224 Hz	1.00 kHz	4.00 kHz	6.70 kHz
		Q	—	4.5	4.5	0.125
23	A. G. Arpeg. 2		L.SHELF	PEAKING	PEAKING	H.SHELF
		G	0.0 dB	-5.5 dB	0.0 dB	+4.0 dB
		F	180 Hz	355 Hz	4.00 kHz	4.25 kHz
		Q	—	7.0	4.5	—
24	Brass Sec.		PEAKING	PEAKING	PEAKING	PEAKING
		G	-2.0 dB	-1.0 dB	+1.5 dB	+3.0 dB
		F	90.0 Hz	850 Hz	2.12 kHz	4.50 kHz
		Q	2.8	2.0	0.70	7.0
25	Male Vocal 1		PEAKING	PEAKING	PEAKING	PEAKING
		G	-0.5 dB	0.0 dB	+2.0 dB	+3.5 dB
		F	190 Hz	1.00 kHz	2.00 kHz	6.70 kHz
		Q	0.11	4.5	0.56	0.11
26	Male Vocal 2		PEAKING	PEAKING	PEAKING	H.SHELF
		G	+2.0 dB	-5.0 dB	-2.5 dB	+4.0 dB
		F	170 Hz	236 Hz	2.65 kHz	6.70 kHz
		Q	0.11	10.0	5.6	—

#	Title	Parameter				
		LOW	L-MID	H-MID	HIGH	
27	Female Vo. 1		PEAKING	PEAKING	PEAKING	PEAKING
		G	-1.0 dB	+1.0 dB	+1.5 dB	+2.0 dB
		F	118 Hz	400 Hz	2.65 kHz	6.00 kHz
		Q	0.18	0.45	0.56	0.14
28	Female Vo. 2		L.SHELF	PEAKING	PEAKING	H.SHELF
		G	-7.0 dB	+1.5 dB	+1.5 dB	+2.5 dB
		F	112 Hz	335 Hz	2.00 kHz	6.70 kHz
		Q	—	0.16	0.20	—
29	Chorus & Harmo		PEAKING	PEAKING	PEAKING	PEAKING
		G	-2.0 dB	-1.0 dB	+1.5 dB	+3.0 dB
		F	90.0 Hz	850 Hz	2.12 kHz	4.50 kHz
		Q	2.8	2.0	0.70	7.0
30	Total EQ 1		PEAKING	PEAKING	PEAKING	H.SHELF
		G	-0.5 dB	0.0 dB	+3.0 dB	+6.5 dB
		F	95.0 Hz	950 Hz	2.12 kHz	16.0 kHz
		Q	7.0	2.2	5.6	—
31	Total EQ 2		PEAKING	PEAKING	PEAKING	H.SHELF
		G	+4.0 dB	+1.5 dB	+2.0 dB	+6.0 dB
		F	95.0 Hz	750 Hz	1.80 kHz	18.0 kHz
		Q	7.0	2.8	5.6	—
32	Total EQ 3		L.SHELF	PEAKING	PEAKING	H.SHELF
		G	+1.5 dB	+0.5 dB	+2.0 dB	+4.0 dB
		F	67.0 Hz	850 Hz	1.90 kHz	15.0 kHz
		Q	—	0.28	0.70	—
33	Bass Drum 3		PEAKING	PEAKING	PEAKING	PEAKING
		G	+3.5 dB	-10.0 dB	+3.5 dB	0.0 dB
		F	118 Hz	315 Hz	4.25 kHz	20.0 kHz
		Q	2.0	10.0	0.40	0.40
34	Snare Drum 3		L.SHELF	PEAKING	PEAKING	PEAKING
		G	0.0 dB	+2.0 dB	+3.5 dB	0.0 dB
		F	224 Hz	560 Hz	4.25 kHz	4.00 kHz
		Q	—	4.5	2.8	0.10
35	Tom-tom 2		L.SHELF	PEAKING	PEAKING	H.SHELF
		G	-9.0 dB	+1.5 dB	+2.0 dB	0.0 dB
		F	90.0 Hz	212 Hz	5.30 kHz	17.0 kHz
		Q	—	4.5	1.25	—
36	Piano 3		PEAKING	PEAKING	PEAKING	H.SHELF
		G	+4.5 dB	-13.0 dB	+4.5 dB	+2.5 dB
		F	100 Hz	475 Hz	2.36 kHz	10.0 kHz
		Q	8.0	10.0	9.0	—
37	Piano Low		PEAKING	PEAKING	PEAKING	H.SHELF
		G	-5.5 dB	+1.5 dB	+6.0 dB	0.0 dB
		F	190 Hz	400 Hz	6.70 kHz	12.5 kHz
		Q	10.0	6.3	2.2	—
38	Piano High		PEAKING	PEAKING	PEAKING	PEAKING
		G	-5.5 dB	+1.5 dB	+5.0 dB	+3.0 dB
		F	190 Hz	400 Hz	6.70 kHz	5.60 kHz
		Q	10.0	6.3	2.2	0.10
39	Fine-EQ Cass		L.SHELF	PEAKING	PEAKING	H.SHELF
		G	-1.5 dB	0.0 dB	+1.0 dB	+3.0 dB
		F	75.0 Hz	1.00 kHz	4.00 kHz	12.5 kHz
		Q	—	4.5	1.8	—
40	Narrator		PEAKING	PEAKING	PEAKING	H.SHELF
		G	-4.0 dB	-1.0 dB	+2.0 dB	0.0 dB
		F	106 Hz	710 Hz	2.50 kHz	10.0 kHz
		Q	4.0	7.0	0.63	—

## DYNAMICS Library List

#	Title	Type	Parameter	Value
1	Gate	GATE	Threshold (dB)	-26
			Range (dB)	-56
			Attack (ms)	0
			Hold (ms)	2.56
			Decay (ms)	331
2	Ducking	DUCKING	Threshold (dB)	-19
			Range (dB)	-22
			Attack (ms)	93
			Hold (ms)	1.20 S
			Decay (ms)	6.32 S
3	A. Dr. BD	GATE	Threshold (dB)	-11
			Range (dB)	-53
			Attack (ms)	0
			Hold (ms)	1.93
			Decay (ms)	400
4	A. Dr. SN	GATE	Threshold (dB)	-8
			Range (dB)	-23
			Attack (ms)	1
			Hold (ms)	0.63
			Decay (ms)	238
5	De-Esser	DE-ESSER	Threshold (dB)	-8
			Frequency (kHz)	2.00
6	Comp	COMPRESSOR	Threshold (dB)	-8
			Ratio ( :1)	2.5
			Attack (ms)	30
			Out gain (dB)	0.0
			Release (ms)	250
7	Expand	EXPANDER	Threshold (dB)	-23
			Ratio ( :1)	1.7
			Attack (ms)	1
			Out gain (dB)	3.5
			Release (ms)	70
8	Compander (H)	COMPANDER-H	Threshold (dB)	-10
			Ratio ( :1)	3.5
			Attack (ms)	1
			Out gain (dB)	0.0
			Release (ms)	250
9	Compander (S)	COMPANDER-S	Threshold (dB)	-8
			Ratio ( :1)	4
			Attack (ms)	25
			Out gain (dB)	0.0
			Release (ms)	180
10	A. Dr. BD	COMPRESSOR	Threshold (dB)	-24
			Ratio ( :1)	3
			Attack (ms)	9
			Out gain (dB)	5.5
			Release (ms)	58
11	A. Dr. BD	COMPANDER-H	Threshold (dB)	-11
			Ratio ( :1)	3.5
			Attack (ms)	1
			Out gain (dB)	-1.5
			Release (ms)	192

#	Title	Type	Parameter	Value
12	A. Dr. SN	COMPRESSOR	Threshold (dB)	-17
			Ratio ( :1)	2.5
			Attack (ms)	8
			Out gain (dB)	3.5
			Release (ms)	12
13	A. Dr. SN	EXPANDER	Threshold (dB)	-23
			Ratio ( :1)	2
			Attack (ms)	0
			Out gain (dB)	0.5
			Release (ms)	151
14	A. Dr. SN	COMPANDER-S	Threshold (dB)	-8
			Ratio ( :1)	1.7
			Attack (ms)	11
			Out gain (dB)	0.0
			Release (ms)	128
15	A. Dr. Tom	EXPANDER	Threshold (dB)	-20
			Ratio ( :1)	2
			Attack (ms)	2
			Out gain (dB)	5.0
			Release (ms)	749
16	A. Dr. OverTop	COMPANDER-S	Threshold (dB)	-24
			Ratio ( :1)	2
			Attack (ms)	38
			Out gain (dB)	-3.5
			Release (ms)	842
17	E. B. Finger	COMPRESSOR	Threshold (dB)	-12
			Ratio ( :1)	2
			Attack (ms)	15
			Out gain (dB)	4.5
			Release (ms)	470
18	E. B. Slap	COMPRESSOR	Threshold (dB)	-12
			Ratio ( :1)	1.7
			Attack (ms)	6
			Out gain (dB)	4.0
			Release (ms)	133
19	Syn. Bass	COMPRESSOR	Threshold (dB)	-10
			Ratio ( :1)	3.5
			Attack (ms)	9
			Out gain (dB)	3.0
			Release (ms)	250
20	Piano1	COMPRESSOR	Threshold (dB)	-9
			Ratio ( :1)	2.5
			Attack (ms)	17
			Out gain (dB)	1.0
			Release (ms)	238
21	Piano2	COMPRESSOR	Threshold (dB)	-18
			Ratio ( :1)	3.5
			Attack (ms)	7
			Out gain (dB)	6.0
			Release (ms)	174

#	Title	Type	Parameter	Value
22	E. Guitar	COMPRESSOR	Threshold (dB)	-8
			Ratio ( :1)	3.5
			Attack (ms)	7
			Out gain (dB)	2.5
			Knee	4
			Release (ms)	261
23	A. Guitar	COMPRESSOR	Threshold (dB)	-10
			Ratio ( :1)	2.5
			Attack (ms)	5
			Out gain (dB)	1.5
			Knee	2
			Release (ms)	238
24	Strings1	COMPRESSOR	Threshold (dB)	-11
			Ratio ( :1)	2
			Attack (ms)	33
			Out gain (dB)	1.5
			Knee	2
			Release (ms)	749
25	Strings2	COMPRESSOR	Threshold (dB)	-12
			Ratio ( :1)	1.5
			Attack (ms)	93
			Out gain (dB)	1.5
			Knee	4
			Release (ms)	1.35 S
26	Strings3	COMPRESSOR	Threshold (dB)	-17
			Ratio ( :1)	1.5
			Attack (ms)	76
			Out gain (dB)	2.5
			Knee	2
			Release (ms)	186
27	BrassSection	COMPRESSOR	Threshold (dB)	-18
			Ratio ( :1)	1.7
			Attack (ms)	18
			Out gain (dB)	4.0
			Knee	1
			Release (ms)	226
28	Syn. Pad	COMPRESSOR	Threshold (dB)	-13
			Ratio ( :1)	2
			Attack (ms)	58
			Out gain (dB)	2.0
			Knee	1
			Release (ms)	238
29	SamplingPerc	COMPANDER-S	Threshold (dB)	-18
			Ratio ( :1)	1.7
			Attack (ms)	8
			Out gain (dB)	-2.5
			Width (dB)	18
			Release (ms)	238
30	Sampling BD	COMPRESSOR	Threshold (dB)	-14
			Ratio ( :1)	2
			Attack (ms)	2
			Out gain (dB)	3.5
			Knee	4
			Release (ms)	35
31	Sampling SN	COMPRESSOR	Threshold (dB)	-18
			Ratio ( :1)	4
			Attack (ms)	8
			Out gain (dB)	8.0
			Knee	hard
			Release (ms)	354

#	Title	Type	Parameter	Value
32	Hip Comp	COMPANDER-S	Threshold (dB)	-23
			Ratio ( :1)	20
			Attack (ms)	15
			Out gain (dB)	0.0
			Width (dB)	15
			Release (ms)	163
33	Solo Vocal1	COMPRESSOR	Threshold (dB)	-20
			Ratio ( :1)	2.5
			Attack (ms)	31
			Out gain (dB)	2.0
			Knee	1
			Release (ms)	342
34	Solo Vocal2	COMPRESSOR	Threshold (dB)	-8
			Ratio ( :1)	2.5
			Attack (ms)	26
			Out gain (dB)	1.5
			Knee	3
			Release (ms)	331
35	Chorus	COMPRESSOR	Threshold (dB)	-9
			Ratio ( :1)	1.7
			Attack (ms)	39
			Out gain (dB)	2.5
			Knee	2
			Release (ms)	226
36	Click Erase	EXPANDER	Threshold (dB)	-33
			Ratio ( :1)	2
			Attack (ms)	1
			Out gain (dB)	2.0
			Knee	2
			Release (ms)	284
37	Announcer	COMPANDER-H	Threshold (dB)	-14
			Ratio ( :1)	2.5
			Attack (ms)	1
			Out gain (dB)	-2.5
			Width (dB)	18
			Release (ms)	180
38	Limiter1	COMPANDER-S	Threshold (dB)	-9
			Ratio ( :1)	3
			Attack (ms)	20
			Out gain (dB)	-3.0
			Width (dB)	90
			Release (ms)	3.91 s
39	Limiter2	COMPRESSOR	Threshold (dB)	0
			Ratio ( :1)	∞
			Attack (ms)	0
			Out gain (dB)	0.0
			Knee	hard
			Release (ms)	319
40	Total Comp1	COMPRESSOR	Threshold (dB)	-18
			Ratio ( :1)	3.5
			Attack (ms)	94
			Out gain (dB)	2.5
			Knee	hard
			Release (ms)	447
41	Total Comp2	COMPRESSOR	Threshold (dB)	-16
			Ratio ( :1)	6
			Attack (ms)	11
			Out gain (dB)	6.0
			Knee	1
			Release (ms)	180

\* At fs=44.1 kHz



## Dynamics Parameters

Input channels provide DYNAMICS section 1 and DYNAMICS section 2. Output channels provide DYNAMICS section 1. An input channel's DYNAMICS section 1 provides the following four types: GATE, DUCKING, COMPRESSOR, and EXPANDER. An input channel's DYNAMICS section 2 provides the following four types: COMPRESSOR, COMPANDER-H (Compander Hard), COMPANDER-S (Compander Soft), and DE-ESSER. An output channel's DYNAMICS section 1 provides the following four types: COMPRESSOR, EXPANDER, COMPANDER-H (Compander Hard), and COMPANDER-S (Compander Soft).

### ■ GATE .....

A gate attenuates signals below a set THRESHOLD level by a specified amount (RANGE).

Parameter	Range	Description
THRESHOLD (dB)	-54 to 0 (55 points)	This determines the level at which the gate effect is applied.
RANGE (dB)	$-\infty$ , -69 to 0 (71 points)	This determines the amount of attenuation when the gate closes.
ATTACK (ms)	0-120 (121 points)	This determines how fast the gate opens when the signal exceeds the threshold level.
HOLD (ms)	44.1kHz: 0.02 ms – 2.13 sec 48kHz: 0.02 ms – 1.96 sec (160 points)	This determines how long the gate stays open once the trigger signal has fallen below the threshold.
DECAY (ms)	44.1kHz: 6 ms – 46.0 sec 48kHz: 5 ms – 42.3 sec (160 points)	This determines how fast the gate closes once the hold time has expired. The value is expressed as the duration required for the level to change by 6 dB.

• I/O Characteristics

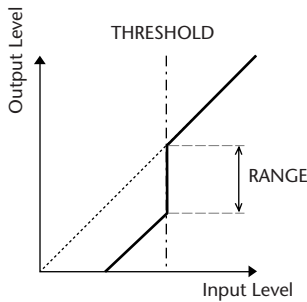

• Time Series Analysis

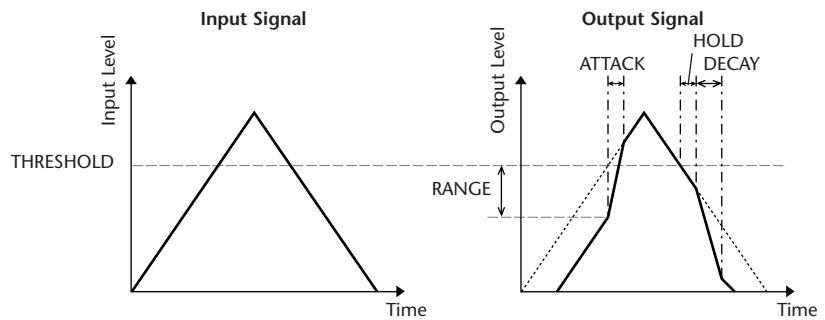

### ■ DUCKING .....

Ducking is commonly used for voice-over applications in which the background music level is reduced automatically when an announcer speaks. When the KEY IN source signal level exceeds the specified THRESHOLD, the output level is attenuated by a specified amount (RANGE).

Parameter	Range	Description
THRESHOLD (dB)	-54 to 0 (55 points)	This determines the level of trigger signal (KEY IN) required to activate ducking.
RANGE (dB)	-70 to 0 (71 points)	This determines the amount of attenuation when ducking is activated.
ATTACK (ms)	0-120 (121 points)	This determines how soon the signal is ducked once the ducker has been triggered.
HOLD (ms)	44.1kHz: 0.02 ms – 2.13 sec 48kHz: 0.02 ms – 1.96 sec (160 points)	This determines how long ducking remains active once the trigger signal has fallen below the THRESHOLD level.
DECAY (ms)	44.1kHz: 6 ms – 46.0 sec 48kHz: 5 ms – 42.3 sec (160 points)	This determines how soon the ducker returns to its normal gain once the trigger signal level drops below the threshold. The value is expressed as the duration required for the level to change by 6 dB.

• I/O Characteristics

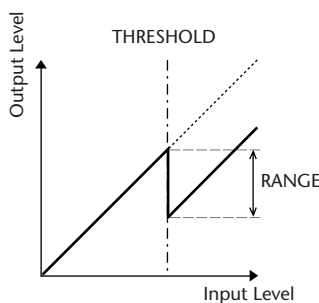

• Time Series Analysis

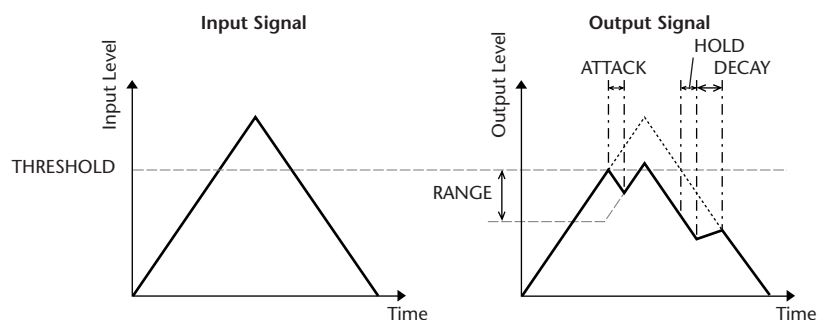

## ■ COMPRESSOR .....

The COMP processor attenuates signals above a specified THRESHOLD by a specified RATIO. The COMP processor can also be used as a limiter, which, with a RATIO of  $\infty:1$ , reduces the level to the threshold. This means that the limiter's output level never actually exceeds the threshold.

Parameter	Range	Description
THRESHOLD (dB)	-54 to 0 (55 points)	This determines the level of input signal required to trigger the compressor.
RATIO	1.0:1, 1.1:1, 1.3:1, 1.5:1, 1.7:1, 2.0:1, 2.5:1, 3.0:1, 3.5:1, 4.0:1, 5.0:1, 6.0:1, 8.0:1, 10:1, 20:1, $\infty:1$ (16 points)	This determines the amount of compression, that is, the change in output signal level relative to change in input signal level.
ATTACK (ms)	0-120 (121 points)	This determines how soon the signal will be compressed once the compressor has been triggered.
RELEASE (ms)	44.1kHz: 6 ms - 46.0 sec 48kHz: 5 ms - 42.3 sec (160 points)	This determines how soon the compressor returns to its normal gain once the trigger signal level drops below the threshold. The value is expressed as the duration required for the level to change by 6 dB.
OUT GAIN (dB)	0.0 to +18.0 (181 points)	This sets the compressor's output signal level.
KNEE	Hard, 1-5 (6 points)	This determines how compression is applied at the threshold. For higher knee settings, compression is applied gradually as the signal exceeds the specified threshold, creating a more natural sound.

- I/O Characteristics (KNEE= hard, OUT GAIN=0.0dB)

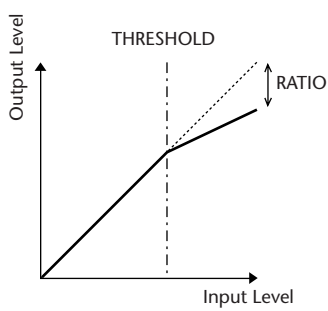

- Time Series Analysis (RATIO=  $\infty:1$ )

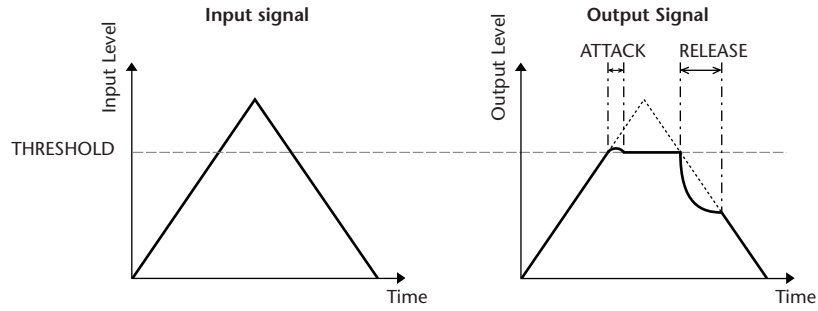

## ■ EXPANDER .....

An expander attenuates signals below a specified THRESHOLD by a specified RATIO.

Parameter	Range	Description
THRESHOLD (dB)	-54 to 0 (55 points)	This determines the level of input signal required to trigger the expander.
RATIO	1.0:1, 1.1:1, 1.3:1, 1.5:1, 1.7:1, 2.0:1, 2.5:1, 3.0:1, 3.5:1, 4.0:1, 5.0:1, 6.0:1, 8.0:1, 10:1, 20:1, $\infty:1$ (16 points)	This determines the amount of expansion.
ATTACK (ms)	0-120 (121 points)	This determines how soon the expander returns to its normal gain once the trigger signal level exceeds the threshold.
RELEASE (ms)	44.1kHz: 6 ms - 46.0 sec 48kHz: 5 ms - 42.3 sec (160 points)	This determines how soon the signal is expanded once the signal level drops below the threshold. The value is expressed as the duration required for the level to change by 6 dB.
OUT GAIN (dB)	0.0 to +18.0 (181 points)	This sets the expander's output signal level.
KNEE	Hard, 1-5 (6 points)	This determines how expansion is applied at the threshold. For higher knee settings, expansion is applied gradually as the signal falls below the specified threshold, creating a more natural sound.

- I/O Characteristics (KNEE= hard, OUT GAIN= 0.0dB)

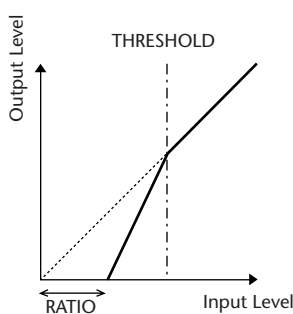

- Time Series Analysis (RATIO=  $\infty:1$ )

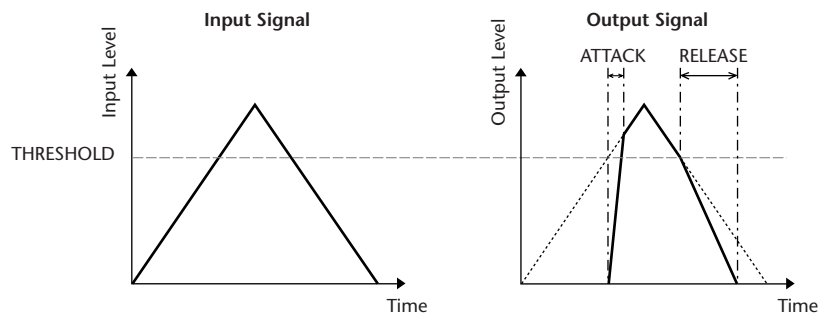

■ **COMPANDER HARD (COMPANDER-H), COMPANDER SOFT (COMPANDER-S)** .....

The hard and soft companders combine the effects of the compressor, expander and limiter.

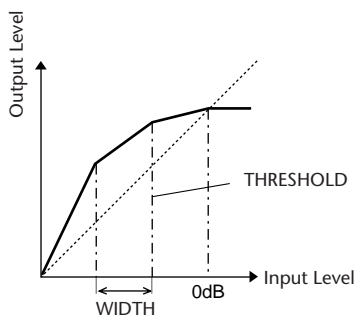

The companders function differently at the following levels:

- ① **0 dB and higher** ..... Functions as a limiter.
- ② **Exceeding the threshold** ..... Functions as a compressor.
- ③ **Below the threshold and width** .... Functions as an expander.

The hard compander has an expansion ratio of 5:1, while the soft compander has an expansion ratio of 1.5:1. The expander is essentially turned off when the width is set to maximum. The compressor has a fixed knee setting of 2.

\* The gain is automatically adjusted according to the ratio and threshold values, and can be increased by up to 18 dB.

\* The OUT GAIN parameter enables you to compensate for the overall level change caused by the compression and expansion processes.

Parameter	Range	Description
<b>THRESHOLD (dB)</b>	-54 to 0 (55 points)	This determines the level at which compression is applied.
<b>RATIO</b>	1.0:1, 1.1:1, 1.3:1, 1.5:1, 1.7:1, 2.0:1, 2.5:1, 3.0:1, 3.5:1, 4.0:1, 5.0:1, 6.0:1, 8.0:1, 10:1, 20:1 (15 points)	This determines the amount of compression.
<b>ATTACK (ms)</b>	0-120 (121 points)	This determines how soon the signal is compressed or expanded once the compander has been triggered.
<b>RELEASE (ms)</b>	44.1kHz: 6 ms – 46.0 sec 48kHz: 5 ms – 42.3 sec (160 points)	This determines how soon the compressor or expander returns to the normal gain once the trigger signal level drops below or exceeds the threshold respectively. The value is expressed as the duration required for the level to change by 6 dB.
<b>OUT GAIN (dB)</b>	-18.0 to 0.0 (181 points)	This sets the compander's output signal level.
<b>WIDTH (dB)</b>	1-90 (90 points)	This determines how far below the threshold expansion will be applied. The expander is activated when the level drops below the threshold and width.

■ **DE-ESSER** .....

This detects and compresses only the sibilants and other high-frequency consonants of the vocal.

Parameter	Range	Description
<b>THRESHOLD</b>	-54 to 0 (55 points)	Threshold level at which the de-esser effect applies.
<b>FREQUENCY</b>	1kHz – 12.5kHz (45 points)	Cutoff frequency of the HPF used to detect the high frequencies.

## Effect Type List

Title	Type	Description
Reverb Hall	REVERB HALL	Concert hall reverberation simulation with gate
Reverb Room	REVERB ROOM	Room reverberation simulation with gate
Reverb Stage	REVERB STAGE	Reverb designed for vocals, with gate
Reverb Plate	REVERB PLATE	Plate reverb simulation with gate
Early Ref.	EARLY REF.	Early reflections without the subsequent reverb
Gate Reverb	GATE REVERB	Gated early reflections
Reverse Gate	REVERSE GATE	Gated reverse early reflections
Mono Delay	MONO DELAY	Simple mono delay
Stereo Delay	STEREO DELAY	Simple stereo delay
Mod.Delay	MOD.DELAY	Simple repeat delay with modulation
Delay LCR	DELAY LCR	3-tap (left, center, right) delay
Echo	ECHO	Stereo delay with crossed left/right feedback
Chorus	CHORUS	Chorus
Flange	FLANGE	Flanger
Symphonic	SYMPHONIC	Proprietary Yamaha effect that produces a richer and more complex modulation than normal chorus
Phaser	PHASER	16-stage stereo phase shifter
Auto Pan	AUTO PAN	Auto-panner
Tremolo	TREMOLO	Tremolo
HQ. Pitch	HQ.PITCH	Mono pitch shifter, producing stable results
Dual Pitch	DUAL PITCH	Stereo pitch shifter
Rotary	ROTARY	Rotary speaker simulation
Ring Mod.	RING MOD.	Ring modulator
Mod.Filter	MOD.FILTER	Modulated filter
Distortion	DISTORTION	Distortion
Amp Simulate	AMP SIMULATE	Guitar amp simulation
Dyna.Filter	DYNA.FILTER	Dynamically controlled filter
Dyna.Flange	DYNA.FLANGE	Dynamically controlled flanger
Dyna.Phaser	DYNA.PHASER	Dynamically controlled phase shifter
Rev+Chorus	REV+CHORUS	Reverb and chorus in parallel

Title	Type	Description
Rev→Chorus	REV→CHORUS	Reverb and chorus in series
Rev+Flange	REV+FLANGE	Reverb and flanger in parallel
Rev→Flange	REV→FLANGE	Reverb and flanger in series
Rev+Sympho.	REV+SYMPHO.	Reverb and symphonic in parallel
Rev→Sympho.	REV→SYMPHO.	Reverb and symphonic in series
Rev→Pan	REV→PAN	Reverb and auto-pan in series
Delay+Er.	DELAY+ER.	Delay and early reflections in parallel
Delay→Er.	DELAY→ER.	Delay and early reflections in series
Delay+Rev	DELAY+REV	Delay and reverb in parallel
Delay→Rev	DELAY→REV	Delay and reverb in series
Dist→Delay	DIST→DELAY	Distortion and delay in series
Multi Filter	MULTI FILTER	3-band parallel filter (24 dB/octave)
Freeze	FREEZE	Simple sampler
Stereo Reverb	ST REVERB	Stereo reverb
M.Band Dyna.	M.BAND DYNA.	Multi-band dynamics processor
M.Band Comp	M.BAND COMP	Multi-band compressor
REV-X Hall	REV-X HALL	New reverb algorithm that delivers dense and rich reverberation, smooth decay, and provides a spaciousness and depth that enhances the original sound. Choose from three types depending on your location and needs; REV-X HALL, REV-X ROOM, and REV-X PLATE.
REV-X Room	REV-X ROOM	
REV-X Plate	REV-X PLATE	

## Effects Parameters

### ■ REVERB HALL, REVERB ROOM, REVERB STAGE, REVERB PLATE

One input, two output hall, room, stage, and plate reverb simulations, all with gates.

Parameter	Range	Description
REV TIME	0.3–99.0 s	Reverb time
INI. DLY	0.0–500.0 ms	Initial delay before reverb begins
HI. RATIO	0.1–1.0	High-frequency reverb time ratio
LO. RATIO	0.1–2.4	Low-frequency reverb time ratio
DIFF.	0–10	Reverb diffusion (left–right reverb spread)
DENSITY	0–100%	Reverb density
E/R DLY	0.0–100.0 ms	Delay between early reflections and reverb
E/R BAL.	0–100%	Balance of early reflections and reverb (0% = all reverb, 100% = all early reflections)
HPF	THRU, 21.2 Hz–8.00 kHz	High-pass filter cutoff frequency
LPF	50.0 Hz–16.0 kHz, THRU	Low-pass filter cutoff frequency
GATE LVL	OFF, –60 to 0 dB	Level at which gate kicks in
ATTACK	0–120 ms	Gate opening speed
HOLD	*1	Gate open time
DECAY	*2	Gate closing speed

\*1. 0.02 ms–2.13 s (fs=44.1 kHz), 0.02 ms–1.96 s (fs=48 kHz)

\*2. 6.0 ms–46.0 s (fs=44.1 kHz), 5.0 ms–42.3 s (fs=48 kHz)

### ■ EARLY REF.

One input, two output early reflections.

Parameter	Range	Description
TYPE	S-Hall, L-Hall, Random, Revers, Plate, Spring	Type of early reflection simulation
ROOMSIZE	0.1–20.0	Reflection spacing
LIVENESS	0–10	Early reflections decay characteristics (0 = dead, 10 = live)
INI. DLY	0.0–500.0 ms	Initial delay before reverb begins
DIFF.	0–10	Reflection diffusion (left–right reflection spread)
DENSITY	0–100%	Reflection density
ER NUM.	1–19	Number of early reflections
FB GAIN	–99 to +99%	Feedback gain
HI. RATIO	0.1–1.0	High-frequency feedback ratio
HPF	THRU, 21.2 Hz–8.00 kHz	High-pass filter cutoff frequency
LPF	50.0 Hz–16.0 kHz, THRU	Low-pass filter cutoff frequency

### ■ GATE REVERB, REVERSE GATE

One input, two output early reflections with gate, and early reflections with reverse gate.

Parameter	Range	Description
TYPE	Type-A, Type-B	Type of early reflection simulation
ROOMSIZE	0.1–20.0	Reflection spacing
LIVENESS	0–10	Early reflections decay characteristics (0 = dead, 10 = live)
INI. DLY	0.0–500.0 ms	Initial delay before reverb begins
DIFF.	0–10	Reflection diffusion (left–right reflection spread)
DENSITY	0–100%	Reflection density
HI. RATIO	0.1–1.0	High-frequency feedback ratio
ER NUM.	1–19	Number of early reflections
FB GAIN	–99 to +99%	Feedback gain
HPF	THRU, 21.2 Hz–8.00 kHz	High-pass filter cutoff frequency
LPF	50.0 Hz–16.0 kHz, THRU	Low-pass filter cutoff frequency

### ■ MONO DELAY

One input, one output basic repeat delay.

Parameter	Range	Description
DELAY	0.0–2730.0 ms	Delay time
FB. GAIN	–99 to +99%	Feedback gain (plus values for normal-phase feedback, minus values for reverse-phase feedback)
HI. RATIO	0.1–1.0	High-frequency feedback ratio
HPF	THRU, 21.2 Hz–8.00 kHz	High-pass filter cutoff frequency
LPF	50.0 Hz–16.0 kHz, THRU	Low-pass filter cutoff frequency
SYNC	OFF/ON	Tempo parameter sync on/off
NOTE	*1	Used in conjunction with TEMPO to determine DELAY

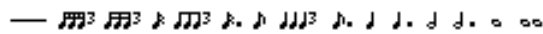
\*1.  (Max. value depends on tempo setting)

### ■ STEREO DELAY

Two input, two output basic stereo delay.

Parameter	Range	Description
DELAY L	0.0–1350.0 ms	Left channel delay time
DELAY R	0.0–1350.0 ms	Right channel delay time
FB. G L	–99 to +99%	Left channel feedback (plus values for normal-phase feedback, minus values for reverse-phase feedback)
FB. G R	–99 to +99%	Right channel feedback (plus values for normal-phase feedback, minus values for reverse-phase feedback)
HI. RATIO	0.1–1.0	High-frequency feedback ratio
HPF	THRU, 21.2 Hz–8.00 kHz	High-pass filter cutoff frequency
LPF	50.0 Hz–16.0 kHz, THRU	Low-pass filter cutoff frequency
SYNC	OFF/ON	Tempo parameter sync on/off
NOTE L	*1	Used in conjunction with TEMPO to determine left channel DELAY
NOTE R	*1	Used in conjunction with TEMPO to determine right channel DELAY

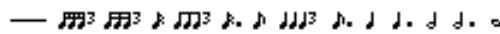
\*1.  (Maximum value depends on the tempo setting)

### MOD. DELAY

One input, two output basic repeat delay with modulation.

Parameter	Range	Description
DELAY	0.0–2725.0 ms	Delay time
FB. GAIN	–99 to +99%	Feedback gain (plus values for normal-phase feedback, minus values for reverse-phase feedback)
HI. RATIO	0.1–1.0	High-frequency feedback ratio
FREQ.	0.05–40.00 Hz	Modulation speed
DEPTH	0–100%	Modulation depth
WAVE	Sine/Tri	Modulation waveform
HPF	THRU, 21.2 Hz–8.00 kHz	High-pass filter cutoff frequency
LPF	50.0 Hz–16.0 kHz, THRU	Low-pass filter cutoff frequency
SYNC	OFF/ON	Tempo parameter sync on/off
DLY.NOTE	*1	Used in conjunction with TEMPO to determine DELAY
MOD.NOTE	*2	Used in conjunction with TEMPO to determine FREQ

\*1. (Maximum value depends on the tempo setting)

\*2.

### DELAY LCR

One input, two output 3-tap delay (left, center, right).

Parameter	Range	Description
DELAY L	0.0–2730.0 ms	Left channel delay time
DELAY C	0.0–2730.0 ms	Center channel delay time
DELAY R	0.0–2730.0 ms	Right channel delay time
FB. DLY	0.0–2730.0 ms	Feedback delay time
LEVEL L	–100 to +100%	Left channel delay level
LEVEL C	–100 to +100%	Center channel delay level
LEVEL R	–100 to +100%	Right channel delay level
FB. GAIN	–99 to +99%	Feedback gain (plus values for normal-phase feedback, minus values for reverse-phase feedback)
HI. RATIO	0.1–1.0	High-frequency feedback ratio
HPF	THRU, 21.2 Hz–8.00 kHz	High-pass filter cutoff frequency
LPF	50.0 Hz–16.0 kHz, THRU	Low-pass filter cutoff frequency
SYNC	OFF/ON	Tempo parameter sync on/off
NOTE L	*1	Used in conjunction with TEMPO to determine DELAY L
NOTE C	*1	Used in conjunction with TEMPO to determine DELAY C
NOTE R	*1	Used in conjunction with TEMPO to determine DELAY R
NOTE FB	*1	Used in conjunction with TEMPO to determine FB. DLY

\*1. (Maximum value depends on the tempo setting)

### ECHO

Two input, two output stereo delay with crossed feedback loop.

Parameter	Range	Description
DELAY L	0.0–1350.0 ms	Left channel delay time
DELAY R	0.0–1350.0 ms	Right channel delay time
FB.DLY L	0.0–1350.0 ms	Left channel feedback delay time
FB.DLY R	0.0–1350.0 ms	Right channel feedback delay time
FB. G L	–99 to +99%	Left channel feedback gain (plus values for normal-phase feedback, minus values for reverse-phase feedback)
FB. G R	–99 to +99%	Right channel feedback gain (plus values for normal-phase feedback, minus values for reverse-phase feedback)
L→R FBG	–99 to +99%	Left to right channel feedback gain (plus values for normal-phase feedback, minus values for reverse-phase feedback)
R→L FBG	–99 to +99%	Right to left channel feedback gain (plus values for normal-phase feedback, minus values for reverse-phase feedback)
HI. RATIO	0.1–1.0	High-frequency feedback ratio
HPF	THRU, 21.2 Hz–8.00 kHz	High-pass filter cutoff frequency
LPF	50.0 Hz–16.0 kHz, THRU	Low-pass filter cutoff frequency
SYNC	OFF/ON	Tempo parameter sync on/off
NOTE L	*1	Used in conjunction with TEMPO to determine DELAY L
NOTE R	*1	Used in conjunction with TEMPO to determine DELAY R
NOTE FBL	*1	Used in conjunction with TEMPO to determine FB. D L
NOTE FBR	*1	Used in conjunction with TEMPO to determine FB. D R

\*1. (Maximum value depends on the tempo setting)

### CHORUS

Two input, two output chorus effect.

Parameter	Range	Description
FREQ.	0.05–40.00 Hz	Modulation speed
AM DEPTH	0–100%	Amplitude modulation depth
PM DEPTH	0–100%	Pitch modulation depth
MOD. DLY	0.0–500.0 ms	Modulation delay time
WAVE	Sine, Tri	Modulation waveform
SYNC	OFF/ON	Tempo parameter sync on/off
NOTE	*1	Used in conjunction with TEMPO to determine FREQ.
LSH F	21.2 Hz–8.00 kHz	Low shelving filter frequency
LSH G	–12.0 to +12.0 dB	Low shelving filter gain
EQ F	100 Hz–8.00 kHz	EQ (peaking type) frequency
EQ G	–12.0 to +12.0 dB	EQ (peaking type) gain
EQ Q	10.0–0.10	EQ (peaking type) bandwidth
HSF F	50.0 Hz–16.0 kHz	High shelving filter frequency
HSF G	–12.0 to +12.0 dB	High shelving filter gain

\*1.



### ■ FLANGE

Two input, two output flange effect.

Parameter	Range	Description
FREQ.	0.05–40.00 Hz	Modulation speed
DEPTH	0–100%	Modulation depth
MOD. DLY	0.0–500.0 ms	Modulation delay time
FB. GAIN	–99 to +99%	Feedback gain (plus values for normal-phase feedback, minus values for reverse-phase feedback)
WAVE	Sine, Tri	Modulation waveform
SYNC	OFF/ON	Tempo parameter sync on/off
NOTE	*1	Used in conjunction with TEMPO to determine FREQ.
LSH F	21.2 Hz–8.00 kHz	Low shelving filter frequency
LSH G	–12.0 to +12.0 dB	Low shelving filter gain
EQ F	100 Hz–8.00 kHz	EQ (peaking type) frequency
EQ G	–12.0 to +12.0 dB	EQ (peaking type) gain
EQ Q	10.0–0.10	EQ (peaking type) bandwidth
HSH F	50.0 Hz–16.0 kHz	High shelving filter frequency
HSH G	–12.0 to +12.0 dB	High shelving filter gain

\*1. 

### ■ SYMPHONIC

Two input, two output symphonic effect.

Parameter	Range	Description
FREQ.	0.05–40.00 Hz	Modulation speed
DEPTH	0–100%	Modulation depth
MOD. DLY	0.0–500.0 ms	Modulation delay time
WAVE	Sine, Tri	Modulation waveform
SYNC	OFF/ON	Tempo parameter sync on/off
NOTE	*1	Used in conjunction with TEMPO to determine FREQ.
LSH F	21.2 Hz–8.00 kHz	Low shelving filter frequency
LSH G	–12.0 to +12.0 dB	Low shelving filter gain
EQ F	100 Hz–8.00 kHz	EQ (peaking type) frequency
EQ G	–12.0 to +12.0 dB	EQ (peaking type) gain
EQ Q	10.0–0.10	EQ (peaking type) bandwidth
HSH F	50.0 Hz–16.0 kHz	High shelving filter frequency
HSH G	–12.0 to +12.0 dB	High shelving filter gain

\*1. 

### ■ PHASER

Two input, two output 16-stage phaser.

Parameter	Range	Description
FREQ.	0.05–40.00 Hz	Modulation speed
DEPTH	0–100%	Modulation depth
FB. GAIN	–99 to +99%	Feedback gain (plus values for normal-phase feedback, minus values for reverse-phase feedback)
OFFSET	0–100	Lowest phase-shifted frequency offset
PHASE	0.00–354.38 degrees	Left and right modulation phase balance
STAGE	2, 4, 6, 8, 10, 12, 14, 16	Number of phase shift stages
SYNC	OFF/ON	Tempo parameter sync on/off
NOTE	*1	Used in conjunction with TEMPO to determine FREQ.
LSH F	21.2 Hz–8.00 kHz	Low shelving filter frequency
LSH G	–12.0 to +12.0 dB	Low shelving filter gain
HSH F	50.0 Hz–16.0 kHz	High shelving filter frequency
HSH G	–12.0 to +12.0 dB	High shelving filter gain

\*1. 

### ■ AUTOPAN

Two input, two output autopanner.

Parameter	Range	Description
FREQ.	0.05–40.00 Hz	Modulation speed
DEPTH	0–100%	Modulation depth
DIR.	*1	Panning direction
WAVE	Sine, Tri, Square	Modulation waveform
SYNC	OFF/ON	Tempo parameter sync on/off
NOTE	*2	Used in conjunction with TEMPO to determine FREQ.
LSH F	21.2 Hz–8.00 kHz	Low shelving filter frequency
LSH G	–12.0 to +12.0 dB	Low shelving filter gain
EQ F	100 Hz–8.00 kHz	EQ (peaking type) frequency
EQ G	–12.0 to +12.0 dB	EQ (peaking type) gain
EQ Q	10.0–0.10	EQ (peaking type) bandwidth
HSH F	50.0 Hz–16.0 kHz	High shelving filter frequency
HSH G	–12.0 to +12.0 dB	High shelving filter gain

\*1. L↔R, L→R, L←R, Turn L, Turn R

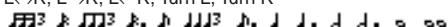
\*2. 

### TREMOLO

Two input, two output tremolo effect.

Parameter	Range	Description
FREQ.	0.05–40.00 Hz	Modulation speed
DEPTH	0–100%	Modulation depth
WAVE	Sine, Tri, Square	Modulation waveform
SYNC	OFF/ON	Tempo parameter sync on/off
NOTE	*1	Used in conjunction with TEMPO to determine FREQ.
LSH F	21.2 Hz–8.00 kHz	Low shelving filter frequency
LSH G	–12.0 to +12.0 dB	Low shelving filter gain
EQ F	100 Hz–8.00 kHz	EQ (peaking type) frequency
EQ G	–12.0 to +12.0 dB	EQ (peaking type) gain
EQ Q	10.0–0.10	EQ (peaking type) bandwidth
HSH F	50.0 Hz–16.0 kHz	High shelving filter frequency
HSH G	–12.0 to +12.0 dB	High shelving filter gain

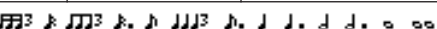
\*1. 

### HQ. PITCH

One input, two output high-quality pitch shifter.

Parameter	Range	Description
PITCH	–12 to +12 semitones	Pitch shift
FINE	–50 to +50 cents	Pitch shift fine
DELAY	0.0–1000.0 ms	Delay time
FB. GAIN	–99 to +99%	Feedback gain (plus values for normal-phase feedback, minus values for reverse-phase feedback)
MODE	1–10	Pitch shift precision
SYNC	OFF/ON	Tempo parameter sync on/off
NOTE	*1	Used in conjunction with TEMPO to determine DELAY

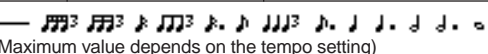
\*1.   
(Maximum value depends on the tempo setting)

### DUAL PITCH

Two input, two output pitch shifter.

Parameter	Range	Description
PITCH 1	–24 to +24 semitones	Channel #1 pitch shift
FINE 1	–50 to +50 cents	Channel #1 pitch shift fine
LEVEL 1	–100 to +100%	Channel #1 level (plus values for normal phase, minus values for reverse phase)
PAN 1	L63 to R63	Channel #1 pan
DELAY 1	0.0–1000.0 ms	Channel #1 delay time
FB. G 1	–99 to +99%	Channel #1 feedback gain (plus values for normal-phase feedback, minus values for reverse-phase feedback)
MODE	1–10	Pitch shift precision
PITCH 2	–24 to +24 semitones	Channel #2 pitch shift
FINE 2	–50 to +50 cents	Channel #2 pitch shift fine
LEVEL 2	–100 to +100%	Channel #2 level (plus values for normal phase, minus values for reverse phase)
PAN 2	L63 to R63	Channel #2 pan
DELAY 2	0.0–1000.0 ms	Channel #2 delay time
FB. G 2	–99 to +99%	Channel #2 feedback gain (plus values for normal-phase feedback, minus values for reverse-phase feedback)
SYNC	OFF/ON	Tempo parameter sync on/off
NOTE 1	*1	Used in conjunction with TEMPO to determine Channel #1 delay
NOTE 2	*1	Used in conjunction with TEMPO to determine Channel #2 delay

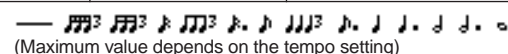
\*1.   
(Maximum value depends on the tempo setting)

### ROTARY

One input, two output rotary speaker simulator.

Parameter	Range	Description
ROTATE	STOP, START	Rotation stop, start
SPEED	SLOW, FAST	Rotation speed (see SLOW and FAST parameters)
SLOW	0.05–10.00 Hz	SLOW rotation speed
FAST	0.05–10.00 Hz	FAST rotation speed
DRIVE	0–100	Overdrive level
ACCEL	0–10	Acceleration at speed changes
LOW	0–100	Low-frequency filter
HIGH	0–100	High-frequency filter

### RING MOD.

Two input, two output ring modulator.

Parameter	Range	Description
SOURCE	OSC, SELF	Modulation source: oscillator or input signal
OSC FREQ	0.0–5000.0 Hz	Oscillator frequency
FM FREQ.	0.05–40.00 Hz	Oscillator frequency modulation speed
FM DEPTH	0–100%	Oscillator frequency modulation depth
SYNC	OFF/ON	Tempo parameter sync on/off
FM NOTE	*1	Used in conjunction with TEMPO to determine FM FREQ

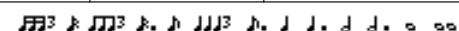
\*1. 

## MOD. FILTER

Two input, two output modulation filter.

Parameter	Range	Description
FREQ.	0.05–40.00 Hz	Modulation speed
DEPTH	0–100%	Modulation depth
PHASE	0.00–354.38 degrees	Left-channel modulation and right-channel modulation phase difference
TYPE	LPF, HPF, BPF	Filter type: low pass, high pass, band pass
OFFSET	0–100	Filter frequency offset
RESO.	0–20	Filter resonance
LEVEL	0–100	Output level
SYNC	OFF/ON	Tempo parameter sync on/off
NOTE	*1	Used in conjunction with TEMPO to determine FREQ

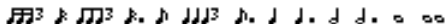
\*1. 

## DISTORTION

One input, two output distortion effect.

Parameter	Range	Description
DST TYPE	DST1, DST2, OVD1, OVD2, CRUNCH	Distortion type (DST = distortion, OVD = overdrive)
DRIVE	0–100	Distortion drive
MASTER	0–100	Master volume
TONE	–10 to +10	Tone
N. GATE	0–20	Noise reduction

## AMP SIMULATE

One input, two output guitar amp simulator.

Parameter	Range	Description
AMP TYPE	*1	Guitar amp simulation type
DST TYPE	DST1, DST2, OVD1, OVD2, CRUNCH	Distortion type (DST = distortion, OVD = overdrive)
DRIVE	0–100	Distortion drive
MASTER	0–100	Master volume
BASS	0–100	Bass tone control
MIDDLE	0–100	Middle tone control
TREBLE	0–100	High tone control
N. GATE	0–20	Noise reduction
CAB DEP	0–100%	Speaker cabinet simulation depth
EQ F	100 Hz–8.00 kHz	EQ (peaking type) frequency
EQ G	–12.0 to +12.0 dB	EQ (peaking type) gain
EQ Q	10.0–0.10	EQ (peaking type) bandwidth

\*1. STK-M1, STK-M2, THRASH, MIDBST, CMB-PG, CMB-VR, CMB-DX, CMB-TW, MINI, FLAT

## DYNA. FILTER

Two input, two output dynamically controlled filter.

Parameter	Range	Description
SOURCE	INPUT, MIDI	Control source: input signal or MIDI Note On velocity
SENSE	0–100	Sensitivity
DIR.	UP, DOWN	Upward or downward frequency change
DECAY	*1	Filter frequency change decay speed
TYPE	LPF, HPF, BPF	Filter type
OFFSET	0–100	Filter frequency offset
RESO.	0–20	Filter resonance
LEVEL	0–100	Output Level

\*1. 6.0 ms–46.0 s (fs=44.1 kHz), 5.0 ms–42.3 s (fs=48 kHz)

## DYNA. FLANGE

Two input, two output dynamically controlled flanger.

Parameter	Range	Description
SOURCE	INPUT, MIDI	Control source: input signal or MIDI Note On velocity
SENSE	0–100	Sensitivity
DIR.	UP, DOWN	Upward or downward frequency change
DECAY	*1	Decay speed
OFFSET	0–100	Delay time offset
FB.GAIN	–99 to +99%	Feedback gain (plus values for normal-phase feedback, minus values for reverse-phase feedback)
LSH F	21.2 Hz–8.00 kHz	Low shelving filter frequency
LSH G	–12.0 to +12.0 dB	Low shelving filter gain
EQ F	100 Hz–8.00 kHz	EQ (peaking type) frequency
EQ G	–12.0 to +12.0 dB	EQ (peaking type) gain
EQ Q	10.0–0.10	EQ (peaking type) bandwidth
HSH F	50.0 Hz–16.0 kHz	High shelving filter frequency
HSH G	–12.0 to +12.0 dB	High shelving filter gain

\*1. 6.0 ms–46.0 s (fs=44.1 kHz), 5.0 ms–42.3 s (fs=48 kHz)

### ■ DYNA. PHASER

Two input, two output dynamically controlled phaser.

Parameter	Range	Description
SOURCE	INPUT, MIDI	Control source: input signal or MIDI Note On velocity
SENSE	0-100	Sensitivity
DIR.	UP, DOWN	Upward or downward frequency change
DECAY	*1	Decay speed
OFFSET	0-100	Lowest phase-shifted frequency offset
FB.GAIN	-99 to +99%	Feedback gain (plus values for normal-phase feedback, minus values for reverse-phase feedback)
STAGE	2, 4, 6, 8, 10, 12, 14, 16	Number of phase shift stages
LSH F	21.2 Hz-8.00 kHz	Low shelving filter frequency
LSH G	-12.0 to +12.0 dB	Low shelving filter gain
HSH F	50.0 Hz-16.0 kHz	High shelving filter frequency
HSH G	-12.0 to +12.0 dB	High shelving filter gain

\*1. 6.0 ms-46.0 s (fs=44.1 kHz), 5.0 ms-42.3 s (fs=48 kHz)

### ■ REV+CHORUS

One input, two output reverb and chorus effects in parallel.

Parameter	Range	Description
REV TIME	0.3-99.0 s	Reverb time
INI. DLY	0.0-500.0 ms	Initial delay before reverb begins
HI. RATIO	0.1-1.0	High-frequency reverb time ratio
DIFF.	0-10	Spread
DENSITY	0-100%	Reverb density
REV/CHO	0-100%	Reverb and chorus balance (0% = all reverb, 100% = all chorus)
HPF	THRU, 21.2 Hz-8.00 kHz	High-pass filter cutoff frequency
LPF	50.0 Hz-16.0 kHz, THRU	Low-pass filter cutoff frequency
FREQ.	0.05-40.00 Hz	Modulation speed
AM DEPTH	0-100%	Amplitude modulation depth
PM DEPTH	0-100%	Pitch modulation depth
MOD. DLY	0.0-500.0 ms	Modulation delay time
WAVE	Sine, Tri	Modulation waveform
SYNC	OFF/ON	Tempo parameter sync on/off
NOTE	*1	Used in conjunction with TEMPO to determine FREQ.

\*1.

### ■ REV→CHORUS

One input, two output reverb and chorus effects in series.

Parameter	Range	Description
REV TIME	0.3-99.0 s	Reverb time
INI. DLY	0.0-500.0 ms	Initial delay before reverb begins
HI. RATIO	0.1-1.0	High-frequency reverb time ratio
DIFF.	0-10	Spread
DENSITY	0-100%	Reverb density
REV.BAL	0-100%	Reverb and chorused reverb balance (0% = all chorused reverb, 100% = all reverb)
HPF	THRU, 21.2 Hz-8.00 kHz	High-pass filter cutoff frequency
LPF	50.0 Hz-16.0 kHz, THRU	Low-pass filter cutoff frequency
FREQ.	0.05-40.00 Hz	Modulation speed
AM DEPTH	0-100%	Amplitude modulation depth
PM DEPTH	0-100%	Pitch modulation depth
MOD. DLY	0.0-500.0 ms	Modulation delay time
WAVE	Sine, Tri	Modulation waveform
SYNC	OFF/ON	Tempo parameter sync on/off
NOTE	*1	Used in conjunction with TEMPO to determine FREQ.

\*1.

### ■ REV+FLANGE

One input, two output reverb and flanger effects in parallel.

Parameter	Range	Description
REV TIME	0.3-99.0 s	Reverb time
INI. DLY	0.0-500.0 ms	Initial delay before reverb begins
HI. RATIO	0.1-1.0	High-frequency reverb time ratio
DIFF.	0-10	Spread
DENSITY	0-100%	Reverb density
REV/FLG	0-100%	Reverb and flange balance (0% = all reverb, 100% = all flange)
HPF	THRU, 21.2 Hz-8.00 kHz	High-pass filter cutoff frequency
LPF	50.0 Hz-16.0 kHz, THRU	Low-pass filter cutoff frequency
FREQ.	0.05-40.00 Hz	Modulation speed
DEPTH	0-100%	Modulation depth
MOD. DLY	0.0-500.0 ms	Modulation delay time
FB. GAIN	-99 to +99%	Feedback gain (plus values for normal-phase feedback, minus values for reverse-phase feedback)
WAVE	Sine, Tri	Modulation waveform
SYNC	OFF/ON	Tempo parameter sync on/off
NOTE	*1	Used in conjunction with TEMPO to determine FREQ.

\*1.

### ■ REV→FLANGE

One input, two output reverb and flanger effects in series.

Parameter	Range	Description
REV TIME	0.3–99.0 s	Reverb time
INI. DLY	0.0–500.0 ms	Initial delay before reverb begins
HI. RATIO	0.1–1.0	High-frequency reverb time ratio
DIFF.	0–10	Spread
DENSITY	0–100%	Reverb density
REV.BAL	0–100%	Reverb and flanged reverb balance (0% = all flanged reverb, 100% = all reverb)
HPF	THRU, 21.2 Hz–8.00 kHz	High-pass filter cutoff frequency
LPF	50.0 Hz–16.0 kHz, THRU	Low-pass filter cutoff frequency
FREQ.	0.05–40.00 Hz	Modulation speed
DEPTH	0–100%	Modulation depth
MOD. DLY	0.0–500.0 ms	Modulation delay time
FB. GAIN	–99 to +99%	Feedback gain (plus values for normal-phase feedback, minus values for reverse-phase feedback)
WAVE	Sine, Tri	Modulation waveform
SYNC	OFF/ON	Tempo parameter sync on/off
NOTE	*1	Used in conjunction with TEMPO to determine FREQ.

\*1.

### ■ REV+SYMPHO.

One input, two output reverb and symphonic effects in parallel.

Parameter	Range	Description
REV TIME	0.3–99.0 s	Reverb time
INI. DLY	0.0–500.0 ms	Initial delay before reverb begins
HI. RATIO	0.1–1.0	High-frequency reverb time ratio
DIFF.	0–10	Spread
DENSITY	0–100%	Reverb density
REV/SYM	0–100%	Reverb and symphonic balance (0% = all reverb, 100% = all symphonic)
HPF	THRU, 21.2 Hz–8.00 kHz	High-pass filter cutoff frequency
LPF	50.0 Hz–16.0 kHz, THRU	Low-pass filter cutoff frequency
FREQ.	0.05–40.00 Hz	Modulation speed
DEPTH	0–100%	Modulation depth
MOD. DLY	0.0–500.0 ms	Modulation delay time
WAVE	Sine, Tri	Modulation waveform
SYNC	OFF/ON	Tempo parameter sync on/off
NOTE	*1	Used in conjunction with TEMPO to determine FREQ.

\*1.

### ■ REV→SYMPHO.

One input, two output reverb and symphonic effects in series.

Parameter	Range	Description
REV TIME	0.3–99.0 s	Reverb time
INI. DLY	0.0–500.0 ms	Initial delay before reverb begins
HI. RATIO	0.1–1.0	High-frequency reverb time ratio
DIFF.	0–10	Spread
DENSITY	0–100%	Reverb density
REV.BAL	0–100%	Reverb and symphonic reverb balance (0% = all symphonic reverb, 100% = all reverb)
HPF	THRU, 21.2 Hz–8.00 kHz	High-pass filter cutoff frequency
LPF	50.0 Hz–16.0 kHz, THRU	Low-pass filter cutoff frequency
FREQ.	0.05–40.00 Hz	Modulation speed
DEPTH	0–100%	Modulation depth
MOD. DLY	0.0–500.0 ms	Modulation delay time
WAVE	Sine, Tri	Modulation waveform
SYNC	OFF/ON	Tempo parameter sync on/off
NOTE	*1	Used in conjunction with TEMPO to determine FREQ.

\*1.

### ■ REV→PAN

This is a 1-in/2-out series-connected reverb and auto-pan effect.

Parameter	Range	Description
REV TIME	0.3–99.0 s	Reverb time
INI. DLY	0.0–500.0 ms	Initial delay before reverb begins
HI. RATIO	0.1–1.0	High-frequency reverb time ratio
DIFF.	0–10	Spread
DENSITY	0–100%	Reverb density
REV.BAL	0–100%	Reverb and panned reverb balance (0% = all panned reverb, 100% = all reverb)
HPF	THRU, 21.2 Hz–8.00 kHz	High-pass filter cutoff frequency
LPF	50.0 Hz–16.0 kHz, THRU	Low-pass filter cutoff frequency
FREQ.	0.05–40.00 Hz	Modulation speed
DEPTH	0–100%	Modulation depth
DIR.	*1	Panning direction
WAVE	Sine, Tri, Square	Modulation waveform
SYNC	OFF/ON	Tempo parameter sync on/off
NOTE	*2	Used in conjunction with TEMPO to determine FREQ.

\*1. L↔R, L→R, L←R, Turn L, Turn R

\*2.

**■ DELAY+ER.**

One input, two output delay and early reflections effects in parallel.

Parameter	Range	Description
DELAY L	0.0–1000.0 ms	Left channel delay time
DELAY R	0.0–1000.0 ms	Right channel delay time
FB. DLY	0.0–1000.0 ms	Feedback delay time
FB. GAIN	–99 to +99%	Feedback gain (plus values for normal-phase feedback, minus values for reverse-phase feedback)
HI. RATIO	0.1–1.0	High-frequency feedback ratio
DLY/ER	0–100%	Delay and early reflections balance (0% = all delay, 100% = all early reflections)
HPF	THRU, 21.2 Hz–8.00 kHz	High-pass filter cutoff frequency
LPF	50.0 Hz–16.0 kHz, THRU	Low-pass filter cutoff frequency
TYPE	S-Hall, L-Hall, Random, Revers, Plate, Spring	Type of early reflection simulation
ROOMSIZE	0.1–20.0	Reflection spacing
LIVENESS	0–10	Early reflections decay characteristics (0 = dead, 10 = live)
INI. DLY	0.0–500.0 ms	Initial delay before reverb begins
DIFF.	0–10	Spread
DENSITY	0–100%	Reverb density
ER NUM.	1–19	Number of early reflections
SYNC	OFF/ON	Tempo parameter sync on/off
NOTE L	*1	Used in conjunction with TEMPO to determine left channel DELAY L
NOTE R	*1	Used in conjunction with TEMPO to determine right channel DELAY R
NOTE FB	*1	Used in conjunction with TEMPO to determine FB. DLY

\*1. (Maximum value depends on the tempo setting)

**■ DELAY→ER.**

One input, two output delay and early reflections effects in series.

Parameter	Range	Description
DELAY L	0.0–1000.0 ms	Left channel delay time
DELAY R	0.0–1000.0 ms	Right channel delay time
FB. DLY	0.0–1000.0 ms	Feedback delay time
FB. GAIN	–99 to +99%	Feedback gain (plus values for normal-phase feedback, minus values for reverse-phase feedback)
HI. RATIO	0.1–1.0	High-frequency feedback ratio
DLY.BAL	0–100%	Delay and early reflected delay balance (0% = all early reflected delay, 100% = all delay)
HPF	THRU, 21.2 Hz–8.00 kHz	High-pass filter cutoff frequency
LPF	50.0 Hz–16.0 kHz, THRU	Low-pass filter cutoff frequency
TYPE	S-Hall, L-Hall, Random, Revers, Plate, Spring	Type of early reflection simulation
ROOMSIZE	0.1–20.0	Reflection spacing
LIVENESS	0–10	Early reflections decay characteristics (0 = dead, 10 = live)
INI. DLY	0.0–500.0 ms	Initial delay before reverb begins
DIFF.	0–10	Spread
DENSITY	0–100%	Reverb density
ER NUM.	1–19	Number of early reflections
SYNC	OFF/ON	Tempo parameter sync on/off
NOTE L	*1	Used in conjunction with TEMPO to determine left channel DELAY L
NOTE R	*1	Used in conjunction with TEMPO to determine right channel DELAY R
NOTE FB	*1	Used in conjunction with TEMPO to determine FB. DLY

\*1. (Maximum value depends on the tempo setting)



### ■ DELAY+REV

One input, two output delay and reverb effects in parallel.

Parameter	Range	Description
DELAY L	0.0–1000.0 ms	Left channel delay time
DELAY R	0.0–1000.0 ms	Right channel delay time
FB. DLY	0.0–1000.0 ms	Feedback delay time
FB. GAIN	–99 to +99%	Feedback gain (plus values for normal-phase feedback, minus values for reverse-phase feedback)
DELAY HI	0.1–1.0	Delay high-frequency feedback ratio
DLY/REV	0–100%	Delay and reverb balance (0% = all delay, 100% = all reverb)
HPF	THRU, 21.2 Hz–8.00 kHz	High-pass filter cutoff frequency
LPF	50.0 Hz–16.0 kHz, THRU	Low-pass filter cutoff frequency
REV TIME	0.3–99.0 s	Reverb time
INI. DLY	0.0–500.0 ms	Initial delay before reverb begins
REV HI	0.1–1.0	High-frequency reverb time ratio
DIFF.	0–10	Spread
DENSITY	0–100%	Reverb density
SYNC	OFF/ON	Tempo parameter sync on/off
NOTE L	*1	Used in conjunction with TEMPO to determine left channel DELAY L
NOTE R	*1	Used in conjunction with TEMPO to determine right channel DELAY R
NOTE FB	*1	Used in conjunction with TEMPO to determine FB. DLY

\*1.  (Maximum value depends on the tempo setting)

### ■ DELAY→REV

One input, two output delay and reverb effects in series.

Parameter	Range	Description
DELAY L	0.0–1000.0 ms	Left channel delay time
DELAY R	0.0–1000.0 ms	Right channel delay time
FB. DLY	0.0–1000.0 ms	Feedback delay time
FB. GAIN	–99 to +99%	Feedback gain (plus values for normal-phase feedback, minus values for reverse-phase feedback)
DELAY HI	0.1–1.0	Delay high-frequency feedback ratio
DLY.BAL	0–100%	Delay and delayed reverb balance (0% = all delayed reverb, 100% = all delay)
HPF	THRU, 21.2 Hz–8.00 kHz	High-pass filter cutoff frequency
LPF	50.0 Hz–16.0 kHz, THRU	Low-pass filter cutoff frequency
REV TIME	0.3–99.0 s	Reverb time
INI. DLY	0.0–500.0 ms	Initial delay before reverb begins
REV HI	0.1–1.0	High-frequency reverb time ratio
DIFF.	0–10	Spread
DENSITY	0–100%	Reverb density
SYNC	OFF/ON	Tempo parameter sync on/off
NOTE L	*1	Used in conjunction with TEMPO to determine left channel DELAY L
NOTE R	*1	Used in conjunction with TEMPO to determine right channel DELAY R
NOTE FB	*1	Used in conjunction with TEMPO to determine FB. DLY

\*1.  (Maximum value depends on the tempo setting)

### ■ DIST→DELAY

One input, two output distortion and delay effects in series.

Parameter	Range	Description
DST TYPE	DST1, DST2, OVD1, OVD2, CRUNCH	Distortion type (DST = distortion, OVD = overdrive)
DRIVE	0–100	Distortion drive
MASTER	0–100	Master volume
TONE	–10 to +10	Tone control
N. GATE	0–20	Noise reduction
SYNC	OFF/ON	Tempo parameter sync on/off
DLY.NOTE	*1	Used in conjunction with TEMPO to determine DELAY
MOD.NOT E	*2	Used in conjunction with TEMPO to determine FREQ.
DELAY	0.0–2725.0 ms	Delay time
FB. GAIN	–99 to +99%	Feedback gain (plus values for normal-phase feedback, minus values for reverse-phase feedback)
HI. RATIO	0.1–1.0	High-frequency feedback ratio
FREQ.	0.05–40.00 Hz	Modulation speed
DEPTH	0–100%	Modulation depth
DLY.BAL	0–100%	Distortion and delay balance (0% = all distortion, 100% = all delayed distortion)

\*1.  (Maximum value depends on the tempo setting)

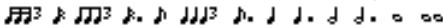
\*2. 

## MULTI FILTER

Two input, two output 3-band multi-filter (24 dB/octave).

Parameter	Range	Description
TYPE 1	LPF, HPF, BPF	Filter 1 type: high pass, low pass, band pass
FREQ. 1	28.0 Hz–16.0 kHz	Filter 1 frequency
LEVEL 1	0–100	Filter 1 level
RESO. 1	0–20	Filter 1 resonance
TYPE 2	LPF, HPF, BPF	Filter 2 type: high pass, low pass, band pass
FREQ. 2	28.0 Hz–16.0 kHz	Filter 2 frequency
LEVEL 2	0–100	Filter 2 level
RESO. 2	0–20	Filter 2 resonance
TYPE 3	LPF, HPF, BPF	Filter 3 type: high pass, low pass, band pass
FREQ. 3	28.0 Hz–16.0 kHz	Filter 3 frequency
LEVEL 3	0–100	Filter 3 level
RESO. 3	0–20	Filter 3 resonance

## FREEZE

One input, two output basic sampler.

Parameter	Range	Description
REC MODE	MANUAL, INPUT	In MANUAL mode, recording is started by pressing the REC and PLAY buttons. In INPUT mode, Record-Ready mode is engaged by pressing the REC button, and actual recording is triggered by the input signal.
REC DLY	–1000 to +1000 ms	Recording delay. For plus values, recording starts after the trigger is received. For minus values, recording starts before the trigger is received.
PLY MODE	MOMENT, CONTI., INPUT	In MOMENT mode, the sample plays only while the that the PLAY button is pressed. In CONT mode, playback continues once the PLAY button has been pressed. The number of times the sample plays is set using the LOOP NUM parameter. In INPUT mode, playback is triggered by the input signal.
TRG LVL	–60 to 0 dB	Input trigger level (i.e., the signal level required to trigger recording or playback)
TRG MASK	0–1000 ms	Once playback has been triggered, subsequent triggers are ignored for the duration of the TRG MASK time.
START	*1	Playback start point in milliseconds
END	*1	Playback end point in milliseconds
LOOP	*1	Loop start point in milliseconds
LOOP NUM	0–100	Number of times the sample plays
PITCH	–12 to +12 semi-tones	Playback pitch shift
FINE	–50 to +50 cents	Playback pitch shift fine
MIDI TRG	OFF, C1–C6, ALL	PLAY button can be triggered by using MIDI Note on/off messages.
START [SAMPLE]	0–131000	Playback start point in samples
END [SAMPLE]	0–131000	Playback end point in samples
LOOP [SAMPLE]	0–131000	Loop start point in samples

\*1. 0.0–5941.0 ms (fs=44.1 kHz), 0.0 ms–5458.3 ms (fs=48 kHz)

## STEREO REVERB

Two input, two output stereo reverb.

Parameter	Range	Description
REV TIME	0.3–99.0 s	Reverb time
REV TYPE	Hall, Room, Stage, Plate	Reverb type
INI. DLY	0.0–100.0 ms	Initial delay before reverb begins
HI. RATIO	0.1–1.0	High-frequency reverb time ratio
LO. RATIO	0.1–2.4	Low-frequency reverb time ratio
DIFF.	0–10	Reverb diffusion (left–right reverb spread)
DENSITY	0–100%	Reverb density
E/R BAL.	0–100%	Balance of early reflections and reverb (0% = all reverb, 100% = all early reflections)
HPF	THRU, 21.2 Hz–8.00 kHz	High-pass filter cutoff frequency
LPF	50.0 Hz–16.0 kHz, THRU	Low-pass filter cutoff frequency

## M. BAND DYNA.

Two input, two output 3-band dynamics processor, with individual solo and gain reduction metering for each band.

Parameter	Range	Description
LOW GAIN	–96.0 to +12.0 dB	Low band level
MID GAIN	–96.0 to +12.0 dB	Mid band level
HI. GAIN	–96.0 to +12.0 dB	High band level
PRESENCE	–10 to +10	For positive values, the threshold of the high band is lowered and the threshold of the low band is increased. For negative values, the opposite will occur. When set to 0, all three bands are affected the same.
L–M XOVR	21.2 Hz–8.00 kHz	Low/mid crossover frequency
M–H XOVR	21.2 Hz–8.00 kHz	Mid/high crossover frequency
SLOPE	–6 dB, –12 dB	Filter slope
CEILING	–6.0 dB to 0.0 dB, OFF	Specifies the maximum output level
CMP. THRE	–24.0 dB to 0.0 dB	Compressor threshold
CMP. RAT	1:1 to 20:1	Compressor ratio
CMP. ATK	0–120 ms	Compressor attack
CMP. REL	*1	Compressor release time
CMP. KNEE	0–5	Compressor knee
CMP. BYP	OFF/ON	Compressor bypass
LOOKUP	0.0–100.0 ms	Lookup delay
EXP. THRE	–54.0 dB to –24.0 dB	Expander threshold
EXP. RAT	1:1 to ∞:1	Expander ratio
EXP. REL	*1	Expander release time
EXP. BYP	OFF/ON	Expander bypass
LIM. THRE	–12.0 dB to 0.0 dB	Limiter threshold
LIM. ATK	0–120 ms	Limiter attack
LIM. REL	*1	Limiter release time
LIM. KNEE	0–5	Limiter knee
LIM. BYP	OFF/ON	Limiter bypass

\*1. 6.0 ms–46.0 s (fs=44.1 kHz), 5.0 ms–42.3 s (fs=48 kHz)

## ■ M.BAND COMP

Two input, two output 3-band compressor, with individual solo and gain reduction metering for each band.

Parameter	Range	Description
LOW GAIN	-96.0 to +12.0 dB	Low band level
MID GAIN	-96.0 to +12.0 dB	Mid band level
HI. GAIN	-96.0 to +12.0 dB	High band level
L-M XOVR	21.2 Hz–8.00 kHz	Low/mid crossover frequency
M-H XOVR	21.2 Hz–8.00 kHz	Mid/high crossover frequency
SLOPE	-6 dB, -12 dB	Filter slope
CEILING	-6.0 dB to 0.0 dB, OFF	Specifies the maximum output level
LOOKUP	0.0–100.0 ms	Lookup delay
LOW THRE	-54.0 dB to 0.0 dB	Low band threshold level
MID THRE	-54.0 dB to 0.0 dB	Mid band threshold level
HI. THRE	-54.0 dB to 0.0 dB	High band threshold level
RATIO	1:1 to 20:1	Compression ratio
ATTACK	0–120 ms	Compressor attack time
RELEASE	*1	Compressor release time
KNEE	0–5	Compressor knee
BYPASS	OFF/ON	Bypasses the compressor

\*1. 6.0 ms–46.0 s (fs=44.1 kHz), 5.0 ms–42.3 s (fs=48 kHz)

## ■ REV-X HALL, REV-X ROOM, REV-X PLATE

Newly-developed two input, two output reverb algorithm. Delivers dense and rich reverberation, smooth decay, and provides a spaciousness and depth that enhances the original sound. Choose from three types depending on your location and needs; REV-X HALL, REV-X ROOM, and REV-X PLATE.

Parameter	Range	Description
REV TIME	0.28–27.94 s*1	Reverb time
INI. DLY	0.0–120.0 ms	Initial delay before reverb begins
HI. RATIO	0.1–1.0	High-frequency reverb time ratio
LO. RATIO	0.1–2.4	Low-frequency reverb time ratio
LO.FREQ	22.0 Hz–18.0 kHz	Frequency point for LO.RATIO setting
DIFF.	0–10	Reverb diffusion (left–right reverb spread)
ROOM SIZE	0–28	Size of room
DECAY	0–53	Gate closing speed
HPF	THRU, 22.0 Hz–8.00 kHz	High-pass filter cutoff frequency
LPF	1.00 kHz–18.0 kHz, THRU	Low-pass filter cutoff frequency

\*1. These values are for when the effect type is REV-X HALL and the ROOM SIZE=28. The range will differ depending on the effect type and ROOM SIZE setting.

## Effects and tempo synchronization

Some of the LS9's effects allow you to synchronize the effect with the tempo. There are two such types of effect; delay-type effects and modulation-type effects. For delay-type effects, the delay time will change according to the tempo. For modulation-type effects, the frequency of the modulation signal will change according to the tempo.

### • Parameters related to tempo synchronization

The following five parameters are related to tempo synchronization.

1) SYNC 2) NOTE 3) TEMPO 4) DELAY 5) FREQ.

SYNC:..... This is the on/off switch for tempo synchronization.

NOTE and TEMPO: ..... These are the basic parameters for tempo synchronization.

DELAY and FREQ.: ..... DELAY is the delay time, and FREQ. is the frequency of the modulation signal. These directly affect the way in which the effect sound will change. DELAY is relevant only for delay-type effects, and FREQ. is relevant only for modulation-type effects.

### • How the parameters are related

Tempo synchronization uses TEMPO and NOTE to calculate a value that will be the basis for the tempo, and continues making adjustments so that this tempo basis stays essentially the same as the DELAY (or FREQ.). This means that when TEMPO, NOTE, and DELAY (or FREQ.) are synchronized, and you change any of these values, the other parameters will be re-set in order to maintain the correct relationship. The parameters that are re-set and the calculation method(\*a) used are as follows.

**If you turn SYNC on → NOTE will be set**

**If you edit NOTE → DELAY (or FREQ.) will be set**

In this case, the DELAY (or FREQ.) value is calculated as follows.

$$\text{DELAY (or FREQ.)} = \text{NOTE} \times 4 \times (60/\text{TEMPO})$$

**If you edit TEMPO → DELAY (or FREQ.) will be set**

In this case, the DELAY (or FREQ.) value is calculated as follows.

$$\text{DELAY (or FREQ.)} = \text{original DELAY (or FREQ.)} \times (\text{previous TEMPO/new TEMPO})$$

Example 1: When SYNC=ON, DELAY=250 ms, TEMPO=120, you change NOTE from 8th note to quarter note

$$\text{DELAY} = \text{new NOTE} \times 4 \times (60/\text{TEMPO})$$

$$= (1/4) \times 4 \times (60/120)$$

$$= 0.5 \text{ (sec)}$$

$$= 500 \text{ ms}$$

Thus, the DELAY will change from 250 ms to 500 ms.

Example 2: When SYNC=ON, DELAY=250 ms, NOTE=8th note, you change TEMPO from 120 to 121

$$\text{DELAY} = \text{original DELAY} \times (\text{previous TEMPO/new TEMPO})$$

$$= 250 \times (120/121)$$

$$= 247.9 \text{ (ms)}$$

Thus, the TEMPO will change from 250 ms to 247.9 ms.

\*a Rounded values are used for the calculation results.

### • Ranges of the NOTE and TEMPO values

The ranges of the NOTE and TEMPO values are limited by the ranges of the DELAY or FREQ. values. You cannot set NOTE or TEMPO values that would cause DELAY or FREQ. to exceed their maximum possible values when synchronized to tempo. This limitation also applies even when SYNC is OFF.

### • Special characteristics of the TEMPO parameter

The TEMPO parameter has the following characteristics that are unlike other parameters.

- It is a common value shared by all effects

- You cannot store it to or recall it from the Effects Library. (You can store it to and recall it from a Scene.)

This means that the TEMPO value may not necessarily be the same when an effect is recalled as when that effect was stored. Here is an example.

Store the effect: TEMPO=120 → Change TEMPO to 60 → Recall the effect: TEMPO=60

Normally when you change the TEMPO, the DELAY (or FREQ.) will be re-set accordingly. However if the DELAY (or FREQ.) were changed, the effect would sound differently when recalled than when it was stored. To prevent the effect from changing in this way between store and recall, the LS9 does not update the DELAY (or FREQ.) value when an effect is recalled, even if the TEMPO is no longer the same as when that effect was stored.

\* The NOTE parameter is calculated based on the following values.

$$\text{♩} = 1/4$$

$$\text{♪} = 1/24$$

$$\text{♩} = 1/16$$

$$\text{♩} = 1/12$$

$$\text{♩} = 3/32$$

$$\text{♩} = 1/8$$

$$\text{♩} = 1/6$$

$$\text{♩} = 3/16$$

$$\text{♩} = 1/4$$

$$\text{♩} = 3/8$$

$$\text{♩} = 1/2$$

$$\text{♩} = 3/4$$

$$\text{♩} = 1/1$$

$$\text{♩} = 2/1$$

# Scene Memory/Effect Library to Program Change Table

## ■ Preset Bank/Ch# 1

Program Change#	Scene/Effect	Preset#	Program Change#	Scene/Effect	Preset#
001		001	065		065
002		002	066		066
003		003	067		067
004		004	068		068
005		005	069		069
006		006	070		070
007		007	071		071
008		008	072		072
009		009	073		073
010		010	074		074
011		011	075		075
012		012	076		076
013		013	077		077
014		014	078		078
015		015	079		079
016		016	080		080
017		017	081		081
018		018	082		082
019		019	083		083
020		020	084		084
021		021	085		085
022		022	086		086
023		023	087		087
024		024	088		088
025		025	089		089
026		026	090		090
027		027	091		091
028		028	092		092
029		029	093		093
030		030	094		094
031		031	095		095
032	Scene	032	096	Scene	096
033		033	097		097
034		034	098		098
035		035	099		099
036		036	100		100
037		037	101		101
038		038	102		102
039		039	103		103
040		040	104		104
041		041	105		105
042		042	106		106
043		043	107		107
044		044	108		108
045		045	109		109
046		046	110		110
047		047	111		111
048		048	112		112
049		049	113		113
050		050	114		114
051		051	115		115
052		052	116		116
053		053	117		117
054		054	118		118
055		055	119		119
056		056	120		120
057		057	121		121
058		058	122		122
059		059	123		123
060		060	124		124
061		061	125		125
062		062	126		126
063		063	127		127
064		064	128		128

## ■ Preset Bank/Ch# 2

Program Change#	Scene/Effect	Preset#	Program Change#	Scene/Effect	Preset#
001		129	065		193
002		130	066		194
003		131	067		195
004		132	068		196
005		133	069		197
006		134	070		198
007		135	071		199
008		136	072		200
009		137	073		201
010		138	074		202
011		139	075		203
012		140	076		204
013		141	077		205
014		142	078		206
015		143	079		207
016		144	080		208
017		145	081		209
018		146	082		210
019		147	083		211
020		148	084		212
021		149	085		213
022		150	086		214
023		151	087		215
024		152	088		216
025		153	089		217
026		154	090		218
027		155	091		219
028		156	092		220
029		157	093		221
030		158	094		222
031		159	095		223
032	Scene	160	096	Scene	224
033		161	097		225
034		162	098		226
035		163	099		227
036		164	100		228
037		165	101		229
038		166	102		230
039		167	103		231
040		168	104		232
041		169	105		233
042		170	106		234
043		171	107		235
044		172	108		236
045		173	109		237
046		174	110		238
047		175	111		239
048		176	112		240
049		177	113		241
050		178	114		242
051		179	115		243
052		180	116		244
053		181	117		245
054		182	118		246
055		183	119		247
056		184	120		248
057		185	121		249
058		186	122		250
059		187	123		251
060		188	124		252
061		189	125		253
062		190	126		254
063		191	127		255
064		192	128		256

■ Preset Bank/Ch# 3

Program Change#	Scene/Effect	Preset#	Program Change#	Scene/Effect	Preset#
001		257	065		
002		258	066		
003		259	067		
004		260	068		
005		261	069		
006		262	070		
007		263	071		
008		264	072		
009		265	073		
010		266	074		
011		267	075		
012		268	076		
013		269	077		
014		270	078		
015		271	079		
016		272	080		
017		273	081		
018		274	082		
019		275	083		
020		276	084		
021		277	085		
022		278	086		
023	Scene	279	087		
024		280	088		
025		281	089		
026		282	090		
027		283	091		
028		284	092		
029		285	093		
030		286	094		
031		287	095		
032		288	096		
033		289	097	No Assign	
034		290	098		
035		291	099		
036		292	100		
037		293	101		
038		294	102		
039		295	103		
040		296	104		
041		297	105		
042		298	106		
043		299	107		
044		300	108		
045		000	109		
046			110		
047			111		
048			112		
049			113		
050			114		
051			115		
052			116		
053			117		
054			118		
055	No Assign		119		
056			120		
057			121		
058			122		
059			123		
060			124		
061			125		
062			126		
063			127		
064			128		

■ Preset Bank/Ch# 4

Program Change#	Scene/Effect	Preset#	Program Change#	Scene/Effect	Preset#
001			065		
002			066		
003			067		
004			068		
005			069		
006			070		
007			071		
008			072		
009			073		
010			074		
011			075		
012			076		
013			077		
014			078		
015			079		
016			080		
017			081		
018			082		
019			083		
020			084		
021			085		
022			086		
023			087		
024			088		
025			089		
026			090		
027			091		
028			092		
029			093		
030			094		
031			095		
032			096		
033	No Assign		097	No Assign	
034			098		
035			099		
036			100		
037			101		
038			102		
039			103		
040			104		
041			105		
042			106		
043			107		
044			108		
045			109		
046			110		
047			111		
048			112		
049			113		
050			114		
051			115		
052			116		
053			117		
054			118		
055			119		
056			120		
057			121		
058			122		
059			123		
060			124		
061			125		
062			126		
063			127		
064			128		



**■ Preset Bank/Ch# 5**

Program Change#	Scene/Effect	Preset#
001	No Assign	
002		
003		
:		
128		

**■ Preset Bank/Ch# 6**

Program Change#	Scene/Effect	Preset#
001	No Assign	
002		
003		
:		
128		

**■ Preset Bank/Ch# 7**

Program Change#	Scene/Effect	Preset#
001	No Assign	
002		
003		
:		
128		

**■ Preset Bank/Ch# 8**

Program Change#	Scene/Effect	Preset#
001	No Assign	
002		
003		
:		
128		

**■ Preset Bank/Ch# 9**

Program Change#	Scene/Effect	Preset#
001	RACK5	001
002		002
003		003
:		:
128		128

**■ Preset Bank/Ch# 10**

Program Change#	Scene/Effect	Preset#
001	RACK6	001
002		002
003		003
:		:
128		128

**■ Preset Bank/Ch# 11**

Program Change#	Scene/Effect	Preset#
001	RACK7	001
002		002
003		003
:		:
128		128

**■ Preset Bank/Ch# 12**

Program Change#	Scene/Effect	Preset#
001	RACK8	001
002		002
003		003
:		:
128		128

**■ Preset Bank/Ch# 13**

Program Change#	Scene/Effect	Preset#
001	No Assign	
002		
003		
:		
128		

**■ Preset Bank/Ch# 14**

Program Change#	Scene/Effect	Preset#
001	No Assign	
002		
003		
:		
128		

**■ Preset Bank/Ch# 15**

Program Change#	Scene/Effect	Preset#
001	No Assign	
002		
003		
:		
128		

**■ Preset Bank/Ch# 16**

Program Change#	Scene/Effect	Preset#
001	No Assign	
002		
003		
:		
128		

■ Bank/Ch#

Program Change#	Scene/Effect	User#
001		
002		
003		
004		
005		
006		
007		
008		
009		
010		
011		
012		
013		
014		
015		
016		
017		
018		
019		
020		
021		
022		
023		
024		
025		
026		
027		
028		
029		
030		
031		
032		
033		
034		
035		
036		
037		
038		
039		
040		
041		
042		
043		

Program Change#	Scene/Effect	User#
044		
045		
046		
047		
048		
049		
050		
051		
052		
053		
054		
055		
056		
057		
058		
059		
060		
061		
062		
063		
064		
065		
066		
067		
068		
069		
070		
071		
072		
073		
074		
075		
076		
077		
078		
079		
080		
081		
082		
083		
084		
085		
086		

Program Change#	Scene/Effect	User#
087		
088		
089		
090		
091		
092		
093		
094		
095		
096		
097		
098		
099		
100		
101		
102		
103		
104		
105		
106		
107		
108		
109		
110		
111		
112		
113		
114		
115		
116		
117		
118		
119		
120		
121		
122		
123		
124		
125		
126		
127		
128		

## Parameters that can be assigned to control changes

Mode	Parameter 1	Parameter 2
NO ASSIGN	—	0
FADER H	INPUT	CH 1–CH 32{64} STIN1L–STIN4R
	OUTPUT	MIX 1–MIX 16 MATRIX 1–MATRIX 8 STE- REO L–MONO(C)
FADER L	INPUT	CH 1–CH 32{64} STIN1L–STIN4R
	OUTPUT	MIX 1–MIX 16 MATRIX 1–MATRIX 8 STEREO L–MONO(C)
CH ON	INPUT	CH 1–CH 32{64} STIN1L–STIN4R
	OUTPUT	MIX 1–MIX 16 MATRIX 1–MATRIX 8 STEREO L–MONO(C)
PHASE	INPUT	CH 1–CH 32{64} STIN1L–STIN4R
INSERT	INPUT	CH 1–CH 32
	OUTPUT	MIX 1–MIX 16 MATRIX 1–MATRIX 8 STEREO L–MONO(C)
DIRECT OUT	ON	CH 1–CH 32{64}
PAN/BALANCE	INPUT	CH 1–CH 32{64} STIN1L–STIN4R
BALANCE	OUTPUT	MIX 1–MIX 16 MATRIX 1–MATRIX 8 STEREO L–STEREO R
TO STEREO	ON	CH 1–CH 32{64} STIN1L–STIN4R
TO MONO	ON	CH 1–CH 32{64} STIN1L–STIN4R
LCR	ON	CH 1–CH 32{64} STIN1L–STIN4R
	CSR	MIX 1–MIX 16
MIX SEND	MIX 1 ON – MIX16 ON	CH 1–CH 32{64} STIN1L–STIN4R
	MIX 1 PRE – MIX 16 POINT	
	MIX 1 LVL H – MIX 16 LVL H	
	MIX 1 LVL L – MIX 16 LVL L	
	MIX 1/ 2 PAN – MIX 15/16 PAN	
MIX TO ST	TO ST ON	MIX 1–MIX 16
	TO MONO ON	
	PAN	
MIX TO MTRX	MTRX1 POINT – MTRX8 POINT	MIX 1–MIX 16
	MTRX1 ON – MTRX8 ON	
	MTRX1 LVL H – MTRX8 LVL H	
	MTRX1 LVL L – MTRX8 LVL L	
	MTRX1/2 PAN – MTRX7/8 PAN	
ST TO MTRX	MTRX1 POINT – MTRX8 POINT	STEREO L–MONO(C)
	MTRX1 ON – MTRX8 ON	
	MTRX1 LVL H – MTRX8 LVL H	
	MTRX1 LVL L – MTRX8 LVL L	
	MTRX1/2 PAN – MTRX7/8 PAN	

Mode	Parameter 1	Parameter 2
INPUT EQ	ON	CH 1–CH 32{64} STIN1L–STIN4R
	LOW Q	
	LOW F	
	LOW G	
	LOW MID Q	
	LOW MID F	
	LOW MID G	
	HIGH MID Q	
	HIGH MID F	
	HIGH MID G	
	HIGH Q	
	HIGH F	
	HIGH G	
	LPF ON	
	LOW TYPE	
HIGH TYPE		
INPUT ATT	INPUT	CH 1–CH 32{64} STIN1L–STIN4R
INPUT HPF	ON	CH 1–CH 32{64} STIN1L–STIN4R
	FREQ	
OUTPUT EQ	ON	MIX 1–MIX 16 MATRIX 1–MATRIX 8 STEREO L–MONO(C)
	LOW Q	
	LOW F	
	LOW G	
	LOW MID Q	
	LOW MID F	
	LOW MID G	
	HIGH MID Q	
	HIGH MID F	
	HIGH MID G	
	HIGH Q	
	HIGH F	
	HIGH G	
	LOW TYPE	
	HIGH TYPE	
OUTPUT ATT	OUTPUT	MIX 1–MIX 16 MATRIX 1–MATRIX 16 STEREO L–MONO(C)
INPUT DYNA1	ON	CH 1–CH 32{64} STIN1L–STIN4R
	ATTACK	
	THRESHOLD	
	RANGE	
	HOLD H	
	HOLD L	
	DECAY/REL H	
	DECAY/REL L	
	RATIO	
	GAIN H	
	GAIN L	
	KNEE/WIDTH	

Mode	Parameter 1	Parameter 2
INPUT DYNA2	ON	CH 1–CH 32{64} STIN1L–STIN4R
	ATTACK	
	THRESHOLD	
	RELEASE H	
	RELEASE L	
	RATIO	
	GAIN H	
	GAIN L	
	KNEE/WIDTH	
	FILTER FREQ	
OUTPUT DYNA1	ON	MIX 1–MIX 16 MATRIX 1–MATRIX 8 STEREO L–MONO(C)
	ATTACK	
	THRESHOLD	
	RELEASE H	
	RELEASE L	
	RATIO	
	GAIN H	
	GAIN L	
	KNEE/WIDTH	
	EFFECT	
MIX BAL		
PARAM 1 H – PARAM 32 L		
GEQ	ON A	RACK1–8
	ON B	
	GAIN A 1 – GAIN A 31	
	GAIN B 1 – GAIN B 31	
MUTE MASTER	ON	MASTER 1–MASTER 8
RECALL SAFE	ON	CH 1–CH 32{64} STIN1L–STIN4R MIX 1–MIX 16 MATRIX 1–MATRIX 8 STEREO L–MONO(C) RACK1–8

# Control change parameter assignments

## ■ PRESET

Control Change#	Mode	Parameter 1	Parameter 2
1	FADER H	INPUT	CH 1
2			CH 2
3			CH 3
4			CH 4
5			CH 5
6			CH 6
7			CH 7
8			CH 8
9			CH 9
10			CH10
11			CH11
12			CH12
13			CH13
14			CH14
15			CH15
16			CH16
17			CH17
18			CH18
19			CH19
20			CH20
21			CH21
22			CH22
23			CH23
24			CH24
25	NO ASSIGN		
26			
27			
28			
29			
30			
31	FADER L	INPUT	CH 1
33			CH 2
34			CH 3
35			CH 4
36			CH 5
37			CH 6
38			CH 7
39			CH 8
40			CH 9
41			CH10
42			CH11
43			CH12
44			CH13
45			CH14
46			CH15
47			CH16
48			CH17
49			CH18
50			CH19
51			CH20
52			CH21
53			CH22
54			CH23
55			CH24
56	NO ASSIGN		
57			
58			
59			
60			
61			
62			
63			

Control Change#	Mode	Parameter 1	Parameter 2
64	CH ON	INPUT	CH 1
65			CH 2
66			CH 3
67			CH 4
68			CH 5
69			CH 6
70			CH 7
71			CH 8
72			CH 9
73			CH10
74			CH11
75			CH12
76			CH13
77			CH14
78			CH15
79			CH16
80			CH17
81			CH18
82			CH19
83			CH20
84			CH21
85			CH22
86			CH23
87			CH24
88	NO ASSIGN		
89	PAN/BALANCE	INPUT	CH 1
90			CH 2
91			CH 3
92			CH 4
93			CH 5
94			CH 6
95			CH 7
102			CH 8
103			CH 9
104			CH10
105			CH11
106			CH12
107	CH13		
108	CH14		
109	CH15		
110	CH16		
111	CH17		
112	CH18		
113	CH19		
114	CH20		
115	CH21		
116	CH22		
117	CH23		
118	CH24		
119	NO ASSIGN		

Control change parameter assignments

Control Change#	Mode	Parameter 1	Parameter 2
1			
2			
3			
4			
5			
6			
7			
8			
9			
10			
11			
12			
13			
14			
15			
16			
17			
18			
19			
20			
21			
22			
23			
24			
25			
26			
27			
28			
29			
30			
31			
33			
34			
35			
36			
37			
38			
39			
40			
41			
42			
43			
44			
45			
46			
47			
48			
49			
50			
51			
52			
53			
54			
55			
56			
57			
58			
59			
60			
61			
62			
63			
64			
65			

Control Change#	Mode	Parameter 1	Parameter 2
66			
67			
68			
69			
70			
71			
72			
73			
74			
75			
76			
77			
78			
79			
80			
81			
82			
83			
84			
85			
86			
87			
88			
89			
90			
91			
92			
93			
94			
95			
102			
103			
104			
105			
106			
107			
108			
109			
110			
111			
112			
113			
114			
115			
116			
117			
118			
119			



## NRPN parameter assignments

Parameter		From (HEX)	To (HEX)
FADER	INPUT	0000	0047
	MIX, MATRIX, STEREO LR	0060	007D
INPUT to Mix9–16 LEVEL	MIX9 SEND	007E	00C5
	MIX10 SEND	00DE	0125
	MIX11 SEND	013E	0185
	MIX12 SEND	019E	01E5
	MIX13 SEND	01FE	0245
	MIX14 SEND	025E	02A5
	MIX15 SEND	02BE	0305
	MIX16 SEND	031E	0365
MIX1–16, STEREO LR to MATRIX LEVEL	MATRIX1 SEND	04FE	0513
	MATRIX2 SEND	0514	0529
	MATRIX3 SEND	052A	053F
	MATRIX4 SEND	0540	0555
	MATRIX5 SEND	0556	056B
	MATRIX6 SEND	056C	0581
	MATRIX7 SEND	0582	0597
	MATRIX8 SEND	0598	05AD
ON	INPUT	05B6	05FD
	MIX, MATRIX, STEREO LR	0616	0633
INPUT to Mix9–16 ON	MIX9 SEND	0634	067B
	MIX10 SEND	0694	06DB
	MIX11 SEND	06F4	073B
	MIX12 SEND	0754	079B
	MIX13 SEND	07B4	07FB
	MIX14 SEND	0814	085B
	MIX15 SEND	0874	08BB
	MIX16 SEND	08D4	091B
MIX1–16, STEREO LR to MATRIX ON	MATRIX1 SEND	0AB4	0AC9
	MATRIX2 SEND	0ACA	0ADF
	MATRIX3 SEND	0AE0	0AF5
	MATRIX4 SEND	0AF6	0B0B
	MATRIX5 SEND	0B0C	0B21
	MATRIX6 SEND	0B22	0B37
	MATRIX7 SEND	0B38	0B4D
	MATRIX8 SEND	0B4E	0B63
MIX1–8 to STEREO ON	MIX TO ST	0B64	0B6B
PHASE	INPUT	0B6C	0BB3
INSERT ON	INPUT	0BCC	0BEB
	MIX, MATRIX, STEREO LR	0C2C	0C49
INPUT to Mix9–16 PRE/POST	MIX9 SEND	0C4A	0C91
	MIX10 SEND	0CAA	0CF1
	MIX11 SEND	0D0A	0D51
	MIX12 SEND	0D6A	0DB1
	MIX13 SEND	0DCA	0E11
	MIX14 SEND	0E2A	0E71
	MIX15 SEND	0E8A	0ED1
	MIX16 SEND	0EEA	0F31
INPUT57–64 to Mix1–8 LEVEL	MIX1 SEND	10CA	10D1
	MIX2 SEND	10D2	10D9
	MIX3 SEND	10DA	10E1
	MIX4 SEND	10E2	10E9
	MIX5 SEND	10EA	10F1
	MIX6 SEND	10F2	10F9
	MIX7 SEND	10FA	1101
	MIX8 SEND	1102	1109
INPUT57–64 to Mix1–8 ON	MIX1 SEND	112A	1131
	MIX2 SEND	1132	1139
	MIX3 SEND	113A	1141
	MIX4 SEND	1142	1149
	MIX5 SEND	114A	1151
	MIX6 SEND	1152	1159
	MIX7 SEND	115A	1161
	MIX8 SEND	1162	1169

Parameter		From (HEX)	To (HEX)
INPUT57–64 to MIX1–8 PRE/POST	MIX1 SEND	118A	1191
	MIX2 SEND	1192	1199
	MIX3 SEND	119A	11A1
	MIX4 SEND	11A2	11A9
	MIX5 SEND	11AA	11B1
	MIX6 SEND	11B2	11B9
	MIX7 SEND	11BA	11C1
	MIX8 SEND	11C2	11C9
INPUT57–64 EQ	LOW TYPE	11EA	11F1
	HIGH TYPE	11F2	11F9
INPUT57–64 HPF	FREQ	11FA	1201
INPUT57–64 to MIX1–8 PAN	MIX1–2	1202	1209
	MIX3–4	120A	1211
	MIX5–6	1212	1219
	MIX7–8	121A	1221
INPUT57–64 to STEREO	ON	1232	1239
INPUT57–64 RECALL SAFE	ON	123A	1241
INPUT57–64 to MONO	ON	1242	1249
INPUT49–64 DYNAMICS1	RATIO	124A	1259
	KNEE/WIDTH	125A	1269
	GAIN	126A	1279
INPUT49–64 DYNAMICS2	HIGH ONLY/FULL	127A	1289
	FILTER FREQ	128A	1299
EQ INPUT, MIX, MATRIX, STEREO LR	ON	130A	1381
	LOW Q	1382	13FF
	LOW FREQ	1400	147D
	LOW GAIN	147E	14FB
	LOW MID Q	14FC	1579
	LOW MID FREQ	157A	15F7
	LOW MID GAIN	15F8	1675
	HIGH MID Q	1676	16F3
	HIGH MID FREQ	16F4	1771
	HIGH MID GAIN	1772	17EF
	HIGH Q	17F0	186D
	HIGH FREQ	186E	18EB
	HIGH GAIN	18EC	1969
	ATT	196A	19B1
	HPF ON	19E8	1A65
	LPF ON	1A66	1AE3
	INPUT DYNAMICS1	ON	1AE4
ATTACK		1B44	1B8B
THRESHOLD		1BA4	1BEB
RANGE		1C04	1C4B
HOLD		1C64	1CAB
DECAY/RELEASE		1CC4	1D0B
INPUT DYNAMICS2 MIX, MATRIX, STEREO LR DYNAMICS1	ON	1D24	1DA1
	ATTACK	1DA2	1E1F
	THRESHOLD	1E20	1E9D
	RELEASE	1E9E	1F1B
	RATIO	1F1C	1F99
PAN/BALANCE	GAIN	1F9A	2017
	KNEE/WIDTH	2018	2095
INPUT to Mix9/10–15/16 PAN	INPUT	2096	20DD
MIX1–16, STEREO LR to MATRIX PAN	MIX9–10	20F6	213D
	MIX11–12	2156	219D
	MIX13–14	21B6	21FD
	MIX15–16	2216	225D
MIX1–8 to STEREO PAN	MATRIX1, 2	2336	234B
	MATRIX3, 4	234C	2361
	MATRIX5, 6	2362	2377
	MATRIX7, 8	2378	238D
BALANCE	MIX TO ST	238E	2395
	MIX, MATRIX, STEREO LR	2396	23B3

Parameter	From (HEX)	To (HEX)
RACK5-8(EFFECT)	BYPASS	26B4 26B7
	MIX BALANCE	26BC 26BF
	PARAM1	26C4 26C7
	PARAM2	26CC 26CF
	PARAM3	26D4 26D7
	PARAM4	26DC 26DF
	PARAM5	26E4 26E7
	PARAM6	26EC 26EF
	PARAM7	26F4 26F7
	PARAM8	26FC 26FF
	PARAM9	2704 2707
	PARAM10	270C 270F
	PARAM11	2714 2717
	PARAM12	271C 271F
	PARAM13	2724 2727
	PARAM14	272C 272F
	PARAM15	2734 2737
	PARAM16	273C 273F
	PARAM17	2744 2747
	PARAM18	274C 274F
	PARAM19	2754 2757
	PARAM20	275C 275F
	PARAM21	2764 2767
	PARAM22	276C 276F
	PARAM23	2774 2777
	PARAM24	277C 277F
	PARAM25	2784 2787
	PARAM26	278C 278F
	PARAM27	2794 2797
	PARAM28	279C 279F
	PARAM29	27A4 27A7
	PARAM30	27AC 27AF
PARAM31	27B4 27B7	
PARAM32	27BC 27BF	
RACK1-3(GEQ)	ON	27C4 27C9
	GAIN1	27CA 27CF
	GAIN2	27D0 27D5
	GAIN3	27D6 27DB
	GAIN4	27DC 27E1
	GAIN5	27E2 27E7
	GAIN6	27E8 27ED
	GAIN7	27EE 27F3
	GAIN8	27F4 27F9
	GAIN9	27FA 27FF
	GAIN10	2800 2805
	GAIN11	2806 280B
	GAIN12	280C 2811
	GAIN13	2812 2817
	GAIN14	2818 281D
	GAIN15	281E 2823
	GAIN16	2824 2829
	GAIN17	282A 282F
	GAIN18	2830 2835
	GAIN19	2836 283B
	GAIN20	283C 2841
	GAIN21	2842 2847
	GAIN22	2848 284D
	GAIN23	284E 2853
	GAIN24	2854 2859
	GAIN25	285A 285F
	GAIN26	2860 2865
	GAIN27	2866 286B
	GAIN28	286C 2871
	GAIN29	2872 2877
	GAIN30	2878 287D
	GAIN31	287E 2883
	FADER	MONO(C)

Parameter	From (HEX)	To (HEX)
INPUT1-56, STIN 1L-4R to Mix1-8 LEVEL	MIX1 SEND	28EA 2929
	MIX2 SEND	292A 2969
	MIX3 SEND	296A 29A9
	MIX4 SEND	29AA 29E9
	MIX5 SEND	29EA 2A29
	MIX6 SEND	2A2A 2A69
	MIX7 SEND	2A6A 2AA9
	MIX8 SEND	2AAA 2AE9
MONO(C) to Matrix LEVEL	MATRIX1 SEND	2BEA 2BEE
	MATRIX2 SEND	2BF0 2BF4
	MATRIX3 SEND	2BF6 2BFA
	MATRIX4 SEND	2BFC 2C00
	MATRIX5 SEND	2C02 2C06
	MATRIX6 SEND	2C08 2C0C
	MATRIX7 SEND	2C0E 2C12
	MATRIX8 SEND	2C14 2C18
ON	MONO(C)	2C2A 2C2E
INPUT1-56, STIN 1L-4R to Mix1-8 ON	MIX1 SEND	2C30 2C6F
	MIX2 SEND	2C70 2CAF
	MIX3 SEND	2CB0 2CEF
	MIX4 SEND	2CF0 2D2F
	MIX5 SEND	2D30 2D6F
	MIX6 SEND	2D70 2DAF
	MIX7 SEND	2DB0 2DEF
	MIX8 SEND	2DF0 2E2F
MONO(C) to Matrix ON	MATRIX SEND	2F30 2F34
MIX9-16 to STE-REO ON	MIX TO ST	2F36 2F3D
INSERT	MONO(C)	2F46 2F4A
INPUT1-56, STIN 1L-4R to MIX1-8 PRE/POST	MIX1 SEND	2F4C 2F8B
	MIX2 SEND	2F8C 2FCB
	MIX3 SEND	2FCC 300B
	MIX4 SEND	300C 304B
	MIX5 SEND	304C 308B
	MIX6 SEND	308C 30CB
	MIX7 SEND	30CC 310B
	MIX8 SEND	310C 314B
MONO(C) EQ	ON	325E 3262
	LOW Q	3264 3268
	LOW FREQ	326A 326E
	LOW GAIN	3270 3274
	LOW MID Q	3276 327A
	LOW MID FREQ	327C 3280
	LOW MID GAIN	3282 3286
	HIGH MID Q	3288 328C
	HIGH MID FREQ	328E 3292
	HIGH MID GAIN	3294 3298
	HIGH Q	329A 329E
	HIGH FREQ	32A0 32A4
	HIGH GAIN	32A6 32AA
	HPF ON	32AC 32B0
LPF ON	32B2 32B6	
INPUT1-56, STIN 1L-4R EQ	LOW TYPE	3440 347F
	HIGH TYPE	3480 34BF
MIX, MATRIX, STE-REO LRC EQ	LOW TYPE	34C0 34E2
	HIGH TYPE	34E4 3506
INPUT1-56, STIN 1L-4R HPF	FREQ	3640 367F
	ON	3680 3684
MONO(C) DYNAMICS1	ATTACK	3686 368A
	THRESHOLD	368C 3690
	RELEASE	3692 3696
	RATIO	3698 369C
	GAIN	369E 36A2
	KNEE/WIDTH	36A4 36A8

Parameter		From (HEX)	To (HEX)
INPUT1-56, STIN 1L-4R to MIX1-8 PAN	MIX1-2	36AA	36E9
	MIX3-4	36EA	3729
	MIX5-6	372A	3769
	MIX7-8	376A	37A9
MONO(C) to Matrix1-8 PAN	MATRIX1,2	382A	382E
	MATRIX3, 4	3830	3834
	MATRIX5, 6	3836	383A
MATRIX7, 8	383C	3840	
MIX9-16 to STEREO ON	MIX TO ST	3842	3849
RACK4-6(GEQ)	ON	3852	3857
	GAIN1	3858	385D
	GAIN2	385E	3863
	GAIN3	3864	3869
	GAIN4	386A	386F
	GAIN5	3870	3875
	GAIN6	3876	387B
	GAIN7	387C	3881
	GAIN8	3882	3887
	GAIN9	3888	388D
	GAIN10	388E	3893
	GAIN11	3894	3899
	GAIN12	389A	389F
	GAIN13	38A0	38A5
	GAIN14	38A6	38AB
	GAIN15	38AC	38B1
	GAIN16	38B2	38B7
	GAIN17	38B8	38BD
	GAIN18	38BE	38C3
	GAIN19	38C4	38C9
	GAIN20	38CA	38CF
	GAIN21	38D0	38D5
	GAIN22	38D6	38DB
	GAIN23	38DC	38E1
	GAIN24	38E2	38E7
	GAIN25	38E8	38ED
	GAIN26	38EE	38F3
	GAIN27	38F4	38F9
	GAIN28	38FA	38FF
	GAIN29	3900	3905
	GAIN30	3906	390B
GAIN31	390C	3911	
LCR IN, MIX	ON	3912	3969
	CSR	396A	39C1
DIRECT OUT	ON	39C2	3A01
INPUT1-56, STIN 1L-4R to STEREO	ON	3A02	3A41
MUTE MASTER	ON	3A5A	3A61
RECALL SAFE	ON	3A66	3AEA
HA	INPUT GAIN 1,9,17,25	3B0F	3B12
	INPUT GAIN 2,10,18,26	3B1F	3B22
	INPUT GAIN 3,11,19,27	3B2F	3B32
	INPUT GAIN 4,12,20,28	3B3F	3B42
	INPUT GAIN 5,13,21,29	3B4F	3B52
	INPUT GAIN 6,14,22,30	3B5F	3B62
	INPUT GAIN 7,15,23,31	3B6F	3B72
	INPUT GAIN 8,16,24,32	3B7F	3B82
	INPUT +48v 1,9,17,25	3B8F	3B92
	INPUT +48v 2,10,18,26	3B9F	3BA2
	INPUT +48v 3,11,19,27	3BAF	3BB2
	INPUT +48v 4,12,20,28	3BBF	3BC2
	INPUT +48v 5,13,21,29	3BCF	3BD2
	INPUT +48v 6,14,22,30	3BDF	3BE2
	INPUT +48v 7,15,23,31	3BEF	3BF2
	INPUT +48v 8,16,24,32	3BFF	3C02
	EXTERNAL GAIN1	3B06	3B09
	EXTERNAL GAIN2	3B16	3B19
	EXTERNAL GAIN3	3B26	3B29
	EXTERNAL GAIN4	3B36	3B39
	EXTERNAL GAIN5	3B46	3B49

Parameter		From (HEX)	To (HEX)
HA	EXTERNAL GAIN6	3B56	3B59
	EXTERNAL GAIN7	3B66	3B69
	EXTERNAL GAIN8	3B76	3B79
	EXTERNAL +48v 1	3B86	3B89
	EXTERNAL +48v 2	3B96	3B99
	EXTERNAL +48v 3	3BA6	3BA9
	EXTERNAL +48v 4	3BB6	3BB9
	EXTERNAL +48v 5	3BC6	3BC9
	EXTERNAL +48v 6	3BD6	3BD9
	EXTERNAL +48v 7	3BE6	3BE9
	EXTERNAL +48v 8	3BF6	3BF9
	EXTERNAL HPF1	3C06	3C09
	EXTERNAL HPF2	3C16	3C19
	EXTERNAL HPF3	3C26	3C29
	EXTERNAL HPF4	3C36	3C39
	EXTERNAL HPF5	3C46	3C49
EXTERNAL HPF6	3C56	3C59	
EXTERNAL HPF7	3C66	3C69	
EXTERNAL HPF8	3C76	3C79	
INPUT1-56, STIN 1L-4R to MONO	ON	3C86	3CC5
MIX to MONO	ON	3CC6	3CD5
SLOT OUT DELAY	ON	3CD6	3CF5
	TIME HIGH	3D06	3D25
OMNI OUT DELAY	TIME LOW	3D36	3D55
	ON	3D66	3D75
DIGITAL OUT DELAY	TIME HIGH	3D76	3D85
	TIME LOW	3D86	3D95
INPUT1-48, STIN 1L-4R DYNAMICS1	ON	3D96	3D97
	TIME HIGH	3D98	3D99
INPUT1-48, STIN 1L-4R DYNAMICS2	TIME LOW	3D9A	3D9B
	RATIO	3D9C	3DD3
KNEE/WIDTH	GAIN	3DD4	3E0B
	GAIN	3E0C	3E43
HIGH ONLY/FULL	FILTER FREQ	3E44	3E7B
	ON	3E7C	3EB3
RACK7-8(GEQ)	ON	3EB4	3EB7
	GAIN1	3EB8	3EBB
	GAIN2	3EBC	3EBF
	GAIN3	3EC0	3EC3
	GAIN4	3EC4	3EC7
	GAIN5	3EC8	3ECB
	GAIN6	3ECC	3ECF
	GAIN7	3ED0	3ED3
	GAIN8	3ED4	3ED7
	GAIN9	3ED8	3EDB
	GAIN10	3EDC	3EDF
	GAIN11	3EE0	3EE3
	GAIN12	3EE4	3EE7
	GAIN13	3EE8	3EEB
	GAIN14	3EEC	3EEF
	GAIN15	3EF0	3EF3
	GAIN16	3EF4	3EF7
	GAIN17	3EF8	3EFB
	GAIN18	3EFC	3EFF
	GAIN19	3F00	3F03
	GAIN20	3F04	3F07
	GAIN21	3F08	3F0B
	GAIN22	3F0C	3F0F
	GAIN23	3F10	3F13
	GAIN24	3F14	3F17
	GAIN25	3F18	3F1B
	GAIN26	3F1C	3F1F
	GAIN27	3F20	3F23
	GAIN28	3F24	3F27
	GAIN29	3F28	3F2B
	GAIN30	3F2C	3F2F
GAIN31	3F30	3F33	
EQ	ATT	3F34	3F4E

## Mixing parameter operation applicability

This table indicates how the behaviors of each of the input channel and output channel parameters are affected by Stereo, Link, Recall Safe, and User Level settings.

### ■ Input Channels

Parameter	Stereo *3	LINK	RECALL SAFE	USER LEVEL
HA	O	INPUT HA	INPUT HA	INPUT HA
NAME, ICON			INPUT NAME	INPUT NAME
LCR	O		INPUT ALL	INPUT PROCESSING
Insert On	O		INPUT ALL	INPUT PROCESSING
Direct Out On/Level	O		INPUT ALL	INPUT PROCESSING
On	O	INPUT ON	INPUT ON	INPUT FADER/ON
Fader	O	INPUT FADER	INPUT FADER	INPUT FADER/ON
Pan/Balance	O		INPUT ALL	INPUT FADER/ON
Att	O	INPUT EQ	INPUT EQ	INPUT PROCESSING
HPF	O	INPUT EQ	INPUT EQ	INPUT PROCESSING
EQ	O	INPUT EQ	INPUT EQ	INPUT PROCESSING
Dynamics1	O*1	INPUT DYNAMICS1*1	INPUT DYNA1	INPUT PROCESSING
Dynamics2	O*1	INPUT DYNAMICS2*1	INPUT DYNA2	INPUT PROCESSING
Mute Assign	O		INPUT ALL	MUTE GROUP ASSIGN
To Mix ON	O	INPUT MIX ON*2	INPUT MIX ON	INPUT FADER/ON
To Mix LEVEL	O	INPUT MIX SEND*2	INPUT MIX SEND	INPUT FADER/ON
To Mix PRE/POST	O		INPUT ALL	INPUT PROCESSING
To Stereo/Mono	O		INPUT ALL	INPUT PROCESSING
Cue	O			
Key In Cue	O			
Mute Safe	O			
Recall Safe	O			
Fade Time	O			STORE

\*1 Except for Key In Source

\*2 Applies to parameters for which the MIX channel 1–16 individual Send Parameter setting and the item in the table are both enabled.

\*3 ST IN 1–4 only.

### ■ MIX Channels

Parameter	Stereo	RECALL SAFE	USER LEVEL
NAME, ICON		MIX NAME	OUTPUT NAME
LCR	O	MIX ALL	MIX PROCESSING
Insert On	O	MIX ALL	MIX PROCESSING
On	O	MIX ON	MIX FADER/ON
Fader	O	MIX FADER	MIX FADER/ON
Pan/Balance	O	MIX ALL	MIX FADER/ON
Att	O	MIX EQ	MIX PROCESSING
EQ	O	MIX EQ	MIX PROCESSING
Dynamics1	O*1	MIX DYNA1	MIX PROCESSING
Mute Assign	O	MIX ALL	MUTE ASSIGN
To Mix ON		WITH MIX SEND	WITH MIX SEND
To Mix LEVEL		WITH MIX SEND	WITH MIX SEND
To Matrix On	O	MIX to MATRIX ON	MIX FADER/ON
To Matrix LEVEL	O	MIX to MATRIX SEND	MIX FADER/ON
To Matrix POINT	O	MIX ALL	MIX PROCESSING
To Stereo/Mono	O	MIX ALL	MIX PROCESSING
Cue	O		
Mute Safe	O		
Recall Safe	O		
Fade Time	O		STORE

\*1 Except for Key In Source

### ■ MATRIX Channels

Parameter	Stereo	RECALL SAFE	USER LEVEL
NAME, ICON		MATRIX NAME	OUTPUT NAME
Insert On	O	MATRIX ALL	MATRIX PROCESSING
On	O	MATRIX ON	MATRIX FADER/ON
Fader	O	MATRIX FADER	MATRIX FADER/ON
Pan/Balance	O	MATRIX ALL	MATRIX FADER/ON
Att	O	MATRIX EQ	MATRIX PROCESSING
Dynamics1	O*1	MATRIX DYNA1	MATRIX PROCESSING
EQ	O	MATRIX EQ	MATRIX PROCESSING
Mute Assign	O	MATRIX ALL	MUTE ASSIGN
To Matrix On		WITH MATRIX SEND	WITH MATRIX SEND
To Matrix LEVEL		WITH MATRIX SEND	WITH MATRIX SEND
Cue	O		
Mute Safe	O		
Recall Safe	O		
Fade Time	O		STORE

\*1 Except for Key In Source

### ■ STEREO, MONO Channels

Parameter	Stereo *2	RECALL SAFE	USER LEVEL
NAME, ICON		STEREO, MONO NAME	OUTPUT NAME
Insert On	O	STEREO, MONO ALL	STEREO, MONO PROCESSING
On	O	STEREO, MONO ON	STEREO, MONO FADER/ON
Fader	O	STEREO, MONO FADER	STEREO, MONO FADER/ON
Pan/Balance	O	STEREO, MONO ALL	STEREO, MONO FADER/ON
Att	O	STEREO, MONO EQ	STEREO, MONO PROCESSING
Dynamics1	O	STEREO, MONO DYNA1	STEREO, MONO PROCESSING
EQ	O	STEREO, MONO EQ	STEREO, MONO PROCESSING
Mute Assign	O	STEREO, MONO ALL	MUTE ASSIGN
To Matrix On	O	STEREO, MONO to MATRIX ON	STEREO, MONO FADER/ON
To Matrix LEVEL	O	STEREO, MONO to MATRIX SEND	STEREO, MONO FADER/ON
To Matrix POINT	O	STEREO, MONO ALL	STEREO, MONO PROCESSING
Cue	O		
Mute Safe	O		
Recall Safe	O		
Fade Time	O		STORE

\*1 Except for Key In Source

\*2 STEREO channel only.

## Functions that can be assigned to user-defined keys

Function	PARAMETER 1	PARAMETER 2	LED	Explanation
NO ASSIGN	—	—	Dark	No assignment
SCENE	RECALL	—	Flash	Recall the currently selected scene
	STORE	—		Store to the currently selected scene
	▲	SCENE +1, LIST UP		SCENE +1 selects the next scene number. LIST UP scrolls the scene list upward by one. Simultaneously pressing [SCENE ▲] and [SCENE ▼] keys will return to the current scene number. After scene 300, wrap around to scene 000.
	▼	SCENE -1, LIST DOWN		SCENE -1 selects the previous scene number. LIST UP scrolls the scene list upward by one. Simultaneously pressing [SCENE ▲] and [SCENE ▼] keys will return to the current scene number. After scene 000, wrap around to scene 300.
	INC RECALL	—		Recall the scene of the next existing number
	DEC RECALL	—		Recall the scene of the previous existing number
	DIRECT RECALL	SCENE #000–#300		Directly recall the scene of the specified number
	RECALL UNDO	—		Lit if UNDO is possible
STORE UNDO	—	Lit if UNDO is possible	Execute STORE UNDO	
TALKBACK	TALKBACK ON	LATCH	ON: lit, OFF: dark	Switch TALKBACK on/off
		UNLATCH	ON: lit, OFF: dark	Turn TALKBACK on while pressed
	SELECTED CH ASSIGN	—	Lit if assignment is the same	When you press this key, the previously-stored assignment state will be applied. While holding down this key, press a SEL key of an output channel to switch the assignment on/off, and its state will be remembered. During this time, the [SEL] LED will be lit if assign is ON, or dark if OFF.
OSCILLATOR	OSCILLATOR ON	—	ON: lit, OFF: dark	Switch the OSC on/off When this turns on, the OSC popup window will appear
	SELECTED CH ASSIGN	—	Lit if assignment is the same	When you press this key, the previously-stored assignment state will be applied. While holding down this key, press a SEL key of an output channel to switch the assignment on/off, and its state will be remembered. During this time, the [SEL] LED will be lit if assign is ON, or dark if OFF.
CUE CLEAR	—	—	Flash	Clear all CUE settings together
MONITOR	MONITOR ON	—	ON: lit, OFF: dark	Switch MONITOR on/off
	SELECTED CH ASSIGN	—	Lit if assignment is the same	When you press this key, the previously-stored assignment state will be applied. While holding down this key, press a SEL key of a MIX or MATRIX channel to switch the assignment on/off, and its state will be remembered. During this time, the [SEL] LED will be lit if assign is ON, or dark if OFF.
	SOURCE SELECT	STEREO L/R, MONO(C), LCR, 2TR IN L/R, INPUT 15/16 {31/32}, PLAYBACK OUT, DEFINE	Lit if the selected monitor source is on	Recall the selected signal to the monitor
	DIMMER ON	—	ON: lit, OFF: dark	Switch the monitor dimmer function on/off
	MONO MONITOR	—	ON: lit, OFF: dark	Switch MONO MONITOR on/off
	MONITOR ON MASTER FADER	—	ON: lit, OFF: dark	If this is on, you can use the master fader to control the monitor level, and the ON key to switch the monitor output on/off
EFFECT BYPASS	RACK 5–8	—	ON: lit, OFF: dark	Bypass the specified effect
TAP TEMPO	CURRENT PAGE	—	Blink in synchronization to the tempo	Use the tap tempo function in the displayed screen
	RACK 5–8	—		Use the tap tempo function for the specified effect
MUTE MASTER	MUTE GROUP 1–8	—	ON: lit, OFF: dark	Switch MUTE GROUP MASTER on/off
METER	PEAK HOLD ON	—	ON: lit, OFF: dark	Turn the meter PEAK HOLD function on/off
	STEREO/MONO(C) SEL	—	MONO (C): lit, STEREO: dark	Switch the top panel STEREO L/R METER function

Function	PARAMETER 1	PARAMETER 2	LED	Explanation
PAGE CHANGE	PAGE BOOKMARK	—	When storing a page: Flash When showing a memorized page: Blink When not showing a memorized page: Lit Not memorized: Dark	Memorize the currently selected screen (hold down the key for two seconds or longer), or display the last-memorized screen (press and release the key within two seconds). Popup windows can also be memorized. In the case of a rack, the number of that rack is also memorized.
	CLOSE POPUP	—	Flash	Close the displayed popup window
CH SELECT	INC, DEC	—	Flash	Increment/Decrement the channel selection
SET BY SEL	SET [+48V]	—	While pressing: Lit	Hold down this key and press SEL to switch it on/off. During this time, the [SEL] LED will be lit if on or dark if off.
	SET [Ø]	—		
	SET [PRE SEND]	—		
	SET [TO STEREO]	—		
	SET [TO MONO]	—		
	SET [TO LCR]	—		
	SET [DIRECT OUT]	—		
SET DEFAULT VALUE	—	—	While pressing: Lit	Hold down this key and press the SELECTED CH encoder to return to the default value. You can also return to the default value by moving the cursor to the knob or fader in the LCD screen, then holding down this key and pressing the [ENTER] key.
SET NOMINAL LEVEL	—	—	While pressing: Lit	While holding down this key, press a [SEL] key to set the fader of that channel to nominal level. You can also push a SELECTED SEND encoder to set the send level to nominal level. You can also return to nominal level by moving the cursor to the knob or fader in the LCD screen, then holding down this key and pressing the [ENTER] key.
SENDS ON FADER	MIX1-16, MATRIX1-8	—	Blinks in SENDS ON FADER mode	Recall the Sends On Fader function to the selected MIX or MATRIX
GEQ	FADER ASSIGN	—	ON: lit, OFF: dark	Turn the GEQ Fader Assign function on/off.
RECORDER	TRANSPORT	PLAY/PAUSE, STOP, FF/Next, REW/Previous, REC	Same as the indication for the corresponding LCD button	Recorder transport functions
		AUTOREC	While pressing: Lit	Shortcut function for STOP → REC → PLAY. Recording will be initiated in a single action. If this is executed during recording, the file being recorded will first be closed, and then recording will continue with a new file.
	DIRECT PLAY	Song title or file name of audio files	While pressing: Lit	Start playback of a specified audio file from the beginning only once. The audio file to be played must be saved in the SONGS folder within the YPE folder. Please note that you won't be able to specify a file that is in the root directory or another folder. When you execute playback, the path in the TITLE LIST screen will change to \YPE\SONGS\.
HELP	—	—	ON: lit, OFF: dark	Switch the Help function on/off



Function	PARAMETER 1	PARAMETER 2	LED	Explanation
LS9 EDITOR	MASTER	—	Flash	Access the LS9 EDITOR screen
	OVERVIEW	CH1-16, CH17-32, {CH33-48, CH49-64, } STIN, MIX, MATRIX, ST/MONO, CUSTOM FADER LAYER CH1-16, {CUSTOM FADER LAYER CH17-32}, CUSTOM FADER LAYER STIN		
	SELECTED CHANNEL	—		
	LIBRARY	DYNAMICS LIBRARY, INPUT EQ LIBRARY, OUTPUT EQ LIBRARY, EFFECT LIBRARY, GEQ LIBRARY		
	PATCH EDITOR	INPUT PATCH, OUTPUT PATCH, INPUT INSERT PATCH, OUTPUT INSERT PATCH, DIRECT OUT PATCH, PATCH LIST		
	RACK EDITOR	RACK, RACK1-8		
	METER	INPUT METER, OUTPUT METER, CUSTOM FADER LAYER		
	GROUP/LINK	MUTE GROUP, CHANNEL LINK		
	SCENE	SCENE MEMORY, RECALL SAFE, FADE TIME		

# MIDI Data Format

This section explains the format of the data that the LS9 is able to understand, send, and receive.

## 1 CHANNEL MESSAGE

### 1.1 NOTE OFF (8n)

#### Reception

These messages are echoed to MIDI OUT if [OTHER COMMAND ECHO] is ON.

They are received if [Rx CH] matches, and used to control effects.

STATUS	1000nnnn	8n	Note off message
DATA	0nnnnnnn	nn	Note number
	0vvvvvvv	vv	Velocity(ignored)

### 1.2 NOTE ON (9n)

#### Reception

These messages are echoed to MIDI OUT if [OTHER COMMAND ECHO] is ON.

They are received if [Rx CH] matches, and used to control effects.

STATUS	1001nnnn	9n	Note on message
DATA	0nnnnnnn	nn	Note number
	0vvvvvvv	vv	Velocity (1-127:on, 0:off)

### 1.3 CONTROL CHANGE (Bn)

Two types of CONTROL CHANGE can be transmitted and received; [NRPN] (Non-Registered Parameter Numbers) and freely-assigned [TABLE] (1CH x 110) messages. Select either [TABLE] or [NRPN].

#### Reception

These messages are echoed to MIDI OUT if [CONTROL CHANGE ECHO] is ON.

If [TABLE] is selected, these messages are received when [CONTROL CHANGE Rx] is ON and [Rx CH] matches, and will control parameters according to the settings of the [CONTROL CHANGE EVENT LIST]. For the parameters that can be assigned, refer to "Parameters that can be assigned to control changes" on page 249.

If [NRPN] is selected, these messages are received when [CONTROL CHANGE Rx] is ON and the [Rx CH] matches; the four messages NRPN control number (62h, 63h) and DATA ENTRY control number (06h, 26h) are used to control the specified parameter.

#### Transmission

If [TABLE] is selected, and if [CONTROL CHANGE Tx] is ON when you operate a parameter that is assigned in the [CONTROL CHANGE EVENT LIST], these messages will be transmitted on the [Tx CH] channel. For the parameters that can be assigned, refer to "Parameters that can be assigned to control changes" on page 249.

If [NRPN] is selected, and if [CONTROL CHANGE Tx] is ON when you operate a specified parameter, the four messages NRPN control number (62h, 63h) and DATA ENTRY control number (06h, 26h) are transmitted on the [Tx CH] channel. For the parameters that can be assigned, refer to "Parameters that can be assigned to control changes" on page 249.

CONTROL CHANGE messages are not used for transmission to LS9 Editor because there is no guarantee that the contents of the assignment tables will match. (PARAMETER CHANGE messages are always used.)

CONTROL CHANGE numbers 0 and 32 are for selecting banks.

STATUS	1011nnnn	Bn	Control change
DATA	00	00	Control number (00)
	0vvvvvvv	vv	Control Value (0-127)

STATUS	1011nnnn	Bn	Control change
DATA	20	20	Control number (32)
	0vvvvvvv	vv	Control Value (0-127)

#### If [TABLE] is selected

STATUS	1011nnnn	Bn	Control change
DATA	0nnnnnnn	nn	Control number (1-5, 7-31, 33-37, 38-95, 102-119) *
	0vvvvvvv	vv	Control Value (0-127)

\* Numbers 0, 32, and 96-101 cannot be used.

\* Control number 6, 38 can be used.

#### Equation for converting a Control Value to parameter data

paramSteps = paramMax-paramMin + 1;  
 add = paramWidth / paramSteps;  
 mod = paramWidth-add \* paramSteps;  
 curValue = paramSteps \* add + mod / 2;

#### (1) If the assigned parameter has fewer than 128 steps

paramWidth = 128; rxValue = Control value;

#### (2) If the assigned parameter has 128 or more but less than 16,384 steps

paramWidth = 16384;

(2-1) When High and Low data is received

rxValue = Control value(High) \* 128 + Control value(Low);

(2-2) When only Low data is received

rxValue = (curValue & 16256) + Control value(Low);

(2-3) When only High data is received

rxValue = Control value(High) \* 128 + (curValue & 127);

#### (3) If the assigned parameter has 16,384 or more but less than 2,097,152 steps

paramWidth = 2097152;

(3-1) When High, Middle, and Low data is received

rxValue = Control value(High) \* 16384 + Control value(Middle) \* 128 + Control value(Low);

(3-2) When only Low data is received

rxValue = (curValue & 2097024) + Control value(Low);

(3-3) When only Middle data is received

rxValue = (curValue & 2080895) + Control value(Middle) \* 128;

(3-4) When only High data is received

rxValue = (curValue & 16383) + Control value(High) \* 16384;

(3-5) When only Middle and Low data is received

rxValue = (curValue & 2080768) + Control value(Middle) \* 128 + Control value(Low);

(3-6) When only High and Low data is received

rxValue = (curValue & 16256) + Control value(High) \* 16384 + Control value(Low);

(3-7) When only High and Middle data is received

rxValue = (curValue & 127) + Control value(High) \* 16384 + Control value(Middle) \* 128;

if ( rxValue > paramWidth)

rxValue = paramWidth;

param = ( rxValue-mod / 2) / add;

#### If [NRPN] is selected

STATUS	1011nnnn	Bn	Control change
DATA	01100010	62	NRPN LSB
	0vvvvvvv	vv	Parameter number LSB
STATUS	1011nnnn	Bn	Control change *
DATA	01100011	63	NRPN MSB
	0vvvvvvv	vv	Parameter number MSB
STATUS	1011nnnn	Bn	Control change *
DATA	00000110	06	Data entry MSB
	0vvvvvvv	vv	Parameter data MSB
STATUS	1011nnnn	Bn	Control change *
DATA	00100110	26	Data entry LSB
	0vvvvvvv	vv	Parameter data LSB

\* The STATUS byte of the second and subsequent messages need not be added during transmission. Reception must occur correctly whether or not the status byte is omitted.

## 1.4 PROGRAM CHANGE (Cn)

### Reception

If [PROGRAM CHANGE ECHO] is ON, bank select messages will also be echoed from MIDI OUT.

If SINGLE CH is selected, these messages are received if [PROGRAM CHANGE Rx] is ON and the [Rx CH] matches. However if [OMNI] is ON, these messages are received regardless of the channel. When these messages are received, scene memory and effect library are recalled according to the settings of the [PROGRAM CHANGE EVENT LIST].

### Transmission

If [PROGRAM CHANGE Tx] is ON, these messages are transmitted according to the [PROGRAM CHANGE Table] settings when scene memory and effect library are recalled.

If SINGLE CH is selected, these messages are transmitted on the [Tx CH] channel.

If the recalled scene memory and effect library has been assigned to more than one PROGRAM NUMBER, the lowest-numbered PROGRAM NUMBER for each MIDI channel will be transmitted.

PROGRAM CHANGE messages are not used for transmission to LS9 Editor because there is no guarantee that the contents of the assignment tables will match. (PARAMETER CHANGE messages are always used.)

You can choose either MULTI MIDI CH or SINGLE CH.

### If SINGLE is selected

You can choose the Rx CH, OMNI CH, and Tx CH.

You can choose whether a bank select message will be added.

A bank of up to 16 can be specified.

### If MULTI is selected

The Rx and Tx channels will be the same.

The assignment table will use the settings for each MIDI channel. Bank select messages will not be added.

You can make settings for up to sixteen MIDI channels.

```
STATUS      1100nnnn Cn Program change
DATA        0nnnnnnn nn Program number (0-127)
```

## 2 SYSTEM REALTIME MESSAGE

### 2.1 SONG SELECT (F3)

Select the track number shown in the TITLE LIST screen of the USB memory recorder.

```
STATUS      11110011 F3 Song select
Song number 0sssssss ss Song number (0-127)
```

### 2.2 TIMING CLOCK (F8)

#### Reception

This message is used to control effects. This message is transmitted twenty-four times per quarter note.

Echoing of this message depends on the OTHER item in the ECHO settings.

```
STATUS      11111000 F8 Timing clock
```

### 2.3 ACTIVE SENSING (FE)

#### Reception

Once this message has been received, MIDI communication will be initialized (e.g., Running Status will be cleared) if no message is received for an interval of 400 ms.

This message is not subject to echoing.

```
STATUS      11111110 FE Active sensing
```

### 2.4 SYSTEM RESET (FF)

#### Reception

When this message is received, MIDI communication will be initialized (e.g., Running Status will be cleared).

This message is not subject to echoing.

```
STATUS      11111111 FF System reset
```

## 3 SYSTEM EXCLUSIVE MESSAGE

### 3.1 MMC

#### < MMC STOP >

##### Reception

If the [DEVICE NO.] matches or is 7F, receives this message and stops.

```
STATUS      11110000 F0 System exclusive message
ID No.      01111111 7F Real time System exclusive
Device ID   0ddddddd dd Destination (00-7E, 7F:all call)
COMMAND     00000110 06 Machine Control Command(MCC) sub-id
            00000001 01 Stop(MCS)
EOX         11110111 F7 End of exclusive
```

#### < MMC PLAY >

##### Reception

If the [DEVICE NO.] matches or is 7F, receives this message and starts playback.

```
STATUS      11110000 F0 System exclusive message
ID No.      01111111 7F Real time System exclusive
Device ID   0ddddddd dd Destination (00-7E, 7F:all call)
COMMAND     00000110 06 Machine Control Command(MCC) sub-id
            00000010 02 Play(MCS)
EOX         11110111 F7 End of exclusive
```

#### < MMC DEFERED PLAY >

##### Reception

If the [DEVICE NO.] matches or is 7F, receives this message and starts playback.

```
STATUS      11110000 F0 System exclusive message
ID No.      01111111 7F Real time System exclusive
Device ID   0ddddddd dd Destination (00-7E, 7F:all call)
COMMAND     00000110 06 Machine Control Command(MCC) sub-id
            00000011 03 Deferred Play(MCS)
EOX         11110111 F7 End of exclusive
```

#### < MMC RECORD STROBE >

##### Reception

If the [DEVICE NO.] matches or is 7F, receives this message, and if stopped, starts recording.

```
STATUS      11110000 F0 System exclusive message
ID No.      01111111 7F Real time System exclusive
Device ID   0ddddddd dd Destination (00-7E, 7F:all call)
COMMAND     00000110 06 Machine Control Command(MCC) sub-id
            00000110 06 Record strobe
EOX         11110111 F7 End of exclusive
```

#### < MMC PAUSE >

##### Reception

If the [DEVICE NO.] matches or is 7F, receives this message, and if playing, pauses.

```
STATUS      11110000 F0 System exclusive message
ID No.      01111111 7F Real time System exclusive
Device ID   0ddddddd dd Destination (00-7E, 7F:all call)
COMMAND     00000110 06 Machine Control Command(MCC) sub-id
            00001001 09 Pause(MCS)
EOX         11110111 F7 End of exclusive
```

### 3.2 BULK DUMP

Command	rx/tx	Function
F0 43 0n 3E cc cc 12 mm ... mm dd dd ... ee F7	rx/tx	BULK DUMP DATA
F0 43 2n 3E 12 mm ... mm dd dd F7	rx	BULK DUMP REQUEST

The LS9 uses the following data types for a bulk dump.

Module Name(mm)	Data Number(dd)
SCENE LIB	"SCENE_" *1) *14) *15)
INPUT EQ LIB	"INEQ_" *2) *7) *8)
OUTPUT EQ LIB	"OUTEQ_" *3) *9) *10) *11)
Dynamics LIB	"DYNA_" *4) *7) *8) *9) *10) *11)
GEQ LIB	"GEQ_" *5) *12)
EFFECT LIB	"EFFECT_" *6) *13)
Mixer Setup	"MIXERSET" Fix (512)
Outport Setup	"OUT_PORT" Fix (512)
Monitor Setup	"MONITOR_" Fix (512)
MIDI Setup	"MIDI_SET" Fix (512)
Lib Number	"LIB_NUM_" Fix (512)
Program Change Table	"PRGMCHG_" Fix (512)
Control Change Table	"CTRLCHG_" Fix (512)
Preference (Current)	"PREF_CUR" Fix (512)
Preference (Admin)	"PREF_ADM" Fix (512)
Preference (Guest)	"PREF_GST" Fix (512)
User Defined Keys (Current)	"UDEF_CUR" Fix (512)
User Defined Keys (Admin)	"UDEF_ADM" Fix (512)
User Defined Keys (Guest)	"UDEF_GST" Fix (512)
Custom Fader Layer (Current)	"CFAD_CUR" Fix (512)
Custom Fader Layer (Admin)	"CFAD_ADM" Fix (512)
Custom Fader Layer (Guest)	"CFAD_GST" Fix (512)
User Level (Current)	"UKEY_CUR" Fix (512)
User Level (Guest)	"UKEY_GST" Fix (512)

- \*1) 0–300 Scene Number (0 Request Only),
- \*2) 1–199 Input EQ Library Number (1–40 Request Only)
- \*3) 1–199 Output EQ Library Number (1–3 Request Only)
- \*4) 1–199 Dynamics Library Number (1–41 Request Only)
- \*5) 0–199 GEQ Library Number (0 Request Only)
- \*6) 1–199 Effect Library Number (1–57 Request Only)
- \*7) 512–575 Input 1–64,
- \*8) 576–583 STIN 1L–4R,
- \*9) 768–783 MIX 1–16,
- \*10) 1024–1031 MATRIX 1-8 (LS9-32 only),
- \*11) 1280–1282 STEREO L–C,
- \*12) 512–519 GEQ 1–8,
- \*13) 512–515 EFFECT 1–4,
- \*14) 512 Current Data,
- \*15) 768 Current Data with Recall Safe,

Data is lost when you write to the preset library. The unique header (Model ID) identifies whether the device is a LS9. To calculate the check sum, add the bytes starting with the byte after BYTE COUNT (LOW) and ending with the byte before CHECK SUM, take the binary complement, and set bit 7 to 0. CHECK SUM = (~sum)&0x7F

Bulk Dumps can be received at any time, and can be transmitted at any time when a Bulk Dump Request is received. A Bulk Dump is transmitted on the [Rx CH] channel in response to a Bulk Dump Request. In the data portion, seven words of 8-bit data are converted into eight words of 7-bit data.

**[Conversion from actual data to bulk data]**

```
d[0-6]: actual data
b[0-7]: bulk data
b[0] = 0;
for( I=0; I<7; I++){
    if( d[I]&0x80){
        b[0] |= 1<<(6-I);
    }
    b[I+1] = d[I]&0x7F;
}
```

**[Recovery from bulk data to actual data]**

```
d[0-6]: actual data
b[0-7]: bulk data
for( I=0; I<7; I++){
    b[0] <= 1;
    d[I] = b[I+1]+(0x80&b[0]);
}
```

### 3.3 PARAMETER CHANGE

**Reception**

This message is echoed if [PARAMETER CHANGE ECHO] is ON. This message is received if [PARAMETER CHANGE Rx] is ON and [Rx CH] matches the Device number included in the SUB STATUS. When a PARAMETER CHANGE is received, the specified parameter will be controlled. When a PARAMETER REQUEST is received, the current value of the specified parameter will be transmitted as a PARAMETER CHANGE with its Device Number as the [Rx CH].

**Transmission**

If [PARAMETER CHANGE Tx] is ON, and you edit a parameter for which CONTROL CHANGE transmission has not been enabled, a PARAMETER CHANGE will be transmitted with the [Tx CH] as its device number. In response to a PARAMETER REQUEST, a PARAMETER CHANGE will be transmitted with [Rx CH] as its device number.

Command	rx/tx	function
F0 43 1n 3E 12 ... F7	rx/tx	LS9 native parameter change
PARAMETER CHANGE		
F0 43 3n 3E 12 ... F7	rx/tx	LS9 native parameter request
PARAMETER REQUEST		

## 4 PARAMETER CHANGE details

### 4.1 CURRENT SCENE, SETUP, BACKUP, USER SETUP

#### 4.1.1 Format (PARAMETER CHANGE)

**Receive**

Data will be received when [PARAMETER CHANGE Rx] is on and the Device number of both [Rx CH] and SUB STATUS are matched. The data will be echoed when [PARAMETER CHANGE ECHO] is on. The corresponding parameter will be changed immediately the data is received.

**Transmission**

Data will be transmitted with the [Device Number] in [Tx CH] when [PARAMETER CHANGE Tx] is on and the parameter is not registered on the [CONTROL CHANGE EVENT LIST].

STATUS	11110000	F0	System exclusive message
ID No.	01000011	43	Manufacturer's ID number (YAMAHA)
SUB STATUS	0001nmmn	1n	n=0-15 (Device number=MIDI Channel)
GROUP ID	00111110	3E	Digital mixer
MODEL ID	00010010	12	LS9
DATA	0ccccccc	cc	
Category			
DATA	0eeeeeee	eh	Element no High.
	0eeeeeee	el	Element no Low.
	0iiiiiii	ih	Index no High.
	0iiiiiii	il	Index no Low.
	0ccccccc	ch	Channel no High.
	0ccccccc	cl	Channel no Low.
	0ddddddd	dd	Data
:	:	:	:
EOX	11110111	F7	End of exclusive

4.1.2 Format (PARAMETER REQUEST)

Receive

Data will be received when [PARAMETER CHANGE Rx] is on and the Device number of both [Rx CH] and SUB STATUS are matched. The data will be echoed when [PARAMETER CHANGE ECHO] is on. The corresponding parameter will be changed via PARAMETER CHANGE immediately the data is received.

STATUS	11110000	F0	System exclusive message
ID No.	01000011	43	Manufacture's ID number (YAMAHA)
SUB STATUS	0001nnnn	3n	n=0-15 (Device number=MIDI Channel)
GROUP ID	00111110	3E	Digital mixer
MODEL ID	00010010	12	LS9
DATA Category	0ccccccc	cc	
DATA	0eeeeeee	eh	Element no High.
	0eeeeeee	e1	Element no Low.
	0iiiiiii	ih	Index no High.
	0iiiiiii	i1	Index no Low.
	0ccccccc	ch	Channel no High.
	0ccccccc	c1	Channel no Low.
EOX	11110111	F7	End of exclusive

4.1.3 Data category

DATA CATEGORY	NAME
0x01	00000001 Current Scene/Setup/Backup/ User Setup Data

4.2 FUNCTION CALL – LIBRARY STORE, RECALL –

4.2.1 Format (PARAMETER CHANGE)

Receive

Data will be received when [PARAMETER CHANGE Rx] is on and the Device number of both [Rx CH] and SUB STATUS are matched. The data will be echoed when [PARAMETER CHANGE ECHO] is on. The corresponding parameter will be changed immediately the data is received.

Transmission

Data will be transmitted with the [Device Number] (MIDI CH) in [Tx CH] when [PARAMETER CHANGE Tx] is on.

STATUS	11110000	F0	System exclusive message
ID No.	01000011	43	Manufacture's ID number (YAMAHA)
SUB STATUS	0001nnnn	1n	n=0-15 (Device number=MIDI Channel)
GROUP ID	00111110	3E	Digital mixer
MODEL ID	00010010	12	LS9
DATA CATEGORY	00000000	00	OTHER DATA
FUNCTION NAME	01001100	"L" (ASCII CODE)	
	01101001	"i" (ASCII CODE)	
	01100010	"b" (ASCII CODE)	
	0ffffff	ff (ASCII CODE)	
	0ffffff	ff (ASCII CODE)	
	0ffffff	ff (ASCII CODE)	
	0ffffff	ff (ASCII CODE)	
	0ffffff	ff (ASCII CODE)	
	0ffffff	ff (ASCII CODE)	
MODULE NAME	0mmmmmm	mm (ASCII CODE)	
	0mmmmmm	mm (ASCII CODE)	
	0mmmmmm	mm (ASCII CODE)	
	0mmmmmm	mm (ASCII CODE)	
	0mmmmmm	mm (ASCII CODE)	
	0mmmmmm	mm (ASCII CODE)	
	0mmmmmm	mm (ASCII CODE)	
	0mmmmmm	mm (ASCII CODE)	
DATA	0nnnnnn	nh	Number High
	0nnnnnn	n1	Number Low
	0ccccccc	ch	Channel High
	0ccccccc	c1	Channel Low
EOX	11110111	F7	End of exclusive

4.2.2 Function Name

FUNCTION NAME	
Store	"LibStr_"
Recall	"LibRcl_"
Unknown Factor Store	"LibUnStr"
Unknown Factor Recall	"LibUnRcl"
Store Undo (only Scene)	"LibStrUd"
Recall Undo (only Scene)	"LibRclUd"

4.2.3 Module Name

MODULE NAME	
Scene	"SCENE_"
Input EQ	"INEQ_"
Output EQ	"OUTEQ_"
Dynamics	"DYNA_"
GEQ	"GEQ_"
Effect	"EFFECT_"

Function		Number	channel*1)	tx/rx
"LibStr_"	SCENE	1- 300	*5)	tx / rx
	INPUT EQ LIB	41- 199	*1)	tx / rx
	OUTPUT EQ LIB	4- 199	*2) *3) *4)	tx / rx
	Dynamics LIB	42- 199	*1) *2) *3) *4) *8)	tx / rx
	GEQ LIB	1- 199	*6)	tx / rx
	EFFECT LIB	58- 199	*7)	tx / rx
	"LibUnStr"	SCENE	1- 300	0
INPUT EQ LIB		41- 199	0	tx
OUTPUT EQ LIB		4- 199	0	tx
Dynamics LIB		42- 199	0	tx
GEQ LIB		1- 199	0	tx
EFFECT LIB		58- 199	0	tx
"LibRcl_"		SCENE	0- 300	*5)
	INPUT EQ LIB	1- 199	*1)	tx / rx
	OUTPUT EQ LIB	1- 199	*2) *3) *4)	tx / rx
	Dynamics LIB	1- 199	*1) *2) *3) *4) *8)	tx / rx
	GEQ LIB	0- 199	*6)	tx / rx
	EFFECT LIB	1- 199	*7)	tx / rx
	"LibUnRcl"	SCENE	0	*5)
INPUT EQ LIB		0	*1)	tx
OUTPUT EQ LIB		0	*2) *3) *4)	tx
Dynamics LIB		0	*1) *2) *3) *4) *8)	tx
GEQ LIB		0	*6)	tx
EFFECT LIB		0	*7)	tx
"LibStrUd"		SCENE	0	0
"LibRclUd"	SCENE	0	0	

- \*1) 0:CH1-63:CH64  
64:ST IN 1L-71:ST IN 4R
- \*2) 256:MIX1-271:MIX16
- \*3) 512:MATRIX1-519:MATRIX8
- \*4) 1024:STEREO L-1026:MONO(C)
- \*5) 512:will be used if the recalling or storing data is only one.
- \*6) 0:RACK1-7:RACK8 If a GEQ is mounted in RACK 1-8.
- \*7) 0:RACK5-3:RACK8 If an effect is mounted in RACK 5-8.
- \*8) 1280:CH 1-1343:CH 64  
1344:STIN 1L-1351:STIN 4R  
(Dynamics2)







4.5.2 Format (PARAMETER REQUEST)

Receive

The PARAMETER CHANGE will be sent with Device number [Rx CH] immediately the data is received.

STATUS	11110000	F0	System exclusive message
ID No.	01000011	43	Manufacturer's ID number (YAMAHA)
SUB STATUS	0011nnnn	3n	n=0-15 (Device number=MIDI Channel)
GROUP ID	00111110	3E	Digital mixer
MODEL ID	00010010	12	LS9
DATA	00000000	00	OTHER DATA
CATEGORY			
FUNCTION NAME	01001100	"L"	(ASCII CODE)
	01101001	"i"	(ASCII CODE)
	01100010	"b"	(ASCII CODE)
	01000101	"E"	(ASCII CODE)
	01111000	"x"	(ASCII CODE)
	01101001	"i"	(ASCII CODE)
	01110011	"s"	(ASCII CODE)
	01110100	"t"	(ASCII CODE)
MODULE NAME	0mmmmmmmm	mm	(ASCII CODE)
	0mmmmmmmm	mm	(ASCII CODE)
	0mmmmmmmm	mm	(ASCII CODE)
	0mmmmmmmm	mm	(ASCII CODE)
	0mmmmmmmm	mm	(ASCII CODE)
	0mmmmmmmm	mm	(ASCII CODE)
	0mmmmmmmm	mm	(ASCII CODE)
	0mmmmmmmm	mm	(ASCII CODE)
	0mmmmmmmm	mm	(ASCII CODE)
DATA	0nnnnnnn	nh	Request Number High
	0nnnnnnn	nl	Request Number Low
EOX	11110111	F7	End of exclusive

4.5.3 Module Name

MODULE NAME		number
SCENE LIB	"SCENE_"	1-300
INPUT EQ LIB	"INEQ_"	41-199
OUTPUT EQ LIB	"OUTEQ_"	4-199
Dynamics LIB	"DYNA_"	42-199
GEQ LIB	"GEQ_"	1-199
EFFECT LIB	"EFFECT_"	58-199

4.6 FUNCTION CALL – COLLECTION STORE –

4.6.1 Format (PARAMETER CHANGE)

Transmission

Data will be transmitted with the [Device Number] in [Tx CH] when [PARAMETER CHANGE Tx] is on.

STATUS	11110000	F0	System exclusive message
ID No.	01000011	43	Manufacturer's ID number (YAMAHA)
SUB STATUS	0001nnnn	1n	n=0-15 (Device number=MIDI Channel)
GROUP ID	00111110	3E	Digital mixer
MODEL ID	00010010	12	LS9
DATA	00000000	00	OTHER DATA
CATEGORY			
FUNCTION NAME	01001100	"C"	(ASCII CODE)
	01101001	"o"	(ASCII CODE)
	01100010	"l"	(ASCII CODE)
	01010101	"U"	(ASCII CODE)
	01101110	"n"	(ASCII CODE)
	01010011	"S"	(ASCII CODE)
	01110100	"t"	(ASCII CODE)
	01110010	"r"	(ASCII CODE)
MODULE NAME	0mmmmmmmm	mm	(ASCII CODE)
	0mmmmmmmm	mm	(ASCII CODE)
	0mmmmmmmm	mm	(ASCII CODE)
	0mmmmmmmm	mm	(ASCII CODE)
	0mmmmmmmm	mm	(ASCII CODE)
	0mmmmmmmm	mm	(ASCII CODE)
	0mmmmmmmm	mm	(ASCII CODE)
	0mmmmmmmm	mm	(ASCII CODE)
	0mmmmmmmm	mm	(ASCII CODE)
	0mmmmmmmm	mm	(ASCII CODE)
DATA	0eeeeeee	ee	Effect number (0:RACK5-3:RACK8)
	0ppppppp	pp	Release:0, Press:1
EOX	11110111	F7	End of exclusive

DATA	0nnnnnnn	nh	Number High
	0nnnnnnn	nl	Number Low
	0ccccccc	ch	Channel High
	0ccccccc	cl	Channel Low
EOX	11110111	F7	End of exclusive

4.6.2 Function Name

Function		Number	tx/rx
"ColUnStr"	Setup	0	tx
	User Defined Key	0	tx
	Program Change	0	tx
	Control Change	0	tx

4.6.3 Module Name

Module Name	
Mixer Setting	"MIXERSET"
Outport Setting	"OUT_PORT"
Monitor Setting	"MONITOR_"
MIDI Setting	"MIDI_SET"
Lib Number	"LIB_NUM_"
Program Change Table	"PRGMCHG_"
Control Change Table	"CTRLCHG_"
Preference(Current)	"PREF_CUR"
Preference(Admin)	"PREF_ADM"
Preference(Guest)	"PREF_GST"
User Defined Keys(Current)	"UDEF_CUR"
User Defined Keys(Admin)	"UDEF_ADM"
User Defined Keys(Guest)	"UDEF_GST"
Custom Fader Layer(Current)	"CFAD_CUR"
Custom Fader Layer(Admin)	"CFAD_ADM"
Custom Fader Layer(Guest)	"CFAD_GST"
User Level(Current)	"UKEY_CUR"
User Level(Guest)	"UKEY_GST"

4.7 FUNCTION CALL – MODULE –

4.7.1 Format (PARAMETER CHANGE)

Receive

Data will be received when [PARAMETER CHANGE Rx] is on and the Device number of both [Rx CH] and SUB STATUS are matched. The data will be echoed when [PARAMETER CHANGE ECHO] is on. The corresponding effect will function immediately the data is received (depending on the effect type).

STATUS	11110000	F0	System exclusive message
ID No.	01000011	43	Manufacturer's ID number (YAMAHA)
SUB STATUS	0001nnnn	1n	n=0-15 (Device number=MIDI Channel)
GROUP ID	00111110	3E	Digital mixer
MODEL ID	00010010	12	LS9
DATA	00000000	00	OTHER DATA
CATEGORY			
FUNCTION NAME	01001101	"M"	
	01101111	"o"	
	01100100	"d"	
	01000110	"f"	
	01111000	"x"	
	01010100	"T"	
	01110010	"r"	
	01100111	"g"	
MODULE NAME	0mmmmmmmm	mm	(ASCII CODE)
	0mmmmmmmm	mm	(ASCII CODE)
	0mmmmmmmm	mm	(ASCII CODE)
	0mmmmmmmm	mm	(ASCII CODE)
	0mmmmmmmm	mm	(ASCII CODE)
	0mmmmmmmm	mm	(ASCII CODE)
	0mmmmmmmm	mm	(ASCII CODE)
	0mmmmmmmm	mm	(ASCII CODE)
	0mmmmmmmm	mm	(ASCII CODE)
	0mmmmmmmm	mm	(ASCII CODE)
DATA	0ppppppp	pp	Release:0, Press:1
EOX	11110111	F7	End of exclusive

4.7.2 Module Name

MODULE NAME		channel
Freeze Play button	"FRZPLAY_"	0:RACK5, 2:RACK7
Freeze Record button	"FRZREC_"	0:RACK5, 2:RACK7

This will not work when the Effect Type is different.

## 4.8 FUNCTION CALL – CHANNEL –

### 4.8.1 Pair ON/OFF Trigger Format (PARAMETER CHANGE)

#### Receive

Data will be received when [PARAMETER CHANGE Rx] is on and the Device number of both [Rx CH] and SUB STATUS are matched. The data will be echoed when [PARAMETER CHANGE ECHO] is on.

```

STATUS      11110000 F0 System exclusive message
ID No.      01000011 43 Manufacture's ID number (YAMAHA)
SUB STATUS  0001nnnn 1n n=0-15 (Device number=MIDI Channel)
GROUP ID    00111110 3E Digital mixer
MODEL ID    00010010 12 LS9
DATA        00000000 00 OTHER DATA
CATEGORY
FUNCTION
NAME        01000011 "C"
            01101000 "h"
            01101100 "l"
            01010000 "p"
            01101001 "i"
            01110010 "x"
            01000011 "C"
            01110000 "p"
MODULE NAME 0mmmmmmmm mm (ASCII CODE)
            0mmmmmmmm mm (ASCII CODE)
            0mmmmmmmm mm (ASCII CODE)
            0mmmmmmmm mm (ASCII CODE)
            0mmmmmmmm mm (ASCII CODE)
            0mmmmmmmm mm (ASCII CODE)
            0mmmmmmmm mm (ASCII CODE)
            0mmmmmmmm mm (ASCII CODE)
            0mmmmmmmm mm (ASCII CODE)
DATA        0sssssss sh Source Channel Number H *1)
            0sssssss sl Source Channel Number L *1)
            0ddddddd dh Destination Channel Number H *1)
            0ddddddd dl Destination Channel Number L *1)
EOX         11110111 F7 End of exclusive

```

### 4.8.2 Module Name

MODULE NAME	
Pair On (with Copy)	"PAIRONCP"
Pair On (with Reset Both)	"PAIRONRS"
Pair Off	"PAIROFF_"

\*1) 0:CH1-63:CH64  
 256:MIX 1- 271:MIX 16  
 512:MATRIX 1-519:MATRIX 8

## 4.9 LEVEL METER DATA

### 4.9.1 Format (PARAMETER CHANGE)

When transmission is enabled by receiving Request for Level Meter, the corresponding metering data will be sent in every 50 millisecond for 10 seconds. If metering information is expected to be continuously sent, Request is needed to be sent in at least every 10 seconds.

#### Receive

The data will be echoed when [PARAMETER CHANGE ECHO] is ON.

#### Transmission

When transmission is enabled by receiving Request, the corresponding metering data will be sent in constant interval for a given period of time (The interval and time will vary depending on devices). When rebooted or port setting is changed, the transmission will be disabled.

When [PARAMETER CHANGE ECHO] is on, the message will be sent as it is.

```

STATUS      11110000 F0 System exclusive message
ID No.      01000011 43 Manufacture's ID number (YAMAHA)
SUB STATUS  0001nnnn 1n n=0-15 (Device number=MIDI Channel)
GROUP ID    00111110 3E Digital mixer
MODEL ID    00010010 12 LS9
DATA        00100001 21 REMOTE LEVEL METER
CATEGORY
DATA        0mmmmmmmm mm ADDRESS UL
            0mmmmmmmm mm ADDRESS LU
            0mmmmmmmm mm ADDRESS LL
            0ddddddd dd Data1
            :           :
EOX         11110111 F7 End of exclusive

```

### 4.9.2 Format (PARAMETER REQUEST)

#### Receive

Data will be received when [PARAMETER CHANGE Rx] is on and the Device number of both [Rx CH] and SUB STATUS are matched. The data will be echoed when [PARAMETER CHANGE ECHO] is on. the corresponding metering data will be sent via [Rx CH] in constant interval for a given period of time (The interval and time will vary depending on devices).

When Address UL = 0x7F is received, all metering data transmission will be immediately stopped [disabled].

#### Transmission

When [PARAMETER CHANGE ECHO] is on, the message will be sent as it is.

```

STATUS      11110000 F0 System exclusive message
ID No.      01000011 43 Manufacture's ID number (YAMAHA)
SUB STATUS  0011nnnn 3n n=0-15 (Device number=MIDI Channel)
GROUP ID    00111110 3E Digital mixer
MODEL ID    00010010 12 LS9
DATA        00100001 21 REMOTE LEVEL METER
CATEGORY
DATA        0mmmmmmmm mm ADDRESS UL
            0mmmmmmmm mm ADDRESS LU
            0mmmmmmmm mm ADDRESS LL
            0ccccccc ch Count H
            0ccccccc cl Count L
EOX         11110111 F7 End of exclusive

```

## Warning/Error Messages

Message	Meaning
xxx Parameters Copied.	Parameter xxx was copied to the copy buffer.
xxx Parameters Initialized.	Parameter xxx was initialized.
xxx Parameters Pasted.	Parameter xxx was pasted from the copy buffer.
xxx Parameters Swapped with Copy Buffer.	Parameter xxx was exchanged with the contents of the copy buffer.
Assignment is Restricted to Max. 8 Sources!	The Monitor Define function allows a maximum of eight sources to be selected, but you attempted to assign more than this.
Cannot Bookmark This Popup.	This popup window cannot be bookmarked.
Cannot Recall to Different Parameter Type!	You attempted to recall a library of a different type.
Cannot Recall!	Failed to recall a scene memory or library.
Cannot Select This Channel.	You attempted to select a channel that cannot be operated due to your user level or some other reason.
Cannot Store!	Failed to store a scene memory or library.
Cannot Undo!	You pressed the [UNDO] button when Undo was not available.
Couldn't Access File.	File on the USB memory could not be accessed for some reason.
Couldn't Write File.	File could not be saved from the USB memory.
Current User Changed. [xxx]	Current user was changed to [xxx].
Directory Not Empty!	You attempted to delete a directory, but failed because there were files remaining in the directory.
EFFECT CUE: Turned Off.	CUE was defeated because you switched from the RACK screen to a different screen.
External HA Connection Conflict!	External HA data could not be recalled, because the state of connections to the external HA differs from when the scene was stored.
File Access is Busy!	The following operation has not been performed yet because the USB memory is being accessed.
File Already Exists!	The USB memory already contains a file/directory with the same name as the one you are attempting to save, rename, or create.
File Error [xx]!	Internal file access error
File Protected!	Overwriting was not possible because the file on the USB memory is write-protected.
Help File Not Found!	Can't find HELP file.
Illegal Address!	The IP address or Gateway address setting is invalid.
Illegal MAC Address! Cannot Use Network.	Communication via the Network connector is not possible because the MAC address setting has been damaged for some reason. Please contact your Yamaha dealer.
Illegal Storage Format!	The USB memory could not be accessed because its format is invalid or unsupported.
KEY IN CUE: Turned Off.	KEY IN CUE was defeated because you switched from the DYNAMICS 1/2 popup window to a different screen.
Loading Aborted.	Loading from USB memory was aborted.
Low Battery!	The backup battery voltage is low.
Maximum Number of Audio Files Exceeded!	The number of songs that can be managed by the USB memory recorder has been exceeded.
Memory Error! All Memories were Initialized.	All data has been initialized because the data in internal backup memory has been lost, due to failure of the backup battery or some other reason. Please contact your Yamaha dealer.
MIDI: Data Framing Error!	An inappropriate signal is being input to the MIDI input port.
MIDI: Data Overrun!	An inappropriate signal is being input to the MIDI input port.
MIDI: Rx Buffer Full!	Too much data is being received at the MIDI input port.
MIDI: Tx Buffer Full!	Too much data is being transmitted from the MIDI output port.
No Access From Recorder!	In the RECORDER screen, it is not possible to move to a level higher than YPE/SONGS/.
No Controllable Knob.	Your operation has been ignored because there is no parameter that corresponds to the knob you operated.
No Corresponding Help Items.	A section in the HELP data cannot be found.
No Response from External HA.	No response from an external AD8HR.
Page Bookmarked.	The current screen or popup has been bookmarked.
Password Changed.	The password has been changed.
PlayBack Failed: Recorder is Busy!	Audio file link playback is not possible because recording is in progress.
Power Supply Fan has Malfunctioned!	The cooling fan of the internal power supply has stopped. If a malfunction has occurred, please contact your Yamaha dealer.
Processing Aborted.	Processing was interrupted.
Recorder Busy: Operation Aborted!	Operation of the JPN button was cancelled because time is required for recorder processing.
Saving Aborted.	Saving to the USB memory has been interrupted.
Scene #xxx is Empty!	No data has been stored in the scene you attempted to recall, or the data has been damaged so that it cannot be recalled.
Scene #xxx is Protected!	You attempted to overwrite (store) a protected scene.
Scene #xxx is Read Only!	You attempted to overwrite (store) a read-only scene.

Message	Meaning
<b>SLOT x: Data Framing Error!</b>	Invalid signals are being input from the SLOT x input port.
<b>SLOT x: Data Overrun!</b>	Invalid signals are being input from the SLOT x input port.
<b>SLOT x: Rx Buffer Full!</b>	Too much data is being received at the SLOT x input port.
<b>SLOT x: Tx Buffer Full!</b>	Too much data is being sent from the SLOT x output port.
<b>Some Song Files Are Unidentified.</b>	There was a song file that could not be identified. It is possible that the song being used for DIRECT PLAY or SCENE PLAY BACK LINK is different than the song that was specified.
<b>Song File Not Found!</b>	The file assigned to SCENE LINK or to the DIRECT PLAY user defined key does not exist.
<b>Storage Full!</b>	The file could not be saved because there is not enough space on the USB memory.
<b>Storage Not Found!</b>	The USB memory could not be recognized.
<b>Storage Not Ready!</b>	Access is not possible because the USB memory is not ready.
<b>Sync Error! [xxx]</b>	The LS9 is not synchronized with the [xxx] signal.
<b>Tap Operation Ignored.</b>	Tap operation was ignored because the TAP TEMPO button is not displayed in the screen.
<b>This Operation is Not Allowed.</b>	This operation has been ignored because the current user does not have permission.
<b>Too Large Files! Loading Failed.</b>	Loading is not possible because the bitmap file is too large. The maximum supported file size is 307,256 bytes.
<b>Too Many Bands Used! Cannot Compare.</b>	More than 15 bands are used, when trying to copy 31band GEQ and then compare with Flex15GEQ.
<b>Too Many EQ Bands Used! Cannot Paste!</b>	More than 15 bands are used, when trying to copy 31band GEQ and then paste to Flex15GEQ.
<b>Total Slot Power Capability Exceeded!</b>	The I/O cards installed in the slots exceed the rated power capacity.
<b>Unsupported File Format!</b>	The file you attempted to load from the USB memory is of an unsupported format.
<b>USB: Data Framing Error!</b>	Invalid signals are being input from the USB connector input port.
<b>USB: Data Overrun!</b>	Invalid signals are being input from the USB connector input port.
<b>USB: Rx Buffer Full!</b>	Too much data is being received at the USB connector input port.
<b>USB: Tx Buffer Full!</b>	Too much data is being transmitted from the USB connector output port.
<b>USB Currently Active for Recorder function!</b>	Since the USB memory recorder is recording or playing back, functions such as Save/Load cannot be used.
<b>USB Currently Active for SAVE or LOAD!</b>	The recorder cannot operate, since mixer scene memory/library data is being saved or loaded in USB memory.
<b>USB Memory Busy: Recorder Stopped!</b>	Recording/playback stopped because time is required for USB memory processing.
<b>USB Memory Full! Recorder Stopped.</b>	Recorder processing was halted because the USB memory capacity ran out while the USB memory recorder was operating.
<b>USB Memory Unmounted! Recorder Stopped.</b>	Recorder processing was halted because the USB memory was disconnected while the USB memory recorder was operating.
<b>USB over current Error! Disconnect USB device.</b>	Excessive current has occurred at the USB connector. Disconnect the USB memory that is connected to the USB connector.
<b>Word Clock Error! Recorder Stopped!</b>	Recorder was halted because synchronization with the word clock was lost.
<b>Wrong Audio File Format!</b>	The format of the audio file is invalid.
<b>Wrong Password!</b>	The password you input was incorrect.
<b>Wrong Word Clock!</b>	The LS9 cannot synchronize because the source selected by MASTER CLOCK SELECT in the WORD CLOCK screen is not appropriate.
<b>You Cannot Create User Key.</b>	The current user does not have permission to create a user key.

## Troubleshooting

<b>Power does not turn on, panel LEDs and the LCD display do not light</b>	<ul style="list-style-type: none"> <li><input type="radio"/> Are the LCD contrast and panel brightness adjusted appropriately? You can adjust the LCD contrast by holding down the [HOME] key and turning the dial.</li> <li><input type="radio"/> Is the LS9's POWER switch turned on?</li> <li><input type="radio"/> If the power still does not turn on, contact your Yamaha dealer.</li> </ul>
<b>Sound is not input</b>	<ul style="list-style-type: none"> <li><input type="radio"/> Is the optional I/O card installed correctly? (→ p. 44)</li> <li><input type="radio"/> Is a signal being input from the external device?</li> <li><input type="radio"/> Is the input port patched to an input channel? (→ p. 99)</li> <li><input type="radio"/> Is the GAIN of the internal head amp or external head amp set to an appropriate level? (→ p. 47, 57)</li> <li><input type="radio"/> Is the EQ attenuator raised? (→ p. 115)</li> <li><input type="radio"/> Could insert be turned on even though it has not been specified correctly? (→ p. 101)</li> <li><input type="radio"/> Is the [ON] key indicator of the input channel lit?</li> <li><input type="radio"/> Is the fader of the input channel raised?</li> </ul>
<b>Sound is not output</b>	<ul style="list-style-type: none"> <li><input type="radio"/> Is the optional I/O card installed correctly? (→ p. 44)</li> <li><input type="radio"/> Is the [ON] key indicator of the STEREO channel lit?</li> <li><input type="radio"/> Is an output port patched to the output channel? (→ p. 95)</li> <li><input type="radio"/> Could LCR be on, and the CSR value be set to 1.0? (→ p. 58)</li> </ul>
<b>Sound is not output from headphones or the MONITOR OUT jacks</b>	<ul style="list-style-type: none"> <li><input type="radio"/> Is the [PHONES] knob or [LEVEL] knob set to an appropriate volume?</li> </ul>
<b>Sound is not loud enough</b>	<ul style="list-style-type: none"> <li><input type="radio"/> Is the GAIN of the internal head amp or external head amp set to an appropriate level? (→ p. 47, 57)</li> <li><input type="radio"/> Is the fader of the input channel raised?</li> <li><input type="radio"/> Could the EQ gain be set to an extremely low setting? (→ p. 115)</li> <li><input type="radio"/> Could the GATE/COMP threshold or ratio be set to an extreme setting? (→ p. 117)</li> <li><input type="radio"/> Is the EQ attenuator raised? (→ p. 115)</li> <li><input type="radio"/> Is the fader of the output channel raised?</li> <li><input type="radio"/> Try using the various screens of the METER function to check the levels. (→ p. 155)</li> </ul>
<b>Sound is distorted</b>	<ul style="list-style-type: none"> <li><input type="radio"/> Is the word clock set correctly? (→ p. 206)</li> <li><input type="radio"/> Is the GAIN of the internal head amp or external head amp set to an appropriate level? (→ p. 47, 57)</li> <li><input type="radio"/> Could the fader of the input channel be raised too high?</li> <li><input type="radio"/> Could the fader of the STEREO channel be raised too high?</li> <li><input type="radio"/> Could the EQ gain be set to an extremely high setting? (→ p. 115)</li> </ul>
<b>Sound is output even though it is not patched to an output channel</b>	<ul style="list-style-type: none"> <li><input type="radio"/> Could you have assigned an input channel to direct out? (→ p. 103)</li> <li><input type="radio"/> Could you have assigned an output channel as the insert out? (→ p. 101)</li> </ul>
<b>The volume of a specific channel rises and falls</b>	<ul style="list-style-type: none"> <li><input type="radio"/> Could GATE/COMP be set to ducking? (→ p. 117)</li> </ul>
<b>Operating a fader does not control the level as you expect</b>	<ul style="list-style-type: none"> <li><input type="radio"/> Is SENDS ON FADER selected and INPUT TO MIX FADER and so on active in the panel?</li> </ul>
<b>Only the sound of a specific channel is heard from the MONITOR OUT or PHONES jack</b>	<ul style="list-style-type: none"> <li><input type="radio"/> Could a [CUE] key be on?</li> </ul>
<b>Noise occurs from an externally connected recorder or other device</b>	<ul style="list-style-type: none"> <li><input type="radio"/> Is the word clock set correctly? (→ p. 206)</li> <li><input type="radio"/> Could the input signal be unsynchronized?</li> <li><input type="radio"/> Could oscillator or talkback be turned on? (→ p. 151, 153)</li> </ul>
<b>High frequency range is attenuated</b>	<ul style="list-style-type: none"> <li><input type="radio"/> Could emphasis be applied? This problem will occur if the input signal status does not match the emphasis data. (→ p. 206)</li> <li><input type="radio"/> Could EQ be applied? (→ p. 115)</li> </ul>
<b>An input signal is being input, but there's no monitor output</b>	<ul style="list-style-type: none"> <li><input type="radio"/> Is the dimmer applied?</li> <li><input type="radio"/> Is the MONITOR C assigned even though its output port has not been connected to external device.</li> </ul>
<b>Not enough headroom, especially when EQ boost is applied</b>	<ul style="list-style-type: none"> <li><input type="radio"/> Use the EQ attenuator function to lower the level. (→ p. 115)</li> </ul>
<b>Signal is delayed</b>	<ul style="list-style-type: none"> <li><input type="radio"/> Check whether the delay setting for each channel is set correctly. (→ p. 95)</li> </ul>
<b>Turning a SELECTED SEND encoder does not change the send level to the MIX/MATRIX bus</b>	<ul style="list-style-type: none"> <li><input type="radio"/> Is the MIX/MATRIX turned on?</li> <li><input type="radio"/> Is the MIX/MATRIX [ON] turned on?</li> <li><input type="radio"/> Is the MIX bus set to VARI type? (→ p. 213)</li> <li><input type="radio"/> If the send point is set to POST, could the fader have been lowered?</li> </ul>
<b>Can't save scene memory or library data</b>	<ul style="list-style-type: none"> <li><input type="radio"/> Are you attempting to save the data to a read-only scene/library or a protected scene? (→ p. 129)</li> </ul>
<b>Can't save to USB memory</b>	<ul style="list-style-type: none"> <li><input type="radio"/> Is the USB memory protected?</li> <li><input type="radio"/> Does the USB memory have enough free capacity to save the data?</li> <li><input type="radio"/> When formatting the USB memory, format it in FAT32 or FAT16 format.</li> <li><input type="radio"/> Could the recorder be playing back?</li> </ul>
<b>Can't transmit/receive MIDI data</b>	<ul style="list-style-type: none"> <li><input type="radio"/> Is the MIDI PORT selected correctly? (→ p. 178)</li> <li><input type="radio"/> Are the mode and channel selected correctly on the transmitting and receiving devices? (→ p. 178)</li> <li><input type="radio"/> Has an event been assigned for the program change? (→ p. 180)</li> </ul>
<b>When you recall a scene, some channels/parameters are not updated</b>	<ul style="list-style-type: none"> <li><input type="radio"/> Could that channel or parameter be set to Recall Safe? Could Focus be turned off in the scene you recalled? Could user level restrictions have been specified? (→ p. 139, 140, 192)</li> </ul>

<p>You turn on a CUE button in the EFFECT PARAM screen, but it is automatically defeated</p>	<p>○ This is defeated automatically when you switch screens in the display. (→ p. 170)</p>
<p>When you recall a scene, it takes a certain amount of time for the faders to stop</p>	<p>○ Could you have specified a fade time? (→ p. 143)</p>
<p>The panel LEDs or LCD display are too dark / too bright</p>	<p>○ This can be adjusted in the MISC SETUP screen. (→ p. 217)</p>
<p>Signal level of a specific frequency is low</p>	<p>○ Could the EQ gain be turned down excessively?          ○ Routing a signal through a GEQ or effect will delay it relative to other signals. If this signal is mixed with the signal via a different signal path, a comb filtering effect will cause the level of a specific frequency to be decreased.</p>
<p>Can't control an external head amp (AD8HR)</p>	<p>○ Is the external head amp connected to the specified port?          ○ Is the audio output signal of the external head amp being input via an I/O card to SLOT 1-3?          ○ Is the input port of the external head amp set correctly?          ○ Could there be a problem with the cable that connects the LS9 and external head amp? Are you using a D-sub 9-pin cross cable?</p>
<p>Can't control the LS9 by LS9 Editor.</p>	<p>○ Refer to LS9 Editor installation guide on our web site.  <a href="http://www.yamahaproaudio.com/">http://www.yamahaproaudio.com/</a></p>
<p>In the LCD display, there are some black points (unlit) or white points (always lit).</p>	<p>○ Unfortunately, this is a common characteristic of TFT-LCDs and not a malfunction.</p>



## General Specifications

<b>Signal Delay</b>	Less than 2.5 ms (INPUT to OMNI OUT @Fs=48kHz)
<b>Dimensions (WxHxD)</b>	LS9-16: 480 x 220 x 500 mm LS9-32: 884 x 220 x 500 mm
<b>Net Weight</b>	LS9-16: 12.0 kg LS9-32: 19.4 kg
<b>Power Requirements</b>	LS9-16: 95 W, 110–240 V, 50/60 Hz LS9-32: 170 W, 110–240 V, 50/60 Hz
<b>Temperature Range</b>	Operating: +10°C to +35°C Storage: -20°C to +60°C
<b>Included Accessories</b>	Owner's Manual, AC Power Cord, Dust Cover (only LS9-32)
<b>Optional Accessories</b>	mini-YGDAl cards, Gooseneck Light LATL (for LS9-32), Rack Mount Kit RK1
<b>AC Power Cord Length</b>	250 cm

		Conditions	Min.	Typ.	Max.	Unit
Sampling Frequency External Clock	Frequency Range		39.69		50.88	kHz
	Jitter of PLL * * The jitter of input clock is less than 1 ns.	Digital Input Fs = 44.1 kHz or 48 kHz			10	ns
	Digital Input Fs = 39.69–50.88 kHz			20		
Sampling Frequency Internal Clock	Frequency	Word Clock: INT 44.1 kHz		44.1		kHz
		Word Clock: INT 48 kHz		48		
	Accuracy	Word Clock: INT 44.1 kHz or 48 kHz			50	ppm
	Jitter	Word Clock: INT 44.1 kHz or 48 kHz			5	ns
Fader	Travel (Stroke)	Resolution: 1,024 steps, +10 to -138, -∞ dB for all faders		100		mm
	Position Error				±1.5	
	Moving Time	From end to the other end, Under normal software control			0.3	

## Input/output characteristics

### □ Analog Input Characteristics

Input Terminals	GAIN	Actual Load Impedance	For Use With Nominal	Input Level			Connector
				Sensitivity *1	Nominal	Max. before clip	
INPUT 1-16 <LS9-16> INPUT 1-32 <LS9-32>	-62 dB	3 k $\Omega$	50-600 $\Omega$ Mics & 600 $\Omega$ Lines	-82 dBu (61.6 $\mu$ V)	-62 dBu (0.616 mV)	-42 dBu (6.16 mV)	XLR-3-31 type (Balanced) *2
	+10 dB			-10 dBu (245 mV)	+10 dBu (2.45 V)	+30 dBu (24.5 V)	

\*1. Sensitivity is the lowest level that will produce an output of +4 dBu (1.23 V) or the nominal output level when the unit is set to maximum gain. (all faders and level controls are maximum position.)

\*2. XLR-3-31 type connectors are balanced. (1=GND, 2=HOT, 3=COLD)

\* In these specifications, 0 dBu = 0.775 Vrms.

\* All input AD converters are 24-bit linear, 128-times oversampling.

\* +48V DC (phantom power) is supplied to INPUT XLR type connectors via each individual software controlled switch.

### □ Analog Output Characteristics

Output Terminals	Actual Source Impedance	For Use With Nominal	Gain Switch *3	Output Level		Connector
				Nominal	Max. before clip	
OMNI OUT 1-8 <LS9-16> OMNI OUT 1-16 <LS9-32>	75 $\Omega$	600 $\Omega$ Lines	+24 dB (default)	+4 dBu (1.23 V)	+24 dBu (12.3 V)	XLR-3-32 type (Balanced) *1
			+18 dB	-2 dBu (616 mV)	+18 dBu (6.16 V)	
PHONES OUT	15 $\Omega$	8 $\Omega$ Phones	—	75 mW *4	150 mW	Stereo Phone Jack (TRS) (Unbalanced) *2
		40 $\Omega$ Phones	—	65 mW *4	150 mW	

\*1. XLR-3-32 type connectors are balanced. (1=GND, 2=HOT, 3=COLD)

\*2. PHONES OUT stereo phone jack is unbalanced. (Tip=LEFT, Ring=RIGHT, Sleeve=GND)

\*3. There are switches inside the body to preset the maximum output level.

\*4. The position of the level control is 10dB lowered from Max.

\* In these specifications, 0 dBu = 0.775 Vrms.

\* All output DA converters are 24-bit, 128-times oversampling.

### □ Digital Input Characteristics

Terminal	Format	Data Length	Level	Connector	
2TR IN DIGITAL	Coaxial	IEC-60958	24 bit	0.5 Vpp/75 $\Omega$	RCA Pin Jack

### □ Digital Output Characteristics

Terminal	Format	Data Length	Level	Connector	
2TR OUT DIGITAL	Coaxial	IEC-60958 Consumer Use	24 bit	0.5 Vpp/75 $\Omega$	RCA Pin Jack

### □ I/O Slot Characteristics

The rear panel provides one slot (LS9-16) or two slots (LS9-32) in which separately sold mini-YGDAI cards can be installed. The following types of card can be used.

Card Name	Function	Input	Output	The number of available cards	
				LS9-16	LS9-32
MY8-AD24	Analog In	8In	—	1	2
MY8-AD96	Analog In	8In	—	1	2
MY8-ADDA96	Analog In/Out	8In	8Out	1	2
MY8-AE	AES/EBU	8In	8Out	1	2
MY8-AE96	AES/EBU	8In	8Out	1	2
MY8-AE96S	AES/EBU	8In	8Out	1	2
MY8-AEB	AES/EBU	8In	8Out	1	2
MY8-AT	ADAT	8In	8Out	1	2
MY8-DA96	Analog Out	—	8Out	1	2
MY8-TD	TASCAM	8In	8Out	1	2
MY4-DA	Analog Out	—	4Out	1	2
MY4-AD	Analog In	4In	—	1	2
MY16-AE	AES/EBU	16In	16Out	1	2
MY16-AT	ADAT	16In	16Out	1	2
MY16-TD	TASCAM	16In	16Out	1	2
MY16-CII	CobraNet	16In	16Out	1	2

Only Slot 1 has a serial interface (LS9-32).

Refer to the Yamaha Pro Audio global website for the most recent information on mini-YGDAI cards.

<http://www.yamahaproaudio.com/>

### □ Control I/O Characteristics

Terminal		Format	Level	Connector
MIDI	IN	MIDI	—	DIN Connector 5P
	OUT	MIDI	—	DIN Connector 5P
WORD CLOCK	IN	—	TTL/75Ω terminated	BNC Connector
	OUT	—	TTL/75Ω	BNC Connector
NETWORK (Ethernet)		100Base-T	100Base-T	RJ-45
USB		USB 1.1 Host	USB *1	USB A Connector (Female)
LAMP (LS9-32 only)		—	0V–12V	XLR-4-31 type *2

\*1. Bus-powered hubs are not supported.

\*2. 4pin=+12V, 3pin=GND, Supported lamp: max. 5W

## Electrical characteristics

All faders are nominal when measured. Output impedance of signal generator: 150 ohms

### □ Frequency Response $F_s = 44.1\text{kHz}$ or $48\text{kHz}@20\text{Hz}-20\text{kHz}$ , referenced to the nominal output level @1kHz

Input	Output	RL	Conditions	Min.	Typ.	Max.	Unit
INPUT 1-16 <LS9-16> INPUT 1-32 <LS9-32>	OMNI OUT 1-8 <LS9-16> OMNI OUT 1-16 <LS9-32>	600 $\Omega$	GAIN: max.	-1.5	0.0	0.5	dB
	PHONES OUT	8 $\Omega$	GAIN: max.	-3.0	0.0	0.5	

### □ Gain Error $F_s = 44.1\text{kHz}$ or $48\text{kHz}@1\text{kHz}$

Input	Output	RL	Conditions	Min.	Typ.	Max.	Unit
INPUT 1-16 <LS9-16> INPUT 1-32 <LS9-32>	OMNI OUT 1-8 <LS9-16> OMNI OUT 1-16 <LS9-32>	600 $\Omega$	Input level: -62dBu, GAIN: max. → Output level: +4.0dBu (Typ.)	-2.0	0.0	2.0	dB
			Input level: +10dBu, GAIN: min. → Output level: +4.0dBu (Typ.)	-2.0	0.0	2.0	
Internal Oscillator	OMNI OUT 1-8 <LS9-16> OMNI OUT 1-16 <LS9-32>	600 $\Omega$	Full scale output, Output level: +24.0dBu	-0.5	0.0	0.5	
	PHONES OUT	8 $\Omega$	-30dBFs, Phones level control: max. → Output level: 0dBu (Typ.)	-0.5	0.0	0.5	

### □ Total Harmonic Distortion $F_s = 44.1\text{kHz}$ or $48\text{kHz}$

Input	Output	RL	Conditions	Min.	Typ.	Max.	Unit
INPUT 1-16 <LS9-16> INPUT 1-32 <LS9-32>	OMNI OUT 1-8 <LS9-16> OMNI OUT 1-16 <LS9-32>	600 $\Omega$	+4dBu@20Hz-20kHz, GAIN: max.			0.1	%
			+4dBu@20Hz-20kHz, GAIN: min.			0.05	
Internal Oscillator	OMNI OUT 1-8 <LS9-16> OMNI OUT 1-16 <LS9-32>	600 $\Omega$	Full scale output @1kHz			0.02	
	PHONES OUT	8 $\Omega$	Full scale output @1kHz, Phones level control: max.			0.2	

\* Total Harmonic Distortion is measured with a 18dB/octave filter @80kHz

### □ Hum & Noise $F_s = 44.1\text{kHz}$ or $48\text{kHz}$ , EIN = Equivalent Input Noise

Input	Output	RL	Conditions	Min.	Typ.	Max.	Unit
INPUT 1-16 <LS9-16> INPUT 1-32 <LS9-32>	OMNI OUT 1-8 <LS9-16> OMNI OUT 1-16 <LS9-32>	600 $\Omega$	$R_s=150\Omega$ , GAIN: max. Master fader: nominal, One channel fader: nominal		-128 EIN		dBu
			$R_s=150\Omega$ , GAIN: min. Master fader: nominal, One channel fader: nominal		-62		
All Inputs <LS9-16>	OMNI OUT 1-8 <LS9-16>	600 $\Omega$	$R_s=150\Omega$ , GAINS: min. Master fader: nominal, All channel faders: nominal			-67	
All Inputs <LS9-32>	OMNI OUT 1-16 <LS9-32>	600 $\Omega$	$R_s=150\Omega$ , GAINS: min Master fader: nominal, All channel faders: nominal			-64	
—	OMNI OUT 1-8 <LS9-16> OMNI OUT 1-16 <LS9-32>	600 $\Omega$	Residual output noise, Stereo Master: off			-86	
—	PHONES OUT	8 $\Omega$	Residual output noise, Phones level control: min.			-86	

\* Hum & Noise are measured with a 6dB/octave filter @12.7kHz; equivalent to a 20kHz filter with infinite dB/octave attenuation.

### □ Dynamic Range $F_s = 44.1\text{kHz}$ or $48\text{kHz}$

Input	Output	RL	Conditions	Min.	Typ.	Max.	Unit
INPUT 1-16 <LS9-16> INPUT 1-32 <LS9-32>	OMNI OUT 1-8 <LS9-16> OMNI OUT 1-16 <LS9-32>	600 $\Omega$	AD + DA, GAIN: min.		108		dB
—	OMNI OUT 1-8 <LS9-16> OMNI OUT 1-16 <LS9-32>	600 $\Omega$	DA Converter		110		

\* Dynamic range is measured with a 6dB/octave filter @12.7kHz; equivalent to a 20kHz filter with infinite dB/octave attenuation.

□ Crosstalk@1kHz

From	To	Conditions	Min.	Typ.	Max.	Unit
INPUT n	INPUT (n-1) or (n+1)	CH 1-16 {1-32}, Adjacent inputs, GAIN: min.			-80	dB
OMNI OUT n	OMNI OUT (n-1) or (n+1)	OMNI OUT 1-8 {1-16}, Input to output			-80	

□ Maximum Voltage Gain@1kHz

Input	Output	RL	Conditions	Min.	Typ.	Max.	Unit
INPUT 1-16 <LS9-16> INPUT 1-32 <LS9-32>	OMNI OUT 1-8 <LS9-16> OMNI OUT 1-16 <LS9-32>	600 Ω	Rs=150Ω, Input GAIN: max.		86		dB

□ Phantom Voltage

Output	Conditions	Min.	Typ.	Max.	Unit
INPUT 1-16 <LS9-16> INPUT 1-32 <LS9-32>	hot & cold: No load	46	48	50	V

# Mixer Basic Parameters

## Libraries

Name	Number	Total
Scene Memory	Preset 1 + User 300	301
Input EQ Library	Preset 40 + User 159	199
Output EQ Library	Preset 3 + User 196	199
Dynamics Library	Preset 41 + User 158	199
Effect Library	Preset 57 + User 142	199
GEQ Library	Preset 1 + User 199	200

## Input Function

Function	Parameter
Phase	Normal/Reverse
Attenuator	-96 to +24 dB
HPF	Slope= 12 dB/Oct Frequency= 20 Hz to 600 Hz
4 Band Equalizer	Frequency= 20 Hz to 20 kHz Gain= -18 dB to +18 dB Q= 0.10 to 10.0 Low Shelving (Low Band) High Shelving, LPF (High Band) Type I/Type II
Insert (only ch1-32)	Insert Point: Pre EQ/Pre Fader/Post On
Direct Out	Direct Out Point: Pre HPF/Pre EQ
Dynamics 1	Type: Gate/Ducking/Comp/Expander Threshold= -54 dB to 0 dB Ratio= 1:1 to ∞:1 Attack= 0 msec to 120 msec Hold= 0.02 msec to 1.96 sec Decay= 5 msec to 42.3 sec (Release) Release= 5msec to 42.3 sec Range= -70 dB to 0 dB Gain= -18 dB to 0 dB, 0 dB to +18 dB Knee= Hard to 5 (soft) Key In: Self Pre EQ/Self Post EQ/Mix Out13-16 Ch1-STIN4R (8ch block) Key In Filter: HPF/LPF/BPF
Dynamics2	Type: Comp/De-Esser/Compander H/Compander S Threshold= -54 dB to 0 dB Ratio= 1:1 to ∞:1 Attack= 0 msec to 120 msec Release= 5 msec to 42.3 sec Gain= -18 dB to 0 dB, 0 dB to +18 dB Knee= Hard to 5 (soft) Key In: Self Pre EQ/Self Post EQ/Mix Out13-16 Ch1-STIN4R (8ch block)
Fader	Level: 1024 steps, ∞, -138 dB to +10 dB
On	On/Off
Mute Group	8 Groups
Mix Send	16 sends Fix/Variable can be set each two mixes Mix Send Point: Pre EQ/Pre Fader/Post On Level: 1024 steps, ∞, -138 dB to +10 dB
LCR Pan	CSR= 0% to 100%

## Output Function

Function	Parameter
Attenuator	-96 to +24 dB
4Band Equalizer	Frequency= 20 Hz to 20 kHz Gain= -18 dB to +18 dB Q= 0.10 to 10.0 Low Shelving (Low Band) High Shelving, LPF (High Band) Type I/Type II
Insert	Insert Point: Pre EQ/Post EQ/Pre Fader/Post On
Dynamics 1	Type: Comp/Expander/Compander H/Compander S Threshold= -54 dB to 0 dB Ratio= 1:1 to ∞:1 Attack= 0 msec to 120 msec Release= 5 msec to 42.3 sec Gain= -18 dB to 0 dB, 0 dB to +18 dB Knee= Hard to 5 (soft) Key In: Self Pre EQ/Self Post EQ/Mix Out13-16 MIX1-16/MTRX1-8/STIN LR/MONO(C) (8ch block)
Fader	Level: 1024 steps, ∞, -138 dB to +10 dB
On	On/Off
Mute Group	8 Groups
Mix to Matrix Stereo to Matrix	Matrix Send Point: Pre Fader/Post On Level: 1024 steps, ∞, -138 dB to +10 dB
Oscillator	Level= 0 to -96dB (1 dB step) On/Off= Software control

## Output Port

Function	Parameter
Out Port Delay	0 msec to 600 msec
Out Port Phase	Normal/Reverse
Attenuator	-96 to +24 dB

## Processor

Function	Parameter
GEQ	31 bands x 4(8) systems
Effects	Stereo In/Stereo Out multi effector x 4 systems

## Pin Assignment

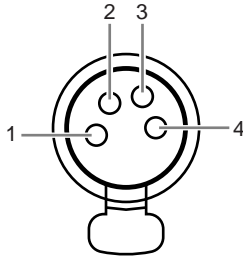

### □ LAMP (LS9-32 only)

Pin	Signal Name
1	NC
2	NC
3	GND
4	+12V



# Dimensions

**LS9-16**

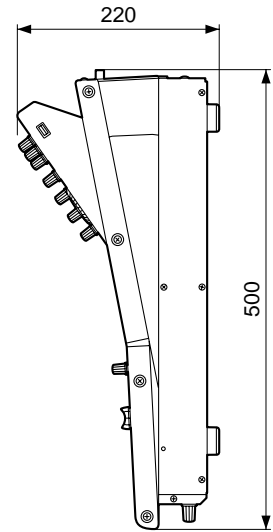
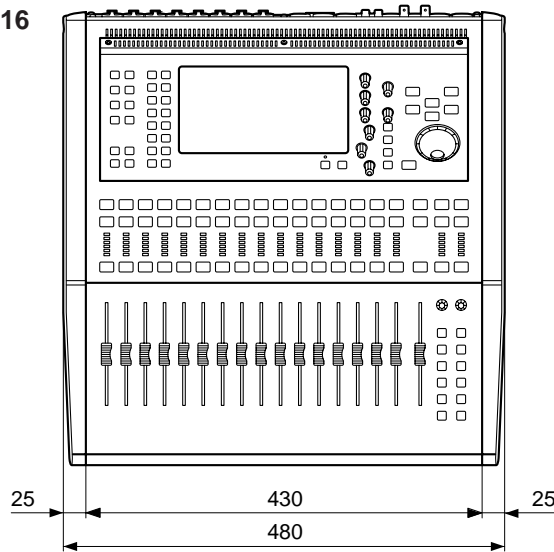

**LS9-32**

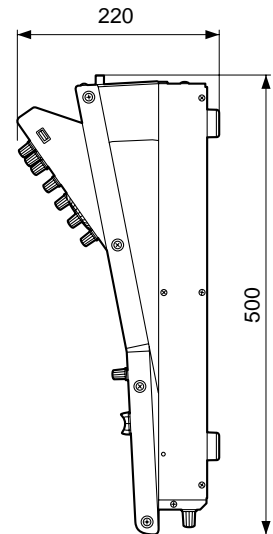
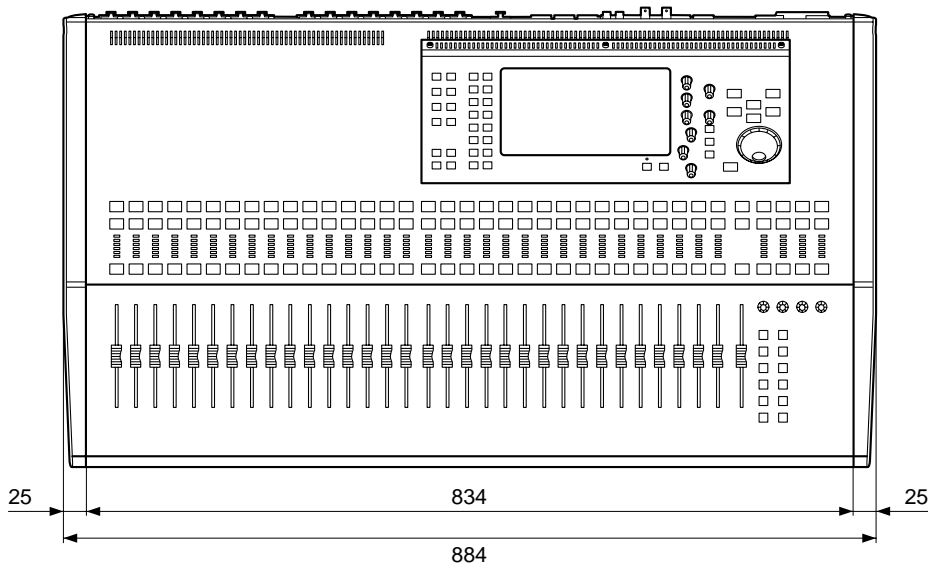

Unit : mm

\* Specifications and descriptions in this owner's manual are for information purposes only. Yamaha Corp. reserves the right to change or modify products or specifications at any time without prior notice. Since specifications, equipment or options may not be the same in every locale, please check with your Yamaha dealer.

European models

Purchaser/User Information specified in EN55103-1 and EN55103-2.

Inrush Current: 16A

Conforms to Environments: E1, E2, E3 and E4

## Attaching the RK1 rackmount kit (sold separately)

You can attach the optional RK-1 rackmount kit to the LS9-16 or LS9-32 and mount it in a rack or an installed system.

- 1 Make sure that the power is turned off.
- 2 Remove screws “A” and detach the side pads.



- Keep the side pad screws together with the pads you removed.

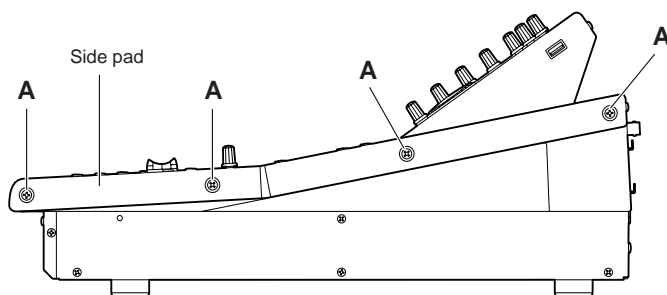

- 3 At the locations indicated by the arrows, tighten the screws to attach the rackmount hardware.

The mixer can be attached at either of two angles, as shown in the following illustration.

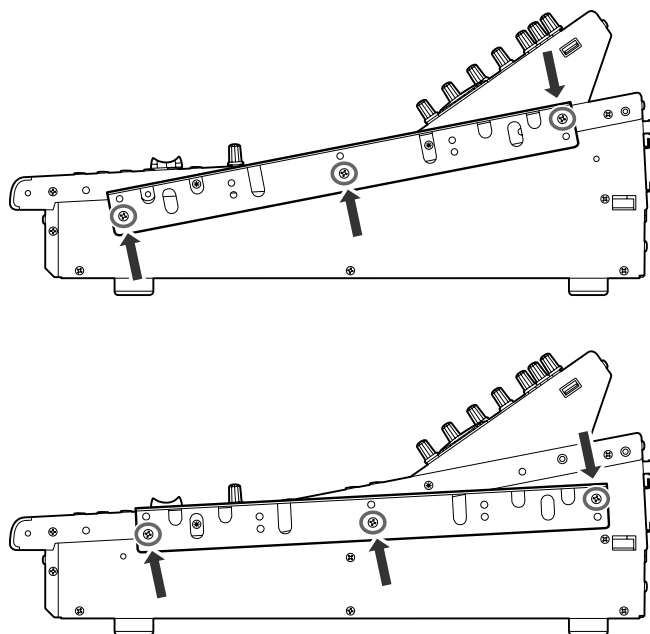

- 4 Attach the hardware to the other side in the same way.

### CAUTION

- When attaching the RK1 rackmount kit, make sure that the power is turned off. You must use the screws that are included with the RK1.

YAMAHA [ Digital Mixing Console ]  
 Model LS9-16/32 MIDI Implementation Chart

Date : 8-Aug-2006  
 Version : 1.0

Function...	Transmitted	Recognized	Remarks
Basic Default Channel Changed	1 - 16 1 - 16	1 - 16 1 - 16	Memorized
Mode Default Messages Altered	x x *****	1, 3 x x	Memorized
Note Number : True voice	x *****	0 - 127 x	
Velocity Note ON Note OFF	x x	o 9nH, v=1-127 x	Effect Control
After Key's Touch Ch's	x x	x x	
Pitch Bend	x	x	
Control Change 0,32 6,38 98,99 1-31,33-98, 102-119	o o o o	o o o o	Bank Select Data Entry NRPN LSB,MSB Assignable Cntrl
Prog Change : True #	o 0 - 127 *****	o 0 - 127 0 - 300	Assignable
System Exclusive	o *1	o *1,*2	
: Song Pos. Common : Song Sel. : Tune	x x x	x o x	Recorder Control
System : Clock Real Time: Commands	x x	o x	Effect Control
Aux :All Sound Off :Reset All Cntrls :Local ON/OFF Mes- :All Notes OFF sages:Active Sense :Reset	x x x x x x	x x x x o o	
Notes:	*1 :Bulk Dump/Request and Parameter Change/Request. *2 :MMC		

Mode 1 : OMNI ON , POLY  
 Mode 3 : OMNI OFF, POLY

Mode 2 : OMNI ON , MONO  
 Mode 4 : OMNI OFF, MONO

o : Yes  
 x : No

## Index

### Numerics

- 2TR IN DIGITAL jack .....25  
 2TR OUT DIGITAL jack .....25

### A

- AC IN connector .....25  
 Adjusting faders .....223  
 Adjusting input/output gain .....224  
 Administrator .....187  
 Analog input connections .....41  
 Analog output connections .....42  
 Assigning a name .....34

### B

- Block Diagram ..... End of Manual  
 BRIGHTNESS field .....217  
 Buttons .....32

### C

- Calibration function .....223, 224  
 Cascade connections .....209  
 CH CLEAR screen .....128  
 CH COPY screen .....126  
 CH LINK screen .....124  
 CH MOVE screen .....127  
 [CHANNEL JOB] key .....19  
 Channel link .....124  
 Channel module section .....17  
 Channel parameters  
   Copying .....126  
   Initializing .....128  
   Moving .....127  
 COMPANDER HARD (COMPANDER-H) .....231  
 COMPANDER SOFT (COMPANDER-S) .....231  
 COMPARE button .....39  
 COMPRESSOR .....230  
 Connections .....41  
 Console lock .....197  
 Constant display area .....30  
 CONTRAST field .....217  
 Control changes .....183  
 Cooling fan vent .....25  
 COPY button .....39  
 Cue function .....145, 148  
 [CUE] key .....149

- CUE screen ..... 149  
 Cursor ..... 32  
 [CUSTOM FADER] key ..... 91  
 Custom fader layer ..... 91

### D

- Data entry section ..... 22  
 DE-ESSER ..... 231  
 DEF button ..... 38  
 Digital input/output connections ..... 43  
 Dimensions ..... 279  
 DIRECT field ..... 82  
 Direct output ..... 103  
 Display ..... 20, 30  
 DISPLAY ACCESS section ..... 19, 29  
 DUCKING ..... 229  
 DYNA field ..... 82  
 Dynamics ..... 117  
 [DYNAMICS 1] encoder ..... 21  
 [DYNAMICS 2] encoder ..... 21  
 DYNAMICS Library List ..... 227  
 Dynamics parameter ..... 229

### E

- Effect Type List ..... 232  
 Effects ..... 166  
   Editing parameters ..... 170  
   Freeze ..... 173  
   Inserting ..... 168  
   Mounting ..... 158  
   Send/return ..... 167  
   Tap tempo ..... 172  
 Effects and tempo synchronization ..... 244  
 Effects Parameters ..... 233  
 Electrical characteristics ..... 275  
 EQ ..... 115  
 EQ field ..... 82  
 EQ [HIGH]/[HIGH MID]/  
   [LOW MID]/[LOW] keys ..... 22  
 EQ Library List ..... 225  
 EQ [Q]/[FREQUENCY]/[GAIN] encoders ..... 21  
 Equalizer ..... 115  
 Error Messages ..... 268  
 EXPANDER ..... 230  
 External head amp ..... 175

**F**

Fade function .....	143
FADER field .....	82
Fader layer .....	27
Firmware versionn .....	14
Focus function .....	139
Front panel .....	26
Functions that can be assigned to user-defined keys .....	257

**G**

GATE .....	229
General Specifications .....	272
GEQ .....	161
Graphic EQ .....	161
31BandGEQ .....	161, 163
Flex15GEQ .....	161, 164
Inserting .....	161
Mounting .....	158
Grounding screw .....	25
Guest .....	187

**H**

HA field .....	82
[HA GAIN] encoder .....	21
HA settings .....	47
Head amp settings .....	47
Headphone output jack .....	26
Help function .....	218
[HOME] key .....	22, 27, 82

**I**

Initializing internal memory .....	222
INPUT channels .....	13, 53
Input channels .....	13, 53
Head amp settings .....	57
Sending to MIX bus .....	62
Sending to STEREO bus .....	50
Sending to STEREO/MONO bus .....	58
INPUT jacks .....	24
Input patching .....	99
Input/output characteristics .....	273
Insert connections .....	101
INSERT field .....	82
Internal clock .....	215
IP address .....	216

**K**

Keyboard window .....	34
Knobs .....	32

**L**

LAMP connector (LS9-32 only) .....	25
LAYER section .....	19, 27
LCR mode .....	58, 71
Level Diagram .....	End of Manual
LIB button .....	35
Libraries .....	35, 120, 174
List window .....	32
Login .....	189
LS9 Editor .....	216
LS9-16 .....	11
LS9-32 .....	11

**M**

MAC address .....	216
MATRIX buses .....	213
MATRIX channels .....	13, 67
[METER] key .....	19
METER screen .....	155
Meters .....	155
MIDI .....	177
MIDI Data Format .....	260
MIDI Implementation Chart .....	281
MIDI IN/OUT connectors .....	25
MISC SETUP screen .....	206
MIX bus types (VARI/FIXED) .....	14
MIX buses .....	213
MIX channels .....	13, 67
Sending to MATRIX buses .....	75
Sending to STEREO/MONO bus .....	71
MIX/MATRIX SELECT section .....	20
MMC .....	186
Monitor function .....	145, 146
[MONITOR] key .....	19
MONITOR screen .....	146
MONO channels .....	13, 67
MUTE field .....	82
Mute group .....	121
MUTE GROUP screen .....	121
Mute safe .....	123

- N**
- Network address .....216
- NETWORK connector .....25, 216
- O**
- OMNI OUT jacks .....24
- Oscillator .....153
- OSCILLATOR screen.....153
- Output channels .....13, 67
- Output patching.....95
- Overview .....9
- P**
- [PAN] encoder.....21
- PAN field .....82
- Parameter changes.....185
- Password .....188, 191
- PASTE button .....39
- PATCH field .....82
- PHONES LEVEL control .....26
- PHONES OUT jack .....26
- Pin Assignment .....278
- Playback.....110
- Popup windows .....31
- POWER switch.....25
- Power user .....187
- Preferences.....194
- Program changes.....180
- R**
- [RACK 1-4] key .....19
- [RACK 5-8] key .....19
- RACK screen .....161, 167
- Rear panel.....11, 23
- Recall Safe function .....140
- RECALL SAFE screen.....140
- Recorder .....105
- [RECORDER] key .....19
- RECORDER screen.....106
- Recording.....108
- S**
- SAVE/LOAD popup window.....199
- SCENE FADE screen .....143
- SCENE FOCUS screen .....139
- SCENE LIST screen .....129
- Scene memory ..... 129
- Clearing..... 137
- Constant display area ..... 30
- Copying/pasting ..... 136
- Cutting..... 138
- Initializing current scene..... 45
- Inserting ..... 138
- Recalling ..... 131
- Sorting and renaming..... 134
- Storing..... 129
- [SCENE MEMORY] key ..... 19
- SCENE PLAYBACK LINK screen ..... 113
- SELECTED CH VIEW screen ..... 31, 82
- Selected channel..... 30
- SELECTED CHANNEL section..... 21, 81
- Adjusting send levels ..... 84
- Assigning to mute group ..... 89
- Basic operations..... 29
- Direct output settings ..... 88
- Dynamics settings ..... 87
- HA settings..... 85
- HPF/EQ settings ..... 87
- Insert settings..... 88
- Output patching..... 86
- Pan/balance ..... 86
- Recall Safe settings ..... 88
- Sending signal to MIX bus ..... 62
- Turning a channel on/off ..... 89
- [SELECTED SEND] encoder ..... 21
- SEND field..... 82
- SENDS ON FADER mode ..... 65, 78
- [SETUP] key..... 19
- Slots ..... 24, 44
- ST IN channels..... 13, 53
- ST IN section..... 17
- ST/MONO mode ..... 58, 71
- STEREO channels ..... 13, 67
- STEREO MASTER section ..... 18
- Stereo meter / Cue section ..... 20
- STEREO/MONO channels
- Sending to MATRIX buses..... 75
- SYSTEM SETUP screen..... 205

**T**

Talkback .....	151
TALKBACK screen .....	151
TITLE LIST screen.....	110
Tool buttons .....	35
Top panel .....	12, 15, 27
Troubleshooting .....	270

**U**

USB connector.....	22
USB memory	
Editing files .....	201
Formatting .....	204
Loading .....	200
Saving.....	199
USB memory recorder .....	105
User .....	187
User authentication keys .....	187, 188, 192
User defined keys .....	132, 196, 257
USER DEFINED KEYS section .....	18, 132, 196
User level.....	187, 192
USER SETUP screen .....	187, 205

**V**

Virtual rack.....	157
VIRTUAL RACK screen.....	158

**W**

Warning .....	268
Word clock .....	14, 46, 206
WORD CLOCK IN/OUT connectors .....	25
WORD CLOCK popup window .....	46, 206





# LS9-16/LS9-32 Block Diagram

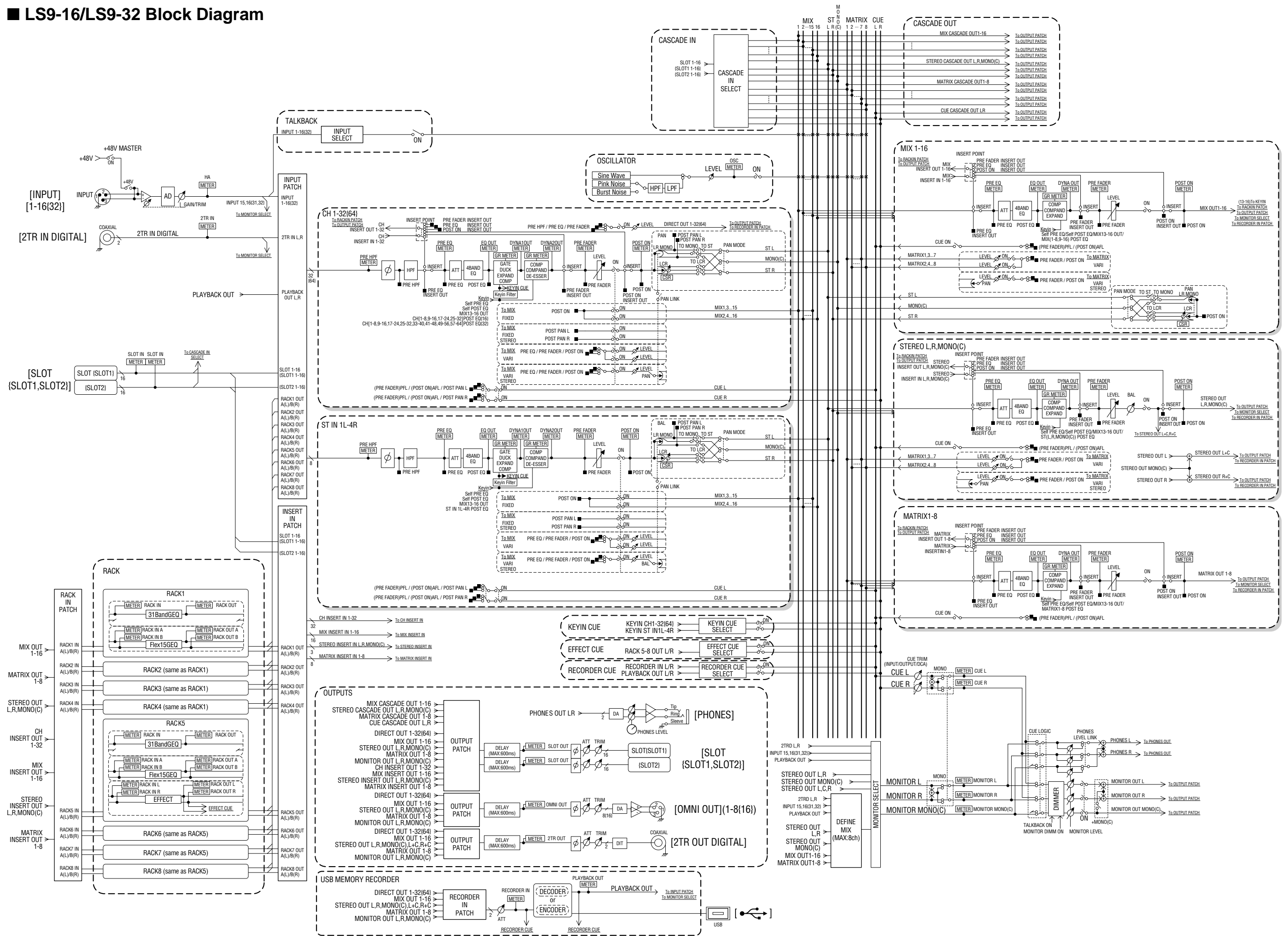

# LS9-16/LS9-32 Level Diagram

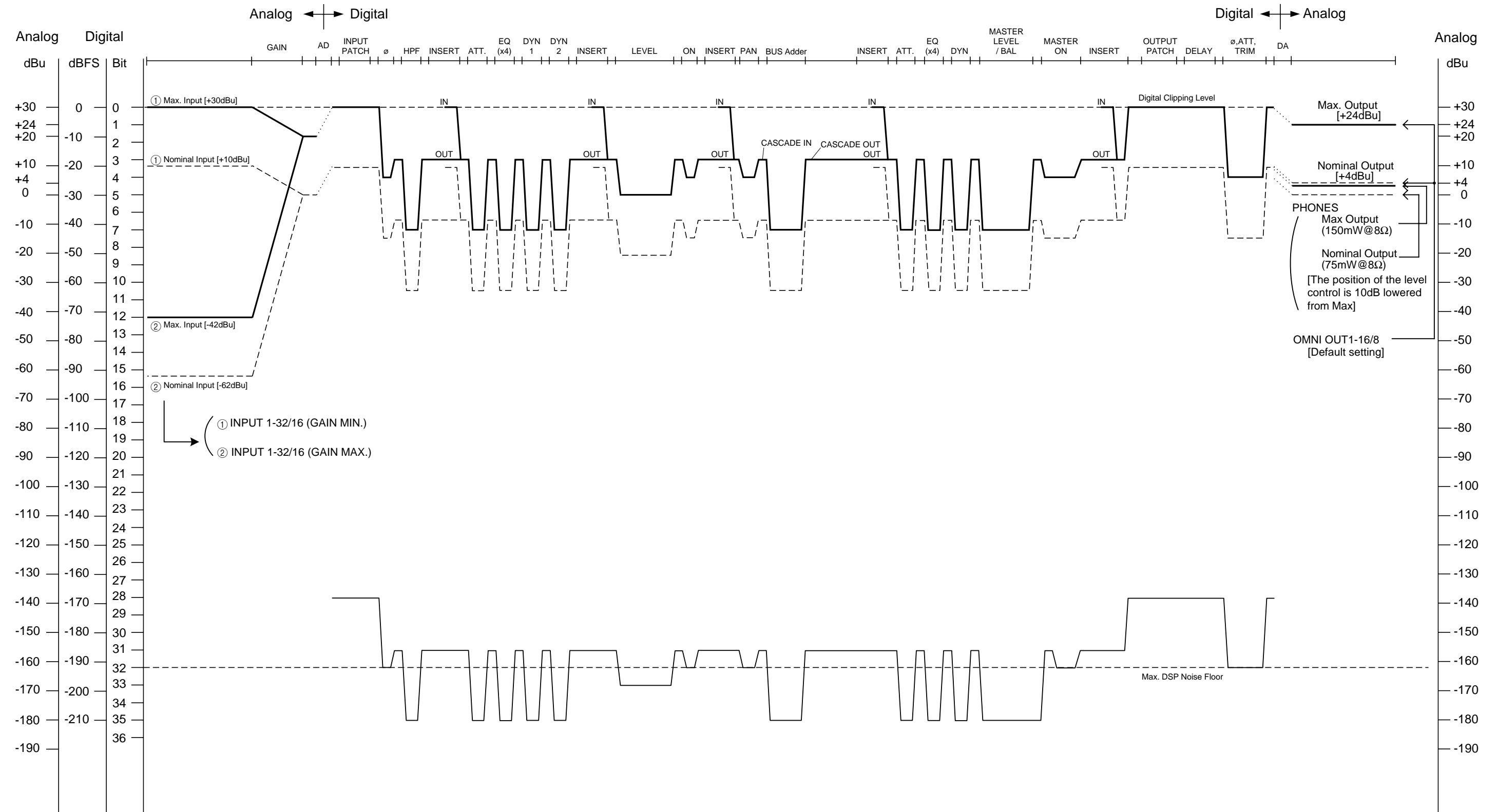

[0dBu = 0.775Vrms]  
 [0dBFS = Full Scale]

For details of products, please contact your nearest Yamaha representative or the authorized distributor listed below.

Pour plus de détails sur les produits, veuillez-vous adresser à Yamaha ou au distributeur le plus proche de vous figurant dans la liste suivante.

Die Einzelheiten zu Produkten sind bei Ihrer unten aufgeführten Niederlassung und bei Yamaha Vertragshändlern in den jeweiligen Bestimmungsländern erhältlich.

Para detalles sobre productos, contacte su tienda Yamaha más cercana o el distribuidor autorizado que se lista debajo.

## NORTH AMERICA

### CANADA

**Yamaha Canada Music Ltd.**  
135 Milner Avenue, Scarborough, Ontario,  
M1S 3R1, Canada  
Tel: 416-298-1311

### U.S.A.

**Yamaha Corporation of America**  
6600 Orangethorpe Ave., Buena Park, Calif. 90620,  
U.S.A.  
Tel: 714-522-9011

## CENTRAL & SOUTH AMERICA

### MEXICO

**Yamaha de México S.A. de C.V.**  
Calz. Javier Rojo Gómez #1149,  
Col. Guadalupe del Moral  
C.P. 09300, México, D.F., México  
Tel: 55-5804-0600

### BRAZIL

**Yamaha Musical do Brasil Ltda.**  
Rua Joaquim Floriano, 913 - 4º andar, Itaim Bibi,  
CEP 04534-013 Sao Paulo, SP. BRAZIL  
Tel: 011-3704-1377

### ARGENTINA

**Yamaha Music Latin America, S.A.  
Sucursal de Argentina**  
Olga Cossettini 1553, Piso 4 Norte  
Madero Este-C1107CEK  
Buenos Aires, Argentina  
Tel: 011-4119-7000

### PANAMA AND OTHER LATIN AMERICAN COUNTRIES/ CARIBBEAN COUNTRIES

**Yamaha Music Latin America, S.A.**  
Torre Banco General, Piso 7, Urbanización Marbella,  
Calle 47 y Aquilino de la Guardia,  
Ciudad de Panamá, Panamá  
Tel: +507-269-5311

## EUROPE

### THE UNITED KINGDOM/IRELAND

**Yamaha Music Europe GmbH (UK)**  
Sherbourne Drive, Tilbrook, Milton Keynes,  
MK7 8BL, England  
Tel: 01908-366700

### GERMANY

**Yamaha Music Europe GmbH**  
Siemensstraße 22-34, 25462 Rellingen, Germany  
Tel: 04101-3030

### SWITZERLAND/LIECHTENSTEIN

**Yamaha Music Europe GmbH  
Branch Switzerland in Zürich**  
Seefeldstrasse 94, 8008 Zürich, Switzerland  
Tel: 044-387-8080

### AUSTRIA/BULGARIA

**Yamaha Music Europe GmbH Branch Austria**  
Schleiergasse 20, A-1100 Wien, Austria  
Tel: 01-60203900

### CZECH REPUBLIC/HUNGARY/ ROMANIA/SLOVAKIA/SLOVENIA

**Yamaha Music Europe GmbH  
Branch Austria (Central Eastern Europe Office)**  
Schleiergasse 20, A-1100 Wien, Austria  
Tel: 01-602039025

### POLAND/LITHUANIA/LATVIA/ESTONIA

**Yamaha Music Europe GmbH  
Branch Sp.z o.o. Oddział w Polsce**  
ul. 17 Stycznia 56, PL-02-146 Warszawa, Poland  
Tel: 022-500-2925

### MARTA

**Olimpus Music Ltd.**  
The Emporium, Level 3, St. Louis Street Msida  
MSD06  
Tel: 02133-2144

### THE NETHERLANDS/ BELGIUM/LUXEMBOURG

**Yamaha Music Europe Branch Benelux**  
Clarissenhof 5-b, 4133 AB Vianen, The Netherlands  
Tel: 0347-358 040

### FRANCE

**Yamaha Music Europe**  
BP 70-77312 Marne-la-Vallée Cedex 2, France  
Tel: 01-64-61-4000

### ITALY

**Yamaha Music Europe GmbH, Branch Italy**  
Viale Italia 88, 20020 Lainate (Milano), Italy  
Tel: 02-935-771

### SPAIN/PORTUGAL

**Yamaha Music Europe GmbH Ibérica, Sucursal  
en España**  
Ctra. de la Coruna km. 17, 200, 28230  
Las Rozas (Madrid), Spain  
Tel: +34-902-39-8888

### GREECE

**Philippos Nakas S.A. The Music House**  
147 Skiathou Street, 112-55 Athens, Greece  
Tel: 01-228 2160

### SWEDEN/FINLAND/ICELAND

**Yamaha Music Europe GmbH Germany filial  
Scandinavia**  
J. A. Wettergrens Gata 1, Box 30053  
S-400 43 Göteborg, Sweden  
Tel: 031 89 34 00

### DENMARK

**Yamaha Music Europe GmbH, Tyskland – filial  
Denmark**  
Generatorvej 6A, DK-2730 Herlev, Denmark  
Tel: 44 92 49 00

### NORWAY

**Yamaha Music Europe GmbH Germany -  
Norwegian Branch**  
Grini Næringspark 1, N-1345 Østerås, Norway  
Tel: 67 16 77 70

### RUSSIA

**Yamaha Music (Russia)**  
Room 37, bld. 7, Kievskaya street, Moscow,  
121059, Russia  
Tel: 495 626 5005

### OTHER EUROPEAN COUNTRIES

**Yamaha Music Europe GmbH**  
Siemensstraße 22-34, 25462 Rellingen, Germany  
Tel: +49-4101-3030

## AFRICA

**Yamaha Corporation,  
Asia-Pacific Sales & Marketing Group**  
Nakazawa-cho 10-1, Naka-ku, Hamamatsu,  
Japan 430-8650  
Tel: +81-53-460-2303

## MIDDLE EAST

### TURKEY/CYPRUS

**Yamaha Music Europe GmbH**  
Siemensstraße 22-34, 25462 Rellingen, Germany  
Tel: 04101-3030

### OTHER COUNTRIES

**Yamaha Music Gulf FZE**  
LOB 16-513, P.O.Box 17328, Jubel Ali,  
Dubai, United Arab Emirates  
Tel: +971-4-881-5868

## ASIA

### THE PEOPLE'S REPUBLIC OF CHINA

**Yamaha Music & Electronics (China) Co.,Ltd.**  
2F, Yunhedasha, 1818 Xinzha-lu, Jingan-qu,  
Shanghai, China  
Tel: 021-6247-2211

### INDIA

**Yamaha Music India Pvt. Ltd.**  
5F Ambience Corporate Tower Ambience Mall Complex  
Ambience Island, NH-8, Gurgaon-122001, Haryana, India  
Tel: 0124-466-5551

### INDONESIA

**PT. Yamaha Musik Indonesia (Distributor)**

**PT. Nusantara**  
Gedung Yamaha Music Center, Jalan Jend. Gatot  
Subroto Kav. 4, Jakarta 12930, Indonesia  
Tel: 021-520-2577

### KOREA

**Yamaha Music Korea Ltd.**  
8F, 9F, Dongsung Bldg. 158-9 Samsung-Dong,  
Kangnam-Gu, Seoul, Korea  
Tel: 02-3467-3300

### MALAYSIA

**Yamaha Music (Malaysia) Sdn., Bhd.**  
Lot 8, Jalan Perbandaran, 47301 Kelana Jaya,  
Petaling Jaya, Selangor, Malaysia  
Tel: 03-78030900

### SINGAPORE

**Yamaha Music (Asia) Pte., Ltd.**  
#03-11 A-Z Building  
140 Paya Lebor Road, Singapore 409015  
Tel: 6747-4374

### TAIWAN

**Yamaha KHS Music Co., Ltd.**  
3F, #6, Sec.2, Nan Jing E. Rd. Taipei.  
Taiwan 104, R.O.C.  
Tel: 02-2511-8688

### THAILAND

**Siam Music Yamaha Co., Ltd.**  
4, 6, 15 and 16th floor, Siam Motors Building,  
891/1 Rama 1 Road, Wangmai,  
Pathumwan, Bangkok 10330, Thailand  
Tel: 02-215-2622

### OTHER ASIAN COUNTRIES

**Yamaha Corporation,  
Asia-Pacific Sales & Marketing Group**  
Nakazawa-cho 10-1, Naka-ku, Hamamatsu,  
Japan 430-8650  
Tel: +81-53-460-2303

## OCEANIA

### AUSTRALIA

**Yamaha Music Australia Pty. Ltd.**  
Level 1, 99 Queensbridge Street, Southbank,  
Victoria 3006, Australia  
Tel: 3-9693-5111

### COUNTRIES AND TRUST TERRITORIES IN PACIFIC OCEAN

**Yamaha Corporation,  
Asia-Pacific Sales & Marketing Group**  
Nakazawa-cho 10-1, Naka-ku, Hamamatsu,  
Japan 430-8650  
Tel: +81-53-460-2303

**HEAD OFFICE** Yamaha Corporation, Pro Audio Division  
Nakazawa-cho 10-1, Naka-ku, Hamamatsu, Japan 430-8650  
Tel: +81-53-460-2441



Yamaha Pro Audio global web site:  
<http://www.yamahaproaudio.com/>

Yamaha Manual Library  
<http://www.yamaha.co.jp/manual/>

C.S.G., Pro Audio Division  
© 2006-2011 Yamaha Corporation

110POTO-J0  
Printed in Japan

WH39070