



MIXING CONSOLE

MG206C

MG166CX

MG166C

Owner's Manual
Bedienungsanleitung
Mode d'emploi
Manual de instrucciones

English

Deutsch

Français

Español

Features

Input Channels.....page 12

With up to 16 (MG166CX/MG166C: 10) mic/line inputs or up to four stereo inputs, the MG mixer can simultaneously connect to a wide range of devices: microphones, line-level devices, stereo synthesizers, and more.

Compression.....page 10

Compression increases the overall level without introducing distortion by compressing excessive peaks in the signals from microphones and guitars.

AUX Sends and Stereo AUX Return.....page 16

You can use the AUX SEND jack to feed the signal sent to an external signal processor, and then return the processed stereo signal through the RETURN jack.

High-quality digital effects (MG166CX).....pages 15, 19

With digital effects built in, the MG166CX can deliver a wide range of sound variations all by itself.

Funktionen

Eingangskanäle.....Seite 30

Mit bis zu 16 Mikrofon-/Line-Eingängen (MG166CX/MG166C: 10) oder bis zu vier Stereoeingängen können viele Geräte gleichzeitig am MG-Mischpult angeschlossen werden: Mikrofone, Geräte mit Leitungsepegel, Stereo-Synthesizer usw.

Kompression.....Seite 28

Kompression erhöht den Durchschnittsepegel, ohne Verzerrung hinzuzufügen, indem übermäßige Pegelspitzen der Signale von Mikrofonen oder Gitarren komprimiert werden.

AUX Sends und Stereo AUX Return.....Seite 34

Von der AUX SEND-Buchse können Sie das Signal einzeln an einen externen Signalprozessor führen, und das verarbeitete Stereosignal über die RETURN-Buchse zurück in das Pult führen.

Hochwertige Digitaleffekte (MG166CX).....Seiten 33, 37

Mit den eingebauten digitalen Effekten kann das MG166CX aus sich heraus eine Reihe von Klangvariationen liefern.

Caractéristiques

Canaux d'entrée.....page 48

Avec 16 entrées micro/ligne (MG166CX/MG166C: 10) ou quatre entrées stéréo maximum, la console de mixage MG peut connecter simultanément une grande variété d'appareils : micros, appareils de ligne, synthétiseurs stéréo, etc.

Compression.....page 46

La compression augmente le niveau général sans engendrer de distorsion en comprimant les pics excessifs des signaux des micros et des guitares.

Envois AUX et retour AUX stéréo.....page 52

Vous pouvez utiliser la prise jack AUX SEND pour envoyer le signal vers une unité de traitement de signaux externes, puis pour renvoyer le signal stéréo traité via la prise jack RETURN.

Effets numériques de qualité supérieure (MG166CX)...pages 51, 55

Grâce aux effets numériques intégrés, la console MG166CX peut proposer de nombreuses variations de sons.

Características

Canales de entrada.....página 66

Con un máximo de 16 entradas de micrófono/línea (MG166CX/MG166C: 10) o cuatro entradas estereofónicas, la mezcladora MG puede conectarse simultáneamente con una gran variedad de dispositivos: micrófonos, dispositivos de nivel de línea, sintetizadores estereofónicos, etc.

Compresión.....página 64

La compresión aumenta el nivel general sin causar distorsión, mediante la compresión del exceso de picos en las señales de los micrófonos y guitarras.

Envíos AUX y retorno AUX estereofónico.....página 70

Puede utilizar la toma AUX SEND para introducir la señal enviada en un procesador de señales externo y luego devolver la señal estereofónica procesada a través de la toma RETURN (retorno).

Efectos digitales de alta calidad (MG166CX).....páginas 69, 73

Gracias a sus efectos digitales incorporados, la mezcladora MG166CX puede producir por sí misma una amplia gama de variaciones de sonido.

EN
DE
FR
ES

IMPORTANT NOTICE FOR THE UNITED KINGDOM

Connecting the Plug and Cord

IMPORTANT. The wires in this mains lead are coloured in accordance with the following code:

BLUE : NEUTRAL
BROWN : LIVE

As the colours of the wires in the mains lead of this apparatus may not correspond with the coloured markings identifying the terminals in your plug proceed as follows:

The wire which is coloured BLUE must be connected to the terminal which is marked with the letter N or coloured BLACK.

The wire which is coloured BROWN must be connected to the terminal which is marked with the letter L or coloured RED.

Making sure that neither core is connected to the earth terminal of the three pin plug.

* This applies only to products distributed by Yamaha-Kemble Music (U.K.) Ltd.

(2 wires)

FCC INFORMATION (U.S.A.)

1. IMPORTANT NOTICE: DO NOT MODIFY THIS UNIT!

This product, when installed as indicated in the instructions contained in this manual, meets FCC requirements. Modifications not expressly approved by Yamaha may void your authority, granted by the FCC, to use the product.

2. IMPORTANT:

When connecting this product to accessories and/or another product use only high quality shielded cables. Cable/s supplied with this product MUST be used. Follow all installation instructions. Failure to follow instructions could void your FCC authorization to use this product in the USA.

3. NOTE:

This product has been tested and found to comply with the requirements listed in FCC Regulations, Part 15 for Class "B" digital devices. Compliance with these requirements provides a reasonable level of assurance that your use of this product in a residential environment will not result in harmful interference with other electronic devices. This equipment generates/uses radio frequencies and, if not installed and used according to the instructions found in the users manual, may cause interference harmful to the operation of other electronic devices. Compliance with FCC regula-

tions does not guarantee that interference will not occur in all installations. If this product is found to be the source of interference, which can be determined by turning the unit "OFF" and "ON", please try to eliminate the problem by using one of the following measures:

Relocate either this product or the device that is being affected by the interference.

Utilize power outlets that are on different branch (circuit breaker or fuse) circuits or install AC line filter/s.

In the case of radio or TV interference, relocate/reorient the antenna. If the antenna lead-in is 300 ohm ribbon lead, change the lead-in to co-axial type cable.

If these corrective measures do not produce satisfactory results, please contact the local retailer authorized to distribute this type of product. If you can not locate the appropriate retailer, please contact Yamaha Corporation of America, Electronic Service Division, 6600 Orangethorpe Ave, Buena Park, CA90620

The above statements apply ONLY to those products distributed by Yamaha Corporation of America or its subsidiaries.

* This applies only to the MG166CX distributed by YAMAHA CORPORATION OF AMERICA, not the MG206C/MG166C.

(class B)

PRECAUTIONS

PLEASE READ CAREFULLY BEFORE PROCEEDING

* Please keep this manual in a safe place for future reference.



WARNING

Always follow the basic precautions listed below to avoid the possibility of serious injury or even death from electrical shock, short-circuiting, damages, fire or other hazards. These precautions include, but are not limited to, the following:

Power supply/Power cord

- Only use the voltage specified as correct for the device. The required voltage is printed on the name plate of the device.
- Use only the included power adaptor (PA-30 or an equivalent recommended by Yamaha).
- Do not place the power cord near heat sources such as heaters or radiators, and do not excessively bend or otherwise damage the cord, place heavy objects on it, or place it in a position where anyone could walk on, trip over, or roll anything over it.

Do not open

- Do not open the device or attempt to disassemble the internal parts or modify them in any way. The device contains no user-serviceable parts. If it should appear to be malfunctioning, discontinue use immediately and have it inspected by qualified Yamaha service personnel.

Water warning

- Do not expose the device to rain, use it near water or in damp or wet conditions, or place containers on it containing liquids which might spill into any openings.
- Never insert or remove an electric plug with wet hands.

If you notice any abnormality

- If the power cord or plug becomes frayed or damaged, or if there is a sudden loss of sound during use of the device, or if any unusual smells or smoke should appear to be caused by it, immediately turn off the power switch, disconnect the electric plug from the outlet, and have the device inspected by qualified Yamaha service personnel.
- If this device or the AC power adaptor should be dropped or damaged, immediately turn off the power switch, disconnect the electric plug from the outlet, and have the device inspected by qualified Yamaha service personnel.



CAUTION

Always follow the basic precautions listed below to avoid the possibility of physical injury to you or others, or damage to the device or other property. These precautions include, but are not limited to, the following:

Power supply/Power cord

- Remove the electric plug from the outlet when the device is not to be used for extended periods of time, or during electrical storms.
- When removing the electric plug from the device or an outlet, always hold the plug itself and not the cord. Pulling by the cord can damage it.
- To avoid generating unwanted noise, make sure there is adequate distance (50 cm or more) between the AC power adaptor and the device.
- Do not cover or wrap the AC power adaptor with a cloth or blanket.

Location

- Before moving the device, remove all connected cables.
- When setting up the device, make sure that the AC outlet you are using is easily accessible. If some trouble or malfunction occurs, immediately turn off the power switch and disconnect the plug from the outlet. Even when the power switch is turned off, electricity is still flowing to the product all the minimum level. When you are not using the product for a long time, make sure to unplug the power cord from the wall AC outlet.

- If this device is to be mounted in an EIA-standard rack, leave the back of the rack open and make sure that it is at least 10 cm away from walls or surfaces. Also, if this device is to be mounted with devices that tend to generate heat, such as power amplifiers, be sure to keep an adequate gap between this device and the heat-generating devices or install ventilation panels to prevent high temperatures from developing inside this device. Inadequate ventilation can result in overheating, possibly causing damage to the device(s), or even fire.
- Avoid setting all equalizer controls and faders to their maximum. Depending on the condition of the connected devices, doing so may cause feedback and may damage the speakers.
- Do not expose the device to excessive dust or vibrations, or extreme cold or heat (such as in direct sunlight, near a heater, or in a car during the day) to prevent the possibility of panel disfiguration or damage to the internal components.
- Do not place the device in an unstable position where it might accidentally fall over.
- Do not block the vents. This device has ventilation holes at the bottom/rear to prevent the internal temperature from becoming too high. In particular, do not place the device on its side or upside down. Inadequate ventilation can result in overheating, possibly causing damage to the device(s), or even fire.
- Do not use the device in the vicinity of a TV, radio, stereo equipment, mobile phone, or other electric devices. Doing so may result in noise, both in the device itself and in the TV or radio next to it.

Connections

- Before connecting the device to other devices, turn off the power for all devices. Before turning the power on or off for all devices, set all volume levels to minimum.

Handling caution

- When turning on the AC power in your audio system, always turn on the power amplifier LAST, to avoid speaker damage. When turning the power off, the power amplifier should be turned off FIRST for the same reason.
- Do not insert your fingers or hands in any gaps or openings on the device (vents, etc.).
- Avoid inserting or dropping foreign objects (paper, plastic, metal, etc.) into any gaps or openings on the device (vents, etc.) If this happens, turn off the power immediately and unplug the power cord from the AC outlet. Then have the device inspected by qualified Yamaha service personnel.
- Do not use the device or headphones for a long period of time at a high or uncomfortable volume level, since this can cause permanent hearing loss. If you experience any hearing loss or ringing in the ears, consult a physician.
- Do not rest your weight on the device or place heavy objects on it, and avoid use excessive force on the buttons, switches or connectors.

XLR-type connectors are wired as follows (IEC60268 standard): pin 1: ground, pin 2: hot (+), and pin 3: cold (-).

Insert TRS phone jacks are wired as follows: sleeve: ground, tip: send, and ring: return.

Yamaha cannot be held responsible for damage caused by improper use or modifications to the device, or data that is lost or destroyed.

Always turn the power off when the device is not in use.

Even when the power switch is in the "STANDBY" position, electricity is still flowing to the device at the minimum level. When you are not using the device for a long time, make sure you unplug the power cord from the wall AC outlet.

The performance of components with moving contacts, such as switches, volume controls, and connectors, deteriorates over time. Consult qualified Yamaha service personnel about replacing defective components.

The MG mixer may heat up by as much as 15 to 20°C while the power is on. This is normal. Please note that the panel temperature may exceed 50°C in ambient temperatures higher than 30°C, and use caution to prevent burns.

* This Owner's Manual applies to the MG206C/MG166CX/MG166C. The main differences between the three models are the number of input channels and whether the internal effects are included. The MG206C has 20 input channels while the MG166CX/MG166C have 16 channels. And only the MG166CX has internal effects.

* In this manual the term "MG mixers" refers to the MG206C, MG166CX and MG166C.

* Illustrations herein are for explanatory purposes only, and may not match actual appearance during operation.

* Company names and product names herein are trademarks or registered trademarks of their respective companies.

Copying of commercially available music or other audio data for purposes other than personal use is strictly prohibited by copyright law. Please respect all copyrights, and consult with a copyright specialist if you are in doubt about permissible use.

Specifications and descriptions in this owner's manual are for information purposes only. Yamaha Corp. reserves the right to change or modify products or specifications at any time without prior notice. Since specifications, equipment or options may not be the same in every locale, please check with your Yamaha dealer.

Introduction

Thank you for your purchase of the Yamaha MG206C/MG166CX/MG166C mixing console. The MG206C/MG166CX/MG166C feature input channels suitable for a wide range of usage environments. And the MG166CX includes high-quality built-in digital effects that can provide some very serious sound. The mixer combines ease of operation with support for multiple usage environments.

Please read through this manual carefully before beginning use, so that you will be able to take full advantage of this mixer's superlative features and enjoy trouble-free operation for years to come.

Contents

Introduction	5
Contents.....	5
Before Turning on the Mixer	5
Turning the Power On.....	5
■ Mixer Basics	6
Quick Guide	6
Making the Most of Your Mixer	8
Balanced, Unbalanced	
—What's the Difference?.....	8
Signal Levels and the Decibel.....	8
To EQ or Not to EQ.....	9
Ambience	10
The Modulation Effects:	
Phasing, Chorus, and Flanging	10
Compression.....	10
■ Reference	11
Setup	11
Front & Rear Panels	12
Channel Control Section.....	12
Digital Effects	15
Master Control Section	16
Digital Effect Program List (Only MG166CX).....	19
Jack List.....	19
Troubleshooting	20
Specifications	75

Accessories

- Owner's Manual
- AC power adaptor (PA-30)*

* May not be included depending on your particular area. Please check with your Yamaha dealer.

Before Turning on the Mixer

- 1 Be sure that the mixer's power switch is in the **STANDBY** position.



Use only the included power adaptor (PA-30) or an equivalent recommended by Yamaha. Use of a different adaptor may result in equipment damage, overheating, or fire.

- 2 Connect the power adaptor to the **AC ADAPTOR IN** connector (1) on the rear of the mixer, and then turn the fastening ring clockwise (2) to secure the connection.

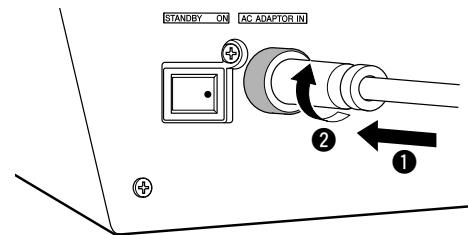

- 3 Plug the power adaptor into a standard household power outlet.



- Be sure to unplug the adaptor from the outlet when not using the mixer, or when there are lightning storms in the area.
- To avoid generating unwanted noise, make sure there is 50 cm or more between the power adaptor and the mixer.

Turning the Power On

Press the mixer's power switch to the **ON** position. When you are ready to turn the power off, press the power switch to the **STANDBY** position.



Note that trace current continues to flow while the switch is in the **STANDBY** position. If you do not plan to use the mixer again for a long while, please be sure to unplug the adaptor from the wall outlet.

Quick Guide

Getting Sound to the Speakers

We begin by connecting a pair of speakers and generating some stereo output. Note that operations and procedures will vary somewhat according to the input devices you are using.

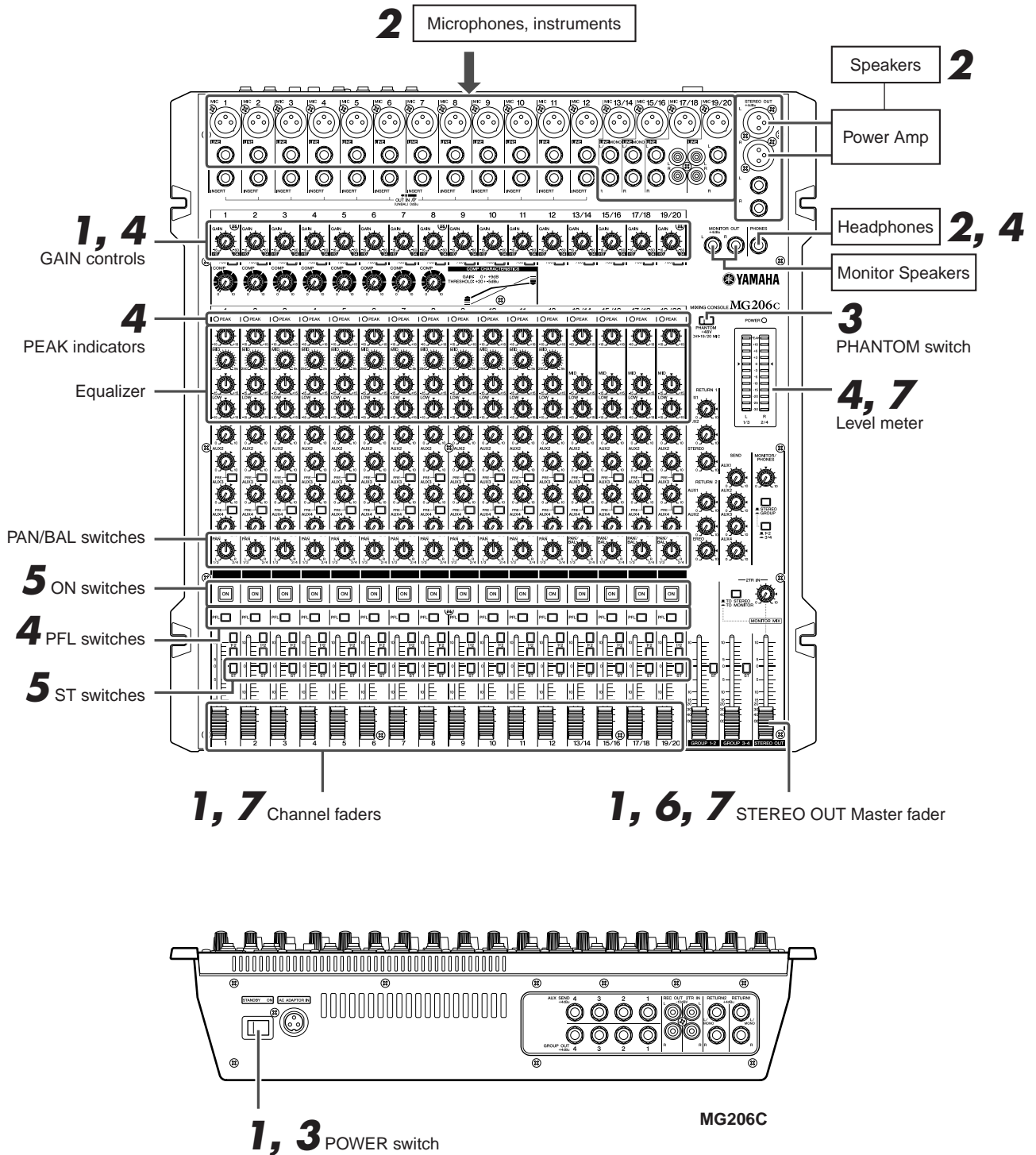

1 Be sure that your mixer is turned off and that all level controls* are turned all the way down.

* STEREO OUT Master fader, Channel faders, GAIN controls, etc.

NOTE Set the equalizer and the PAN/BAL controls to their ▼ positions.

2 Turn off any other external devices, then connect microphones, instruments, and speakers.

- NOTE**
- For information on connecting external devices see the Connection Example on page 11.
 - Connect electric guitars and basses through an intermediary device such as a direct box, preamp, or amp simulator. Connecting these instruments directly to the MG mixer may result in degraded sound and noise.

3 To avoid damage to your speakers, power up the devices in the following order: Peripheral devices → MG mixer → power amps (or powered speakers). Reverse this order when turning power off.



CAUTION

If you are using condenser microphones that require phantom power, turn the MG mixer's phantom power switch on before turning on the power to the power amp or powered speakers. See page 17 for more detail.

4 Adjust the channel GAIN controls so that the corresponding PEAK indicators flash briefly on the highest peak levels.

NOTE To use the level meter to get an accurate reading of the incoming signal level, turn the channel PFL switch on. Adjust the GAIN controls so that the level meter indication occasionally rises above the "▼" (0) level.

Note that the PHONES jack outputs the pre-fader signal from all channels on which the PFL switch is ON so that those signals can be monitored via the headphones.

5 Turn on the ON and ST switches for each channel you are using.

6 Set the STEREO OUT Master fader to the "0" position.

7 Set the Channel faders to create the desired initial balance, then adjust the overall volume using the STEREO OUT Master fader.

- NOTE**
- To use the level meter to view the level being applied to the STEREO L/R buses, set the PFL switch off (■) and the MONITOR switch to STEREO (■).
 - If the PEAK indicator lights frequently, lower the Channel faders a little to avoid distortion.

Making the Most of Your Mixer

You've got yourself a mixer and now you're ready to use it.

Just plug everything in, twiddle the controls, and away you go ... right?

Well, if you've done this before you won't have any problems, but if this is the first time you've ever used a mixer you might want to read through this little tutorial and pick up a few basics that will help you get better performance and make better mixes.

Balanced, Unbalanced—What's the Difference?

In a word: "noise." The whole point of balanced lines is noise rejection, and it's something they're very good at. Any length of wire will act as an antenna to pick up the random electromagnetic radiation we're constantly surrounded by: radio and TV signals as well as spurious electromagnetic noise generated by power lines, motors, electric appliances, computer monitors, and a variety of other sources. The longer the wire, the more noise it is likely to pick up. That's why balanced lines are the best choice for long cable runs. If your "studio" is basically confined to your desktop and all connections are no more than a meter or two in length, then unbalanced lines are fine—unless you're surrounded by extremely high levels of electromagnetic noise. Another place balanced lines are almost always used is in microphone cables. The reason for this is that the output signal from most microphones is very small, so even a tiny amount of noise will be relatively large, and will be amplified to an alarming degree in the mixer's high-gain head amplifier.

Balanced noise cancellation

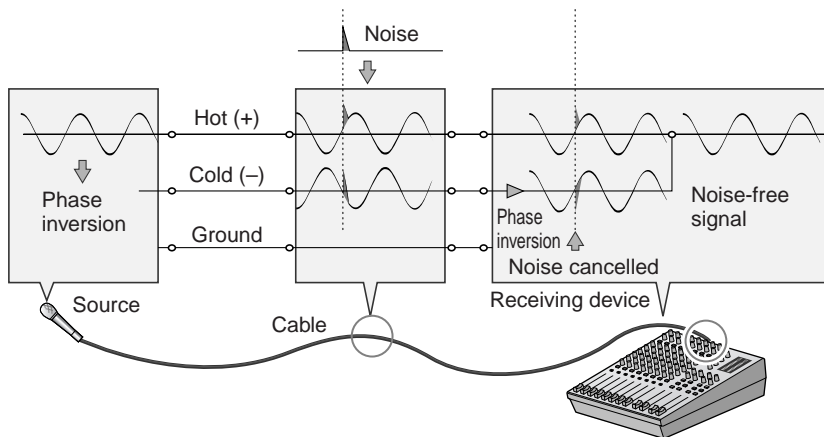

To summarize

Microphones	Use balanced lines.
Short line-level runs	Unbalanced lines are fine if you're in a relatively noise-free environment.
Long line-level runs	The ambient electromagnetic noise level will be the ultimate deciding factor, but balanced is best.

Signal Levels and the Decibel

Let's take a look at one of the most commonly used units in audio: the decibel (dB). If the smallest sound that can be heard by the human ear is given an arbitrary value of 1, then the loudest sound that can be heard is approximately 1,000,000 (one million) times louder. That's too many digits to deal with for practical calculations, and so the more appropriate "decibel" (dB) unit was created for sound-related measurements. In this system the difference between the softest and loudest sounds that can be heard is 120 dB. This is a non-linear scale, and a difference of 3 dB actually results in a doubling or halving of the loudness.

You might encounter a number of different varieties of the dB: dBu, dBV, dBm and others, but the dBu is the basic decibel unit. In the case of dBu, "0 dBu" is specified as a signal level of 0.775 volts. For example, if a microphone's output level is -40 dBu (0.00775 V), then to raise that level to 0 dBu (0.775 V) in the mixer's preamp stage requires that the signal be amplified by 100 times.

A mixer may be required to handle signals at a wide range of levels, and it is necessary match input and output levels as closely as possible. In most cases the "nominal" level for a mixer's input and outputs is marked on the panel or listed in the owner's manual.

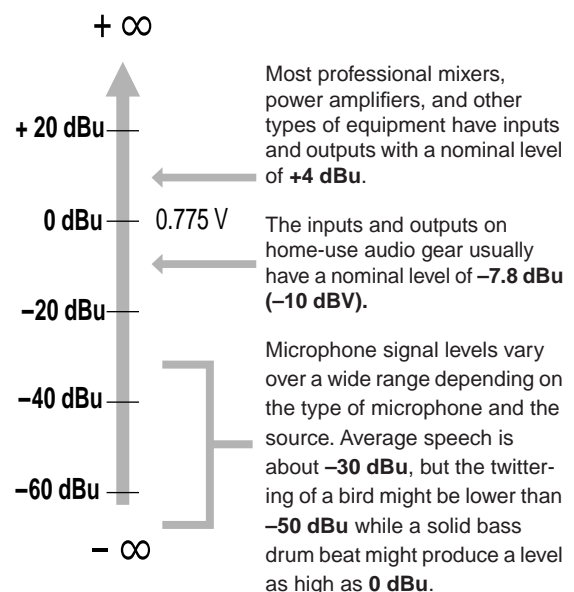

Most professional mixers, power amplifiers, and other types of equipment have inputs and outputs with a nominal level of **+4 dBu**.

The inputs and outputs on home-use audio gear usually have a nominal level of **-7.8 dBu (-10 dBV)**.

Microphone signal levels vary over a wide range depending on the type of microphone and the source. Average speech is about **-30 dBu**, but the twittering of a bird might be lower than **-50 dBu** while a solid bass drum beat might produce a level as high as **0 dBu**.

To EQ or Not to EQ

In general: less is better. There are many situations in which you'll need to cut certain frequency ranges, but use boost sparingly, and with caution. Proper use of EQ can eliminate interference between instruments in a mix and give the overall sound better definition. Bad EQ—and most commonly bad boost—just sounds terrible.

Cut for a Cleaner Mix

For example: cymbals have a lot of energy in the mid and low frequency ranges that you don't really perceive as musical sound, but which can interfere with the clarity of other instruments in these ranges. You can basically turn the low EQ on cymbal channels all the way down without changing the way they sound in the mix. You'll hear the difference, however, in the way the mix sounds more "spacious," and instruments in the lower ranges will have better definition. Surprisingly enough, piano also has an incredibly powerful low end that can benefit from a bit of low-frequency roll-off to let other instruments—notably drums and bass—do their jobs more effectively. Naturally you won't want to do this if the piano is playing solo.

The reverse applies to kick drums and bass guitars: you can often roll off the high end to create more space in the mix without compromising the character of the instruments. You'll have to use your ears, though, because each instrument is different and sometimes you'll want the "snap" of a bass guitar, for example, to come through.

The fundamental and harmonic frequency ranges of some musical instruments.

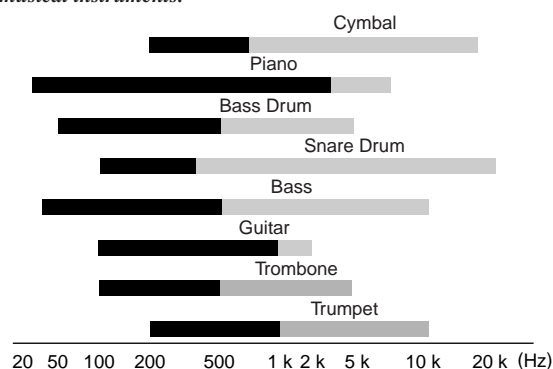

- Fundamental: The frequency that determines the basic musical pitch.
- Harmonics: Multiples of the fundamental frequency that play a role in determining the timbre of the instrument.

Some Frequency Facts

The lowest and highest frequencies than can be heard by the human ear are generally considered to be around 20 Hz and 20,000 Hz, respectively. Average conversation occurs in the range from about 300 Hz to about 3,000 Hz. The frequency of a standard pitchfork used to tune guitars and other instruments is 440 Hz (this corresponds to the "A3" key on a piano tuned to concert pitch). Double this frequency to 880 Hz and you have a pitch one octave higher (i.e. "A4" on the piano keyboard). In the same way you can halve the frequency to 220 Hz to produce "A2" an octave lower.

Boost with Caution

If you're trying to create special or unusual effects, go ahead and boost away as much as you like. But if you're just trying to achieve a good-sounding mix, boost only in very small increments. A tiny boost in the midrange can give vocals more presence, or a touch of high boost can give certain instruments more "air." Listen, and if things don't sound clear and clean try using cut to remove frequencies that are cluttering up the mix rather than trying to boost the mix into clarity.

One of the biggest problems with too much boost is that it adds gain to the signal, increasing noise and potentially overloading the subsequent circuitry.

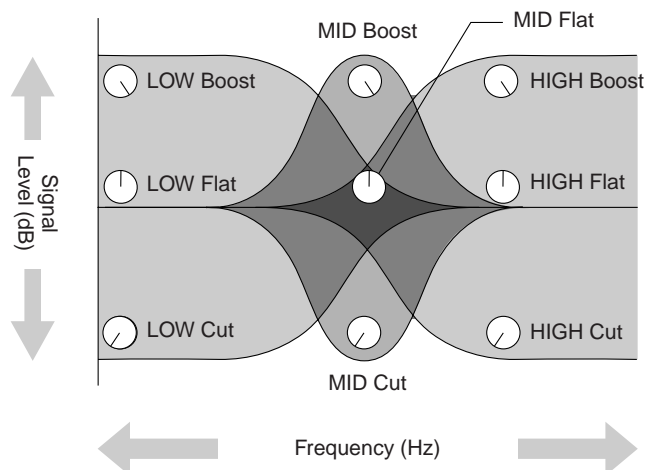

Ambience

Your mixes can be further refined by adding ambience effects such as reverb or delay. The MG166CX's internal effects can be used to add reverb or delay to individual channels in the same way as external effects processors. (Refer to page 15).

Reverb and Delay Time

The optimum reverb time for a piece of music will depend on the music's tempo and density, but as a general rule longer reverb times are good for ballads, while shorter reverb times are more suited to up-tempo tunes. Delay times can be adjusted to create a wide variety of "grooves". When adding delay to a vocal, for example, try setting the delay time to dotted eighth notes corresponding to the tune's tempo.

Reverb Tone

Different reverb programs will have different "reverb tone" due to differences in the reverb time of the high or low frequencies. Too much reverb, particularly in the high frequencies, can result in unnatural sound and interfere with the high frequencies in other parts of the mix. It's always a good idea to choose a reverb program that gives you the depth you want without detracting from the clarity of the mix.

Reverb Level

It's amazing how quickly your ears can lose perspective and fool you into believing that a totally washed-out mix sounds perfectly fine. To avoid falling into this trap start with reverb level all the way down, then gradually bring the reverb into the mix until you can just hear the difference. Any more than this normally becomes a "special effect."

The Modulation Effects:

Phasing, Chorus, and Flanging

All of these effects work on basically the same principle: a portion of the audio signal is "time-shifted" and then mixed back with the direct signal. The amount of time shift is controlled, or "modulated", by an LFO (Low-frequency Oscillator).

For phasing effects the shift is very small. The phase difference between the modulated and direct signals causes cancellation at some frequencies and reinforces the signal at others and this causes the shimmering sound we hear.

For chorus and flanging the signal is delayed by several milliseconds, with the delay time modulated by an LFO, and recombined with the direct signal. In addition to the phasing effect described above, the delay modulation causes a perceived pitch shift which, when mixed with the direct signal, results in a harmonically rich swirling or swishing sound.

The difference between chorus and flanging effects is primarily in the amount of delay time and feedback used—flanging uses longer delay times than chorus, whereas chorus generally uses a more complex delay structure. Chorus is most often used to thicken the sound of an instrument, while flanging is usually used as an outright "special effect" to produce otherworldly sonic swoops.

Compression

One form of compression known as "limiting" can, when properly used, produce a smooth, unified sound with no excessive peaks or distortion. A common example of the use of compression is to "tame" a vocal that has a wide dynamic range in order to tighten up the mix. With the right amount of compression you'll be able to clearly hear whispered passages while passionate shouts are still well balanced in the mix. Compression can also be valuable on bass guitar. Too much compression can be a cause of feedback, however, so use it sparingly.

Most compressors require several critical parameters to be set properly to achieve the desired sound. The MG compressor makes achieving great sound much easier: all you need to do is set a single "compression" control and all of the pertinent parameters are automatically adjusted for you.

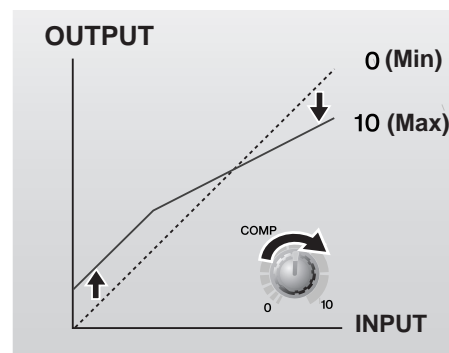

Setup

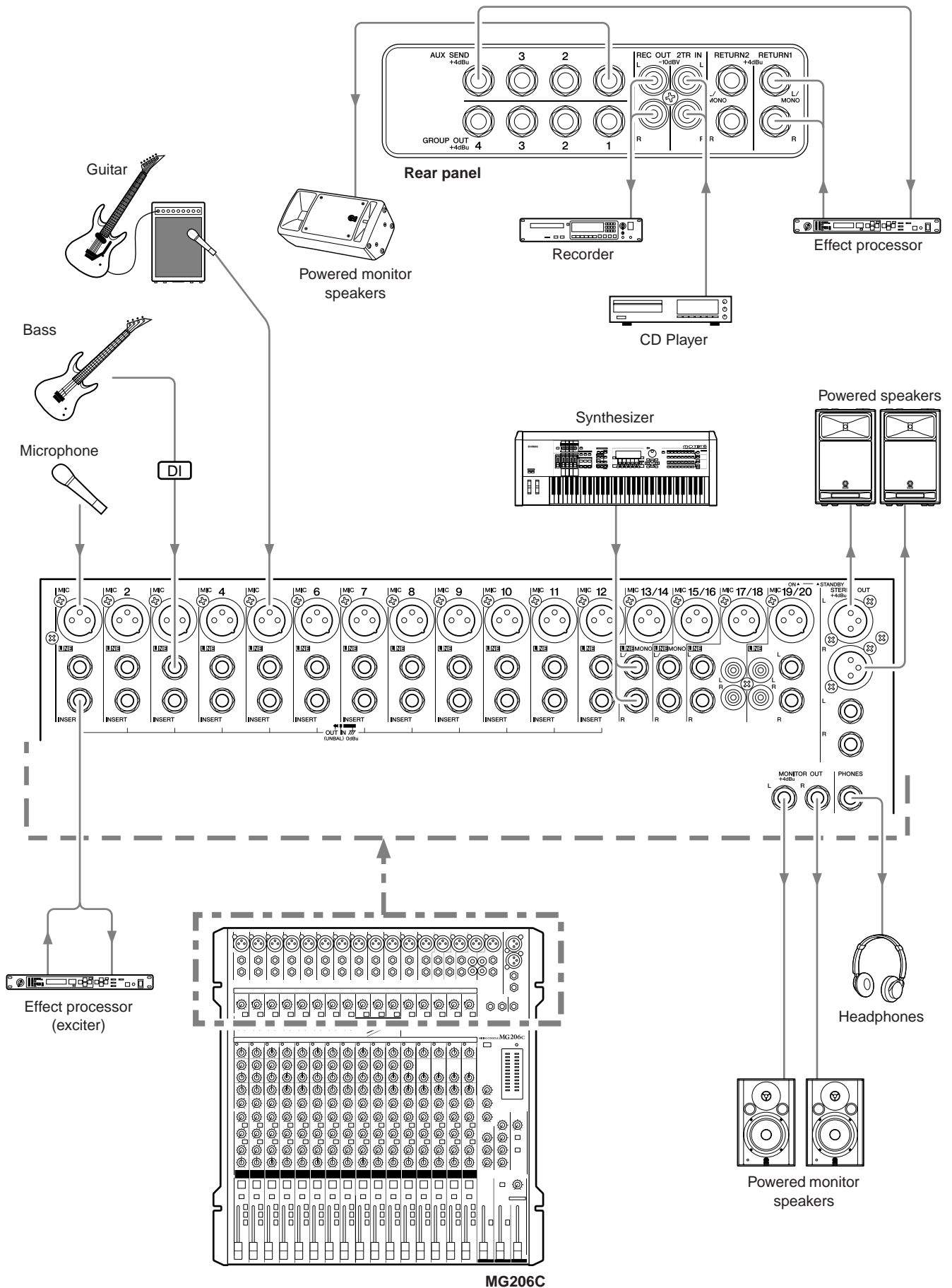

Front & Rear Panels

Channel Control Section

● MG206C

Channels 1 to 8 (Monaural) Channels 9 to 12 (Monaural)
 Channels 13/14 and 15/16 (Stereo) Channels 17/18 and 19/20 (Stereo)

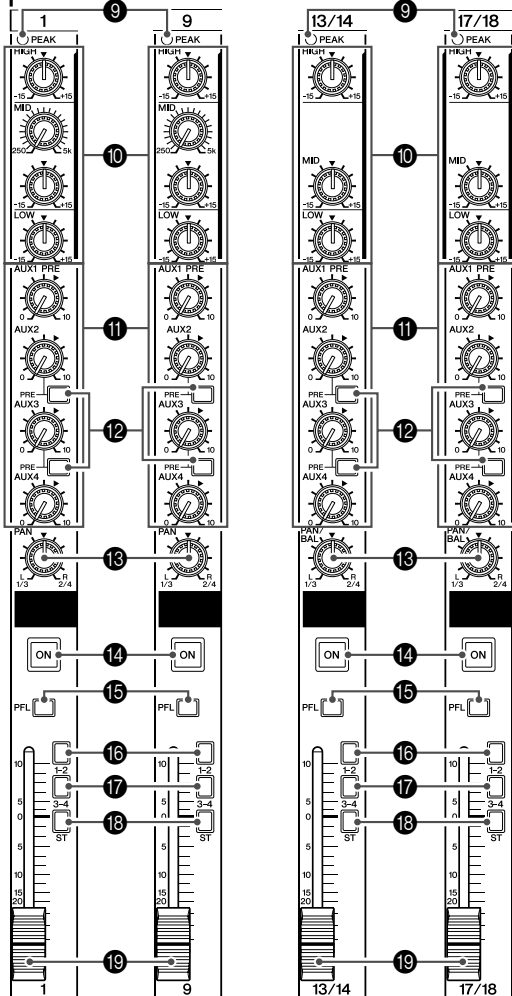
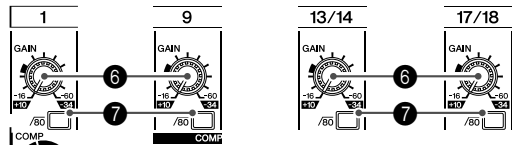
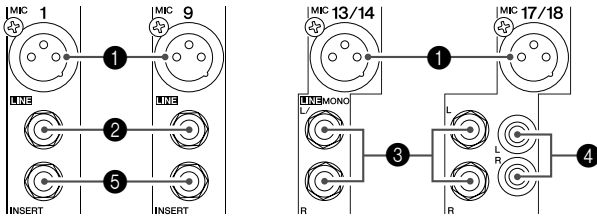

● MG166CX/MG166C

* ⑪ MG166C : EFFECT → AUX3

Channels 1 to 6 (Monaural) Channels 7 and 8 (Monaural)
 Channels 9/10 and 11/12 (Stereo) Channels 13/14 and 15/16 (Stereo)

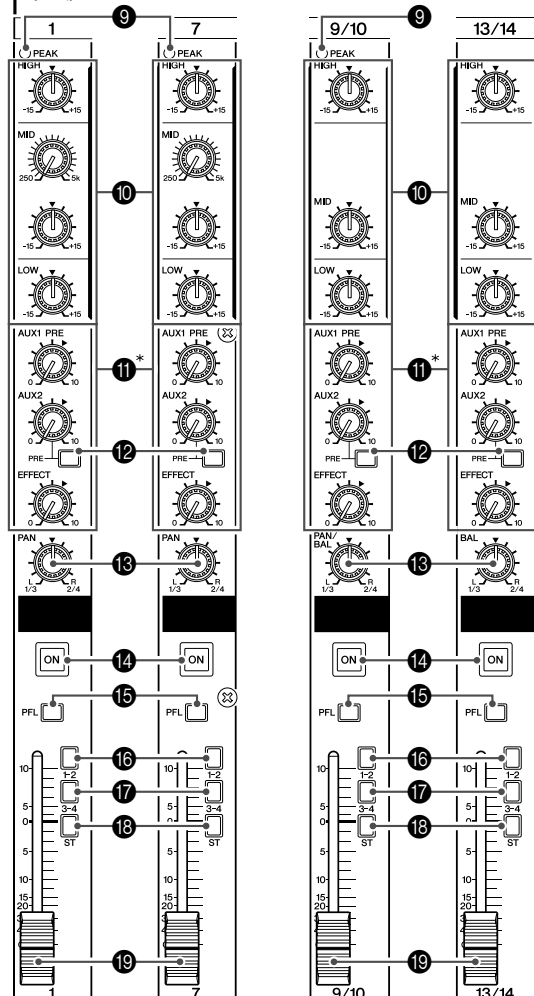
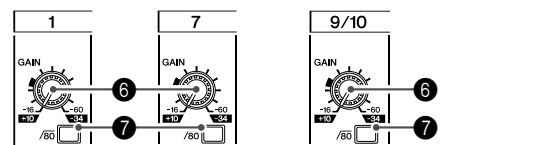
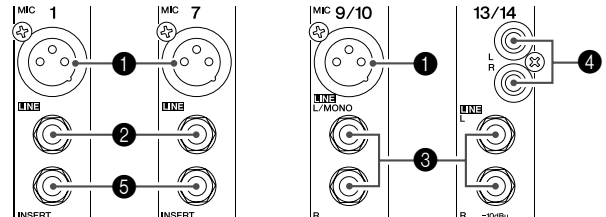

1 MIC Input jacks

These are balanced XLR-type microphone input jacks. (1: Ground; 2: Hot; 3: Cold)

2 LINE Input Jacks (monaural channels)

These are balanced TRS phone-jack line inputs. (T: Hot; R: Cold; S: Ground). You can connect either balanced or unbalanced phone plugs to these jacks.

3 LINE Input Jacks (stereo channels)

These are unbalanced phone-jack stereo line inputs.

4 LINE Input Jacks (stereo channels)

These are unbalanced stereo RCA pin jacks.

NOTE On channels that provide multiple input jack options only one type of jack can be used at a time.

5 INSERT Jacks

These jacks can be used to insert an external signal-processing device between the equalizer and fader of the corresponding monaural input channel. The INSERT jacks are ideal for connecting devices such as graphic equalizers, compressors, or noise filters into the corresponding channels.

NOTE These are TRS (tip, ring, sleeve) phone jacks that carry both the send and return signal (tip = send/out; ring = return/in; sleeve = ground). Patching external devices via an INSERT jack requires a special cable such as illustrated below (insert cable sold separately).

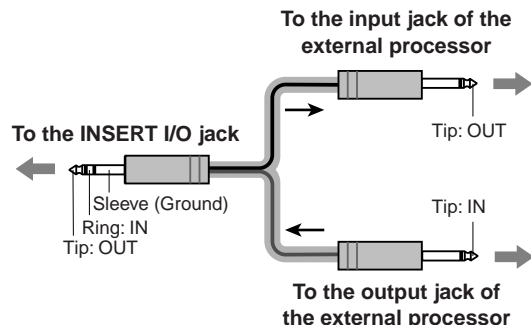

The signal output from the INSERT jacks is reverse-phased. This should not be a problem when connecting to an effect unit, but please be aware of the possibility of phase conflict when connecting to other types of device. A reversed-phased signal may result in degraded sound quality or even complete sound cancellation.

6 GAIN Control

Adjusts the input signal level. To get the best balance between the S/N ratio and the dynamic range, adjust the gain so that the PEAK indicator 9 lights only occasionally and briefly on the highest input transients. The -60 to -16 scale is the MIC input adjustment range. The -34 to +10 scale is the LINE input adjustment range.

7 $\sqrt{80}$ Switch (High-Pass Filter)

This switch toggles the HPF on or off. To turn the HPF on, press the switch in (—). The HPF cuts frequencies below 80 Hz (the HPF does not apply to the line inputs of stereo input channels 3, 4).

8 COMP Control

Adjusts the amount of compression applied to the channel. As the knob is turned to the right the compression ratio increases while the output gain is automatically adjusted accordingly. The result is smoother, more even dynamics because louder signals are attenuated while the overall level is boosted.

NOTE Avoid setting the compression too high, as the higher average output level that results may lead to feedback.

9 PEAK indicator

The peak level of the post-EQ signal is detected, and the PEAK indicator lights red when the level reaches 3 dB below clipping.

For XLR-equipped stereo input channels, both the post-EQ and post-mic-amp peak levels are detected, and the indicator lights red if either of these levels reaches 3 dB below clipping.

10 Equalizer (HIGH, MID and LOW)

This three-band equalizer adjusts the channel's high, mid, and low frequency bands. Setting the knob to the "▼" position produces a flat response in the corresponding band.

Turning the knob to the right boosts the corresponding frequency band, while turning to the left attenuates the band. The monaural channels have MID frequency controls to adjust the midrange frequency band.

The following table shows the EQ type, frequency, and maximum cut/boost for each of the three bands.

Band	Type	Frequency	Maximum Cut/Boost
HIGH	Shelving	10 kHz	±15 dB
MID	Peaking	2.5 kHz*	
LOW	Shelving	100 Hz	

* The monaural channel MID frequency can be adjusted from 250 Hz to 5 kHz. The MID frequency is 2.5 kHz when the MID frequency control is set at the center position.

11 AUX, EFFECT Control

Adjusts the level of the signal sent from the channel to the AUX and EFFECT buses. These knobs should generally be set close to the “▼” position. These controls send either the signal from immediately prior to the channel fader (pre-fader signal) or the signal after the channel fader (post-fader signal) to the corresponding buses. The types of signals sent by the AUX and EFFECT controls on each mixer model are as follows:

• MG206C

AUX1: Pre-fader
 AUX2, 3: Pre-fader/post-fader (determined by the AUX PRE switch 12)
 AUX4: Post-fader

• MG166CX

AUX1: Pre-fader
 AUX2: Pre-fader/post-fader (determined by the AUX PRE switch 12)
 EFFECT: Post-fader

• MG166C

AUX1: Pre-fader
 AUX2: Pre-fader/post-fader (determines by the AUX PRE switch 12)
 AUX3: Post-fader

- NOTE**
- To send the signal to the STEREO bus engage the ON switch (▲).
 - On stereo channels, the L (odd) and R (even) input signals are mixed and sent to the AUX and EFFECT buses.

12 AUX PRE Switch

Selects whether the pre-fader or the post-fader signal is fed to the AUX buses. If the switch is on (▲), the mixer sends the pre-fader signal to the AUX buses, so that AUX outputs are not affected by the channel fader 19. If the switch is off (■) the mixer sends the post-fader signal to the AUX buses.

13 PAN Control PAN/BAL Control BAL Control

The PAN control determines the stereo positioning of the channel signal on the GROUP 1/2 and GROUP 3/4 buses or on the STEREO L/R bus. The BAL control knob sets the balance between left and right channels. Signals input to the L input (odd channel) go to the GROUP 1 or 3 buses or to the STEREO L bus; signals input to the R input (even channel) go to the GROUP 2 or 4 buses or the STEREO R bus.

- NOTE** On channels where this knob provides both PAN and BAL control, the knob operates as a PAN control when input is received via the MIC jack or L (MONO) input only, and as a BAL control when input is received via both L and R inputs.

14 ON Switch

Turn this switch on to send the signal to the buses. The switch lights orange when on.

15 PFL (Pre-Fader Listen) Switch

This switch lets you monitor the channel's pre-fader signal. Press the switch in (▲) so that it lights to turn it on. When the switch is on the channel pre-fader signal is output to the PHONES and MONITOR OUT jacks for monitoring.

16 1-2 Switch

This switch assigns the channel's signal to the GROUP 1/2 bus.

- NOTE** To send the signal to the GROUP 1/2 bus turn the ON switch on (▲).

17 3-4 Switch

This switch assigns the channel's signal to the GROUP 3/4 bus.

- NOTE** To send the signal to the GROUP 3/4 bus turn the ON switch on (▲).

18 ST Switch

This switch assigns the channel's signal to the STEREO L/R bus.

- NOTE** To send the signal to the STEREO bus turn the ON switch on (▲).

19 Channel Fader

Adjusts the level of the channel signal. Use these faders to adjust the balance between the various channels.

- NOTE** Set the fader sliders for unused channels all the way down to minimize noise.

Digital Effects

* Only the MG166CX has digital effects.

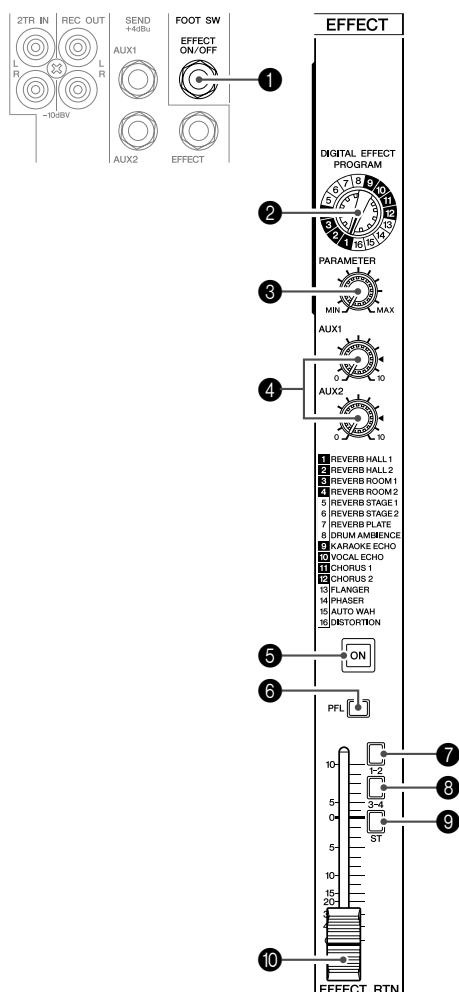

1 FOOT SWITCH Jack

A Yamaha FC5 foot switch (sold separately) can be connected to this jack and used to toggle the digital effects ON and OFF.

2 PROGRAM Dial

Selects one of the 16 internal effects. See page 19 for details about the internal effects.

3 PARAMETER Control

Adjusts the parameter (depth, speed, etc.) for the selected effect. The last value used with each effect type is saved.

NOTE When you change to a different effect type, the mixer automatically restores the value that was previously used with that type (regardless of the current position of the PARAMETER knob). These parameter values are reset when the power is turned off.

4 AUX Control

Adjusts the level of the signal sent from the internal digital effect unit to the AUX buses.

NOTE The signal level sent to the AUX buses is not affected by the EFFECT RTN fader.

5 ON Switch

Switches the internal effect on or off. The internal effect is applied only if this switch is turned on. The switch lights orange when on.

An optional Yamaha FC5 foot switch (sold separately) can be used to toggle the digital effects ON and OFF.

NOTE The ON switch lights and the internal effect unit is active when the power is initially turned on.

6 PFL Switch

Turn this switch on to send the effect signal to the PFL bus.

7 1-2 Switch

This switch assigns the effect signal to the GROUP 1/2 bus.

8 3-4 Switch

This switch assigns the effect signal to the GROUP 3/4 bus.

9 ST Switch

This switch assigns the effect signal to the STEREO L/R bus.

10 EFFECT RTN Fader

Adjusts the signal level sent from the internal digital effect unit to the STEREO bus.

Master Control Section

● MG206C

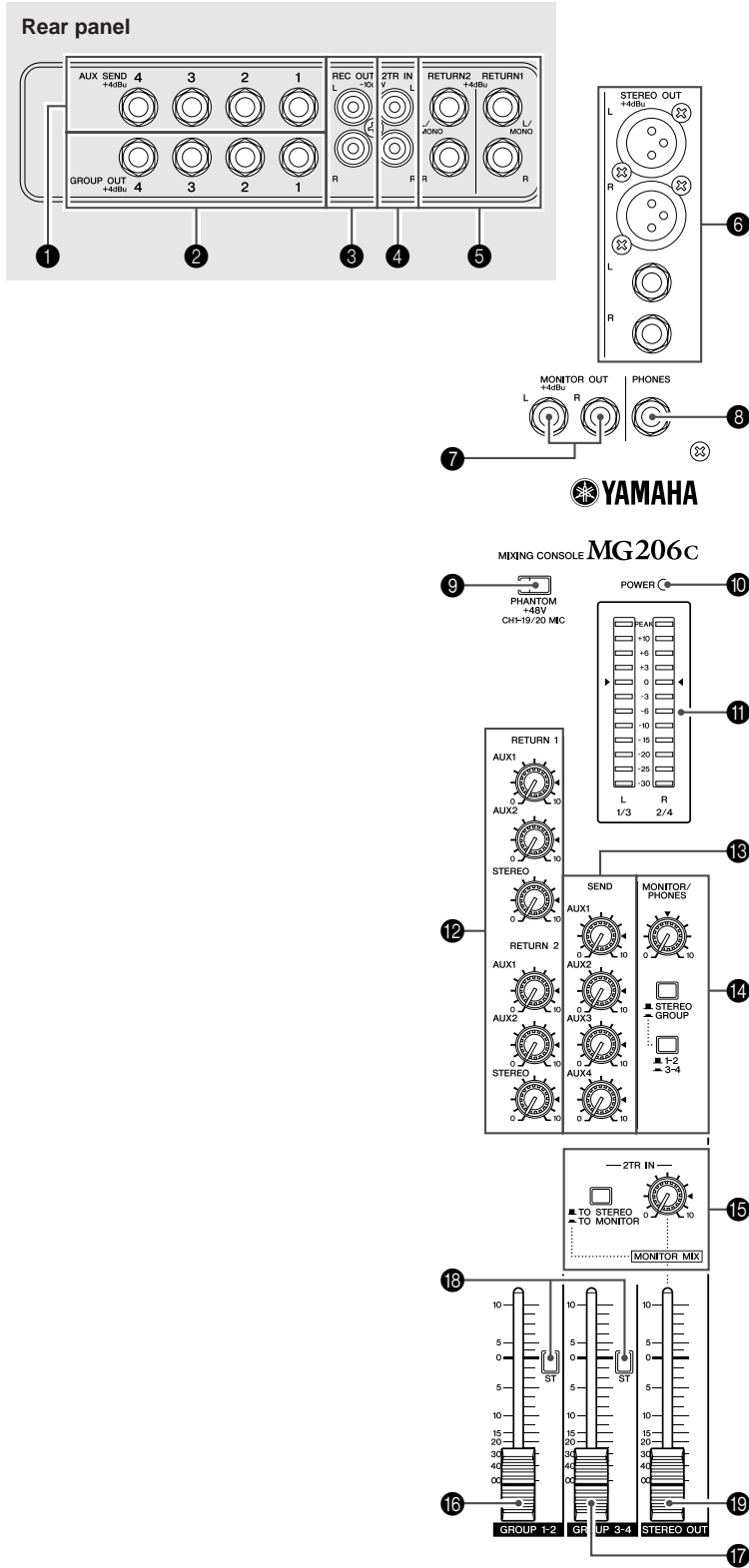

● MG166CX/MG166C

* 1, 13 MG166C : EFFECT → AUX3

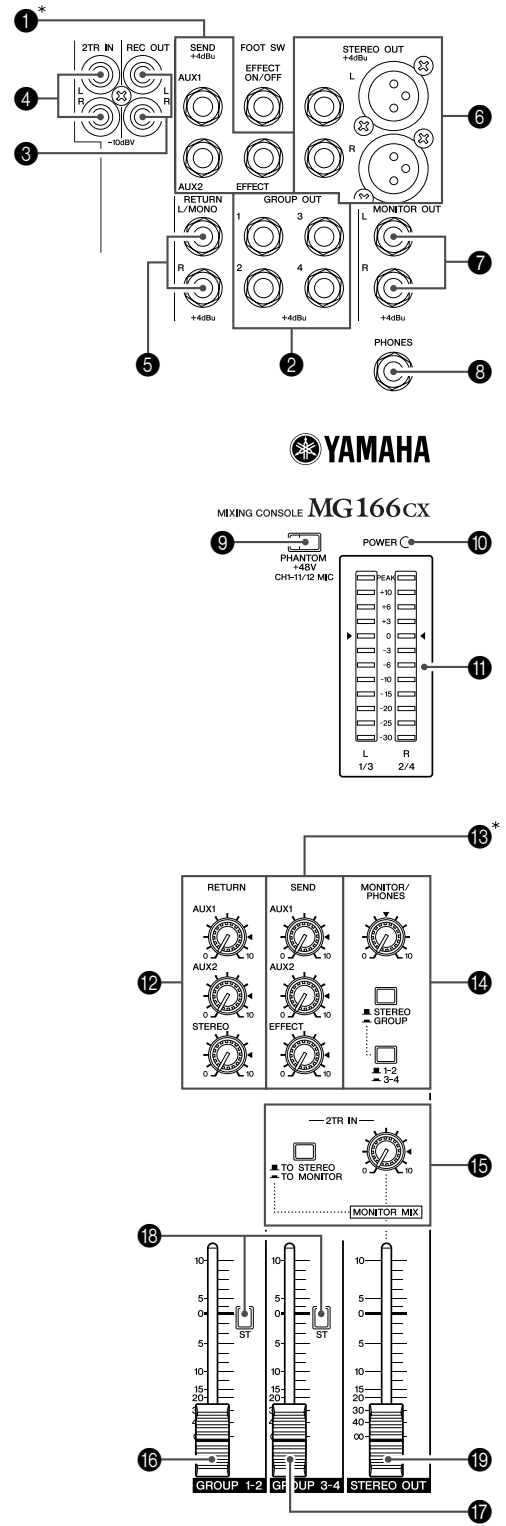

1 SEND Jacks (AUX, EFFECT)

These impedance balanced* TRS phone jacks output the signals from the AUX/EFFECT buses. The pre-fader send option should be selected if you are connecting to a monitor system, while the post-fader send option is the best choice when connecting to external signal processors (e.g. effects units). See "AUX, EFFECT Control" on page 14 for information on the types of signals sent by the AUX and EFFECT controls on each mixer model.

2 GROUP OUT (1 to 4) Jacks

These impedance-balanced* TRS phone jacks output the GROUP 1/2 and 3/4 signals. Use these jacks to connect to the input jacks of an multi-track recorder, external mixer, or other such device.

3 REC OUT (L, R) Jacks

These RCA pin jacks can be connected to an external recorder such as an MD recorder in order to record the same signal that is being output via the STEREO OUT jacks.

NOTE The mixer's STEREO OUT Master fader has no affect on the signal output via these jacks. Be sure to make appropriate level adjustments at the recording device.

4 2TR IN Jacks

These RCA pin jacks input a stereo sound source. Use these jacks when you want to connect a CD player directly to the mixer.

NOTE Select where you want to send the signal using the 2TR IN switch, and adjust the signal level using the 2TR IN control in the Master Control section.

5 RETURN L (MONO), R Jacks

These are unbalanced phone-jack type line inputs. The signal received by these jacks can be sent to the STEREO L/R bus as well as the AUX1 and AUX2 buses. When a stereo signal is returned a mono mix of the signal is sent to the AUX1 and AUX2 buses. These jacks are typically used to receive the signal returned from an external effect device (reverb, delay, etc.).

NOTE

- These jacks can also be used as an auxiliary stereo input.
- If you connect to the L (MONO) jack only, the mixer will recognize the signal as monaural and will send the identical signal to both the L and R jacks.

6 STEREO OUT (L, R) Jacks

These jacks deliver the mixer's stereo output. You use these jacks, for example, to connect to the power amplifier driving your main speakers. You can also connect these jacks to a recording device when you wish to record mixer's stereo output while using the STEREO OUT Master fader 19 for level control.

• XLR jacks

XLR-type balanced output jacks.

• LINE jacks

TRS phone-type balanced output jacks.

7 MONITOR OUT jacks

These are impedance-balanced* TRS phone-type output jacks.

NOTE The signal output by these jacks is determined by the MONITOR switch, the 2TR IN switch, and the PFL switches on the input channels.

8 PHONES Jack

Connect a pair of headphones to this TRS phone-type output jack. The PHONES jack outputs the same signal as the MONITOR OUT jacks.

9 PHANTOM +48 V Switch

This switch toggles phantom power on and off. When the switch is on the mixer supplies +48V phantom power to all channels that have XLR mic input jacks. Turn this switch on when using one or more phantom-powered condenser microphones.

NOTE When this switch is on the mixer supplies DC +48 V power to pins 2 and 3 of all XLR-type MIC INPUT jacks.



• Be sure to leave this switch off if you do not need phantom power.

• When turning the switch on, be sure that only condenser microphones are connected to the XLR input jacks. Devices other than condenser mics may be damaged if connected to the phantom power supply. Note, however, that the switch may be left on when connecting to balanced dynamic microphones.

• To prevent damage to speakers, be sure to turn off power amplifiers (or powered speakers) before turning this switch on or off. We also recommend that you turn all output controls (STEREO OUT Master fader, GROUP 1-2 fader, GROUP 3-4 fader, etc.) to their minimum settings before operating the switch to avoid the risk of loud noises that could cause hearing loss or device damage.

10 POWER Indicator

This indicator lights when the mixer's power is ON.

11 Level Meter

This LED meter displays the level of the signal selected by the MONITOR switch 14, 2TR IN switch 15 and PFL switch. The "0" segment corresponds to the nominal output level. The PEAK indicator lights red when the output reaches the clipping level.

12 RETURN

• AUX1, AUX2 Control

Adjusts the level at which the L/R signal received at the RETURN jacks (L (MONO) and R) is sent to the AUX1 and AUX2 buses.

• STEREO Control

Adjusts the level at which the signal received at the RETURN jacks (L (MONO) and R) is sent to the STEREO L/R bus.

NOTE

- If you supply a signal to the RETURN L (MONO) jack only, the mixer sends the same signal to both the L and R STEREO buses.

- (MG206C) Signals input via the RETURN1 jacks are adjusted using the RETURN1 AUX1, AUX2 and the STEREO controls, and signals input via the RETURN2 jacks are adjusted using the RETURN2 AUX1, AUX2 and the STEREO controls.

* impedance balanced

Since the hot and cold terminals of impedance balanced output jacks have the same impedance, these output jacks are less affected by induced noise.

13 Master SEND Controls (AUX, EFFECT)

Adjusts the signal level sent to the SEND (AUX, EFFECT) jacks.

NOTE If you are using the MG166CX, the Master SEND control (EFFECT) does not affect the level of the signal sent from the EFFECT bus to the internal digital effect processor.

14 MONITOR/PHONES

• MONITOR switches

These switches select the signal sent to the MONITOR OUT jacks, PHONES jack and the level meter from STEREO L/R bus, GROUP 1/2 bus or GROUP 3/4 bus.

STEREO L/R bus: STEREO (■)

GROUP 1/2 bus: GROUP (■), 1-2 (■)

GROUP 3/4 bus: GROUP (■), 3-4 (■)

• MONITOR Control

Controls the level of the signal output to the PHONES jack and the MONITOR OUT jacks.

15 2TR IN

• 2TR IN Switch

If this switch is set to TO MONITOR (■), the signals input via the 2TR IN jacks are sent to the MONITOR OUT jacks, the PHONES jack, and the level meter. If it is set to TO STEREO (■), the signals are sent to the STEREO L/R bus.

• 2TR IN Control

Adjusts the level of the signal sent from the 2TR IN jacks.

The following illustration shows how the switch settings correspond to the signal selection.

Switches			Signals output via the MONITOR/PHONES jacks	
PFL	MONITOR/PHONES	2TR IN		
ON ■	—	—	PFL	
OFF ■	STEREO ■	TO STEREO ■	STEREO (+ 2TR IN)	
		TO MONITOR ■	STEREO + 2TR IN [MONITOR MIX] *	
	GROUP ■	1-2 ■	TO STEREO ■	GROUP 1-2
			TO MONITOR ■	GROUP 1-2 (+ 2TR IN)
		3-4 ■	TO STEREO ■	GROUP 3-4
			TO MONITOR ■	GROUP 3-4 (+ 2TR IN)

* **MONITOR MIX** : When overdubbing, you can adjust the levels of the monitor playback signal and the signal being recorded separately.

MONITOR MIX Signal Flow

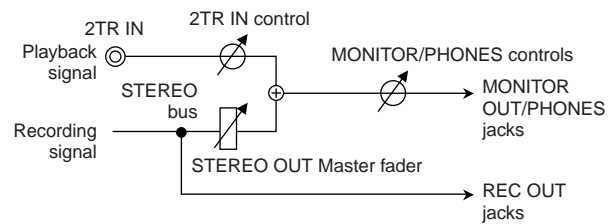

NOTE If the input channel PFL switch is on (■), then only the PFL output from that channel is sent to the MONITOR OUT jacks, PHONES jack, and level meter.

16 GROUP 1-2 Fader

Adjusts the signal level sent to the GROUP OUT 1/2 jacks.

17 GROUP 3-4 Fader

Adjust the signal level to the GROUP OUT 3/4 jacks.

18 ST Switch

If this switch is on, the signals are sent to the STEREO L/R bus via the GROUP 1-2 fader or GROUP 3-4 fader. The GROUP 1 and 3 signals go to STEREO L and the GROUP 2 and 4 signals go to STEREO R.

19 STEREO OUT Master Fader



Adjusts the signal level sent to the STEREO OUT jacks.

Digital Effect Program List (Only MG166CX)

No	Program	Parameter	Description
1	REVERB HALL 1	REVERB TIME	Reverb simulating a large space such as a concert hall.
2	REVERB HALL 2	REVERB TIME	
3	REVERB ROOM 1	REVERB TIME	Reverb simulating the acoustics of a small space (room).
4	REVERB ROOM 2	REVERB TIME	
5	REVERB STAGE 1	REVERB TIME	Reverb simulating a large stage.
6	REVERB STAGE 2	REVERB TIME	
7	REVERB PLATE	REVERB TIME	Simulation of a metal-plate reverb unit, producing a more hard-edged sound.
8	DRUM AMBIENCE	REVERB TIME	A short reverb that is ideal for use with kick drum.
9	KARAOKE ECHO	DELAY TIME	Echo designed for karaoke (sing-along) applications.
10	VOCAL ECHO	DELAY TIME	Echo suitable for vocals.
11	CHORUS 1	LFO Frequency	Creates a thick sound by modulating the delay time. The PARAMETER control adjusts the frequency of the LFO* that modulates the delay time.
12	CHORUS 2	LFO Frequency	
13	FLANGER	LFO Frequency	A sweeping pitched effect. The PARAMETER control adjusts the frequency of the LFO* that modulates the delay time.
14	PHASER	LFO Frequency	Phase modulation produces a cyclical phasing effect. The PARAMETER control adjusts the frequency of the LFO* that modulates the delay time.
15	AUTO WAH	LFO Frequency	A wah-wah effect with cyclical filter modulation. The PARAMETER control adjusts the frequency of the LFO* that modulates the delay time.
16	DISTORTION	DRIVE	Adds a sharp-edged distortion to the sound.

* "LFO" stands for Low Frequency Oscillator. An LFO is normally used to modulate another signal, determining the modulation speed and waveform shape.

Jack List

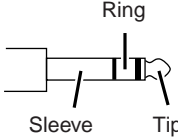
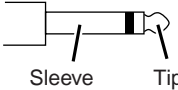
Input and Output Jacks	Polarities	Configurations
MIC INPUT, STEREO OUT	Pin 1: Ground Pin 2: Hot (+) Pin 3: Cold (-)	<div style="display: flex; justify-content: space-around;"> <div style="text-align: center;"> <p>INPUT</p>  </div> <div style="text-align: center;"> <p>OUTPUT</p>  </div> </div> <p style="text-align: right;">XLR Jack</p>
LINE INPUT (monaural channels) GROUP OUT, STEREO OUT, MONITOR OUT, AUX SEND, EFFECT SEND (Only MG166CX)*	Tip: Hot (+) Ring: Cold (-) Sleeve: Ground	 <p style="text-align: right;">TRS Phone Jack</p>
INSERT	Tip: Output Ring: Input Sleeve: Ground	
PHONES	Tip: L Ring: R Sleeve: Ground	 <p style="text-align: right;">Phone Jack</p>
RETURN LINE INPUT (stereo channels)	Tip: Hot Sleeve: Ground	

* These jacks will also accept connection to phone plugs. If you use monaural plugs, the connection will be unbalanced.

Troubleshooting

<p>Power doesn't come on.</p>	<ul style="list-style-type: none"> <input type="checkbox"/> Is the supplied power adaptor properly plugged into an appropriate AC wall outlet? <input type="checkbox"/> Is the supplied power adaptor properly plugged into the mixer?
<p>No sound.</p>	<ul style="list-style-type: none"> <input type="checkbox"/> Are microphones, external devices, and speakers connected correctly? <input type="checkbox"/> Are the ON switch and ST switch of the channels you are using turned ON? <input type="checkbox"/> Are the channel GAIN controls, Channel fader, STEREO OUT Master fader and GROUP 1-2/3-4 fader set to appropriate levels? <input type="checkbox"/> Are the MONITOR switch and 2TR IN switch set properly? <input type="checkbox"/> Are your speaker cables connected properly, or are they shorted? <input type="checkbox"/> If the above checks do not identify the problem, call Yamaha for service. (Refer to the page 71 for a list of service centers.)
<p>Sound is faint, distorted, or noisy.</p>	<ul style="list-style-type: none"> <input type="checkbox"/> Are the channel GAIN controls, Channel fader, STEREO OUT Master fader and GROUP 1-2/3-4 fader set to appropriate levels? <input type="checkbox"/> Are two different instruments connected to the XLR-type and phone jacks, or to the phone and RCA pin jacks on one channel? Please connect to only one of these jacks on each channel. <input type="checkbox"/> Is the input signal from the connected device set to an appropriate level? <input type="checkbox"/> Are you applying the effects at an appropriate level? <input type="checkbox"/> Are microphones connected to the MIC input jacks? <input type="checkbox"/> If you are using condenser microphones, is the PHANTOM +48 V switch turned ON?
<p>No effect is applied. (If you are using MG166CX)</p>	<ul style="list-style-type: none"> <input type="checkbox"/> Check that the EFFECT control on each channel is correctly adjusted. <input type="checkbox"/> Be sure that the internal effect unit's ON switch is turned ON. <input type="checkbox"/> Be sure that the EFFECT PARAMETER control and EFFECT RTN fader are correctly adjusted.
<p>I want spoken words to be heard more clearly.</p>	<ul style="list-style-type: none"> <input type="checkbox"/> Be sure that the $\sqrt{80}$ switches are ON. <input type="checkbox"/> Adjust the equalizers (HIGH, MID and LOW) on each channel.
<p>I want to output a monitor signal through speakers.</p>	<ul style="list-style-type: none"> <input type="checkbox"/> Connect a powered speaker to the AUX 1, 2 or 3 jack (MG206C), or to the AUX1 or 2 jack (MG166CX/MG166C) and turn the PRE switch on each channel on. Then adjust the output signal by using the AUX controls on each channel and the Master SEND control.
<p>The level meter doesn't show the output signal level.</p>	<ul style="list-style-type: none"> <input type="checkbox"/> Are the PFL switches for the channels that you are not using turned on?

Specifications

MG206C

Electrical Specifications

			MIN	TYP	MAX	UNIT
Frequency Response	STEREO OUT	GAIN: min (CHs 1–19/20) 20 Hz–20 kHz Nominal output level @ 1 kHz Input: CHs 1 to 19/20, RETURN, 2TR IN	-3.0	0.0	1.0	dB
	GROUP OUT					
	AUX SEND					
	MONITOR OUT, REC OUT					
Total Harmonic Distortion (THD + N)	STEREO OUT	+14 dBu @ 20 Hz–20 kHz, Input GAIN Control at minimum			0.1	%
Hum & Noise	CH INPUT 1–12 MIC	EIN (Equivalent Input Noise): $R_s = 150 \Omega$, GAIN: maximum			-128	dBu
	STEREO OUT	STEREO OUT, GROUP 1-2 fader and GROUP 3-4 fader at nominal level and all channels' ST and 1-2, 3-4 switches off.			-88	
	GROUP OUT					
	AUX SEND	Master/AUX control at nominal level and all CH AUX controls at minimum.			-81	
	STEREO OUT	STEREO OUT, GROUP 1-2, GROUP 3-4 faders and one CH fader at nominal level.			-64	
Crosstalk (1 kHz)	Adjacent Input	CHs 1–12			-70	dB
	Input to Output	STEREO L/R, CHs 1–12, PAN: panned hard left or right			-70	
Maximum voltage gain (1 kHz)	$R_s = 150 \Omega$ INPUT GAIN: maximum	MIC to CH INSERT OUT		60		dB
		MIC to STEREO OUT		84		
		MIC to GROUP OUT		94		
		MIC to GROUP to ST		62.2		
		MIC to REC OUT		94		
		MIC to MONITOR OUT, ST TO MONITOR		83		
		MIC to PHONES OUT		76		
		MIC to AUX SEND PRE		86		
		MIC to AUX SEND POST		58		
		CH 17/18, 19/20 LINE to STEREO OUT		47		
		CH 17/18, 19/20 LINE to GROUP OUT		57		
		CH 17/18, 19/20 LINE to AUX SEND PRE		16		
		CH 17/18, 19/20 LINE to AUX SEND POST		9		
	$R_s = 150 \Omega$	RETURN to STEREO OUT		27.8		
		RETURN to AUX SEND				
	$R_s = 600 \Omega$	2TR IN to STEREO OUT		48	V	
Phantom Voltage	MIC	no load				

General Specifications

Input HPF		80 Hz, 12 dB/oct
Input equalization	CHs 1–12	HIGH: 10 kHz (shelving) MID: 250 Hz–5 kHz (peaking) LOW: 100 Hz (shelving)
± 15 dB maximum Turn over/roll-off frequency of shelving: 3 dB below maximum variable level.	CH 13/14–19/20	HIGH: 10 kHz (shelving) MID: 2.5 kHz (peaking) LOW: 100 Hz (shelving)
PEAK Indicator		Red LED turns on when post EQ signal (either post MIC HA or post EQ signal for CHs 13/14–19/20) reaches -3 dB below clipping (+17 dBu).
LED Level Meter	Pre MONITOR Level STEREO/GROUP/PFL bus	2x12 points LED meter (PEAK, +10, +6, +3, 0, -3, -6, -10, -15, -20, -25, -30 dB) PEAK lights if the signal level reaches 3 dB below the clipping level.
Power Supply Adaptor	PA-30	AC 35 VCT, 1.4 A, Cable Length = 3.6 m
Power Consumption		40 W
Dimensions (W x H x D)		478 mm x 102 mm x 496 mm
Net Weight		6.0 kg

All faders are nominal if not specified.
Output impedance of signal generator: 150 ohms

Input Specifications

Input Connectors	Gain	Input Impedance	Appropriate Impedance	Sensitivity *	Nominal Level	Max. before Clipping	Connector Specifications
CH INPUT MIC (CHs 1–12)	-60 dB	3k Ω	50–600 Ω Mics	-80 dBu (0.078 mV)	-60 dBu (0.775 mV)	-40 dBu (7.75 mV)	XLR-3-31 type (balanced [1 = GND, 2 = HOT, 3 = COLD])
	-16 dB			-36 dBu (12.3 mV)	-16 dBu (123 mV)	+4 dBu (1.23 V)	
CH INPUT LINE (CHs 1–12)	-34 dB	10k Ω	600 Ω Lines	-54 dBu (1.55 mV)	-34 dBu (15.5 mV)	-14 dBu (155 mV)	TRS phone jack (balanced [Tip = HOT, Ring = COLD, Sleeve = GND])
	+10 dB			-10 dBu (245 mV)	+10 dBu (2.45 V)	+30 dBu (24.5 V)	
ST CH MIC INPUT (CHs 13/14–19/20)	-60 dB	3k Ω	50–600 Ω Mics	-80 dBu (0.078 mV)	-60 dBu (0.775 mV)	-40 dBu (7.75 mV)	XLR-3-31 type (balanced [1 = GND, 2 = HOT, 3 = COLD])
	-16 dB			-36 dBu (12.3 mV)	-16 dBu (123 mV)	-6 dBu (389 mV)	
ST CH LINE INPUT (CHs 13/14, 15/16)	-34 dB	10k Ω	600 Ω Lines	-54 dBu (1.55 mV)	-34 dBu (15.5 mV)	-14 dBu (155 mV)	Phone jack (unbalanced)
	+10 dB			-10 dBu (245 mV)	+10 dBu (2.45 V)	+30 dBu (24.5 V)	
ST CH INPUT (CHs 17/18, 19/20)	-34 dB	10k Ω	600 Ω Lines	-54 dB (1.55 mV)	-34 dB (15.5 mV)	-14 dB (155 mV)	Phone jack (unbalanced) RCA pin jack
	+10 dB			-10 dBu (245 mV)	+10 dBu (2.45 V)	+30 dBu (24.5 V)	
CH INSERT IN (CHs 1–12)	—	10k Ω	600 Ω Lines	-20 dBu (77.5 mV)	0 dBu (0.775 V)	+20 dBu (7.75 V)	TRS phone Jack (unbalanced [Tip = Out, Ring = In, Sleeve = GND])
RETURN (L, R)	—	10k Ω	600 Ω Lines	-12 dBu (195 mV)	+4 dBu (1.23 V)	+24 dBu (12.3 V)	Phone jack (unbalanced)
2TR IN (L, R)	—	10k Ω	600 Ω Lines	-26 dBV (50.1 mV)	-10dBV (0.316V)	+10dBV (3.16 V)	RCA pin jack

Where 0 dBu = 0.775 Vrms and 0 dBV = 1 Vrms

* Sensitivity : The lowest level that will produce an output of +4 dB (1.23 V), or the nominal output level when the unit is set to the maximum level. (All faders and level controls are at their maximum position.)

Output Specifications

Output Connectors	Output Impedance	Appropriate Impedance	Nominal Level	Max. before clipping	Connector Specifications
STEREO OUT (L, R)	75 Ω	600 Ω Lines	+4dBu (1.23 V)	+24 dBu (12.3 V)	XLR-3-32 type (balanced [1 = GND, 2 = HOT, 3 = COLD]) TRS phone jack (balanced [Tip = HOT, Ring = COLD, Sleeve = GND])
GROUP OUT (1–4)	150 Ω	10k Ω Lines	+4dBu (1.23 V)	+20 dBu (7.75 V)	TRS phone jack (impedance balanced [Tip = HOT, Ring = COLD, Sleeve = GND])
AUX SEND (1–4)	150 Ω	10k Ω Lines	+4dBu (1.23 V)	+20 dBu (7.75 V)	TRS phone jack (impedance balanced [Tip = HOT, Ring = COLD, Sleeve = GND])
CH INSERT OUT (CHs 1–12)	75 Ω	10k Ω Lines	0 dBu (0.775 V)	+20 dBu (7.75 V)	TRS phone jack (unbalanced [Tip = Out, Ring = In, Sleeve = GND])
REC OUT (L, R)	600 Ω	10k Ω Lines	-10 dBV (0.316 V)	+10 dBV (3.16 V)	RCA pin jack
MONITOR OUT (L, R)	150 Ω	10k Ω Lines	+4 dBu (1.23 V)	+20 dBu (7.75 V)	TRS phone jack (impedance balanced [Tip = HOT, Ring = COLD, Sleeve = GND])
PHONES OUT	100 Ω	40 Ω Phones	3 mW	75 mW	TRS phone jack

Where 0 dBu = 0.775 Vrms and 0 dBV = 1 Vrms

MG166CX/MG166C

Electrical Specifications

		MIN	TYP	MAX	UNIT		
Frequency Response	STEREO OUT	GAIN: min (CHs 1–11/12) 20 Hz–20 kHz Nominal output level @1 kHz Input: CHs 1 to 15/16, RETURN, 2TR IN	-3.0	0.0	1.0	dB	
	GROUP OUT						
	EFFECT/AUX* SEND						
	MONITOR OUT, REC OUT						
Total Harmonic Distortion (THD + N)	STEREO OUT	+14 dBu @ 20 Hz–20 kHz, Input GAIN Control at minimum			0.1	%	
Hum & Noise	CH INPUT 1–8 MIC	EIN (Equivalent Input Noise): $R_s = 150 \Omega$, GAIN: maximum				-128	dBu
	STEREO OUT	STEREO OUT, GROUP 1-2 fader and GROUP 3-4 fader at nominal level and all channels' ST and 1-2, 3-4 switches off.				-88	
	GROUP OUT						
	EFFECT/AUX* SEND	Master EFFECT/AUX* control at nominal level and all CH EFFECT/AUX* controls at minimum.				-81	
	STEREO OUT	STEREO OUT, GROUP 1-2, GROUP 3-4 faders and one CH fader at nominal level.				-64	
Crosstalk (1 kHz)	Adjacent Input	CHs 1–8				-70	dB
	Input to Output	STEREO L/R, CHs 1–8, PAN: panned hard left or right				-70	
Maximum voltage gain (1 kHz)	$R_s = 150 \Omega$ INPUT GAIN: maximum	MIC to CH INSERT OUT				60	dB
		MIC to STEREO OUT				84	
		MIC to GROUP OUT				94	
		MIC to GROUP to ST				62.2	
		MIC to REC OUT				94	
		MIC to MONITOR OUT, ST TO MONITOR				83	
		MIC to PHONES OUT				76	
		MIC to AUX SEND PRE				86	
		MIC to AUX SEND POST, EFFECT* SEND				58	
		CH 9/10, 11/12 LINE to STEREO OUT				47	
		CH 9/10, 11/12 LINE to GROUP OUT				57	
		CH 9/10, 11/12 LINE to AUX SEND POST, EFFECT* SEND				34	
		CH 13/14, 15/16 to STEREO OUT				16	
		CH 13/14, 15/16 to GROUP OUT				9	
Phantom Voltage	MIC	$R_s = 150 \Omega$	RETURN to STEREO OUT			27.8	V
		$R_s = 600 \Omega$	RETURN to EFFECT/AUX* SEND			48	

General Specifications

Input HPF	CHs 1–11/12	80 Hz, 12 dB/oct
Input equalization	CHs 1–8	HIGH: 10 kHz (shelving) MID: 250 Hz–5 kHz (peaking) LOW: 100 Hz (shelving)
	CH 9/10–15/16	HIGH: 10 kHz (shelving) MID: 2.5 kHz (peaking) LOW: 100 Hz (shelving)
PEAK Indicator		Red LED turns on when post EQ signal (either post MIC HA or post EQ signal for CHs 9/10–15/16) reaches -3 dB below clipping (+17 dBu).
Internal Digital Effect (Only MG166CX)		16 PROGRAM, PARAMETER control Foot Switch (Digital Effect On/Off)
LED Level Meter	Pre MONITOR Level STEREO/GROUP/PFL bus	2x12 points LED meter (PEAK, +10, +6, +3, 0, -3, -6, -10, -15, -20, -25, -30 dB) PEAK lights if the signal level reaches 3 dB below the clipping level.
Power Supply Adaptor	PA-30	AC 35 VCT, 1.4 A, Cable Length = 3.6 m
Power Consumption		35 W (MG166CX), 30 W (MG166C)
Dimensions (W x H x D)		478 mm x 102 mm x 496 mm
Net Weight		5.5 kg (MG166CX), 5.3 kg (MG166C)

All faders are nominal if not specified.
Output impedance of signal generator: 150 ohms

* MG166CX: AUX1, 2, EFFECT
MG166C: AUX1, 2, 3

Input Specifications

Input Connectors	Gain	Input Impedance	Appropriate Impedance	Sensitivity *	Nominal Level	Max. before Clipping	Connector Specifications
CH INPUT MIC (CHs 1–8)	-60 dB	3k Ω	50–600 Ω Mics	-80 dBu (0.078 mV)	-60 dBu (0.775 mV)	-40 dBu (7.75 mV)	XLR-3-31 type (balanced [1 = GND, 2 = HOT, 3 = COLD])
	-16 dB			-36 dBu (12.3 mV)	-16 dBu (123 mV)	+4 dBu (1.23 V)	
CH INPUT LINE (CHs 1–8)	-34 dB	10k Ω	600 Ω Lines	-54 dBu (1.55 mV)	-34 dBu (15.5 mV)	-14 dBu (155 mV)	TRS phone jack (balanced [Tip = HOT, Ring = COLD, Sleeve = GND])
	+10 dB			-10 dBu (245 mV)	+10 dBu (2.45 V)	+30 dBu (24.5 V)	
ST CH MIC INPUT (CHs 9/10, 11/12)	-60 dB	3k Ω	50–600 Ω Mics	-80 dBu (0.078 mV)	-60 dBu (0.775 mV)	-40 dBu (7.75 mV)	XLR-3-31 type (balanced [1 = GND, 2 = HOT, 3 = COLD])
	-16 dB			-36 dBu (12.3 mV)	-16 dBu (123 mV)	-6 dBu (389 mV)	
ST CH LINE INPUT (CHs 9/10, 11/12)	-34 dB	10k Ω	600 Ω Lines	-54 dBu (1.55 mV)	-34 dBu (15.5 mV)	-14 dBu (155 mV)	Phone jack (unbalanced)
	+10 dB			-10 dBu (245 mV)	+10 dBu (2.45 V)	+30 dBu (24.5 V)	
ST CH INPUT (CHs 13/14, 15/16)	—	10k Ω	600 Ω Lines	-30 dBu (24.5 mV)	-10 dBu (245 mV)	+10 dBu (2.45 V)	Phone jack (unbalanced) RCA pin jack
CH INSERT IN (CHs 1–8)	—	10k Ω	600 Ω Lines	-20 dBu (77.5 mV)	0 dBu (0.775 V)	+20 dBu (7.75 V)	TRS phone Jack (unbalanced [Tip = Out, Ring = In, Sleeve = GND])
RETURN (L, R)	—	10k Ω	600 Ω Lines	-12 dBu (195 mV)	+4 dBu (1.23 V)	+24 dBu (12.3 V)	Phone jack (unbalanced)
2TR IN (L, R)	—	10k Ω	600 Ω Lines	-26 dBV (50.1 mV)	-10dBV (0.316V)	+10dBV (3.16 V)	RCA pin jack

Where 0 dBu = 0.775 Vrms and 0 dBV = 1 Vrms

* Sensitivity : The lowest level that will produce an output of +4 dB (1.23 V), or the nominal output level when the unit is set to the maximum level. (All faders and level controls are at their maximum position.)

Output Specifications

Output Connectors	Output Impedance	Appropriate Impedance	Nominal Level	Max. before clipping	Connector Specifications
STEREO OUT (L, R)	75 Ω	600 Ω Lines	+4dBu (1.23 V)	+24 dBu (12.3 V)	XLR-3-32 type (balanced [1 = GND, 2 = HOT, 3 = COLD]) TRS phone jack (balanced [Tip = HOT, Ring = COLD, Sleeve = GND])
GROUP OUT (1–4)	150 Ω	10k Ω Lines	+4dBu (1.23 V)	+20 dBu (7.75 V)	TRS phone jack (impedance balanced [Tip = HOT, Ring = COLD, Sleeve = GND])
EFFECT/AUX* SEND	150 Ω	10k Ω Lines	+4dBu (1.23 V)	+20 dBu (7.75 V)	TRS phone jack (impedance balanced [Tip = HOT, Ring = COLD, Sleeve = GND])
CH INSERT OUT (CHs 1–8)	75 Ω	10k Ω Lines	0 dBu (0.775 V)	+20 dBu (7.75 V)	TRS phone jack (unbalanced [Tip = Out, Ring = In, Sleeve = GND])
REC OUT (L, R)	600 Ω	10k Ω Lines	-10 dBV (0.316 V)	+10 dBV (3.16 V)	RCA pin jack
MONITOR OUT (L, R)	150 Ω	10k Ω Lines	+4 dBu (1.23 V)	+20 dBu (7.75 V)	TRS phone jack (impedance balanced [Tip = HOT, Ring = COLD, Sleeve = GND])
PHONES OUT	100 Ω	40 Ω Phones	3 mW	75 mW	TRS phone jack

Where 0 dBu = 0.775 Vrms and 0 dBV = 1 Vrms

* MG166CX: AUX1, 2, EFFECT
MG166C: AUX1, 2, 3

■ Dimensional Diagrams (MG206C/MG166CX/MG166C)

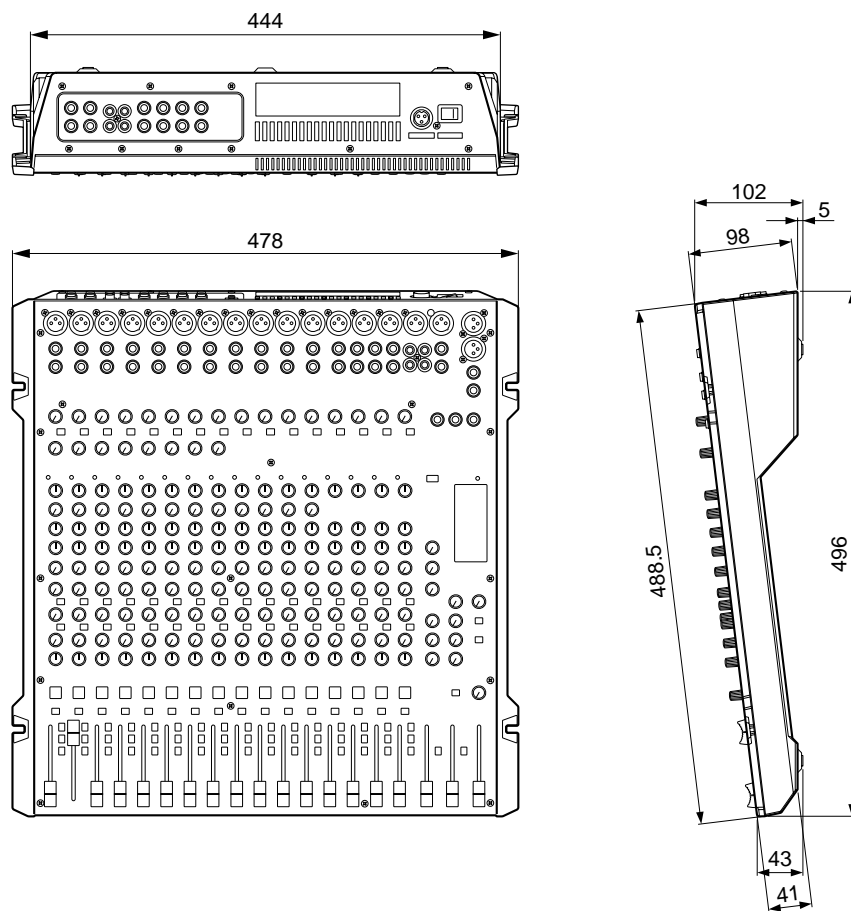

Unit: mm

■ Rack Mounting

To mount the MG mixer, it requires 12U of rack space.



If the MG mixer is to be mounted with devices that tend to generate heat, such as power amplifiers, be sure to install ventilation panels to prevent high temperatures from developing inside the mixer.

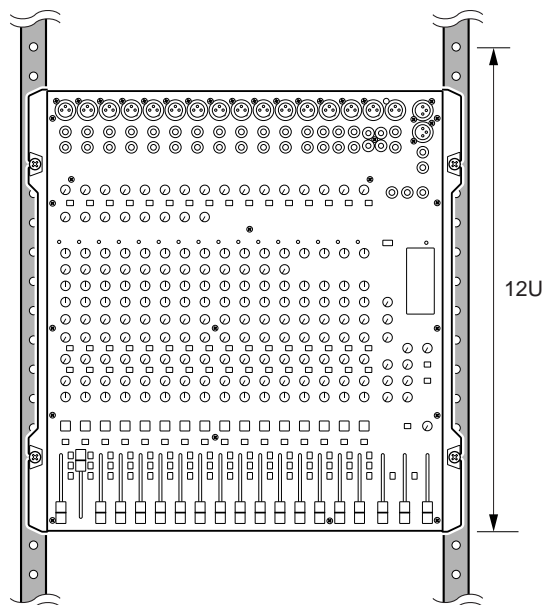

* 12U (Approx. 534mm)

* Specifications and descriptions in this owner's manual are for information purposes only. Yamaha Corp. reserves the right to change or modify products or specifications at any time without prior notice. Since specifications, equipment or options may not be the same in every locale, please check with your Yamaha dealer.

■ Block Diagram and Level Diagram (MG206C)

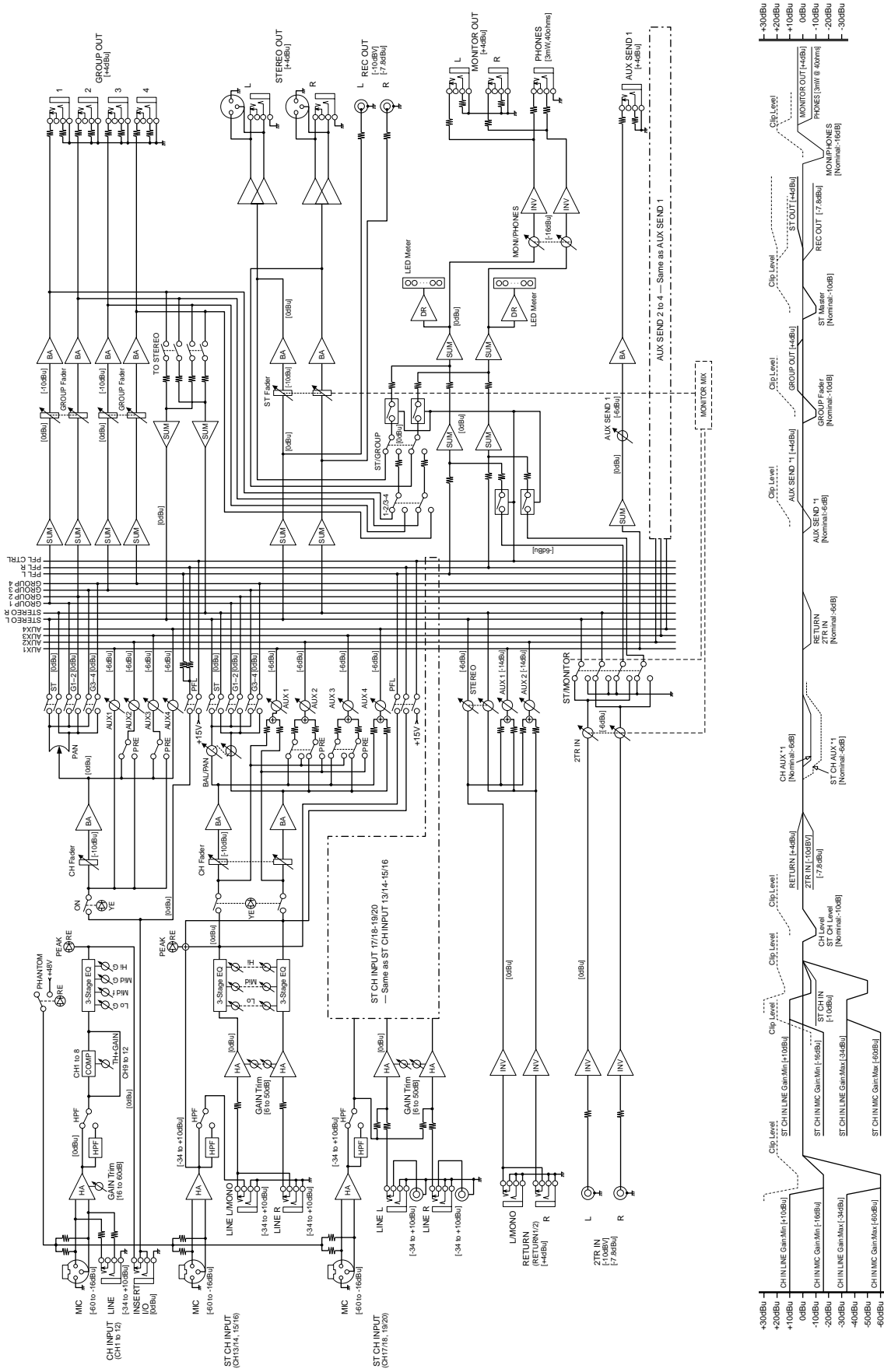

■ Block Diagram and Level Diagram (MG166CX/MG166C)

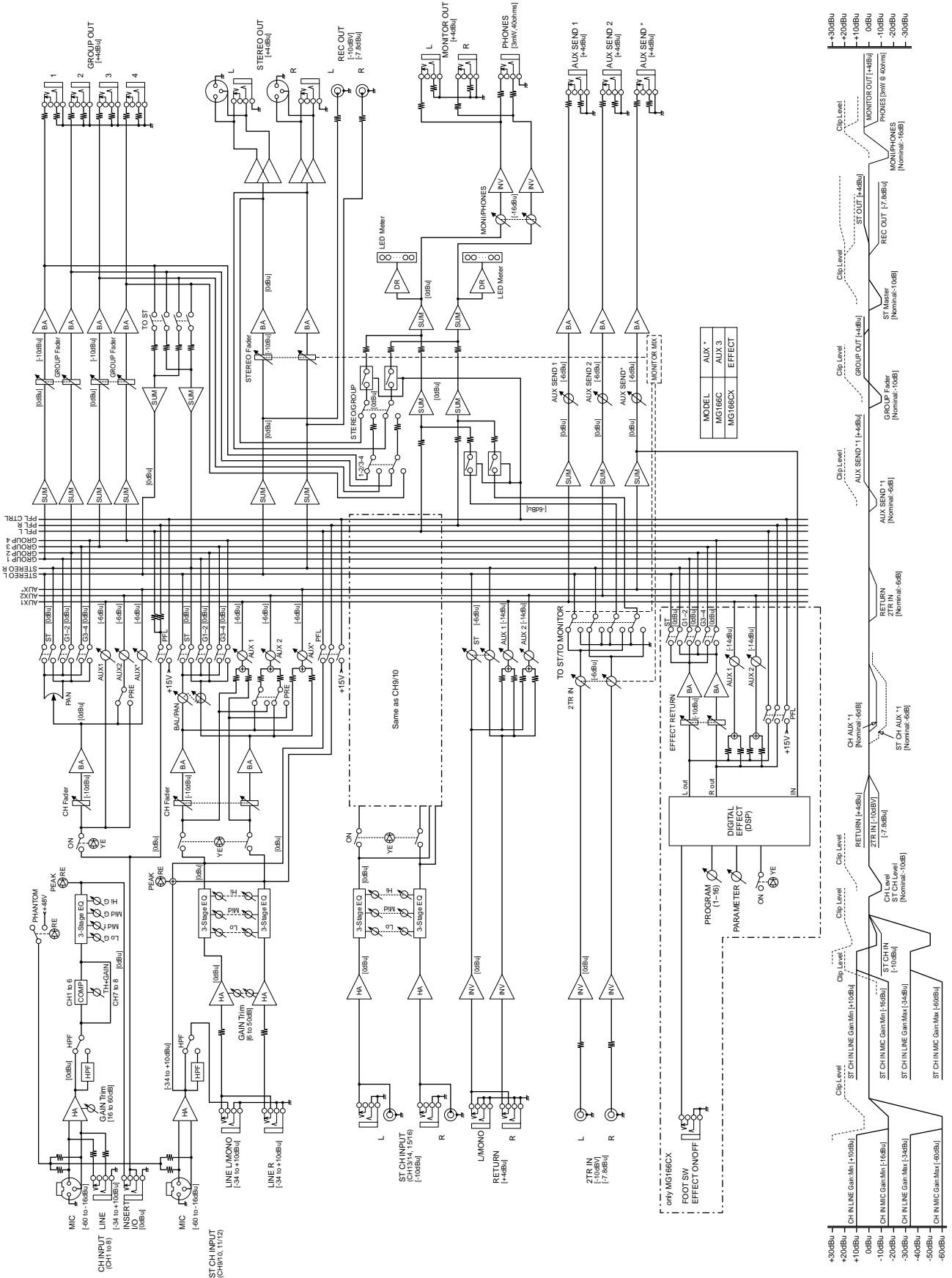

For details of products, please contact your nearest Yamaha representative or the authorized distributor listed below.

Pour plus de détails sur les produits, veuillez-vous adresser à Yamaha ou au distributeur le plus proche de vous figurant dans la liste suivante.

Die Einzelheiten zu Produkten sind bei Ihrer unten aufgeführten Niederlassung und bei Yamaha Vertragshändlern in den jeweiligen Bestimmungsländern erhältlich.

Para detalles sobre productos, contacte su tienda Yamaha más cercana o el distribuidor autorizado que se lista debajo.

NORTH AMERICA

CANADA

Yamaha Canada Music Ltd.
135 Milner Avenue, Scarborough, Ontario,
M1S 3R1, Canada
Tel: 416-298-1311

U.S.A.

Yamaha Corporation of America
6600 Orangethorpe Ave., Buena Park, Calif. 90620,
U.S.A.
Tel: 714-522-9011

CENTRAL & SOUTH AMERICA

MEXICO

Yamaha de México S.A. de C.V.
Calz. Javier Rojo Gómez #1149,
Col. Guadalupe del Moral
C.P. 09300, México, D.F., México
Tel: 55-5804-0600

BRAZIL

Yamaha Musical do Brasil Ltda.
Rua Joaquim Floriano, 913 - 4º andar, Itaim Bibi,
CEP 04534-013 Sao Paulo, SP. BRAZIL
Tel: 011-3704-1377

ARGENTINA

Yamaha Music Latin America, S.A.
Sucursal de Argentina
Viamonte 1145 Piso2-B 1053,
Buenos Aires, Argentina
Tel: 1-4371-7021

PANAMA AND OTHER LATIN AMERICAN COUNTRIES/ CARIBBEAN COUNTRIES

Yamaha Music Latin America, S.A.
Torre Banco General, Piso 7, Urbanización Marbella,
Calle 47 y Aquilino de la Guardia,
Ciudad de Panamá, Panamá
Tel: +507-269-5311

EUROPE

THE UNITED KINGDOM

Yamaha-Kemble Music (U.K.) Ltd.
Sherbourne Drive, Tilbrook, Milton Keynes,
MK7 8BL, England
Tel: 01908-366700

GERMANY

Yamaha Music Central Europe GmbH
Siemensstraße 22-34, 25462 Rellingen, Germany
Tel: 04101-3030

SWITZERLAND/LIECHTENSTEIN

Yamaha Music Central Europe GmbH,
Branch Switzerland
Seefeldstrasse 94, 8008 Zürich, Switzerland
Tel: 01-383 3990

AUSTRIA

Yamaha Music Central Europe GmbH,
Branch Austria
Schleiergasse 20, A-1100 Wien, Austria
Tel: 01-60203900

CZECH REPUBLIC/SLOVAKIA/ HUNGARY/SLOVENIA

Yamaha Music Central Europe GmbH,
Branch Austria, CEE Department
Schleiergasse 20, A-1100 Wien, Austria
Tel: 01-602039025

POLAND

Yamaha Music Central Europe GmbH
Sp.z. o.o. Oddział w Polsce
ul. 17 Stycznia 56, PL-02-146 Warszawa, Poland
Tel: 022-868-07-57

THE NETHERLANDS/ BELGIUM/LUXEMBOURG

Yamaha Music Central Europe GmbH,
Branch Benelux
Clarissenhof 5-b, 4133 AB Vianen, The Netherlands
Tel: 0347-358 040

FRANCE

Yamaha Musique France
BP 70-77312 Marne-la-Vallée Cedex 2, France
Tel: 01-64-61-4000

ITALY

Yamaha Musica Italia S.P.A.
Combo Division
Viale Italia 88, 20020 Lainate (Milano), Italy
Tel: 02-935-771

SPAIN/PORTUGAL

Yamaha-Hazen Música, S.A.
Ctra. de la Coruna km. 17, 200, 28230
Las Rozas (Madrid), Spain
Tel: 91-639-8888

SWEDEN

Yamaha Scandinavia AB
J. A. Wettergrens Gata 1
Box 30053
S-400 43 Göteborg, Sweden
Tel: 031 89 34 00

DENMARK

YS Copenhagen Liaison Office
Generatorvej 6A
DK-2730 Herlev, Denmark
Tel: 44 92 49 00

NORWAY

Norsk filial av Yamaha Scandinavia AB
Grini Næringspark 1
N-1345 Østerås, Norway
Tel: 67 16 77 70

OTHER EUROPEAN COUNTRIES

Yamaha Music Central Europe GmbH
Siemensstraße 22-34, 25462 Rellingen, Germany
Tel: +49-4101-3030

AFRICA

Yamaha Corporation,
Asia-Pacific Music Marketing Group
Nakazawa-cho 10-1, Naka-ku, Hamamatsu,
Japan 430-8650
Tel: +81-53-460-2313

MIDDLE EAST

TURKEY/CYPRUS

Yamaha Music Central Europe GmbH
Siemensstraße 22-34, 25462 Rellingen, Germany
Tel: 04101-3030

OTHER COUNTRIES

Yamaha Music Gulf FZE
LOB 16-513, P.O.Box 17328, Jubel Ali,
Dubai, United Arab Emirates
Tel: +971-4-881-5868

ASIA

THE PEOPLE'S REPUBLIC OF CHINA

Yamaha Music & Electronics (China) Co.,Ltd.
25/F., United Plaza, 1468 Nanjing Road (West),
Jingan, Shanghai, China
Tel: 021-6247-2211

INDONESIA

PT. Yamaha Music Indonesia (Distributor)
PT. Nusantik
Gedung Yamaha Music Center, Jalan Jend. Gatot
Subroto Kav. 4, Jakarta 12930, Indonesia
Tel: 21-520-2577

KOREA

Yamaha Music Korea Ltd.
8F, 9F, Dongsung Bldg. 158-9 Samsung-Dong,
Kangnam-Gu, Seoul, Korea
Tel: 080-004-0022

MALAYSIA

Yamaha Music Malaysia, Sdn., Bhd.
Lot 8, Jalan Perbandaran, 47301 Kelana Jaya,
Petaling Jaya, Selangor, Malaysia
Tel: 3-78030900

SINGAPORE

Yamaha Music Asia Pte., Ltd.
#03-11 A-Z Building
140 Paya Lebar Road, Singapore 409015
Tel: 747-4374

TAIWAN

Yamaha KHS Music Co., Ltd.
3F, #6, Sec.2, Nan Jing E. Rd. Taipei.
Taiwan 104, R.O.C.
Tel: 02-2511-8688

THAILAND

Siam Music Yamaha Co., Ltd.
891/1 Siam Motors Building, 15-16 floor
Rama 1 road, Wangmai, Pathumwan
Bangkok 10330, Thailand
Tel: 02-215-2626

OTHER ASIAN COUNTRIES

Yamaha Corporation,
Asia-Pacific Music Marketing Group
Nakazawa-cho 10-1, Naka-ku, Hamamatsu,
Japan 430-8650
Tel: +81-53-460-2317

OCEANIA

AUSTRALIA

Yamaha Music Australia Pty. Ltd.
Level 1, 99 Queensbridge Street, Southbank,
Victoria 3006, Australia
Tel: 3-9693-5111

COUNTRIES AND TRUST TERRITORIES IN PACIFIC OCEAN

Yamaha Corporation,
Asia-Pacific Music Marketing Group
Nakazawa-cho 10-1, Naka-ku, Hamamatsu,
Japan 430-8650
Tel: +81-53-460-2313

HEAD OFFICE Yamaha Corporation, Pro Audio & Digital Musical Instrument Division
Nakazawa-cho 10-1, Naka-ku, Hamamatsu, Japan 430-8650
Tel: +81-53-460-2441



Yamaha Pro Audio global web site:
<http://www.yamahaproaudio.com/>

Yamaha Manual Library
<http://www.yamaha.co.jp/manual/>

U.R.G., Pro Audio & Digital Musical Instrument Division, Yamaha Corporation
© 2007 Yamaha Corporation

WJ74360 703POAP7.3-01A0
Printed in China