

**MIXING CONSOLE****MG82CX  
MG102C****Owner's Manual  
Bedienungsanleitung  
Mode d'emploi  
Manual de instrucciones****Features**

- Input Channels.....page 10**  
With up to four mic/line inputs or up to three (four for MG102C) stereo inputs, the MG mixer can simultaneously connect to a wide range of devices: microphones, line-level devices, stereo synthesizers, and more.
- Compression.....page 9**  
Compression increases the overall level without introducing distortion by compressing excessive peaks in the signals from microphones and guitars.
- AUX Sends and Stereo AUX Return.....page 12**  
You can use the AUX SEND jack to feed the signal sent to an external signal processor, and then return the processed stereo signal through the RETURN jack.
- High-quality digital effects (MG82CX).....page 13, 57**  
With digital effects built in, the MG82CX can deliver a wide range of sound variations all by itself.

**Funktionen**

- Eingangskanäle.....Seite 23**  
Mit bis zu vier Mikrofon-/Line-Eingängen oder bis zu drei (vier beim MG102C) Stereoeingängen können viele Geräte gleichzeitig am MG-Mischpult angeschlossen werden: Mikrofone, Geräte mit Leitungspiegel, Stereo-Synthesizer uvm.
- Kompression.....Seite 22**  
Kompression erhöht den Durchschnittspegel, ohne Verzerrung hinzuzufügen, indem übermäßige Pegelspitzen der Signale von Mikrofonen oder Gitarren komprimiert werden.
- AUX Sends und Stereo AUX Return.....Seite 25**  
Von der AUX SEND-Buchse können Sie das Signal einzeln an einen externen Signalprozessor führen, und das verarbeitete Stereosignal über die RETURN-Buchse zurück in das Pult führen.
- Hochwertige Digitaleffekte (MG82CX).....Seite 26, 57**  
Mit den eingebauten digitalen Effekten kann das MG82CX aus sich heraus eine Reihe von Klangvariationen liefern.

**Caractéristiques**

- Canaux d'entrée.....page 36**  
Avec quatre entrées micro/ligne ou trois entrées stéréo maximum (quatre pour la console MG102C), la console de mixage MG peut connecter simultanément une grande variété d'appareils : micros, appareils de ligne, synthétiseurs stéréo, etc.
- Compression.....page 35**  
La compression augmente le niveau général sans engendrer de distorsion en comprimant les pics excessifs des signaux des micros et des guitares.
- Envois AUX et retour AUX stéréo.....page 38**  
Vous pouvez utiliser la prise jack AUX SEND pour envoyer le signal vers une unité de traitement de signaux externes, puis pour renvoyer le signal stéréo traité via la prise jack RETURN.
- Effets numériques de qualité supérieure (MG82CX).....page 39, 57**  
Grâce aux effets numériques intégrés, la console MG82CX peut proposer de nombreuses variations de sons.

**Características**

- Canales de entrada.....página 49**  
Con un máximo de cuatro entradas de micrófono/línea o tres entradas estereofónicas (cuatro en el modelo MG102C), la mezcladora MG puede conectarse simultáneamente con una gran variedad de dispositivos: micrófonos, dispositivos de nivel de línea, sintetizadores estereofónicos, etc.
- Compresión.....página 48**  
La compresión aumenta el nivel general sin causar distorsión, mediante la compresión del exceso de picos en las señales de los micrófonos y guitarras.
- Envíos AUX y retorno AUX estereofónico.....página 51**  
Puede utilizar la toma AUX SEND para introducir la señal enviada en un procesador de señales externo y luego devolver la señal estereofónica procesada a través de la toma RETURN (retorno).
- Efectos digitales de alta calidad (MG82CX).....página 52, 57**  
Gracias a sus efectos digitales incorporados, la mezcladora MG82CX puede producir por sí misma una amplia gama de variaciones de sonido.

## IMPORTANT NOTICE FOR THE UNITED KINGDOM

### Connecting the Plug and Cord

IMPORTANT. The wires in this mains lead are coloured in accordance with the following code:

BLUE : NEUTRAL  
BROWN : LIVE

As the colours of the wires in the mains lead of this apparatus may not correspond with the coloured markings identifying the terminals in your plug proceed as follows:

The wire which is coloured BLUE must be connected to the terminal which is marked with the letter N or coloured BLACK.

The wire which is coloured BROWN must be connected to the terminal which is marked with the letter L or coloured RED.

Making sure that neither core is connected to the earth terminal of the three pin plug.

• This applies only to products distributed by Yamaha-Kemble Music (U.K.) Ltd.

(2 wires)

## FCC INFORMATION (U.S.A.)

### 1. IMPORTANT NOTICE: DO NOT MODIFY THIS UNIT!

This product, when installed as indicated in the instructions contained in this manual, meets FCC requirements. Modifications not expressly approved by Yamaha may void your authority, granted by the FCC, to use the product.

### 2. IMPORTANT:

When connecting this product to accessories and/or another product use only high quality shielded cables. Cable/s supplied with this product MUST be used. Follow all installation instructions. Failure to follow instructions could void your FCC authorization to use this product in the USA.

### 3. NOTE:

This product has been tested and found to comply with the requirements listed in FCC Regulations, Part 15 for Class "B" digital devices. Compliance with these requirements provides a reasonable level of assurance that your use of this product in a residential environment will not result in harmful interference with other electronic devices. This equipment generates/uses radio frequencies and, if not installed and used according to the instructions found in the users manual, may cause interference harmful to the operation of other electronic devices. Compliance with FCC

regulations does not guarantee that interference will not occur in all installations. If this product is found to be the source of interference, which can be determined by turning the unit "OFF" and "ON", please try to eliminate the problem by using one of the following measures:

Relocate either this product or the device that is being affected by the interference.

Utilize power outlets that are on different branch (circuit breaker or fuse) circuits or install AC line filter/s.

In the case of radio or TV interference, relocate/reorient the antenna. If the antenna lead-in is 300 ohm ribbon lead, change the lead-in to co-axial type cable.

If these corrective measures do not produce satisfactory results, please contact the local retailer authorized to distribute this type of product. If you can not locate the appropriate retailer, please contact Yamaha Corporation of America, Electronic Service Division, 6600 Orangethorpe Ave, Buena Park, CA90620

The above statements apply ONLY to those products distributed by Yamaha Corporation of America or its subsidiaries.

\* This applies only to the MG82CX distributed by YAMAHA CORPORATION OF AMERICA, not the MG102C.

(class B)

# PRECAUTIONS

## PLEASE READ CAREFULLY BEFORE PROCEEDING

\* Please keep this manual in a safe place for future reference.

### **WARNING**

Always follow the basic precautions listed below to avoid the possibility of serious injury or even death from electrical shock, short-circuiting, damages, fire or other hazards. These precautions include, but are not limited to, the following:

#### **Power supply/Power cord**

- Only use the voltage specified as correct for the device. The required voltage is printed on the name plate of the device.
- Use only the specified AC power adaptor (PA-10) or an equivalent recommended by Yamaha.  
If you intend to use the device in an area other than in the one you purchased, the included power cord may not be compatible. Please check with your Yamaha dealer.
- Do not place the power cord near heat sources such as heaters or radiators, and do not excessively bend or otherwise damage the cord, place heavy objects on it, or place it in a position where anyone could walk on, trip over, or roll anything over it.

#### **Do not open**

- Do not open the device or attempt to disassemble the internal parts or modify them in any way. The device contains no user-serviceable parts. If it should appear to be malfunctioning, discontinue use immediately and have it inspected by qualified Yamaha service personnel.

#### **Water warning**

- Do not expose the device to rain, use it near water or in damp or wet conditions, or place containers on it containing liquids which might spill into any openings.
- Never insert or remove an electric plug with wet hands.

#### **If you notice any abnormality**

- If the power cord or plug becomes frayed or damaged, or if there is a sudden loss of sound during use of the device, or if any unusual smells or smoke should appear to be caused by it, immediately turn off the power switch, disconnect the electric plug from the outlet, and have the device inspected by qualified Yamaha service personnel.
- If this device or the AC power adaptor should be dropped or damaged, immediately turn off the power switch, disconnect the electric plug from the outlet, and have the device inspected by qualified Yamaha service personnel.

### **CAUTION**

Always follow the basic precautions listed below to avoid the possibility of physical injury to you or others, or damage to the device or other property. These precautions include, but are not limited to, the following:

#### **Power supply/Power cord**

- Remove the electric plug from the outlet when the device is not to be used for extended periods of time, or during electrical storms.
- When removing the electric plug from the device or an outlet, always hold the plug itself and not the cord. Pulling by the cord can damage it.
- To avoid generating unwanted noise, make sure there is 50cm or more between the AC power adaptor and the device.
- Do not cover or wrap the AC power adaptor with a cloth or blanket.

#### **Location**

- Before moving the device, remove all connected cables.
- When setting up the device, make sure that the AC outlet you are using is easily accessible. If some trouble or malfunction occurs, immediately turn off the power switch and disconnect the plug from the outlet.
- Avoid setting all equalizer controls and faders to their maximum. Depending on the condition of the connected devices, doing so may cause feedback and may damage the speakers.
- Do not expose the device to excessive dust or vibrations, or extreme cold or heat (such as in direct sunlight, near a heater, or in a car during the day) to prevent the possibility of panel disfiguration or damage to the internal components.
- Do not place the device in an unstable position where it might accidentally fall over.

- Do not use the device in the vicinity of a TV, radio, stereo equipment, mobile phone, or other electric devices. Doing so may result in noise, both in the device itself and in the TV or radio next to it.

#### **Connections**

- Before connecting the device to other devices, turn off the power for all devices. Before turning the power on or off for all devices, set all volume levels to minimum.

#### **Handling caution**

- When turning on the AC power in your audio system, always turn on the power amplifier LAST, to avoid speaker damage. When turning the power off, the power amplifier should be turned off FIRST for the same reason.
- Do not insert your fingers or hands in any gaps or openings on the device.
- Avoid inserting or dropping foreign objects (paper, plastic, metal, etc.) into any gaps or openings on the device. If this happens, turn off the power immediately and unplug the power cord from the AC outlet. Then have the device inspected by qualified Yamaha service personnel.
- Do not use the device or headphones for a long period of time at a high or uncomfortable volume level, since this can cause permanent hearing loss. If you experience any hearing loss or ringing in the ears, consult a physician.
- Do not rest your weight on the device or place heavy objects on it, and avoid use excessive force on the buttons, switches or connectors.

XLR-type connectors are wired as follows (IEC60268 standard): pin 1: ground, pin 2: hot (+), and pin 3: cold (-).  
Insert TRS phone jacks are wired as follows: sleeve: ground, tip: send, and ring: return.

Yamaha cannot be held responsible for damage caused by improper use or modifications to the device, or data that is lost or destroyed.

Always turn the power off when the device is not in use.

Even when the power switch is in the "STANDBY" position, electricity is still flowing to the device at the minimum level. When you are not using the device for a long time, make sure you unplug the power cord from the wall AC outlet.

The performance of components with moving contacts, such as switches, volume controls, and connectors, deteriorates over time. Consult qualified Yamaha service personnel about replacing defective components.

The MG mixer may heat up by as much as 15 to 20°C while the power is on. This is normal. Please note that the panel temperature may exceed 50°C in ambient temperatures higher than 30°C, and use caution to prevent burns.

- \* This Owner's Manual applies to both the MG82CX and MG102C. The main difference between the two models is that the MG82CX includes digital effects while the MG102C has no internal effects.
- \* In this manual the term "MG mixers" refers to both the MG82CX and MG102C. In cases where different features need to be described for each model, the MG82CX feature will be described first, followed by the MG102C feature in brackets: MG82CX (MG102C).
- \* Illustrations herein are for explanatory purposes only, and may not match actual appearance during operation.
- \* Company names and product names herein are trademarks or registered trademarks of their respective companies.

Copying of commercially available music or other audio data for purposes other than personal use is strictly prohibited by copyright law. Please respect all copyrights, and consult with a copyright specialist if you are in doubt about permissible use.

Specifications and descriptions in this owner's manual are for information purposes only. Yamaha Corp. reserves the right to change or modify products or specifications at any time without prior notice. Since specifications, equipment or options may not be the same in every locale, please check with your Yamaha dealer.

## Introduction

Thank you for your purchase of the YAMAHA MG82CX/MG102C mixing console. The MG82CX/MG102C feature input channels suitable for a wide range of usage environments. And the MG82CX includes high-quality built-in digital effects that can provide some very serious sound. The mixer combines ease of operation with support for multiple usage environments.

Please read through this manual carefully before beginning use, so that you will be able to take full advantage of this mixer's superlative features and enjoy trouble-free operation for years to come.

## Contents

<b>Introduction</b> .....	<b>5</b>
Contents .....	5
Before Turning on the Mixer .....	5
Turning the Power On.....	5

## Mixer Basics

<b>Quick Guide</b> .....	<b>6</b>
<b>Making the Most of Your Mixer</b> .....	<b>7</b>
Balanced, Unbalanced—What's the Difference?....	7
Signal Levels and the Decibel .....	7
To EQ or Not to EQ .....	8
Ambience.....	9
The Modulation Effects: .....	9
Phasing, Chorus, and Flanging .....	9
Compression.....	9

## Reference

<b>Front &amp; Rear Panels</b> .....	<b>10</b>
Channel Control Section.....	10
Master Control Section .....	11
DIGITAL EFFECT .....	13
Rear Input/Output Section .....	13
<b>Setup</b> .....	<b>14</b>
Jack List.....	14
<b>Troubleshooting</b> .....	<b>15</b>
Mounting to a Microphone Stand.....	15
<b>Specifications</b> .....	<b>55</b>

### Accessories

- Owner's Manual
  - AC power adaptor (PA-10)\*
- \* May not be included depending on your particular area. Please check with your Yamaha dealer.

## Before Turning on the Mixer

- 1** Be sure that the mixer's power switch is in the **STANDBY** position.



Use only the PA-10 adaptor included with this mixer. Use of a different adaptor may result in equipment damage, overheating, or fire.

- 2** Connect the power adaptor to the **AC ADAPTOR IN** connector (①) on the rear of the mixer, and then turn the fastening ring clockwise (②) to secure the connection.)

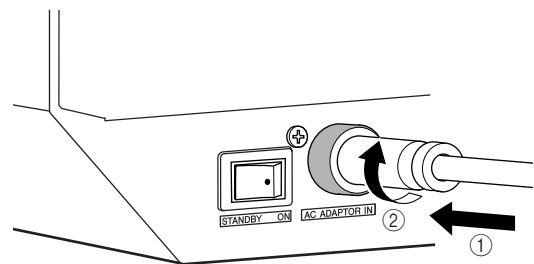

- 3** Plug the power adaptor into a standard household power outlet.



- Be sure to unplug the adaptor from the outlet when not using the mixer, or when there are lightning storms in the area.
- To avoid generating unwanted noise, make sure there is 50 cm or more between the power adaptor and the mixer.

## Turning the Power On

Press the mixer's power switch to the **ON** position. When you are ready to turn the power off, press the power switch to the **STANDBY** position.



Note that trace current continues to flow while the switch is in the **STANDBY** position. If you do not plan to use the mixer again for a long while, please be sure to unplug the adaptor from the wall outlet.

# Quick Guide

## Getting Sound to the Speakers

We begin by connecting a pair of speakers and generating some stereo output. Note that operations and procedures will vary somewhat according to the input devices you are using.

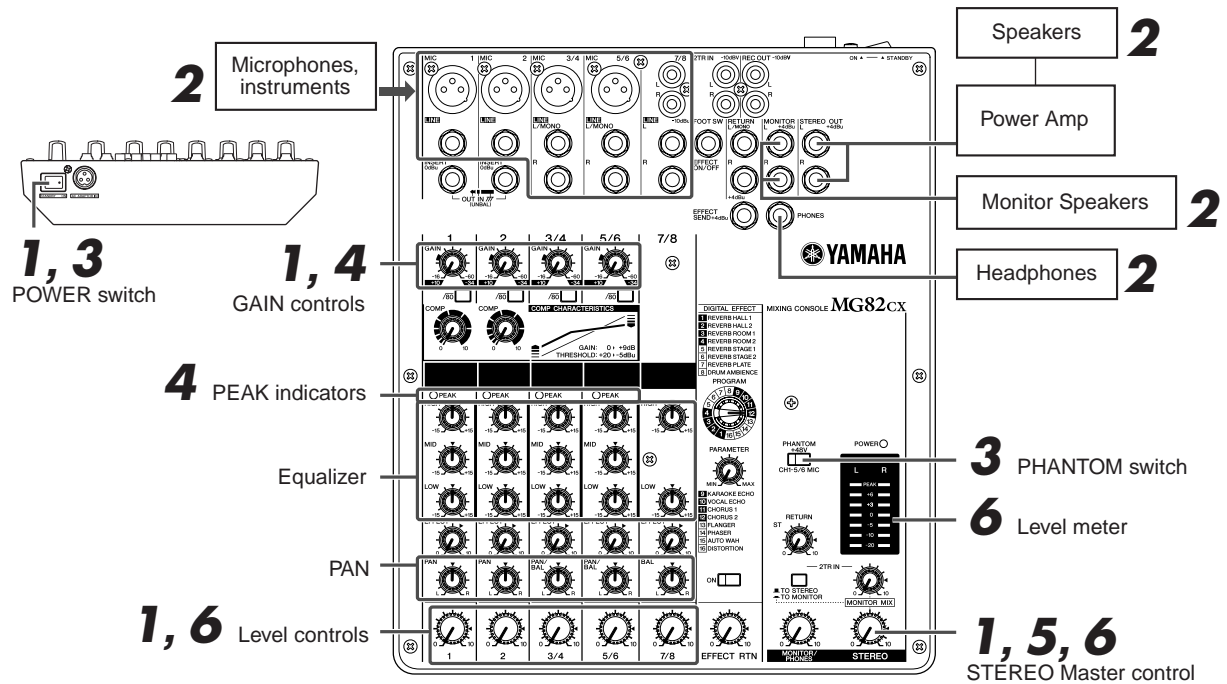

### 1 Be sure that your mixer is turned off and that all level\* controls are turned all the way down.

\* STEREO Master control, Level controls, Gain Control, etc.

#### NOTE

Set the equalizer and the pan controls to their ▼ positions.

### 2 Turn off any other external devices, then connect microphones, instruments, and speakers.

#### NOTE

- \* For information on connecting external devices see the Connection Example on page 14.
- \* Connect electric guitars and basses through an intermediary device such as a direct box, preamp, or amp simulator. Connecting these instruments directly to the MG mixer may result in degraded sound and noise.

### 3 To avoid damage to your speakers, power up the devices in the following order: Peripheral devices → MG mixer → power amps (or powered speakers). Reverse this order when turning power off.

#### NOTE

If you are using microphones that require phantom power, turn the MG mixer's phantom power switch on before turning on the power to the power amp or powered speakers. See page 12 for more detail.

### 4 Adjust the channel GAIN controls so that the corresponding peak indicators flash briefly on the highest peak levels.

### 5 Set the STEREO Master control to the “▼” position.

### 6 Set the Level control to create the desired initial balance, then adjust the overall volume using the STEREO Master control.

#### NOTE

- \* Use the LEVEL meter to view the level being applied to the STEREO L/R buses.
- \* If the PEAK indicator lights frequently, lower the LEVEL controls a little to avoid distortion.

# Making the Most of Your Mixer

You've got yourself a mixer and now you're ready to use it.

Just plug everything in, twiddle the controls, and away you go ... right?

Well, if you've done this before you won't have any problems, but if this is the first time you've ever used a mixer you might want to read through this little tutorial and pick up a few basics that will help you get better performance and make better mixes.

## Balanced, Unbalanced—What's the Difference?

In a word: "noise." The whole point of balanced lines is noise rejection, and it's something they're very good at. Any length of wire will act as an antenna to pick up the random electromagnetic radiation we're constantly surrounded by: radio and TV signals as well as spurious electromagnetic noise generated by power lines, motors, electric appliances, computer monitors, and a variety of other sources. The longer the wire, the more noise it is likely to pick up. That's why balanced lines are the best choice for long cable runs. If your "studio" is basically confined to your desktop and all connections are no more than a meter or two in length, then unbalanced lines are fine—unless you're surrounded by extremely high levels of electromagnetic noise. Another place balanced lines are almost always used is in microphone cables. The reason for this is that the output signal from most microphones is very small, so even a tiny amount of noise will be relatively large, and will be amplified to an alarming degree in the mixer's high-gain head amplifier.

### Balanced noise cancellation

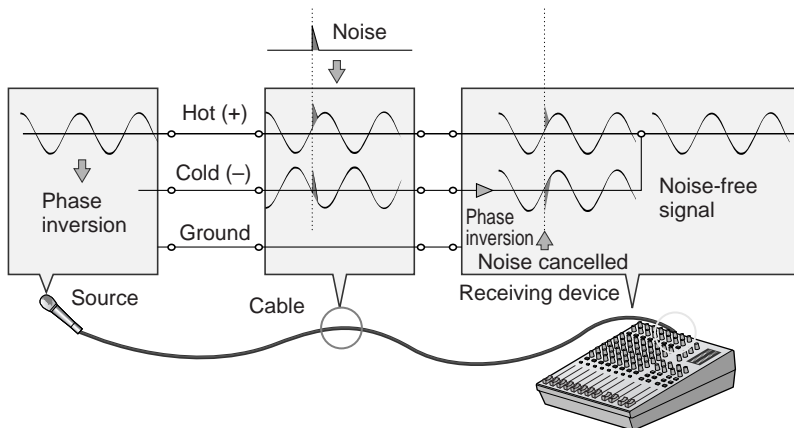

### To summarize

Microphones:	Use balanced lines.
Short line-level runs:	Unbalanced lines are fine if you're in a relatively noise-free environment.
Long line-level runs:	The ambient electromagnetic noise level will be the ultimate deciding factor, but balanced is best.

## Signal Levels and the Decibel

Let's take a look at one of the most commonly used units in audio: the decibel (dB). If the smallest sound that can be heard by the human ear is given an arbitrary value of 1, then the loudest sound that can be heard is approximately 1,000,000 (one million) times louder. That's too many digits to deal with for practical calculations, and so the more appropriate "decibel" (dB) unit was created for sound-related measurements. In this system the difference between the softest and loudest sounds that can be heard is 120 dB. This is a non-linear scale, and a difference of 3 dB actually results in a doubling or halving of the loudness.

You might encounter a number of different varieties of the dB: dBu, dBV, dBm and others, but the dBu is the basic decibel unit. In the case of dBu, "0 dBu" is specified as a signal level of 0.775 volts. For example, if a microphone's output level is -40 dBu (0.00775 V), then to raise that level to 0 dBu (0.775 V) in the mixer's preamp stage requires that the signal be amplified by 100 times.

A mixer may be required to handle signals at a wide range of levels, and it is necessary match input and output levels as closely as possible. In most cases the "nominal" level for a mixer's input and outputs is marked on the panel or listed in the owner's manual.

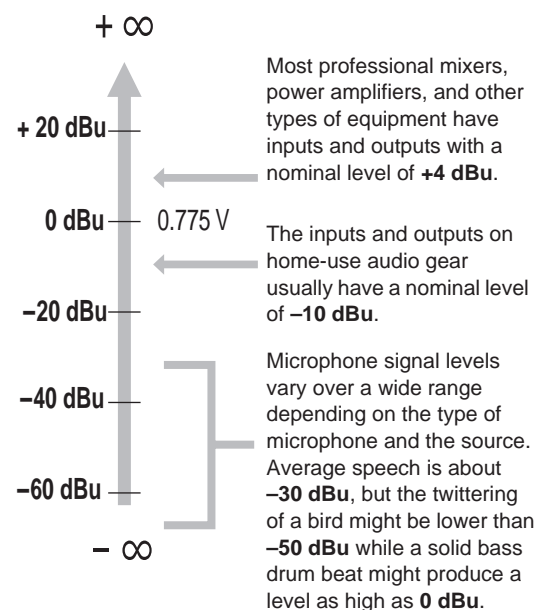

## To EQ or Not to EQ

In general: less is better. There are many situations in which you'll need to cut certain frequency ranges, but use boost sparingly, and with caution. Proper use of EQ can eliminate interference between instruments in a mix and give the overall sound better definition. Bad EQ—and most commonly bad boost—just sounds terrible.

### Cut for a Cleaner Mix

For example: cymbals have a lot of energy in the mid and low frequency ranges that you don't really perceive as musical sound, but which can interfere with the clarity of other instruments in these ranges. You can basically turn the low EQ on cymbal channels all the way down without changing the way they sound in the mix. You'll hear the difference, however, in the way the mix sounds more "spacious," and instruments in the lower ranges will have better definition. Surprisingly enough, piano also has an incredibly powerful low end that can benefit from a bit of low-frequency roll-off to let other instruments—notably drums and bass—do their jobs more effectively. Naturally you won't want to do this if the piano is playing solo.

The reverse applies to kick drums and bass guitars: you can often roll off the high end to create more space in the mix without compromising the character of the instruments. You'll have to use your ears, though, because each instrument is different and sometimes you'll want the "snap" of a bass guitar, for example, to come through.

The fundamental and harmonic frequency ranges of some musical instruments.

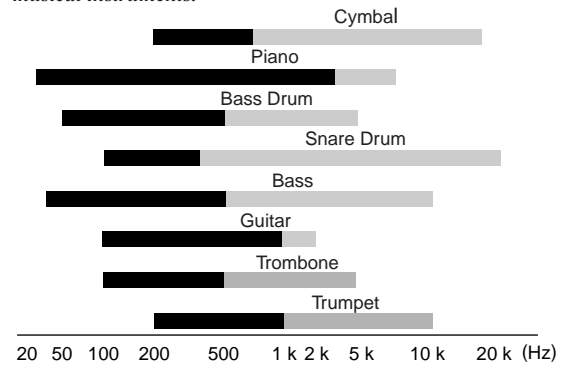

- Fundamental: The frequency that determines the basic musical pitch.
- Harmonics: Multiples of the fundamental frequency that play a role in determining the timbre of the instrument.

### Some Frequency Facts

The lowest and highest frequencies than can be heard by the human ear are generally considered to be around 20 Hz and 20,000 Hz, respectively. Average conversation occurs in the range from about 300 Hz to about 3,000 Hz. The frequency of a standard pitchfork used to tune guitars and other instruments is 440 Hz (this corresponds to the "A3" key on a piano tuned to concert pitch). Double this frequency to 880 Hz and you have a pitch one octave higher (i.e. "A4" on the piano keyboard). In the same way you can halve the frequency to 220 Hz to produce "A2" an octave lower.

### Boost with Caution

If you're trying to create special or unusual effects, go ahead and boost away as much as you like. But if you're just trying to achieve a good-sounding mix, boost only in very small increments. A tiny boost in the midrange can give vocals more presence, or a touch of high boost can give certain instruments more "air." Listen, and if things don't sound clear and clean try using cut to remove frequencies that are cluttering up the mix rather than trying to boost the mix into clarity. One of the biggest problems with too much boost is that it adds gain to the signal, increasing noise and potentially overloading the subsequent circuitry.

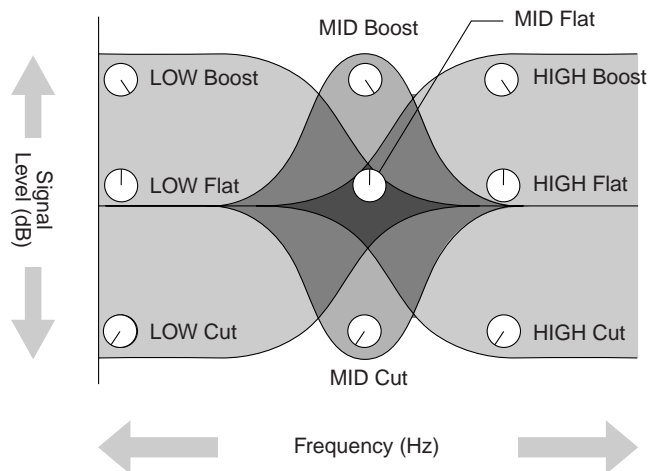



## Ambience

Your mixes can be further refined by adding ambience effects such as reverb or delay. The MG's internal effects can be used to add reverb or delay to individual channels in the same way as external effects processors. (Refer to page 13).

### Reverb and Delay Time

The optimum reverb time for a piece of music will depend on the music's tempo and density, but as a general rule longer reverb times are good for ballads, while shorter reverb times are more suited to up-tempo tunes. Delay times can be adjusted to create a wide variety of "grooves". When adding delay to a vocal, for example, try setting the delay time to dotted eighth notes corresponding to the tune's tempo.

### Reverb Tone

Different reverb programs will have different "reverb tone" due to differences in the reverb time of the high or low frequencies. Too much reverb, particularly in the high frequencies, can result in unnatural sound and interfere with the high frequencies in other parts of the mix. It's always a good idea to choose a reverb program that gives you the depth you want without detracting from the clarity of the mix.

### Reverb Level

It's amazing how quickly your ears can lose perspective and fool you into believing that a totally washed-out mix sounds perfectly fine. To avoid falling into this trap start with reverb level all the way down, then gradually bring the reverb into the mix until you can just hear the difference. Any more than this normally becomes a "special effect."

## The Modulation Effects: Phasing, Chorus, and Flanging

All of these effects work on basically the same principle: a portion of the audio signal is "time-shifted" and then mixed back with the direct signal. The amount of time shift is controlled, or "modulated", by an LFO (Low-frequency Oscillator). For phasing effects the shift is very small. The phase difference between the modulated and direct signals causes cancellation at some frequencies and reinforces the signal at others and this causes the shimmering sound we hear.

For chorus and flanging the signal is delayed by several milliseconds, with the delay time modulated by an LFO, and recombined with the direct signal. In addition to the phasing effect described above, the delay modulation causes a perceived pitch shift which, when mixed with the direct signal, results in a harmonically rich swirling or swishing sound.

The difference between chorus and flanging effects is primarily in the amount of delay time and feedback used—flanging uses longer delay times than chorus, whereas chorus generally uses a more complex delay structure. Chorus is most often used to thicken the sound of an instrument, while flanging is usually used as an outright "special effect" to produce otherworldly sonic swoops.

## Compression

One form of compression known as "limiting" can, when properly used, produce a smooth, unified sound with no excessive peaks or distortion. A common example of the use of compression is to "tame" a vocal that has a wide dynamic range in order to tighten up the mix. With the right amount of compression you'll be able to clearly hear whispered passages while passionate shouts are still well balanced in the mix. Compression can also be valuable on bass guitar. Too much compression can be a cause of feedback, however, so use it sparingly.

Most compressors require several critical parameters to be set properly to achieve the desired sound. The MG compressor makes achieving great sound much easier: all you need to do is set a single "compression" control and all of the pertinent parameters are automatically adjusted for you.

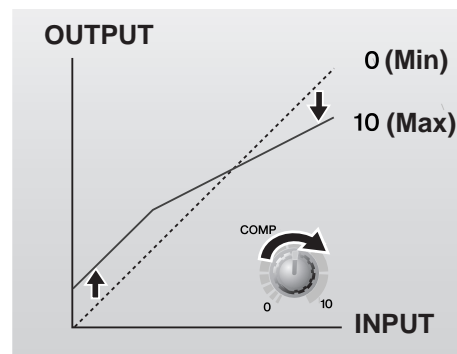

# Front & Rear Panels

The following applies to both the MG82CX and MG102C. In cases where different features need to be described for each model, the MG82CX feature will be described first, followed by the MG102C feature in brackets: MG82CX (MG102C).

## Channel Control Section

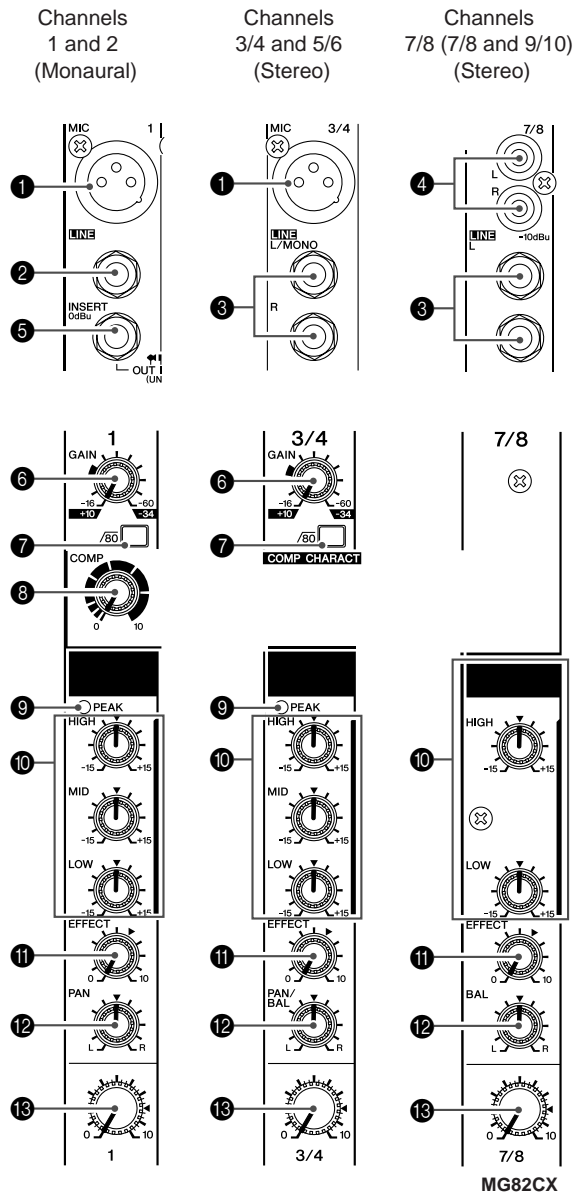

### 1 MIC Input Jacks (CHs 1 to 5/6)

These are balanced XLR-type microphone input jacks (1:Ground; 2:Hot; 3:Cold).

### 2 LINE Input Jacks (CHs 1, 2)

These are balanced TRS phone-jack line inputs (T:Hot; R:Cold; S:Ground).

You can connect either balanced or unbalanced phone plugs to these jacks.

### 3 LINE Input Jacks (CHs 3/4 to 7/8 (CHs 3/4 to 9/10))

These are unbalanced phone-jack stereo line inputs.

### 4 LINE Input Jacks (CH 7/8, (CHs 7/8, 9/10))

These are unbalanced stereo RCA pin jacks.

**NOTE** Where an input channel provides both a MIC input jack and a LINE input jack, or a LINE input jack and an RCA pin jack, you can use either jack but not both at the same time. Please connect to only one jack on each channel.

### 5 INSERT Jacks (CHs 1, 2)

Each of these jacks provides an insert point between the equalizer and level control of the corresponding input channel (CHs 1, 2). The INSERT jacks can be used to independently connect devices such as graphic equalizers, compressors, or noise filters into the corresponding channels. These are TRS (tip, ring, sleeve) phone jacks that carry both the send and return signal (tip = send/out; ring = return/in; sleeve = ground).

**NOTE** Patching external devices via an INSERT jack requires a special insert cable such as illustrated below (insert cable sold separately).

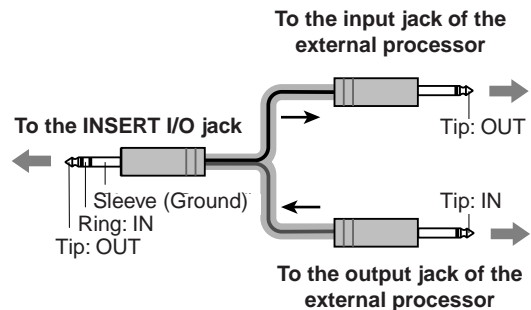

The signal output from the INSERT jacks is reverse-phased. This should not be a problem when connecting to an effect unit, but please be aware of the possibility of phase conflict when connecting to other types of device.

### 6 GAIN Control

Adjusts the input signal level.

To achieve the best balance between S/N ratio and dynamic range, adjust the level so that the PEAK indicator **9** lights only occasionally and briefly on the highest input transients. The -60 to -16 scale is the MIC input adjustment range. The -34 to +10 scale is the LINE input adjustment range.

### 7 $\sqrt{80}$ Switch (High Pass Filter)

This switch toggles the HPF on or off. To turn the HPF on, press the switch in (**—**). The HPF cuts frequencies below 80 Hz (the HPF does not apply to the line inputs of stereo input channels **3 4**).

## 8 COMP Control

Adjusts the amount of compression applied to the channel. As the knob is turned to the right the compression ratio increases while the output gain is automatically adjusted accordingly. The result is smoother, more even dynamics because louder signals are attenuated while the overall level is boosted.

**NOTE** Avoid setting the compression too high, as the higher average output level that results may lead to feedback.

## 9 PEAK Indicator

The peak level of the post-EQ signal is detected, and the PEAK indicator lights red when the level reaches 3 dB below clipping. For XLR-equipped stereo input channels (3/4 and 5/6), both the post-EQ and post-mic-amp peak levels are detected, and the indicator lights red if either of these levels reaches 3 dB below clipping.

## 10 Equalizer (HIGH, MID, and LOW)

This three-band equalizer adjusts the channel's high, mid, and low frequency bands. CH 7/8 (CHs 7/8, 9/10) have two bands: high and low. Setting the knob to the ▼ position produces a flat response in the corresponding band. Turning the knob to the right boosts the corresponding frequency band, while turning to the left attenuates the band. The following table shows the EQ type, frequency, and maximum cut/boost for each of the three bands.

Band	Type	Frequency	Maximum Cut/Boost
HIGH	Shelving	10 kHz	±15 dB
MID	Peaking	2.5 kHz	
LOW	Shelving	100 Hz	

## 11 EFFECT (AUX) Control

Adjusts the level of the signal sent from the channel to the EFFECT (AUX) bus. Note that the signal level sent to the bus is also affected by the Level control 13. On stereo channels (CHs 3/4 to 7/8 (CHs 3/4 to 9/10)) the signals from the L (odd) and R (even) channels are mixed and then sent to the EFFECT (AUX) bus.

## 12 PAN Control (CHs 1, 2)

### PAN/BAL Control (CHs 3/4, 5/6)

### BAL Control (CH 7/8 (CHs 7/8, 9/10))

The PAN control determines the stereo positioning of the channel signal on the Stereo L and R buses.

The BAL control knob sets the balance between left and right channels. Signals input to the L input (odd channel) go to the Stereo L bus; signals input to the R input (even channel) go to the Stereo R bus.

**NOTE** On channels where this knob provides both PAN and BAL control (channels 3/4 and 5/6), the knob operates as a PAN control when input is received via the MIC jack or L (MONO) input only, and as a BAL control when input is received via both L and R inputs.

## 13 Level Control

Adjusts the level of the channel signal. Use these knobs to adjust the balance between the various channels.

**NOTE** Set the controls for unused channels all the way down to minimize noise.

# Master Control Section

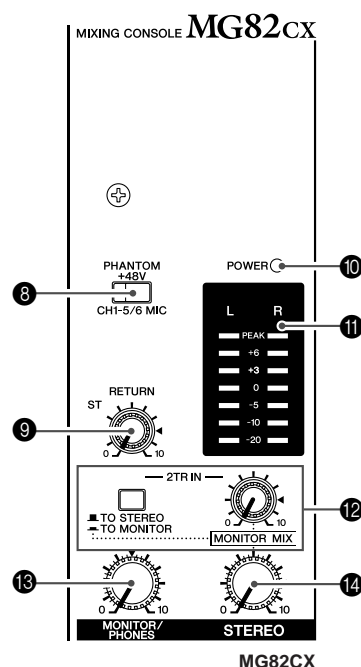
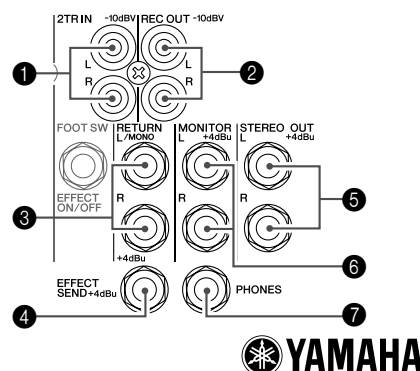

## 1 2TR IN Jacks

These RCA pin jacks can be used to input a stereo sound source. Use these jacks when you want to connect a CD player directly to the mixer.

**NOTE** Select where you want to send the signal using the 2TR IN switch, and adjust the signal level using the 2TR IN control in the Master Control section.

## 2 REC OUT (L, R) Jacks

These RCA pin jacks can be connected to an external recorder such as an MD recorder in order to record the same signal that is being output via the STEREO OUT jacks.

**NOTE** The mixer's STEREO Master control has no effect on the signal output via these jacks. Be sure to make appropriate level adjustments at the recording device.

### 3 RETURN L (MONO), R Jacks

These are unbalanced phone-jack type line inputs. The signal received by these jacks is sent to the STEREO L/R buses. These jacks are typically used to receive the signal returned from an external effect device (reverb, delay, etc.).

**NOTE** These jacks can also be used as an auxiliary stereo input. If you connect to the L (MONO) jack only, the mixer will recognize the signal as monaural and will send the identical signal to both the L and R jacks.

### 4 SEND EFFECT (AUX) Jack

This is an impedance balanced\* phone-jack type output that outputs the signal from the EFFECT (AUX) bus. You can use this jack, for example, to connect to an external effect unit.

### 5 STEREO OUT (L, R) Jacks

These are impedance balanced\* phone-jack type outputs that output the signals adjusted by the STEREO Master control. You can use these jacks, for example, to connect to the power amplifier driving your main speakers.

### 6 MONITOR (L, R) Jacks

These are impedance balanced\* phone-jack type outputs that output the signals adjusted by the MONITOR/PHONES control. Connect these jacks to your monitor system.

### 7 PHONES Jack

Connect a pair of headphones to this stereo phone jack. The PHONES jack outputs the same signal as the MONITOR OUT jacks.

### 8 PHANTOM +48 V Switch

This switch toggles phantom power on and off. When the switch is on the mixer supplies +48V phantom power to all channels that have XLR mic input jacks (CHs 1–5/6). Turn this switch on when using one or more phantom-powered condenser microphones.

**NOTE** When this switch is on the mixer supplies DC +48 V power to pins 2 and 3 of all XLR-type MIC INPUT jacks.



- Be sure to leave this switch off (■) if you do not need phantom power.
- When tuning the switch on (■), be sure that only condenser mics are connected to the XLR input jacks (CHs: 1 to 5/6). Devices other than condenser mics may be damaged if connected to the phantom power supply. Note, however, that the switch may be left on when connecting to balanced dynamic microphones.
- To avoid damage to speakers, be sure to turn off amplifiers (or powered speakers) before turning this switch on or off. We also recommend that you turn all output controls (STEREO Master control, etc.) to their minimum settings before operating the switch to avoid the risk of loud noises that could cause hearing loss or device damage.

### 9 RETURN Control

Adjusts the level at which the signal received at the RETURN jacks (L (MONO) and R) is sent to the STEREO L/R bus.

**NOTE** If you supply a signal to the RETURN L (MONO) jack only, the mixer sends the same signal to both the L and R Stereo buses.

### 10 POWER Indicator

This indicator lights when the mixer's power is ON.

### 11 Level Meter

This LED meter displays the level of the signal sent to the MONITOR jacks and the PHONES jack. The “0” segment corresponds to the nominal output level. The PEAK segment lights red when the output reaches the clipping level.

### 12 2TR IN

#### • 2TR IN Switch

If it is set to TO STEREO (■), the signals are sent to the STEREO L/R buses. If this switch is set to TO MONITOR (■), the signals input via the 2TR IN jacks are sent to the MONITOR OUT jacks, the PHONES jack, and the level meter. The MONITOR MIX feature becomes available when it is set to TO MONITOR (■).

\* **MONITOR MIX**: When overdubbing, you can adjust the levels of the monitor playback signal and the signal being recorded separately.

#### MONITOR MIX Signal Flow

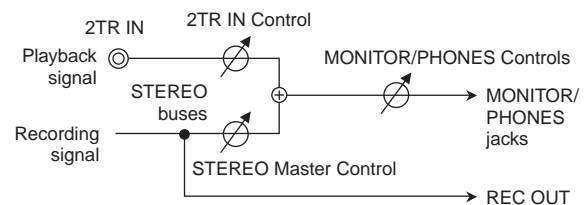

#### • 2TR IN control

Adjusts the level of the signal sent from the 2TR IN jacks to the STEREO L/R buses.

### 13 MONITOR/PHONES Control

Controls the level of the signal output to the PHONES jack and the MONITOR jacks.

### 14 STEREO Master Control

Adjusts the signal level sent to the STEREO OUT jacks.

\* Impedance Balanced

Since the hot and cold terminals of impedance balanced output jacks have the same impedance, these outputs are less affected by induced noise.

## DIGITAL EFFECT

\*Only the MG82CX has digital effects.

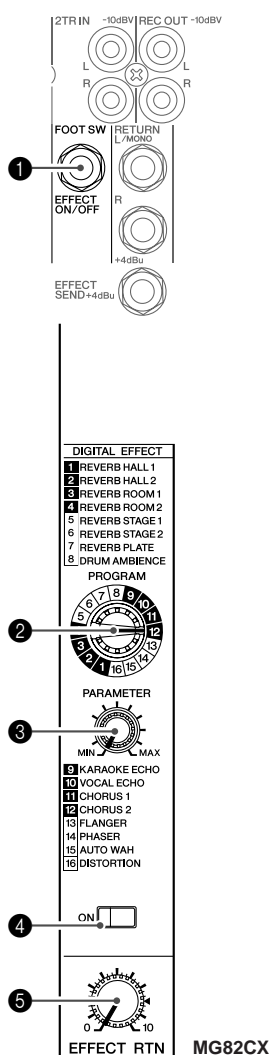

### 1 FOOT SWITCH Jack

A YAMAHA FC5 foot switch (sold separately) can be connected to this jack and used to toggle the digital effects ON and OFF.

### 2 PROGRAM Dial

Selects one of the 16 internal effects. See page 18 for details about the internal effects.

### 3 PARAMETER Control

Adjusts the parameter (depth, speed, etc.) for the selected effect. The last value used with each effect type is saved.

**NOTE** When you change to a different effect type, the mixer automatically restores the value that was previously used with the newly selected effect (regardless of the current position of the PARAMETER Control knob).

These parameter values are reset when the power is turned off.

### 4 ON Switch

Switches the internal effect on or off. The internal effect is applied only if this switch is turned on. The switch lights orange when on.

An optional YAMAHA FC5 foot switch (sold separately) can be used to toggle the digital effects ON and OFF.

**NOTE** The ON switch lights and the internal effect unit is active by default when the power is initially turned on.

### 5 EFFECT RTN Control

Adjusts the signal level sent from the internal digital effect unit to the STEREO buses.

## Rear Input/Output Section

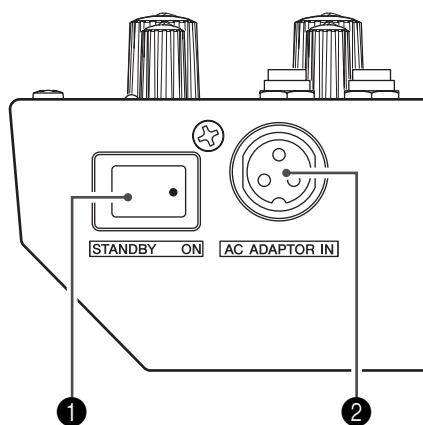

### 1 POWER Switch

Use this switch to turn the mixer's power ON or to STANDBY mode.



Note that a small current continues to flow while the switch is in the STANDBY position. If you do not plan to use the mixer for a while, be sure to unplug the AC adaptor from the wall outlet.

### 2 AC ADAPTOR IN Connector

Connect the supplied PA-10 power adaptor to this connector (see page 5).



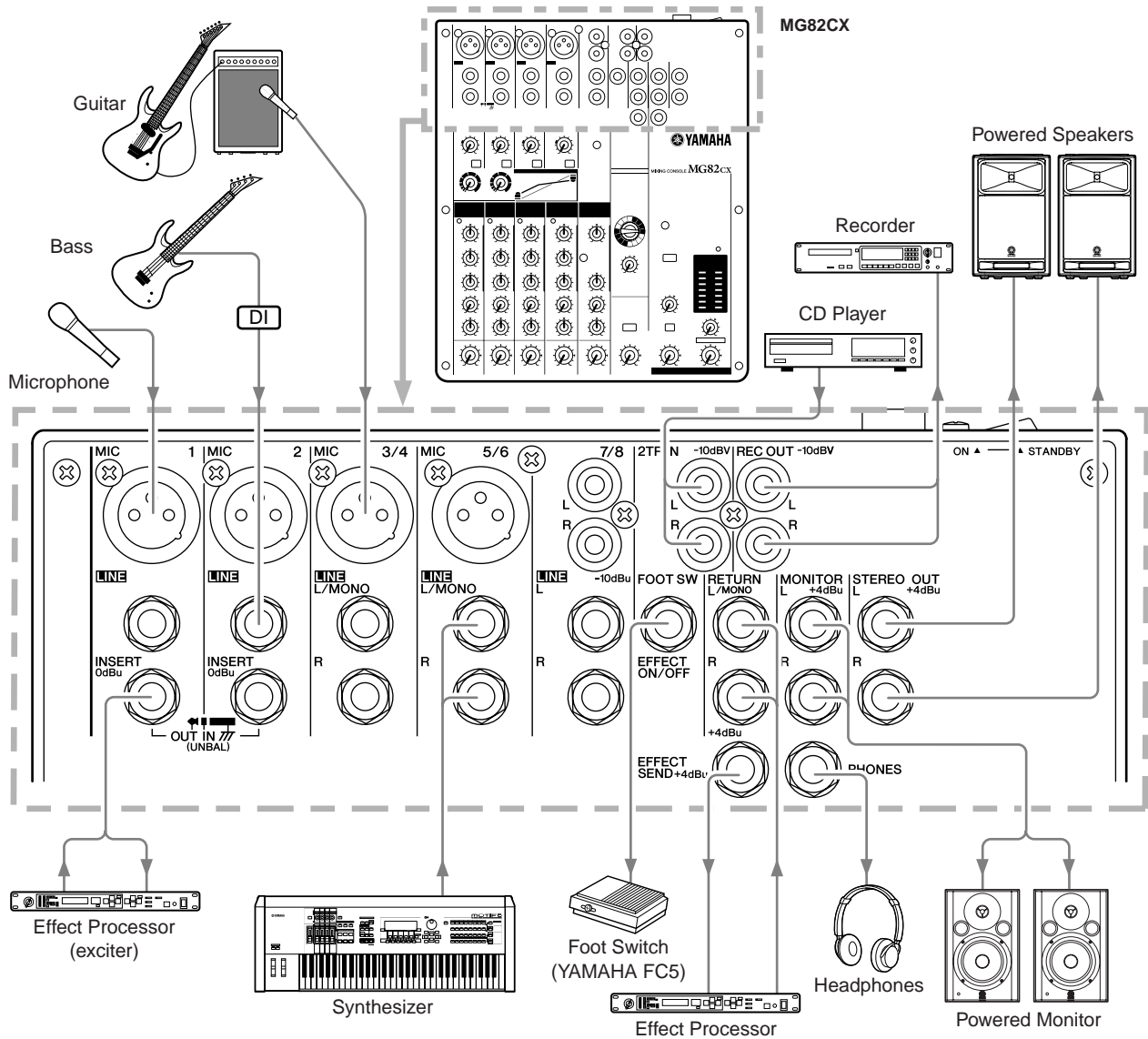

Use only the PA-10 adaptor included with this mixer. Use of a different adaptor may result in fire or electric shock.

# Setup

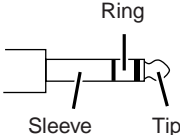
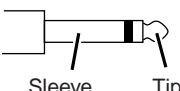
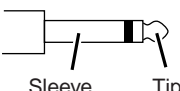
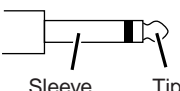

## Jack List

Input and Output Jacks	Polarities	Configurations
MIC INPUT	Pin 1: Ground Pin 2: Hot (+) Pin 3: Cold (-)	INPUT  OUTPUT 
LINE INPUT (CHs 1, 2) STEREO OUT, MONITOR OUT, EFFECT (AUX)*	Tip: Hot (+) Ring: Cold (-) Sleeve: Ground	
INSERT	Tip: Output Ring: Input Sleeve: Ground	
PHONES	Tip: L Ring: R Sleeve: Ground	
RETURN LINE INPUT (CHs 3/4 to 7/8 (CHs 3/4 to 9/10))	Tip: Hot Sleeve: Ground	

\* These jacks will also accept connection to monaural phone plugs. If you use monaural plugs, the connection will be unbalanced.

# Troubleshooting

<p>■ <b>Power doesn't come on.</b></p>	<p><input type="checkbox"/> Is the supplied power adaptor properly plugged into an appropriate AC wall outlet?</p> <p><input type="checkbox"/> Is the supplied power adaptor properly plugged into the mixer?</p>
<p>■ <b>No sound.</b></p>	<p><input type="checkbox"/> Are microphones, external devices, and speakers connected correctly?</p> <p><input type="checkbox"/> Are the channel GAIN controls, LEVEL controls, STEREO Master control set to appropriate levels?</p> <p><input type="checkbox"/> Is the MONITOR switch set properly?</p> <p><input type="checkbox"/> Are your speaker cables connected properly, or are they shorted?</p> <p><input type="checkbox"/> If the above checks do not identify the problem, call Yamaha for service. (Refer to the page 59 for a list of service centers.)</p>
<p>■ <b>Sound is faint, distorted, or noisy.</b></p>	<p><input type="checkbox"/> Are the channel GAIN controls, LEVEL controls, STEREO Master control set to appropriate levels?</p> <p><input type="checkbox"/> Are two different instruments connected to the XLR-type and phone jacks, or to the phone and RCA pin jacks on one channel? Please connect to only one of these jacks on each channel.</p> <p><input type="checkbox"/> Is the input signal from the connected device set to an appropriate level?</p> <p><input type="checkbox"/> Are you applying the effects at an appropriate level?</p> <p><input type="checkbox"/> Are microphones connected to the MIC input jacks on channels 1 to 5/6?</p> <p><input type="checkbox"/> If you are using condenser microphones, is the PHANTOM +48 V switch turned ON?</p>
<p>■ <b>No effect is applied.</b> (If you are using MG82CX)</p>	<p><input type="checkbox"/> Check that the EFFECT control on each channel is correctly adjusted.</p> <p><input type="checkbox"/> Be sure that the internal effect unit's ON switch is turned ON.</p> <p><input type="checkbox"/> Be sure that the EFFECT PARAMETER control and EFFECT RTN control are correctly adjusted.</p>
<p>■ <b>I want spoken words to be heard more clearly.</b></p>	<p><input type="checkbox"/> Be sure that the <math>\sqrt{80}</math> switches are ON.</p> <p><input type="checkbox"/> Adjust the equalizers (HIGH, MID and LOW) on each channel.</p>
<p>■ <b>I want to output a monitor signal through speakers.</b></p>	<p><input type="checkbox"/> Connect a powered speaker to the EFFECT (AUX) jack*. Then adjust the output signal by using the EFFECT (AUX) controls* on each channel.</p>

\* The MG82CX feature is described first, followed by the MG102C feature in brackets: MG82CX (MG102C).

## Mounting to a Microphone Stand



- When using the mixer on a microphone stand, be sure to set the stand on a level and stable surface. Do not set up the stand in locations subject to vibrations or wind.
- Note that mixer may be damaged if the stand should fall over. Attach the connection cables carefully so that the cables will not catch on the equipment and cause it to fall. For example: arrange the cables so that they run parallel with the microphone pole down to the base of the stand.
- Leave ample free space around the stand.

- 1 Turn the mixer upside-down, and hold the microphone-stand adaptor (BMS-10A; sold separately) against the bottom of the mixer so that the screw holes are aligned (1). Screw the adaptor firmly into place with the two screws (2).

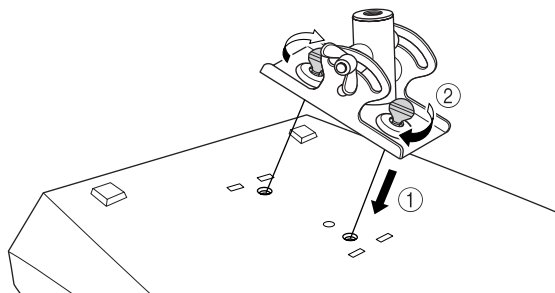

- 2 Turn the mixer right-side up, and mount it onto your microphone stand.
- 3 Loosen the angle adjustment wingnut (1), adjust the mixer's angle as desired (2), and then tighten the wingnut securely (3).

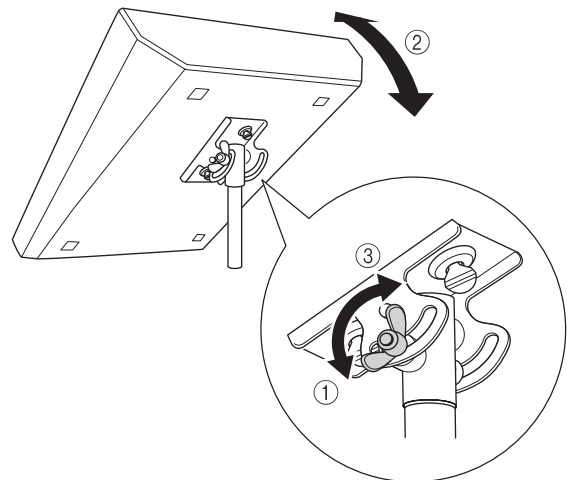

For more information, refer to the BMS-10A Owner's Manual.

# Specifications

## Electrical Specifications

		MIN	TYP	MAX	UNIT
Frequency Response	STEREO OUT	GAIN: min (CHs 1-5/6)	-3.0	1.0	dB
	EFFECT SEND (AUX SEND*)	20 Hz-20 kHz	-3.0	1.0	
	MONITOR OUT, REC OUT	Nominal output level @1 kHz	-3.0	1.0	
Total Harmonic Distortion (THD + N)	STEREO OUT	+14 dBu, 20 Hz-20 kHz, Input Gain Control at minimum		0.1	%
Hum & Noise  Hum & Noise are measured with a 6 dB/octave filter @12.7 kHz; equivalent to a 20 kHz filter with infinite dB/octave attenuation.	Input: CH INPUT 1, 2 MIC	EIN (Equivalent Input Noise): Rs = 150 Ω, GAIN: maximum (CH1, 2)		-128	dBu
	STEREO OUT	STEREO Master control at nominal level and all CH Level control at minimum.		-87	
	EFFECT SEND (AUX SEND*)	All CH EFFECT (AUX*) controls at minimum.		-85	
	STEREO OUT	STEREO Master control and one CH level control at nominal level (CH1, 2)		-64	
	STEREO OUT	Residual Output Noise		-100	
Crosstalk (1 kHz)	Adjacent Input	CH1, 2		-70	dB
	Input to Output	STEREO L/R, CH 1, 2, PAN: panned hard left or right		-70	
Maximum Voltage Gain (1 kHz)  All level controls are maximum when measured PAN/BAL: panned hard left or hard right.	Rs = 150 Ω INPUT GAIN: maximum	MIC to CH INSERT OUT		60	dB
		MIC to STEREO OUT		76	
		MIC to REC OUT		58.2	
		MIC to MONITOR OUT		92	
		MIC to PHONES OUT		81	
		MIC to EFFECT SEND (AUX SEND*)		76	
		LINE to STEREO OUT		50	
		LINE to EFFECT SEND (AUX SEND*)		47	
	ST CH 7/8, (CHs 7/8, 9/10*) to STEREO OUT		26		
Rs = 150 Ω	RETURN to STEREO OUT		12		
Rs = 600 Ω	2TR IN to STEREO OUT		23.8		
Phantom Voltage	MIC	no load		48	V

## General Specifications

Input HPF		CHs 1-5/6, 80 Hz, 12 dB/oct
Input Equalization  Turn over/roll-off frequency of shelving: 3 dB below maximum variable level. ±15 dB maximum	CHs 1-5/6	HIGH: 10 kHz (shelving)
		MID: 2.5 kHz (peaking)
	CH 7/8 (CHs 7/8, 9/10*)	LOW: 100 Hz (shelving)
		HIGH: 10 kHz (shelving)
PEAK Indicator		LOW: 100 Hz (shelving)
Internal Digital Effect*		Red LED turns on when post EQ signal (either post MIC HA or post EQ signal for CHs 3/4, 5/6) reaches -3 dB below clipping (+17 dBu).
LED Level Meter	Pre MONITOR Level	16 PROGRAM, PARAMETER control Foot Switch (Digital Effect On/Off)
Power Supply Adaptor	PA-10	2x7 points LED meter (PEAK, +6, +3, 0, -5, -10, -20 dB) PEAK lights if the signal level reaches 3 dB below the clipping level.
Power Consumption		AC 38 VCT, 0.62 A, Cable Length = 3.6 m
Power Consumption		21 W
Dimensions (W x H x D)		256.6 mm x 62.2 mm x 302.5 mm
Net Weight		1.6 kg (MG82CX), 1.5 kg (MG102C)

All level controls are nominal if not specified.

Output impedance of signal generator: 150 ohms

\* The MG82CX feature is described first, followed by the MG102C feature in brackets: MG82CX (MG102C)



## Input Specifications

Input Connectors	Gain	Input Impedance	Appropriate Impedance	Sensitivity *	Nominal Level	Max. before Clipping	Connector Specifications
CH INPUT MIC (CHs 1, 2)	-60 dB	3 k $\Omega$	50–600 $\Omega$ Mics	-72 dBu (0.195 mV)	-60 dBu (0.775 mV)	-40 dBu (7.75 mV)	XLR-3-31 type (balanced [1 = GND, 2 = HOT, 3 = COLD])
	-16 dB			-28 dBu (30.8 mV)	-16 dBu (123 mV)	+4 dBu (1.23V)	
CH INPUT LINE (CHs 1, 2)	-34 dB	10 k $\Omega$	600 $\Omega$ Lines	-46 dBu (3.88 mV)	-34 dBu (15.5 mV)	-14 dBu (155 mV)	TRS phone jack (balanced [Tip = HOT, Ring = COLD, Sleeve = GND])
	+10 dB			-2 dBu (0.615 V)	+10 dBu (2.45 V)	+30 dBu (24.5 V)	
ST CH MIC INPUT (CHs 3/4, 5/6)	-60 dB	3 k $\Omega$	50–600 $\Omega$ Mics	-72 dBu (0.195 mV)	-60 dBu (0.775 mV)	-40 dBu (7.75 mV)	XLR-3-31 type (balanced [1 = GND, 2 = HOT, 3 = COLD])
	-16 dB			-28 dBu (30.8 mV)	-16 dBu (123 mV)	-6 dBu (389 mV)	
ST CH LINE INPUT (CHs 3/4, 5/6)	-34 dB	10 k $\Omega$	600 $\Omega$ Lines	-46 dBu (3.88 mV)	-34 dBu (15.5 mV)	-14 dBu (155 mV)	Phone jack (unbalanced)
	+10 dB			-2 dBu (0.615 V)	+10 dBu (2.45 V)	+30 dBu (24.5V)	
ST CH INPUT (CH 7/8 (CHs 7/8, 9/10))	—	10 k $\Omega$	600 $\Omega$ Lines	-22 dBu (61.5 mV)	-10 dBu (245 mV)	+10 dBu (2.45 V)	Phone jack (unbalanced) RCA pin jack
CH INSERT IN (CHs 1, 2)	—	10 k $\Omega$	600 $\Omega$ Lines	-12 dBu (195 mV)	0 dBu (0.775 V)	+20 dBu (7.75 V)	TRS phone jack (unbalanced [Tip = Out, Ring = In, Sleeve = GND])
RETURN (L, R)	—	10 k $\Omega$	600 $\Omega$ Lines	-8 dBu (308 mV)	+4 dBu (1.23 V)	+24 dBu (12.3 V)	Phone jack (unbalanced)
2TR IN (L, R)	—	10 k $\Omega$	600 $\Omega$ Lines	-22 dBV (79.4 mV)	-10 dBV (0.316 V)	+10 dBV (3.16 V)	RCA pin jack

Where 0 dBu = 0.775 Vrms and 0 dBV = 1 Vrms

\* Sensitivity : The lowest level that will produce an output of +4 dB (1.23 V), or the nominal output level when the unit is set to the maximum level. (All level controls are at their maximum position.)

## Output Specifications

Output Connectors	Output Impedance	Appropriate Impedance	Nominal Level	Max. before clipping	Connector Specifications
STEREO OUT (L, R)	150 $\Omega$	10 k $\Omega$ Lines	+4 dBu (1.23 V)	+20 dBu (7.75 V)	Phone jack (impedance balanced [Tip = HOT, Ring = COLD, Sleeve = GND])
EFFECT SEND (AUX SEND*)	150 $\Omega$	10 k $\Omega$ Lines	+4 dBu (1.23 V)	+20 dBu (7.75 V)	Phone jack (impedance balanced [Tip = HOT, Ring = COLD, Sleeve = GND])
CH INSERT OUT (CHs 1, 2)	75 $\Omega$	10 k $\Omega$ Lines	0 dBu (0.775 V)	+20 dBu (7.75 V)	Phone jack (unbalanced [Tip = OUT, Ring = IN, Sleeve = GND])
REC OUT (L, R)	600 $\Omega$	10 k $\Omega$ Lines	-10 dBV (0.316 V)	+10 dBV (3.16 V)	RCA Pin jack
MONITOR OUT (L, R)	150 $\Omega$	10 k $\Omega$ Lines	+4 dBu (1.23 V)	+20 dBu (7.75 V)	Phone jack (impedance balanced [Tip = HOT, Ring = COLD, Sleeve = GND])
PHONES OUT	100 $\Omega$	40 $\Omega$ Phones	3 mW	75 mW	Stereo phone jack

Where 0 dBu = 0.775 Vrms and 0 dBV = 1 Vrms

\* The MG82CX feature is described first, followed by the MG102C feature in brackets: MG82CX (MG102C)

## ■ Digital Effect Program List

No	Program	Parameter	Description
1	REVERB HALL 1	REVERB TIME	Reverb simulating a large space such as a concert hall.
2	REVERB HALL 2	REVERB TIME	
3	REVERB ROOM 1	REVERB TIME	Reverb simulating the acoustics of a small space (room).
4	REVERB ROOM 2	REVERB TIME	
5	REVERB STAGE 1	REVERB TIME	Reverb simulating a large stage.
6	REVERB STAGE 2	REVERB TIME	
7	REVERB PLATE	REVERB TIME	Simulation of a metal-plate reverb unit, producing a more hard-edged sound.
8	DRUM AMBIENCE	REVERB TIME	A short reverb that is ideal for use with kick drum.
9	KARAOKE ECHO	DELAY TIME	Echo designed for karaoke (sing-along) applications.
10	VOCAL ECHO	DELAY TIME	Echo suitable for vocals.
11	CHORUS 1	LFO Frequency	Creates a thick sound by modulating the delay time. The PARAMETER control adjusts the frequency of the LFO* that modulates the delay time.
12	CHORUS 2	LFO Frequency	
13	FLANGER	LFO Frequency	A sweeping pitched effect. The PARAMETER control adjusts the frequency of the LFO* that modulates the delay time.
14	PHASER	LFO Frequency	Phase modulation produces a cyclical phasing effect. The PARAMETER control adjusts the frequency of the LFO* that modulates the delay time.
15	AUTO WAH	LFO Frequency	A wah-wah effect with cyclical filter modulation. The PARAMETER control adjusts the frequency of the LFO* that modulates the delay time.
16	DISTORTION	DRIVE	Adds a sharp-edged distortion to the sound.

\* "LFO" stands for Low Frequency Oscillator. An LFO is normally used to modulate another signal, determining the modulation speed and waveform shape.

## ■ Dimensional Diagrams

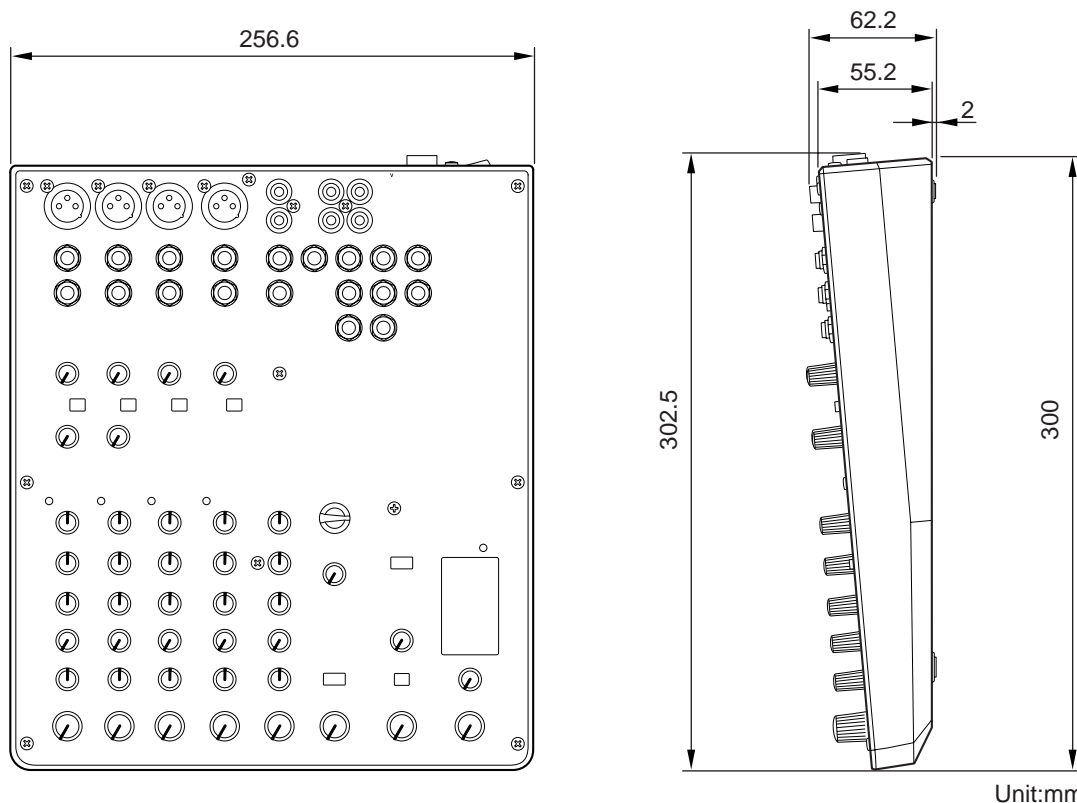

# ■ Block Diagram and Level Diagram

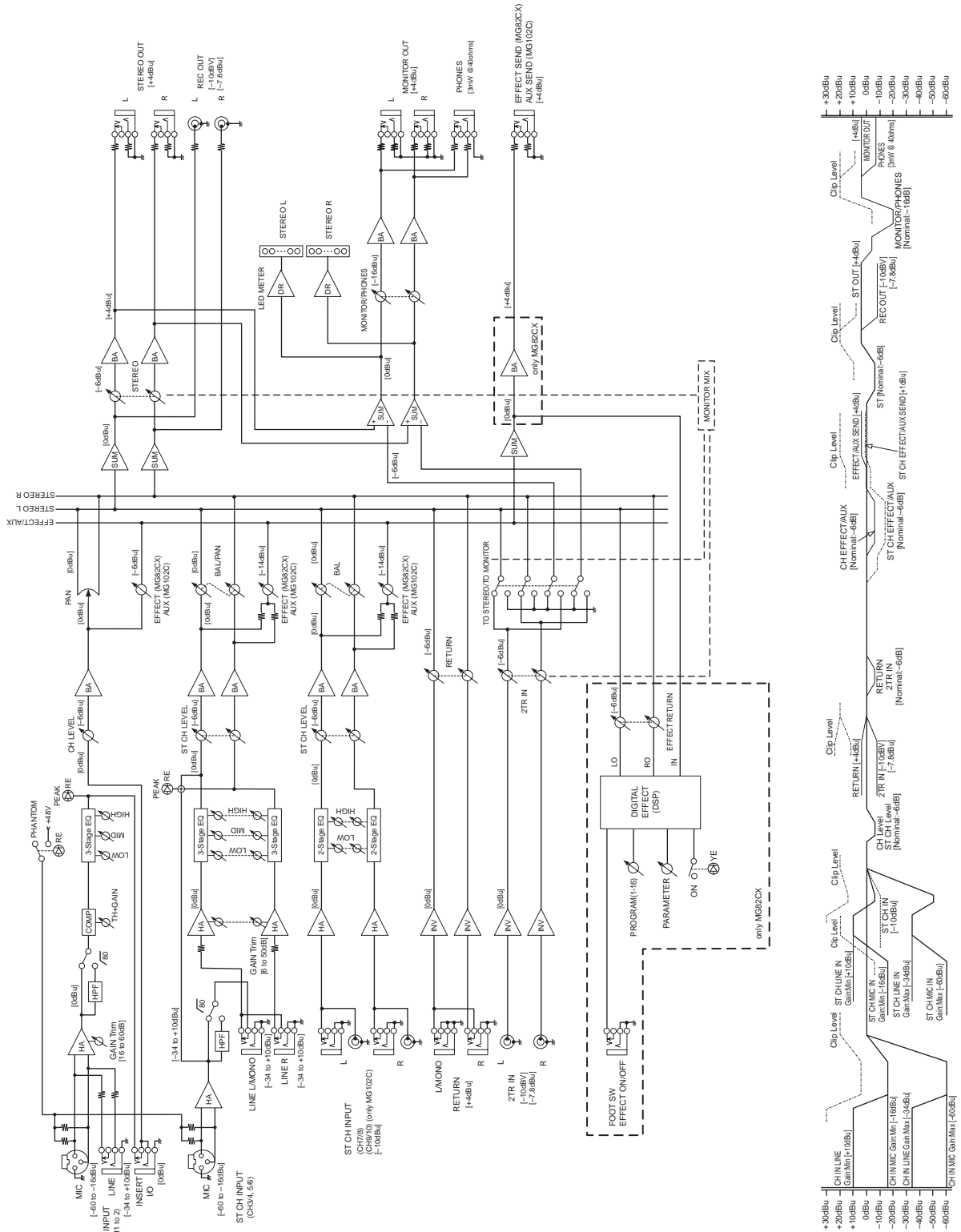

For details of products, please contact your nearest Yamaha representative or the authorized distributor listed below.

Pour plus de détails sur les produits, veuillez-vous adresser à Yamaha ou au distributeur le plus proche de vous figurant dans la liste suivante.

Die Einzelheiten zu Produkten sind bei Ihrer unten aufgeführten Niederlassung und bei Yamaha Vertragshändlern in den jeweiligen Bestimmungsländern erhältlich.

Para detalles sobre productos, contacte su tienda Yamaha más cercana o el distribuidor autorizado que se lista debajo.

## NORTH AMERICA

### CANADA

**Yamaha Canada Music Ltd.**  
135 Milner Avenue, Scarborough, Ontario,  
M1S 3R1, Canada  
Tel: 416-298-1311

### U.S.A.

**Yamaha Corporation of America**  
6600 Orangethorpe Ave., Buena Park, Calif.  
90620, U.S.A.  
Tel: 714-522-9011

## CENTRAL & SOUTH AMERICA

### MEXICO

**Yamaha de México S.A. de C.V.**  
Calz. Javier Rojo Gómez #1149,  
Col. Guadalupe del Moral  
C.P. 09300, México, D.F., México  
Tel: 55-5804-0600

### BRAZIL

**Yamaha Musical do Brasil Ltda.**  
Rua Joaquim Floriano, 913 - 4º andar, Itaim Bibi,  
CEP 04534-013 Sao Paulo, SP. BRAZIL  
Tel: 011-3704-1377

### ARGENTINA

**Yamaha Music Latin America, S.A.  
Sucursal de Argentina**  
Viamonte 1145 Piso2-B 1053,  
Buenos Aires, Argentina  
Tel: 1-4371-7021

### PANAMA AND OTHER LATIN AMERICAN COUNTRIES/ CARIBBEAN COUNTRIES

**Yamaha Music Latin America, S.A.**  
Torre Banco General, Piso 7,  
Urbanización Marbella, Calle 47 y Aquilino de la  
Guardia, Ciudad de Panamá, Panamá  
Tel: +507-269-5311

## EUROPE

### THE UNITED KINGDOM

**Yamaha-Kemble Music (U.K.) Ltd.**  
Sherbourne Drive, Tilbrook, Milton Keynes,  
MK7 8BL, England  
Tel: 01908-366700

### GERMANY

**Yamaha Music Central Europe GmbH**  
Siemensstraße 22-34, 25462 Rellingen, Germany  
Tel: 04101-3030

### SWITZERLAND/LIECHTENSTEIN

**Yamaha Music Central Europe GmbH,  
Branch Switzerland**  
Seefeldstrasse 94, 8008 Zürich, Switzerland  
Tel: 01-383 3990

### AUSTRIA

**Yamaha Music Central Europe GmbH,  
Branch Austria**  
Schleiergasse 20, A-1100 Wien, Austria  
Tel: 01-60203900

### CZECH REPUBLIC/SLOVAKIA/ HUNGARY/SLOVENIA

**Yamaha Music Central Europe GmbH,  
Branch Austria, CEE Department**  
Schleiergasse 20, A-1100 Wien, Austria  
Tel: 01-602039025

### POLAND

**Yamaha Music Central Europe GmbH  
Sp.z. o.o. Oddział w Polsce**  
ul. 17 Stycznia 56, PL-02-146 Warszawa, Poland  
Tel: 022-868-07-57

### THE NETHERLANDS/ BELGIUM/LUXEMBOURG

**Yamaha Music Central Europe GmbH,  
Branch Benelux**  
Clarissenhof 5-b, 4133 AB Vianen,  
The Netherlands  
Tel: 0347-358 040

### FRANCE

**Yamaha Musique France**  
BP 70-77312 Marne-la-Vallée Cedex 2, France  
Tel: 01-64-61-4000

### ITALY

**Yamaha Musica Italia S.P.A.  
Combo Division**  
Viale Italia 88, 20020 Lainate (Milano), Italy  
Tel: 02-935-771

### SPAIN/PORTUGAL

**Yamaha-Hazen Música, S.A.**  
Ctra. de la Coruna km. 17, 200, 28230  
Las Rozas (Madrid), Spain  
Tel: 91-639-8888

### SWEDEN

**Yamaha Scandinavia AB**  
J. A. Wettergrens Gata 1  
Box 30053  
S-400 43 Göteborg, Sweden  
Tel: 031 89 34 00

### DENMARK

**YS Copenhagen Liaison Office**  
Generatorvej 6A  
DK-2730 Herlev, Denmark  
Tel: 44 92 49 00

### NORWAY

**Norsk filial av Yamaha Scandinavia AB**  
Grini Næringspark 1  
N-1345 Østerås, Norway  
Tel: 67 16 77 70

### OTHER EUROPEAN COUNTRIES

**Yamaha Music Central Europe GmbH**  
Siemensstraße 22-34, 25462 Rellingen, Germany  
Tel: +49-4101-3030

## AFRICA

**Yamaha Corporation,  
Asia-Pacific Music Marketing Group**  
Nakazawa-cho 10-1, Hamamatsu,  
Japan 430-8650  
Tel: +81-53-460-2313

## MIDDLE EAST

### TURKEY/CYPRUS

**Yamaha Music Central Europe GmbH**  
Siemensstraße 22-34, 25462 Rellingen, Germany  
Tel: 04101-3030

### OTHER COUNTRIES

**Yamaha Music Gulf FZE**  
LB21-128 Jebel Ali Freezone  
P.O.Box 17328, Dubai, U.A.E.  
Tel: +971-4-881-5868

## ASIA

### THE PEOPLE'S REPUBLIC OF CHINA

**Yamaha Music & Electronics (China)  
Co.,Ltd.**  
25/F., United Plaza, 1468 Nanjing Road (West),  
Jingan, Shanghai, China  
Tel: 021-6247-2211

### INDONESIA

**PT. Yamaha Music Indonesia (Distributor)  
PT. Nusantik**  
Gedung Yamaha Music Center, Jalan Jend. Gatot  
Subroto Kav. 4, Jakarta 12930, Indonesia  
Tel: 21-520-2577

### KOREA

**Yamaha Music Korea Ltd.**  
Tong-Yang Securities Bldg. 16F 23-8  
Yoido-dong, Youngdungpo-ku, Seoul, Korea  
Tel: 02-3770-0660

### MALAYSIA

**Yamaha Music Malaysia, Sdn., Bhd.**  
Lot 8, Jalan Perbandaran, 47301 Kelana Jaya,  
Petaling Jaya, Selangor, Malaysia  
Tel: 3-78030900

### SINGAPORE

**Yamaha Music Asia Pte., Ltd.**  
#03-11 A-Z Building  
140 Paya Lebor Road, Singapore 409015  
Tel: 747-4374

### TAIWAN

**Yamaha KHS Music Co., Ltd.**  
3F, #6, Sec.2, Nan Jing E. Rd. Taipei.  
Taiwan 104, R.O.C.  
Tel: 02-2511-8688

### THAILAND

**Siam Music Yamaha Co., Ltd.**  
891/1 Siam Motors Building, 15-16 floor  
Rama 1 road, Wangmai, Pathumwan  
Bangkok 10330, Thailand  
Tel: 02-215-2626

### OTHER ASIAN COUNTRIES

**Yamaha Corporation,  
Asia-Pacific Music Marketing Group**  
Nakazawa-cho 10-1, Hamamatsu,  
Japan 430-8650  
Tel: +81-53-460-2317

## OCEANIA

### AUSTRALIA

**Yamaha Music Australia Pty. Ltd.**  
Level 1, 99 Queensbridge Street, Southbank,  
Victoria 3006, Australia  
Tel: 3-9693-5111

### COUNTRIES AND TRUST TERRITORIES IN PACIFIC OCEAN

**Yamaha Corporation,  
Asia-Pacific Music Marketing Group**  
Nakazawa-cho 10-1, Hamamatsu,  
Japan 430-8650  
Tel: +81-53-460-2313

**HEAD OFFICE** Yamaha Corporation, Pro Audio & Digital Musical Instrument Division  
Nakazawa-cho 10-1, Hamamatsu, Japan 430-8650  
Tel: +81-53-460-2441



Yamaha Pro Audio global web site:  
<http://www.yamahaproaudio.com/>

Yamaha Manual Library  
<http://www.yamaha.co.jp/manual/>

U.R.G., Pro Audio & Digital Musical Instrument Division, Yamaha Corporation  
© 2006 Yamaha Corporation

WH63250|608POAP3.3-01A0  
Printed in China