

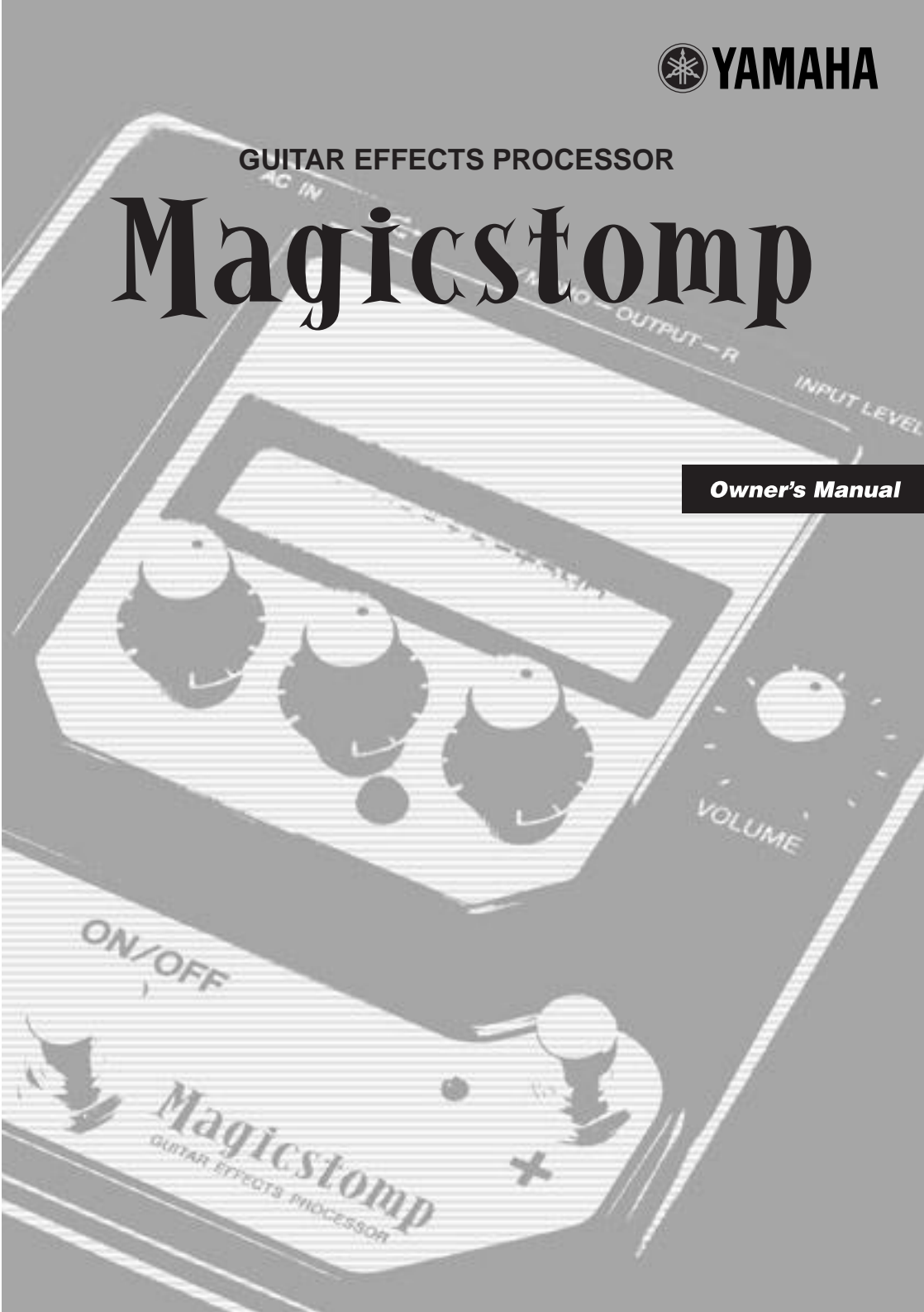

GUITAR EFFECTS PROCESSOR

Magicstomp

Owner's Manual



FCC INFORMATION (U.S.A.)

1. IMPORTANT NOTICE: DO NOT MODIFY THIS UNIT!

This product, when installed as indicated in the instructions contained in this manual, meets FCC requirements. Modifications not expressly approved by Yamaha may void your authority, granted by the FCC, to use the product.

2. IMPORTANT: When connecting this product to accessories and/or another product use only high quality shielded cables. Cable/s supplied with this product **MUST** be used. Follow all installation instructions. Failure to follow instructions could void your FCC authorization to use this product in the USA.

3. NOTE: This product has been tested and found to comply with the requirements listed in FCC Regulations, Part 15 for Class "B" digital devices. Compliance with these requirements provides a reasonable level of assurance that your use of this product in a residential environment will not result in harmful interference with other electronic devices. This equipment generates/uses radio frequencies and, if not installed and used according to the instructions found in the users manual, may cause interference harmful to the operation of other electronic devices. Compliance with FCC regulations does

not guarantee that interference will not occur in all installations. If this product is found to be the source of interference, which can be determined by turning the unit "OFF" and "ON", please try to eliminate the problem by using one of the following measures:

Relocate either this product or the device that is being affected by the interference.

Utilize power outlets that are on different branch (circuit breaker or fuse) circuits or install AC line filter/s.

In the case of radio or TV interference, relocate/reorient the antenna. If the antenna lead-in is 300 ohm ribbon lead, change the lead-in to coaxial type cable.

If these corrective measures do not produce satisfactory results, please contact the local retailer authorized to distribute this type of product. If you can not locate the appropriate retailer, please contact Yamaha Corporation of America, Electronic Service Division, 6600 Orangethorpe Ave, Buena Park, CA90620

The above statements apply **ONLY** to those products distributed by Yamaha Corporation of America or its subsidiaries.

* This applies only to products distributed by YAMAHA CORPORATION OF AMERICA.

CANADA

This Class B digital apparatus complies with Canadian ICES-003.

Cet appareil numérique de la classe B est conforme à la norme NMB-003 du Canada.

- This applies only to products distributed by Yamaha Canada Music Ltd.
- Ceci ne s'applique qu'aux produits distribués par Yamaha Canada Musique Ltée.



The exclamation point within the equilateral triangle is intended to alert the user to the presence of important operating and maintenance (servicing) instructions in the literature accompanying the product.



The lightning flash with arrowhead symbol, within the equilateral triangle, is intended to alert the user to the presence of uninsulated "dangerous voltage" within the product's enclosure that may be of sufficient magnitude to constitute a risk of electrical shock.

IMPORTANT SAFETY INSTRUCTIONS

INFORMATION RELATING TO PERSONAL INJURY, ELECTRICAL SHOCK, AND FIRE HAZARD POSSIBILITIES HAS BEEN INCLUDED IN THIS LIST.

WARNING- When using any electrical or electronic product, basic precautions should always be followed. These precautions include, but are not limited to, the following:

1. Read all Safety Instructions, Installation Instructions, Special Message Section items, and any Assembly Instructions found in this manual BEFORE making any connections, including connection to the main supply.

2. Do not attempt to service this product beyond that described in the user-maintenance instructions. All other servicing should be referred to qualified service personnel.

3. Main Power Supply Verification: Yamaha products are manufactured specifically for the supply voltage in the area where they are to be sold. If you should move, or if any doubt exists about the supply voltage in your area, please contact your dealer for supply voltage verification and (if applicable) instructions. The required supply voltage is printed on the name plate. For name plate location, please refer to the graphic found in the Special Message Section of this manual.

4. WARNING: Do not place this product or any other objects on the power cord or place it in a position where anyone could walk on, trip over, or roll anything over power or connecting cords of any kind. The use of an extension cord is not recommended! If you must use an extension cord, the minimum wire size for a 25' cord (or less) is 18 AWG. NOTE: The smaller the AWG number, the larger the current handling capacity. For longer extension cords, consult a local electrician.

5. Ventilation: Electronic products, unless specifically designed for enclosed installations, should be placed in locations that do not interfere with proper ventilation. If instructions for enclosed installations are not provided, it must be assumed that unobstructed ventilation is required.

6. Temperature considerations: Electronic products should be installed in locations that do not seriously contribute to their operating temperature. Placement of this product close to heat sources such as; radiators, heat registers etc., should be avoided.

7. This product was NOT designed for use in wet/damp locations and should not be used near water or exposed to rain. Examples of wet /damp locations are; near a swimming pool, spa, tub, sink, or wet basement.

8. This product should be used only with the components supplied or; a cart, rack, or stand that is recommended by the manufacturer. If a cart, rack, or stand is used, please observe all safety markings and instructions that accompany the accessory product.

9. The power supply cord (plug) should be disconnected from the outlet when electronic products are to be left unused for extended periods of time. Cords should also be disconnected when there is a high probability of lightning and/or electrical storm activity.

10. Care should be taken that objects do not fall and liquids are not spilled into the enclosure through any openings that may exist.

11. Electrical/electronic products should be serviced by a qualified service person when:

- The power supply cord has been damaged; or
- Objects have fallen, been inserted, or liquids have been spilled into the enclosure through openings; or
- The product has been exposed to rain; or
- The product does not operate, exhibits a marked change in performance; or
- The product has been dropped, or the enclosure of the product has been damaged.

12. This product, either alone or in combination with an amplifier and headphones or speaker/s, may be capable of producing sound levels that could cause permanent hearing loss. DO NOT operate for a long period of time at a high volume level or at a level that is uncomfortable. If you experience any hearing loss or ringing in the ears, you should consult an audiologist.

IMPORTANT: The louder the sound, the shorter the time period before damage occurs.

13. Some Yamaha products may have benches and/or accessory mounting fixtures that are either supplied as a part of the product or as optional accessories. Some of these items are designed to be dealer assembled or installed. Please make sure that benches are stable and any optional fixtures (where applicable) are well secured BEFORE using. Benches supplied by Yamaha are designed for seating only. No other uses are recommended.

PLEASE KEEP THIS MANUAL

Magicstomp

Owner's Manual

*Thank you for purchasing the Yamaha MAGICSTOMP.
To get the most out of this product, we urge you to thoroughly
read this manual before use. Also, please keep the manual in a
safe place for future reference.*

Contents

Precautions	6
Package Contents	6
MAGICSTOMP's Main Features	7
Component Names & Functions	8
Top Panel	8
Rear Panel	8
Connections	10
Using the MAGICSTOMP	12
Turn on the amplifier and play	12
Try out some of the other patches	12
Create your own sound	14
Use the knobs to adjust the effect	14
Saving Patches	16
Storing edited patches (STORE)	16
Giving the patch a name	18
Giving the patch a name (Name Edit Mode)	18
Tuner Mode	20
Using the tuner	20
Factory Set (Restore Factory Defaults)	21
Restoring the factory defaults	21
Editing Patches with a Computer	22
Data Flow	23
Using the Sound Editor for MAGICSTOMP	23
For Windows Users	24
For Macintosh Users	26
Error Messages	28
Trouble Shooting	28
Specifications	29
SOFTWARE LICENSING AGREEMENT	30

Precautions

- Avoid using the MAGICSTOMP in the following locations to prevent possible damage:
 - In direct sunlight or next to heating equipment.
 - In extremely cold or hot locations.
 - Locations exposed to high humidity or excessive dust.
 - Locations subject to strong shocks or vibration.
- Before making any connections, make sure that the power is switched OFF on the MAGICSTOMP and any external devices.
- To protect speakers from possible damage, always set the VOLUME knob to "0" before switching the power ON/OFF.
- When connecting any devices to this unit, make sure that the power is switched OFF first.
- Do not apply excessive force to the switches, knobs and controls.
- The MAGICSTOMP is a precision device. Handle it with care and avoid dropping or jarring it.
- For safety, always remove the power adaptor from the AC wall outlet if there is any danger of lightning striking in your area.
- Keep the MAGICSTOMP away from neon signs or fluorescent lighting to prevent noise pickup.
- To prevent damage and possibly electrical shock, never open the case and tamper with the internal circuitry.
- Never use benzene, thinner or other volatile liquids for cleaning, as these chemicals may cause damage or discoloration to the finish. Always use a dry, soft cloth to wipe off dust and dirt.

Package Contents

The following items are included in the MAGICSTOMP package. Check to see that you have everything listed here.

- MAGICSTOMP 1
- CD-ROM 1
- Power Adaptor * 1
- USB Cable 1
- Owner's Manual (this booklet) 1
- Patch List 1

* May not be included depending on your particular area. Please check with your Yamaha dealer.

CAUTION

- **Before breaking the seal on the CD-ROM package, please carefully read the "Software Licensing Agreement" on page 30.**
- **Never attempt to play back the included CD-ROM on an audio CD player. Doing so may result in damage to your hearing as well as to your CD player/audio speakers.**

MAGICSTOMP's Main Features

[Harnessing the power of Yamaha's DSP technology]

- The MAGICSTOMP utilizes a powerful 32-bit DSP designed by Yamaha to deliver amp simulations and effects from the DG series amplifiers and DG, AG, and UD-Stomp effects. It also produces a variety of digital effects derived from the Yamaha SPX series with unprecedented audio quality and function.

[New algorithms deliver stunning effects and powerful amplifier simulations for guitarists]

- New "Distortion & Amp type" effect creates a variety of sounds from overdrive to powerful fuzz effects.
- New algorithms created by VCM (Virtual Circuitry Modeling) technology delivers vintage type phaser and flanger effects.

[Professional quality preset tone patches make the MAGICSTOMP ready to use out of the box]

- Close collaboration with artists from around the world have produced a variety of ready to use, professional quality effects.
<<99 On-board preset patches + CD-ROM patch library>>
<<99 User patches allow editing and storing>>

[Feels and operates like a compact effector]

- Simple design and controls (4 knobs, 3 footswitches) provide guitarists with a familiar operating environment. Operation is simple and straightforward to provide quick sound creation.

[Upload new patch data via USB]

- Patches supplied on the accompanying CD-ROM or downloaded from the internet can be uploaded into the MAGICSTOMP via the USB cable. You can also store customized sound patches in your computer.

[Create custom effects on your computer with dedicated software based patch editor]

- Use the supplied USB cable to connect the MAGICSTOMP to your computer, then use the accompanying "Sound Editor For MAGICSTOMP" application to edit the effects parameters and set parameters that can be controlled with the MAGICSTOMP's three control knobs. Create your own custom patches to make your own MAGICSTOMP.

[Built-in chromatic auto tuner]

- The MAGICSTOMP also includes a built-in chromatic auto tuner, which is extremely useful in live performances and recording.

Component Names & Functions

■ Top Panel

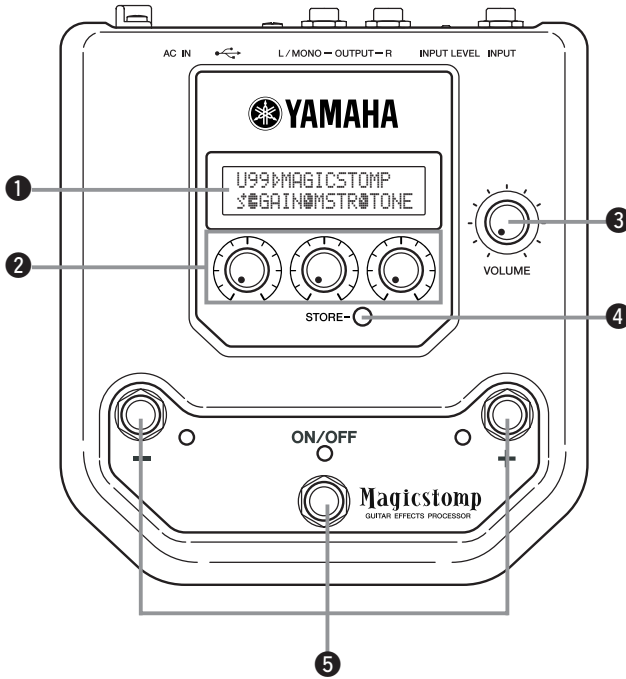

■ Rear Panel

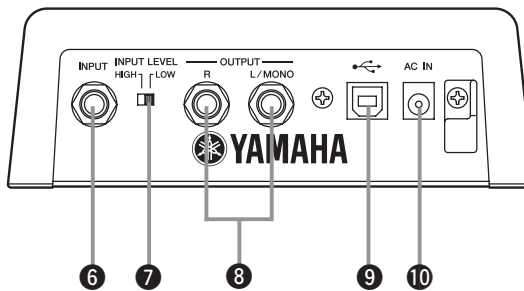

1 Display

Displays information for the currently selected patch or operating conditions of the MAGICSTOMP.

2 CONTROL Knobs

These are used to control patch parameters. (→ page 14)

3 VOLUME Knob

Controls the overall output volume of the MAGICSTOMP. (→ page 12)

4 STORE Button

This button is used to store patches that have been edited in the MAGICSTOMP. (→ page 16)

5 – Switch, + Switch, ON/OFF Switch

These switches select patches, switch the patch ON or OFF, or switch modes. (→ page 12, 13, 18, 20)

6 INPUT Jack

For connecting an instrument such as a guitar, synthesizer, etc., to the MAGICSTOMP. (→ page 11)

7 INPUT LEVEL HIGH/LOW Switch

Selects HIGH or LOW impedance to match the input level with the output level of the instrument connected to the INPUT jack. (→ page 11)

8 OUTPUT L/MONO, R Jacks

For connecting the MAGICSTOMP to a guitar amplifier, recorder, PA mixer, etc. Use the L/MONO jack when connecting to monaural devices. (→ page 11)

9 USB Jack

For connecting the MAGICSTOMP to a computer. This lets you edit patch voices on the computer or move patch data between the computer and the MAGICSTOMP. (→ page 23)

10 AC IN Jack (Power Adaptor)

Connect the power adaptor to this jack. (→ page 10)

** Power is switched ON when the power adaptor is connected (and supplying power) to the main unit.*

Connections

CAUTION

- In order to prevent electric shock or damage to your equipment, turn OFF the power on the guitar amp, etc., and set the MAGICSTOMP's volume to its minimum level before making any connections.
- Use ONLY a Yamaha AC-10 Power Adaptor (or other adaptor specifically recommended by Yamaha).
Using another adaptor may result in damage, overheating or fire, which can be very dangerous.
- Make sure to use the recommended AC voltage as indicated on the power adaptor.

- The MAGICSTOMP automatically switches "ON" when power is connected and supplied to the device.
- Connect a guitar, bass or any line level instrument such as a synthesizer, etc., to the INPUT jack. The MAGICSTOMP can also be connected to the effect loop of an amplifier, mixer, or other similar device.
- Set the INPUT LEVEL switch to match the output level of the instrument or device that is connected to the MAGICSTOMP. If the sound is distorted when the switch is set to the HIGH position, change the setting to LOW. If you feel output is low when the switch is set to the LOW position, change the setting to HIGH.
- When using patches with stereo output, we recommend connecting the MAGICSTOMP's output jacks to a stereo device.
- When connecting to a monaural device, use the OUTPUT L/MONO jack.
- When connecting the power adaptor to the MAGICSTOMP's AC IN jack, you can wrap the power adaptor cord around the cord hook as shown in the illustration below (this helps keeping the plug from being accidentally pulled out).

CAUTION

- Don't let the cord bend sharply or kink when wrapping the cord around the hook. An excessive bend can cut the cord or start a fire.

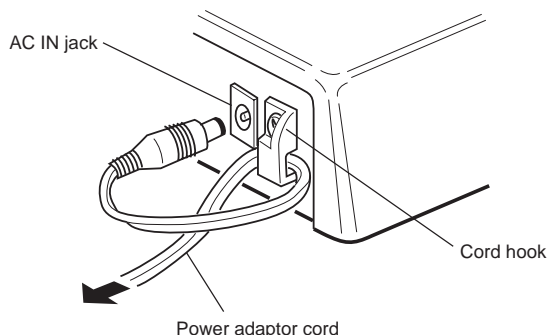

● Using the MAGICSTOMP with a guitar or other instrument

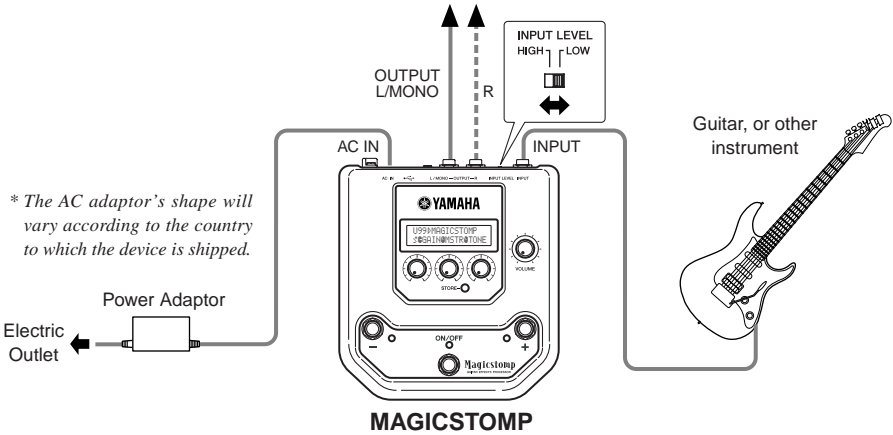
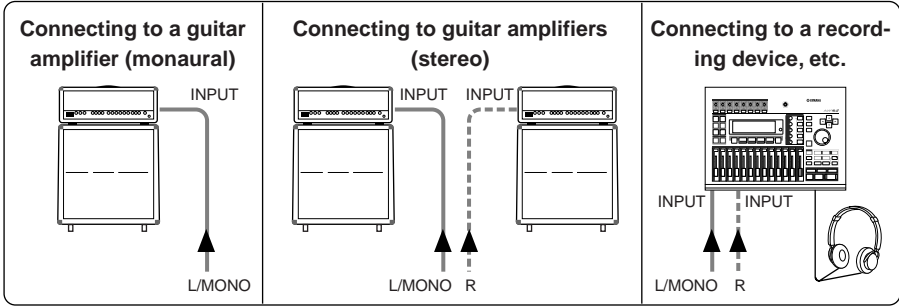

● Using the MAGICSTOMP in an effect loop

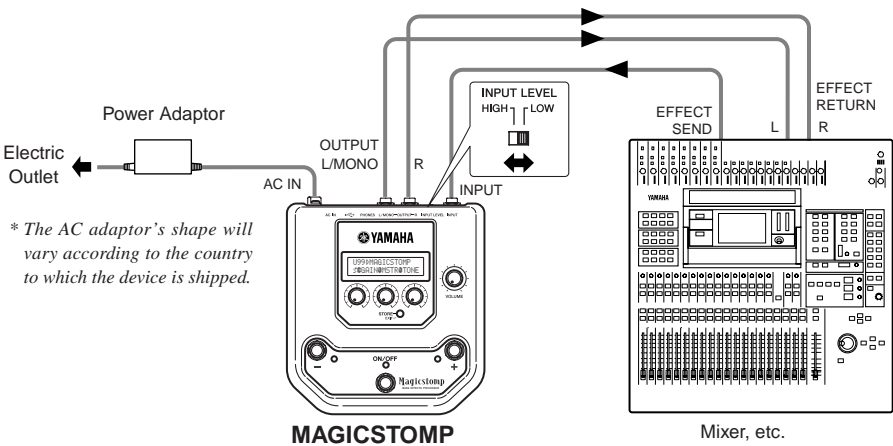

Using the MAGICSTOMP

The MAGICSTOMP comes loaded with a variety of effect patches (programmed effects). First, give some of the presets a try and see what's available.

■ Turn on the amplifier and play

You'll hear the currently selected patch.

Use the MAGICSTOMP's VOLUME knob to adjust the MAGICSTOMP's output volume.

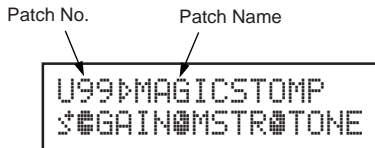

■ Try out some of the other patches

The MAGICSTOMP has a total of 198 patches. 99 of those are User Patches (U01 – U99) to which you can save (overwrite) data of patches that you have created. The other 99 are Preset Patches (P01 – P99) which can not be overwritten with new data. You can however, edit the Preset Patches and save them in the User Patch section.

** When shipped from the factory, the MAGICSTOMP's User Patch section contains the same data as found in the Preset Patches.*

● Two ways to select patches

When the MAGICSTOMP is shipped from the factory, its [UP/DOWN MODE] is already set for the patch selection mode. In this mode, just press the + switch to move to the next greater patch number, and press the – switch to move to the next lesser patch number. Hold either switch down and the patch numbers will quickly cycle up or down in order.

In this mode, the ON/OFF switch is used to switch the patch (effect) on or off.

Pressing the – switch decreases the patch number by 1

Pressing the + switch increases the patch number by 1

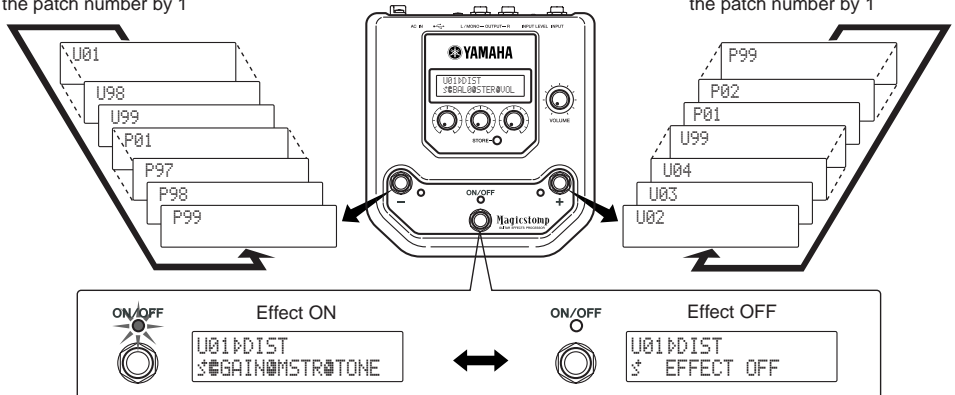

The other way to select patches is with the **[Performance Mode]**.

In this mode, the **-**, **+**, and **ON/OFF** switches are used to turn three adjacent patches ON and OFF.

① To enter the Performance Mode, press and hold any two switches (from **-, **+**, and **ON/OFF**).**

“PERFORMANCE MODE” appears in the display to inform you that the MAGICSTOMP is now in the Performance Mode.

② Press and hold the **- or **+** switch to change the patch set.**

- switch: U01/02/03→P97/98/99→P94/95/96→...

+ switch: U01/02/03→U04/05/06→U07/08/09→...

* Patch sets (three adjacent patches make a patch set) have been predetermined. (U01, U02, U03), (U04, U05, U06) (U97, U98, U99), (P01, P02, P03) (P97, P98, P99).

* When the MAGICSTOMP switches to the Performance Mode, the patch set containing the patch number selected with the Up/Down Mode is selected.

③ To return to the UP/DOWN Mode, press and hold any two switches (from **-, **+**, and **ON/OFF**).**

“UP/DOWN MODE” appears in the display to inform you that the MAGICSTOMP is now in the Up/Down Mode.

Example) Switching from the Up/Down Mode (patch U06 is selected) to the Performance Mode.

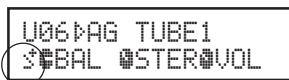

Up/Down Mode

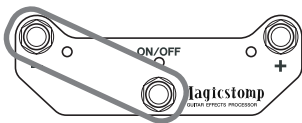

Press and hold any two of the three switches

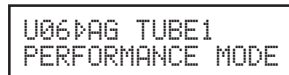

Performance Mode

When in the Performance Mode, the lamp of the currently selected patch lights (U05 is selected in the illustration below).

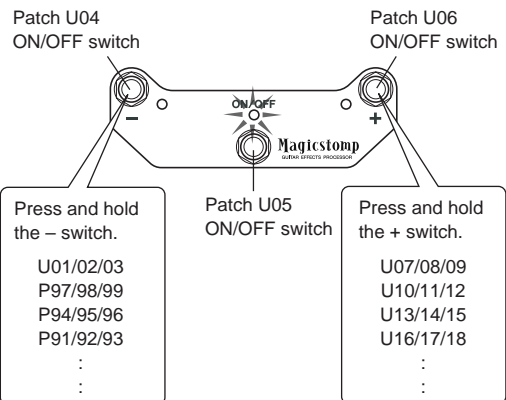

When all three patches are switched OFF, the display appears as follows (all lamps are off).

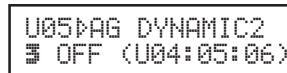

Create your own sound

■ Use the knobs to adjust the effect

The three knobs located below the display let you adjust different characteristics of the effect.

The parameters that these knobs adjust, differ according to the selected patch.

The name of the parameters that these knobs adjust, and the relative knob position of each of the parameters are shown on the lower half of the display.

In the example shown below, the following parameter names and knob values are shown starting with the left knob.

DRIV (Drive): 8.9, MSTR (Master): 4.0, TONE: 2.8

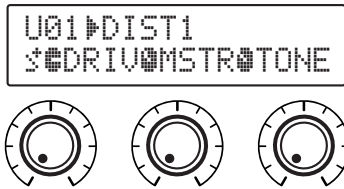

When the knob's position does not match the value for the selected parameter, you'll need to rotate the knob until it matches the position that corresponds to the parameter value before you can change the setting.

Let's rotate the DRIV knob. Before rotating the knob, its parameter name is shown in the display.

[Fig. 1]

When the knob is rotated, the set value (8.9) is indicated in the display, and will not change until you rotate the knob past the 3 o'clock position. **[Fig. 2]**



[Fig. 1]

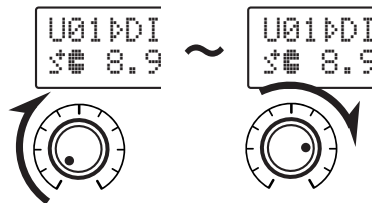

[Fig. 2]

After you rotate the knob past the 3 o'clock position, the actual value that corresponds to the knob's position is indicated in the display. Also, the ▷ mark to the right of the patch number will change to ▸ to indicate that the parameter's value has changed. **[Fig. 3]**

Once the parameter's value has been changed, the value shown in the display will reflect the position of the knob. **[Fig. 4]**

If the knob is not moved for a few seconds, the value display will return to the parameter name display.

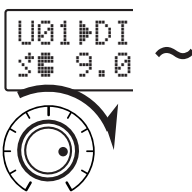

[Fig. 3]

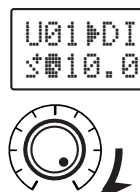

[Fig. 4]

OK, now try and edit a patch to your liking.

** Parameters for the patch(effect) can only be adjusted when the MAGICSTOMP is in its normal operating mode (when a patch is selected and the effect is switched "ON"). Parameters can not be adjusted if the effect is switched "OFF" or when the MAGICSTOMP is in the Store Mode (→page 16), Name Edit Mode (→page 18) or Tuner Mode (→page 20).*

Information on the parameters can be found in the PDF file in the accompanying CD-ROM. Look in the (Macintosh only: [International] folder →) [Manual] folder → and get the [EffectListE.pdf]. This list offers descriptions on each of the effect parameters.

** Acrobat Reader is required to view the PDF file on your computer. (→page 25, 27)*

Could you make something you like?

If you did, you can use the store operation described in the next section to save your settings in the MAGICSTOMP.

If you select another patch before carrying out the store operation, or disconnect the power, all changes you made will be lost and the data will return to its original condition.

Inside the accompanying CD-ROM, you'll find an editing application called "Sound Editor for MAGICSTOMP" that lets you use a computer to edit the patches (effects) in the MAGICSTOMP.

The MAGICSTOMP has a total of 63 different effect types, that each utilize a variety of parameters in addition to the three that can be controlled with the MAGICSTOMP's three control knobs. With the Sound Editor you can change any of the effect's parameters as you like, to create elaborate effects. You can also assign any parameters you like to the MAGICSTOMP's three control knobs.

The Sound Editor also lets you use the patch library that is included in the accompanying CD-ROM and store patches you have created with your computer, in the MAGICSTOMP.

We also recommend that you use the "Sound Editor for MAGICSTOMP" to gain a greater understanding of how the MAGICSTOMP works. Refer to page 22 for more information.

Saving Patches

■ Storing edited patches (STORE)

The MAGICSTOMP lets you store your original patches in its User Patch memory (U01-U99). After creating a patch you like, use the following procedure to store the patch.

* Patches can not be stored in the Preset Patch memory (P01-P99).

* The volume knob's setting is not stored with patch data.

The store operation takes your edited data and writes it to the destination patch number that you've selected, overwriting the old patch data with the new. Depending upon your needs, either overwrite the original patch with new data, or select another patch number to store the new data to.

● To rewrite (overwrite) the original patch with new data

① After you're done editing, press the [STORE] button.

"PRESS[STORE]1sec" appears in the lower half of the display.

The destination patch number to which the patch will be stored, and the patch name (under which the data will be stored) appears on the upper half of the display.

* If the [STORE] button is pressed when a Preset Patch is currently selected, the corresponding User Patch number is automatically selected as the destination patch number for storing.



② You can also give the patch a new name.

To change the name of the patch, follow steps ② through ④ described on page 18.

③ Press and hold the [STORE] button (about 1 second) until "NOW STORING..." appears on the display.



* To cancel the store operation, press and quickly release the [STORE] button (within 1 second) and the MAGICSTOMP returns to its original condition (the changed patch name returns to its original name).

To store the data to the file's original patch number (overwrite) and with the same patch name, press and hold the [STORE] button for more than 1 second to execute the store operation after you're done editing.

* This store procedure can not be used when editing a Preset Patch. You must first assign a User Patch number as the destination patch number before executing the store operation.

● Saving the data to a different patch number

- ① After you're done editing, press the [STORE] button.



- ② Select the patch number to which you want to save the data.

Use the - or + switches to select the destination patch number to which you want to save your data.

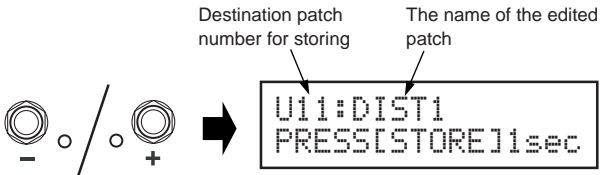

- ③ You can also give the patch a new name.

To change the name of the patch, follow steps ② through ④ described on page 18.

- ④ Press and hold the [STORE] button (about 1 second) until “NOW STORING...” appears on the display.



**To cancel the store operation, press and quickly release the [STORE] button (within 1 second) and the MAGICSTOMP returns to its original condition (the changed patch name returns to its original name).*

In additions to creating and storing new patches, you can use the store operation to put patches in the same order that you use them in performance making selection while playing quick and convenient.

Giving the patch a name

■ Giving the patch a name (Name Edit Mode)

You can use up to 12 characters when making a name for a User Patch.

* Names of Preset Patches (P01-P99) can not be changed.

① Press the [STORE] button.

“PRESS[STORE]1sec” appears in the lower half of the display.



② Press and hold the ON/OFF switch until “NAME EDIT MODE” appears on the display.

The cursor appears below the first character of the patch name.

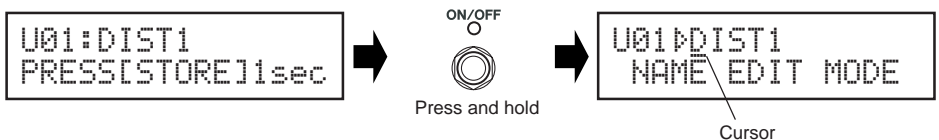

③ Move the cursor to change characters.

Use the – and + switches to move the cursor to the character you want to change, then use the three knobs to select the character.

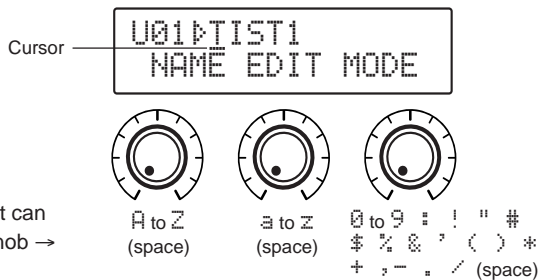

The characters that can be set with each knob →

- Moves the cursor to the left (←)
- Press simultaneously with the [STORE] button to delete the character selected with the cursor.

* Holding down the switch (and button) repeats the same operation continuously.



- Moves the cursor to the right (→)
- Press simultaneously with the [STORE] button to insert a space where the cursor is.

* Holding down the switch (and button) repeats the same operation continuously.

Giving the patch a name

Up to 12 characters can be used in a patch name.

** Only 11 characters are displayed when the USB connection is used.*

④ After you've changed the name, press the ON/OFF switch.

The MAGICSTOMP is now in store standby mode.



⑤ Press and hold the [STORE] button (about 1 second) until “NOW STORING...” appears in the display.

The new patch name is stored with the patch.

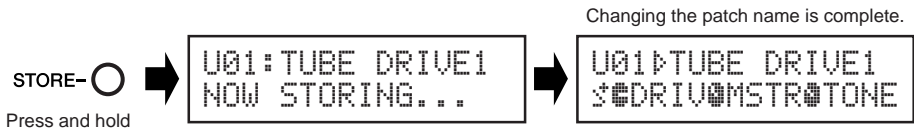

** To cancel the patch name edit operation, press and quickly release the [STORE] button (within 1 second) and the MAGICSTOMP returns to its original condition (the patch name returns to its original name).*

Tuner Mode

This mode is used for tuning your guitar. In the Tuner Mode, the MAGICSTOMP functions as a chromatic tuner.

** The MAGICSTOMP's OUTPUT jack is muted (no sound output) when the MAGICSTOMP is in the Tuner Mode.*

■ Using the tuner

1 Press and hold the ON/OFF switch until the tuner display (shown below) appears on the display.

With your guitar connected to the INPUT jack, use the display to tune your guitar.

** The Tuner Mode is not available during the store operation.*

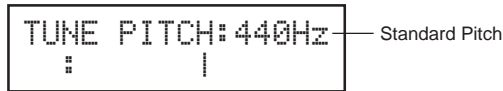

2 If you want to use a standard pitch other than 440Hz, use the – or + switches.

The standard pitch can be set anywhere between 438Hz and 445Hz in the MAGICSTOMP.

3 Play the string you want to tune (play a single tone).

1. First, tune the guitar until the name of the note you want to tune to appears on the display.
2. When the string's pitch is low, > mark will be displayed and the – switch's lamp will be lit. When the string's pitch is high, < mark will be displayed and the + switch's lamp will be lit. The string's pitch is in tune when ">|<" appears in the display and the ON/OFF switch's lamp is lit.

4 Press the ON/OFF switch to return to the original display.

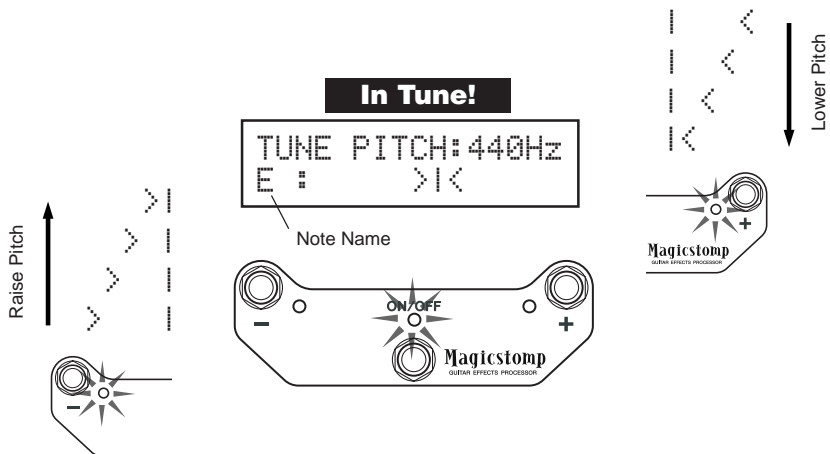

Factory Set (Restore Factory Defaults)

■ Restoring the factory defaults

Hold down both the ON/OFF switch and [STORE] button then plug in the power adaptor connected to the unit, and "FACTORY SET" will appear in the display.

A rectangular LCD display showing the text "FACTORY SET" on the first line and "NO: [-] YES: [+]" on the second line.

Press the + switch and the display will ask for your confirmation.

** Pressing the – switch cancels the Factory Set operation and the MAGICSTOMP will start normal operation.*

A rectangular LCD display showing the text "FACTORY SET" on the first line and "SURE?PUSH[STORE]" on the second line.

Press the [STORE] button to execute the Factory Set operation. All settings in the User Patch memory will be overwritten with factory default settings, which are the same as the Preset Patches.

** Press either the –, + or ON/OFF switch to cancel the factory set operation, and the MAGICSTOMP will start normal operation.*

When you restore the factory default settings, all data for the current settings in the User Patch memory will be lost. We recommend that you make a note of, or back up to a computer, any important data or settings.

Editing Patches with a Computer

In the CD-ROM that came with your MAGICSTOMP you'll find some patch files (**library file format**) that contain patches other than those found in the MAGICSTOMP's Preset Patches (P01-P99). You can select any of the patches you like from the library and transfer them to the MAGICSTOMP's User Patches (U01-U99).

Also found in the accompanying CD-ROM is the **"Sound Editor for MAGICSTOMP"** application that lets you use your computer to edit those parameters that can not be edited with the MAGICSTOMP's control knobs, to create your own original patches.

Using the application is easy. Launch the "Sound Editor for MAGICSTOMP" application and select a patch library in the library window, then click to open the editor window in which you can edit all of the selected effect's parameters. On the computer's display you can set the patch type (effect type), patch name, and assign parameters that can be controlled with the MAGICSTOMP's control knobs. After editing the patch, it can be transferred to the MAGICSTOMP's the User Patch memory.

Library Window

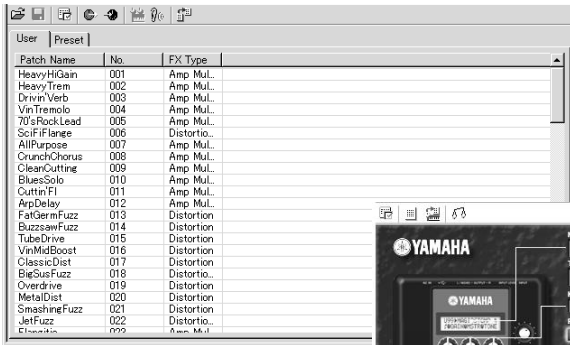

Edit Window



■ Data Flow

- Use the supplied USB cable to connect the USB jack on your computer (Windows or Macintosh) to the MAGICSTOMP's USB jack.
- The “Sound Editor for MAGICSTOMP” application found in the accompanying CD-ROM can be used to edit MAGICSTOMP patches or transfer patch data between the MAGICSTOMP and your computer. This application can also be used to write patch data files found in the CD-ROM to the MAGICSTOMP.
- Also included in the CD-ROM are “USB-MIDI Driver” and “OMS” (required for Macintosh computers only) applications which are needed to allow communication between your computer and the MAGICSTOMP.

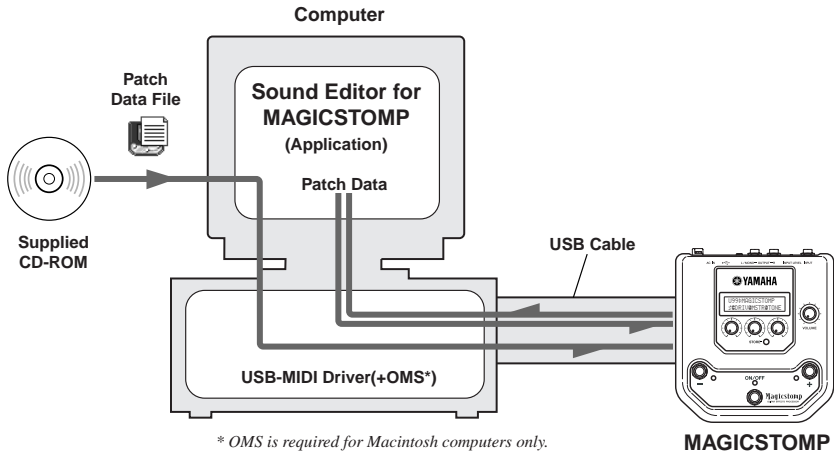

■ Using the Sound Editor for MAGICSTOMP

Before breaking the seal on the CD-ROM package, please carefully read the “Software Licensing Agreement” on page 30. After you’ve read agreement follow the steps described below to install and use the application.

1. **Make sure the your computer meets the operating requirements of the Sound Editor for MAGICSTOMP and driver applications. (Windows → page 24, Macintosh → page 26)**
2. **The CD-ROM also includes the Sound Editor for MAGICSTOMP Owner’s Manual and Installation Guide for the supplied drivers, plus the MAGICSTOMP Effect List all in PDF file format. To view these files you’ll need Acrobat Reader installed on your computer. If it isn’t already installed on your computer, install the Acrobat Reader application from the accompanying CD-ROM. (Windows → page 25, Macintosh → page 27)**

** The three PDF files described above are found in the [Manual] folder in the accompanying CD-ROM.*

For Windows Users

● Contents of the CD-ROM

Folder Name	Application Name	Contents
ACROREAD	Acrobat Reader *1*2	Enables you to view each application's PDF file.
Manual	PDF Manuals (for J: 3 files, for E: 3 files) • SoundEditor_J.pdf / SoundEditor_E.pdf • InstallGuide_J.pdf / InstallGuide_E.pdf • EffectList_J.pdf / EffectList_E.pdf	Sound Editor for MAGICSTOMP Owner's Manual Installation Guide for softwares for MAGICSTOMP MAGICSTOMP Effect List
USBdrv_	YAMAHA USB MIDI driver (for Win98/Me)	Driver needed when connecting the MAGICSTOMP to the computer with a USB cable.
USBdrv2K_	YAMAHA USB MIDI driver (for Win2000/XP)	
Tools	Sound Editor for MAGICSTOMP *1	Enables you to edit MAGICSTOMP patch data on your computer.
Sample	Patch Library	MAGICSTOMP patch files. These patches can be transferred to the MAGICSTOMP using the "Sound Editor for MAGICSTOMP".

*1 These applications are supplied with online/PDF manuals.

*2 Unfortunately, Yamaha makes no guarantee concerning the stability of these programs nor can it offer user support for them.

● Minimum System Requirements

The system requirements below may differ slightly depending on the particular operating system.

• Sound Editor for MAGICSTOMP

OS: Windows 98/Me/2000/XP Home Edition/XP Professional
Computer: 166 MHz or higher; Intel Pentium/Celeron processor
Available Memory: 32 MB or more
Hard Disk: 30 MB or more
Display: 800 x 600 or more, High Color (16 bit)

• USB MIDI Driver

OS: Windows 98/Me/2000/XP Home Edition/XP Professional
Computer: 166 MHz or higher; Intel Pentium/Celeron processor
Available Memory: 32 MB or more (64 MB or more is recommended)
Hard Disk: 2 MB or more

● Installing Acrobat Reader

PDF files (**E.pdf) for the Sound Editor for MAGICSTOMP Owner's Manual and installation guides for the accompanying application or drivers, plus the MAGICSTOMP Effect List are all found in the accompanying CD-ROM → "Manual" folder.

In order to view these PDF files, you'll need to install Acrobat Reader. Follow the steps described below to install "Acrobat Reader".

** Acrobat Reader (English and Japanese) is included in the accompanying CD-ROM. If a different language version of Acrobat Reader is already installed in your computer, use that version to view the files.*

1 In the accompanying CD-ROM, double click on the "Acroread" folder.
The file "ar***enu.exe" appears (** indicates the version number).

2 Double-click on "ar***enu.exe."
Acrobat Reader Setup Dialog box will be displayed.

3 Execute the installation by following the on-screen directions.

After installation is complete, the Acrobat folder appears on your PC (in Program Files, as the default).

For information on using the Acrobat Reader, refer to the Reader Guide in the Help menu.

For Macintosh Users

● Contents of the CD-ROM (“International” folder)

**The “Japanese” folder contains the Japanese version of the software.*

Folder Name	Application Name	Contents
ACROREAD	Acrobat Reader *1*2	Enables you to view each application’s PDF file.
Manual	PDF Manuals (3 files) • SoundEditor_E.pdf • InstallGuide_E.pdf • EffectList_E.pdf	Sound Editor for MAGICSTOMP Owner’s Manual Installation Guide for softwares for MAGICSTOMP MAGICSTOMP Effect List
OMS	Open Music System (OMS) 2.3.8 *1*2	Enables you to run MIDI applications on the MAC OS.
	USB-MAGICSTOMP (in theThe “OMS Setup for YAMAHA” folder)	MAGICSTOMP’s OMS setup file.
USBdrv_	YAMAHA USB MIDI driver	Driver needed when connecting the MAGICSTOMP to the computer with a USB cable.
Tools	Sound Editor for MAGICSTOMP *1	Enables you to edit MAGICSTOMP patch data on your computer.
Sample	Patch Library	MAGICSTOMP patch files. These patches can be transferred to the MAGICSTOMP using the “Sound Editor for MAGICSTOMP”.

*1 These applications are supplied with online/PDF manuals.

*2 Unfortunately, Yamaha makes no guarantee concerning the stability of these programs nor can it offer user support for them.

● Minimum System Requirements

The system requirements below may differ slightly depending on the particular operating system.

● Sound Editor for MAGICSTOMP

OS:	Mac OS 8.6 through Mac OS 9.22 (The Mac OS X and Mac Classic environments are not supported)
Computer:	A Macintosh computer with a PowerPC or later CPU
Available Memory:	16 MB or more
Hard Disk:	32 MB or more
Display:	800 x 600, 32,000 colors or more

● USB MIDI Driver

OS:	Mac OS 8.5 through Mac OS 9.22 (The Mac OS X and Mac Classic environments are not supported)
Computer:	A Macintosh computer with a USB connector and a PowerPC or later CPU
Memory:	64 MB or more (128 MB or more is recommended) * Turn off virtual memory.
Hard disk:	2 MB or more
Other:	OMS 2.3.8 (included in the CD-ROM in the package)

● Installing Acrobat Reader

PDF files (**E.pdf) for the Sound Editor for MAGICSTOMP Owner's Manual and installation guides for the accompanying application or drivers, plus the MAGICSTOMP Effect List are all found in the accompanying CD-ROM → "International" folder → "Manual" folder.

In order to view these PDF files, you'll need to install Acrobat Reader. Follow the steps described below to install "Acrobat Reader".

** Installation is not required if you already have Acrobat Reader installed on your computer.*

** Acrobat Reader (English and Japanese) is included in the accompanying CD-ROM. If a different language version of Acrobat Reader is already installed in your computer, use that version to view the files.*

1 In the accompanying CD-ROM, double click on the "International" folder → "Acroread" folder. "Acrobat Reader Installer" appears.

2 Double-click on "Acrobat Reader Installer."
Acrobat Reader Setup Dialog box will be displayed.

3 Execute the installation by following the on-screen directions.

After installation is complete, the Acrobat folder appears on your PC (in Hard Disk, as the default).

For information on using the Acrobat Reader, refer to the Reader Guide in the Help menu.

Error Messages

One of the following messages may appear in the MAGICSTOMP's display if an error occurs during operation. If so, please stop operation and check the following points to find a solution to the problem.

BAD DATA:U**
PUSH ANY KEY

The data being bulk transmitted is damaged. After restoring (overwrite, store, etc.) the user patch data that corresponds to the patch number, try transmitting the data again.

MIDI ERROR!
PUSH ANY KEY

An error occurred while transmitting data. Check the USB cable connection, computer settings, etc.

BULK ERROR!
PUSH ANY KEY

An error occurred while transmitting or receiving bulk data. Check the USB cable connection. Also, if the error occurs about halfway through the operation, setting the interval speed to a slower setting sometimes solves the problem.

USB ERROR!
PUSH ANY KEY

The hardware is damaged. Please contact the dealer from whom you purchased the product.

Trouble Shooting

• No Sound

- Is the power adapter properly connected?
- Is the volume control on the instrument connected to the INPUT jack turned up?
- Is the volume knob set to "0"?
- Is the effect's output level set to "0"?

• Sound level is low

- Switch the input level to the "HIGH" position. (→ P.10)

• Effect is not active

- Is the effect's output level set to "0"?
- Is the effect switched OFF (all lamps are off)?

• Can not change to another patch

- Check the display. If the MAGICSTOMP is in its Tuner Mode (→P.20) or Name Edit Mode (→P.18) you can not change to another patch.

• Adjusting the control knob has no effect on the sound

- Rotate the knob until the value shown on the display changes, and then try setting. (→P.14)

Specifications

Digital Section

- Digital signal processing effector
- Includes special editor application "Sound Editor for MAGICSTOMP"
- Patch Select: 2 Modes
- Built-in Chromatic Auto Tuner

Communications

Receive: Parameter Change, Bulk In (1 patch), Bulk In (99 patch)
Transmit: Bulk Out (99 patch)

Controller/Switch

Knob x4
CONTROL1, 2, 3, VOLUME

Push Switch x4
-, +, ON/OFF, STORE

Slide Switch x1
INPUT LEVEL (HIGH/LOW)

Display

16 x 2 character LCD (w/Back light)
LED x 3 (-, +, ON/OFF)

Connections

INPUT: Standard Monaural Phone Jack
OUTPUT L/MONO, R: Standard Monaural Phone Jack
USB
AC IN

A/D Converter

24 bit + 3 bit Floating

D/A Converter

24 bit

Sampling Frequency

44.1 kHz

Memory Allocations

Preset: 99
User: 99

Input Level/Impedance

INPUT HIGH: -25dBm/1 M Ω
INPUT LOW : -15dBm/1 M Ω

Output Level/Impedance

OUTPUT L/MONO, R: 0dBm/1 k Ω

Power

Power Adaptor
AC Output: AC 12 V, 1 A

Power Consumption

12 W

Dimensions (W x H x D)

164 x 62 x 176 mm
(6-7/16" x 2-7/16" x 6-15/16")

Weight

910 g (2lbs.)

Accessories

AC-10 power adaptor (included or optional depending on local)
CD-ROM
USB Cable
Owner's Manual (this booklet)
Patch List

** Specifications and design may change without notice.*

SOFTWARE LICENSING AGREEMENT

The following is a legal agreement between you, the end user, and Yamaha Corporation ("Yamaha"). The enclosed Yamaha software program is licensed by Yamaha to the original purchaser for use only on the terms set forth herein. Please read this licensing agreement with care. Opening this package indicates that you accept all terms outlined herein. If you do not agree to the terms, return this package unopened to Yamaha for a full refund.

1. GRANT OF LICENSE AND COPYRIGHT

Yamaha grants you, the original purchaser, the right to use one copy of the enclosed software program and data ("SOFTWARE") on a single-user computer system. You may not use it on more than one computer or computer terminal. The SOFTWARE is owned by Yamaha and is protected by Japanese copyright laws and all applicable international treaty provisions. You are entitled to claim ownership of the media in which the SOFTWARE is included. Therefore, you must treat the SOFTWARE like any other copyrighted materials.

2. RESTRICTIONS

The SOFTWARE program is copyrighted. You may not engage in reverse engineering or reproduction of the SOFTWARE by other conceivable methods. You may not reproduce, modify, change, rent, lease, resell, or distribute the SOFTWARE in whole or in part, or create derivative works from the SOFTWARE. You may not transmit or network the SOFTWARE with other computers. You may transfer ownership of the SOFTWARE and the accompanying written materials on a permanent basis provided that you retain no copies and the recipient agrees to the terms of the licensing agreement.

3. TERMINATION

The licensing condition of the software program becomes effective on the day that you receive the SOFTWARE. If any one of the copyright laws or clauses of the licensing conditions is violated, the licensing agreement shall be terminated automatically without notice from Yamaha. In this case, you must destroy the licensed SOFTWARE and its copies immediately.

4. PRODUCT WARRANTY

Yamaha warrants to the original purchaser that if the SOFTWARE, when used in normal conditions, will not perform the functions described in the manual provided by Yamaha, the sole remedy will be that Yamaha will replace any media which proves defective in materials or workmanship on an exchange basis without charge. Except as expressly set forth above, the SOFTWARE is provided "as is," and no other warranties, either expressed or implied, are made with respect to this software, including, without limitation the implied warranties of merchantability and fitness for a particular purpose.

5. LIMITED LIABILITY

Your sole remedies and Yamaha's entire liability are as set forth above. In no event will Yamaha be liable to you or any other person for any damages, including without limitation any incidental or consequential damages, expenses, lost profits, lost savings or other damages arising out of the use or inability to use such SOFTWARE even if Yamaha or an authorized dealer has been advised of the possibility of such damages, or for any claim by any other party.

6. GENERAL

This license agreement shall be interpreted according to and governed by Japanese laws.

