

OWNER'S MANUAL

MUSIC PRODUCTION SYNTHESIZER
Integrated Sampling Sequencer / RealTime External Control Surface / Studio Connections

MOTIF XS6

MOTIF XS7

MOTIF XS8

MOTIF XS



SPECIAL MESSAGE SECTION

PRODUCT SAFETY MARKINGS: Yamaha electronic products may have either labels similar to the graphics shown below or molded/stamped facsimiles of these graphics on the enclosure. The explanation of these graphics appears on this page. Please observe all cautions indicated on this page and those indicated in the safety instruction section.

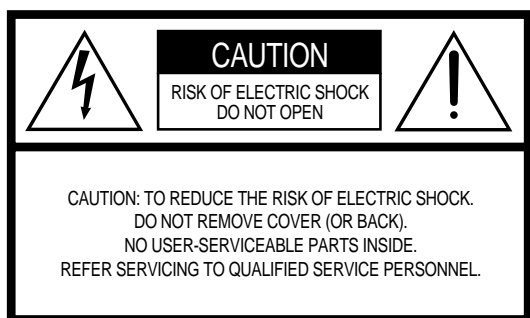

The exclamation point within the equilateral triangle is intended to alert the user to the presence of important operating and maintenance (servicing) instructions in the literature accompanying the product.

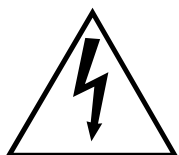

The lightning flash with arrowhead symbol, within the equilateral triangle, is intended to alert the user to the presence of uninsulated "dangerous voltage" within the product's enclosure that may be of sufficient magnitude to constitute a risk of electrical shock.

IMPORTANT NOTICE: All Yamaha electronic products are tested and approved by an independent safety testing laboratory in order that you may be sure that when it is properly installed and used in its normal and customary manner, all foreseeable risks have been eliminated. DO NOT modify this unit or commission others to do so unless specifically authorized by Yamaha. Product performance and/or safety standards may be diminished. Claims filed under the expressed warranty may be denied if the unit is/has been modified. Implied warranties may also be affected.

SPECIFICATIONS SUBJECT TO CHANGE: The information contained in this manual is believed to be correct at the time of printing. However, Yamaha reserves the right to change or modify any of the specifications without notice or obligation to update existing units.

ENVIRONMENTAL ISSUES: Yamaha strives to produce products that are both user safe and environmentally friendly. We sincerely believe that our products and the production methods used to produce them, meet these goals. In keeping with both the letter and the spirit of the law, we want you to be aware of the following:

Battery Notice: This product MAY contain a small non-rechargeable battery which (if applicable) is soldered in place. The average life span of this type of battery is approximately five years. When replacement becomes necessary, contact a qualified service representative to perform the replacement.

Warning: Do not attempt to recharge, disassemble, or incinerate this type of battery. Keep all batteries away from children. Dispose of used batteries promptly and as regulated by applicable laws. Note: In some areas, the servicer is required by law to return the defective parts. However, you do have the option of having the servicer dispose of these parts for you.

Disposal Notice: Should this product become damaged beyond repair, or for some reason its useful life is considered to be at an end, please observe all local, state, and federal regulations that relate to the disposal of products that contain lead, batteries, plastics, etc.

NOTICE: Service charges incurred due to lack of knowledge relating to how a function or effect works (when the unit is operating as designed) are not covered by the manufacturer's warranty, and are therefore the owners responsibility. Please study this manual carefully and consult your dealer before requesting service.

NAME PLATE LOCATION: The graphic below indicates the location of the name plate. The model number, serial number, power requirements, etc., are located on this plate. You should record the model number, serial number, and the date of purchase in the spaces provided below and retain this manual as a permanent record of your purchase.

MOTIF XS6

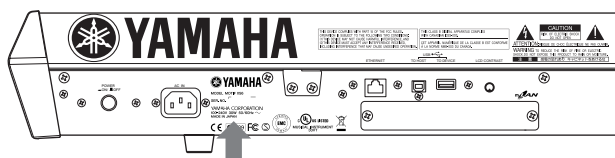

MOTIF XS7

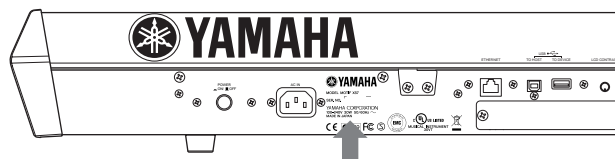

MOTIF XS8

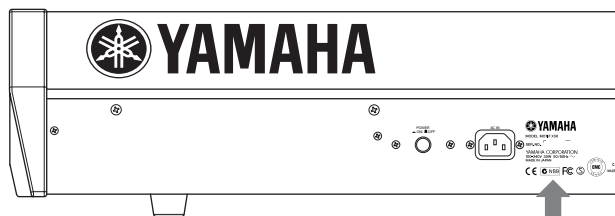

Model _____

Serial No. _____

Purchase Date _____

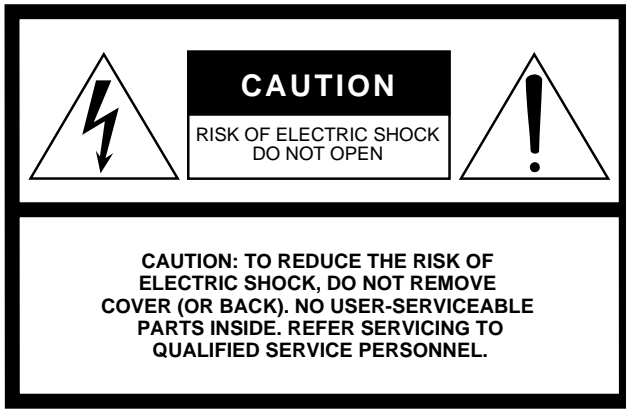

Explanation of Graphical Symbols

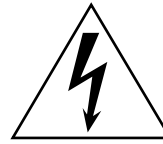

The lightning flash with arrowhead symbol within an equilateral triangle is intended to alert the user to the presence of uninsulated “dangerous voltage” within the product’s enclosure that may be of sufficient magnitude to constitute a risk of electric shock to persons.



The exclamation point within an equilateral triangle is intended to alert the user to the presence of important operating and maintenance (servicing) instructions in the literature accompanying the product.

The above warning is located on the rear of the unit.

IMPORTANT SAFETY INSTRUCTIONS

- 1 Read these instructions.
- 2 Keep these instructions.
- 3 Heed all warnings.
- 4 Follow all instructions.
- 5 Do not use this apparatus near water.
- 6 Clean only with dry cloth.
- 7 Do not block any ventilation openings. Install in accordance with the manufacturer’s instructions.
- 8 Do not install near any heat sources such as radiators, heat registers, stoves, or other apparatus (including amplifiers) that produce heat.
- 9 Do not defeat the safety purpose of the polarized or grounding-type plug. A polarized plug has two blades with one wider than the other. A grounding type plug has two blades and a third grounding prong. The wide blade or the third prong are provided for your safety. If the provided plug does not fit into your outlet, consult an electrician for replacement of the obsolete outlet.
- 10 Protect the power cord from being walked on or pinched particularly at plugs, convenience receptacles, and the point where they exit from the apparatus.
- 11 Only use attachments/accessories specified by the manufacturer.
- 12 Use only with the cart, stand, tripod, bracket, or table specified by the manufacturer, or sold with the apparatus. When a cart is used, use caution when moving the cart/apparatus combination to avoid injury from tip-over.
- 13 Unplug this apparatus during lightning storms or when unused for long periods of time.
- 14 Refer all servicing to qualified service personnel. Servicing is required when the apparatus has been damaged in any way, such as power-supply cord or plug is damaged, liquid has been spilled or objects have fallen into the apparatus, the apparatus has been exposed to rain or moisture, does not operate normally, or has been dropped.



WARNING

TO REDUCE THE RISK OF FIRE OR ELECTRIC SHOCK, DO NOT EXPOSE THIS APPARATUS TO RAIN OR MOISTURE.

(98-6500)

PRECAUTIONS

PLEASE READ CAREFULLY BEFORE PROCEEDING

* Please keep this manual in a safe place for future reference.



WARNING

Always follow the basic precautions listed below to avoid the possibility of serious injury or even death from electrical shock, short-circuiting, damages, fire or other hazards. These precautions include, but are not limited to, the following:

Power supply/Power cord

- Only use the voltage specified as correct for the instrument. The required voltage is printed on the name plate of the instrument.
- Check the electric plug periodically and remove any dirt or dust which may have accumulated on it.
- Use only the supplied power cord/plug.
- Do not place the power cord near heat sources such as heaters or radiators, and do not excessively bend or otherwise damage the cord, place heavy objects on it, or place it in a position where anyone could walk on, trip over, or roll anything over it.
- Be sure to connect to an appropriate outlet with a protective grounding connection. Improper grounding can result in electrical shock.

Do not open

- This instrument contains no user-serviceable parts. Do not attempt to disassemble or modify the internal components in any way.

Water warning

- Do not expose the instrument to rain, use it near water or in damp or wet conditions, or place containers on it containing liquids which might spill into any openings.
- Never insert or remove an electric plug with wet hands.

Fire warning

- Do not put burning items, such as candles, on the unit.
A burning item may fall over and cause a fire.

If you notice any abnormality

- If the power cord or plug becomes frayed or damaged, or if there is a sudden loss of sound during use of the instrument, or if any unusual smells or smoke should appear to be caused by it, immediately turn off the power switch, disconnect the electric plug from the outlet, and have the instrument inspected by qualified Yamaha service personnel.



CAUTION

Always follow the basic precautions listed below to avoid the possibility of physical injury to you or others, or damage to the instrument or other property. These precautions include, but are not limited to, the following:

Power supply/Power cord

- Always connect the three-pin attachment plug to a properly grounded power source. (For more information about the main power supply, see page 19.)
- When removing the electric plug from the instrument or an outlet, always hold the plug itself and not the cord. Pulling by the cord can damage it.
- Remove the electric plug from the outlet when the instrument is not to be used for extended periods of time, or during electrical storms.
- Do not connect the instrument to an electrical outlet using a multiple-connector. Doing so can result in lower sound quality, or possibly cause overheating in the outlet.

Location

- Do not expose the instrument to excessive dust or vibrations, or extreme cold or heat (such as in direct sunlight, near a heater, or in a car during the day) to prevent the possibility of panel disfiguration or damage to the internal components.
- Do not use the instrument in the vicinity of a TV, radio, stereo equipment, mobile phone, or other electric devices. Otherwise, the instrument, TV, or radio may generate noise.
- Do not place the instrument in an unstable position where it might accidentally fall over.
- Before moving the instrument, remove all connected cables.
- When setting up the product, make sure that the AC outlet you are using is easily accessible. If some trouble or malfunction occurs, immediately turn off the power switch and disconnect the plug from the outlet. Even when the power switch is turned off, electricity is still flowing to the product at the minimum level. When you are not using the product for a long time, make sure to unplug the power cord from the wall AC outlet.

Connections

- Before connecting the instrument to other electronic components, turn off the power for all components. Before turning the power on or off for all components, set all volume levels to minimum. Also, be sure to set the volumes of all components at their minimum levels and gradually raise the volume controls while playing the instrument to set the desired listening level.

Maintenance

- When cleaning the instrument, use a soft, dry cloth. Do not use paint thinners, solvents, cleaning fluids, or chemical-impregnated wiping cloths.

Handling caution

- Do not insert a finger or hand in any gaps on the instrument.
- Never insert or drop paper, metallic, or other objects into the gaps on the panel or keyboard. If this happens, turn off the power immediately and unplug the power cord from the AC outlet. Then have the instrument inspected by qualified Yamaha service personnel.
- Do not place vinyl, plastic or rubber objects on the instrument, since this might discolor the panel or keyboard.
- Do not rest your weight on, or place heavy objects on the instrument, and do not use excessive force on the buttons, switches or connectors.
- Do not use the instrument/device or headphones for a long period of time at a high or uncomfortable volume level, since this can cause permanent hearing loss. If you experience any hearing loss or ringing in the ears, consult a physician.

Saving data

Saving and backing up your data

- DRAM data (see page 79) is lost when you turn off the power to the instrument. Save the data to the flash ROM/a USB storage device/external device such as a computer.
Data stored to the flash ROM may be lost due to malfunction or incorrect operation. Save important data to a USB storage device/external device such as a computer.
- Never attempt to turn off the power while data is being written to Flash ROM (while an "Executing..." or "Please keep power on" message is shown). Turning the power off in this state results in loss of all user data and may cause the system to freeze (due to corruption of data in the Flash ROM). This means that this synthesizer may not be able to start up properly, even when turning the power on next time.

Backing up the USB storage device/external media

- To protect against data loss through media damage, we recommend that you save your important data onto two USB storage devices/external media.

Yamaha cannot be held responsible for damage caused by improper use or modifications to the instrument, or data that is lost or destroyed.

Always turn the power off when the instrument is not in use.

About the latest Firmware Version

Yamaha may from time to time update firmware of the product and the accessory application software without notice for improvement. We recommend that you check our web site for later releases and upgrade your firmware of the MOTIF XS or the accessory application software.

<http://www.yamahasyth.com/>

Note that the explanations in this Owner's Manual apply to the version of firmware when this Owner's Manual was produced. For details about the additional functions due to later releases, refer to the above website.

Introduction

Congratulations and thank you for your purchase of the Yamaha MOTIF XS6/MOTIF XS7/MOTIF XS8 Music Production Synthesizer! You now own what is perhaps the best-sounding, most versatile, and certainly most powerful synthesizer and total music production instrument on the planet. We strove to put virtually all our synthesizer technology and music making know-how into one instrument—and we succeeded. The new MOTIF XS not only gives you the latest and greatest sounds and rhythms (as well as the ability to create and sample your own), it gives you powerful, easy-to-use tools for playing, combining and controlling these dynamic sounds/rhythms—in real time, as you perform!

Take time to look through this manual carefully. It's packed with important information on how to get the most from this amazing instrument. Dive in now and enjoy!

How to use the manual

The documentation for MOTIF XS consists of the following booklets.

■ Owner's Manual (this book)

Start Guide (page 19)

This tutorial section gives you a guided tour through the various functions of this instrument, and provides important hands-on experience in playing and using it.

Using a Computer (page 43)

In this section, we'll show you how set up the instrument with a computer (via USB and mLAN) and how to use it with software programs such as the MOTIF XS Editor and Cubase.

Basic Section

- **Basic Structure (page 54)**
This section provides a detailed overview of all of the main functions and features of this instrument, and shows how they fit together.
- **Basic Operation (page 81)**
This section introduces you to the basic operating conventions of this instrument, such as editing values and changing settings.
- **Connections (page 83)**
This section covers how to connect the MOTIF XS to various external devices such as MIDI instruments, computers and USB storage devices.

Reference (page 88)

This is the MOTIF XS encyclopedia. Here, all parameters, settings, functions, features, modes and operations are explained in full detail.

Appendix (page 286)

This section contains detailed information about this instrument, including Specifications and Alert Messages, as well as instructions for installing optional equipment (e.g., DIMM modules and the mLAN16E2 interface).

- **Troubleshooting (page 288)**

If this instrument does not function as expected or you have some problem with the sound or operation, refer to this section before calling your Yamaha dealer or service center. Most common problems and their solutions are covered here in a very simple and easy-to-understand way.

■ Data List (separate booklet)

This contains various important lists such as the Voice List, Waveform List, Effect List, MIDI Data Format, and MIDI Implementation Chart.

■ Data List 2 (separate online documentation)

This contains various lists such as the Performance List, Master Program List, Mixing Template List, Arpeggio Type List and Remote Control Function List. This special online documentation can be downloaded from the Manual Library site.

<http://www.yamaha.co.jp/manual/>

Accessories

AC Power cord

Owner's manual (this book)

Data List

Disc x 1 (containing DAW software)*

* For details, see page 305.

SPECIAL NOTICE

- The contents of this Owner's Manual and the copyrights thereof are under exclusive ownership by Yamaha Corporation.
- The illustrations and LCD screens as shown in this owner's manual are for instructional purposes only, and may appear somewhat different from those on your instrument.
- This product incorporates and bundles computer programs and contents in which Yamaha owns copyrights or with respect to which it has license to use others' copyrights. Such copyrighted materials include, without limitation, all computer software, style files, MIDI files, WAVE data, musical scores and sound recordings. Any unauthorized use of such programs and contents outside of personal use is not permitted under relevant laws. Any violation of copyright has legal consequences. DON'T MAKE, DISTRIBUTE OR USE ILLEGAL COPIES.
- This device is capable of using various types/formats of music data by optimizing them to the proper format music data for use with the device in

advance. As a result, this device may not play them back precisely as their producers or composers originally intended.

- Copying of the commercially available musical data including but not limited to MIDI data and/or audio data is strictly prohibited except for your personal use.
- Windows is the registered trademark of Microsoft® Corporation.
- Apple and Macintosh are trademarks of Apple Computer, Inc., registered in the U.S. and other countries.
- Steinberg and Cubase are the registered trademarks of Steinberg Media Technologies GmbH.
- ETHERNET is the registered trademark of Xerox Corporation.
- The company names and product names in this Owner's Manual are the trademarks or registered trademarks of their respective companies.

Main Features

■ Responsive, expressive keyboard (page 12)

The MOTIF XS6 features a 61-key keyboard, while the MOTIF XS7 has 76 keys with the high-quality FSX keyboard and the MOTIF XS8 has 88 keys with the high-quality BH (Balanced Hammer) keyboard. All are equipped with a touch response feature (both initial touch and aftertouch). These allow you to expressively change the sound in various ways—initial touch by the strength with which you play the keys, and aftertouch by how strongly you press the keys when holding them down.

■ Wide Variety of Voices and Category Search Function (page 24)

The MOTIF XS features a huge number and wide range of dynamic, authentic Voices. Use the Category Search function to quickly call up the Voices you want, based on their instrument type.

■ Eight Elements for each Voice (page 56)

Each Normal Voice can contain up to eight separate sound Elements, enabling Voices of great complexity and rich texture. These Elements can also be controlled in real time—by using the panel sliders, the [ASSIGNABLE FUNCTION] buttons, or by the way you play the keyboard. Special “Mega Voices” are also available, letting you recreate the unique performance sounds of acoustic instruments.

■ Powerful Arpeggio feature with four different types (pages 24 and 62)

Arpeggio automatically plays a variety of sequenced phrases in response to the keys you play. This function is especially powerful with Drum Voices—letting you easily call up various rhythm patterns at the touch of a key, and providing instant inspiration for song creation and performance. With Normal Voices, Arpeggio changes harmonically according to the chords you play, helping you as you compose or perform. Up to four Arpeggios can be running simultaneously, and of course, in perfect sync. Velocity control, Accent Phrase and Random SFX features—as well as the eight panel Knobs—give you even greater expressive, realtime control over Arpeggio playback.

■ Performance consisting of up to four Voices (page 28)

Performance mode lets you use four different Voices together—in layers or in a keyboard split. Moreover, the MOTIF XS gives you comprehensive control over the Performance in real time, as you play—letting quickly select Parts, turn Parts on/off, turn Arpeggio playback on/off, and more. You can also record your Performance in this mode directly to the Song or Pattern tracks by pressing the [REC] button.

■ Integrated Sampling Sequencer—seamlessly combines audio and MIDI recording (pages 39, 161 and 242)

The MOTIF XS provides full Sample recording and editing features, plus sample memory (with optional DIMM modules). Wide data compatibility lets you load AIFF and WAV files, as well as samples and program/voice data from other popular samplers, such as the Yamaha A-series.

Adding to the flexibility is a powerful Slice feature that automatically chops up your rhythms and riffs into their individual beats and notes. This lets you manipulate the component parts of your sample loops as MIDI data, and gives you the power to easily change tempo and even the rhythmic feel, without disturbing the pitch or sound quality.

■ Loop Remix (page 175)

This feature divides the data (Audio sample as well as MIDI sequence data) in a specified track to a variety of note lengths, and randomly rearranges a portion of the data to create totally new variations.

■ Extensive Effect Processing (page 68)

The MOTIF XS gives you a wide array of signal processing options, including separate Reverb and Chorus, an overall Master Effect, including multi-band compression, five-band master EQ, and a total of eight independent Insertion Effects. The latter include a huge variety of effects, plus a special Vocoder feature.

■ Eight Knobs and Sliders (pages 26, 34, 90 and 136)

Comprehensive real-time control with eight knobs and eight sliders let you change the Voice in real time, adjust Mixing of the Song/Pattern, and control DAW software (such as Cubase) on your computer.

■ Pattern mode—for creating a Song (page 208)

Pattern mode functions let you craft different rhythmic sections and riffs as individual elements—which you can easily and intuitively combine in real time to create full rhythm tracks. The Sections you create can be combined together in Pattern Chains, and these Chains can be conveniently converted to Song data.

■ Song Scene and Mixing Voice—for creating a Song (pages 179 and 230)

Song Scene is another powerful tool that lets you take “snapshots” of the sequencer track settings (such as pan, volume, track mute and so on). Then, during playback or recording, simply switch among the Scenes for instant, dynamic changes.

In addition to being able to create User Voices in the Voice mode, you can create special Mixing Voices for Songs and Patterns, letting you customize Voices specifically for your Song/Pattern recordings.

■ Master mode—for live performance (page 251)

The Master mode lets you use the MOTIF XS as a master keyboard controller (with independent Zones), and easily reconfigure the instrument between Voice/Performance play and Song/Pattern play in live applications.

■ Equipped with a variety of connectors (pages 16, 17 and 18)

A full rear panel of input/output connections provides maximum interfacing flexibility. These include Assignable Outputs, A/D Inputs, Digital Output, MIDI, Ethernet, mLAN (standard on the MOTIF XS8 and optionally available for the MOTIF XS6/7) and two USB connectors.

■ Computer connectivity (page 43)

The comprehensive set of connectors—Ethernet, mLAN and USB TO HOST—make interfacing with computers and your favorite software exceptionally easy. In particular, the new Ethernet connection gives you fast transfer of your MOTIF XS files to and from a computer on the same network.

■ Quick Setup for using a computer (page 270)

This function lets you instantly reconfigure the MOTIF XS for different computer/sequencer related applications by calling up specially programmed presets.

■ Editor software for the MOTIF XS (page 50)

The instrument is also compatible with the MOTIF XS Editor—a comprehensive, easy-to-use editing software program that lets you edit (via USB connection) the Mixing setups and Mixing Voices to be used for Song/Pattern playback. The MOTIF XS Editor is free and can be downloaded from the Yamaha website.

■ Integration with Cubase (page 49)

The MOTIF XS is specially designed to work seamlessly with Cubase, Steinberg’s full-featured DAW software—giving you a comprehensive, all-in-one music production system, in which hardware and software are fully integrated.

Contents

Introduction	6
How to use the manual.....	6
Accessories.....	6
Main Features.....	7
The Controls & Connectors	10
Front Panel	10
Rear Panel.....	16
Start Guide	19
Step 1: Setting Up.....	19
Power Supply	19
Connecting speakers or headphones.....	19
Turning the power on	19
Adjusting the sound and the display contrast	20
Playing the sounds.....	20
Selecting and playing the sounds.....	20
Modes	20
Listening to the Demo Song.....	21
Resetting the User Memory to the Initial Factory Settings.....	22
Step 2: Selecting and Playing a Voice	23
Selecting a Voice	23
Voice Play mode indications	23
Selecting a Drum Voice.....	23
Using the Category Search function	24
Playing the Arpeggio.....	24
Changing the Arpeggio type.....	25
Using the Controllers.....	25
Using the Knobs.....	26
Adjusting the tuning to other instruments	27
Transpose	27
Step 3: Selecting and Playing a Performance.....	28
Selecting a Performance.....	28
Performance Play mode indications	28
How Voices are assigned to Parts of a Performance.....	28
Creating a Performance by combining Voices	29
Changing the Arpeggio settings for each Part	30
Using the Controllers and Knobs	31
Recording your Performance	31
Step 4: Creating Your Original Song	33
Terminology.....	33
Song Playback	33
Preparing for Realtime Recording.....	34
Start Recording!	35
Correcting wrong notes.....	35
Creating a swing feel—Play Effect.....	36
Storing the created Song	36
Saving Song data to a USB storage device.....	36
Step 5: Creating a Pattern.....	37
Pattern Structure	37
Listening to the Demo Patterns	37
Viewing the Demo Pattern's Patch display	38
Viewing the Demo Pattern's Mixing display	38
Creating a Pattern by using Arpeggio	39
Creating a Pattern with audio—Sampling.....	39
Storing the Pattern and Saving the Sample	42

Using a Computer	43
Connecting to a Computer	43
Creating a Song by Using a Computer	47
Integration Between Yamaha Editors and Cubase	49
Controlling a DAW on Your Computer from the MOTIF XS	51
Basic Section	54
Basic Structure	54
Mode Structure	54
The Seven Functional Blocks.....	55
Tone Generator Block.....	56
Sampling Block.....	59
Audio Input block.....	59
Sequencer Block	59
Arpeggio Block.....	62
Controller Block	67
Effect Block.....	68
About MIDI	76
Internal Memory	79
Basic Operation	81
Connections	83
Connecting External MIDI Instruments	83
Connecting to an MTR (Multi-track Recorder).....	84
Using USB storage devices.....	85
Network connection	86
Reference	88
Playing the Keyboard in the Voice Play Mode	88
Editing a Normal Voice.....	96
Editing a Drum Voice	127
Voice Job—Convenient Functions.....	133
Playing in the Performance Mode	135
Editing a Performance	141
Performance Job—Convenient Functions	159
Creating a Voice/Performance by Using the Sampling Function	161
Song Playback.....	178
Song Recording	186
Editing MIDI Events (Song Edit)	192
Song Job.....	195
Pattern Playback	208
Pattern Recording	218
Editing MIDI Events (Pattern Edit).....	220
Pattern Jobs	222
Multi-timbral Tone Generator Settings for Song/Pattern Playback (Mixing mode).....	229
Audio Recording to Song/Pattern (Sampling mode)	242
Using as a Master Keyboard (Master mode)	251
System Settings (Utility mode, etc.).....	259
File Management (File mode).....	272
Appendix	286
Display Messages	286
Troubleshooting.....	288
Installing Optional Hardware	293
Specifications.....	297
Index.....	299
About the accessory disk.....	305

The Controls & Connectors

Front Panel

MOTIF XS6

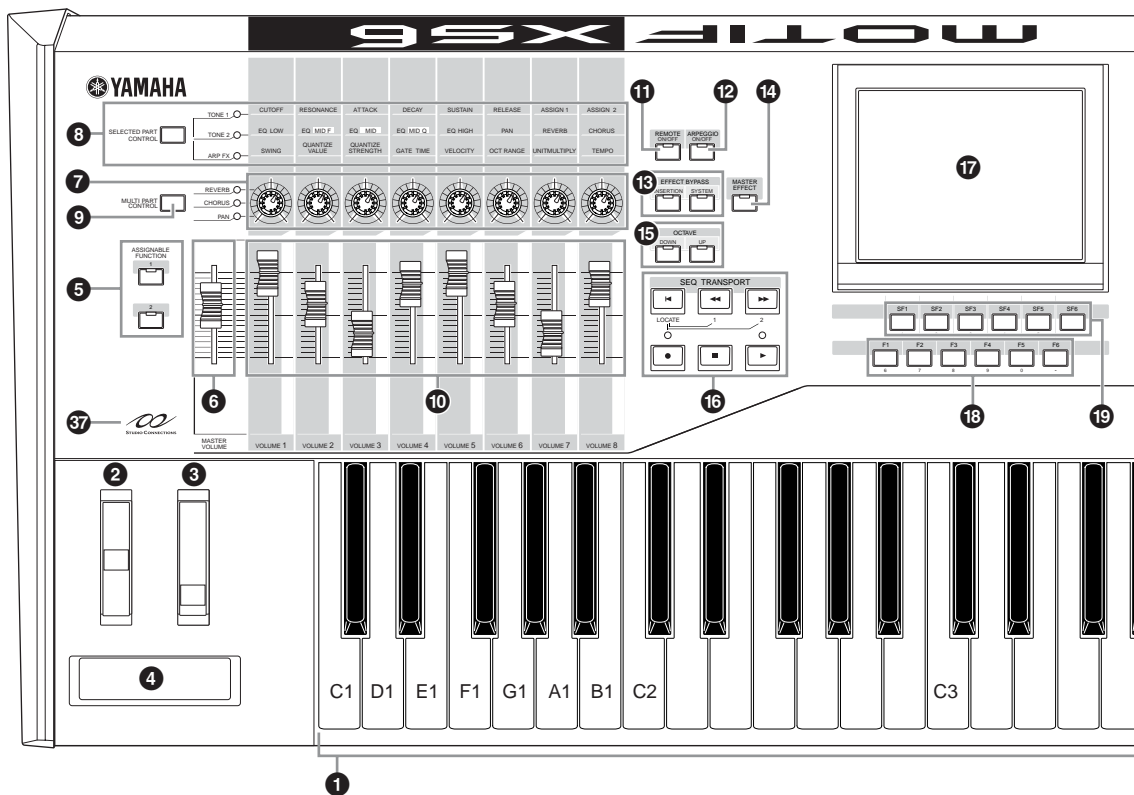

MOTIF XS7

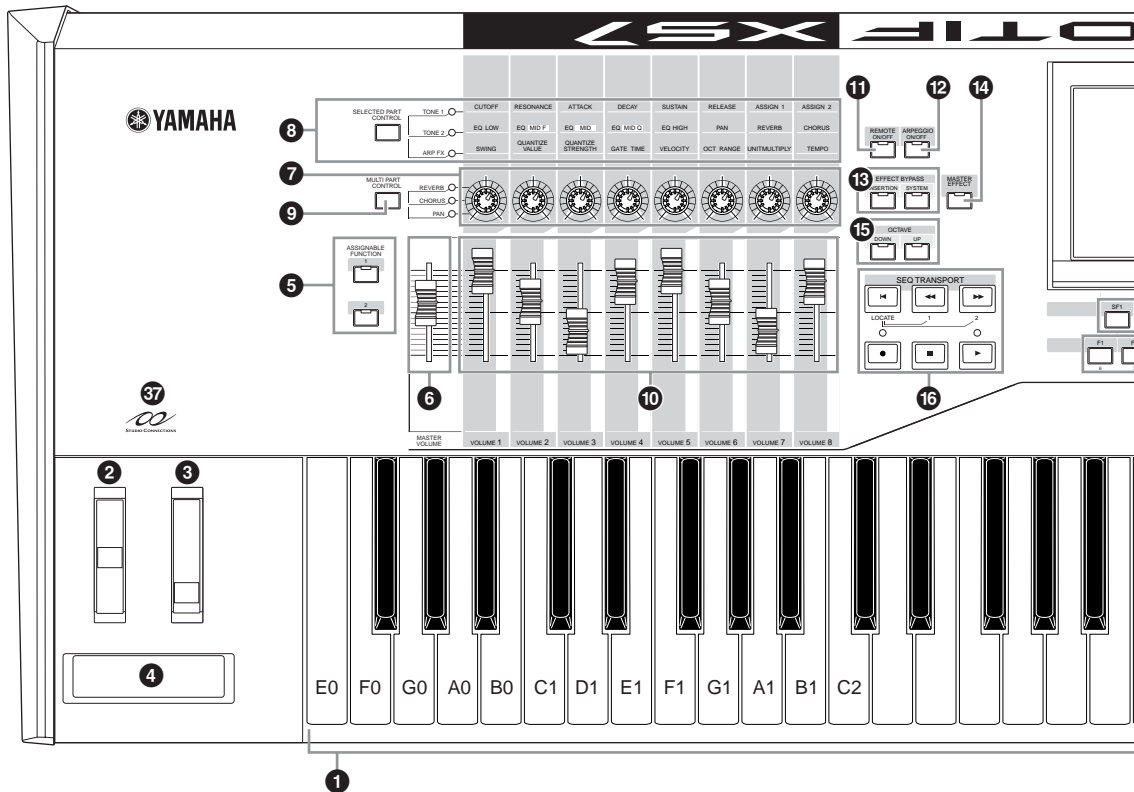

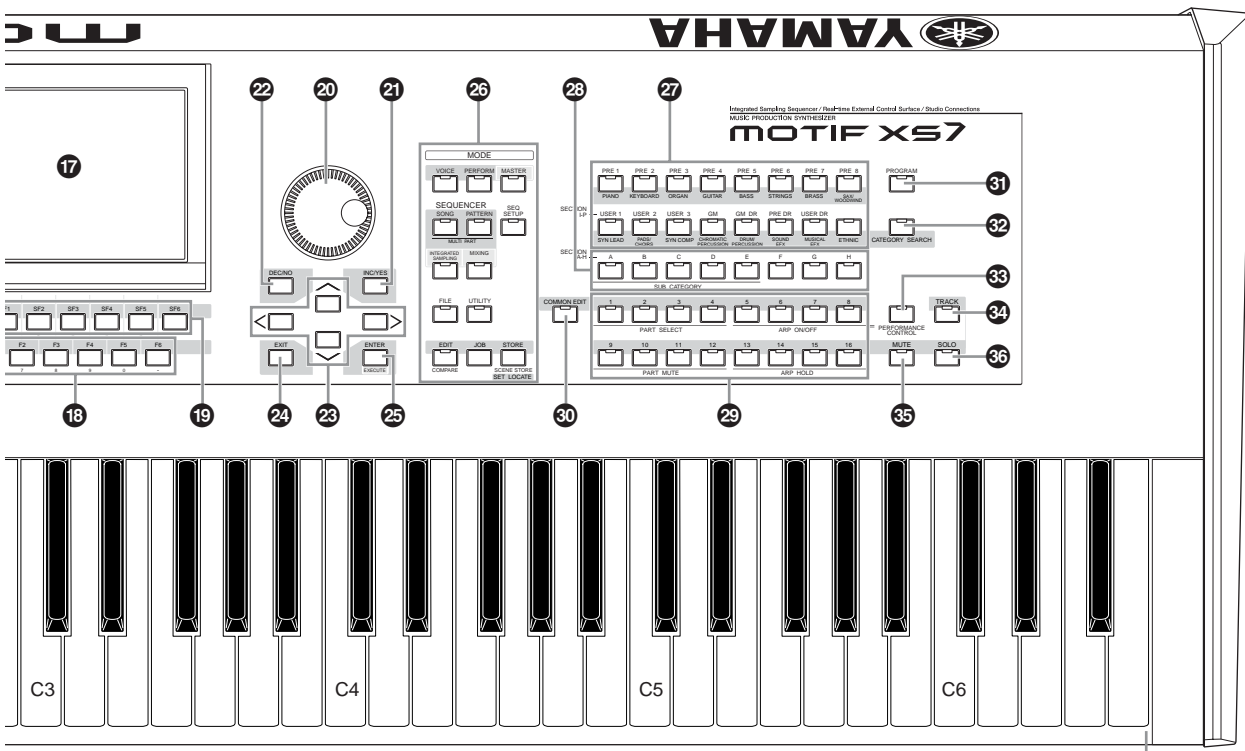
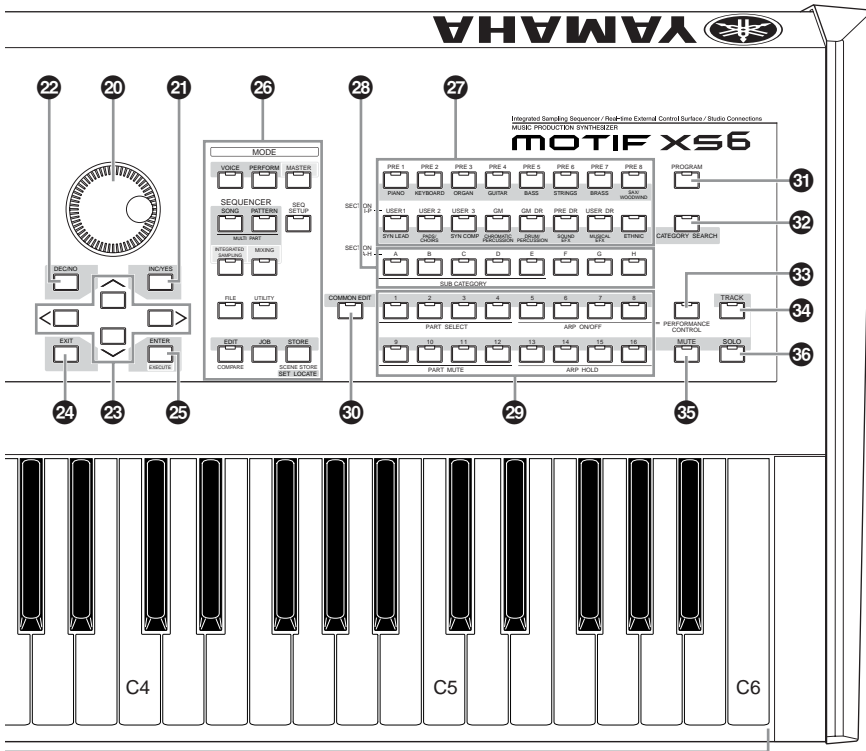

MOTIF XS8

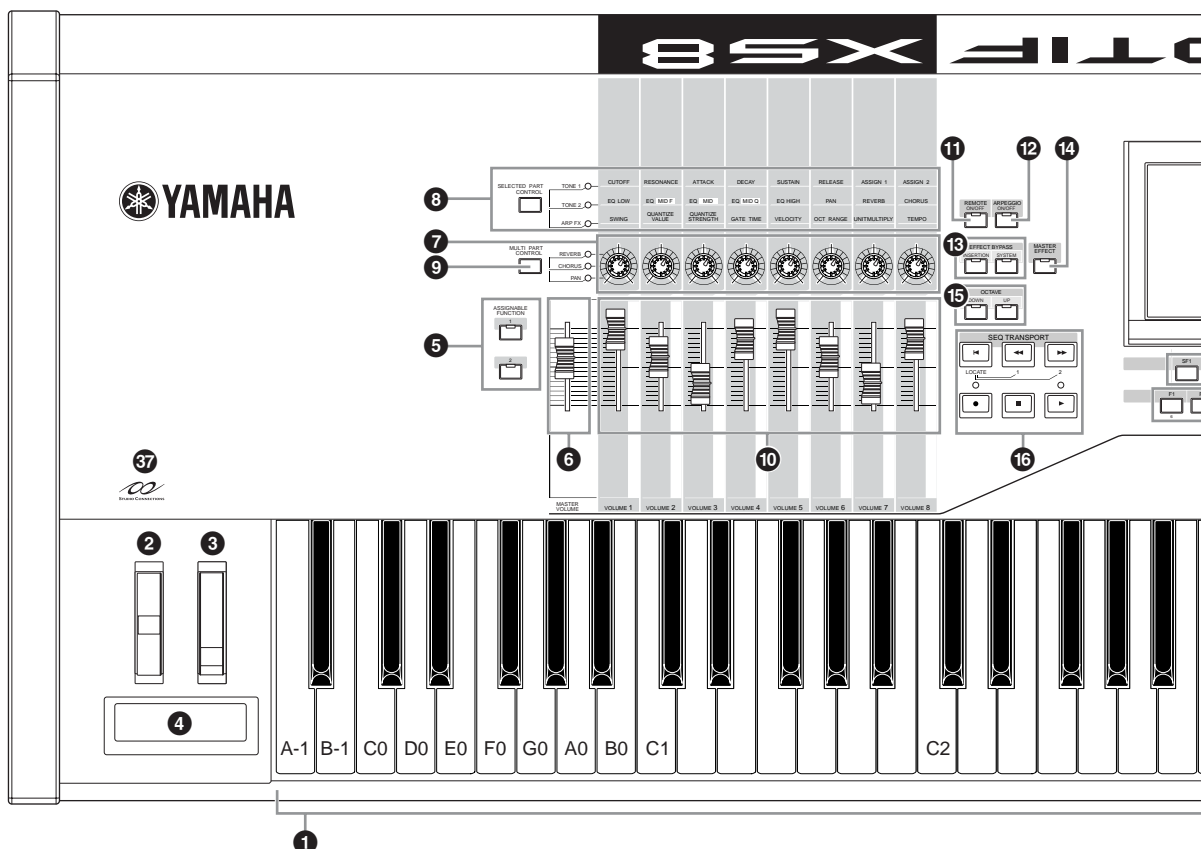

1 Keyboard

The MOTIF XS6 features a 61-key keyboard, while the MOTIF XS7 has 76 keys and the MOTIF XS8 has 88 keys. All are equipped with a touch response feature (both initial touch and aftertouch). With initial touch, the instrument senses how strongly or softly you play the keys, and uses that playing strength to affect the sound in various ways, depending on the selected Voice. With aftertouch, the instrument senses how much pressure you apply to the keys while playing, and uses that pressure to affect the sound in various ways, depending on the selected Voice. Moreover, any of a variety of functions can be assigned to aftertouch for each Voice (page 104).

2 Pitch Bend wheel (page 67)

Controls the pitch bend effect. You can also assign other functions to this controller.

3 Modulation wheel (page 67)

Controls the modulation effect. You can also assign other functions to this controller.

4 Ribbon Controller (page 67)

This controller is touch sensitive, and is controlled by running your finger lightly across its surface laterally. You can also assign other functions to this controller.

5 ASSIGNABLE FUNCTION buttons (page 67)

According to the XA Mode (Expanded Articulation Mode) settings in the Voice Element Edit mode, you can call up

the specific Element of the selected Voice by pressing each of these buttons during your keyboard performance. In addition, you can assign other functions to these buttons.

6 MASTER VOLUME (page 20)

Move the slider upwards to raise the output level from the OUTPUT L/R jacks and the PHONES jack.

7 Knobs (pages 26, 31, 89, 136, 181 and 252)

These eight highly versatile knobs let you adjust various aspects or parameters of the current Voice. Use the [SELECTED PART CONTROL] button or [MULTI PART CONTROL] button to change the functions assigned to the knobs.

8 [SELECTED PART CONTROL] button (pages 26, 64, 89, 136, 181 and 252)

Pressing this button changes the functions assigned to the eight knobs. The lamp next to the currently active parameters will light. A function of each knob is applied to the current Voice in the Voice mode while a function of each knob is applied only to the currently selected Part (or to all Parts depending on the setting) in the Performance/Song/Pattern mode.

NOTE Note that the functions assigned to the Knobs printed "ASSIGN1" and "ASSIGN2" with the TONE 1 lamp turned on are always applied to all Parts in the Performance mode and the specified Part in the Song/Pattern mode.

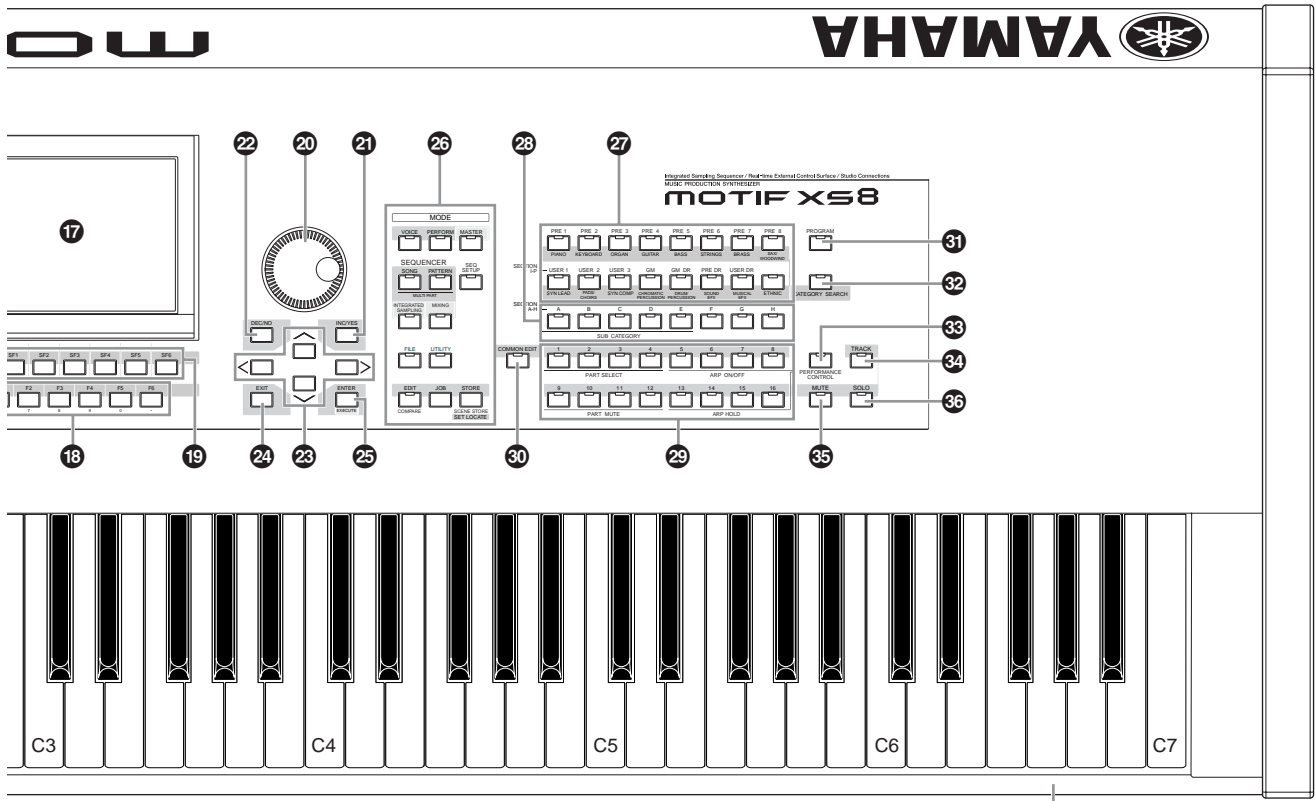

9 [MULTI PART CONTROL] button (pages 136 and 180)

Pressing this button changes the functions assigned to the eight knobs in the Performance /Song/Pattern mode. The lamp next to the currently active parameters will light. In the Performance mode, the four knobs at the left end correspond to Parts 1 – 4. In the Song/Pattern mode, all knobs correspond to Parts 1 – 8 or 9 – 16 (depending on the currently selected Part).

10 Control Sliders

These sliders control the volume of the sound in different ways depending on the mode selected:

Voice mode—volume of the eight Elements (page 91)

Performance mode—volume of the four Parts (page 137)

Song/Pattern modes—volume of the eight Parts, including the current Part (page 180)

Master mode—volume (page 252) or specified Control Change number (page 257) of the eight Zones

NOTE If all of the Control Sliders are set to the minimum, you may not hear any sound from the instrument, even when playing the keyboard or a Song/Pattern. If this is the case, raise all the sliders to a suitable level.

NOTE The MASTER VOLUME slider adjusts the audio output level from this instrument. On the other hand, the Control Slider adjusts the volume for the Element of the Voice or the Part of the Performance/Song/Pattern as a parameter. Accordingly, the values set via the Control Sliders can be stored as the Voice, Performance, Song, or Pattern data.

11 [REMOTE ON/OFF] button (page 52)

The Remote mode lets you control sequencer software on your computer from the panel controls of the instrument. Turn the [ON/OFF] button on to enter the Remote mode.

12 [ARPEGGIO ON/OFF] button (pages 65, 101 and 135)

Press this button to enable or disable playback of the Arpeggio for each Voice, Performance, Song, or Pattern. If the Arpeggio Switch of the selected Part is set to off in the Performance/Song/Pattern mode, however, pressing this button has no effect.

13 EFFECT BYPASS buttons (page 260)

The extensive effect block of the instrument provides Insertion effects (eight sets, with two effect units per set), System Effects (Reverb and Chorus), and Master Effects. The effects can be applied to the keyboard-played Voices and to Song/Pattern playback. When the lamp of the [INSERTION] or [SYSTEM] button is turned on, the corresponding Effect is off (or bypassed).

NOTE When the checkbox of the Reverb/Chorus is set to off in the [UTILITY] → [F1] General → [SF2] FXBypass display, the Reverb/Chorus is maintained (not bypassed) even if you turn the [SYSTEM] button on.

14 [MASTER EFFECT] button (pages 146 and 264)

When this button is pressed (the lamp lights), the Master Effect is applied to the overall sound of this instrument. Also, to access the Master Effect setting display, press and hold the [MASTER EFFECT] button for a second or two.

15 OCTAVE [UP] and [DOWN] buttons (pages 91, 92, 138, 251 and 260)

Use these buttons to change the note range of the keyboard. To restore the normal octave setting, press both buttons simultaneously.

16 SEQ TRANSPORT buttons (pages 21, 178 and 208)

These buttons control recording and playback of the Song/Pattern sequence data.

[⏪] (Top) button

Instantly returns to the beginning of the current Song or Pattern (i.e., the first beat of the first measure).

[⏮] (Reverse) button

Press briefly to move back one measure at a time, or hold to continuously rewind.

[⏭] (Forward) button

Press briefly to move forward one measure at a time, or hold to continuously fast-forward.

[●] (Record) button

Press this to enable recording (Song or Pattern phrase). (The indicator lights.)

[■] (Stop) button

Press to stop recording or playback.

[▶] (Play) button

Press to start playback from the current point in the Song or Pattern. During recording and playback, the indicator flashes at the current tempo.

17 LCD Display

The large backlit LCD displays the parameters and values related to the currently selected operation or mode.

18 [F1] – [F6] (Function) buttons (page 81)

These buttons located directly below the LCD display call up the corresponding functions indicated in the display.

19 [SF1] – [SF5] (Sub Function) buttons (page 81)

These buttons located directly below the LCD display call up the corresponding sub functions indicated in the display. These buttons can be also used to call the Arpeggio type in some displays of the Play mode, Edit mode and Record mode. These buttons can be also used as Scene buttons (pages 179, 182, 209 and 211) in the Song Play/Song Record/Pattern Play/Pattern Record modes.

20 Data dial (page 81)

For editing the currently selected parameter. To increase the value, turn the dial right (clockwise); to decrease the value, turn the dial left (counter-clockwise). If a parameter with a wide value range is selected, you can change the value in broader strokes by quickly turning the dial.

21 [INC/YES] button (page 81)

For increasing the value of the currently selected parameter. Also use it to actually execute a Job or a Store operation.

22 [DEC/NO] button (page 81)

For decreasing the value of the currently selected parameter. Also use it to cancel a Job or a Store operation.

NOTE You can also use the [INC/YES] and [DEC/NO] buttons to quickly move through parameter values in 10-unit jumps, especially those with large ranges. Simply hold down one of the buttons (of the direction you want to jump), and simultaneously press the other. For example, to jump in the positive direction, hold down the [INC/YES] button and press [DEC/NO].

23 Cursor buttons (page 81)

The cursor buttons move the “cursor” around the LCD display screen, highlighting and selecting the various parameters.

24 [EXIT] button (page 55)

The menus and displays of the MOTIF XS are organized according to a hierarchical structure. Press this button to exit from the current display and return to the previous level in the hierarchy.

25 [ENTER] button

Use this button to actually enter a number when selecting a Memory or Bank for Voice or Performance. Also use this button to execute a Job or a Store operation.

26 MODE buttons (page 55)

These buttons select the MOTIF XS operating modes (e.g., Voice mode).

27 Bank buttons (pages 23 and 88)

Each button selects a Voice or Performance Bank. When the [CATEGORY SEARCH] button is turned on, these buttons can be used to select the Main category (printed below each button). When the [TRACK] button is turned on in the Pattern mode, these lower buttons are used to select the desired Section from I – P.

28 Group [A] – [H] buttons (pages 23 and 88)

Each button selects a Voice or Performance Group. When the [CATEGORY SEARCH] button is turned on, these buttons can be used to select the Sub category. When the [TRACK] button is turned on in the Pattern mode, these buttons are used to select the desired Section from A – H.

29 Number [1] – [16] buttons (pages 23 and 88)

Use of these buttons differs depending on the on/off status of the [TRACK], [MUTE], [SOLO] and [PERFORMANCE CONTROL] buttons.

Functions of the Number [1] – [16] buttons

Mode	[PERFORMANCE CONTROL] button	[TRACK] button	[MUTE] button	[SOLO] button
Voice Play	—	Keyboard transmit channel setting	—	—
Normal Voice Edit	—	Changes the Edit mode from Common Edit to Element Edit and Element selection (1 – 8)	Element Mute setting (1 – 8)	Solo Element selection (1 – 8)
Drum Voice Edit	—	Changes the Edit mode from Common Edit to Drum Key Edit	—	—
Performance Play	Performance Control (30)	Keyboard transmit channel setting	Part Mute setting (1 – 4)	Solo Part selection (1 – 4)
Performance Edit	Performance Control (30)	Part selection (1 – 4)	Part Mute setting (1 – 4)	Solo Part selection (1 – 4)
Master Play	—	Keyboard transmit channel setting (when memorizing the Voice mode or Performance mode to the current Master) or Song/Pattern track selection (when memorizing the Song mode or Pattern mode to the current Master)	—	—
Master Edit	—	Changes the Edit mode from Common Edit to Zone Edit and Zone selection (1 – 8)	—	—
Song Play/ Pattern Play	—	Song/Pattern track selection	Song/Pattern track Mute setting	Solo track selection
Song Mixing/ Pattern Mixing	—	Song/Pattern Part selection	Song/Pattern Part Mute setting	Solo Part selection
Mixing Voice Edit	Element selection (1 – 8)	Element selection (1 – 8)	Element Mute setting (1 – 8)	Solo Element selection (1 – 8)

30 [COMMON EDIT] button

Turning this button on enters the Common Edit mode, which lets you edit the parameters commonly applied to all Elements, Parts or Zones in the Voice Edit mode, Performance Edit mode, Song Mixing Edit mode, Pattern Mixing Edit mode, and Mixing Voice Edit mode.

31 [PROGRAM] button

When this button is turned on, using the Bank/Group/Number buttons selects a Voice, Performance, Song, Pattern, and Master in the corresponding mode.

32 [CATEGORY SEARCH] button (page 24)

When this button is turned on in the Voice Play mode/Song Mixing mode/Pattern Mixing mode, the Bank buttons can be used to select a main category and the Group buttons [A] – [E] can be used to select a sub category of the Voice. When this button is turned on in the Performance mode, the Bank buttons can be used to select the Performance category and the Group buttons [A] – [E] can be used to select the Performance sub category.

33 [PERFORMANCE CONTROL] button (page 135)

This button is available only in the Performance Mode. When this button is turned on, the following functions are assigned to the Number buttons [1] – [16].

Number buttons	Function
[1] – [4]	Selecting Parts 1 – 4.
[5] – [8]	Setting the Arpeggio Switch to on/off for Parts 1 – 4.
[9] – [12]	Setting the mute status for Parts 1 – 4.
[13] – [16]	Setting the Arpeggio Hold for Parts 1 – 4.

34 [TRACK] button (page 34)

Turning this button on in the Song/Pattern mode enables the Number [1] – [16] buttons for selecting corresponding Song/Pattern tracks. When this button is turned on in the

Pattern mode, the Group buttons [A] – [H] can be used to select the desired Section from A – H and the lower buttons of the Bank buttons can be used to select the desired Section from I – P.

The on/off status of this button affects the Number [1] – [16] buttons in different ways, depending on the currently selected mode. (Refer to “Number [1] – [16] buttons” above.)

35 [MUTE] button (pages 33 and 179)

Turning this button on in the Normal Voice Edit mode and Mixing Voice Edit mode enables the Number buttons [1] – [8] for muting Voice Elements (1 – 8). Turning this button on in the other modes enables the Number buttons [1] – [16] for muting Performance Parts (1 – 4), Song Tracks/Parts (1 – 16), and Pattern Tracks/Parts (1 – 16). Refer to “Number [1] – [16] buttons” above.

36 [SOLO] button (pages 33 and 179)

Turning this button on in the Normal Voice Edit mode and Mixing Voice Edit mode enables the Number buttons [1] – [8] for soloing a Voice Element (1 – 8). Turning this button on in the other modes enables the Number buttons [1] – [16] for soloing a Performance Part (1 – 4), a Song Track/Part (1 – 16), and a Pattern Track/Part (1 – 16). Refer to “Number [1] – [16] buttons” above.

37 Studio Connections logo

Studio Connections is a joint project begun by Steinberg and Yamaha. Music production systems now increasingly rely on both software and hardware, and there is a pressing need for closer integration between the two. Studio Connections provides a comprehensive and seamless music production environment—making the use of hardware and software both easier and much more efficient.



Rear Panel

MOTIF XS6

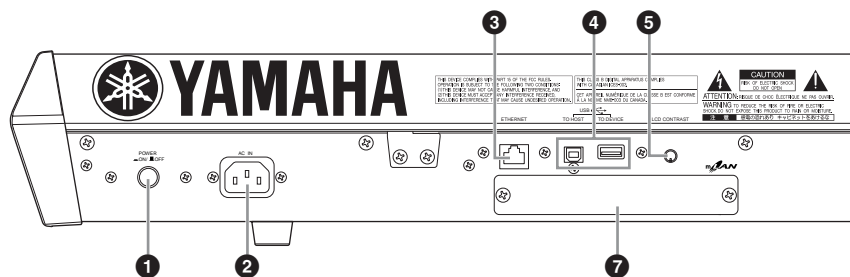

MOTIF XS7

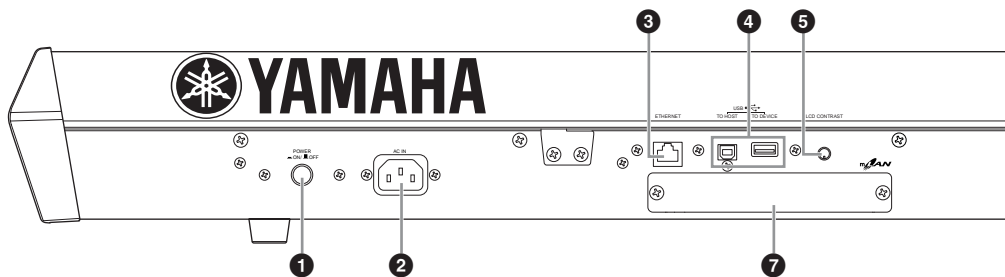

MOTIF XS8

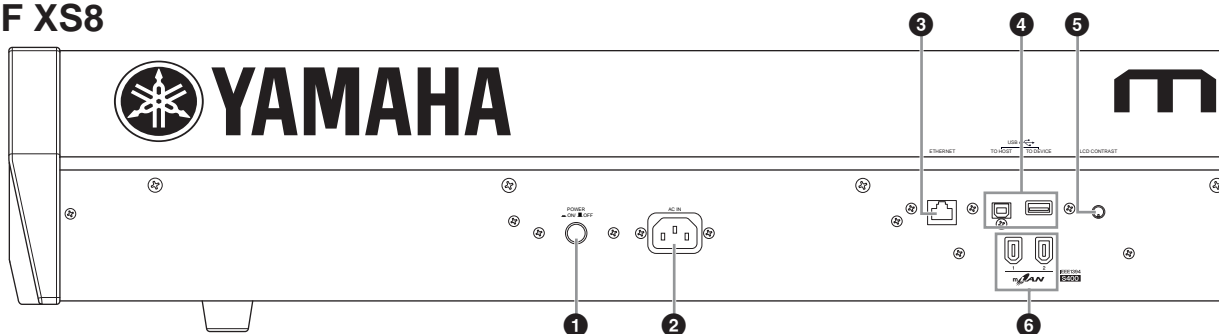

1 POWER switch (page 19)

Press to turn power ON or OFF.

2 AC IN (AC Power Cord Socket) (page 19)

Be sure to plug the AC power cord into this socket before plugging the power cord into an AC outlet. Use only the AC power cord supplied with this instrument. If the supplied cord is lost or damaged and needs to be replaced, contact your Yamaha dealer. The use of an inappropriate replacement can pose a fire and shock hazard!

3 ETHERNET connector (page 86)

You can connect the MOTIF XS to a LAN network by using this connector and a LAN cable. When connected to a network, the MOTIF XS is capable of mounting and accessing drives of computers on the same network.

4 USB connectors (pages 43 and 85)

There are two different types of USB connectors, and the rear panel of the instrument features both. The USB TO HOST connector is used to connect this instrument to the computer via the USB cable and allows you to transfer MIDI data between the devices. Unlike MIDI, USB can handle multiple ports via a single cable.

The USB connection between the instrument and the computer can only be used for transfer of MIDI data. No audio data can be transferred via USB.

The USB TO DEVICE connector is used to connect this instrument to a USB storage device (hard disk drive, CD-ROM drive, flash disk, etc.) via the USB cable. This lets you save data created on this instrument to an external USB storage device and load data from a USB device to the instrument. Save/Load operations can be performed in the File mode.

NOTE For details about USB, see pages 43 and 85.

USB

USB is an abbreviation for Universal Serial Bus. It is a serial interface for connecting a computer with peripheral devices, and enables much faster data transfer compared to conventional serial port connections.



5 LCD Contrast Control (page 20)

Use this control to set the LCD display for optimum legibility.

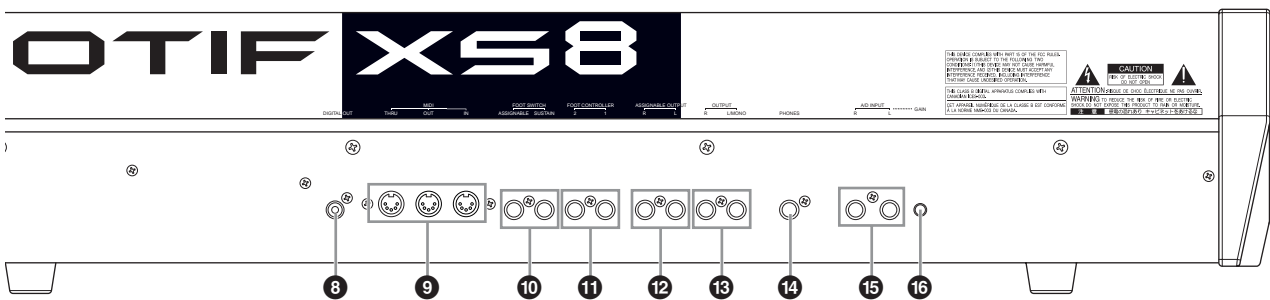
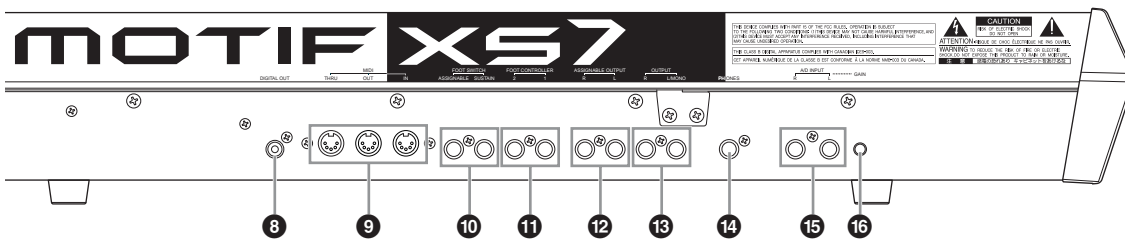
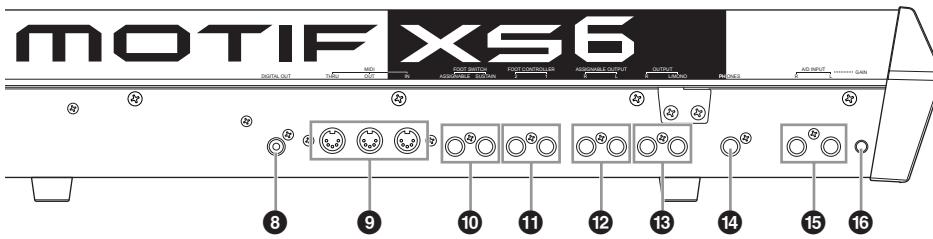

6 mLAN (IEEE1394) connector 1, 2 (only MOTIF XS8) (page 44)

The MOTIF XS is equipped with two mLAN connectors to which a IEEE1394 (6-pin) cable can be plugged in. These connectors enable you to connect the MOTIF XS to IEEE1394-compatible (FireWire/i.LINK) computers. If the connecting device features a 6-pin IEEE1394 jack, use a standard 6-pin to 6-pin IEEE1394 cable. If it features a 4-pin IEEE1394 jack, use a standard 6-pin to 4-pin IEEE1394 cable.

7 mLAN expansion board (mLAN16E2) cover (MOTIF XS6, MOTIF XS7) (page 294)

The optional mLAN16E2 can be installed by removing this cover of the MOTIF XS6/MOTIF XS7. By installing an mLAN16E2 board, you can upgrade your MOTIF XS6 or MOTIF XS7 for convenient and easy connection to an IEEE1394-compatible computer.

NOTE Yamaha recommends that you use an IEEE1394 cable with a length of 4.5 meters or less.

NOTE The digital audio output via the mLAN connector is fixed to a resolution of 24 bit/44.1 kHz.

About mLAN

"mLAN" is a digital network designed for musical applications.



It uses and extends the industry standard IEEE1394 high performance serial bus. By connecting an mLAN-equipped MOTIF XS (a MOTIF XS6/7 to which the optional mLAN16E2 is installed or a MOTIF XS8) to a computer in a peer-to-peer connection via an IEEE1394 cable, you can transfer audio data for all channels and MIDI data for all ports simultaneously between the MOTIF XS and the computer. This kind of connection, its capabilities and uses are referred to as "mLAN" in this Owner's Manual and the MOTIF XS instrument.

For details and the latest information on mLAN, refer to the following URL:

<http://www.yamahasyth.com/>

*The name "mLAN" and its logo (above) are trademarks.

8 DIGITAL OUT connector

Use this connector to output digital signals over coaxial (RCA-pin) cable. The digital signal format is CD/DAT (S/P DIF). This connector outputs a digital signal of 44.1 kHz/24 bit. By using this jack, you can record the keyboard performance or Song/Pattern playback of this synthesizer to external media (e.g., a CD recorder) with exceptionally high-quality sound—thanks to the direct digital connection.

9 MIDI IN/OUT/THRU connectors (page 83)

MIDI IN is for receiving control or performance data from another MIDI device, such as an external sequencer. MIDI THRU is simply for redirecting any received MIDI data (via MIDI IN) to connected devices, allowing convenient chaining of additional MIDI instruments. MIDI OUT is for transmitting all control, performance and playback data from the MOTIF XS to another MIDI device, such as an external sequencer.

10 FOOT SWITCH jacks (pages 104, 123, 147 and 260)

For connection of an optional FC3/FC4/FC5 Footswitch to the SUSTAIN jack and a FC4/FC5 Footswitch to the ASSIGNABLE jack. When connected to the SUSTAIN jack, the Footswitch controls sustain. When connected to ASSIGNABLE, it can control one of various different assignable functions.

11 FOOT CONTROLLER jacks (pages 104 and 147)

For connection of optional foot controllers (FC7 and FC9). Each jack lets you continuously control one of various different assignable functions—such as volume, tone, pitch, or other aspects of the sound.

12 ASSIGNABLE OUT L and R jacks

Line level audio signals are output from this instrument via these phone jacks (1/4" mono phone plug). These outputs are independent of the main output (at the L/MONO and R jacks below), and can be freely assigned to any of the Drum Voice keys or the Parts. This lets you route specific Voices or sounds for processing with a favorite outboard effect unit. The Parts which can be assigned to these jacks are as follows:

- Audio Part in the Voice mode (page 265)
- Drum Voice key to which the drum/percussion instrument is assigned (page 130)
- Any Part of a Performance* (pages 148 and 153)
- Any Part of a Song* (pages 234 and 235)
- Any Part of a Pattern* (pages 234 and 235)

* Including the Audio Input Part

13 OUTPUT L/MONO and R jacks (page 19)

Line level audio signals are output via these phone jacks. For monophonic output, use just the L/MONO jack.

14 PHONES (Headphone) jack (page 19)

This standard stereo phones jack is for connection to a set of stereo headphones.

15 A/D INPUT jacks (pages 40, 147, 232 and 265)

External audio signals can be input via these phone jacks (1/4" mono phone plug). Various devices such as microphone, guitar, bass, CD player, synthesizer can be connected to these jacks and their audio input signal can be sounded as the Audio Part of the Voice, Performance, Song, or Pattern. In the Sampling mode (page 242), these jacks are used for capturing audio data as samples. In addition, you can use the special Vocoder feature by connecting a microphone to this L jack and inputting your Voice to the microphone.

Use 1/4" mono phone plugs. For stereo signals (such as from audio equipment), use both jacks. For mono signals (such as from a microphone or guitar), use only the L jack.

16 GAIN knob (page 40)

For adjusting the input gain of the audio at the A/D INPUT jacks (above). Depending on the connected device (microphone, CD player, etc.), you may need to adjust this for optimum level.

Step 1: Setting Up

Power Supply

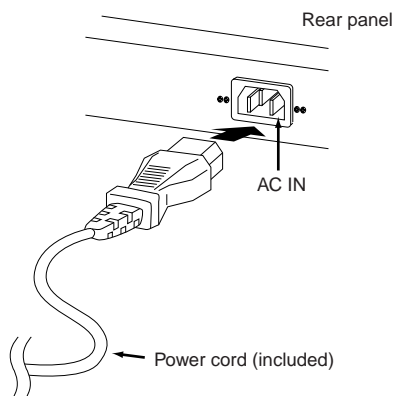

- 1 Make sure the **POWER** switch on the MOTIF XS is set to **OFF**.
- 2 Connect the supplied power cord to the **AC IN** on the instrument's rear panel.
- 3 Connect the other end of the power cord to an **AC** outlet.

Make sure your MOTIF XS meets the voltage requirement for the country or region in which it is being used.

WARNING

Make sure your MOTIF XS is rated for the AC voltage supplied in the area in which it is to be used (as listed on the rear panel). Connecting the unit to the wrong AC supply can cause serious damage to the internal circuitry and may even pose a shock hazard!

WARNING

Use only the AC power cord supplied with the MOTIF XS. If the supplied cord is lost or damaged and needs to be replaced, contact your Yamaha dealer. The use of an inappropriate replacement can pose a fire and shock hazard!

WARNING

The type of AC power cord provided with the MOTIF XS may be different depending on the country in which it is purchased (a third prong may be provided for grounding purposes). Improper connection of the grounding conductor can create the risk of electrical shock. Do NOT modify the plug provided with the MOTIF XS. If the plug will not fit the outlet, have a proper outlet installed by a qualified electrician. Do not use a plug adapter which defeats the grounding conductor.

Connecting speakers or headphones

Since the MOTIF XS has no built-in speakers, you will need to monitor the sound of the instrument by using external equipment. Connect a set of headphones, powered speakers, or other playback equipment as required.

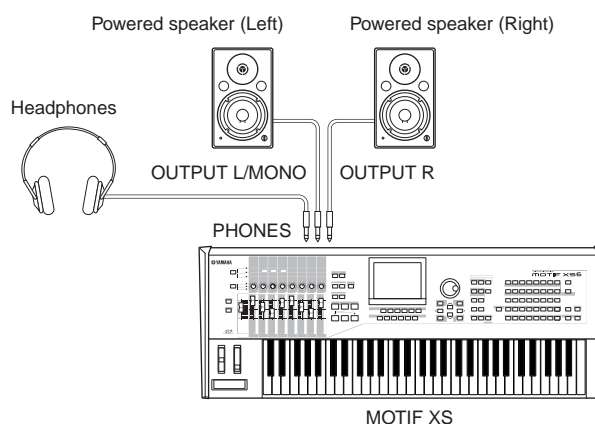

Turning the power on

Make sure the volume settings of the MOTIF XS and external devices such as powered speakers are turned down to the minimum before turning the power on.

When connecting the MOTIF XS to the powered speakers, turn on the power switch of each device in the following order.

- When turning the power on: First, the MOTIF XS, then the connected powered speakers.
- When turning the power off: First, the connected powered speakers, then the MOTIF XS.

Please keep in mind that the **POWER** switch is located at the right side (from the view of the keyboard) of the **AC IN** socket on the rear panel of the MOTIF XS.

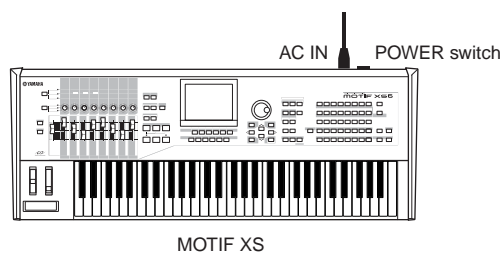

CAUTION

Even when the **POWER** switch is turned off, electricity is still flowing to the instrument at the minimum level. When you are not using the instrument for a long time, make sure you unplug the power cord from the wall AC outlet.

Adjusting the sound and the display contrast

Adjust the volume levels of the MOTIF XS and the connected amplifier/speaker system. If the display is not easily visible, use the Contrast control to adjust for optimum visibility.

Adjust the volume with the MASTER VOLUME slider.

Adjust the display contrast with the Contrast control.

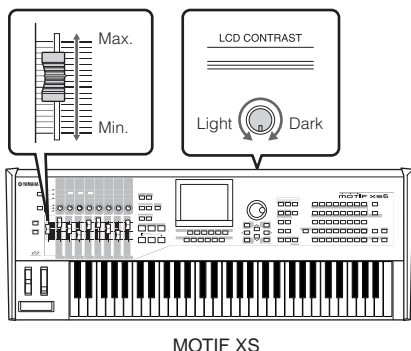

MOTIF XS

CAUTION

Do not listen with the headphones at high volume for long periods of time. Doing so may cause hearing loss.

NOTE Keep in mind that the LCD display is not a touch screen type. Do not touch and press the display directly or forcefully.

Playing the sounds

Try playing some of the realistic and dynamic MOTIF XS sounds from the keyboard now. When you turn the power on, the display below appears.

Indicates that the Master mode is selected. Indicates the type of selected program. Indicates the name and number of selected program.



NOTE In the default settings, the Master mode is selected. For details about the modes, refer to the section "Modes."

NOTE Keep in mind that the example displays shown in this manual are for instruction purposes only, and the contents (for example, the Demo Song/Pattern names) may differ slightly from those on your instrument.

In this condition you can play the keyboard and hear the sounds of the selected program. The top of the Master Play display (page 251) indicates the Master program number and the status (Mode, Bank, Program Number and its

name) registered to the current Master program. Let's try playing the keyboard.

NOTE For details about Banks, see pages 88 and 135.

Selecting and playing the sounds

In the default setting, the Master mode provides a total of 128 programs each of which includes the mode (Voice, Performance, Song and Pattern) and its program number. Try out the different Master programs to play various Voices and Performances. You can change the Master program number by using the [INC/YES] button, [DEC/NO] button, or the data dial.

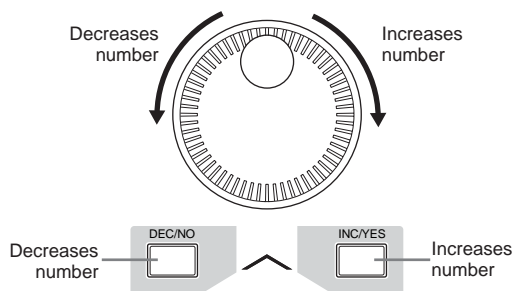

Modes

In order to make operation of the MOTIF XS as comprehensive and as smooth as possible, all functions and operations have been grouped in "modes," many of which also have a number of "sub modes." The MOTIF XS provides the nine main modes which are divided into several sub modes. You can master the MOTIF XS by understanding the mode structure. To enter the desired mode, press the corresponding Mode button. For more details about modes and sub modes, see page 54.

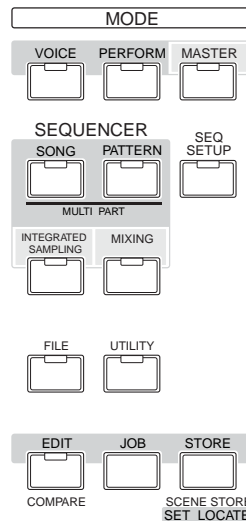

Listening to the Demo Song

Try listening to the preset Demo Songs, enjoy the high-quality sound, and get a taste for how you can use the MOTIF XS to create your own music.

Playing the Demo Song

- 1 Press the [SONG] button to enter the Song Play mode.

The Track View display of the Song Play mode appears.

- 2 Press the SEQ TRANSPORT [▶] (Play) button to start the Demo Song.

The Song currently shown on the display starts.

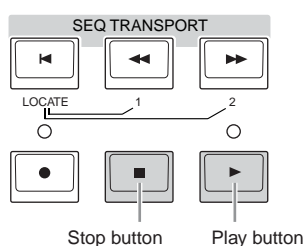

NOTE To adjust the volume level of the Demo Songs, use the MASTER VOLUME slider.

- 3 Press the SEQ TRANSPORT [■] (Stop) button to stop the Demo Song.

Selecting another Song

- 1 Make sure that the cursor is located on the Song Number in the Track View display.

The highlighted frame within the display is called the "cursor." You can move the cursor up, down, left and right by using the Cursor buttons. If the cursor is located on another parameter, move the cursor to the Song Number.

Song number Song name

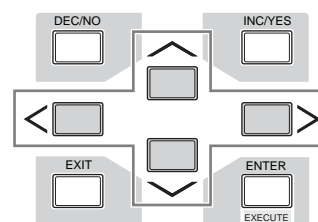

NOTE Keep in mind that the example displays shown in this manual are for instruction purposes only, and may appear somewhat different from those on your instrument.

- 2 Press the [INC/YES] and [DEC/NO] buttons or rotate the data dial to change the Demo Song number.

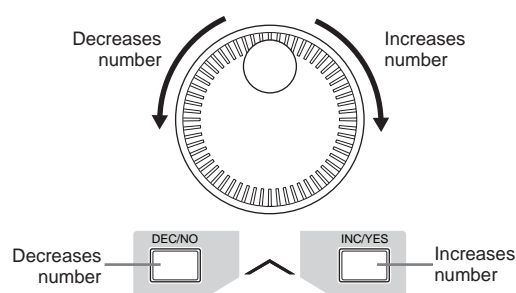

NOTE You can change the value of various parameters as well as the Song number by using the [DEC/NO]/[INC/YES] button or data dial after moving the cursor to the desired location. This basic operation is used for all of the selection and adjustment operations on the instrument.

Loading the Demo data

In the default settings (when shipped from the factory), several Demo Songs and Patterns are stored to the instrument, starting at Song 01 and Pattern 01. However, you may delete them by recording your original data or loading a different Song/Pattern from an external USB storage device. To restore the original Demo data, follow the instructions below.

CAUTION

Loading the Demo data overwrites all the Songs or Patterns. Before loading the Demo data, please check whether or not there is important data in the Songs or Patterns. If there is important data in the Songs or Patterns, save it to the external USB storage device or a computer on the network before loading the Demo data. For information about how to save, see page 278.

1 Press the [FILE] button and [UTILITY] button simultaneously.

The Demo Load display appears.

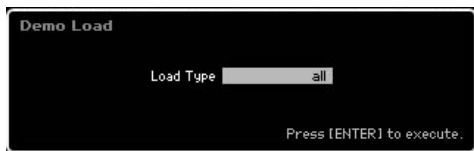
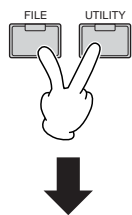

2 Make sure that the Load Type is set to “all,” then press the [ENTER] button to load the Demo data.

A display prompt appears to confirm whether or not the destination data (Song/Pattern) should be deleted.

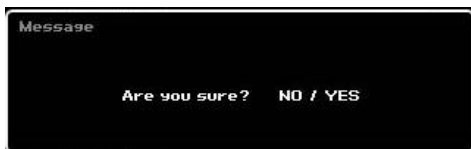
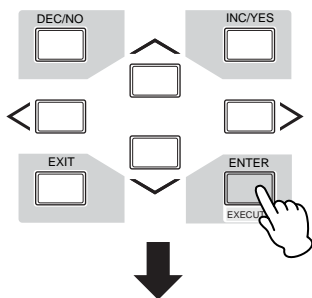

NOTE If you want to load only the Demo Song data, set the Load Type to “song.” If you want to load only the Demo Pattern data, set the Load Type to “pattern.”

3 Press the [INC/YES] button to execute the Demo Load operation.

The Demo data is loaded to the Song and Pattern memory location, then the Song Play Track View display appears.

NOTE If you set the Load Type to “pattern” in step 2 above, the Pattern Play display (page 210) appears after loading.

NOTE For more information about the Track View display of the Song, see page 181. For more information about the Pattern Play display, see page 210.

Resetting the User Memory to the Initial Factory Settings

The original factory settings of this synthesizer’s User Memory can be restored as follows.

NOTE When connecting a computer to the MOTIF-RACK XS via a IEEE1394 cable, disable the driver used for this connection beforehand, and follow the procedure below to execute Factory Set.

CAUTION

When the factory settings are restored, all the Voice, Performance, Song, Pattern, and system settings in the Utility mode you created will be erased. Make sure you are not overwriting any important data. Be sure to save all important data to your USB storage device or a computer on the network before executing this procedure (page 278).

1 Press the [UTILITY] button then the [JOB] button to call up the Factory Set display (page 269).

2 Press the [ENTER] button.

The display prompts you for confirmation. Press the [DEC/NO] button to cancel the Load operation.

3 Press the [INC/YES] button to execute the Factory Set.

After the Factory Set has been completed, a “Completed” message appears and operation returns to the original display.

CAUTION

For Factory Set operations that take longer to process, you will see the message “Now executing Factory Set...” during processing. While such a message is shown on the display, never attempt to turn off the power while data is being written to Flash ROM. Turning the power off in this state results in loss of all user data and may cause the system to freeze (due to corruption of data in the Flash ROM). This means that this synthesizer may not be able to start up properly, even when turning the power on next time.

CAUTION

When entering the checkmark to the box of the Power On Auto Factory Set and executing the Factory Set, the Factory Set will automatically be executed each time turning the power on. Keep in mind that this also means that your original data in Flash ROM will be erased each time you turn on the power. Therefore, the checkmark of this box should normally be removed. If you remove the checkmark of this box and execute the Factory Set, the Factory Set will not be executed when turning the power on next time.

Step 2:

Selecting and Playing a Voice

Try playing some of the realistic and dynamic Voices from the keyboard now. **Press the [VOICE] button** to enter the Voice Play mode, then enjoy the powerful, authentic sounds of the MOTIF XS Voices, as well as the enormous range and wealth of sounds available.

Selecting a Voice

Here, try selecting the Grand Piano for example. Press the [PROGRAM] button (1) so that its lamp lights, press the Bank button [PRE 1] (2) to select the Preset Bank 1, press the Group button [A] (3) then Number button [1] (4) to select a Voice “PRE: 001 (A01).”

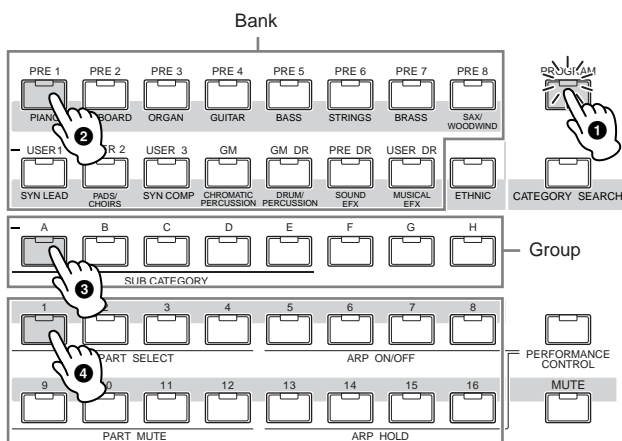

Number



Next, press the Number button [2] to select the Voice “PRE: 002 (A02),” the 2nd Voice within the same Bank and Group. Select other Voices (003, 004, etc.) in the same way by pressing the appropriate Number button ([3], [4], etc.). To select a specific Voice from the 128 Voices available in Preset Bank 1, first press the appropriate Bank button [A] – [H], then press the desired Number button [1] – [16]. You can also use the [DEC/NO] button, [INC/YES] button, and data dial to select a Voice within a certain Bank. You can scroll through the Voices within the same Bank across the different Groups by rotating the data dial or pressing the [DEC/NO]/[INC/YES] button.

Now, enjoy various Voices by following the above operations. 128 Voices are available for each Bank. Press the [PRE 2] to [PRE 8] and [GM] buttons to select Voices in other Banks.

Voice Play mode indications

The top of the display in the Voice Play mode indicates the Voice related information, such as Bank, Voice number (Group and Number), Category 1, Category 2, and Voice name. See below.

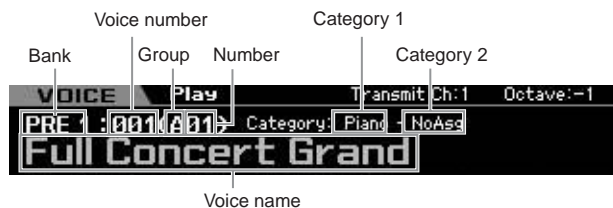

Below is a list of the Categories and their panel abbreviations.

Abbreviation	Category
Piano	Piano
Keys	Keyboard instruments (Harpichord, Clav, etc.)
Organ	Organ
Guitr	Guitar
Bass	Bass
Strng	Strings
Brass	Brass
SaxWW	Saxophone and other woodwind instruments
SynLd	Synth Lead
Pads	Synth Pad
SyCmp	Synth Comp
CPerc	Chromatic Percussion (Marimba, Glockenspiel, etc.)
Dr/Pc	Drum/Percussion
S.EFX	Sound Effect
M.EFX	Musical Effect
Ethnc	Ethnic

Selecting a Drum Voice

Next, try out the Drum Voice. For example, select the Drum Voice of the Preset Drum Bank. Press the [PROGRAM] button so that its lamp lights, press the Bank button [PRE DR] to select the Preset Drum Bank, press the Group button [A], and finally press Number button [1] to select the Voice “PDR: 001 (A01).” Now the Drum Voice has been selected.

Now play the Drum Voice. You’ll notice that with the Drum Voice, unlike the Normal Voice you tried in the previous page, each key of the keyboard has a different drum instrument assigned to it. This allows you to easily create and play rhythm patterns made up of various drum/ percussion instruments.

Using the Category Search function

Since the MOTIF XS has such a huge variety of Voices and so many to choose from, it may be difficult or time consuming to find the Voice you want. This is where the convenient Category Search function comes in handy. It lets you select desired Voices easily, based on general instrument categories. Here for example, we'll try selecting a Guitar Voice.

In the Voice Play mode, press the [CATEGORY SEARCH] button so that its indicator lights. The Category Search window appears on the display, indicating that you can use the Cursor buttons and data dial to select the desired Category, Sub Category and Voice. In this state, you can also use the Bank/Group/Number buttons on the panel to select a Voice. Browse the Category names printed below the Bank buttons as illustrated below then press the desired button. In this example, press the [GUITAR] button.

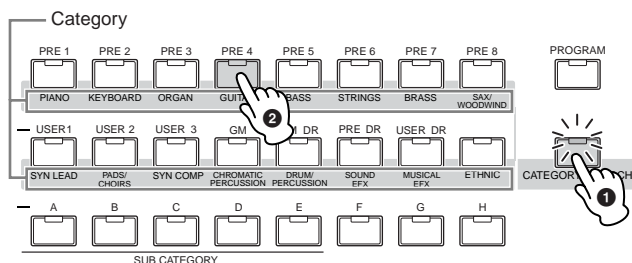

The Voice list of the selected Category appears in the display. You can select the desired Voice by moving the cursor upward or downward.



At the bottom of the display, the Sub Categories are shown at the tabs corresponding to the [SF1] – [SF5] buttons respectively. When the Guitar Category is selected, guitar types such as Acoustic Guitar, Electric Guitar, and Electric Distortion Guitar are shown as Sub Categories. From this display for example, you can instantly call up the Clean Guitar Sub Category by pressing [SF2], which corresponds to "E.Cln" in the display. This feature lets you quickly and easily get at the specific kinds of Voices you want to use. Press any of the [CATEGORY SEARCH], [EXIT] and [ENTER] buttons to return to the original display.

NOTE From this display, you can register your favorite Voices to the Favorite Category. For details, see page 88.

Playing the Arpeggio

This function lets you trigger rhythm patterns, riffs and phrases using the current Voice by simply playing notes on the keyboard. Since the preset Voices already have their own Arpeggio types pre-assigned, all you need to do is select the desired Voice and turn on the Arpeggio function. For certain Voices, simply selecting the Voice will turn Arpeggio on.

Try selecting different Voices and check out the various Arpeggio types.

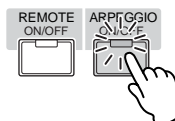

For example, select the Voice numbered "A01" of the Preset Drum Bank, turn the [ARPEGGIO ON/OFF] button on, then hold down a key (any key) on the keyboard, and listen as a rhythm is played automatically. The rhythm stops when you release the key. Other preset Voices also have their own appropriate Arpeggio types for automatic playing of arpeggio/rhythm patterns.

Up to five Arpeggio types can be assigned to the [SF1] – [SF5] buttons for each Voice.

When a certain Voice is selected, the same sequence is played back both regardless of the pressed note or notes. When a certain Voice is selected, on the other hand, the different sequence is played back depending on which notes are played or how they are played. Check out how Arpeggios are played back for different Voices by selecting various Voices and playing notes in various ways.

Changing the Arpeggio type

The Arpeggio type assigned to each of the [SF1] – [SF5] buttons can be changed as desired.

- 1 From the Voice Play display, press the [F4] button to call up the Arpeggio display.

These global parameters apply to all the [SF1] – [SF5] buttons as a group.



These parameters can be set for each of the [SF1] – [SF5] buttons.

- 2 Press one of the [SF1] – [SF5] buttons.

The lower half of the display will be changed for the pressed button. The upper half of the display is common to all the [SF1] – [SF5] buttons.

- 3 In the lower half of the display, select the Category, Sub Category and Type of the Arpeggio.

The Category determines the instrument type, the Sub Category determines the rhythm type, and the Type determines the Arpeggio type itself. Press any note to trigger the Arpeggio playback to find your favorite one.

Go on and assign Arpeggio types in the same way to the other [SF] buttons as desired.

NOTE For details about the Arpeggio, see page 62.

Using the Controllers

The MOTIF XS gives you an amazing amount of control options. Not only is it equipped with conventional Pitch Bend and Modulation Wheels, it also features special Knobs, Sliders, Ribbon Controller, and Assignable Function buttons.

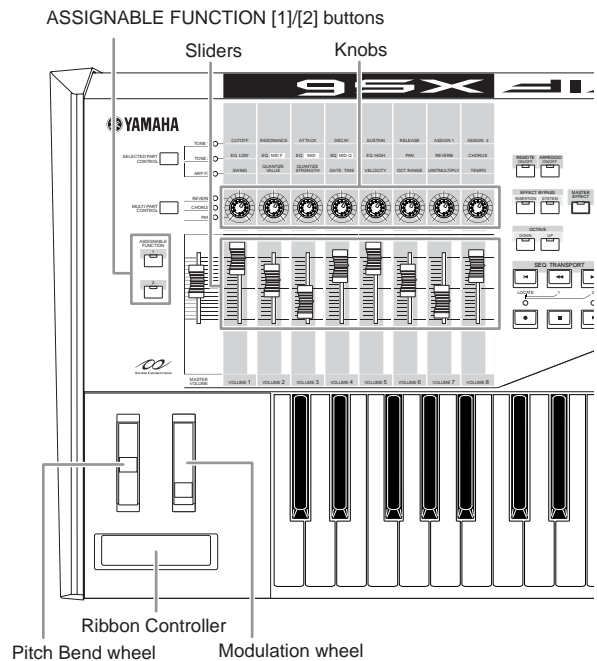

The Voice Play display indicates the functions assigned to the controllers. Keep in mind that the name of the Voice may include an abbreviation of the controller most suitable for use when playing the Voice. Using the controllers such as Knobs, Sliders, and the ASSIGNABLE FUNCTION buttons change various aspects of the Voice's sound in real time—while you play.



Indicates the controller assignment

Display	Functions
AS1, AS2	Indicates the functions assigned to the respective Knobs (printed "ASSIGN 1" and "ASSIGN 2") with the TONE1 lamp turned on.
AF1, AF2	Indicates the functions assigned to the two ASSIGNABLE FUNCTION buttons.
MW	Indicates the functions assigned to the Modulation Wheel.
RB	Indicates the functions assigned to the Ribbon Controller.

NOTE For more information about controllers, see page 67.

Using the Knobs

Try using the Knobs with your left hand while playing the keyboard with your right with the Voice A01 "Full Concert Grand."

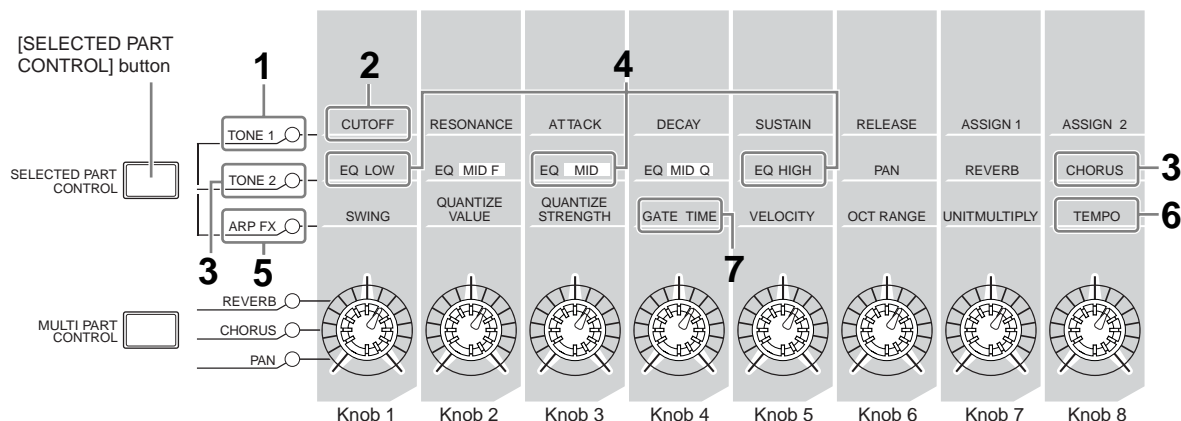

1 Press the [SELECTED PART CONTROL] button a few times so that the TONE 1 lamp lights.

The Control Function window appears when a display other than the Voice Play display is shown. Holding the [SELECTED PART CONTROL] button for a while will light the lamp of the TONE1 lamp.

2 Rotate the Knob 1 (at the far left) while playing keyboard.

Turning the knob clockwise results in a brighter sound, while turning it counterclockwise results in a softer, muffled sound. The sound changes in this way because Knob 1 is assigned to the Cutoff Frequency parameter (labeled CUTOFF in the matrix above Knob 1 and next to TONE 1).

NOTE The functions assigned to each of Knobs and current values are shown in the display.



3 Press the [SELECTED PART CONTROL] button a few times so that the TONE 2 lamp lights, then rotate the Knob (at the far right).

The CHORUS (as printed above the Knob) is applied to the current Voice.

NOTE A red point on the Knob or Slider graphic indicates the current value to which the Knob or Slider is set. Moving the Knob or Slider has no effect on the sound until this point is reached. Once you move the Knob or Slider past this point, the red point disappears and moving the Knob or Control Slider affects the sound.

4 Turn Knob 1, Knob 3, and Knob 5 with the TONE 2 lamp turned on.

You can change the sound by boosting or attenuating the LOW, MID and HIGH band (as printed above the Knobs respectively) of the EQ (equalizer).

5 Press the [SELECTED PART CONTROL] button a few times so that the ARP FX lamp lights, turn [ARPEGGIO ON/OFF] on, then turn the Knobs with your left hand while playing the notes with your right hand.

In this status, all the Knobs can be used to change how the Arpeggio is played back.

6 Rotate Knob 8 (at the far left) while playing keyboard to change the tempo of the Arpeggio.

7 Rotate Knob 4 to change the gate time of the Arpeggio notes, for example, from staccato to legato playback.

Try out other Knobs as well.

NOTE For more information about the functions assigned to the Knobs in the Voice mode, see page 90.

By using the Knobs in this way, you can change the sound of the Preset Voice to create your original Voice.

NOTE Controlling the knobs does not affect some voices.

Storing the Voice

The MOTIF XS has space for three Banks of your own User Voices. Store the Voice by pressing the [STORE] button. For details, see page 97.

Adjusting the tuning to other instruments

When you play the MOTIF XS with other instruments, you may need to tune the overall sound of the MOTIF XS to match that of the other instruments in the group.

- 1 Press the [UTILITY] button to enter the Utility mode, press the [F1] button, then press the [SF1] button to call up the Play display as below.



- 2 Move the cursor to Tune, then set the value.

In this example, we'll change the value from "440 Hz" to "442 Hz." Since the Tune parameter is actually adjusted in cents (1 cent = 1/100th of a semitone), the corresponding value in Hertz is shown at right. Since 1 Hz is roughly equivalent to 4 cents, set this value to "+8.0."

- 3 Press the [STORE] button to store the Utility setting.

Transpose

This function allows the overall pitch of the MOTIF XS to be transposed up or down in semitone increments/decrements. You can play the same notes on the keyboard even when the pitch of the song is shifted up or down in semitones.

- 1 Press the [UTILITY] button to enter the Utility mode, press the [F1] button, then press the [SF1] button to call up the Play display as shown.

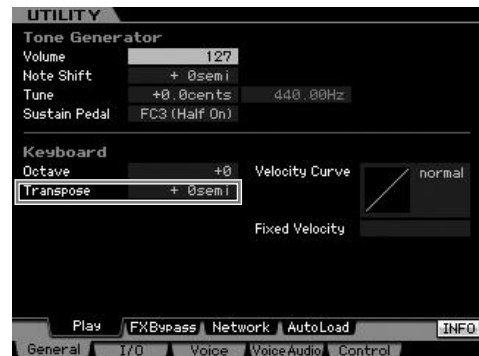

- 2 Move the cursor to Transpose, then set the value.

Set the value to "+1" to transpose the pitch up by a semitone, or set it to "-1" to transpose it down by a semitone. To transpose it up or down by a whole tone, set this to "+/-2"; to transpose by an octave, set it to "+/-12."

⚠ CAUTION

To transpose by octaves, use the Octave parameter (above Transpose).

- 3 Press the [STORE] button to store the Utility setting.

NOTE Make sure to press the [STORE] button to store the Utility settings. Please keep in mind that the Utility settings will be lost if you turn off the power without executing the Store operation.

Step 3: Selecting and Playing a Performance

As in the Voice Play mode, the Performance Play mode is where you select and play the instrument sounds of this synthesizer. However, in the Performance mode, you can mix several different Voices together in a layer, or split them across the keyboard, or even set up a combination layer/split. Each Performance can contain up to four different Parts.

Press the [PERFORM] button to enter the Performance Play mode.

Selecting a Performance

Selecting a Performance is done in basically the same way as selecting a Voice. The Category Search function is available also in the Performance Play mode. Note that the MOTIF XS has no Preset Performances and provides only three User Banks. Consequently, press any of the [USR1] – [USR3] buttons to select a Performance after pressing the [PROGRAM] button.

Performance Play mode indications

The Performance Play display indicates the Voice names for each of four parts making up the Performance at the bottom right corner. Except for this, the display is almost same as in the Voice Play mode.

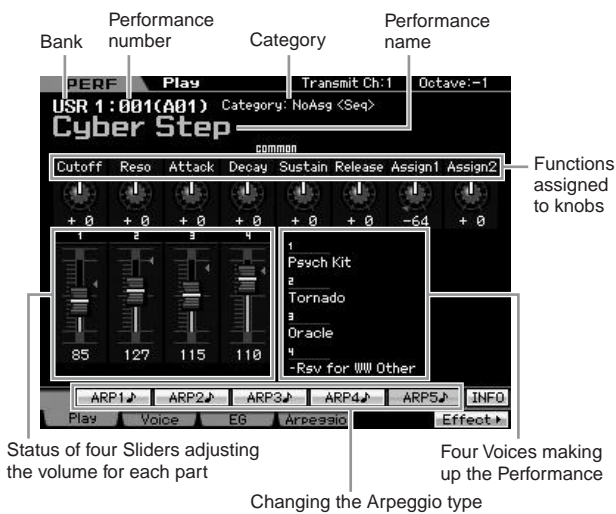

Performance Structure

Layer

This method lets you play multiple (two or more) Voices simultaneously by pressing any notes. In the Performance mode, you can create a thicker sound by combining two similar Voices—for example, two different Strings Voices, each with a different attack speed.

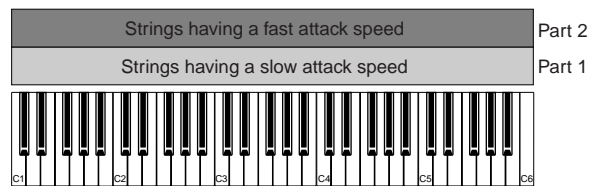

Performance Structure

Split by Note range

This method lets you play different Voices with your left hand and right hand. By assigning the Strings to the lower range and assigning the Flute to the higher range separately as illustrated below, you can play the Strings as accompaniment with your left hand and play the Flute as melody with your right hand,

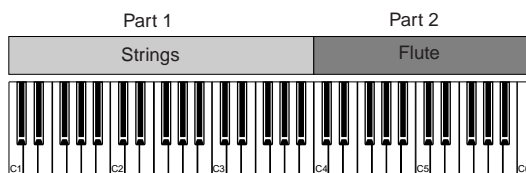

Performance Structure

Split by Velocity range

This method lets you trigger different Voices depending on your playing strength (velocity). In this example below, playing the note with low velocities triggers the Strings having the slow attack speed. Playing the note with middle velocities triggers the Strings having the fast attack speed. Playing the note with high velocities triggers the Orchestra Hit.

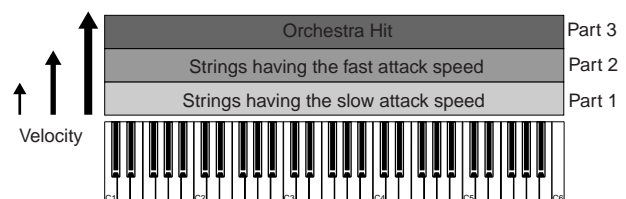

How Voices are assigned to Parts of a Performance

By default (when shipped from the factory), various types of Performances are provided in the User Banks. For some of these Performances, it may not be immediately obvious how to play them or use them, since they are more complicated than normal Voices. In this section, you'll learn the typical ways in which Performances are created, and thus better understand how to play and use them.

Each Performance can contain up to four different Parts. Here covers the typical four types of the Voice assignment to these four parts.

Performance Structure **Using the Arpeggio**

With this method, you can play all the parts of a band by yourself. This type of Performance also uses different Arpeggio types assigned to the individual Parts, making it even easier to sound like a full band. In the example below, the Drum pattern (by Arpeggio) will be played back indefinitely even when you release the notes, the Bass line (by Arpeggio) will be played back by your left hand performance, and the Guitar backing (by Arpeggio) or Piano Arpeggio will be played back by your right hand performance.

In addition, you can change the Arpeggio Type assignment for each Part by pressing any of the [SF1] – [SF5] buttons.

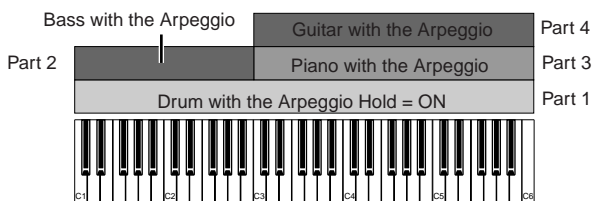

Using or combining the four methods described above gives you the ability to create a rich variety of Performances.

By default, many Performances stored in the User Banks may be created via the above methods. Try out various Performances and see which method is used for each.

Creating a Performance by combining Voices

After checking out the pre-programmed Performances in the User Banks, try creating your own original Performance. In this section, we'll create a Performance by combining two Voices.

Preparing to create a Performance (Initializing the Performance)

1 In the Performance Play mode, press the [JOB] button, and then the [F1] button.

The Initialize display is shown. Make sure that the check box of "All Parameters" is checked. For details about the Initialize function, refer to page 159.

2 Press the [ENTER] button. (The display prompts you for confirmation.)

3 Press the [INC/YES] button to initialize the Performance.



Keep in mind that when you execute the Store operation by pressing the [STORE] button here, the Performance at the destination will be replaced with the Initialized Performance above.

NOTE For details about the Store operation, refer to page 142.

4 Press the [PERFORM] button.

The current Performance name will change to "Initialized Perform" in the display.

NOTE When you initialize a Performance, the Voice at Preset Bank 1, Voice number 1 is assigned to each of all Parts and all the Parts are turned on by default.

Playing several Voices together (Layer)

Try combining two Voices by assigning your favorite Voice to Part2.

1 In the Performance Play display, press the [F2] button to call up the Voice display.

From this display, you can confirm what Voices are assigned to the Parts. You can also confirm that all the Parts are turned on after executing the Initialize function above.

2 Move the cursor to the Part 2, then select the desired Voice by setting a Bank and Voice number.

NOTE From this display, you can use the Category Search function to select a Voice. Like in the Voice mode (page 24), use the [CATEGORY SEARCH] button. Please note that the category names printed below the Bank buttons correspond not to the Performance Category but to the Voice Category.

3 Move the cursor to the PART SW check box for Parts 3 and 4, then remove the checkmark by pressing the [DEC/NO] button.

When the check mark is removed from the check box, the corresponding part is turned off. Here, turn the Part 1 and 2 on.



4 Play the keyboard.

The Part 1 (Piano Voice) and Part 2 (the Voice you have selected above) are sounded simultaneously in a layer.

Next, let's play different Voices with the left and right hands.

Split

You can play different Voices with the left and right hands by assigning one Voice to Part 1, with a note range in the lower section of the keyboard, and a different Voice to Part 2, with a note range in the higher section of the keyboard.

- 1 Move the cursor to the NOTE LIMIT HI of the Part 1.
- 2 Set the highest note of the Part 1 by pressing the corresponding key while holding the [SF6] KBD button.
The illustration of the keyboard indicates the specified note range in color.
- 3 Move the cursor to the NOTE LIMIT LO of the Part 2.
- 4 Set the lowest note of the Part 2 by pressing the corresponding key while holding the [SF6] KBD button.
The illustration of the keyboard indicates the specified note range in color.

5 Play the keyboard.

The notes you play with your left hand sound the Piano Voice (Part 1), while the notes you play with your right hand sound the different Voice (Part 2) you have selected.

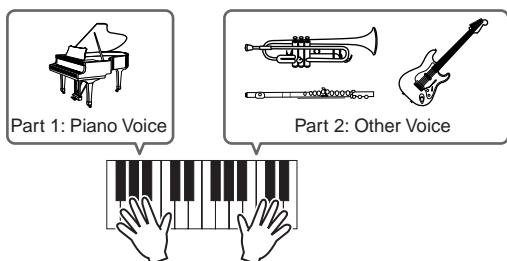

Adjusting the Part levels and storing the Performance

- 1 Adjust the Volume settings of Parts 1 and 2 by using the Control sliders.
- 2 Store the settings as a User Performance by pressing the [STORE] button.

For details, see page 142.

! CAUTION

If you are editing a Performance and you select a different Performance without storing your edited one, all the edits you've made will be erased.

! CAUTION

The preset data of the Performances is stored in the User Bank memory. Storing the Performance data you created erases the preset Performance data. If you wish to restore the preset data of the Performance, execute the Factory Set Job in the Utility mode, resulting that your original data will be erased. Consequently, make sure to save any important data to an external USB storage device to avoid losing your important data.

Changing the Arpeggio settings for each Part

Try changing the Arpeggio settings for each Part. You can assign the rhythm or backing pattern that best matches the desired style of music to the Performance.

- 1 From the Voice Play display, press the [F4] button to call up the Arpeggio display.
- 2 Press the desired one from the [SF1] – [SF5] buttons.

The lower half of the display will be changed depending on the pressed button. The top of the display (Common Switch, Sync Quantize Value and Tempo) is common to all the Sub Function buttons.

Settings common to the [SF1] – [SF5] buttons



Step 2

- 3 Select the Category, Sub Category and Type of the Arpeggio for each of the Parts 1 – 4.

The Category determines the instrument type, the Sub Category determines the rhythm type, and the Type determines the Arpeggio type itself. Set the BANK to "PRE" when using a Preset Arpeggio type.

Arpeggio Hold parameter



Note that the Arpeggio Hold parameter is useful as well as the Arpeggio type selection. When this parameter is set to "on," the Arpeggio playback continues even if the note is released. This parameter should be set to "on" when the Drum Voice is assigned to the Part and you

wish to have playback of the Arpeggio (rhythm pattern) continue regardless of whether you hold the note or not.

NOTE Categories and Sub Categories can easily be selected by calling up their respective lists on the display. When moving the cursor, for example, to the Category and pressing the [SF6] button, the Category List appears at the cursor location. You can select the desired one by using the data dial, [INC/YES] and [DEC/NO] buttons. After selecting, pressing the [ENTER] button actually calls up the selected Arpeggio type. This operation is very useful and convenient in selecting from the huge variety of available Arpeggios.

Go on and assign Arpeggio types in the same way to the other [SF] buttons as desired. After setting the Arpeggio related parameters, store the settings to internal memory as a User Performance. For details, see page 142.

Using the Controllers and Knobs

Like in the Voice mode, you can use the controllers and knobs in the Performance mode. Try selecting different Performances and using the controllers and knobs.

Recording your Performance

While experimenting and playing around with Arpeggios in the Performance mode, you may find some rhythm patterns and phrases that you like, and you may want to store them for future recall. The best and easiest way to capture these is to record your keyboard playing to a Song or Pattern.

Performance Record Structure

By using the Performance Record function, your keyboard performance for Parts 1 – 4 will be recorded to tracks 1 – 4 of the Song/Pattern respectively. Controller/Knob operations and Arpeggio playback as well as your keyboard playing in the Performance mode can be recorded to the specified track as MIDI events.

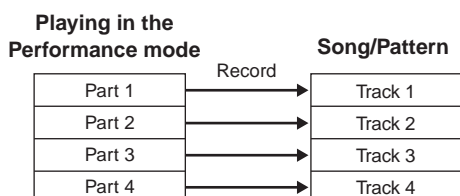

NOTE For details about the track structure of the Song/Pattern, see "Basic Structure" on page 61.

Recording the Melody and Arpeggio playback to the Song

When the Song is selected as destination of the Performance recording, you can record your keyboard playing with the Arpeggio without having to worry about measure limits or running out of recording space. It is a good idea, for example, to record your keyboard playing, freely calling up various Arpeggio types, then editing the Song later as necessary. You may even want to 'keep the recorder running' as you improvise, then listen back later and pick out the best parts to create your final Song. Try recording as shown in the instructions below.

- In the Performance Play mode, select a Performance for recording.**
- Press the [●] (Record) button to call up the Performance Record display.**

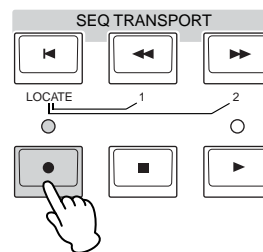



- Set the following parameters as required in the Performance Record display.**



- Sequencer Mode = "song"**
By setting this parameter to "song," you can record your keyboard performance to the Song.
- Song number**
Select a destination song. Executing Performance recording overwrites and erases all the previously recorded data of the specified Song. Make sure to select a Song which contains no data.
- Time Signature = "4/4"**
Set the same value here as that of the Arpeggio type. Normally, set this to "4/4."
- Tempo**
Set the desired tempo of the metronome and Arpeggio for recording.

5 Key On Start Switch =  (on)

When set to “on,” recording starts immediately when you press any note on the keyboard. Set this parameter to “on” when using the Arpeggio.

NOTE  Indicates the off status, whereas  indicates the on status.

6 Copy Performance Parameters = on

Enter the checkmark when you wish to copy the parameter settings for Parts 1 – 4 of the Performance to Parts 1 – 4 of the Song Mixing.

7 Click  (on)

Press the [F5] button to turn the metronome on if you wish to use the metronome.

4 Press any note to start recording.

Play the keyboard in time with the metronome. You can change the Arpeggio type and settings by pressing any of the [SF1] – [SF5] buttons while recording.

5 Press the  (Stop) button to stop recording and return to the Performance Play display.

After recording, press the [SONG] button to enter the Song Play mode then play the recorded Song. As desired, record the keyboard performance to another track in the Song Record mode and edit the recorded data in the Song Edit mode or Song Job mode to finalize the Song data.

Recording Arpeggio playback to a Pattern

If you record your keyboard playing along with Arpeggio playback in the Performance mode to a Pattern, you can quickly create full and complete rhythm patterns lasting just a few measures. These short “Patterns” of MIDI sequence data can be played back repeatedly in a loop and then conveniently used as ‘building blocks’ for your original Songs.

Follow the instructions below, playing with your favorite Arpeggios in the Performance mode, and record your improvisations to a Pattern. Once you’ve recorded three or four good Patterns, you’ll have enough building blocks to create a complete Song!

1 In the Performance Play mode, select a Performance for recording.

Find the Performance which triggers your favorite rhythm pattern or phrases via the Arpeggio.

2 Press the  (Record) button to call up the Performance Record display.

3 Set the following parameters as required in the Performance Record display.



1 Sequencer Mode = “pattern”

By setting this parameter to “pattern,” you can record your keyboard performance to the Pattern.

2 Pattern number

Select a destination Pattern number. Executing the Performance Recording overwrites and erases all the previously recorded data of the specified Pattern. Make sure to select a Pattern which contains no data.

3 Section

Select a Section to be recorded, from A – P. If you create several Sections, you can use them as rhythm variations within a single Song.

4 Section Length

Set the length of the Section to be recorded. Set the value to 1 – 4 according to the length of the current Arpeggio types.

5 Time Signature = “4/4”

Set the same value here as that of the Arpeggio type. Normally, set this to “4/4.”

6 Tempo

Set the desired tempo of the metronome and Arpeggio for recording.

7 Key On Start Switch =  (on)

When set to “on,” recording starts immediately when you press any note on the keyboard. Set this parameter to “on” when using the Arpeggio.

8 Copy Performance Parameters = on

Enter the checkmark when you wish to copy the parameter settings for Parts 1 – 4 of the Performance to Parts 1 – 4 of the Pattern Mixing.

9 Click  (on)

Press the [F5] button to turn the metronome on if you wish to use the metronome.

4 Press any note to start recording. The recording stops when the end of the Pattern length is reached.

Recording stops returns to the Performance Play display. Please note that loop recording is not available in the Performance Record mode, although it is available in the Pattern Record mode.

Create several Sections in the Performance Record mode, then create a Pattern Chain by connecting the Sections together to create an entire Song. For details, see page 213.

Step 4:

Creating Your Original Song

Now that you've learned some of the basic features of the MOTIF XS—including how to select Voices and Performances, play with the Arpeggios, and record your playing and Arpeggio playback to a Song or Pattern—you're ready to create your own original Song.

The MOTIF XS features a built-in multitrack sequencer for recording your keyboard performance as MIDI data. This function by itself is enough to create full, complex multi-instrument arrangements and complete Songs. However, the MOTIF XS (with optional DIMMs installed) allows you to also record and edit audio tracks—such as vocal and guitar parts.

Terminology

Song

Songs and Patterns are MIDI sequence data consisting of up to 16 tracks. A Song on this synthesizer is effectively the same as a Song on a MIDI sequencer, and playback automatically stops at the end of the recorded data.

Track

This is a memory location on the sequencer where your musical performances (made up of MIDI events) are stored. The MOTIF XS provides 16 tracks, which correspond to the 16 Parts of the Mixing.

Mixing

This is a program in which multiple Voices are assigned to Parts for multi-timbral play in the Song and Pattern modes. Each Mixing can contain up to 16 parts and a separate Mixing can be created for each Song.

NOTE For more information about the Song structure including the Track and Mixing, see page 59.

Realtime Recording

With realtime recording, the instrument functions in the same way as a MD recorder, recording the performance data as it is played. This allows you to capture all the nuances of an actual performance. Realtime Record features three available methods: Replace, Overdub and Punch In/Out. Replace lets you overwrite an already recorded track with new data. Overdub lets you add more data to a track that already contains data. Punch In/Out lets you re-record only over a specific area of the track.

Song Playback

Before you learn how to create a Song, you should know something about the mute/solo functions and how to use the sliders during Song playback. Call up a Demo Song (page 21) then try out the following operations while playing back the Demo Song.

Track mute

You can mute a specific track or tracks of the Song.

1 Press the [MUTE] button so that its lamp lights.

The lamps of the Number buttons light.

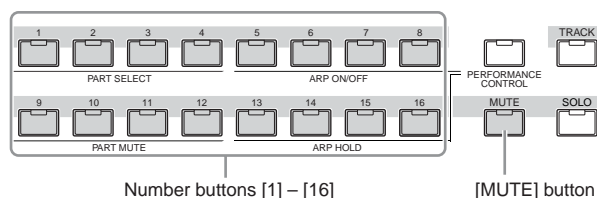

2 Press any of the Number buttons [1] – [16] so that its lamp will be turned off and the corresponding track will be muted.

Multiple tracks can be muted simultaneously.

3 Press the button which is turned off so that its lamp lights and the corresponding track will be sounded.

Track solo

You can solo a specific track of the Song.

1 Press the [SOLO] button so that its lamp lights.

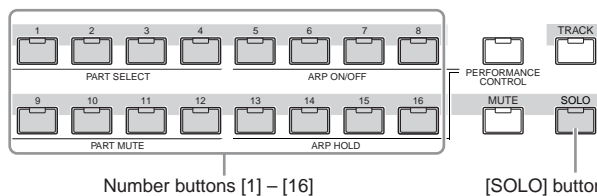

2 Press any of the number buttons [1] – [16] so that its lamp flashes to solo the corresponding track.

Press another number button to change the soloed track.

3 Press the [TRACK] or [MUTE] button to return to the original status.

Adjusting the volume of each Part

You can adjust the volume for each of eight Parts, using the panel sliders.

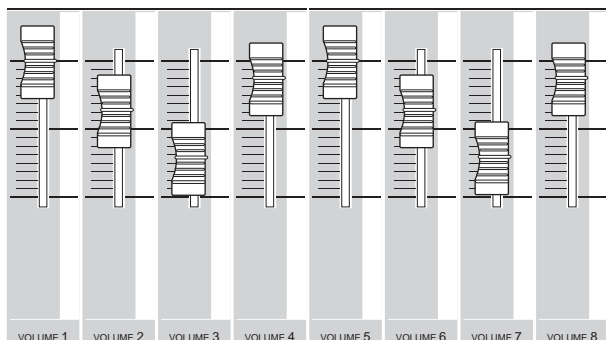

When one of Tracks 1 – 8 is currently selected, the eight sliders are used to adjust the volume for Parts 1 – 8. When one of Tracks 9 – 16 is selected, the sliders are used to adjust the volume for Parts 9 – 16. The track can be selected by turning the [TRACK] button on and pressing the desired Number button.

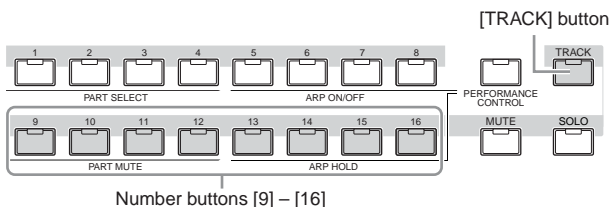

In addition to sliders, Knobs 1 – 8 can be used to affect the sound of the Song playback in real time. For details, see page 180.

Preparing for Realtime Recording

Soon you'll record your keyboard performance, recording a melody to Track 1. First though, you'll need to set up the MOTIF XS for realtime recording.

1 Press the [SONG] button to enter the Song Play mode then select a Song containing no data.

2 Press the [●] (Record) button to enter the Song Record mode.

The Record Setup display appears.

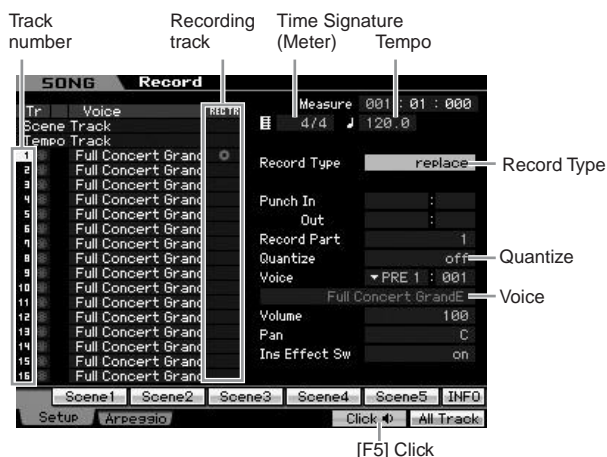

3 Set the following parameters on the Record Setup display.

3-1 With the [TRACK] lamp turned on, press the Number button [1] to set the recording track to 1. The red circle symbol is shown at the REC TR column of Track 1. The Record Part is automatically set to 1.

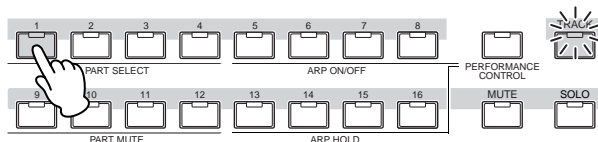

3-2 Move the cursor to Time Signature (Meter) then set the value. Here, set this to "4/4."

3-3 Move the cursor to Tempo then set the desired value. Here, set this to "144."

3-4 Move the cursor to Record Type then select "replace." This method overwrites the previous recorded data.

3-5 Set Quantize to "240." This convenient feature lets you automatically quantize the notes in real time, as you record. Quantize aligns the timing of note events to the nearest beat. Normally, the smallest note value in the notation sheet (you will play) should be set.

3-6 Select the Voice for recording by specifying the Bank and Number. The value set here is applied to Part 1 of the Mixing.

3-7 Press the [F5] button to turn the Metronome on. Pressing the [F5] button toggles the Metronome on and off.

Start Recording!

After completing recording setup above, press the [▶] (Play) button to start recording. Press the [▶] (Play) button so that its indicator flashes, then actually start recording after the count-in.



When you reach the end of the above notation, press the [■] (Stop) button to stop recording. If you've played any wrong notes, press the [■] (Stop) button, then try recording again.

After recording the above melody to Track 1, set the REC TR to 2 in the Recording Setup display, then record the bass line below to Track 2.

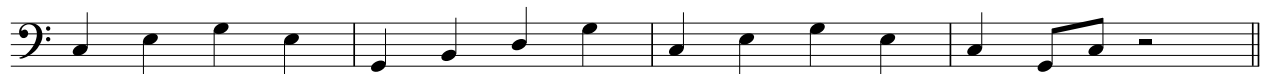

Correcting wrong notes

If you've played any wrong notes while recording and wish to correct them, press the [EDIT] button from the Song Play mode to go to the Song Edit mode. Song Edit lets you clean up and edit data of already recorded Songs or insert new data to the Songs.

Check for any mistakenly recorded or wrong events on the Event List display of the Song Edit mode, then correct them as needed.

1 Select the recorded Song then press the [EDIT] button to enter the Song Edit mode.

The Event List display appears.

2 Select the track to be edited.

Press the Number button [1] or [2]. The list of the MIDI events recorded in the previous section appears on the display.

NOTE Various MIDI events as well as note on/off data are shown on the display if you operate controllers such as Pitch Bend wheel, knobs and sliders while recording.

Location	Notes	Gate time	Selected track	Velocity
SON 6 Edit			TR: 1	Meas: 001
MEAS BEAT CLOCK	NOTE	GATE	SEL	VEL
001 : 01 : 192	Note D 2	000 : 320	048	
: : 434	Note E 2	000 : 207	051	
: 02 : 160	Note F 2	000 : 304	052	
: : 438	Note G 2	000 : 263	039	
: 03 : 165	Note A 2	000 : 306	045	
: : 436	Note B 2	000 : 278	049	
: 04 : 199	Note C 3	000 : 309	062	
: : 456	Note D 3	000 : 321	040	
002 : 01 : 214	Note C 3	000 : 222	062	
: : 405	Note B 2	000 : 307	064	
: 02 : 201	Note A 2	000 : 253	060	
: : 430	Note G 2	000 : 251	043	
: 03 : 194	Note F 2	000 : 241	059	

MEAS	BEAT	CLOCK
001	01	192

Measure Beat Clock

3 Use the Cursor buttons to move the cursor to the location to be edited.

After confirming the location at which the wrong data is recorded, use the Up/Down Cursor button to move the cursor to the location, then use the Left/Right Cursor button to move the cursor to the data type to be corrected. If you recorded a wrong note data at the 2nd note of the 3rd beat ("F" on the notation), move the cursor to the location indicated MEAS (measure) = 002, BEAT = 03 and CLOCK = 240. Then, move the cursor to NOTE if you wish to correct the note data and move the cursor to GATE if you wish to correct the gate time (note length).

NOTE Each key has a note name; for example, the lowest (farthest left) key on the keyboard corresponds to C1 and the highest (farthest right) key to C6. See page 10.

NOTE The Song location at which you edit or input the event is indicated by MEAS (measure), BEAT and CLOCK. A quarter-note (one beat when the time signature is set to "4/4") consists of 480 divisions. The length of each note (gate time) is indicated by Beat and Clock. For example, 001:000 is equivalent to the 4th note and 000:240 is equivalent to 8th note.

4 Turn the data dial to edit the value.

The entire line of the edited event will start flashing. You can also set the note directly from the keyboard, by holding down the [SF6] KBD button and pressing the desired note.

5 Press the [ENTER] button to actually enter the edited data (the entire line of the edited event will stop flashing).

Repeat steps 3 and 5 to correct other wrong events.

6 After completing editing, press the [EXIT] button to return back to the Song Play mode.

NOTE If you wish to delete an unnecessary note, move the cursor to the corresponding location, then press the [F6] button.

NOTE For details about the Event List, see page 192.

Creating a swing feel—Play Effect

The Play Effect feature lets you alter the rhythm in a variety of musically useful ways—for example, to take something that was recorded ‘straight’ and give it a swing feel. Let’s change the melody you recorded above, and apply a swing feel to it here.

1 From the Song Play display, press the [F2] button to call up the Play FX display.

Quantize Value of Track 1 Swing Rate of Track 2

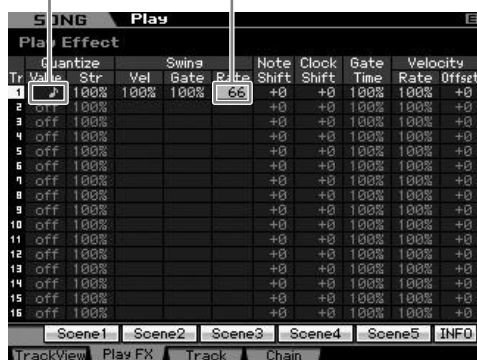

2 Move the cursor to the Quantize Value of Track 1, then select the 8th note icon.

3 Move the cursor to the Swing Rate of Track 1, then select “66%.”

This parameter determines the strength or amount of swing applied. Selecting “66%” delays each of the up beat notes to triplet values.

NOTE If you’ve recorded a bass part to track 2, make sure to apply the same settings to this track as well.

After completing the settings, press the [⏪] (Top) button, then press the [▶] (Play) button to start the Song. You can hear the swing feel playback.

Applying the Play Effect setting to the actual MIDI data

The Play Effect setting temporarily changes how the Song data is played back, but does not actually change the Song MIDI itself. If you want to save the Play Effect changes as part of the Song data (for example, as a Standard MIDI file), you can use the Job operation to permanently apply the Play Effect settings. To execute this Job, press the [JOB] button, the [F5] button, then select “05: Normalize Play Effect.” For details, see page 205.

Storing the created Song

After recording, make sure to store the created Song to internal memory by pressing the [STORE] button to call up the Song Store window.

CAUTION

When you execute the Store operation, the settings for the destination memory will be overwritten. Important data should always be backed up to a separate storage device.

Saving Song data to a USB storage device

Storing different Song data to the same destination memory, loading the Demo data, and executing the Initialize Job overwrites and erases the previously stored Song data. Be sure to save important data to a separate USB storage device connected to the USB TO DEVICE connector on the rear panel in the File mode. For details, see page 278. When you want to load a Song to DAW software on your computer, save the Song to a separate USB storage device as a Standard MIDI file. For details, see page 279.

NOTE The words “save” and “store” here refer to two different operations. The “Save” operation saves the created data as a file to an external device (in the File mode), whereas the “Store” operation stores the data to internal memory in each mode.

Step 5:

Creating a Pattern

The Patterns of the MOTIF XS feature short but fully realized instrumental parts that you can repeat (loop), combine, and arrange in any order you want—giving you the basic material for creating a Song. This section covers what you can do in the Pattern mode.

Pattern Structure

The MOTIF XS provides two modes for creating a Song: Song mode and Pattern mode.

In the Song mode, you can record the Song from the beginning to the end by playing the keyboard. In the Pattern mode, on the other hand, you can create the accompaniment of the Song by creating several sections, such as intro, melody A, main theme and ending by recording your rhythm pattern to the different Sections, then combining them as a Pattern Chain.

The Pattern mode also lets you record your rhythm patterns or riffs to the different Sections as you wish—and as the inspiration hits—then combine the Sections into a Pattern Chain to create a complete Song. Along with the Arpeggio feature and Performance recording, you have a wide range of easy-to-use tools to quickly create fully arranged, professional sounding Songs.

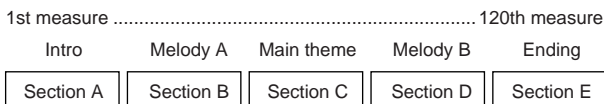

NOTE You can create a Pattern Chain (page 213) by programming the order of Sections. The created Pattern Chain can be converted to Song data by using the Pattern Chain Edit (page 215).

Listening to the Demo Patterns

Before creating your own original pattern, you should give a listen to some of the preset Demo Patterns. These specially recorded Patterns cover a wide range of musical genres and are full of great hints and ideas on how you can create and use Patterns in your own music.

- 1 Load the Demo Patterns following the procedure on page 21.
- 2 Press the [PATTERN] button to enter the Pattern mode.
The Pattern Play display will appear.

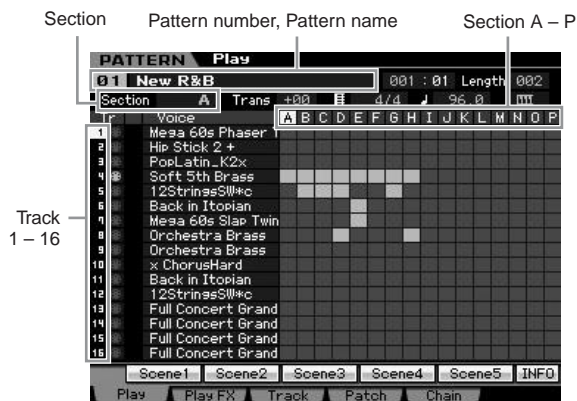

NOTE As indicated in the Pattern Play display, a Pattern consists of 16 separate tracks. Accordingly, a Pattern is played back via the various instrument Voices such as bass, guitar and keyboard.

- 3 Select a Pattern by turning the data dial.
- 4 Press the [▶] (Play) button to start playback of the Pattern.
The Pattern will be played back repeatedly until you press the [■] (Stop) button.
- 5 Change the Section from A – P.

Pressing the [A] – [H] buttons calls up Sections A – H and pressing the [USER 1] – [USER DR] and [ETHNIC] buttons calls up the Sections I – P.

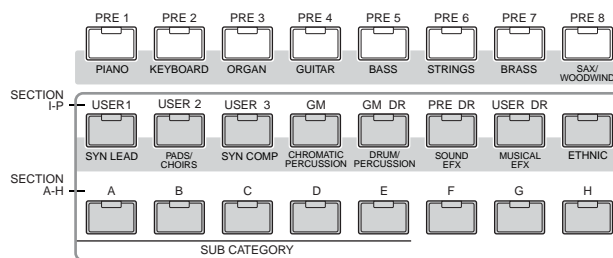

NOTE By changing the Sections, you can create rhythmic variations, and easily improvise arrangements (such as intro, verse, chorus, verse, chorus, ending) in real time.

Now, try other Patterns.

Viewing the Demo Pattern's Patch display

From the Patch display called up via the [F4] button, you can confirm what "Phrase" is assigned to each track of the Pattern Section.

A "Phrase" is a short musical/rhythmic passage consisting of a single track for a single instrument, such as drum, bass, and guitar. This MIDI sequence data can be used as small building blocks for a Song, and can be assigned to any track and any Section. A single Pattern provides memory space for 256 of your own original User Phrases.

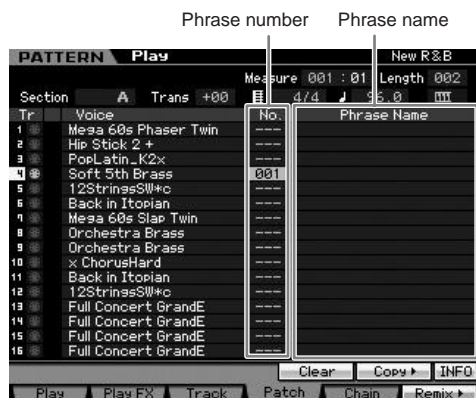

As indicated in this display, the performance data is recorded to the Phrase then the Phrase is assigned to the recording track. Note that the created Phrase can be assigned to a different track of the same/different Section.

Section A

Track 1	Phrase 001
Track 2	Phrase 002
:	:
Track 16	Phrase 003

Section B

Track 1	Phrase 002
Track 2	Phrase 003
:	:
Track 16	Phrase 004

Phrase 001	MIDI data
Phrase 002	MIDI data
Phrase 003	MIDI data
Phrase 004	MIDI data
:	:

Try changing the Phrase for each track and assign each Phrase to an empty track.

NOTE Please keep in mind that Phrases are provided only for the Demo Patterns and the number of provided Phrases differs depending on the Demo Pattern. When you want to use a Phrase assigned to a different Pattern, execute the Copy Phrase function by using the [SF5] Copy button. For details, see page 212.

Viewing the Demo Pattern's Mixing display

A Mixing refers to the multi-timbral tone generator settings for the Pattern playback. A Mixing consists of 16 Parts, which correspond to the tracks, and in this display you can adjust the various mixing related parameters for each Part. From the Pattern Play display, press the [MIXING] button to call up the Mixing display, letting you confirm the Mixing settings for each Part: Voice, volume, pan, etc. Now, let's adjust the Mixing parameters in the Mixing display.



1 From the Pattern Play display, press the [MIXING] button to enter the Mixing mode. The Mixing display will appear.

2 To select the desired Part, press the [TRACK] button (the lamp lights), then press the appropriate Number button [1] – [16].

Here, select the Part corresponding to the track to which the Phrase is assigned.

NOTE If you want to confirm to which track the Phrase is assigned, press the [EXIT] button to return to the Pattern Play display.

3 Move the cursor to the Bank and Number, then change the Voice by specifying the Bank and Number.

If you press the [PROGRAM] button (the lamp lights), you can select the desired Voice by using the appropriate Bank buttons, Group buttons and the Number buttons.

4 Move the cursor to the desired parameter, such as pan or volume, then rotate the data dial to change the value.

NOTE If you wish to edit more detailed Mixing parameters, enter the Mixing Edit mode by pressing the [EDIT] button. For more information about the Mixing Edit, see page 233.

The Mixing settings are included in each Pattern and can be stored as an entire Pattern. For instructions on storing a Pattern, see page 218.

Creating a Pattern by using Arpeggio

In addition to creating a Pattern by recording your keyboard performance conventionally, you can also use the powerful Arpeggio playback features of the MOTIF XS (described below) and even record audio data from commercially available sample CDs.

This section explains how to create a Pattern by using Arpeggio.

- 1 Press the [PATTERN] button to enter the Pattern Play mode.
- 2 Press the [RECORD] button to call up the Record Setup display.
- 3 Press the [F2] button to call up the Record Arpeggio display.

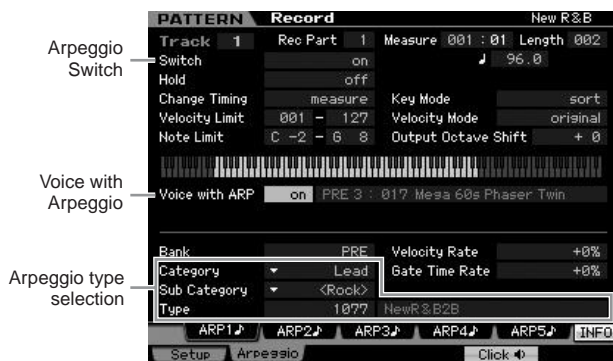

- 4 Set the following parameters as required in the Arpeggio Record display.

- 4-1 Set the Switch parameter to on.
- 4-2 Set the Voice with Arpeggio (ARP) parameter to on. When this is set to "on," the Voice matching the selected Arpeggio type is automatically called up each time the Arpeggio type is changed.
- 4-3 Select the Arpeggio type by specifying the Category, Sub Category and Type.

- 5 Press the [F1] button to call up the Record Setup display.



- 6 Set the following parameters in the Record Setup display.

- 6-1 To select the desired track, press the [TRACK] button (the lamp lights), then press the appropriate Number button [1] – [16].
- 6-2 Set the Time Signature to "4/4."
- 6-3 Set the Pattern length to a value equivalent to the Arpeggio length.
- 6-4 Turn the Keyboard Start icon "on."
- 6-5 Set the Loop parameter to "off."
- 6-6 Set the Quantize parameter to "off."

- 7 After completing setup, press a note on the keyboard to start recording.

Recording will stop automatically when the last measure (specified by the Length) is reached.

Creating a Pattern with audio—Sampling

In this section, you'll learn how to record audio data (from commercially available sample CDs, for example) to the Pattern track, using the versatile Sampling feature. After recording the audio, you can slice it into individual Samples, which can then be played back at any desired tempo—without compromising the sound or introducing pitch changes. These step-by-step instructions assume that the recorded audio data is a one-measure drum pattern in 4/4 time.

Important

In order to use the Sampling function, DIMM modules must be installed to the instrument. For details on installing DIMMs, see page 295. The recorded (edited) sample data residing temporarily in DIMM is lost when the power is turned off. Make sure to prepare a USB storage device or a computer connected to the same network as the MOTIF XS before using the Sampling function.

Sampling Setup

- 1 Turn the power off and set the GAIN knob on the rear panel to the minimum.

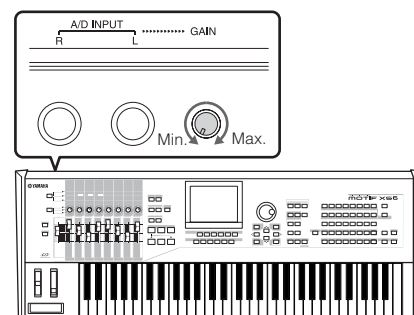

- 2 Connect an audio device (CD player, etc.) to the A/D INPUT connector on the rear panel.

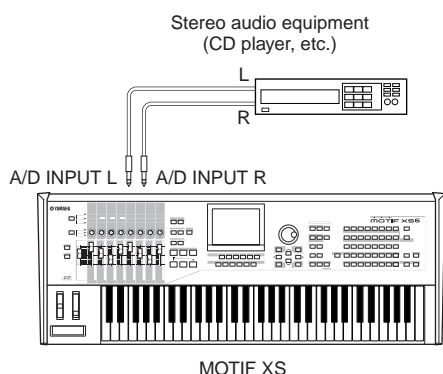

- 3 Turn the power of the MOTIF XS on.
- 4 Press the [UTILITY] button to enter the Utility mode, then press the [F2] button to call up the I/O display.

- 5 Set the Mic/Line parameter to “line.”

Sampling Setup is completed.

Sampling

- 1 Press the [PATTERN] button to enter the Pattern Play mode, then select a Pattern and Section to be recorded.
- 2 Press the [INTEGRATED SAMPLING] button to enter the Sampling mode.
- 3 Press the [F6] button to call up the Setup display.
- 4 Set the following parameters as required in the Setup display.



- 1 Set the Recording Type to “slice+seq.”
- 2 Set the Input Source to “A/D Input.”
- 3 Set the Stereo/Mono parameter to “stereo.”
- 4 Set the Record Next to “off.”
- 5 Set the Frequency to “44.1 kHz.”
- 6 Select the destination track.

- 5 Press the [F6] button to call up the Standby display.

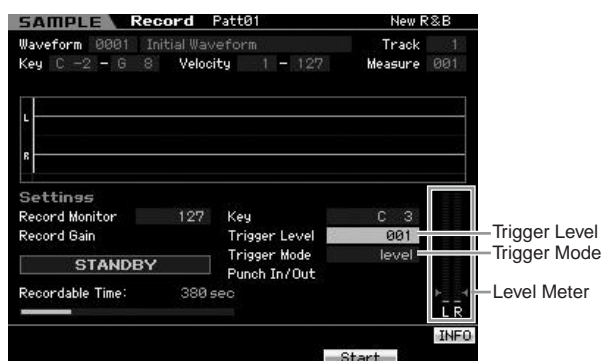

- 6 Set the Trigger Mode to “level,” then set the Trigger Level to “1.”

NOTE The Trigger Mode parameter lets you determine how the Sampling actually starts. When Trigger Mode is set to “level,” sampling will begin automatically as soon as the input signal exceeds the specified Trigger Level. Since Trigger Level is set to “1” here, sampling will begin automatically as soon as the audio signal is input from the CD player. When the Trigger mode is set to “manual,” actual Sampling starts by pressing the [F5] Start button.

- 7 Play back the audio source (CD player) and adjust the audio input level with the GAIN knob on the rear panel to get the appropriate level. Adjust the GAIN so that the level is high enough for a clean recording but not so high as to cause clipping or distortion.

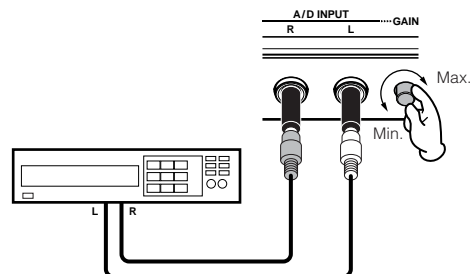

NOTE Please note that the input sound may be clipped or distorted if the meter reaches maximum level.

- 8 Stop playback of the audio source (CD player).
- 9 Press the [F5] button to call up the WAITING indicator (Trigger Standby status).

10 Start the CD player.

Since the Trigger Level is set to “1” here, sampling will begin automatically as soon as the audio signal is input from the CD player. In this example, record a one-measure drum pattern from the CD.

11 Press the [F6] button to stop sampling, then stop the CD player.

The wave of the recorded audio signal will be shown on the display.

12 Press the [SF1] button to hear your newly recorded sound.

Sample Edit **Setting the End Point of the Recorded Sample**

The start point of the recorded Sample will probably be at the correct place—the first beat of the measure—since Sampling start was set to begin automatically with the Trigger Level setting. However, the end point may not be at the end of the measure as desired, since Sampling was stopped manually. Accordingly, you may need to edit the End Point of the recorded sample so that playback of the recorded sample properly matches the beat timing.

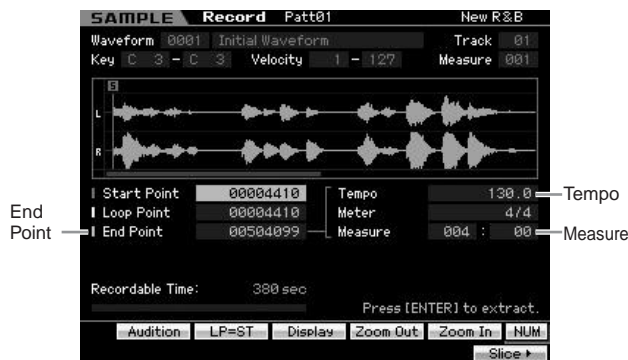

1 Press the [SF2] button once or twice so that the LP=ST is shown.

2 Move the cursor to the End Point then adjust the value by using the data dial.

Press the [SF1] button to hear the sample. Adjust the End Point so that the Sample plays back smoothly and continuously without stutters, glitches or problems in timing.

3 After setting the Ending Point, press the [ENTER] button to delete unnecessary data (located after the End point).

After the display prompts you for confirmation, then press the [INC/YES] button to execute the Extract operation.

NOTE Many commercially available sample/loop CDs include information on the tempo, measure and meter of specific

loops. If this information is available, enter the appropriate values to the parameters above.

Sample Edit **Slice**

Next, let's use the Slice function to match the recorded sample with the tempo. This Slice feature lets you automatically divide the recorded sample into separate “slices.” These slices are then assigned to successive notes and arranged as MIDI data. This lets you manipulate the component parts of your sample loops as MIDI data, and gives you the power to easily change tempo and even the rhythmic feel, without disturbing the pitch or sound quality.

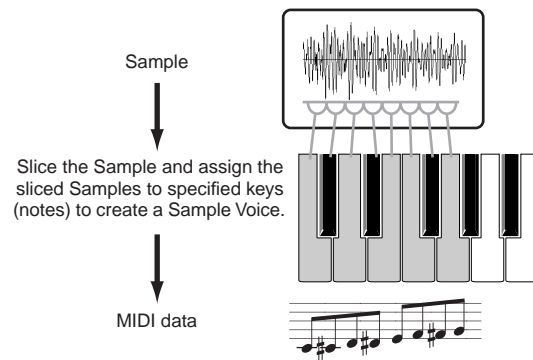

NOTE Before executing the Slice operation, you'll need to accurately adjust the length of the sample by adjusting the End Point.

1 Press the [F6] button to call up the Slice display.

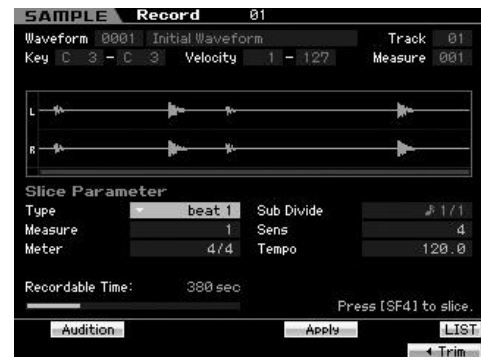

2 Set the following parameters on the Slice display.

Since the recorded sample is a one-measure drum pattern in 4/4 time, set the parameters below as shown.

2-1 Set the Slice Type to “beat 1.”

2-2 Set the Measure to “1.”

2-3 Set the Sensitivity to “4.”

3 Press the [SF4] button to execute the Slice operation.

4 Press the keys to which the sliced sample are assigned in order (from C1 for the MOTIF XS6, E0 for the MOTIF XS7, and A-1 for the MOTIF XS8) to confirm whether or not the Sample has been sliced properly.

Listen carefully to the results. If you're not satisfied, press the [SF4] Apply button again to abort the Slice operation and return the sample to the original status, then try the operation again. Repeat steps 2 – 4 by trying another Slice Type and adjusting the value of the Sensitivity until you are satisfied with the sound.

5 Press the [ENTER] button to fix the Slice result as Sample data.

6 Press the [PATTERN] button to call up the Pattern Play display then press the [▶] (Play) button to hear the sliced Sample.

You can change the tempo of the sliced rhythm pattern. Try changing the tempo in the Pattern Play mode.



Storing the Pattern and Saving the Sample

After the Sampling operation, store the created Pattern to internal memory then save the Sample to a separate USB storage device. For instructions on storing a Pattern, see page 218. For instructions on saving a Sample, see page 279.

⚠ CAUTION

Sample data will be lost when the power is turned off. Make sure to save the Sample data to a USB storage device or to a computer connected to the same network as the MOTIF XS in the File mode after the Sampling operation.

NOTE After creating several Patterns (Sections), use the Pattern Chain feature (page 213) to string them together.

Using a Computer

Connecting to a Computer

Although the MOTIF XS is exceptionally powerful and versatile all by itself, connecting it to a computer—via USB or IEEE1394 cable—provides even greater power and versatility. This feature lets you transfer audio data (via an IEEE1394 cable only) and MIDI data (via both USB and IEEE1394 cable) between the MOTIF XS and your computer. In this section you'll learn how to make the connections.

NOTE This section shows how to connect the MOTIF XS to a computer directly. Other MIDI devices can be connected between MOTIF XS and the computer. For details about connection between the MOTIF XS and another MIDI device, see page 83. For details about connection between the MIDI device and the computer, refer to the owner's manual of the particular MIDI device.

Using a USB TO HOST connector

This section shows you how to connect the MOTIF XS to a computer via a USB cable. Note that the MIDI data can be transmitted through a USB cable.

NOTE Since the MOTIF XS has no built-in speakers, you'll need an external audio system or a set of stereo headphones to properly monitor it. For details, refer to "Start Guide" on page 19.

1 Download the USB-MIDI driver from our website:

http://www.global.yamaha.com/download/usb_midi/

NOTE Information on system requirements is also available at the above web site.

NOTE The USB-MIDI driver may be revised and updated without prior notice. Make sure to check and download the latest version from the above site.

2 Install the downloaded USB-MIDI driver to the computer.

For instructions on installing, refer to the online Installation Guide included in the downloaded file package. When connecting the MOTIF XS to a computer in the Installation procedure, connect the USB cable to the USB TO HOST of the MOTIF XS and the USB connector of the computer as shown below.

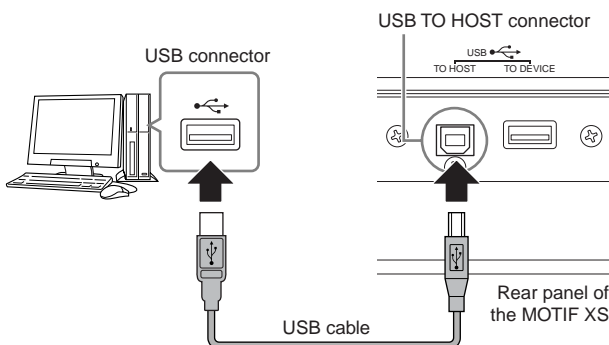

3 Make sure that the USB TO HOST connector of the MOTIF XS is enabled.

Press the [UTILITY] button to enter the Utility mode, then press the [F5] button followed by the [SF2] button

to call up the MIDI display (page 267). Set the MIDI In/Out parameter to "USB."

4 Press the [STORE] button to store this setting.

Precautions when using the USB TO HOST connector

When connecting the computer to the USB TO HOST connector, make sure to observe the following points. Failing to do so risks freezing the computer and corrupting or even losing the data. If the computer or the instrument freezes, turn the power to the instrument off or restart the computer.

CAUTION

- Before connecting the computer to the USB TO HOST connector, exit from any power-saving mode (such as suspended, sleep, standby) of the computer.
- Before turning on the power to the instrument, connect the computer to the USB TO HOST connector.
- Execute the following before turning the power to the instrument on/off or plugging/unplugging the USB cable to/from the USB TO HOST connector.
 - Quit any open applications (such as MOTIF XS Editor and sequencer software).
 - Make sure that data is not being transmitted from the instrument. (Data is transmitted only by playing notes on the keyboard or playing back a Song.)
- While a USB device is connected to the instrument, you should wait for six seconds or more between these operations: (1) when turning the power of the instrument off then on again, or (2) when alternately connecting/disconnecting the USB cable.

MIDI channels and MIDI ports

MIDI song data can be sent independently over sixteen separate channels, and this instrument is capable of simultaneously playing sixteen separate parts via these channels. While a single MIDI cable is equipped to handle data over up to sixteen channels simultaneously, a USB connection or a IEEE1394 connection is capable of handling far more—thanks to the use of MIDI ports. Each MIDI port can handle sixteen channels, and the USB connection or IEEE1394 connection allows up to eight ports, letting you use up to 128 channels (8 ports x 16 channels) on your computer.

When connecting the MOTIF XS to a computer using a USB cable or an IEEE1394 cable, the MIDI ports are defined as follows:

Port 1

The tone generator block in the MOTIF XS can recognize and use only this port.

When playing the MOTIF XS as a tone generator from the external MIDI instrument or computer, you should set the MIDI Port to 1 on the connected MIDI device or computer.

Port 2

This port is used to control the DAW software on the computer from the MOTIF XS by using the Remote Control feature.

Port 3

This port is used as the MIDI Thru Port. The MIDI data received over Port 3 via the USB TO HOST or mLAN connector will be re-transmitted to an external MIDI device via the MIDI OUT connector. The MIDI data received over Port 3 via the MIDI IN connector will be re-transmitted to an external device (computer, etc.) via the USB TO HOST or mLAN connector.

When using a USB connection or IEEE1394 connection between the MOTIF XS and the computer, make sure to match the MIDI transmit port and the MIDI receive port as well as the MIDI transmit channel and the MIDI receive channel following the above description.

Using a MIDI interface

Use standard MIDI cables to connect the MOTIF XS to a computer, connecting the MIDI IN and MIDI OUT terminals on the MOTIF XS to the appropriate terminals on a MIDI interface.

Using a mLAN connector

This section shows you how to connect the MOTIF XS to a computer via an IEEE1394 (FireWire) cable. Note that the audio data as well as MIDI data can be transmitted through an IEEE1394 cable.

NOTE The MOTIF XS6/7 can be connected to the mLAN compatible device or a computer equipped with the IEEE1394 connector only when an optional mLAN16E2 has been installed to the MOTIF XS6/7. For instructions on installing the mLAN16E2, see page 294.

NOTE The mLAN-equipped MOTIF XS can provide up to 6 Mono In (3 Stereo In), 16 Mono Out (8 Stereo Out) audio channels and 3 MIDI In/3 MIDI Out channels.

1 Download the proper AI Driver from our website:

<http://www.yamahasyth.com/download/>

NOTE Information on system requirements is also available at the above web site.

NOTE The AI Driver may be revised and updated without prior notice. Make sure to check and download the latest version from the above site.

2 Install the downloaded AI Driver to the computer.

For instructions on installing, refer to the online Installation Guide included in the downloaded file package. When connecting the MOTIF XS to a computer in the Installation procedure, connect the IEEE1394 cable to the mLAN connector of the MOTIF XS and the IEEE1394 connector of the computer as shown below.

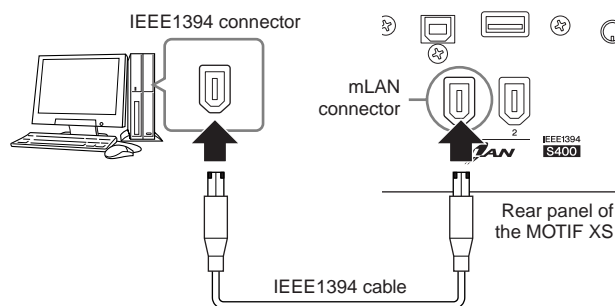

CAUTION

Be sure to connect the IEEE1394 (mLAN) cable plug to the mLAN jack with the correct orientation.

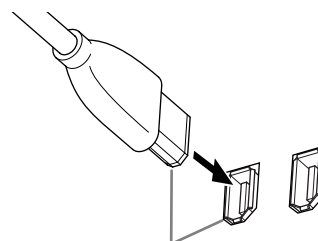

Plug in the jack with the correct orientation.

NOTE For optimum results, use an IEEE1394 cable shorter than 4.5 meters.

3 Make sure that the mLAN connector of the MOTIF XS is enabled for MIDI communication.

Press the [UTILITY] button to enter the Utility mode, then press the [F6] button followed by the [SF2] button to call up the MIDI display (page 267). Set the MIDI In/Out parameter to "mLAN."

4 Make sure that the mLAN connector of the MOTIF XS is enabled for audio communication.

When transmitting audio signals via the mLAN connector, set the Output Select parameter of the MOTIF XS. When receiving audio signals via the mLAN connector, set the mLAN audio input part parameters of the MOTIF XS. For details, see page 45.

5 Press the [STORE] button to store this setting.

What you can do with the IEEE1394 connection

You can integrate the MOTIF XS with DAW software on a computer by connecting the mLAN equipped MOTIF XS (MOTIF XS6/7 to which the optional mLAN16E2 is installed or MOTIF XS8) to a computer in a peer-to-peer arrangement. For details, see below.

- Transfer data of multiple audio channels between the MOTIF XS and the computer (up to 16 channels from the MOTIF XS to the computer and up to 6 channels from the computer to the MOTIF XS)
- Simultaneously record to the sequence software (a) your performance on the MOTIF XS and (b) the performance of the computer sequence software that uses the MOTIF XS as a MIDI tone generator
- Monitor via the MOTIF XS the audio output from the computer and the audio output from the MOTIF XS
- Use Cubase 4 together with the MOTIF XS with a variety of convenient functions (page 49)

NOTE The capabilities and uses of connecting the MOTIF XS to a computer via an IEEE1394 cable in a peer-to-peer arrangement is referred to as "mLAN" in this Owner's Manual and the MOTIF XS instrument. For details and the latest information on mLAN, refer to the following URL:
<http://www.yamahasyth.com/>

Signal flow of audio and MIDI data via an IEEE1394 cable

The illustration below shows the flow of audio signals and MIDI messages when connecting the MOTIF XS and a computer via an IEEE1394 cable.

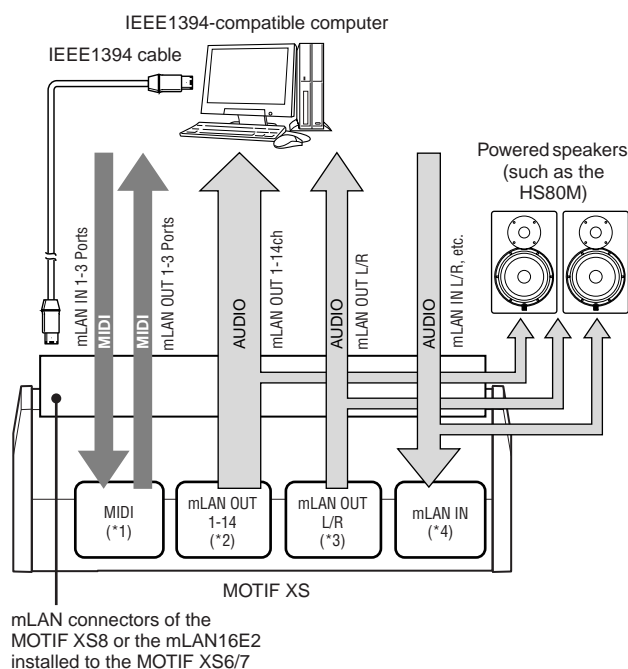

MIDI transmission/reception (*1)

Setting the port on the MOTIF XS is not necessary since the MIDI Port of the MOTIF XS is automatically fixed according to the application. For information on which port should be selected on your computer, refer to page 43.

Audio signal transmission

■ mLAN OUT 1 – 14 (*2)

Audio signals are output via mLAN OUT 1 – 14 when the MOTIF XS Output Select parameter is set to any of the settings "m1&2" – "m13&14" and "m1" – "m14" in one of the following displays.

[VOICE] (When a Drum Voice is selected) → [EDIT] → Key selection → [F1] Oscillator (page 130)

[VOICE] → [UTILITY] → [F4] VoiceAudio → [SF1] Output (page 266)

[PERFORM] → [EDIT] → [COMMON EDIT] → [F4] Audio In → [SF1] Output (page 148)

[PERFORM] → [EDIT] → Part selection → [F1] Voice → [SF2] Output (page 153)

[SONG]/[PATTERN] → [MIXING] → [EDIT] → [COMMON EDIT] → [F4] Audio In → [SF1] Output (page 234)

[SONG]/[PATTERN] → [MIXING] → [EDIT] → Part selection → [F1] Voice → [SF2] Output (page 235)

■ OUTPUT L/R (*3)

The audio signal is output via both the OUTPUT L/R and mLAN OUT L/R channels when the Output Select parameter described above is set to "L&R."

Audio signal reception (*4)

The mLAN IN Main Out Monitor L/R and mLAN IN Assignable Out Monitor L/R are available as well as the mLAN IN L/R as the mLAN audio input channel of the MOTIF XS. These channels can be used for monitoring the sound when using the DAW software on the computer. The audio signal received via the mLAN IN Main Out Monitor L/R will be output via the OUTPUT L/R jacks while the audio signal received via the mLAN IN Assignable Out Monitor L/R will be output via the ASSIGNABLE OUTPUT L/R jacks. Setting the audio output channel on the computer determines which channel is used. As for audio signals received via the mLAN connector, parameters such as volume and output channel can be applied as the mLAN audio input part of the MOTIF XS. The display of these parameter settings differs depending on the mode, as listed below.

[VOICE] → [UTILITY] → [F4] VoiceAudio → [SF1] Output → mLAN setting (page 266)

[PERFORM] → [EDIT] → [COMMON EDIT] → [F4] Audio In → [SF1] Output → mLAN setting (page 148)

[SONG]/[PATTERN] → [MIXING] → [EDIT] → [COMMON EDIT] → [F4] Audio In → [SF1] Output → mLAN setting (page 234)

mLAN Audio Channels of the MOTIF XS and the computer

When connecting the MOTIF XS to a computer via an IEEE1394 cable, set the audio channel of the computer referring to the table below.

Input Channel of the MOTIF XS	Output Channel of the computer
mLAN IN Main Out Monitor L, R	1, 2
mLAN IN L, R	3, 4
mLAN IN Assignable Out Monitor L, R	5, 6
Output Channel of the MOTIF XS	Input Channel of the computer
mLAN OUT L, R (L&R)*	1, 2
mLAN OUT 1 – 14 (m1 – m14)*	3 – 16

Creating a Song by Using a Computer

By connecting the MOTIF XS to your computer via USB or mLAN, you can use a DAW or sequence software on the computer to create your own original songs. This section contains an overview on how to use a DAW or sequence software on the computer with the MOTIF XS after connecting.

NOTE The acronym DAW (digital audio workstation) refers to music software for recording, editing and mixing audio and MIDI data. The main DAW applications are Cubase, Logic, SONAR and Digital Performer. Though all of these can be effectively used with the MOTIF XS, we recommend using Cubase when creating songs together with the instrument.

Song playback from a computer using the MOTIF XS as a tone generator

The instructions below show how to use the Song or Pattern mode of the MOTIF XS as a MIDI tone generator. In this case, actual MIDI sequence data is to be transmitted from a DAW or sequencer on the computer.

Setting up the MOTIF XS

- 1 Press the [SONG] or [PATTERN] button to enter the Song mode or Pattern mode.
- 2 Select a Song or Pattern which contains no data.
- 3 Press the [MIXING] button to enter the Mixing mode.
- 4 Set up the Mixing for parts 1 – 16 as necessary.
For details about Mixing, see page 229.

Setting up the DAW on the computer

- 1 Set the MIDI output port of the tracks to Port 1 of USB or mLAN.
When connecting via a USB cable, set this to “Yamaha MOTIF XS6(7, 8)-1” or “YAMAHA MOTIF XS6(7, 8) Port1.” When connecting via an IEEE1394 cable, set this to “mLAN MIDI Out” or “MOTIF XS.”
- 2 Enter the MIDI data to each track of the DAW/sequencer on the computer.

The tone generator settings of the part corresponding to the MIDI track will be set in the Mixing mode on the MOTIF XS.

NOTE By using the MOTIF XS Editor, you can create your original Mixing setup of the MOTIF XS from your computer. The created Mixing setup can be saved as a file for future recall.

NOTE By using the Studio Manager V2, you can use the MOTIF XS Editor as a plug-in software within Cubase and save the edited Mixing setup of the MOTIF XS as a project file of Cubase.

Recording your performance on the MOTIF XS to computer

The instructions below show how to use the MOTIF XS as a Master Keyboard. The note events you play on the MOTIF XS are transmitted and recorded to a track of a DAW/sequencer software on your computer, then returned back to the tone generator block of the MOTIF XS.

Setting up the MOTIF XS

- 1 Set Local Control to “off.”
Press the [UTILITY] button to enter the Utility mode, then press the [F5] followed by the [SF2] button to call up the MIDI display (page 267). Move the cursor to the Local Control the set this parameter to “off.” When MIDI Thru is set to “on” in a DAW/sequencer software on your computer, the note events you play on the MOTIF XS are transmitted to the computer then returned back to the MOTIF XS, producing a “double” sound, since the tone generator block is receiving performance data (MIDI data) from both the keyboard directly and the computer. To prevent such a situation, you need to separate the keyboard block from the tone generator block of the MOTIF XS. This is why Local Control should be set to “off.”
- 2 Press the [STORE] button to store this setting.
- 3 Press the [SONG] or [PATTERN] button to enter the Song mode or Pattern mode when you want to using the MOTIF XS as a multi-timbral tone generator.

Setting up the DAW on the computer

- 1 Set MIDI Thru to “on” on the DAW.
By setting MIDI Thru to “on,” the MIDI data generated by playing the keyboard and transmitted to the computer will be returned back to the MOTIF XS. As shown in the example below, the MIDI data transmitted from the MOTIF XS then recorded to the computer via MIDI channel 1 will be returned back from the computer to the MOTIF XS via MIDI channel 3 according to the setting of the recording track. As a result, the tone generator of the MOTIF XS will sound the MIDI data generated by playing the keyboard as the MIDI data of channel 3.

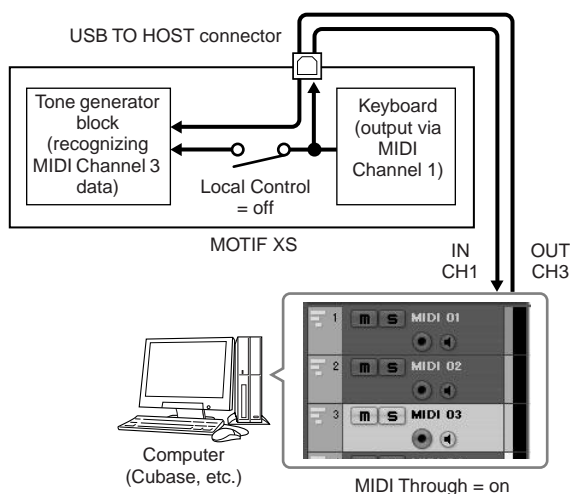

NOTE The above explanation can be applied to the case when connecting the MOTIF XS to the computer via an IEEE1394 cable as well as via a USB cable.

Using another tone generator together with the MOTIF XS

By using another tone generator (such as the MOTIF-RACK ES) together with the MOTIF XS as illustrated below, you can play up to 32 Parts simultaneously.

Setting up the MOTIF XS

- 1 Connect the MIDI OUT connector to the MIDI IN connector of the external tone generator module such as MOTIF-RACK ES, as illustrated below.
- 2 Make sure to set the MOTIF XS to the multi-timbral tone generator by entering the Song mode or Pattern mode.

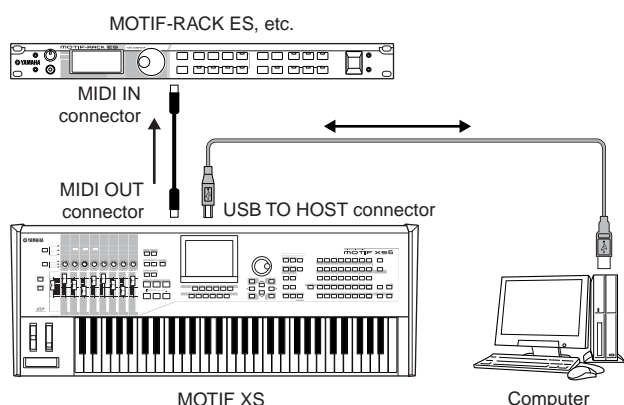

Setting up the DAW on the computer

- 1 Set the MIDI output port of the tracks (for playing the MOTIF XS) to Port 1 of USB or mLAN.
When connecting via a USB cable, set this to "Yamaha MOTIF XS6(7, 8)-1" or "YAMAHA MOTIF XS6(7, 8) Port1."
When connecting via an IEEE1394 cable, set this to "mLAN MIDI Out" or "MOTIF XS."

- 2 Set the MIDI output port of the tracks (for playing the MOTIF-RACK ES) to Port 3 of USB or mLAN.

When connecting via a USB cable, set this to "Yamaha MOTIF XS6(7, 8)-3" or "YAMAHA MOTIF XS6(7, 8) Port3."
When connecting via an IEEE1394 cable, set this to "mLAN MIDI Out (3)" or "MOTIF XS MIDI OUT."

NOTE Please keep in mind that the MIDI Thru Port of the MOTIF XS (in other words, the port with which the received MIDI data is to be transmitted to another external device via the MIDI OUT connector) is fixed to 3.

Using the MOTIF XS as an audio interface

By using the A/D INPUT connector and mLAN connector, the MOTIF XS can conveniently be used as an audio interface for your computer. Note that you need install the optional mLAN16E2 when using the MOTIF XS6/7 for this application.

Setting up the MOTIF XS

- 1 Set the parameters as below so that the audio signal input via the A/D INPUT connector is output via the mLAN connector to the computer.
In the Voice mode, press the [UTILITY] button to enter the Utility mode, press the [F4] button followed by the [SF1] button to call up the Output display (page 265). From this display, move the cursor to the Output Select of the A/D Input, then select one of the following settings: "m1&2" – "m9&10," "m11&12" and "m13&14."
- 2 Set the parameters as below so that the audio signal output from the computer and input to the MOTIF XS via the mLAN connector is output from the OUTPUT L/R or ASSIGNABLE OUTPUT L/R connectors.
From the Output display called in step 1, move the cursor to the Output Select of the mLAN, then select "L&R" or "asL&R."

NOTE The setting here applies to the audio signals output from mLAN ports 3 and 4 of a computer.

- 3 Press the [STORE] button to store this setting.

Setting up the DAW on the computer

Install the AI Driver and make the proper settings. Select ASIO mLAN (when using an ASIO driver) or mLAN Audio Out (when using a WDM driver) as Audio driver.

NOTE Confirming the Audio Ports is much easier when using Cubase and installing the Extensions for Steinberg DAW. For details, see below.

Integration Between Yamaha Editors and Cubase

Yamaha and Steinberg have formed a partnership to develop a useful and convenient environment for effectively using Yamaha hardware (including the MOTIF XS) together with Steinberg software. This section explains how you can use Cubase 4 and the special joint Yamaha/Steinberg Studio Connections software.

For more details, including the latest information and software downloads, refer to the following URL.
<http://www.yamahasynth.com/download/>

What you can do by using Cubase 4 together with the MOTIF XS

IMPORTANT

To use the following features and operations, you'll first need to install the AI driver and Extensions for Steinberg DAW.

Automatic setting of the IEEE1394 connection

When using a hardware synthesizer such as the MOTIF XS with computer software, a variety of settings—such as audio connection, driver setup and port setup—must be made. Those complicated settings will be made automatically for you as soon as you connect the MOTIF XS to a computer via an IEEE1394 cable.

Indicating the Audio/MIDI port including the model name when connecting via an IEEE1394 cable

The Device Setup window of the Cubase indicates the Audio Port or MIDI Port including the model name such as “MOTIF XS Main L” and “MOTIF XS MIDI IN,” making it easy to confirm the current connection or change the connection. For details, see the illustration below.

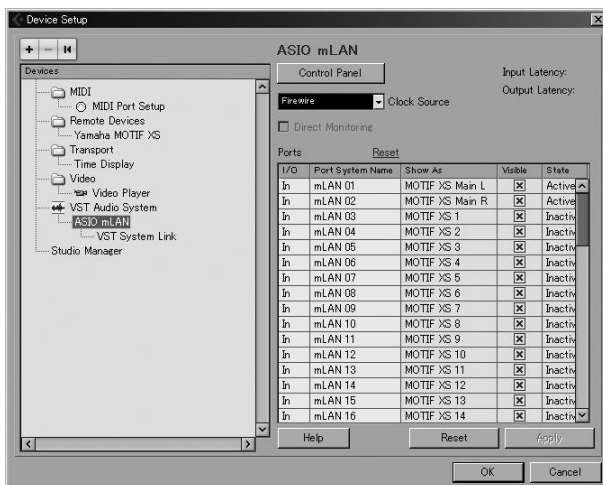

Using the Project Template for multi-channel audio recording via an IEEE1394 cable

When creating a new project file within Cubase, you can select the template for multi-channel audio recording using the MOTIF XS. By selecting a template, you can easily perform the recording in Cubase without having to make complicated or detailed settings.



For details refer to the following page:
<http://www.yamahasynth.com/>

Studio Connections

What is Studio Connections?



Studio Connections is a sophisticated software/hardware solution that lets you seamlessly integrate hardware synthesizers such as MOTIF XS and

MO into your computer music system. If you are using sequencer software that is compatible with Studio Connections (such as Cubase 4) and the MOTIF XS Editor, you can use the MOTIF XS within your sequencer, just as if it were a plug-in software synthesizer—without the need for any complicated connections or complex setup procedures.

Furthermore, you can save all MOTIF XS settings along with the project (song) file of the sequencer. Then, when you open the project again, all your MOTIF XS settings for the song are instantly recalled. This eliminates the repetitive work of recreating all your hardware settings when you reopen a song file.

For details about Studio Connections, visit our web site at: <http://www.studioconnections.org/>

Tools compatible with Studio Connections

Studio Manager

Studio Manager V2 is a cross-platform application that enables you to start multiple Editors that control Yamaha hardware products remotely, and to save multiple Editor settings. You can run Studio Manager as a stand-alone application, or as a plug-in within DAW applications such as Cubase SX 3.0 or later. In either case, the basic functionality is the same.

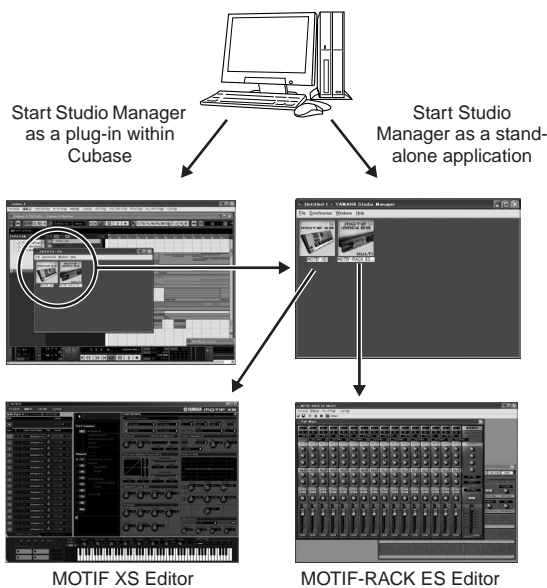

MOTIF XS Editor

What is MOTIF XS Editor?

The MOTIF XS Editor lets you edit the Mixing setup and Mixing Voice in the Song/Pattern mode of the MOTIF XS from your computer, giving you even greater editing convenience. The data created on the MOTIF XS Editor is transferred between the computer and the MOTIF XS via a USB or IEEE1394 cable as bulk data. You can load files created on the MOTIF XS Editor to the MOTIF XS in the File mode via the LAN connection or by using a USB storage device. Furthermore, the data edited on the MOTIF XS is always synchronized with the data on the computer (MOTIF XS Editor) and vice versa. This provides a smooth, seamless interface, and makes it very easy to create and edit your data.

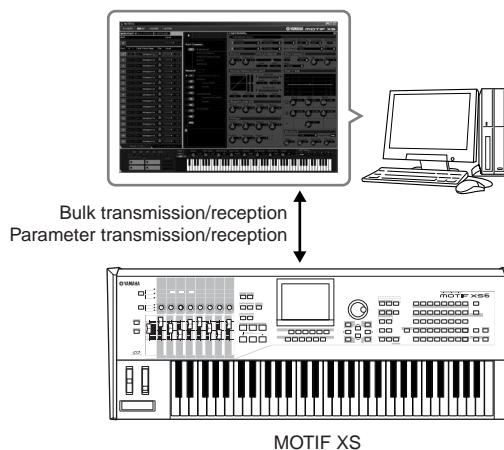

Using the MOTIF XS Editor

1. Using as a stand alone editor.
The MOTIF XS Editor is a client application using Studio Manager as host. To use the MOTIF XS Editor, start Studio Manager then start the MOTIF XS Editor as a plug-in software within the Studio Manager.
2. Using within Cubase
To use the MOTIF XS Editor within Cubase, you'll need register Studio Manager to Cubase. Installing Studio Manager automatically registers it to Cubase. After registering, start the MOTIF XS Editor as a plug-in of the Studio Manager.

NOTE For Macintosh computers, the MOTIF XS Editor can be used with Cubase 4 or later.

The Studio Manager and MOTIF XS Editor can be downloaded from the following URL:

<http://www.yamahasyth.com/download/>

For instructions on using the Studio Manager and MOTIF XS Editor, refer to the respective PDF manuals included with the software.

Controlling a DAW on Your Computer from the MOTIF XS

The MOTIF XS features a highly convenient Remote Control mode which lets you control the DAW software on your computer the MOTIF XS panel (when the instrument is connected to the computer via USB). For example, you can start/stop playback of the DAW software on the computer by using the SEQ TRANSPORT buttons and control the song position on the DAW software by using the data dial, [INC/YES] and [DEC/NO] buttons instead of using the mouse or keyboard of the computer. The DAW applications Cubase, Logic, SONAR and Digital Performer can be controlled by the Remote Control mode of the MOTIF XS.

Remote Function

The Remote Control lets you control the following operations.

- You can use the sliders, knobs and buttons of the MOTIF XS to control the sequencer tracks and mixer channels of the DAW on the computer.

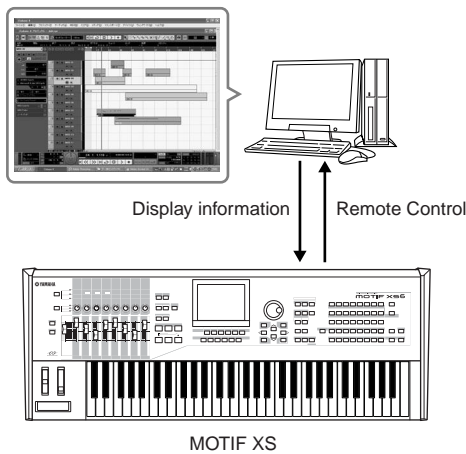

- You can view the parameter values on the LCD display of the MOTIF XS as well as on the computer display, since the values of the controlled parameters are returned back to the MOTIF XS from the computer.

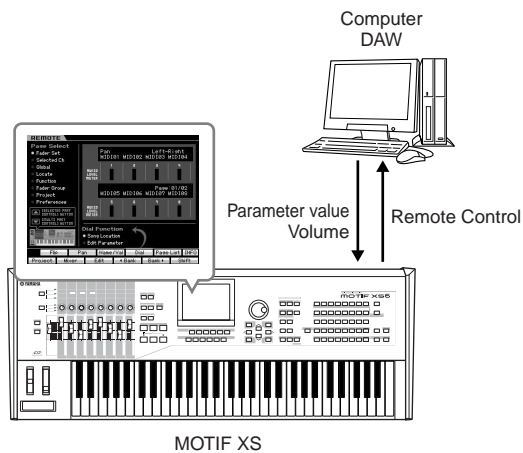

Computer Software that can be controlled from the MOTIF XS

Windows	Macintosh
Cubase 4, Cubase Studio 4, Cubase AI 4	Cubase 4, Cubase Studio 4, Cubase AI 4
Sonar 5 Version 5.2	Logic Pro 7 Version 7.2.1
	Digital Performer 5.1

Setting up for Remote Control

Setting up on the MOTIF XS

- Connect the MOTIF XS to the computer via a USB or IEEE1394 cable (pages 43 and 44).
- Press the [UTILITY] button to enter the Utility mode then press the [F6] button and the [SF1] button to call up the Remote Setting display (page 267).
- Set the DAW type to the desired DAW.
- Press the [STORE] button to store this setting.
- Start the DAW software on the computer connected to the MOTIF XS.

Setting up the DAW of the computer

This section explains how to set up after starting each application.

NOTE When the cable between the MOTIF XS and the Windows computer is disconnected or the MOTIF XS is turned off accidentally, the DAW will not recognize the MOTIF XS again even if you connect the cable again or turn the MOTIF XS on. If this occurs, exit the DAW software, then restart it after setting up the MOTIF XS and making sure the connection is secure.

Cubase

- 1 Pull down the [Devices] menu and select [Device Setup] to call up the “Device Setup” window.
- 2 Click the [+] button and add the “Mackie Control” or “Yamaha MOTIF XS.”
- 3 Select the device of “Mackie Control” or “Yamaha MOTIF XS” added to the list.
- 4 Set the MIDI Input Port to “Yamaha MOTIF XS6(7, 8)-2” or “YAMAHA MOTIF XS6(7, 8) Port2” or “mLAN MIDI In (2)” or “MOTIF XS Remote,” then set the MIDI Output Port to “Yamaha MOTIF XS6 (7, 8)-2” or “YAMAHA MOTIF XS6(7, 8) Port2” or “mLAN MIDI Out (2)” or “MOTIF XS Remote.”

NOTE Unlike with the Mackie Control, the MOTIF XS does not support UserA and UserB (FootSw).

NOTE When connecting the MOTIF XS to a computer via an IEEE1394 cable, starting Cubase (with the Extension Module installed) executes the above settings automatically. The Extension Module can be downloaded from the following URL:
<http://www.yamahasyth.com/download/>

* Mackie Control is the trademark of Mackie Designs, Inc.

SONAR

- 1 Pull down the [Options] menu and select [MIDI Devices] to call up the “MIDI Devices” window.
- 2 Add “Yamaha MOTIF XS6(7, 8)-2” or “mLAN MIDI In (2)” to the Input Device, then add “Yamaha MOTIF XS6(7, 8)-2” or “mLAN MIDI Out (2)” to the Output Device.
- 3 Pull down the [Options] menu and select [Control Surfaces] to call up the Control Surface window.
- 4 Click the [+] button, select “Mackie Control,” then set the Input Port to “Yamaha MOTIF XS6(7, 8)-2” or “mLAN MIDI In (2)” and set the Output Port to “Yamaha MOTIF XS6(7, 8)-2” or “mLAN MIDI Out (2).”

Digital Performer

- 1 In the Audio/MIDI setup of a Macintosh computer, connect Port 2 of the interface to Port 2 of the tone generator. When there is only one Port for the tone generator, add the new Port, then connect it to the interface.
- 2 Pull down the [Setup] menu and select [Control Surfaces] to call up the Control Surface window.
- 3 Click the [+] button.
- 4 Select “Mackie Control” in the Driver section.
- 5 In the box for setting “Unit” and “MIDI,” select “Mackie Control” in the “Unit” section and select “MOTIF XS New Port 2” in the “MIDI” section.

Logic

- 1 Set the software to be controlled to “Logic” in the Utility mode, then press the [REMOTE ON/OFF] button so that its lamp lights to enter the Remote Control mode.
- 2 Start Logic on the computer.
Logic automatically recognizes the MOTIF XS as Logic Control and performs the required settings.
- 3 Set both the Input Port and the Output Port to “Yamaha MOTIF XS6 (7, 8) Port 2.”

Remote Control mode

To enter the Remote Control mode, press the REMOTE [ON/OFF] button (the lamp flashes). The REMOTE display appears (like those shown below), and the panel controls (such as buttons, knobs, sliders, and data dial) are enabled for Remote operation of the computer software (their normal functions are disabled). Press this button again to exit from the Remote Control mode.

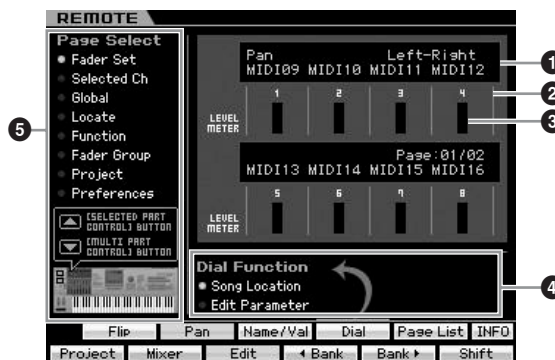

1 Knob Functions/Values

Indicates the function assigned to the knob and the current value. When the same function is assigned to all eight knobs, the function is indicated only at the column of knob 1. The knob function can be specified by pressing one of the [F1] – [F5] and [SF1] – [SF4] buttons after selecting a page in the Page Select (5) menu. For details about the functions of the knobs for each DAW software, refer to the Remote Control Function List in the Data List 2 (PDF documentation) which can be downloaded from the online Yamaha Manual Library. Visit the following URL, enter “MOTIF XS” in the Model Name box, then click “Search.” In the results, you can find “Data List 2” for the MOTIF XS. Yamaha Manual Library URL:

<http://www.yamaha.co.jp/manual/>

2 Channel number

Indicates the channel number. The background of the selected channel number turns black. The channel number can be changed by using the [F4] ◀ Bank and [F5] Bank ▶ buttons.

3 LEVEL METER

Indicates the volume level of playback for each channel in real time.

4 Dial Function

Indicates the function assigned to the data dial. The circle is shown at left of the active function. You can change the dial function by pressing the [SF4] button only when "Dial" is shown on the tab corresponding to the [SF4] button. When no channel is selected on the display, the song location function is assigned to the data dial, regardless of the [SF4] tab indication, even if the edit parameter is set here. Controlling any knob changes the function of the data dial automatically to the edit parameter, allowing you to edit the channel parameter of the knob.

Settings: Song Location, Edit Parameter

Song Location

Moves the current location of song playback.

Edit Parameter

Changes the value of the current parameter.

5 Page Select

Determines the functions assigned to the [F1] – [F5] and [SF1] – [SF5] buttons by selecting a page. The circle is shown at left of the selected page. Use the [SELECTED PART CONTROL] and [MULTI PART CONTROL] button to select the desired page, with the result that the functions assigned to the [F1] – [F5] and [SF1] – [SF5] buttons are changed. The page structure differs depending on the DAW software on your computer. For details, refer to the Remote Control Function List in the Data List 2 (PDF) documentation which can be downloaded from the online Yamaha Manual Library. Visit the following URL, enter "MOTIF XS" in the Model Name box, then click "Search." In the results, you can find "Data List 2" for the MOTIF XS. Yamaha Manual Library URL:

<http://www.yamaha.co.jp/manual/>

[SF5] Page List

Pressing this button calls up the Page List display. The Page List display indicates five sets of functions assigned to the [F1] – [F5] and [SF1] – [SF5] buttons together. The active function set of five sets is highlighted. Also from this display, use the [SELECTED PART CONTROL] and [MULTI PART CONTROL] button to change the function set.



[SF6] INFO (Information)

Pressing this button calls up the Information window about the Remote Control function. From the Information window, any panel operation (pressing a button, turning a knob, controlling a slider) indicates the following three types of information about the operated controller (button, knob or slider). To close this window, press the [SF6] INFO button again.

Panel Button

Indicates the controller name on the panel.

Function

Indicates the function of the operated controller.

LED

Indicates the function of the lamp for the operated controller.

NOTE No description here indicates that the lamp for the operated controller has no function or the operated controller has no lamp.

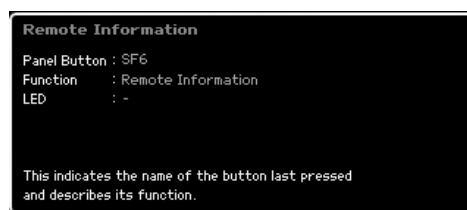

NOTE If communication between the DAW on the computer and the MOTIF XS has not been achieved, pressing the [REMOTE ON/OFF] button calls up the display indicating "Computer DAW Software Control Mode" as shown below. If this happens, restart the DAW application software. If doing this does not achieve communication, press the [REMOTE ON/OFF] button again to exit from the Remote Control mode, then try setting up for Remote Control (page 51) again.

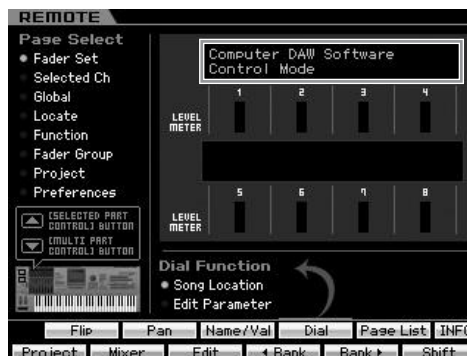

For details about the Remote Control functions, refer to the PDF documentation by visiting the following URL.

Yamaha Manual Library URL:
<http://www.yamaha.co.jp/manual/>

Visit the above URL, enter "MOTIF XS" in the Model Name box, then click "Search." In the results, you can find "Data List 2" for the MOTIF XS.

Basic Structure

Mode Structure

In order to make operation of the MOTIF XS as smooth as possible, all functions and operations have been grouped in “modes,” many of which also have a number of “sub modes.”

The MOTIF XS provides nine main modes which are divided into several sub modes. For details, see the mode table below.

Mode table

Mode	Sub Mode	Function	How to enter the mode	Page
Voice mode	Voice Play mode	Playing a Voice	[VOICE]	88
	Voice Edit mode	Editing/Creating a Voice	[VOICE] → [EDIT]	96
	Voice Job	Initializing a Voice, etc.	[VOICE] → [JOB]	133
	Voice Store mode	Storing a Voice to internal memory	[VOICE] → [STORE]	97
Performance mode	Performance Play mode	Playing a Performance	[PERFORM]	135
	Performance Edit mode	Editing/Creating a Performance	[PERFORM] → [EDIT]	141
	Performance Job mode	Initializing a Performance, etc.	[PERFORM] → [JOB]	159
	Performance Store mode	Storing a Performance to internal memory	[PERFORM] → [STORE]	142
Song mode	Song Play mode	Playing a Song	[SONG]	178
	Song Record mode	Recording a Song	[SONG] → [●] (Record)	186
	Song Edit mode	Editing the MIDI events of a Song	[SONG] → [EDIT]	192
	Song Job mode	Converting and transforming Song data	[SONG] → [JOB]	195
	Song Store mode	Storing a Song to internal memory	[SONG] → [STORE]	186
Pattern mode	Pattern Play mode	Playing a Pattern	[PATTERN]	208
	Pattern Record mode	Recording a Pattern	[PATTERN] → [●] (Record)	218
	Pattern Edit mode	Editing the MIDI events of a Pattern	[PATTERN] → [EDIT]	220
	Pattern Job mode	Converting and transforming Pattern data	[PATTERN] → [JOB]	222
	Pattern Store mode	Storing a Pattern to internal memory	[PATTERN] → [STORE]	218
Mixing mode	Mixing Play mode	Setting multi-timbral tone generator settings for Song/Pattern playback	[SONG]/[PATTERN] → [MIXING]	231
	Mixing Edit mode	Editing a Mixing program	[SONG]/[PATTERN] → [MIXING] → [EDIT]	233
	Mixing Job mode	Initializing a Mixing, etc.	[SONG]/[PATTERN] → [MIXING] → [JOB]	236
	Mixing Store mode	Storing a Mixing to internal memory	[SONG]/[PATTERN] → [MIXING] → [STORE]	233
	Mixing Voice Edit mode	Editing a Mixing Voice	[SONG]/[PATTERN] → [MIXING] → [F6] Vce Edit	239
	Mixing Voice Job mode	Initializing a Mixing Voice, etc.	[SONG]/[PATTERN] → [MIXING] → [F6] Vce Edit → [JOB]	240
	Mixing Voice Store mode	Storing a Mixing Voice to internal memory	[SONG]/[PATTERN] → [MIXING] → [F6] Vce Edit → [STORE]	240
Sampling mode	Sampling Record mode	Recording audio signals to create a Voice/Performance	[VOICE]/[PERFORM] → [INTEGRATED SAMPLING]	161
	Sampling Record mode	Recording audio signals to a Song/Pattern	[SONG]/[PATTERN] → [INTEGRATED SAMPLING]	242
	Sampling Edit mode	Editing a sample	[INTEGRATED SAMPLING] → [EDIT]	167
	Sampling Job mode	Converting and transforming Sample data	[INTEGRATED SAMPLING] → [JOB]	171
Utility mode	Utility mode	Setting System related parameters	[UTILITY]	259
	Utility Job mode	Resetting the User Memory to the Initial Factory Settings	[UTILITY] → [JOB]	269
	Sequencer Setup	Setting sequencer (Song/Pattern) related parameters	[SONG]/[PATTERN] → [SEQ SETUP]	269
Master mode	Master Play mode	Playing a Master	[MASTER]	251
	Master Edit mode	Editing/Creating a Master	[MASTER] → [EDIT]	253
	Master Job mode	Initializing a Master, etc.	[MASTER] → [JOB]	257
	Master Store mode	Storing a Master to internal memory	[MASTER] → [STORE]	254
File mode	File mode	Managing Files and Folders (Directories)	[FILE]	272

NOTE In addition to the modes above, the MOTIF XS features the Remote Control mode. In this mode, you can control the DAW software on your computer from the panel operations of the MOTIF XS connected to the computer via USB. For details, see page 51.

Selecting Modes

Mode and sub mode selection is accomplished by using the corresponding mode buttons. For details, see the Mode table above. To return back from the sub mode to the “parent” mode, press the [EXIT] button.

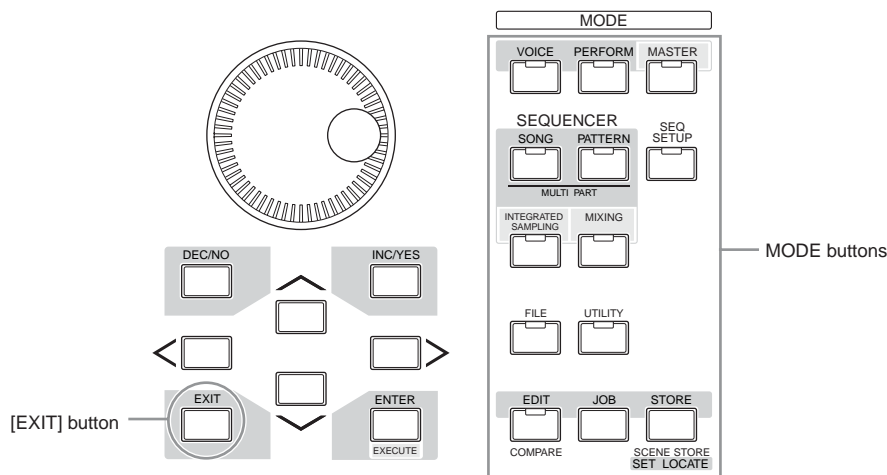

The Seven Functional Blocks

The MOTIF XS system consists of 7 main functional blocks: Tone Generator, Sampling, Audio Input, Sequencer, Arpeggio, Controller, and Effect.

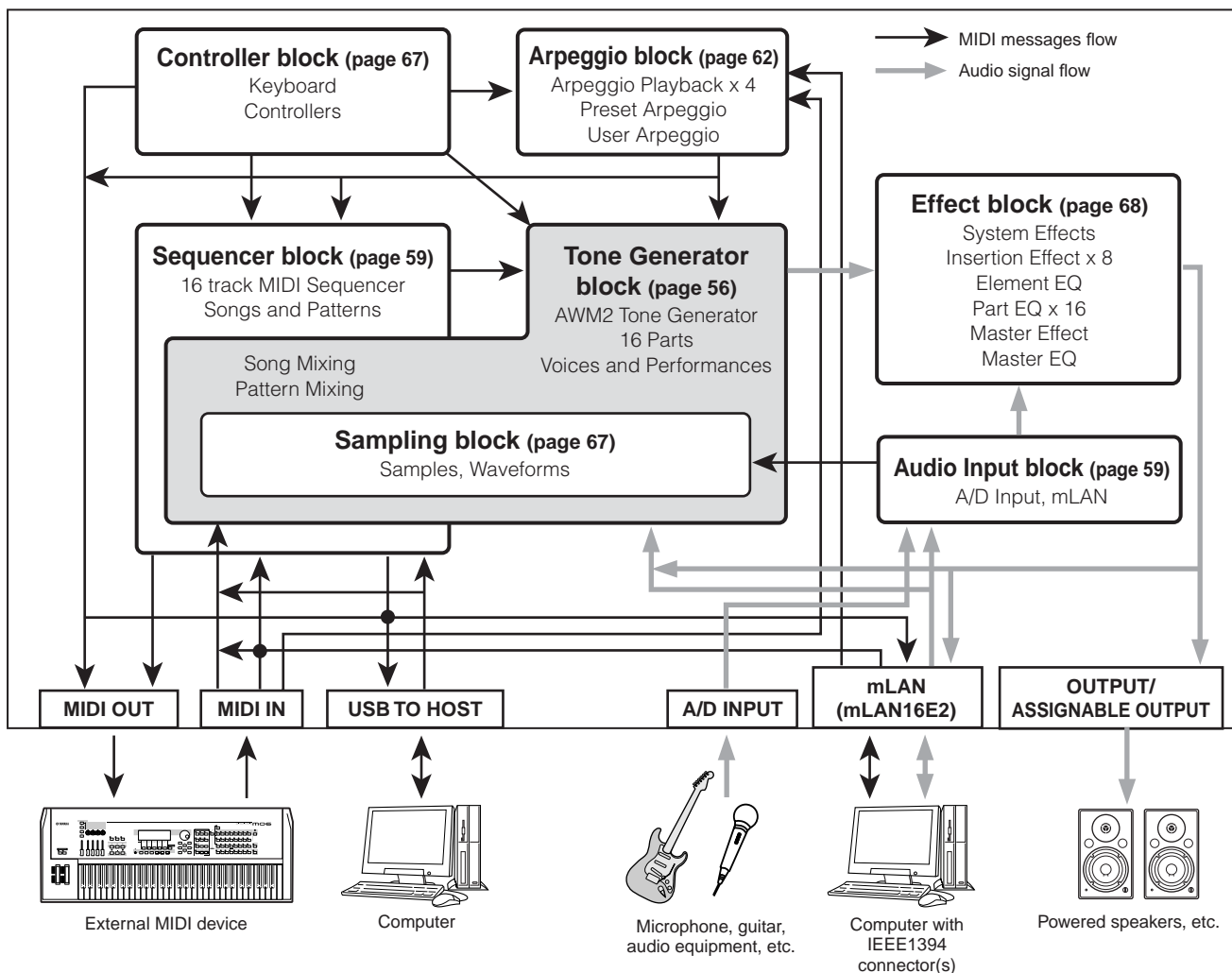

Tone Generator Block

The tone generator block is what actually produces sound in response to the MIDI messages received from the Sequencer block, the Controller block, the Arpeggio block and from the external MIDI instrument via the MIDI IN connector or the USB connector. The structure of the tone generator block differs depending on the mode.

Tone Generator block in the Voice Mode

Part structure in the Voice mode

In this mode, the tone generator block receives MIDI data over a single channel. This status is referred to as a “single timbre” tone generator. A Voice is played from the keyboard, using a single part.

Keep in mind that song data on an external sequencer consisting of multiple MIDI channels will not play back properly in this mode. If you are using an external MIDI sequencer or computer to play the instrument, make sure to use the Song mode or Pattern mode.

Voice

A program that contains the sonic elements for generating a specific musical instrument sound is referred to as a “Voice.” Internally, there are two Voice Types: Normal Voices and Drum Voices. Normal Voices are mainly pitched musical instrument type sounds that can be played over the range of the keyboard. Drum Voices are mainly percussion/drum sounds that are assigned to individual notes on the keyboard.

NOTE For instructions on editing a Normal Voice, see page 96. For instructions on editing a Drum Voice, see page 127.

Normal Voices & Drum Voices

Normal Voice

This is a Voice which is played conventionally from the keyboard, with standard pitches sounding for each key. A Normal Voice consists of up to eight Elements. Depending on the settings in the Voice Edit mode, these Elements are sounded simultaneously, or the different Elements are sounded according to the note range, velocity range and the XA (Expanded Articulation) settings.

The illustration below is an example of a Normal Voice. Since the six Elements here are distributed across both the note range of the keyboard and the velocity range, a different Element sounds depending on which note you play and how strongly you play it. In the note distribution, Elements 1 and 2 sound in the lower range of the keyboard, Elements 3 and 4 sound in the middle range, and Elements 5 and 6 sound in the higher range. In the velocity distribution, Elements 1, 3 and 5 sound when

playing the keyboard softly, while Elements 2, 4 and 6 sound when playing it strongly. In a practical example of this in use, a piano Voice could be composed of six different samples. Elements 1, 3 and 5 would be the sounds of the piano played softly, over the respective note ranges, while Elements 2, 4 and 6 would be strongly played sounds, for each respective note range. Actually, the MOTIF XS is even more flexible than this, since it allows up to eight independent Elements.

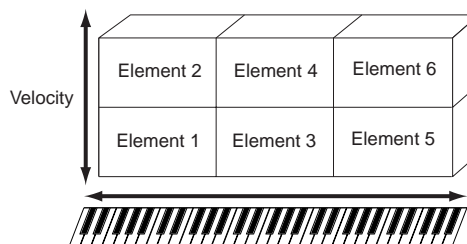

Drum Voice

Drum Voices are mainly percussion/drum sounds that are assigned to individual notes on the keyboard. A collection of assigned percussion/drum waves or Normal Voices is known as a Drum Kit.

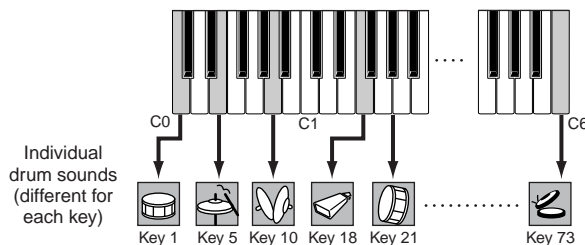

Expanded Articulation (XA)

Expanded Articulation (XA) is a specially designed tone generation system of the MOTIF XS that provides greater performance flexibility and acoustic realism. It allows you to more effectively recreate realistic sound and natural performance techniques—such as legato and staccato—and provides other unique modes for random and alternate sound changes as you play.

Realistic legato performance

Conventional synthesizers recreate a legato effect by continuing the volume envelope of a previous note on to the next one, in the mono mode. However, this results in an unnatural sound different from that of an actual acoustic instrument. The MOTIF XS more accurately reproduces a legato effect by allowing specific Elements to be sounded when playing legato and other Elements to be played

normally (with the XA Control parameter settings “normal” and “legato”).

Authentic note release sound

Conventional synthesizers are not good at realizing the sound produced when the note of the acoustic instrument is released. The MOTIF XS realizes the sound produced when the note of the acoustic instrument is released, by setting the XA Control parameter of a certain Element to “key off sound.”

Subtle sound variations for each note played

Conventional synthesizers attempt to reproduce this by randomly changing the pitch and/or filter. However, this produces an electronic effect and is different from the real sound changes on an acoustic instrument. The MOTIF XS more accurately reproduces these subtle sound variations by using the XA Control parameter settings, “wave cycle” and “wave random.”

Switching among different sounds to recreate the natural performance on an acoustic instrument

Acoustic instruments have their own unique characteristics—even specific, unique sounds that are produced only at certain times in a performance. These include the flutter tonguing on a flute or playing high harmonics on an acoustic guitar. The MOTIF XS recreates these by allowing you to switch between the sounds while you play—using the ASSIGNABLE FUNCTION buttons and the XA Control parameter settings, “AF 1 on,” “AF 2 on” and “all AF off.”

New sounds and new styles of playing

The highly versatile functions above can be applied effectively not only to acoustic sounds but also to synthesizer and electronic Voices as well. The XA feature opens up enormous potential for realizing authentic sounds, performing expressively and coming up with creative new styles of playing.

To create sounds such as those described above using Expanded Articulation, refer to page 113.

Elements and Drum Keys

Elements and Drum Keys are the smallest “building blocks” in the MOTIF XS that comprise a Voice; in fact, only one Element or one Drum Key could be used to create a Voice. These small sound units can be built, enhanced and processed by a variety of traditional synthesizer parameters, such as Oscillator, Pitch Filter, Amplitude, and LFO (shown below).

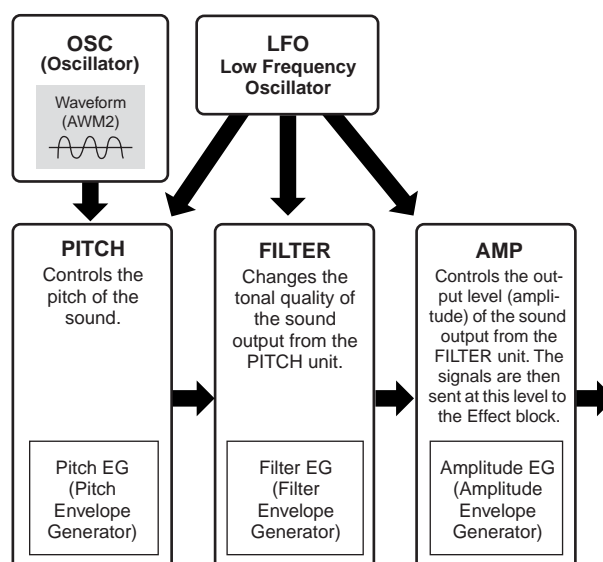

Oscillator

This unit outputs the wave which determines the basic pitch. You can assign the waveform (or basic sound material) to each Element of a Normal Voice or each Key of a Drum Voice. In the case of a Normal Voice, you can set the note range for the Element (the range of notes on the keyboard over which the Element will sound) as well as the velocity response (the range of note velocities within which the Element will sound). In addition, the XA related parameters can be set in this unit.

Oscillator related parameters can be set in the Oscillator display (pages 112 and 129).

Pitch

This unit controls the pitch of the sound (wave) output from the Oscillator. In the case of a Normal Voice, you can detune separate Elements, apply Pitch Scaling and so on. Also, by setting the PEG (Pitch Envelope Generator), you can control how the pitch changes over time.

Pitch related parameters can be set in the Pitch display (page 114) and Pitch EG display (page 115) of the Voice Edit mode. Note that Pitch related parameters of a Drum Voice can be set in the Oscillator display.

Filter

This unit modifies the tone of the sound output from Pitch by cutting the output of a specific frequency portion of the sound. Also, by setting the FEG (Filter Envelope Generator), you can control how the Cutoff Frequency of the Filter changes over time.

Filter related parameters can be set in the Filter display (pages 117 and 131), Filter EG display (page 119) and Filter Scale display (page 121) of the Voice Edit mode.

Amplitude

This unit controls the output level (amplitude) of the sound output from the Filter block. The signals are then sent at this level to the Effect block. Also, by setting the AEG (Amplitude Envelope Generator), you can control how the volume changes over time.

Amplitude related parameters can be set in the Amplitude display (pages 122 and 131), Amplitude EG display (page 123) and Amplitude Scale display (page 124) of the Voice Edit mode.

LFO (Low Frequency Oscillator)

As its name suggests, the LFO produces a wave of a low frequency. These waves can be used to vary the pitch, filter or amplitude of each Element to create effects such as vibrato, wah and tremolo. LFO can be set independently for each Element; it can also be set globally for all Elements.

LFO related parameters can be set in the Common LFO display (page 105) and the Element LFO display (page 125) of the Voice Edit mode.

Memory structure of Voice

Normal Voice

Preset Banks 1 – 8	1024 Normal Voices (128 Voices for each Bank)
GM Bank	128 Voices
User Banks 1 – 3	384 Normal Voices (128 Voices for each Bank) (Picked up from Preset Voices by default)

Drum Voice

Preset Drum Bank	32 Voices
GM Drum Bank	1 Voice
User Drum Bank	64 Voices (Picked up from Preset Voices by default)

Tone Generator block in the Performance Mode

Part structure in the Performance mode

In this mode, the tone generator block receives MIDI data over a single channel. This status is referred to as a “single timbre” tone generator. This mode lets you play a Performance (which multiple Voices (Parts) are combined—in a layer, or in other configurations) using the keyboard.

Keep in mind that song data on an external sequencer consisting of multiple MIDI channels will not play back properly in this mode. If you are using an external MIDI sequencer or computer to play the instrument, make sure to use the Song mode or Pattern mode.

Performance

A program in which multiple Voices (Parts) are combined in a layer, or in other configurations is referred to as a

“Performance.” Each Performance can contain up to four different Parts (Voices). Each Performance can be created by editing parameters unique to each part and parameters common to all the Parts.

Memory structure of Performance

Three User Banks are provided. Each Bank contains 128 Performances. Accordingly, a total of 384 User Performances are provided. These 384 Performances are preprogrammed by default and can be changed in the Performance mode.

Tone Generator block in the Song mode/Pattern mode

Part structure of the tone generator block in the Song mode/Pattern mode

In these modes, multiple Parts are provided and different Voices and different melodies or phrases can be played back for each Part. Because these modes let you set the MIDI channel for each part of the tone generator block, you can use an external MIDI sequencer as well as the sequencer block of the instrument to play the sounds. The sequence data of each track plays the corresponding Parts (those having the same MIDI channel assignment) in the tone generator block.

About Mixing

A program in which multiple Voices are assigned to Parts for multi-timbral play in the Song and Pattern modes is referred to as a “Mixing.” Each Mixing can contain up to 16 parts. Each Mixing can be created by editing parameters unique to each Part and parameters common to all the Parts in the Mixing mode (page 233).

Memory structure of Mixing

A Mixing program is provided for each Song or Pattern. Selecting a different Song/Pattern calls up the different Mixing program.

Song mode

64 Mixing settings (one Mixing for each Song)

Pattern mode

64 Mixing settings (one Mixing for each Pattern)

Maximum Polyphony

Maximum polyphony refers to the highest number of notes that can be sounded simultaneously from the internal tone generator of the instrument. The maximum polyphony of this synthesizer is 128. When the internal tone generator block receives a number of notes exceeding the maximum polyphony, previously played notes are cut off. Keep in mind this may be especially noticeable with Voices not having decay. Furthermore, the maximum polyphony applies to the number of Voice Elements used, not the number of Voices. When Normal Voices that include up to eight Elements are used, the maximum number of simultaneous notes may be less than 128.

Sampling Block

The Sampling Block lets you bring your own recorded sounds—your voice, an instrument, rhythms, special sound effects, etc.—into the system of this synthesizer, and play those sounds just like any other voices. These sounds, the audio data can be captured from the A/D Input and mLAN connector (MOTIF XS8, or MOTIF XS 6/7 with the mLAN16E2 installed) with up to 16 bit and 44.1 kHz quality.

Keep in mind that the data created by the Sampling operation differs depending on the mode from which you entered the Sampling mode: Voice/Performance or Song/Pattern. See pages 161 and 242 respectively.

Audio Input block

This block handles the audio signal input from the A/D Input and the mLAN connector (MOTIF XS8, and MOTIF XS 6/7 with the optional mLAN16E2 installed). Various parameters such as volume, pan, and effect can be set for the audio signal and the sound is output together with other Voices. The Insertion Effect as well as the System Effects can be applied to the audio signal input via the A/D INPUT connector.

The Audio Input related parameters can be set in the following display.

Mode	Display	Page
Voice mode	[F4] Voice Audio display in the Utility mode	265
Performance mode	[F4] Audio In display in the Performance Edit mode	147
Song/Pattern mode	[F4] Audio In display in the Mixing Edit mode	234

The gain of the audio signal from the A/D INPUT connector can be adjusted via the Gain knob (page 18) on the rear panel.

Sequencer Block

This block lets you create Songs and Patterns by recording and editing your performances as MIDI data (from the controller block), then playing it back with the tone generator block.

Sequencer block in the Song mode

What is a Song?

A Song (page 33) is made by the MIDI sequence data created by recording your keyboard performance to each track. A Song on this synthesizer is effectively the same as a Song on a MIDI sequencer, and playback automatically stops at the end of the recorded data.

Song Track Structure

A Song consists of 16 separate tracks, a Scene track, and a Tempo track.

Sequence tracks 1 – 16

Record your keyboard performance to these tracks using Realtime recording (page 186) and edit the recorded data in the Song Edit mode (page 192).

Scene track

This track lets you record Scene change settings, such as the status of track mute and solo. These can be set in the Song Play display (page 178) and recalled during Song playback. During Song playback, the track mute and solo settings change automatically according to the settings you've recorded to the Scene track. You can record this track with using Realtime recording (page 186) and edit the recorded data in the Song Edit mode (page 192).

Tempo track

This track lets you record Tempo change settings. During Song playback, the Tempo changes automatically according to the settings you've recorded to this track. You can record this track with using Realtime recording (page 186) and edit the recorded data in the Song Edit mode (page 192).

Song Chain

This function allows Songs to be "chained" together for automatic sequential playback. For instructions on using this, see page 185.

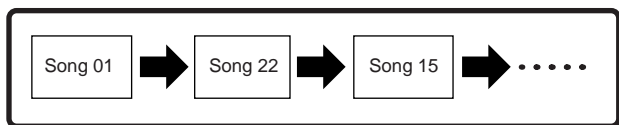

Sequencer Block in the Pattern mode

What is a Pattern?

In the MOTIF XS, the term "Pattern" refers to a relatively short musical or rhythmic phrase—1 to 256 measures—which is used for looped playback. Therefore, once Pattern playback starts, it continues until you press the [■] (Stop) button.

Section

Patterns are more than just a single phrase—they include 16 variations called "Sections." These Sections can be changed during playback and used as rhythmic/backing variations for the various parts of a Song. For example, you could use one Section for the verse, another for the chorus, and a third for the bridge. The Pattern related settings such as tempo and Mixing do not change even when the Section is switched, keeping the overall playback consistent in feel and rhythm through the changes.

For instructions on selecting a Pattern and Section, see page 208.

Pattern Chain

Pattern Chain allows you to string several different Sections (within a single Pattern) together to make a single, complete Song. You can have the MOTIF XS automatically change Sections by creating a Pattern Chain beforehand, recording Pattern playback with Section changes from the Pattern Chain display. You can also use this feature when creating Songs based on a certain Pattern, since the created Pattern Chain can be converted into a Song in the Pattern Chain Edit (page 215). One Pattern Chain can be created for each Pattern.

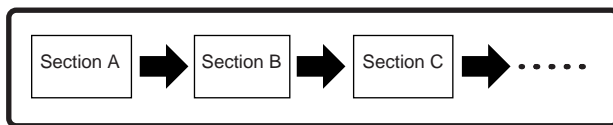

Phrase

This is the basic MIDI sequence data in a track—and the smallest unit—used in creating a Pattern. "Phrase" is a short musical/rhythmic passage for a single instrument, such as a rhythm pattern for the rhythm part, a bass line for the bass part, or a chord backing for the guitar part. This synthesizer features memory space for 256 of your own original User Phrases.

NOTE The MOTIF XS provides no Preset Phrases.

Pattern Track Structure

A Pattern consists of 16 separate tracks, a Scene track, and a Tempo track (just as in a Song). See page 59.

Pattern Tracks and Phrases

A Pattern consists of 16 tracks to which the Phrase can be assigned. MIDI data cannot be directly recorded to each track in the Pattern mode. Recording is done to an empty user phrase. The newly created phrase is automatically assigned to the recording track.

Track 1	Phrase 001	← Phrase 001	MIDI data
Track 2	Phrase 002	← Phrase 002	MIDI data
:	:	← Phrase 003	MIDI data
Track 16	Phrase 003	←	:

Sequencer Block applied to both the Song and Pattern

MIDI tracks and Audio tracks

Depending on the recording method, the Song/Pattern tracks (1 – 16) of this synthesizer are divided into two groups: MIDI tracks and Audio tracks.

MIDI tracks are created by recording your keyboard performance in the Song Record mode/Pattern Record mode. MIDI sequence data is recorded to the MIDI track and the Normal Voice or Drum Voice is assigned to the Mixing part corresponding to the track.

Audio tracks are created by recording audio signal from the external equipment or microphone via the A/D Input jack in the Sampling Record mode. Actually, audio data is not recorded directly to a track but rather is sampled via the Sampling operation. The recorded audio signal is stored as a Sample Voice to a Song/Pattern. The stored Sample Voice will automatically be assigned to the Mixing Part corresponding to the specified track, and the MIDI data for triggering the Sample Voice is recorded to the specified track. During playback, the MIDI data of the track triggers the Sample Voice. As a result, the track effectively functions as an Audio recorded track.

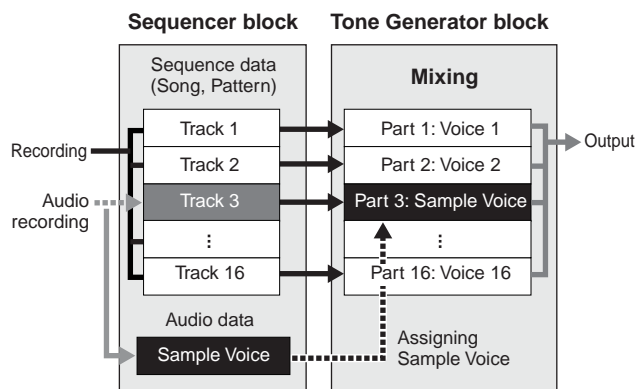

Audio data is recorded to a Sample Voice which is to be assigned to a Song/Pattern, and note on/off events for triggering the recorded audio signal are recorded to Track 3.

- MIDI data
- Audio data
- MIDI data for triggering the Sample Voice

Play Effect (Play FX)

The Play Effect lets you change the rhythmic “feel” of the Pattern playback by changing the timing and velocity of the notes temporarily and on playback only, leaving the original data intact. This feature can be set in the Play FX display of the Song Play mode and Pattern Play mode. See pages 183 and 211 respectively. If you find a setting you like, you can convert it to actual MIDI data by using the Song Job (page 195) or Pattern Job (page 222).

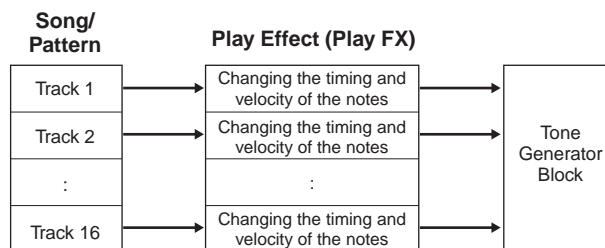

Sequencer Block applied to the Performance mode

Performance Recording

You can record your keyboard performance in the Performance mode to the Song or Pattern. You can record knob operations, controller operations and Arpeggio playback as well as your keyboard playing to the specified track as MIDI events. (Knob operations that cannot be recorded include sustain level, EQ settings, Arpeggio related settings, and Pan/Reverb Send/Chorus Send of the multi part control.) Arpeggio playback data for Parts 1 – 4 of the Performance will be recorded to the tracks 1 – 4 of the Song/Pattern respectively. Your keyboard performance and controller/knob operations (common to Parts 1 – 4) will be recorded to tracks 1 – 4 separately.

NOTE For instructions on recording a Performance, see page 140.

Arpeggio Block

This block lets you automatically trigger musical and rhythmic phrases using the current Voice by simply pressing a note or notes on the keyboard. The Arpeggio sequence also changes in response to the actual notes or chords you play, giving you a wide variety of inspiring musical phrases and ideas—both in composing and performing.

Four Arpeggio types can be played back at the same time even in the Song mode and Pattern mode.

Arpeggio Category

The Arpeggio types are divided into 17 categories (excepting “NoAsg”) as listed below.

Category List

ApKb	Acoustic Piano & Keyboard
Organ	Organ
GtPl	Guitar / Plucked
GtMG	Guitar for “Mega Voice”
Bass	Bass
BaMG	Bass for “Mega Voice”
Strng	Strings
Brass	Brass
RdPp	Reed / Pipe
Lead	Synth Lead
PdMe	Synth Pad / Musical Effect
CPrc	Chromatic Percussion
DrPc	Drum / Percussion
Seq	Synth Seq
Chord	Chord Seq
Hybrd	Hybrid Seq
Cntr	Control
NoAsg	No Assignment

NOTE Categories named “GtMG” and “BaMG” include Arpeggio types appropriate for using with a Mega Voice.

Mega Voices and Mega Voice Arpeggios

Normal Voices use velocity switching to make the sound quality and/or level of a Voice change according to how strongly or softly you play the keyboard. This makes these Voices respond naturally. However Mega Voices have a very complex structure with many different layers that is not suitable for playing manually. Mega Voices were developed specifically to be played by Mega Voice arpeggios to produce incredibly realistic results. You should always use Mega Voices with Mega Voice Arpeggios (included in “GtMG” and “BaMG” category). See the Voice with ARP parameter on page 189 for more details.

Arpeggio Sub Category

The Arpeggio categories are divided into sub categories as listed below. Because the sub categories are listed based on the music genre, it is easy to find the sub category appropriate for your desired music style.

Sub Category List

Rock	Rock	Z.Pad	Zone Velocity for Pad*
R&B	R&B	Filtr	Filter
Elect	Electronic	Exprs	Expression
Jazz	Jazz	Pan	Pan
World	World	Mod	Modulation
Genrl	General	Pbend	Pitch Bend
Comb	Combination	Asign	Assign 1/2
Zone	Zone Velocity*	NoAsg	No Assignment

NOTE Arpeggio types belonging to the Sub Categories marked with an asterisk (*) contain some velocity ranges, to each of which a different phrase is assigned. When a type of these categories is selected in the Voice mode, it is a good idea to set the Velocity Limit of each Element to the same range as below.

Velocity ranges of each Arpeggio type

2Z_****: 1 – 90, 91 – 127

4Z_****: 1 – 70, 71 – 90, 91 – 110, 111 – 127

8Z_****: 1 – 16, 17 – 32, 33 – 48, 49 – 64, 65 – 80, 81 – 96, 97 – 108, 109 – 127

PadL_****: 1 – 1, 2 – 2, 3 – 127

PadH_****: 1 – 112, 113 – 120, 121 – 127

Arpeggio Type Name

The Arpeggio Types are named according to certain rules and abbreviations. Once you understand these rules and abbreviations, you’ll find it easy to browse through and select the desired Arpeggio Types.

Arpeggio type with “_ES” at the end of the type name (example: HipHop1_ES)

These Arpeggio types use the same multi track Arpeggio architecture as the MOTIF ES. This ES type of arpeggio has the following benefits:

- These arpeggios can create complex notes and chords even when triggered by one note.
- The arpeggio closely follows the notes played on the keyboard (but the area where the arpeggio is assigned) allowing a good deal of harmonic freedom and the possibility to “solo” using these arpeggios.

For details, see page 64.

Arpeggio type with “_XS” at the end of the type name (example: Rock1_XS)

These Arpeggios use a newly developed chord recognition technology to determine what notes should be played back by the Arpeggio. This XS type of arpeggio has the following benefits:

- The arpeggios respond only to any area on the keyboard where an XS type of arpeggio is assigned. Other areas of the keyboard do not effect the chord recognition. This allows very natural keyboard playing across the entire keyboard with arpeggio generated bass and backing parts.
- The arpeggio will always play harmonically correct parts. These are especially useful for bass and chordal backing parts.

See page 64 for more details.

NOTE Combining these two kinds of Arpeggios types (named “*_ES” and “*_XS”) in performances when creating Songs and Patterns allows tremendous interactivity and creative freedom.

Arpeggio type with a normal name (example: UpOct1)

In addition to the above types, there are three playback types: the Arpeggios created for use of Normal Voices and played back using only the played notes and their octave notes (page 64), the Arpeggios created for use of Drum Voices (page 65), and Arpeggios containing mainly non-note events (page 65).

How to use the Arpeggio Type List

The Arpeggio Type list in the Data List 2 (PDF) documentation contains the following columns.

1	2	3	4	5	6	7	8	9	10
Main Category	Sub Category	ARP No.	ARP Name	Time Signature	Length	Original Tempo	Accent	Random SFX	Voice Type
ApKb	Rock	1	70sRockB	4 / 4	2	130			Acoustic Piano
ApKb	Rock	2	70sRockC	4 / 4	1	130			:
ApKb	Rock	3	70sRockD	4 / 4	2	130			
ApKb	Rock	4	70sRockE	4 / 4	4	130			
ApKb	Rock	5	70sRockF	4 / 4	2	130			
ApKb	Rock	6	70sRockG	4 / 4	1	130			
ApKb	Rock	7	70sRockH	4 / 4	1	130			

NOTE Note that this list is for illustration purposes only. For a complete listing of the Arpeggio Types, refer to the Data List 2.

1 Category

Indicates an Arpeggio Category.

2 Sub Category

Indicates an Arpeggio Sub Category.

3 ARP No. (Arpeggio Number)

4 ARP Name

Indicates the Arpeggio Name.

5 Time Signature

Indicates the time signature or meter of the Arpeggio type.

6 Length

Indicates the data length (amount of measures) of the Arpeggio type. When the Loop parameter^{*1} is set to “off,” the Arpeggio plays back for this length and stops.

7 Original Tempo

Indicates the appropriate tempo value of the Arpeggio type. Note that this tempo is not set automatically when selecting an Arpeggio type.

8 Accent

The circle indicates that the Arpeggio uses the Accent Phrase feature (page 64).

9 Random SFX

The circle indicates that the Arpeggio uses the SFX feature (page 64).

10 Voice Type

Indicates the voice type appropriate for the Arpeggio Type. When the Voice With Arpeggio parameter^{*2} is set to “on” in the Song/Pattern Record mode, the voice of this type is automatically selected.

^{*1} The Loop parameter can be set in the Arpeggio Other display of Voice Common Edit (page 102), Performance Part Edit (page 156) and Mixing Part Edit (page 235).

^{*2} The Voice with Arpeggio parameter can be set in the Arpeggio display (page 189) of the Song/Pattern Record display.

Arpeggio related settings

There are several methods for triggering and stopping the Arpeggio playback. In addition, you can set whether or not SFX sounds and special Accent Phrases are triggered along with the normal sequence data. This section covers the Arpeggio related parameters which can be set in the Voice, Performance and Mixing modes.

Turning Arpeggio playback on/off

The following three settings are available for turning the Arpeggio playback on/off.

To play the Arpeggio only when the note is pressed:	Set the Hold parameter to “off” and the Trigger mode to “gate.”
To continue the Arpeggio even if the note is released:	Set the Hold parameter to “on.”
To toggle the Arpeggio playback on/off whenever the note is pressed:	Set the Trigger mode to “toggle.” The Hold parameter can be set to either “on” or “off.”

NOTE For the displays including the Hold and Trigger mode parameter, refer to “Arpeggio setting display” below.

Using the knobs to control Arpeggios

When the ARP FX lamp is turned on by pressing the [SELECTED PART CONTROL] button a few times, you can use the knobs to control Arpeggio playback. Try this out and listen for the changes in the sound. For details, see page 90.

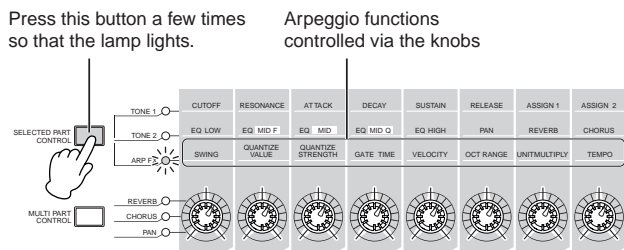

Accent Phrase

Accent Phrases are composed of sequence data included in some Arpeggio types, sounding only when you play notes at a velocity higher (stronger) than that specified in the Accent Velocity Threshold parameter. If it is hard to play at velocities necessary to trigger the Accent Phrase, set the Accent Velocity Threshold parameter to a lower value.

NOTE For the displays including the Accent Velocity Threshold parameter, refer to “Arpeggio setting display” below.

NOTE For information on Arpeggio types that use this function, refer to the Arpeggio Type List in the Data List 2 (PDF) documentation, available from the online Yamaha Manual Library.

Random SFX

Some Arpeggio types feature a Random SFX function which will trigger special sounds (such as guitar fret noises) when the note is released. The following parameters affecting Random SFX are provided.

For turning the Random SFX on/off:	Random SFX parameter
For setting the volume of the SFX sound:	Random SFX Velocity Offset parameter
For determining whether or not the volume of the SFX sound is controlled by velocity:	Random SFX Key On Control parameter

NOTE For the displays that include Random SFX, Random SFX Velocity Offset and Random SFX Key On Control, refer to “Arpeggio setting display” below.

NOTE For information on Arpeggio types that use this function, refer to the Arpeggio Type List in the Data List 2 (PDF) documentation, available from the online Yamaha Manual Library.

Arpeggio setting displays

Mode	Display	Page
Voice mode	Arpeggio Main display of Voice Common Edit	101
	Arpeggio Other display of Voice Common Edit	102
Performance mode	Arpeggio Main display of Performance Part Edit	154
	Arpeggio Other display of Performance Part Edit	156
Song mode/Pattern mode (for playback)	Arpeggio Main display of Mixing Part Edit	235
	Arpeggio Other display of Mixing Part Edit	235
Song Record mode	Arpeggio display of Song Record	189
Pattern Record mode	Arpeggio display of Pattern Record	

Arpeggio playback types

The Arpeggio playback features four main playback types as described below.

Arpeggio Types for Normal Voices

Arpeggio types (belonging to the categories except for the DrPC and Cntr) created for use of Normal Voices have the following three playback types.

Playback only of the played notes

The Arpeggio is played back using only the played note and its octave notes.

Playback of a programmed sequence according to the played notes

These Arpeggio types have the several sequences each of which is suited for a certain chord type. Even if you press only one note, the Arpeggio is played back using the programmed sequence—meaning that notes other than the ones you play may be sounded. Pressing another note triggers the transposed sequence regarding the pressed note as a root note. Adding notes to those already held changes the sequence accordingly. An Arpeggio with such a playback type has “_ES” at the end of the type name.

Playback of a programmed sequence according to the played chord type

These Arpeggio types created for use with Normal Voices are played back to match the chord type determined by detecting the notes you play on the keyboard. An Arpeggio with such a playback type has “_XS” at the end of the type name.

NOTE When the Key Mode parameter is set to “sort” or “sort+direct,” the same sequence is played back no matter what order you play the notes. When the Key Mode parameter is set to “thru”

or “thru+direct,” a different sequence is played back depending on the order you play the notes.

NOTE Since these types are programmed for Normal Voices, using them with Drum Voices may not give musically appropriate results.

Arpeggio Types for Drum Voices (Category: DrPc)

These arpeggio types are programmed specifically for use with Drum Voices, giving you instant access to various rhythm patterns. Three different playback types are available.

Playback of a drum pattern

Pressing any note(s) will trigger the same rhythm pattern.

Playback of a drum pattern, plus additional played notes (assigned drum instruments)

Pressing any note will trigger the same rhythm pattern. Adding notes to the one already held produces additional sounds (assigned drum instruments) for the drum pattern.

Playback only of the played notes (assigned drum instruments)

Playing a note or notes will trigger a rhythm pattern using only the notes played (assigned drum instruments). Keep in mind that even if you play the same notes, the triggered rhythm pattern differs depending on the order of the notes played. This gives you access to different rhythm patterns using the same instruments simply by changing the order in which you play the notes when the Key Mode parameter is set to “thru” or “thru+direct.”

NOTE The three playback types above are not distinguished by category name or type name. You'll have to actually play the types and hear the difference.

NOTE Since these types are programmed for Drum Voices, using them with Normal Voices may not give musically appropriate results.

Arpeggio Types containing mainly non-note events (Category: Cntr)

These arpeggio types are programmed primarily with Control Change and Pitch Bend data. They are used to change the tone or pitch of the sound, rather than play specific notes. In fact, some types contain no note data at all. When using a type of this category, set the Key Mode parameter to “direct,” “thru+direct,” or “sort+direct.”

NOTE The Key Mode parameter can be set in the Arpeggio Main display of Voice Common Edit (page 101), Performance Part Edit (page 154) and Mixing Part Edit (page 235).

Tips for Arpeggio playback

Arpeggio playback in the Voice Play mode

Try out the Arpeggio playback assigned to the preset Voice.

- 1 In the Voice Play mode, make sure that the [ARPEGGIO ON/OFF] button is lit, then play any note to trigger Arpeggio playback.**
- 2 Try playing different notes and chords on the keyboard and listen to the Arpeggio play.**
Arpeggio playback responds in different ways, depending on the order of the notes you play and, of course, the selected Arpeggio Type. Also, try hitting the notes strongly and listen for the Accent Phrase feature.
- 3 Try out various Arpeggio types by pressing the [SF1] – [SF5] buttons.**
NOTE If the 8th note icon is not shown at the right of ARP1 – ARP5 (meaning that Arpeggio Type is set to off in the corresponding display), the Arpeggio Type does not change even if you press the corresponding [SF1] ARP1 – [SF5] ARP5 button.
- 4 Use the knobs to control Arpeggio playback after pressing the [SELECTED PART CONTROL] button a few times (the ARP FX lamp lights).**

Now that you've listened to the Arpeggio Types assigned to the preset Voice, go on and try out some of the other Arpeggio Types available.

- 5 During Arpeggio playback, press the [F4] button to call up the Arpeggio display, then select an Arpeggio type.**

For best results, you should select a Category and Sub Category containing Arpeggio Types that most closely match the currently selected Voice. Once you find an Arpeggio Type that fits, keep it in the display settings and store the Voice (below).

- 6 Store the Arpeggio settings as a User Voice.**

For detailed instructions on storing a Voice, see page 97.

Arpeggio playback/recording in the Performance mode

Call up some of the Performances in User Banks 1 – 3, and play some of the Arpeggios assigned by default to the Performances. In the Performance mode, each of four Arpeggio types is assigned to each of four Parts. This means up to four Arpeggio types can be played back simultaneously. Let's play the Performance making full use of this function.

1 Make sure that the [ARPEGGIO ON/OFF] button is lit, then play any note to trigger Arpeggio playback.

Steps 2 – 4 are same as in “Arpeggio playback in the Voice mode” above. Once you've tried out the Arpeggio Types assigned to the Performance, go on and try some of the other Arpeggio Types available.

5 During Arpeggio playback, press the [F4] button to call up the Arpeggio display then select an Arpeggio type for each Part.

For best results, you should select a Category and Sub Category containing Arpeggio Types that most closely match the Voice for the Part. Once you find an Arpeggio Type that fits, keep it in the display settings and store the Performance (below).

6 Store the Arpeggio settings as a User Performance.

For detailed instructions on storing a Performance, see page 142.

You can record your keyboard performance to a Song/Pattern in the Performance Record mode. Keep in mind that any Arpeggio playback you trigger in the Performance mode can be recorded to the Song or Pattern as well. For details about the Performance recording, see page 140.

NOTE The Arpeggio playback data is recorded to the Song or Pattern track as MIDI sequence data. Note that pressing the note only triggers the Arpeggio playback. The Song or Pattern data will not trigger the Arpeggio playback.

Arpeggio playback/recording in the Pattern mode

Arpeggios are also useful for creating Phrases, which can be used as the basic building blocks in making a Pattern. Create User Phrases as desired then assign them to the desired track in the Patch display (page 212). This section shows how to record a Arpeggio playback to a Pattern track.

1 Select an Arpeggio type in the Arpeggio display (page 219) of the Pattern Record mode.

When the Arpeggio With Voice Switch parameter is set to “on,” the Voice appropriate for this Arpeggio type is automatically selected.

2 Record playback of the selected Arpeggio to the Pattern track.

Record different Arpeggios to other tracks by repeating steps 1 – 2. It is a good idea to assign a name to the created Phrase in the Pattern Patch display (page 212) for future recall.

3 Create Pattern data by assigning the created Phrases to the Section in the Pattern Patch display (page 212).

For example, create a Section A for the intro, a Section B for the verse, a Section C for the chorus, and a Section D for the ending—and you have the basic blocks to build an original Song.

4 Create the Pattern Chain data by programming the playback order of the Sections.

Pattern Chain allows you to string several different Patterns together to make a single Song. For details, see page 213.

5 Convert the Pattern Chain data to Song data.

For details, see page 215.

Creating an original Arpeggio type

In addition using the preset Arpeggios, you can also create your own original Arpeggio data. The procedure is as follows.

1 Record the MIDI sequence data to a Song or Pattern.

Up to four tracks can be used in creating an Arpeggio. Up to 16 unique note numbers can be recorded to the Arpeggio track. If more than 16 different note numbers have been recorded to the MIDI sequence data, the Convert operation automatically reduces the notes in excess of the limit. Because of this, be careful to record only up to 16 different notes when you create an Arpeggio.

2 Convert the recorded MIDI sequence data to Arpeggio data.

Use the “Put Track to Arpeggio” Job in the Song Job mode (page 206) or the Pattern Job mode (page 227). After setting the related parameters, press the [ENTER] button to execute the Job.

The created Arpeggio types can be selected from the User bank in the Arpeggio display.

Controller Block

This block consists of the keyboard, Pitch Bend and Modulation Wheels, Ribbon Controller, Knobs, Sliders and so on. The keyboard itself doesn't generate sounds, but instead generates/transmits note on/off, velocity and other information (MIDI messages) to the synthesizer's tone generator block when you play notes. The controllers also generate/transmit MIDI messages. The synthesizer's tone generator block produces the sound according to the MIDI messages transmitted from the keyboard and controllers.

Keyboard

The keyboard transmits the note on/off messages to the Tone Generator Block (for sounding) and Sequencer Block (for recording). The keyboard is also used for triggering Arpeggio playback. You can change the note range of the keyboard in octaves by using the OCTAVE [UP] and [DOWN] buttons, transpose the notes in the Play display (page 259) of the Utility mode, and set how the actual velocity is generated according to the strength with which you play notes in the same display.

Pitch Bend wheel

Use the Pitch Bend wheel to bend notes up (roll the wheel away from you) or down (roll the wheel toward you) while playing the keyboard. This wheel is self-centering and will automatically return to normal pitch when released. Try out the Pitch Bend wheel while pressing a note on the keyboard.

Each preset Voice has its own default Pitch Bend Range setting. The Pitch Bend Range setting for each Voice can be changed in the Play Mode display (page 98) of the Voice Edit mode. From this display you can also reverse the Pitch Bend function—so that moving the wheel up lowers the pitch, and moving it down raises the pitch. Functions other than Pitch Bend can be assigned to the Pitch Bend wheel in the Controller Set display (page 104) of the Voice Edit mode.

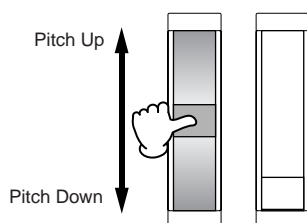

Modulation wheel

Even though the Modulation wheel is conventionally used to apply vibrato to the sound, many of the preset Voices have other functions and effects assigned to the wheel. The more you move this wheel up, the greater the effect that is applied to the sound. Try out the Modulation wheel with various preset Voices while playing the keyboard. To avoid accidentally applying effects to the current Voice,

make sure the Modulation wheel is set to minimum before you start playing. Various functions can be assigned to the Modulation wheel in the Controller Set display (page 104) of the Voice Edit mode.

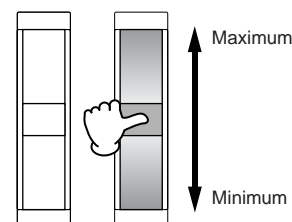

Ribbon Controller

The Ribbon Controller is touch sensitive, and is controlled by running your finger laterally across the surface. Various functions are assigned to each preset Voice. Try out the Ribbon Controller with various preset Voices while playing the keyboard. Various functions can be assigned to the Ribbon Controller in the Controller Set display (page 104) of the Voice Edit mode. You can also determine whether the Ribbon Controller value returns to the center, or stays at the point where you released your finger in the General Other display (page 100) of the Voice Common Edit mode.

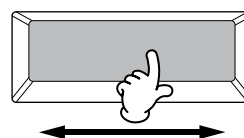

Assignable Function Buttons

According to the XA (Expanded Articulation) Control settings in the Oscillator display (page 112) of the Voice Element Edit mode, you can call up the specific Element of the current Voice by pressing each of these buttons during your keyboard performance. You can select how the on/off status of these buttons is switched by using the Assignable Function 1 Mode and Assignable Function 2 Mode parameters in the General Other display (page 100) of the Voice Common Edit mode. Furthermore, you can assign various functions (other than calling up specific Elements) to these buttons.

Knobs and Sliders

These eight knobs let you change various aspects of the Voice's sound in real time—while you play. The eight sliders let you adjust the volume of the Voice Elements, Performance Parts and Mixing Parts.

For more information about how to use the knobs and sliders in the respective modes, see page 90 (Voice mode), page 136 (Performance mode), and page 180 (Song/Pattern mode).

Effect Block

This block applies effects to the output of the tone generator block, and audio input block, processing and enhancing the sound. Effects are applied in the final stages of editing, letting you change the sound of the created Voice as desired.

Effect structure

System Effects—Reverb and Chorus

System Effects are applied to the overall sound—a Voice, an entire Performance, a Song, etc. With System Effects, the sound of each Part is sent to the effect according to the effect Send Level for each Part. The processed sound (referred to as “wet”) is sent back to the mixer, according to the Return Level, and output—after being mixed with the unprocessed “dry” sound. This arrangement lets you prepare an optimum balance of the effect sound and the original sound of the Parts.

Insertion Effect

Insertion Effects can be applied individually to each Part. Insertion Effects are mainly used to directly process a single Part. The depth of the effect is adjusted by setting the dry/wet balance. Since an Insertion Effect can only be applied to one particular Part, it should be used for sounds you want to drastically change or for sounds that use an effect unintended for other sounds. You can also set the balance so that only the effect sound is heard, by setting Wet to 100%. This synthesizer features eight sets of Insertion Effects (one set has A and B units). They can be applied to all Parts of the Performance, and applied to eight Parts (maximum) of the Song/Pattern. Another important Insertion Effect is the Vocoder, which can be applied only to one Part.

NOTE In the Voice mode, the Vocoder Effect can be applied to each of the Voices. In the Mixing (Song/Pattern) and Performance mode, the Vocoder Effect can be applied only to Part 1. The Vocoder Effect does not work even if you assign the Voice (to which the Vocoder is applied in the Voice mode) to the other parts (Part 2 or higher).

Master Effect

This block applies effects to the final stereo output signal of the entire sound.

Element EQ

The Element EQ is applied to each element of the Normal Voice and each key of the Drum Voice. You can specify which shape is used among six types, such as shelving and peaking.

Part EQ

This 3-band parametric EQ is applied to each part of the Performance/Song Mixing/Pattern Mixing. The high band and low band are the shelving type. The middle band is the peaking type.

Master EQ

Master EQ is applied to the final (post-effect), overall sound of the instrument. In this EQ, all five bands can be set to peaking, or the lowest and highest bands can also be set to shelving.

Effect connection in each mode

In the Voice mode

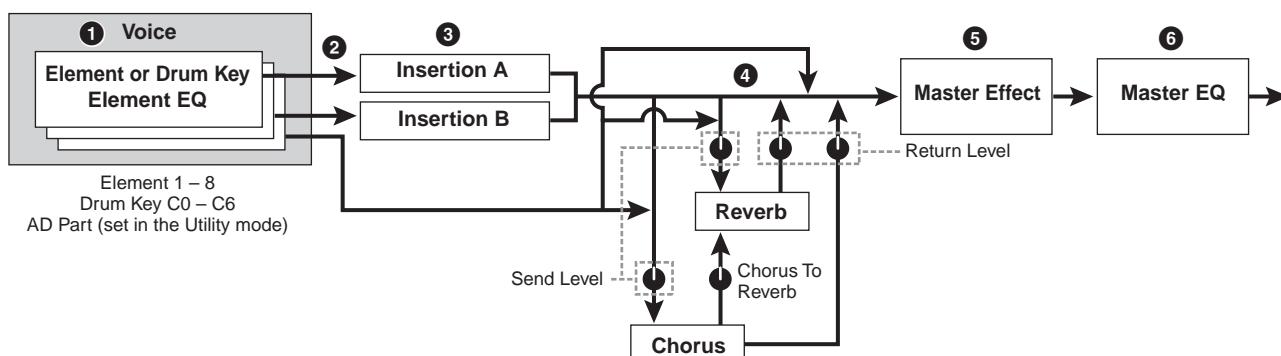

- 1 Sets the Element EQ parameters applied to each Element (for a Normal Voice) and each key (for a Drum Voice).**

The Element EQ parameters can be set in the EQ display (pages 126 and 132) of the Voice Edit mode.

- 2 Determines which Insertion Effect, A or B, is applied to each Element (or to each key when a Drum Voice is selected).**

The Insertion Effect can also be bypassed. This can be set in the Connect display (page 107) of the Voice Common Edit or the Oscillator display (page 112) of the Voice Element Edit (or Key Edit).

NOTE These two display types are linked and feature the same settings, only in different formats.

- 3 Determines the Insertion A/B connection from the following four types: parallel, A ► B, B ► A, and Vocoder.**

This block also selects the Effect Types of Insertion A and B respectively and sets the related parameters.

These can be set in the Connect display (page 107) and the Insertion A/B display (page 109) of Voice Common Edit.

- 4 Determines the Send Level/Return Level to/from the Reverb/Chorus and the signal level sent from the Chorus to the Reverb.**

This block also selects the Effect Types of Reverb and Chorus respectively and sets the related parameters. These can be set in the Connect display (page 107) and the Reverb display/Chorus display (page 109) of Voice Common Edit.

- 5 Selects the Master Effect type and sets the Effect parameters in the Master Effect display (page 264) of the Utility mode.**

- 6 Sets the Master EQ parameters in the Master EQ display (page 264) of the Utility mode.**

In the Performance mode

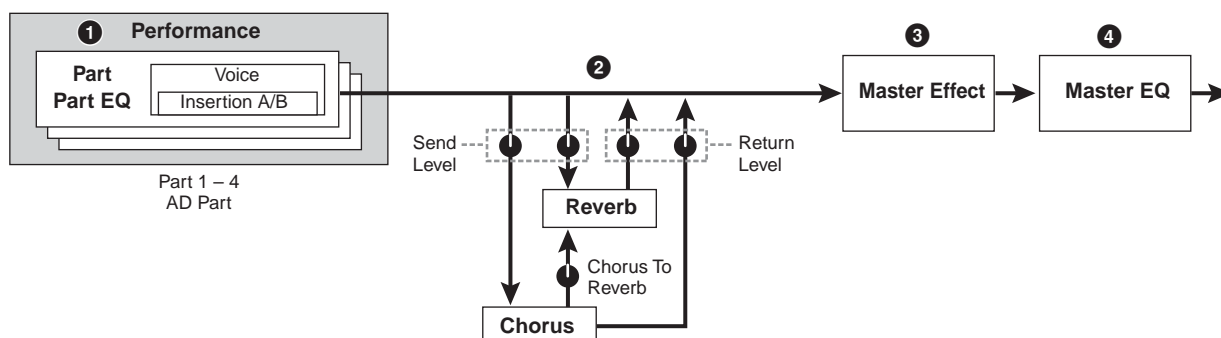

1 Sets the Part EQ parameters applied to each part in the EQ display (page 144) of Performance Part Edit.

2 Determines the Send Level/Return Level to/from the Reverb/Chorus and the signal level sent from the Chorus to the Reverb.

This block also selects the Effect Types of Reverb and Chorus respectively and sets the related parameters. These can be set in the Connect display (page 149) and the Reverb display/Chorus display (page 150) of Performance Common Edit.

3 Selects the Master Effect type and sets the Effect parameters in the Master Effect display (page 146) of Performance Common Edit.

4 Sets the Master EQ parameters in the Master EQ display (page 146) of Performance Common Edit.

NOTE The Effect settings of **1** – **3** in the Voice mode illustrated on page 69 are available also in the Performance mode.

Mixing mode

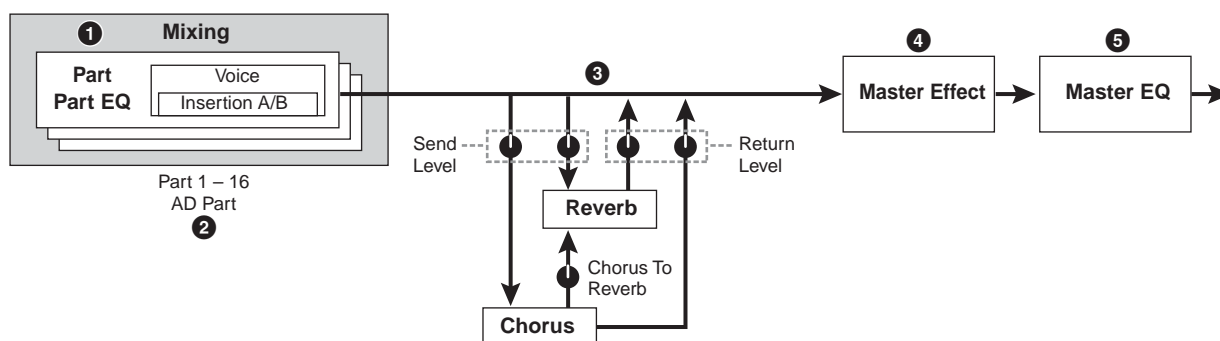

1 Sets the Part EQ parameters applied to each part in the EQ display (page 236) of Mixing Part Edit.

2 Selects the eight Parts to which the Insertion Effect is applied from Parts 1 – 16 and the AD Part.

This can be set in the Insertion Effect Switch display (page 234) of the Mixing Edit.

3 Determines the Send Level/Return Level to/from the Reverb/Chorus and the signal level sent from the Chorus to the Reverb.

This block also selects the Effect Types of Reverb and Chorus respectively and sets the related parameters. These can be set in the Connect display (page 234) and the Reverb display/Chorus display (page 235) of Mixing Common Edit.

4 Selects the Master Effect type and sets the Effect parameters in the Master Effect display (page 234) of Mixing Common Edit.

5 Sets the Master EQ parameters in the Master EQ display (page 234) of Mixing Common Edit.

NOTE The Effect settings of **1** – **3** in the Voice mode illustrated on page 69 are available for up to eight parts for which the Insertion Effect is turned on.

Effect Category and Type

This section explains the Effect categories and their types. The Effect Type list described below for each category contains the columns: Rev (Reverb), Cho (Chorus), Ins (Insertion) and Mas (Master Effect). The checkmarks indicated in these columns means the Effect Type is available for each block. These Effect types (with the checkmarks indicated in each list) can be selected from the panel controls.

Reverb

Also called “reverberation,” this refers to the sound energy remaining in a room or closed space after the original sound stops. Similar to yet different from echo, reverb is the indirect, diffuse sound of reflections from the walls and ceiling that accompany the direct sound. The characteristics of this indirect sound depends on the size of the room or space and the materials and furnishings in the room. Reverb Effect types use digital signal processing to simulate these characteristics.

Effect Type	Rev	Cho	Ins	Description
REV-X HALL	✓	–	–	Reverb emulating the acoustics of a concert hall using the REV-X technology.
R3 HALL	✓	–	–	Reverb emulating the acoustics of a concert hall using the algorithm derived from the Yamaha ProR3.

Effect Type	Rev	Cho	Ins	Description
SPX HALL	✓	✓	✓	Reverb emulating the acoustics of a concert hall derived from the Yamaha SPX1000.
REV-X ROOM	✓	–	–	Reverb emulating the acoustics of a room using the REV-X technology.
R3 ROOM	✓	–	–	Reverb emulating the acoustics of a room using the algorithm derived from the Yamaha ProR3.
SPX ROOM	✓	✓	✓	Reverb emulating the acoustics of a room derived from the Yamaha SPX1000.
R3 PLATE	✓	–	–	Reverb emulating a metal plate using the algorithm derived from the Yamaha ProR3.
SPX STAGE	✓	✓	✓	Reverb appropriate for a solo instrument derived from the Yamaha SPX1000.
SPACE SIMULATOR	✓	–	–	Reverb which lets you set the space size by specifying the width, height, and depth.

Delay

An effect (or device) that delays an audio signal.

Effect Type	Rev	Ins	Mas	Description
CROSS DELAY	✓	✓	–	The feedback of the two delayed sounds is crossed.
TEMPO CROSS DELAY	✓	✓	–	Cross delay synchronized with the tempo of Song/Pattern/Arpeggio.
TEMPO DELAY MONO	✓	✓	–	Mono delay synchronized with the tempo of Song/Pattern/Arpeggio.
TEMPO DELAY STEREO	✓	✓	–	Stereo delay synchronized with the tempo of Song/Pattern/Arpeggio.
CONTROL DELAY	–	✓	–	Delay with delay time controllable in real time.
DELAY LR	✓	✓	–	Produces two delayed sounds: L and R.
DELAY LCR	✓	✓	–	Produces three delayed sounds: L, R and C (center).
DELAY LR (Stereo)	✓	✓	✓	Produces two delayed sounds in stereo: L and R.

Chorus

Depending on the particular chorus type and parameters, this can make a voice sound “larger,” as if several identical instruments were playing in unison, or it can give a voice greater warmth and depth.

Effect Type	Cho	Ins	Description
G CHORUS	✓	✓	A Chorus Effect that produces a richer and more complex modulation than normal chorus.
2 MODULATOR	✓	✓	A Chorus Effect consisting of the pitch modulation and the amplitude modulation.
SPX CHORUS	✓	✓	An effect which uses a 3-phase LFO to add modulation and spaciousness to the sound.
SYMPHONIC	✓	✓	A multi-stage version of SPX CHORUS modulation.

Effect Type	Cho	Ins	Description
ENSEMBLE DETUNE	✓	✓	Chorus effect without modulation, created by adding a slightly pitch-shifted sound.

Flanger

This effect creates a swirling, metallic sound.

Effect Type	Cho	Ins	Description
VCM FLANGER	✓	✓	Flanger with VCM technology producing a vintage sound.
CLASSIC FLANGER	✓	✓	Conventional type of flanger.
TEMPO FLANGER	✓	✓	Tempo-synchronized flanger.
DYNAMIC FLANGER	–	✓	Dynamically controlled flanger.

Phaser

Cyclically modulates the phase to add modulation to the sound.

Effect Type	Cho	Ins	Description
VCM PHASER MONO	✓	✓	Mono phaser with VCM technology producing a vintage sound.
VCM PHASER STEREO	✓	✓	Stereo phaser with VCM technology producing a vintage sound.
TEMPO PHASER	✓	✓	Tempo-synchronized phaser.
DYNAMIC PHASER	–	✓	Dynamically controlled phase shifter

Tremolo & Rotary

The tremolo effect cyclically modulates the volume. The Rotary Speaker effect simulates the characteristic vibrato effect of a rotary speaker.

Effect Type	Ins	Description
AUTO PAN	✓	An effect which cyclically moves the sound left/right and front/back.
TREMOLO	✓	An effect which cyclically modulates the volume.
ROTARY SPEAKER	✓	Simulation of a rotary speaker

Distortion

This type can be used mainly for guitar, adding distortion with an edge to the sound.

Effect Type	Ins	Mas	Description
AMP SIMULATOR 1	✓	–	A simulation of a guitar amp.
AMP SIMULATOR 2	✓	–	A simulation of a guitar amp.
COMP DISTORTION	✓	–	Since a Compressor is included in the first stage, steady distortion can be produced regardless of changes in input level.
COMP DISTORTION DELAY	✓	✓	Compressor, Distortion and Delay are connected in series.

Compressor

Compressor is an effect commonly used to limit and compress the dynamics (softness/loudness) of an audio signal. For signals that vary widely in dynamics, such as vocals and guitar parts, it “squeezes” the dynamic range, effectively making soft sounds louder and loud sounds softer. When used with gain to boost the overall level, this creates a more powerful, more consistently high-level sound. Compression can be used to increase sustain for electric guitar, smooth out the volume of a vocal, or bring a drum kit or rhythm pattern further up-front in the mix.

Effect Type	Ins	Mas	Description
VCM COMPRESSOR 376	✓	✓	Compressor with VCM technology.
CLASSIC COMPRESSOR	✓	–	Conventional type of compressor.
MULTI BAND COMP	✓	✓	3-band type compressor.

Wah

This Effect cyclically modulates the tone brightness (cutoff frequency of a filter). Auto Wah modulates the tone via LFO, Touch Wah modulates the tone via volume (note on velocity) and Pedal Wah modulates the tone the pedal control.

Effect Type	Ins	Description
VCM AUTO WAH	✓	Modulates the tone via the LFO.
VCM TOUCH WAH	✓	Modulates the tone via the volume (note on velocity).
VCM PEDAL WAH	✓	Modulates the tone via the pedal control. For best results, assign the Pedal Control parameter of this Effect type to the Foot Controller in the Controller Set display, then use the Foot Controller to control this effect in real time.

Lo-Fi

This Effect intentionally degrades the audio quality of the input signal via several methods such as lowering the sampling frequency.

Effect Type	Ins	Mas	Description
LO-FI	✓	✓	Degrades the audio quality of the input signal to get a lo-fi sound.
NOISY	✓	–	Adds the noise to the current sound.
DIGITAL TURNTABLE	✓	–	Simulates the noise of an analog record.

Tech

This Effect changes the tonal characteristics radically by using a filter and modulation.

Effect Type	Ins	Mas	Description
RING MODULATOR	✓	✓	An effect that modifies the pitch by applying amplitude modulation to the frequency of the input.
DYNAMIC RING MODULATOR	✓	–	Dynamically controlled Ring Modulator

Effect Type	Ins	Mas	Description
DYNAMIC FILTER	✓	✓	Dynamically controlled filter
AUTO SYNTH	✓	–	Processes the input signal into a synthesizer-type sound.
ISOLATOR	✓	✓	Controls the level of a specified frequency band of the input signal.
SLICE	✓	✓	Slices the AEG of the Voice sound.
TECH MODULATION	✓	–	Adds a unique feeling of modulation similar to ring modulation.

Vocoder

The Vocoder effect does not belong to any category. When you want to use this effect, set the INSERTION CONNECT parameter in the Effect Connect display (page 109) to “ins L.”

Effect Type	Ins	Description
VOCODER	✓	This effect extracts characteristics from the microphone sound and applies it to the Voice played from the keyboard. This creates a distinctive, “robot voice” effect which is generated when you play the keyboard and sing or speak into the microphone at the same time.

Misc

This category includes the other effect types.

Effect Type	Cho	Ins	Description
VCM EQ 501	–	✓	Vintage 5-band parametric EQ with VCM technology.
PITCH CHANGE	–	✓	Changes the pitch of the input signal.
EARLY REFLECTION	✓	✓	This effect isolates only the early reflection components of the reverb.
HARMONIC ENHANCER	–	✓	Adds new harmonics to the input signal to make the sound stand out.
TALKING MODULATOR	–	✓	Adds a vowel sound to the input signal.
DAMPER RESONANCE	–	✓	Simulates the resonance produced when the damper pedal of the piano is pressed.

VCM (Virtual Circuitry Modeling)

VCM is a technology that authentically models the elements in analog circuitry (such as resistors and capacitors). Effect types using the VCM technology produce the uniquely warm characteristics of vintage processing gear.

VCM Compressor 376

This effect emulates the characteristics of analog compressors, used as standard effects in recording studios. It frames and thickens the sound, and is suitable for drum and bass sounds.

VCM Equalizer 501

This effect emulates the characteristics of analog equalizers used in the 1970s, recreating a warm, high-quality flanger effect.

VCM Flanger

These effects emulate the characteristics of analog flanger used in the 1970s, recreating a warm, high-quality flanger effect.

VCM Phaser Mono, VCM Phaser Stereo

This effect emulates the characteristics of analog phasers used in the 1970s, recreating a warm, high-quality phaser effect.

VCM Auto Wah, VCM Touch Wah, VCM Pedal Wah

These effects emulate the characteristics of analog Wah used in the 1970s, recreating a warm, high-quality wah-wah effect.

REV-X

REV-X is a reverb algorithm developed by Yamaha. It provides a high-density, richly reverberant sound quality, with smooth attenuation, spread and depth that work together to enhance the original sound. The MOTIF XS features two types of REV-X effects: REV-X Hall and REV-X Room.

Effect Parameters

Each of the Effect Types has parameters determining how the Effect is applied to the sound. A variety of sounds can be obtained from a single effect type by setting these parameters. For information about the Effect parameters, see below.

Preset settings for Effect parameters

Preset settings for parameters of each effect type are provided as templates and can be selected in the Effect Type selection display. To get a desired effect sound, try first selecting one of the Presets close to your imagined sound, then change the parameters as necessary.



Effect Parameters

NOTE Some parameters below may appear in different effect types with the same name, but actually have different functions depending on the particular effect type. For these parameters, two or three types of explanations are given.

Parameter name	Descriptions
AEG Phase	Offsets the phase of the AEG.
AM Depth	Determines the depth of the amplitude modulation.
AM Inverse R	Determines the phase of the amplitude modulation for the R channel.
AM Speed	Determines the amplitude modulation speed.
AM Wave	Selects the wave for modulating the amplitude.
AMP Type	Selects the amplifier type to be simulated.
Analog Feel	Adds the characteristics of an analog flanger to the sound.
Attack	Determines the amount of time that elapses between the playing of a key and the start of the compressor effect.
Attack Offset	Determines the amount of time that elapses between the playing of a key and the start of the wah effect.
Attack Time	Determines the attack time of the envelope follower.
Bit Assign	Determines how the Word Length is applied to the sound.
Bottom ^{*1}	Determines the minimum value of the wah filter.
BPF1-10 Gain	Determines each output gain of BPFs 1 - 10 of the Vocoder effect.
Click Density	Determines the frequency at which the click sounds.
Click Level	Determines the click level.
Color ^{*2}	Determines the fixed phase modulation.
Common Release	This is a parameter of "Multi Band Comp." This parameter determines the amount of time that elapses between the releasing of a note and the end of the effect.
Compress	Determines the minimum input level at which the compressor effect is applied.
Control Type	This is a parameter of "Control Delay." When set to "Normal," the delay effect is always applied to the sound. When set to "Scratch," the delay effect is not applied if both the Delay Time and Delay Time Offset are set to "0."
Damper Control	When the half-damper compatible FC3 footswitch is connected to the SUSTAIN jack, the Damper Control parameter is controlled by the FC3 over a range of 0 - 127, allowing for partial damper effects, such as is available on an actual grand piano.
Decay	Controls how the reverb sound decays.
Delay Level C	Determines the level of the delayed sound for the center channel.
Delay Mix	Determines the level of the delayed mixed sound when multiple effects are applied.
Delay Offset	Determines the offset value of the delay modulation.
Delay Time	Determines the delay of the sound in note value or absolute time.
Delay Time C, L, R	Determines the delay time for each channel: center, left and right.
Delay Time L>R	Determines the amount of time between the moment the sound is input from the L channel and the moment the sound is output to the R channel.
Delay Time Ofst R	Determines the delay time for the R channel as offset.
Delay Time R>L	Determines the amount of time between the moment the sound is input from the R channel and the moment the sound is output to the L channel.
Delay Transition Rate	Determines the speed (rate) at which the delay time is changed from the current value to the specified new value.
Density	Determines the density of the reverberations or reflections.
Depth	When "Space Simulator" is selected, this parameter determines the depth of the simulated room. When "VCM Flanger" is selected, this parameter determines the amplitude of the LFO wave which controls the cyclic change of the delay modulation.

Basic Structure

Basic Operation

Connections

Basic Section

Parameter name	Descriptions
Depth	When phaser type is selected, this parameter determines the amplitude of the LFO wave which controls the cyclic change of the phase modulation.
Detune	Determines the amount of pitch to be detuned.
Device	Selects the device for changing how to distort the sound.
Diffusion	Determines the spread of the selected effect.
Direction	Determines the direction of the modulation controlled by the envelope follower.
Divide Freq High	Determines the high frequency for dividing the entire sound into three bands.
Divide Freq Low	Determines the low frequency for dividing the entire sound into three bands.
Divide Min Level	Determines the minimum level of the portions extracted via the slice effect.
Divide Type	Determines how the sound (wave) is sliced by the note length.
Drive	When one of the distortion, noisy and slice effects is selected, this parameter determines the extent to which the sound is distorted. When one of the misc effects is selected, this parameter determines the extent to which the enhancer or talking modulator is applied.
Drive Horn	Determines the depth of the modulation generated via the rotation of the horn.
Drive Rotor	Determines the depth of the modulation generated via the rotation of the rotor.
Dry Level	Determines the level of the dry sound (to which the effect is not applied).
Dry LPF Cutoff Frequency	Determines the cutoff frequency of the low pass filter applied to the dry sound.
Dry Mix Level	Determines the level of the dry sound (to which the effect is not applied).
Dry Send to Noise	Determines the level of the dry signal sent to the noise effect.
Dry/Wet Balance	Determines the balance of the dry sound and effect sound.
Dyna Level Offset	Determines the offset value added to the output from the envelope follower.
Dyna Threshold Level	Determines the minimum level at which the envelope follower starts.
Edge	Sets the curve that determines how the sound is distorted.
Emphasis	Determines the change of the characteristics in high frequencies.
EQ Frequency	Determines the center frequency for each band of the EQ.
EQ Gain	Determines the level gain of the EQ center frequency for each band.
EQ High Frequency	Determines the center frequency of the high EQ band that is attenuated/boosted.
EQ High Gain	Determines the amount of boost or attenuation applied to the high EQ band.
EQ Low Frequency	Determines the center frequency of the low EQ band that is attenuated/boosted.
EQ Low Gain	Determines the amount of boost or attenuation applied to the low EQ band.
EQ Mid Frequency	Determines the center frequency of the middle EQ band that is attenuated/boosted.
EQ Mid Gain	Determines the amount of boost or attenuation applied to the middle EQ band.
EQ Mid Width	Determines the width of the middle EQ band.
EQ Width	Determines the width of the EQ band.
ER/Rev Balance	Determines the level balance of the early reflection and reverb sound.
F/R Depth	This parameter of "Auto Pan" (available when PAN Direction is set to "L turn" and "R turn") determines the depth of the F/R (front/rear) pan.
FB Hi Damp Ofst R	Determines the amount of decay in high frequencies for the R channel as offset.
FB Level Ofst R	Determines the feedback level for the R channel as offset.
Feedback	Determines the level of the sound signal output from the effect block and returned to its own input.
Feedback High Damp	Determines how the high frequencies of the feedback sound decay.
Feedback Level	When one of the reverb and early reflection effects is selected, this parameter determines the feedback level of the initial delay. When one of the delay, chorus, flanger, comp distortion delay, and TEC effects is selected, this parameter determines the feedback level output from the delay and returned to the input. When "Tempo Phaser" or "Dynamic Phaser" is selected, this parameter determines the feedback level output from the phaser and returned to the input.
Feedback Level 1, 2	Determines the feedback level of the delayed sound in each of the 1st and 2nd series.
Feedback Time	Determines the delay time of the feedback.
Feedback Time 1, 2, L, R	Determines the time of the feedback delay 1, 2, L and R.
Filter Type	When "Lo-Fi" is selected, this parameter selects the tonal characteristic type. When "Dynamic Filter" is selected, this parameter determines the filter type.
Fine 1, 2	Determines the pitch finely for each of the 1st series and 2nd series.

Parameter name	Descriptions
Formant Offset	This parameter of the Vocoder adds the offset value to the cutoff frequency of BPF for the Inst input.
Formant Shift	This parameter of the Vocoder shifts the cutoff frequency of the BPF for Inst input.
Gate Switch	When set to "off," the output from the HPF and the Noise Generator is passed through the gate. When set to "on," the output from the HPF and the Noise Generator passes through the gate only if the audio signal is input to the Inst.
Gate Time	Determines the gate time of the sliced portion.
Height	Determines the height of the simulated room.
Hi Resonance	Adjusts the resonance of the high frequencies.
High Attack	Determines the amount of time from the moment a note is pressed to the moment the compressor is applied to the high frequencies.
High Gain	Determines the output gain for the high frequencies.
High Level	Determines the level of the high frequencies.
High Mute	Switches the mute status of the high frequencies.
High Ratio	When "REV-X Hall" or "REV-X Room" is selected, this parameter determines the ratio of the high frequencies. When "Multi Band Comp" is selected, this parameter determines the ratio of the compressor for the high frequencies.
High Threshold	Determines the minimum input level at which the effect is applied to the high frequencies.
Horn Speed Fast	Determines the speed of the horn when the slow/fast switch is set to "fast."
Horn Speed SLow	Determines the speed of the horn when the slow/fast switch is set to "slow."
HPF Freq	Determines the Cutoff frequency for the High Pass Filter applied to the microphone sound.
HPF Output Level	Determines how much the output from high pass filter is mixed with the output from the Vocoder.
Initial Delay	Determines the amount of time that elapses between the direct, original sound and the initial reflections.
Initial Delay 1, 2	Determines the delay time until the initial reflection for each of the 1st series and 2nd series.
Initial Delay Lch, Rch	Determines the amount of time that elapses between the direct, original sound and the initial reflections (echoes) that follow it for each of R and L channels.
Input Level	Determines the input level of the signal to which the compressor is applied.
Input Mode	Selects mono or stereo configuration for the input sound.
Input Select	Selects an input channel.
Inst Input Level	Determines the level of the instrument sound to which the Vocoder is applied.
L/R Depth	Determines the depth of the L/R pan effect.
L/R Diffusion	Determines the spread of the sound.
Lag	Determines the lagging time additionally applied to the delayed sound specified via a note length.
LFO Depth	When one of "SPX Chorus," "Symphonic," "Classic Flanger," and "Ring Modulator" is selected, this parameter determines the depth of the modulation. When "Tempo Phase" is selected, this parameter determines the frequency of the phase modulation.
LFO Phase difference	Determines the L/R phase difference of the modulated wave.
LFO Phase Reset	Determines how to reset the initial phase of the LFO.
LFO Speed	When one of the chorus effects, flanger effects, tremolo and ring modulator is selected, this parameter determines the frequency of the modulation. When "Tempo Phaser" is selected, this parameter determines the modulation speed via a note type. When "Auto Pan" is selected, this parameter determines the frequency of the Auto Pan.
LFO Wave	When any of the flanger effects and "Ring Modulator," this parameter selects the wave for modulation. When "Auto Pan" is selected, this parameter determines the panning curve. When "VCM Auto Wah" is selected, this parameter selects the wave, sine or square.
Liveness	Determines the decay characteristic of Early Reflection.
Low Attack	Determines the amount of time from the moment a note is pressed to the moment the compressor is applied to the low frequencies.
Low Gain	Determines the output gain for the low frequencies.
Low Level	Determines the output level for the low frequencies.
Low Mute	Determines whether the low frequency band is off or on.
Low Ratio	When "REV-X Hall" or "REV-X Room" is selected, this parameter determines the ratio of the low frequencies. When "Multi Band Comp" is selected, this parameter determines the ratio of the compressor for the low frequencies.
Low Threshold	Determines the minimum input level at which the effect is applied to the low frequencies.
LPF Resonance	Determines the resonance of the low pass filter for the input sound.
Manual	When "VCM Flanger" is selected, this parameter determines the offset value of the delay modulation.

Parameter name	Descriptions
Manual	When "VCM Phaser mono" or "VCM Phaser stereo" is selected, this parameter determines the offset value of the phase modulation.
Meter	Changes the meter.
Mic Gate Threshold	Determines the threshold level of the noise gate for the microphone sound.
Mic Level	Determines the input level of the microphone sound.
Mic L-R Angle	Determines the L/R angle of the microphone.
Mid Attack	Determines the amount of time from the moment a note is pressed to the moment the compressor is applied to the mid frequencies.
Mid Gain	Determines the output gain for the mid frequencies.
Mid Level	Determines the output level for the mid frequencies.
Mid Mute	Switches the mute status of the mid frequencies.
Mid Ratio	Determines the ratio of the compressor for the mid frequencies.
Mid Threshold	Determines the minimum input level at which the effect is applied for the mid frequencies.
Mix	Determines the volume of the effect sound.
Mix Level	Determines the level of the effect sound mixed to the dry sound.
Mod Depth	Determines the depth of the modulation.
Mod Depth Ofst R	Determines the depth of the modulation for R channel as offset.
Mod Feedback	Determines the feedback level to the modulation.
Mod Gain	Determines the gain of the modulation.
Mod LPF Cutoff Frequency	Determines the cutoff frequency of the low pass filter applied to the modulated sound.
Mod LPF Resonance	Determines the resonance of the low pass filter for the modulated sound.
Mod Mix Balance	When "Noisy" is selected, this parameter determines the mix balance of the modulated element. When "Tech Modulation" is selected, this parameter determines the volume of the modulated sound.
Mod Speed	Determines the modulation speed.
Mod Wave Type	Selects the wave type for modulation.
Mode	Determines the phaser type, or more specifically, the factor for forming the phaser effect.
Modulation Phase	Determines the L/R phase difference of the modulated wave.
Move Speed	Determines how long it takes to move the sound from the current status to the sound specified via the Vowel parameter.
Noise Input Level	Determines the noise level which is to be input.
Noise Level	Determines the noise level.
Noise LPF Cutoff Frequency	Determines the cutoff frequency of the low pass filter applied to the noise.
Noise LPF Q	Determines the resonance of the low pass filter applied to the noise.
Noise Mod Depth	Determines the depth of the noise modulation.
Noise Mod Speed	Determines the speed of the noise modulation.
Noise Tone	Determines the characteristics of the noise.
On/Off Switch	Turns the isolator on or off.
OSC Frequency Coarse	Determines the frequency for modulating the input wave.
OSC Frequency Fine	Finely determines the frequency for modulating the input wave.
Output	Determines the level of the signal output from the effect block.
Output Gain	Determines the gain of the signal output from the effect block.
Output Level	Determines the level of the signal output from the effect block.
Output Level 1, 2	Determines the level of the signal output from the 1st block and 2nd block respectively.
Over Drive	Determines the degree and character of the distortion effect.
Pan 1, 2	Determines the pan for each of the 1st series and 2nd series.
Pan AEG Min Level	This parameter of the Slice effect determines the minimum level of the AEG applied to the panned sound.
Pan AEG Type	This parameter of the Slice effect determines the type of the AEG applied to the panned sound.
Pan Depth	Determines the depth of the pan effect.
Pan Direction	Determines the direction toward which the stereo pan position of the sound moves.
Pan Type	Determines the pan type.
Pedal Control	When "VCM PEDAL WAH" is selected, this parameter determines the cutoff frequency of the wah filter. For best results, assign this parameter to the Foot Controller in the Controller Set display, then use the Foot Controller to control this parameter.
Pedal Response	Determines how the sound responds to the change of the damper control.
Phase Shift Offset	Determines the offset value of the phase modulation.
Pitch 1, 2	Determines the pitch in semitones for each of the 1st series and 2nd series.
PM Depth	Determines the depth of the pitch modulation.
Pre Mod HPF Cutoff Frequency	Determines the Cutoff frequency of the High Pass Filter before the modulation.
Pre-LPF Cutoff Frequency	Determines the Cutoff frequency of the Low Pass Filter before the modulation.
Pre-LPF Resonance	Determines the Resonance of the Low Pass Filter for the input sound.

Parameter name	Descriptions
Presence	This parameter of the guitar amp effect controls high frequencies.
Ratio	Determines the ratio of the compressor.
Release	Determines the amount of time that elapses between the releasing of a key and the end of the compressor effect.
Release Curve	Determines the release curve of the envelope follower.
Release Time	Determines the release time of the envelope follower.
Resonance	Determines the resonance of the filter.
Resonance Offset	Determines the resonance as offset.
Reverb Delay	Determines the delay time from the early reflections until the reverberations.
Reverb Time	Determines the reverb time.
Room Size	Determines the size of the room in which the instrument sounds.
Rotor Speed Fast	Determines the speed of the rotor when the slow/fast switch is set to "fast."
Rotor Speed Slow	Determines the speed of the rotor when the slow/fast switch is set to "slow."
Rotor/Horn Balance	Determines the volume balance of the horn and rotor.
Sampling Freq. Control	Controls the sampling frequency.
Sensitivity	When one of "Dynamic Flanger," "Dynamic Phaser," and the TEC effects is selected, this parameter determines the sensitivity of the modulation applied to the input change. When one of the VCM Touch Wah effects is selected, this parameter determines the sensitivity of the wah filter's change applied to the input change.
Slow-Fast Time of H	Determines how long it takes for the rotation speed of the horn to change from the current speed (slow or fast) to the other one (fast or slow) when the rotation speed is switched.
Slow-Fast Time of R	Determines how long it takes for the rotation speed of the rotor to change from the current speed (slow or fast) to the other one (fast or slow) when the rotation speed is switched.
Space Type	Selects the type of space simulation.
Speaker Type	Selects the type of speaker simulation.
Speed	When "VCM Flanger" is selected, this parameter determines the frequency of the LFO wave which controls the cyclic change of the delay modulation. When any of the phaser types is selected, this parameter determines the frequency of the LFO wave which controls the cyclic change of the phase modulation. When "VCM Auto Wah" is selected, this parameter determines the speed of the LFO.
Speed Control	Switches the rotary speed.
Spread	Determines the spread of the sound.
Stage	Determines the step number of the phase shifter.
Threshold	Determines the minimum input level at which the effect is applied.
Top ³	Determines the maximum value of the wah filter.
Type	When "VCM Flanger" is selected, this parameter determines the flanger type. When any of the wah effects is selected, this parameter determines the type of Wah. When "Early Reflection" is selected, this parameter determines the type of the reflection sound.
Vocoder Attack	Determines the attack time of the Vocoder sound.
Vocoder Release	Determines the release time of the Vocoder sound.
Vowel	Selects a vowel type.
Wall Vary	Determines the wall status of the simulated room. Higher settings produces more diffuse reflections.
Width	Determines the width of the simulated room.
Word Length	Determines the degree of sound roughness.

*1 The Bottom parameter is available only when the value is less than that of the Top parameter.

*2 The Color parameter may not be effective depending on the values of the Mode and Stage parameters.

*3 The Top parameter is available only when the value is more than that of the Bottom parameter.

About MIDI

MIDI (Musical Instrument Digital Interface) is a standard which allows electronic musical instruments to communicate with each other, by sending and receiving compatible Note, Control Change, Program Change and various other types of MIDI data, or messages.

This synthesizer can control other MIDI devices by transmitting note related data and various types of controller data. It can also be controlled by incoming MIDI messages which automatically determine the tone generator mode, select MIDI channels, voices and effects, change parameter values, and of course play the voices specified for the various Parts.

MIDI channels

MIDI performance data is assigned to one of sixteen MIDI channels. Using these channels, 1 – 16, the performance data for sixteen different instrument parts can be simultaneously sent over one MIDI cable.

Think of the MIDI channels as TV channels. Each TV station transmits its broadcasts over a specific channel. Your home TV set receives many different programs simultaneously from several TV stations and you select the appropriate channel to watch the desired program.

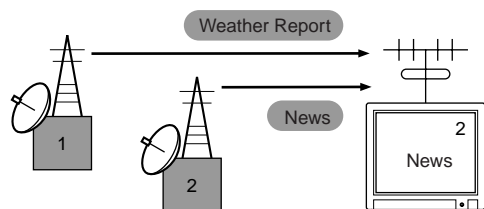

MIDI operates on the same basic principle. The transmitting instrument sends MIDI data on a specific MIDI channel (MIDI Transmit Channel) via a single MIDI cable to the receiving instrument. If the receiving instrument's MIDI channel (MIDI Receive Channel) matches the Transmit Channel, the receiving instrument will sound according to the data sent by the transmitting instrument. For information on how to set the MIDI transmit channel and the MIDI receive channel, see page 267.

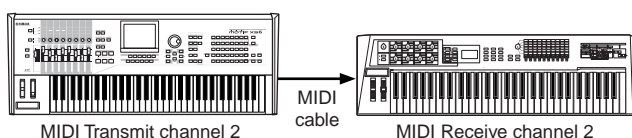

MIDI messages transmitted/recognized by this synthesizer

The messages transmitted/received by the MOTIF XS are shown in the MIDI Data Format and MIDI Implementation Chart in the separate Data List booklet. The MOTIF XS tone generator block (indicated "synth. part" in the Data List) and sequencer block (indicated "seq. part" in the Data List) handle different MIDI messages. The MIDI messages which the sequencer block can receive can be recorded to tracks of a Song/Pattern. On the other hand, the MIDI messages which the tone generator can receive can affect the MOTIF XS sound.

MIDI events handled by the MOTIF XS

This section covers MIDI events, the data format by which the MIDI messages generated by your keyboard performance are recorded to a track of a Song/Pattern. These events described below can be edited or inserted in the displays of the Song Edit/Pattern Edit modes.

Note

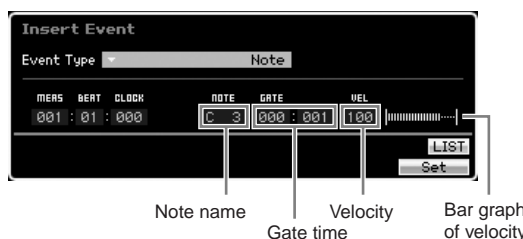

These are the events that define notes, making up the largest portion of all performance data. The note name (C -2 – G8) defines the pitch. The gate time specifies the length of the note in beats and clocks. Velocity (1 – 127) is "how hard" the note is played. The bar graph to the right is a graphic representation of the value.

Pitch Bend

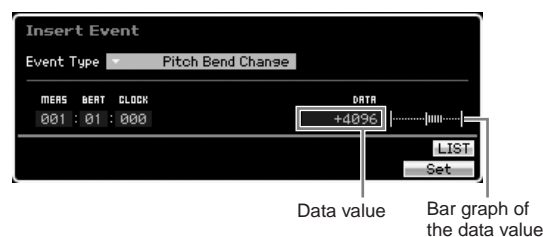

Pitch bend events are generated by pitch bend wheel operation and define continuous changes in pitch. The value (-8192 – +0000 – +8191) is a numerical representation of pitch bend wheel position. The bar graph to the right is a graphic representation of the value.

Program Change (PC)

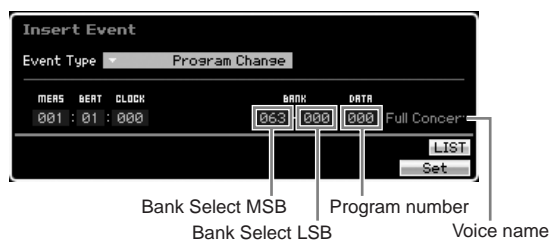

Program change events select Voices. The Bank Select MSB and LSB parameters are actually included in the Control Change category, below, but since in the MOTIF XS these

Basic Structure
Basic Operation
Connections

three events are used to select Voices, they are grouped and described here. Bank Select MSB and LSB select the Voice Bank. The program number selects a Voice from the Voice category and bank specified by the MSB and LSB. For a list of the Voices, see the separate Data List booklet. When you specify a program change as a number in the range of 0 – 127, specify a number that is one less than the program number listed in the Voice List. For example, to specify program number 128, you would actually enter program change 127.

Control Change (CC)

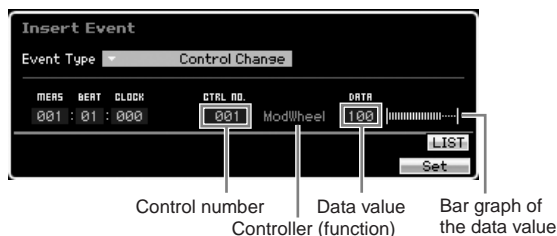

Control Change events control Voice and effect parameters. Control Change events are generated when a controller such as a modulation wheel or foot controller is operated. The Control number (000 – 127) specifies the controller (function), such as volume or pan. The value (000 – 127) specifies the “position” of the controller assigned to the selected control number. The bar graph to the right is a graphic representation of the data value.

Some of the more important control numbers and controllers are listed below.

NOTE When “---” is shown at the column of the Controller (Function), the Control number can be handled by the sequencer block and cannot be handled by the tone generator block.

Modulation Wheel (Control Number 001)

The MIDI data produced when a modulation wheel is operated. No modulation is applied when the value is “0,” and “127” produces maximum modulation.

Portamento Time (Control Number 005)

This MIDI message controls the portamento effect. No portamento is produced when the value is “0,” and “127” produces maximum portamento time. Portamento is only produced when Portamento (Control Number 065) is ON.

Data Entry MSB (Control Number 006)

Data Entry LSB (Control Number 038)

These parameters specify the value of RPN MSB, RPN LSB (page 78), NRPN MSB, and NRPN LSB events. The value is represented by two control change data numbers—the MSB and the LSB.

Volume (Control Number 007)

Sets the volume for each individual Part. No sound is produced when the value is “0,” and “127” produces maximum volume.

Pan (Control Number 010)

Sets the pan position for each individual Part. The sound is panned fully left when the value is “0” and fully right when the value is “127.” The displayed values are -64 – +63.

Expression (Control Number 011)

Sets the expression for each individual Part. No sound is produced when the value is “0,” and “127” produces maximum volume. This parameter produces volume variations during playback.

Sustain (Hold 1) (Control Number 064)

This MIDI message represents sustain pedal ON/OFF operations. Notes playing when the pedal is pressed will be sustained. When the value is “0” – “63” sustain is OFF, and when the data is “64” – “127” sustain is ON.

Portamento (Control Number 065)

This MIDI message turns portamento ON or OFF. When the value is “0” – “63” portamento is OFF, and when the data is “64” – “127” portamento is ON. The length (degree) of the portamento effect is controlled by Portamento Time (Control Number 005).

Sostenuto Pedal (Control Number 066)

This MIDI message represents sostenuto pedal ON/OFF operations. When the value is “0” – “63” sostenuto is OFF, and when the data is “64” – “127” sostenuto is ON.

Harmonic Content (Control Change 071)

Adjusts the resonance of the filter assigned to a Voice. The resonance is adjusted by using the data range of 0 – 127 as an offset value with a display range of -64 – +63 which is added to the Voice data.

Release Time (Control Change 072)

Adjusts the release time of the Voice AEG. The release time is adjusted by using the data range of 0 – 127 as an offset value with a display range of -64 – +63 which is added to the Voice data.

Attack Time (Control Change 073)

Adjusts the attack time of the Voice AEG. The attack time is adjusted by using the data range of 0 – 127 as an offset value with a display range of -64 – +63 which is added to the Voice data.

Brightness (Control Change 074)

Adjusts the cutoff frequency of the filter assigned to a Voice. The cutoff is adjusted by using the data range of 0 – 127 as an offset value with a display range of -64 – +63 which is added to the Voice data.

Decay Time (Control Change 075)

Adjusts the decay time of the Voice AEG. The decay time is adjusted by using the data range of 0 – 127 as an offset value with a display range of -64 – +63 which is added to the Voice data.

Effect Send Level 1 (Reverb Effect) (Control Number 091)

Specifies the reverb effect send level.

Effect Send Level 3 (Chorus Effect) (Control Number 093)

Specifies the delay/chorus effect send level.

Effect Send Level 4 (Variation Effect) (Control Number 094)

Specifies the variation effect send level.

NOTE This MIDI event cannot be handled by the tone generator block, although it can be recorded to a Song/Pattern track.

Data Increment (Control Number 096)

Data Decrement (Control Number 097)

These MIDI messages increment or decrement by one the value of pitch bend sensitivity, fine tune, or coarse tune settings made using RPN (page 78).

NRPN MSB (Non-Registered Parameter Number MSB) (Control Number 099)

NRPN LSB (Non-Registered Parameter Number LSB) (Control Number 098)

Used primarily as offset values for vibrato, filter, EG and other settings. Data Entry is used to set the parameter value after specifying the parameter using the NRPN MSB and LSB. Once an NRPN is specified, the following data entry message received on the same channel is processed as the value of that NRPN. Prevent operational errors by transmitting an RPN Null message (7FH, 7FH) after using these messages to perform a control operation. Refer to "NRPN" for information about the parameter (page 79).

NOTE This MIDI event cannot be handled by the tone generator block, although it can be recorded to a Song/Pattern track.

**RPN MSB (Registered Parameter Number MSB)
(Control Number 101)**

**RPN LSB (Registered Parameter Number LSB)
(Control Number 100)**

Used primarily as offset values for pitch bend sensitivity, tuning, and other part settings. Data Entry (page 77) is used to set the parameter value after specifying the parameter using the RPN MSB and RPN LSB. Once an RPN is specified, the following data entry message received on the same channel is processed as the value of that RPN. Prevent operational errors by transmitting a Null message (7FH, 7FH) after using these messages to perform a control operation. Refer to "RPN" for information about the parameter.

All Sound Off (Control Number 120)

Turns all currently sounding notes off for all Parts.

Reset All Controllers (Control Number 121)

Resets all controllers to their initial values. The following parameters are affected: Pitch Bend, Channel Pressure, Polyphonic Key Pressure, Modulation, Expression, Hold 1, Portamento, Sostenuto, Soft Pedal, Portamento Control, RPN*, NRPN* (*The RPN and NRPN are specified as having no number, and no internal data is changed). The following data is not affected: Program Change, Bank Select MSB and LSB, Volume, Pan, Dry Send Level, Effect Send Level 1, 3, and 4, Pitch Sensitivity, Fine Tuning, Coarse Tuning.

Omni Mode Off (Control Number 124)

Performs the same operation as when an All Notes Off message is received. The receive channel is set to 1.

Omni Mode On (Control Number 125)

Performs the same operation as when an All Notes Off message is received. Only the receive channel is set to Omni On.

Mono (Control Number 126)

Performs the same operation as when an All Sound Off message is received. If the 3rd byte parameter (the parameter that determines the mono number) is 0 – 16, the Parts corresponding to those channels are set to mono.

Poly (Control Number 127)

Performs the same operation as when an All Sound Off message is received, and the Parts corresponding to those channels are set to poly.

RPN Parameter List

RPN Number		Parameter Name	Data Entry (Range)		Initial Value	Function
MSB	LSB		MSB	LSB		
000	000	Pitch Bend Sensitivity	000 – 024	—	024	Specifies the amount of pitch bend produced in response to pitch bend data in semitone increments.
000	001	Fine Tune	-64 – +63	—	+00	Adjusts the tuning in cent increments.
000	002	Coarse Tune	-24 – +24	—	+00	Adjusts the tuning in semitone increments.
127	127	Null	—	—	—	voids the RPN and NRPN settings so no tone generator settings are changed when subsequent Data Entry messages are received.

Channel Aftertouch (CAT)

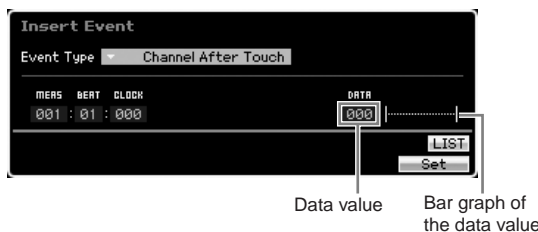

This event is generated when pressure is applied to a key after the note is played. The data (000 – 127) represents the amount of pressure applied to the key. The bar graph to the right is a graphic representation of the value.

Polyphonic Aftertouch (PAT)

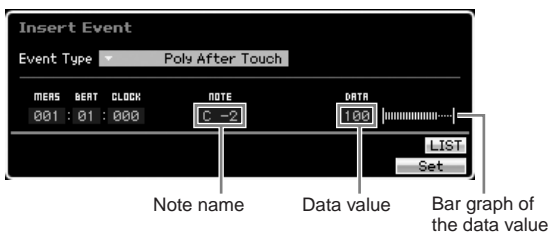

This event is generated when pressure is applied to a key after the note is played. Unlike the Channel Aftertouch event, however, individual data is provided for each key. Note Name (C -2 – G8) specifies the key. The data (000 – 127) represents the amount of pressure applied to the key. The bar graph to the right is a graphic representation of the value.

NOTE The Polyphonic Aftertouch cannot be handled by the tone generator block although this event can be recorded to a Song/Pattern track.

Registered Parameter Number (RPN)

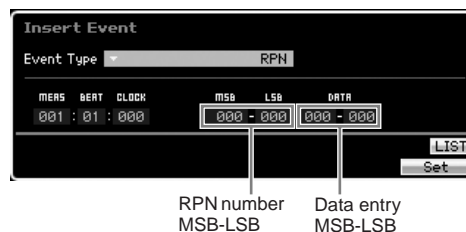

Changes parameter values for each tone generator part. Normally three types of control change data are sent: RPN MSB (101), RPN LSB (100), and Data Entry MSB (6). In the MOTIF XS, Data Entry LSB (38) is added to this and the resulting group of control change events is handled as one. Once an RPN is specified, the following data entry message received on the same channel is processed as the value of that RPN. Prevent operational errors by transmitting a Null message (7FH, 7FH) after using these messages to perform a control operation. The MOTIF XS tone generator block allows control of the 4 following parameters:

Non-Registered Parameter Number (NRPN)

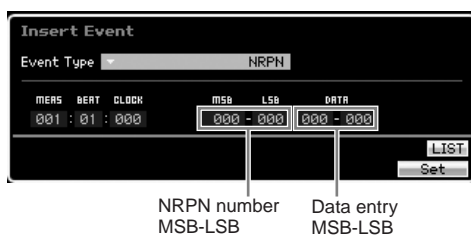

Changes parameter values for each tone generator Part. There is no compatibility between different manufacturers. Numerous parameters specific to each tone generator can be controlled to produce tonal changes. Normally three types of control change data are sent: NRPN MSB (99), NRPN LSB (98), and Data Entry MSB (6). In the MOTIF XS, this group of control change events is handled as one. Once an NRPN is specified, the following data entry message received on the same channel is processed as the value of that NRPN. Prevent operational errors by transmitting an RPN Null message (7FH, 7FH) after using these messages to perform a control operation. For filter cutoff frequency, resonance, and other independent control change parameters, it is normal to use

the independent control change parameters rather than the NRPN.

NOTE This MIDI event cannot be handled by the tone generator block, although it can be recorded to a Song/Pattern track.

System Exclusive

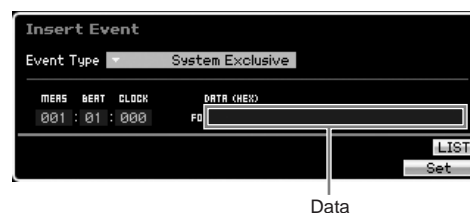

Changes internal tone generator settings such as Voice and effect settings, remote switch control, tone generator mode switching, and others via MIDI. The 2nd byte is a manufacturer ID number, and there is no data compatibility between manufacturers. This type of event is used to control MOTIF XS-specific functions. The cursor can be used to scroll through the data if the data size is greater than 17 bytes.

Internal Memory

As you use the MOTIF XS, you will create many different kinds of data, including Voices, Performances, Songs, and Patterns. This section describes how to maintain the various types of data and use the memory devices/media for storing them.

Internal Memory

Below are explanations of the basic terms related to memory.

Flash ROM

ROM (Read Only Memory) is memory designed specifically for reading out of data, and as such data cannot be written to it. Unlike conventional ROM, Flash ROM can be overwritten—allowing you to store your own original data. The contents of Flash ROM are maintained even when the power is turned off.

DRAM

RAM (Random Access Memory) is memory designed specifically for data writing and data reading operations. There are two different kinds of RAM, depending on the condition for storing the data: SRAM (Static RAM) and DRAM (Dynamic RAM). The MOTIF XS is equipped with only DRAM. The created data stored on DRAM is lost when the power is turned off. Because of this, you should always store any data residing in DRAM to the USB storage device or the computer connected to the network before turning off the power.

NOTE Among data residing in DRAM, only Waveform data can be saved to the external USB storage device or a computer mounted by the MOTIF XS.

DIMM

DIMM modules must be installed in order to use the Sampling function or to load audio data (Waveform/WAV file/AIFF file) to the instrument. As with DRAM described above, the created data stored on DIMM is lost when the power is turned off. Because of this, you should always store any data residing in DIMM to the USB storage device or the computer connected to the network before turning off the power.

Edit Buffer and User Memory

The edit buffer is the memory location for edited data of these types: Voice, Performance, Master, Song Mixing, and Pattern Mixing. Data edited in this location will be stored to the User Memory.

If you select another Voice, Performance, Master, Song, or Pattern, the entire contents of the edit buffer will be rewritten with the newly selected Voice/Performance/Master/Song Mixing/Pattern Mixing data. Make sure to store any important data before selecting another Voice, etc.

Edit Buffer and Recall Buffer

If you've selected another Voice/Performance/Song/Pattern without storing the one you were editing, you can recall your original edits, since the edit buffer's contents are stored in backup memory.

NOTE Keep in mind that the recall buffer is not available in the Master Edit mode.

Memory Structure

This diagram details the relationship among the functions of the MOTIF XS and the internal memory and external devices such as USB storage device and computer.

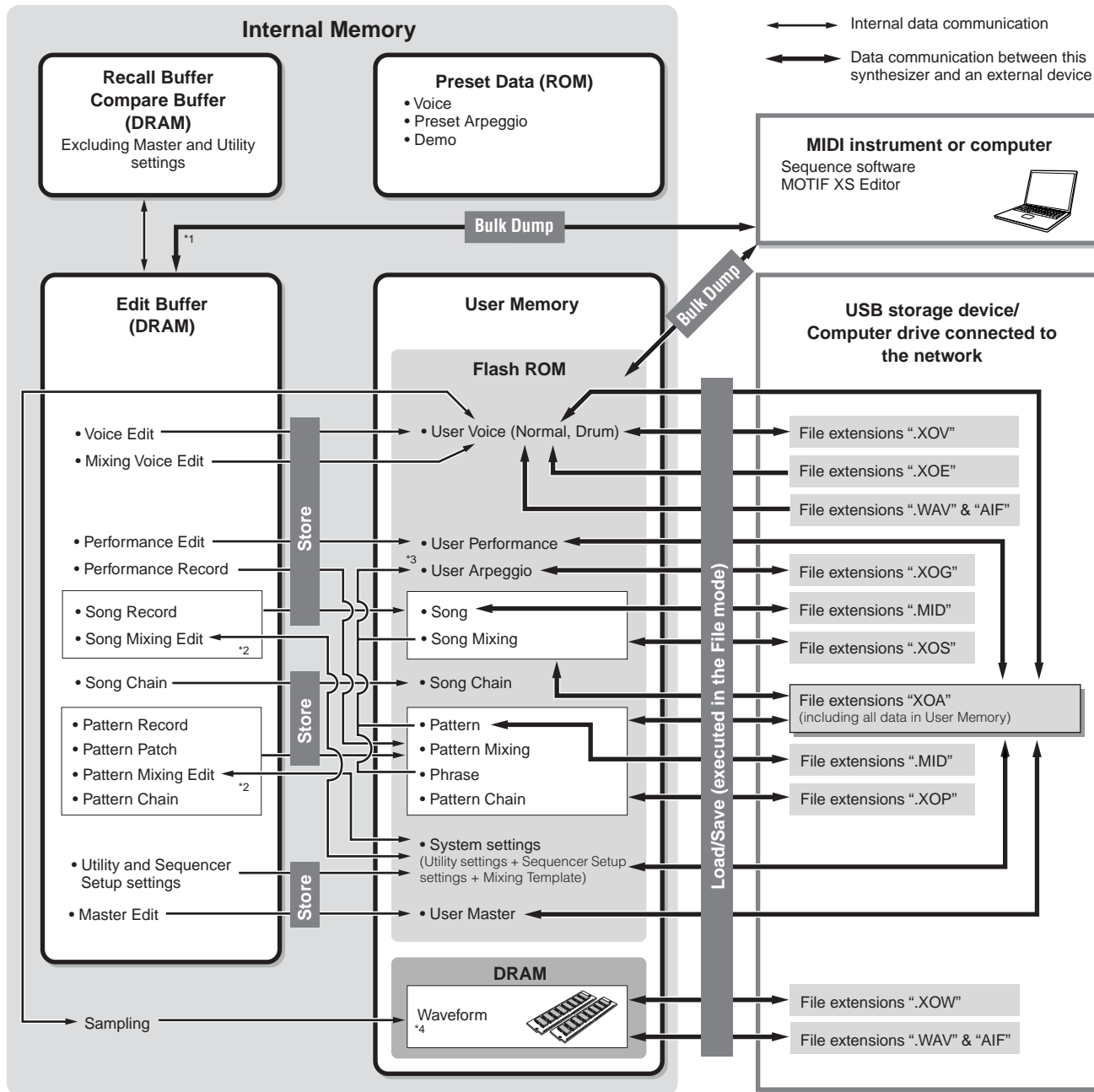

*1 Only the currently edited data can be transmitted as Bulk data. Note that the Mixing Voice cannot be transmitted as Bulk data.

*2 The Mixing settings can be stored/recalled as a template in the Song Mixing Job mode/Pattern Mixing Job mode.

*3 You can convert the MIDI sequence data recorded in the Song Record mode/Pattern Record mode to Arpeggio data. This can be executed with the following operations: [SONG] → [JOB] → [F5] Track → 07: Put Track to Arpeggio or [PATTERN] → [JOB] → [F5] Track → 07: Put Track to Arpeggio

*4 In order to create a Waveform by sampling or importing an audio file, optional DIMM modules must be installed.

Basic Operation

Moving the Cursor

Use these four buttons to navigate the display, moving the cursor around the various selectable items and parameters in the screen. When selected, the relevant item is highlighted (the cursor appears as a dark block with inverse characters). You can change the value of the item (parameter) at which the cursor is located by using the data dial, [INC/YES] and [DEC/NO] buttons.

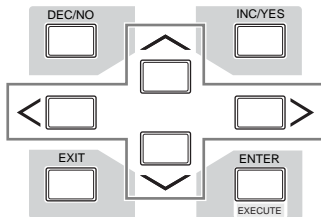

Changing (editing) parameter values

Rotating the data dial to the right (clockwise) increases the value, while rotating it to the left (counter-clockwise) decreases it. For parameters with large value ranges, you can increase the value by 10 by simultaneously holding down the [INC/YES] button and pressing the [DEC/NO] button.

To decrease by 10, do the opposite; simultaneously hold down the [DEC/NO] button and press the [INC/YES] button.

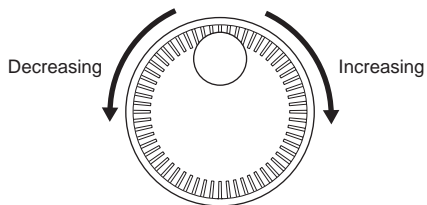

Functions and Sub-Functions

Each mode described above contains various displays, with various functions and parameters. To navigate your way through these displays and select a desired function, use the [F1] – [F6] buttons and the [SF1] – [SF5] buttons. When you select a mode, the available displays or menus appear directly above the buttons at the bottom of the display (as shown below).

Depending on the currently selected mode, up to six functions are available and can be called up with the [F1] – [F6] buttons. Keep in mind that the available functions differ depending on the selected mode.

Depending on the currently selected mode, up to five functions (sub-functions) are available and can be called up with the [SF1] – [SF5] buttons (the [SF6] button is used

mainly to call up the INFO and LIST displays). Keep in mind that the available functions differ depending on the selected mode. (Some displays may not have any sub-functions for these buttons.)

The example display below is called up by pressing the [F5] button then pressing the [SF1] button.

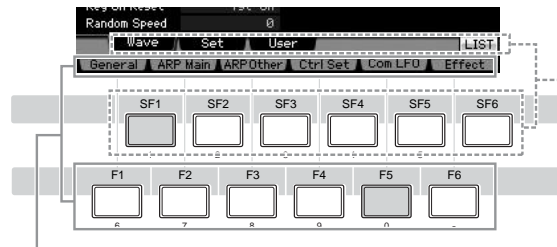

These functions can be selected via the corresponding button ([F1] – [F6]).

These functions can be selected via the corresponding button ([SF1] – [SF6]).

Inputting a number directly

For parameters having large value ranges (such as the start and end points of a sample), you can also enter the value directly, using the buttons below the LCD display as a numeric keypad. When the cursor is located on such a parameter, the [NUM] icon appears at the lower right corner of the LCD display. When the [SF6] NUM button is pressed in this status, each digit (1 – 9, 0) is assigned to the [SF1] – [SF5] and [F1] – [F5] buttons as shown below, allowing you to input a number directly by using these buttons. Depending on the selected parameter, a negative value can be input. When such a parameter is selected and you wish to input a negative value, press the [F6] button (to which “-” is assigned) then use the [SF1] – [SF5] and [F1] – [F5] buttons.

After completing the number input, press the [ENTER] button to actually enter the number.

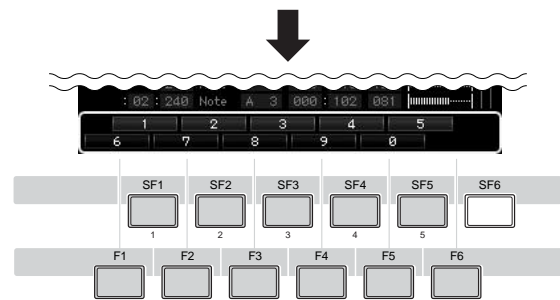
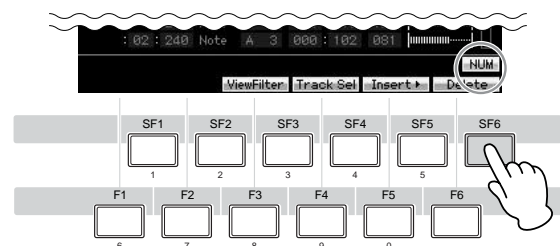

You can use these buttons as the numeric keypad.

Naming (Inputting Characters)

You can freely name the data you've created, such as Voices, Performances, Songs, Patterns and files saved to a USB storage device.

When the cursor is located on such a naming parameter, the CHAR icon appears at the lower right corner of the display. When pressing the [SF6] button in this status, the Input Character window appears as shown below. In the Edit area, you can move the cursor to determine the location at which the character is to be input by using the [F1] and [F2] buttons. In the Character List, you can move the cursor to determine the character to be input by using the Cursor buttons, [INC/YES] button, [DEC/NO] button and the data dial. After selecting the character, press the [F4] button to actually enter the selected character to the location specified in the Edit area. To delete the character at the cursor location, press the [F5] Delete button. To delete all the characters, press the [F6] All Clear button. After completing the character input, press the [ENTER] button to actually enter the currently edited name.

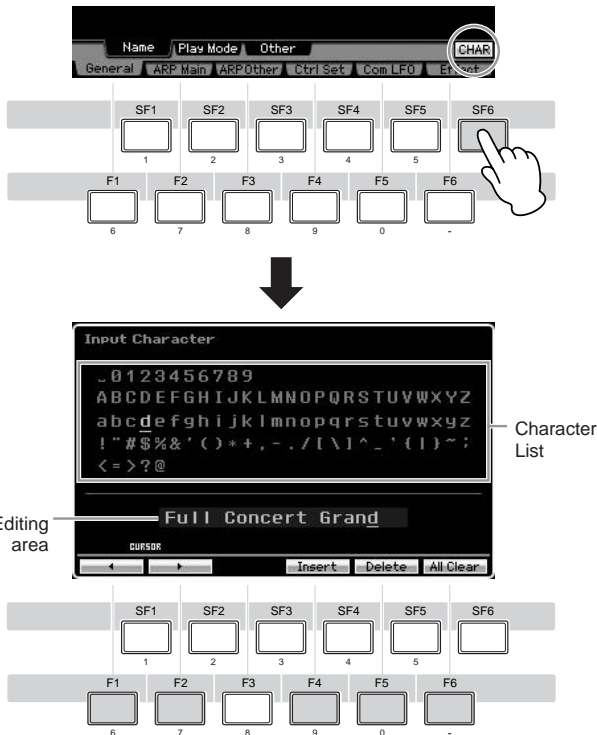

Calling up the List

Depending on the parameter, you can call up a convenient pop-up List by pressing the [SF6] LIST button, from which you can select the desired parameter setting or item. When the cursor is located on such a parameter (indicated with an upside down triangular arrow), the LIST icon appears at the lower right corner of the display. In this condition, press the [SF6] button to call up the List. To select the desired item or setting, use the [INC/YES], [DEC/NO] buttons and the data dial. After selecting, press the [ENTER] button to fix the selection and close the List.

This indicates that you can call up the List by pressing the [SF6] LIST button.

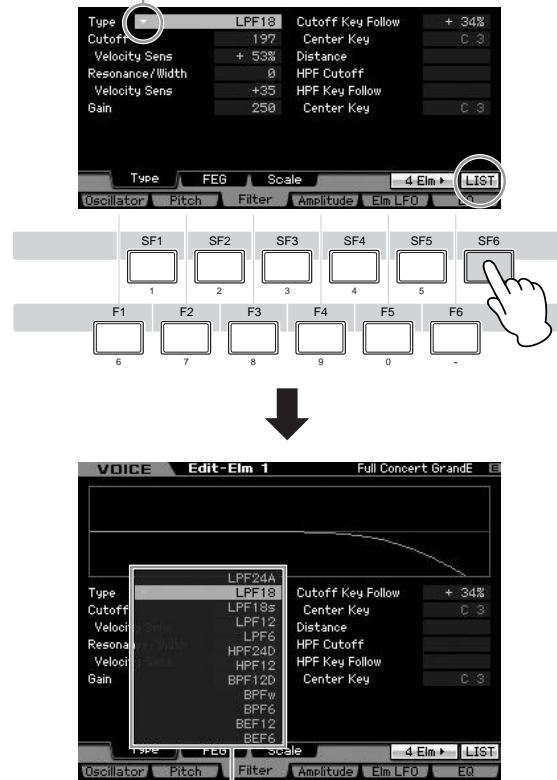

The List appears. You can select one from this List.

Note (Key) and Velocity settings

Several parameters let you set a key range or velocity range for a function—for example, in setting up a keyboard split—by specifying certain note values. You can use the [INC/YES] and [DEC/NO] buttons or data dial to set these parameters, or you can directly enter the values from the keyboard by pressing the appropriate keys. When the cursor is located on such a parameter, the KBD icon appears at the lower right corner of the display. You can set the note or velocity directly from the Keyboard, by holding down the [SF6] button and pressing the desired key.

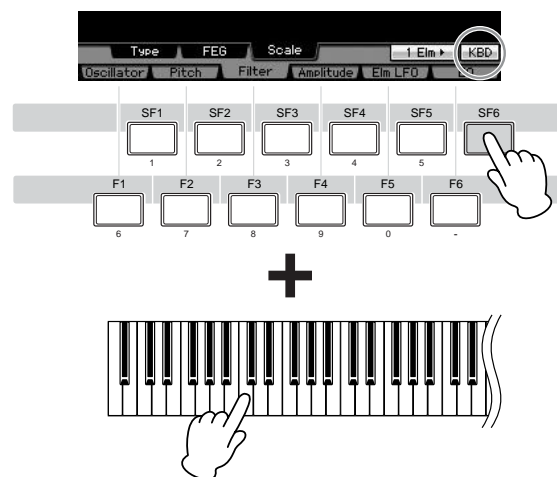

Connections

NOTE For the external connections depicted below, you will also need speakers or headphones to listen to the sound. See “Start Guide” on page 19.

Connecting External MIDI Instruments

With a standard MIDI cable (available separately), you can connect an external MIDI instrument, and control it from the MOTIF XS. Likewise, you can use an external MIDI instrument (such as a keyboard or sequencer) to control the sounds of the MOTIF XS. Below are several different MIDI connection examples; use the one most similar to your intended setup.

NOTE Any one of these interfaces can be used for MIDI data transmission/reception: the MIDI connectors, the mLAN connector (available only for the MOTIF XS8, and MOTIF XS6/7 with an optional mLAN16E2 installed), or the USB connector. However, they cannot be used at the same time. Select which connector is used for MIDI data transfer in the MIDI display (page 267) of the Utility mode.

Controlling an external tone generator or synthesizer from the MOTIF XS

This connection lets you sound an external MIDI tone generator (synthesizer, tone generator module, etc.) by playing the MOTIF XS or playing back the Song/Pattern of the MOTIF XS. Use this connection when you wish to sound the other instrument along with the MOTIF XS.

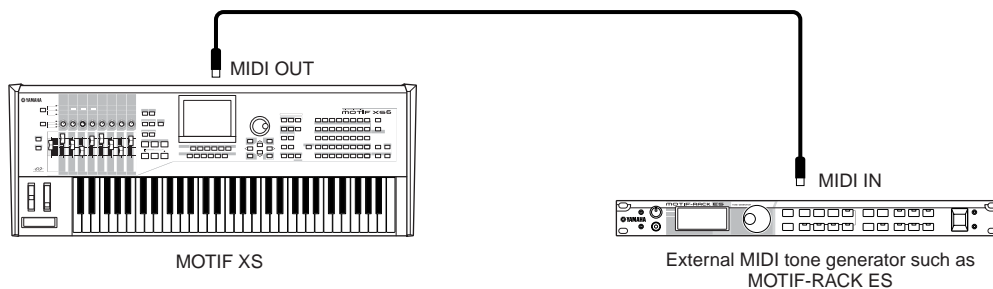

Make sure match the MIDI Transmit Channel of the MOTIF XS with the MIDI Receive Channel of the external MIDI tone generator. The MIDI Transmit Channel in the Voice mode and Performance mode can be set in the MIDI display (page 267) of the Utility mode. The Transmit Channels of each track can be set in the Song Track display (page 184) of the Song Play mode. The Transmit Channels of each track can be set in the Pattern Track display (page 211) of the Pattern Play mode.

Controlling from an external MIDI keyboard

Use an external keyboard or synthesizer (such as the S90 ES) to remotely select and play the Voices of the MOTIF XS.

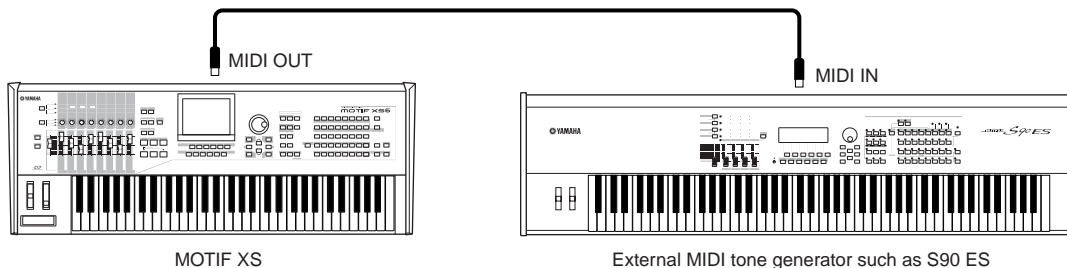

Make sure match the MIDI Transmit Channel of the external MIDI instrument with the MIDI Receive Channel of the MOTIF XS. For details on setting the MIDI Transmit Channel of the external MIDI instrument, refer to the Owner's Manual of the MIDI instrument. The MIDI Receive Channel in the Voice mode and Performance mode can be set in the MIDI display (page 267) of the Utility mode. The MIDI Receive Channels in the Song mode and Pattern mode can be set in the Voice display (page 235) of the Mixing Part Edit mode.

Controlling another MIDI device via MIDI THRU

The playback data of an external MIDI sequencer is used to play the sounds of another MIDI instrument (connected to the MIDI THRU connector) along with the MOTIF XS. The MIDI THRU connector simply redirects any received MIDI data (via MIDI IN) to connected instrument.

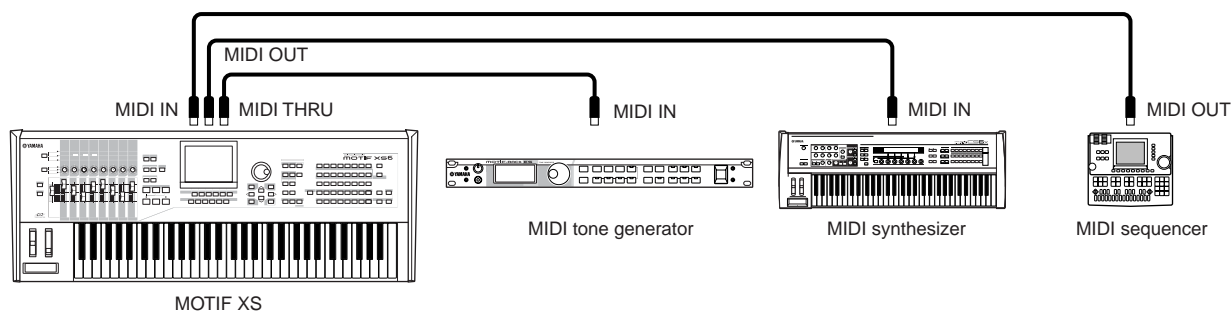

In this case, make sure that the MOTIF XS is set to the Song mode or Pattern mode. If the instrument is set to the Voice mode or to the Performance mode in which multi-channel MIDI messages are not recognized, the external sequence data (containing multi-channel data) will not play back properly on the MOTIF XS. In addition, you may have to make certain MIDI synchronization settings (see below). Likewise, make sure to set the MIDI tone generator (connected to the MIDI THRU connector) to the multi-timbral mode. In addition, you'll need to enable the MOTIF XS to respond to external clock, set from the MIDI display (page 267) in the Utility mode.

Connecting to an MTR (Multi-track Recorder)

Since this synthesizer can receive the MTC (MIDI Time Code) and can transmit the MMC (MIDI Machine Control), you can produce music by synchronizing to an MTC- or MMC-compatible multi-track recording device. You can use two types of MTR control (illustrated below) by setting the MIDI Sync to MTC in the MIDI display (page 267) of the Utility mode.

NOTE MTC and MMC are available only in the Song mode.

Synchronizing the MOTIF XS to the MTC signal from an external MTR

After receiving the MTC signal transmitted from the MTR by starting the MTR playback, the Song of the MOTIF XS will start at the moment the MTC Start Offset time set in the MIDI display (page 267) of the Utility mode is received.

NOTE MTC (MIDI Time Code) allows simultaneous synchronization of multiple audio devices via standard MIDI cables. It includes data corresponding to hours, minutes, seconds, and frames. The MOTIF XS does not transmit MTC. An instrument such as the Yamaha AW2400 which can transmit MTC is necessary as an MTC master.

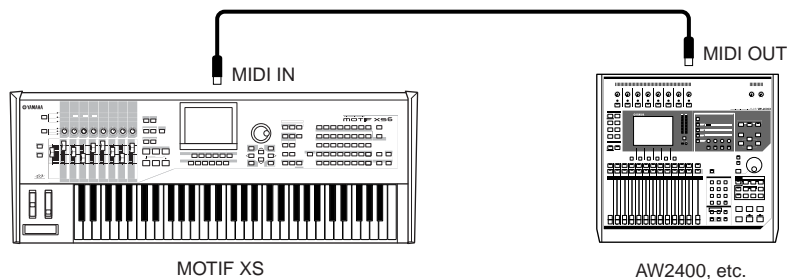

Controlling an MTR by using MMC transmitted from the MOTIF XS

You can control the start/stop and fast forward/rewind of an MMC-compatible MTR from the SEQ TRANSPORT buttons on the front panel of this synthesizer, outputting MMC messages via MIDI.

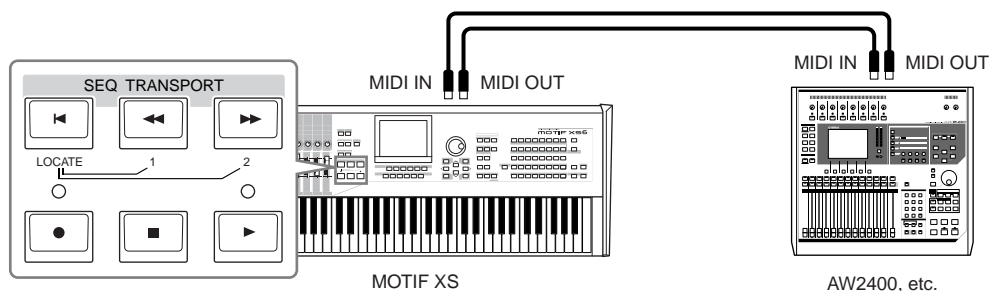

NOTE MMC (MIDI Machine Control) allows remote control of multitrack recorders, MIDI sequencers, etc. An MMC-compatible multitrack recorder, for example, will automatically respond to start, stop, fast forward, and fast reverse operations performed on the controlling sequencer, thus keeping playback of the sequencer and multitrack recorder aligned.

Using USB storage devices

You can connect a USB storage device such as flash memory or a hard disk unit to the USB TO DEVICE connector on the rear panel and save/load the files (including data created on the MOTIF XS) to and from it. When using USB storage devices, follow the important precautions below.

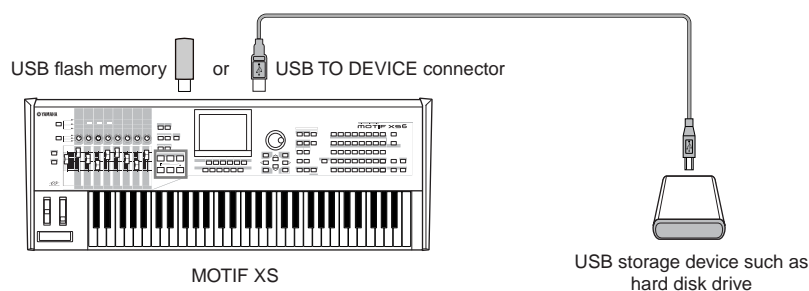

Compatible USB devices

Connect only a USB storage device (such as hard disk, CD-ROM, flash disk and other drives) to the USB TO DEVICE connector. Other devices such as a computer keyboard or mouse cannot be used. Both bus-powered (powered by the host device) or self-powered (battery or external power supply) types can be used. The MOTIF XS does not necessarily support all commercially available USB storage devices. Yamaha cannot guarantee operation of USB storage devices that you purchase. Before purchasing USB storage devices, please consult your Yamaha dealer, or an authorized Yamaha distributor (see list at end of the Owner's Manual) for advice, or visit the following website: <http://www.yamahasyth.com/>

NOTE Although CD-R/W drives can be used to load data to the instrument, they cannot be used for saving data. However, you can transfer the data to a computer and save it to a CD using the CD-R/W drive on the computer.

Formatting USB storage media

When an unformatted USB storage device is connected to the USB TO DEVICE connector or when unformatted media is inserted to the USB device connected to the USB TO DEVICE connector, the indication "unknown device (usb***)" is shown in the device list on the [F3] Format window of the File mode. If this happens, execute the Format operation in the Format display (page 278).

NOTE The three asterisks (***) in the example indication above denote the sequential serial numbers of the connected devices which need to be formatted. When several partitions are included in a single device, the partition number is indicated at the right of the serial number.

Precautions when using the USB TO DEVICE connector

⚠ CAUTION

- Never turn the USB device's power on/off and never plug/unplug the USB cable when the connected USB storage device is the self-powered type. Doing so may result in the operation of the synthesizer "freezing" or hanging up.
- While the instrument is accessing data (such as in the Save, Load and Delete operations in the File mode), do NOT unplug the USB cable, do NOT remove the media from the device, and do NOT turn the power off to either device. Doing so may corrupt the data on either or both devices.

Protecting your data (write-protect)

To prevent important data from being inadvertently erased, apply the write-protect provided with each storage device or media.

Network connection

LAN connection

The MOTIF XS can be connected to a LAN network via the ETHERNET cable. When the MOTIF XS is connected to the LAN network, the File mode lets you save the file created on the MOTIF XS to the computer drive connected to the same network. Connect the MOTIF XS to the router or hub with a LAN cable. Connect a computer to the router or hub with a LAN cable or the wireless connection.

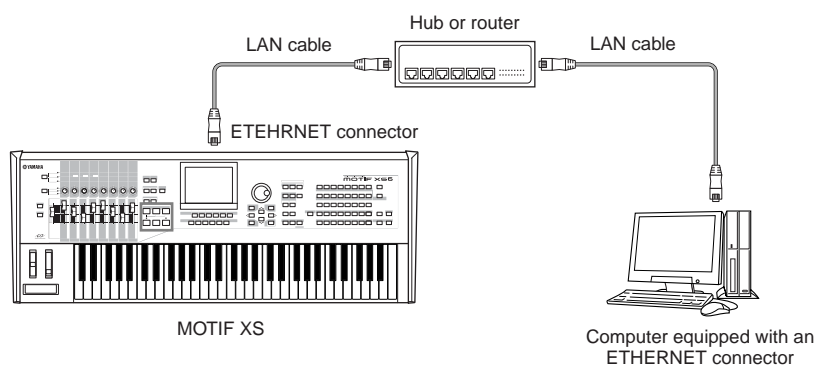

NOTE Make sure to use a straight LAN cable.

NOTE Due to EU regulations, users within Europe should use an STP (shielded twisted pair) cable to prevent electromagnetic interference.

NOTE If your computer is not equipped with an ETHERNET connector, install a commercially available LAN adaptor to the PCI slot or PC Card slot of your computer.

NOTE If you have a broadband router to connect your computer to the Internet, use an unused ETHERNET connector on the router to connect the MOTIF XS. Keep in mind however, that this does not allow you the MOTIF XS to be connected to the Internet, but only to other computers and drives on the network.

Network Settings

After the LAN connection is completed, you should set the network related parameters to make the connection active. Once the MOTIF XS has been connected to the network, files can be saved or loaded between the MOTIF XS and the computer connected to the same network. Call up the Network display (page 260) in the Utility mode.

File Sharing for accessing a computer from the MOTIF XS

Follow the instructions below so that you can access a computer from the MOTIF XS via the LAN network.

1 Call up the Network display (page 260) of the Utility mode.

Press the [UTILITY] button to enter the Utility mode then press the [F1] button and the [SF3] button to call up the Network display.

2 Set the parameters related to the network.

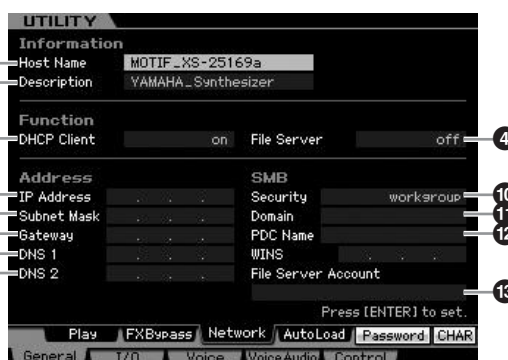

Here, the minimum required settings (parameters 3 and 10) are explained. For details on the other parameters, see page 260.

3 DHCP Client

Set this parameter to "on," if you have the network using the device with the DHCP server function such as a broadband router. When this is set to on, setting

parameters ⑤ – ⑨ are not necessary. Set this parameter to “off,” if your network does not use a device with the DHCP server function.

⑩ Security

Set this parameter to “workgroup,” if your network administrator does not specify otherwise.

Parameters ① and ② are not necessary here. Parameters ⑤ – ⑨ are necessary to be set if your network does not use a device with the DHCP server function. For details, see page 260. For instructions on setting these parameters, consult your network administrator or provider. For information on the other parameters, refer to the explanation of the Network display (page 260) in the Utility mode.

3 Press the [ENTER] button to actually apply the settings to the MOTIF XS.

4 Set the shared directory on your computer.

On your computer, set the folder which you want to access from the MOTIF XS via network to the shared folder. For details, refer to the owner’s manual of your computer.

5 Confirm whether or not the MOTIF XS and the computer are properly connected to the network.

Press the [FILE] button to enter the File mode, then press the [F2] button to call up the Mount display (page 277). If the MOTIF XS and the computer are connected properly, the computer name is shown in the HOST column. If the computer name is not shown, press the [SF5] Char button then enter the computer name directly in the Host (⑭) column. If the MOTIF XS and the computer are connected properly, the name you input will be recognized.

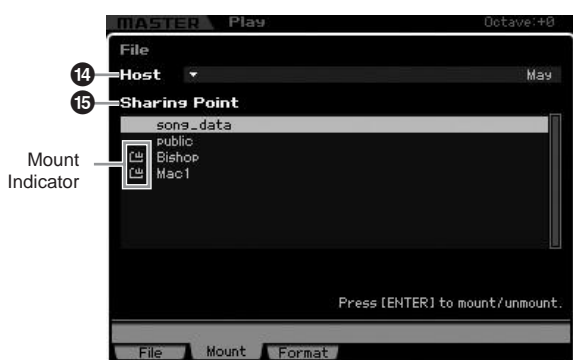

NOTE Confirm the computer name on the operating system of your computer. For details, refer to the owner’s manual of your computer.

6 In the File mode of the MOTIF XS, access the computer via network so that the shared directory appears on the display.

Call up the Mount display of the File mode. When setting the HOST (①) to a computer name containing the desired shared directory, “Press [ENTER] to access” appears on the display. Next, press the [ENTER] button so that the display prompts you to enter the password as illustrated

below. Here, enter the User Account of your computer to the User Name box, enter the password of your computer to the Password box, then press the [ENTER] button so that the access between the MOTIF XS and the computer is established. The shared directories of the selected computer are listed in the Sharing Point box (②).

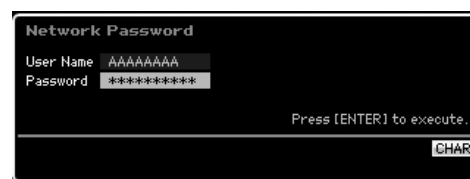

NOTE Once access between the MOTIF XS and the computer has been established, the shared directories are automatically listed on the display simply by selecting a computer in the Host column. If you turn the power off, however, the operations for establishing access (entering the User Account and Password) are necessary after turning the power on next time.

NOTE For details about how to confirm the User Account and Password of your computer, refer to the owner’s manual of your computer.

NOTE If a password has not been set on your computer, you need not enter the password. Access can be established even if you enter no password.

7 Mount the desired directories.

In the Sharing Point box (②), you can mount the shared directory by moving the cursor to the desired directory, then pressing the [ENTER] button. The mount indicator appears at the left side of the mounted directory’s name.

By following the instructions above, you can access a computer from the MOTIF XS via the LAN network. For details, see page 86.

File Sharing for accessing the MOTIF XS from a computer

Follow the instructions below so that you can access the MOTIF XS (actually a USB storage device connected to the MOTIF XS) from a computer via the LAN network. Call up the Network display (page 260) in the Utility mode.

NOTE Keep in mind that the internal Flash memory of the MOTIF XS cannot be accessed from a computer via the LAN network. Only the data saved to a USB storage device connected to the MOTIF XS can be accessed from a computer via the LAN network. If you want to share files between the MOTIF XS and a computer, save the data stored in internal Flash memory to an external USB storage device.

1 Call up the Network display (page 260) then set the File Server Account (⑬).

If the account has not been set, the MOTIF XS can be accessed using the account named “nobody.”

2 Set the password.

Press the [SF5] Password button to call up the password window. For instructions on setting, see page 262.

3 Set the File Server parameter (④) to “on.”

Playing the Keyboard in the Voice Play Mode

The Voice mode is used for selecting, playing, and editing a desired Voice. The Voice Play mode is the main 'portal' by which you enter the Voice mode, and it is here where you select and play a Voice. Some of the Voice settings can also be edited in this mode. To call up the Voice Play display and enter the Voice mode, simply press the [VOICE] button.

Selecting a Voice

This synthesizer has 128 Voices in each of 15 Banks: Preset 1 – 8, User 1 – 3, GM, Preset Drum, User Drum, and GM Drum. The Bank consists of eight Groups (A to H), each of which contains 16 Voices. To select the desired Voice, select the Bank, Group, then Number.

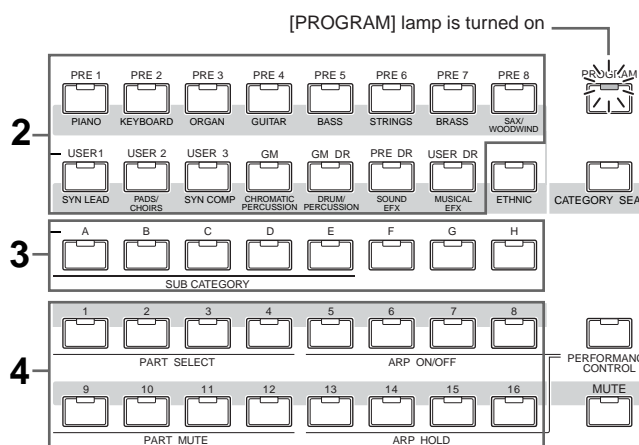

1 Press the [VOICE] button to enter the Voice Play mode.

The [PROGRAM] lamp lights, indicating that you can select the desired Voice by specifying the Bank/Group/Number.

2 Select a Voice Bank.

Press one of the Bank buttons listed below to select a Bank. Selecting a Bank calls up the Voice Select window.

Buttons	Banks
[PRE 1] – [PRE 8] buttons	Preset Banks 1 – 8
[USER 1] – [USER 3] buttons	User Banks 1 – 3
[GM] button	GM Bank
[GM DR] button	GM Drum Bank
[PRE DR] button	Preset Drum Bank
[USER DR] button	User Drum Bank

3 Select a Group.

Press one of the [A] to [H] buttons to select a Group. If you've selected a Drum Bank in the previous step, press one of the [A] to [D] buttons to select a Group. The name list of the 16 Voices in the selected Group will

appear on the display. Note that the GM Drum Bank contains only one Drum Voice, indicating that you cannot select a Group.

4 Select a Voice.

Press one of the [1] to [16] buttons to select a Voice. In this way (Steps 2 – 4), you can call up your desired Voice.

NOTE When selecting the Voice within the same Bank or Group, it is not necessary to select the Bank or Group again. You can use the [INC/YES] and [DEC/NO] buttons or data dial to select the Voice number. This operation lets you call up Voices in subsequent or previous Groups and Banks.

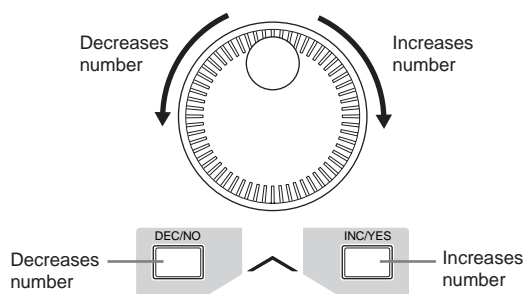

Select a Voice using the Category Search function

The MOTIF XS features a Category Search function that gives you quick access to the sound you want, irrespective of their Bank locations. For instructions on using the Category Function, refer to "Start Guide" on page 24.

Grouping your most-used Voices together—Favorite Category

Category Search also has a convenient Favorite Category that lets you bring together your most often used and favorite Voices for easy selection. This is one more useful way the MOTIF XS lets you quickly select the Voices you need from the huge number available.

Registering your favorite Voices to the Favorite Category

- 1 Press the [VOICE] button to enter the Voice Play mode.
- 2 Call up the Category Search window.
Press the [CATEGORY SEARCH] button so that its indicator lights and the Category Search window appears.
- 3 Select your favorite Voice.
Find the desired Voice by following the instructions on page 24.
- 4 Register the Voice to the Favorite Category.
Press the [F5] button to register the Voice and turn on the Favorite Switch. A checkmark appears in the box to the left of the Voice name, indicating that the Voice has been included in the Favorite Category. (Pressing the [F5] button again turns the checkmark off, clearing the selected Voice from the Favorite Category.) To clear all previously registered Voices from the Favorite Category—useful for when you want to create the Favorite Category from scratch—press the [F6] button.



Selecting a Voice from the Favorite Category

- 1 Call up the Favorite Select window.
From the Category Search window, press the [F4] button to call up the Favorite Select window. The Favorite Select window shows all Voices registered to the Favorite Category.



2 Select a Voice.

Select the desired Voice by using the [INC/YES] and [DEC/NO] buttons or data dial to move the cursor upward or downward in the Voice List.

NOTE The order of the Voices in the Favorite Category cannot be changed. If you want to create a custom order of Voices for quick selection during your performance, store the Voices to one of the User banks.

Using Knobs and Control Sliders

One of the more powerful performance features of the MOTIF XS is its extensive set of real-time controls—especially the Knobs and Control Sliders. These let you adjust a variety of parameters for the current Voice, such as effect depth, attack/release characteristics, tonal color, and others. These real-time controls can be used to change the sound as you play or to quickly edit and customize the Voice. Three functions can be assigned to each knob, alternatively selected via the [SELECTED PART CONTROL] button. Each time the button is pressed, the lamp lights alternatively in descending order, TONE1 → TONE2 → ARP FX. For details, see page 26 in the Start Guide.

NOTE If the [E] (Edit) Indicator appears in the top right of the display, the current Voice can be stored (page 97) as a new User Voice.

NOTE Holding down the [SELECTED PART CONTROL] button for a few seconds will alternate the lit lamp from the current one to TONE 1.

NOTE A red point on the Knob or Slider graphic indicates the current value to which the Knob or Slider is set. Moving the Knob or Slider has no effect on the sound until this point is reached. Once you move the Knob or Slider past this point, the red point disappears and moving the Knob or Control Slider affects the sound.

NOTE You can confirm the functions assigned to the eight knobs in the Voice Play display, called up via the [F1] button. When a display other than the Voice display is shown, you can confirm the knob functions by pressing the [SELECTED PART CONTROL] button, which calls up the Control Function window.

Red point (current value)



Knob Functions

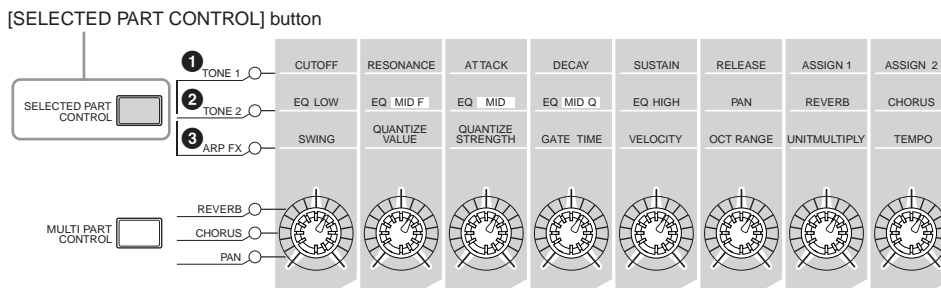

1 When the TONE 1 lamp is turned on:		Moving Knobs 1 and 2 changes the Filter parameters on the EG/EQ display. Moving Knobs 3 – 6 changes the Amplitude EG parameters.
Knob 1	CUTOFF	Raises or lowers the Filter Cutoff Frequency (page 94) to adjust the tone brilliance.
Knob 2	RESONANCE	Raises or lowers the Resonance (page 94) to boost the level of the signal in the area of the cutoff frequency. By emphasizing the overtones in this area, this can produce a distinctive "peaky" tone, making the sound brighter and harder.
Knob 3	ATTACK	Increases or decreases the EG Attack Time (page 94) of the current Voice. The smaller the value, the faster the attack.
Knob 4	DECAY	Increases or decreases the EG Decay Time (page 94) of the current Voice to determine how fast the volume falls from maximum attack level to the sustain level. The smaller the value, the faster the decay.
Knob 5	SUSTAIN	Increases or decreases the EG Sustain Level (page 94) at which the volume will continue while a key is held, after the initial attack and decay. Turn the knob counter-clockwise to make the sound cut off more sharply after the decay.
Knob 6	RELEASE	Increases or decreases the EG Release Time (page 94) of the sound to determine how fast the volume falls from the sustain level to zero when a key is released. The lower the value, the faster the release.
Knob 7	ASSIGN 1	A variety of functions can be assigned to these Knobs. You can confirm the functions currently assigned to these Knobs in the Voice Play display (page 91). The Controller Set display (page 104) in the Voice Common Edit mode lets you assign the functions to these Knobs.
Knob 8	ASSIGN 2	
2 When the TONE 2 lamp is turned on:		Moving Knobs 1 – 5 changes the EQ parameters in the EG/EQ display (page 94). Moving Knobs 6 – 8 changes the parameters in the Play Mode display (page 98) and the Effect Connect display (page 107) of the Voice Common Edit mode.
Knob 1	EQ LOW	Increases or decreases the EQ Low Gain (page 95) to change the sound.
Knob 2	EQ MID F (EQ Middle Frequency)	Increases or decreases the EQ Middle Frequency (page 95) around which the band is adjusted via Knob 3 (EQ MID).
Knob 3	EQ MID (EQ Middle Gain)	Increases or decreases the EQ Middle Gain (page 95) to change the current Voice.
Knob 4	EQ MID Q (EQ Middle Q)	Increases or decreases the EQ Middle Q (page 95) to change the width of the band over which you can adjust the gain via Knob 3 (EQ Middle Gain). Turning Knob 4 clockwise increases the Q value to reduce the band width. Turning Knob 4 counter-clockwise decreases the Q value to widen the band width.
Knob 5	EQ HIGH (EQ High Gain)	Increases or decreases the EQ High Gain (page 95) to change the current Voice.
Knob 6	PAN	Adjusts the stereo pan position of the current Voice (page 99).
Knob 7	REVERB	Adjusts the Reverb Send Level (page 108).
Knob 8	CHORUS	Adjusts the Chorus Send Level (page 108).
3 When the ARP FX lamp is turned on:		Moving Knobs changes the Arpeggio related parameters in the Voice Common Edit mode. This operation is available when the Arpeggio function is turned on.
Knob 1	SWING	Adjusts the swing feel of the Arpeggio playback (page 103). Turning it clockwise increases the swing feel whereas turning it counter-clockwise decreases it.
Knob 2	QUANTIZE VALUE	Adjusts the Quantize Value (page 102), or note resolution, to which the note data of the Arpeggio will be aligned. Turning it clockwise increases the gate time of the note type set as the Quantize Value whereas turning it counter-clockwise decreases it.
Knob 3	QUANTIZE STRENGTH	Adjusts the Quantize Strength (page 103) by which note events of the Arpeggio are pulled toward the nearest quantize beats. Turning the Knob clockwise pulls note events to the quantize beat.
Knob 4	GATE TIME	Adjusts the Gate Time Rate (page 103) of the Arpeggio notes. Turning it clockwise lengthens the gate times to produce legato playback whereas turning it counter-clockwise shortens them.
Knob 5	VELOCITY	Adjusts the Velocity Rate (page 103) of the Arpeggio notes.
Knob 6	OCT RANGE (Octave Range)	Adjusts the Octave Range (page 103) for the Arpeggio playback.
Knob 7	UNITMULTIPLY	Adjusts the Unit Multiply (page 102) of the Arpeggio playback to expand/reduce the Arpeggio playback time based on tempo.
Knob 8	TEMPO	Adjusts the tempo for the Arpeggio playback.

NOTE Controlling the Knob adds the parameter value to the current one for the current Voice. Accordingly, if the parameter has been already set to the maximum or minimum value, its value will not be changed even if you operate the Knob.

Control Slider functions

The eight Control Sliders let you adjust the volume of eight Elements (page 56) making up the current Normal Voice. Each of the Control Sliders 1 – 8 corresponds to each of Elements 1 – 8. It is a good idea to check which Elements are used for the current Normal Voice by using the Information display (page 93) before using the Control Sliders. Keep in mind that when a Drum Voice is selected, a single Slider may affect the volume of all sounds/keys simultaneously.

The [E] Indicator

When changing the value of the parameter in the Voice Play or Edit mode, the [E] (Edit) Indicator will appear on the top right corner of the LCD display. This gives a quick confirmation that the current Voice has been modified but not yet stored. To store the current edited status, follow the instructions on page 97.



Keyboard MIDI transmit channel setting

You can set the MIDI transmit channel over which the keyboard/controller performance sends MIDI data (to an external sequencer, tone generator, or other device).

- 1 Press the [TRACK] button so that its lamp lights.
- 2 Pressing any of the Number buttons [1] – [16] to determine the MIDI transmit channel.
- 3 After setting, press the [PROGRAM] button to return to the original status.

NOTE This parameter is same as the Keyboard Transmit Channel (page 268) in the MIDI display of the Utility mode. Making a setting here automatically changes the setting of that parameter as well.

Keyboard Octave setting

Sometimes when playing a Voice, you may wish to play in a lower or higher pitch range. For example, you may want to shift the pitch down lower to get extra bass notes, or shift up to get higher notes for leads and solos. The Octave Up/Down controls let you do this quickly and easily. Each time you press the OCTAVE [UP] button on the panel, the overall pitch of the Voice goes up by one octave. Likewise, each press of the OCTAVE [DOWN] button takes the pitch down by one octave. The range is from -3 to +3, with 0 being standard pitch. The current octave setting is shown at the top right of the display. You can instantly restore standard pitch (0) by simultaneously pressing both the OCTAVE [UP] button and the OCTAVE [DOWN] button (both lamps turn off).

The lamp status of the OCTAVE [DOWN]/[UP] button lets you recognize at a glance the current octave setting. When set to one octave down or up, the corresponding lamp lights. When set to two octaves down or up, the corresponding lamp flashes slowly. When set to three octaves down or up, the corresponding lamp flashes quickly.

NOTE This parameter is same as the Octave (page 260) in the Play display of the Utility mode. Making a setting here automatically changes the setting of that parameter as well.

NOTE If you wish to shift notes on the keyboard up or down in semitones, edit the Transpose parameter (page 260) in the Play display of the Utility mode.

Using the Arpeggio function

The Arpeggio function lets you trigger rhythm patterns, riffs and phrases using the current Voice by simply playing notes on the keyboard. For instructions on using the Arpeggio, refer to the Start Guide on page 24.

The Voice Play display

The Voice Play display is the first display called up when pressing the [VOICE] button and entering the Voice mode.



1 Voice Bank

Indicates the Bank of the current Voice. The Voice Bank is the memory that includes data of Normal Voices and Drum Voices. There are 15 Voice Banks as follows.

PRE1 – 8 (Preset Bank 1 – 8)

Each of these Banks includes 128 different preset Voices.

USR1 – 3 (User Bank 1 – 3)

These Banks can be used for storing the Voices you create and edit. 128 different Voices are pre-programmed in each of these Banks.

GM

This Bank contains 128 different Voices which correspond to the order specified by the General MIDI (GM) format.

GMDR (GM Drum Bank)

This Bank contains a single Drum Voice, in which the drum instrument assignment corresponds to the General MIDI (GM) format.

PDR (Preset Drum Bank)

This Bank includes 64 different preset Drum Voices.

UDR (User Drum Bank)

This Bank can be used for storing the Drum Voices you create and edit.

GM Voices

GM (General MIDI) is a worldwide standard for Voice organization and MIDI functions of synthesizers and tone generators. It was designed primarily to ensure that any song data created with a specific GM device would sound virtually the same on any other GM device—no matter the manufacturer or the model. The GM Voice bank on this synthesizer is designed to appropriately play back GM song data. However, keep in mind that the sound may not be exactly the same as played by the original tone generator.

2 Voice Number (Group/Number)

Each Voice within a Bank is assigned to a Voice Number of 001 to 128.

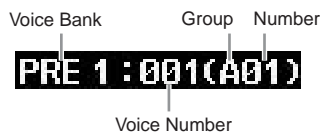

Voice Numbers 001 to 128 are converted to the format (shown in the parentheses) related to Banks A to H and Numbers 1 to 16 (for each Bank). This format is related to the Group buttons [A] – [H] and the Number buttons [1] – [16]. The Voice Numbers and the corresponding Group/Numbers are listed below.

Group/Number	Voice Number
A01 – 16	001 – 016
B01 – 16	017 – 032
C01 – 16	033 – 048
D01 – 16	049 – 064
E01 – 16	065 – 080
F01 – 16	081 – 096
G01 – 16	097 – 112
H01 – 16	113 – 128

3 Category (Main Category 1/Main Category 2)

Indicates the Main Category of the selected Voice. “Category” is a keyword that indicates the instrument characteristics or the type of sound. A Preset Voice is registered to two Main Categories. The Category settings can be edited in the General display (page 98) of the Voice Common Edit. For details, refer to the explanation of the General display.

4 Voice Name

Indicates the name of the current Voice.

5 Transmit CH (MIDI Transmit Channel)

Indicates the MIDI channel over which the keyboard/controller performance sends MIDI data (to an external sequencer, tone generator, or other device). For information about how to set the value, see page 91.

6 Octave

Indicates Keyboard Octave setting set via the OCTAVE buttons. This parameter determines how much higher or lower the pitch of each key is compared to normal pitch.

7 Control Function

Indicates the status of the Knobs and Control Sliders on the panel. This is same as the Control Function window (page 89).

8 Assign Settings

Indicates the functions assigned to the respective Knobs, ASSIGNABLE FUNCTION buttons, and other controllers. The function assignment can be set in the Control Assign display (page 147) of the Performance Common Edit mode and Controller Set display (page 104) of the Voice Common Edit mode.

MW (Modulation Wheel)

Indicates the function assigned to the Modulation Wheel.

RB (Ribbon Controller)

Indicates the function assigned to the Ribbon Controller.

AF1, AF2 (Assignable Function 1, 2)

Indicates the functions assigned to the two ASSIGNABLE FUNCTION buttons.

AS1, AS2 (Assign 1, 2)

Indicates the functions assigned to the respective Knobs (printed “ASSIGN 1” and “ASSIGN 2”) when the TONE1 lamp is lit.

9 [SF1] ARP1 – [SF5] ARP5 (Arpeggio 1 – 5)

The Arpeggio types are assigned to the buttons with the 8th note icon on the display tab. You can call them up by pressing these buttons any time during your keyboard performance. Assigning Arpeggio types to the buttons can be done from the Arpeggio display (page 95).

10 [SF6] INFO (Information)

Pressing this button calls up the information page of the current Voice. For details, refer to “Voice Information” below.

11 [F1] Play (Voice Play)

Pressing this button returns from the previous display to the Voice Play display.

12 [F2] Porta (Portamento)

Pressing this button calls up the Portamento display (page 93).

13 [F3] EG/EQ (Envelope Generator/Equalizer)

Pressing this button to call up the display that contains the basic EG, Filter, and EQ settings (page 94).

14 [F4] Arpeggio

Pressing this button calls up the Arpeggio display (page 95).

15 [F6] Effect

Pressing this button calls up the Effect Connect display (page 107) of the Voice Common Edit mode.

Voice information—[SF6] INFO (Information)

This display indicates the information of the current Voice. Settings cannot be changed here.



1 Bank

Indicates the Bank of the selected Voice program. The values in parentheses indicates the Bank Select MSB and LSB which can be used to select the current Voice via MIDI.

2 Program (Voice Number)

To each Voice within a Bank, a Number of 001 to 128 is assigned. The values in parentheses indicates Group and Number.

**3 Main Category 1
Main Category 2**

Indicates the Main Category 1/Main Category 2 of the current Voice.

4 Name

Indicates the name of the current Voice.

5 Voice Type

Indicates whether the current Voice type is the Normal Voice or Drum Voice.

6 Mono/Poly

Indicates whether the current Voice is set to Mono (only one note can be played at a time) or Poly (multiple notes can be played at a time).

7 Element Switch

Indicates the status (active/inactive) of the eight Elements making up the current Voice. Elements that are active are indicated by their corresponding numbers. An asterisk "*" indicates the corresponding Element is muted although the Element Switch parameter is turned on.

A hyphen "-" indicates the corresponding Element Switch parameter is turned off.

8 Portamento

Indicates the Portamento Switch on/off status (page 93) of the current Voice.

9 Pitch Bend Range

Indicates the Upper/Lower setting of the Pitch Bend Range (page 99) for the current Voice.

10 Effects

Indicates the Effect settings (for Insertion A, Insertion B, Reverb and Chorus) of the current Voice.

NOTE Parameters 6, 7 and 8 are not available when the Drum Voice is selected.

Portamento settings—[F2] Porta

From this display you can select monophonic or polyphonic playback and set the Portamento parameters. Portamento is used to create a smooth transition in pitch from the first note played on the keyboard to the next. The value set here is applied to the parameters having the same names in the Play Mode display (page 91) of the Voice Common Edit mode.

NOTE This display is not available when a Drum Voice is selected.

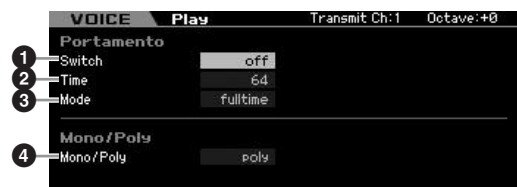

1 Portamento Switch

2 Portamento Time

3 Portamento Mode

4 Mono/Poly Mode

These are the same as in the Play Mode display (page 98) of the Voice Common Edit.

Voice mode

Performance mode

Sampling mode 1

Song mode

Pattern mode

Mixing mode

Sampling mode 2

Master mode

Utility mode

File mode

Reference

Applying the Portamento to the Voice

Follow the instructions below to apply the Portamento to the current Voice you play on the keyboard.

- 1 Press the [VOICE] button to enter the Voice Play mode.**
Select a Voice to which the Portamento is applied. The Portamento is effective especially for a Voice that sustains or continues to sound while the key is being held down.
- 2 Press the [F2] button to call up the Portamento display.**
- 3 Set the Portamento Switch to on.**
- 4 Set the Portamento Time.**
For best results, set this to a relatively high value.
- 5 Play two different keys alternatively to confirm the Portamento.**
It is a good idea to press a certain note then press the one octave higher or lower note for confirming how the Portamento is applied.

Changing tonal color—[F3] EG/EQ

You can change the tonal color or timbre of the sound by editing the EG/EQ settings for all Elements making up the Voice. The EG settings made here will be applied to the same parameters in the Amplitude EG display (page 123) and Filter EG display (page 119) for all Elements as an offset. In other words, editing the value here will add to or subtract from the current value. Accordingly, if the parameter has been already set to the maximum or minimum value, its value will not be changed even if you set the parameter to higher or lower value in this display. Note that the EQ settings here are applied to the Voice directly.



1 AEG (Amplitude EG)

Using the AEG, you can control the transition in volume from the moment the sound starts is to the moment the sound stops.

Attack (Attack Time)

Determines the speed of attack from the time a key is played until the maximum initial level of the EG is reached.

Decay (Decay Time)

Determines how fast the volume falls from maximum attack level to the sustain level.

Sustain (Sustain Level)

Determines the sustain level at which the volume will continue while a note is held, after the initial attack and decay. The smaller the value, the sharper the sound.

Release (Release Time)

Determines how fast the volume falls from the sustain level to zero when a note is released.

Settings: -64 – +0 – +63

NOTE When a Drum Voice is selected, the Sustain Level and Release Time are not available. "--" appears at each of the corresponding columns and these parameters cannot be edited.

2 FEG (Filter EG)

Using the FEG, you can control the transition in tonal color (Cutoff Frequency) from the moment the sound starts to the moment the sound stops. Actual transition of tonal color differs depending on the Filter type (page 117) of the Voice Element.

Attack (Attack Time)

Determines the speed of filter variation from the time a note is played until the maximum initial level of the Cutoff Frequency is reached.

Decay (Decay Time)

Determines how fast the Cutoff Frequency falls from maximum attack level to the sustain level.

Release (Release Time)

Determines how fast the Cutoff Frequency falls from the sustain level to zero when a note is released.

Depth

Determines the range over which the cutoff frequency of the Filter EG changes. A setting of 0 will result in no change in the cutoff frequency. The farther from 0 the value is, the larger the range of the cutoff frequency. For negative values, the change of the cutoff frequency is reversed.

Settings: -64 – +0 – +63

3 Filter

This unit modifies the tonal color of the sound by cutting the output of a specific frequency portion of the sound. Actual tonal color differs depending on the Filter type (page 117) of the Voice Element. The Low Pass Filter cuts the signals above the Cutoff Frequency while the High Pass Filter cuts the signals below the Cutoff Frequency.

Cutoff

Determines the Cutoff Frequency for the Filter, when the Low Pass Filter is selected, for example, the larger the value the brighter the decay.

Reso (Resonance)

Determines the emphasis given to the Cutoff Frequency. Higher values result in a more pronounced effect.

Settings: -64 – +0 – +63

4 EQ

This is a parametric EQ featuring three bands (High, Mid and Low). You can attenuate or boost the level of each frequency band (High, Mid, Low) to change the Voice sound. For the Mid band, you can also set the Q (Band Width).

Frequency

Determines the frequency for each frequency band. Set the value to the frequency around which you wish to attenuate or boost.

Settings:

Low: 50.1Hz – 2.00kHz
 Mid: 139.7Hz – 10.1kHz
 High: 503.8Hz – 14.0kHz

Gain

Determines the level gain for the Frequency (set above), or the amount the selected frequency band is attenuated or boosted. The higher the value, the greater the Gain. The lower the value, the lesser the Gain.

Settings: -12.00 dB – +0.00 dB – +12.00 dB

Q (Bandwidth)

Determines the Q (bandwidth) for the Mid band. The higher the value, the smaller the bandwidth. The lower the value, the wider the bandwidth.

Settings: 0.7 – 10.3

NOTE The Q setting is available only for the Mid band, which is a Peaking type EQ. Peaking (referring to the “peak” shape) lets you attenuate/boost a specific frequency and allows you to control how wide or narrow the bandwidth is. On the other hand, the EQ shape of the High and Low band is the Shelving type which lets you attenuate/boost the signal at frequencies above or below the specified Frequency setting.

5 EQ graph

Indicates the EQ settings as a graph. The vertical axis indicates the gain, and the horizontal axis indicates the frequency.

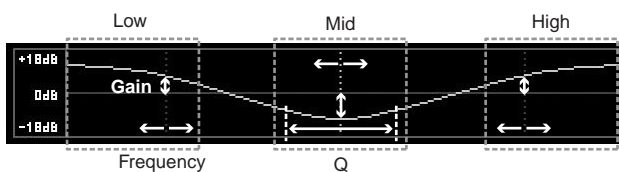

Arpeggio settings—[F4] Arpeggio

This display determines the basic settings of the Arpeggio. Keep in mind that the parameters of Bank (6) – Type (9) have five settings which can be edited in each of the [SF1] ARP1 through [SF5] ARP5 displays. The value set here is applied to the parameters having the same names in the Arpeggio Main display (page 101) of the Voice Common Edit mode.



Arpeggio Type Name

- 1 Switch
- 2 Hold
- 3 Tempo
- 4 Velocity Limit
- 5 [SF1] ARP1 – [SF5] ARP5 (Arpeggio 1 – 5) buttons
- 6 Bank
- 7 Category
- 8 Sub Category
- 9 Type

These are the same as in the Arpeggio Main display (page 101) of the Voice Common Edit.

Editing a Normal Voice

“Editing” refers to the process of creating a Voice by changing the parameters that make up the Voice. This can be done in Voice Edit, a sub mode within the Voice mode. To enter the Voice Edit mode, press the [VOICE] button to first call up the Voice mode, then press the [EDIT] button.

Common Edit and Element Edit

A Normal Voice, which contains pitched musical instrument-type sounds that can be played over the range of the keyboard, can consist of up to eight Elements. There are two types of Normal Voice Edit displays: those for Common Edit to edit the settings common to all Elements, and those for Element Edit to edit individual Elements.

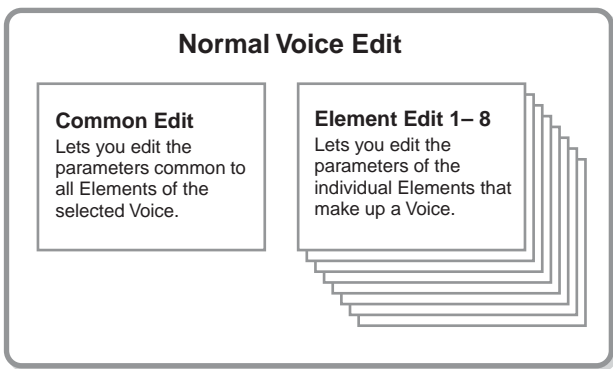

Editing Normal Voices

- 1 Press the [VOICE] button to enter the Voice Play mode.**
Select a Normal Voice to be edited.
- 2 Press the [EDIT] button to enter the Voice Edit mode.**
- 3 Call up the desired Edit display, Common Edit or Element Edit.**
To call up the Common Edit display, press the [COMMON EDIT] button. To call up the Element Edit display, press one of the Number buttons [1] – [8] to select the Element to be edited.

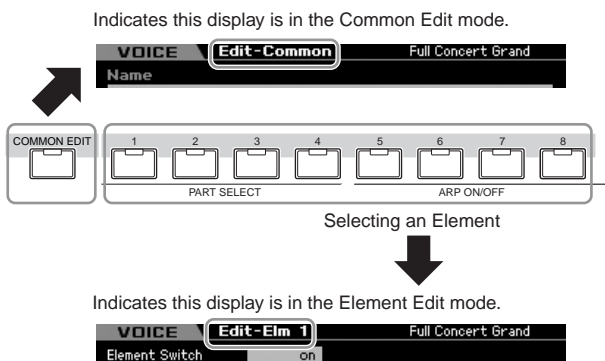

4 Call up the desired display.

To find the desired display, note the tab menu items corresponding to the [F1] – [F6] buttons and [SF1] – [SF5] buttons at the bottom of the display.



Tab menus corresponding to the [F1] – [F6] buttons

Tab menus corresponding to the [SF1] – [SF6] buttons

NOTE By pressing the [SF6] button, you can use various functions such as the Information display, Character input (page 82), Number button function (page 81), and List display/selection (page 82). The function called up via the [SF6] button differs depending on the selected parameter where the cursor is located.

5 Move the cursor to the desired parameter.

6 Edit the value by using the [INC/YES], [DEC/NO] buttons and the data dial.

7 Repeat steps 3 – 6 as desired.

8 Enter the desired name for the edited Voice.

Use the Name display (page 98) of the Voice Common Edit mode.

9 Store the edited Voice.

Press the [STORE] button to call up the Store window (page 97) then store the edited Voice.

CAUTION

The edited Voice will be lost when selecting the different Voice or turning the power off. Make sure to store the Voice data to the internal memory by pressing the [STORE] button before selecting a different Voice or turning the power off.

NOTE If desired, save the edited and stored Voices to a USB storage device connected to the USB TO DEVICE connector or a computer connected to the network to which the MOTIF XS is also connected. Keep in mind that edited Voice data is stored to internal User memory (Flash ROM) and is maintained even when turning the power off. As such it is not necessary to save the data to an external device; however, we still recommend that you save or archive all important data to an external device. Refer to page 278 for details.

Convenient functions for editing Voices

Switching an Element on/off

In the Voice Edit mode, you can always use the number buttons [1] – [8] to select an Element. The [1] – [8] buttons indicate the Element being edited. To switch each Element on/off, turn the [MUTE] button on, and then use number buttons [9] – [16].

Use number buttons [1] – [8] to select the Element you want to edit

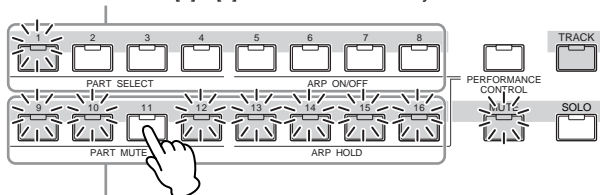

Use number buttons [9] – [16] to turn each Element on/off

Soloing the Element to be edited

If you want to turn on only the Element you're editing, press the [SOLO] button to turn it on, and then press a number button [1] – [8] or [9] – [16]. For example, if you want to turn on only Element 1 and edit it, press the [1] or [9] button to make the [1] indicator light and the [9] indicator flash.

Use number buttons [1] – [8] / [9] – [16] to turn on only the Element you want to edit

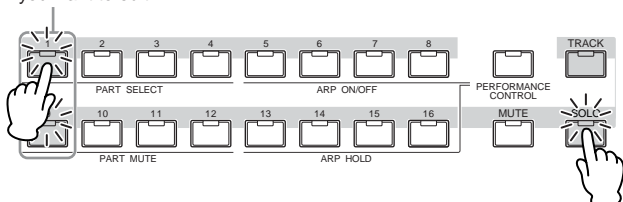

The [E] Indicator

The [E] (Edit) indicator will appear in the Voice Edit mode as well as in the Voice Play mode. For details, see page 97.

Compare function

The Compare function lets you switch between the just-edited Voice and its original, unedited condition, allowing you to hear how your edits affect the sound.

1 Press the [EDIT] button to call up the Compare mode.

In the Voice Edit mode (with the [EDIT] lamp lit), press the [EDIT] button so that its lamp flashes. The [E] indicator at the top right of the screen will change to the [C] indicator and the Voice settings prior to editing will temporarily be reinstated for comparison purposes.

When the [E] indicator is shown in the Voice Play mode, press the [EDIT] button to enter the Voice Edit mode then press the [EDIT] button again to call up the Compare mode.

Compare indicator (sound prior to editing)

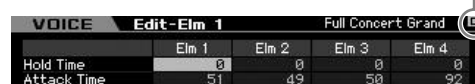

2 Press the [EDIT] button again to return to the original status.

When the [C] indicator is shown at the right top of the display, press the [EDIT] button (the lamp lights continuously, and the [C] indicator changes back to the [E] indicator).

Compare the edited sound with the unedited sound as desired by repeating steps 1 and 2.

NOTE While Compare is active, you cannot make edits to the Voice.

Storing the created Voice

1 Press the [STORE] button to call up the Voice Store window.



2 Set the destination for storing the Voice.

Select the destination User Bank (USER 1 – 3 for the Normal Voice, USER DR for the Drum Voice) and the Voice number to be stored by using the data dial, [INC/YES] and [DEC/NO] buttons. You can also use the [USER 1] – [USER 3], [USER DR], Group [A] – [H], and Number [1] – [16] buttons to specify the destination.

3 Press the [ENTER] button. (The display prompts you for confirmation.)

To cancel the Store operation, press the [DEC/NO] button.

4 Press the [INC/YES] button to execute the Store operation.

After the Voice has been stored, a “Completed” message appears and operation returns to the Voice Play display. In this condition, the just stored Voice is selected as shown in the display, letting you instantly play the just edited Voice.

⚠ CAUTION

When you execute the Store operation, the settings for the destination memory will be overwritten. Important data should always be backed up to a separate USB storage device. For detailed instructions on saving, see page 278.

NOTE Keep in mind that the destination of “Store” is internal memory (Flash ROM) whereas the destination of “Save” is external memory such as a USB storage device.

Common Edit parameters

[VOICE] → Normal Voice selection → [EDIT] → [COMMON EDIT]

Common Edit lets you edit the parameters common to all Elements of the selected Normal Voice.

About the asterisk (*) marks

For users who are new to Voice editing and may be confused by the large amount of parameters, the most basic and easy-to-understand parameters are conveniently marked with asterisks. If you are just starting out with Voice editing, try these parameters first.

General settings for the selected Voice—[F1] General

Naming the edited Voice—[SF1] Name



1 Name*

Enters the desired name for the Voice. The Voice name can contain up to 20 characters.

You can call up the character list by pressing the [SF6] CHAR button, then select the desired one from the list. For detailed instructions on naming, refer to “Basic Operation” on page 82.

2 Main Category 1*

3 Sub Category 1*

4 Main Category 2*

5 Sub Category 2*

Determines the two Main Categories and their Sub Categories to which the Voice belongs respectively. “Category” can be used as a keyword representing the characteristic of the Voice. The appropriate setting makes it easy to find the desired Voice from a variety of Voices. There are 16 Main Categories which indicate types of instruments. There are up to five Sub Categories for each Main Category, indicating more detailed types of instruments.

Settings: See the following list.

Main Category	Sub Category					
Acoustic Piano	Pn	Acoustic	Layer	Modern	Vintage	Arpeggio
Keyboard	Kb	Electric Piano	FM Piano	Clavi	Synth	Arpeggio
Organ	Or	Tone Wheel	Combo	Pipe	Synth	Arpeggio
Guitar	Gt	Acoustic	Electric Clean	Electric Distortion	Synth	Arpeggio
Bass	Bs	Acoustic	Electric	Synth	Arpeggio	—
Strings	St	Solo	Ensemble	Pizzicato	Synth	Arpeggio
Brass	Br	Solo	Brass Ensemble	Orchestra	Synth	Arpeggio
Sax / Woodwind	SW	Saxophone	Flute	Woodwind	Reed / Pipe	Arpeggio
Synth Lead	Ld	Analog	Digital	Hip Hop	Dance	Arpeggio
Synth Pad/Choir	Pd	Analog	Warm	Bright	Choir	Arpeggio
Synth Comp	Sc	Analog	Digital	Fade	Hook	Arpeggio
Chromatic Percussion	Cp	Mallet Percussion	Bell	Synth Bell	Pitched Drum	Arpeggio
Drum / Percussion	Dr	Drums	Percussion	Synth	Arpeggio	—
Sound Effect	Se	Moving	Ambient	Nature	Sci-Fi	Arpeggio
Musical Effect	Me	Moving	Ambient	Sweep	Hit	Arpeggio
Ethnic	Et	Bowed	Plucked	Struck	Blown	Arpeggio

[NOTE] You can call up the list by pressing the [SF6] LIST button then select the desired one from the list. For details, see page 82.

Play Mode Settings such as Micro Tuning and Mono/Poly—[SF2] Play Mode

From this display, you can make various settings such as Mono or Poly, Pitch, Portamento, and Micro Tuning.



1 Volume*

Determines the output level of the Voice. Set this parameter to adjust the balance between the current Voice and other Voices.

Settings: 0 – 127

2 Pan*

Determines the stereo pan position of the Voice. You can also adjust this parameter using the PAN knob on the front panel.

Settings: L63 (far left) – C (center) – R63 (far right)

NOTE Note that this Voice Pan parameter may have little or no audible effect if the Pan for a specific element is set to the left position and the Pan for another element is set to the right position.

3 Note Shift*

Determines the transpose setting for the amount (in semitones) by which the pitch is raised or lowered.

Settings: -24 – +0 – 24

4 PB Range Upper (Pitch Bend Range Upper)***5 PB Range Lower (Pitch Bend Range Lower)***

Determines the maximum Pitch Bend range in semitones. Setting the Upper parameter to +12 would result in a maximum pitch rise of one octave when the Pitch Bend wheel is moved upwards. On the other hand, the Lower setting of -12 would result in the pitch being lowered up to a maximum of one octave (12 semitones) when the Pitch Bend wheel is moved downwards.

Settings: -48 semi – +0 semi – +24 semi

6 Bank (Micro Tuning Bank)

Determines the Micro Tuning Bank.

Settings: PRE, USR

PRE (Preset)

Contains the 13 preset Micro Tuning types.

USR (User)

Contains your original Micro Tuning types created in the Micro Tuning display (page 265) of the Utility mode.

7 Tuning Number

Determines the Micro Tuning number. The Preset Bank provides 13 types including the most common “equal temperament.”

Settings:

Preset Bank: 1 – 13 (See the Micro Tuning list below.)

User Bank: 1 – 8

8 Tuning Root

Sets the base note for each scale. For some scales this setting may not be necessary.

Settings: C – B

What is Micro Tuning?

This function lets you change the keyboard scale from normal tuning (equal temperament) to one of a variety of special scales. You can determine the scale type for each voice by simply selecting a Tuning number. You can also use original Micro Tuning types that you’ve created in the Micro Tuning display (page 265) of the Utility mode.

Micro Tuning List

Micro Tuning No.	Type	Micro Tuning Root	Comments
1	Equal	—	The “compromise” tuning used for most of the last 200 years of Western music, and found on most electronic keyboards. Each half step is exactly 1/12 of an octave, and music can be played in any key with equal ease. However, none of the intervals are perfectly in tune.
2	PureMajor	C – B	This tuning is designed so that most of the intervals (especially the major third and perfect fifth) in the major scale are pure. This means that other intervals will be correspondingly out of tune. You need to specify the key (C – B) you will be playing in.
3	PureMinor	C – B	The same as Pure Major, but designed for the minor scale.
4	Werckmeist	C – B	Andreas Werckmeister, a contemporary of Bach, designed this tuning so that keyboard instruments could be played in any key. Each key has a unique character.
5	Kirnberger	C – B	Johann Philipp Kirnberger, an 18th century composer, created this tempered scale to allow performances in any key.
6	Vallot&Yng	C – B	Francescantonio Vallotti and Thomas Young (both mid-1700s) devised this adjustment to the Pythagorean tuning, in which the first six fifths are lowered by the same amount.
7	1/4 Shift	—	This is the normal equal tempered scale shifted up 50 cents.
8	1/4 tone	—	Twenty-four equally spaced notes per octave. (Play twenty-four notes to move one octave.)
9	1/8 tone	—	Forty-eight equally spaced notes per octave. (Play forty-eight notes to move one octave.)
10	Indian	—	Usually observed in Indian music (white keys only).
11	Arabic 1	C – B	Usually observed in Arabic music.
12	Arabic 2		
13	Arabic 3		

9 Mono/Poly*

Selects monophonic or polyphonic.

Settings: mono, poly

mono

When set to “mono,” the selected Voice is played back monophonically (only a single note is played back simultaneously). For many instrument sounds (such as bass and synth lead), this allows a more natural and smooth sounding legato performance than when this parameter is set to “poly.”

poly

When set to “poly,” the selected Voice is played back polyphonically (multiple notes can be played back simultaneously or a chord is played back).

Voice mode

Performance mode

Sampling mode 1

Song mode

Pattern mode

Mixing mode

Sampling mode 2

Master mode

Utility mode

File mode

Reference

10 Key Assign Mode

When this is set to “single,” double playback of the same note is prevented. This is useful when two or more instances of the same note are received nearly simultaneously, or without a corresponding note off message. To allow playback of each instance of the same note, set this to “multi.”

Settings: single, multi

single

When this is set to “single” and double playback of the same note are transmitted to the internal tone generator, the first note will be stopped then the next note will be sounded.

multi

When this is set to “multi” and double playback of the same note are transmitted to the internal tone generator, all the notes are sounded simultaneously.

11 Portamento Switch*

Determines whether Portamento is applied to the current Voice or not.

Settings: on, off

12 Portamento Time*

Determines the pitch transition time when Portamento is applied. The effect of the parameter differs depending on the settings of the Portamento Time Mode (14). Higher values result in a longer pitch change time.

Settings: 0 – 127

13 Portamento Mode

Determines how Portamento is applied to your keyboard performance.

Settings: fingered, fulltime

fingered

Portamento is only applied when you play legato (playing the next note before releasing the previous one).

fulltime

Portamento is applied to all notes.

14 Portamento Time Mode

Determines how the pitch changes in time.

Settings: rate1, time1, rate2, time2

rate1

Pitch changes at the specified rate.

time1

Pitch changes in the specified time.

rate2

Pitch changes at the specified rate within an octave.

time2

Pitch changes in the specified time within an octave.

15 Portamento Legato Slope

When the Mono/Poly is set to “mono,” legato playing may produce an unnatural attack depending on the waveform assigned to the selected Voice. To solve such a problem, you can use this parameter to adjust the attack of the Voice. Normally, this should be set to a low value for waveforms with short attack times, and should be set to a high value for waveforms with long attack times.

Settings: 0 – 7

Other settings—[SF3] Other

From this display, you can set the control functions for the Knobs, and the up/down range for the Pitch Bend wheel.

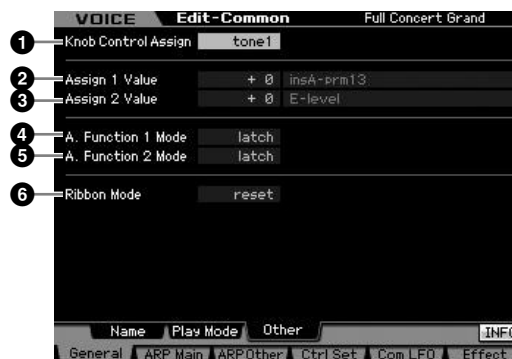

1 Knob Control Assign

Determines which lamp among the TONE 1, TONE 2, and ARP FX is turned on when selecting a Voice. This setting can be stored for each Voice.

Settings: tone1, tone2, ARP FX

2 Assign 1 Value

3 Assign 2 Value

Indicates the level of the Knobs printed “ASSIGN 1” and “ASSIGN 2” at the time at which the Voice is selected with the TONE 1 lamp turned on. The functions assigned to the Knobs are indicated at right of the values respectively.

Settings: -64 – +0 – +63

NOTE The functions assigned to the ASSIGN 1/2 Knobs can be set in the Controller Set display (page 104).

4 A. Function 1 Mode (Assignable Function 1 Mode)

5 A. Function 2 Mode (Assignable Function 2 Mode)

Determines whether the ASSIGNABLE FUNCTION [1] and [2] buttons functions as a latch type or momentary type. When set to “latch,” pressing the button alternates the lamp status between on and off. When set to “momentary,” pressing/holding the button turns the lamp on and releasing the button turns the lamp off.

Settings: momentary, latch

6 Ribbon Mode (Ribbon Controller mode)

Determines how the Ribbon Controller responds when released. When set to reset, releasing your finger from the Ribbon Controller automatically returns the value to the center. When set to hold, releasing your finger from the Ribbon Controller maintains the value at the last point of contact.

Settings: hold, reset

Arpeggio settings—[F2] ARP Main (Arpeggio Main)

This display determines the basic settings of the Arpeggio. Keep in mind that parameters Bank (11) through Gate Time Rate Offset (16) have five settings which can be edited in each of the [SF1] ARP1 through [SF5] ARP5 displays. For details about Arpeggio, see page 62.

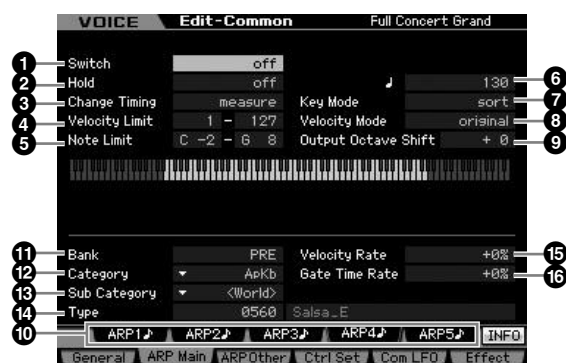

NOTE Depending on the selected parameter, the KBD icon appears on the tab corresponding to the [SF6] button. In this condition, you can enter the note number or velocity by pressing the appropriate note on the keyboard while holding the [SF6] KBD button. For details, see page 82.

1 Switch

Determines whether Arpeggio is on or off. When calling up a Voice for which the Common Switch is set to on, the [ARPEGGIO ON/OFF] button on the panel will be turned on automatically.

Settings: on, off

2 Hold*

When this is set to “on,” the Arpeggio cycles automatically, even if you release your fingers from the keys.

Settings: sync-off (see below), off, on

sync-off

When set to “sync-off,” the Arpeggio playback continues to run silently, even when you release the keys. Pressing any key turns the Arpeggio playback on again, and the Arpeggio is heard from the point in the cycle where playback is resumed.

3 Change Timing*

Determines the actual timing at which the Arpeggio type is switched when you select another type during Arpeggio playback. When set to “realtime,” the Arpeggio type is switched immediately. When set to “measure,” the Arpeggio type is switched at the top of the next measure.

Settings: realtime, measure

4 Velocity Limit

Determines the lowest and highest velocity which can trigger the Arpeggio playback. This lets you set the velocity range with which you press the note to trigger the Arpeggio playback. You can also create separate low and high trigger ranges for the Arpeggio playback, with a velocity “hole” in the middle, by specifying the maximum value first. For example, setting a Velocity Limit of 93 – 34 lets you play

the Arpeggio from two separate velocity ranges: soft (1 – 34) and hard (93 – 127). Notes played at middle velocities between 35 and 92 do not play the Arpeggio.

Settings: 001 – 127

5 Note Limit

Determines the lowest and highest notes in the Arpeggio’s note range. Notes played in this range trigger the Arpeggio. For example, setting a Note Limit of “C5 – C4” lets you trigger the Arpeggio by playing notes in the two ranges of C -2 to C4 and C5 to G8; notes played between C4 and C5 have no effect on the Arpeggio.

Settings: C -2 – G8

NOTE Please keep in mind that no sound is produced when the Key Mode is set to “sort” or “thru” and notes are played outside the Note Limit setting here.

6 Tempo*

Determines the Arpeggio Tempo. This parameter can be changed via the Knob directly.

Settings: 5 – 300

NOTE If you are using this instrument with an external sequencer, MIDI computer, or other MIDI device, and you want to synchronize it to that device, set the MIDI sync (5) parameter in the MIDI display (page 268) of the Utility mode to “MIDI” or “auto.” In this case, the Tempo parameter here indicates “MIDI” or “auto” and cannot be changed.

7 Key Mode

Determines how the Arpeggio plays back when playing the keyboard.

Settings: sort, thru, direct, sort+direct, thru+direct

sort

When you play specific notes (for example, the notes of a chord), the same sequence plays, no matter what order you play the notes.

thru

When you play specific notes (for example, the notes of a chord), the resulting sequence differs depending on the order of the notes.

direct

Note events of the Arpeggio sequence do not play; only the notes you play on the keyboard are heard. When the Arpeggio plays back, the events such as Pan and Brightness are applied to the sound of your keyboard performance. Use this setting when the Arpeggio types includes non-note data or when the Category type “Ctrl” is selected.

sort+direct

The Arpeggio is played back according to the “sort” setting here, and the note pressed is also sounded.

thru+direct

The Arpeggio is played back according to the “thru” setting here, and the note pressed is also sounded.

NOTE Some Arpeggio types belonging to the “Cntr” Category may not have note events (page 65). When such an Arpeggio type is selected and the Key Mode is set to “sort” or “thru,” no sound is produced even if you press a note on the keyboard.

8 Velocity Mode

Adjusts the velocity of the Arpeggio notes.

Settings: original, thru

original

The Arpeggio plays back at the preset velocities included in the Arpeggio sequence data.

thru

The Arpeggio plays back according to the velocity of your playing. For example, if you play the notes strongly, the playback volume of the Arpeggio increases.

9 Output Octave Shift

Specifies the maximum Arpeggio range in octaves.

Settings: -10 – +10

10 [SF1] ARP1 – [SF5] ARP5 (Arpeggio 1 – 5) buttons

The six parameters Bank (11) through Gate Time Rate Offset (16) at the lower half part of the display, can be edited in each of the [SF1] ARP1 through [SF5] ARP5 displays. You can set the parameters in the lower half of the display for each of the five Arpeggio settings by pressing one of the [SF1] – [SF5] buttons. The 8th note icon shown in the tab menu indicates that any Arpeggio Type (other than “off”) is selected in the display corresponding to the Sub Function button.

Settings: [SF1] – [SF5] (Sub Function) buttons

11 Bank*

Determines the Arpeggio Bank containing the desired Arpeggio type. Select “PRE” if you wish to select a preset Arpeggio Type. Select “USER” if you wish to select an Arpeggio Type you originally created and stored.

Settings: PRE, USR

NOTE For detailed instructions on creating your original Arpeggio type, see page 66.

12 Category*

13 Sub Category*

You can select the Category and its Sub Category including your desired Arpeggio Type. This parameter is available when “PRE” is selected as the Bank.

Settings: Refer to the Arpeggio Category List on page 62.

NOTE You can call up the list by pressing the [SF6] LIST button then select the desired one from the list. For details, see page 82.

14 Type*

Determines the desired Arpeggio Type number from the specified Category. The name of the selected Arpeggio Type is shown at right of the specified number on the display. Refer to the Arpeggio Type List in Data List 2 (separate online documentation).

For details about Data List 2, refer to “How to use the manual” (page 6).

NOTE For details about how to use the Arpeggio Type List, see page 63.

15 Velocity Rate

Determines the offset value by which the Arpeggio notes will be shifted from their original velocities. If the resultant velocity value is less than zero it will be set to 1, and if the resultant velocity is greater than 128 it will be set to 127.

This parameter can be changed via the Knob directly.

Settings: -100% – +0% – +100%

16 Gate Time Rate

Determines the Gate Time (length) of the Arpeggio notes. The Gate Time cannot be decreased beyond its normal minimum of 1; any values outside that range will automatically be limited to the minimum. This parameter can be changed via the Knob directly.

Settings: -100% – +0% – +100%

Arpeggio settings—[F3] ARP Other (Arpeggio Other)

By changing the timing and velocity of the notes, you can change the rhythmic “feel” of the Arpeggio playback.



1 Unit Multiply

Adjusts the Arpeggio playback time based on tempo. By using this parameter, you can create a different Arpeggio type from the original one. For example, if you set a value of 200%, the playback time will be doubled (tempo is halved). On the other hand, if you set a value of 50%, the playback time will be halved and the tempo doubled. Normal playback time is 100%. This parameter can be changed via the Knob directly.

Settings: 50%, 66%, 75%, 100%, 133%, 150%, 200%

2 Quantize Value*

Determines to what beats the note data in the Song will be aligned, or determines to what beats in the Song the swing is applied.

This parameter can be changed via the Knob directly.

Settings: 60 (32nd note), 80 (16th note triplet), 120 (16th note), 160 (8th note triplet), 240 (8th note), 320 (1/4 note triplet), 480 (1/4 note)

3 Quantize Strength

Sets the “strength” by which note events are pulled toward the nearest quantize beats. A setting of 100% produces exact timing set via the Quantize Value parameter above. A setting of 0% results in no quantization. A setting of 50% results in the note events being pulled halfway between 0% and 100%.

This parameter can be changed via the Knob directly.

Settings: 0% – 100%

4 Swing*

Delays notes on even-numbered beats (backbeats) to produce a swing feel. Settings above 1 delay the Arpeggio notes, whereas settings below 1 advance them. A setting of 0 produces exact timing set via the Quantize Value, resulting in no swing. Judicious use of this setting lets you create swing rhythms and triplet feels, such as shuffle and bounce.

This parameter can be changed via the Knob directly.

Settings: -120 – +120

5 Velocity Rate

Determines how much the velocity of the Arpeggio playback is offset from the original value. For example, a setting of 100% means the original velocities are used. Settings below 100% will reduce the velocities of the Arpeggio notes, whereas settings above 100% will increase the velocities. If the resultant velocity value is less than zero it will be set to 1, and if the resultant velocity is greater than 128 it will be set to 127.

Settings: 0 – 200%

6 Gate Time Rate

Determines how much the Gate Time (length) of the Arpeggio notes is offset from the original value. A setting of 100% means the original gate times are used. Settings below 100% will shorten the gate times of the Arpeggio notes, whereas settings above 100% will lengthen them. The Gate Time cannot be decreased beyond its normal minimum of 1; any values outside that range will automatically be limited to the minimum.

Settings: 0 – 200%

7 Octave Range

Specifies the maximum Arpeggio range in octaves. Positive value settings increase the octave range of the Arpeggio playback upward, whereas negative value settings increase it downward. This parameter can be changed via the Knob directly.

Settings: -3 – +0 – +3

8 Loop

When this is set to “on,” the Arpeggio cycles while notes are held. When this is set to “off,” the Arpeggio plays only once even if notes are held.

Settings: off, on

9 Trigger Mode

When this is set to “gate,” pressing the note starts Arpeggio playback and releasing the note stops it. When this is set to “toggle,” pressing the note starts/stops Arpeggio playback and releasing the note does not affect Arpeggio playback. Normally, this parameter should be set to “gate.”

Settings: gate, toggle

NOTE The Trigger Mode “toggle” setting overcomes the Hold “on” setting in the Arpeggio Main display (page 101). In other words, even when the Hold parameter is set to “on,” pressing the note start/stops Arpeggio playback when the Trigger Mode is set to “toggle.”

10 Accent Vel Threshold (Accent Velocity Threshold)

Some Arpeggio types include special sequence data called “Accent Phrase,” which will be played back only when the velocities higher than a specified value are received. This parameter determines the minimum velocity that will trigger the Accent Phrase.

Settings: off, 1 – 127

11 Accent Start Quantize

Determines the start timing of the Accent Phrase when the Velocity specified in Accent Vel Threshold above is received. When set to off, the Accent Phrase starts as soon as the Velocity is received. When set to on, the Accent Phrase starts on the beat specified for each Arpeggio type after the Velocity is received.

Settings: off, on

12 Random SFX

Some Arpeggio types feature the Random SFX function which will trigger the special sound such as fret noise of the guitar when the note is released. This parameter determines whether the Random SFX is active or not.

Settings: off, on

13 Random SFX Velocity Offset

Determines the offset value by which the Random SFX notes will be shifted from their original velocities. If the resultant velocity value is less than zero it will be set to 1, and if the resultant velocity is greater than 128 it will be set to 127.

Settings: -64 – +0 – +63

14 Random SFX Key On Control

When this is set to “on,” the Random SFX special sound is played with the preprogrammed velocity. When this is set to “off,” the Random SFX special sound is played with the velocity generated when the note is pressed.

Settings: off, on

Voice mode

Performance mode

Sampling mode 1

Song mode

Pattern mode

Mixing mode

Sampling mode 2

Master mode

Utility mode

File mode

Reference

Controller settings—[F4] Ctrl Set (Controller Set)

The controllers such as knobs on the front panel can be used to change and adjust a variety of parameters for each Voice—in real time, and simultaneously. For example, keyboard aftertouch can be used to control vibrato and the Modulation Wheel could be used to control tonal brightness.

The function settings for all the controllers are referred to as a “Controller Set,” and up to six Controller Sets can be created for each Voice. The controller is referred to as Source, and the controlled function is referred to as Destination. From this display, you can determine the Controller Sets.

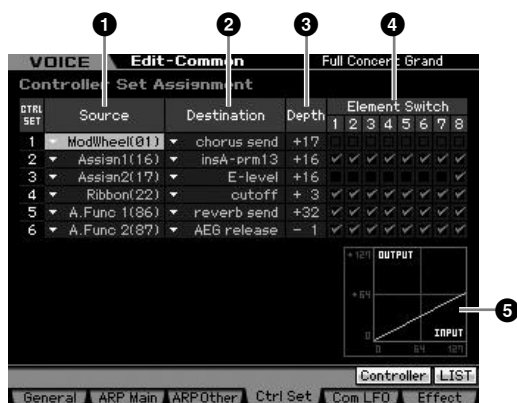

NOTE Depending on the selected parameter, the LIST icon is shown at the tab menu corresponding to the [SF6] button. In this condition, you can call up the list by pressing the [SF6] LIST button, then select the desired item from the list. For details, see page 82.

1 Source*

Determines which panel controller is to be assigned and used for the selected Set. You can also assign multiple functions to a controller. You can set this parameter by operating the desired controller while holding the [SF5] Controller button.

Settings:

PitchBend

Indicates the built-in Pitch Bend wheel.

ModWheel

Indicates the built-in Modulation wheel.

AfterTch (Aftertouch)

Indicates the event generated when pressure is applied to a key after the note is played.

FootCtrl1 (Foot Controller2)

FootCtrl2 (Foot Controller2)

Indicates the Foot Controller connected to each of the FOOT CONTROLLER 1 and 2 jacks on the rear panel.

FootSw (Footswitch)

Indicates the Footswitch connected to the FOOT SWITCH ASSIGNABLE jack on the rear panel.

Ribbon

Indicates the built-in Ribbon Controller.

Breath

Indicates the external controller which sends the control change number assigned to the Breath Controller in the Utility mode (page 264) to the MOTIF XS via MIDI.

Assign1

Assign2

Indicates the Knobs printed “ASSIGN 1” and “ASSIGN 2” with the TONE 1 lamp turned on.

A. Func 1

A. Func 2

Indicates the built-in ASSIGNABLE FUNCTION [1] and [2] buttons.

NOTE You can determine the degree to which the Pitch Bend wheel affects the Destination parameter (below) by setting the Pitch Bend Range Upper (4) and Pitch Bend Range Lower (5) in the Play Mode display (page 98).

2 Destination*

Determines the parameter that is controlled by the Source controller (above). You can select a parameter for each controller from the 67 parameters, such as volume, pitch and LFO depth.

Settings: Settings: Refer to the Control List in the separate Data List booklet.

NOTE Regarding “Insertion Effect A Parameter 1 – 16,” “Insertion Effect B Parameter 1 – 16” and “Insertion Effect L Parameter 1 – 32” described in the Control List, the actual parameter names of the selected Effect type are shown on the display. If one of these names is shown, no function is assigned to that parameter.

Setting examples of the Destination

To control the volume:	Volume
To apply vibrato to the Voice:	Common LFO Depth 1 – 3 (C-LFO dpth1 – 3) *1
To change the pitch:	Element Pitch (coarse tune) *2
To control the brightness of the Voice:	Element Filter Frequency (cutoff) *2
To change the speed of the Rotary Speaker:	Insertion A/B Parameter 1 (insA-prm1/insB-prm1) *3
To apply a wah pedal to the Voice:	Insertion A/B Parameter 1 (insA-prm1/insB-prm1) *4

Concerning *1 – *4, the following settings are necessary in addition to the above setting.

*1 [F4] Com LFO → [SF1] Wave → Play Mode = loop
[F4] Com LFO → [SF2] Set → Control Dest = P mod

*2 [F3] Ctrl Set → Element Switch = on

*3 [F6] Effect → Insertion A/B Type = Rotary Speaker
[F6] Effect → Element Out = insA/insB

*4 [F6] Effect → Insertion A/B Type = Wah effect
[F6] Effect → Element Out = insA/insB

3 Depth*

Determines the degree to which the Source controller affects the Destination parameter. For negative values, the controller operation is reversed; maximum controller settings produce minimum parameter changes.

Settings: -64 – +0 – +63

4 Element Switch*

Determines whether or not the selected controller affects each individual element. This parameter is disabled when the Destination (2) described above is set to a parameter unrelated to the Voice Elements.

5 Graph (Indication only)

The horizontal axis indicates the value generated via the Source of the selected Set, whereas the vertical axis indicates the degree to which the Destination parameter is affected.

Modulating the Voice—[F5] Com LFO (Common LFO)

Determines how the vibrato, tremolo and wah effect are produced by using the LFO (Low Frequency Oscillator). From the following displays, you can set the basic LFO parameters common to all elements of the Voice.

LFO Wave settings—[SF1] Wave (Common LFO Wave)

This display contains a variety of LFO parameters, including LFO wave type, speed and effects such as LFO delay or fade in/out.

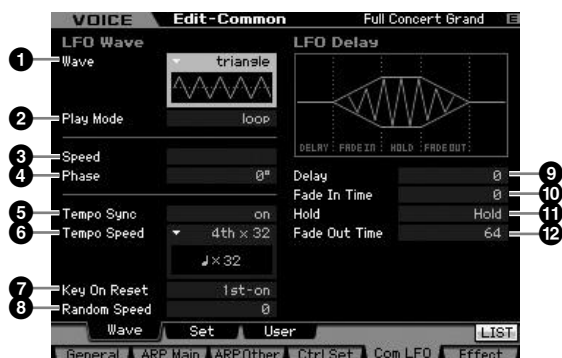

NOTE Depending on the selected parameter, the LIST icon is shown at the tab menu corresponding to the [SF6] button. In this condition, you can call up the list by pressing the [SF6] LIST button, then select the desired item from the list. For details, see page 82.

1 Wave*

Selects the Wave and determines how the LFO waveform vibrates. The illustration of the selected wave is shown on the display.

Settings: triangle, triangle+, saw up, saw down, squ1/4, squ1/3, square, squ2/3, squ3/4, trapezoid, S/H1, S/H2, user

user
You can create your original LFO wave by selecting this. The LFO wave can be created in the Common LFO User display (page 105).

2 Play Mode

Determines whether the LFO cycles repeatedly (loop) or only once (one shot).

Settings: loop, one shot

3 Speed*

Determines the speed of the LFO Wave. The higher the value, the faster the speed.

Settings: 0 – 63

4 Phase

Determines the starting phase point for the LFO Wave when it is reset.

Settings: 0°, 90°, 120°, 180°, 240°, 270°

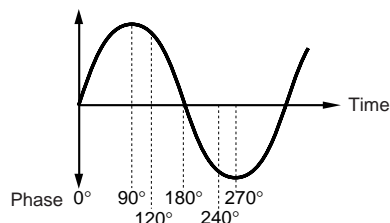

5 Tempo Sync

Determines whether or not the LFO speed is synchronized to the tempo of the Arpeggio or sequencer (Song or Pattern).

Settings: off (not synchronized), on (synchronized)

NOTE When this parameter is set to “on” and the MIDI sync parameter in the MIDI display of the Utility mode (page 268) is set to “MIDI,” the LFO speed is synchronized with the external clock.

6 Tempo Speed

This parameter is available only when Tempo Sync above has been set to “on.” It allows you to make detailed note value settings that determine how the LFO pulses in sync with the Arpeggio or sequencer.

Settings: 16th, 8th/3 (eighth-note triplets), 16th. (dotted sixteenth note), 8th (eighth note), 4th/3 (quarter-note triplets), 8th. (dotted 8th note), 4th (quarter notes), 2nd/3 (half-note triplets), 4th. (dotted quarter notes), 2nd (half notes), whole/3 (whole-note triplets), 2nd. (dotted half note), 4thx4 (quarter-note quadruplets; four quarter notes to the beat), 4thx5 (quarter-note quintuplets; five quarter notes to the beat), 4thx6 (quarter-note sextuplets; six quarter notes to the beat), 4thx7 (quarter-note septuplets; seven quarter notes to the beat), 4thx8 (quarter-note octuplets; eight quarter notes to the beat), 4thx16 (sixteen quarter notes to the beat), 4thx32 (32 quarter notes to the beat), 4thx64 (64 quarter notes to the beat)

NOTE The note type setting above is synchronized with the tempo of the Arpeggio/Song/Pattern playback.

7 Key On Reset

Determines whether or not the LFO is reset each time a note is pressed. The following three settings are available.

Settings: off, each-on, 1st-on

off

The LFO cycles freely with no key synchronization. Pressing a key starts the LFO wave at whatever phase the LFO happens to be at that point.

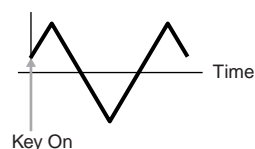

Reference

- Voice mode
- Performance mode
- Sampling mode 1
- Song mode
- Pattern mode
- Mixing mode
- Sampling mode 2
- Master mode
- Utility mode
- File mode

each-on

The LFO resets with each note you play and starts a waveform at the phase specified by the Phase parameter (above).

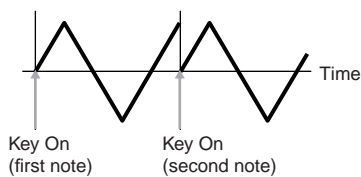

1st-on

The LFO resets with each note you play and starts a waveform at the phase specified by the Phase parameter (above). If you play a second note while the first is being held, the LFO continues cycling according to the same phase as triggered by the first note. In other words, the LFO only resets if the first note is released before the second is played.

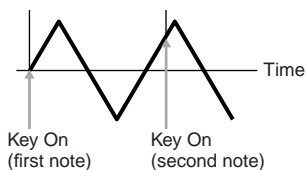

NOTE The starting phase is determined by the Phase parameter (4) although the starting phase is shown as 0 in the illustration.

8 Random Speed

Determines the degree to which the LFO speed changes at random. A setting of “0” results in the original speed. Higher values result in a larger degree of speed change. This parameter cannot be set when the Tempo Sync (5) is set to on.

Settings: 0 – 127

9 Delay*

Determines the delay time between the moment you press note on the keyboard and the moment the LFO comes into effect. A higher value results in a longer delay time.

Settings: 0 – 127

10 Fade In Time

Determines the amount of time for the LFO effect to fade in after the Delay time has elapsed. A higher value results in a slower fade-in. When set to “0,” the LFO effect will not fade in and reach the maximum level immediately after the Delay time has elapsed.

Settings: 0 – 127

11 Hold (Hold Time)

Determines the length of time for which the LFO is held at its maximum level. A higher value results in a longer Hold time. A setting of 127 produces no fade out.

Settings: 0 – 126, hold

12 Fade Out Time

Determines the amount of time for the LFO effect to fade out (after the Hold time has elapsed). A higher value results in a slower fade-out.

Settings: 0 – 127

LFO Effect Settings—[SF2] Set (Common LFO Set)

From this display you can select the destination parameter for the LFO (which aspect of the sound the LFO controls), the Elements to be affected by the LFO, and the LFO Depth. Three Destinations can be assigned, and you can choose from several parameters per Destination.

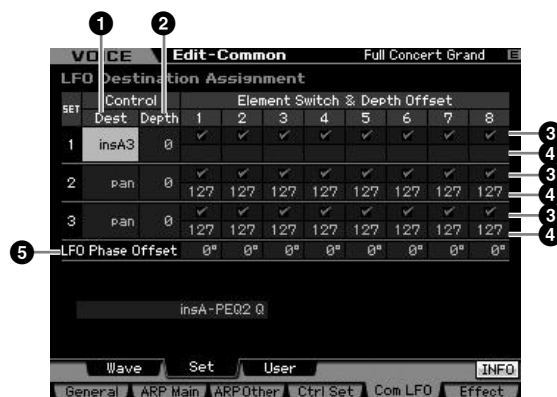

1 Control Dest (Control Destination)*

Determines the parameters which are to be controlled (modulated) by the LFO Wave.

Settings: insA1 – insA16, insB1 – insB16, insL1 – insL32, A mod, P mod, F mod, reso, pan, LFOspd

insA1 – insA16, insB1 – insB16, insL1 – insL32 (Effect parameters)

Each parameter of the selected Effect type is modulated cyclically. When one of those parameters is selected, the corresponding parameter name of the selected Effect type is shown at the lower section of the display.

A mod (Amplitude Modulation Depth)

A tremolo effect produced by cyclically modulating the volume.

P mod (Pitch Modulation Depth)

A vibrato effect produced by cyclically modulating the pitch.

F mod (Filter Modulation Depth)

A wah effect produced by cyclically modulating the tonal brightness.

reso (Resonance)

A special wah effect produced by cyclically modulating the resonance.

pan

An effect produced by cyclically modulating the stereo pan position.

LFOspd (Element LFO Speed)

When this is selected, the Common LFO speed cyclically modulates the Element LFO speed.

2 Control Depth*

Determines the LFO Wave Depth.

Settings: 0 – 127

3 Element Switch 1 – 8*

Determines whether or not each Element is to be affected by the LFO.

Settings: (active), (inactive)

4 Depth Offset 1 – 8

Determines the offset values of the Control Depth parameter (above) for the respective Elements. If the resultant Control Depth value is less than zero it will be set

to 0, and if the resultant Control Depth value is greater than 127 it will be set to 127.

Settings: 0 – 127

5 LFO Phase Offset

Determines the offset values of the Phase parameter in the [SF1] Wave display for the respective Elements.

Settings: 0°, 90°, 120°, 180°, 240°, 270°

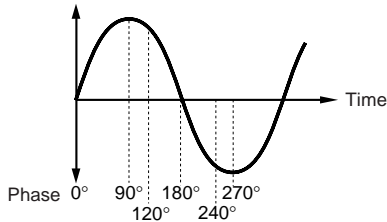

Making your own LFO—[SF3] User (Common LFO User)

From this display you can create your own original LFO wave. You can create a custom LFO wave consisting of up to sixteen steps. The created LFO wave becomes available when the Wave parameter in the Common LFO Wave display is set to “user.”

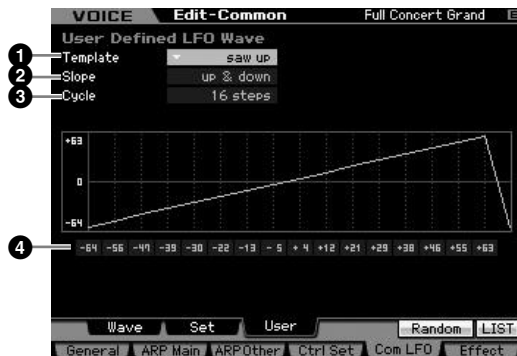

1 Template

You can select a pre-programmed template for the LFO wave.

Settings: all -64, all 0, all +63, saw up, saw down, even step, odd step

- all -64
Values of all the steps are set to -64.
- all 0
Values of all the steps are set to 0.
- all +63
Values of all the steps are set to +63.
- saw up
Creates a saw shaped upward wave.
- saw down
Creates a saw shaped downward wave.

even step
Values of all odd steps are set to +63, and values of all even steps are set to -64.

odd step
Values of all even steps are set to +63, and values of all odd steps are set to -64.

NOTE You can call up the list by pressing the [SF6] LIST button then select the desired one from the list. For details, see page 82.

NOTE You can use the [SF5] Random button to call up the base wave at random. Each time you press the [SF5] Random button, a different LFO wave appears on the display randomly.

2 Slope

Determines the slope or ramp characteristics of the LFO wave.

Settings: off, up, down, up&down

- off
Creates no slope.
- up
Creates an upward slope.
- down
Creates a downward slope.
- up&down
Creates an upward then downward slope.

3 Cycle

Determines the amount of steps for creating the wave.

Settings: 2, 3, 4, 6, 8, 12, 16

4 Level 1 – 16

Determines the level for each step.

Settings: -64 – +63

Effect settings—[F6] Effect

Determines the Effect connection and values of other parameters for the selected Voice. For details about the structure in the Voice mode, see page 69.

Effect Connection Settings—[SF1] Connect

This display gives you at-a-glance, overall view of the effect routing and comprehensive control over the effects.

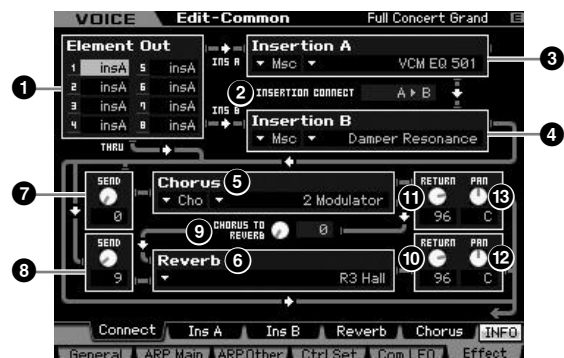

NOTE Depending on the selected parameter, the LIST icon is shown at the tab menu corresponding to the [SF6] button. In this condition, you can call up the list by pressing the [SF6] LIST button, then select the desired item from the list. For details, see page 82.

- Voice mode
- Performance mode
- Sampling mode 1
- Song mode
- Pattern mode
- Mixing mode
- Sampling mode 2
- Master mode
- Utility mode
- File mode
- Reference

1 Element Out 1 – 8*

Determines which Insertion Effect (A or B) is used to process each individual Element. The “thru” setting lets you bypass the Insertion Effects for the specified element. When INSERTION CONNECT (2) is set to “ins L,” the signal from each Element is output to the Insertion L regardless of the setting here.

Settings: thru (through), ins A (Insertion A), ins B (Insertion B)

2 INSERTION CONNECT (Insertion Connection)

From this display you can set the effect routing for Insertion Effects A and B. The setting changes are shown on the diagram in the display, giving you a clear picture of how the signal is routed. For details, see page 69.

Settings: parallel, ins A ► B, ins B ► A, ins L

parallel

Signals processed with the Insertion Effect A and B block will be sent to Master Effect, Master EQ, Reverb and Chorus block.

ins A ► B

Signals processed with the Insertion Effect A will be sent to the Insertion Effect B and signals processed with the Insertion Effect B is sent to Master Effect, Master EQ, Reverb and Chorus block.

ins B ► A

Signals processed with the Insertion Effect B will be sent to the Insertion Effect A and signals processed with the Insertion Effect A is sent to Master Effect, Master EQ, Reverb and Chorus block.

ins L

The Insertion Effects A and B are unified, then used as the Vocoder. Signals processed with the Vocoder block will be sent to Master Effect, Master EQ, Reverb and Chorus block.

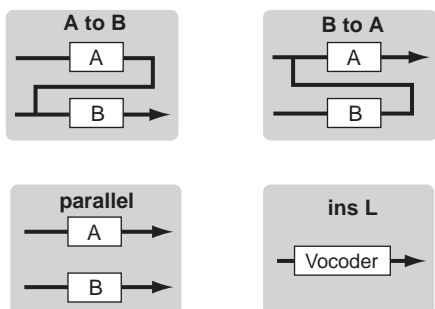

NOTE When “ins L” is selected, “ins L” is shown in the tab menu of the [SF2] button and the tab menu of the [SF3] button disappears.

NOTE For detailed instructions on using the Vocoder, see page 109.

NOTE When “ins L” is selected, the audio signal will be output from this instrument in mono.

3 Insertion A (Insertion A Category/Type)*

4 Insertion B (Insertion B Category/Type)*

Determines the Effect type for Insertion A and B. From the Category column, you can select one of the Effect Categories, each of which contains similar Effect types. From the Type column, you can select one of the Effect Types listed in the selected Category.

Settings: Details about the Effect categories and types are described on page 70.

5 Chorus (Chorus Category/Type)*

Selects a Chorus Effect type after selecting a category. From the Category column, you can select one of the Effect Categories, each of which contains similar Effect types. From the Type column, you can select one of the Effect types listed in the selected Category.

Settings: Details about the Effect categories and types are described on page 70.

6 Reverb (Reverb Type)*

Determines the Reverb Effect type. It is not necessary to select a Category because there is only one category in Reverb.

Settings: Details about the Effect types are described on page 70.

7 Chorus Send*

Adjusts the chorus send level. The higher the value the deeper the Chorus.

Settings: 0 – 127

8 Reverb Send*

Adjusts the reverb send level. The higher the value the deeper the reverb.

Settings: 0 – 127

9 CHORUS TO REVERB

Determines the Send level of the signal sent from the Chorus Effect to the Reverb Effect. The higher the value, the deeper the Reverb that is applied to the Chorus-processed signal.

Settings: 0 – 127

10 Reverb Return

Determines the Return level of the Reverb Effect.

Settings: 0 – 127

11 Chorus Return

Determines the Return level of the Chorus Effect.

Settings: 0 – 127

12 Reverb Pan

Determines the pan position of the Reverb effect sound.

Settings: L63 (far left) – C (center) – R63 (far right)

13 Chorus Pan

Determines the pan position of the Chorus effect sound.

Settings: L63 (far left) – C (center) – R63 (far right)

Effect Parameter settings—[SF2] Ins A, [SF3] Ins B, [SF4] Reverb, [SF5] Chorus

From these displays, you can set the Effect related parameters when the INSERTION CONNECT parameter (2) is set to “parallel” or “ins A ▶ B” or “ins B ▶ A.”



NOTE Depending on the selected parameter, the LIST icon is shown at the tab menu corresponding to the [SF6] button. In this condition, you can call up the list by pressing the [SF6] LIST button, then select the desired item from the list. For details, see page 82.

1 Category

2 Type

From the Category column, you can select one of the Effect Categories each of which contains similar Effect types. From the Type column, you can select one of the Effect Types listed in the selected Category.

Settings: Details about the Effect categories and types are described on page 70.

NOTE The Category (1) is not shown in the Reverb display.

3 Preset

You can set various parameters in order to change how the sound is affected by the selected Effect type. This parameter lets you call up the preprogrammed settings of these effect parameters.

4 Effect Parameters

The number of parameters and values available differs depending on the currently selected effect type. Refer to page 73 for details about the Effect parameters. Refer to the separate Data List booklet for information on the parameters for each Effect type.

Effect Parameter Settings—[SF2] Ins L (Insertion Large)

From this display, you can set the Vocoder related parameters. This display called up via the [SF2] button is available only when the INSERTION CONNECT parameter (2) is set to “ins L” in the Connect display (page 107). Vocoder is a distinctive, “robot voice” effect which extracts the characteristic of the microphone sound and adds it to the sound via your keyboard performance. To create this Vocoder effect, you play the keyboard and sing or speak into the microphone at the same time. To use the Vocoder effect, connect a microphone to the A/D INPUT connector on the rear panel, then follow the instructions on page 111.

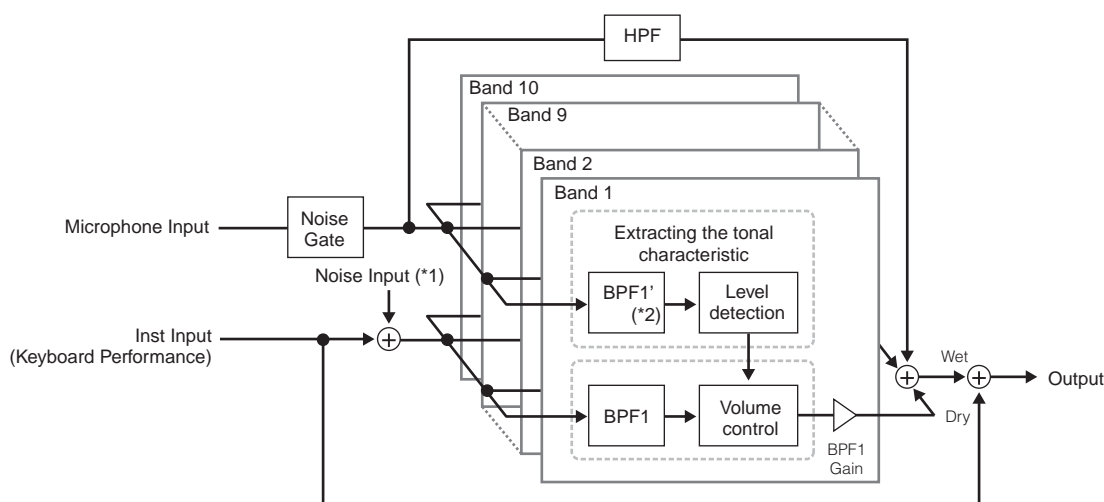

*1 The noise generated in the Vocoder unit is used.

*2 The cutoff frequency of the BPF1' may not be same as the one of the BPF1. This depends on the settings of the Formant Shift and Formant Offset.



1 Type

Determines whether or not the Vocoder is applied to the current Voice. When set to “Thru,” the Vocoder is not applied to the Voice.

Settings: Thru, Vocoder

2 Vocoder Attack

Determines the attack time of the Vocoder sound. The higher the value, the slower the attack.

Settings: 1ms – 200ms

3 Vocoder Release

Determines the release time of the Vocoder sound. The higher the value, the slower the decay.

Settings: 10ms – 3000ms

4 Mic Gate Threshold

Determines the threshold level of the noise gate for the microphone sound. If noise interferes with the Vocoder effect, set this parameter to a relatively high value to prevent noise from producing inadvertent, unexpected sounds.

Settings: -72dB – -30dB

5 Gate Switch

Determines whether or not the microphone sound will be output from the HPF while you release the notes. Normally, set this to “on.”

Settings: off, on

off: The microphone sound always will be output. (You can always hear the microphone sound.)

on: The microphone sound will be output only while pressing the note.

6 HPF Freq (High Pass Filter Frequency)

Determines the HPF cutoff frequency for the microphone input sound. Setting this to a low value results in a minimally processed input sound—in other words, close to the original. Setting this to higher values emphasizes the higher frequency consonant and sibilant sounds (which make words easier to understand).

Settings: thru, 500Hz – 16.0kHz

7 HPF Output Level

Determines the level of the microphone sound output from the HPF (High Pass Filter).

Settings: 0 – 127

8 Formant Shift

Determines the amount (in BPF) by which the cutoff frequency value of the BPFs (for the Inst Input) is shifted. This parameter can be used to adjust the pitch of the Vocoder sound.

Settings: -2, -1, +0, +1, +2

9 Formant Offset

Adjusts the cutoff frequencies of all BPFs (for the Inst Input) finely. This parameter can be used to adjust the pitch of the Vocoder sound finely.

Settings: -63 – +0 – +63

10 Mic Level

Determines the microphone sound level, which is to be input to the Vocoder.

Settings: 0 – 127

11 Inst Input Level

Determines the level of the keyboard performance sound, which is to be input to the Vocoder.

Settings: 0 – 127

12 Noise Input Level

Determines the noise level which is input to the Vocoder. This can be used to emphasize sibilant and plosive sounds, and make the speech-like characteristics more pronounced.

Settings: 0 – 127

13 Output Level

Determines the output level of the Vocoder.

Settings: 0 – 127

14 Dry/Wet Balance

Determines the balance between the dry sound to which the effect is not applied and the wet sound to which the effect is applied. The higher the W setting, the deeper the effect.

Settings: D63>W – D=W – D<W63

15 BPF1 – 10 Gain (Band Pass Filter 1 – 10 Gain)

Determines each output gain of the BPF 1 – 10 for the Inst Input (keyboard performance sound). The BPF1 corresponds to the lowest Formant while the BPF 10 corresponds to the highest Formant.

Settings: -18dB – +18dB

Vocoder structure

The human voice consists of sounds generated from the vocal cords, and filtered by the throat, nose and mouth. These resonant sections have specific frequency characteristics and they function effectively as a filter, creating many formants (harmonic content). The Vocoder effect extracts the filter characteristics of the voice from the microphone input and recreates the vocal formants by the use of multiple band pass filters. The machine-like 'robot' voice is created by passing the pitched sounds of musical instruments (such as a synthesizer sound) through the filters.

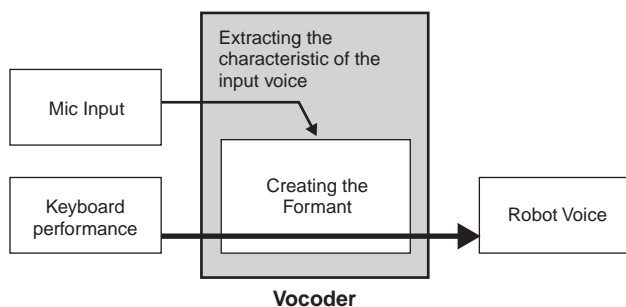

Using the Vocoder effect

After connecting a microphone to the A/D INPUT connector on the rear panel, follow the instructions below to use the Vocoder effect.

1 Set the Vocoder related parameters.

In the Voice Play mode, press the [UTILITY] button to enter the Utility mode, press the [F4] button, then press the [SF1] button to call up the Output display (page 265). Set the Output Select (4) to "ins L."

NOTE When using the Vocoder in the Performance mode, set the Output Select parameter to "ins L" in the Output display (page 266) of the Performance Edit mode. When using the Vocoder in the Song/Pattern mode, set the Output Select parameter to "ins L" in the Audio In display (page 234) of the Mixing Edit mode.

2 Set the Input Gain of the A/D INPUT connector to microphone.

In the Utility mode, press the [F2] button to call up the Input/Output display (page 263), then set the Mic/Line parameter to "mic."

3 In the Voice Play mode, select the desired Voice to which the Vocoder is applied.

4 Select the Vocoder as the Insertion Effect connection.

In the Voice Play mode, press the [EDIT] button then [COMMON EDIT] button to enter the Voice Common Edit. Press the [SF1] button to call up the Connect display (page 107), set the INSERTION CONNECT parameter to "ins L," then set the Insertion L parameter to "Vocoder."

NOTE When the INSERTION CONNECT (2) is set to "ins L," the audio signal will be output from this instrument in mono.

5 Set the Vocoder related parameters if necessary.

Input your voice to the microphone while pressing the note(s) to generate the machine-like Vocoder sound. Press the [SF2] button to call up the Insertion L display, then set the related parameters while listening to the Vocoder sound.

6 Press the [STORE] button to call up the Store window (page 97) then store the edited Voice.

Element Edit parameters

[VOICE] → Normal Voice selection → [EDIT] → [1] – [8]

If you wish to edit the sounds that make up a Voice and the basic parameters that determine the sound, such as Oscillator, Pitch, Filter, Amplitude, and EG (Envelope Generator), call up the Element Edit display.

About the asterisk (*) marks

For users who are new to Voice editing and may be confused by the large amount of parameters, the most basic and easy-to-understand parameters are conveniently marked with asterisks in this section. If you are just starting out with Voice editing, try these parameters first.

Selected Element display/ Four-Element display

In the Element Edit mode, you can use two types of display. One type of display lets you edit parameters for the currently selected Element and the other type of display lets you view parameters for four Elements. You can switch between these two types by pressing the [SF5] button. When the display for four Elements is shown, you can switch between the displays for Elements 1 – 4 and 5 – 8 by using the left and right cursor buttons.

The display indicating the settings of the current Element



The display indicating the settings of four Elements

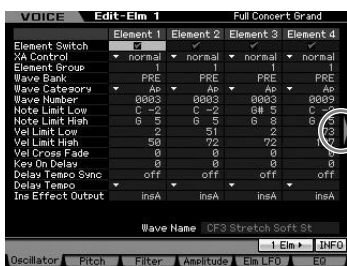

This icon indicates that you can call up the display for another four Elements.

Setting the Waveform and Note range of the Element—[F1] Oscillator



NOTE Depending on the selected parameter, the LIST icon is shown at the tab menu corresponding to the [SF6] button. In this condition, you can call up the list by pressing the [SF6] LIST button, then select the desired item from the list. For details, see page 82.

1 Element Switch*

Determines whether the currently selected Element is on or off. When this is set to off, the currently edited Element will not sound.

Settings: off (inactive), on (active)

2 XA Control (Expanded Articulation Control)

Expanded Articulation (XA) is a special feature of the MOTIF XS that provides greater performance flexibility and realism (see box on next page). This parameter determines how the XA feature of the Element works. Try setting this parameter referring to the four types of the XA Mode described below. You can realize the desired sound depending on your performance articulation by assigning the same Element Group to the Elements having the same type of the XA mode.

Settings: normal, legato, key off sound, wave cycle, wave random, all AF off, AF 1 on, AF 2 on

normal

When this is selected, the Element will sound normally each time you press the note.

legato

When this is selected and the Mono mode is selected, an alternate Element (different from the one used when XA mode is set to “normal”) will be played when you play the keyboard in legato fashion (playing the next note of a single-note line or melody before releasing the previous note).

key off sound

When this is selected, the Element will sound each time you release the note.

wave cycle

When this is selected for multiple Elements, each Element sounds alternately according to its numerical order each time you play a note. (In other words, playing the first note will sound Element 1, the second note Element 2, and so on.)

wave random

When this is selected for multiple Elements, each Element will sound randomly each time you press the note.

all AF off

When this is selected, the Element will sound when both of the ASSIGNABLE FUNCTION buttons are turned off.

AF 1 on

When this is selected, the Element will sound when the ASSIGNABLE FUNCTION [1] button is turned on.

AF 2 on

When this is selected, the Element will sound when the ASSIGNABLE FUNCTION [2] button is turned on.

Expanded Articulation (XA) features

Expanded Articulation (XA) is a newly designed, sophisticated tone generation system that allows you to more effectively recreate realistic sound and natural performance techniques—such as legato and staccato—often used on acoustic instruments but up to now unavailable or difficult to realize on electronic keyboards. It also provides other unique modes for random and alternate sound changes as you play.

Realistic legato performance

Specify an Element or Elements to be sounded when playing legato.

→ Set the XA control parameter for the desired Elements to "legato."

Authentic note release sound

Specify an Element or Elements to be sounded upon releasing a note. For example, this could be used to recreate the characteristic pluck sound on a harpsichord when a note is released.

→ Set the XA control parameter for the desired Elements to "key off sound."

Different sounds for each note played

Specify different Elements to be sounded in order or randomly.

→ Set the XA control parameter for the desired Elements to "wave cycle" or "wave random."

Switching among different sounds to recreate the natural performance on an acoustic instrument

Specify which Elements will be sounded according to the on/off status of the ASSIGNABLE FUNCTION buttons. For example, this could be used on an acoustic guitar Voice to switch between playing normally and playing high harmonics.

→ Set the XA control parameter for the desired Elements to "all AF off," "AF 1 on," or "AF 2 on."

New sounds and new styles of playing

The highly versatile functions above can be applied effectively not only to acoustic sounds but also to synthesizer and electronic Voices as well. The XA feature opens up enormous potential for realizing authentic sounds, performing expressively and coming up with creative new styles of playing.

3 Element Group

Determines the group of the XA mode so that the Elements of the same group are called up in order or randomly. Assign the same group number to the Elements having the same type of XA mode.

The setting here is not available when the XA mode parameters of all Elements are set to "normal."

Settings: 1 – 8

4 Wave Bank (Waveform Bank)*

Determines the Waveform Bank assigned to the Element, Preset or User. User Waveforms can be created based on the samples recorded in the Sampling mode.

Settings: PRE (preset waveform), USR (user waveform)

NOTE For details about Waveform, refer to the explanation of the Sampling mode on page 161.

5 Wave Category***6 Wave Number***

Determines the Waveform assigned to the Element by selecting the Waveform Category and Number. For a complete list of Waveforms in the Preset Bank, refer to the Waveform List in the separate Data List booklet.

7 Key On Delay

Determines the time (delay) between the moment you press a note on the keyboard and the point at which the sound is actually played. The higher the value, the longer the delay time.

Settings: 0 – 127

8 Delay Tempo Sync

Determines whether or not the Key On Delay above is synchronized to the tempo of the Arpeggio or sequencer (Song or Pattern).

Settings: off (not synchronized), on (synchronized)

9 Delay Tempo

Determines the timing of the Key On Delay when the Delay Tempo Sync is set to on.

Settings: 16th, 8th/3 (eighth-note triplets), 16th. (dotted sixteenth note), 8th (eighth note), 4th/3 (quarter-note triplets), 8th. (dotted 8th note), 4th (quarter notes), 2nd/3 (half-note triplets), 4th. (dotted quarter notes), 2nd (half notes), whole/3 (whole-note triplets), 2nd. (dotted half note), 4thx4 (quarter-note quadruplets; four quarter notes to the beat), 4thx5 (quarter-note quintuplets; five quarter notes to the beat), 4thx6 (quarter-note sextuplets; six quarter notes to the beat), 4thx7 (quarter-note septuplets; seven quarter notes to the beat), 4thx8 (quarter-note octuplets; eight quarter notes to the beat)

10 Vel Cross Fade (Velocity Cross Fade)

This determines how gradually the sound of an Element decreases in volume in proportion to the distance of velocity changes outside the Velocity Limit setting (10). A setting of 0 produces no sound outside the Velocity Limit. The higher the value, the more gradual the level decreases. The practical application of this parameter is to create natural-sounding velocity cross fades, in which different Elements (Waveforms) change gradually depending on how strongly or softly you play.

Settings: 0 – 127

11 Velocity Limit

Determines the minimum and maximum values of the velocity range within which each Element will respond. Each Element will only sound for notes played within its specified velocity range. For example, this lets you have one Element sound when you play softly and have a different one sound when you play strongly. If you specify the maximum value first and the minimum value second, for example “93 to 34,” then the velocity range covered will be “1 to 34” and “93 to 127.”

Settings: 1 – 127

12 Note Limit

Determines the lowest and highest notes of the keyboard range for each Element. The selected Element will sound only when you play notes within this range. If you specify the highest note first and the lowest note second, for example “C5 to C4,” then the note range covered will be “C -2 to C4” and “C5 to G8.”

Settings: C -2 – G8

NOTE You can also set the Key directly from the keyboard, by holding down the [SF6] INFO button and pressing the desired key. For details, see page 82.

13 Ins Effect Output (Insertion Effect Output)

Determines which Insertion Effect (A or B) is used to process each individual element. The “thru” setting lets you bypass the Insertion Effects for the specific key. This parameter is the same as Element Out 1 – 8 on the Connect display (page 107) in Voice Common Edit. Making a setting here automatically changes the setting of that parameter as well. When INSERTION CONNECT (2) is set to “Ins L,” the signal from each Element is output to the Insertion L regardless of the setting here.

Settings: thru (through), ins A (Insertion A), ins B (Insertion B)

Pitch Settings—[F2] Pitch

Tuning and Pitch Scaling—[SF1] Tune

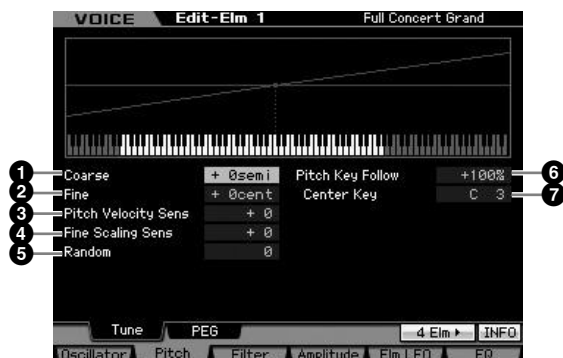

1 Coarse (Coarse Tuning)

Determines the pitch of each Element in semitones.

Settings: -48 semi – +0 semi – +48 semi

2 Fine (Fine Tuning)

Determines the pitch of each Element in cents.

Settings: -64 cents – +0 cents – +63 cents

3 Pitch Velocity Sens (Pitch Velocity Sensitivity)

Determines how the pitch of the Element responds to velocity. Positive settings will cause the pitch to rise the harder you play the keyboard and negative settings will cause it to fall. A setting of 0 results in no change in pitch.

Settings: -64 – +0 – +63

4 Fine Scaling Sens (Fine Scaling Sensitivity)

Determines the degree to which the notes (specifically, their position or octave range) affect the pitch in fine tuning (set above) of the selected Element, assuming C3 as the basic pitch. A positive setting will cause the pitch of lower notes to change lower and that of higher notes to change higher. Negative values will have the opposite effect.

Settings: -64 – +0 – +63

5 Random

This lets you randomly vary the pitch of the Element for each note you play. The higher the value, the greater the pitch variation. A value of “0” results in no pitch change.

Settings: 0 – 127

6 Pitch Key Follow

Determines the sensitivity of the Key Follow effect (the pitch interval of adjacent notes), assuming the pitch of the Center Key (7) as standard. At +100% (the normal setting), adjacent notes are pitched one semitone (100 cents) apart. At 0%, all notes are the same pitch specified as the Center Key. For negative values, the settings are reversed.

Settings: -200% – +0% – +200%

NOTE This parameter is useful for creating alternate tunings, or for use with sounds that do not need to be spaced in semitones, such as pitched drum sounds in a Normal Voice.

7 Center Key

Determines the central note or pitch for the Pitch Key Follow. The note number set here is the same pitch as normal regardless of the Pitch Key Follow setting.

Settings: C -2 – G8

NOTE You can also set the note directly from the Keyboard, by holding down the [SF6] button and pressing the desired key. See “Basic Operation” on page 82.

Pitch Key Follow and Center Key

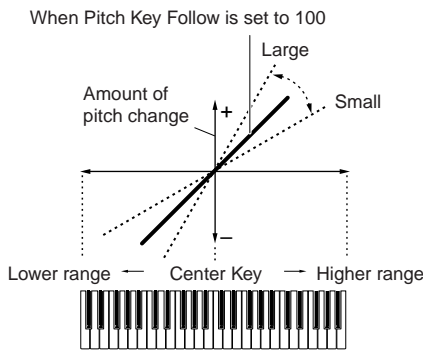

Pitch EG Settings—[SF2] PEG (Pitch EG)

From this display you can set the Pitch EG parameters. Using the PEG, you can control the transition in pitch from the moment the sound starts to the moment it stops.

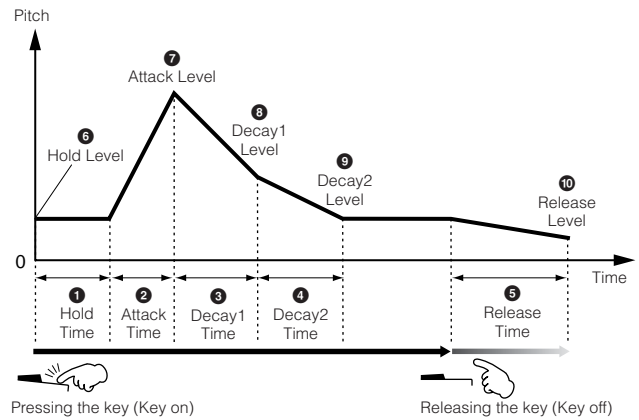

Time

The Time parameters let you set the time between the adjoining points of the level parameters below. A higher value results in a longer time until reaching the next level.

Settings: 0 – 127

1 Hold Time

Determines the time between the moment you press a note on the keyboard and the moment the envelope starts to rise.

2 Attack Time

Determines the speed of attack from the initial pitch (Hold Level) to the normal pitch of the Voice after the hold time has elapsed.

3 Decay 1 Time

Determines how fast the envelope falls from the normal pitch (Attack Level) of the Voice to the pitch specified as the Decay 1 Level.

4 Decay 2 Time

Determines how fast the envelope falls from the pitch specified as the Decay1 Level to the pitch specified as the Decay2 Level.

5 Release Time

Determines how fast the envelope falls from the pitch specified as the Decay2 Level to the pitch specified as the Release Level when the note is released.

Level

The Level parameters let you set the amount of the pitch deviation based on the standard pitch specified at the Coarse Tuning and Fine Tuning in the Tune display (page 114) at each envelope point.

Settings: -128 – +0 – +127

6 Hold Level

Determines the initial pitch at the moment the note is pressed.

Voice mode

Performance mode

Sampling mode 1

Song mode

Pattern mode

Mixing mode

Sampling mode 2

Master mode

Utility mode

File mode

Reference

7 Attack Level

Determines the normal pitch of the pressed note.

8 Decay 1 Level

Determines the level which the pitch of sound reaches from the Attack Level after the Decay1 time elapses.

9 Decay 2 Level

Determines the sustain-level pitch which will be maintained while a note is held.

10 Release Level

Determines the final pitch reached after the note is released.

11 EG Depth

Determines the range over which the pitch envelope changes. A setting of 0 will cause the pitch not to change. The farther from 0 the value is, the larger the pitch range. For negative values, the pitch change is reversed.

Settings: -64 – +0 – +63

12 EG Depth Vel Sens (EG Depth Velocity Sensitivity)

Determines how the pitch range of the Element responds to velocity. When this is set to a positive value, high velocities cause the pitch range to expand and low velocities cause it to contract, as shown below. When this is set to a negative value, high velocities cause the pitch range to contract and low velocities cause it to expand. When this is set to 0, the pitch envelope does not change no matter what the velocity.

Settings: -64 – +0 – +63

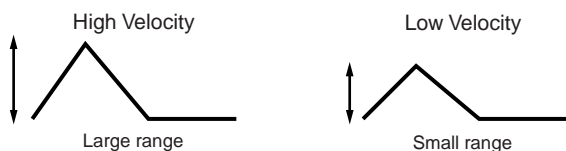

13 EG Depth Vel Curve (EG Depth Velocity Curve)

The five curves determine how the pitch range will be generated according to the velocity (strength) with which you play notes on the keyboard. The horizontal axis of the graph is the velocity, and the vertical axis is the pitch range.

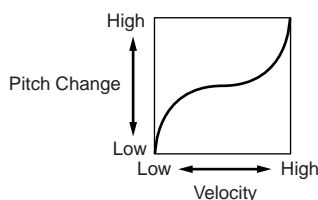

Settings: Curve 0 – 4

14 EG Time Velocity Sens (EG Time Velocity Sensitivity)

Determines how the PEG transition time (speed) responds to velocity, or the strength with which the note is pressed. When this is set to a positive value, high velocities result in a fast PEG transition speed while low velocities result in a slow speed, as shown below. When this is set to a negative value, high velocities result in a slow PEG transition speed while low velocities result in a fast speed. When this is set to 0, the PEG transition speed does not change no matter what the velocity.

Settings: -64 – +0 – +63

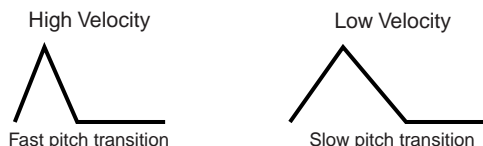

15 EG Time Segment

Determines the part of the Pitch EG which the EG Time Velocity Sensitivity (14) affects.

Settings: attack, atk+dcy, decay, atk+rls, all

attack

The EG Time Velocity Sensitivity affects the Attack Time and Hold Time.

atk+dcy (attack+decay)

The EG Time Velocity Sensitivity affects the Attack Time, Decay1 Time, and Hold Time.

decay

The EG Time Velocity Sensitivity affects the Decay 1/2 Time.

atk+rls (attack+release)

The EG Time Velocity Sensitivity affects the Attack Time, Release Time, and Hold Time.

all

This EG Time Velocity Sensitivity affects all the Pitch EG Time parameters.

16 EG Time Key Follow

Determines the degree to which the notes (specifically, their position or octave range) affect the pitch EG times of the selected Element. When this is set to a positive value, high notes result in a high pitch EG transition speed while low notes result in a slow speed. When this is set to a negative value, high notes result in a slow pitch EG transition speed while low notes result in a high speed. When this is set to 0, the pitch EG transition speed does not change no matter what the pressed note.

Settings: -64 – +0 – +63

17 Center Key

Determines the central note or pitch for the EG Time Key Follow (16). When the Center Key note is played, the PEG behaves according to its actual settings.

Settings: C -2 - G8

EG Time Key Follow and Center Key

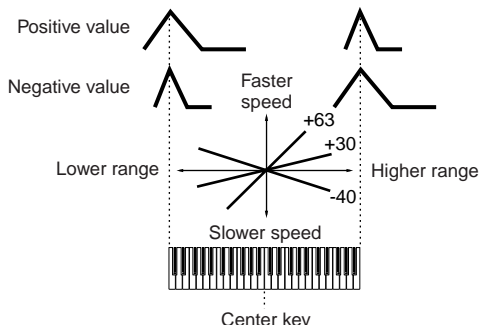

NOTE You can also set the note directly from the Keyboard, by holding down the [SF6] button and pressing the desired key. See "Basic Operation" on page 82.

Adjust the brightness using the Filter—[F3] Filter

Selecting a Filter Type—[SF1] Type

From this display you can select a Filter Type for the current Element. The tonal characteristics of the Voice and Filter functions differ depending on which Filter type is selected here.



1 Type*

Determines the Filter Type for the current Element.

Settings: LPF24D, LPF24A, LPF18, LPF18s, LPF12, LPF6, HPF24D, HPF12, BPF12D, BPFw, BPF6, BEF12, BEF6, Dual LPF, Dual HPF, Dual BPF, Dual BEF, LPF12+BPF6, thru

About Filter Types

LPF (Low Pass Filter)

This is a Filter type that only passes signals below the Cutoff Frequency. The sound can be brightened by raising the cutoff frequency of the filter. On the other hand, the sound can be darkened by lowering the cutoff frequency of the filter. You can produce a distinctive "peaky" sound by raising the Resonance to boost the signal level in the area of the Cutoff Frequency. This filter type is most popular and useful for producing classic synthesizer sounds.

LPF24D

A dynamic 24 dB/oct low-pass filter with a characteristic digital sound. Compared to the LPF24A type (below), this filter can produce a more pronounced resonance effect.

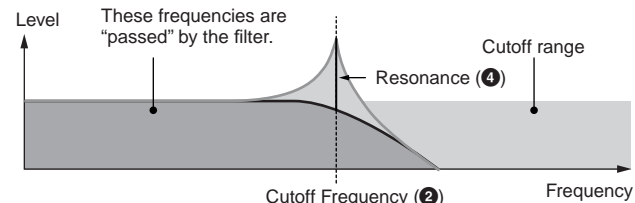

LPF24A

A digital dynamic low-pass filter with characteristics similar to a 4-pole analog synthesizer filter.

LPF18

3-pole 18 dB/oct low-pass filter.

LPF18s

3-pole 18 dB/oct low-pass filter. This filter has a smoother cutoff slope than the LPF18 type.

HPF (High Pass Filter)

This is a Filter type that only passes signals above the Cutoff Frequency. You can then use the Resonance to add further character to the sound.

HPF24D

A dynamic 24 dB/oct high-pass filter with a characteristic digital sound. This filter can produce a pronounced resonance effect.

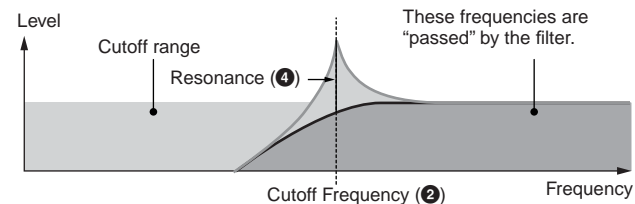

HPF12

12 dB/oct dynamic high-pass filter.

BPF (Band Pass Filter)

This Filter type is a combination of a LPF and HPF. When this Filter Type is selected, you can set the Cutoff Frequency around which the audio signal is passed.

BPF12D

The combination of a -12 dB/oct HPF and LPF with a characteristic digital sound.

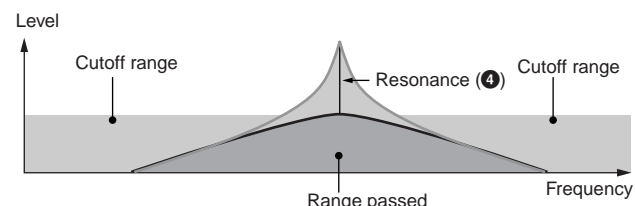

- Voice mode
- Performance mode
- Sampling mode 1
- Song mode
- Pattern mode
- Mixing mode
- Sampling mode 2
- Master mode
- Utility mode
- File mode
- Reference

Editing a Normal Voice

BPF6

The combination of a -6 dB/oct HPF and LPF.

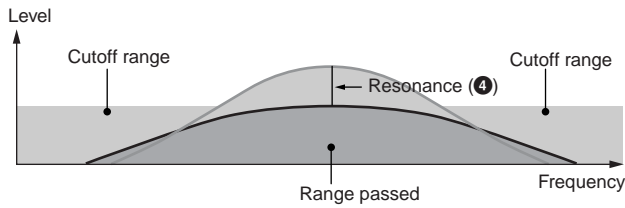

BPFw

A 12 dB/oct BPF that combines HPF and LPF filters to allow wider bandwidth settings.

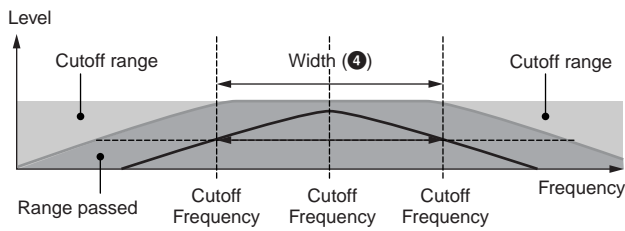

BEF (Band Elimination Filter)

When this Filter Type is selected, you can set the Cutoff Frequency around which the audio signal is muted or eliminated. The Band Elimination Filter has an opposite effect on the sound compared to the Band Pass Filter.

BEF12

BEF6

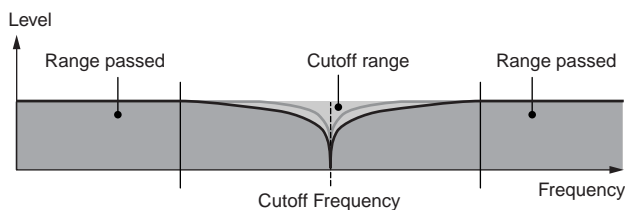

Dual Type Filter

This type is a combination of two same filter types. You can edit the distance between the two Cutoff Frequencies.

Dual LPF

Two 12 dB/oct low-pass filters connected in parallel.

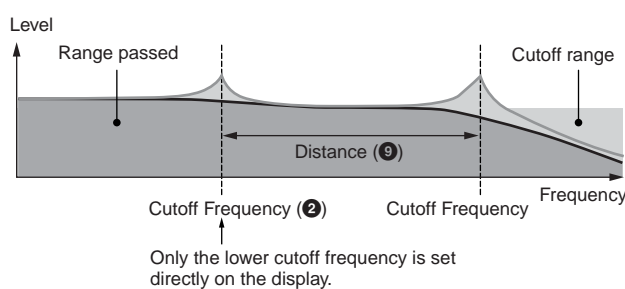

Dual HPF

Two -12 dB/oct high-pass filters connected in parallel.

Dual BPF

Two -6 dB/oct band-pass filters connected in parallel.

Dual BEF

Two -6 dB/oct band-elimination filters connected in parallel.

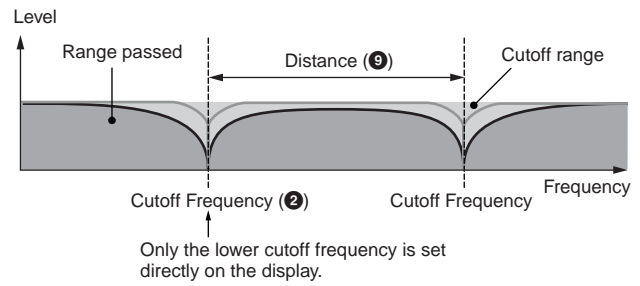

Combination Type Filter

This type is a combination of two different filter types. You can edit the distance between the two Cutoff Frequencies.

LPF12+HPF12

A combination of a -12 dB/oct low-pass filter and high-pass filter. When this Filter Type is selected, HPF Cutoff (10) and HPF Key Follow Sensitivity (11) can be set. Only the LPF graph is shown on the display.

LPF6+HPF6

A combination of a -6 dB/oct low-pass filter and high-pass filter. When this Filter Type is selected, HPF Cutoff (10) and HPF Key Follow Sensitivity (11) can be set. Only the LPF graph is shown on the display.

LPF12+BPF6

A combination of a low-pass filter and band-pass filter. You can edit the distance between the two Cutoff Frequencies.

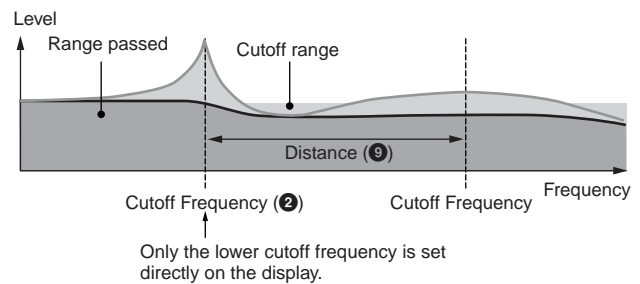

2 Cutoff*

Determines the Cutoff Frequency for the Filter, or the central frequency around which the Filter is applied. The tonal characteristics of the Voice and function of the Cutoff Frequency differ depending on which Filter type is selected. Set this parameter while confirming the Filter graph shown on the display.

Settings: 0 – 255

3 Cutoff Velocity Sens (Cutoff Velocity Sensitivity)

Determines how the Cutoff Frequency (2) responds to velocity, or the strength with which you play notes. For positive settings, the more strongly you play the keyboard, the higher the cutoff frequency becomes. A setting of 0 will cause the Cutoff Frequency not to change no matter what velocity. Negative settings will cause the Cutoff Frequency to rise the more softly you play the keyboard.

Settings: -200% – 0% – +200%

4 Resonance*/ Width

This parameter's function varies according to the selected Filter Type. If the selected filter is an LPF, HPF, BPF (excluding the BPFw), or BEF, this parameter is used to set the Resonance. For the BPFw, it is used to adjust the frequency bandwidth

Resonance is used to set the amount of Resonance (harmonic emphasis) applied to the signal at the cutoff frequency. This can be used in combination with the cutoff frequency parameter to add further character to the sound. The Width parameter is used to adjust the width of the band of signal frequencies passed by the filter with the BPFw. When the Filter Type is set to "LPF6" or "thru," this parameter is not available.

Settings: 0 – 127

5 Resonance Velocity Sens (Resonance Velocity Sensitivity)

Determines the degree to which resonance responds to velocity, or the strength with which you play notes. For positive values, the higher the velocity, the greater the resonance. A setting of 0 results in no change of the Resonance value. For negative values, the lower the velocity, the greater the resonance.

Settings: -64 – +0 – +63

6 Gain

Determines the Gain of the signal sent to the filter. The lower the value, the lower the Gain. The tonal characteristics generated by the filter differ depending on the value set here.

Settings: 0 – 255

7 Cutoff Key Follow

Determines the degree to which the notes (specifically, their position or octave range) affect the Cutoff Frequency (set above) of the selected Element, assuming C3 as the basic pitch. A positive setting will lower the Cutoff frequency for lower notes and raise it for higher notes. A negative setting will have the opposite effect.

Settings: -200% – 0% – +200%

8 Center Key (Indication only)

This indicates that the central note for Cutoff Key Follow (7) above is C3. Keep in mind that this is for display purposes only; the value cannot be changed.

Cutoff Key Follow and Center Key

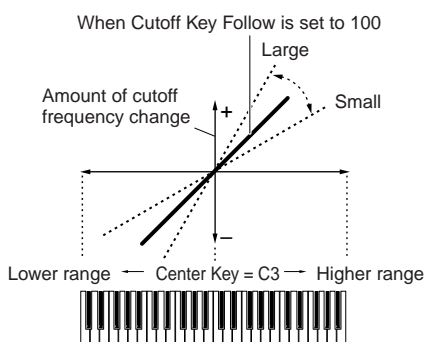

9 Distance

Determines the distance between the two Cutoff frequencies, for the Dual Filter types (which feature two identical filters combined in parallel), and the LPF12 + BPF6 type. When any of other filter types is selected, this parameter is not available.

Settings: -128 – +0 – +127

10 HPF Cutoff (High Pass Filter Cutoff Frequency)

Determines the central frequency for the Key Follow parameter (below) of the HPF. When a filter type "LPF12" or "LPF6" is selected, this parameter is available.

Settings: 0 – 255

11 HPF Key Follow (High Pass Filter Key Follow)

Determines the degree to which the notes (specifically, their position or octave range) affect the Cutoff Frequency (set above) of the HPF. A positive setting will lower the Cutoff frequency for lower notes and raise it for higher notes. A negative setting will have the opposite effect. When a filter type "LPF12" or "LPF6" is selected, this parameter is available.

Settings: -200% – 0% – +200%

12 Center Key

This indicates that the central note for High Pass Filter Key Follow (11) above is C3. Keep in mind that this is for display purposes only; the value cannot be changed.

Filter EG Settings—[SF2] FEG (Filter EG)

From this display you can set the Filter EG parameters. Using the FEG, you can control the change in tone from the moment the sound starts to the moment it stops.

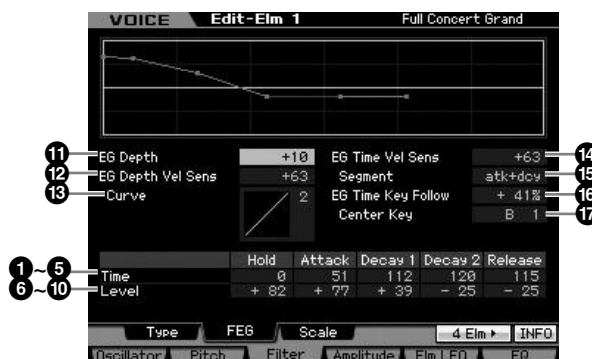

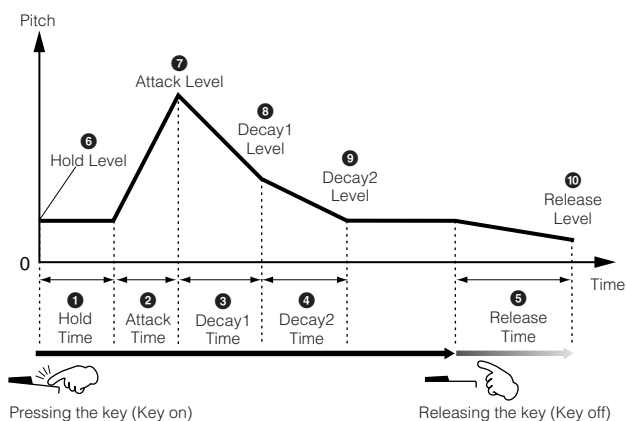

Time

The Time parameters let you set the time between the adjoining points of the level parameters below. A higher value results in a longer time until reaching the next level.

Settings: 0 – 127

1 Hold Time

Determines the time between the moment you press a note on the keyboard and the moment the envelope starts to rise.

2 Attack Time

Determines the speed of attack from the initial cutoff frequency (Hold Level) to the maximum level of the Voice after the hold time has elapsed.

3 Decay 1 Time

Determines how fast the envelope falls from the maximum cutoff frequency (Attack Level) to the cutoff frequency specified as the Decay 1 Level.

4 Decay 2 Time

Determines how fast the envelope falls from the cutoff frequency specified as the Decay1 Level to the cutoff frequency specified as the Decay2 Level.

5 Release Time

Determines how fast the envelope falls from the cutoff frequency specified as the Decay2 Level to the cutoff frequency specified as the Release Level when the note is released.

Level

The Level parameters let you set the amount of the filter change at each point based on the cutoff frequency specified in the Filter Type display (page 117).

Settings: -128 – +0 – +127

6 Hold Level

Determines the initial cutoff frequency at the moment the note is pressed.

7 Attack Level

Determines the maximum cutoff frequency which the envelope reaches after a note is pressed.

8 Decay 1 Level

Determines the level which the cutoff frequency reaches from the Attack Level after the Decay1 time elapses.

9 Decay 2 Level

Determines the cutoff frequency which will be maintained while a note is held.

10 Release Level

Determines the final cutoff frequency reached after the note is released.

11 EG Depth

Determines the range over which the cutoff frequency envelope changes. A setting of 0 will cause the cutoff frequency not to change. The farther from 0 the value is, the larger the range of the cutoff frequency. For negative values, the change of the cutoff frequency is reversed.

Settings: -64 – +0 – +63

12 EG Depth Vel Sens (EG Depth Velocity Sensitivity)

Determines how the range of the cutoff frequency responds to velocity. When this is set to a positive value, high velocities cause the Filter EG range to expand and low velocities cause it to contract, as shown below. When this is set to a negative value, high velocities cause the Filter EG range to contract and low velocities cause it to expand. When this is set to 0, the Filter EG range does not change no matter what the velocity.

Settings: -64 – +0 – +63

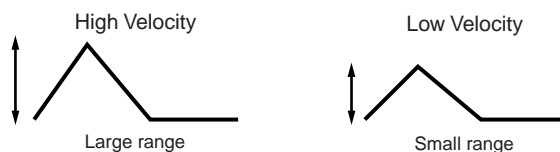

13 EG Depth Vel Sens Curve (EG Depth Velocity Sensitivity Curve)

The five curves determine how the FEG transition range changes according to the velocity (strength) with which you play notes on the keyboard. The selected curve is indicated by the graphic on the display. The horizontal axis of the graph is the velocity, and the vertical axis is the Cutoff Frequency range. For example, the illustration below indicates that the middle range of velocities (around 64) causes the FEG transition range not to change and the higher/lower range of velocities causes it to change more greatly.

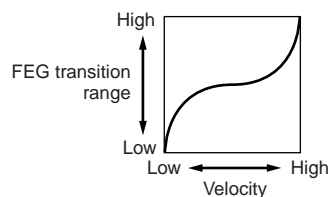

Settings: Curve 0 – 4

14 EG Time Velocity Sens (EG Time Velocity Sensitivity)

Determines how the FEG transition time (speed) responds to velocity, or the strength with which the note is pressed. When this is set to a positive value, high velocities result in a fast FEG transition speed while low velocities result in a slow speed, as shown below. When this is set to a negative value, high velocities result in a slow FEG transition speed while low velocities result in a fast speed. When this is set to 0, the pitch transition speed does not change no matter what the velocity.

Settings: -64 – +0 – +63

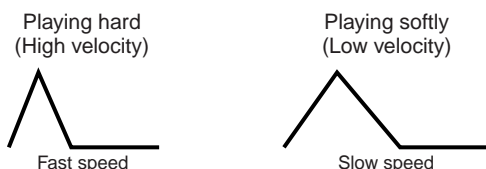

15 EG Time Velocity Sens Segment (EG Time Velocity Sensitivity Segment)

Determines the part of the Filter EG which the EG Time Velocity Sensitivity (14) affects.

Settings: attack, atk+dcy, decay, atk+rls, all

attack

The EG Time Velocity Sensitivity affects the Attack Time and Hold Time.

atk+dcy (attack+decay)

The EG Time Velocity Sensitivity affects the Attack Time, Decay1 Time, and Hold Time.

decay

The EG Time Velocity Sensitivity affects the Decay 1/2 Time.

atk+rls (attack+release)

The EG Time Velocity Sensitivity affects the Attack Time, Release Time, and Hold Time.

all

The EG Time Velocity Sensitivity affects all the Filter EG Time parameters.

16 EG Time Key Follow

Determines the degree to which the notes (specifically, their position or octave range) affect the Filter EG times of the selected Element. When this is set to a positive value, high notes result in a fast Filter EG transition speed while low notes result in a slow speed. When this is set to a negative value, high velocities result in a slow Filter EG transition speed while low notes result in a fast speed. When this is set to 0, the Filter EG transition speed does not change no matter what note is pressed.

Settings: -200% – 0% – +200%

17 Center Key

Determines the central note or pitch for the EG Time Key Follow (16). When the Center Key note is played, the FEG behaves according to its actual settings.

Settings: C -2 – G8

EG Time Key Follow and Center Key

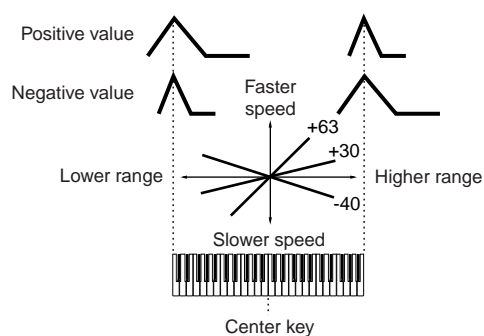

NOTE You can also set the note directly from the Keyboard, by holding down the [SF6] button and pressing the desired key. See “Basic Operation” on page 82.

Filter Scaling settings—[SF3] Scale

Filter Scaling controls the filter cutoff frequency according to the positions of the notes on the keyboard. You can divide the entire keyboard by four break points, and assign different offset values of Cutoff Frequency to them respectively.

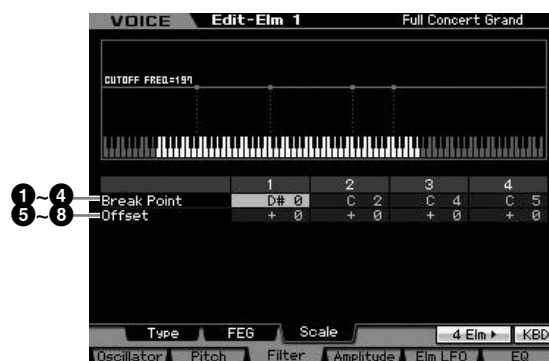

1 – 4 Break Point 1 – 4

Determines the four Break Points by specifying the note numbers respectively.

Settings: C -2 – G8

NOTE You can also set the Break Point directly from the keyboard, by holding down the [SF6] INFO button and pressing the desired key. See “Basic Operation” on page 82.

NOTE Break Point 1 to Break Point 4 will be automatically be arranged in ascending order across the keyboard.

5 – 8 Offset 1 – 4

Determines the offset value to the Cutoff Frequency at each Break Point.

Settings: -128 – +0 – +127

NOTE Regardless of the size of these Offsets, the minimum and maximum Cutoff limits (values of 0 and 127, respectively) cannot be exceeded.

NOTE Any note played below the Break Point 1 note results in the Break Point 1 Level setting. Likewise, any note played above the Break Point 4 note results in the Break Point 4 Level setting.

Voice mode
Performance mode
Sampling mode 1
Song mode
Pattern mode
Mixing mode
Sampling mode 2
Master mode
Utility mode
File mode

Reference

Setting example of Filter Scaling

The best way to understand Filter Scaling is by example. For the settings shown in the example display below, the basic Cutoff frequency value is 64, and the various Offset values at the selected Break point settings change that basic value accordingly. The specific changes to the Cutoff frequency are shown in the diagram below. The Cutoff frequency changes in a linear fashion between successive Break Points as shown.

	1	2	3	4
Break Point	C#1	D#2	C3	A4
Offset	-4	+10	+17	+4

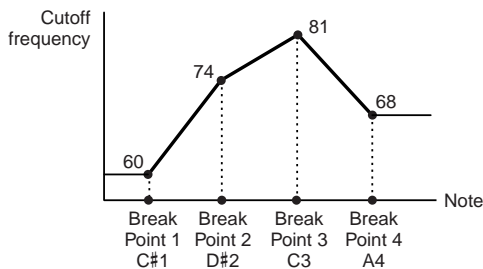

Output Level settings—[F4] Amplitude

Level and Pan settings—[SF1] Level/Pan



1 Level*

Determines the output level of the Element.

Settings: 0 – 127

2 Level Velocity Sens (Level Velocity Sensitivity)*

Determines how the output level of the Element responds to velocity. Positive settings will cause the output level to rise the harder you play the keyboard. A setting of 0 will cause the output level not to change. Negative settings will cause the output level to rise the more softly you play the keyboard.

Settings: -64 – +0 – +63

3 Level Velocity Sens Offset

(Level Velocity Sensitivity Offset)

Raises or lowers the level specified at the Level Velocity Sensitivity (2). A setting of 64 results in the original values of the Level Velocity Sensitivity (2) being used. Settings above 64 will raise the level specified at the Level Velocity Sensitivity (2). Settings below 64 will reduce the level.

Settings: 0 – 127

4 Level Velocity Sens Curve

(Level Velocity Sensitivity Curve)*

The five curves determine how the actual velocity will be generated according to the velocity (strength) with which you play notes on the keyboard. The selected curve is indicated by the graphic on the display.

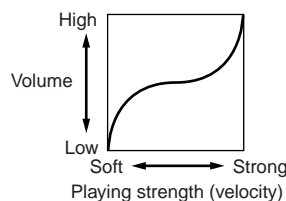

Settings: Curve 0 – 4

5 Level Key Follow

Determines the degree to which the notes (specifically, their position or octave range) affect the amplitude level (set above) of the selected Element, assuming C3 as the basic pitch. A positive setting will lower the output level for lower notes and raise it for higher notes. A negative setting will have the opposite effect.

Settings: -200% – +0% – +200%

6 Center Key (Indication only)

This indicates that the central note for Level Key Follow (5) above is C3. Keep in mind that this is for display purposes only; the value cannot be changed.

Level Key Follow and Center Key

When Level Key Follow is set to 100

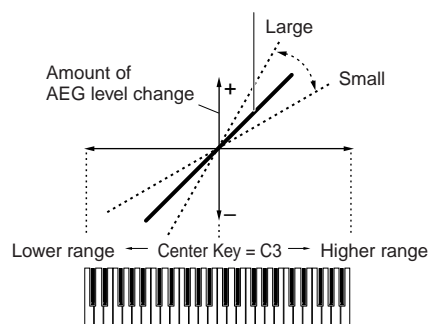

7 Pan*

Adjusts the stereo pan position of the sound.

Settings: L63 (far left) – C (center) – R63 (far right)

8 Alternate Pan

Determines the amount by which the sound is panned alternately left and right for each note you press, assuming the pan position set above as center. Higher values increase the width of the Pan range.

Settings: L64 – C – R63

9 Random Pan

Determines the amount by which the sound of the selected Element is panned randomly left and right for each note you press. The Pan setting (above) is used as the Center Pan position.

Settings: 0 – 127

10 Scaling Pan

Determines the degree to which the notes (specifically, their position or octave range) affect the Pan position (set above), left and right, of the selected Element. At note C3, the main Pan setting (above) is used for the basic Pan position. A positive setting will move the pan position leftward for lower notes and move it rightward for higher notes. A negative setting will have the opposite effect.

Settings: -64 – +0 – +63

Amplitude EG Settings—[SF2] AEG (Amplitude EG)

From this display you can set the Amplitude EG parameters. Using the AEG, you can control the transition in volume from the moment the sound starts to the moment the sound stops.

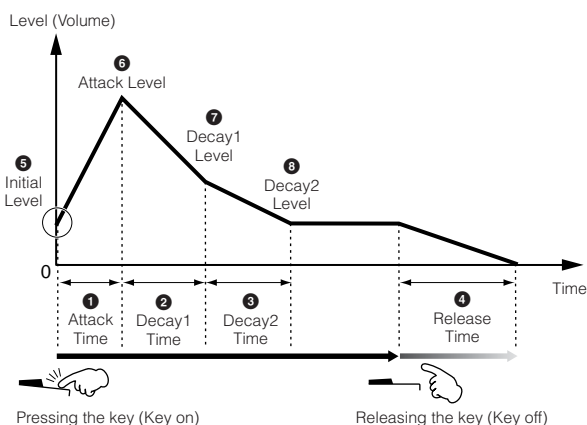
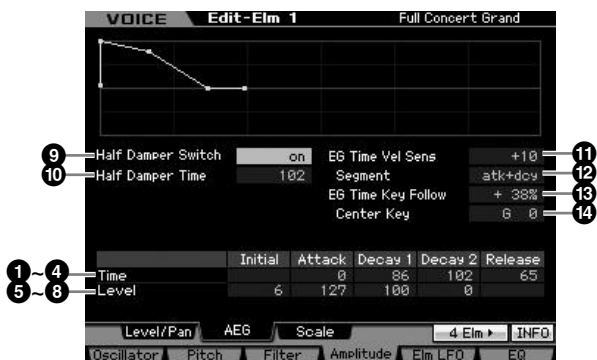

Time*

The Time parameters let you set the time between the adjoining points of the level parameters below. A higher value results in a longer time until reaching the next level.

Settings: 0 – 127

1 Attack Time

Determines how quickly the sound reaches its maximum level after the key is pressed.

2 Decay 1 Time

Determines how fast the envelope falls from the Attack Level to the Decay 1 Level.

3 Decay 2 Time

Determines how fast the envelope falls from the Decay1 Level to the Decay2 Level (sustain level).

4 Release Time

Determines how quickly the sound decays to silence after the key is released.

Level

The Level parameters let you set the amount of the transition at each point based on the level specified in the Level/Pan display (page 122).

Settings: 0 – 127

5 Initial Level

Determines the initial level at the moment the note is pressed.

6 Attack Level

Determines the maximum level which the envelope reaches after a note is pressed.

7 Decay 1 Level

Determines the level which the envelope reaches from the Attack Level after the Decay1 time elapses.

8 Decay 2 Level

Determines the level which will be maintained while a note is held.

9 Half Damper Switch

When the Half Damper Switch is set to on, you can produce a “half-pedal” effect just as on a real acoustic piano by using the optional FC3 Foot Controller connected to the FOOT SWITCH SUSTAIN jack on the rear panel.

Settings: on, off

NOTE When you wish to recreate a half-damper effect using the optional FC3, set the Sustain Pedal parameter to “FC3 (half on)” in the Play Display (page 259) of the Utility mode. Note that this setting is not necessary when controlling the half-damper by sending the Control Change messages from an external MIDI device to the instrument.

10 Half Damper Time

Determines how quickly the sound decays to silence after the key is released while holding down the Foot Controller FC3 with the Half Damper Switch parameter (9) turned on. After releasing the key, you can control the decay time of the sound via the Foot Controller position, with the Half Damper Time of the AEG being the maximum decay value and the Release Time of the AEG being the minimum decay value.

When you release the pedal, the decay time after the key is released is equivalent to the AEG Release Time. You can create a piano-like effect by setting the Release Time to a small value and setting the Half Damper Time to a large value.

The setting here is available only when the Half Damper Switch parameter (9) is set to on and you use the optional FC3 connected to the rear panel.

Settings: 0 – 127

11 EG Time Velocity Sens (EG Time Velocity Sensitivity)

Determines how the AEG transition time (speed) responds to velocity, or the strength with which the note is pressed. When this is set to a positive value, high velocities result in a fast AEG transition speed while low velocities result in a slow speed, as shown below. When this is set to a negative value, high velocities result in a slow AEG transition speed while low velocities result in a fast speed. When this is set to 0, the amplitude transition speed does not change no matter what the velocity.

Settings: -64 – +0 – +63

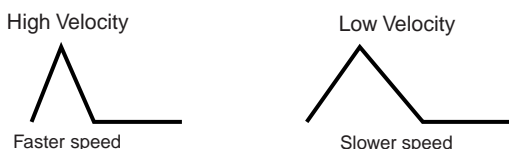

12 EG Time Velocity Sens Segment (EG Time Velocity Sensitivity Segment)

Determines the part of the Amplitude EG which the EG Time Velocity Sensitivity (11) affects.

Settings: attack, atk+dcy, decay, atk+rls, all

attack

The EG Time Velocity Sensitivity affects the Attack Time.

atk+dcy (attack+decay)

The EG Time Velocity Sensitivity affects the Attack Time and Decay Time.

decay

The EG Time Velocity Sensitivity affects the Decay Time.

atk+rls (attack+release)

The EG Time Velocity Sensitivity affects the Attack Time and Release Time.

all

The EG Time Velocity Sensitivity affects all the Amplitude EG Time parameters.

13 EG Time Key Follow

Determines the degree to which the notes (specifically, their position or octave range) affect the Amplitude EG times of the selected Element. When this is set to a positive value, high notes result in a fast Amplitude EG transition

speed while low notes result in a slow speed. When this is set to a negative value, high velocities result in a slow Amplitude EG transition speed while low notes result in a fast speed. When this is set to 0, the Amplitude EG transition speed does not change no matter what the pressed note.

Settings: -200% – 0% – +200%

14 Center Key

Determines the central note for the EG Time Key Follow (13). When the Center Key note is played, the AEG behaves according to its actual settings.

Settings: C -2 – G8

NOTE You can also set the Key directly from the keyboard, by holding down the [SF6] KBD button and pressing the desired key. For details, see page 82.

EG Time Key Follow and Center Key

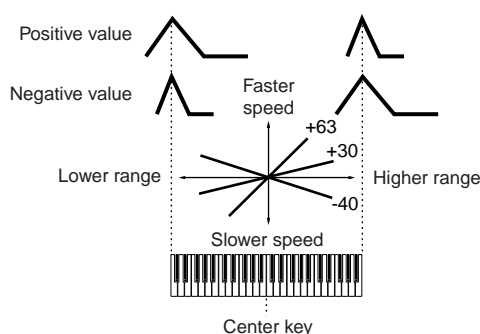

Amplitude Scaling settings—[SF3] Scale

Amplitude Scaling controls the amplitude output level according to the positions of the notes on the keyboard. You can divide the entire keyboard by four break points, and assign different offset values of amplitude to them respectively.

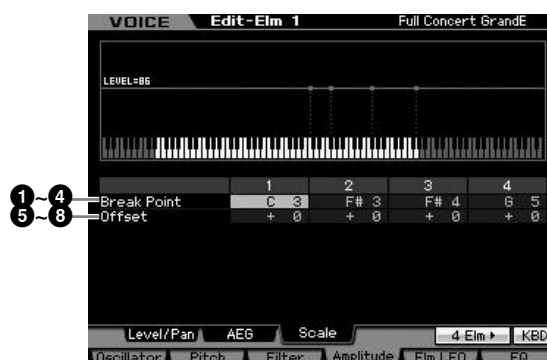

1 – 4 Break Point 1 – 4

Determines the four Break Points by specifying the note numbers respectively.

Settings: C -2 – G8

NOTE You can also set the Break Point directly from the Keyboard, by holding down the [SF6] KBD button and pressing the desired key. See "Basic Operation" on page 82.

NOTE Break Point 1 to Break Point 4 will be automatically be arranged in ascending order across the keyboard.

5 – 8 Offset 1 – 4

Determines the offset value to the level at each Break Point.

Settings: -128 – +0 – +127

Setting example of Amplitude Scaling

The best way to understand Amplitude Scaling is by example. For the settings shown in the example display below, the basic Amplitude (volume) value for the selected Element is 80, and the various Offset values at the selected Break point settings change that basic value accordingly. The specific changes to the Amplitude are shown in the diagram below. The Amplitude changes in a linear fashion between successive Break Points as shown.

	1	2	3	4
Break Point	C1	C2	C3	C4
Offset	-4	+10	+17	+4

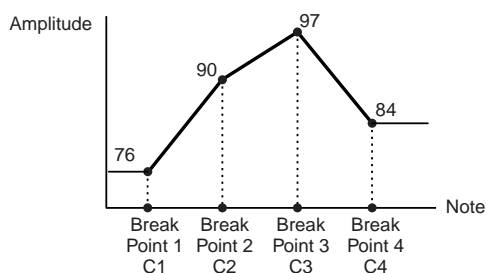

Modulating the Voice—[F5] Elm LFO (Element LFO)

This display gives you a comprehensive set of controls over the LFO for each individual Element. The LFO can be used to create vibrato, wah, tremolo and other special effects, by applying it to the pitch, filter and amplitude parameters.

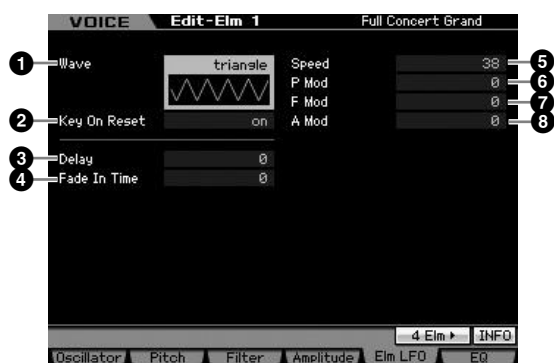

1 Wave

Selects the Wave and determines how the LFO waveform modulates the sound.

Settings: saw, triangle, square

2 Key On Reset

Determines whether or not the LFO is reset each time a note is played.

Settings: off, on

off

The LFO cycles freely with no key synchronization. Pressing a key starts the LFO wave at whatever phase the LFO happens to be at that point.

on

The LFO resets with each note you play and starts a wave at the phase specified by the Phase parameter (above).

3 Delay

Determines the delay time between the moment you press note on the keyboard and the moment the LFO comes into effect. A higher value results in a longer delay time.

Settings: 0 – 127

4 Fade In Time

Determines the amount of time for the LFO effect to fade in after the Delay time has elapsed. A higher value results in a slower fade-in. When set to “0,” the LFO effect will not fade in and reach the maximum level immediately after the Delay time has elapsed.

Settings: 0 – 127

5 Speed

Determines the speed of the LFO Wave. The higher the value, the faster the LFO speed.

Settings: 0 – 63

6 P Mod (Pitch Modulation Depth)

Determines the amount (depth) by which the LFO wave varies (modulates) the pitch of the sound. The higher the setting, the greater the depth of control.

Settings: 0 – 127

7 F Mod (Filter Modulation Depth)

Determines the amount (depth) by which the LFO wave varies (modulates) the Filter Cutoff frequency. The higher the setting, the greater the depth of control.

Settings: 0 – 127

8 A Mod (Amplitude Modulation Depth)

Determines the amount (depth) by which the LFO wave varies (modulates) the amplitude or volume of the sound. The higher the setting, the greater the depth of control.

Settings: 0 – 127

Equalizer (EQ) Settings—[F6] EQ

From this display, you can set the EQ parameters for each Element.

1 Type

Determines the EQ Type. The number of parameters and values available differs depending on the selected EQ type.

Settings:

2 Band, PEQ

See below.

Boost 6, Boost 12, Boost 18

Boosts the entire band of the selected Element by +6dB, +12dB, and +18dB respectively.

thru

If you select this, the equalizers are bypassed and the entire signal is unaffected.

When the EQ Type is set to “2 Band”

This is a “shelving” equalizer, which combines separate high and low frequency bands.



2 Low Frequency

Determines the standard frequency of the lower EQ band.

Settings: 50.1 Hz – 2.00 kHz

3 High Frequency

Determines the standard frequency of the higher EQ band.

Settings: 503.8 Hz – 10.1 kHz

4 Low Gain

Determines the amount by which signals below the Low Frequency (2) will be boosted/attenuated.

Settings: -12.00 dB – +0.00 dB – +12.00 dB

5 High Gain

Determines the amount by which signals above the High Frequency (3) will be boosted/attenuated.

Settings: -12.00 dB – +0.00 dB – +12.00 dB

When the EQ Type is set to “PEQ”

The Parametric EQ for the single band is used to attenuate or boost signal levels (gain) around the Frequency. This type features 32 different “Q” settings, which determine the frequency band width of the equalizer.



2 Low Frequency

Determines the center frequency.

Settings: 139.7 Hz – 12.9 kHz

4 Low Gain

Determines the amount by which signals below the Low Frequency (2) will be boosted/attenuated.

Settings: -12.00 dB – +0.00 dB – +12.00 dB

6 Q

Determines the Q (bandwidth) for the band. The lower the setting, the greater the bandwidth. The higher the setting, the smaller the bandwidth.

Settings: 0.7 – 10.3

Editing a Drum Voice

“Editing” refers to the process of creating a Voice by changing the parameters that make up the Voice. This can be done in Voice Edit, a sub mode within the Voice mode. In this section, we’ll show you how to edit a Drum Voice. To enter the Drum Voice Edit mode, press the [VOICE] button to enter the Voice mode, select a Drum Voice, then press the [EDIT] button.

Common Edit and Key Edit

Each Drum Voice can consist of up to 73 Drum Keys, assigned to notes spread across the keyboard (C0 to C6). There are two types of Drum Voice Edit displays: those for Common Edit to edit the settings common to all keys, and those for Key Edit to edit individual keys.

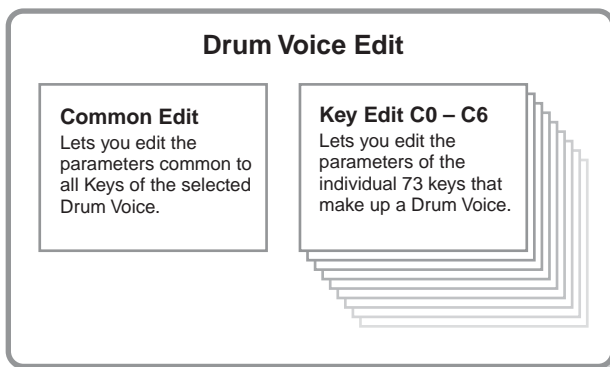

Editing Drum Voices

- 1 Press the [VOICE] button to enter the Voice Play mode.**
Select a Drum Voice to be edited.
- 2 Press the [EDIT] button to enter the Voice Edit mode.**
- 3 Call up the desired Edit display, Common Edit or Key Edit.**
To call up the Common Edit display, press the [COMMON EDIT] button. To call up the Key Edit display, press the Number button [1]. In the Drum Key Edit mode, press the Key to which your desired drum instrument sound is assigned.

Common Edit display

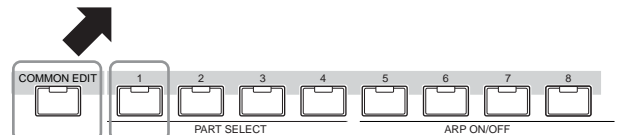

Selecting a Drum Key

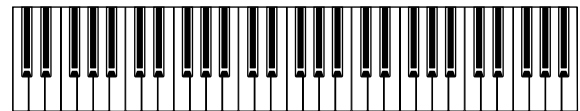

Key Edit display



4 Call up the desired display.

To find the desired display, note the tab menu items corresponding to the [F1] – [F6] buttons and [SF1] – [SF5] buttons. Each tab menu of the [F1] – [F6] buttons contains sub menus which correspond to the [SF1] – [SF5] buttons at the bottom of the display.

NOTE By pressing the [SF6] button, you can use various functions such as the Information display, Character input (page 82), Number button function (page 81), and List display/selection (page 82). The function called up via the [SF6] button differs depending on the selected parameter where the cursor is located.

5 Move the cursor to the desired parameter.

6 Edit the value by using the [INC/YES], [DEC/NO] buttons and the data dial.

7 Repeat steps 3 – 6 as desired.

8 Enter the desired name for the edited Voice.

Use the Name display (page 98) of the Voice Common Edit mode.

9 Store the edited Voice.

Press the [STORE] button to call up the Store window (page 97) then store the edited Voice.

⚠ CAUTION

The edited Voice will be lost when selecting the different Voice or turning the power off. Make sure to store the Voice data to the internal memory by pressing the [STORE] button before selecting a different Voice or turning the power off.

NOTE If desired, save the edited and stored Voices to a USB storage device connected to the USB TO DEVICE connector or a computer connected to the network to

which the MOTIF XS is also connected. Keep in mind that edited Voice data is stored to internal User memory (Flash ROM) and is maintained even when turning the power off. As such it is not necessary to save the data to an external device; however, we still recommend that you save or archive all important data to an external device. Refer to page 278 for details.

NOTE Other convenient functions are also available in the Drum Voice Edit mode. For details, see page 97.

Common Edit parameters

[VOICE] → Drum Voice selection → [EDIT] → [COMMON EDIT]

The Common Edit lets you edit the parameters common to all Drum Keys of the selected Drum Voice.

General Settings for the selected Voice—[F1] General

NOTE The Common Edit parameters of the Drum Voice are basically the same as those of the Normal Voice. However, some parameters having the same name as those of the Normal Voice are not available for the Drum Voice.

Naming the edited Voice—[SF1] Name

This is the same as in Normal Voice Common Edit. See page 98.

Play Mode Settings such as Micro Tuning and Mono/Poly—[SF2] Play Mode

This is the same as in Normal Voice Common Edit. See page 98.

Other settings—[SF3] Other

This is the same as in Normal Voice Common Edit. See page 100.

Arpeggio settings—[F2] ARP Main (Arpeggio Main)

This is the same as in Normal Voice Common Edit. See page 101.

Arpeggio settings—[F3] ARP Other (Arpeggio Other)

By changing the timing and velocity of the notes, you can change the rhythmic “feel” of the Arpeggio playback. This is the same as in Normal Voice Common Edit. See page 102.

Controller settings—[F4] Ctrl Set (Controller Set)

This is the same as in Normal Voice Common Edit. See page 104. Please note that the Element Switch parameter is not available in Drum Voice Common edit.

Effect settings—[F6] Effect

Effect Connection Settings—[SF1] Connect

This display gives you comprehensive control over the effects. The functions on this display are basically same as in Normal Voice Common Edit (page 107). The different point is that the Insertion Effect Out parameter is set not for each Element but for each Drum Key. In addition to that, three more parameters (14 – 16) are available.

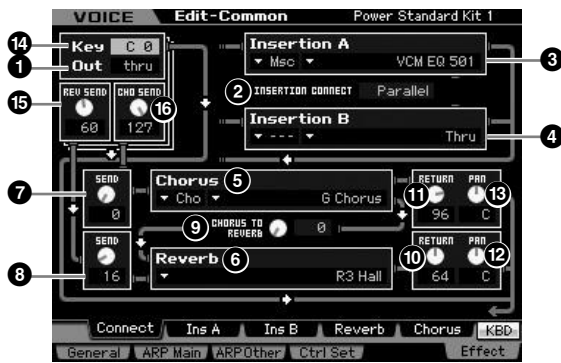

1 Out (Insertion Effect Out)

Determines which Insertion Effect (A or B) is used to process each individual Drum Key. Parameters can be set for each Drum Key. When INSERTION CONNECT (2) is set to “ins L,” the signal from each Drum Key is output to the Insertion L regardless of the setting here.

Settings: thru (through), Ins A (Insertion A), Ins B (Insertion B)

Parameters 2 – 13 are same as the ones on the Connect display (page 107) in the Normal Voice Edit mode.

14 Key

Determines the Drum Key to be edited. The Insertion Effect Out (1), Key Reverb Send (15) and Key Chorus Send (16) can be set for each Drum Key.

Settings: C0 – C6

15 REV SEND (Key Reverb Send)

Determines the level of the Drum key sound (the bypassed signal) that is sent to Reverb effect. The setting here is available only when the Insertion Effect Out parameter (1) is set to “thru.”

Settings: 0 – 127

NOTE When the Insertion Effect Out parameter (1) is set to “Ins A” or “Ins B,” you can determine the level of the Drum Key sound (output from Insertion Effect A or B) that is sent to the Reverb effect by setting the value of the Insertion Reverb Send parameter indicated only in this case.

16 CHO SEND (Key Chorus Send)

Determines the level of the Drum key sound (the bypassed signal) that is sent to Chorus effect. The setting here is available only when the Insertion Effect Out parameter (1) is set to “thru.”

Settings: 0 – 127

NOTE When the Insertion Effect Out parameter (1) is set to “Ins A” or “Ins B,” you can determine the level of the Drum Key sound (output from Insertion Effect A or B) that is sent to the Chorus effect by setting the value of the Insertion Chorus Send parameter indicated only in this case.

Effect Parameter settings—[SF2] Ins A – [SF5] Chorus

This is the same as in Normal Voice Common Edit. See page 109.

Key Edit parameters

[VOICE] → Drum Voice selection → [EDIT] → Key selection

If you wish to edit the sounds that make up a Voice and the basic parameters that determine the sound, such as Oscillator, Pitch, Filter, Amplitude, and EG (Envelope Generator), call up the Key Edit display.

About the asterisk (*) marks

For users who are new to Voice editing and may be confused by the large amount of parameters, the most basic and easy-to-understand parameters are conveniently marked with asterisks in this section. If you are just starting out with Voice editing, try these parameters first.

Setting the wave and note range of the Key—[F1] Oscillator

This display lets you set the Waveform and Note range of the selected Key.



NOTE Depending on the selected parameter, the LIST icon is shown at the tab menu corresponding to the [SF6] button. In this condition, you can call up the list by pressing the [SF6] LIST button, then select the desired item from the list. For details, see page 82.

1 Key*

Determines the Drum Key to be edited. You can select the desired percussion instrument by pressing the note.

Settings: C0 – C6

2 Element Switch*

Determines whether the currently selected Key is used or not. When this is set to off, the currently edited Key will not sound.

Settings: off (inactive), on (active)

Voice mode
Performance mode
Sampling mode 1
Song mode
Pattern mode
Mixing mode
Sampling mode 2
Master mode
Utility mode
File mode

Reference

3 Wave Bank (Waveform Bank)*

Determines the Waveform Bank assigned to the Drum Key, Preset or User. User Waveforms can be created based on the samples recorded in the Sampling mode.

Settings: PRE (preset waveform),USR (user waveform)

NOTE For details about Waveform, refer to the explanation of the Sampling Mode on page 161.

4 Wave Category (Waveform Category)*

5 Wave Number (Waveform Number)*

Determines the Waveform assigned to the Drum Key by selecting the Waveform Category and Number. For a complete list of Waveforms in the Preset Bank, refer to the Waveform List in the separate Data List booklet.

6 Assign Mode*

When this is set to “single,” double playback of the same note is prevented. This is useful when two or more instances of the same note are received nearly simultaneously, or without a corresponding note off message. To allow playback of each instance of the same note, set this to “multi.” In general, you should probably set this to “multi”—especially for tambourine and cymbal sounds that you would want to ring out to their full decay, when playing them multiple times in succession. Please keep in mind that the “multi” setting consumes the overall polyphony and it may cause sounds to be cut off.

Settings: single, multi

single

When this is set to “single” and double playback of the same note are transmitted to the internal tone generator, the first note will be stopped then the next note will be sounded.

multi

When this is set to “multi” and double playback of the same note are transmitted to the internal tone generator, all the notes are sounded simultaneously.

7 Receive Note Off

Determines whether or not the selected Drum Key responds to MIDI Note Off messages. This should be set to on when the selected Drum Key has a sustained, non-decaying sound (such as a snare roll), so that you can stop the sound by releasing the note.

Settings: off, on

8 Alternate Group*

Determines the Alternate Group to which the key is assigned. In a real drum kit, some drum sounds cannot physically be played simultaneously, such as open and closed hi-hats. You can prevent keys from playing back simultaneously by assigning them to the same Alternate Group. Up to 127 Alternate Groups can be defined. You can also select “off” here if you wish to allow the simultaneous playback of sounds.

Settings: off, 1 – 127

9 Ins Effect Output (Insertion Effect Output)

Determines which Insertion Effect (A or B) is used to process each individual Drum Key. This parameter is same as the Ins Effect Output in the Connect display (page 107) in Voice Common Edit. Making a setting here automatically changes the setting of that parameter as well. When INSERTION CONNECT (2) is set to “ins L” in the Connect display, Insertion L is used to process each individual Drum Key, even if “ins A” or “ins B” is selected.

Settings: thru (through), ins A (Insertion Effect A), ins B (Insertion Effect B)

10 Reverb Send*

Determines the level of the Drum Key sound (the bypassed signal) that is sent to Reverb effect. This is available only when Insertion Effect Output (above) is set to “thru.” The setting made here will be applied to the same parameters in the Connect display (page 107) of the Voice Common Edit.

Settings: 0 – 127

11 Chorus Send*

Determines the level of the Drum Key sound (the bypassed signal) that is sent to Chorus effect. This is available only when Insertion Effect Output (above) is set to “thru.” The setting made here will be applied to the same parameters in the Connect display (page 107) of the Voice Common Edit.

Settings: 0 – 127

12 Output Select

Determines the specific output(s) for the individual Drum key signal. You can assign each individual Drum Key sound to be output from a specific hardware output jack on the rear panel. This parameter is useful when you wish to apply a connected external effect to a specific drum instrument. The setting here is available only when the Insertion Effect Output parameter (9) is set to “thru.”

Settings: See the table below.

LCD	Output jacks	Stereo/Mono
L&R	OUTPUT L and R	Stereo
asL&R	ASSIGNABLE OUTPUT L and R	Stereo
m1&2	mLAN OUTPUT 1 and 2	Stereo (1: L, 2: R)
m3&4	mLAN OUTPUT 3 and 4	Stereo (3: L, 4: R)
m5&6	mLAN OUTPUT 5 and 6	Stereo (5: L, 6: R)
m7&8	mLAN OUTPUT 7 and 8	Stereo (7: L, 8: R)
m9&10	mLAN OUTPUT 9 and 10	Stereo (9: L, 10: R)
m11&12	mLAN OUTPUT 11 and 12	Stereo (11: L, 12: R)
m13&14	mLAN OUTPUT 13 and 14	Stereo (13: L, 14: R)
asL	ASSIGNABLE OUTPUT L	Mono
asR	ASSIGNABLE OUTPUT R	Mono
m1	mLAN OUTPUT 1	Mono
:	:	:
m14	mLAN OUTPUT 14	Mono

NOTE The mLAN settings (m1 – m14) are available only for the MOTIF XS8. The mLAN settings are available for MOTIF XS6/7 only when an optional mLAN16E2 has been installed.

13 Coarse (Pitch Coarse Tuning)*

Determines the pitch of each Drum Key in semitones.

Settings: -48 semi – +0 semi – +48 semi

14 Fine (Pitch Fine Tuning)*

Determines the pitch of each Drum Key in cent.

Settings: -64 cent – +0 cent – +63 cent

15 Pitch Velocity Sens (Pitch Velocity Sensitivity)

Determines how the pitch of the Drum Key responds to velocity. Positive settings will cause the pitch to rise the harder you play the keyboard. A setting of 0 will cause the pitch not to change. Negative settings will cause the pitch to rise the more softly you play the keyboard.

Settings: -64 – +0 – +63

16 [SF5] PageHold

Normally in the Drum Voice Edit mode, pressing a note on the keyboard alternates the key (instrument) being edited automatically. When the [SF5] PageHold button is turned on, the key (instrument) being edited is maintained even if you press any other note on the keyboard. This allows you to edit a certain key while adjusting the level balance between the key being edited and the other keys.

Adjust the brightness using the Filter—[F3] Filter

Each Drum Key has its own independent low pass filter and high pass filter. You can adjust the tonal characteristics of each drum sound by setting the Cutoff Frequency and Resonance.

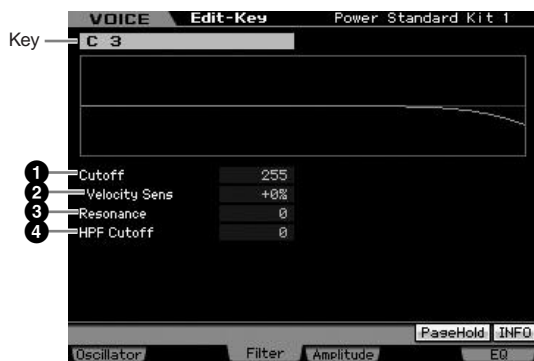

1 Cutoff*

Raises or lowers the cutoff frequency of the low pass filter to adjust the tone brilliance. The sound can be brightened by raising the cutoff frequency, and darkened or muffled by lowering it.

Settings: 0 – 255

2 Cutoff Velocity Sens (Cutoff Velocity Sensitivity)*

Determines how the Cutoff Frequency responds to velocity, or the strength with which you play notes. Positive settings will cause the Cutoff Frequency to rise the harder you play the keyboard. A setting of 0 will cause the Cutoff Frequency not to change depending on velocity. Negative settings will cause the Cutoff Frequency to rise the more softly you play the keyboard.

Settings: -200% – +0% – +200%

3 Resonance*

Determines the emphasis given to the Cutoff Frequency to add further character to the sound. Higher values result in a more pronounced effect.

Settings: 0 – 127

4 HPF Cutoff (High Pass Filter Cutoff Frequency)*

Determines the Cutoff Frequency of the High Pass Filter.

Settings: 0 – 255

Amplitude settings—[F4] Amplitude

From the following displays, you can set various parameters for the selected Drum Key, such as Volume, Pan, and Amplitude EG.



1 Level*

Determines the output level of the Drum Key.

Settings: 0 – 127

2 Velocity Sens (Velocity Sensitivity)*

Determines how the output level of the Drum Key responds to velocity. Positive settings will cause the output level to rise the harder you play the keyboard. A setting of 0 will cause the output level not to change. Negative settings will cause the output level to rise the more softly you play the keyboard.

Settings: -64 – +0 – +63

3 Pan*

Adjusts the stereo pan position of the sound.

Settings: L63 (far left) – C (center) – R63 (far right)

4 Alternate Pan

Determines the amount by which the sound is panned alternately left and right for each note you press, assuming the pan position set above as center. Higher values increase the width of the Pan range.

Settings: L64 – C – R63

5 Random Pan

Determines the amount by which the sound of the selected Drum Key is panned randomly left and right for each note you press. The Pan setting (above) is used as the Center Pan position.

Settings: 0 – 127

Amplitude EG

Using the AEG, you can control the transition in volume from the moment the sound starts to the moment it stops.

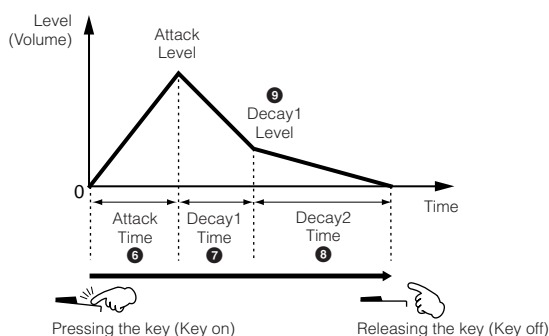

Time*

The Time parameters let you set the time between the adjoining points of the level parameters below. A higher value results in a longer time until reaching the next level.

Settings: 0 – 127 (0 – 126, hold for Decay 2 Time)

6 Attack Time

Determines how long it takes for the sound to reach full volume (Attack Level) when a note is pressed.

7 Decay 1 Time

Determines how long it takes for the sound to fall from the Attack Level to the Decay1 Level after the note is pressed.

8 Decay 2 Time

Determines how quickly the sound decays from the Decay1 Level to silence after the note is released.

Level*

The Level parameter lets you set the AEG level.

Settings: 0 – 127

9 Decay 1 Level

Determines the level which the AEG level reaches from the Attack Level after the Decay1 time elapses.

Equalizer (EQ) Settings—[F6] EQ

From this display, you can set the EQ parameters for each Drum Key.

This is the same as in Normal Voice Common Edit. See page 126.

Voice Job—Convenient Functions

The Voice Job mode features some convenient data organization and initialization tools, for use when creating Voices and archiving them.

Voice Job—Basic Operation

- 1 In the Voice mode, press the [JOB] button to enter the Voice Job mode.**
- 2 Press one of the [F1] to [F4] buttons to call up the desired Job display.**
- 3 Move the cursor to the desired parameter, then set the value.**
Set the parameters for executing the Job.
- 4 Press the [ENTER] button. (The display prompts you for confirmation.)**
To cancel the Job, press the [DEC/NO] button.
- 5 Press the [INC/YES] button to execute the Job.**
After the Job has been completed, a “Completed” message appears and operation returns to the original display.
- 6 Press the [VOICE] button to return to the Voice Play mode.**

CAUTION

Even if you execute the Job, selecting a different Voice or turning the power off without storing will erase the Voice data. Make sure to store the Voice data to internal memory by pressing the [STORE] button before selecting a different Voice or turning the power off.

Initializing the Voice—[F1] Init (Initialize)

This function lets you reset (initialize) all Voice parameters to their default settings. You can also selectively initialize certain parameters, such as Common settings, settings for each Element/Drum Key, and so on.

This function is very useful when creating a completely new Voice from scratch.

The parameters available for initializing will vary depending on the type of Voice currently selected (Normal/Drum).

When a Normal Voice is selected:

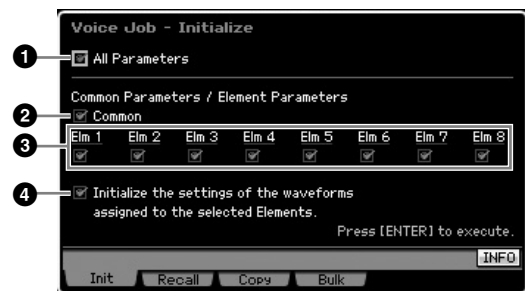

1 All Parameters

If you place a checkmark here, all the parameters of the selected Voice will be initialized.)

2 Common Parameters

If you place a checkmark here, all the Common Edit parameters of the selected Voice will be initialized.

3 Element Parameters 1 – 8

If you place a checkmark here, all the Element Edit parameters of the selected Element will be initialized.

4 Initialize the settings of the waveforms assigned to the selected Elements.

If you place a checkmark here, all the Waveform settings of the selected Element will be initialized.

When a Drum Voice is selected:

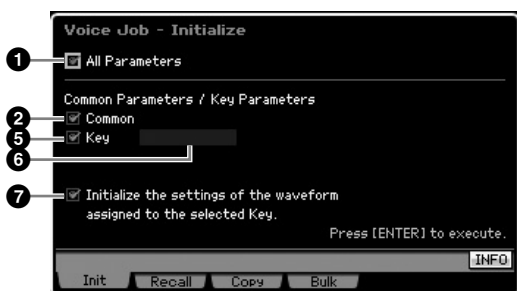

5 Key Parameters

If you place a checkmark here, all the Key Edit parameters of the selected Key will be initialized.

6 Drum Key

Determines the Drum Key to be initialized.

Settings: C0 – C6

7 Initialize the settings of the waveform assigned to the selected Key.

If you place a checkmark here, all the Waveform settings of the selected Drum Key will be initialized.

Edit Recall—[F2] Recall

If you are editing a Voice but you have not stored it before switching to another Voice, the edits you have made will be cleared. If this happens, you can use the Recall function to restore the Voice with your latest edits intact.

Copying another Voice Element to the current one—[F3] Copy

From this window you can copy Common and Element/Drum Key parameter settings from any Voice to the Voice you are editing. This is useful if you are creating a Voice and wish to use some parameter settings from another Voice. When Current Voice (2) is set to on, you can copy the parameter settings from an Element to a different Element of the same Voice.

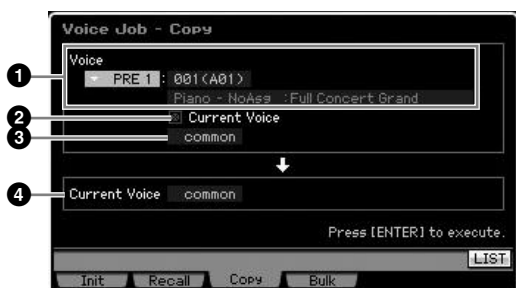

1 Voice as source

Determines the Bank and the Voice number to be copied. The available parameters will vary depending on the type of Voice currently selected (Normal/Drum). This parameter cannot be set when the Current Voice (2) is turned on.

2 Current Voice

When this is set to on, the currently selected Voice (the one you are editing now) is selected as source. Accordingly, you can copy the parameter settings from an Element to the different Element of the same Voice.

3 Data type of the source Voice

Determines the source data type including the Element number or Drum Key. The available parameters will vary depending on the type of Voice currently selected (Normal/Drum).

Settings: common, element 1 – 8 (Normal Voice), key C9 – C6 (Drum Voice)

4 Data type of the destination Voice

Determines the destination data type including the Element number or Drum Key. The available parameters will vary depending on the type of Voice currently selected (Normal/Drum).

When the data type of the source Voice (above) is set to “common,” this parameter will be fixed to “common.”

Settings: common, element 1 – 8 (Normal Voice), key C9 – C6 (Drum Voice)

Transmitting the Voice data via MIDI (Bulk Dump)—[F4] Bulk (Bulk Dump)

This function lets you send your edited parameter settings for the currently selected Voice to a computer or another MIDI device for data archiving. To execute the Bulk Dump operation, press the [ENTER] button.

NOTE In order to execute Bulk Dump, you will need to set the correct MIDI Device Number. For details, see page 268.

NOTE The Bulk Dump data includes only the MIDI messages and does not include the Waveforms.

Playing in the Performance Mode

The Performance mode is used for selecting, playing, and editing the desired Performance. Performances can be made up of a maximum of four Parts (Voices), selected from the internal tone generator Parts 1 – 4. The Performance Play mode is the main 'portal' by which you enter the Performance mode, and it is here where you select and play a Performance. Some of the Performance settings can also be edited in this mode. To call up the Performance Play display and enter the Performance mode, simply press the [PERFORM] button.

Selecting a Performance

The MOTIF XS contains 128 Performances in each of the User Banks 1 – 3.

Selecting a Performance is done in basically the same way as selecting a Voice (see page 88). As in the Voice Play mode, you can use the Category Search (page 24) and Favorite Category (page 88) functions in the Performance Play mode. Note that the Category function in the Performance mode does not allow you to use the Bank/Group/Number buttons.

Switching a Part on/off

The Performance Play mode lets you turn the four Parts of the current Performance on or off as desired. You can enable this by pressing the [PERFORM] button to enter the Performance Play mode.

Turning specific Parts on/off (Mute function)

You can turn individual Parts on/off by using the Mute function.

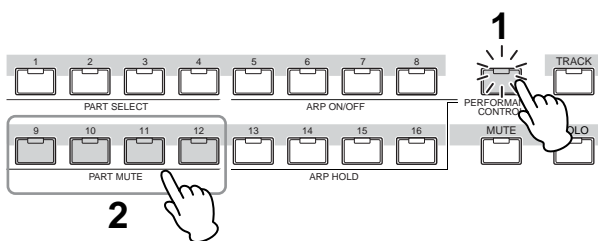

1 Press the [PERFORMANCE CONTROL] button.

The PERFORMANCE CONTROL lamp lights, indicating that each Part can be turned on/off.

2 Press any of the Number buttons [9] – [12].

The lamp of the pressed button will be turned off and the corresponding Part will be muted. Press the same button again to turn the lamp on and disengage the mute function for that Part. You can turn multiple Parts on/off by pressing their buttons.

NOTE Parts can also be muted by using the [MUTE] and [PART SELECT] buttons. Press the [MUTE] button (the lamp lights), then use the appropriate Number buttons [1] – [4] to mute and unmute the desired Part.

Soloing a specific Part

The Solo function is the opposite of Mute, and lets you instantly solo a specific Part and mute all others.

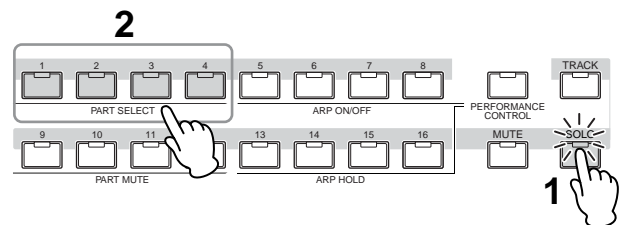

1 Press the [SOLO] button.

The SOLO lamp lights, indicating that Solo is enabled.

2 Press any of the Number buttons [1] – [4].

The lamp of the pressed button will flash and only the corresponding Part will be sounded. Press any other Number button to change the solo Part.

Using the Arpeggio Function

The Arpeggio function lets you trigger rhythm patterns, riffs and phrases using the current Voice by simply playing notes on the keyboard. In the Performance mode, each of four Arpeggio types is assigned to each of four Parts. This means four Arpeggio types can be played back simultaneously. Try selecting different Performances and check out the various Arpeggio types.

NOTE For details about Arpeggio, see page 62.

Using the Arpeggio Function in the Performance mode

Since the preset Performances already have their own Arpeggio types pre-assigned, you can play the Arpeggio by selecting the desired Performance, turning on the [ARPEGGIO ON/OFF] button, then pressing any note. Instructions on using Arpeggio are basically the same as in the Voice mode.

Turning Arpeggio playback on/off for each Part

You can turn Arpeggio playback on or off for each Part of the Performance as described below.

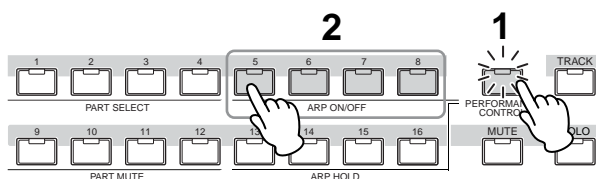

1 Press the [PERFORMANCE CONTROL] button.

The [PERFORMANCE CONTROL] lamp lights, indicating that Arpeggio playback for each Part can be turned on/off.

2 Pressing each of the [5] – [8] buttons toggles the Arpeggio playback on and off for each Part.

If any of the [5] – [8] lamps is turned off, the Arpeggio playback of the corresponding Part is muted.

Turning the Arpeggio Hold parameter on/off for each Part

You can turn the Arpeggio Hold parameter (page 154) on or off for each Part of the Performance as described below. When the Arpeggio Hold parameter is set to “on,” the Arpeggio playback continues even if the note is released.

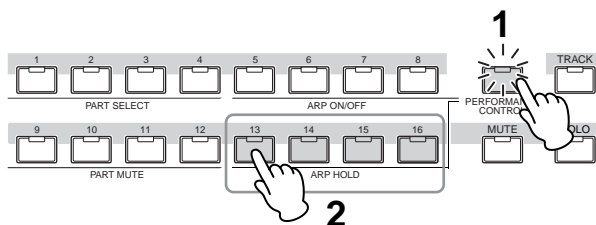

1 Press the [PERFORMANCE CONTROL] button.

The [PERFORMANCE CONTROL] lamp lights, indicating that Arpeggio Hold for each Part can be turned on/off.

2 Pressing each of the [13] – [16] buttons toggles the Arpeggio Hold parameter on and off for each Part.

If any of the [13] – [16] lamps is turned on, the Arpeggio Hold parameter of the corresponding Part is turned on.

NOTE When the Arpeggio Hold parameter is set to “sync-off” in the Arpeggio Main display (page 154), pressing each of the [13] – [16] buttons switches the Arpeggio Hold setting between on and sync-off.

Using Knobs

One of the more powerful performance features of the MOTIF XS is its extensive set of real-time controls—especially the Knobs and Control Sliders. These let you adjust a variety of parameters for the current Performance, such as effect depth, attack/release characteristics, tonal color, and others. These real-time controls can be used to change the sound as you play or to quickly edit and customize the Performance. One of six functions can be assigned to each knob, alternatively selected via the [SELECTED PART CONTROL] button and the [MULTI PART CONTROL] button.

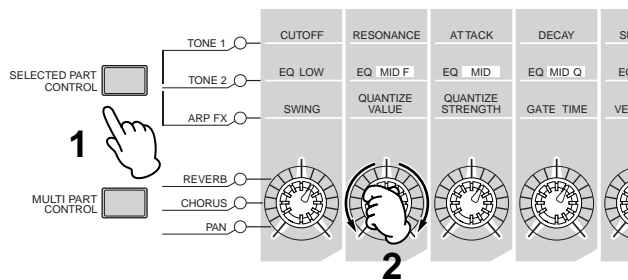

1 Select the function setting to be assigned to the Knobs.

Press the [SELECTED PART CONTROL] button or [MULTI PART CONTROL] button several times to select the function setting to be assigned to the Knobs. Each time either button is pressed, the lamp lights alternatively in descending order, TONE 1 → TONE 2 → ARP FX (when pressing [SELECTED PART CONTROL]) or REVERB → CHORUS → PAN (when pressing [MULTI PART CONTROL]). The functions assigned to the Knobs are changed according to the lamp status.

NOTE To check which functions are currently assigned to the Knobs, call up the Control Function window by pressing the [SELECTED PART CONTROL] button or [MULTI PART CONTROL] button.

NOTE Holding down the [SELECTED PART CONTROL] button for a few seconds will alternate the lit lamp from the current one to TONE 1. Likewise, holding down the [MULTI PART CONTROL] button for a few seconds will alternate the lit lamp from the current one to REVERB.

NOTE A red point on the Knob or Slider graphic indicates the current value to which the Knob or Slider is set. Moving the Knob or Slider has no effect on the sound until this point is reached. Once you move the Knob or Slider past this point, the red point disappears and moving the Knob or Control Slider affects the sound.

Red point (indicating the current value)

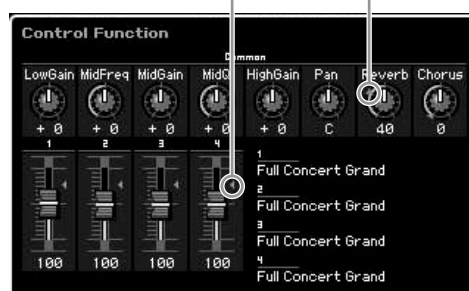

2 Change tonal color.

Moving the Knobs changes various aspects of the Voice's sound in real time—while you play. When one of the TONE 1, TONE 2 or ARP FX lamps are lit, the eight Knobs are used to control the corresponding functions as printed on the panel (the same as in the Voice mode). For details, see page 90. When one of the REVERB, CHORUS or PAN lamps are lit, the following functions are assigned to the four leftmost Knobs.

Active lamp	Functions of the left four knobs
REVERB	Adjusts the reverb depth for Parts 1 – 4
CHORUS	Adjusts the chorus depth for Parts 1 – 4
PAN	Adjusts the pan position for Parts 1 – 4

NOTE If the [E] (Edit) indicator appears at the top right of the display when you adjust the Knobs, the current Performance can be stored (page 142) as a new User Performance.

Changing a Part to be controlled

You can change a Part to be controlled by Knob operations via any of the following instruction.

- 1 Turn the [PERFORMANCE CONTROL] lamp on by pressing the [SELECTED PART CONTROL] button to call up the Control Function window.
- 2 Select the desired Part by pressing the [1] – [4] buttons and [COMMON EDIT] button.

By pressing the [COMMON EDIT] button, Knob operations will be applied to all four Parts. By pressing the one of the [1] – [4] buttons, Knob operations will be applied only to the selected Part. Note that controlling the knobs printed “ASSIGN 1” and “ASSIGN 2” of “TONE 1” will always affect the sound of all Parts.

NOTE Note that the Control Function window cannot be called up even if you press the [SELECTED PART CONTROL] button in the Performance Play display. If you wish to change a Part in the Performance Play display, press the [PERFORMANCE CONTROL] button (the lamp lights), then press one of the [1] – [4] and [COMMON EDIT] buttons.

Using Sliders

The far left four sliders adjust the volume for each of four Parts. Each of the Control Sliders 1 – 4 corresponds to the same numbered Part. The status of the sliders is shown on the display.

The Performance Play display

You can call up the Performance Play display by pressing the [PERFORM] button.



1 Performance Bank

2 Performance Number (Group/Number)

Indicates the Bank and Number of the selected Performance. A Bank is a memory location that includes data of 128 different Performances. Three Banks (User 1 – 3) are provided. Each Performance within a Bank is assigned to a Performance Number of 001 to 128. Performance Numbers 001 to 128 are converted to the format (shown in parentheses) of Banks A to H and Numbers 1 to 16 (for the Bank). This format corresponds to the Group buttons [A] – [H] and the Number buttons [1] – [16]. The Performance Numbers and the corresponding Group/Numbers are listed below.

Group/Number	Performance Number
A01 – 16	001 – 016
B01 – 16	017 – 032
C01 – 16	033 – 048
D01 – 16	049 – 064
E01 – 16	065 – 080
F01 – 16	081 – 096
G01 – 16	097 – 112
H01 – 16	113 – 128

3 Category (Main Category <Sub Category>)

Indicates the Category of the selected Performance. “Category,” consisting of Main Category and Sub Category, is a keyword that indicates the instrument characteristics or the type of sound. Each Performance can be registered to a Main Category and its Sub Category. The Category settings can be edited in the General display (page 143) of the Performance Common Edit mode.

4 Performance name

Indicates the name of the current Performance.

5 Transmit Ch (MIDI Transmit Channel)

Indicates the Keyboard MIDI transmit channel. For information about how to set the value, see page 91.

6 Octave

Indicates Keyboard Octave setting set via the OCTAVE buttons. This parameter determines how much higher or lower the pitch of each key is compared to normal pitch.

7 Control Function

Indicates the status of the Knobs and Control Sliders on the panel. This is same as the Control Function window (page 136).

8 Voice name

Indicates the names of the Voices assigned to Parts 1 – 4.

9 [SF1] ARP1 – [SF5] ARP5 (Arpeggio 1 – 5)

The Arpeggio types are assigned to the buttons with the 8th note icon on the display tab. You can call them up by pressing these buttons any time during your keyboard performance. Assigning Arpeggio types to the buttons can be done from the Arpeggio display (page 139).

10 [SF6] INFO (Information)

Pressing this button calls up the Information window of the current Performance.

11 [F1] Play

Pressing this button returns from the previous display to the Performance Play display.

12 [F2] Voice

Pressing this button calls up the display (page 138) that lets you select a Voice for each Part and specify the note range it can be played from.

13 [F3] EG (Envelope Generator)

Pressing this button calls up the display (page 139) that contains the basic EG settings.

14 [F4] Arpeggio

Pressing this button calls up the display (page 139) that lets you set the Arpeggio related parameters.

15 [F6] Effect

Pressing this button calls up the Effect setup display (page 149) of the Performance Common Edit.

The [E] Indicator

When changing the value of the parameter in the Performance Play or Edit mode, the [E] (Edit Indicator) will appear on the top right corner of the LCD display. This gives a quick confirmation that the current Performance has been modified but not yet stored. To store the current edited status, follow the instructions on page 142.

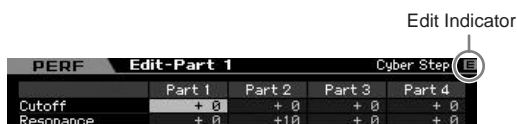

Performance information—[SF6] INFO (Information)

This display indicates the information of the current Performance. Settings cannot be changed here.

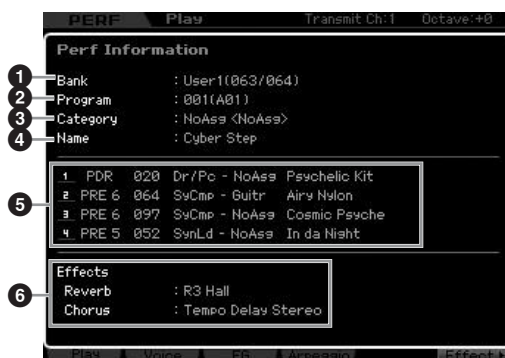

1 Bank

Indicates the Bank of the selected Performance program. The values in parentheses indicates the Bank Select MSB and LSB which can be used to select the current Voice via MIDI.

2 Program (Performance number)

To each Performance within a Bank, a Number of 001 to 128 is assigned. The values in parentheses indicates Group and Number.

3 Category

Indicates the Category of the selected Performance.

4 Name

Indicates the name of the current Performance.

5 Part 1 – 4

Indicates the Bank, Number, Main Category 1/2, and name of the Voice which is assigned to each Part.

6 Effects

Indicates Reverb and Chorus settings of the selected Performance.

Parameters for the Voice assigned to each Part—[F2] Voice

This display lets you specify the Voice and its note range of each Part. The setting made here will be applied to the same parameters in the Voice display (page 151) of Part Edit.

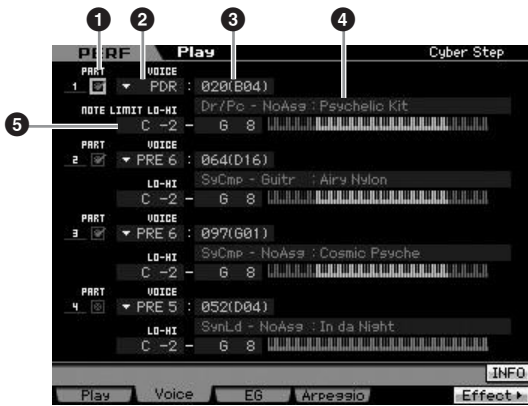

1 PART (Part Switch)

Determines whether the Part is used (on) or not used (off).

2 Voice Bank

3 Voice Number

4 Voice Name

Determines the Voice Bank and Number for each Part. The two category names of the selected Voice are shown at the Voice name column.

5 NOTE LIMIT LO-HI

Determines the lowest and highest notes in the Part's note range. You can also create a lower and an upper range for the Voice, with a note range "hole" in the middle, by specifying the highest note first. For example, setting a Note Limit of "C5 – C4" lets you play the Voice from two separate ranges: C -2 to C4 and C5 to G8. Notes played between C4 and C5 do not play the selected Voice.

Settings: C -2 – G8

NOTE You can also set the Key directly from the keyboard, by holding down the [SF6] KBD button and pressing the desired key. For details, see page 82.

Changing the tonal characteristics— [F3] EG (Envelope Generator)

This display lets you set the EG (Envelope Generator) and Filter. The settings made here will be applied to the same parameters in the EG display (page 157) of Part Edit as offset.



1 AEG (Amplitude EG)

Determines the transition in volume from the moment a key is pressed to the moment at which it is released. The AEG consists of four parameters: Attack time, Decay time, Sustain level, and Release time. For details, see page 94.

Settings: -64 – +0 – +63

2 FEG (Filter EG)

Determines the transition in tonal brilliance from the moment a key is pressed to the moment at which it is released. The FEG consists of four parameters: Attack time, Decay time, Release time, and Depth. For details, see page 94.

Settings: -64 – +0 – +63

3 Filter

You can produce a relatively bright or darker sound by reducing or enhancing the harmonics. There are two parameters: Cutoff (Cutoff Frequency) and Reso (Resonance). For details, see page 94.

Settings: -64 – +0 – +63

Arpeggio settings—[F4] Arpeggio

This display determines the basic settings of the Arpeggio. There are two types of parameters: Common parameters (Common Switch, Tempo and Sync Quantize Value indicated at the top of the display) and Part parameters (others). As for the Part parameters, five different Arpeggio types can be assigned to each of the four Parts, and are selectable with the [SF1] – [SF5] buttons. Press the appropriate [SF1] – [SF5] button to call up the desired Arpeggio/Part combination. Arpeggio related settings on the display are automatically assigned to the corresponding [SF1] – [SF5] buttons. The settings made here will be applied to the same parameters in the General Other display (page 145) of Common Edit, the Arpeggio Main display (page 154) and the Arpeggio Other display (page 156) of Part Edit.

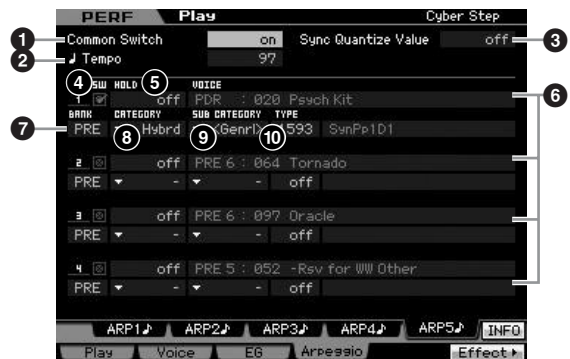

1 Common Switch

Determines whether Arpeggio is on or off. When calling up the Performance for which this parameter is set to on, the [ARPEGGIO ON/OFF] button on the panel will be turned on automatically.

Settings: on, off

- Voice mode
- Performance mode
- Sampling mode 1
- Song mode
- Pattern mode
- Mixing mode
- Sampling mode 2
- Master mode
- Utility mode
- File mode
- Reference

2 Tempo

Determines the Arpeggio Tempo. For details, refer to the Arpeggio Main display (page 154) of Part Edit.

3 Sync Quantize Value

Determines the actual timing at which the next Arpeggio playback starts when you trigger it while the Arpeggio of a certain Part is played back. When set to “off,” the next Arpeggio starts as soon as you trigger it. Note that the number shown at right of each value indicates the resolution in clocks.

Settings: off, 60 (32nd note), 80 (16th note triplet), 120 (16th note), 160 (8th note triplet), 240 (8th note), 320 (1/4 note triplet), 480 (1/4 note)

4 SW (Switch)

Determines whether Arpeggio is on or off for each Part.

NOTE When the [PERFORMANCE CONTROL] button is pressed so that its lamp is turned on, the Number buttons [5] – [8] can be used to turn the Arpeggio playback of Parts 1 – 4 on or off.

5 HOLD

This is the same as in the Arpeggio Main display (page 154) of Part Edit.

6 Voice Bank/Voice Number/Voice Name (Indication only)

Indicates the Bank, Number, and name of the Voice which is assigned to each Part. You can set them on the [F2] Voice display. Setting the Voice with ARP (7) to “on” in the Arpeggio Main display of the Performance Part Edit mode automatically selects the Voice matching the currently selected Arpeggio Type.

7 BANK

8 CATEGORY

9 SUB CATEGORY

10 TYPE

These are the same as in the Arpeggio Main display (page 154) of Part Edit.

Recording your keyboard performance in the Performance mode

[PERFORM] → [RECORD]

You can record your keyboard performance in the Performance mode to a Song or Pattern. Knob operations (with the exception of some parameters described on page 61), controller operations and Arpeggio playback as well as your keyboard playing in the Performance mode can be recorded to the specified track as MIDI events.

CAUTION

Performance recording overwrites all tracks of the destination Song or Pattern Section. Please check whether or not the destination Song or Pattern Section contains data before recording. You can check whether or not each track contains data at the track status line on the

display. Select a Song or Pattern Section containing no data as the destination or save all the Song/Pattern data to the external USB memory storage device before recording.

Performance Recording procedure

Refer to page 31 in the Start Guide.



1 Sequencer Mode

Determines to which destination (Song or Pattern) your Performance playing will be recorded.

Settings: pattern, song

2 Pattern number (Song number)

Determines the Pattern or Song number as the destination for recording. The name of the selected Pattern or Song is indicated at the right of the number.

3 Section

Determines the Section as the destination for recording when the Sequencer Mode is set to “pattern.” Keep in mind that the data recorded to the selected destination Section will be overwritten and erased as soon as recording starts.

4 Section Length

Specifies the length of the Section when the Sequencer Mode is set to “pattern.”

Settings: 001 – 256

5 Time Signature (Meter)

Determines the time signature.

Settings: 1/16 – 16/16, 1/8 – 16/8, 1/4 – 8/4

6 Tempo

Determines the tempo for recording. While recording, the Arpeggio is played back at the tempo set here.

Settings: 5.0 – 300.0

NOTE When MIDI Sync (page 268) is set to “MIDI” or “auto,” “MIDI” or “auto” is displayed here and Tempo cannot be set.

NOTE When the Sequencer Mode (1) is set to “pattern,” the Tempo setting here will be recorded to the Pattern. Even if the destination Pattern contains already recorded data, the Tempo value will be replaced by the newly recorded one. When the Sequencer Mode (1) is set to “song,” the Tempo setting here will be recorded to the Tempo track of the destination Song, if the Tempo track contains no data.

7 Key On Start Switch

When set to on, recording starts immediately when you press any note on the keyboard.

Settings: on, off

8 Copy Performance Parameters

Determines whether or not the Performance parameter settings are copied to the Mixing of the destination Song or Pattern.

Settings: on, off

9 Measure (Indication only)

Indicates the current location of the recording via Measure and Beat.

10 Track Status (Indication only)

Indicates whether each track of the selected Song or Pattern section contains sequence data or not.

11 [SF1] ARP1 – [SF5] ARP5 (Arpeggio 1 – 5)

The Arpeggio types are assigned to the Sub Function buttons with the 8th note icon on the display tab. You can call them up by pressing these buttons any time while recording. The Arpeggio Type can be set in the Arpeggio display (page 139).

Editing a Performance

The Performance Edit mode lets you create your own original Performances—containing up to four different Parts (Voices)—by editing the various parameters. To enter the Performance Edit mode, press the [PERFORM] button to enter the Performance mode, then press the [EDIT] button.

Common Edit and Part Edit

Each performance can contain a maximum of four Parts, There are two types of Performance Edit displays: those for Common Edit to edit the settings common to all four Parts, and those for editing individual Parts.

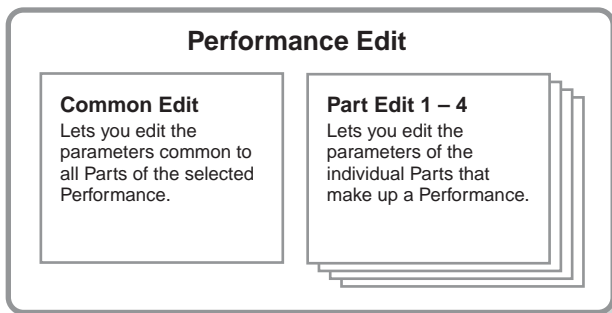

To call up the Common Edit display, press the [COMMON EDIT] button. To call up the Part Edit display, press any of the Number buttons [1] – [4]. In the Part Edit mode, you can select the desired Part by using the Number buttons [1] – [4].

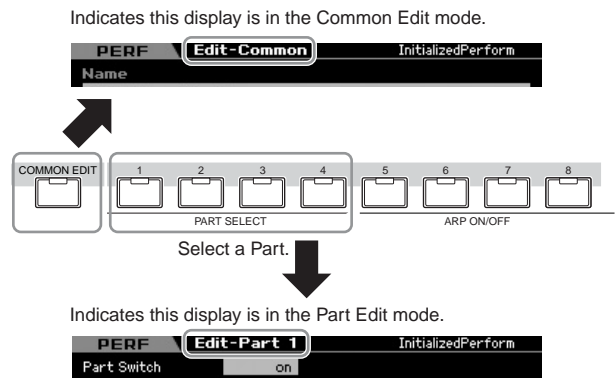

4 Call up the desired display.

To find the desired display, note the tab menu items corresponding to the [F1] – [F6] buttons and [SF1] – [SF5] buttons. Each tab menu of the [F1] – [F6] buttons contains sub menus which correspond to the [SF1] – [SF5] buttons at the bottom of the display.



Tab menu corresponding to the [F1] – [F6] buttons

Tab menu corresponding to the [SF1] – [SF6] buttons

5 Move the cursor to the desired parameter.

Performance Edit Procedure

- 1 Press the [PERFORM] button to enter the Performance Play mode, then select a Performance to be edited.
- 2 Press the [EDIT] button to enter the Performance Edit mode.
- 3 Call up the desired Edit display, Common Edit or Part Edit.

6 Edit the value by using the [INC/YES], [DEC/NO] buttons and the data dial.

7 Repeat steps 3 – 6 as desired.

8 Enter the desired name for the edited Performance.

Use the Name display (page 143) of the Performance Common Edit mode.

9 Store the edited Performance.

Press the [STORE] button to call up the Store window (page 142) then store the edited Performance.

CAUTION

The edited Performance will be lost when selecting the different Performance or turning the power off. Make sure to store the Performance data to the internal memory by pressing the [STORE] button before selecting a different Performance or turning the power off.

NOTE If desired, save the edited and stored Performances to a USB storage device connected to the USB TO DEVICE connector or a computer connected to the network to which the MOTIF XS is also connected. Keep in mind that edited Performance data is stored to internal User memory (Flash ROM) and is stored even when turning the power off. As such it is not necessary to save the data to an external device; however, we still recommend that you save or archive all important data to an external device. Refer to page 278 for details.

Convenient functions for editing Performances

Turning specific Parts on/off (Mute function)

This is the same as in the Performance Play mode (page 135).

Soloing a specific Part

This is the same in the Performance Play mode (page 135).

The [E] Indicator

This is the same as in the Performance Play mode. See page 138.

Compare function

The Compare function lets you switch between the just-edited Performance and its original, unedited condition, allowing you to hear how your edits affect the sound.

1 In the Performance Edit mode, press the [EDIT] button to call up the Compare mode.

In the Performance Edit mode (with the [EDIT] lamp lit), press the [EDIT] button so that its lamp flashes. The [E] indicator at the top right of the screen will change to the [C] indicator and the Performance settings prior to editing will temporarily be reinstated for comparison purposes. When the [E] indicator is shown in the Performance Play mode, press the [EDIT] button to enter the Performance Edit mode then press the [EDIT] button again to call up the Compare mode.

Compare indicator (sound prior to editing)

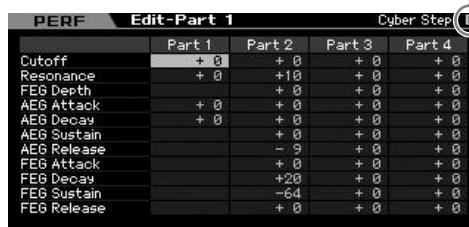

2 Press the [EDIT] button again to return to the original status.

When the [C] indicator is shown at the right top of the display, press the [EDIT] button (the lamp lights continuously, and the [C] indicator changes back to the [E] indicator).

Compare the edited sound with the unedited sound as desired by repeating steps 1 and 2.

Storing the created Performance

1 Press the [STORE] button to call up the Performance Store window.



2 Set the destination for storing the Performance.

Select a Performance Bank and Number as destination by using the data dial, [INC/YES] and [DEC/NO] buttons.

You can also use the [USER 1] – [USER 3], Group [A] – [H], and Number [1] – [16] buttons to specify the destination.

3 Press the [ENTER] button. (The display prompts you for confirmation.)

To cancel the Store operation, press the [DEC/NO] button.

4 To execute the Store operation, press the [INC/YES] button.

After the Performance has been stored, a “Completed” message appears and operation returns to the Performance Play display.

⚠ CAUTION

When you execute the Store operation, the settings for the destination memory will be overwritten. Important data should always be saved to a USB storage device connected to the USB TO DEVICE terminal or to a computer connected to the same network as the MOTIF XS. For detailed instructions on saving, see page 278.

Common Edit parameters

[PERFORM] → Performance selection → [EDIT] → [COMMON EDIT]

Common Edit lets you edit the parameters common to all Parts of the selected Performance. This covers all parameters of the Common Edit.

About the asterisk (*) marks

For users who are new to editing and may be confused by the large amount of parameters, the most basic and easy-to-understand parameters are conveniently marked with asterisks in this section. If you are just starting out with editing a Performance, try these parameters first.

General Settings for the selected Performance—[F1] General

Naming the edited Performance—[SF1] Name

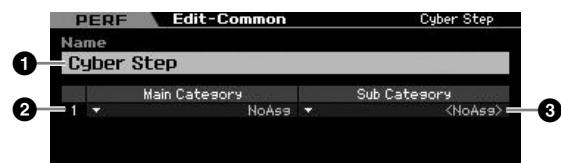

1 Name*

Enter the desired name for the currently edited Performance. The Performance name can contain up to 10 characters. You can call up the Character List by pressing the [SF6] CHAR button and enter the name. For detailed instructions on naming, refer to “Basic Operation” on page 82.

2 Main Category*

3 Sub Category*

Determines the Main Category and Sub Category of the Performance. “Category” can be used as a keyword representing the characteristic of the Performance. The appropriate setting makes it easy to find the desired Performance from a variety of Performances. The Main Category indicates the types of instruments and is divided into Sub Categories.

Settings: See the following list.

Performance Category

Main		Sub			
Rock	Rock / Pop	Top40	Top40		
		Clsic	Classic Rock		
		Hard	Hard Rock		
		Cntry	Country		
		Blues	Blues		
		Folk	Folk		
		Balad	Ballad		
		Film	Film		
		NoAsg	No Assignment		
		R&B	R&B / Hip Hop	HipHp	Hip Hop
Modrn	Modern R&B				
Clsic	Classic R&B				
Funk	Funk				
NoAsg	No Assignment				
Elect	Electronic			Tekno	Techno
		Trnce	Trance		
		House	Dance Pop / House		
		D&B	Breakbeats / D&B		
		Chill	Chillout / Ambient		
		NoAsg	No Assignment		
		Jazz	Jazz	Swing	Swing
				Modrn	Modern Jazz
Smoth	Smooth Jazz				
JzFnk	Jazz Funk				
Club	Club Jazz				
NoAsg	No Assignment				
World	World	Latin	Latin		
		Regae	Reggae / Dancehall		
		Ethno	Ethnic / World		
		NoAsg	No Assignment		
SpLyr	Splits & Layers	Piano	Piano		
		Organ	Organ		
		Synth	Synth		
		Symph	Symphonic		
		Strng	Strings		

Main		Sub	
SpLyr	Splits & Layers	WWind	Woodwind
		Brass	Brass
		Guitr	Guitar
		Bass	Bass
		Cperc	Chromatic Percussion
		Pad	Pad
		NoAsg	No Assignment
FX	FX	Seq	Sequence
		Hard	Hard
		Soft	Soft
		S.EFX	Sound Effect
		NoAsg	No Assignment
NoAsg	No Assignment	NoAsg	No Assignment

NOTE You can call up the list and select the desired item by pressing the [SF6] LIST button. For details, see page 82.

Portamento settings—[SF2] Porta

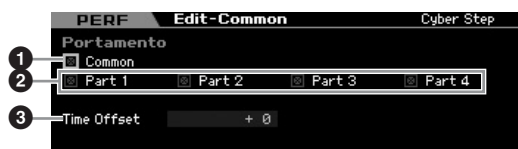

1 Portamento Common*

Determines whether or not Portamento is applied to the current Performance. When this is set to on, Portamento is applied to the Part for which the Part Switch parameter is set to on.

2 Portamento Part 1 – 4*

Determines whether Portamento is applied to each Part or not.

3 Portamento Time Offset*

Determines the pitch transition time when Portamento is applied. You can adjust Portamento time for the Voice assigned to each Part as offset. Higher values result in a longer pitch change time.

Settings: -64 – +63

EQ settings for each Part—[SF3] Part EQ

From this display, you can edit the value on the [F5] EQ display (page 158) as offset to change the tonal characteristic.

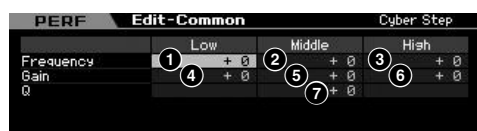

This is a three-band (Low, Mid, High) parametric EQ. The High band and Low band are the shelving type. The Middle band is the peaking type.

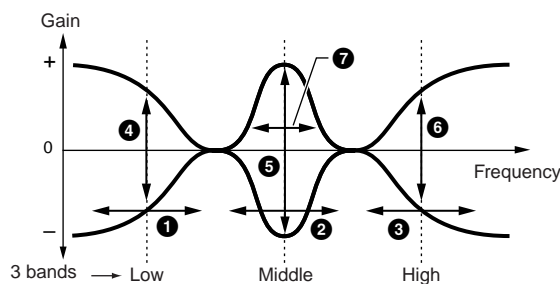

Frequency

Determines the center frequency. Frequencies around each of three points are attenuated/boosted by the Gain setting below. Higher values produce a higher frequency.

Settings: -64 – +63

1 Low Frequency

Determines the center frequency of the lower EQ band.

2 Mid Frequency

Determines the center frequency of the middle EQ band.

3 High Frequency

Determines the center frequency of the higher EQ band.

Gain

Determines the level gain for each frequency (set above), or the amount the selected frequency band is attenuated or boosted.

Settings: -64 – +63

4 Low Gain

Determines the amount by which signals below the Low Frequency (1) will be boosted/attenuated.

5 Mid Gain

Determines the amount at which signals at the Mid Frequency (2) will be boosted/attenuated.

6 High Gain

Determines the amount by which signals above the High Frequency (3) will be boosted/attenuated.

7 Q (Bandwidth)

Determines the frequency bandwidth for each frequency band. The larger the setting, the greater the bandwidth. The lower the setting, the smaller the bandwidth.

Settings: -64 – +63

Other settings—[SF4] Other

From this display, you can set the control functions for the Knobs, and the up/down range for the Pitch Bend wheel.



1 Knob Control Assign

Determines which lamp among the TONE 1, TONE 2, ARP FX, REVERB, CHORUS and PAN is turned on when selecting a Performance. This setting can be stored for each Performance.

Settings: tone1, tone2, ARP FX, reverb, chorus, pan

2 Assign 1 Value

3 Assign 2 Value

Indicates the level of the Knobs printed “ASSIGN1” and “ASSIGN2” at the time at which the Performance is selected with the TONE1 lamp turned on. The functions assigned to the Knobs are indicated at right of the values respectively.

Settings: -64 – +0 – +63

NOTE The functions assigned to the ASSIGN 1/2 Knobs can be set in the Controller Set display (page 104).

4 A. Function 1 Mode (Assignable Function 1 Mode)

5 A. Function 2 Mode (Assignable Function 2 Mode)

Determines whether the ASSIGNABLE FUNCTION [1] and [2] buttons functions as a latch type or momentary type. When set to “latch,” pressing the button alternates the lamp status between on and off. When set to “momentary,” pressing/holding the button turns the lamp on and releasing the button turns the lamp off.

Settings: momentary, latch

6 Ribbon Mode (Ribbon Controller mode)

Determines the behavior of the Ribbon Controller. When set to reset, releasing your finger from the Ribbon Controller automatically returns the value to the center. When set to hold, releasing your finger from the Ribbon Controller maintains the value at the last point of contact.

Settings: hold, reset

7 ARP Common Switch

Determines whether Arpeggio is on or off. This parameter is the same as the Common Switch parameter in the Arpeggio display (page 139) of the Performance Play mode.

8 ARP Sync Quantize Value

This parameter is the same as the Sync Quantize Value parameter in the Arpeggio display (page 139) of the Performance Play mode.

Output Level and Master Effect settings—[F2] Level/MEF

Output Level settings—[SF1] Level

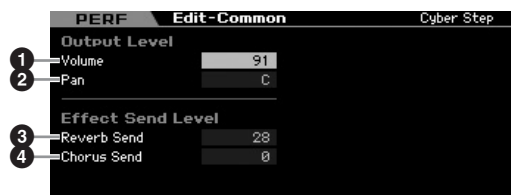

1 Volume*

Determines the output level of the entire Performance. You can adjust the overall volume, keeping the balance between all Parts.

Settings: 0 – 127

2 Pan*

Determines the stereo pan position of the Performance. You can also adjust this parameter using the PAN knob on the front panel.

Settings: L63 (far left) – C (center) – R63 (far right)

NOTE Note that this Performance Pan parameter may have little or no audible effect if the Pan for a specific Part is set to the left position and the Pan for another Part is set to the right position.

3 Reverb Send*

Adjusts the reverb send level. The higher the value the deeper the reverb. You can also adjust this parameter using the knob on the front panel.

Settings: 0 – 127

4 Chorus Send*

Adjusts the chorus send level. The higher the value the deeper the chorus. You can also adjust this parameter using the knob on the front panel.

Settings: 0 – 127

NOTE When Reverb Send/Chorus Send is set to “0” in the Performance Part Edit mode, the setting here is not available.

Voice mode

Performance mode

Sampling mode 1

Song mode

Pattern mode

Mixing mode

Sampling mode 2

Master mode

Utility mode

File mode

Reference

Master Effect settings—[SF2] MasterFX



NOTE Depending on the selected parameter, the LIST icon is shown at the tab menu corresponding to the [SF6] button. In this condition, you can call up the list by pressing the [SF6] LIST button, then select the desired item from the list. For details see page 82.

1 Switch

Determines whether Master Effect is applied or not to the selected Performance. You can turn it on or off by pressing the [MASTER EFFECT] button on the front panel.

Settings: on, off

2 Type

Selects an Effect Type. Details about the Effect types are described on page 70.

Settings: See the Effect Type list in the separate Data List booklet.

3 Preset

You can set various parameters in order to change how the sound is affected by the selected Effect type. This parameter lets you call up the pre-programmed settings of these effect parameters.

4 Effect Parameters

The number of parameters and values available differs depending on the currently selected effect type. Refer to page 73 for details about the Effect parameters. Refer to the separate Data List booklet for information on the parameters for each Effect type.

Master EQ settings—[SF3] MasterEQ

From this display you can apply five-band equalization to all Parts of the selected Performance.

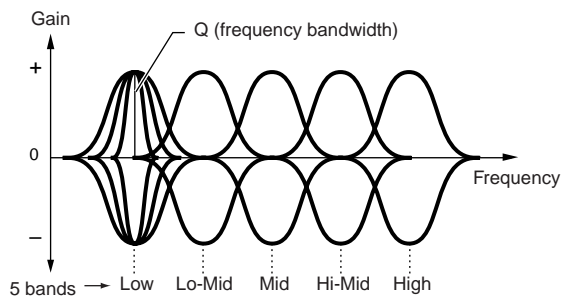
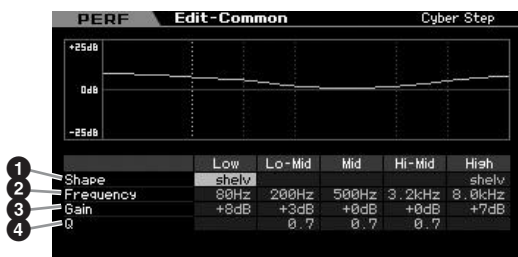

1 Shape

Enables you to select one of two equalizer shapes: shelving or peaking. This parameter is available for Low and High.

Settings: shelv, peak

shelv (Shelving type)

This type of EQ shape lets you attenuate/boost the signal at frequencies above or below the specified Frequency setting.

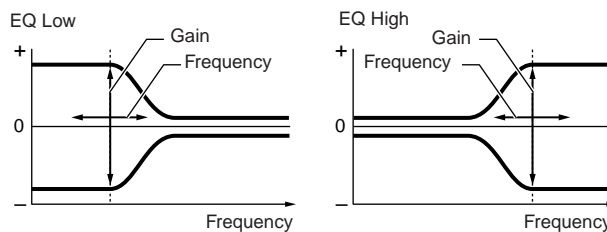

peak (Peaking type)

This type of EQ shape lets you attenuate/boost the signal at the specified Frequency setting.

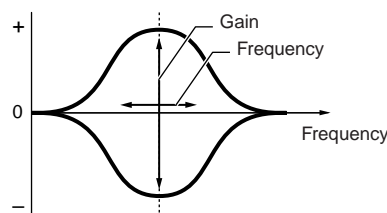

2 Frequency

Determines the center frequency. Frequencies around this point are attenuated/boosted by the Gain setting below.

Settings:

Low

When the Shape is set to "shelv": 32Hz – 2.0kHz

When the Shape is set to "peak": 63Hz – 2.0kHz

Lo-Mid, Mid, Hi-Mid

100 Hz – 10.0 kHz

High

500 Hz – 16.0 kHz

3 Gain

Determines the level gain for the Frequency (set above), or the amount the selected frequency band is attenuated or boosted.

Settings: -12dB – +0dB – +12dB

4 Q (Bandwidth)

This varies the signal level at the Frequency setting to create various frequency curve characteristics. The higher the setting the smaller the Q (Bandwidth). The lower the setting, the greater the Q (Bandwidth).

Settings: 0.1 – 12.0

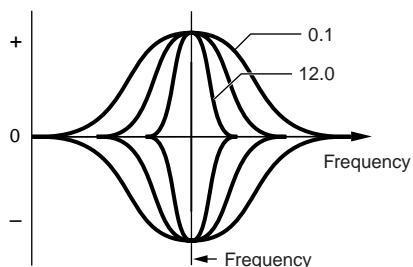

NOTE When the Shape parameters (1) of the Low and High are set to “shelv,” the Q parameters (4) of the Low and High are not available.

Controller settings—[F3] Ctrl Asgn (Controller Assign)

You can assign MIDI Control Change Numbers to the controllers and knobs on the front panel for the selected Performance. For example, you could use the ASSIGN 1 and 2 knobs to control effect depth, while using the Foot Controller to control modulation. These control assignments are called “Controller Assign.” You can have independent Controller Assign settings for each Performance.

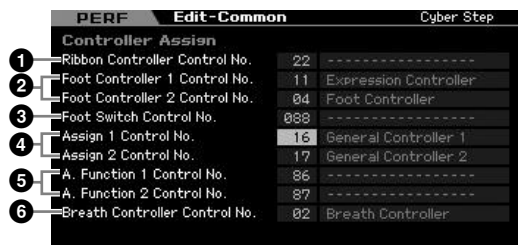

1 Ribbon Controller Control No.

Determines the Controller Change number generated when you run your finger across the surface of the Ribbon Controller.

Settings: 00 – 95

2 Foot Controller 1 Control No. Foot Controller 2 Control No.

Determines the Control Change number generated when you use the Foot Controller connected to the FOOT CONTROLLER jack.

Settings: 00 – 95

3 Foot Switch Control No.

Determines the Control Change number generated when you use the Footswitch connected to the FOOT SWITCH ASSIGNABLE jack.

Settings: 000 – 100

NOTE When a Control Change number of 96 or higher is selected, the function indicated to the right of the number is enabled for control, but no MIDI Control Change number is actually assigned to the Footswitch.

4 Assign 1 Control No. Assign 2 Control No.

Determines the Control Change number generated when you control the ASSIGN1 knob and ASSIGN2 knob with the TONE1 lamp turned on.

Settings: 00 – 95

5 A. Function 1 Control No. A. Function 2 Control No.

Determines the Control Change numbers generated when you press the ASSIGNABLE FUNCTION buttons.

Settings: 00 – 95

6 Breath Controller Control No.

Determines the Control Change number generated when you use a Breath Controller connected to the MIDI IN connector of this instrument.

Settings: 00 – 95

Audio In settings—[F4] Audio In

You can set parameters related to audio input from the A/D INPUT connector and the mLAN connector.

NOTE The mLAN Input (m1 – 14) is available only for the MOTIF XS8. This is available for MOTIF XS6/7 only when an optional mLAN16E2 has been installed.

Output Settings—[SF1] Output

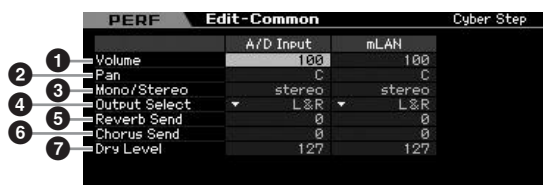

1 Volume

Determines the output level of the Audio Input Part.

Settings: 0 – 127

2 Pan

Determines the stereo pan position of the Audio Input Part.

Settings: L63 (far left) – C (center) – R63 (far right)

3 Mono/Stereo

Determines the signal configuration for the Audio Input Part, or how the signal or signals are routed (stereo or mono).

Settings: L mono, R mono, L+R mono, stereo

L mono

Only the L channel of the audio input is used.

Voice mode
Performance mode
Sampling mode 1
Song mode
Pattern mode
Mixing mode
Sampling mode 2
Master mode
Utility mode
File mode

R mono

Only the R channel of the audio input is used.

L+R mono

The L and R channels of the audio input are mixed and processed in mono.

stereo

Both the L and R channels of the audio input are used.

4 Output Select

Determines the output jack assignment for the Audio Input Part.

Settings: See the table below.

LCD	Output jacks	Stereo/Mono
L&R	OUTPUT L and R	Stereo
asL&R	ASSIGNABLE OUTPUT L and R	Stereo
m1&2	mLAN OUTPUT 1 and 2	Stereo (1: L, 2: R)
m3&4	mLAN OUTPUT 3 and 4	Stereo (3: L, 4: R)
m5&6	mLAN OUTPUT 5 and 6	Stereo (5: L, 6: R)
m7&8	mLAN OUTPUT 7 and 8	Stereo (7: L, 8: R)
m9&10	mLAN OUTPUT 9 and 10	Stereo (9: L, 10: R)
m11&12	mLAN OUTPUT 11 and 12	Stereo (11: L, 12: R)
m13&14	mLAN OUTPUT 13 and 14	Stereo (13: L, 14: R)
asL	ASSIGNABLE OUTPUT L	Mono
asR	ASSIGNABLE OUTPUT R	Mono
m1	mLAN OUTPUT 1	Mono
:	:	:
m14	mLAN OUTPUT 14	Mono
ins L (A/D input only)	Internal Vocoder Module	Mono

NOTE You can call up the list and select the desired item by pressing the [SF6] LIST button. For details, see page 82.

5 Reverb Send

Determines the Send level of the Audio Input Part signal sent to the Reverb effect. The higher the value, the deeper the reverb.

Settings: 0 – 127

6 Chorus Send

Determines the Send level of the Audio Input Part signal sent to the Chorus effect. The higher the value, the deeper the Chorus.

Settings: 0 – 127

7 Dry Level

Determines the level of the Audio Input Part which has not been processed with the System Effects (Reverb, Chorus). The higher the value, the shallower the Reverb and Chorus.

Settings: 0 – 127

Insertion Effect Connection of A/D Input —[SF2] Connect

From this display, you can set the Insertion Effect Types applied to the Audio Input signal in the Performance mode. The System Effect can be set in the Effect display (page 149). Keep in mind that the Insertion Effect cannot be applied to the audio input signal via the mLAN connector.

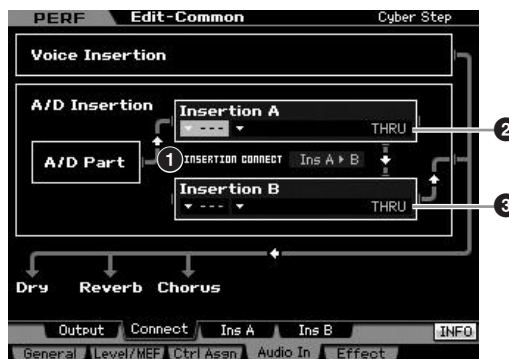

1 INSERTION CONNECT (Insertion Connection)

From this display you can set the effect routing for Insertion effects A and B. The setting changes are shown on the diagram in the display, giving you a clear picture of how the signal is routed.

Settings: Ins A ► B, Ins B ► A

Ins A ► B (A to B)

Signals processed with the Insertion Effect A will be sent to the Insertion Effect B and signals processed with the Insertion Effect B is sent to Reverb and Chorus.

Ins B ► A (B to A)

Signals processed with the Insertion Effect B will be sent to the Insertion Effect A and signals processed with the Insertion Effect B is sent to Reverb and Chorus.

2 Insertion A (Insertion A Category/Type)*

3 Insertion B (Insertion B Category/Type)*

Determines the Effect type for Insertion A and B. From the Category column, you can select one of the Effect Categories, each of which contains similar Effect types. From the Type column, you can select one of the Effect Types listed in the selected Category.

Settings: Details about the Effect categories and types are described on page 70.

NOTE You can call up the list by pressing the [SF6] LIST button then select the desired one from the list. For details, see page 82.

Effect Parameter settings—[SF3] Ins A, [SF4] Ins B



NOTE Depending on the selected parameter, the LIST icon is shown at the tab menu corresponding to the [SF6] button. In this condition, you can call up the list by pressing the [SF6] LIST button, then select the desired item from the list. For details see page 82.

1 Category

2 Type

From the Category column, you can select one of the Effect Categories each of which contains similar Effect types. From the Type column, you can select one of the Effect Types listed in the selected Category.

Settings: Details about the Effect categories and types are described on page 70.

3 Preset

You can set various parameters in order to change how the sound is affected by the selected Effect type. This parameter lets you call up the pre-programmed settings of these effect parameters.

4 Effect Parameters

The number of parameters and values available differs depending on the currently selected effect type. Refer to page 73 for details about the Effect parameters. Refer to the separate Data List booklet for information on the parameters for each Effect type.

Effect settings—[F5] Effect

From the following displays, you can set the Effect connection and values of other parameters. For details about the structure in the Performance mode, see page 69.

Effect Connection settings—[SF1] Connect

This display gives you at-a-glance, overall view of the effect routing and comprehensive control over the effects.

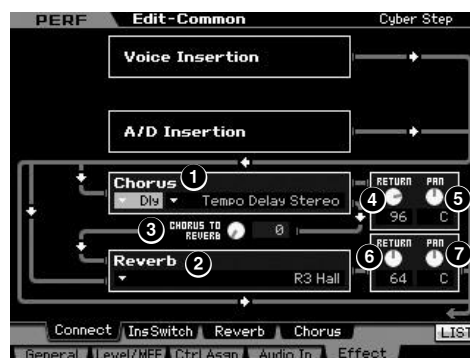

NOTE Depending on the selected parameter, the LIST icon is shown at the tab menu corresponding to the [SF6] button. In this condition, you can call up the list by pressing the [SF6] LIST button, then select the desired item from the list. For details see page 82.

1 Chorus (Chorus Category/Type)

Selects a Chorus Effect type after selecting a category. From the Category column, you can select one of the Effect categories, each of which contains similar Effect types. From the Type column, you can select one of the Effect types listed in the selected category.

Settings: Details about the Effect categories and types are described on page 70.

2 Reverb (Reverb Type)

Determines the Reverb Effect type. It is not necessary to select a Category because there is only one category in Reverb.

Settings: Details about the Effect types are described on page 70.

3 CHORUS TO REVERB

Determines the Send level of the signal sent from the Chorus Effect to the Reverb Effect. The higher the value, the deeper the Reverb that is applied to the Chorus-processed signal.

Settings: 0 – 127

4 Chorus Return

Determines the Return level of the Chorus Effect.

Settings: 0 – 127

5 Chorus Pan

Determines the pan position of the Chorus effect sound.

Settings: L63 (far left) – C (center) – R63 (far right)

6 Reverb Return

Determines the Return level of the Reverb Effect.

Settings: 0 – 127

7 Reverb Pan

Determines the pan position of the Reverb effect sound.

Settings: L63 (far left) – C (center) – R63 (far right)

Setting the parts available for the Insertion Effect—[SF2] InsSwitch

In this display, you can select which Parts (from Performance Parts 1 – 4 and the A/D Input Part) will be assigned to the eight Insertion Effects.



1 Part 1 – 4, A/D

Determines the Parts available for the Insertion Effect. When this switch is set to on, the Insertion Effect of the Voice assigned to the Part is enabled. Make sure that this parameter is set to on for any Parts/Voices to which you need to apply Insertion Effects. The MOTIF XS features eight Insertion effect systems, letting you set this parameter to on for all five Parts.

NOTE For the A/D Input Part, the Insertion Effect type/parameter can be set from the Insertion A/B display in the Audio In parameter of the Performance Common Edit mode. For Parts 1 – 4, the Insertion Effect type/parameter settings cannot be set in the Performance Edit mode because their settings are included in the Voice assigned to each Part. If you wish to edit the Insertion Effect settings for each Part, enter the Voice Edit mode, then edit the Effect settings for the appropriate Voice.

Reverb and Chorus Settings—[SF3] Reverb, [SF4] Chorus



NOTE Depending on the selected parameter, the LIST icon is shown at the tab menu corresponding to the [SF6] button. In this condition, you can call up the list by pressing the [SF6] LIST button, then select the desired item from the list. For details see page 82.

1 Type

From the Type column, you can select one of the Effect Types listed in the selected Category.

Settings: Details about the Effect types are described on page 70.

2 Preset

You can set various parameters in order to change how the sound is affected by the selected Effect type. This parameter lets you call up the pre-programmed settings of these effect parameters.

3 Effect Parameters

The number of parameters and values available differs depending on the currently selected effect type. Refer to page 73 for details about the Effect parameters. Refer to the separate Data List booklet for information on the parameters for each Effect type.

Part Edit parameters

[PERFORM] → Performance selection → [EDIT] → Part selection

In the Performance Part Edit mode, you can edit the parameters of the individual Parts such as Voice, Arpeggio, EG and EQ settings.

About the asterisk (*) marks

For users who are new to editing and may be confused by the large amount of parameters, the most basic and easy-to-understand parameters are conveniently marked with asterisks in this section. If you are just starting out with editing Performance Parts, try these parameters first.

Selected Part display/Four-Part display

In the Performance Part Edit mode, you can use two types of display. One type of display lets you edit parameters for the currently selected Part and the other type of display lets you view parameters for four Parts. You can switch between these two types by pressing the [SF5] button. Note that the display for four Parts is not available for the [F2] ARP Main and the [F3] ARP Other displays.

The display for the currently selected Part

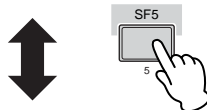

The display for all four Parts of the current Performance

Selecting a Part to be edited

After pressing the [PERFORMANCE CONTROL] or [TRACK] button so that its lamp lights, press one of the [1] – [4] buttons to select a Part to be edited.

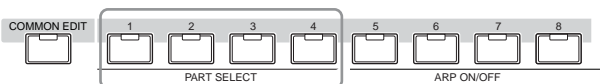

Selecting a Part

NOTE For details about useful functions such as Mute/Solo and Jobs, see pages 142 and 159.

Setting the Wave and Note range of the Part—[F1] Voice

Voice Settings for each Part—[SF1] Voice



1 Part Switch*

Determines whether the currently edited Part is on or off. When this is set to off, the currently edited Element will not sound.

Settings: off (inactive), on (active)

2 Bank*

3 Number*

Determines the Voice assigned to the current Part by specifying the Voice Bank and Number.

NOTE You can call up the list and select the desired item by pressing the [SF6] LIST button. For details, see page 82.

4 Param. with Voice (Parameter with Voice)

Determines whether or not the following parameter settings of the selected Voice are copied from the Voice to the current Part when you change a Voice for the current Part individually.

- Arpeggio settings
- Filter Cutoff Frequency
- Filter Resonance
- Amplitude EG
- Filter EG
- Pitch Bend Range (Upper/Lower)
- Note Shift

NOTE Regardless of the Parameter with Voice setting (4), the settings of Mono/Poly (10), Portamento Part Switch (11), Portamento Time (12) and Portamento Mode (13) are not

Voice mode
Performance mode
Sampling mode 1
Sampling mode 2
Song mode
Pattern mode
Mixing mode
Master mode
Utility mode
File mode
Reference

copied when a Drum Voice is selected. However, these parameters are copied when a Normal Voice is selected.

Settings: off (not copied), on (copied)

5 Volume*

Determines the volume for each Part. Use this parameter to adjust the balance between the current Part and other Parts.

Settings: 0 – 127

6 Pan*

Determines the stereo pan position for the Part.

Settings: L63 (far left) – C (center) – R63 (far right)

NOTE Note that this Part Pan parameter may have little or no audible effect if the Pan for a specific Element is set to the left position and the Pan for another Element is set to the right position.

7 Voice Element Pan

Determines whether the individual pan settings for each Voice (made in the Voice Element Edit mode) are applied or not. When this is set to “off,” the basic pan position for the selected Part is set to center.

Settings: on, off

8 Note Shift*

Adjusts the pitch of the Part in semitones.

Settings: -24 – +0 – +24

9 Detune

Adjusts the tuning of the Part in cent increments.

Settings: -12.8 Hz – +0 Hz – +12.7 Hz

10 Mono/Poly*

Determines the playback method of the Voice for each Part—monophonic (single note only) or polyphonic (multiple notes).

Settings: mono, poly

mono

When set to “mono,” the selected Performance is played back monophonically (only a single note is played back simultaneously). For many instrument sounds (such as bass and synth lead), this allows a more natural and smooth sounding legato performance than when this parameter is set to “poly.”

poly

When set to “poly,” the selected Performance is played back polyphonically (multiple notes can be played back simultaneously or a chord is played back).

11 Portamento Part Sw*

Determines whether Portamento is applied to the current Performance or not.

Settings: off, on

12 Portamento Time*

Determines the pitch transition time. Higher values mean longer transition times.

Settings: 0 – 127

13 Portamento Mode

Determines how Portamento is applied to your keyboard performance.

Settings: fingered, fulltime

fingered

Portamento is only applied when you play legato (playing the next note before releasing the previous one).

fulltime

Portamento is applied to all notes.

14 Velocity Limit

Determines the minimum and maximum values of the velocity range within which each Part will respond. Each Part will only sound for notes played within its specified velocity range. If you specify the maximum value first and the minimum value second, for example “93 to 34,” there will be a velocity “hole” and the velocity range covered will be “1 to 34” and “93 to 127.”

Settings: 1 – 127

NOTE You can also set the velocity from the keyboard by holding down the [SF6] KBD button and pressing any key with the desired velocity (strength). For details, see page 82.

15 Note Limit

Set the lowest and highest notes of the keyboard range for each Part. Each Part will only sound for notes played within its specified range. You can also create a lower and an upper range for the Element, with a note range “hole” in the middle, by specifying the highest note first. For example, setting a Note Limit of “C5 – C4” lets you play the Element from two separate ranges: C -2 to C4 and C5 to G8. Notes played between C4 and C5 do not play the selected Element.

Settings: C -2 – G8

NOTE You can also set the Key directly from the keyboard, by holding down the [SF6] KBD button and pressing the desired key. For details, see page 82.

Output settings—[SF2] Output

From this display, you can set the Reverb/Chorus depth and the Output jack assignment for each Part.

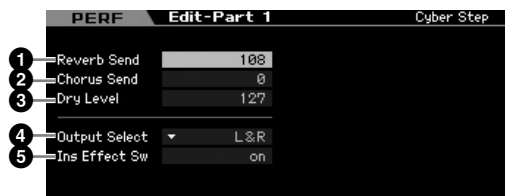

1 Reverb Send

Determines the Send level of each Part signal sent to the Reverb effect. The higher the value, the deeper the Reverb.

Settings: 0 – 127

2 Chorus Send

Determines the Send level of each Part signal sent to the Chorus effect. The higher the value, the deeper the Chorus.

Settings: 0 – 127

3 Dry Level

Determines the level of each Part which has not been processed with the System Effects (Reverb, Chorus). The higher the value, the shallower the Reverb and Chorus.

Settings: 0 – 127

4 Output Select

Determines the specific output(s) for the individual Part. You can assign each individual Part's Voice to be output from a specific hardware output jack on the rear panel.

Settings: See the table below.

LCD	Output jacks	Stereo/Mono
L&R	OUTPUT L and R	Stereo
asL&R	ASSIGNABLE OUTPUT L and R	Stereo
m1&2	mLAN OUTPUT 1 and 2	Stereo (1: L, 2: R)
m3&4	mLAN OUTPUT 3 and 4	Stereo (3: L, 4: R)
m5&6	mLAN OUTPUT 5 and 6	Stereo (5: L, 6: R)
m7&8	mLAN OUTPUT 7 and 8	Stereo (7: L, 8: R)
m9&10	mLAN OUTPUT 9 and 10	Stereo (9: L, 10: R)
m11&12	mLAN OUTPUT 11 and 12	Stereo (11: L, 12: R)
m13&14	mLAN OUTPUT 13 and 14	Stereo (13: L, 14: R)
asL	ASSIGNABLE OUTPUT L	Mono
asR	ASSIGNABLE OUTPUT R	Mono
m1	mLAN OUTPUT 1	Mono
:	:	:
m14	mLAN OUTPUT 14	Mono
drum	See below*	See below*

* About "drum" setting, see below.

When "drum" is selected and the Normal Voice is assigned to the edited Part, the sound will be output via the OUTPUT L and R jacks in stereo.

When "drum" is selected and the Drum Voice is assigned to the edited Part, the sound will be output via the jacks set in the Drum Key Edit display as the Output Select parameter.

NOTE The mLAN settings (m1 – m14) are available only for the MOTIF XS8. The mLAN settings are available for MOTIF XS6/7 only when an optional mLAN16E2 has been installed.

NOTE You can call up the list and select one by pressing the [SF6] LIST button. For details, see page 82.

5 Ins Effect Sw (Insertion Effect Switch)

Determines whether or not the current Part is available for the Insertion Effect. When this parameter is set to on, the Insertion Effect of the Voice assigned to the Part is enabled. You can set the Insertion Effect Switch parameter for all Parts (including the A/D Input part) from the Insertion Effect Switch display (page 150) in the Performance Common Edit mode.

Other Settings—[SF3] Other



1 PB Range Upper (Pitch Bend Range Upper) 2 PB Range Lower (Pitch Bend Range Lower)

Determines the maximum Pitch Bend range in semitones. Setting the Upper parameter to +12 would result in a maximum pitch rise of one octave when the Pitch Bend wheel is moved upwards. A Lower setting of -12 would result in the pitch being lowered up to a maximum of one octave (12 semitones) when the Pitch Bend wheel is moved downwards.

Settings: -48 – +0 – +24

3 Vel Sens Depth (Velocity Sensitivity Depth)

Determines the degree to which the resulting volume of the tone generator responds to your playing strength. The higher the value, the more the volume changes in response to your playing strength (as shown below). When this is set to 0, the volume remains the same no matter how strongly or softly you play. This would be useful, for example, for authentic playing of an Organ Voice.

Settings: 0 – 127

When Offset (below) is set to 64:

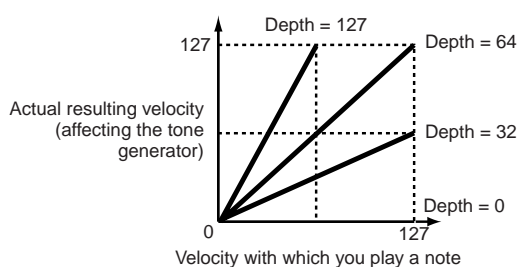

4 Velocity Sens Depth Offset (Velocity Sensitivity Depth Offset)

Determines the amount by which played velocities are adjusted for the actual resulting velocity effect. This lets you raise or lower all velocities by the same amount—allowing you to automatically compensate for playing too strongly or too softly. If the result is 0 or less, the value is set to 0. If the result is higher than 127, the value is set to 127.

Settings: 0 – 127

- Voice mode
- Performance mode
- Sampling mode 1
- Song mode
- Pattern mode
- Mixing mode
- Sampling mode 2
- Master mode
- Utility mode
- File mode
- Reference

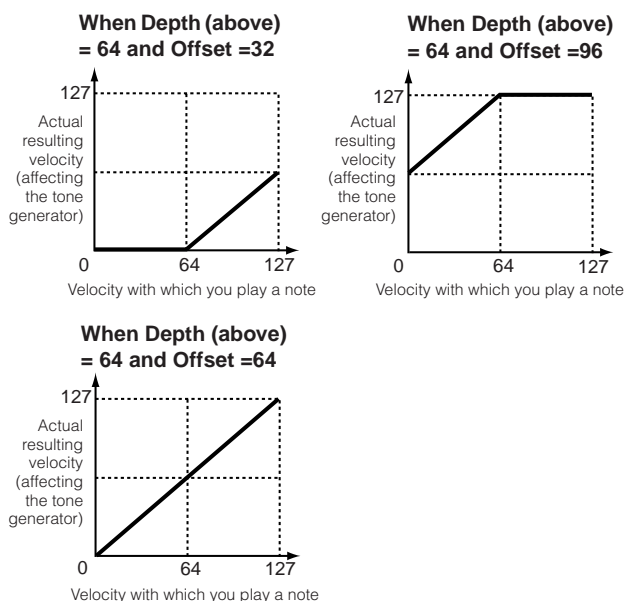

Arpeggio Settings—[F2] ARP Main (Arpeggio Main)

This display determines the basic settings of the Arpeggio. The settings of parameters (11 or more) shown at the bottom of the display can be registered to the [SF1] – [SF5] buttons.

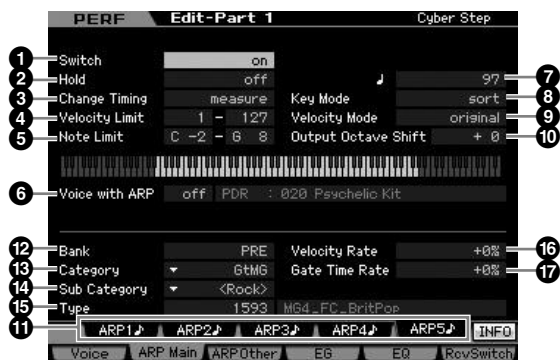

NOTE The Four-Part display cannot be called up from this display.

NOTE The KBD icon is shown on the tab corresponding to the [SF6] button depending on the selected parameter. In this condition, you can enter the note number or velocity by pressing the appropriate note on the keyboard while holding the [SF6] KBD button. For details, see page 82.

1 Switch*

Determines whether Arpeggio for each Part is on or off.

Settings: off, on

2 Hold*

When this is set to “on,” the Arpeggio cycles automatically, even if you release your fingers from the keys, and it continues to cycle until the next key is pressed.

Settings: sync-off (see below), off, on

sync-off

When set to “sync-off,” the Arpeggio playback continues to run silently, even when you release the keys. Pressing any key turns the Arpeggio playback on again.

NOTE For details about how to use the Arpeggio Type List in Data List 2 (separate online documentation), see page 63.

3 Change Timing*

Determines the actual timing at which the Arpeggio type is switched when you select another type during Arpeggio playback. When set to “realtime,” the Arpeggio type is switched immediately. When set to “measure,” the Arpeggio type is switched at the top of the next measure.

Settings: realtime, measure

4 Velocity Limit

Determines the lowest and highest velocity which can trigger the Arpeggio playback. This lets you set the velocity range with which you press the note to trigger the Arpeggio playback. You can also create separate low and high trigger ranges for the Arpeggio playback, with a velocity “hole” in the middle, by specifying the maximum value first. For example, setting a Velocity Limit of 93 – 34 lets you play the Arpeggio from two separate velocity ranges: soft (1 – 34) and hard (93 – 127). Notes played at middle velocities between 35 and 92 do not play the Arpeggio.

Settings: 1 – 127

NOTE Please keep in mind that no sound is produced when the Key Mode is set to “sort” or “thru” and notes are played outside the Note Limit setting here.

5 Note Limit

Determines the lowest and highest notes in the Arpeggio's note range. Notes played in this range trigger the Arpeggio. For example, setting a Note Limit of “C5 – C4” lets you trigger the Arpeggio by playing notes in the two ranges of C -2 to C4 and C5 to G8; notes played between C4 and C5 have no effect on the Arpeggio.

Settings: C -2 – G8

NOTE Please keep in mind that no sound is produced when the Key Mode is set to “sort” or “thru” and notes are played outside the Note Limit setting here.

6 Voice with ARP

To each type of the Arpeggio, the appropriate Voice is registered. This parameter determines whether or not the appropriate Voice registered to each Arpeggio type is assigned to the edited Part. When set to “on,” the appropriate Voice is assigned to the edited Part in place of the currently assigned Voice. When set to “off,” the appropriate Voice is not assigned to the edited Part. The currently assigned Voice is maintained. The name of the Voice registered to the Arpeggio Type is shown at the right side.

Settings: off (not copied), on (copied)

7 Tempo*

Determines the Arpeggio Tempo.

Settings: 5.0 – 300.0

NOTE If you are using this instrument with an external sequencer, MIDI computer, or other MIDI device, and you want to synchronize it with that device, set the MIDI sync (5) parameter in the MIDI display (page 267) of the Utility mode to “MIDI” or “auto.” In this case, the Tempo parameter here indicates “MIDI” or “auto” and cannot be changed.

8 Key Mode

Determines how the Arpeggio plays back when playing the keyboard.

Settings: sort, thru, direct, sort+direct, thru+direct

sort

When you play specific notes (for example, the notes of a chord), the same sequence plays, no matter what order you play the notes.

thru

When you play specific notes (for example, the notes of a chord), the resulting sequence differs depending on the order of the notes.

direct

Note events of the Arpeggio sequence do not play; only the notes you play on the keyboard are heard. When the Arpeggio plays back, the events such as Pan and Brightness are applied to the sound of your keyboard performance. Use this setting when the Arpeggio types includes non-note data or when the Category type “Ctrl” is selected.

sort+direct

The Arpeggio is played back according to the “sort” setting here, and the note pressed is also sounded.

thru+direct

The Arpeggio is played back according to the “thru” setting here, and the note pressed is also sounded.

NOTE Some Arpeggio types belonging to the “Cntr” Category may not have note events (page 65). When such an Arpeggio type is selected and the Key Mode is set to “sort” or “thru,” no sound is produced even if you press a note on the keyboard.

9 Velocity Mode

Adjusts the velocity of the Arpeggio notes.

Settings: original, thru

original

The Arpeggio plays back at the preset velocities included in the Arpeggio sequence data.

thru

The Arpeggio plays back according to the velocity of your playing. For example, if you play the notes strongly, the playback volume of the Arpeggio increases.

10 Output Octave Shift

Specifies the maximum Arpeggio range in octaves.

Settings: -10 – +10

11 [SF1] ARP1 – [SF5] ARP5 (Arpeggio 1 – 5) buttons

The six parameters Bank (12) through Gate Time Rate (17) at the lower half Part of the display, can be edited in each of the [SF1] ARP1 through [SF5] ARP5 displays. You can set the parameters in the lower half of the display for each of the five Arpeggio settings by pressing one of the [SF1] – [SF5] buttons. The 8th note icon shown in the tab menu indicates any Arpeggio Type (other than “off”) is selected in the display corresponding to the Sub Function button.

Settings: [SF1] – [SF5] (Sub Function) buttons

12 Bank*

Determines the Arpeggio Bank containing the desired Arpeggio type. Select “PRE” if you wish to select a preset Arpeggio Type. Select “USR” if you wish to select an Arpeggio Type you originally created and stored.

Settings: PRE, USR

NOTE For detailed instructions on creating your original Arpeggio type, see page 66.

13 Category*

14 Sub Category*

Determines the Arpeggio Category and Sub Category including the desired Arpeggio type. These parameters are available when “PRE” is selected as the Bank.

Settings: Refer to the Arpeggio Category List on page 62.

NOTE You can call up the list by pressing the [SF6] LIST button then select the desired item from the list.

NOTE For details about how to use the Arpeggio Type List in Data List 2 (separate online documentation), see page 63.

15 Type*

Determines the desired Arpeggio Type number from the specified Category. The name of the selected Arpeggio Type is shown at right of the specified number on the display. Refer to the Arpeggio Type List in Data List 2 (separate online documentation), described on page 6.

16 Velocity Rate

Determines the offset value by which the Arpeggio notes will be shifted from their original velocities. If the resultant velocity value is less than zero it will be set to 1, and if the resultant velocity is greater than 128 it will be set to 127. This parameter can be changed via the Knob directly.

Settings: -100% – +0% – +100%

17 Gate Time Rate

Determines the Gate Time (length) of the Arpeggio notes. The Gate Time cannot be decreased beyond its normal minimum of 1; any values outside that range will automatically be limited to the minimum.

This parameter can be changed via the Knob directly.

Settings: -100% – +0% – +100%

Voice mode

Performance mode

Sampling mode 1

Song mode

Pattern mode

Mixing mode

Sampling mode 2

Master mode

Utility mode

File mode

Reference

Arpeggio settings—[F3] ARP Other (Arpeggio Other)

By changing the timing and velocity of the notes, you can change the rhythmic “feel” of the Arpeggio playback.



NOTE The Four-Part display cannot be called up from this display.

1 Unit Multiply

Adjusts the Arpeggio playback time based on tempo. By using this parameter, you can create a different Arpeggio type from the original one. For example, if you set a value of 200%, the playback time will be doubled (tempo is halved). On the other hand, if you set a value of 50%, the playback time will be halved and the tempo doubled. Normal playback time is 100%. This parameter can be changed via the Knob directly.

Settings: 50%, 66%, 75%, 100%, 133%, 150%, 200%

2 Quantize Value*

Determines to what beats the note data in the Arpeggio sequence data will be aligned, or determines to what beats in the Arpeggio sequence data the swing is applied. This parameter can be changed via the Knob directly. The number shown at right of each value indicates the length assumes that the quarter-note resolution is 480.

Settings: 60 (32nd note), 80 (16th note triplet), 120 (16th note), 160 (8th note triplet), 240 (8th note), 320 (1/4 note triplet), 480 (1/4 note)

3 Quantize Strength

Sets the “strength” by which note events are pulled toward the nearest quantize beats. A setting of 100% produces exact timing set via the Quantize Value parameter above. A setting of 0% results in no quantization. A setting of 50% results in the note events being pulled halfway between 0% and 100%. This parameter can be changed via the Knob directly.

Settings: 0% – 100%

4 Swing*

Delays notes on even-numbered beats (backbeats) to produce a swing feel. Settings above 1 delay the Arpeggio notes, whereas settings below 1 advance them. A setting of 0 produces exact timing set via the Quantize Value, resulting in no swing. Judicious use of this setting lets you create swing rhythms and triplet feels, such as shuffle and

bounce. This parameter can be changed via the Knob directly.

Settings: -120 – +120

5 Velocity Rate

Determines how much the velocity of the Arpeggio playback is offset from the original value. For example, a setting of 100% means the original values are used. Settings below 100% will reduce the velocities of the Arpeggio notes, whereas settings above 100% will increase the velocities. If the resultant velocity value is less than zero it will be set to 1, and if the resultant velocity is greater than 128 it will be set to 127. This parameter can be changed via the Knob directly.

Settings: 0% – 200%

6 Gate Time Rate

Determines how much the Gate Time (length) of the Arpeggio notes is offset from the original value. For example, a setting of 100% means the original values are used. Settings below 100% will reduce the velocities of the Arpeggio notes, whereas settings above 100% will increase the velocities. The Gate Time cannot be decreased beyond its normal minimum of 1; any values outside that range will automatically be limited to the minimum. This parameter can be changed via the Knob directly.

Settings: 0% – 200%

7 Octave Range

Specifies the maximum Arpeggio range in octaves. Positive value settings increase the octave range of the Arpeggio playback upward, whereas negative value settings increase it downward. This parameter can be changed via the Knob directly.

Settings: -3 – +0 – +3

8 Loop

When this is set to “on,” the Arpeggio cycles while notes are held. When this is set to “off,” the Arpeggio plays only once even if notes are held.

Settings: off, on

9 Trigger Mode

When this is set to “gate,” pressing the note starts Arpeggio playback and releasing the note stops it. When this is set to “toggle,” pressing the note starts/stops Arpeggio playback and releasing the note does not affect Arpeggio playback. Normally, this parameter should be set to “gate.”

Settings: gate, toggle

NOTE The Trigger Mode “toggle” setting overcomes the Hold “on” setting in the Arpeggio Main display (page 154). In other words, even when the Hold parameter is set to “on,” pressing the note start/stops Arpeggio playback when the Trigger Mode is set to “toggle.”

10 Accent Vel Threshold (Accent Velocity Threshold)

Some preset Arpeggio types include the special sequence data called “Accent Phrase,” which will be played back only when the velocities higher than a specified value are received. This parameter determined the minimum velocity that will trigger the Accent Phrase.

Settings: off, 1 – 127

11 Accent Start Quantize

Determines the start timing of the Accent Phrase when the Velocity specified in Accent Vel Threshold above is received. When set to off, the Accent Phrase starts as soon as the Velocity is received. When set to on, the Accent Phrase starts on the beat specified for each Arpeggio type after the Velocity is received.

Settings: off, on

12 Random SFX

Some Arpeggio types feature the Random SFX function which will trigger the special sound such as fret noise of the guitar when the note is released. This parameter determines whether the Random SFX is active or not.

Settings: off, on

13 Random SFX Velocity Offset

Determines the offset value by which the Random SFX notes will be shifted from their original velocities. If the resultant velocity value is less than zero it will be set to 1, and if the resultant velocity is greater than 128 it will be set to 127.

Settings: -64 – +0 – +63

14 Random SFX Key On Control

When this is set to “on,” the Random SFX special sound is played with the pre-programmed velocity. When this is set to “off,” the Random SFX special sound is played with the velocity generated when the note is pressed.

Settings: off, on

15 MIDI Out Switch (MIDI Output Switch)

When this is set to on, Arpeggio playback data is output from the MIDI terminal.

Settings: off (not output), on (output)

16 MIDI Out Channel (MIDI Output Channel)

Determines the MIDI transmit channel for Arpeggio playback data. When this is set to “kbd,” Arpeggio playback data is output via the MIDI transmit channel (page 137) set in the Performance Play mode.

Settings: 1 – 16, kbd (Keyboard Channel)

EG Settings—[F4] EG

You can control the sound transition from the moment a key is pressed to the moment at which it is released. You can also adjust the tone brilliance by setting the Cutoff Frequency and Resonance.



1 AEG (Amplitude EG)

Determines the AEG (Amplitude Envelope Generator) parameters for each Part. The following parameters can be used to control the change in volume from the moment a note is pressed on the keyboard to the moment the sound stops. The setting made here will be applied to the AEG parameters (page 123) of each Voice as offset.

Attack (Attack Time)

Determines the speed of attack from the time a key is played until the maximum initial level of the EG is reached.

Decay (Decay Time)

Determines how fast the volume falls from maximum attack level to the sustain level.

Sustain (Sustain Level)

Determines the sustain level at which the volume will continue while a note is held, after the initial attack and decay.

Release (Release Time)

Determines how quickly the sound decays to silence after the key is released.

Settings: -64 – +0 – +63

NOTE When a Drum Voice is selected, Sustain Level and Release Time are not available.

2 FEG (Filter EG)

Determines the FEG (Filter Envelope Generator) parameters for each Part. Using the FEG, you can control the transition in tonal color (Cutoff Frequency) from the moment the sound starts to the moment it stops. The setting made here will be applied to the FEG parameters (page 119) of each Voice as offset.

Attack (Attack Time)

Determines the speed of filter variation from the time a note is played until the maximum initial level of the Cutoff Frequency is reached.

Decay (Decay Time)

Determines how fast the Cutoff Frequency falls from maximum attack level to the sustain level.

Release (Release Time)

Determines how fast the Cutoff Frequency falls from the sustain level to zero when a note is released.

Depth

Determines the range over which the cutoff frequency of the Filter EG changes. A setting of 0 will cause the cutoff frequency not to change. The farther from 0 the value is, the larger the range of the cutoff frequency. For negative values, the change of the cutoff frequency is reversed.

Settings: -64 – +0 – +63

NOTE When a Drum Voice is selected, not all of the parameters are available. Unavailable parameters are blank and cannot be edited.

3 Filter

Determines the Cutoff Frequency and Resonance for the Filter to change the Performance sound. The setting made here will be added to the same parameters (page 117) of each Voice as offset.

Cutoff

Determines the cutoff frequency for the Filter. The frequency set here is the center frequency at which the signals are affected when they pass through each filter.

Settings: -64 – +0 – +63

Resonance/Width

This parameter's function varies according to the selected Filter Type. If the selected filter is an LPF, HPF, BPF (excluding the BPFw), or BEF, this parameter is used to set the Resonance. If the selected filter is a BPFw, this parameter is used to adjust the frequency bandwidth.

Resonance is used to set the amount of Resonance (harmonic emphasis) applied to the signal at the cutoff frequency. This can be used in combination with the cutoff frequency parameter to add further character to the sound.

The Width parameter is used to adjust the width of the band of signal frequencies passed by the filter with the BPFw.

Settings: -64 – +0 – +63

Equalizer (EQ) Settings—[F5] EQ

From this display you can apply 3-band parametric EQ to each individual Part, for fine adjustment of the sound. The EQ shapes for Low and High are fixed as shelving types.



1 Frequency

Determines the center frequency. Frequencies around this point are attenuated/boosted by the Gain setting below. Higher values produce higher frequencies.

Settings:

Low

50.1 Hz – 2.0 kHz

Middle

139.7 Hz – 10.1 kHz

High

503.8 Hz – 14.0 kHz

2 Gain

Determines the level gain for the Frequency (set above), or the amount the selected frequency band is attenuated or boosted.

Settings: -12 dB – +0 dB – +12 dB

3 Q (Bandwidth)

This varies the signal level at the Frequency setting to create various frequency curve characteristics. The higher the setting the smaller the Q (Bandwidth). The lower the setting, the greater the Q (Bandwidth).

Settings: 0.7 – 10.3

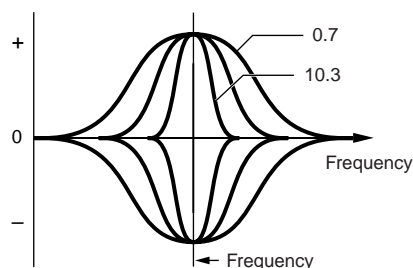

MIDI Receive settings—[F6] RcvSwitch (Receive Switch)

From this display you can set how each individual Part responds to various MIDI data, such as Control Change and Program Change messages. When the relevant parameter is set to “on,” the corresponding Part responds to the appropriate MIDI data. Each of the Controller names in this display indicates the MIDI data generated by using the corresponding Controller.

NOTE For Parts to which the Drum Voice is assigned, Sustain is not available.

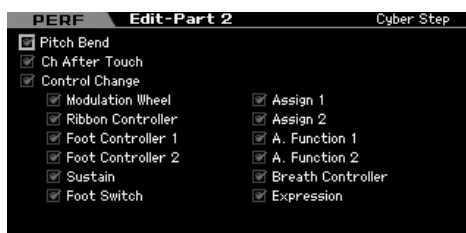

Performance Job—Convenient Functions

The Performance Job mode features some convenient data organization and initialization tools, for use when creating Performances and archiving them. Press the [JOB] button in the Performance mode to enter the Performance Job mode.

Performance Job—Basic Operation

- 1 In the Performance mode, press the [JOB] button to enter Performance Job Mode.**
- 2 Select the desired Job menu by pressing the appropriate button, [F1] – [F4].**
- 3 Move the cursor to the desired parameter, then set the value.**
- 4 Press the [ENTER] button. (The display prompts you for confirmation.)**
To cancel the Job, press the [DEC/NO] button.
- 5 Press the [INC/YES] button to execute the Job.**
After the Job has been completed, a “Completed” message appears and operation returns to the original display.
- 6 Press the [PERFORM] button to return to the Performance Play mode.**

CAUTION

Even if you execute the Job, selecting a different Performance or turning the power off without storing will erase the Performance data. Make sure to store the Performance data to internal memory by pressing the [STORE] button before selecting a different Performance or turning the power off.

Initializing the Performance—[F1] Init (Initialize)

This function lets you reset (initialize) all Performance parameters to their default settings. It also allows you to selectively initialize certain parameters, such as Common settings, settings for each Part, and so on.



① All Parameters

All settings for the selected Performance are initialized. When this is set to on, the cursor cannot be moved.

② Common Parameters

Common parameter settings for the selected Performance are initialized.

NOTE The Insertion Effect Switch is a Part parameter. Therefore, checkmark the box of Part 1 – 4 described below if you wish to initialize the Insertion Effect Switch parameter settings.

③ Part Parameters

Part 1 – 4

Parameter settings for Parts which are turned on are initialized.

A/D (A/D Input)

This is the Part input from the external audio equipment connected to the A/D INPUT jack. When this is checkmarked, parameter settings for the A/D Input Part (page 147) of Common Edit are initialized.

mLAN

This is the Part input from the external equipment connected to the mLAN jack via the IEEE1394 cable. When this is checkmarked, parameter settings for the mLAN Part (page 147) of the Common Edit are initialized.

Edit Recall—[F2] Recall

If you are editing a Performance but you have not stored it before switching to another Performance, the edits you have made will be cleared. If this happens, you can use the Recall function to restore the Performance with your latest edits intact.

Performance Copy function—[F3] Copy

Copying parameter settings from another Performance—[SF1] Part

This convenient operation lets you copy Common Edit and Part Edit settings of a certain Performance to the currently edited Performance. This is useful if you are creating a Performance and wish to use some parameter settings of another Performance.



1 Performance

Determines the Bank and the Performance number to be copied. This parameter cannot be set when the Current Performance (below) is turned on.

2 Current Performance

When this is set to on, the currently selected Performance (the one you are editing now) is selected as source. Accordingly, you can copy the parameter settings from a Part to a different Part of the same Performance.

3 Data type of the source

Determines the source data type including the Part number. According to the setting here, the Data type of the destination below will be automatically set to the appropriate item.

Settings: Common, Part 1 – 4, A/D, mLAN

NOTE The Insertion Effect Switch is a Part parameter. Therefore, the Insertion Effect Switch parameter settings of the selected part are copied only when selecting one of the Parts 1 – 4.

4 Data type of the destination

Determines the destination data type including the Part number. When the data type of the source Voice (above) is set to “common,” this parameter will be fixed to “common.”

Settings: Common, Part 1 – 4, A/D, mLAN

Copying the Voice Effect settings—[SF2] Voice

This convenient operation lets you copy Effect and Master EQ settings of a certain Voice assigned to a certain Performance to the currently edited Performance. This would come in handy when a certain Performance has settings that you want to use in your Performance program.



1 Performance

Determines the Bank and the Performance number to be copied. This parameter cannot be set when the Current Performance (below) is turned on.

2 Current Performance

When this is set to on, the currently selected Performance (the one you are editing now) is selected as source.

3 Source Part

Determines the Part of the source Performance. The name of the Voice assigned to the selected Part is shown.

4 Effect Unit Settings

Determines which Effect units are copied. You can select Effect units to be copied from Reverb, Chorus, Master EQ and Master Effect.

NOTE Even when each of the Reverb and Chorus is set to “on,” executing the Job does not copy the Send Level from the Voice to the Performance. If you want to apply the same depth of the Reverb and Chorus as in the Voice mode to the copied Voice, set the Reverb Send (1) and Chorus Send (2) in the Voice Output display of the Performance Part Edit mode to the same value manually as in the Voice Edit mode.

Transmitting the Performance data via MIDI—[F4] Bulk (Bulk Dump)

This function lets you send your edited parameter settings for the currently selected Performance to a computer or another MIDI device for data archiving. To execute the Bulk Dump operation, press the [ENTER] button.

NOTE In order to execute Bulk Dump, you'll need to set the correct MIDI Device Number. For details, see page 268.

NOTE The Bulk Dump data includes only the MIDI messages and does not include the Waveforms.

Creating a Voice/Performance by Using the Sampling Function

The MOTIF XS has a powerful Sampling function that lets you record audio signals—such as vocals from a microphone or electric guitar—and integrate the resulting Samples with the Voices and Performances of the instrument. When you enter the Sampling mode from the Voice mode or Performance mode, you can create your own original Samples, edit them, assign them to a Waveform, and then assign the original Waveform to a User Voice or Performance.

This section covers the Sampling functions when entering the Sampling mode by pressing the [INTEGRATED SAMPLING] button in the Voice mode or the Performance mode.

NOTE You can also enter the Sampling mode by pressing the [INTEGRATED SAMPLING] button in the Song mode or the Pattern mode. Keep in mind that the Sampling functions differ depending on from which mode the Sampling mode is called up, the Voice/Performance mode or the Song/Pattern mode. See page 242 for instructions on using the Sampling function in the Song mode/Pattern mode.

The Sampling mode structure

In this section, you'll learn about the structure and organization of Samples, Key Banks and Waveforms, as well as their relationship to Voices and Performances.

Sample

A Sample is digital audio data, made by directly recording a signal, such as that of vocals or electric guitar, to the MOTIF XS. Throughout this manual, the words “Sample” and “Wave” are sometimes used interchangeably; however, you should be careful to distinguish between “Wave” (raw audio data) and “Waveform” (collected audio data used to make up a Voice).

Samples can be obtained into the instrument via the following methods: Recording audio signal in the Sampling mode, loading a WAV file or AIFF file from the USB storage device connected to the MOTIF XS in the File mode, and loading a WAV file or AIFF file from the hard disk connected to the network to which the MOTIF XS is connected. Because the obtained Sample data will be lost by turning the power off, Samples residing in the MOTIF XS internal memory should be saved as digital data (in WAV or AIFF format) to a USB storage device or to a computer connected via network to the MOTIF XS.

Sample, Key Bank and Waveform

Samples are assigned and stored to Waveforms on the MOTIF XS. Before you can actually record a Sample or load a Sample from a USB storage device, you'll need to specify a Waveform number as a destination. This Waveform then serves as the “container” for the Sample.

Each of the Waveforms can contain multiple Samples. To assign these Samples to a different space or container, you can set the key range and velocity range for each Sample. With this setting, the different Sample is played back depending on the pressed note and its velocity. The note range and velocity range to which each of the Samples is assigned is called the Key Bank.

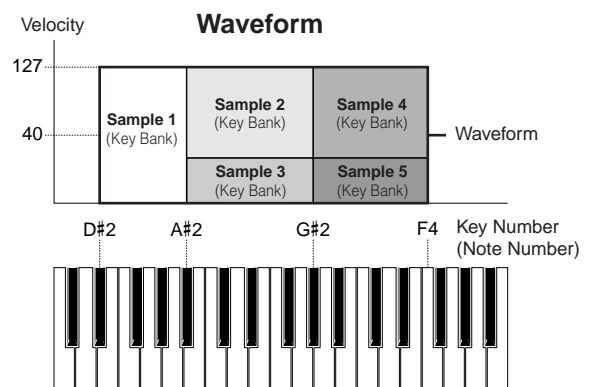

Voices and Waveform

You can play the Waveform by assigning it to a Voice then playing the keyboard with that Voice. You can assign the Waveform to an Element of the Voice in the Voice Element Edit mode (page 112). The Voice Edit mode lets you assign the Waveform you've created with the Sampling function to the edited Element, just as you would any of the 2670 preset Waveforms included on the instrument.

NOTE Keep in mind that you can assign the User Voices created in the Sampling mode entered from the Voice/Performance mode to Mixing parts of the Song/Pattern. You can also assign the Waveforms created in the Sampling mode entered from the Song/Pattern mode to Elements of the Voice in the Voice Edit mode.

Sampling Main display

The Sampling Main display, the entrance of the Sampling mode, is called up when pressing the [INTEGRATED SAMPLING] button from the current mode.

Pressing the [INTEGRATED SAMPLING] button in the Voice mode or Performance mode calls up the Sampling mode dedicated to creation of Samples (Waveforms) assigned to the Voice/Performance. Press the [EXIT] button to return to the original mode, Voice or Performance.

Selecting a Waveform and Key Bank— [INTEGRATED SAMPLING]

The Sampling Main display lets you select the Waveform and its Key Bank then hear the sound of the Sample assigned to the selected Key Bank.

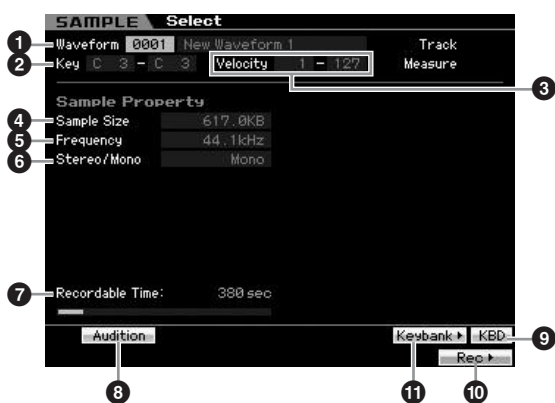

1 Waveform

Determines the Waveform number. The name of the selected Waveform is displayed.

Settings: 0001 - 1024

2 Key (Key Range) (Indication only)

Indicates the Range of the Key Bank.

3 Velocity (Velocity Range) (Indication only)

Indicates the velocity range of the currently selected Key Bank.

4 Sample Size (Indication only)

Indicates the size of the Sample assigned to the selected Key Bank.

5 Frequency (Indication only)

Indicates the sampling frequency of the Sample assigned to the selected Key Bank.

NOTE The rate at which digital readings are taken is referred to as the sampling frequency. Higher sampling frequencies result in higher quality sound. 44.1kHz is the standard value as the Sampling Frequency.

6 Stereo/Mono (Indication only)

Indicates whether the Sample assigned to the selected Key Bank is stereo or mono.

7 Recordable Time (Indication only)

Indicates the available sampling time using the available memory. The time indicated here is calculated assuming a mono signal with a sampling frequency of 44.1 kHz. The graph illustration indicates the already used memory amount as a blue line.

8 [SF1] Audition

You can hear the Sample assigned to the selected Key Bank by holding this button. This lets you check how the Sample will actually sound when played back.

9 [SF6] KBD (Keyboard)

You can also select the Key Bank belonging to the selected Waveform directly from the keyboard, by holding down the [SF6] KBD button and pressing the desired key.

10 [F6] Rec (Record)

Pressing this button to call up the Sampling Record Setup display. This display is used for setting up the instrument for Sampling. For details, see page 164.

11 [SF5] Keybank

Pressing this button calls up the list of the Key Banks making up the Waveform. You can select the desired Key Bank from this list by using the data dial, cursor up/down button, [INC/YES] and [DEC/NO] button.

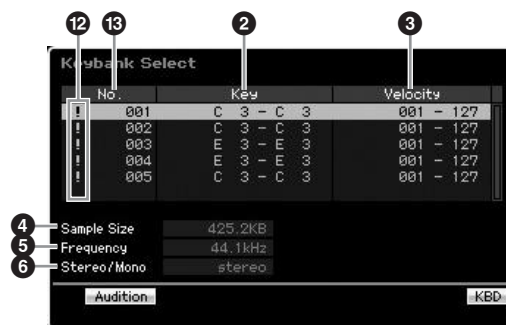

Regarding the parameters 2 - 6, refer to the parameter having the same name in the Sampling Main display.

12 Duplication symbol

This symbol appears when the key range and velocity range overlaps the ones of the other Key Bank. For information on how the samples assigned to the overlapped Key Banks are played back, see page 170.

13 Key Bank number (Indication only)

Indicates the Key Bank number of the selected Waveform.

Sampling Record

[INTEGRATED SAMPLING] → [F6] Rec

The Sampling Record function lets you record sounds—such as vocals from a connected microphone, the signal from an electric guitar, or audio from an external CD or MP3 player—directly to the MOTIF XS, and store them to the instrument as Samples. The Samples obtained via the Sampling function can be played back from the keyboard by assigning them first to a Waveform, then a Voice.

Important

In order to use the Sampling function, DIMM modules must be installed to the instrument. For details on installing DIMMs, see page 295. The recorded (edited) Sample data residing temporarily in DIMM is lost when the power is turned off. Make sure to prepare the USB storage device or a computer connected to the same network as the MOTIF XS before using the Sampling function.

Sampling Procedure

In this section, you'll learn how to create a Voice or Performance by using the Sampling function.

1 Connect a microphone or other audio equipment to the MOTIF XS.

For information about how to do this, see page 39. If you want to use the sound of the MOTIF XS as a recording source (with the Resampling function), this step is unnecessary.

2 Enter the Voice mode or Performance mode.

When entering the Performance mode, select a Performance to which the Sample will be assigned.

3 Press the [INTEGRATED SAMPLING] button to enter the Sampling mode. (The indicator lights.)

The Sampling Main display appears.

4 Press the [F6] Rec button to call up the Record Setup display (page 164).

Set the following parameters in the Setup display. The numbers in parentheses below refer to the parameters in the Sample Record display on the next page.

- The Input Source (2) determines the connector from which the audio source (microphone, audio equipment, etc.) is input.
- The Waveform (6) determines the Waveform number.
- The Voice (10) determines the Voice Bank and Number.
- The Part (9) determines the Performance part to which the Voice is assigned when entering the Sampling mode from the Performance mode.
- Set other parameters as necessary.

5 Press the [F6] Standby button to call up the Record Standby display (page 166).

Set the following parameters on the Standby display. Numbers in the parentheses are equivalent to the numbers pointing parameters on the Standby display.

- Set the Trigger Mode (8) to determine the method by which Sampling will be triggered. Normally, set this to "level."

- If you set the Trigger Mode (8) to "level," you will also need to set the Trigger Level (7). Set this parameter so that the red triangle of the level meter (indicating the Trigger Level) is slightly below the level at which the sound is input.

6 Adjust the input sound level for optimum level.

Try to set the input level as high as possible without clipping for the best sound quality. Follow the instructions below to adjust the input level.

- When the Input Source is set to A/D Input, adjust the input signal level by using the GAIN knob on the rear panel. If you cannot adjust the input level appropriately, change the Mic/Line setting (page 263) in the Utility mode.
- When the Input Source is set to Resample, adjust the input signal level by setting the Record Gain.
- When the Input Source is set to mLAN, the input level cannot be adjusted.

7 Turn the Confirm function on or off by pressing the [SF1] button.

The Confirm tab turns green when set to on, and turns gray when set to off. When Confirm is turned on, you can easily listen back to your just-recorded Sample and conveniently re-record it if you are not satisfied with the results.

8 Press the [F5] Start button to start the Sampling operation.

When the Trigger Mode (8) is set to "manual," pressing the button immediately starts Sampling (a RECORDING indication appears in the display).

When the Trigger Mode (8) is set to "level," pressing the button enables Sampling but does not start it (a WAITING indication appears in the display).

9 Play the sound to be sampled.

When the Trigger Mode (8) is set to "level" and an audio signal exceeding the specified Trigger Level (7) is input to the instrument, the RECORDING indication replaces the WAITING indication and Sampling starts. During Sampling, a graphic representation of the recorded audio appears in the display.

10 Press the [F6] Stop button to stop Sampling.

If you set Confirm to on in step 7 above, the Sampling Finished display (page 167) appears. Press the [SF1] Audition button to hear the sampled sound. If you are satisfied with the results, press the [ENTER] button to store the sampled sound as a “Sample” and return to the Setup display. If you are not satisfied with the results and you wish to try again, press the [EXIT] button to return to the Standby display and try Sampling from step 5 again.

If you set Confirm to off in step 7 above, the sampled sound will be stored as a “Sample” automatically.

NOTE When you set Record Next (4) to “on” in step 4 above, the instrument returns to the STANDBY display after the Sample data is fixed. In this case, you can leave the Sampling Record mode by pressing the [EXIT] button.

11 Save the created Waveform to a USB storage device.

For detailed instructions on saving, see page 278.

CAUTION

The recorded (edited) Sample data resides temporarily in DIMM (page 79). Any data in DIMM will be lost when turning the power off. You should always save any data residing in DIMM to a USB storage device or a computer connected to the same network as the MOTIF XS before turning off the power.

Sampling Setup—[F6] Rec

From this display you can set up various parameters for Sampling. Press the [F6] button from the Sampling Main display to call up this display. Press the [EXIT] button to go back to the Sampling Main display.



1 Recording Type

Determines the Sampling type. Keep in mind that this parameter is fixed to “sample” when entering the Sampling mode from the Voice/Performance mode.

2 Input Source

Determines the input connector via which the signal to be sampled will be received.

Settings: A/D Input, resample, mLAN

A/D Input

Analog audio from the A/D INPUT jacks is recognized as the recording source.

resample

Audio signal from the OUTPUT jacks of the MOTIF XS is received and recognized as the recording source.

mLAN

Audio signal from the mLAN connector (available for MOTIF XS8 and available for MOTIF XS6/7 only when the optional mLAN16E2 has been installed) is recognized as the recording source. The audio signal here is transmitted from the computer via mLAN Ports 3 and 4.

3 Stereo/Mono

Determines whether the audio signal is recorded as mono Sample or stereo Sample.

Settings: monoL, monoR, monoL+R, stereo

monoL

The L-channel signal will be recorded as a mono Sample.

monoR

The R-channel signal will be recorded as a mono Sample.

monoL+R

The L-channel and R-channel signals will be mixed and recorded as a mono Sample.

stereo

A stereo Sample will be recorded.

4 Record Next

When set to on, the next key is set as destination of Sampling automatically after the Sampling operation is finished (including assignment of the Sample to a Key Bank), and the Standby display appears. This parameter is useful when you wish to record multiple Samples in succession.

When you wish to obtain Samples successively from a special CD containing various materials in each track, for example, you can set this parameter to on and set the Trigger Mode to “level”—and conveniently have the instrument record consecutive Samples automatically. To leave the Sampling Record mode, press the [EXIT] button.

Settings: on, off

NOTE When both of the [SF1] Confirm and the Record Next are turned on before the Sampling starts, the FINISHED display appears as soon as the Sampling is finished. From the FINISHED display, fix the Sample data by pressing the [ENTER] button so that the instrument returns to the STANDBY display.

NOTE This parameter is useful when you wish to assign individual Samples to the keys one by one to create a Drum Voice by using the special CD containing sound of each drum instrument as source.

NOTE Keep in mind that the Record Next parameter may be fixed to “off” and cannot be changed. This occurs when you enter the Sampling mode from the Voice mode/Performance mode, set the Voice to something other than “off,” and set the Source (above) to “resample.”

5 Frequency

Specifies the sampling frequency. When the Input Source (2) is set to “mLAN,” this parameter is fixed to “44.1kHz.” Normally, this parameter should be set to “44.1kHz,” the highest setting. If you wish to obtain a lo-fi sound, select a value other than 44.1 kHz. At settings other than 44.1 kHz, the sound monitored during recording may be different from the recorded sound, depending on the source signal.

Settings: 44.1k (44.1 kHz), 22.0kLo (22.05 kHz Lo-Fi), 11.0kLo (11.025 kHz Lo-Fi), 5.5kLo (5.5125 kHz Lo-Fi)

6 Waveform

Determines the Waveform number as destination.

Settings: 0001 – 1024

CAUTION

The Sampling operation overwrites any data previously existing at the destination Waveform number. Important data should always be saved to a USB storage device connected to the USB TO DEVICE terminal or to a computer connected to the same network as the MOTIF XS (page 278).

7 Keybank

Determines the note number of the Key Bank as destination. The value set here can be changed in the Sampling Edit mode (page 167).

Settings: C -2 – G8

NOTE You can also set the Key directly from the keyboard, by holding down the [SF6] KBD button and pressing the desired key. For details, see page 82.

8 Track

This parameter is not available when entering the Sampling mode from the Voice/Performance mode.

9 Part

Determines the Performance Part to which the Voice (10) created by Sampling is assigned. When set to off, the obtained Sample is not assigned to the Performance part. This parameter is available when entering the Sampling mode from the Performance mode. When the Voice (10) is set to off, this parameter cannot be set even if entering the Sampling mode from the Performance mode.

Settings: off, 1 – 4

10 Voice

Determines the voice to which the Waveform (6) created via the Sampling is assigned by specifying the Voice Bank and Number. Setting the Voice Bank to any of USER1 – 3 assigns the Waveform (6) to the Element 1 of the new Normal Voice created via Sampling. Setting the Voice Bank to UDR assigns the Waveform (6) to the Drum Key (11) of the specified Drum Voice. When this is set to “off,” only a Waveform (6) is created; the Sample is not stored as a User Voice.

Settings:

Voice Bank: Off, USER1 – 3 (User 1 – 3), UDR (User Drum)
Voice Number: 001 – 128

CAUTION

When the Voice Bank is set to any of USER1 – 3, the Sampling operation overwrites any data already existing in the destination Voice number. Important data should always be saved to a USB storage device connected to the USB TO DEVICE terminal or to a computer connected to the same network as the MOTIF XS (page 278).

11 Drum Key

Determines the Key to which the Waveform (6) is assigned when the Voice Bank (10) is set to “UDR.”

Settings: C0 – C6

12 Recordable Time (Indication only)

Indicates the available Sampling time using the available memory. The time indicated here is calculated assuming a mono signal with a sampling frequency of 44.1 kHz. The amount of memory space currently being used is shown in the display as a blue line.

13 [SF6] INFO (Information)

Indicates the amount of Sampling memory used.

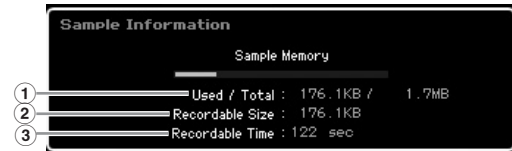

1 Used/Total (Indication only)

Indicates the amount of memory being used and the total amount available.

2 Recordable Size (Indication only)

Indicates the amount of free memory.

3 Recordable Time (Indication only)

Indicates the available Sampling time using the available memory. The time indicated here is calculated assuming that the sampling frequency is 44.1 kHz with mono.

14 [F6] Standby

Pressing this button calls up the Sampling Record Standby display. This display is used for executing Sampling. For details, see page 166.

Sampling Record—[F6] Standby

This display is used for executing Sampling. Press the [F6] button from the Setup display to call up this display. Press the [EXIT] button to go back to the Setup display.



- 1** **Waveform** (Indication only)
Indicates the number and name of the selected Waveform.
 - 2** **Key (Key Range)** (Indication only)
Indicates the key range of the currently selected Key Bank.
 - 3** **Velocity (Velocity Range)** (Indication only)
Indicates the velocity range of the currently selected Key Bank.
 - 4** **Record Monitor**
Determines the output level of the monitor for the input signal while Sampling. The time indicated here is calculated assuming a mono signal with a sampling frequency of 44.1 kHz. This monitor signal is output from the PHONES jack or the OUTPUT R and L/MONO jacks.
Settings: 0 – 127
 - 5** **Record Gain**
This parameter is available only when the Input Source (page 164) is set to “resample” (recording the sound of the MOTIF XS itself). This determines the recording gain when resampling. The higher the value, the greater the volume of the resampled sound. Before executing the Sampling operation, you can set the appropriate gain by checking the volume via the Level Meter (10) while playing the keyboard.
Settings: -12dB, -6dB, +0dB, +6dB, +12dB
 - 6** **Key**
Indicates the Keybank (page 165) set in the Sampling Record Setup display. The Key Bank can be changed both here and in Sampling Edit (page 167) after the Sampling operation.
Settings: C -2 – G8
- NOTE** You can also set the Key directly from the keyboard, by holding down the [SF6] KBD button and pressing the desired key. For details, see page 82.

7 Trigger Level

When the Trigger Mode (8) is set to “level,” you’ll also need to set the Trigger Level. Sampling will begin as soon as an input signal exceeding the specified trigger level is received. The level set here will be indicated as a red triangle in the level meter. For best results, set this as low as possible to capture the entire signal, but not so low as to record unwanted noise.

Settings: 000 – 127

8 Trigger Mode

Determines the method by which Sampling will be triggered.

Settings: level, manual

level

Sampling starts as soon as an input signal exceeding the specified Trigger Level (7) is received.

manual

Sampling starts soon after you press the [F6] REC button. This setting lets you start Sampling at your desired timing regardless of the input level from audio source.

9 Recordable Time (Indication only)

Indicates the available Sampling time using the available memory. The time indicated here is calculated assuming a mono signal with a sampling frequency of 44.1 kHz. The amount of memory space currently being used is shown in the display as a blue line.

10 Level Meter

This graph indicates the input level of the input source. Try to get the input level as high as possible without clipping for the best sound quality.

NOTE Follow the instructions below to adjust the input level.

- When the Input Source is set to A/D Input, adjust the input signal level by using the GAIN knob on the rear panel. If you cannot adjust the input level appropriately, change the Mic/Line setting (page 263) in the Utility mode.
- When the Input Source is set to Resample, adjust the input signal level by setting the Record Gain (5).
- When the Input Source is set to mLAN, the input level cannot be adjusted.

11 [SF1] Confirm

This determines whether you can confirm the recorded Sample (on) or not (off) after Sampling is finished. This is useful for conveniently recording again if you are not satisfied with the Sampling results. When this is turned off, the recorded sample is fixed as data as soon as the Sampling is finished then the instrument returns to the Setup display (page 164). Please note that the instrument returns to the STANDBY display after the Sampling is finished when Record Next is turned on in the Setup display.

12 [F5] Start

Press this button to start Sampling.
When the Trigger mode is set to “level,” pressing the [F5] Start button calls up the WAITING indication on the display. Actual Sampling does not start. When audio signal exceeding the specified Trigger Level (7) is input to the instrument, the RECORDING indication replaces the WAITING indication and Sampling starts.

When the Trigger Mode (8) is set to “manual,” pressing this button starts Sampling immediately.

Sampling RECORDING display

During Sampling, a graphic representation of the recorded audio appears in the display.

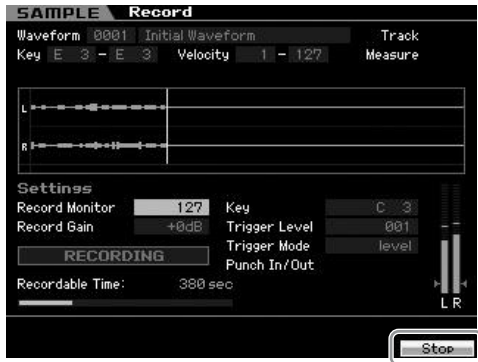

[F6] Stop

Press this button to stop Sampling. When Sampling is complete, the FINISHED display appears.

Sampling FINISHED display (when Confirm is set to on)

When the [SF1] Confirm is turned on before Sampling starts, the FINISHED display below appears as soon as

Sampling is finished. From this display, you can hear and confirm the Sample by pressing the [SF1] Audition button. If you are satisfied with the sound, press the [ENTER] button to fix the Sampling result as Sample data. If you are not satisfied with the Sampling result, press the [EXIT] button then try again.

When [SF1] Confirm is turned off before Sampling starts, the Sampling operation will automatically fix the Sample data and return to the Setup display (page 164).

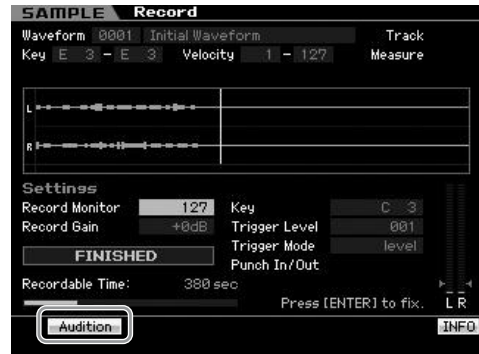

[SF1] Audition

You can hear the recorded Sample by holding this button. This lets you check whether the Sampling has been executed appropriately or not.

NOTE When [SF1] Confirm (page 166) is turned off before the Sampling starts, the Sampling operation will automatically fix the Sample data and return to the Setup display (page 164). Please note that the instrument returns to the STANDBY display after Sampling is finished when Record Next is turned on in the Setup display.

Sampling Edit

[INTEGRATED SAMPLING] → [EDIT]

The Sampling Edit mode gives you comprehensive, detailed controls for editing the recorded Sample and changing the Sample settings. Press the [EDIT] button from the Sampling Main display to call up the Sampling Edit display. Press the [EXIT] button to go back to the Sampling Main display.

Sampling Edit procedure

1 Press the [INTEGRATED SAMPLING] button to enter the Sampling mode. (The indicator lights.)

The Sampling Main display (page 162) appears.

2 Select a Waveform and Key Bank.

Select a Waveform and Key Bank to which the Sample to be edited is assigned.

3 Press the [EDIT] button to enter the Sampling Edit mode.

4 Press the [F1] Trim or [F2] Param (Parameter) button.

Set the desired parameter in each display.

5 Press the [SF1] Audition button to hear the sound.

Repeat steps 4 and 5 as desired.

6 Press the [EXIT] button to go back to the Sampling Main display.

Hint

A convenient Extract function lets you delete unneeded portions of the Sample prior to the start point and after the end point, allowing you to save memory for additional Sampling.

- 1 Press the [F1] Trim button to call up the Trim display.**
- 2 Press the [ENTER] button. (The display prompts you for confirmation.)**
If you wish to cancel the operation, press the [DEC/NO] button.
- 3 Press the [INC/YES] button to execute Extract.**

NOTE The data deleted via the Extract operation cannot be recovered. Before executing the Extract, you may want to back up this Sample by using the Copy Job (page 172).

Tips for editing the Samples

How to play the Sample (Play Mode settings)

There are two methods for playing back the Sample: One shot and Loop. Loop lets you play the specified range of the Sample repeatedly in a loop. One Shot, on the other hand, lets you play the entire Sample only once. You'll need to determine which type (Loop or One Shot) is used by setting the Play Mode parameter in the Parameter display (page 170).

Fine-tuning playback of One Shot Samples

You can determine the playback range of the Sample by setting the Start Point (6) and End Point (8) in the Trim display (page 168). These parameters effectively let you mute unnecessary or unwanted audio from the beginning and end of your Sample. To cut sound at the end of playback, decrease the End Point value, moving it leftward on the wave display. Similarly, to cut sound at the beginning of playback, increase the Start Point value, moving it rightward on the wave display. In general, you'll want to set the Start Point so that the beginning of the Sample plays back immediately when triggered. Use the [SF1] Audition button to check playback of the Sample, that it sounds smooth and natural. After setting and confirming the Start/End Points, trim them permanently from the Sample by using the Extract operation (page 177).

Fine-tuning playback of Loop Samples

Setting the Start and End Points in a Loop Sample is generally more crucial and painstaking than with One Shot Samples. The Start and End Points must be set accurately to ensure that the Loop plays back smoothly and continuously without stutters or glitches. You'll also need to make sure (with rhythmic loops) that the Loop is in perfect rhythm and no beats are lost.

1 Set the Play Mode to "loop."

Press the [F2] Param button to call up the Parameter display (page 170) then set the Play Mode (6) to "loop."

2 Set the Start Point to the 1st beat of the 1st measure.

Press the [F1] Trim button to call up the Trim display (page 168) then set the Start Point (6).

3 Set the Loop Point to the value same as the Start Point.

Press the [SF2] button so that the LP=ST is shown.

4 While holding the [SF1] Audition button, adjust the End Point so that looped playback of the Sample is smooth and matches the beat timing.

5 Execute the Extract operation (page 177).

How to set the tempo of the Sample

If you do not know the tempo of the Sample containing the rhythm pattern, follow the instructions below.

1 While holding the [SF1] Audition button, adjust the Start Point and End Point so that looped playback of the Sample is smooth and matches the beat timing.

Make sure to also use the Extract operation to delete unnecessary parts from the Sample.

2 Set the time signature and measure.

Press the [F1] Trim button to call up the Trim display (below) then set the time signature (10) and measure (11).

3 Increase or decrease the Tempo (9) as necessary so that the End Point (8) becomes equivalent to the end point applied to the original Sample.

Set the Tempo (9) to a large value then decrease it gradually so that the End Point (8) increases gradually. Once you reach a certain value, the End Point no longer increases, even when you decrease the Tempo. The resulting value is the End Point applied to the original Sample. The final Tempo value is the most appropriate tempo for Sample playback.

Sample Playback settings—[F1] Trim

This display lets you set the playback range and loop range of the Sample.



1 Waveform (Indication only)

Indicates the number and name of the selected Waveform.

2 Key (Key Range) (Indication only)

Indicates the key range of the currently selected Key Bank.

3 Velocity (Velocity Range) (Indication only)

Indicates the velocity range of the currently selected Key Bank.

4 Track (Indication only)

Indicates the track of the current Song/Pattern. This is available only when entering the Sampling mode from the Song/Pattern mode.

5 Measure (Indication only)

Indicates the measure number of the selected Song/Pattern. This is available only when entering the Sampling mode from the Song/Pattern mode.

6 Start Point

Determines the Start point for Sample playback. The part at the left side of this point will not be played back. When pressing the [SF2] button, the value of the Loop Point (7) is copied to the Start Point.

Settings: 0000000 – End point

7 Loop Point

Determines the Loop point at which the loop playback starts. When the Play mode is set to “loop,” the Sample is played back between this Loop point and the End point (6).

Settings: 0000000 – End point

8 End Point

Determines the End point for Sample playback. The part at the right side of this point will not be played back. The End Point (8) will be automatically determined so that the length between the Start Point and the End Point matches the settings of the Tempo (9), Meter (10), and Measure (11).

Settings: 0000000 – (depending on the Sample's length)

9 Tempo

Determines the Tempo of Sample playback. Setting the Tempo changes the End Point (8) so that the length between the Start Point and the End Point matches the settings of the Meter and Measure.

Settings: 5.0 – 300.0

10 Meter

Determines the meter (time signature) of Sample playback. Setting the Meter changes the End Point (8) so that the length between the Start Point and the End Point matches the settings of the Tempo and Measure.

Settings: 1/16 – 16/16, 1/8 – 16/8, 1/4 – 8/4

11 Measure

Determines the Sample length for playback based on measure and beat values, an intuitive and musically useful way to set Sample playback. Setting the Measure changes

the End Point (8) so that the length between the Start Point and the End Point matches the settings of the Tempo and Meter.

Settings:

Measure: 000 – 032

Beat: 00 – 15 (Varies depending on the Meter setting.)

NOTE The Measure setting here indicates the length between the Start Point and End Point of the sample. When you wish to play two measures beginning from the Start Point of the sample, set the Measure parameter to “002:00.”

12 Recordable Time (Indication only)

Indicates the available Sampling time using the available memory. The time indicated here is calculated assuming a mono signal with a sampling frequency of 44.1 kHz. The amount of memory space currently being used is shown in the display as a blue line.

13 [SF1] Audition

You can hear the selected Sample by holding this button. This lets you check whether the Sample has been edited appropriately or not.

14 [SF2] LP=ST

When the menu indication here is “LP=ST,” the Start (Start Point) and the Loop (Loop Start Point) will share the same address, meaning that both of them will be changed simultaneously, even if just one of them is changed. Pressing the [SF2] button in this condition changes the menu from “LP=ST” to “LP≠ST.” When the menu indication here is “LP≠ST,” the Start (Start Point) and the Loop (Loop Start Point) can be changed independently. When pressing the [SF2] button in this condition, the address value of the Start will be copied to the one of the Loop, with the result that both of them share the same address value. The menu indication also changes from “LP≠ST” to “LP=ST.”

15 [SF3] Display

Pressing the [SF3] button adjusts the zoom level so that the entire wave, including the Start Point and End Point, is shown on the display.

16 [SF4] Zoom Out

17 [SF5] Zoom In

Press the [SF4] and [SF5] buttons to zoom in and out of the wave display.

18 [F1] Trim

Pressing this button returns from the previous display to the Trim display.

19 [F2] Param (Parameter)

Pressing this button calls up the display that lets you set the Sample-related parameters and Key Bank range.

20 [SF6] NUM

When “NUM” is shown in the tab, you can use the [F1] – [F6] buttons and the [SF1] – [SF5] buttons as the numeric key pads by pressing the [SF6] button.

Voice mode
Performance mode
Sampling mode 1
Song mode
Pattern mode
Mixing mode
Sampling mode 2
Master mode
Utility mode
File mode
Reference

Sample Parameter settings—[F2] Param

This display lets you set Sample-related parameters such as Key Range and Velocity Range.

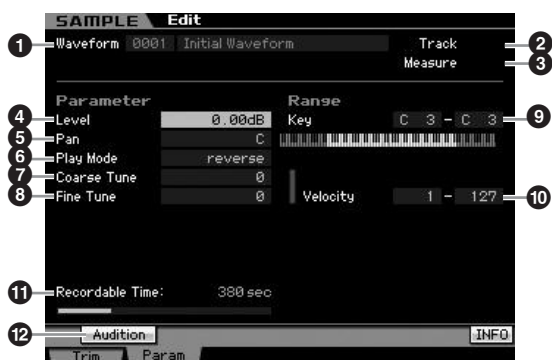

Parameters 1 – 3 are same as the ones on the Trim display (page 168).

NOTE The KBD icon is shown on the tab corresponding to the [SF6] button depending on the selected parameter. In this condition, you can enter the note number or velocity by pressing the appropriate note on the keyboard while holding the [SF6] KBD button. For details, see page 82.

4 Level

Determines the output level of the selected Sample.

Settings: -95.25 dB – +0.00 dB

5 Pan

Determines the stereo pan position of the sound.

Settings: L64 (far left) – C (center) – R63 (far right)

6 Play Mode

Determines how the Sample is played back.

Settings: loop, one shot, reverse

loop

Sample playback begins from the Start point, continues to the Loop point, then repeats indefinitely between the Loop point and End point. This setting is useful for short rhythmic passages, riffs and beats that you want to play back repeatedly and continuously.

one shot

The Sample plays back one time from Start point to End point. This setting can be used for solos, sound effects and vocal passages that are used once without looping.

reverse

The Sample plays back one time in reverse from End point to Start point. This is useful for creating reversed cymbal sounds and other special effects.

7 Coarse Tune

Determines the coarse tuning for the pitch of the Sample in semitones.

Settings: -64 – +0 – +63

8 Fine Tune

Determines the fine tuning for the pitch of the Sample in cents.

Settings: -64 – +0 – +63

9 Key Range

Indicates the key range of the Key Bank to which the selected Sample is assigned. By assigning different Samples from a single Waveform to separate key ranges, you can create a Voice that produces different sounds depending on what key you play.

Settings: C -2 – G8

10 Velocity (Velocity Range)

Indicates the velocity range of the Key Bank to which the selected Sample is assigned. By assigning different Samples from a single Waveform to separate velocity ranges, you can create a Voice that produces different sounds depending on how strongly you play the keyboard.

Settings: 1 – 127

11 Recordable Time (Indication only)

Indicates the available Sampling time using the available memory. The time indicated here is calculated assuming a mono signal with a sampling frequency of 44.1 kHz. The amount of memory space currently being used is shown in the display as a blue line.

12 [SF1] Audition

You can hear the selected Sample by holding this button. This lets you check how the Sample will actually sound when played back.

When different Key Banks overlap:

When playing back a certain key with a certain velocity belonging to different Key Banks (in other words, different samples are assigned to this key and velocity), not all relevant samples may be played back and priority will be given to the two audio channels starting from the sample(s) assigned to the Key Bank having a smaller number. When a stereo sample is assigned to the Key Bank of the smallest number, for example, only that sample will be played back. When a mono sample is assigned to the Key Bank of the smallest number and a different sample is assigned to the Key Bank of the second smallest number, for 2nd example, only those two samples will be played back. When a mono sample is assigned to the Key Bank of the smallest number and a stereo sample is assigned to the Key Bank of the second smallest number, for 3rd example, only the mono sample will be played back. This rule applies to all modes of the instrument.

Sampling Job

[INTEGRATED SAMPLING] → [JOB]

The Sampling Job mode lets you process and modify Samples you have recorded. 18 Sampling Jobs are available.

Function	Description
[F1] Keybank	Jobs related to Samples assigned to the specified Key Bank
01: Copy	This Job copies a specified Key Bank to another Waveform. Also the Sample assigned to the Key Bank is copied.
02: Delete	This Job deletes the specified Key Bank and its Sample.
03: Move	This Job moves a specified Key Bank to another Waveform. Also the Sample assigned to the Key Bank is moved.
04: Normalize	This Job maximizes (normalizes) the overall level of the specified Sample.
05: Time-Stretch	This Job lets you change the tempo of the Sample without changing the pitch.
06: Convert Pitch	This Job lets you change the pitch of the Sample without changing the tempo.
07: Fade In/Out	This Job lets you create a fade-in and fade-out for the Sample.
08: Half Sampling Frequency	This Job lets you halve the sampling frequency of the specified Sample.
09: Stereo to Mono	This Job lets you convert a stereo Sample to a mono Sample.
10: Loop-Remix	This Job lets you automatically cut the Sample into separate "slices" and randomly rearrange the slices for special effects and unusual rhythmic variations.
11: Slice	This Job lets you divide the Sample into separate slices following the specified settings. When entering this Job from the Song/Pattern mode, note data for playing the slices in sequence is also created. Note data playback sounds just like the original Sample being played back.
[F2] Waveform	Waveform Jobs
01: Copy	This Job lets you copy the data of one Waveform to another. The Key Banks and Samples included in the Waveform are also copied by this Job.
02: Delete	This Job lets you delete a specific Waveform from memory. The Key Banks and Samples included in the Waveform are also deleted.
03: Extract	This Job lets you delete all unnecessary Sample data (located ahead of the Start Point and located after the End Point).
04: Transpose	This Job lets you transpose the Key Bank setting of a specified Waveform in semitones.
05: Rename	This Job lets you edit the name of the specified Waveform.
[F5] Other	Other Jobs
01: Optimize Memory	This Job optimizes the memory (DRAM) for Sampling.
02: Delete All	This Job deletes all the Waveforms.

Voice mode
Performance mode
Sampling mode 1
Song mode
Pattern mode
Mixing mode
Sampling mode 2
Master mode
Utility mode
File mode
Reference

Sample Job procedure

1 Press the [JOB] button in the Sampling mode to enter the Sampling Job mode.

2 Call up the desired Job group.

Select the Job group by pressing one of the [F1] Keybank, [F2] Waveform, and [F3] Other buttons.

3 Call up the desired Job display.

Move the cursor to the desired Job by using the data dial, [INC/DEC] and [DEC/NO] buttons or Cursor up/down button, then press the [ENTER] button. The desired Job display appears. Press the [EXIT] button to go back to the Job menu display.

4 Set the value of the desired parameters.

Move the cursor to the desired parameter, then set the value by using the data dial, [INC/YES] and [DEC/NO] button.

When "Apply" appears on the menu corresponding to the [SF4] button, go to step 5. When "Apply" does not appear, go to step 7.

5 Press the [SF4] Apply button to execute the Job.

At this time, the Sample has been modified temporarily and not fixed as data.

6 Confirm the result of the Job operation.

Press the [SF1] Audition button to hear the modified Sample. If you are satisfied with the result, go on to the step 7. If you are not satisfied with the results and want to try again, press the [SF4] Apply button again to abort the Job operation and return the Sample to the original status. In this case, attempt the operation again from step 4.

7 Press the [ENTER] button to fix the Job result as Sample data.

⚠ CAUTION

You cannot return the modified Sample to the original after fixing the Job result. Important data should always be saved to a USB storage device connected to the USB TO DEVICE terminal or to a computer connected to the same network as the MOTIF XS (page 278).

8 Press the [EXIT] button twice to go back to the Sampling Main display.

NOTE If there is no data in the specified Waveform and Key Bank, "No Data" will appear on the display and the job cannot be executed.

NOTE Some Jobs cannot be executed if there is not enough memory space. The amount of the available memory space can be confirmed at the bottom of the Sampling Job display or in the Information display (page 165).



Available memory space

⚠ CAUTION

Even if the Job operation has been completed, the data will be lost when turning the power off. Make sure to save the Waveform data to a USB storage device or to a computer connected to the same network as the MOTIF XS in the File mode (page 278) after the Job operation.

[F1] Keybank

This display contains Jobs for editing Samples. The Sample to be edited can be specified via the Waveform number and Key Bank.

Basic Operations in the Key Bank Jobs

The Key Bank Jobs provide the basic operations using the [SF1] button and the [SF5] button.



[SF1] Audition

You can hear the Sample assigned to the selected Keybank by holding this button. This lets you check how the Sample will actually sound when played back.

[SF5] Keybank

Pressing this button calls up the Key Bank list, from which you can select the desired Key Bank. For details, see page 162.

[SF6] KBD (Keyboard)

This menu appears only when the cursor is located at the Waveform. You can also select the Key Bank belonging to the selected Waveform directly from the keyboard, by holding down the [SF6] KBD button and pressing the desired key.

[SF6] INFO (Information)

When "INFO" is shown at the tab menu corresponding to the [SF6] button, press [SF6] to call up the Information window indicating the memory status for Sampling. For details, see page 165.

01: Copy

This Job copies the data of a Sample contained in a specified Key Bank to another Key Bank. Also the Sample assigned to the Key Bank is copied. This is useful if you are creating a Waveform and wish to use the Sample data from another Waveform.



① Source Key Bank

② Destination Key Bank

The source Key Bank is set by using the [SF5] Keybank button or [SF6] KBD button to select the key in the waveform after selecting the Waveform number (0001 – 1024). The source Key Bank is set by moving the cursor to the Key value and using the Data dial or [SF6] KBD button to select the desired key after selecting the Waveform number (0001 – 1024). The Velocity range values of the destination Key Bank are automatically set to the same as those of the source Key Bank.

NOTE You can hear the sample assigned to the source Key Bank by pressing the [SF1] Audition button.

02: Delete

This Job deletes the specified Key Bank and its Sample. By deleting unnecessary Samples, you can increase the available memory space.



1 Key Bank to be deleted

Determines the Key Bank to be deleted by setting the Waveform number (0001 – 1024). The Key range and Velocity range of the Key Bank to which the selected Waveform is assigned are automatically shown below the Waveform number.

03: Move

This Job moves a specified Key Bank to another Waveform. Also the Sample assigned to the Key Bank is moved.



1 Source Key Bank

2 Destination Key Bank

Determines the Key Banks of source and destination respectively by setting the Waveform number (0001 – 1024). Setting the source Waveform number calls up one of the Key Banks (the Key range and Velocity range) which can be changed by pressing the [SF5] Keybank button and [SF6] KBD button. The Key range and Velocity range of the destination Key Bank are automatically set to the same values as those of the source Key Bank.

NOTE You can hear the sample assigned to the source Key Bank by pressing the [SF1] Audition button.

04: Normalize

This Job maximizes (normalizes) the overall level of the specified Sample. This is useful for bringing up the volume of a Sample that was inadvertently recorded at a low level.



1 Key Bank

Determines the Key Bank to which the desired Sample is assigned by specifying the Waveform number (0001 – 1024). The Key range and Velocity range of the Key Bank to which the selected Waveform is assigned are automatically shown below the Waveform number.

2 Ratio

Determines the post-normalization Sample level. A setting of 100% maximizes the level so that the highest peak level in the Sample is just below clipping (maximum digital signal level). Settings higher than 100% will raise the Sample level above the maximum, producing deliberate clipping. Normally, set this to 100% or less.

Settings: 1% – 800%

CAUTION

The Job execution is divided into two stages: temporary data conversion via the [SF4] Apply button and actual data entry via the [ENTER] button. The Job result will be lost if you call up a different display without finalizing the data via the [ENTER] button.

05: Time-Stretch

This Job lets you change the length of the Sample without changing the pitch. By using this Job, you can synchronize Sample playback with Song/Pattern playback, since changing the Sample length also changes the tempo of Sample playback



Voice mode
 Performance mode
 Sampling mode 1
 Song mode
 Pattern mode
 Mixing mode
 Sampling mode 2
 Master mode
 Utility mode
 File mode
 Reference

1 Key Bank

Determines the Key Bank to which the desired Sample is assigned by specifying the Waveform number (0001 – 1024). The Key range and Velocity range of the Key Bank to which the selected Waveform is assigned are automatically shown below the Waveform number.

2 Ratio

Determines the length of the post-process Sample as a ratio of the length of the original Sample (100%). The tempo change can be calculated as follows.

Ratio value = (original tempo/modified tempo) x 100.

Settings: 25% – 400%

3 Accuracy

Determines the quality of the resulting Sample by specifying which aspect of the original is to be emphasized: sound quality or rhythmic feel.

Settings: sound4 – sound1, normal, rhythm1 – rhythm 2

sound4 – sound1

These settings place emphasis on sound quality, with the “sound4” setting producing the highest sound quality.

normal

Produces an optimum balance of sound quality and rhythmic feel.

rhythm1 – rhythm2

These settings place emphasis on rhythmic feel, with the “rhythm2” setting producing the most accurate rhythmic feel.

! CAUTION

The Job execution is divided into two stages: temporary data conversion via the [SF4] Apply button and actual data entry via the [ENTER] button. The Job result will be lost if you call up a different display without finalizing the data via the [ENTER] button.

06: Convert Pitch

This Job lets you change the pitch of the Sample without changing the tempo.



1 Key Bank

Determines the Key Bank to which the desired Sample is assigned by specifying the Waveform number (0001 – 1024). The Key range and Velocity range of the Key Bank to which the selected Waveform is assigned are automatically shown below the Waveform number.

2 Pitch

Determines the amount and direction of pitch shift in semitone increments.

Settings: -12 – +0 – +12

3 Fine

Determines the amount and direction of pitch shift in cent increments (1 cent = 1/100th of a semitone). 1 cent is equivalent to 1/100th of a semitone.

Settings: -50 – +0 – +50

! CAUTION

The Job execution is divided into two stages: temporary data conversion via the [SF4] Apply button and actual data entry via the [ENTER] button. The Job result will be lost if you call up a different display without finalizing the data via the [ENTER] button.

07: Fade In/Out

This Job lets you create a fade-in and fade-out for the Sample.



1 Key Bank

Determines the Key Bank to which the desired Sample is assigned by specifying the Waveform number (0001 – 1024). The Key range and Velocity range of the Key Bank to which the selected Waveform is assigned are automatically shown below the Waveform number.

2 Fade Type

Determines the type of level fade: fade-in or fade-out.

Settings: fade in, fade out

3 Length

Determines the length of the fade-in or fade-out. When a fade-in is selected, this parameter specifies the length of the fade starting at the specified Start point. When a fade-out is selected, this parameter specifies the length of the fade starting at the beginning of the fade and ending at the specified End point.

A Length setting of 4410 is roughly equivalent to 0.1 seconds when the Frequency is set to 44.1 kHz in the Setup display (page 164) of the Sampling mode.

Settings: 0000000 – End point

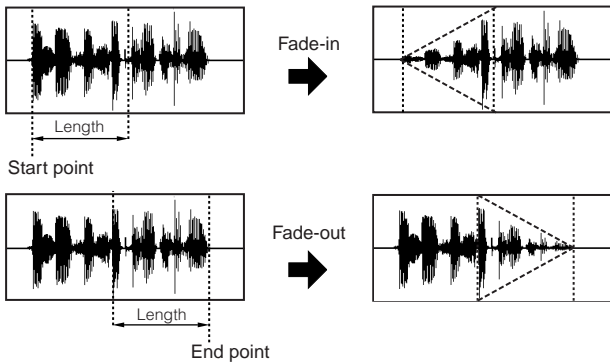

CAUTION

The Job execution is divided into two stages: temporary data conversion via the [SF4] Apply button and actual data entry via the [ENTER] button. The Job result will be lost if you call up a different display without finalizing the data via the [ENTER] button.

08: Half Sampling Frequency

This Job lets you halve the sampling frequency of the specified Sample. This can be used to convert hi-fi Samples to a lo-fi sound, and reduce the Sample size by half to conserve memory.

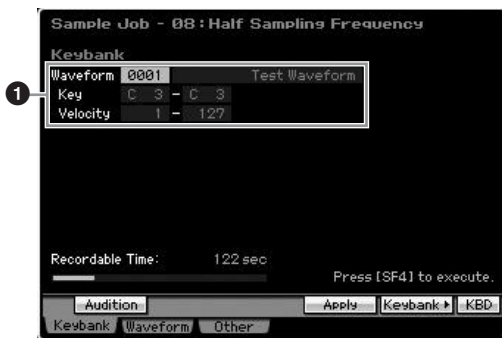

1 Key Bank

Determines the Key Bank to which the desired Sample is assigned by specifying the Waveform number (0001 – 1024). The Key range and Velocity range of the Key Bank to which the selected Waveform is assigned are automatically shown below the Waveform number.

CAUTION

The Job execution is divided into two stages: temporary data conversion via the [SF4] Apply button and actual data entry via the [ENTER] button. The Job result will be lost if you call up a different display without finalizing the data via the [ENTER] button.

09: Stereo to Mono

This Job lets you convert a stereo Sample to a mono Sample.



1 Key Bank

Determines the Key Bank to which the desired Sample is assigned by specifying the Waveform number (0001 – 1024). The Key range and Velocity range of the Key Bank to which the selected Waveform is assigned are automatically shown below the Waveform number.

2 Type

Determines which channel, or both channels, of the stereo Sample will be converted to a mono Sample.

Settings: L+R>mono, L>mono, R>mono

L+R>mono

The left and right channels of a stereo Sample are mixed and converted to a mono Sample.

L>mono

The left channel of a stereo Sample is converted to a mono Sample.

R>mono

The right channel of a stereo Sample is converted to a mono Sample.

CAUTION

The Job execution is divided into two stages: temporary data conversion via the [SF4] Apply button and actual data entry via the [ENTER] button. The Job result will be lost if you call up a different display without finalizing the data via the [ENTER] button.

10: Loop-Remix

This Job lets you automatically cut the Sample into separate “slices” and randomly rearrange the slices for special effects and unusual rhythmic variations.



Voice mode
Performance mode
Sampling mode 1
Song mode
Pattern mode
Mixing mode
Sampling mode 2
Master mode
Utility mode
File mode

1 Key Bank

Determines the Key Bank to which the desired Sample is assigned by specifying the Waveform number (0001 – 1024). The Key range and Velocity range of the Key Bank to which the selected Waveform is assigned are automatically shown below the Waveform number.

2 Type

Determines the degree to which the looped portion of the Sample will be sliced.

Settings: 1 – 4

3 Variation

Determines how the original Sample is varied by this Job.

Settings: normal1 – 2, reverse1 – 2

normal1 – 2

These settings slice and rearrange the Sample data, without performing any other audio changes.

reverse1 – 2

In addition to slicing and rearranging, these settings reverse the playback of some of the slices.

CAUTION

The Job execution is divided into two stages: temporary data conversion via the [SF4] Apply button and actual data entry via the [ENTER] button. The Job result will be lost if you call up a different display without finalizing the data via the [ENTER] button.

11: Slice

This Job lets you divide the Sample into separate “slices,” the number of which is determined by the note length (with Measure, Meter, and Sub Divide). Sliced Samples are assigned to each of keys in ascending order from the Key Bank specified at the Lowest Key (7) parameter. When entering this Job from the Song/Pattern mode, note data for playing the slices in sequence is also created. Playing back the note data and the slices in order results in the same sound as the original “un-sliced” Sample.

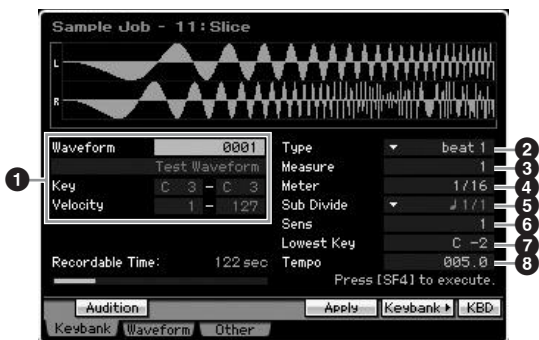

1 Key Bank

Determines the Key Bank to which the desired Sample is assigned by specifying the Waveform number (0001 – 1024). The Key range and Velocity range of the Key Bank to which the selected Waveform is assigned are automatically shown below the Waveform number.

7 Lowest Key

Specifies the lowest key number from which the sliced Samples are assigned in order.

Settings: C -2 – G8

NOTE In the Record Slice display of the Sampling Record mode (page 248), this parameter is fixed to “C1” for the MOTIF XS6, “E0” for the MOTIF XS7, and “A -1” for the MOTIF XS8, and cannot be set.

2 Type (Slice Type)

3 Measure

4 Meter

5 Sub Divide

6 Sens

8 Tempo

With the exception of the Lowest Key parameter, all parameters and settings are the same as in the Record Slice display of the Sampling Record mode (page 248) which appears after Sampling is completed with the Type set to “slice+seq.”

CAUTION

The Job execution is divided into two stages: temporary data conversion via the [SF4] Apply button and actual data entry via the [ENTER] button. The Job result will be lost if you call up a different display without finalizing the data via the [ENTER] button.

[F2] Waveform Jobs

This display contains Jobs for editing Waveforms.

01: Copy

This Job lets you copy the data of one Waveform to another. The Key Banks and Samples included in the Waveform are also copied by this Job.

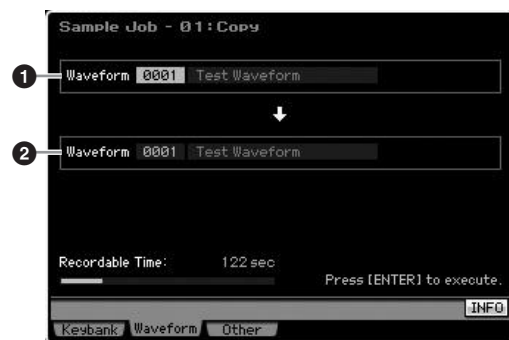

1 Waveform as source

2 Waveform as destination

Determines the copy source and destination Waveform numbers.

CAUTION

This operation overwrites any data previously existing at the destination Waveform number.

02: Delete

This Job lets you delete a specific Waveform from memory. The Key Banks and Samples included in the Waveform are also deleted.

Waveform

Determines the Waveform number to be deleted.

03: Extract

This Job lets you delete all unnecessary parts of the Sample (located ahead of the Start Point and located after the End Point).

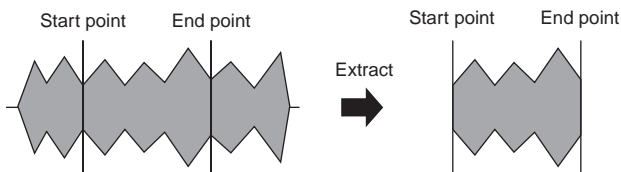

Waveform

Determines the Waveform number to be extracted.

04: Transpose

This Job lets you transpose the Key Bank setting of a specified Waveform in semitones or in octaves.

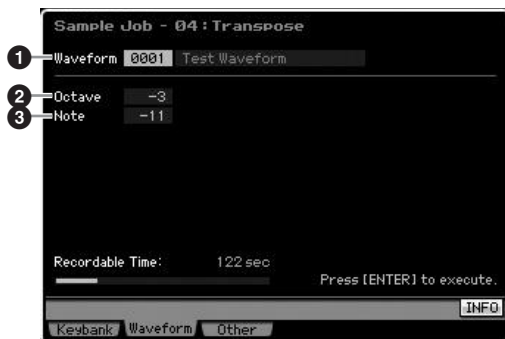

1 Waveform

Determines the Waveform number to which this Job is applied.

2 Octave

Determines the amount in octaves by which the Key Bank is transposed. When you want to transpose by less than one octave, set this to "0" and use the Note parameter below.

Settings: -3 - +0 - +3

3 Note

Determines the amount in semitones by which the Key Bank is transposed. When you want to transpose by exact octaves, set this to "0" and use the Octave parameter above.

Settings: -11 - +0 - +11

05: Rename

This Job lets you assign a name to the selected Waveform.

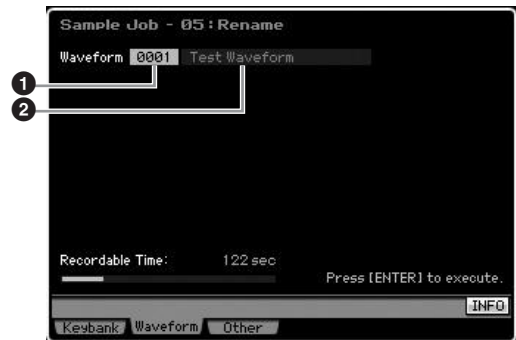

1 Waveform

Determines the Waveform number to which this Job is applied.

2 Name

Determines the Waveform name which can contain up to 10 characters. For detailed instructions on naming, refer to "Basic Operation" on page 82.

[F5] Other Jobs

01: Optimize Memory

This Job optimizes the memory (DIMM) for Sampling. Optimization consolidates areas of used and unused (available) memory to create the largest possible area of contiguous available memory. In some cases, the amount of remaining memory will be increased when you execute the Optimize Memory Job.

02: Delete All

This Job deletes all the user Waveforms. The Key Banks and Samples included in the Waveform are also deleted.

Song Playback

The Song mode lets you record, edit and play your own original Songs. The Song Play mode is the main ‘portal’ by which you enter the Song mode, and it is here where you select and play a Song. Some of the Song settings—such as the rhythmic feel—can also be edited in this mode. To call up the Song Play display and enter the Song mode, simply press the [SONG] button.

NOTE From the Track View display in the Song Play mode, you can select the Voice of the Mixing Part corresponding to the current Track by pressing the [CATEGORY SEARCH] button.

Song Playback Procedure

1 Press the [SONG] button to enter the Song Play mode.

This operation calls up the Track View display in the Song Play mode.

Song number Song name



2 Select a Song.

Move the cursor to the Song number, then select the desired Song by using the data dial, [INC/YES] and [DEC/NO] buttons. The name of the selected Song is displayed.

NOTE If you press the [PROGRAM] button so that its lamp lights, you can select the desired Song by using the Group [A] – [D] buttons and the Number [1] – [6] buttons. Song numbers and the corresponding buttons are as follows.

Button Combinations	Song number
[A]+[1] – [16]	01 – 16
[B]+[1] – [16]	17 – 32
[C]+[1] – [16]	33 – 48
[D]+[1] – [16]	49 – 64

3 Press the [▶] (Play) button to start the selected Song.

When playback of the selected Song is finished, the Song automatically stops.

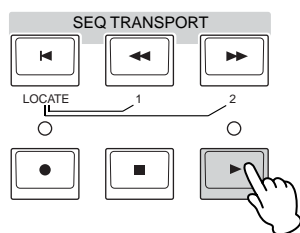

Press the [■] (Stop) button to stop playback of the Song. Press the [▶] (Play) again to resume playback from that point.

Playback types

Playback from the middle of the Song

To start playback of the Song from midway through the Song, set the desired location by using the controls below, then press the [▶] (Play) button. These operations can be also executed during playback.

Forward	Press the [▶▶] (Forward) button.
Fast forward	Hold the [▶▶] (Forward) button.
Rewind	Press the [◀◀] (Rewind) button.
Fast Rewind	Hold the [◀◀] (Rewind) button.
Move to the top of the Song	Press the [⏪] button.
Move to location 1	While holding the [⏪] button, press the [◀◀] (Rewind) button.
Move to location 2	While holding the [⏪] button, press the [▶▶] (Forward) button.

When the Song is not played back properly:

Keep in mind that starting a Song from somewhere in the middle may cause playback problems, such as the wrong sound, incorrect pitch or unexpected volume changes. This may occur because the MIDI events recorded at the start the Song have not been recognized by the tone generator section, since playback has started at a different point in the Song, with different MIDI events. To prevent this from happening, set the Song Event Chase parameter (4) to “PC+PB+Ctrl” or “all” in the Other display (page 271) of Sequencer Setup (called up via the [SEQ SETUP] button). With this setting, the Song will be played back properly even when starting playback from the middle of the Song.

Assigning specific measure numbers to Locations 1 and 2

To assign specific measure numbers to locations 1 and 2, select the desired measure number then press the [◀◀]/[▶▶] (Rewind/Forward) button while holding the [STORE] button. The setting here will be shown at the top of the display.



From this display, you can change the Song playback position by following the operations below.

Fast Forward/Rewind

- 1 Move the cursor to Measure.
- 2 Move forward or backward through the measures by using the [INC/YES], [DEC/NO] buttons and the data dial.

Moving to a desired location in the Song

- 1 Move the cursor to Measure.
- 2 Press the [SF6] NUM button so that the [SF1] – [SF5] and [F1] – [F6] buttons function as number buttons.

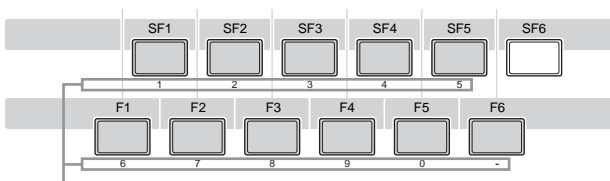

The [SF1] – [SF5] and [F1] – [F6] buttons function as number buttons.

- 3 Enter the destination measure by using the [SF1] – [SF5] and [F1] – [F5] buttons.
The measure number you input will appear at the top of the display.

Shows the measure number to be entered.



- 4 Press the [ENTER] button to actually move the Song playback position to the destination set above.

Track mute/solo

To mute a track

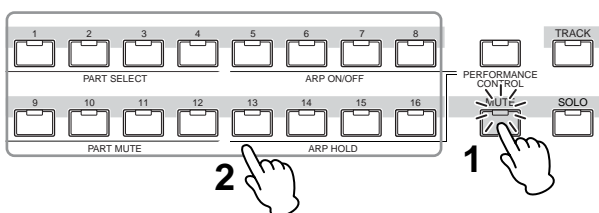

- 1 Press the [MUTE] button so that its indicator lights.
- 2 Press any of the Number buttons [1] to [16] corresponding to the track you want to mute.
When pressing any of the Number buttons [1] – [16], the lamp of the pressed button will be turned off and the corresponding track will be muted. Pressing the same Number button again enables output of the playback sound.

To solo a track

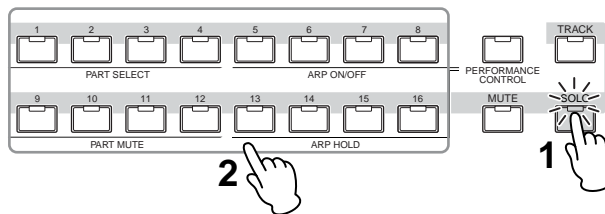

- 1 Press the [SOLO] button so that its indicator lights.
- 2 Press any of the Number buttons [1] to [16] corresponding to the track you want to solo.
When pressing any of the Number buttons [1] – [16], the lamp of the pressed button will flash and only the corresponding track will be sounded. Pressing the different Number button changes the soloed track.

Change the tempo

- 1 Move the cursor to Tempo.
- 2 Edit the Tempo value by using the [INC/YES], [DEC/NO] buttons and the data dial.



Assigning various settings related to Song playback (Song Scene)

You can assign five different “snapshots” of important Song-related parameters such as transpose, tempo, track mute status, and the basic Song Mixing setup to the [SF1] – [SF5] buttons as Song Scenes. One of the convenient advantages of Song Scene is that it lets you instantly and automatically execute parameter settings that normally require many button presses or controller operations. Use it during Song recording or playback to make instantaneous setting changes.

Song Scene parameters

Tempo	Song mode	Track View display (page 181)
Transpose		
Play Effect settings for 16 tracks		
Volume settings for 16 Mixing Parts	Mixing mode	Part 1-16 display (page 231)
Pan settings for 16 Mixing Parts		
Reverb Send settings for 16 Mixing Parts		
Chorus Send settings for 16 Mixing Parts		
Cutoff Frequency settings for 16 Mixing Parts		EG display (page 235)
Resonance settings for 16 Mixing Parts		
AEG Attack settings for 16 Mixing Parts		
AEG Release settings for 16 Mixing Parts		

- Voice mode
- Performance mode
- Sampling mode 1
- Song mode
- Pattern mode
- Mixing mode
- Sampling mode 2
- Master mode
- Utility mode
- File mode
- Reference

Registering the Song Scene

After making the desired settings for the Scene, simultaneously hold down the [STORE] button and press one of the [SF1] to [SF5] buttons. The 8th note icon is shown in the tab corresponding to the Sub Function button to which the Song Scene is registered. Press the [STORE] button to store the Song data including the Song Scene setting.

CAUTION

The Song Scene settings registered to the [SF1] – [SF5] buttons will be lost if you change the Song or turn the power off without executing the Store operation.

Recalling the Song Scene

You can recall the Song Scene by press one of the [SF1] to [SF5] buttons.

Song Chain Playback

Song Chain Playback allows you to put together a play list of preset Songs, in any desired order, and have them automatically play back in sequence. You can set the order of Song playback then start the Chain Playback from the Song Chain display.

NOTE For instructions on programming the Song Chain, refer to the description about the Song Chain display (page 185).

1 From the Track Vies display, press the [F4] button to call up the Song Chain display (page 185).



2 Press the [▶] (Play) button to start the Song Chain playback.

The Songs are played back according to the order of the Chain. When an empty Song is assigned to the Chain number, one measure of silence is counted, followed by playback of the next Song. When a “skip” is assigned to the Chain number, the assigned Song will be ignored or skipped then next Song will start. When a “stop” is assigned to the Chain number, playback will be stopped at that Song. Press the [▶]

(Play) button to restart playback from the next Chain number.

If an “end” is assigned to the Chain number, playback will stop at the end of the Song.

3 If you wish to stop playback in the middle of a Song Chain, press the [■] (Stop) button.

NOTE The Song Chain can only be played back in the Song Chain display, and not from any other display.

Knobs and Sliders

By using the knobs on the front panel, you can adjust various parameters such as pan, effect, cutoff frequency and resonance for each part (track) of the Song. By using the sliders, you can change the volume of each Part (track) and adjust the relative balance among the Parts (tracks).

Adjusting the Pan and Effect parameters for each Part

Press the [MULTI PART CONTROL] button to call up the Control Function window.

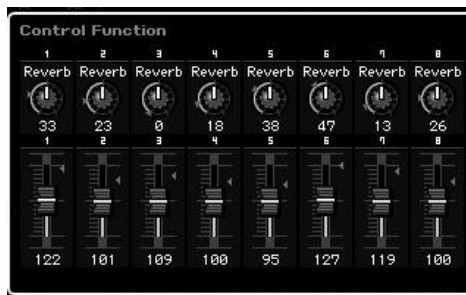

Switching the Parts to be edited: 1 – 8 and 9 – 16

When the Control Function window is shown after pressing the [MULTI PART CONTROL] button, each knob/slider controls each Part and you can change the target parts to be controlled between Parts 1 – 8 and 9 – 16. When the target Parts are 9 – 16 (the display is for Parts 9 – 16), pressing any of the [1] – [8] buttons changes the target Parts from 9 – 16 to 1 – 8. When the target Parts are 1 – 8 (the display is for Parts 1 – 8), pressing any of the [9] – [16] buttons changes the target Parts from 1 – 8 to 9 – 16.

Knob Functions

Pressing the [MULTI PART CONTROL] button turns on the lamps in the descending order: REVERB → CHORUS → PAN. When the REVERB lamp is turned on, the knobs let you adjust the Reverb Send for each part. When the CHORUS lamp is turned on, the knobs let you adjust the Chorus Send for each part. When the PAN lamp is turned on, the knobs let you adjust the Pan for each part.

NOTE Holding down the [MULTI PART CONTROL] button for a few seconds will alternate the lit lamp from the current one to REVERB.

Adjusting the Cutoff Frequency and Resonance for each Part

Press the [SELECTED PART CONTROL] button to call up the Control Function window.

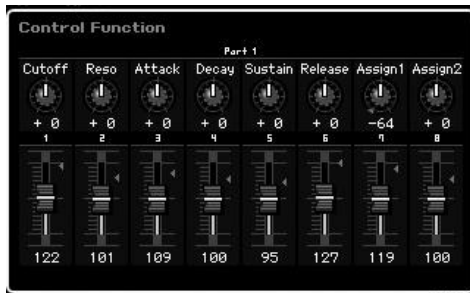

Selecting a target Part

The functions assigned to the knobs are applied only to the currently selected Part. To change the Part, call up the Control Function window, then press one of the [1] – [16] buttons.

Knob Functions

As listed below, various functions are assigned to Knobs 1 – 8 depending on which lamp is turned on—the TONE 1, TONE 2, and ARP FX lamps which can be switched via the [SELECTED PART CONTROL] button.

	Knob 1	Knob 2	Knob 3	Knob 4
TONE 1	Cutoff	Reso	Attack	Decay
TONE 2	LowGain	MidFreq	MidGain	MidQ
ARP FX	Swing	Qt Val	Qt Str	GateT

	Knob 5	Knob 6	Knob 7	Knob 8
TONE 1	Sustain	Release	Assign1	Assign2
TONE 2	HighGain	Pan	Reverb	Chorus
ARP FX	Velocity	Octave	UnitMlt	Tempo

NOTE For details about each function, see page 90.

Adjusting the volume of each Part

The Sliders lets you adjust the volume for each Part.

Switching the Parts to be edited: 1 – 8 and 9 – 16

When the current part is any of 1 – 8, the eight sliders adjust the volume for Parts 1 – 8. When the current Part is any of 9 – 16, the eight sliders adjust the volume for Parts 9 – 16. The Part can be selected by turning the [TRACK] on and pressing the desired Number button.

Mixing Setup for each track

To edit the Mixing parameters such as Voice, volume and pan for each track, press the [MIXING] button to enter the Mixing mode (page 229) then edit them for the Mixing Part corresponding to the desired track. Note that track 1 does not always correspond to the Mixing Part 1. As illustrated below, each track of the Song sequence data and each Mixing Part of the tone generator block are connected when the transmit channel (TxCH) equals the receive channel (RcvCH). In other words, the sequence data of each track plays the corresponding Parts (those having the same MIDI channel assignment) in the tone generator block. The Transmit Channels of each track can be set in the Song Track display (page 184) of the Song Play mode while the Receive Channels of each Part can be set in the Voice display (page 235) of the Mixing mode.

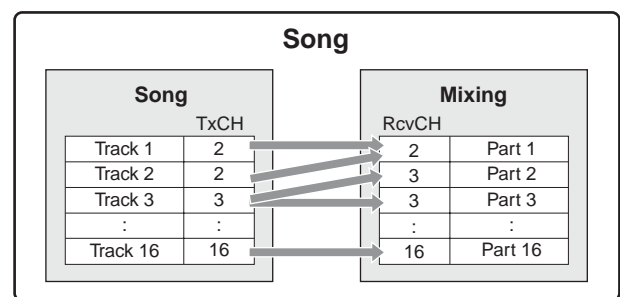

Track View display—[F1] TrackView

[SONG]

This display always appears first when the Song mode is engaged.

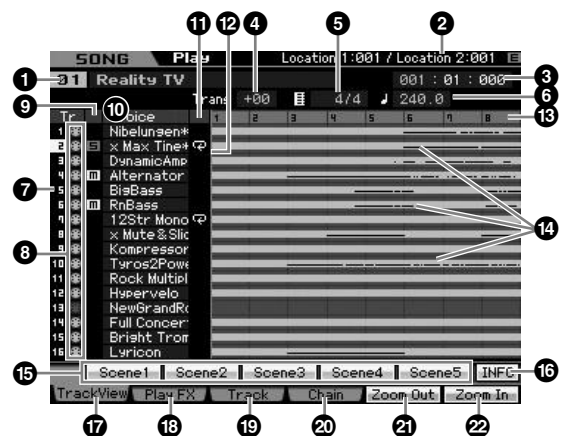

1 Song number, Song name

Determines the Song to be played back.

Settings:

Song number: 01 – 64

Song name: See the Note below.

NOTE You can edit the Song name by moving the cursor to the corresponding location and pressing the [SF6] CHAR button. For details, see page 82.

Voice mode

Performance mode

Sampling mode 1

Song mode

Pattern mode

Mixing mode

Sampling mode 2

Master mode

Utility mode

File mode

Reference

2 Location (Indication only)

Indicates the measure number assigned to Location 1 and 2. For detailed instructions on setting the Location, see page 178.

3 Meas (Measure)

Determines the location at which playback starts. This also indicates the current location of playback. For detailed instructions on setting the measure, see page 178.



Settings:

Measure: 001 – 999
Beat, Clock: Indication only

4 Trans (Transpose)

Adjusts the tuning in semitone increments.

Settings: -36 – +36

5 Time signature (Meter)

Determines the meter (time signature) of the Song. The setting here is applied to the specified Measure (3) and subsequent measures. This allows you to enter different time signatures in the middle of a song. When setting the Measure (3) at which playback starts to a time signature other than that at the song beginning, for example, the time signature before the Measure (3) is maintained even if you change the time signature here.

Settings: 1/16 – 16/16, 1/8 – 16/8, 1/4 – 8/4

6 Tempo

Determines the Song playback tempo.

Settings: 5.0 – 300.0

NOTE If you are using this instrument with an external sequencer, a computer, or other MIDI device, and you want to make the Song tempo controlled by the external device(s), set the MIDI sync (5) parameter in the MIDI display (page 267) of the Utility mode to "MIDI." In that case, the Tempo parameter here indicates "MIDI" and cannot be changed.

7 Track number (Indication only)

Indicates the track number.

8 Data status (Indication only)

Indicates whether the data is recorded or not to each of tracks.

Blank: Indicates the track is empty.

: Indicates the MIDI sequence data has been recorded. This is handled as a MIDI track.

: Indicates the sample data has been recorded in addition to MIDI sequence data. This is handled as an Audio track.

NOTE For Mixing Parts that correspond to Audio tracks, a Sample Voice is assigned. For Mixing Parts that correspond to MIDI tracks, a Voice other than a Sample Voice is assigned. For more information about Audio tracks and MIDI tracks, see page 61.

9 Mute/Solo (Indication only)

Indicates the Mute/Solo status for each track. For detailed instructions on setting Mute/Solo, see page 179.

Blank: Neither Mute nor Solo are assigned to this track.

: Indicates muted track.

: Indicates soloed track.

10 Voice Name

Indicates the Voice name of the Mixing Part corresponding to each track.

11 Loop (Indication only)

Determines whether or not Loop playback is set for each track. The track for which Loop is turned on plays repeatedly following the setup of the Track Loop display (page 185).

Settings: Blank (Loop off), (Loop on)

12 Song Position Line

Indicates the current location of the Song playback set at Measure above.

13 Measure number (Indication only)

Indicates the measure number. By pressing the [F5] Zoom Out or [F6] Zoom In button, you can zoom in or zoom out over the interval between the adjacent measures.

14 Sequence data bar

Indicates whether data has been recorded or not to each of tracks. You can check the range over which the data is recorded for each track. For MIDI tracks, you can view all the timings at which MIDI events have been recorded.

You can check the data status.

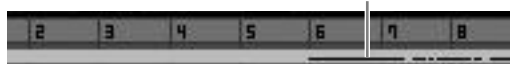

15 [SF1] Scene1 – [SF5] Scene5

You can assign the settings of the Song-related parameters (Song Scene) and the Arpeggio-related parameters to these buttons. You can also recall the settings by pressing these buttons. For detailed instructions on registering Scenes, see page 179. For detailed instructions on setting the Arpeggio-related parameters, see page 189.

NOTE The Arpeggio is not available during Song playback. Pressing the [SF1] Scene 1 – [SF5] Scene 5 buttons during playback changes only the Song Scene.

NOTE After registering the Song Scene, the 8th note icon will appear on the tab corresponding to the pressed button. You can confirm whether the Arpeggio Type is assigned to that button in the Arpeggio display (page 189) of Song Record.

16 [SF6] INFO (Information)

You can view the amount of free and used sequencer memory. The sequencer memory covers the all Songs and Patterns recorded in the respective modes. When the used memory amount reaches the maximum capacity, no further Songs or Patterns can be stored. If this occurs, use the Clear Song Job (page 207) or Clear Pattern Job (page 228) to delete any unnecessary Songs or Patterns.

You can go back to the previous display by pressing the [SF6] button or the [EXIT] button.

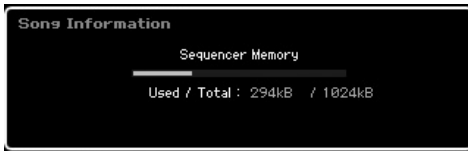

17 [F5] Zoom Out

18 [F6] Zoom In

Changes the zoom level of Measure number (13) of the Track View display. Press the [F5] Zoom Out button to reduce the Zoom level so that a wider range can be displayed. Press the [F6] Zoom In button to raise the Zoom level so that a magnified view can be displayed.

19 [F1] TrackView

Calls up the Track View display.

20 [F2] Play FX (Play Effect)

Calls up the Play Effect display (below). By changing the timing and velocity of the notes, you can change the rhythmic “feel” of the Song playback.

21 [F3] Track

Calls up the Song Track Output Channel display (page 184).

22 [F4] Chain

Calls up the Song Chain display (page 185). This display lets you play back multiple Songs sequentially.

Changing the rhythmic “feel” of the Song—[F2] Play FX (Play Effect)

By changing the timing and velocity of the notes, you can change the rhythmic “feel” of Song playback. The Play Effect settings made here are only temporary and don't change the actual data in the Song. The Play Effect settings can be applied actually to the Song data by using the Normalize Play Effect Job.

Tr.	Quantize		Swing		Note Shift		Clock Shift		Gate Time		Velocity	
	Value	Str	Vel	Gate	Rate	Rate	Rate	Rate	Rate	Rate	Rate	Offset
1	off	100%					+0	+0	100%	100%		+0
2	♩	100%	100%	100%	0	+0	+0	+0	100%	100%		+0
3	♩	100%	100%	100%	0	+0	+0	+0	100%	100%		+0
4	♩	100%	100%	100%	0	+0	+0	+0	100%	100%		+0
5	off	100%				+0	+0	+0	100%	100%		+0
6	off	100%				+0	+0	+0	100%	100%		+0
7	off	100%				+0	+0	+0	100%	100%		+0
8	off	100%				+0	+0	+0	100%	100%		+0
9	off	100%				+0	+0	+0	100%	100%		+0
10	off	100%				+0	+0	+0	100%	100%		+0
11	off	100%				+0	+0	+0	100%	100%		+0
12	off	100%				+0	+0	+0	100%	100%		+0
13	off	100%				+0	+0	+0	100%	100%		+0
14	off	100%				+0	+0	+0	100%	100%		+0
15	off	100%				+0	+0	+0	100%	100%		+0
16	off	100%				+0	+0	+0	100%	100%		+0

1 Track number (Indication only)

Indicates the track number.

2 Quantize

This lets you align the timing of the note events according to the specified note type. Here, set the two parameters for each track: Value and Str (Strength).

Quantize Value

Determines to what beats the note data in the Arpeggio sequence data will be aligned, or determines to what beats in the Arpeggio sequence data the swing is applied.

Settings: off, 32nd note, 16th note triplet, 16th note, 8th note triplet, 8th note, 1/4 note triplet, 1/4 note

Quantize Str (Quantize Strength)

Sets the “strength” by which note events are pulled toward the nearest quantize beats. A setting of 100% produces exact timing set via the Quantize Value parameter above. A setting of 0% results in no quantization. A setting of 50% result that the note events are pulled to the half point between the 0% and 100%.

Settings: 0% – 100%

When quarter-note quantization is applied to the original data:

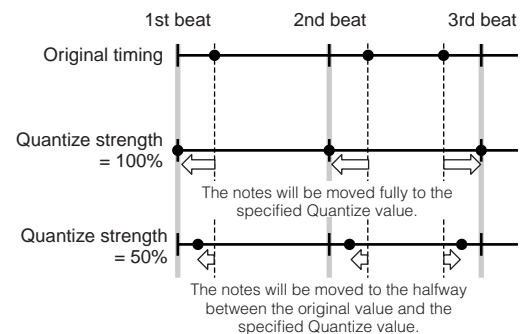

3 Swing

Adjusts the timing, velocity, and gate time (the length of time a note sounds) of the even-numbered back-beat notes to enhance the swing feel. This parameter delays notes on even-numbered beats (backbeats) to produce a swing feel. For example, if the meter is 4/4 and the quantize value is quarter notes, the 2nd and 4th beats of the measure will be delayed. When a triplet value is specified, the last note of each triplet is affected by the Swing parameter.

When the quarter-note swing is applied to the original data:

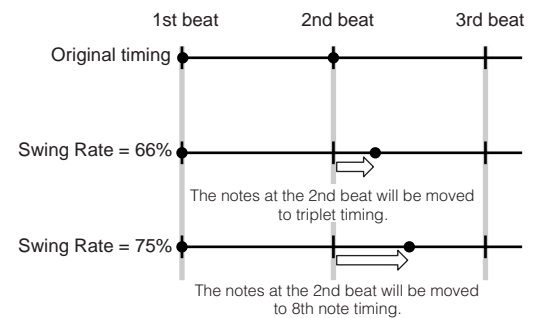

Here, edit the Swing settings for each track by specifying the Swing Vel (Swing Velocity), Swing Gate, and Swing Rate. When the Quantize value is set to “off,” all the Swing parameters are not available.

- Voice mode
- Performance mode
- Sampling mode 1
- Song mode
- Pattern mode
- Mixing mode
- Sampling mode 2
- Master mode
- Utility mode
- File mode
- Reference

Swing Vel (Swing Velocity)

Adjusts the velocity of the corresponding notes to accentuate the swing rhythmic feel. Settings below 100% reduce the velocities of notes on even-numbered beats (backbeats), and settings above 100% increase the velocities proportionately. If the result is 0 or less, the value is set to 1. If the result is higher than 127, the value is set to 127.

Settings: 0% – 100% – 200%

Swing Gate (Swing Gate Time)

Adjusts the gate time of the corresponding notes to accentuate the swing rhythmic feel. Settings below 100% will shorten the gate times of notes on even-numbered beats (backbeats), whereas settings above 100% will lengthen them. If an adjusted gate time value is less than 1, the value is rounded off to 1.

Settings: 0% – 100% – 200%

Swing Rate

Delays notes on even-numbered beats (backbeats) to produce a swing feel. Settings above 50% will delay notes to produce a more pronounced swing feel.

Settings:

Quantize Value	Settings
When the Quantize Value is set to off	0 – 0
When the Quantize Value is set to 32nd note	0 – 30
When the Quantize Value is set to 16th note triplet	0 – 40
When the Quantize Value is set to 16th note	0 – 60
When the Quantize Value is set to 8th note triplet	0 – 80
When the Quantize Value is set to 8th note	0 – 120
When the Quantize Value is set to 1/4 note triplet	0 – 160
When the Quantize Value is set to 1/4 note	0 – 240

4 Note Shift*

Raises or lowers the pitch of all notes in the selected track in semitones.

Settings: -99 – +0 – +99

5 Clock Shift

Shifts the timing of all notes in the selected track forward or backward in clock increments.

Settings: -120 – +0 – +120

6 Gate Time Rate

Raises or lowers the gate time of all notes in the selected track. If an adjusted gate time value is less than 1, the value is rounded off to 1.

Settings: 0% – 100% – 200%

7 Velocity

Raises or lowers the velocity of all notes in the selected track. If the result is 0 or less, the value is set to 1. If the result is higher than 127, the value is set to 127.

Velocity Rate

Alters the velocity of notes by the specified percentage.

Settings: 0% – 100% – 200%

Velocity Offset

Increases or decreases the velocity of notes by the specified offset value.

Settings: -99 – +0 – +99

Output Channels and Loop settings for each track—[F3] Track

This display lets you set the Output Channel and set the Loop Playback related parameters for each track.

Track Channel Settings—[SF1] Out (Output Channel)

This display lets you set the MIDI Transmit Channel for each track.



1 Voice (Indication only)

Indicates the Voice name of the Mixing Part corresponding to each track.

NOTE In the Part 1 – 16 display (page 231) of the Mixing mode, you can change the Voice of the Mixing Part corresponding to the track.

2 TxCh (Transmit Channel)

Determines the MIDI transmit channel of the sequence data for each track. Tracks set to “off” will not sound. In the Song mode, the MIDI data created by playing the keyboard/knobs/wheels is sent to the tone generator block or the external MIDI devices via the MIDI output channel of the currently selected track.

Settings: 1 – 16, off

3 Int (Internal Switch)

Determines whether musical performance data of each track is sent to the internal tone generator block or not. When set to “off,” the performance data will not be sent to the internal tone generator block.

4 Ext (External Switch)

Determines whether performance data of each track is sent to the external MIDI device or not. When set to “off,” the performance data will not be sent to the external MIDI device.

Loop Playback Settings—[SF2] Loop

These allow you to set specific tracks for Loop Playback and determine what range of measures will be used for the Loop.

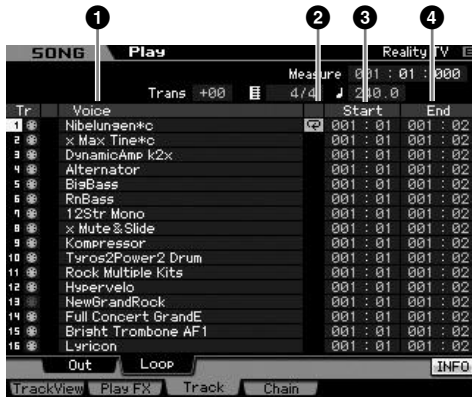

1 Voice (Indication only)

Indicates the Voice name of the Mixing Part corresponding to each track.

NOTE In the Part 1 – 16 display (page 231) of the Mixing mode, you can change the Voice of the Mixing Part corresponding to the track.

2 Loop

Determines whether or not the Loop Playback is active for each track. The track of which the Loop is turned on plays from Start (3) to End (4) repeatedly.

Settings: Blank (Loop off),  (Loop on)

3 Start (Start Point)

4 End (End Point)

Determines the range of the looped playback. The track of which the Loop is turned on plays from the Start Point to the End Point repeatedly.

Settings: Measure : Beat

Song Chain Playback—[F4] Chain (Song Chain)

Song Chain Playback allows you to put together a play list of preset Songs, in any desired order, and have them automatically play back in sequence. From this display, you can program the order of the Song playback.



1 Chain Number (Indication only)

Indicates the order of the Song playback. Numbers 1 – 100 are provided and you can view these numbers by scrolling the display. The Song Chain will be played back in order from the Song assigned to 001.

2 Song number

3 Song name (Indication only)

Determines the Song number to be played back in the chain. The Song name is shown when you specify the Song number. If an empty Song is assigned to a certain Chain number, that number will be skipped after a one-measure count. In addition to Song numbers, “skip,” “end,” and “stop” commands can be assigned to the Song Chain numbers.

Settings: skip, end, stop, 01 – 64

skip

Skips (ignores) the selected chain number and continues playback from the next chain number.

end

Indicates the end mark of the Song Chain data.

stop

Stops Song Chain playback at that chain number. You can restart the song chain playback from the next chain number by pressing the  (Play) button.

Programming the Song Chain

Follow the instructions below to program the Song Chain. Keep in mind that the Song Chain program will be stored automatically; it is not necessary to execute the Store operation.

1 From the Track View display, press the [F4] button to call up the Song Chain display.

2 Program the desired order of the Songs.

Move the cursor to “001” by using the cursor buttons and select the desired Song by using the Data Dial, or the [INC/YES] and [DEC/NO] buttons. In the same manner, assign other Songs to locations 002, 003, 004, and so on.

3 Use “skip” if you want to delete the Song already assigned to the Chain number.

Move the cursor to the Song number to be deleted, then assign the “skip” command to that location by using the data dial, or the [INC/YES] and [DEC/NO] buttons. The assigned Chain number will be ignored during playback.

4 Assign “end” to the Chain number at which you wish to stop the Song Chain playback.

When playback reaches a Chain number to which the “end” command has been assigned, playback will stop. If you want to stop playback at a certain Chain number and restart from the next Chain number, assign the “stop” command to that Chain number.

NOTE The Song Chain will be stored as part of system data.

NOTE For details about Song Chain playback, see page 180.

Song Recording

In the Song Record mode, you can use the sequencer to record your keyboard performance, track by track, to a selected Song. Press the [●] (Record) button from the Song Play mode to enter the Song Record mode.

NOTE Recording the audio data for a Song can be executed in the Sampling Record mode (page 244).

Realtime Recording

This method lets you record the performance data as it is played, allowing you to capture all the nuances of an actual keyboard performance. Recording can be carried out while monitoring playback of other already-recorded tracks. You can also transmit sequence data from an external MIDI instrument to the MOTIF XS and simultaneously record up to 16 tracks (page 190). The Realtime recording consists of three methods: Replace, Overdub, and Punch.

Song Recording procedure

Here in outline form is the process of recording a Song.

- 1 Press the [SONG] button to enter the Song Play mode, then select a Song to be recorded (page 178).**

Select an empty Song if you wish to create a new Song from scratch. If an empty Song is not found, delete any unnecessary Song(s) by using the Clear Song Job (page 207).
- 2 Press the [●] (Record) button to call up the Record Setup display (page 187).**

Prepare for recording by setting the time signature, tempo, track to be recorded, Voice, and recording method. If you wish to record using an Arpeggio, set the necessary parameters from the Arpeggio display (page 189).
- 3 Record your keyboard performance.**

For details, see page 189.
- 4 Edit the recorded Song using the Song Job (page 195) and Song Edit (page 192).**
- 5 Press the [STORE] button to store the recorded Song to internal User Memory.**

CAUTION
The recorded Song will be lost when selecting a different Song, calling up a different mode, or turning the power off. Make sure to store the Song data to internal memory by pressing the [STORE] button before selecting a different Song, calling up a different mode, or turning the power off.
- 6 Save the created Song data to a USB storage device or to a connected computer as desired (page 278).**

Song Store—[STORE]

This section covers how to store the Songs you have recorded and edited. By executing the Store operation, the Song data you have created will be maintained even if the power has been turned off. Pressing the [STORE] button calls up the Song Store window.

The following data will be stored by the Song Store operation.

Sequence data

MIDI data generated and recorded by your keyboard performance including the controller operations.

Tone Generator data

Mixing settings (Common Edit parameters and Part Edit parameters)

NOTE The Mixing Voices can be edited in the Mixing Voice Store window (page 240).

To use Song Store:

1 Call up the Song Store window.

Pressing the [STORE] button calls up the Song Store window.

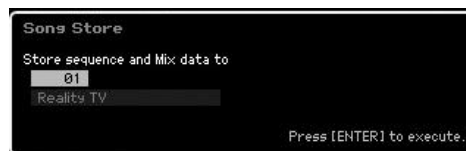

2 Select a destination Song number.

The name of the selected Song number is shown.

CAUTION

This operation overwrites any data already existing in the destination Song.

3 Press the [ENTER] button. (The display prompts you for confirmation.)

Press the [DEC/NO] button to cancel the Store operation. Song Store is canceled, and operation returns to the previous display.

4 Press the [INC/YES] button to execute the Store operation.

After the Song has been stored, a “Completed” message appears and operation returns to the Song Play display.

NOTE If there is not enough memory space for the Song/Pattern, an alert message appears, and you will not be able to store any additional Songs/Patterns. If this happens, delete unnecessary Patterns/Songs by using the Song/Pattern Job, then try the Store operation again.

Preparing the Song Recording— [F1] Setup

From this display you can set up various parameters for recording a Song.

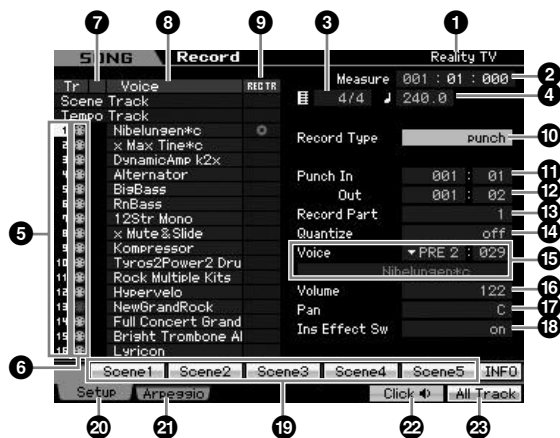

1 Song name (Indication only)

Indicates the name of the currently selected Song. The Song can be selected in the Song Play display (page 178).

2 Meas (Measure)

Determines the location at which playback starts. This also indicates the current location of the recording.

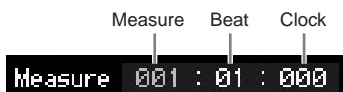

Settings:

Measure: 001 – 999
Beat, Clock: Indication only

3 Time signature (Meter)

Determines the meter (time signature) of the Song.

Settings: 1/16 – 16/16, 1/8 – 16/8, 1/4 – 8/4

4 Tempo

Sets the tempo for recording in real time.

Settings: 5.0 – 300.0

NOTE The tempo value set here will be the tempo of the Song after recording.

NOTE If you are using this instrument with an external sequencer, a computer, or other MIDI device, and you want to have the Song recording tempo controlled by the external device(s), set the MIDI sync (5) parameter in the MIDI display (page 267) of the Utility mode to "MIDI." In that case, the Tempo parameter here indicates "MIDI" and cannot be changed.

5 Track number (Indication only)

Indicates the track number.

6 Track type (Indication only)

Indicates the track type: MIDI track or Audio track. For Mixing Parts that correspond to Audio tracks, a Sample Voice is assigned. For Mixing Parts that correspond to MIDI tracks, a Voice other than a Sample Voice is assigned. For Mixing Parts that correspond to empty tracks, no Voice is assigned.

Settings: (MIDI Track), (Audio track), blank (no Voice is assigned)

7 Mute/Solo (Indication only)

Indicates the Mute/Solo status for each track. For detailed instructions on setting Mute/Solo, see page 179.

Blank: Neither Mute nor Solo are assigned to this track.

: Indicates muted track.

: Indicates soloed track.

8 Voice name (Indication only)

Indicates the Voice name of the Mixing part corresponding to each track.

9 REC TR (Record Track)

Determines the track to be recorded. Move the cursor to the desired track or press any of the Number buttons [1] – [16] with the TRACK lamp turned on so that the red circle is shown in the corresponding column of the REC TR. To set all tracks to the Record Track, press the [F6] button (red circles are shown in all columns of REC TR).

Settings: Scene Track, Tempo Track, 1 – 16, All Track

Scene Track

Records track mute on/off events and Song Scene changing timing events.

Tempo Track

Records tempo change information during playback.

1 – 16

Records your actual musical performance. Your keyboard performance will be recorded to the track selected here.

All Track

Simultaneous recording to all 16 sequence tracks. Multi-channel data from an external MIDI device can be recorded at once.

10 Record Type

Determines a Recording method.

Settings: replace, overdub, punch

replace

You can use this method when you want to overwrite an already recorded track with new data in real time. The original data will be erased.

overdub

You can use this method when you want to add more data to a track that already contains data. Previously recorded data will be maintained.

punch

You can use this method when you want to overwrite data to a specified range of a track that already contains data. You can overwrite the already recorded data from the starting point to the ending point (measure/beat) that was specified before recording.

NOTE When the Record Track (5) is set to "Tempo Track" or "Scene Track," "overdub" cannot be selected here.

Voice mode

Performance mode

Sampling mode 1

Song mode

Pattern mode

Mixing mode

Sampling mode 2

Master mode

Utility mode

File mode

Reference

11 Punch In**12 Punch Out**

When punch (Punch In/Out) is selected as the Record Type explained above, the recording start position (Punch In position) and finish position (Punch Out position) are specified here.

Settings: 001 : 01 – 999 : 16

13 Record Part (Indication only)

Indicates the Mixing Part corresponding to the Record Track.

Settings: 01 – 16

14 Quantize (Record Quantize)

This convenient feature lets you automatically quantize the notes in real time, as you record. Quantize aligns the timing of note events to the nearest beat. This parameter determines whether real-time Quantize is on or not, and the resolution to which the notes will be aligned. The number shown at right of each value indicates the length assumes that the quarter-note resolution is 480.

Settings: off, 60 (32nd note), 80 (16th note triplet), 120 (16th note), 160 (8th note triplet), 240 (8th note), 320 (1/4 note triplet), 480 (1/4 note)

15 Voice

Determines the Voice for the recording track by specifying the Voice Bank and Voice number. The setting here is applied to the Voice setting for the Record Part (13). The name of the selected Voice is indicated in the next line.

Settings:**Voice Bank**

PRE1 – 8, USR1 – 3, GM, PDR (Preset Drum Voice), UDR (User Drum Voice), GMDR (GM Drum Voice), SMPL (Sample Voice)*, MIXV (Mixing Voice)**

* The SMPL (Sample Voice) can be created by recording audio signal to a track in the Sampling mode. Here, you can select only a Sample Voice which is currently stored to the currently selected Song. For details, see page 242.

** The MIXV (Mixing Voice) is edited and stored in the Mixing mode. Here, you can select only a Mixing Voice which is currently stored to the currently selected Song. For details, see page 230.

Voice number: 001 – 128

NOTE You can call up the list and select the desired one by pressing the [SF6] LIST button. For details, see page 82.

16 Volume

Determines the volume for the recording track. The setting here is applied to the Volume setting for the Record Part (13).

Settings: 0 – 127

17 Pan

Determines the stereo pan position of the sound. The setting here is applied to the Pan setting for the Record Part (13).

Settings: L63 – C – R63

18 Ins Effect Sw (Insertion Effect Switch)

Determines whether the Insertion Effect assigned to the Voice is used or not. The setting here is applied to the Insertion Effect Switch setting for the Record Part (13).

Settings: off, on

NOTE The MOTIF XS features eight Insertion Effects, letting you set this parameter to on for up to eight Parts. If eight Parts are already turned on, the parameter cannot be turned on for additional Parts. In this case, another Part must be turned off. To do this, set the Insertion Effect Switch parameter for another Part to “off” in the Part 1 – 16 display (page 231) of the Mixing mode.

19 [SF1] Scene1 – [SF5] Scene5

Pressing these buttons while recording changes the Song Scene and Arpeggio settings simultaneously. For details, see page 181.

20 [F1] Setup

Pressing this button returns from the previous display to the Record Setup display.

21 [F2] Arpeggio

Calls up the Record Arpeggio display. From this display you can set various Arpeggio-related parameters for the Song recording.

22 [F5] Click

Switches the metronome on/off. Pressing the [F5] button toggles the Click function on and off.

NOTE From the Click display (page 270) of the SEQ SETUP, you can make various settings for the metronome click, such as the note resolution, volume, and lead-in count for recording.

23 [F6] All Track

Pressing this button sets all 16 tracks to the Record Track. For details, see page 187.

Arpeggio Settings—[F2] Arpeggio

From this display you can set various Arpeggio-related parameters for the Song recording.

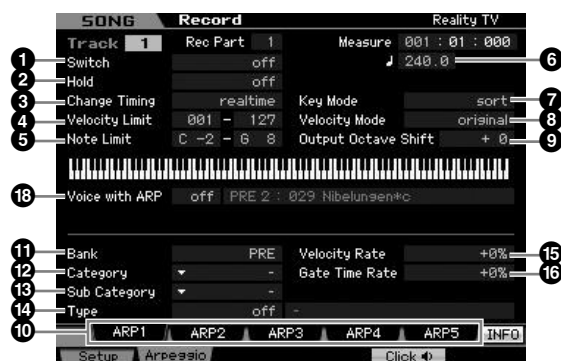

Parameters ① – ⑰ are same as the ones in the Arpeggio Main display (page 101) in the Voice Common Edit mode.

⑱ Voice with ARP (Voice with Arpeggio)

Each Arpeggio type is assigned a specific Voice best suited to the type. When an Arpeggio type has been assigned to a recorded track, this parameter determines whether or not the Voice assigned to the Arpeggio type will also be used for the recorded track. When set to “on,” the appropriate Voice is assigned to the recorded track in place of the currently assigned Voice. When set to “off,” the appropriate Voice is not assigned to the recorded track. The currently assigned Voice is maintained. The name of the Voice registered to the Arpeggio Type is shown at the right side.

Settings: off (not copied), on (copied)

Calling up the Arpeggio Type by using the [SF1] Scene 1 – [SF5] Scene 5 buttons

The Arpeggio type set in the Arpeggio display of the Song Record can be called up together with the Song Scene via the [SF1] Scene 1 – [SF5] Scene 5 buttons in the Setup display (page 187) and the Track View display (page 181). The 8th note icon at right of Scene 1 – 5 in the tab indicates that the Song Scene is registered to the corresponding button. If the Arpeggio Type is set to “off” in the Arpeggio display of the Song Record, pressing the corresponding Sub Function button in the Setup display/Track View display will not change the Arpeggio type even if the 8th note icon is shown.

Realtime Recording Procedure

This section explains how to record your performance using the Realtime Recording features. Please keep in mind that the procedure differs depending on the Record Type and Record Track set from the Record Setup display.

Replace Recording

[SONG] → [●] (Record) → Record track selection → Type=replace → [▶] (Play)

By using this method, any previous data in the recorded track will be erased (overwritten) and replaced by the new data. The first recording is lost, and the new one takes its place. This is handy when you need to re-record the same Part several times.

NOTE If you accidentally overwrite important data when using Replace Recording, cancel the recording by using the Undo/Redo Job (page 196).

Recording Procedure for individual tracks 1 – 16

This section covers how to record your keyboard performance data to tracks 1 – 16 with Replace Recording.

- 1 Press the [SONG] button to call up the Song Play display (page 178), then select a Song to be recorded.**

Select an empty Song if you wish to create a new Song from scratch.
- 2 Press the [●] (Record) button to call up the Record Setup display (page 187). From this display, set the Record track to one of 1 – 16 then set the Recording type to “replace.”**

If necessary, set various parameters such as tempo, time signature, measure, quantize, and voice.
- 3 Press the [F5] Click button to turn the Click on when you wish to use the metronome.**

In the Click display (page 270) called up via the [SEQ SETUP] button, you can make various settings for the metronome click, such as the note resolution, volume, and lead-in count for recording.
- 4 Press the [▶] (Play) button so that its indicator flashes, then start recording after the count-in.**

Play the keyboard and/or controller to record.
- 5 Press the [■] (Stop) button to stop recording and return to the Song Play display.**

Recording Procedure for multiple tracks ("All Track" setting)

The sequence data transmitted from an external MIDI instrument can be recorded simultaneously up to 16 tracks.

- 1 Connect an external MIDI sequencer or a computer to the MOTIF XS then switch on the power to the MOTIF XS.**
- 2 Set the MIDI related parameters in the Utility mode.**
Press the [UTILITY] button, [F5] Control button, then [SF2] MIDI button to call up the MIDI Control display (page 267). From this display, set MIDI sync to "MIDI," then set the Sequencer Control to "in" or "in/out."
- 3 Press the [SEQ SETUP] button to call up the [F1] Click display (page 270), then set the Recording Count parameter to "off."**
- 4 Press the [SONG] button to call up the Song Play display (page 178), then select a Song to be recorded.**
Select an empty Song if you wish to create a new Song from scratch.
- 5 Press the [●] (Record) button to call up the Record Setup display (page 187). From this display, set the Record track to "All Track" then set the Recording type to "replace." Set the Time Signature to the same one as the original Song to be recorded, then set Quantize to "off."**
- 6 Start playback of the external MIDI sequencer or computer application software.**
Recording begins automatically as soon as playback starts.
- 7 Stop playback of the external MIDI sequencer or computer application software.**
Recording stops automatically and operation returns to the Song Play display.

Recording Procedure for the Tempo Track

Here's how to record the Tempo data to the Tempo track in real time.

- 1 Press the [SONG] button to call up the Song Play display (page 178), then select a Song to be recorded.**

- 2 Press the [●] (Record) button to call up the Record Setup display (page 187). From this display, set the Record track to "Tempo Track" then set the Recording type to "replace."**

If necessary, set various parameters such as tempo, time signature, measure, quantize.

- 3 Press the [F5] Click button to turn the Click on when you wish to use the metronome.**

In the Click display (page 270) called up via the [SEQ SETUP] button, you can make various settings for the metronome click, such as the note resolution, volume, and lead-in count for recording.

- 4 Press the [▶] (Play) button so that its indicator flashes, then start recording after the count-in.**

Enter the tempo at the desired timing during playback by using the [DEC/NO]/[INC/YES] buttons and the Data Dial.

- 5 Press the [■] (Stop) button to stop recording and return to the Song Play display.**

NOTE You can edit the tempo from the Song Edit display for the Tempo track (page 192).

Recording Procedure for the Scene Track

Here's how to record the Track Mute on/off events and Scene changing timing events to the Scene track in real time.

- 1 Press the [SONG] button to call up the Song Play display (page 178), then select a Song to be recorded.**
- 2 Press the [●] (Record) button to call up the Record Setup display (page 187). From this display, set the Record track to "Scene Track" then set the Recording type to "replace."**
If necessary, set various parameters such as tempo, time signature, measure, quantize.
- 3 Press the [F5] Click button to turn the Click on when you wish to use the metronome.**
In the Click display (page 270) called up via the [SEQ SETUP] button, you can make various settings for the metronome click, such as the note resolution, volume, and lead-in count for recording.

- 4 Press the [MUTE] button (the lamp lights).**

- 5 Press the [▶] (Play) button so that its indicator flashes, then start recording after the count-in.**

Press one of the [1] – [16] buttons or the [F1] Scene 1 – [F5] Scene 5 buttons at the desired timing.

6 Press the [■] (Stop) button to stop recording and return to the Song Play display.

NOTE You can edit the Track on/off and the Scene change events from the Song Edit display for the Tempo track (page 192).

Rehearsal before recording

To temporarily disengage the record mode and enter the Rehearsal mode, simply press the [●] (Record) button during realtime recording. The [●] (Record) indicator flashes and playback will continue uninterrupted but no data will be recorded. This convenient Rehearsal mode feature lets you easily and temporarily disable recording in order to practice a Part or try out various ideas (while listening to the other tracks) without actually recording. To return to the record mode press the [●] (Record) button again so that the [●] (Record) indicator lights continuously.

Overdub Recording

[SONG] → [●] (Record) → Record track selection
→ Type=overdub → [▶] (Play)

This method allows material to be added to existing material on a track. The first recording is kept, and the new one is added. This makes it easy to create Parts by recording them a little at a time.

The Overdub Recording procedure is almost same as the Replace except that the Record type is set to “overdub.”

NOTE When the Record Track (Ⓢ) is set to “Tempo Track” or “Scene Track,” “overdub” cannot be selected here.

Re-recording a specific section of an already-recorded Song (Punch In/Out)

[SONG] → [●] (Record) → Record track selection
→ Type=punch → [▶] (Play)

Realtime recording can also be done between specified start (punch-in) and end (punch-out) points. This allows you to record a specified section of a previously-recorded track without having to re-record the entire track. Start recording with this method and playback begins. Actual recording will begin automatically when the punch-in point is reached and recording will be disengaged when the punch-out point is reached.

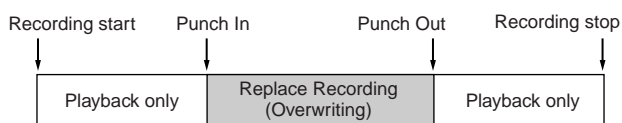

Punch In/Out setup

- 1 Press the [●] (Record) button to call up the Record Setup display (page 187).
- 2 Set the Recording type to “punch.”
- 3 Move the cursor to the punch in and punch out, then set their points respectively by entering measure and beat.

Except for setting the punch in and punch out, perform the same procedure as the Replace Recording procedure.

Voice mode

Performance mode

Sampling mode 1

Song mode

Pattern mode

Mixing mode

Sampling mode 2

Master mode

Utility mode

File mode

Reference

Editing MIDI Events (Song Edit)

The Song Edit mode lets you edit the already recorded Songs or insert the new data to the Songs. It can be used to correct mistakes as well as add dynamics or effects such as vibrato to refine and finish the Song. Press the [EDIT] button from the Song Play mode to go to the Song Edit mode.

NOTE The Song Edit mode gives you comprehensive, detailed controls for editing the MIDI events of individual Song tracks. MIDI events are messages (such as note on/off, note number, program change number, etc.) that make up the data of a recorded track.

Event List display and Insert Event window

The Song Edit mode consists of the Event List display and the Insert Event window. The Event List display lets you correct or delete already inserted MIDI events and the Insert Event window lets you insert new events to the Song. Press the [EDIT] button from the Song Play mode to go to the Event List display. Press the [F5] button to call up the Insert Event window.

Event List display

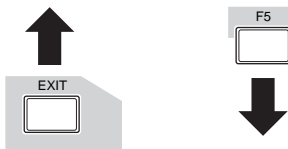
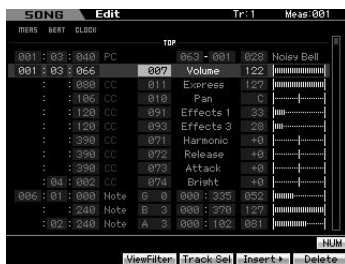

Insert Event window



Event List display

The Event List display lets you correct or delete existing events.

Insert Event window

The Insert Event window lets you insert new events to the Song.

Pressing the [F5] button on the Event List display calls up the Insert Event window. To return back to the Event List display, press the [EXIT] button.

Editing the recorded data

This section shows how to correct or delete previously recorded events.

1 Press the [EDIT] button from the Song Play display to call up the Event List display (page 193).

2 Select the track to be edited.

Pressing the [F4] Track Sel button switches the Recording track among Tracks 1 – 16, the Scene track and the Tempo track. When “1 – 16 tracks” is selected, you can select the track to be edited by pressing any of the Number buttons [1] – [16].

3 Move the cursor to the event or parameter to be edited.

Use the [^]/[V] (Cursor Up/Down) button to move the cursor to the desired timing. Press the [◀] (Rewind)/[▶] (Fast Forward) button to move the cursor by single measures. Use the [←]/[→] (Cursor Left/Right) button to move the cursor to the parameter to be edited.

NOTE For details about each event and parameter, see page 76.

NOTE The Event List window may have an overwhelming number of events, and it may be difficult to find a specific desired event. To help narrow down your search, use the View Filter function. This conveniently lets you specify which classes of events will be displayed and which will not, making it much easier and faster to find desired events. For information about the View Filter display, see page 194.

4 Change the parameter settings or location of the event.

Edit the value by using the [INC/YES], [DEC/NO] buttons and the data dial. The edited event will flash on the display.

Change the event location by editing the MEAS (measure), BEAT, and CLOCK. Press the [F6] button to delete the event at the cursor location.

NOTE When “NUM” is indicated in the tab corresponding to the [SF6] button, you can use the [F1] – [F6] buttons and the [SF1] – [SF5] buttons as numeric key pads by pressing the [SF6] NUM button.

NOTE The note and velocity can be edited also by pressing the desired note on the keyboard, even though the [KBD] icon is not shown.

- After you've finished editing a parameter, press the [ENTER] button to confirm and enter the edit (the event will stop flashing).

If the cursor is moved to a new event while the current event is still flashing, editing of the current event is cancelled.

- Press [EXIT] to go back to the Song Play mode.

Inserting the New Event

This section shows how to insert new events to the current Song.

- From the Event List display, press the [F5] Insert button to call up the Insert Event window.
- Specify the event type to be inserted, the insertion point (measure, beat, and clock), and parameter value of the event.

For details about each event and parameter, see page 76.

Event type

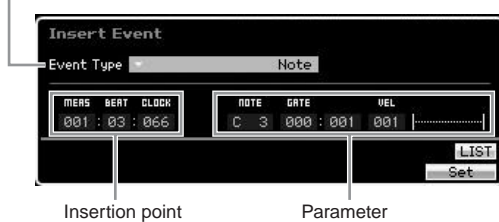

Insertion point

Parameter

- Press the [F6] Set button to insert the specified event at the specified location.

The Insert Event window remains open, allowing you to continue inserting new events. Press the [ENTER] button to actually insert the event and close the Insert Event window.

- Press the [EXIT] button to go back to the Event List display.

Event List display

In the Event List display, MIDI events (including mainly values such as note number, velocity, and control change value) are listed and can be edited.

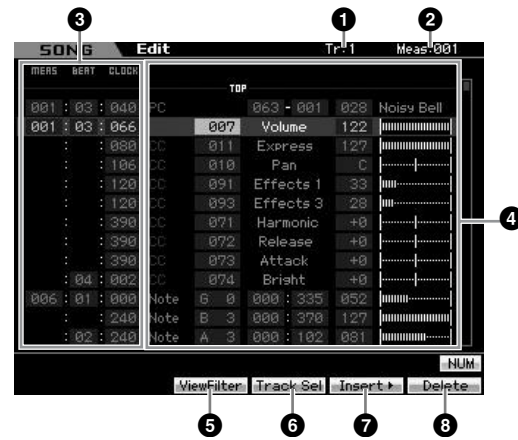

NOTE Depending on the selected parameter, the NUM icon is shown at the tab menu corresponding to the [SF6] button. In this condition, you can use the [SF1] – [SF5] and [F1] – [F5] buttons as number buttons by pressing the [SF6] NUM button. For details, see page 81.

- TR (Track)** (Indication only)

Indicates the selected track. You can change the track to be edited by using the [F4] Track Sel button and the Number [1] – [16] buttons.

Settings: Track 01 – 16, Scene, Tempo

- Measure** (Indication only)

Indicates the selected measure. You can change the measure by using the [◀] (Rewind) and the [▶] (Forward) buttons.

Settings:

Measure: 001 – 999

- MEAS (Measure), BEAT, CLOCK**

Indicates the location of the corresponding event.

Changing any of these values changes the location of the event accordingly.

Settings:

Measure: 001 – 999

Beat: 1 – 16 (depends on meter)

Clock: 000 – 479 (depends on meter)

- Event and Parameters**

Indicates the type of each event. For details about each event and parameter, see page 76.

Settings:

When TR is set to 01 – 16:

Note

PB (Pitch Bend)

PC (Program Change)

CC (Control Change)

CAT (Channel Aftertouch)

PAT (Polyphonic Aftertouch)

RPN

NRPN

EXC (System Exclusive)

CMM (Channel Mode Messages)

Voice mode

Performance mode

Sampling mode 1

Song mode

Pattern mode

Mixing mode

Sampling mode 2

Master mode

Utility mode

File mode

Reference

When TR is set to "scn" (Scene):

Scene Memory

Track Mute

When TR is set to "tmp" (Tempo):

Tempo Change

5 [F3] ViewFilter

Calls up the View Filter setting display (below).

6 [F4] Track Sel (Track Select)

You can switch between the display for tracks 1 – 16, the Scene track, and the Tempo track by pressing this button. When any one of tracks 1 – 16 is selected, you can select a different track number by pressing the appropriate Number button [1] – [16].

7 [F5] Insert

Calls up the Insert Event window (page 193).

8 [F6] Delete

Deletes the currently selected event. This button is not available when the cursor is located at the top or bottom of the Song data.

Changing the MIDI event view—[F3] View Filter

MIDI song data generally has a large amount of recorded events, and the Event List window may be overcrowded with them. Since it may be difficult to find a specific event, you can use the View Filter function to help narrow down your search. This conveniently lets you specify which classes of events will be displayed and which will not, making it much easier and faster to find desired events. From the Event List display, call up the View Filter display by pressing the [F3] View Filter button.



1 Event types

Only the event which the checkbox is marked will be shown on the Event List display.

Settings: Note, Pitch Bend, Program Change, Control Change*, Channel After Touch, Poly After Touch, RPN, NRPN, System Exclusive, Channel Mode Message

* You can specify the Control Number (0 – 119, all).

2 [F5] Clear All

Pressing this button removes the checkmarks of all events. If you wish to indicate specific events, it is a good idea to press the [F5] button to first remove the checkmarks of all events, then enter the checkmarks of your desired events.

3 [F6] Set All

Pressing this button enters the checkmarks for all events, letting you view all recorded events.

Song Job

The Song Job mode contains a comprehensive set of editing tools and data transform functions you can use to change the sound of the Song. It also includes a variety of convenient operations, such as copying or erasing data. 30 Jobs are available.

Function	Description
[F1] Undo/Redo	Undo job cancels the changes made by the most recent operation, restoring the data to its previous state. Redo job cancel Undo and restores the changes.
[F2] Note	Note data Jobs
01: Quantize	Quantization is the process of adjusting the timing of note events by moving them closer to the nearest exact beat. You can use this feature, for example, to improve the timing of a performance recorded in real time.
02: Modify Velocity	This Job alters the velocity values of the specified range of notes, letting you selectively boost or cut the volume of those notes.
03: Modify Gate Time	This Job alters the gate times of the specified range of notes.
04: Crescendo	This Job lets you create a crescendo or decrescendo over the specified range of notes. (Crescendo is a gradual increase in volume, and decrescendo is a gradual decrease.)
05: Transpose	This Job changes the pitch of the notes in semitones.
06: Glide	This Job replaces all notes following the first note in the specified range with pitch bend data, producing smooth glides from note to note.
07: Create Roll	This Job creates a series of repeated notes (like a drum roll) in the specified range with the specified continuous changes in clock step and velocity. This is ideal for creating fast staccato rolls and special stuttering effects.
08: Sort Chord	This job sorts chord events (simultaneous note events) by order of pitch.
09: Separate Chord	This Job slightly separates notes in chords within the specified range, inserting a specified number of clocks between each note. Use this Job after the Chord Sort Job above, to create guitar-like upstroke or downstroke effects.
[F3] Event	Event Jobs
01: Shift Clock	This Job shifts all data events in the specified range forward or backward by the specified number of clocks.
02: Copy Event	This Job copies all data from a specified source range to a specified destination location.
03: Erase Event	This Job clears all specified events from the specified range, effectively producing a segment of silence.
04: Extract Event	This Job moves all instances of specified event data from a specified range of a track to the same range in a different track.
05: Create Continuous Data	This Job creates continuous pitch bend or control change data over the specified range.
06: Thin Out	This Job thins out the specified type of continuous data in the specified range—allowing you to free up memory space for other data or further recording.
07: Modify Control Data	This Job lets you change the values of specified data such as Pitch Bend and Control Change in the specified range.
08: Beat Stretch	This Job performs time-expansion or compression over the selected range.
[F4] Measure	Measure Jobs
01: Create Measure	This Job creates empty measures at the specified location in all tracks.
02: Delete Measure	This Job deletes the specified measures.
[F5] Track	Track Jobs
01: Copy Track	This Job copies all data of the selected type from a specified source track to a specified destination track.
02: Exchange Track	This Job exchanges or “swaps” the specified type of data between two specified tracks in the current Song.
03: Mix Track	This job mixes all data from two selected tracks.
04: Clear Track	This Job deletes all data of the selected type from the selected track.
05: Normalize Play Effect	This job rewrites the data in the selected track so that it incorporates the current Play FX/Groove/MIDI Delay settings.
06: Divide Drum Track	This Job separates the note events in a drum performance assigned to a specified track, and places the notes corresponding to different drum instruments in separate tracks (tracks 1 through 8).
07: Put Track to Arpeggio	This Job copies data in the specified measures of a track for creating Arpeggio data.
08: Copy Phrase	This Job copies the Phrase (created in the Pattern mode) to a specified track of the current Song.
[F6] Song	Song Jobs
01: Copy Song	This Job copies all data from a selected source Song to a selected destination Song.
02: Split Song to Pattern	This Job allows you to copy a Part of the current Song to a specific Pattern.
03: Clear Song	This job deletes all data from the selected Song or all Songs. It can also be used to delete all 64 Songs at the same time.

Voice mode

Performance mode

Sampling mode 1

Song mode

Pattern mode

Mixing mode

Sampling mode 2

Master mode

Utility mode

File mode

Reference

Song Job Procedure

- 1 Press the [JOB] button to enter the Song Job mode.
- 2 Select the desired Job menu by pressing one of the [F1] – [F6] buttons.
- 3 Move the cursor to the desired Job by using the data dial, cursor buttons, [INC/DEC] and [DEC/NO] buttons, then press the [ENTER] button to call up the Job display.
- 4 Move the cursor to the desired parameter, then set the value by using the data dial, [INC/YES] and [DEC/NO] buttons.
- 5 After setting, press the [ENTER] button to execute the Job.

“Completed” will appear when the Job is done.

! CAUTION

In some Jobs, the operation overwrites any data previously existing in the destination memory. Important data should always be saved to a USB storage device connected to the USB TO DEVICE terminal or to a computer connected to the same network as the MOTIF XS (page 278).

- 6 Press the [EXIT] button twice to go back to the Song Play display.

NOTE If there is no data in the specified range, “No Data” will appear on the display and the Job cannot be executed. If you make a mistake or want to compare the sound of the data before and after executing a Job, press the [F1] button to use the Undo/Redo function.

! CAUTION

Even if a Job operation has been completed, selecting a different Song or turning the power off without storing will erase the Song data. Make sure to store the Song data to internal memory by pressing the [STORE] button before selecting a different Song or turning the power off.

NOTE In some Jobs, you need specify the range (start point and end point as illustrated below) to which the Job is applied. Keep in mind that the end point itself is not included in the range. The actual range to which the Job is applied is from the start point to the point that is one clock less than the end point. This rule applies to cases in which you specify only the Measure; however, the example illustration below shows specifying the Measure, Beat and Clock.

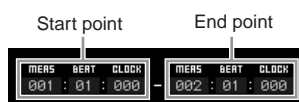

NOTE Some of the Jobs which enable you to copy the Sample Voice from the source to the destination execute the actual copy operation only when the Bank Select and Program Change events which specify the Sample Voice are recorded in the source Track.

[F1] Undo/Redo

The Undo Job cancels the changes you made in your most recent recording session, editing session, or Job, restoring the data to its previous state. This allows you to recover from accidental data loss. Redo is available only after using Undo, and lets you restore the changes you made before undoing them.



- 1 Indicates the operation to be affected by Undo or Redo.
- 2 Indicates the Undo/Redo target. When the changes you made in your most recent operation cannot be a target of the Undo/Redo, “Impossible” is shown here.

! CAUTION

Undo/Redo does not work with Mixing operations.

! CAUTION

Even if you have stored Song data, you can recall the data which was lost via the most recent operation by executing Undo. Make sure to execute the Undo/Redo operation before changing the song number or leaving the Song mode. This is because the Undo/Redo cannot be executed after changing the song number or leaving the Song mode.

[F2] Note Jobs

01: Quantize

Quantization is the process of adjusting the timing of note events by moving them closer to the nearest exact beat. You can use this feature, for example, to improve the timing of a performance recorded in real time.



1 Track and range

Determines the track (01 – 16, all) and range (Measure : Beat : Clock) to which the Quantize is applied.

2 Quantize (Resolution)

Determines the note timing to which the note data will be aligned. The number shown at right of each value indicates the length assumes that the quarter-note resolution is 480.

Settings:

	60	1/32 note
	80	1/16 note triplets
	120	1/16 note
	160	1/8 note triplets
	240	1/8 note
	320	1/4 note triplets
	480	1/4 note
	200	1/16 note and 1/16 note triplets
	400	1/8 note and 1/8 note triplets

NOTE You can call up the list and select the desired one by pressing the [SF6] LIST button. For details, see page 82.

3 Strength

Sets the "strength" by which note events are pulled toward the nearest quantize beats. A setting of 0% results in no change, whereas a setting of 100% moves note events exactly to the quantize beats. A setting of 50% results in the note events being pulled halfway between 0% and 100%.

Settings: 000% – 100%

4 Swing Rate

Delays notes on even-numbered beats (backbeats) to produce a swing feel. Judicious use of this setting lets you create swing rhythms and triplet feels, such as shuffle and bounce.

The functions and settings of this parameter differ depending on the Quantize resolution setting.

Settings: Depends on the Quantize (2) setting. Refer to the settings of the Swing parameter in the Play FX display (page 183).

If the Quantize value is 1/4 note, 8th note, 16th note, 32nd note:

For example, if the meter is 4/4 and the quantize value is quarter notes, the 2nd and 4th beats of the measure will be delayed. A setting of 100% is equivalent to twice the length of the specified Quantize value. A setting of 50% produces exact timing and therefore no swing feel. Settings above 51% delays the note timing to increase the amount of swing. A setting of 66% moves the notes to a triplet delay, with 75% being equivalent to a dotted-note delay.

If the Quantize value is 1/4 note triplet, 8th note triplet, 16th note triplet:

When a triplet quantize value is used, the last note of each triplet is delayed. A setting of 100% is equivalent to twice the length of the specified Quantize value. A setting of 66% produces exact timing and therefore no swing feel. Settings above 67% delays the note timing to increase the amount of swing. A setting of 75% moves the notes to a dotted-note delay, with 83% being equivalent to a sextuplet delay.

If the Quantize value is 8th note + 8th note triplet, 16th note + 16th note triplet:

Even-numbered beats will be delayed. A setting of 100% is equivalent to twice the length of a 8th note or 16th note. A setting of 50% produces exact timing and therefore no swing feel. Settings above 51% delays the note timing to increase the amount of swing, with 66% being equivalent to a triplet delay.

NOTE The Swing Rate is applied to notes which are located on even-numbered beats (backbeats) by setting the Strength to 100%. If the Strength is set to less than 100%, the Swing Rate may delay notes not on even-numbered beats and produce an unexpected rhythm. To prevent this, you should set Strength to 100% when using the Swing Rate.

5 Gate Time

Determines the gate time (the length of time a note sounds) of the even-numbered backbeat notes to enhance the swing feel. When a triplet quantize value is used, the gate time of the last note of each triplet is adjusted. When the quantize value is 8th note + 8th note triplet or 16th note + 16th note triplet, the gate time of the even-numbered 8th note or 16th note beats will be adjusted.

Settings below 100% will shorten the gate times of notes on even-numbered beats (backbeats), whereas settings above 100% will lengthen them. If an adjusted gate time value is less than 1, the value is rounded off to 1.

Settings: 000% – 200%

02: Modify Velocity

This Job alters the velocity values of the specified range of notes, letting you selectively boost or cut the volume of those notes. Velocity changes are calculated as follows:

Adjusted velocity = (original velocity x Rate) + Offset

If the result is 0 or less, the value is set to 1. If the result is higher than 127, the value is set to 127.



1 Track and range

Determines the Song track (01 – 16, all) and range (Measure : Beat : Clock) over which the Job is applied.

2 Set All

Sets the velocities of all target notes to the same fixed value (1 to 127). When set to "off" the Set All parameter has no effect. When set to a value other than "off," the Rate and Offset parameters below are unavailable and cannot be set.

Settings: off, 001 – 127

3 Rate

Determines the percentage by which the target notes will be shifted from their original velocities. Settings below 100% reduce the velocities, and settings above 100% increase the velocities proportionately. A setting of 100

produces no change. When the Set All parameter (above) is set to other than “off,” this parameter cannot be set.

Settings: 000% – 200%

4 Offset

Determines the offset value by which the target notes will be shifted from their original velocities. Settings below 0 reduce the velocities, and settings above 0 increase the velocities. A setting of 0 produces no change. When the Set All parameter (above) is set to other than “off,” this parameter cannot be set.

Settings: -127 – +127

03: Modify Gate Time

This Job alters the gate times of the specified range of notes. Gate time changes are calculated as follows:

Adjusted gate time = (original gate time x Rate) + Offset.

If the result is 0 or less, the value is rounded off to 1.



1 Track and range

Determines the Song track (01 – 16, all) and range (Measure : Beat : Clock) over which the Job is applied.

2 Set All

Sets the gate times of all target notes to the same fixed value. When set to “off” the Set All parameter has no effect. When set to a value other than “off,” the Rate and Offset parameters below are unavailable and cannot be set.

Settings: off, 0001 – 9999

3 Rate

Determines the percentage by which the gate time of the target notes will be changed. Settings below 100% shorten the notes, and settings above 100% lengthen the notes proportionately. A setting of 100 produces no change. When the Set All parameter (above) is set to other than “off,” this parameter cannot be set.

Settings: 000% – 200%

4 Offset

Adds a fixed value to the Rate-adjusted gate time values. Settings below 0 shorten the gate time, and settings above 0 lengthen the gate time. A setting of 0 produces no change. When the Set All parameter (above) is set to other than “off,” this parameter cannot be set.

Settings: -9999 – +9999

04: Crescendo

This Job lets you create a crescendo or decrescendo over the specified range of notes. Crescendo is a gradual increase in volume, and decrescendo is a gradual decrease.



1 Track and range

Determines the Song track (01 – 16, all) and range (Measure : Beat : Clock) over which the Job is applied.

2 Velocity Range

Determines the intensity of the crescendo or decrescendo. The velocity values of the notes in the specified range are gradually increased or decreased starting at the first note in the range. The velocity of the last note in the range becomes the original velocity of the note plus the Velocity Range value. If the resultant velocity is outside the 1 – 127 range, it is set to 1 or 127 accordingly. Settings greater than 0 produce a crescendo, and settings less than 0 produce a decrescendo. A setting of 0 produces no effect.

Settings: -127 – +127

NOTE Executing this Job changes velocities of the note on events in the specified range to produce the crescendo/decrescendo. Note that this Job cannot apply the crescendo/decrescendo to long sustained note having a long gate time. If you wish to do this, use the “Create Continuous Data” Job with the Event Type set to “Control Change 11.”

05: Transpose

Changes the pitch of the notes in semitones.



1 Track and range

Determines the Song track (01 – 16, all) and range (Measure : Beat : Clock) over which the Job is applied.

2 Note

Determines the range of notes for which Transpose is applied. You can also set the Note directly from the Keyboard, by holding down the [SF6] button and pressing the desired key.

Settings: C -2 – G8

3 Transpose

Sets the transpose value. A setting of +12 transposes up one octave, while a setting of -12 transposes down an octave. A setting of 0 produces no change.

Settings: -127 – +127

06: Glide

This Job replaces all notes following the first note in the specified range with pitch bend data, producing smooth glides from note to note.

**1 Track and range**

Determines the Song track (01 – 16, all) and range (Measure : Beat : Clock) over which the Job is applied.

2 Glide Time

Determines the time of the glide. Higher values produce a longer and smooth glide between notes.

Settings: 000 – 100

3 PB (Pitch Bend) Range

The Pitch Bend Range value indicates the maximum range of pitch controlled via the Pitch Bend event in semitones. This parameter determines the Pitch Bend range for the Voice assigned to the Mixing Part corresponding to the selected track. Executing the Job replaces the note events with the Pitch Bend events by following the Pitch Bend range specified here.

Settings: 01 – 24

NOTE If the interval between adjoining notes is greater than the Pitch Bend range set here in the specified range, the corresponding notes will not be converted by executing this Job. If such a situation occurs, set the PB Range (3) to the value more than the interval. If there is a one octave interval, for example, in the specified range, set the PB Range to a value of 12 or higher.

NOTE Please note that the Song may not play back properly if you set the PB Range (3) to the value different from the one set via the Voice Edit mode. In order that the Song plays back properly, insert the MIDI event below to the corresponding track in the Song Edit display (page 193).
RPN [000-000] xxx
(Enter the Pitch Bend value to xxx.)

07: Create Roll

This Job creates a series of repeated notes (like a drum roll) in the specified range with the specified continuous changes in clock step and velocity. This is ideal for creating fast staccato rolls and special stuttering effects. This Job also allows you to program crescendo or decrescendo volume changes in the Roll data.

**1 Track and range**

Determines the Song track (01 – 16, all) and range (Measure : Beat : Clock) over which the Job is applied.

2 Start Step**3 End Step**

Determines the size of the step (i.e., the number of clocks) between each note in the roll. The smaller the value, the finer the roll. Both the starting and ending clock values can be specified, making it easy to create rolls in which the step size varies during the roll.

Settings: 015 – 999

NOTE If you want to create a roll that goes from 64th – 32nd notes, set the Start and End step values to around 30 – 60, respectively.

4 Note

Determines the specific note (or instrument in Drum Voices) for the roll effect. You can also set the note directly from the Keyboard, by holding down the [SF6] button and pressing the desired key.

Settings: C -2 – G8

5 Start Velocity**6 End Velocity**

Determines the velocity of the notes in the roll. Both the starting and ending velocity values can be specified, making it easy to create rolls in which the velocity increases or decreases. This lets you create rolls that gradually increase or decrease in volume (crescendo/decrescendo).

Settings: 001 – 127

08: Sort Chord

This job sorts chord events (simultaneous note events) by order of pitch. The sort affects the order of the notes in the Event List display (page 193), but does not change the timing of the notes. When used to pre-process chords before using the Separate Chord Job (below), Chord Sort can be used to simulate the “stroke” or strumming sound of guitars and similar instruments.



1 Track and range

Determines the Song track (01 – 16, all) and range (Measure : Beat : Clock) over which the Job is applied.

2 Type

Determines how the chord note data is sorted.

Settings: up, down, up&down, down&up

up

The notes are sorted in ascending order. After executing this Job with this setting, execute the Separate Chord Job to create a guitar-like upstroke strum.

down

The notes are sorted in descending order. After executing this Job with this setting, execute the Separate Chord Job to create a guitar-like downstroke strum.

up&down

Sorts chord notes on downbeats in ascending order and chord notes on up beats in descending order, based on the Grid setting, below. After executing this Job with this setting, execute the Separate Chord Job to create a guitar-like upstroke and downstroke strum.

down&up

Sorts chord notes on downbeats in descending order and chord notes on up beats in ascending order. After executing this Job with this setting, execute the Separate Chord Job to create a guitar-like upstroke and downstroke strum.

3 Grid

Determines the type of note that serves as the basis for the Chord Sort Job.

Settings: 32nd note, 16th note triplet, 16th note, 8th note triplet, 8th note, 1/4 note triplet, 1/4 note

NOTE You can call up the list and select the desired item by pressing the [SF6] LIST button. For details, see page 82.

09: Separate Chord

This Job slightly separates notes in chords within the specified range, inserting a specified number of clocks between each note. Use this Job after the Chord Sort Job above, to create guitar-like upstroke or downstroke effects.



1 Track and range

Determines the Song track (01 – 16, all) and range (Measure : Beat : Clock) over which the Job is applied.

2 Clock

Determines the number of clock cycles inserted between adjacent chord notes. Depending on the setting here, the note event may overstep the next note or the range (set above). If such a situation occurs, the overstepping note events are moved to the point (clock) before the next note or within the range when executing the Job.

Settings: 000 – 999

[F3] Event Jobs

01: Shift Clock

This Job shifts all data events in the specified range forward or backward by the specified number of clocks.



1 Track and range

Determines the Song track (01 – 16, tempo, scene, all) and range (Measure : Beat : Clock) over which the Job is applied.

2 Clock

Determines the amount by which the data will be delayed or advanced in measures, beats, and clocks.

Settings: 001:1:000 – 999:4:479 (when the Meter is 4/4)

NOTE The available values of the beat and clock differ depending on the meter.

3 Direction

Determines the direction in which the data will be shifted. Advance moves the data toward the beginning of the sequence, while Delay shifts the data toward the end of the sequence.

Settings: Advance, Delay

02: Copy Event

This Job copies all data from a specified source range to a specified destination location.



1 Track and range

Determines the Song track (01 – 16, tempo, scene, all) and range (Measure : Beat : Clock) over which the Job is applied.

2 Number of Times

Determines the number of times the data is copied.

Settings: x 01 – x 99

3 Track and location

Determines the destination track (01 – 16, tempo, scene, all) and range (Measure : Beat : Clock) of the destination.

CAUTION

When Copy Event is executed, any data already existing at the Destination location will be overwritten.

03: Erase Event

This Job clears all specified events from the specified range, effectively producing a segment of silence.



1 Track and range

Determines the Song track (01 – 16, tempo, scene, all) and range (Measure : Beat : Clock) over which the Job is applied.

2 Event Type

Determines the event type to be erased. All events are cleared when “all” is selected. Individual Control numbers can be specified when erasing CC & Ch.Mode events.

Settings:

When Track is set to one of 01 – 16:

Note, Program Change, Pitch Bend, CC & Ch.Mode (Control Change and Channel Mode Message)*, Ch After Touch (Channel Aftertouch), Poly After Touch (Polyphonic Aftertouch), System Exclusive, all
 * You can specify the Control Number (000-127, all).

When Track is set to “tempo”:

Tempo Change

When Track is set to “scene”:

Scene Memory, Track Mute

NOTE You can call up the list and select the desired item by pressing the [SF6] LIST button. For details, see page 82.

04: Extract Event

This Job moves all instances of specified event data from a specified range of a track to the same range in a different track.



1 Track and range

Determines the Song track (01 – 16) and range (Measure : Beat : Clock) over which the Job is applied.

2 Event Type

Determines the event type to be extracted. Specific Note Numbers and Control Numbers (of the Control Change and Channel Mode message) can also be specified as required.

Settings: Note*, Program Change, Pitch Bend, CC & Ch.Mode (Control Change and Channel Mode Message)*, Ch After Touch (Channel Aftertouch), Poly After Touch (Polyphonic Aftertouch), System Exclusive
 * You can specify the Note Number (C -2 – G8, all) and Control Number (000 – 127, all) respectively.

NOTE When the Event Type is set to “Note,” you can also set the Key directly from the keyboard by holding down the [SF6] KBD button and pressing the desired key.

3 Track

Determines the destination track (01 – 16).

CAUTION

The original data in the source range specified above will be erased.

Reference

- Voice mode
- Performance mode
- Sampling mode 1
- Song mode
- Pattern mode
- Mixing mode
- Sampling mode 2
- Master mode
- Utility mode
- File mode

05: Create Continuous Data

This Job creates continuous pitch bend or control change data over the specified range.



1 Track and range

Determines the Song track (01 – 16, tempo, all) and range (Measure : Beat : Clock) over which the Job is applied.

2 Event Type

Determines the event type to be created.

Settings:

When the Track is set to one of 01 – 16 and all:
Pitch Bend, Control Change*, Ch. After Touch (Channel Aftertouch), System Exclusive

*You can also specify the Control Number (0 – 119)

When the Track is set to "tempo":

Tempo Change

NOTE You can produce accelerando/ritardando by applying this Job to the Tempo track. This is useful, for example, in slowing down the tempo in the Ending section of a Song.

NOTE When "System Exclusive" is selected, the continuous data of the Master Volume is created.

NOTE You can call up the list and select the desired one by pressing the [SF6] LIST button. For details, see page 82.

3 Data Range

Determines the lower and upper limits for the data range to be created.

Settings: 0 – 127 (-8192 – +8191 when the Event Type is set to "Pitch Bend" and 5.0 – 300.0 when the Event Type is set to "Tempo Change.")

4 Clock

Determines the number of clocks to be inserted between each created event.

Settings: 001 – 999

5 Curve

Determines the curve of the continuous data. Refer to the graph below for approximate curve shapes.

Settings: -16 – +16

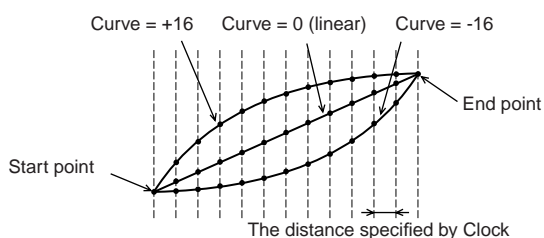

6 Number of Times

Determines the number of times the data creation is to be repeated. For example, if data is created in the range M001:1:000 – M003:1:000 and this parameter is set to 03, the same data will be created at M003:1:000 – M005:1:000 and M005:1:000 – M007:1:000. This Job lets you insert continuous volume (expression) or filter cutoff variations to create tremolo or wah effects.

Settings: x 01 – x 99

06: Thin Out

This Job thins out or selectively removes the specified type of continuous data in the specified range—allowing you to free up memory space for other data or further recording.



1 Track and range

Determines the Song track (01 – 16, tempo, all) and range (Measure : Beat : Clock) over which the Job is applied.

2 Event Type

Determines the event type to be thinned. The Thin Out Job will not work on continuous data that has a clock interval of greater than 60 clocks per event.

Settings:

When the Track is set to one of 01 – 16 and all:

Pitch Bend, CC & Ch. Mode (Control Change and Channel Mode Message)*, Ch. After Touch (Channel Aftertouch), Poly After Touch (Polyphonic Aftertouch)

*You can also specify the Control Number (0 – 127, all)

When the Track is set to "tempo":

Tempo Change

07: Modify Control Data

This Job lets you change the values of specified data such as Pitch Bend and Control Change in the specified range. Data changes are calculated as follows:

Modified value = (original value x Rate) + Offset.

Any result lower than the minimum is set to the minimum; any result higher than the maximum is set to the maximum.



1 Track and range

Determines the Song track (01 – 16, tempo, all) and range (Measure : Beat : Clock) over which the Job is applied.

2 Event Type

Determines the event type to be modified.

Settings:

When the Track is set to one of 01 – 16 and all: Pitch Bend, CC & Ch. Mode (Control Change and Channel Mode Message)*, Ch. After Touch (Channel Aftertouch), Poly After Touch (Polyphonic Aftertouch)

*You can also specify the Control Number (0 – 127, all)

When the Track is set to “tempo”:

Tempo Change

3 Set All

Sets all target events to the same fixed value. When set to “off” the Set All parameter has no effect. When set to a value other than “off,” the Rate and Offset parameters are unavailable and cannot be set.

Settings: off, 000 – 127 (off, -8192 - +8191 when the Event Type is set to “Pitch Bend” and off, 5.0 – 300.0 when the Event Type is set to “Tempo Change.”)

4 Rate

Determines the percentage by which the target events will be shifted from their original values. When the Set All parameter (above) is set to other than “off,” this parameter cannot be set.

Settings: 000% – 200%

5 Offset

Adds a fixed value to the Rate-adjusted event values. When the Set All parameter (above) is set to other than “off,” this parameter cannot be set.

Settings: -127 – +127 (-8192 – +8191 for pitch bend)

08: Beat Stretch

This Job performs time-expansion or compression over the selected range.



1 Track and range

Determines the Song track (01 – 16, tempo, all) and range (Measure : Beat : Clock) over which the Job is applied.

2 Rate

Determines the amount of time expansion or compression as a percentage. Settings higher than 100% produce expansion, and settings below 100% produce compression. A setting of 100 produces no change.

Settings: 025% – 400%

NOTE Only the end point of the range will be shifted forward or backward by executing the Beat Stretch Job. The data outside the specified range will be maintained. When expanding the data, the converted data may overlap the data outside the range. When compressing the data, an interval of silence will be created between the end of the compressed data and the start of the next data outside the range.

[F4] Measure Jobs

01: Create Measure

This Job creates empty measures at the specified location in all tracks. When empty measures are inserted, measure and meter data following the insert point are moved forward accordingly. If the insert point is set after the last measure containing data, only the meter data at that point is set without actually inserting any measures.

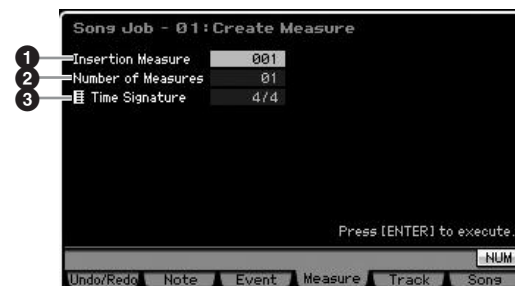

1 Insertion point

Determines the insert point (measure number) at which the newly created blank measures will be inserted.

Settings: 001 – 999

2 Number of measures to be inserted

Determines the number of empty measures to be created and inserted.

Settings: 01 – 99

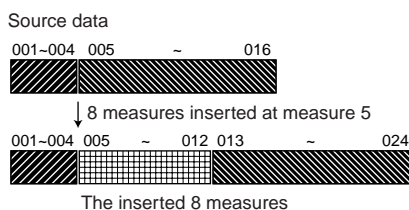
**3 Meter of measures to be inserted**

Determines the meter or time signature of the measures to be created. You may find it convenient to use this parameter when you need to create a Song that incorporates meter changes.

Settings: 1/16 – 16/16, 1/8 – 16/8, 1/4 – 8/4

02: Delete Measure

This Job deletes the specified measures. Measure and meter data following the deleted measures are moved backward accordingly.

**1 Delete range**

Specifies the range of measures to be deleted.

Settings: 001 – 999

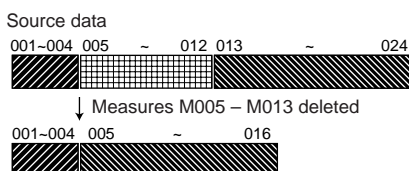
**[F5] Track Jobs****01: Copy Track**

This Job copies all data of the selected type from a specified source track to a specified destination track.

**1 Source Song and Track**

Determines the copy source Song and track (01 – 16). When the Current box is checked, the current Song is selected as Source.

2 Data Type to be copied

Determines the type(s) of data to be copied.

Settings: Sequencer Event (all events in the track), Play Effect, Mix Part Parameter (all Mixing Part parameters), Sample Voice

NOTE When there is no memory available in the destination Song for Sample Voice data, an alert message will appear on the display and the Sample Voice data will not be copied even though the check box of the Sample is marked. If this occurs, use the Delete Job (page 241) in the Mixing Voice Job to delete any unused Sample Voices, then try again.

3 Destination Song and Track

Determines the destination Song and track (01 – 16). When the Current box is checked, the current Song is selected as Destination.

CAUTION

The copy operation overwrites any data previously existing on the destination track.

CAUTION

Undo/Redo cannot be used to undo/redo a Sample Voice copy operation.

02: Exchange Track

This Job exchanges or “swaps” the specified type of data between two specified tracks in the current Song.



1 Track

Determines the tracks (01 – 16) to which the Job is applied.

2 Data Type

Determines the type(s) of data to be exchanged. Select the desired type by checkmarking the appropriate box.

Settings: Sequencer Event (all events in the track), Play Effect, Mix Part Parameters

03: Mix Track

This job mixes all data from two selected tracks (1 and 2), and places the result in track 2. Keep in mind that applying this Job to tracks with Sample Voices does not mix the Sample Voices. The Sample Voice itself will not be mixed.

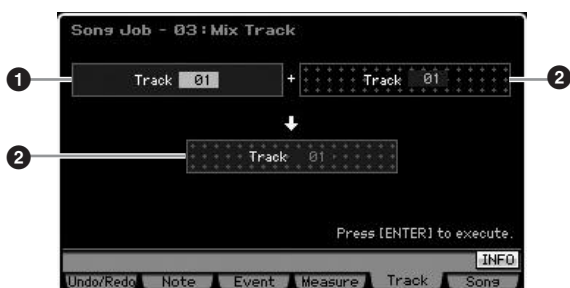

04: Clear Track

This Job deletes all data of the selected type from the selected track.



1 Track

Determines the Song track (01 – 16, tempo, scene, all) to which the Job is applied.

2 Data type to be cleared

Determines the type(s) of data to be cleared. Select the desired type by checkmarking the appropriate box.

Settings: Sequencer Event (all events in the track), Play Effect, Mix Part Parameter (all Mixing Part parameters), Sample Voice

CAUTION

Undo/Redo cannot be used to undo/redo a Clear operation for tracks that contain sample data.

NOTE The Waveform on DIMM cannot be deleted via this Job even if the Sample Voice box is checked. If you want to actually delete the Waveform, use the Delete Job (page 177) in the Sampling Job mode.

05: Normalize Play Effect

This job rewrites the data in the selected track so that it incorporates the current Play Effect settings.

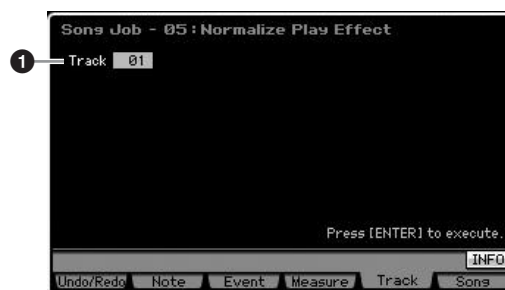

1 Track

Determines the Song track (01 – 16, all) to which the Job is applied.

06: Divide Drum Track

This Job separates the note events in a drum performance assigned to a specified track, and places the notes corresponding to different drum instruments in separate tracks (tracks 1 through 8). The division table below is designed assuming the GM Drum Voice is used. If you want to apply this Job to the sequence data using a Drum Voice other than a GM Voice, you should confirm the arrangement of the drum/percussion instruments for each Drum Voice by using the separate Data List booklet.



Voice mode
Performance mode
Sampling mode 1
Song mode
Pattern mode
Mixing mode
Sampling mode 2
Master mode
Utility mode
File mode
Reference

1 Track

Determines the Song track (01 – 16) to which the Job is applied.

Track 1	Bass Drum
Track 2	Click, Bass Drum, Snare Drum, etc.
Track 3	Snare Drum
Track 4	Brush SD, Side Stick, Hand Clap, etc.
Track 5	Hi Hat
Track 6	Ride Cymbal
Track 7	Tom, Crash/Splash/Chinese Cymbal
Track 8	Percussion, etc.

* The drum instruments of the different note numbers will be assigned to each of tracks, meaning that the Bass Drum of Track 1 is different from the Bass Drum of Track 2, for example.

CAUTION

Executing the Divide Drum Track overwrites any data previously existing on the destination tracks 1 – 8. Important data should always be saved to a USB storage device connected to the USB TO DEVICE terminal or to a computer connected to the same network as the MOTIF XS (page 278).

07: Put Track to Arpeggio

This Job copies data in the specified measures of a track for creating Arpeggio data. Up to 16 unique note numbers can be recorded to the Arpeggio track. If more than 16 different note numbers have been recorded to the MIDI sequence data, the Convert operation reduces the notes in excess of the limit. Because of this, be careful to record only up to 16 different notes when you create an Arpeggio, especially when using all four tracks.



1 Range

Determines the range of measures to be copied to the Arpeggio data.

Settings: 001 – 999

2 ARP Category (Arpeggio Category)

Determines the Category setting (Main Category and Sub Category) for the created Arpeggio data. The Main Categories are listed on page 62.

NOTE You can call up the list and select the desired one by pressing the [SF6] LIST button. For details, see page 82.

3 ARP No. (Arpeggio number/name)

Determines the User Arpeggio number (001 – 256) and name as destination. The Arpeggio name can contain up to 20 characters. You can call up the Character List display by pressing the [SF6] CHAR button and enter the name. For detailed instructions in naming, refer to “Basic Operation” on page 82.

CAUTION

Any previous Arpeggio data in this number will be overwritten.

4 Original Notes Root

Determines the root note when the Convert Type of any track is set to “org notes.”

Settings: C -2 – G8

NOTE You can also set the Key directly from the keyboard, by holding down the [SF6] KBD button and pressing the desired key. For details, see page 82.

5 Track

Determines the track of the source Song for each Arpeggio track.

6 Convert Type

Determines how the MIDI sequence data (of Song tracks) will be converted to Arpeggio data from the three ways below. This parameter can be set for each track.

Settings: normal, fixed, org notes

normal

The Arpeggio is played back using only the played note and its octave notes.

fixed

Playing any note(s) will trigger the same MIDI sequence data.

org notes (original notes)

Basically same as “fixed” with the exception that the Arpeggio playback notes differ according to the played chord.

08: Copy Phrase

This Job copies the Phrase (created in the Pattern mode) to a specified track of the current Song.

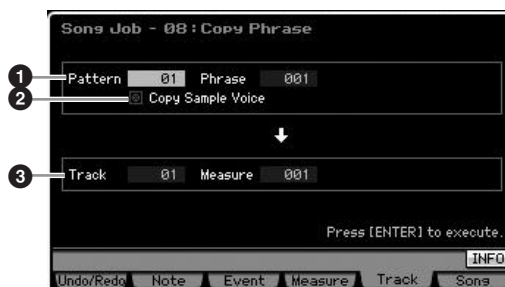

1 Source Pattern, Phrase

Determines the source Pattern and Phrase number.

2 Copy Sample Voice

When this box is checkmarked, Sample Voices assigned to the source phrase (actually the corresponding Mixing Part) are copied to the destination track, and are assigned to the

corresponding Mixing Part of the current Song. This parameter has no effect when no Sample Voice is used by the selected phrase.

3 Track, Measure

Determines the destination Track (01 – 16) and Measure number (001 – 999) at which the copied Phrase starts.

⚠ CAUTION

This Job overwrites any data already existing in the destination track with the exception of the Mixing setup.

[F6] Song Jobs

01: Copy Song

This Job copies all data from a selected source Song to a selected destination Song.



- 1 Source Song
- 2 Destination Song

⚠ CAUTION

This Job overwrites any data already existing in the destination Song.

02: Split Song to Pattern

This Job allows you to copy a Part of the current Song to a specific Pattern,

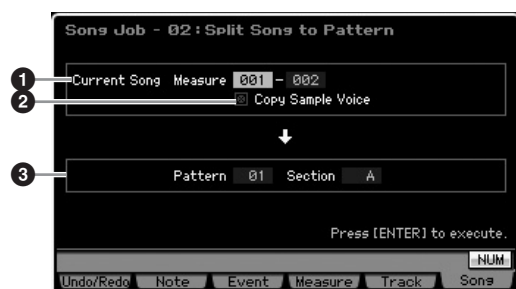

1 Range

Determines the range of measures to be copied to a Pattern.

Settings: 001 – 999

2 Copy Sample Voice

When this box is checkmarked, Sample Voices used by the source Song are copied to the destination Pattern as Sample Voices, and are assigned to the Mixing Part corresponding to the destination track. This checkbox has no effect if no Sample Voices are assigned to the tracks in the source Song.

3 Pattern, Section

Determines the destination Pattern and Section (A – P).

⚠ CAUTION

This Job overwrites any data including the Mixing setup already existing in the destination Pattern and section.

03: Clear Song

This job deletes all data (including the Sample Voices and Mixing Voices) from the selected Song or all Songs. It can also be used to delete all 64 Songs at the same time.



1 Song

Determines the Song number to be erased.

NOTE The Waveform in DIMM cannot be deleted via this Job even if the Sample Voice is used in the specified Song. If you want to actually delete the Waveform assigned to the Sample Voice used in the specified Song, use the Delete Job (page 177) in the Sampling Job mode.

Pattern Playback

The Pattern mode lets you play, record, edit and play your own original rhythm patterns. The Pattern Play mode is the main 'portal' by which you enter the Pattern mode, and it is here where you select and play a Pattern. You can also create your own Patterns by assembling Phrases—short rhythmic passages and 'building blocks'—and create Pattern Chains in which Patterns can be combined together in custom order. To enter the Pattern Play mode, simply press the [PATTERN] button.

NOTE The word "Pattern" refers to a short rhythmic passage of several measures which is looped and played back indefinitely. A Pattern includes 16 variations called "Sections." You can use Sections by changing them during playback. A Pattern consists of 16 tracks and can be created by assigning a Phrase to each track from the Patch display (page 212). For details about the Patterns, Sections and Phrases, see page 60.

NOTE From the Play display in the Pattern Play mode, you can select the Voice of the Mixing Part corresponding to the current Track by pressing the [CATEGORY SEARCH] button.

Pattern Playback Procedure

1 Press the [PATTERN] button to call up the Pattern Play display (page 210).

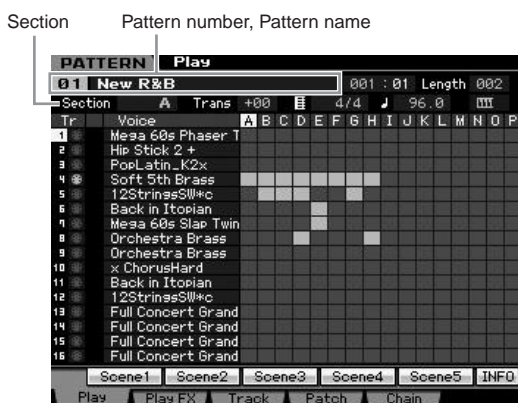

2 Select a Pattern.

Move the cursor to the Pattern number, then select the desired Pattern by using the data dial, [INC/YES] and [DEC/NO] button. The name of the selected Pattern is displayed. If you press the [PROGRAM] button so that its lamp lights, you can select the desired Pattern by using the Group [A] – [D] buttons and the Number [1] – [16] buttons. Pattern numbers and the corresponding buttons are as follows.

Button Combinations	Pattern Number
[A]+[1] – [16]	01 – 16
[B]+[1] – [16]	17 – 32
[C]+[1] – [16]	33 – 48
[D]+[1] – [16]	49 – 64

3 Select a Section (A – P) of the selected Pattern.

Move the cursor to the Section, then select the desired Section by using the data dial, [INC/YES] and [DEC/NO] button. If you press the [TRACK] button so that its lamp lights, you can select the desired Section by using the SECTION [A] – [H] buttons for Sections A – H, [USER 1] – [USER DR] buttons and [ETHNIC] button for Sections I – P.

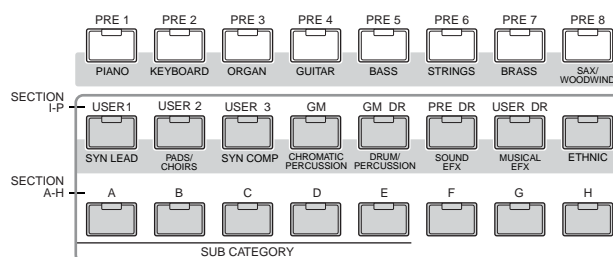

4 Press the [▶] (Play) button to start playback of the Pattern.

Pattern playback continues repeatedly until you press the [■] (Stop) button. Press the [■] (Stop) button to stop playback of the Pattern. Press the [▶] (Play) button again to resume playback from that point.

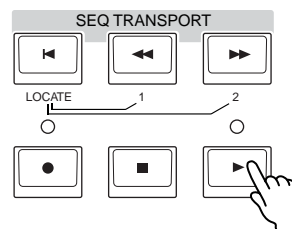

Playback types

Starting playback by pressing a note

When the Keyboard Start function is set to on, Pattern playback begins as soon as you press a key on the keyboard. Move the cursor to the Keyboard Start icon then press the [INC/YES] button to enable Keyboard Start. In this status, press any key to start Pattern playback.

Keyboard Start



Playback from the middle of the Pattern

To start playback of the Pattern from midway through the Pattern, set the desired location by using the controls below, then press the [▶] (Play) button. These operations can also be executed during playback.

Forward	Press the [▶▶] (Forward) button.
Fast forward	Hold the [▶▶] (Forward) button.
Rewind	Press the [◀◀] (Rewind) button.
Fast Rewind	Hold the [◀◀] (Rewind) button.
Move to the top of the Pattern	Press the [⏮] button.

Fast Forward/Rewind

This operation is the same as in the Song Play mode. See page 179.

Jumping to a specific location in the Pattern

This operation is the same as in the Song Play mode. See page 179.

Changing the Section during playback

To change Sections during playback, press the [TRACK] button (the lamp lights), then use the SECTION [A] – [H] buttons, [USER1] – [USER DR] buttons and [ETHNIC] button. When selecting a different Section during Pattern playback, “NEXT” and the next Section name appear in the Section column at the top of the display. After the current Section reaches the specified timing, the next Section starts. If you record rhythm patterns such as intro, melody A, fill-in, main theme, and ending to each of Sections, you can play an entire Song by selecting the appropriate Sections during playback.



Current Section or Next Section is indicated here.

Track mute/solo

This operation is the same as in the Song Play mode. See page 179.

Change the tempo

This operation is the same as in the Song Play mode. See page 179.

Assigning various settings related to Pattern playback (Pattern Scene)

From the Pattern Play display, you can assign five different “snapshots” of important Pattern-related parameters such as transpose, tempo, track mute/solo status, and the basic Mixing setup to the [SF1] – [SF5] buttons as Pattern Scenes. One of the convenient advantages of Pattern Scene is that it lets you instantly and automatically execute parameter settings that normally require many button presses or controller operations. Use it during Pattern recording or playback to make instantaneous setting changes. Pattern Scene parameters are same as the ones of Song Scene. See page 179.

Registering the Pattern Scene

After making the desired settings for the Scene, simultaneously hold down the [STORE] button and press one of the [SF1] to [SF5] buttons. The 8th note icon is shown in the tab corresponding to the Sub Function button to which the Pattern Scene is registered. Press the [STORE] button to store the Pattern data including the Pattern Scene setting.



The Pattern Scene settings registered to the [SF1] – [SF5] buttons will be lost if you change the Pattern or turn the power off without executing the Store operation.

Recalling the Pattern Scene

You can recall the Pattern Scene by press one of the [SF1] to [SF5] buttons.

Pattern Chain Playback

The Pattern Chain function lets you program Sections in your own custom order, and have them change automatically during playback to create a seamless sequence of backing parts and accompaniment for your live performance or recorded Song. The Chain Play display (page 213) is the ‘portal’ for entering the Pattern Chain function and lets you play back the programmed Pattern Chain. Press the [F5] Chain button from the Pattern Play mode to go to the Pattern Chain Play display.

Pattern Chains can be created from the Chain Record display (page 214) and the Insert function (page 216) on the Chain Edit display. Pattern Chains can be edited in the Chain Edit display (page 214).

- Voice mode
- Performance mode
- Sampling mode 1
- Song mode
- Pattern mode
- Mixing mode
- Sampling mode 2
- Master mode
- Utility mode
- File mode
- Reference

Mixing Setup for each track

In the Pattern mode as well as in the Song mode, you can set the Mixing parameters such as Voice, volume and pan for each part (track). The structure and parameters are the same as in the Song mode. See page 181.

Knobs and Control Sliders

By using the knobs and sliders on the front panel, you can adjust various parameters such as pan, effect, cutoff frequency and resonance for each Part (track) of the Pattern. For more information, see page 180.

Pattern Playback—[F1] Play

This display always appears first when the Pattern mode is engaged. You can play the Pattern by specifying a Section after selecting a Pattern.

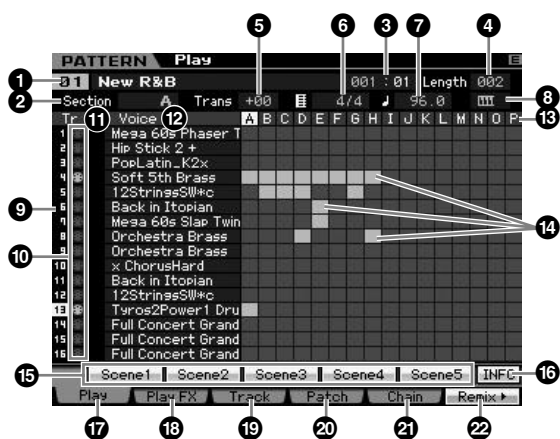

NOTE Depending on the selected parameter, the NUM icon is shown at the tab menu corresponding to the [SF6] button. In this condition, you can use the [SF1] – [SF5] and [F1] – [F5] buttons as number buttons by pressing the [SF6] NUM button. For details, see page 81.

1 Pattern number, Pattern name

Determines the Pattern by specifying the number (01 – 64). The name of the selected Pattern is shown. You can change the Pattern name by moving the cursor here and pressing the [SF6] CHAR button.

NOTE For detailed instructions on naming, refer to “Basic Operation” on page 82.

2 Section

Selects a Section of the selected Pattern. A Pattern can include up to 16 variations called Sections, which can be changed in real time during playback. The Section can be selected via the [A] – [H] buttons (printed “SECTION A – H”) and the [USER1] – [ETHNIC] buttons (printed “SECTION I – P”). For details, see page 209.

Settings: A – P

3 Measure

Determines the location at which playback starts. This also indicates the current location of playback. The Measure can be set via the SEQ TRANSPORT buttons. For details, see page 178.

Settings:

Measure: 001 – 256 (Available range of measure differs depending on the length below.)

Beat: Indication only



4 Length

Determines the Pattern Length.

Settings: 001 – 256

5 Trans (Transpose)

6 Time signature (Meter)

7 Tempo

These are the same as in the Song Play mode. See page 210.

8 Keyboard Start

When Keyboard Start is set to on, Pattern playback begins as soon as you press a key on of the keyboard.

Settings: (on), (off)

9 Track number (Indication only)

Indicates the track number.

10 Track type (Indication only)

Indicates the track type: MIDI track or Audio track. For Mixing Parts that correspond to Audio tracks, a Sample Voice is assigned. For Mixing Parts that correspond to MIDI tracks, a Voice other than a Sample Voice is assigned. For Mixing Parts that correspond to empty tracks, no Voice is assigned. For more about MIDI Tracks and Audio Tracks, see page 61.

Settings: (MIDI Track), (Audio Track)

11 Mute/Solo (Indication only)

Indicates the Mute/Solo status for each track. For detailed instructions on setting Mute/Solo, see page 179.

Blank: Neither Mute nor Solo are not assigned to this track.

: Indicates muted track.

: Indicates soloed track.

12 Voice (Voice Name)

Indicates the Voice name of the Mixing Part corresponding to each track.

13 Section

14 Data indicator

Indicates whether the data is recorded or not to each track of Sections A – P. The data indicator is shown at the column of which the Section/Track contains recorded data.

15 [SF1] Scene1 – [SF5] Scene5

You can assign the settings of the Pattern-related parameters (Pattern Scene) and Arpeggio-related parameters to these buttons. You can also recall these settings by pressing these buttons. For detailed instructions on registering Scenes, see page 179. For detailed instructions on setting the Arpeggio-related parameters, see page 189.

NOTE The Arpeggio is not available during Pattern playback. Pressing the [SF1] Scene 1 – [SF5] Scene 5 buttons during playback changes only the Pattern Scene.

NOTE After registering the Pattern Scene, the 8th note icon will appear on the tab corresponding to the pressed button. You can confirm whether or not the Arpeggio Type is assigned to that button in the Arpeggio display (page 189) of the Pattern Record.

16 [SF6] INFO (Information)

You can view the amount of free and used sequencer memory. The sequencer memory covers the all Songs and Patterns recorded in the respective modes. When the used memory amount reaches the maximum capacity, no further Songs or Patterns can be stored. If this occurs, use the Song Job or Pattern Job to delete any unnecessary Songs or Patterns. You can go back to the previous display by pressing the [SF6] button or the [EXIT] button.



17 [F1] Play

Calls up the Play display.

18 [F2] Play FX (Play Effect)

Calls up the Play Effect display.

19 [F3] Track

Calls up the Track display.

20 [F4] Patch

Calls up the Patch display (page 212).

21 [F5] Chain (Pattern Chain)

Calls up the Pattern Chain display (page 213).

22 [F6] Remix

Calls up the Remix display (page 217). This menu is shown only when the cursor is located on the track containing data.

Changing the rhythmic “feel” of the Pattern—[F2] Play FX (Play Effect)

By changing the timing and velocity of the notes, you can change the rhythmic “feel” of Pattern playback. The Play Effect settings made here are only temporary and don't change the actual data in the Pattern. The Play Effect settings can be applied actually to the Pattern data by using the Normalize Play Effect Job.

The operation is same as in the Song Play mode. See page 183.

Track Settings—[F3] Track

This display lets you set the MIDI Transmit Channel for each track.



Regarding parameters with no number, refer to the Play display (page 210).

- 1 Pattern name** (Indication only)
Indicates the name of the current Pattern.
- 2 Voice (Voice name)** (Indication only)
- 3 TxCh (Transmit Channel)**
- 4 Int (Internal Switch)**
- 5 Ext (External Switch)**

These are the same as in the Song Play mode. See page 184.

Pattern Creating—[F4] Patch

This display lets you assign a Phrase to each track to create a Pattern. 16 Sections named A – P can be created for each Pattern. You can assign a User Phrase created with the current Pattern selected. If you wish to use User phrases recorded to tracks of other Patterns, use the Phrase Data Copy function, selected with the [SF5] button.

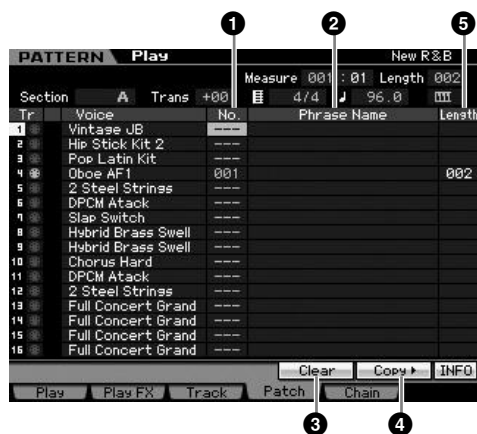

Regarding parameters with no number, refer to the Play display (page 210).

1 No. (Phrase Number)

Determines the Phrase number to be assigned to a track. You can select one of the 256 User Phrases stored to the selected Pattern. Please note that the User Phrases have no data by default. When set to “---,” the track becomes empty.

Settings: --- (off), 001 – 256

NOTE The MOTIF XS features no Preset Phrase data.

2 Phrase Name

Indicates the name of the selected Phrase. You can change the Phrase name by moving the cursor here and pressing the [SF6] CHAR button.

NOTE For detailed instructions on naming, refer to “Basic Operation” on page 82.

3 [SF4] Clear

Pressing this button clears the Phrase assignment to the currently selected track and leaves the track empty. Move the cursor to the Phrase (track) to be cleared then press the [SF4] button.

4 [SF5] Copy

Pressing this button copies a Phrase in another Pattern to the selected one then assign it to the specified track. This is useful if you are creating a Pattern and wish to use the Phrase data from another Pattern.



1 Source phrase

Determines the Pattern number and the Phrase number (001 – 256) to be copied.

2 Copy Sample Voice

When this box is checkmarked, Sample Voices assigned to the source phrase are copied to the destination phrase as Sample Voices, and are assigned to the corresponding tracks in the selected Pattern.

3 Current Pattern Phrase and Track

Determines the number (001 – 256) of the destination Phrase and track (1 – 16) to which the Phrase is assigned.

CAUTION

Any previous data in the copy destination will be overwritten. Important data should always be saved to a USB storage device connected to the USB TO DEVICE terminal or to a computer connected to the same network as the MOTIF XS (page 278).

CAUTION

Undo/Redo cannot be used to undo/redo a Sample Voice copy operation.

5 Length (Indication only)

Indicates the length of each Phrase assigned to each track.

Creating a Pattern

1 Select a Pattern from the Play display (page 210).

2 Press the [F4] button to call up the Patch display.

3 Select a Section (A – P).

Move the cursor to the Section, then select the desired Section by using the data dial, [INC/YES] and [DEC/NO] button.

4 Set the meter (time signature), tempo, and length of the Pattern.

Move the cursor to the desired parameter (such as length, time signature or tempo), then set the value by using the data dial, [INC/YES] and [DEC/NO] button.

5 Assign the desired Phrase to each track.

Move the cursor to a track then set a Phrase number by using the data dial, [INC/YES] and [DEC/NO] buttons. Phrase assignment can be executed also during Pattern playback.

To confirm whether the Phrase is assigned properly or not, solo the track to which the Phrase is assigned by following the procedure below. Press the [SOLO] button so that its indicator lights and press any of the Number [1] – [16] buttons to select a track to which you assigned the Phrase.

There are three methods that can be used to create a Phrase:

- Recording the new phrase using the Pattern Record function (page 218)
- Copying the Phrase from another Pattern by using the [SF5] button.
- Converting a Part of the Song data to a Phrase by using the Get Phrase from Song Job (page 225).

6 Repeat steps 3 through 5 above to finalize an entire Pattern.

Create Sections used for the intro, melody A, melody B, main theme and ending of the entire Song.

NOTE It is a good idea to use the Copy Pattern Job (page 227) if you wish to create a Section that is based on or sounds similar to an already existing Section.

7 Press the [STORE] button to store the Pattern.

For detailed instructions on storing a Pattern, see page 218.

Pattern Chain—[F5] Chain (Pattern Chain)

Pattern Chain allows you to string several different Sections together to make a one complete Song. For example, create a Section A for the intro, a Section B for the verse, a Section C for the chorus, and a Section D for the ending—and you have the basic blocks to build an original Song. The created Pattern Chain data can be converted to MIDI sequence data and stored to a Song. To call up the Pattern Chain display, press the [F5] Chain button from the Pattern Play mode.

A Pattern Chain can be created for each Pattern, letting you call up a different, dedicated Pattern Chain each time you select a Pattern.

The following events can be recorded to the Pattern Chain.

- Playback order of Sections
- Pattern track on/off—Solo and Mute
- Tempo change
- Time signature change

There are two methods to create a Pattern Chain: Recording playback of a Pattern in the Pattern Record display in real time, and programming the playback order of Sections one by one in the Pattern Chain Edit display. The Pattern Chain data recorded in real time can be edited in the Pattern Chain Edit display.

Pattern Chain Playback—[F5] Chain

The Pattern Chain display lets you play the Pattern Chain data you've created. Press the [F5] Chain button from the Pattern Play mode to go to the Pattern Chain Play display.

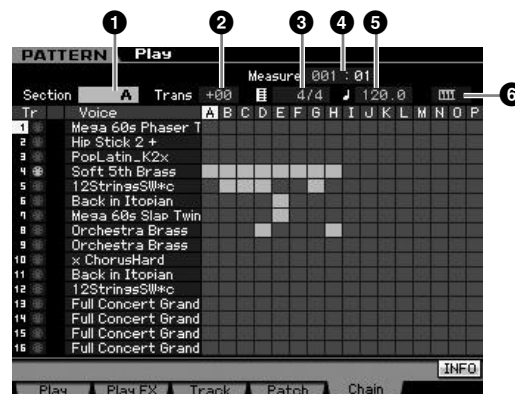

The operation in the Pattern Chain display is basically same as in the Pattern Play display with the exception that the Pattern number cannot be selected. For details on parameters which are not explained here, refer to the Pattern Play display (page 210).

NOTE Depending on the selected parameter, the NUM icon is shown at the tab menu corresponding to the [SF6] button. In this condition, you can use the [SF1] – [SF5] and [F1] – [F5] buttons as number buttons by pressing the [SF6] NUM button. For details, see page 81.

1 Section

Indicates the currently played Section. “NEXT” will be shown here when playback is waiting for the timing of the Section change.

2 Trans (Transpose)

Adjusts the pitch of the Pattern Chain playback in semitone increments.

Settings: -36 – +0 – +36

3 Time signature

Indicates the time signature currently assigned to the Pattern. During playback, the current time signature is shown here.

4 Measure

Indicates the measure number of the currently playing Pattern Chain. You can start playback from the middle of the Pattern Chain by specifying the measure here then pressing the [▶] (Play) button.

Settings: 001 – 999

5 Tempo

Indicates the tempo currently assigned to the Pattern. During playback, the current tempo is shown here.

Settings: 5.0 – 300.0

6 Keyboard Start

When Keyboard Start is set to on, Pattern Chain playback begins as soon as you press a key on of the keyboard.

Settings: on, off

Pattern Chain Playback Procedure

To start Pattern Chain playback, call up the Pattern Chain display, then press the (Play) button. When the end of the Pattern Chain data is reached, playback automatically stops. You can also press the (Stop) button during playback to stop playback of the Pattern Chain. Press the (Play) again to resume playback from that point. Depending on the particular Chain data, the Pattern plays back with automatic changes of the Section, track mute and tempo—all of which are indicated on the display in real time.

NOTE You can confirm the Pattern Chain data by calling up the Pattern Chain Edit display.

Pattern Chain Recording in Realtime— Chain Record

From the Pattern Chain Record display, you can record playback of the Pattern—along with any realtime changes you make. Press the (Record) button from the Pattern Chain Play display to call up the Pattern Chain Record display. Press the (EXIT) button to go back to the Chain Play display.

Events such as Section change, Track mute on/off and Tempo change can be recorded as Pattern Chain data. The Record Type is fixed to “replace” and cannot be changed. Accordingly, recording the events overwrites data in the already recorded range. You can also use the Insert function (page 216) on the Chain Edit display to create the Pattern Chain data.



For details on parameters indicated with numbers above, refer to the Chain display (page 213). For details on all other parameters, refer to the Pattern Play display (page 210).

Pattern Chain Recording Procedure

1 Select a Pattern in the Chain Play display.

This step is necessary because each Pattern has its own dedicated Pattern Chain data.

2 Press the (Record) button.

The (Record) indicator lights and the Chain Record display appears.

3 Set up the parameters for the start of recording.

Set the basic parameters for recording (e.g., Section, Recording Track mute setting, Time Signature, Tempo and so on). After setting, move the cursor to the Tempo.

4 Set the measure at which recording starts.

Normally, press the (Top) button to set the top as recording start measure.

5 Press the (Play) button to start recording.

To change Sections in realtime and record them, press the (TRACK) button (the lamp lights), then use the – buttons, – buttons and button. To make Track Mute on/off settings, press the (MUTE) button (the lamp lights), then press the appropriate Number – buttons. The tempo can be changed by pressing the /[] button, turning the data dial, or using the – and – buttons as numeric keys after pressing the button.

6 Press the (Stop) button to stop recording.

7 Press the (STORE) button to store the recorded Chain data on the internal User Memory.

NOTE For more information on storing a Pattern, see page 218.

Editing a Pattern Chain— Chain Edit

This mode gives you comprehensive, detailed controls for editing the events of the recorded Pattern Chain. Events such as Section change, Track mute on/off, Tempo change and Meter can be recorded as Pattern Chain data. Press the (EDIT) button from the Chain Play display to call up the Chain Edit display. Press the (EXIT) button to go back to the Chain Play display.

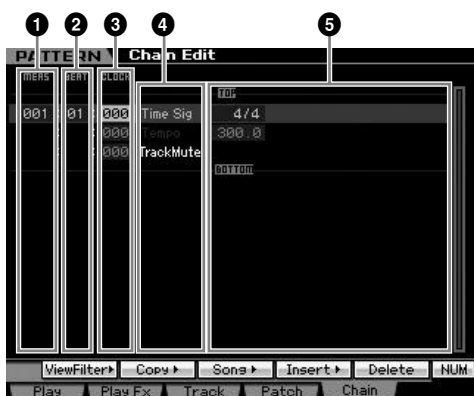

- 1 MEAS (Measure)
- 2 BEAT
- 3 CLOCK

Indicates the location of the corresponding event. Changing any of these values changes the location of the event accordingly.

Settings:

MEAS (Measure): 001 – 256

BEAT: 01 – 16 (The available range may change depending on the Meter.)

CLOCK: 000 – 479 (The available range may change depending on the Meter.)

- 4 Event Type
- 5 Setting Values

The following events are available in the Pattern Chain mode.

Section	Change timing of Sections A – P and End event of the data.
TrackMute	The "M" indicates the corresponding track is muted.
Tempo	005.0 – 300.0
TimeSig (Time Signature)	1/16 – 16/16, 1/8 – 16/8, 1/4 – 8/4

[SF1] View Filter

This display lets you select the event types that appear on the Chain Edit display. This is particularly useful when many types of events are mixed together, but you only want to display the events you intend to edit.



- 1 Time Signature
- 2 Section
- 3 Track Mute
- 4 Tempo Change

Only events with checked boxes will appear in the Chain Edit display. If the box is set to off, the corresponding event will disappear in the Chain Edit display.

[SF2] Copy

The function of this display lets you copy events from a specified range to another range.



- 1 Source Range
- 2 Destination Location (Top Measure)

Determines the source range and the top measure of the destination.

Settings: 001 – 256

- 3 Number of Times

Determines the number of times the data is copied.

Settings: 01 – 99

[SF3] Song (Convert to Song)

Converts the current Pattern chain to MIDI sequence data and copies the data to a specified Song. This function is useful for quickly creating backing and accompaniment parts for Song data.

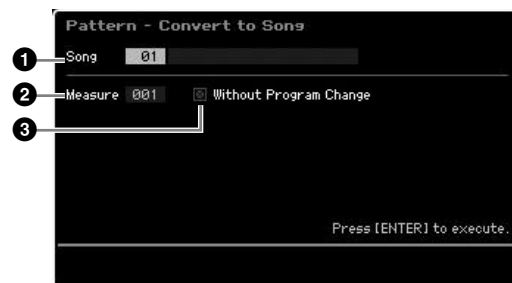

- 1 Destination Song

Determines the destination Song by specifying the number (01 – 64). The name of the selected Song is displayed.

- 2 Destination Location (Top Measure)

Determines the beginning measure number of the destination.

Settings: 001 – 999

- 3 Without Program Change

When this box is checkmarked, the settings of the Mixing and Tempo are copied to the destination Song (1). The Tempo value is copied to the top measure (2) of the destination Song. When the checkmark is removed, the Voice settings in each Phrase are also copied to the top measure (2) of the destination Song as Program Change events.

- Voice mode
- Performance mode
- Sampling mode 1
- Song mode
- Pattern mode
- Mixing mode
- Sampling mode 2
- Master mode
- Utility mode
- File mode

⚠ CAUTION

This Job operation overwrites any data previously existing in the destination Song and the Undo/Redo (page 223) Job cannot be used after executing this Job. Important data should always be saved to a USB storage device connected to the USB TO DEVICE terminal or to a computer connected to the same network as the MOTIF XS (page 278).

[SF4] Insert

From this display, you can insert a new event to the Pattern Chain. After setting the following parameters, press the [F6] Set button or [ENTER] button to actually insert the event.

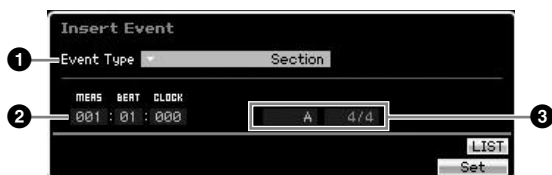

1 Event Type

Determines the event type to be inserted.

Settings: Time Signature, Section, end, Tempo Change, Track Mute end
Indicates the end position of the Pattern Chain.

2 Inserting location

Specifies the location at which the new event will be inserted.

Settings:
MEAS (Measure): 001 – 999
BEAT: 01 – 16 (depends on the meter)
CLOCK: 000 – 479 (depends on the meter)

3 Value of the selected event type

Enters the value of the event to be inserted. The values available differ depending on the selected Event Type (1).

Settings:
Time Signature: 1/16 – 16/16, 1/8 – 16/8, 1/4 – 8/4
Section: A – P, end (end of the data)
Tempo Change: 005.0 – 300.0
Track Mute: **m** (mute on), blank (mute off)

[SF5] Delete

Deletes the currently selected event. This button is not available when the cursor is located at the Time Signature event, Tempo Change or top/bottom of the data.

Pattern Chain Edit Procedure

1 Select a Pattern on the Chain Play display.

This step is necessary because each Pattern has its own dedicated Pattern Chain data.

2 Press the [EDIT] button to call up the Chain Edit display.

3 Edit the already-recorded events.

Move the cursor to each of parameters, then set the value by using the data dial, [INC/YES] and [DEC/NO] buttons. To make it easier to find desired parameters, use the View Filter display called up via the [SF1] button. You can use the Copy function called up via the [SF2] button to copy the events from a specified range to another range.

If you wish to delete the event, move the cursor to the event to be deleted then press the [SF5] button.

If you wish to insert a new event, press the [SF4] button to call up the Insert display. From this display, you can input the events one by one.

4 Convert the created Pattern Chain data to a Song.

By using the Convert To Song display called up via the [SF3] button, you can convert the created Pattern Chain data to MIDI sequence data and copy the converted data to a specified Song. This function is useful for quickly creating backing and accompaniment parts for Song data.

5 Store the created Pattern Chain data to internal User Memory.

From the Store window called up via the [STORE] button, you can store the current Pattern including the created Pattern Chain data to internal memory. After storing the Pattern data, the Pattern Chain included in the Pattern is maintained even if the power is turned off.

Entering New Events

1 From the Chain Edit display, press the [SF4] Insert button to call up the Insert window.

2 Specify the event type to be inserted, the insertion point (measure, beat, and clock), and parameter value of the event.

3 Press the [F6] Set button to insert the specified event at the specified location.

You can continue inserting new events since the Insert Event window remains open. Press the [ENTER] button to actually insert the event and close the Insert window.

4 Press the [EXIT] button to go back to the Chain Play display.

Dividing the Pattern data to create a new Pattern—[F6] Remix

The Remix function divides the MIDI data in a selected track into several pieces of a specified note length, and randomly rearranges a portion of the data, letting you easily create completely new and unique rhythm variations—all from a single Pattern.

NOTE When Remix is used on a track containing a sliced sample voice, the various segments of the sample are rearranged with varied timing. The sample voices can be created by executing the Sampling with the Sampling Type set to “slice+seq” or executing the Sample Slice Job.

NOTE The Remix display is available only when the cursor is located on the track containing data.

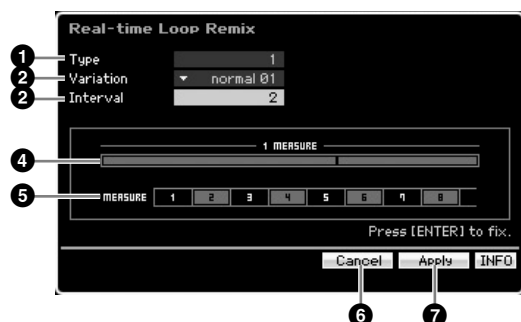

1 Type

Determines how a single measure is divided. The dividing point and the amount differ depending on the Type setting here. The diagram of the selected Type will be shown. See below (4).

Settings: 1 – 16

2 Variation

Determines how the segments divided by Type (1) will be rearranged. The division and rearrangement rules differ depending on the Variation setting.

Settings: normal 01 – 16, reverse 01 – 16, break 01 – 16, pitch 01 – 16, roll 01 – 16, fill 01 – 48

normal 01 – 16

The divided data is only rearranged. 16 variations are provided.

reverse 01 – 16

In addition to rearrangement of the divided data, some portions of the data may be played in reverse. 16 variations are provided.

break 01 – 16

In addition to rearrangement of the divided data, some portions of the data may be deleted to create breaks. 16 variations are provided.

pitch 01 – 16

In addition to rearrangement of the divided data, some portions of the data may be pitch-shifted. 16 variations are provided.

roll 01 – 16

In addition to rearrangement of the divided data, some portions of the data may be played with a roll effect. 16 variations are provided.

fill 01 – 48

In addition to rearrangement of the divided data, some portions of the data may be played with fill-in. 48 variations are provided.

3 Interval

Determines the measure interval with which the Remix operation is executed. In other words, this parameter determines the measures to which Remix is applied. When

this parameter is set to “1,” Remix is applied to all measures. When set to “2,” Remix is applied to the data of the 2nd measure, 4th measure, 6th measure, and so on. When set to “3,” Remix is applied to the data of the 3rd measure, 6th measure, 9th measure, and so on. The measures to which Remix is applied are shown on the display. See below (5).

Settings: 1 – 8

4 Type diagram

Indicates the division point and the amount of division determined by Type (1). The diagram below indicates the division points in 16th note resolution. When Type is set to “1,” for example, the data is divided at the upbeat before beat 4. When Type is set to “2,” the data is divided at three points: the upbeat before beat 2, the downbeat of beat 3, and the upbeat before beat 4.

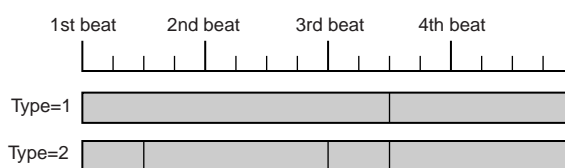

5 Interval diagram

Indicates the measures to which the Remix is applied. These measures are located at the same interval determined by the Interval (3) parameter. The example below results when setting the Interval (3) to “2.”



6 [SF4] Cancel

Pressing this button cancels the most recent Remix which has not been fixed yet. This button is not available after the result of Remix is fixed or before Remix is executed.

7 [SF5] Apply

Pressing this button executes Remix. If you are not satisfied with the result after Remix is executed, press the [SF4] button and try Remix again. If you are satisfied with the result, press the [ENTER] button to fix the remixed data.

Remix Procedure

- 1 Set the Type (1), Variation (2) and Interval (3).
- 2 Press the [SF5] button to execute Remix.
- 3 Confirm the result of the Remix operation.
If you are not satisfied with the result of the Remix, press the [SF4] button then try again.
- 4 Press the [ENTER] button to fix the Remix result.
- 5 Press the [STORE] button to store the Pattern to internal User Memory.

Pattern Recording

In the Pattern Record mode, you can record your keyboard performance to create a Phrase as a basic material of the Pattern data. The created Phrase is assigned to the specified track automatically. Press the [●] (Record) button from the Pattern Play mode to enter the Pattern Record mode.

NOTE Recording of audio data can be done in the Sampling Record mode (page 242).

Realtime Recording

This method lets you record the performance data as it is played, allowing you to capture all the nuances of an actual keyboard performance. Recording can be done while monitoring playback of other already-recorded tracks. You can select one of two methods for Realtime recording: Replace and Overdub.

Pattern Recording procedure

Here in outline form is the process of recording a Pattern.

1 Select a Pattern, then select a Section to be recorded.

Press the [PATTERN] button to go to the Pattern Play display (page 210), and select a Pattern, then a Section to be recorded. Select an empty Pattern if you wish to create a new Pattern from scratch. If an empty Pattern is not available, delete an unnecessary Pattern by using the Clear Pattern Job (page 228).

2 Press the [●] (Record) button to call up the Record Setup display (page 219).

3 Set recording-related parameters in the Record Setup display.

Select the track to be recorded and the Recording method to prepare for Pattern Recording. When selecting a track to which no Phrase has been assigned, your keyboard performance will be recorded to an empty Phrase which will be assigned to the recording track. When selecting a track that already has an assigned Phrase, that Phrase will be replaced by your recorded performance. If you wish to record using an Arpeggio, set the necessary parameters from the Arpeggio display (page 219).

4 Record your keyboard performance in real time to create a Phrase.

Press the [▶] (Play) button to start recording. Press the [■] (Stop) button to stop recording.

5 Edit the recorded Phrase using the Pattern Job (page 222) and Pattern Edit (page 220).

6 Store the Pattern (including the recorded Phrase) to internal User Memory.

Press the [STORE] button to call up the Pattern Store window then store the created Pattern.

This ensures that the created Pattern will be retained even if the power is turned off.

CAUTION

The recorded Pattern will be lost when selecting a different Pattern, calling up a different mode, or turning the power off. Make sure to store the Pattern data to internal memory by pressing the [STORE] button before selecting a different Pattern, calling up a different mode, or turning the power off.

7 Save the created Pattern data to a USB storage device or to a connected computer as desired (page 278).

Storing a Pattern—[STORE] (Pattern Store)

This section covers how to store the Pattern you have recorded and edited. By executing the Store operation, the Pattern data you have created will be retained even if the power has been turned off. Pressing the [STORE] button calls up the Pattern Store window.

The following data will be stored by Pattern Store.

Sequence data

Currently selected Pattern (Section A – P), Pattern Chain, Phrase 001 – 256

Tone Generator data

Mixing settings (Common Edit parameters and Part Edit parameters)

NOTE The Mixing Voices can be edited in the Mixing Voice Store window (page 240).

The Pattern Store operation is the same as that of Voice Store (page 97) and Song Store (page 186).

CAUTION

This operation overwrites any data already existing in the destination Pattern. Select a Pattern number containing no data or unnecessary data.

NOTE If there is not enough memory space for the Song/Pattern, an alert message appears, and you will not be able to store any additional Songs/Patterns. If this happens, delete unnecessary Patterns/Songs by using the Song/Pattern Job, then try the Store operation again.

Preparing the Pattern Recording— [F1] Setup

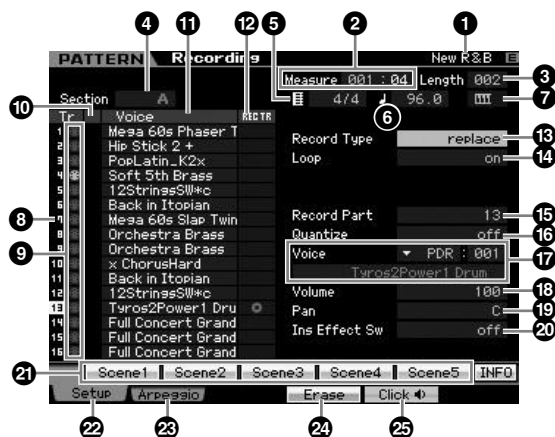

1 Pattern name (Indication only)
Indicates the name of the current Pattern. The Pattern can be selected in the Pattern Play display (page 210).

2 Measure
Determines the measure from which recording starts. This also indicates the current location of recording.

Settings:
Measure: 001 – 256
Beat: Indication only



3 Length
Determines the Pattern Length. This also represents the length of the Phrase created via Recording procedure.

Settings: 001 – 256

4 Section (Indication only)
Indicates the Section to be recorded. The Section can be set from the Pattern Play display (page 210).

5 Time signature (Meter)
Specifies the meter (time signature) for the Pattern.
Settings: 1/16 – 16/16, 1/8 – 16/8, 1/4 – 8/4

6 Tempo
This is the same as in the Song Record mode. See page 187.

7 Keyboard Start
When Keyboard Start is set to on, Pattern recording begins as soon as you press a key on of the keyboard.

Settings: **III** (on), **III** (off)

- 8 Track number** (Indication only)
- 9 Track type** (Indication only)
- 10 Mute/Solo** (Indication only)
- 11 Voice Name** (Indication only)

These are the same as in the Song Record mode. See page 187.

12 REC TR (Record Track)
Determines the track to be recorded. Move the cursor to the desired track or press any of the Number buttons [1] – [16] with the TRACK lamp turned on so that the red circle is shown in the corresponding column of the REC TR.

Settings: 1 – 16

13 Record Type
Determines the Recording method.

Settings: replace, overdub
replace
You can use this method when you want to overwrite an already recorded track with new data in real time. The original data will be erased.
overdub
You can use this method when you want to add more data to a track that already contains data. Previously recorded data will be maintained.

14 Loop (Loop Recording)
Determines whether the Recording is looped or not when executing Realtime recording. When set to on, the phrase will play repeatedly during real-time recording. This can be handy when recording drum Parts with the Recording type set to “overdub,” allowing you to add different instruments on each pass. When set to off, recording stops after one pass through the phrase.

- 15 Record Part**
- 16 Quantize (Record Quantize)**
- 17 Voice**
- 18 Volume**
- 19 Pan**
- 20 Ins Effect Sw (Insertion Effect Switch)**

These are the same as in the Song Record mode. See page 188.

21 [SF1] Scene1 – [SF5] Scene5
You can change the settings of the Pattern-related parameters (Pattern Scene) and Arpeggio-related parameters by pressing these buttons. For details, refer to the description of the same buttons in the Pattern Play mode on page 211.

22 [F1] Setup
Pressing this button returns from the previous display to the Record Setup display.

23 [F2] Arpeggio (Record Arpeggio)
The operation is same as the one in the Record Arpeggio display (page 189) in the Song mode.

Voice mode
Performance mode
Sampling mode 1
Song mode
Pattern mode
Mixing mode
Sampling mode 2
Master mode
Utility mode
File mode

24 [F4] Erase

This menu appears as soon as Recording starts. During Pattern recording, pressing the key while holding the [F4] button erases all the note events of the pressed key. This is useful in loop recording since it allows you to quickly delete wrong notes played for a specific key.

25 [F5] Click

This is the same as in the Song Record mode. See page 188.

Realtime Recording Procedure

This section explains how to record your performance using the Realtime Recording features. Please keep in mind that the procedure differs depending on the Record Type and Record Track set from the Record Setup display. The operation is same as the one in the Song Record display (page 189).

Editing MIDI Events (Pattern Edit)

The Pattern Edit mode lets you edit the already recorded Phrases or insert the new data to the Phrases. It can be used to correct mistakes as well as add dynamics or effects such as vibrato to refine and finish the Phrase. Press the [EDIT] button from the Pattern Play mode to go to the Pattern Edit mode.

NOTE The Pattern Edit mode gives you comprehensive, detailed controls for editing the MIDI events of individual Pattern tracks. MIDI events are messages (such as note on/off, note number, program change number, etc.) that make up the data of a recorded phrase.

NOTE Like the Song Edit mode, Pattern Edit consists of the Event List display and the Insert Event window. The Event List display lets you correct or delete already inserted MIDI events and the Insert Event window lets you insert new events to the Pattern. By using the Insert Event window, you can input the events one by one. The Event List display will always appear when the Pattern Edit mode is first called up.

Editing the recorded data

Here in outline form is the process of correcting or deleting already recorded events.

1 Select a track to be edited in the Pattern Play display.

If you wish to edit a certain phrase, press the [F4] button to call up the Patch display (page 212), then select the desired Phrase.

2 Press the [EDIT] button to enter the Pattern Edit mode.

The Event List display (page 221) of the Pattern appears.

NOTE You can select the desired track with the Number buttons [1] – [16] by pressing the [TRACK] button (the lamp lights) after entering the Pattern Edit mode.

3 Move the cursor to the event or parameter to be edited.

Use the [Λ]/[V] (Cursor Up/Down) button to move the cursor to the desired timing. Press the [◀◀] (Rewind)/[▶▶] (Fast Forward) button to move the cursor by single measures. Use the [<]/[>] (Cursor Left/Right) button to move the cursor to the parameter to be edited.

NOTE For details about each event and parameter, see page 76.

NOTE Use the View Filter function (page 221) to help you quickly find desired events.

4 Change the parameter settings or location of the event.

Edit the value by using the [INC/YES], [DEC/NO] buttons and the data dial. The edited event will flash on the display.

Change the event location by editing the MEAS (measure), BEAT, and CLOCK.

Press the [F6] button to delete the event at the cursor location.

5 After you've finished editing a parameter, press the [ENTER] button to confirm and enter the edit (the event will stop flashing).

If the cursor is moved to a new event while the current event is still flashing, editing of the current event is cancelled.

6 Press the [EXIT] button to go back to the Pattern Play display.

7 Press the [STORE] button to call up the Pattern Store window (page 218), then store the created Pattern.

Inserting the New Event

This section shows how to insert new events to the current Song.

- 1 From the Event List display, press the [F5] Insert button to call up the Insert Event window.

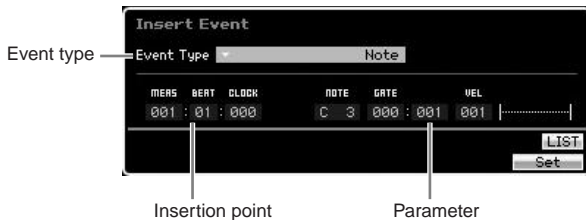

- 2 Specify the event type to be inserted, the insertion point (measure, beat, and clock), and parameter value of the event.

When the cursor is located on the Event Type, you can call up the list of event types to be input by pressing the [SF6] LIST button and select one from the list. For details about each event and parameter, see page 76.

- 3 Press the [F6] Set button to insert the specified event at the specified location.

The Insert Event window remains open, allowing you to continue inserting new events. Press the [ENTER] button to actually insert the event and close the Insert Event window.

- 4 Press the [EXIT] button to go back to the Event List display.

Event List display

In the Event List display, MIDI events (including mainly values such as note number, velocity, and control change value) are listed and can be edited. Here you can edit or delete previously recorded events.

This is the same as the Event List display in the Song Edit mode. For details, see page 193.

Changing the MIDI event view—[F2] ViewFilter

This is the same as the View Filter in the Song Edit mode. For details, see page 194.

Pattern Jobs

The Pattern Job mode contains a comprehensive set of editing tools and data transform functions you can use to change the sound of the Pattern or Phrase. It also includes a variety of convenient operations, such as copying or erasing data. 36 Pattern Jobs are available.

Function	Description
[F1] Undo/Redo	Undo Job cancels the changes made by the most recent operation, restoring the data to its previous state. Redo Job cancel Undo and restores the changes.
[F2] Note	Note data Jobs
01: Quantize	These are the same as in the Song Job mode. See page 195.
02: Modify Velocity	
03: Modify Gate Time	
04: Crescendo	
05: Transpose	
06: Glide	
07: Create Roll	
08: Sort Chord	
09: Separate Chord	
[F3] Event	Event Jobs
01: Shift Clock	These are the same as in the Song Job mode. See page 195.
02: Copy Event	
03: Erase Event	
04: Extract Event	
05: Create Continuous Data	
06: Thin Out	
07: Modify Control Data	
08: Beat Stretch	
[F4] Phrase	Phrase Jobs
01: Copy Phrase	This Job copies a selected Phrase to the designated destination Phrase.
02: Exchange Phrase	This Job exchanges the contents of two specified Phrases.
03: Mix Phrase	This Job mixes all data from two selected user Phrases.
04: Append Phrase	This Job appends one Phrase to the end of another to create one longer Phrase.
05: Split Phrase	This Job splits a selected Phrase into two separate Phrases.
06: Get Phrase from Song	This Job copies a segment of sequence-track data from a Song into the designated destination Phrase.
07: Put Phrase to Song	This Job copies a selected user Phrase into a specified area of a selected Song.
08: Clear Phrase	This Job deletes all data from the selected Phrase.
[F5] Track	Track Jobs
01: Copy Track	This Job copies all data of the selected type from a specified source track to a specified destination track.
02: Exchange Track	This Job exchanges or "swaps" the specified type of data between two specified tracks in the current Song.
03: Mix Track	This Job mixes all data from two selected tracks.
04: Clear Track	This Job deletes all data of the selected type from the selected track.
05: Normalize Play Effect	This Job rewrites the data in the selected track so that it incorporates the current Play FX/Groove/MIDI Delay settings.
06: Divide Drum Track	This Job separates the note events in a drum performance assigned to a specified track, and places the notes corresponding to different drum instruments in separate tracks (tracks 1 through 8).
07: Put Track to Arpeggio	This Job copies data in the specified measures of a track for creating Arpeggio data.
[F6] Pattern	Pattern Jobs
01: Copy Pattern	This Job copies all data from a selected source Pattern to a selected destination Pattern.
02: Append Pattern	This Job appends one Pattern to the end of another to create one longer Pattern.
03: Split Pattern	This Job splits a selected Pattern into two separate Patterns.
04: Clear Pattern	This Job deletes all data from the selected Pattern, or from all Patterns.

Pattern Job Procedure

- 1 From the Pattern Play display, press the [JOB] button to enter the Pattern Job mode.
- 2 Select the desired Job menu by pressing one of the [F1] – [F6] buttons.
- 3 Move the cursor to the desired Job by using the data dial, [INC/DEC] and [DEC/NO] buttons, then press the [ENTER] button to call up the Job display.
- 4 Move the cursor to the desired parameter, then set the value by using the data dial, [INC/YES] and [DEC/NO] buttons.
- 5 After setting, press the [ENTER] button to execute the Job.

“Completed” will appear when the Job is done.

CAUTION

In some Jobs, the operation overwrites any data previously existing in the destination memory. Important data should always be saved to a USB storage device connected to the USB TO DEVICE terminal or to a computer connected to the same network as the MOTIF XS (page 278).

- 6 Press the [EXIT] button twice to go back to the Pattern Play display.

NOTE If there is no data in the specified range, “No Data” will appear on the display and the Job cannot be executed.

NOTE If you make a mistake or want to compare the sound of the data before and after executing a Job, press the [F1] button to use the Undo/Redo function.

CAUTION

Even if a Job operation has been completed, selecting a different Pattern or turning the power off without storing will erase the Pattern data. Make sure to store the Pattern data to internal memory by pressing the [STORE] button before selecting a different Pattern or turning the power off.

NOTE Some of the Jobs which enable you to copy the Sample Voice from the source to the destination execute the actual copy operation only when the Bank Select and Program Change events which specify the Sample Voice are recorded in the source Track.

[F1] Undo/Redo

This is the same as in the Song Job mode. See page 196.

[F2] Note Jobs

The Note Jobs in the Pattern mode are basically same as in the Song Job mode. However, unlike in the Song Job

mode, Pattern Note Jobs are applied to the Phrases (001 – 256) and a selected range in the Phrase (measure : beat : clock).

[F3] Event Jobs

The Event Jobs in the Pattern mode are basically same as in the Song Job mode. However, unlike in the Song Job mode, Pattern Event Jobs are applied to the Phrases (001 – 256) and a selected range in the Phrase (measure : beat : clock).

NOTE In “03: Erase Event Job,” “Tempo Change,” “Scene Memory,” or “Track Mute” cannot be selected as Event Types, unlike in the Song Erase Event Job.

NOTE In “05: Create Continuous Data Job” and “07: Modify Control Data Job,” “Tempo Change” cannot be selected as Event Types, unlike in the Song Job mode.

[F4] Phrase Jobs

01: Copy Phrase

This Job copies a selected Phrase to the designated destination Phrase. Also the Sample Voices used in the selected Phrase can be copied. This is useful if you are creating a Pattern and wish to use the Phrase data from another Pattern.



1 Source Phrase

2 Destination Phrase

Determines the Pattern number (01 – 64) and Phrase number (001 – 256) of the source and destination respectively.

3 Copy Sample Voice

When this box is checkmarked, Sample Voices assigned to the source Phrase are copied to the destination Phrase as Sample Voices, and are assigned to the corresponding tracks in the selected Pattern. Make sure to set this parameter to on when coping the Phrase using the Sample Voice. When there is no memory available in the destination Pattern for Sample Voice data, an alert message will appear on the display and the Sample Voice data will not be copied. If this occurs, use Sample Job 02: Delete to delete any unused samples, then try again.

CAUTION

Any previous data in the copy destination will be overwritten.

CAUTION

Undo/Redo cannot be used to undo/redo a Sample Voice copy operation.

02: Exchange Phrase

This Job exchanges or “swaps” the contents of two specified Phrases. This is useful if you wish to exchange two Phrases each of which is assigned to a different Pattern.



- 1 Phrase to be exchanged**
- 2 Phrase to be exchanged**

Determines the Pattern number (01 – 64) and Phrase number (001 – 256) to be exchanged respectively.

NOTE If this Job is applied to Phrases which use Sample Voices, the Sample Voices will not be exchanged.

03: Mix Phrase

This Job mixes all data from two selected user Phrases—**1** and **2**—and places the result in Phrase **2**. This is useful if you wish to create a new Phrase by mixing two Phrases played, for example, by different drum instruments.



- 1 Original Phrase**
 - 2 Original Phrase and Destination Phrase**
- Determines the Pattern numbers (01 – 64) and Phrase numbers (001 – 256) to be mixed respectively. Executing the Job mixes all data from two selected user Phrases—**1** and **2**—and places the result in Phrase **2**.

NOTE Keep in mind that applying this Job to Phrases with Sample Voices does not mix the Sample Voices.

04: Append Phrase

This Job appends one Phrase (**1**) to the end of another (**2**) to create one longer Phrase.

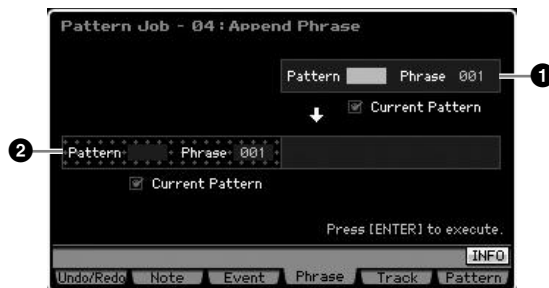

- 1 Original Phrase**
 - 2 Original Phrase and Destination Phrase**
- Determines the Pattern numbers (01 – 64) and Phrase numbers (001 – 256) to be appended respectively. Executing the Job appends one Phrase (**1**) to the end of the Phrase (**2**).

NOTE If this Job is applied to Phrases which use Sample Voices, the Sample Voices of the source Phrase (**1**) will not be appended.

NOTE If the Pattern length becomes greater than 256 measures as a result of the this Job, an error message will be displayed and the Job will be aborted.

05: Split Phrase

This Job splits a selected Phrase (**1**) into two separate Phrases (**1** and **2**). Phrase **1** is divided at the Split Point (**3**).

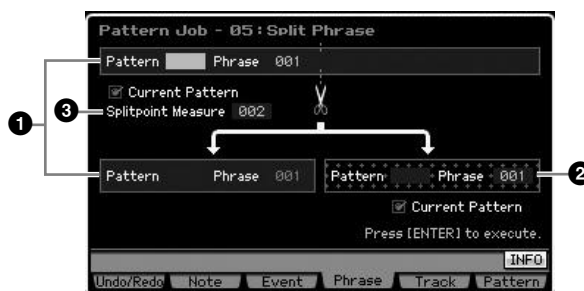

- 1 Original Phrase**
 - 2 Destination Phrase**
- Determines the original Phrase to be split by selecting the Pattern number (01 – 64) and Phrase number (001 – 256). Executing the Job leaves the part before the Split Point (**3**) of the original Phrase.
- Determines the split destination Phrase by selecting the Pattern number (off, 01 – 64) and Phrase number (off, 001 – 256). Executing the Job copies the part after the Split Point to this split destination Phrase. When either the Pattern or the Phrase is set to “off,” the part after the Split Point of the original Phrase will be deleted.

CAUTION

This Job overwrites any data already existing in the split destination Phrase (2).

3 Split Point Measure

Determines the measure (002 – 256) at which the Phrase will be split.

06: Get Phrase from Song

This Job copies a segment of sequence-track data from a Song into the designated destination Phrase. This Job is useful when you've found a drum or bass pattern in a Song and want to use it in the Pattern.



1 Source Song, Track and Measures

Determines the source Song number (01 – 64), Track number (01 – 16) and measure range (001 – 999) of the Song. If the specified measure range is more than 257, an alert message will appear on the display and the Job will be aborted. If this occurs, set the Measure again so that this range is within 256 measures.

2 Destination Phrase

Determines the destination Phrase by selecting the Phrase number (001 – 256). The destination Phrase can be specified among the Phrases of the current Pattern.

CAUTION

Any previous data in the copy destination will be overwritten.

3 Copy Sample Voice

When the Copy Sample box is checkmarked, Sample Voices used in the source data are copied to the destination Phrase as Sample Voices, and are assigned to the destination Pattern track. Make sure to set this parameter to on when copying a track using a Sample Voice. When there is no memory available in the destination Pattern (current Pattern) for Sample Voice data, an alert message will appear on the display and the Sample Voice data will not be copied. If this occurs, use Sample Job 02: Delete to delete any unused samples, then try again.

CAUTION

Undo/Redo cannot be used to undo/redo a Sample Voice copy operation.

07: Put Phrase to Song

This Job copies a selected user Phrase into a specified area of a selected Song.

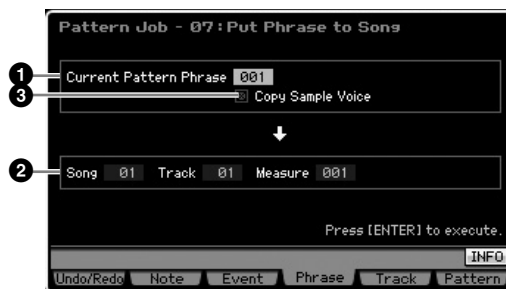

1 Source Phrase

Determines the Phrase number (001 – 256) to be copied.

2 Destination Song, Track and Measure

Determines the destination Song number (01 – 64), Track number (01 – 16) and measure range (001 – 999).

CAUTION

The copy operation overwrites any data previously existing on the destination track and measure range.

3 Copy Sample Voice

When the Copy Sample box is checkmarked, Sample Voices used by the source Phrase are copied to the destination Song as Sample Voices, and are assigned to the destination Song track. Make sure to set this parameter to on when coping a Phrase using a Sample Voice. When there is no memory available in the destination Song for Sample Voice data, an alert message will appear on the display and the Sample Voice data will not be copied. If this occurs, use Sample Job 02: Delete to delete any unused samples, then try again.

CAUTION

Undo/Redo cannot be used to undo/redo a Sample Voice copy operation.

08: Clear Phrase

This Job deletes all data from the selected Phrase.



1 Phrase

Determines the Phrase number (001 – 256) to be cleared.

Voice mode
Performance mode
Sampling mode 1
Song mode
Pattern mode
Mixing mode
Sampling mode 2
Master mode
Utility mode
File mode
Reference

2 Clear Sample Voice

When the checkbox is checked, the Sample Voice used in the Phrase specified above will also be cleared.

CAUTION

Undo/Redo (page 196) cannot be used to undo/redo a Delete sample operation.

[F5] Track Jobs

01: Copy Track

This Job copies all data of the selected type from a specified source track to a specified destination track. This is useful if you are creating a Pattern and wish to use the track data from another Pattern.



- 1 Source Track
- 2 Destination Track

Determines the Pattern number (01 – 64), Section (A – P) and Track (01 – 16) of source and destination respectively.

CAUTION

Any previous data in the copy destination will be overwritten.

- 3 Data Type to be copied

Determines the type(s) of data to be copied.

Settings: Sequencer Event (all events in the track), Play Effect, Mix Part Parameter (all Mixing Part parameters), Sample Voice

NOTE When there is no memory available in the destination Pattern for Sample Voice data, an alert message will appear on the display and the Sample Voice data will not be copied even though the check box of the Sample Voice is marked. If this occurs, use Sample Job 02: Delete to delete any unused samples, then try again.

CAUTION

Undo/Redo (page 196) cannot be used to undo/redo a Delete sample operation.

02: Exchange Track

This is the same as in the Song Job mode. See page 205.

03: Mix Track

This is the same as in the Song Job mode. See page 205.

04: Clear Track

This Job deletes all data of the selected type from the selected track.



- 1 Tracks

Determines the track to be cleared by specifying the Section (A – P, all) and Track (01 – 16, all).

- 2 Data type to be cleared

Determines the type(s) of data to be cleared. Select the desired type by checkmarking the appropriate box.

Settings: Sequencer Event (all events in the track), Play Effect, Mix Part Parameter (all Mixing Part parameters), Sample Voice

CAUTION

Undo/Redo cannot be used to undo/redo a Clear operation for tracks that contain sample data.

05: Normalize Play Effect

This is the same as in the Song Job mode. See page 205.

06: Divide Drum Track

This is the same as in the Song Job mode. See page 205.

07: Put Track to Arpeggio

This Job copies data in the specified measures of a track for creating Arpeggio data. Up to 16 unique note numbers can be recorded to the Arpeggio track. If more than 16 different note numbers have been recorded to the MIDI sequence data, the Convert operation reduces the notes in excess of the limit. Because of this, be careful to record only up to 16 different notes when you create an Arpeggio, especially when using all four tracks.

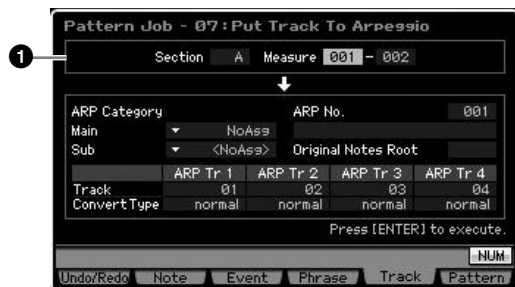

1 Range

Determines the range which will be converted to the arpeggio data by specifying the Section (A – P) and Measure (001 – 256).

Other parameters are the same as in the Song Job mode. See page 206.

[F6] Pattern Jobs

01: Copy Pattern

This Job copies all data from a selected source Pattern to a selected destination Pattern.

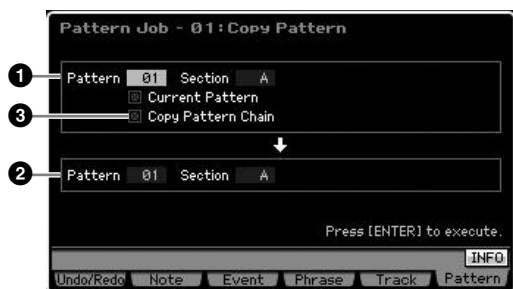

1 Source Pattern

2 Destination Pattern

Determines the source and destination Pattern by selecting the Pattern number (01 – 64) and Section (A – P, all). If you set the source Section to “all,” the destination Section is also set to “all” automatically, with the result that all source Pattern data is copied to the destination.

3 Copy Pattern Chain

When this box is checkmarked, Pattern Chain data as well as Pattern data will be copied.

02: Append Pattern

This Job appends one Pattern (1) to the end of another (2) to create one longer Pattern. Actually, the Phrases making up the source Pattern (1) will be appended to the end of the Phrases making up the destination Pattern (2). This Job is useful if you wish to connect different Patterns together.

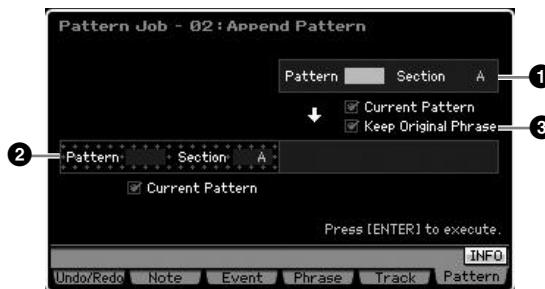

1 Original Pattern

2 Original Pattern and Destination Pattern

Determines the two Patterns to be connected by selecting the Pattern numbers (01 – 64) and Sections (A – P) respectively. Executing the Job appends one Pattern (1) to the end of the other Pattern (2). The result of this Job will be overwritten to the destination Pattern (2).

3 Keep Original Phrase

When this box is checkmarked, the original destination Pattern data is retained in memory, along with the new appended Pattern data. When the Keep Original Phrase checkbox is checked, this Job requires twice the number of empty user Phrases as the number of tracks containing data in which to store the appended Phrase data. If the required space is not available, an alert message will appear and the Job will be aborted. If this occurs use the Clear Phrase Job to delete unused Phrases then try again. If the box is not checkmarked, the original destination Pattern is erased and replaced with the newly created Phrases.

NOTE If this Job is applied to Patterns which use Sample Voices, the Sample Voices of the source Phrase (1) will not be appended.

NOTE If the Pattern length becomes greater than 256 measures as a result of this Job, an error message will be displayed and the Job will be aborted.

Voice mode
Performance mode
Sampling mode 1
Song mode
Pattern mode
Mixing mode
Sampling mode 2
Master mode
Utility mode
File mode
Reference

03: Split Pattern

This Job splits a selected Pattern (1) into two separate Patterns (1 and 2). The Pattern 1 is divided at the Split Point (3). Actually, the Phrases making up the source Pattern (1) will be divided and the divided Phrases after the Split Point will be assigned to the tracks of the destination Pattern.

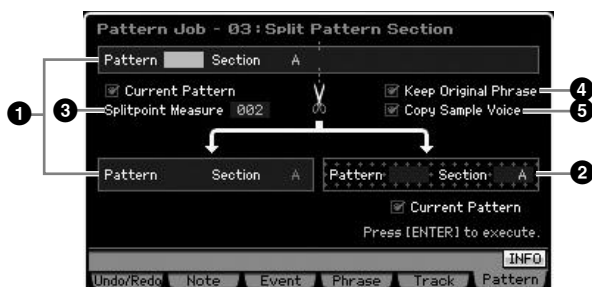

1 Original Pattern

Determines the original Pattern to be split by selecting the Pattern number (01 – 64) and Section (A – P). Executing the Job leaves the part before the Split Point in the original Phrase.

2 Destination Pattern

Determines the split destination Pattern by selecting the Pattern number (01 – 64) and Section (off, A – P). Executing the Job moves the part after the Split Point to this split destination Pattern. When either of the Pattern number or Section is set to “off,” the part after the Split Point (3) of the original pattern (1) will be deleted.



CAUTION
This Job overwrites any data already existing in the split destination Pattern (2).

3 Splitpoint Measure

Specifies the measure at which the Pattern will be split.

Settings: 002 – 256

4 Keep Original Phrase

When this box is checkmarked, the Phrase of the original Pattern is retained in memory and the results of the Split Job are written to empty Phrases. When the Keep Original Phrase checkbox is checked, this Job requires twice the number of empty user Phrases as the number of tracks containing data in which to store the appended Phrase data. If the required space is not available, an alert message will appear and the Job will be aborted. If this occurs, use the Clear Phrase Job to delete unused Phrases and try again.

When this box is not checkmarked, the Phrases making up the original Pattern are erased and replaced with the newly created Phrases.

5 Copy Sample Voice

When this box is checkmarked, Sample Voices (if included in the original Pattern) are copied to the destination Pattern.

04: Clear Pattern

This Job clears specified Pattern. You can also clear only the specified Section of the selected Pattern.



1 Pattern (Pattern and Section) to be cleared

Determines the Pattern to be cleared. When the Pattern is set to “all,” all the Pattern data will be cleared. When the Section is set to “all,” all data from the selected Pattern will be cleared.

2 Clear Pattern Chain

When the checkbox is checked, the Pattern Chain data will also be cleared. When the checkbox is not checked, the Pattern Chain data will not be cleared.

NOTE The Waveform on DIMM cannot be deleted via this Job even if the Sample Voice is used in the specified Section. If you want to actually delete the Waveform assigned to the Sample Voice used in the specified Section, use the Delete Job (page 177) in the Sampling Job mode.

Multi-timbral Tone Generator Settings for Song/Pattern Playback (Mixing mode)

The setting of the tone generator block for Song/Pattern playback is referred to as Mixing. The Mixing mode lets you change the Voice and effect settings for each Part.

To enter the Mixing mode, press the [MIXING] button in the Song mode or Pattern mode.

NOTE The Mixing mode cannot be called up from the Voice mode, Performance mode, or Master mode.

The Mixing mode structure

This section explains in detail about the Mixing mode and what you can do in the Mixing mode.

About Mixing

In the Song/Pattern mode, the internal tone generator block functions as the multi-timbral tone generator in order to receive and handle MIDI sequence data consisting of multiple channels. The settings for the multi-timbral tone generator are collectively referred to as a "Mixing." A Mixing program is provided for each Song or Pattern. Selecting a different Song/Pattern calls up the different Mixing program.

Common Edit and Part Edit

The Mixing Edit mode consists of two sub modes: Common Edit and Part Edit. Common Edit lets you edit the global settings common to all Parts, such as the Master Effect, the Master EQ, and the Controller settings. Part Edit lets you adjust various parameters for each of 16 Parts according to the corresponding Song/Pattern track.

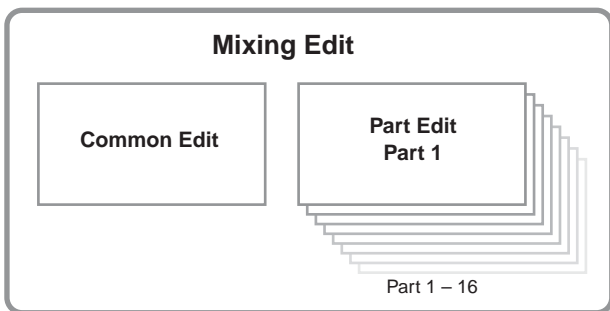

Effect and EQ structure in the Mixing mode

In the Mixing mode, two EQ blocks and three Effect blocks are available.

The two EQ blocks in the Mixing mode are Part EQ and Master EQ. Part EQ is applied to each of the Mixing Parts and can be set in the EQ display (page 236) of Part Edit. In addition, the Part EQ parameters can be adjusted at the same time for all parts in the Part EQ display (page 233) of Common Edit. On the other hand, Master EQ is applied to the overall sound (all the Mixing Parts) and can be set in the Master EQ display (page 234) of Common Edit.

The Effect blocks in the Mixing mode are Reverb, Chorus, and Master Effect. Reverb and Chorus are applied to the overall sound and the related parameters can be set in the Reverb/Chorus display (page 235) of Common Edit. The depth (send level) of the Reverb/Chorus can be set for each Part in the Connect display (page 234) of Part Edit. On the other hand, Master Effect is applied to the overall sound (all the Mixing Parts) and can be set in the Master Effect display (page 234) of Common Edit.

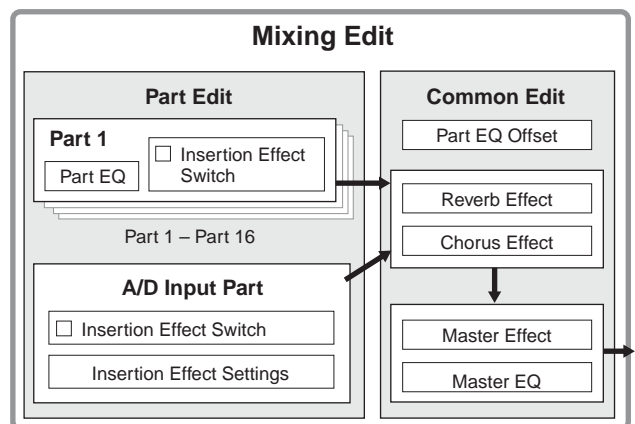

Insertion Effect in the Mixing mode

In addition to the three Effect blocks above, special Insertion Effects are available in the Mixing mode. Keep in mind that Insertion Effects cannot be applied to all 16 parts simultaneously. The MOTIF XS features eight Insertion Effects, allowing you to independently process up to eight Parts from among the 1 – 16 parts and the A/D Input part. You can specify the parts to which the Insertion Effect is applied by setting the Insertion Effect Switch parameter in the 1 – 16 display (page 231) and the Audio Part display (page 232) of the Mixing Play mode.

The most common use for Insertion Effects is in applying compression or dynamics processing to an individual Part, or applying a special effect that is only to be used on one Part, such as distortion or rotary speaker.

The Insertion Effect parameters can be set in the following displays.

Part 1-16:

The Insertion Effect parameters for each of the Parts 1 – 16 can be set by editing the Voice assigned to each Part in the Connect display and Insertion A/B display of Mixing Voice Edit (page 239). The edited voice can be stored (page 240) as a Mixing Voice or User Voice.

A/D Input Part:

The Insertion Effect parameters for the A/D Input Part can be set in the Insertion A/B display (page 234) of Common Edit.

Mixing Voices

Up to 16 Normal Voices can be stored for each Song/Pattern Mixing. This type of Voice is called a Mixing Voice.

Normally, the Voice stored in the Voice mode is assigned to each Mixing Part. In this method, the sound of the Song/Pattern you created may be changed unexpectedly if you edit or delete the Voice used for the Song/Pattern Mixing. Mixing Voices are provided to prevent these accidental sound changes. To use this feature, call up a Voice from User Banks 1 – 3, store the selected Voice to the Mixing Voice Bank, assign it to the desired Part, then edit the Mixing as needed. In addition, make sure to store the Voice as a Mixing Voice after editing the Voice in the Mixing mode.

Up to 16 Mixing Voices are provided for each Mixing program, or in other words, for each Song/Pattern. Selecting a different Song/Pattern calls up a different Mixing belonging to the new selected Song/Pattern.

If you wish to use a Mixing Voice of a certain Song/Pattern for another Song/Pattern, execute the copy operation (page 241) in the Mixing Voice Job mode.

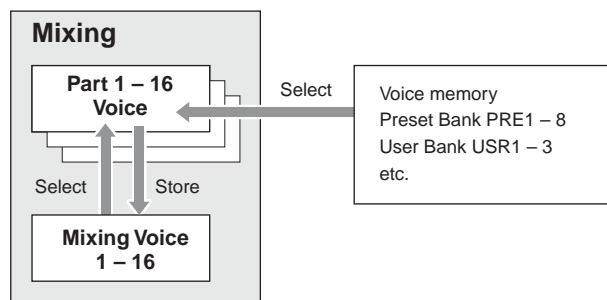

Note that up to 256 Mixing Voices can be stored for all Songs and Patterns. Accordingly, the Mixing Voice memory will become full and additional Voices cannot be stored if you've stored 16 different Voices for 16 different Songs. If such a situation occurs, use the Delete Job (page 241) to delete any unnecessary Mixing Voices in the Mixing Voice Job mode.

NOTE You can confirm the amount of currently unused (available) memory via the Mixing Voice Information window (page 240).

Mixing Setup Procedure

- 1 In the Song or Pattern mode, select a Song or Pattern to be edited.**
- 2 Press the [MIXING] button to enter the Mixing mode.**
The Part 1 – 16 display (page 231) of the Mixing Play appears.
- 3 Select a Voice and set other parameters such as volume and pan for each Part from the Part 1 – 16 display or the Audio Part display.**
- 4 Set the parameters common to all Parts or those exclusive for each Part.**

If you wish to edit parameters common to all parts such as Master Effect, Master EQ and Controller settings, press the [EDIT] button from the Mixing Play display, then press the [COMMON EDIT] button to enter the Common Edit display (page 233).

If you wish to edit more detailed Mixing Part parameters, enter the Part Edit mode (page 235) by pressing the [EDIT] button, then press the desired one of the Number buttons [1] – [16]. If you wish to edit parameters for the Audio Part, press the [EDIT] button from the Mixing Play mode and press the [COMMON EDIT] button then [F4] button to call up the Audio In display (page 234).

5 Edit the Voice assigned to the Part as desired.

If you wish to edit a Voice assigned to each Part, press the [F6] button in the Mixing Play display to call up the Mixing Voice Edit display (page 239).

The Mixing Voice Common Edit mode (page 241) can be called up by pressing the [COMMON EDIT] button. The Mixing Voice Element Edit mode (page 241) can be called up by pressing one of the Number buttons [1] – [8].

6 Store the edited voice as a Mixing Voice as desired.

In the Mixing Voice Edit mode, press the [STORE] button to call up the Mixing Voice Store window (page 240).

7 Store the edited Mixing program to the Song/Pattern.

In the Song Play mode, press the [STORE] button to call up the Song Store window or Pattern Store window. For detailed instructions on storing, see page 186.

8 Press the [SONG] or [PATTERN] button to exit from the Mixing mode to the previous mode.**Mixing mode structure**

The Mixing mode structure is as follows:

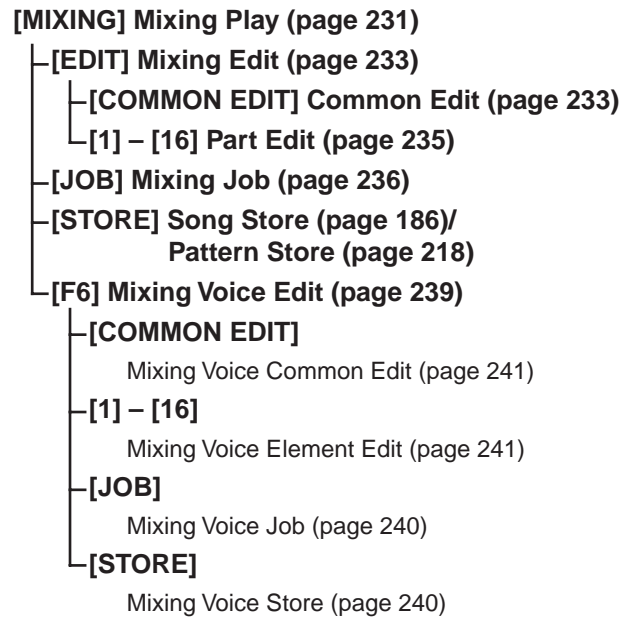
**Mixing Play mode**

The Mixing Play display will appear when pressing the [MIXING] button in the Song mode or Pattern mode. Here you can edit the Mixing parameters which are important for creating a Song/Pattern.

**Part Settings on the Mixer display—
[F1] Part1 – 16**

Here you can edit the main parameters for each Mixing Part. The basic parameters for creating a Song are gathered on this display from the Voice display (page 235) and the Output display (page 235) in the Mixing Part Edit mode. The settings made here are automatically applied to the corresponding parameters in the displays in the Mixing Part Edit mode, and vice versa.

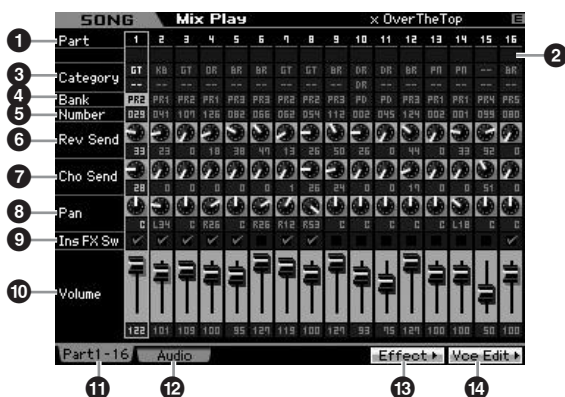
**1 Part** (Indication only)

Indicates the Part numbers. When the [TRACK] lamp is turned on, the Part can be selected via the Number buttons [1] – [16].

2 Mute/Solo/Edit (Indication only)

Indicates the status of each Part. When the [MUTE] lamp is turned on, the Mute on/off status for each Part can be switched via the Number buttons [1] – [16]. When the [SOLO] lamp is turned on, the Solo Part can be selected via the Number buttons [1] – [16].

Settings: (Mute), (Solo), (Edit Indicator)

Edit Indicator

Indicates that the Mixing Voice for the Part is modified but not stored yet.

3 Category (Indication only)

Indicates the two main categories of the current Voice. When the [CATEGORY SEARCH] lamp is turned on, you can select the desired Voice by using the Category Search function (page 24). The name of the selected Voice is shown at the top right of the display.

4 Bank**5 Number**

These determine the selected Voice. Press the [PROGRAM] button (the lamp lights), then the desired Voice by using the [PRE 1] – [USER DR] buttons, [A] – [H] buttons and the [1] – [16] buttons. The name of the selected Voice is shown at the right top of the display.

Settings:

Number: 1 – 128

Bank: PR1 – 8 (Preset 1 – 8), US1 – 3 (User 1 – 3), GM, GD (GM Drum), PD (Preset Drum), UD (User Drum), SP (Sample Voice), MV (Mixing Voice)

6 Rev Send (Reverb Send)

Adjusts the Reverb send level for each Part. The higher the value, more pronounced the Reverb effect.

Settings: 0 – 127

7 Cho Send (Chorus Send)

Adjusts the Chorus send level for each Part. The higher the value, more pronounced the Chorus effect.

Settings: 0 – 127

8 Pan

Determines the position in the stereo field for each Part.

Settings: L63 (far left) – C (center) – R63 (far right)

9 Ins FX Sw (Insertion Effect Switch)

Determines the Parts available for the Insertion Effect. When this switch is set to on, the Insertion Effect of the Voice assigned to the Part enabled. Make sure that this parameter is set to on for any Parts/Voices to which you need to apply Insertion Effects.

The MOTIF XS features eight Insertion effect systems, letting you set this parameter to on for up to eight Parts. If eight Parts are already turned on, the parameter cannot be turned on for additional Parts. In this case, the switch for another Part must be turned off before you can turn the switch for the desired Part on. Please note that the Insertion Effects are available simultaneously for up to eight Parts including the A/D Input Part.

Settings: (on), (off)

10 Volume

Determines the output level of the Part.

Settings: 0 – 127

11 [F1] Part 1 – 16

Calls up this display from the Audio Mixer display.

12 [F2] Audio (Audio Part)

Calls up the Audio Part display for setting the Audio Input.

13 [F5] Effect

Calls up the Effect display (page 234) in the Common Edit mode.

14 [F6] Vce Edit (Mixing Voice Edit)

Enters the Mixing Voice Edit mode, letting you edit the Voice assigned to the current Part. If the Drum Voice or Sample Voice is assigned to the current Part, this button does not appear and the Mixing Voice is not available.

Audio Input settings—[F2] Audio

From this display you can set parameters related to audio input from the [A/D INPUT] connector and the mLAN connector (available for the MOTIF XS8 and available for the MOTIF XS6/7 with the mLAN16E2 installed). The basic parameters for creating a Song are gathered on this display from the Audio In display (page 234) in the Mixing Common Edit mode. The settings made here will be applied to the same parameters on the displays in the Mixing Common Edit mode, and vice versa.

**1 Part (Indication only)**

Indicates the Part numbers.

AD (A/D Input Part)

Lets you set parameters related to audio input from the A/D INPUT connector.

mL (mLAN)

Lets you set parameters related to audio input from the mLAN connector (available for the MOTIF XS8 and available for the MOTIF XS6/7 with the mLAN16E2 installed). The audio signal here is transmitted from the computer via mLAN Ports 3 and 4.

The settings made here are automatically applied to the corresponding parameters in the Part 1 – 16 display (page 231).

2 Rev Send (Reverb Send)**3 Cho Send (Chorus Send)****4 Pan****5 Ins FX Sw (Insertion Effect Switch)*****6 Volume**

* Available for the A/D Input Part only

Mixing Edit

The Mixing Edit mode lets you control typical mixer settings such as volume balance, pan position and effects, allowing you to fine tune the Song/Pattern data. Mixing Edit consists of Part Edit and Common Edit.

Useful functions for editing Mixing

Turning specific Parts on/off (Mute function)

You can turn individual Parts on/off by using the Mute function.

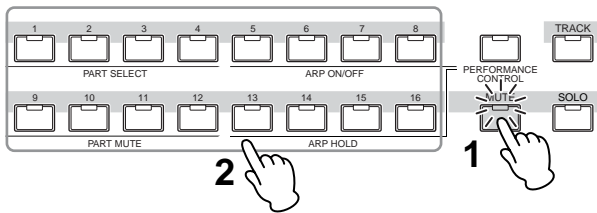

1 Press the [MUTE] button.

The [MUTE] lamp lights, indicating that each Part can be turned on/off.

2 Press any of the Number buttons [1] – [16].

The lamp of the pressed button will be turned off and the corresponding Part will be muted.

Press the same button again to turn the lamp on and disengage the mute function for that Part. You can turn multiple Parts on/off by pressing their buttons.

Soloing a specific Part

The Solo function is the opposite of Mute, and lets you instantly solo a specific Part and mute all others.

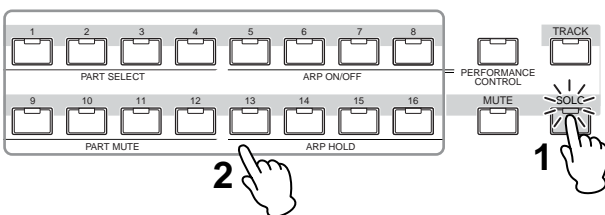

1 Press the [SOLO] button.

The [SOLO] lamp lights, indicating that the specific Part can be soloed.

2 Press any of the Number buttons [1] – [16].

The lamp of the pressed button will be turned on and only the corresponding Part will be sounded.

Press any other number button to change the solo Part.

The [E] Indicator

When changing the value of the parameter in the Mixing Play or Edit mode, the [E] (Edit Indicator) will appear on the top right corner of the LCD display. This gives a quick confirmation that the current Mixing has been modified but not yet stored. To store the current edited status, follow the instructions on page 97.



Compare function

The Compare function lets you switch between the just-edited Mixing and its original, unedited condition, allowing you to hear how your edits affect the sound. For instructions on using Compare, refer to the same function in the Voice mode on page 97.

Storing the created Mixing

The created mixing setup can be stored as part of the data of a Song or Pattern. For instructions on storing a Song/Pattern, see pages 186 and 218.

Common Edit parameters

[SONG]/[PATTERN] → [MIXING] → [EDIT] → [COMMON EDIT]

The Common Edit mode lets you edit the parameters common to all Mixing Parts.

Controller settings—[F1] General

Determines the function for the Knobs and ASSIGNABLE FUNCTION buttons for each Song/Pattern.

The function is the same as the one in the Other display (page 145) in the Performance Common Edit mode.

Master Effect and Master EQ settings— [F2] MasterFX (Master Effect)

[SF2] MasterFX (Master Effect)

This display lets you set the type and parameters of the Master Effect.

The function is the same as the one in the Master Effect display (page 146) in the Performance Common Edit mode.

[SF3] MasterEQ

From this display you can apply five-band equalization to all Parts of the selected Mixing.

The function is the same as the one in the Master EQ display (page 146) in the Performance Common Edit mode.

Controller Settings—[F3] Ctrl Asgn (Controller Assign)

The controllers and knobs on the front panel can be used to change and adjust a variety of parameters—in real time, and simultaneously. For example, you could use the ASSIGN 1 and 2 knobs to control effect depth, while using the Foot Controller to control modulation. These control assignments are called “Controller Assign.” You can set different Control Set assignments for each Mixing. The function is same as the one on the Controller Assign display (page 147) in the Performance Common Edit mode.

Audio Input Part Settings—[F4] Audio In

You can set parameters related to audio input from the A/D INPUT connector and the mLAN connector.

The mLAN Input is available only for the MOTIF XS8. This is available for MOTIF XS6/7 only when an optional mLAN16E2 has been installed.

[SF1] Output

From this display you can set the Send level of the Audio Input Part signal sent to the Reverb/Chorus effect and the output jack assignment for the Audio Input Part.

The function of this display is the same as the one in the Output display (page 147) in the Performance Common Edit mode.

[SF2] Connect

Determines the effect routing for Insertion Effects A and B. The setting changes are shown on the diagram in the display, giving you a clear picture of how the signal is routed. The function of this display is the same as the one in the Insertion Effect Connection display (page 148) in the Performance Common Edit mode.

[SF3] Ins A (Insertion Effect A) [SF4] Ins B (Insertion Effect B)

From this display, you can also set the type and its parameters of the Insertion Effect.

The function of this display is the same as the one in the Insertion Effect A/Insertion Effect B display (page 149) in the Performance Common Edit mode.

Effect Settings—[F5] Effect

From the following displays, you can set the Effect connection and values of other parameters. For details about the Effect structure in the Mixing mode, see page 70.

[SF1] Connect

From this display, you can set the Return level of the Reverb/Chorus effect, Effect Pan, and Chorus to Send Level.

The function of this display is the same as the one in the Connection display (page 149) in the Performance Common Edit mode.

[SF2] Ins Switch (Insertion Effect Switch)

In this display, you can select which Parts (from Mixing Parts 1 – 16 and the Audio Input Part) will be assigned to the eight Insertion Effects.

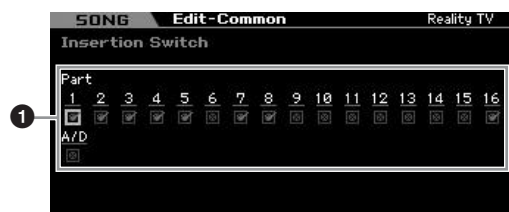

1 Part 1 – 16, A/D

Determines the Parts available for the Insertion Effect. When this switch is set to on, the Insertion Effect of the Voice assigned to the Part is enabled. Make sure that this parameter is set to on for any Parts/Voices to which you need to apply Insertion Effects.

The MOTIF XS features eight Insertion effect systems, letting you set this parameter to on for up to eight Parts. If eight Parts are already turned on, the parameter cannot be turned on for additional Parts. In this case, the switch for another Part must be turned off before you can turn the switch for the desired Part on.

NOTE For the Audio Input Part, the Insertion Effect type/parameter can be set on the Insertion A/B display (page 234) in the Mixing Common Edit mode. For Parts 1 – 16, the Insertion Effect type/parameter settings cannot be set in the Mixing Edit mode because their settings are included in the Voice assigned to each Part. If you wish to edit the Insertion Effect settings for each Part, enter the Mixing Voice Edit mode, then edit the Effect settings for the Voice.

[SF3] Reverb

[SF4] Chorus

From the Type column on these displays, you can select the Reverb/Chorus type. From the Preset column, you can select one of the templates that call up the pre-programmed settings of various parameters of the selected Reverb/Chorus type. From these displays, you can also set each parameter of the selected Effect type individually and manually. The function of these displays is the same as those of the Reverb display and Chorus display (page 150) in the Performance Common Edit mode.

Part Edit parameters

[SONG]/[PATTERN] → [MIXING] → [EDIT] →
[1] – [16] Part selection

In the Part Edit mode, you can edit the parameters of the individual Parts such as Voice, Arpeggio, EG and EQ settings.

Selected Part display/Four-Part display

Just as with the Performance Part Edit mode, you can use two types of display in the Mixing Part Edit mode. One type of display lets you edit parameters for the currently selected Part and the other type of display lets you view parameters for four Parts. You can switch between these two types by pressing the [SF5] button. Note that the display for four Parts is not available for the [F2] ARP Main and the [F3] ARP Other displays.

Selecting a Part to be edited

Press one of the [1] – [16] buttons to select a Part to be edited.

NOTE For details about useful functions such as Mute and Solo, see page 233.

Part Basic Settings—[F1] Voice

[SF1] Voice

This display lets you specify the MIDI receive channel for the current Part as well as the Voice. The other parameters except for Receive Channel (1) are the same as those in the Voice display (page 151) in the Performance Part Edit mode.



1 Receive Channel

Determines the MIDI receive channel for the selected Part. Since MIDI data may be coming from many channels at once, you should set this to match the particular channel over which the desired controlling data is being sent

Settings: 01 – 16, off

[SF2] Output

From this display, you can set the Reverb/Chorus depth and the Output jack assignment for each Part. The function of this display is the same as the one in the Output display (page 152) in the Performance Part Edit mode.

[SF3] Other

From this display, you can set parameters related to pitch bend and velocity. The function of this display is the same as the one in the Other display (page 153) in the Performance Part Edit mode.

Arpeggio Basic Settings—[F2] ARP Main (Arpeggio Main)

This display determines the basic settings of the Arpeggio. The settings of parameters shown at the bottom of the display can be registered to the [SF1] – [SF5] buttons. The function is the same as the one in the Arpeggio Main display (page 154) in the Performance Part Edit mode.

Changing rhythmic feel of the Arpeggio—[F3] ARP Other (Arpeggio Other)

By changing the timing and velocity of the notes, you can change the rhythmic “feel” of the Arpeggio playback. The function of this display is the same as the one in the Arpeggio Other display (page 156) in the Performance Part Edit mode.

EG Settings—[F4] EG (Envelope Generator)

These settings let you control the sound transition from the moment a key is pressed to the moment at which it is released. You can also adjust the tone brilliance by setting the Cutoff Frequency and Resonance. The function of this display is the same as the one in the EG display page 157) in the Performance Part Edit mode.

Voice mode

Performance mode

Sampling mode 1

Song mode

Pattern mode

Mixing mode

Sampling mode 2

Master mode

Utility mode

File mode

Reference

Equalizer (EQ) Settings—[F5] EQ (Equalizer)

You can apply 3-band parametric EQ to each Part to adjust the sound.

The function is the same as the one in the EQ display (page 158) in the Performance Part Edit mode.

MIDI Receive Settings—[F6] RcvSwitch (Receive Switch)

From this display you can set how each individual Part responds to various MIDI data, such as Control Change and Program Change messages. When the relevant parameter is set to “on,” the corresponding Part responds to the appropriate MIDI data.

The function is the same as the one in the Receive Switch display (page 158) in the Performance Part Edit mode. In addition to the parameters which can be set in the Performance Part Edit mode, the Program Change and Bank Select can be set in this display of the Mixing mode.

Mixing Job—Convenient functions

The Mixing Job mode features some convenient data organization and initialization tools, for use when creating Performances and archiving them. To enter the Mixing Job mode, press the [JOB] button in the Mixing mode. Press the [EXIT] button to return to the Mixing Play mode.

Mixing Job Procedure

- 1 In the Mixing mode or Mixing Edit mode, press the [JOB] button to enter the Mixing Job mode.
- 2 Call up the desired Mixing Job menu by pressing the appropriate button ([F1] – [F6]).
- 3 Set the parameters for executing the Job.
- 4 Press the [ENTER] button. (The display prompts you for confirmation.)
To cancel the Job, press the [DEC/NO] button.
- 5 Press the [INC/YES] button to execute the Job.
After the Job has been completed, a “Completed” message appears and operation returns to the original display.
- 6 Press the [MIXING] button to return to the Mixing Play mode.

CAUTION

Even if you execute the Job, selecting a different Song/Pattern or turning the power off without storing will erase the Mixing data. Make sure to store the Song/Pattern data (including the Mixing) to internal memory by pressing the [STORE] button before selecting a different Song/Pattern or turning the power off.

Initializing the Mixing—[F1] Init

This function lets you reset (initialize) all Mixing parameters to their default settings. It also allows you to selectively initialize certain parameters, such as Common settings, settings for each Part, and so on.

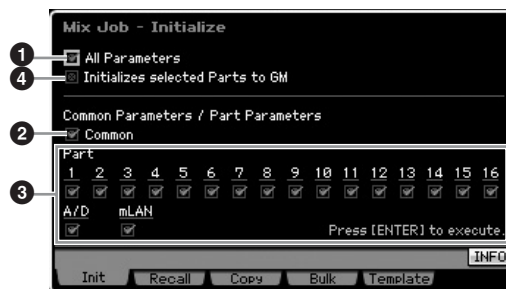

1 All Parameters

All settings for the selected Mixing are initialized. When this is set to on, the Common parameters (2) and Part parameters (3) cannot be set.

2 Common Parameters

Common parameter settings for the selected Mixing are initialized.

NOTE The Insertion Effect Switch is a Part parameter. Therefore, checkmark the desired boxes of Parts 1 – 16 (described below) if you wish to initialize the Insertion Effect Switch parameter settings.

3 Part Parameters

Part 1 – 16

Mixing Part Edit settings (page 235) for Parts which are turned on are initialized.

A/D (A/D Input)

This Part is input from the external audio equipment connected to the A/D INPUT jack. Parameter settings for the A/D input Part (page 234) of Common Edit are initialized.

mLAN

This Part is input from the external audio equipment connected to the mLAN jack. When this is checkmarked, parameter settings for the mLAN Part (page 234) of Common Edit are initialized.

NOTE The “mL” setting is available only for the MOTIF XS8. This is available for MOTIF XS6/7 only when an optional mLAN16E2 has been installed.

4 Initialize selected Parts to GM

When this box is checked, executing the Job resets the selected Parts to standard GM tone generator settings. When the checkbox of All Parameters (1) is marked, all parameters will be reset to the GM settings. When the checkbox of All Parameters (1) is not marked, checked parameters (from Common, 1 – 16, AD and mLAN) will be reset to the GM settings.

[F2] Recall

If you are editing a Song/Pattern Mixing program and select a different Song/Pattern without storing the one you're editing, all the edits you've made will be erased. If this happens, you can use Recall function to restore the Mixing with your latest edits intact.

Copying parameter settings from another Mixing, Voice and Performance—[F3] Copy**Copying parameter settings from another Mixing (Copy Part)—[SF1] Part**

This convenient operation lets you copy Common Edit and Part Edit settings of a certain Mixing to the currently edited Mixing. This is useful if you are creating a Mixing and wish to use some parameter settings from another Mixing.

**Source setup****1 In the Song mode: Song number
In the Pattern mode: Pattern number**

Determines the source Mixing by selecting the Song number (Pattern number while in the Pattern mode). The name of the selected Song or Pattern is indicated at right. To select the current Mixing as source, enter the checkmark in the Current Mix checkbox.

2 Data type

Determines the source data type.

Settings: Common, Part1 – 16, A/D, mLAN

NOTE The Insertion Effect Switch is a Part parameter. Therefore, the Insertion Effect Switch parameter settings are copied only when selecting one of the Parts 1 – 16.

Destination setup**3 Currently edited Part**

Determines the destination Part of the currently edited Mixing.

Settings: Common, Part1 – 16, A/D, mLAN

Copying the Voice Common Edit settings to the Mixing (Copy Voice)—[SF2] Voice

This Job lets you copy the Common Edit effect settings of the Voice assigned to the specified Part to the current Mixing. This would come in handy when a certain Voice has effect settings that you want to use in your Mixing program.

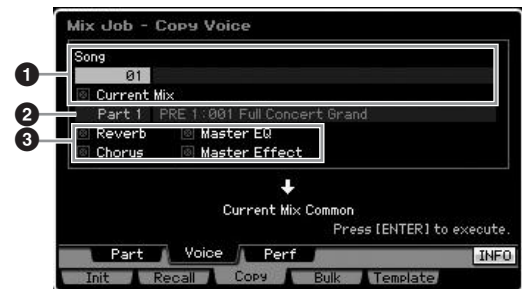
**1 In the Song mode: Song number
In the Pattern mode: Pattern number, Section**

Determines the Bank and the Mixing program number to be copied. The name of the selected Song or Pattern is indicated at right. If you wish to select the current Mixing as source, enter the checkmark in the Current Mix check box.

2 Part number

Selects the Part (01 – 16) to which the source Voice is assigned. The name of the selected Song or Pattern is indicated at right.

3 Data type

Determines the source data type. By checking the appropriate box, the corresponding data settings are copied from the source Voice to the destination Mixing. The other parameter settings are not copied from the Voice to the current Mixing.

Copying the Performance Edit settings to the Mixing Edit (Copy Performance)—[SF3] Perf

This Job lets you copy the settings of the Performance Edit to the current Mixing. This would come in handy when a certain Performance has settings that you want to use in your Mixing program.



1 Bank, Performance number

Determines the Bank and the Performance number to be copied. The name of the selected Performance is shown at right.

2 Data type

Determines whether or not the settings of the listed parameters are copied. By checking the box of the Insertion Effect Switch, the Insertion Effect Switch settings are copied from Performance Parts 1 – 4 to the Mixing Parts set as Destination Parts (3). If the boxes of the other parameters are checkmarked, the settings of the checked parameters are copied from the Performance Common mode to the Mixing Common mode. All other parameter settings in the Common Edit and Part Edit modes will be copied from the Performance to the current Mixing.

3 Destination Parts

Determines the four parts of the current Mixing as destination.

Settings: 1 – 4, 5 – 8, 9 – 12, 13 – 16

Transmitting the Mixing Settings to an external MIDI device (Bulk Dump)—[F4] Bulk

This function lets you send specified parameter settings for the currently edited Mixing to a computer or another MIDI device for data archiving. To execute the Bulk Dump, press the [ENTER] button.

NOTE The Bulk Dump data includes only the MIDI messages and does not include the Waveforms.

NOTE In order to execute Bulk Dump, you'll need to set the correct MIDI Device Number. For details, see page 268.

Mixing Template—[F5] Template

Storing/Recalling the Mixing to/from the Template—[SF1] Mix

This Job lets you store your edited Mixing program to User memory as a Mixing Template and recall it. 32 Mixing Templates can be stored. 32 Mixing Templates can be used both in the Song mode and the Pattern mode.



1 Template

Determines the Mixing Template to be stored or recalled. Pressing the [SF5] button to store the current Mixing while pressing the [SF4] button to recall the Mixing Template stored to User Memory.

Settings: 01 – 32

2 Mixing Template name

Enters the name of the Mixing Template. For detailed instructions on naming, see page 82.

Copying the Performance Edit settings to a Mixing (Template Performance)—[SF2] Perf

This Job lets you copy the settings of the Performance Edit settings to the current Mixing. This would come in handy when a certain Performance has settings that you want to use in your Mixing program.



1 Bank, Performance number

Determines the Bank (USR 1 – 3) and the Performance number (001 – 128) to be copied. The name of the selected Performance is indicated at right.

NOTE The difference between the Copy Performance and the Template Performance is the MIDI receive channel set via the Job execution. All the Mixing parts set via the Copy Performance have the same MIDI channel whereas all the Mixing parts set via the Template Performance have different MIDI channels. This means that a Mixing setup created via the Template Performance can be used as a multi-timbral tone generator.

2 Destination Parts

Determines the four parts of the current Mixing as destination.

Settings: 1 – 4, 5 – 8, 9 – 12, 13 – 16

Mixing Voice Edit

Mixing Voices are Normal Voices that have been specially edited for and saved to specific Song/Pattern Mixings. Up to 16 Mixing Voices can be stored to each Song/Pattern Mixing. In this mode, you can edit the Voices assigned to Mixing Parts 1 – 16 respectively and store them as Mixing Voices. Mixing Voice Jobs are also available, providing convenient tools for organizing your created Mixing Voices.

Keep in mind that Drum Voices cannot be edited in the Mixing Voice Edit mode.

Press the [F6] Vce Edit button to enter the Mixing Voice Edit mode.

NOTE For more information about Mixing Voices, see page 230.

Editing Mixing Voices

- 1 Press the [MIXING] button in the Song mode or Pattern mode to call up the Mixing Play display (page 231) in the Mixing mode.

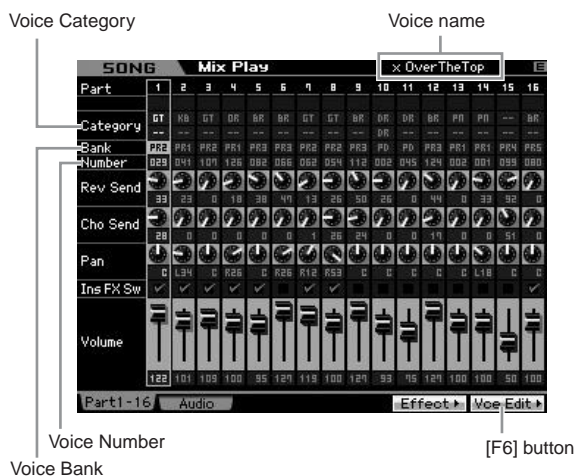

- 2 Move the cursor to the Part to which the desired Voice is assigned.

The name of the selected Voice is shown at right top of the display. You can also select the Voice here. To do this, press the [PROGRAM] button (the lamp lights), then select the desired Voice by using the Bank buttons [PRE 1] – [GM], Group buttons [A] – [H] and the Number buttons [1] – [16].

NOTE Keep in mind that Drum Voices cannot be edited in the Mixing Voice Edit mode.

- 3 Press the [F6] Vce Edit button to enter the Mixing Voice Edit mode.

- 4 Call up the Common Edit display or Element Edit display.

To call up the Common Edit display, press the [COMMON EDIT] button. To edit more global parameters related to the overall Voice and how it's processed, such as Arpeggio, Controller, and Effects, call up the Common Edit display.

To call up the Element Edit display, press one of the Number buttons [1] – [8] to select the Element to be edited. If you wish to edit the sounds that make up a

Voice and the basic parameters that determine the sound, such as Oscillator, Pitch, Filter, Amplitude, and EG (Envelope Generator), call up the Element Edit display.

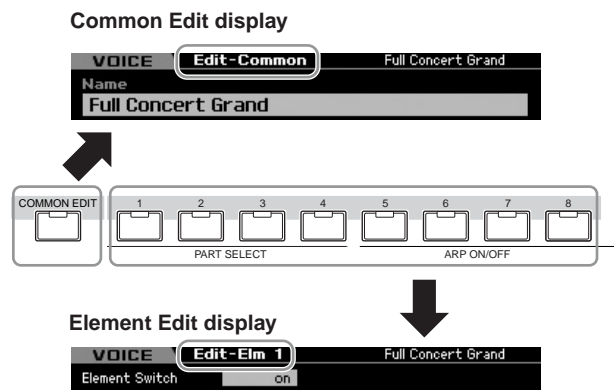

- 5 Call up the Edit display including the parameters you wish to edit by pressing the [F1] – [F6] buttons and [SF1] – [SF5] buttons.

Both Common Edit and Element Edit consist of several displays. To find a desired display, note the tab menu corresponding to the [F1] – [F5] buttons and [SF1] – [SF5] buttons.

- 6 Move the cursor to the desired parameter.

- 7 Edit the value by using the [INC/YES], [DEC/NO] buttons and the data dial.

- 8 Edit the Mixing Voice by repeating steps 4 – 7 as desired.

- 9 Enter a name for the Mixing Voice from the Name display (page 98) of the Common Edit.

For detailed instructions on naming, see page 82.

- 10 If you wish to store the edited Voice, press the [STORE] button to call up the Store window (page 233).

For detailed instructions on storing, see page 186.

- 11 Press the [EXIT] or [MIXING] button to return to the Mixing Play mode.

Useful functions in the Mixing Voice Edit mode

Switching an Element on/off

This is the same as in the Voice Element Edit mode (page 97).

Soloing an Element to be edited

This is the same as in the Voice Element Edit mode (page 97).

The [E] Indicator

This is the same as in the Voice Element Edit mode (page 97).

Compare function

This is the same as in the Voice Element Edit mode (page 97).

Mixing Voice Information—[SF6] INFO

This window indicates the information of the current Mixing Voice. You can call up this display by pressing the [SF6] INFO button in the Mixing Voice Edit mode. Keep in mind that the Information window can be called up only when the [SF6] tab menu indicates “INFO.”

Press any of the panel buttons to return to the original status.

Storing the created Mixing Voice

[MIXING] → [F6] Vce Edit → [STORE]

- 1 When the [E] indicator is shown on the display in the Mixing Voice Edit mode, press the [STORE] button.

The Mixing Voice Store window appears.

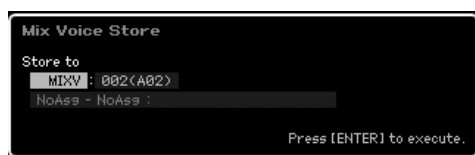

- 2 Specify the destination for storing the Mixing Voice.

Select a Mixing Voice (MIXV) number as destination by using the data dial, [INC/YES] and [DEC/NO] buttons.

You can store the Voice edited in the Mixing Voice Edit mode also as a User Normal Voice by setting the Voice Bank to “USR1,” “USR2,” and “USR3.”

- 3 Press the [ENTER] button.

The display prompts you for confirmation. To cancel the Store operation, press the [DEC/NO] button.

- 4 Press the [INC/YES] button to execute the Store operation.

After the Mixing Voice has been stored, a “Completed” message appears and operation returns to the original display.

⚠ CAUTION

When you execute the Store operation, the settings for the destination memory will be overwritten. Important data should always be backed up to a separate USB storage device or to a computer connected via network to the MOTIF XS. For detailed instructions on saving, see page 278.

Mixing Voice Job

[MIXING] → [F6] Vce Edit → [JOB]

The Mixing Voice Job mode provides convenient tools for organizing your created Mixing Voices.

Mixing Voice Job Procedure

- 1 Press the [JOB] button in the Mixing Voice Edit mode to enter the Mixing Voice Job mode.
- 2 Call up the desired Mixing Voice Job by pressing the appropriate button ([F2] – [F4]).
- 3 Set the parameters for executing the Job.

Move the cursor to the desired parameter, then set the value.
- 4 Press the [ENTER] button. (The display prompts you for confirmation.)

To cancel the Job, press the [DEC/NO] button.
- 5 Press the [INC/YES] button to execute the Job.

After the Job has been completed, a “Completed” message appears and operation returns to the original display.

⚠ CAUTION

Even if a Job operation has been completed, selecting a different Voice or turning the power off without storing will erase the Voice data. Make sure to store the Voice data to internal memory by pressing the [STORE] button before selecting a different Voice or turning the power off.

- 6 Press the [EXIT] button to return to the Mixing Voice Edit mode.

Recalling the unedited sound—[F2] Recall

If you are editing a Mixing Voice but have not stored it before switching to another Mixing Voice, the edits you have made will be cleared. If this happens, you can use the Recall function to restore the Mixing Voice with your latest edits intact.

Copying another Mixing Voice Element to the current one—[F3] Copy

This Job lets you copy the Mixing Voice stored to a specified Song/Pattern to another Song/Pattern.

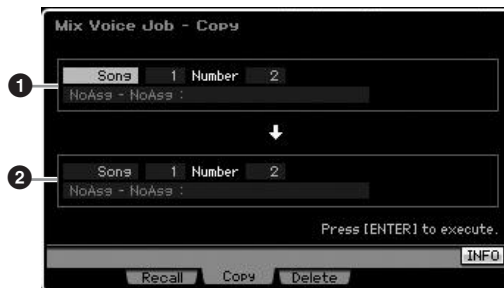

1 Source Mixing Voice

Determines the source Mixing Voice by selecting Song or Pattern (01 – 64) then specifying the number (01 – 16, all). The main category 1/main category 2 and name of the selected Mixing Voice is indicated in the lower line.

2 Destination Mixing Voice

Determines the destination Mixing Voice. Same as above.

Deleting a Mixing Voice—[F3] Delete

This Job deletes an unnecessary Mixing Voice. Note that up to 256 Mixing Voices can be stored for all Songs and Patterns. Accordingly, the Mixing Voice memory will become full and additional Voices cannot be stored if you've stored 16 different Voices for 16 different Songs. If this occurs, use this Job to delete any unused Mixing Voices.

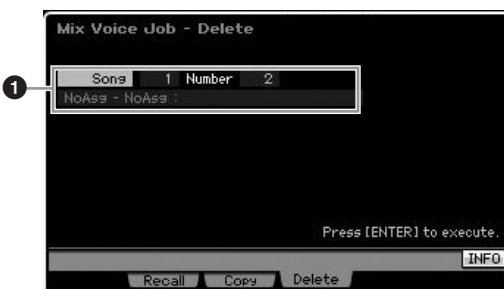

1 Mixing Voice to be deleted

Determines the Mixing Voice to be erased.

Settings:

Song/Pattern: song, pattern

Song/Pattern number: 01 – 64

Mixing Voice number: 01 – 16, all

Common Edit parameters

[MIXING] → [F6] Vce Edit → [COMMON EDIT]

This is the same as in the Normal Voice Common Edit mode. See page 98. However, some parameters having the same name as those in the Voice Common Edit mode are not available in the Mixing Voice Edit mode.

Element Edit parameters

[MIXING] → [F6] Vce Edit → Element selection from [1] – [8]

This is the same as in the Normal Voice Element Edit mode. See page 112.

Voice mode

Performance mode

Sampling mode 1

Song mode

Pattern mode

Mixing mode

Sampling mode 2

Master mode

Utility mode

File mode

Reference

Audio Recording to Song/Pattern (Sampling mode)

In addition to its use in the Voice and Performance modes, the Sampling mode can also be entered from the Song and Pattern modes. This lets you record audio (such as vocals, electric guitar, or audio from an external device), and use it directly on a Song/Pattern track as a Sample Voice. This section covers the Sampling functions when entering the Sampling mode by pressing the [INTEGRATED SAMPLING] button in the Song mode or the Pattern mode.

NOTE You can also enter the Sampling mode by pressing the [INTEGRATED SAMPLING] button in the Voice mode or the Performance mode. Keep in mind that the Sampling functions differ depending on from which mode the Sampling mode is called up, the Voice/Performance mode or the Song/Pattern mode. See page 161 for instructions on using the Sampling function in the Voice mode/Performance mode.

The Sampling mode structure

In this section, you'll learn about the structure and organization of Samples when recording audio to a Song/Pattern, as well as the relationship between Samples, Sample Voices, and Mixings.

NOTE For details about Samples, Waveforms, and Key Banks, see page 161.

Audio Recording to Song/Pattern

Because Songs and Patterns on the MOTIF XS handle only MIDI data, audio signal cannot be recorded directly to a track even by executing the Sampling operation.

Audio data you've recorded to a track via the Sampling operation will be stored as a Sample Voice to a Song/Pattern. The stored Sample Voice will automatically be assigned to the Mixing Part corresponding to the recorded track. In addition, the MIDI data for triggering the Sample Voice will be recorded to the track. During playback, the MIDI data of the track will trigger the Sample Voice. Consequently, the resulting track effectively functions as an Audio track.

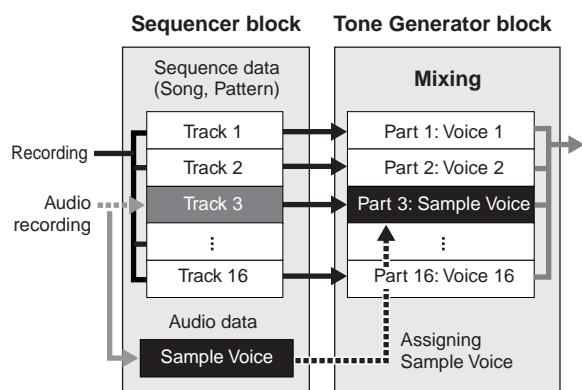

Audio data is recorded to a Sample Voice which is to be assigned to a Song/Pattern, and note on/off events for triggering the recorded audio signal are recorded to Track 3.

- MIDI data
- Audio data
- MIDI data for triggering the Sample Voice

About Slice

The Slice function is an important operation of Sampling in the Song/Pattern modes, since it allows you to easily divide the audio into smaller parts which can then be triggered and controlled in many musically useful ways.

Slice actually performs two operations on a Sample simultaneously.

First, Slice creates a Sample Voice by dividing the original Sample into smaller Samples of a specific note value (such as 8th notes or 16th notes) depending on the rhythm, then assigns the Samples to Key Banks. The created Sample Voice is automatically assigned to the Mixing part corresponding to the recorded Track.

Second, the Slice function creates sequence data consisting of note events to which the sliced Samples are assigned in order. The note events in the created sequence data are arranged according to the Key Bank assignment chromatically, with each gate time of the note events matching the original Sample's rhythm (e.g., 8th notes or 16th notes).

The end result is that you can hear the same sound from both of the original Sample and the sliced Sample. If this were the only result, Slice wouldn't be of much use. However, once a Sample is 'sliced' in this way, it can be changed and played back in many convenient and creative ways.

Firstly, you can change the tempo of the Sample in real time. While the MOTIF XS features a Time Stretch Job for changing the tempo of the Sample, this Job cannot be used in real time during your keyboard performance because it takes some time to convert the Sample data. On the other hand, by using sliced Samples, you can change the speed of Sample playback by changing the tempo value of the Song/Pattern in real time.

The second benefit is that you can quickly and easily create variations of the original Sample by changing the playback of the sliced Samples.

For example, you could change the velocities and timing points of the note events to which the sliced Samples are assigned. This lets you create accents in the playback or change the rhythm of the Sample to a swing feel, for example. Furthermore, you can change the actual order of the Sample slices (as note events), making it exceptionally easy to come up with new and unusual sound variations.

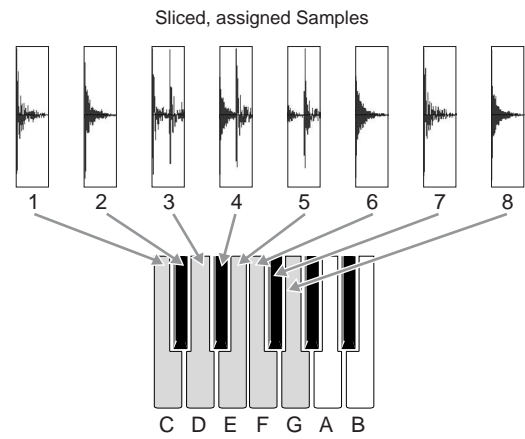

Example 1

 Phrase order to be played → 1, 2, 3, 4, 5, 6, 7, 8

Example 2

 → 1, 3, 1, 4, 5, 8, 3, 6

You can produce melodic or rhythmic variations simply by changing the sequence of the note events.

Voice mode
 Performance mode
 Sampling mode 1
 Song mode
 Pattern mode
 Mixing mode
 Sampling mode 2
 Master mode
 Utility mode
 File mode
Reference

Sampling Main display

The Sampling Main display, the entrance of the Sampling mode, is called up when entering the Sampling mode from the current mode. Pressing the [INTEGRATED SAMPLING] button in the Song mode or Pattern mode calls up the Sampling mode dedicated to creation of Sample Voices assigned to a Song/Pattern track. Press the [EXIT] button to return to the original mode, Song or Pattern.

NOTE This section covers the Sampling mode called up from the Song/Pattern mode. See page 162 for instructions on using the Sampling function in the Voice mode/Performance mode.

Selecting a Waveform and Key Bank— [INTEGRATED SAMPLING]

The Sampling Main display lets you select the Waveform and its Key Bank and hear the sound of the Sample assigned to the selected Key Bank.



The parameters ① – ⑦ and the [SF1], [SF5], [SF6], and [F6] buttons are same as in the Sampling mode called up from the Voice mode/Performance mode. See page 162.

⑧ Track (Indication only)

Indicates the track number of the currently selected Song/Pattern.

⑨ Measure (Indication only)

Indicates the measure number of the currently selected Song/Pattern.

NOTE Keep in mind that you can assign the User Voices created in the Sampling mode entered from the Voice/Performance mode to Mixing parts of the Song/Pattern. You can also assign the Waveforms created in the Sampling mode entered from the Song/Pattern mode to Elements of the Voice in the Voice Edit mode.

Sampling Record

[INTEGRATED SAMPLING] → [F6] Rec

The Sampling Record function lets you record sounds—such as vocals from a connected microphone, the signal from an electric guitar, or audio from an external CD or MP3 player—and store the audio as a Sample Voice, which is used in the tracks of a Song/Pattern. See page 39 for instructions on using the Sampling function in the Song mode/Pattern mode.

NOTE This section covers the Sampling mode called up from the Song/Pattern mode. See page 163 for instructions on using the Sampling function in the Voice mode/Performance mode.

Important

In order to use the Sampling function, DIMM modules must be installed to the instrument. For details on installing DIMMs, see page 295. The recorded (edited) Sample data residing temporarily in DIMM is lost when the power is turned off. Make sure to prepare the USB storage device or a computer connected to the same network as the MOTIF XS before using the Sampling function.

Sampling Setup—[F6] Rec

From this display you can set up various parameters for Sampling. Press the [F6] button from the Sampling main display to call up this display. Press the [EXIT] button to go back to the Sampling Main display.

After setting up, press the [F6] Standby button to call up the Record Standby display (page 245).



1 Recording Type

Determines the recording method. The Sampling procedure and created Sample data differ depending on the setting here.

Settings: slice+seq, sample, sample+note

slice+seq

The recorded Sample is automatically divided into “slices” to be stored as a Sample Voice then these slices are assigned to successive notes on the keyboard. These notes are then automatically arranged in MIDI sequence data (to the specified track) for playback. For example, if a 1-measure drum pattern is sampled and a 8th note size is specified, the recorded measure will be sliced into (approximately) eight Samples which will be assigned to the eight consecutive notes on the keyboard.

sample

The recorded audio signal is just stored as a Sample Voice. This setting produces no MIDI sequence data resulting that the recorded Sample is not played back even when playing back the Song/Pattern.

sample+note

In addition to sample data, the appropriate note data for playing the sample is created and recorded to the specified Track (8).

2 Input Source

Determines the input connector via which the signal to be sampled will be received. Refer to the description of the same-named parameter on page 164.

3 Stereo/Mono

Determines whether new Samples will be recorded as stereo or mono Samples. Refer to the description of the same-named parameter on page 164.

4 Record Next

This is available when the Recording Type in the Setup display is set to “sample.” Refer to the description of the same-named parameter on page 164.

5 Frequency

Specifies the sampling frequency. Refer to the description of the same-named parameter on page 165.

6 Waveform

Determines the Waveform number as destination.

Settings: 0001 – 1024

CAUTION

This operation overwrites any data previously existing at the destination Waveform number. Important data should always be saved to a USB storage device connected to the USB TO DEVICE terminal or to a computer connected to the same network as the MOTIF XS (page 278).

7 Keybank

Determines the note number of the Key Bank as destination. The value set here can be changed in the Sampling Edit mode (page 250). Keep in mind that this parameter cannot be set when the Recording Type is set to “slice+seq.”

Settings: C -2 – G8

NOTE When the Recording Type is set to “slice+seq,” sliced Samples will be assigned to the notes in order chromatically, starting with C1 (MOTIF XS6), E0 (MOTIF XS7) and A -1 (MOTIF XS8) respectively.

NOTE You can also set the Key directly from the keyboard, by holding down the [SF6] KBD button and pressing the desired key. For details, see page 82.

8 Track

Determines the track number to which the recorded Sample is assigned. After recording is finished, the created Sample Voice is to be assigned to the Mixing part corresponding to the Track specified here. When the Recording Type is set to “slice+seq” or “sample+note,”

the note data for playing back the Sample Voice will be created in the Track specified here.

Settings: 01 – 16

9 Part

This parameter is not available when entering the Sampling mode from the Song mode/Pattern mode.

10 Voice

This parameter is not available when entering the Sampling mode from the Song mode/Pattern mode.

11 Drum Key

This parameter is not available when entering the Sampling mode from the Song mode/Pattern mode.

12 Recordable Time (Indication only)

Indicates the available Sampling time using the available memory. The time indicated here is calculated assuming a mono signal with a sampling frequency of 44.1 kHz. The amount of memory space currently being used is shown in the display as a blue line.

13 [F6] Standby

Pressing this button to call up the Sampling Standby display.

This display is used for executing the Sampling. For details, see page 245.

Sampling Standby and Start—[F6] Standby

This display is used for starting Sampling. Press the [F6] button from the Setup display to call up this display. Press the [EXIT] button to go back to the Setup display.

After setting the parameters as necessary, press the [F5] Start button to start the Sampling procedure. Note that the actual Sampling start timing differs depending on the Trigger Mode setting.

When the Trigger Mode (10) is set to “level”:

Even if you press the [F5] Start button, the WAITING indication just appears on the display and actual Sampling does not start. When audio signal exceeding the specified Trigger Level (9) is input, the RECORDING indication replaces the WAITING indication and Sampling starts.

When the Trigger Mode (10) is set to “meas”:

Even if you press the [F5] Start button, the WAITING indication just appears on the display and actual Sampling does not start. Set the Measure (5) at which the Song/Pattern playback starts, input a measure number larger than the Measure value (5) to the Punch In/Out parameter (11), then press the [▶] (Play) button to start playback. After starting playback, actual sampling will begin at the

specified Punch In measure, and end at the specified Punch Out measure.

When the Trigger Mode (10) is set to “manual”:

Actual Sampling (Recording) starts when you press the [F5] Start button.

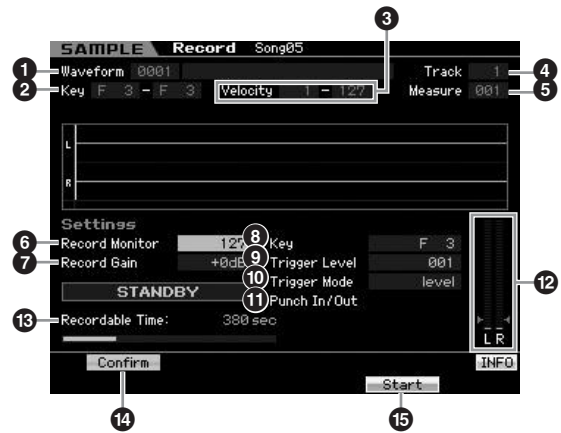

1 Waveform (Indication only)

Indicates the number and name of the selected Waveform.

2 Key Range (Indication only)

Indicates the key range of the currently selected Key Bank.

3 Velocity (Velocity Range) (Indication only)

Indicates the velocity range of the currently selected Key Bank.

4 Track (Indication only)

Indicates the track number to which the recorded Sample is assigned.

5 Measure

Indicates the measure number of the currently selected Song/Pattern. You can change the measure number by using the [◀]/[▶] (Reverse/Fast Forward) buttons.

Settings:

When entering the Sampling mode from the Song mode: 001 – 999
When entering the Sampling mode from the Pattern mode: 001 – 256

6 Record Monitor

Determines the output level of the monitor for the input signal. This monitor signal is output from the PHONES jack or the OUTPUT R and L/MONO jacks.

Settings: 0 – 127

7 Record Gain

This parameter is available only when the Input Source (page 244) is set to “resample.” Determines the recording gain when resampling. The higher the value, the greater the volume of the resampled sound. Before executing the Sampling (Recording) operation, you can set the appropriate gain by checking the volume via the Level Meter (12) while playing the keyboard.

Settings: -12dB, -6dB, +0dB, +6dB, +12dB

Reference

- Voice mode
- Performance mode
- Sampling mode 1
- Song mode
- Pattern mode
- Mixing mode
- Sampling mode 2
- Master mode
- Utility mode
- File mode

8 Key

Indicates the Key Bank (page 244) set in the Sampling Record Setup display. The Key Bank can be changed both here and in Sampling Edit (page 250) after the Recording is finished.

Settings: C -2 – G8

[NOTE] You can also set the Key directly from the keyboard, by holding down the [SF6] KBD button and pressing the desired key. For details, see page 82.

9 Trigger Level

When the Trigger Mode (10) is set to “level,” you’ll also need to set the Trigger Level. Sampling (Recording) will begin as soon as an input signal exceeding the specified trigger level is received. The level set here will be indicated as a red triangle in the level meter. For best results, set this as low as possible to capture the entire signal, but not so low as to record unwanted noise.

Settings: 000 – 127

10 Trigger Mode

Determines the method by which Sampling will be triggered.

Settings: level, meas, manual

level

Sampling starts as soon as an input signal exceeding the specified trigger level (9) is received.

meas (measure)

This should be set together with the Punch In/Out measure (11). After the [F6] Start button is pressed, actual sampling will begin at the specified Punch In measure, and end at the specified Punch Out measure. Sampling will also stop when the Song/Pattern is stopped by pressing the [■] (Stop) button. This method lets you recording the audio signal while monitoring the sound of other Tracks.

manual

Sampling starts soon after you press the [F6] REC button. This setting lets you start Sampling at the desired timing regardless of the input level from audio source.

11 Punch In/Out

This parameter is available only when the Trigger Mode (10) is set to “meas.” The Punch In value determines the measure number at which sampling starts automatically while the Punch Out value determines the measure number at which sampling stops automatically.

Settings: 001 – 999 (Song mode), 001 – 256 (Pattern mode)

12 Level Meter

13 Recordable Time (Indication only)

Refer to the description of the same-named parameter on page 165.

14 [SF1] Confirm

This is available when Recording Type in the Setup display (page 244) is set to “sample” or “sample+note.”

15 [F5] Start

Press this button to start Sampling.

Sampling RECORDING display

During Sampling, a graphic representation of the recorded audio appears in the display.

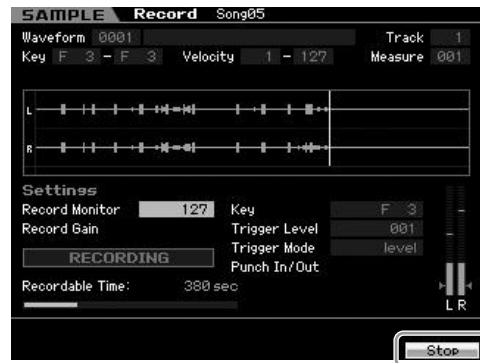

[F6] Stop

Press this button to stop Sampling (Recording).

In each of the following cases, the “FINISHED” display appears after Sampling is finished.

- When Recording Type (page 244) is set to “sample” or “sample+note” and [SF1] Confirm is turned on
- When Recording Type (page 244) to “slice+seq”

From the FINISHED display, you can listen to the just-recorded Sample by pressing the [SF1] button. See below for details.

Sampling FINISHED display

When [F2] Confirm is turned on before the Sampling starts, the FINISHED display below appears as soon as the Sampling is finished. From this display, you can hear and confirm the Sample by pressing the [SF1] Audition button. If you are satisfied with the sound, press the [ENTER] button to fix the Sampling result as Sample data. If you are not satisfied with the Sampling result, press the [EXIT] button then try again.

When [F2] Confirm is turned off before Sampling starts, the Sampling operation will automatically fix the Sample data and return to the Setup display (page 244).

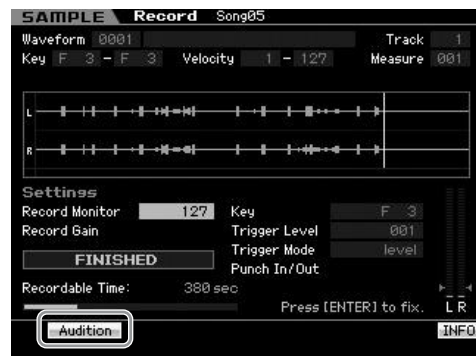

[SF1] Audition

You can hear the recorded Sample by holding this button.

This lets you hear precisely how the Sample is played back.

NOTE When Recording Type (page 244) is set to “sample” or “sample+note” and [SF1] Confirm is turned off, stopping Recording will automatically fix the just-recorded Sample data and the instrument will return to the Setup display (page 244). Please note that the instrument returns to the STANDBY display as soon as Sampling is finished if Record Next is turned on in the Setup display before the Sampling operation.

NOTE When Recording Type (page 244) is set to “slice+seq,” stopping Recording calls up the Record Trim display (page 247).

Trimming the Sample—Record Trim display

When Recording Type (page 244) is set to “slice+seq,” stopping Recording (and subsequently fixing the sampled data when Confirm is turned on) calls up this display. From this display, you can delete unwanted portions of the Sample, located ahead of the Start point and located after the End point). Press the [EXIT] button to go back to the Setup display.

The procedure in the Record Trim display is as follows.

1 Set the Start Point to the point at which the actual sound of the recorded Sample starts.

You can use the [SF1] Audition button to listen to the Sample and [SF4] Zoom Out/[SF5] Zoom In button to view the wave of the Sample.

NOTE By pressing the [SF6] NUM button, you can use the [SF1] – [SF5] and [F1] – [F6] buttons as number buttons. Pressing the [EXIT] button return their buttons to the original status. For details, see page 81.

2 Set the Tempo (9), Meter (10), and Measure (11) for Sample playback.

The End Point (8) will be automatically changed so that the length between the Start Point and the End Point matches the settings here.

3 Set the Loop Point (7) as necessary.

When the menu indication of the [SF2] button is “LP=ST,” the Start (Start Point) and the Loop (Loop Start Point) will share the same address, meaning that both of them will be changed simultaneously, even if just one of them is changed. Pressing the [SF2] button in this condition changes the menu from “LP=ST” to “LP≠ST.” When the menu indication here is “LP≠ST,” the Start (Start Point) and the Loop (Loop Start Point) can be changed independently. When pressing the [SF2] button in this condition, the address value of the Start will be copied to the one of the Loop, with the result that both of them share the same address value. The menu indication of the [SF2] button also changes from “LP≠ST” to “LP=ST.”

4 Press the [ENTER] button. (The display prompts you for confirmation.)

If you wish to cancel the operation, press the [DEC/NO] button.

5 Press the [INC/YES] button to execute the Extract operation to delete unwanted portions of the Sample.

6 Press the [F6] Slice button to call up the Slice display.

CAUTION

The data deleted via the Extract operation cannot be recovered. If you have accidentally deleted a necessary portion of the Sample, press the [EXIT] button to return to the Setup display, then execute the Sampling operation again.



Parameters 1 – 5 are the same as the ones in the Standby display (page 245).

6 Start Point

Determines the Start point for Sample playback. The part at the left side of this point will not be played back.

Settings: 0000000 – End point

7 Loop Point

Determines the Loop point at which the loop playback starts. When the Play mode is set to “loop,” the Sample is played back between this Loop point and the End point (6).

Settings: 0000000 – End point

8 End Point

Determines the End point for Sample playback. The part at the right side of this point will not be played back. The End Point will be automatically determined so that the length between the Start Point and the End Point matches the settings of the Tempo (9), Meter (10), and Measure (11).

Settings: 0000000 – (depending on the Sample's length)

9 Tempo

Determines the Tempo of Sample playback. Setting the Tempo changes the End Point (8) so that the length between the Start Point and the End Point matches the settings of the Meter and Measure.

Settings: 5.0 – 300.0

10 Meter

Determines the meter (time signature) of Sample playback. Setting the Meter changes the End Point (8) so that the length between the Start Point and the End Point matches the settings of the Tempo and Measure.

Settings: 1/16 – 16/16, 1/8 – 16/8, 1/4 – 8/4

11 Measure

Determines the amount of measures for Sample playback. Setting the Measure changes the End Point (8) so that the length between the Start Point and the End Point matches the settings of the Tempo and Meter.

Settings:

Measure: 000 – 032

Beat: 00 – 15 (Varies depending on the Meter setting.)

12 Recordable Time (Indication only)

Indicates the available Sampling time using the available memory. The time indicated here is calculated assuming a mono signal with a sampling frequency of 44.1 kHz. The amount of memory space currently being used is shown in the display as a blue line.

13 [SF1] Audition

You can hear the selected Sample by holding this button. This lets you hear precisely how the Sample is played back.

14 [SF2] LP=ST

When the menu indication here is “LP=ST,” the Start (Start Point) and the Loop (Loop Start Point) will share the same address, meaning that both of them will be changed simultaneously, even if just one of them is changed. Pressing the [SF2] button in this condition changes the menu from “LP=ST” to “LP≠ST.” When the menu indication here is “LP≠ST,” the Start (Start Point) and the Loop (Loop Start Point) can be changed independently. When pressing the [SF2] button in this condition, the address value of the Start will be copied to the one of the Loop, with the result that both of them share the same address value. The menu indication also changes from “LP≠ST” to “LP=ST.”

15 [SF3] Display

Pressing the [SF3] button adjusts the zoom level so that the entire wave, including the Start Point and End Point, is shown on the display.

16 [SF4] Zoom Out**17 [SF5] Zoom In**

Press these buttons to zoom in and out of the wave indication of the Sample in the display.

18 [F6] Slice

Pressing this button calls up the Record Slice display.

19 [SF6] NUM

When “NUM” is shown in the tab, you can use the [F1] – [F6] buttons and the [SF1] – [SF5] buttons as numeric keys by pressing the [SF6] button.

Slicing the Sample—Record Slice display

When the Recording Type (page 244) is set to “slice+seq,” you can call up this display by pressing the [F6] Slice button in the Record Slice display. From this display, you can divide the recorded Sample into several slices according to the rhythm of the original Sample. By executing the Slice operation, the recorded Sample is first divided into “slices” to be stored as a Sample Voice, then these slices are assigned to successive notes on the keyboard. These notes are then automatically arranged in MIDI sequence data (to the specified track) for playback.

The procedure on the Record Slice display is as follows.

- 1 Select a Slice Type (6).**
- 2 Set the amount of Measures (7) for Sample playback.**
- 3 Set the Meter (8), Sub Divide (9), and Sensitivity (10).**
- 4 Press the [SF4] Apply button to execute Slice.**
The Apply indication color will change from green to gray. At this time, the Sample has been modified temporarily and is not fixed as data.
- 5 Confirm the result of the Slice operation.**
Press the [SF1] Audition button to hear the modified Sample. If you are satisfied with the result, go on to the step 6. If you are not satisfied with the results and want to try again, press the [SF4] Apply button again to abort the Slice operation and return the Sample to the original status. The Apply indication color returns to green. In this case, attempt the operation again from step 1.
- 6 Press the [ENTER] button to fix the Slice result as Sample data.**
The instrument returns to the Setup display.
- 7 Press the [EXIT] button a number of times to go back to the Song mode or Pattern mode.**
Listen to the recorded track having the sliced Sample.
- 8 Before turning the power off, store the Song or Pattern data to internal memory then save the created Waveform to a USB storage device or to a computer connected via network to the MOTIF XS.**

For information about how to store and save, see pages 186 and 278.

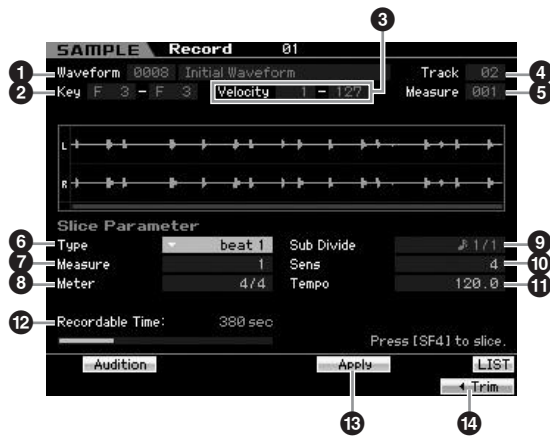

Parameters ① – ⑤ are the same as the ones in the Standby display (page 245).

⑥ Type

Select the type that best suits the original phrase. Specifies how the Sample is sliced, and to some extent determines the resulting sound quality.

Settings: beat1 – 3, phrase1 – 4, quick

beat1 – 3

This slice type is suited for percussive phrases such as drums or bass with a fast attack and short decay. Three variations are provided.

Phrase1 – 4

Ideal for phrases containing cymbals or other instruments with a long decay. Four variations are provided.

quick

Regardless of the phrase content, the Sample is divided at the specified note sub-divisions. The number of slices per measure is calculated by multiplying the top number of the Meter (time signature) parameter by the bottom number of the Sub Divide parameter.

NOTE For helpful hints on getting the Slice Type parameter to work for different Samples, see “Tips for using the Slice Types” below.

NOTE You can call up the list and select the desired item by pressing the [SF6] LIST button. For details, see page 82.

⑦ Measure

Determines the amount of measures for Sample playback. When the Slice operation is executed, sequence data corresponding to the specified number of measures is created.

The sequence data is created from the beginning of the current measure at which Sampling is started.

Settings: 1 – 8

⑧ Meter

Specifies the meter (time signature) of the Sample. The setting here is the basic slice unit.

Settings: 1/16 – 16/16, 1/8 – 16/8, 1/4 – 8/4

⑨ Sub Divide

The Meter parameter sets the basic slice unit, and Sub Divide specifies even finer resolution for phrases containing regions with shorter notes. For a one-measure phrase including quarter notes and eighth notes, for example, the Meter should be set to 4/4 and Sub Divide to

1/2. This parameter has no effect when the Slice Type parameter is set to beat 1 – 2.

Settings:

When Meter is set to 1 – 8/4: quarter note (1/1), 8th note (1/2), 4th note triplet (1/3), 16th note (1/4), 8th note triplet (1/6), 32nd note (1/8), 16th note triplet (1/12)

When Meter is set to 1 – 16/8: 8th note (1/1), 16th note (1/2), 8th note triplet (1/3), 32nd note (1/4), 16th note triplet (1/6)

When Meter is set to 1 – 16/16: 16th note (1/1), 32nd note (1/2), 16th note triplet (1/3)

NOTE The maximum slice resolution for stereo Samples is 64 slices, and for mono Samples 128 slices.

⑩ Sens (Sensitivity)

Further adjusts the sub-divisions specified by the Sub Divide parameter. Higher values result in higher resolution, allowing even finer notes and smaller sounds to be detected and sliced. Use the Audition function (press [SF1]) to hear the results, and if you're not satisfied with them, change the setting and try again.

This parameter has no effect when the “quick” slice type is selected.

Settings: 1 – 5

⑪ Tempo

Determines the Tempo with which the sliced Samples are to be played back via the [SF1] Audition button. The value set here is applied to the tempo of Song/Pattern playback.

Settings: 005 – 300

⑫ Recordable Time (Indication only)

Indicates the available Sampling time using the available memory. The time indicated here is calculated assuming a mono signal with a sampling frequency of 44.1 kHz. The amount of memory space currently being used is shown in the display as a blue line.

⑬ [SF4] Apply

When this tab menu is displayed in green, Sampling (Recording) has already finished and the Slice operation has not been executed yet. In such a situation, pressing this button executes the Slice and changes the tab menu color to gray.

When this tab menu is displayed in gray, both the Sampling (Recording) and the Slice operations have been executed. In this status, pressing this button returns to the before-slice status with the “Apply” color in green.

⑭ [F6] Trim

Pressing this button calls up the Record Trim display (page 247), allowing you to delete unwanted portions of the Sample.

Tips for using the Slice Types

Slicing percussive phrases having short decays

First, try slicing using “beat1.” If the result has a weak attack or the release portions of the phrase seem to overlap, try again using “beat2.” Try adjusting the envelope sensitivity for finer control.

If after using “beat1” the attack portions overlap or the overall rhythmic feel is degraded, try again using “beat3.” Make final adjustments with the Envelope Sensitivity parameter.

Slicing phrases having long decays

First, try slicing using “phrase1.” If the result has a weak attack or the release portions of the phrase seem to overlap, try again using “phrase2.” Make final adjustments with the Envelope Sensitivity parameter.

If after using “phrase1” the points between the slices sounds rough and the overall feel is choppy, try again using “phrase3” or “phrase4” and set Sub Divide to a finer resolution. Make final adjustments with the Envelope Sensitivity parameter. The “phrase3” setting is generally best for sustained strings or brass type sounds with no vibrato—in other words, the pitch remains constant. It can also produce echo-like effects when applied to percussive phrases with short decay.

If after using “phrase1” the points between the slices sounds rough and the overall feel is choppy, try again using “phrase4” and set Sub Divide to a finer resolution. Make final adjustments with the Envelope Sensitivity parameter. The “phrase4” setting is generally best for sustained strings or brass type sounds with vibrato, as well as vocal phrases.

Wave Memory Required for Slice Operations

Individual wave data slices created through Slice operations require approximately 1.5 times the original memory because a tail section is automatically added and fade-in and fade-out sections are automatically created at the beginning and end of the wave data. This helps to maintain maximum sound quality when the tempo is increased, and results in smoother connections between slices (no tail section is created when the “quick” slice type is selected).

A memory work area is required for the processing calculations carried out for each Slice operation, as well as sufficient memory to hold the completed waveforms. When the sampling frequency is 44.1 kHz, the approximate amount of memory (expressed in kilobytes) required for each Slice type is listed below.

beat 1	Original wave size X N + (0.3 X number of slices)
beat 2	Original wave size X N + (0.2 X number of slices)
beat 3	Original wave size X N + (0.3 X number of slices)
phrase 1	Original wave size X N + (5.8 X number of slices)
phrase 2	Original wave size X N + (1.4 X number of slices)
phrase 3	Original wave size X N + (0.4 X number of slices)
phrase 4	Original wave size X N + (1.4 X number of slices)
quick	Original wave size X N + (0.7 X number of slices)

For mono Samples N = 5.5, and for stereo Samples N = 8. Also, the number of slices is doubled for stereo Samples.

Sampling Edit

[INTEGRATED SAMPLING] → [EDIT]

The Sampling Edit mode gives you comprehensive, detailed controls for editing the recorded Sample and changing the Sample settings. Press the [EDIT] button from the Sampling Main display to call up the Sampling Edit display. Press the [EXIT] button to go back to the Sampling Main display.

Same as in the Sampling mode called up from the Voice mode/Performance mode. For information about Sampling Edit, see page 167.

Sampling Job

[INTEGRATED SAMPLING] → [JOB]

The Sampling Job mode lets you process and modify Samples you have recorded. 18 Sampling Jobs are available.

Same as in the Sampling mode called up from the Voice mode/Performance mode. For information about the Sampling Jobs, see page 171.

Using as a Master Keyboard (Master mode)

This synthesizer is loaded with such a wealth of different features, functions and operations, you may find it difficult to locate and call up the particular feature you need. This is where the Master function comes in handy. You can use it to memorize the operations you use most often in each mode, and call them up instantly anytime you need them with a single button press. The MOTIF XS has space for a total of 128 of your own User Master settings. Press the [MASTER] button to enter the Master Play mode.

Master Play mode

To enter the Master Play mode and call up the Master Play display, press the [MASTER] button from the current mode.

Selecting a Master Program

The MOTIF XS features 128 specially programmed Masters, stored to internal User Memory (Flash ROM). The Bank consists of eight Groups (A to H), each of which contains 16 Master programs. To call up the desired Master program, select the appropriate Group and Number.

Playing the Keyboard in the Master Play mode—[MASTER]

In the Master Play mode, you can select a Master program and play the keyboard according to the settings of the selected Master program. Changing the Master number lets you call up one of the modes and various settings such as tone generator settings (multi-timbral or single) and MIDI settings.



1 Master Number (Group/Number)

Indicates the selected Master number.

NOTE Master numbers 001 to 128 are converted to the format (shown in the parentheses) related to Banks A to H and Program Numbers 1 to 16 (for the Bank). This format is related to the Group buttons [A] – [H] and the Number buttons [1] – [16]. The Master numbers and the corresponding Group/Numbers are listed below.

Group/Number	Program Number
A01 – 16	001 – 016
B01 – 16	017 – 032
C01 – 16	033 – 048
D01 – 16	049 – 064
E01 – 16	065 – 080
F01 – 16	081 – 096
G01 – 16	097 – 112
H01 – 16	113 – 128

2 Master name (Indication only)

Indicates the name of the current Master.

3 Mode (Indication only)

Indicates the mode memorized to the current Master. One the modes (Voice, Performance, Pattern or Song) is indicated here.

4 Program number (Indication only)

Determines the Program number (Voice number, Performance number, Song number, or Pattern number) that is called up when the Master is selected. The program type differs depending on the memorized mode.

When the Voice mode is memorized:	Voice Bank/Number
When the Performance mode is memorized:	Performance Bank/Number
When the Song mode is memorized:	Song Number
When the Pattern mode is memorized:	Pattern Number

5 Octave

Indicates the Keyboard Octave setting set via the OCTAVE buttons. This parameter determines how much higher or lower the pitch of each key is compared to normal pitch.

6 Knobs 1 – 8

Indicates the parameters to which respective Knobs 1 – 8 are assigned and their current values. Pressing the [SELECTED PART CONTROL] button repeatedly switches among the parameter sets (indicated by the lamps). For information about the parameters, see below.

When the Voice mode is memorized:	See page 89.
When the Performance mode is memorized:	See page 136.
When the Song mode is memorized:	See page 180.
When the Pattern mode is memorized:	See page 210.

7 Control Sliders 1 – 8

Indicates the levels of respective Control Sliders 1 – 8. The target to be adjusted by the Control Sliders differs depending on the mode memorized to the current Master.

When the Voice mode is memorized:	Volume for Elements 1 – 8
When the Performance mode is memorized:	Volume for Parts 1 – 4
When the Song mode is memorized:	Volume for Parts 1 – 16
When the Pattern mode is memorized:	

[SF1] ARP1 – [SF5] ARP5 (Arpeggio 1 – 5)

When the memorized mode is Voice or Performance, a different Arpeggio type is assigned to each of the [SF1] ARP1 – [SF5] ARP5 buttons according to the Voice or Performance number. The Arpeggio types are assigned to the buttons with the 8th note icon on the display tab. You can call them up by pressing these buttons any time during your keyboard performance.

[SF1] Scene1 – [SF5] Scene5

When the memorized mode is Song or Pattern, a different Scene setting is assigned to each of the [SF1] – [SF5] buttons according to the Song or Pattern number.

[SF6] INFO (Information)

Press this button to call up the information window of the current Master.

Master Information—[SF6] INFO (Information)

This window indicates the information of the current Master. Settings cannot be changed here.

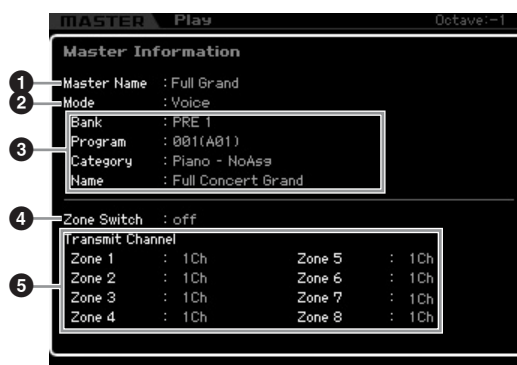

1 Master Name

Indicates the name of the current Master.

2 Mode

Indicates the mode memorized to the current Master. One of the modes (Voice, Performance, Pattern or Song) is indicated here.

3 Program

Indicates the number and name of the program (Voice, Performance, Song, or Pattern) that is called up when the Master is selected. The program differs depending on the memorized mode.

When the Voice mode is memorized:	Voice Bank, Number, Category, Name
When the Performance mode is memorized:	Performance Bank, Number, Category, Name
When the Song mode is memorized:	Song number, Song name
When the Pattern mode is memorized:	Pattern number, Pattern name

4 Zone Switch

Determines whether or not the keyboard will be divided into (up to) eight independent areas (called “Zones”). For details about Zones, see page 253.

5 Transmit Channel

Indicates the MIDI transmit channel of each Zone (when the Zone Switch is set to on).

Master Edit

The Master Edit mode lets you create your own original Master programs—containing up to eight different Zones (keyboard areas)—by editing the various parameters. To enter the Master Edit mode, press the [EDIT] button in the Master Play mode. Press the [EXIT] button to return to the original display.

Common Edit and Zone Edit

In the Master mode, you can divide the keyboard into (up to) eight independent areas (called “Zones”). Different MIDI channels and different functions of the Knobs and Control Sliders can be assigned to each Zone. This makes it possible to control several Parts of the multi-timbral tone generator simultaneously by a single keyboard or to control Voices of an external MIDI instrument over several different channels in addition to the internal Voices of this synthesizer itself—letting you use the MOTIF XS to effectively do the work of several keyboards. You can set the parameters related to the eight Zones in the Master Edit mode and store the settings as a User Master.

There are two types of Master Edit displays: those for editing parameters common to all eight Zones and those for editing individual Zones.

Master Edit Procedure

- 1 Press the [MASTER] button to enter the Master Play mode, then select a Master.
- 2 Press the [EDIT] button to enter the Master Edit mode.
- 3 Set the Zone Switch parameter to “on” in the Other display as necessary.
- 4 Call up the Common Edit display or Zone Edit display.

To call up the Common Edit display, press the [COMMON EDIT] button. You can specify the mode and program number called up when the Master is selected, and the Master name in the Common Edit mode.

To call up the Zone Edit display, press one of the Number buttons [1] – [8] to select the Zone to be edited. Here you can set various parameters such as the keyboard range and MIDI Transmit Channel for each Zone in the Zone Edit mode.

Common Edit display

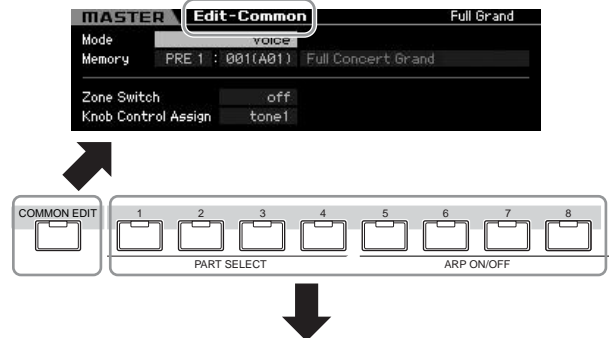

Zone Edit display

- 5 Call up the Edit display including the parameters you wish to edit by pressing the [F1] – [F5] buttons and [SF1] – [SF2] buttons. For information about the parameters, see pages 254 and 255.
- 6 Move the cursor to the desired parameter.
- 7 Edit the value by using the [INC/YES], [DEC/NO] buttons and the data dial.
- 8 Repeat steps 4 – 7 as desired.
- 9 Enter a name for the Master in the Name display (page 254) of Common Edit.
- 10 If you wish to store the edited Master, press the [STORE] button to call up the Store window (page 254).

For detailed instructions on storing, see page 254.

⚠ CAUTION

The edited Master will be lost when selecting a different Master, calling up a different mode, or turning the power off. Make sure to store the Master data to internal memory by pressing the [STORE] button before selecting a different Master, calling up a different mode, or turning the power off.

NOTE Save the edited and stored Master data to a USB storage device or to a computer connected via network to the MOTIF XS as necessary. Keep in mind that edited Master data is stored to internal User memory (Flash ROM) and is maintained even when power is turned off. Therefore it is not necessary to save the data to an external device; however, we still recommend that you save or archive all important data to an external device. Refer to page 278 for details.

The [E] Indicator

When changing the value of the parameter in the Master Edit mode, the [E] (Edit Indicator) will appear on the top right corner of the display. This gives a quick confirmation that the current Master has been modified but not yet stored. To store the current edited status, follow the instructions below.

Storing the created Master

[MASTER] → [STORE]

1 Press the [STORE] button in the Master mode.

The Master Store window appears.

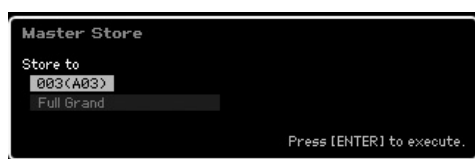

2 Specify the destination for storing the Master.

Select a Master number as destination by using the data dial, [INC/YES] and [DEC/NO] button. You can use the [USER 1] button, [A] – [H] buttons and [1] – [16] buttons to select a Master number.

3 Press the [ENTER] button. (The display prompts you for confirmation.)

To cancel the Store operation, press the [DEC/NO] button.

4 Press the [INC/YES] button to execute the Store operation.

After the Master has been stored, a “Completed” message appears and operation returns to the Master Play display.

CAUTION

When you execute the Store operation, the settings for the destination memory will be overwritten. Important data should always be backed up to a separate USB storage device or to a computer connected via network to the MOTIF XS. For detailed instructions on saving, see page 278.

Common Edit parameters

[MASTER] → [EDIT] → [COMMON EDIT]

Common Edit lets you edit the parameters common to all Zones of the selected Master.

Naming the edited Master—[F1] Name

From this display, you can name the edited Master. Press the [F1] button from the Common Edit display to call up this display. Press the [EXIT] button to return to the original display. For detailed instructions on naming, refer to “Basic Operation” on page 82.

Other Parameter Settings—[F2] Other

From this display you can set basic parameters for the Master, including the mode that is called up with the Master and the program number.



1 Mode

Determines the mode that is called up when the Master number is selected.

Settings: voice, performance, pattern, song

2 Memory

Determines the Program number that is called up when the Master is selected. The name of the selected Voice/Performance/Song/Pattern is shown.

Settings: Differs depending on the Mode setting above.

When the Mode is set to Voice:

Voice Bank: PRE1 – 8, USR1 – 3, GM, GMDR, PDR, UDR
Voice Number: 001 (A01) – 128 (H16)

When the Mode is set to Performance:

Performance Bank: USR1 – 3
Performance Number: 001 (A01) – 128 (H16)

When the Mode is set to Pattern:

Pattern Number: 01 – 64

When the Mode is set to Song:

Song number: 01 – 64

3 Zone Switch

Determines whether or not the keyboard will be divided into (up to) eight independent areas (called “Zones”). For details about Zones, see page 253.

Settings: on, off

4 Knob Ctrl Assign (Knob Control Assign)

From this display you can set which row of Knob functions will be lit and selected. When set to “zone,” selecting the Master lights no lamp and automatically calls up the Knob/Slider functions specifically set for each respective Zone (page 257).

Settings: Differs depending on the Mode setting above. Note that “zone” can be selected only when the Zone Switch (3) is set to “on.”

When the Mode is set to Voice:
tone 1, tone 2, ARP FX, zone

When the Mode is set to Performance, Pattern or Song:
tone 1, tone 2, ARP FX, reverb, chorus, pan, zone

5 [F6] Get Name

Pressing the [F6] button assigns the name of the currently selected Voice/Performance/Song/Pattern to the Master name.

Zone Edit parameters

[MASTER] → [EDIT] → [1] – [8]

These parameters are for editing the individual Zones that make up a Master. To call up the Zone Edit display, press the [EDIT] button in the Master Play mode, then press any of the Number buttons [1] – [8]. Press the [EXIT] button to return to the Master Play display.

MIDI Transmit Channel/Switch Settings —[F1] Transmit

From this display you can set how each Zone transmits MIDI messages when you play the keyboard.

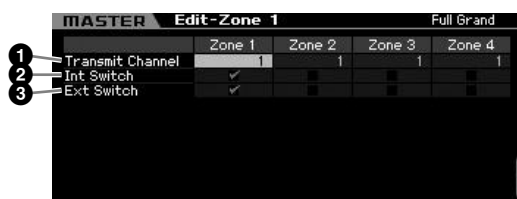

1 Transmit Channel

Determines the MIDI Transmit Channel for each Zone.

Settings: 1 – 16

2 Int Switch (Internal Switch)

Determines whether or not MIDI data for each Zone is transmitted to the internal tone generator.

NOTE When the Local Control parameter is set to “off” on the MIDI display (page 267) in the Utility mode, MIDI data for each Zone will not be transmitted to the internal tone generator, even if the Int Switch parameter is set to “on.”

3 Ext Switch (External Switch)

Determines whether or not MIDI data for each Zone is transmitted to an external MIDI device.

Note Range Setting for each Zone— [F2] Note

From this display you can set the pitch- and keyboard-related parameters for each Zone—allowing you to set up Zone splits and determine the pitch range for each Zone.

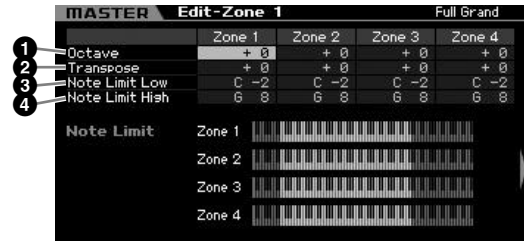

1 Octave

Determines the amount in octaves by which the range of the Zone is shifted up or down. You can adjust the offset up or down over a maximum range of three octaves.

Settings: -3 – +0 (Default) – +3

2 Transpose

Determines the amount in semitones by which the range of the Zone is shifted up or down.

Settings: -11 – +0 (Default) – +11

3 Note Limit Low

4 Note Limit High

Determines the lowest and highest notes of the range for each Zone.

Settings: C -2 – G8

NOTE You can also set the note directly from the Keyboard, by holding down the [SF6] button and pressing the desired key.

MIDI Transmit Switch Settings—[F3] Tx Switch (Transmit Switch)

MIDI Transmit Switch for the Voice related messages—[SF1] Program

From this display, you can determine whether or not MIDI messages controlling Voice selection for each Zone are transmitted to the internal/external tone generator.

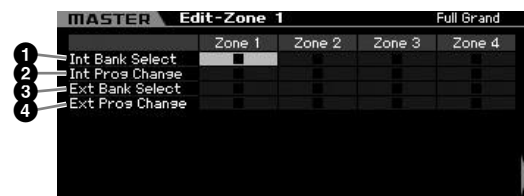

1 Int Bank Select (Internal Bank Select)

Determines whether or not to transmit Bank Select MSB/LSB messages to the internal tone generator.

Voice mode

Performance mode

Sampling mode 1

Song mode

Pattern mode

Mixing mode

Sampling mode 2

Master mode

Utility mode

File mode

Reference

2 Int Prog Change (Internal Program Change)

Determines whether or not to transmit Program Change messages to the internal tone generator.

3 Ext Bank Select (External Bank Select)

Determines whether or not to transmit Bank Select MSB/LSB messages to the external tone generator via MIDI.

4 Ext Prog Change (External Program Change)

Determines whether or not to transmit Program Change messages to the external tone generator via MIDI.

MIDI Transmit Switch for the Other messages —[SF2] Control

From this display, you can determine whether or not MIDI messages controlling non-Voice-related settings such as Control Change, Pitch Bend and Channel Aftertouch are transmitted to the internal/external tone generator.

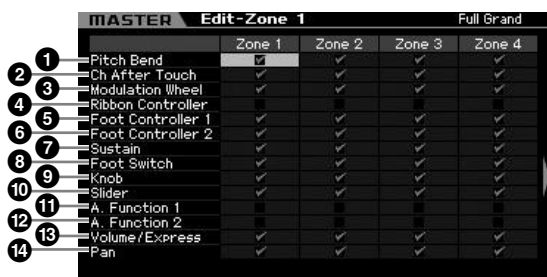

When you wish to transmit a certain MIDI message from a certain Zone to the internal/external tone generator, checkmark the corresponding box.

1 Pitch Bend

MIDI messages generated by using the Pitch Bend Wheel.

2 Ch After Touch (Channel After Touch)

MIDI messages generated by pressing and holding a note on the keyboard.

3 Modulation Wheel

MIDI messages generated by using the Modulation Wheel.

4 Ribbon Controller

MIDI messages generated by using the Ribbon Controller.

5 Foot Controller 1

MIDI messages generated by using the optional Foot Controller connected to the rear panel.

6 Foot Controller 2

MIDI messages generated by using the optional Foot Controller connected to the rear panel.

7 Sustain

MIDI messages generated by using the optional Footswitch connected to the SUSTAIN jack on the rear panel.

8 Foot Switch

MIDI messages generated by using the optional Footswitch connected to the ASSIGNABLE jack on the rear panel.

9 Knob

MIDI messages generated by using the Knobs.

10 Slider

MIDI messages generated by using the Sliders.

11 A. Function 1 (Assignable Function 1)

12 A. Function 2 (Assignable Function 2)

MIDI messages generated by using the ASSIGNABLE FUNCTION buttons.

13 Volume/Express (Expression)

MIDI Volume messages generated by using the Knobs and Sliders.

14 Pan

MIDI Pan messages generated by using the Knobs and Sliders.

Default Settings for each Zone—[F4] Preset

From this display you can make the Voice-related settings for each Zone which will be transmitted as MIDI messages automatically when the Master is selected.



1 Bank MSB (Bank Select MSB)

2 Bank LSB (Bank Select LSB)

3 Program Change

Determines the Voice-related settings for each Zone in the selected Master. These MIDI messages are transmitted to an external/internal tone generator when the Master is selected.

Settings:

- Bank MSB (Bank Select MSB): 000 – 127
- Bank LSB (Bank Select LSB): 000 – 127
- Program Change: 001 – 128

4 Volume

Determines the Volume settings for each Zone in the selected Master. The MIDI messages of the Volume are transmitted to an external/internal tone generator when the Master is selected.

Settings: 000 – 127

5 Pan

Determines the Pan settings for each Zone in the selected Master. The MIDI messages of the Pan are transmitted to an external/internal tone generator when the Master is selected.

Settings: L64 – C – R63

6 [F6] MIDI Send

When set to “on,” changing the value in this display transmits the corresponding MIDI messages to an external/internal tone generator.

Knob and Slider Settings—[F5] KnobSlider

From this display, you can determine which Control Change numbers are transmitted to an external/internal tone generator when you use the Knobs and Sliders for each Zone.

MASTER Edit-Zone 1		Full Grand			
	Zone 1	Zone 2	Zone 3	Zone 4	
1 Control Knob No.	10	10	10	10	
Function Name	Pan	Pan	Pan	Pan	
2 Control Slider No.	7	7	7	7	
Function Name	Volume	Volume	Volume	Volume	

NOTE This parameter is available only when the Knob Control Assign parameter is set to “zone” in the Other display (page 254) of the Common Edit. In other words, this parameter is available only when all the lamps of the [SELECTED PART CONTROL] and [MULTI PART CONTROL] are turned off.

1 Control Knob No.

Determines which Control Change numbers are transmitted when you use the Knobs for each Zone. The function name is automatically shown below the number you select.

Settings: 0 – 95

2 Control Slider No.

Determines which Control Change numbers are transmitted when you use the Control Sliders for each Zone. The function name is automatically shown below the number you select.

Settings: 0 – 95

Master Job

The Master Job mode features convenient data initialization and archiving tools. To enter the Master Job mode, press the [JOB] button in the Master mode. Press the [EXIT] button to return to the original display.

Master Job Procedure

- 1 In the Master mode, press the [JOB] button to enter the Master Job mode.**
- 2 Select the Job you wish to execute by pressing the [F1] or [F4] button.**
- 3 Set the parameters for executing the Job.**
- 4 Press the [ENTER] button. (The display prompts you for confirmation.)**
To cancel the Job, press the [DEC/NO] button.

- 5 Press the [INC/YES] button to execute the Job.**
After the Job has been completed, a “Completed” message appears and operation returns to the original display.
- 6 Press the [MASTER] button to return to the Master Play display.**

Initializing the Master—[F1] Init

This function lets you reset (initialize) all Master parameters to their default settings. It also allows you to selectively initialize certain parameters, such as Common settings and Zone settings.



1 All Parameters

Determines whether or not all settings for the selected Master are initialized. When set to “on,” other parameters in this display cannot be set.

Settings: (on), (off)

2 Common

Determines whether or not all Common parameter settings for the selected Master are initialized. When set to “on,” ZONE cannot be set.

Settings: (on), (off)

3 Zone

Determines whether or not all Zone parameter settings for the selected Master are initialized. When set to “on,” executing the Job initializes all the parameter settings of Common Edit.

Settings: (on), (off)

4 Initialize Type

Determines how the Zone parameter settings for the selected Master are initialized. Three methods of Initializing are available.

Settings: split, zone, layer

split

Sets the Zone 1 and Zone 2 to on, then splits the keyboard range using Zone 1 and Zone 2. “Upper Ch” determines the MIDI transmit channel of the upper range of the keyboard, “Lower Ch” determines the MIDI transmit channel of the lower range of the keyboard, and “Split Point” determines the note (C -2 – G8) number which separates the upper range and lower range of the keyboard.

zone

Sets Zones 1 – 4 to on, Zones 5 – 8 to off, and the MIDI Transmit Channels to 1 – 8 respectively.

layer

Sets the Zone 1 and Zone 2 to on, then lets you layer two Parts. “Upper Ch” and “Lower Ch” determine the MIDI transmit channels of the two Zones respectively.

5 Upper Ch (Upper Channel)

6 Lower Ch (Lower Channel)

Determines the MIDI transmit channels of Zone 1 and Zone 2 respectively when the Initialize Type is set to “layer” or “split.”

Settings: 1 – 16

7 Split Point

Determines the Split Point that divides the keyboard into the Zone 1 and Zone 2 when the Initialize Type is set to “split.” By setting this parameter, the Note Limit High of Zone 1 is automatically set to the note one semitone lower than the Split Point set here and the Note Limit Low of Zone 2 is automatically set to the note same as the Split Point set here.

Settings: C -2 – G8

NOTE The Note Limit High and Note Limit Low parameters can be set in the Note display (page 255) of the Zone Edit.

Transmitting the Master Settings to an external MIDI device (Bulk Dump)

This function lets you send all your edited parameter settings for the currently selected Master to a computer or another MIDI device for data archiving. Press the [ENTER] button to execute the Bulk Dump.

NOTE The Bulk Dump data includes only the MIDI messages and does not include the Waveforms.

NOTE In order to execute Bulk Dump, you will need to set the correct MIDI Device Number. For details, see page 268.

System Settings (Utility mode, etc.)

In the Utility mode, you can set parameters that apply to the entire system of the MOTIF XS. To enter the Utility mode, press the [UTILITY] button. Pressing the [EXIT] button returns to the original display. For system settings related to the sequencer in Song/Pattern/Arpeggio playback, call up the Sequencer Setup display by pressing the [SEQ SETUP] button in the Song/Pattern/Performance mode.

Basic Procedure in the Utility mode

1 Enter the Utility mode.

Press the [UTILITY] button to enter the Utility mode. (The indicator lights.)

2 Calls up the desired display.

Note the tab menus of the [F1] – [F6] and [SF1] – [SF5] buttons to find the desired function, then press the relevant button to call up the desired display.

3 Set the desired parameter.

Move the cursor to each parameter, then set the value by using the data dial, [INC/YES] and [DEC/NO] button.

⚠ CAUTION

When “Press [ENTER] to set” is shown on the display, make sure to press the [ENTER] button before going to the next step. If you do not, the settings will not be stored, even if you press the [STORE] button in the next step.

4 Press the [STORE] button to store the Utility setting and Sequencer Setup to internal memory.

⚠ CAUTION

All Utility settings will be lost when the power is turned off without storing.

NOTE The parameter settings in the Utility displays and Sequencer Setup displays are treated and stored as a single unit. This means that when you execute the Store operation in the Utility mode, the settings in the Sequencer Setup displays are also stored, and vice versa.

5 Press the [EXIT] button to exit from the Utility mode to the original mode.

System Information—[SF6] INFO

This display indicates the MIDI IN/OUT settings and Network settings. This display cannot be edited.

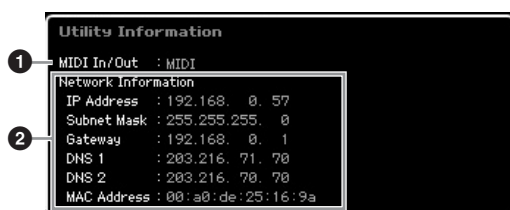

1 MIDI IN/OUT (Indication only)

Indicates the hardware terminal via which the MIDI data is input or output. The related parameters can be set in the MIDI display (page 268).

2 Network Information

Indicates the network settings. The related parameters can be set in the Network display (page 260).

General Settings—[F1] General

Tone Generator and Keyboard settings —[SF1] Play

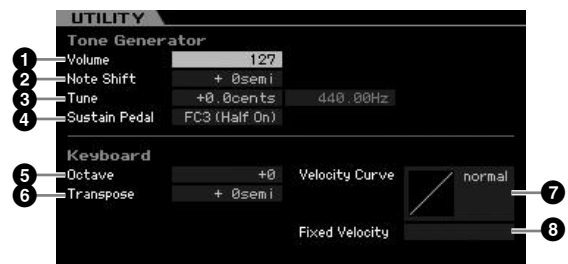

Tone Generator

From this section, you can make overall settings for the internal tone generator. The settings here only affect the internal tone generator block. The MIDI output will not be affected.

1 Volume

Determines the overall volume of the instrument.

Settings: 0 – 127

2 Note Shift

Determines the amount (in semitones) by which the pitch of all notes is shifted.

Settings: -24 semi – +0 semi – +24 semi

3 Tune

Determines the fine tuning of the overall sound. You can adjust the tuning in cent increments.

Settings: -102.4 cents – +0 cents – +102.3 cents

4 Sustain Pedal

Determines which model of an optional Foot Controller connected to the FOOT SWITCH SUSTAIN jack is recognized. When you connect an optional FC3 (equipped with the half-damper feature) for producing a “half-damper” effect (as on a real acoustic piano), set this parameter to “FC3 (half on)” and set the Half Damper Switch parameter to “on” in the Amplitude EG display (page 123) of Voice Element Edit. If you don’t need or want to disable the half-damper feature and still use an FC3, set this parameter to “FC3 (half off).” When you connect an optional FC4 or FC5 (which is not equipped with the half-damper feature), set this parameter to “FC4” or “FC5.”

Settings: FC3 (half on), FC3 (half off), FC4/5

NOTE Note that this setting is not necessary when controlling the half-damper feature via Control Change messages from an external MIDI device to the instrument.

Keyboard

From this section, you can set the keyboard-related parameters. The settings here affect the MIDI messages generated by playing the keyboard.

5 Octave

Determines the amount in octaves by which the range of the keyboard is shifted up or down. This setting can be changed also by pressing any of the OCTAVE buttons.

Settings: -3 – +0 – +3

6 Transpose

Determines the amount in semitones by which the range of the keyboard is shifted up or down.

Settings: -11 semi – +0 semi – +11 semi

NOTE If you transpose beyond the note range limits (C -2 and G8), notes in the adjacent octaves will be used.

7 Velocity Curve

The five curves determine how the actual velocity will be generated and transmitted according to the velocity (strength) with which you play notes on the keyboard. The graph shown in the display indicates the velocity response curve. (The horizontal line represents the received velocity values (strength of your playing), while the vertical line represents the actual velocity values transmitted to the internal/external tone generators.)

Settings: normal, soft, hard, wide, fixed

normal

This linear “curve” produces one-to-one correspondence between the strength of your keyboard playing (velocity) and the actual sound change.

soft

This curve provides increased response, especially for lower velocities.

hard

This curve effectively lessens the overall response compared to the “norm” curve.

wide

This setting provides opposite response curves for lower and higher velocities. It widens the apparent dynamic range of the controller, producing less sound change in the softer range and more change in the higher range.

fixed

This setting produces the same amount of sound change (set in Fixed Velocity below), no matter what your playing strength.

8 Fixed Velocity

This parameter is available only when you select the “fixed” Velocity Curve above. The velocity of the note you play is fixed at the value set here.

Settings: 1 – 127

System Effect Bypass Settings—[SF2] FXBypass

From this display you can select the specific effect(s) to be bypassed when the EFFECT BYPASS [SYSTEM] button is turned on. The bypassed effect is then temporarily disabled.



1 Reverb

When this is set to on and the [SYSTEM] button is turned on, the Reverb effect is bypassed.

2 Chorus

When this is set to on and the [SYSTEM] button is turned on, the Chorus effect is bypassed.

Network Settings—[SF3] Network

From this display, you can set parameters for connecting the MOTIF XS to the network system via the ETHERNET connector. Make sure to press the [ENTER] button after setting in this display. If you do not, the settings will not be stored, even if you press the [STORE] button.

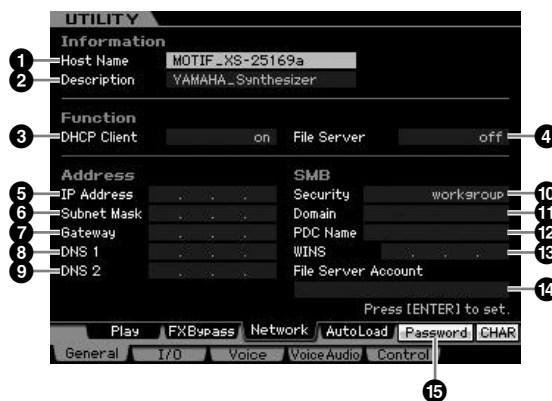

1 Host Name

Determines the Host Name (NetBIOS name) of the MOTIF XS. This is used when accessing the MOTIF XS from a computer connected to the network. Set a unique Host Name that will not conflict with any other computer. In general, the default Host Name will suffice, so there should be no need to change this. For detailed instructions on naming, see page 82.

2 Description

Here, you can input a short summary or memo about your MOTIF XS. The description input here can be browsed from the other computer connected to the network. This is useful when several MOTIF XSs are connected to the same network. In general, the default Description will suffice, so there should be no need to change this. For detailed instructions on inputting a character, see page 82.

3 DHCP Client

Determines whether or not the MOTIF XS is handled as the client device of the DHCP server. When this is set to “on,” the MOTIF XS is handled as a client device of the DHCP server. The DHCP (Dynamic Host Configuration Protocol) is a standard or protocol by which IP addresses and other low-level network configuration information can be dynamically and automatically assigned each time your MOTIF XS is connected to the network. If the DHCP server covers the network, set this parameter to “on.” If you wish to set a specific IP address or there is no DHCP server, set this parameter to “off.”

Settings: on, off

4 File Server

Determines whether the File Server function of the MOTIF XS is active or not. When this parameter is set to “on,” the another computer on the same network can access files on the USB storage device connected to the USB TO DEVICE connector of the MOTIF XS.

Settings: on, off

NOTE Make sure to set the Password (15) of this instrument before setting this parameter to “on.” If this is set to “on” before the Password is set, “Password is unspecified” appears.

5 IP Address

Determines the IP Address, a string of numbers assigned to each computer or your MOTIF XS connected to a network, indicating the device’s location on the network. When the MOTIF XS is connected to the network which the DHCP server covers and the DHCP Client parameter above is set to “on,” this parameter is automatically set, and you will not need to input it manually. When the DHCP Client (3) is set to “off” and you do not know how to set this parameter, consult your network administrator or Internet provider.

Settings: 0 – 255

6 Subnet Mask

Indicates the Subnet Mask, a setting used to divide a large-scale network into several smaller networks. When the MOTIF XS is connected to the network which the DHCP server covers and the DHCP Client parameter above is set to “on,” this parameter is automatically set resulting that you need not input here. When the DHCP Client (3) is set to “off” and you do not know how to set this parameter, consult your network administrator or Internet provider.

Settings: 0 – 255

7 Gateway

Determines the Gateway, a system which links different networks or systems, and makes possible data transfer and conversion despite differing communications standards. When the MOTIF XS is connected to the network which the DHCP server covers and the DHCP Client parameter above is set to “on,” this parameter is automatically set, and you will not need to input it manually.

Settings: 0 – 255

8 DNS1 (Domain Name Server1)

9 DNS2 (Domain Name Server2)

Determines the address for the Domain Name server. Up to two servers (primary DNS1 and secondary DNS2) can be set. When you do not use the Domain Name server, set both of the DNS1 and DNS2 to “0.0.0.0.” When you use only the DNS1, set the DNS2 to “0.0.0.0.” When the MOTIF XS is connected to the network which the DHCP server covers and the DHCP Client parameter above is set to “on,” this parameter is automatically set, and you will not need to input it manually.

Settings: 0 – 255

10 Security

Determines the certification type when another computer on the network accesses the MOTIF XS. If you wish to certificate the computer by using the Account (14) and password, set this parameter to “workgroup.” If you wish to certificate the computer by using the domain controller on the network, set this parameter to “domain.”

Settings: domain, workgroup

11 Domain

Enters the Domain name or Workgroup name. Input the Domain name or Workgroup name to the same name as that of the online device you wish to use for accessing the MOTIF XS. For detailed instructions on inputting characters, see page 82.

12 WINS

Determines the address for the WINS (Windows Internet Name Service) server. When the PDC Name (13) is set to the Host name (NetBIOS name), you will set the address of the WINS server. If you are not using the WINS server, set this parameter to “0.0.0.0.”

Settings: 0 – 255

13 PDC Name (Primary Domain Controller Name)

Determines the Host name (NetBIOS name) of the Domain Controller or IP address on the network. When the Security (10) is set to “domain,” the certification will be executed by using the Domain Controller set here.

14 File Server Account

Determines the account name (user name) used when another computer on the network accesses the MOTIF XS. For detailed instructions on inputting characters, see page 82.

NOTE The account is not set by default. When no account is set, the MOTIF XS can be accessed by the account named “nobody.”

15 [SF5] Password

Pressing this button calls up the Password display that lets you set or change the password necessary for accessing the MOTIF XS from an online device connected to the network. When shipped from the factory, the password is not set. Make sure to set the password if you wish to access the MOTIF XS from an external computer via the LAN network.

**Password Settings
[SF3] → [SF5] Password**

From this display, you can set the password of the MOTIF XS. By using the password set here, external online devices can access the File mode of the MOTIF XS.



1 Current Password

This column is provided for inputting the current password. The password can be up to eight characters and no less than five characters. For detailed instructions on inputting characters, see page 82. “None” is shown when the password is not set.

2 New Password

This column is provided for inputting the new password. The password can be up to eight characters and no less than five characters. For detailed instructions on inputting characters, see page 82.

3 Confirm Password

This column is provided for inputting the new password once again to confirm it. The password can be up to eight characters and no less than five characters. For detailed instructions on inputting characters, see page 82.

Password Setting

After inputting the Current Password, New Password and Confirm Password (New Password), press the [ENTER] button to set the New Password. If an error occurs, one of the following error messages will be shown on the display.

Password is invalid.

The password you input to “Current Password” is wrong. Input the correct password again.

Confirmed password is invalid.

The password you input to “Confirm Password” is not same as the password you input to “New Password.”

Password is too short.

The password you input to “New Password” is too short. Input the password again, using five or more characters.

NOTE If you forget the current password, execute the Factory Set Job (page 269) to reset the password setting, then input the new password again.

Setting the default display when turning the power on—[SF4] Auto Load

From this display, you can specify certain automatic tasks that the MOTIF XS will perform when power is turned on.

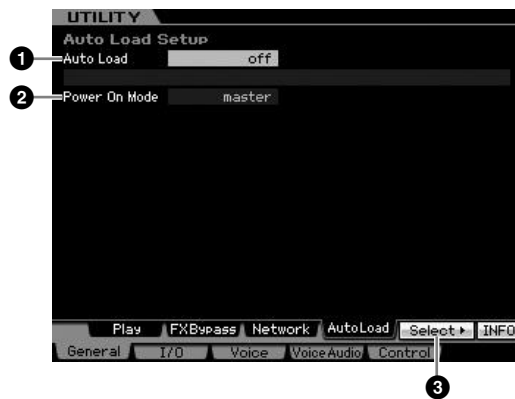

1 Auto Load

Determines whether the Auto Load function is on or off. When this is on, the instrument will automatically load the specified files (from the USB storage device) to User memory—whenever the power is turned on. The file to be loaded is shown on this display. The file to be loaded can be specified via the [SF5] Get button.

Settings: on, off

2 Power On Mode

This determines the default power-on mode (and memory bank)—letting you select which condition is automatically called up when you turn the power on.

Settings:

performance

When turning the power on next time, the Performance Play mode is entered and the first program number (USER: 001) is selected automatically.

voice (USER1)

When turning the power on next time, the Voice Play mode is entered and the first program number of User Voices (USR: 001) is selected automatically.

voice (PRE1)

When turning the power on next time, the Voice Play mode is entered and the first program number of Preset Voices (PRE: 001) is selected automatically.

voice (GM)

When turning the power on next time, the Voice Play mode is entered and the first program number of Preset GM Voices (GM: 001) is selected automatically.

master

When turning the power on next time, the Master Play mode is entered and the first program number (001) is selected automatically.

NOTE Make sure to store the Utility settings to the internal memory by pressing the [STORE] button before turning the power off. Please keep in mind that the Utility settings will be lost if you turn off the power without executing the Store operation.

3 [SF5] Select

Pressing this button calls up the Select Auto Load File display. From this display you can specify the file (in the external storage device) to be loaded automatically when turning the power on (when Auto Load is set to on).

Specifying the Auto Load File [SF4] → [SF5] Select

From this display you can specify the file (in the external storage device) to be loaded automatically when turning the power on (when Auto Load is set to on). Move the cursor to the desired file then press the [ENTER] button to determine the Auto Load File.

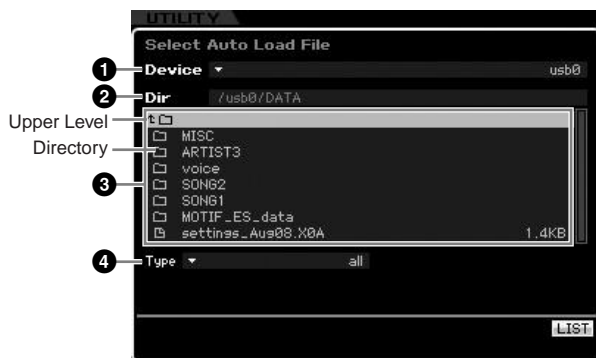

Parameters 1 – 4 are the same as the ones in the File window (page 275) of the File mode.

Audio In/Out Settings—[F2] I/O (Input/Output)

From this display you can set Audio In/Out parameters.

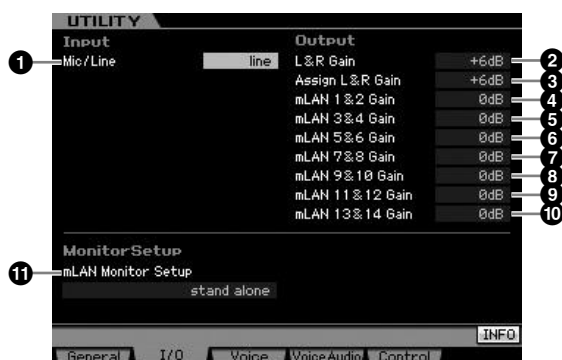
**1 Mic/Line**

When using the A/D INPUT jacks, this determines the input source, microphone (mic) or line.

Settings: mic, line

mic

Intended for low output equipment, such as a microphone, electric guitar or bass.

line

Intended for high output equipment, such as a keyboard, synthesizer, or CD player.

2 L&R Gain

Determines the output gain of the OUTPUT L/MONO and R jacks.

Settings: 0dB, +6dB

3 Assign L&R Gain

Determines the output gain of the ASSIGNABLE OUTPUT L and R jacks.

Settings: 0dB, +6dB

4 – 10 mLAN Gain

Determines the output gain of the mLAN connector.

Settings: 0dB, +6dB

11 mLAN Monitor Setup

Determines the audio signal flow for monitoring the sound when using the MOTIF XS with DAW software installed on a computer connected to the MOTIF XS via an IEEE1394 cable.

NOTE You will need to properly set up the DAW software in addition to making the settings here. For details, see page 47.

Settings: stand alone, with PC, with PC (DirectMonitor)

stand alone

This should be selected when you are using the MOTIF XS alone or are not using the DAW software even with a computer connected to the MOTIF XS via an IEEE1394 cable. When this is selected, the audio signal of the MOTIF XS will be output directly via the OUTPUT L/MONO and R jacks normally.

with PC

This should be selected when you are using the MOTIF XS as an audio device with the DAW software. When this is selected, the audio signal of the MOTIF XS will be output to the DAW software on a computer via an IEEE1394 cable, merged and mixed with the DAW sound, returned back to the MOTIF XS, then output via the OUTPUT L/MONO and R jacks. Selecting this allows you to apply VST Effects within the DAW software to the MOTIF XS sound.

with PC (DirectMonitor)

This should be selected when recording your keyboard performance to the DAW software on the computer. The audio signal of the MOTIF XS will be output directly via the OUTPUT L/MONO and R jacks with the audio signal sent from the DAW software via an IEEE1394 cable. Keep in mind that the Rec Monitor of the DAW software should be set to "off" in order to prevent "double" sound from occurring.

NOTE When "with PC" is selected, there may be a short delay between when you play the keyboard and when you hear the resulting sound.

NOTE Set this parameter to "stand alone" when the MOTIF XS is not connected to an external device via an IEEE1394 cable.

System Settings for the Voice mode—[F3] Voice

From the following displays, you can set parameters related to the Master Effect, Master EQ, Audio Input part, Controller, and Micro Tuning in the Voice mode. These settings will be applied to all Voices. The following displays are available only when entering the Utility mode from the Voice mode.

Master Effect Settings—[SF1] MasterFX (Master Effect)

This display lets you set Master Effect parameters in the Voice mode. This display can be called up by pressing and holding the [MASTER EFFECT] button on the front panel in the Voice mode.



1 Switch

Determines whether the Master Effect is applied or not to the Voice. When this is set to on, entering the Voice mode turns the [MASTER EFFECT] lamp on.

Settings: on, off

Other parameters are same as the ones on the Master Effect display (page 146) in the Performance Common Edit mode.

Master EQ settings—[SF2] MasterEQ

This display lets you set Master EQ parameters in the Voice mode, allowing you to control EQ over five independent frequency bands. This EQ affects all Voices. This display is available only when entering the Utility mode from the Voice mode.



The function is same as the one on the Master EQ display (page 146) in the Performance Common Edit mode.

Controller Settings—[SF3] Control

From this display you can set parameters related to output of the Arpeggio MIDI data and the controller assignment in the Voice mode. The settings here affect all Voices. This display is available only when entering the Utility mode from the Voice mode.



1 ARP MIDI Out Switch

When this is set to on, Arpeggio playback data is output from the MIDI terminal.

Settings: on, off

2 ARP Transmit Ch (Arpeggio Transmit Channel)

Determines the MIDI transmit channel through which Arpeggio playback data will be sent (when the Switch parameter above is set to on).

Settings: 1 – 16

3 Controller Assign

You can assign MIDI Control Change Numbers to the controllers and knobs on the front panel. For example, you could use the ASSIGN 1 and 2 knobs to control effect depth, while using the Foot Controller to control modulation. These control assignments are called "Controller Assign."

The function is same as the one in the Controller Assign display (page 147) in the Performance Common Edit mode.

Creating your original Micro Tuning— [SF4] Tuning

From this display, you can create your original Micro Tuning in the User Bank. You can copy a Micro Tuning to another number, then create new one based on it. This display is available only when entering the Utility mode from the Voice mode.

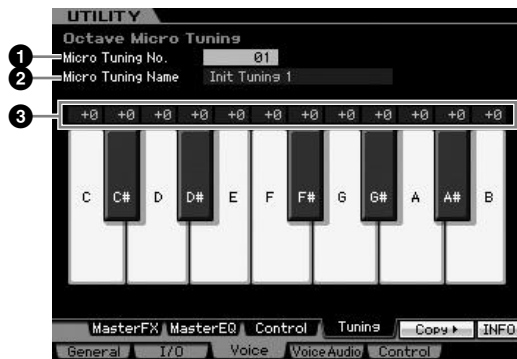

1 Micro Tuning No.

Determines the destination to which the created Micro Tuning setting is stored.

Settings: 1 – 8

2 Micro Tuning Name

Enters the desired name for the Micro Tuning. For detailed instructions on naming, see page 82.

3 Tuning Offset

Lets you tune the individual notes of the keyboard in cents to create your original Micro Tuning.

Settings: -99 – +0 – +99 cents

[SF5] Copy

From this display called up via this button, you can copy a Micro Tuning to another number then create a new Micro Tuning based on it.

Micro Tuning Copy Procedure

- 1 Select a Micro Tuning number as source.
- 2 Press the [SF5] button to call up the Copy display.
- 3 Select a Micro Tuning number as destination.
- 4 Press the [ENTER] button to execute the Copy operation.

Audio Input Settings in the Voice mode— [F4] VoiceAudio

You can set parameters related to audio input signal from the [A/D INPUT] connector and the mLAN connector in the Voice mode. This display is available only when entering the Utility mode from the Voice mode.

NOTE The mLAN Input (m1 – m14) is available only for the MOTIF XS8. This is available for MOTIF XS6/7 only when an optional mLAN16E2 has been installed.

Output Settings—[SF1] Output

From this display you can set various parameters of the Audio Input signal in the Voice mode, such as Output jacks, Volume, Pan, and Effect depth. This display is available only when entering the Utility mode from the Voice mode.



1 Volume

Determines the output level of the Audio Input Part.

Settings: 0 – 127

2 Pan

Determines the stereo pan position of the Audio Input Part.

Settings: L63 (far left) – C (center) – R63 (far right)

3 Mono/Stereo

Determines the signal configuration for the Audio Input Part, or how the signal or signals are routed (stereo or mono).

Settings: stereo, L mono, R mono, L+R mono

stereo

Both the L and R channels of the audio input are used.

L mono

Only the L channel of the audio input is used.

R mono

Only the R channel of the audio input is used.

L+R mono

The L and R channels of the audio input are mixed and processed in mono.

4 Output Select

Determines the output jack assignment for the Audio Input Part.

Settings: See the table below.

LCD	Output jacks	Stereo/Mono
L&R	OUTPUT L and R	Stereo
asL&R	ASSIGNABLE OUTPUT L and R	Stereo
m1&2	mLAN OUTPUT 1 and 2	Stereo (1: L, 2: R)
m3&4	mLAN OUTPUT 3 and 4	Stereo (3: L, 4: R)
m5&6	mLAN OUTPUT 5 and 6	Stereo (5: L, 6: R)
m7&8	mLAN OUTPUT 7 and 8	Stereo (7: L, 8: R)
m9&10	mLAN OUTPUT 9 and 10	Stereo (9: L, 10: R)
m11&12	mLAN OUTPUT 11 and 12	Stereo (11: L, 12: R)
m13&14	mLAN OUTPUT 13 and 14	Stereo (13: L, 14: R)
asL	ASSIGNABLE OUTPUT L	Mono
asR	ASSIGNABLE OUTPUT R	Mono
m1	mLAN OUTPUT 1	Mono
:	:	:
m14	mLAN OUTPUT 14	Mono
ins L (A/D Input only)	Internal Vocoder module	Mono

NOTE You can call up the list and select the desired item by pressing the [SF6] LIST button. For details, see page 82.

5 Reverb Send

Determines the Send level of the Audio Input Part signal sent to the Reverb effect. The higher the value, the more pronounced the Reverb.

Settings: 0 – 127

6 Chorus Send

Determines the Send level of the Audio Input Part signal sent to the Chorus effect. The higher the value, the more pronounced the Chorus.

Settings: 0 – 127

7 Dry Level

Determines the level of the Audio Input Part which has not been processed with the System Effects (Reverb, Chorus). The higher the value, the less pronounced the Reverb and Chorus.

Settings: 0 – 127

NOTE The Reverb Send (5), Chorus Send (6), and Dry Level (7) parameters are not available when Output Select (4) is set to “insL.”

Insertion Effect Connection Settings— [SF2] Connect

From this display you can set the Insertion Effect connection of the Audio Input signal in the Voice mode. This display is available only when entering the Utility mode from the Voice mode.

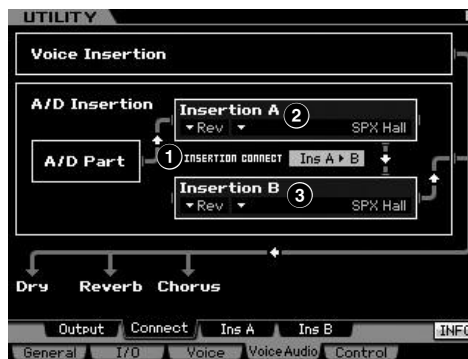

1 INSERTION CONNECT (Insertion Connection)

Determines the effect routing for Insertion effects A and B. The setting changes are shown on the diagram in the display, giving you a clear picture of how the signal is routed.

Settings: Ins A ► B, Ins B ► A

Ins A ► B

Signals processed with Insertion Effect A will be sent to Insertion Effect B and signals processed with Insertion Effect B are sent to Reverb and Chorus.

Ins B ► A

Signals processed with Insertion Effect B will be sent to Insertion Effect A and signals processed with Insertion Effect A are sent to Reverb and Chorus.

2 Insertion A (Insertion A Category/Type)*

3 Insertion B (Insertion B Category/Type)*

Determines the Effect type for Insertion A and B. From the Category column, you can select one of the Effect Categories, each of which contains similar Effect types. From the Type column, you can select one of the Effect Types listed in the selected Category.

Settings: Details about the Effect categories and types are described on page 70.

NOTE You can call up the list and select the desired item by pressing the [SF6] LIST button. For details, see page 82.

Insertion Effect Type Settings—[SF3] Ins A, [SF4] Ins B

From these displays, you can set the Insertion Effect Types applied to the Audio Input signal in the Voice mode. These displays are available only when entering the Utility mode from the Voice mode.



NOTE Depending on the selected parameter, the LIST icon is shown at the tab menu corresponding to the [SF6] button. In this condition, you can call up the list by pressing the [SF6] LIST button, then select the desired item from the list. For details, see page 82.

1 Category

2 Type

From the Category column, you can select one of the Effect Categories, each of which contains similar Effect types. From the Type column, you can select one of the Effect Types listed in the selected Category. Details about the Effect categories are described on page 70.

3 Preset

This lets you call up pre-programmed settings for each Effect Type, designed to be used for specific applications and situations.

4 Effect Parameters

The number of parameters and values available differs depending on the currently selected effect type. Refer to page 73 for details about the Effect parameters. Refer to the separate Data List booklet for information on the parameters for each Effect type.

Remote Control and MIDI settings—[F5] Control

From the following displays, you can set parameters related to the Remote Control function and MIDI settings.

DAW Settings—[SF1] Remote

Lets you specify the DAW application software to be controlled by the MOTIF XS. The MOTIF XS can control Cubase 4, Logic Pro 7.2, SONAR 5.2 and Digital Performer 5.

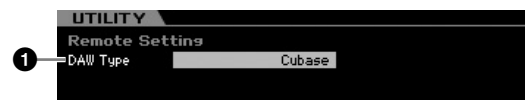

1 DAW Type

Determines the DAW application software to be controlled by the MOTIF XS.

Settings: Cubase, Logic, Sonar, Digital Performer

NOTE When the [REMOTE ON/OFF] lamp is turned on, simply selecting a DAW type calls up the Remote settings automatically.

MIDI Settings—[SF2] MIDI

From this display, you can set the MIDI related parameters.

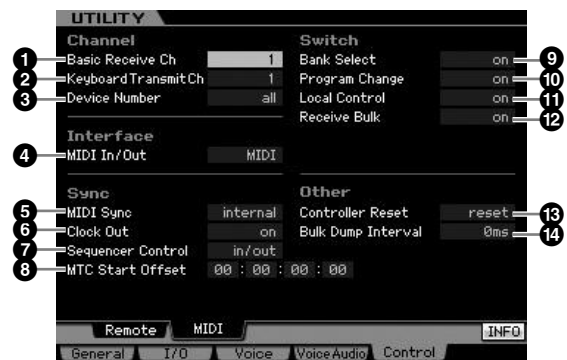

1 Basic Receive Ch

Determines the MIDI receive channel when this synthesizer is set to single-timbre tone generator mode (Voice/Performance modes).

Settings: 1 – 16, omni, off

omni

When this is selected, all channel messages are received.

NOTE In the multi-timbral tone generator mode (Song/Pattern modes), each Mixing Part receives MIDI data according to its assigned MIDI receive channel. This can be set in the Voice display (page 235) of the Mixing Part Edit mode.

2 Keyboard Transmit Ch

Determines the MIDI channel over which the instrument sends MIDI data (to an external sequencer, tone generator, or other device). This parameter is available in the single-timbre tone generator mode (Voice/Performance modes).

Settings: 1 – 16, off

NOTE In the Song/Pattern mode, the MIDI data created by playing the keyboard/knobs/wheels is sent to the tone generator block or the external MIDI devices via the MIDI output channel of the currently selected track. The Output Channels of each track can be set in the Output Channel display (page 184) of the Song Play mode.

3 Device Number

Determines the device number used by this synthesizer in receiving or transmitting data. This number must match the Device Number of the external MIDI device when transmitting/receiving bulk data, parameter changes or other system exclusive messages.

Settings: 1 – 16, all, off

all

When this is selected, system exclusive messages for all MIDI device numbers are received. When system exclusive messages such as bulk dump are transmitted from the MOTIF XS with this setting, the MOTIF XS is recognized as Device Number 1.

off

When this is selected, system exclusive messages such as bulk dump and parameter change cannot be transmitted or received. When you try execute transmission or reception of system exclusive messages, an error message appears.

4 MIDI In/Out

Determines which physical output/input terminal(s) will be used for transmitting/receiving MIDI data.

Settings: MIDI, USB, mLAN (when the optional mLAN16E2 has been installed to the MOTIF XS6/7)

NOTE The three terminal types above cannot be used at the same time. Only one of them can be used to transmit/receive MIDI data.

5 MIDI Sync

Determines whether Song/Pattern/Arpeggio playback will be synchronized to the instrument's internal clock or an external MIDI clock.

Settings: Internal, MIDI, auto, MTC

internal

Synchronization to internal clock. Use this setting when this synthesizer is to be used alone or as the master clock source for other equipment.

MIDI

MIDI Synchronization to a MIDI clock received from an external MIDI instrument via MIDI.

auto

When MIDI clock is transmitted continuously from an external MIDI device or computer, the internal clock of the MOTIF XS is not effective and the MOTIF XS is synchronized with the external clock. When MIDI clock is not transmitted from the external MIDI device or computer, the internal clock of the MOTIF XS continues to run in sync with the latest received tempo of the external MIDI device or computer (DAW software). Note that the tempo cannot be changed on the MOTIF XS when this value is selected. This setting is useful when you wish to alternate between external clock and internal clock.

MTC (MIDI Time Code)

Synchronization to an MTC signal received via MIDI. MMC signals are transmitted via MIDI. Use this setting when this synthesizer is to be used as a MIDI slave, such as when synchronized to an MTC-capable MTR. The MTC Sync function is available only in the Song mode.

NOTE When this parameter is set to "MIDI," make sure that the external MIDI instrument connected to the MOTIF XS will transmit the MIDI clock to the MOTIF XS.

NOTE When MIDI Sync is set to "MTC," Songs and Arpeggios cannot play back in the Song mode but Patterns and Arpeggios can play back in the Pattern mode.

NOTE MTC (MIDI Time Code) allows simultaneous synchronization of multiple audio devices via standard MIDI cables. It includes data corresponding to hours, minutes, seconds, and frames. The MOTIF XS does not transmit MTC.

NOTE MMC (MIDI Machine Control) allows remote control of multitrack recorders, MIDI sequencers, etc. An MMC-compatible multitrack recorder, for example, will automatically respond to start, stop, fast forward, and fast reverse operations performed on the controlling sequencer, thus keeping playback of the sequencer and multitrack recorder aligned.

6 Clock Out

Determines whether MIDI clock (F8H) messages will be transmitted via MIDI.

Settings: on, off

7 Sequencer Control

Determines whether Sequencer Control signals—start (FAH), continue (FBH), stop (FCH), and song position pointer (F2H)—will be received and/or transmitted via the MIDI OUT/USB terminal.

Settings: off, in, out, in/out

off

Not transmitted/recognized.

in

Recognized but not transmitted.

out

Transmitted but not recognized.

in/out

Transmitted/recognized.

8 MTC Start Offset (MIDI Time Code Start Offset)

Determines the specific time code point from which sequence playback starts, when MTC is received. This feature can be used to accurately align playback of this synthesizer with an external MTC-compatible device.

Settings: Hour: Minute: Second: Frame

Hour: 00 – 23

Minute: 00 – 59

Second: 00 – 59

Frame: 00 – 29

9 Bank Select

This switch enables or disables Bank Select messages, both in transmission and reception. When this is set to "on," this synthesizer responds to incoming Bank Select messages, and it also transmits appropriate Bank Select messages (when using the panel). When this is set to "off," Bank Select messages cannot be transmitted/received.

Settings: off, on

10 Program Change

This switch enables or disables Program Change messages, both in transmission and reception. When this is set to "on," this synthesizer responds to incoming Program Change messages, and it also transmits appropriate Program Change messages (when using the

panel). When this is set to “off,” Program Change messages cannot be transmitted/received.

Settings: off, on

11 Local Control

This determines whether or not the tone generator of the instrument responds to your keyboard playing. Normally, this should be set to “on”—since you’ll want to hear the sound of the MOTIF XS as you play it. Even if this is set to “off,” the data will be transmitted via MIDI. Also, the internal tone generator block will respond to messages received via MIDI.

Settings: off, on

12 Receive Bulk

Determines whether or not Bulk Dump data can be received.

Settings: protect (not received), on (received)

13 Controller Reset

Determines the status of the controllers (Modulation Wheel, Aftersustain, Foot Controller, Breath Controller, Knobs, etc.) when switching between voices. When this is set to “hold,” the controllers are kept at the current setting. When this is set to “reset,” the controllers are reset to the default states (below).

Settings: hold, reset

If you select “reset,” the controllers will be reset to the following states/positions:

Pitch Bend	Center
Modulation Wheel	Minimum
Aftersustain	Minimum
Foot Controller	Maximum
Footswitch	Off
Ribbon Controller	Center
Breath Controller	Maximum
Assignable Function	Off
Expression	Maximum
Sustain	Off

14 Bulk Dump Interval

Determines the interval time of the Bulk Dump transmission when the Bulk Dump function is used, the Bulk Request is received, or system exclusive messages recorded to a sequence track are played back. The Bulk Dump function lets you save the data in the Edit buffer (DRAM) or Flash ROM and transmit as Bulk data (system exclusive message) to an external MIDI instrument or sequence software on a computer. This data can then be sent back to the instrument, restoring all the settings you archived.

Settings: 0 – 900 ms

NOTE When the Bulk Dump function is used or the Bulk Request is received, the maximum value of the interval time is fixed to 30ms, meaning that the Bulk transmission is executed at an interval time of 30ms, even if this parameter is set to a value above 31ms. When system exclusive messages recorded to a track of a Song or Pattern are played back, value settings above 31ms will be available, meaning that the Bulk transmission is executed with the interval time as set here, regardless of the tempo setting of the Song or Pattern.

Resetting the User Memory to the Initial Factory Settings—[JOB] (Factory Set)

In the Utility Job mode, you can restore this synthesizer’s User memory (page 79) to the factory default settings (Factory Set). Please note that the setting of the Power On Auto Factory Set on this display will be stored automatically by executing the Factory Set.

⚠ CAUTION

When the factory settings are restored, all the Voice, Performance, Song, Pattern, and system settings in the Utility mode you created will be erased. Make sure you are not overwriting any important data. Be sure to save all important data to a USB storage device or to a computer connected to the same network as the MOTIF XS (page 278) before executing this procedure.



1 Power On Auto Factory Set

When this parameter is set to “on,” turning the power on will restore the User memory to the factory default settings and load the demo songs and demo patterns. Normally, this should be set to “off.”

Settings: on, off

⚠ CAUTION

When the Power On Auto Factory Set parameter is set to “on,” turning the power off erases all the User memory data such as Voice, Performance, Song, Pattern and Utility settings.

For instructions on executing the Factory Set Job, see page 22.

Sequencer Settings—[SEQ SETUP]

In the Song mode, Pattern mode or Performance mode, pressing the [SEQ SETUP] button calls up the display for setting the overall sequencer parameters. After setting these, press the [STORE] button to store the settings of both the Sequencer Setup parameters and the Utility parameters.

⚠ CAUTION

All Sequencer Setup settings will be lost if the power is turned off without storing.

NOTE In the Voice mode and Master mode with the Mode parameter (page 254) set to “Voice,” the [SEQ SETUP] button cannot be used.

Metronome Settings—[F1] Click

From this display you can set the parameters related to the click sound (metronome) that is used during recording or playback in the Song/Pattern/Performance mode.

NOTE Since the click sound is created with the internal tone generator, using click playback affects the overall polyphony of this synthesizer.

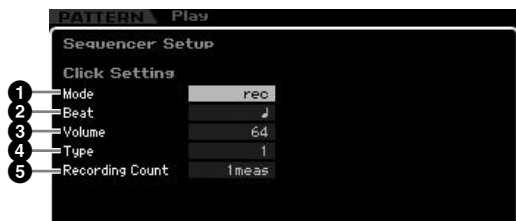

1 Mode

Determines whether and when the metronome click will sound.

Settings: off, rec, rec/play, always

off

The click will not sound.

rec

The click will sound during Song/Pattern/Performance recording only.

rec/play

The click will sound during recording and playback.

always

The click will always sound in the Song/Pattern mode.

2 Beat

Determines on which beats the metronome click will sound.

Settings: ♪ (16th notes), ♪ (8th notes), ♪ (quarter notes), ♪ (half notes), ♪ (whole notes)

3 Volume

Determines the click sound volume.

Settings: 0 – 127

4 Type

Determines the click sound type. Ten types are available, including conventional metronome and stick sounds.

Settings: 1 – 10

5 Recording Count

Determines the number of count-in measures provided before recording actually starts after pressing the [▶] (Play) button in the Record standby mode.

Settings: off (Recording starts as soon as the [▶] button is pressed), 1 meas – 8 meas

MIDI Filter Settings—[F2] MIDI Filter

From this display you can set which MIDI events will be recognized/transmitted via MIDI. The settings made here apply only to Song/Pattern playback data; they do not affect the MIDI events generated by your keyboard playing or panel operations and Arpeggio playback in the Voice and Performance modes. The Song/Pattern playback data will pass through the MIDI Filter before being sent to the internal tone generator block as well as the MIDI OUT connector.

MIDI messages transmitted from the external MIDI instrument will pass through the MIDI Filter before being recorded to the Song/Pattern track. They will be sent to the internal tone generator without passing through the MIDI Filter.

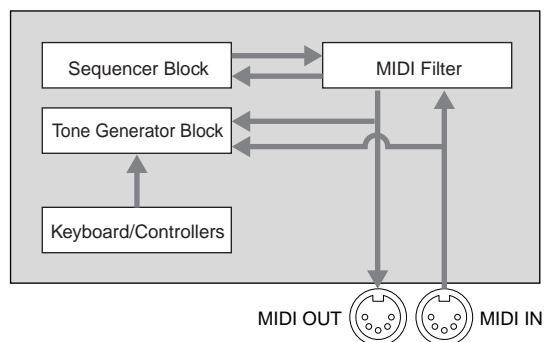

MIDI events to which the Filter is applied:

Note, Program Change, Control Change, Pitch Bend, Channel After Touch, Polyphonic After Touch, System Exclusive, Channel Mode Message

Settings: (not transmitted/recognized), (transmitted/recognized)

Using the Quick Setup function—[F3] Quick (Quick Setup)

From this display, you can instantly call up appropriate sequencer-related panel settings by selecting convenient preset setups, allowing you to simultaneously set a variety of important sequencer-related parameters.



NOTE The Track INT Switch and Track EXT Switch parameters are not available when calling up the Quick Setup window from the Performance mode.

1 Setup Number

Determines the Setup number. The parameter settings of the selected Setup are indicated as new settings on the right (3).

Settings: 1 – 4

1	Using internal Sequencer	This setup is useful when you use the internal sequencer function (Song or Pattern) by itself.
2	Recording internal sequencer to computer	This setup is useful when you transmit the Song or Pattern playback data to an external computer and record it to an application software on the computer.
3	Recording to computer	This setup is useful when you record your keyboard performance to an application software on the computer.
4	Recording Arpeggio to computer	This setup is useful when you transmit the Arpeggio playback data to an external computer and record it to an application software on the computer.

2 Current settings

Indicates the current settings of the related parameters. After selecting a Setup (1), indicated as new settings on the right (3), press the [ENTER] button to actually call up the selected Setup (1), which are then indicated as the current settings (2).

3 New settings

Indicates the parameter settings of the selected Setup above (1).

Other Settings for the Song/Pattern— [F4] Other

From this display you can set parameters related to the Song/Pattern mode, such as Pattern change timing.

NOTE The settings here do not affect the Performance mode.



1 Quantize

Determines the quantize value for Section (Pattern) switching during playback when you change the Section. When set to "1," Patterns (Sections) will always switch on the first beat of the next measure during playback after you change the Section. When set to "1/16," Sections can be switched on any 16th beat during playback.

Settings: 1 (1 measure), 1/2 (Half note), 1/4 (Quarter note), 1/8 (8th note), 1/16 (16th note)

2 Tempo Hold

Determines whether or not the tempo setting will switch to the tempo value stored with each Pattern when a new Pattern is selected during playback. When set to "on," the tempo will be retained when Patterns are switched. When set to "off," the tempo will switch to that stored with the new Pattern when Patterns are switched. Normally, set this to "off."

Settings: on, off

NOTE The tempo setting data in the Pattern Chain is not affected by this parameter.

3 Load Mixing

Determines whether the Mixing settings are loaded (on) or not (off) when the Song/Pattern number is changed. Normally, set this to "on."

Settings: on, off

NOTE When the Load Mixing parameter is set to "off," song changes via Song Chain playback do not change the Mixing setup.

4 Song Event Chase

Normally, if a Song or Pattern is played back from mid-point and/or fast-forward or rewind are used, certain data types (such as Program Change, Pitch Bend, and Control Change) may not play back as expected. Setting this to a specific event ensures the playback integrity of the event, even when fast forwarding or rewinding.

Settings: off, PC (Program Change), PC+PB+Ctrl (Program Change + Pitch Bend + Control Change)

NOTE Keep in mind that settings other than "off" may result in slower operation—for example, a pause before starting playback, or slower rewind/fast-forward speed.

NOTE When this is set to "all," an excessive amount of MIDI data may be generated, possibly resulting in a MIDI error on the connected device.

File Management (File mode)

The File mode provides tools for transferring data (such as Voice, Performance, Song, Pattern and Waveform) between the MOTIF XS and external storage devices such as USB storage device and hard disk unit connected to the USB TO DEVICE connector. By mounting the hard disk drive of the computer connected to the MOTIF XS via the network, you can also transfer data between the MOTIF XS and an online computer.

To enter the File mode, press the [FILE] button. The file types available differ depending on the mode selected before calling up the File mode.

NOTE When the MOTIF XS is connected to a network, the File mode can be used to access the drives of computers on the network. To do this, make sure the MOTIF XS is properly connected to the network (page 86) and set the necessary parameters in the Network display (page 260) of the Utility mode.

Terminology in the File mode

File

Just as with a computer, various data types such as Voice, Performance, Song and Pattern created on the MOTIF XS can be treated as a file and saved to an external USB storage device or the hard disk drive of a computer connected to the network.

File Name

Just as with a computer, you can assign the name to the file in the File mode. The file name can contain up to 20 alphabetical characters on the display of the MOTIF XS. Files having the same name cannot be saved in the same directory.

Extension

The three letters following the file name (after the period) such as “.mid” and “.wav” are referred to as a file “extension.” The extension indicates the type of file and cannot be changed by the panel operation of the MOTIF XS. The File mode of the MOTIF XS supports ten different extension types, according to the particular data. For details, see page 273.

File size

Refers to the memory amount of the file. The file size is determined by the amount of data saved to the file. Generally, the size of an audio file including the Waveforms is much larger than the size of a MIDI file. File sizes are indicated in conventional computer terms by B (Byte), KB (Kilo Byte), MB (Mega Byte) and GB (Giga Byte). 1KB is equivalent to 1024 Byte, 1MB is equivalent to 1024KB, and 1GB is equivalent to 1024MB.

Device

Refers to a memory storage unit (such as a hard disk) to which the file is saved. The MOTIF XS can handle and mount various types of USB storage devices connected to the USB TO DEVICE connector computer drives connected via network to the MOTIF XS.

Directory (Dir)

This is an organizational feature on a data storage device (such as hard disk), allowing you to group data files together according to type or application. Directories can be nested in hierarchical order for organizing data. The “directory” is equivalent to the “folder” used as a computer term. The File mode of the MOTIF XS allows you to assign a name to a directory like a file. Please note that the directory name does not contain the extension.

Changing the current directory (folder)

Using the illustration below as an example, this shows you how to change the current directory. First, open the root directory to find directories A and B. Next, open the directory A to find directories C and D. Finally, open the directory C to find only the files saved in the directory C. This allows you to call up folders nested down in the lower levels of the folder hierarchy.

To select a different directory higher up (for example, moving from directory C to directory B), first go to the next highest level (directory A). Next, go up one more level (to the root directory). Now that both A and B are available, open directory B. In this way you can move up or down through the folder hierarchy.

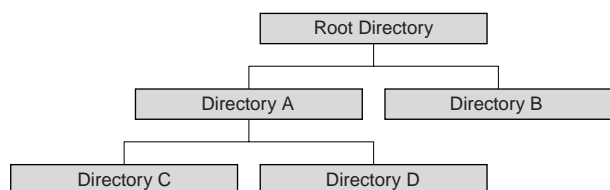

NOTE To go down from the current directory in the File window (page 275), move the cursor to the desired directory in the Directory/File list then press the [ENTER] button. To go up from the current directory, move the cursor to the top line in the Directory/File list then press the [ENTER] button.

Path

The location of the directories (folders) and files currently indicated at the “Dir” line on the display is referred to as a “path.” This indicates the current directory, what device it belongs to, and in which folder(s) it is contained. “Directory C” illustrated above is described as path “USB_HDD/A/C.”

Mount

Refers to the operation so that an external memory device becomes active for the instrument. The USB storage device is automatically mounted as soon as connected to the USB TO DEVICE connector on the rear panel of the MOTIF XS. The hard disk drive of the computer connected to the MOTIF XS via the network can be mounted in the Mount display (page 277).

Format

The operation of initializing a storage device (such as a hard disk) is referred to as “format.” The File mode of the MOTIF XS allows you to format the USB memory storage device connected to the USB TO DEVICE connector. The format operation erases all data from the target memory device and is irreversible.

Save/Load

“Save” means that the data created on the MOTIF XS is saved to the external memory device as a file, while “Store” means that the data created on the MOTIF XS is stored to internal memory. “Load” means that the file on the external memory device is loaded to internal memory.

File types that can be handled by the MOTIF XS

The MOTIF XS supports various file types that can be saved and loaded. Refer to the following two lists.

File types that can be saved

Type	File extension*	Description
All	.XOA	All data in this synthesizer's internal User Memory (Flash ROM) is treated as a single file, and can be saved to the USB storage device.
All Voice	.XOV	All the User Voice data in this synthesizer's internal User Memory (Flash ROM) is treated as a single file, and can be saved to the USB storage device. Also the Waveforms obtained via the Sampling function and assigned to any of the Voices are saved together.
All Arpeggio	.XOG	All the User Arpeggio data in this synthesizer's internal User Memory (Flash ROM) is treated as a single file, and can be saved to the USB storage device.
All Song	.XOS	All the User Song data in this synthesizer's internal User Memory (Flash ROM) is treated as a single file, and can be saved to the USB storage device. The Song data includes Mixing settings, Mixing Voices and Sample Voices.
All Pattern	.XOP	All the User Pattern data in this synthesizer's internal User Memory (Flash ROM) is treated as a single file, and can be saved to the USB storage device. The Pattern data includes Mixing settings, Mixing Voices and Sample Voices.
SMF	.MID	Sequence track (1 – 16) and Tempo track data of Songs or Patterns created in the Song/Pattern mode can be saved to the USB storage device as Standard MIDI File (format 0) data.
All Waveform	.XOW	Sample data created in the Sampling mode can be saved to the USB storage device as a WAV file (Windows audio format). The Waveform data includes all the Samples (waves).
WAV	.WAV	A Sample created in the Sampling mode can be saved to the USB storage device as a WAV file (Windows audio format).
AIFF	.AIF	A Sample created in the Sampling mode can be saved to the USB storage device as an AIFF file (Macintosh audio format).

* Automatically assigned to the saved file.

File types that can be loaded

Type	File extension*	Description
All	.XOA	Files of the “All” type saved to the USB storage device can be loaded and restored to the instrument. When the box at the left of “without System” is checkmarked, only the Utility mode settings will not be loaded.
all without system	.XOA	Files of the “all” type saved to the USB storage device can be loaded and restored to the instrument, with the exception of the Utility and Sequencer Setup settings.
All Voice	.XOV	Files of the “All Voice” type saved to the USB storage device can be loaded and restored to the instrument.

Voice mode

Performance mode

Sampling mode 1

Song mode

Pattern mode

Mixing mode













Sampling mode 2

Master mode

Utility mode

File mode

Reference

Type	File extension*	Description
Voice	.X0A .X0V	A specified Voice in a file that is saved to the USB storage device as "All" or "All Voice" type can be individually selected and loaded to the instrument. Please note that the file icons  of "X0A" and "X0V" are changed to  (as virtual folders) when this file type is selected (page 280).
Performance	.X0A	A specified Performance in a file that is saved to the USB storage device as "All" type can be individually selected and loaded to the instrument. Please note that the file icon  of "X0A" is changed to  (as a virtual folder) when this file type is selected (page 282).
All Arpeggio	.X0G	Files of the "All Arpeggio" type saved to the USB storage device can be loaded and restored to the instrument.
All Song	.X0S	Files of the "All Song" type saved to the USB storage device can be loaded and restored to the instrument.
Song	.X0A .X0S .MID	A specified Song in a file that is saved to the USB storage device as "All" or "All Song" type can be individually selected and loaded to the instrument. Please note that the file icons  of "X0A" and "X0S" are changed to  (as virtual folders) when this file type is selected (page 283).
All Pattern	.X0P	Files of the "All Pattern" type saved to the USB storage device can be loaded and restored to the instrument.
Pattern	.X0A .X0P .MID	A specified Song in a file that is saved to the USB storage device as "All" or "All Pattern" type can be individually selected and loaded to the instrument. Please note that the file icons  of "X0A" and "X0P" are changed to  (as virtual folders) when this file type is selected (page 283).
All Waveform	.X0W	Files of the "All" or "All Waveform" types saved to the USB storage device can be loaded and restored to the instrument.
Waveform	.X0A .X0W	A specified Waveform in a file that is saved to the USB storage device as "All" or "All Waveform" type can be individually selected and loaded to the instrument. Please note that the file icons  of "X0A" and "X0W" are changed to  (as virtual folders) when this file type is selected (page 281).
WAV	.WAV	WAV format files can be loaded to the instrument. For details, see page 284.
AIFF	.AIF	AIFF format files can be loaded to the instrument. For details, see page 284.
Sample Voice	.X0A .X0S .X0P	A specified Sample Voice in a file that is saved to the USB storage device as "All" or "All Song" or "All Pattern" type can be individually selected and loaded to the instrument. Please note that the file icons  of "X0A," "X0S" and "X0P" are changed to  (as virtual folders) when this file type is selected (page 283). This file type is available only when entering the File mode from the Song mode/Pattern mode.
MOTIF XS Editor	.X0E	The file (.X0E) created via the MOTIF XS Editor software (available from the Yamaha site) on your computer can be loaded to the instrument. The file of this editor type includes all User Voices and Mixing data handled by the MOTIF XS. Note that only User Voice data can be loaded to the MOTIF XS.

* Assigned to the file which can be loaded.

Data Compatibility with the MOTIF ES6/MOTIF ES7/MOTIF ES8

Among the data created on the MOTIF ES6/MOTIF ES7/MOTIF ES8, Voices, Performances, Waveforms, Sample Voices can be loaded to the MOTIF XS6/MOTIF XS7/MOTIF XS8.

• "All" data of the MOTIF ES

Files of the "All" type (extension: W7A) saved to the USB storage device connected to the MOTIF ES can be loaded to the MOTIF XS. To do this, set the Type to "All" in the [F1] File window of the MOTIF XS.

• Voices

A specified Voice in a file (extension: W7A, W7V) that is saved to the storage device as "All" or "All Voice" type on the MOTIF ES can be individually selected and loaded to the MOTIF XS. Set the Type in the [F1] File display to "Voice" and execute the Load procedure. All Voice data in a file (extension: W7A) that has been saved to the storage device as "All" type on the MOTIF ES can be selected and loaded to the MOTIF XS.

Likewise, a file (extension: W7V) that is saved to the USB storage device as "All Voice" type on the MOTIF ES can be loaded to the MOTIF XS. Set the Type in the [F1] File display to "All Voice" and execute the Load procedure. In addition, Voice Editor files (extension: W7E) can be loaded to the MOTIF XS. Set the Type in the [F1] File display to "Voice Editor" and execute the Load procedure.

NOTE The Voices loaded to the MOTIF XS 6/7/8 may not produce the exact same sound as those on the original MOTIF ES 6/7/8, since the contents of the preset Waveforms and the Effect structure are different between the two instrument series.

• Performance

A specified Performance in a file (extension: W7A) that is saved to the storage device as "All" type on the MOTIF ES can be individually selected and loaded to the MOTIF XS. Set the Type in the [F1] File display to "Performance" and execute the Load procedure.

• Waveforms

A specified Waveform in a file (extension: W7A, W7W) that is saved to the storage device as "All" or "All Waveform" type on the MOTIF ES can be individually selected and loaded to the MOTIF XS. Set the Type in the [F1] File display to "Waveform" and execute the Load procedure. Likewise, a file (extension: W7W) that is saved to the storage device as "All Waveform" type on the MOTIF ES can be loaded to the MOTIF XS. Set the Type in the [F1] File display to "All Waveform" and execute the Load procedure.

• Sample Voices

A specified Sample Voice (extension: W7A, W7S, W7P) in a file that is saved to the storage device as "All" or "All Song" or "All Pattern" type on the MOTIF ES can be individually selected and loaded to the MOTIF XS. Set the Type in the [F1] File display to "Sample Voice" and execute the Load procedure.

File Type Setting example when saving:

Data to be saved		File type
All data		All
User Voice		All Voice
Performance		All
Songs	When User Voices are used in the Songs:	All
	When no User Voices are used in any of the Songs:	All Song
	When you wish to transfer a Song to an external MIDI sequencer or computer:	SMF
Pattern	When User Voices are used in the Patterns:	All
	When User Voices are not used in all the Patterns:	All Pattern
	When you wish to transfer a Pattern to an external MIDI sequencer or computer:	SMF
Sampling data	All waveforms	All Waveform
	When you wish to transfer a Sample to a computer:	WAV, AIFF

File Management—[F1] File

The File window lets you use all file-related functions such as device selection, selecting a path, save, load, rename and delete.

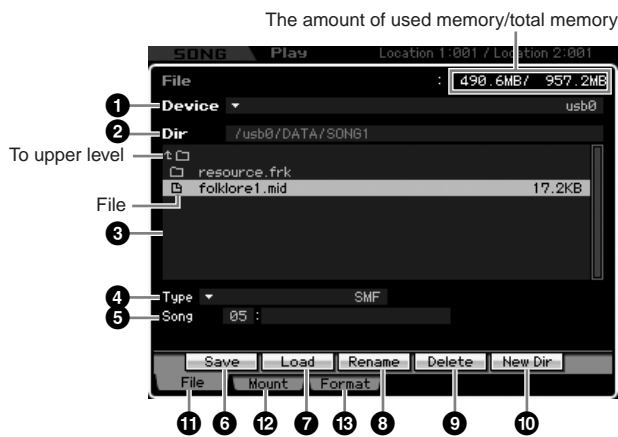

1 Device

Here, you can select the desired device from the ones mounted (recognized) by the File mode. The device selected here is called “Current Device.” When selecting a device, the root directory of the selected device appears in the Dir column. The amount of used memory and total memory on the selected device appears at the top right of the display.

NOTE You can call up the list by pressing the [SF6] LIST button then select the desired item from the list. For details, see page 82.

2 Dir (Directory)

Indicates the current directory with the path. The contents (files and folders) included in the current directory are listed in the Directory/File list box below. The current directory can be changed in the Directory/File list box below.

3 Directory/File list

Indicates the directories and files in the current Directory. In this box, the directories and files are listed in alphabetical order, with the exception of the top line which is provided for moving to the next highest directory. You can distinguish the directory and file by the indicator at left end of each line.

□ Directory (Folder)

▣ File

The directory name is shown on the Directory line while the file name with the extension and file size are shown on the File line.

Moving between the directory levels

To go down from the current directory, move the cursor to the desired directory in the Directory/File list then press the [ENTER] button. To go up from the current directory, move the cursor to the top line in the Directory/File list then press the [ENTER] button.

4 Type

Determines the data type to be saved or loaded. The available type differs depending on the mode selected before calling up the File mode. For details about the data types, see pages 273 and 274. You can call up the File Type List by pressing the [SF6] LIST button then select the desired one from the list. For details, see page 82.

5 Memory location of the data type above

Determines the memory location of the data type above such as Voice Bank/number, Performance Bank/Number, Song number and Pattern number. The available values differ depending on the Type setting above. For details about the source memory to be saved, see page 278. For details about the target memory to be loaded, see page 280.

6 [SF1] Save

Pressing this button executes the Save operation. For detailed instructions on saving, see page 278.

7 [SF2] Load

Pressing this button executes the Load operation. For detailed instructions on loading, see page 280.

8 [SF3] Rename

Pressing this button calls up the window for entering the new name of the selected file. The File name can contain up to 20 characters. For detailed instructions on naming, refer to “Basic Operation” on page 82.

Follow the instructions below to change the name of the file.

- 1 Select a file to be renamed by moving the cursor in the Directory/File list.
- 2 Press the [SF3] button to call up the Input Character window.
- 3 Enter the new name of the selected file.
- 4 Press the [ENTER] button to actually change the name of the selected file.

9 [SF4] Delete

Pressing this button to call up the Delete window.

Follow the instructions below to delete a file.

- 1 Select a file to be deleted by moving the cursor in the Directory/File list.
- 2 Press the [SF4] button to call up the Delete window.
- 3 Press the [ENTER] button to delete the selected file.

10 [SF5] New Dir (New Directory)

Pressing this button creates a new directory in the current directory. The directory name can contain up to 10 characters. For detailed instructions on naming, refer to “Basic Operation” on page 82.

Follow the instructions below to create a new directory.

- 1 Press the [SF5] button to call up the Input Character window.
- 2 Enter the name of the new Directory.
- 3 Press the [ENTER] button to actually enter the name of the newly created directory.

11 [F1] File

Pressing this button calls up the File window from another window in the File mode.

12 [F2] Mount

Pressing this button calls up the Mount window. For details, see page 277.

13 [F3] Format

Pressing this button calls up the Format window. For details, see page 278.

Basic Procedure in the File mode**1 Press the [FILE] button to enter the File mode.**

The File window (page 275) appears.

2 Mount the memory devices to which the file is saved or from which the file is loaded.

The USB storage device is automatically mounted as soon as it is connected to the USB TO DEVICE connector on the rear panel. The hard disk drive of the computer connected to the MOTIF XS via the network can be mounted in the Mount display (page 277).

3 Select the desired device.

Select the desired device from the ones mounted in step 2.

4 Move the path to the desired directory.

Select the desired directory in the selected device. To go down from the current directory, move the cursor to the desired directory in the Directory/File list then press the [ENTER] button. To go up from the current directory, move the cursor to the top line in the Directory/File list then press the [ENTER] button. The Dir line indicates the current directory name with the path and the lower box lists the directories and files belonging to the current directory.

NOTE If you wish to create a new directory and save the file there, press the [SF5] New Dir button. For detailed instructions on creating a new directory, see the left column.

5 Select the desired data type from the Type column (4).

In the Directory/File list box, only files related to the selected file type are listed.

NOTE Depending on the mode selected before calling up the File mode, the available data types differ. If you cannot find the data type which you wish to handle, for example “voice,” press the [EXIT] button to exit from the File window, press the [VOICE] button to enter the Voice mode, then press the [FILE] button to call up the File window again.

6 Select the desired file by moving the cursor in the Directory/File list (3).

This operation is not necessary when you execute Save or New Directory. When you wish to execute the Rename or Delete operation, press the [SF3] Rename button or the [SF4] Delete button. For detailed instructions on renaming and deleting, see page 276 and left column.

7 Select a memory location of the data type specified in step 5 as source or destination.

When you wish to execute the Save or Load operation, press the [SF1] Save button or the [SF2] Load button. For detailed instructions on saving and loading, see pages 278 and 280.

Online Device Mounting—[F2] Mount

From this display, you can mount the shared directories on the hard disk drive of a computer connected via network to the MOTIF XS.



1 Host

From the computers connected to the network, this parameter determines the host computer containing the device is to be mounted. Here, the computer name set in your computer is shown.

You can call up the Device List by pressing the [SF6] LIST button then select the desired item from the list. For details, see page 82. Here, the computer name set in your computer is shown.

NOTE If the desired computer name is not shown in the Host (1) parameter, you can call up the Character List by pressing the [SF5] CHAR button and enter the computer name manually. For detailed instructions on naming, refer to “Basic Operation” on page 82.

NOTE Confirm the computer name on your computer. For details, refer to the owner’s manual of your computer.

2 Sharing Point

Here, the shared directories of the host computer set above are listed. You can also mount or unmount each of the shared directories.

NOTE Keep in mind that the names of the shared folders authorized on the computer are shown here.

Mounting/Unmounting a directory

You can mount the shared directory by moving the cursor to the desired directory then pressing the [ENTER] button. The mount indicator appears at the left side of the name of the mounted directory. You can unmount the shared directory by pressing the [ENTER] button again. The mount indicator disappears.

Mount Procedure

Follow the instructions below to mount the memory drive of the computer connected to the network.

1 Connect the MOTIF XS to the network.

Network related parameters can be set in the Network display (page 260) in the Utility mode.

2 Press the [FILE] button to enter the File mode, then press the [F2] button to call up the Mount window.

3 Select a host computer at the Host column (1).

If the desired computer name is not shown in the Host (1) parameter, you can call up the Character List by pressing the [SF5] CHAR button and enter the computer name manually. For detailed instructions on naming, refer to “Basic Operation” on page 82. If you select a computer which has not been accessed by the MOTIF XS, “Press [ENTER] to access” appears on the display. When pressing the [ENTER] button, the display prompts you to enter the password as illustrated below. Here, enter the User Account of your computer to the User Name box, enter the password of your computer to the Password box, then press the [ENTER] button so that the access between the MOTIF XS and the computer is established. The shared directories of the selected computer are listed in the Sharing Point box (2).



NOTE Once access between the MOTIF XS and the computer has been established, the shared directories are automatically listed in the display simply by selecting a computer from the Host column. If the power is turned off, the operations for establishing the access (entering the User Account and Password) are necessary after turning the power on next time.

NOTE For details about how to confirm the User Account and Password of your computer, refer to the owner’s manual of your computer.

NOTE When a Password is not assigned to your computer, simply pressing the [ENTER] button without inputting any characters establishes the access between the MOTIF XS and your computer.

4 Mount the desired directories.

In the Sharing Point box (2), you can mount the shared directory by moving the cursor to the desired directory, then pressing the [ENTER] button. The mount indicator appears at the left side of the name of the mounted directory. You can unmount the shared directory by pressing the [ENTER] button again. The mount indicator disappears. The mounted directories can be selected in the File window (page 275).

Formatting a Device—[SF3] Format

From this display, you can format memory storage devices such as a hard disk connected to the USB TO DEVICE connector.



① Device

The connected and mounted devices are listed here, letting you select the device to be formatted. A device that requires formatting is indicated by “unknown device (usb***).” The three asterisks (***) in the indication denote the sequential serial numbers of the connected devices which need to be formatted. When several partitions are included in a single device, the partition number is indicated at the right of the serial number.

② Volume Label

Determines the Volume Label of the selected device. The Volume Label is the name assigned to the device. The Volume Label can contain up to 11 characters. For detailed instructions on naming, refer to “Basic Operation” on page 82.

Format Procedure

- 1 Connect the device to be formatted to the USB TO DEVICE terminal.
- 2 Select a device to be formatted from the Device list (①).
- 3 Enter the Volume Label (②) as desired.
- 4 Press the [ENTER] button. (The display prompts you for confirmation.)
Press the [DEC/NO] button to cancel the Format.
- 5 Press the [INC/YES] button to execute the Format operation.

⚠ CAUTION

If you format the device, all the previously recorded data will be deleted. Make sure to check beforehand whether or not the device contains important data. When checking the contents of the device in the [F1] File window, keep in mind that some files (which are not listed on pages 273 and 274) are not shown on the display of the MOTIF XS, even if the File Type is set to “all.”

Saving a file

The saving procedure differs depending on the file type to be saved and the mode selected before calling up the File window. This section explains the procedure relevant to following three cases.

- Saving all user data or all data of a specific type
- Saving the sample of a specific Voice
- Saving a Song or a Pattern Section as a Standard MIDI File

Saving all user data or all data of a specific type



- 1 Select a device and directory as destination by following “Basic Procedure in the File mode” on page 276.

NOTE When you wish to save all 64 songs, press the [SONG] button to enter the Song mode then press the [FILE] button to call up the File window. When you wish to save all 64 patterns, press the [PATTERN] button to enter the Pattern mode then press the [FILE] button to call up the File window.

NOTE Follow the instructions below after selecting a Voice, Performance, Song or Pattern to which the Sample to be saved is assigned in each of the modes.

- 2 Set the Type to the desired one of “all,” “all voice,” “all arpeggio,” “all waveform,” “editor,” “all song,” and “all pattern.”
- 3 Press the [SF1] Save button to call up the window for entering the file name.
- 4 Enter the file name, press the [ENTER] button then the [INC/YES] button to save the data of the specified type to the external memory device.

The file name can contain up to 20 characters. For detailed instructions on naming, refer to “Basic Operation” on page 82.

Saving the sample of a specific Voice

You can save the sample of a specific Voice to an external memory device as a WAV file or an AIFF file for storage or editing on a computer. This method is available when entering the File mode from any mode. For details about file types that can be saved, see page 273.



NOTE When entering the File mode from the Performance mode/Song mode/Pattern mode and saving/loading the sample assigned to the Normal Voice, only the sample assigned to the Element 1 is available.

1 Select a device and directory as destination by following “Basic Procedure in the File mode” on page 276.

2 Set the Type to “WAV” or “AIFF.”

NOTE Keep in mind that some parameter settings, such as Start Point, are not saved when saving the Sample of a specific Voice as WAV or AIFF format. This means that the WAV file or AIFF file saved in the File mode will be played back from the top (including the section before the Start Point) on an external device, such as a computer.

3 Select the source data.

When entering the File mode from the Voice mode, select an Element (for a Normal Voice) and Key to which the Sample to be saved is assigned. When entering the File mode from the Performance/Song/Pattern mode, select a Part and Key to which the Voice including the Sample to be saved is assigned.

NOTE Preset Waveforms cannot be saved to an external storage device. If you select a Performance/Song/Pattern Part to which the preset Voice is assigned or you select a Normal Voice Element or Drum Voice Key to which the preset Waveform is assigned, an error message appears.

NOTE The available source data differs depending on the mode selected before entering the File mode. When entering the File mode from the Voice mode, the available source data differs depending on the type of the already selected Voice: Normal Voice or Drum Voice. Make sure to select a Voice/Performance/ Song/Pattern to which the desired Sample is assigned before entering the File mode.

4 Press the [SF1] Save button to call up the window for selecting a Key Bank.

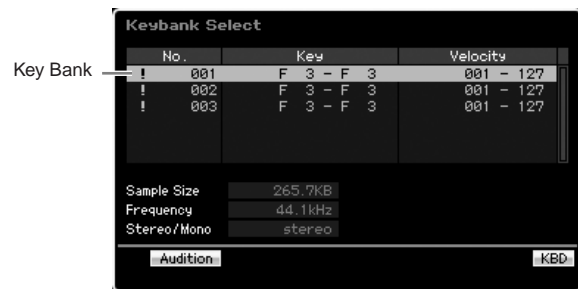

NOTE For information about this window, refer to the explanation about the Keybank parameter in the Sampling Main display described on page 162.

5 Select a Key Bank to which the sample is assigned by moving the cursor.

Press the [SF1] Audition button to hear the sampled sound.

6 Press the [ENTER] button to call up the window for entering the file name.

7 Enter the file name, press the [ENTER] button then the [INC/YES] button to save the data to the external memory device.

The file name can contain up to 20 characters. For detailed instructions on naming, refer to “Basic Operation” on page 82.

Saving a Song or a Pattern Section as a Standard MIDI File

You can save a Song or a Pattern Section as a Standard MIDI File in the File mode. The Standard MIDI File format is common and can be used on other MIDI sequencers and computer music software. This method is available when entering the File mode from the Song mode/Pattern mode.



1 Select a device and directory as destination by following “Basic Procedure in the File mode” on page 276.

2 Set the Type to “SMF.”

3 Select the source data.

NOTE The available source memory differs depending on the mode selected before entering the File mode. When you want to save a Song, enter the File mode from the Song mode. When you want to save a Pattern, enter the File mode from the Pattern mode.

4 Press the [ENTER] button to call up the window for entering the file name.

5 Enter the file name, press the [ENTER] button then the [INC/YES] button to save the data to the external memory device.

The file name may contain up to 20 characters. For detailed instructions on naming, refer to “Basic Operation” on page 82.

Loading a file

The loading procedure differs depending on the file type to be loaded and the mode selected before calling up the File window. This section explains the procedure relevant to following eight cases.

- Loading all user data or all data of a specific type (all voices, all songs, all patterns, etc.)
- Loading a specific Voice from an “all” or “all voice” file
- Loading a specific Waveform from an “all” or “all waveform” file
- Loading a specific Performance from an “all” file
- Loading a specific Song or Pattern from an “all” or “all song” or “all pattern” file
- Loading a specific Sample Voice from an “all” or “all song” or “all pattern” file
- Loading a WAV file or an AIFF file
- Loading a SMF file (Standard MIDI file)

Loading all user data or all data of a specific type



1 Select a device and directory including the source file by following “Basic Procedure in the File mode” on page 276.

NOTE When you wish to load all 64 Songs, press the [SONG] button to enter the Song mode then press the [FILE] button to call up the File window. When you wish to load all 64 Patterns, press the [PATTERN] button to enter the Pattern mode then press the [FILE] button to call up the File window.

2 Set the Type to the desired one of “all,” “all without system,” “all voice,” “all arpeggio,” “all waveform,” “editor,” “all song,” and “all pattern.”

Only available files according to the Type are listed in the Directory/File list box on the display.

3 Select the file to be loaded.

You can select any of the files listed in the Directory/File list box on the display.

4 Press the [SF2] button (a prompt for confirmation appears).

Press the [DEC/NO] button to cancel the Load operation.

5 Press the [INC/YES] button to execute the Load operation.

⚠ CAUTION

The Load operation overwrites any data previously existing in the destination internal memory. Important data should always be saved to a USB storage device connected to the USB TO DEVICE terminal or to a computer connected to the same network as the MOTIF XS (page 278).

Loading a specific Voice from an “all” or “all voice” file



1 Select a device and directory as source by following “Basic Procedure in the File mode” on page 276.

2 Set the Type to “voice.”

Only available files according to the Type are listed in the Directory/File list box on the display.

NOTE In this step, the Load menu corresponding to the [SF2] button is not shown in the display. The Load menu appears when selecting a Voice to be loaded in step 6.

3 Specify the destination memory location in the User memory.

Select a Voice Bank and number as destination.

NOTE When entering the File mode from the Performance/Song/Pattern mode, set a Part to which the loaded Voice is to be assigned as well as a Voice Bank and number.

NOTE When loading a Drum Voice, select the User Drum Voice Bank (UDR) as the destination memory location (5). When loading a Normal Voice, select one of the User Normal Voice Banks (USR1 – 3) as the destination memory location (5). If the appropriate Voice Bank is not set, pressing the [SF2] Load button calls up an error message.

4 Move the cursor to the file to be loaded.

You can select any of the files listed in the Directory/File list box on the display.

5 Press the [ENTER] button so that the Voices of the specified Bank are listed in the Directory/File list box.

When the Normal Voice Bank is selected in step 3, you can change the Voice Bank as source by pressing one of the Bank buttons (USR1 – 3) on the front panel.



Voice List

6 Move the cursor to the desired Voice.

The Load menu corresponding to the [SF2] button appears.

7 Press the [SF2] button (a prompt for confirmation appears).

Press the [DEC/NO] button to cancel the Load operation.

8 Press the [INC/YES] button to execute the Load operation.

CAUTION

The Load operation overwrites any data previously existing in the destination internal memory. Important data should always be saved to a USB storage device connected to the USB TO DEVICE terminal or to a computer connected to the same network as the MOTIF XS (page 278).

Loading a specific Waveform from an “all” or “all waveform” file



1 Select a device and directory as source by following “Basic Procedure in the File mode” on page 276.

2 Set the Type to “waveform.”

Only available files according to the Type are listed in the Directory/File list box on the display.

NOTE In this step, the Load menu corresponding to the [SF2] button is not shown in the display. The Load menu appears when selecting a Waveform to be loaded in step 6.

3 Specify the destination memory location in the User memory.

Select an Element (for a Normal Voice) to which the Waveform (loaded to an empty number) is to be assigned.

NOTE When entering the File mode from the Performance/Song/Pattern mode, set a Part to which the Voice including the loaded Waveform is to be assigned.

NOTE Please note that Waveforms cannot be loaded to a Drum Voice.

4 Select the file to be loaded.

You can select any of the files listed in the Directory/File list box on the display.

- 5 Press the [ENTER] button so that the Waveforms in the selected file are listed on the display.

Waveforms



- 6 Move the cursor to the desired Waveform. The Load menu corresponding to the [SF2] button appears.

- 7 Press the [SF2] button (a prompt for confirmation appears).

Press the [DEC/NO] button to cancel the Load operation.

- 8 Press the [INC/YES] button to execute the Load operation.

CAUTION

The Load operation overwrites any data previously existing in the destination internal memory. Important data should always be saved to a USB storage device connected to the USB TO DEVICE terminal or to a computer connected to the same network as the MOTIF XS (page 278).

Loading a specific Performance from an “all” file

This method is available only when entering the File mode from the Performance mode.



- 1 Select a device and directory as source by following “Basic Procedure in the File mode” on page 276.

- 2 Set the Type to “performance.”

Only available files according to the Type are listed in the Directory/File list box on the display.

NOTE In this step, the Load menu corresponding to the [SF2] button is not shown in the display. The Load menu appears when selecting a Performance to be loaded in step 6.

- 3 Specify the destination memory location in the User memory.

Select a Performance Bank and number.

NOTE When the Performance number is set to “all,” all the Performances in the selected Bank will be loaded.

- 4 Select the file to be loaded.

You can select any of the files listed in the Directory/File list box on the display.

- 5 Press the [ENTER] button so that the Performances in the selected Bank are listed on the display.

You can change the Performance Bank as source by pressing the Bank buttons on the front panel.

Performances



- 6 Move the cursor to the desired Performance.

The Load menu corresponding to the [SF2] button appears.

- 7 Press the [SF2] button (a prompt for confirmation appears).

Press the [DEC/NO] button to cancel the Load operation.

- 8 Press the [INC/YES] button to execute the Load operation.

CAUTION

The Load operation overwrites any data previously existing in the destination internal memory. Important data should always be saved to a USB storage device connected to the USB TO DEVICE terminal or to a computer connected to the same network as the MOTIF XS (page 278).

Loading a specific Song or Pattern from an “all” or “all song” or “all pattern” file

This method is available only when entering the File mode from the Song mode or Pattern mode.



1 Select a device and directory as source by following “Basic Procedure in the File mode” on page 276.

2 Set the Type to “song” or “pattern.”

Only available files according to the Type are listed in the Directory/File list box on the display.

NOTE In this step, the Load menu corresponding to the [SF2] button is not shown in the display. The Load menu appears when selecting a Song or Pattern to be loaded in step 6.

3 Specify the destination memory location in the User memory.

Select a Song number or Pattern number.

4 Select the file to be loaded.

You can select any of the files listed in the Directory/File list box on the display.

5 Press the [ENTER] button so that the Songs or Patterns in the selected file are listed on the display.



6 Move the cursor to the desired Song or Pattern.

The Load menu corresponding to the [SF2] button appears.

7 Press the [SF2] button (a prompt for confirmation appears).

Press the [DEC/NO] button to cancel the Load operation.

8 Press the [INC/YES] button to execute the Load operation.

⚠ CAUTION

The Load operation overwrites any data previously existing in the destination internal memory. Important data should always be saved to a USB storage device connected to the USB TO DEVICE terminal or to a computer connected to the same network as the MOTIF XS (page 278).

Loading a specific Sample Voice from an “all” or “all song” or “all pattern” file

This method is available only when entering the File mode from the Song mode or Pattern mode.



1 Select a device and directory as source by following “Basic Procedure in the File mode” on page 276.

2 Set the Type to “sample voice.”

Only available files according to the Type are listed in the Directory/File list box on the display.

NOTE In this step, the Load menu corresponding to the [SF2] button is not shown in the display. The Load menu appears when selecting a Sample Voice to be loaded in step 7.

3 Specify the destination memory location in the User memory.

Select a Part to which the loaded Sample Voice is to be assigned.

NOTE The Sample Voice is loaded to an empty number assigned to the Song or Pattern selected before entering the File mode.

4 Select the file to be loaded.

You can select any of the files listed in the Directory/File list box on the display.

5 Press the [ENTER] button so that the Songs or Patterns in the selected file are listed on the display.**6 Press the [ENTER] button so that the Sample Voices in the selected Song or Pattern are listed on the display.****7 Move the cursor to the desired Sample Voice.**

The Load menu corresponding to the [SF2] button appears.

8 Press the [SF2] button (a prompt for confirmation appears).

Press the [DEC/NO] button to cancel the Load operation.

9 Press the [INC/YES] button to execute the Load operation.**⚠ CAUTION**

The Load operation overwrites any data previously existing in the destination internal memory. Important data should always be saved to a USB storage device connected to the USB TO DEVICE terminal or to a computer connected to the same network as the MOTIF XS (page 278).

Loading a WAV file or an AIFF file**1 Select a device and directory as source by following “Basic Procedure in the File mode” on page 276.****2 Set the Type to “WAV” or “AIFF.”**

Only available files according to the Type are listed in the Directory/File list box on the display.

3 Specify the destination memory location in the User memory.

Select an Element (for a Normal Voice) or Key (for a Drum Voice) to which the WAV or AIFF file (loaded to an empty Waveform number) is to be assigned.

NOTE When entering the File mode from the Performance/Song/Pattern mode, set a Part to which the Voice including the loaded WAV or AIFF file is to be assigned.

4 Select the file to be loaded.

You can select any of the files listed in the Directory/File list box on the display.

5 Press the [SF2] button (a prompt for confirmation appears).

Press the [DEC/NO] button to cancel the Load operation.

6 Press the [INC/YES] button to execute the Load operation.**⚠ CAUTION**

The Load operation overwrites any data previously existing in the destination internal memory. Important data should always be saved to a USB storage device connected to the USB TO DEVICE terminal or to a computer connected to the same network as the MOTIF XS (page 278).

Loading a SMF file (Standard MIDI file)

This method is available only when entering the File mode from the Song mode or Pattern mode.



1 Select a device and directory as source by following “Basic Procedure in the File mode” on page 276.

2 Set the Type to “SMF.”

Only available files according to the Type are listed in the Directory/File list box on the display.

3 Specify the destination memory location in the User memory.

Select a Song number or Pattern Number/Section to which the Standard MIDI File is to be loaded.

NOTE When you want to load the SMF file to a Song, enter the File mode from the Song mode. When you want to load the SMF file to a Pattern, enter the File mode from the Pattern mode.

4 Select the file to be loaded.

You can select any of the files listed in the Directory/File list box on the display.

5 Press the [SF2] button (a prompt for confirmation appears).

Press the [DEC/NO] button to cancel the Load operation.

6 Press the [INC/YES] button to execute the Load operation.

CAUTION

The Load operation overwrites any data previously existing in the destination internal memory. Important data should always be saved to a USB storage device connected to the USB TO DEVICE terminal or to a computer connected to the same network as the MOTIF XS (page 278).

Display Messages

LCD Indication	Description
Are you sure?	Confirms whether you want to execute a specified operation or not.
Arpeggio memory full.	The internal memory for Arpeggio data is full, preventing storing the recorded sequence data as an Arpeggio.
Bad disk or memory.	The external storage device connected to this synthesizer is unusable. Format the external storage device and try again.
Bulk data protected.	Bulk data cannot be received because of the setting in the Utility mode. For details, see page 268.
Can't access to the host	The MOTIF XS cannot access a host computer.
Can't execute to the Preset Wave.	This message appears when you try to save the preset Waveform to an external storage device.
Can't undo. Are you sure?	When certain Song/Pattern Jobs are executed, internal memory becomes too full for use of the Undo operation.
Completed.	The specified load, save, format, or other Job has been completed.
Confirmed password is invalid.	The new password cannot be registered because the confirmed password does not match the new password.
Connecting to USB device...	Recognizing the USB storage device connected to the USB TO DEVICE terminal.
Copy protected.	You have attempted to export or save a copy-protected digital audio source.
Device number is off.	Bulk data cannot be transmitted/received since the device number is off.
Device number mismatch.	Bulk data cannot be transmitted/received since the device numbers don't match.
Directory is not empty.	You have attempted to delete a folder that contains data.
Disk or memory is full.	The external storage device is full and no more data can be saved. Use a new external storage device, or make space by erasing unwanted data from the storage device.
Disk or memory is write-protected.	The external storage device is write protected, or you have attempted to write to a read-only medium such as CD-ROM.
Disk or memory read/write error.	An error occurred while reading or writing to/from an external storage device.
File already exists.	A file having the same name as the one you are about to save already exists.
File is not found.	The specified file was not found on the external storage device during a load operation.
File or directory path is too long.	The file or directory you tried to access cannot be accessed because the amount of characters indicating the path is too long.
Illegal bulk data.	An error occurred while receiving the Bulk data or Bulk Request message.
Illegal file name.	The specified file name is invalid. Try entering a different name.
Illegal file.	The file specified for loading is unusable by this synthesizer or cannot be loaded in the current mode.
Illegal parameters.	This message appears when trying to execute the Song Job or Pattern Job with invalid settings.
Illegal sample data.	The Sample file specified for loading is unusable by this synthesizer.
Keybank full	The maximum overall number of Key Banks has been exceeded when executing Sampling related operations including Jobs and Load.
MIDI buffer full.	Failed to process the MIDI data because too much data was received at one time.
MIDI checksum error.	An error occurred when receiving bulk data.
Mixing Voice full.	The Mixing Voice cannot be stored because the number of Voices already stored has exceeded the maximum capacity.
mLAN identity ID check OK.	The MOTIF XS has been connected to the computer properly via an IEEE1394 cable.
No data.	When a Song/Pattern Job is executed, the selected track or range contains no data. Select an appropriate track or range. In addition, this message appears when a Job related to a Mixing Voice cannot be executed because the specified Mixing Voice is not available.
No DIMM Memory installed.	An appropriate pair of expansion DIMMs is not properly installed, or the pair is not properly matched.
No sample data.	This message appears when a Sample-related Job cannot be executed because the specified Sample is not available.
Now collecting the information of the network...	This message appears while obtaining the network information.
Now executing Factory set...	Indicates this synthesizer is restoring the factory-programmed settings.
Now loading...	Indicates that a file is being loaded.
Now receiving MIDI bulk data...	Indicates this synthesizer is receiving MIDI bulk data.

LCD Indication	Description
Now saving...	Indicates that a file is being saved.
Now scanning autoload file.	Scanning for the files specified for Auto Load.
Now transmitting MIDI bulk data...	Indicates this synthesizer is transmitting MIDI bulk data.
Overwrite. Are you sure?	A save operation will overwrite data on the external storage device as destination, and this message confirms whether it is OK to continue or not. Press [INC/YES] or [DEC/NO] as required.
Password is invalid.	The password you input does not match the already registered password,
Password is too short.	The password you input to "New Password" is too short. Input at least five characters as a password.
Password is unspecified.	This message appears when setting the File Server Switch parameter to "ON" though a password has not been registered.
Phrase limit exceeded.	The maximum number of Phrases (256) has been exceeded when recording, executing a Pattern Job, or editing.
Please keep power on.	The data is being written to Flash ROM. Never attempt to turn off the power while data is being written to Flash ROM. Turning the power off while this message is shown results in loss of all user data and may cause the system to freeze (due to corruption of data in the Flash ROM). This may also result in the MOTIF XS being unable to properly start up the next time the power is turned on.
Please select User Voice.	This message appears when entering the File mode from the Performance mode and selecting a Part to which a preset Voice is assigned in the Waveform Load operation. Assign a User Voice to the destination Part then execute the Load operation.
Please stop sequencer.	The operation you have attempted to execute cannot be done during Song/Pattern playback.
Sample frequency is too low.	The sampling frequency is too low and the Frequency Convert Job cannot be executed.
Sample is too long.	The Sample size is too large and the Time Stretch Job cannot be executed.
Sample is too short.	The Sample length is too short and the Frequency Convert Job cannot be executed.
Sample memory full.	The Sample memory is full and further Sampling operations, Jobs, or load operations cannot be executed.
Sample Voice full	The maximum overall number of Sample Voices has been exceeded when executing the Sampling related operations including the Job and Load.
Scene stored.	The Song Scene has been stored to one of the [SF1] – [SF5] buttons.
Sequence memory full.	The internal memory for Sequence data is full, preventing any further operation (such as recording, editing, Job execution, MIDI reception/transmission, or loading from the external storage device). Try again after erasing unwanted Song, Pattern, or User Phrase data.
The edited sequence data will be discarded. Are you sure?	Indicates that the operation will delete the currently edited Song or Pattern.
The received MIDI bulk data's type is not compatible with the current mode/voice type.	This message appears when MIDI bulk data is received in a different mode other than the currently selected mode. The bulk data is received in the same mode as the transmitting mode. This message also appears when the Voice type (Normal Voice/Drum Voice) of the destination Mixing Parts is different from the bulk-dump-transferred Voice type. The destination Parts assigned to the same Voice type as the bulk-dump-transferred Voice type are selected.
This Performance uses User Voices.	The Performance you have loaded includes User Voice data. Check whether the Voice you saved exists at the appropriate User voice bank.
Too many Samples.	The maximum overall number of samples (8192) has been exceeded.
USB connection terminated. Press any button.	A break in the connection with the USB storage device has occurred because of an abnormal electric current. Disconnect the USB storage device from the USB TO DEVICE connector, then press any of the panel buttons.
Utility/Sequencer Setup settings stored.	The settings in the Utility mode have been stored.
Waveform full	The maximum overall number of Waveforms has been exceeded when executing the Sampling related operations including Jobs and Load.
When the checkbox is "on," all user data is initialized the next time the power is turned on.	(Self-explanatory)

Troubleshooting

No sound? Wrong sound? When a problem like this occurs, please check the following points before assuming that the product is faulty. You may solve your problem by executing the Factory Set (page 22) after backing up your data to an external storage device. If the problem persists, consult your Yamaha dealer.

No Sound.

- Are all eight sliders set to appropriate levels (other than zero or minimum)?
- Is the MOTIF XS properly connected to related external equipment (e.g., amplifier, speaker, headphone) via audio cables?
Since the MOTIF XS has no built-in speakers, you will need an external audio system or a set of stereo headphones to properly monitor it.
- Check the Local Control parameter and the mLAN Monitor Setup parameter in the Utility mode.
When the MOTIF XS is used as stand alone and the Local Control parameter is set to off or the mLAN Monitor Setup parameter is set to “with PC,” no sound is produced even if you play the keyboard.

[UTILITY] → [F5] Control → [SF2] MIDI → Switch → Local Control (page 269)

[UTILITY] → [F2] I/O → mLAN Monitor Setup (page 263)

- Is the power of this synthesizer and any external equipment connected to this synthesizer turned on?
- Have you made all the appropriate level settings—including the Master Volume on this synthesizer and the volume settings on any connected external equipment?
- Is the Foot Controller pressed down (when it is connected to the FOOT CONTROLLER jack)?
- Are the MIDI volume or MIDI expression settings too low when using the external controller?
- Is this synthesizer properly connected to related external equipment (e.g., amplifier or speaker) via audio cables?
- Are the effect and filter settings appropriate?
If you are using the filter, try changing the cutoff frequency. Some cutoff settings may filter out all of the sound.

[VOICE] → [EDIT] → [COMMON EDIT] → [F6] Effect (page 107)

[PERFORM] → [EDIT] → [COMMON EDIT] → [F5] Effect (page 149)

[SONG]/[PATTERN] → [MIXING] → [F5] Effect (page 234)

[VOICE] → [EDIT] → Element/Key selection → [F3] Filter (page 117)

[PERFORM] → [EDIT] → Part selection → [F4] EG → Filter (page 158)

[SONG]/[PATTERN] → [MIXING] → [EDIT] → Part selection → [F4] EG → Filter (page 235)

[PERFORM]/[SONG]/[PATTERN] → [SEQ SETUP] → [F2] MIDI Filter (page 270)

- Are the volume or expression settings too low?

[UTILITY] → [F1] General → [SF1] Play → Volume (page 259)

[VOICE] → [EDIT] → [COMMON EDIT] → [F1] General → [SF2] Play Mode → Volume (page 98)

[VOICE] → [EDIT] → Element/Key selection → [F4] Amplitude → [SF1] Level/Pan → Level (page 122)

[PERFORM] → [EDIT] → [COMMON EDIT] → [F2] Level/MEF → [SF1] Level → Volume (page 145)

[PERFORM] → [EDIT] → Part selection → [F1] Voice → [SF1] Voice → Volume (page 152)

[SONG]/[PATTERN] → [MIXING] → [F1] Part 1-16 → Volume (page 232)

- Are the parameter settings such as Element Switch, Part Switch, Note Limit and Velocity Limit appropriate?

[VOICE] → [EDIT] → Element/Key selection → [F1] Oscillator (page 112)

[PERFORM] → [F2] Voice (page 138)

[PERFORM] → [EDIT] → Part selection → [F1] Voice → [SF1] Voice → Part Switch (page 151)

- When the Element to which “Legato” of the XA Control parameter is assigned does not sound, is the Mono/Poly parameter of the Element set to “Mono”? Or, is a value other than “Legato” of the XA Control parameter assigned to another Element within an Element Group?

[VOICE] → [F2] Porta → Mono/Poly Mode = mono (page 93)

[VOICE] → [EDIT] → Element selection → [F1] Oscillator → XA Control (page 112)

[VOICE] → [EDIT] → Element selection → [F1] Oscillator → Element Group (page 113)

- When the Element to which “Key Off Sound” of the XA Control parameter is assigned does not sound, are you releasing the note after the AEG decays?

The “Key Off Sound” Element will take over the AEG level of the previous Element if both the Elements belong to the same Element Group. To solve such a problem, release the note before the AEG level decays to minimum or set the “Key Off Sound” Element to the different Element Group from the previous Elements.

[VOICE] → [EDIT] → Element selection → [F1] Oscillator → Element Group (page 113)

- When the Element to which “AF1 on,” “AF2 on,” or “all AF off” of the XA Control parameter is assigned does not sound, is the corresponding ASSIGNABLE FUNCTION button pressed?
- Is “Vocoder” selected as the Insertion Effect Type of the Voice?
If so, set the parameters related to the AD Part and A/D INPUT connector to the appropriate values then play the keyboard while inputting your voice into the microphone connected to the MOTIF XS. Check whether or not the Gain Knob on the rear panel is set to the minimum position. For details, see page 39.

[VOICE] → [EDIT] → [COMMON EDIT] → [F6] Effect → [SF1] Connect → INSERTION CONNECT (page 108)

[VOICE] → [UTILITY] → [F4] Voice Audio → [SF1] Output → Output Select = InsL (page 266)

[VOICE] → [UTILITY] → [F2] I/O → Input → Mic/Line = mic (page 263)

- When playing the keyboard in the Performance/Song/Pattern mode produces no sound, has a Voice been assigned to each Part?

[PERFORM] → [F2] Voice (page 138)

[SONG]/[PATTERN] → [MIXING] → [F1] Part 1-16 (page 231)

- When the Song/Pattern playback produces no sound, are the output channel of each track in the play mode and the receive channel of each Part in the Mixing mode set appropriately?

[SONG] → [F3] Track → [SF1] Out (page 184)

[PATTERN] → [F3] Track (page 211)

[SONG]/[PATTERN] → [MIXING] → [EDIT] → Part selection → [F1] Voice → [SF1] Voice → Receive Channel (page 235)

- When the Song/Pattern playback produces no sound, are the Velocity Rate and Velocity Offset settings of the Play FX appropriate?

[SONG]/[PATTERN] → [F2] Play FX → Velocity Offset (pages 184 and 211)

Playback continues without stopping.

- When the [ARPEGGIO ON/OFF] button is turned on, press it so that its lamp is turned off.
- When in the Song mode or Pattern mode, press the [■] (Stop) button.
- When the click sound continues, check the following parameter setting. Set this parameter to something other than “always” because this setting always plays back the click sound regardless of the sequencer status.

[PERFORM]/[SONG]/[PATTERN] → [SEQ SETUP] → [F1] Click → Mode (page 270)

Distorted sound.

- Are the effect settings appropriate?
Use of an effect at certain settings may produce distortion.

[VOICE] → [EDIT] → [COMMON EDIT] → [F6] Effect (pages 107 and 128)

[PERFORM] → [EDIT] → [COMMON EDIT] → [F5] Effect (page 149)

[SONG]/[PATTERN] → [MIXING] → [F5] Effect (page 234)

Use of the Master Effect at certain settings may produce distortion.

[VOICE] → [UTILITY] → [F3] Voice → [SF1] Master FX (page 264)

[PERFORM] → [EDIT] → [COMMON EDIT] → [F2] Level/MEF → [SF2] Master FX (page 146)

[SONG]/[PATTERN] → [MIXING] → [EDIT] → [COMMON EDIT] → [F2] Master FX → [SF2] Master FX (page 234)

- Are the filter settings appropriate?
Excessively high filter resonance settings can cause distortion.

[VOICE] → [EDIT] → Element/Key selection → [F3] Filter (page 117)

[PERFORM] → [EDIT] → Part selection → [F4] EG → Filter (page 158)

[SONG]/[PATTERN] → [MIXING] → [EDIT] → Part selection → [F4] EG → Filter (page 235)

- Is any of the following volume parameters set so high that clipping is occurring?

[UTILITY] → [F1] General → [SF1] Play → Volume (page 259)

[VOICE] → [EDIT] → [COMMON EDIT] → [F1] General → [SF2] Play Mode → Volume (page 98)

[PERFORM] → [EDIT] → [COMMON EDIT] → [F2] Level/MEF → [SF1] Level → Volume (page 145)

[SONG]/[PATTERN] → [MIXING] → [F1] Part 1-16 → Volume (page 232)

Sound is cut off.

- Is the entire sound (via your keyboard playback and Song/Pattern/Arpeggio playback) exceeding the maximum polyphony of the MOTIF XS? (page 59)

Only one note sounds at a time.

- When this situation occurs, the Mono/Poly parameter in the current mode is set to “mono.” If you wish to play chords, set this parameter to “poly.”

[VOICE] → [F2] Porta → Mono/Poly Mode (page 93)

[PERFORM] → [EDIT] → Part selection → [F1] Voice → [SF1] Voice → Mono/Poly (page 152)

[SONG]/[PATTERN] → [MIXING] → [EDIT] → Part selection → [F1] Voice → [SF1] Voice → Mono/Poly (page 235)

Pitch or intervals are wrong.

- Is the Master Tune parameter in the Utility mode set to a value other than “0”?

[UTILITY] → [F1] General → [SF1] Play → Tune (page 259)

- Is the Note Shift parameter in the Utility mode set to a value other than “0”?

[UTILITY] → [F1] General → [SF1] Play → Note Shift (page 259)

- When the voice produces a wrong pitch, is the appropriate tuning system selected from Micro Tuning parameter in the Voice Edit mode?

[VOICE] → [EDIT] → [COMMON EDIT] → [F1] General → [SF2] Play Mode → Bank, Tuning Number, Tuning Root (page 99)

- When the Voice produces a wrong pitch, is the LFO Pitch Modulation Depth in the Voice Edit mode set too high?

[VOICE] → [EDIT] → Element/Key selection → [F5] Elm LFO → P Mod (page 125)

- When the Performance/Song/Pattern produces a wrong pitch, is the Note Shift parameter of each Part set to a value other than “0”?

[PERFORM] → [EDIT] → Part selection → [F1] Voice → [SF1] Voice (page 151)

[SONG]/[PATTERN] → [MIXING] → [EDIT] → Part selection → [F1] Voice → [SF1] Voice (page 235)

- When the Song/Pattern playback produces a wrong pitch, is the Note Shift parameter in the Play FX display set to a value other than “0”?

[SONG]/[PATTERN] → [F2] Play FX → Note Shift (page 184)

No effect is applied.

- Is the [EFFECT BYPASS] button turned off? (page 13)

- Have the REVERB and CHORUS knobs been turned fully counter-clockwise (to the minimum)?

- Have any or all of the Elements' Insertion Effect Output parameters been set to “thru” in the effect setting display in the Voice Edit mode?

[VOICE] → [EDIT] → [COMMON EDIT] → [F6] Effect → [SF1] Connect → Element Out 1-8 (page 108)

- Have any or all of the effect types been set to “thru” or “off”?

- When this occurs in the Performance mode/Song mode/Pattern mode, check whether the Insertion Switch (INS SW) parameters are set properly or not.

[PERFORM] → [EDIT] → [COMMON EDIT] → [F5] Effect → [SF2] InsSwitch (page 150)

[PERFORM] → [EDIT] → Part selection → [F1] Voice → [SF1] Voice (page 151)

[SONG]/[PATTERN] → [MIXING] → [F1] Part 1-16 → Ins FX Sw (page 232)

[SONG]/[PATTERN] → [MIXING] → [COMMON EDIT] → [F5] Effect → [SF2] Ins Switch (page 234)

The Edit Indicator appears, even when parameters are not being edited.

- Keep in mind that even though the Edit mode is not active, simply moving a Knob/Slider or playing back the Song/Pattern changes the current Voice, Performance, or Mixing, causing the Edit Indicator to appear.

Cannot start the Arpeggio.

- Check whether the [ARPEGGIO ON/OFF] button is turned on or off.

- Is the MIDI Sync parameter set to internal (using internal clock)?

[UTILITY] → [F5] Control → [SF2] MIDI → MIDI Sync = internal (page 268)

- When the User Arpeggio type is selected, does the currently selected Arpeggio actually contain data?

- Are the Arpeggio related parameters such as Note Limit and Velocity Limit set appropriately?

[VOICE] → [EDIT] → [COMMON EDIT] → [F2] ARP Main (page 101)

[PERFORM] → [EDIT] → Part selection → [F2] ARP Main (page 154)

[SONG]/[PATTERN] → [MIXING] → [EDIT] → Part selection → [F2] ARP Main (page 235)

- When this situation occurs in the Performance/Song/Pattern mode, check the Arpeggio Switch parameter. If this parameter for the current Part is set to off, Arpeggio playback will not be triggered by your keyboard performance even if the [ARPEGGIO ON/OFF] button is turned on.

[PERFORM] → [F4] Arpeggio → Common Switch (page 139)

[PERFORM] → [EDIT] → Part selection → [F2] ARP Main → Switch (page 154)

[SONG]/[PATTERN] → [MIXING] → [EDIT] → Part selection → [F2] ARP Main → Switch (page 235)

Cannot stop the Arpeggio.

- When Arpeggio playback does not stop even if you release the key, set the Arpeggio Hold parameter to “off.”

[VOICE] → [EDIT] → [COMMON EDIT] → [F2] ARP Main → Hold (page 101)

[PERFORM] → [EDIT] → Part selection → [F2] ARP Main → Hold (page 154)

[PERFORM] → [PERFORMANCE CONTROL] → Number buttons [13] – [16] (page 136)

[SONG]/[PATTERN] → [MIXING] → [EDIT] → Part selection → [F2] ARP Main → Hold (page 235)

The Voice assigned to the Performance produces different sound from the one in the Voice mode.

- This is normal because the Voice sound is determined by the parameter settings in the Performance mode. For the Performance Parts, you will need to apply basically the same parameter settings as those used in the Voice mode. Regarding the Effect settings except for the send level, you can copy the settings in the Voice mode to the Performance part in the following display. By executing this Job, you can ensure that the Voice will sound the same in the Performance mode as it does in the Voice mode.

[PERFORM] → [JOB] → [F3] Copy → [SF2] Voice (page 160)

[PERFORM] → [EDIT] → Part selection → [F1] Voice → [SF2] Output → Reverb Send/Chorus Send (page 152)

The Song/Pattern cannot be started even when pressing the [▶] (Play) button.

- Does the selected Song or Pattern (phrase) actually contain data?
- Is the Remote Control feature turned on?
- Is the MIDI Sync parameter set to internal (using internal clock)?

[UTILITY] → [F5] Control → [SF2] MIDI → MIDI Sync = internal (page 268)

Song/Pattern (Phrase) cannot be recorded.

- Is there enough free memory for recording? (pages 182 and 211)
The total MOTIF XS memory capacity determines the number of Songs/Patterns (phrases) that can be recorded. For example, if the memory contains Songs/Patterns (phrases) that use up a large amount of memory, the memory may become full even though the available Pattern or Song numbers are not all used.

Cannot enter the Pattern Job mode/Pattern Mixing mode even when pressing the [JOB] button in the Pattern mode.

- Check whether the MOTIF XS is in the Pattern Chain mode or not.
If so, exit from the Pattern Chain mode, then press the [JOB] button or [MIXING] button.

The drum sound is wrong or unexpected when changing the transpose value in the Song/Pattern Play mode.

- This is normal. Changing the transpose setting while playing a Drum Voice will produce different sounds for the same keys played.

Microphone does not work properly.

- Check whether the Mic/Line parameter is set to “mic” or not.

[UTILITY] → [F2] I/O → Mic/Line = mic (page 263)

- Check whether the Gain Knob on the rear panel is set to minimum position or not.

Cannot record samples.

- If you cannot enter the Sampling mode even though you've pressed the [INTEGRATED SAMPLING] button, check whether DIMMs have been installed or not. In order to enter the Sampling mode and record Samples, DIMM modules must be installed.
- Have you exceeded the maximum allowable number of samples (key banks)?
- Is there enough sample memory available?
- Is the Sampling Source setting appropriate?
- Is the Trigger mode set appropriately?

Data communication via MIDI/USB/mLAN between the computer and the MOTIF XS does not work properly.

- Check whether the Port settings on the computer are appropriate or not.
- Check whether or not the MIDI IN/OUT parameter is set to the appropriate value.

[UTILITY] → [F5] Control → [SF2] MIDI → MIDI In/Out (page 268)

The MOTIF XS does not sound properly even when playing back the Song data on the computer or the MIDI instrument connected to the MOTIF XS.

- Make sure to set the MOTIF XS to the Song mode or Pattern mode. The Voice mode or Performance mode may not produce the proper sound even when playing back the Song data on the MIDI instrument or the computer connected to the MOTIF XS.

Network connection does not work.

- If you've forgotten password for accessing the MOTIF XS, execute the Factory Set then set the password again.

[UTILITY] → [F1] General → [SF3] Network → [SF5] Password (page 262)

- When the DHCP server is connected to the network and the DHCP Client parameter is set to "on," you need not set the IP address because it is automatically set. When the DHCP server is not connected to the network and you wish to set a specific IP address, set the DHCP Client parameter to "off," then set the IP address manually.

[UTILITY] → [F1] General → [SF3] Network → DHCP Client (page 261)

- If the network settings do not become active even if you set the related parameters, make sure to press the [ENTER] button after setting. Then, you will need to press the [STORE] button to store the settings. If you do not store the network settings, these will be erased after you turn off the power.

[UTILITY] → [F1] General → [SF3] Network (page 260)

- The characters of a file or directory may be garbled when loading the file from the computer drive to the MOTIF XS. If such a problem occurs, replace the garbled character with the correct one on the MOTIF XS display. Keep in mind that 2-byte character codes such as Kanji and Kana cannot be shown on the display of the MOTIF XS.

- When "Password is unspecified." appears after setting the File Server parameter to "on," make sure to set the Password before setting the File Server parameter to "on." This is because the Security parameter has been set to "workgroup" and the Account and Password are necessary when the files are shared.

[UTILITY] → [F1] General → [SF3] Network → [SF5] Password (page 262)

MIDI bulk data transmission/reception does not work properly.

- Is the Receive Bulk parameter set to off?
Set the Receive Bulk parameter to on.

[UTILITY] → [F5] Control → [SF2] MIDI → Receive Bulk (page 269)

- When receiving the MIDI bulk data transmitted via the Bulk Dump function and recorded to the external MIDI device, you need to set the MIDI Device Number to the same value as when transmitting.

[UTILITY] → [F5] Control → [SF2] MIDI → Device Number (page 268)

- When transmission does not work properly, is the device number of the MIDI instrument connected to the MOTIF XS set to match the Device Number Parameter in the Utility mode?

[UTILITY] → [F5] Control → [SF2] MIDI → Device Number (page 268)

Cannot save data to the external USB storage device.

- Is the USB storage device being used write protected? (Write-protect should be set to off for saving data.)
- Is the USB storage device being used properly formatted?
Press the [FILE] button to enter the File mode, then set the device to the USB storage device. Check the amount of currently available (unused) memory of the USB storage device indicated at the right top of the display.
- Is the USB storage device guaranteed by Yamaha?
For details, see page 85.

Installing Optional Hardware

Available devices

The following optional devices can be installed to the MOTIF XS.

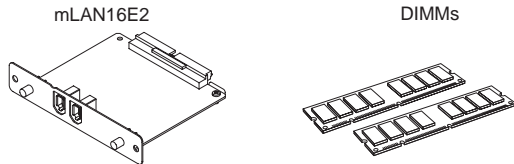

Installation locations

mLAN16E2

MOTIF XS6



Rear cover for the mLAN16E2

MOTIF XS7



Rear cover for the mLAN16E2

DIMM

MOTIF XS6

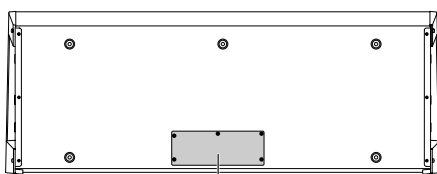

Bottom cover for the DIMM

MOTIF XS7

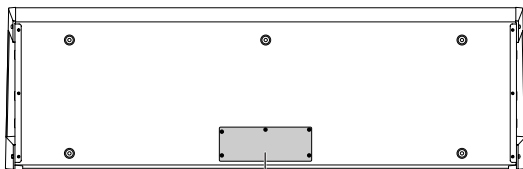

Bottom cover for the DIMM

MOTIF XS8

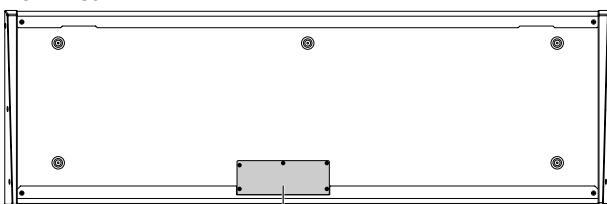

Bottom cover for the DIMM

Installation Precautions

Before installing the optional hardware, make sure you have a Philips screwdriver and ample space to work.

! WARNING

- Before beginning installation, switch off the power to the instrument and connected peripherals, and unplug them from the power outlet. Installation or removal of any devices should be started ONLY after the instrument (and the optional hardware) returns to normal room temperature. Then remove all cables connecting the instrument to other devices. (Leaving the power cord connected while working can result in electric shock. Leaving other cables connected can interfere with work.)
- Be careful not to drop any screws inside the instrument during installation. (This can be prevented by keeping the optional units and cover away from the instrument while attaching). If this does happen, be sure to remove the screw(s) from inside the unit before turning the power on. Loose screws inside the instrument can cause improper operation or serious damage. If you are unable to retrieve a dropped screw, consult your Yamaha dealer for advice.
- Install the optional units carefully as described in the procedure below. Improper installation can cause shorts which may result in irreparable damage and pose a fire hazard.
- Do not disassemble, modify, or apply excessive force to board areas and connectors on optional units. Bending or tampering with boards and connectors may lead to electric shock, fire, or equipment failures.

! CAUTION

- It is recommended that you wear gloves to protect your hands from metallic projections on optional units and other components. Touching leads or connectors with bare hands may cause finger cuts, and may also result in poor electrical contact or electrostatic damage.
- Be careful of static electricity. Static electricity discharge can damage the IC chips on the mLAN16E2. Before you handle the optional mLAN16E2, to reduce the possibility of static electricity, touch unpainted metal parts or a ground wire on the devices that are grounded.
- Handle the optional units with care. Dropping or subjecting them to any kind of shock may cause damage or result in a malfunction.
- Do not touch the exposed metal parts in the circuit board. Touching these parts may result in a faulty contact.
- Be careful not to misplace any of the screws.
- Do not use any screws other than what are installed on the instrument. Use of incorrect screws can cause damage.

mLAN16E2

The optionally available mLAN expansion board (mLAN16E2) can be installed to the MOTIF XS6 and MOTIF XS7. The MOTIF XS8 is equipped with two mLAN connectors equivalent to the mLAN16E2 by default.

Installing the mLAN16E2

- 1 Turn the power of the MOTIF XS off, and disconnect the AC power cord. Also, make sure to disconnect the MOTIF XS from any connected external devices.
- 2 Remove the cover for the mLAN16E2 from the rear panel.

With the rear panel of this synthesizer facing you, remove the two screws from the cover.

Important

Keep the removed screws in a safe place. They will be used when installing the mLAN16E2. Be careful not to misplace them. Keep the cover and fixing screws in a safe place for future use.

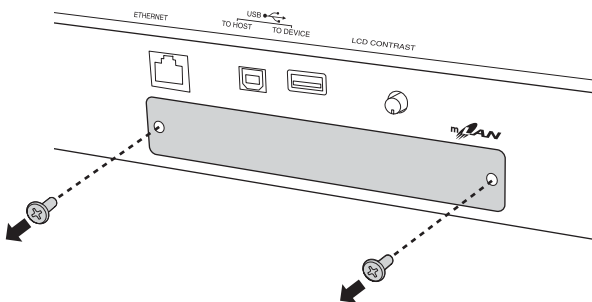

CAUTION

After removing the cover, you will see the metal fittings at the bottom of the opening. To avoid cutting or scraping your fingers, be careful not to touch them when installing the mLAN16E2.

- 3 Insert the mLAN16E2 along the guide rails.

Push the mLAN16E2 all the way into the slot so that the connector at the end of the mLAN16E2 is correctly inserted into the connector inside the slot.

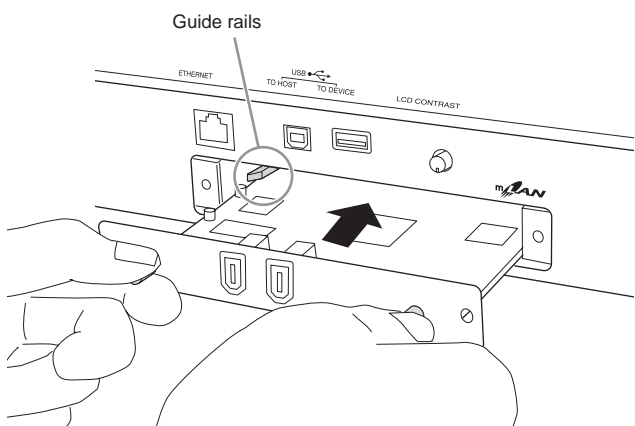

- 4 Replace the cover with the two screws you removed in step 2 above.

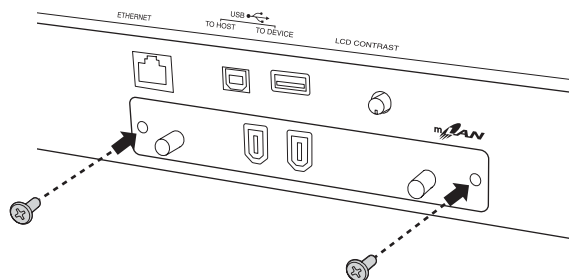

CAUTION

Malfunctions or incorrect operation may occur if the mLAN16E2 is not properly fastened.

Optional DIMM Installation

This section explains how to install DIMM memory modules to the MOTIF XS.

Compatible DIMMs

The MOTIF XS does not necessarily support all commercially available DIMMs. Yamaha cannot guarantee operation of DIMMs that you purchase. Before purchasing DIMMs, please consult your Yamaha dealer, or an authorized Yamaha distributor (see list at end of the Owner's Manual) for advice, or see the following website: <http://www.yamahasyth.com/>

DIMM Type and DIMM Configuration

- Yamaha recommends that you purchase DIMMs that conform to the JEDEC* standard. Please be aware, however, that conformance to this standard does not constitute a guarantee that the DIMMs will operate correctly on the MOTIF XS.

*JEDEC (Joint Electron Device Engineering Council) sets standards for terminal configurations within electronic devices.
- Use only 168-pin DIMMs of 64, 128, 256 or 512 MB capacity (synchronized DRAM; PC100 or PC133).
- When installing DIMMs, make sure to install them in a matched pair of the same capacity. You cannot install only one module and leave the second memory socket open. Also make sure each DIMM in the pair is of the same manufacturer and the same type. DIMMs of different makers and configurations may not work together.
- When purchasing DIMMs, make sure that the DIMM design does not utilize more than 18 memory chips per module. (DIMMs comprised of more than 18 chips do not operate correctly on the MOTIF XS.)

64MB x 2 = 128MB

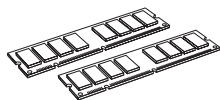

128MB x 2 = 256MB

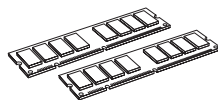

256MB x 2 = 512MB

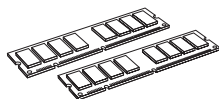

512MB x 2 = 1GB

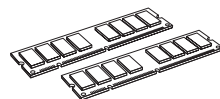

DIMM Installation

- Turn the power of the MOTIF XS off, and disconnect the AC power cord. Also, make sure to disconnect the MOTIF XS from any connected external devices.
- Turn over the MOTIF XS so that the keyboard faces down, giving you direct access to the underside of the instrument.

To protect the Knobs, Wheels and Sliders from damage, place the keyboard so the four corners are supported by something that provides sufficient support like magazines or cushions. Place supports at all four corners, taking care not to touch the Knobs, Wheels and Sliders.

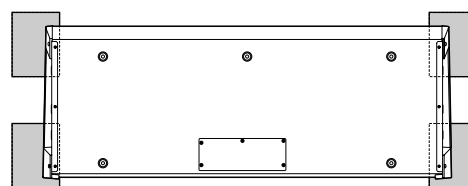

View of the keyboard from the bottom

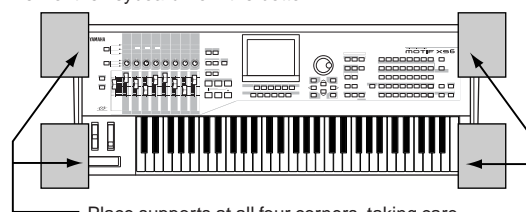

Place supports at all four corners, taking care not to touch the Knobs, Wheels and Sliders.

CAUTION

Since the instrument—particularly the MOTIF XS8—is very heavy, this procedure should not be done alone, but by two or three people.

- Remove the cover from the bottom.

With the rear panel of the MOTIF XS facing you, remove the screws from the cover by using the Phillips screwdriver. After removing the screws, slide the cover away to remove it.

Important

Keep the removed screws in a safe place. They will be used when re-attaching the cover to the instrument after installing the DIMMs.

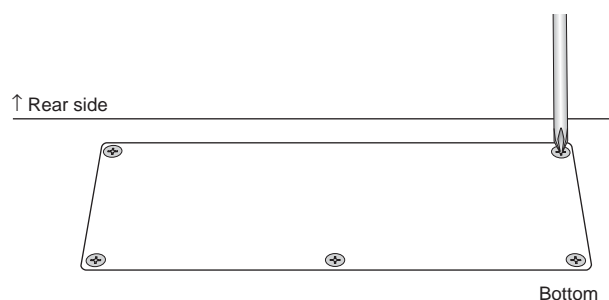

4 Insert the two DIMMs into the DIMM sockets.

Location for DIMM installation

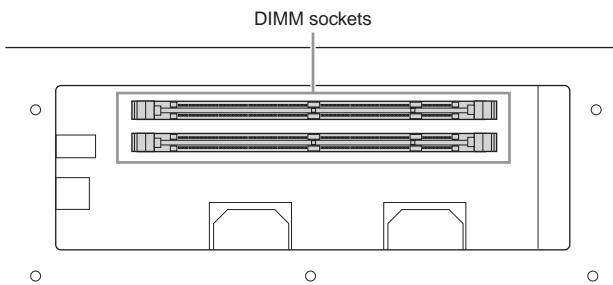

Installing the DIMM modules to the sockets

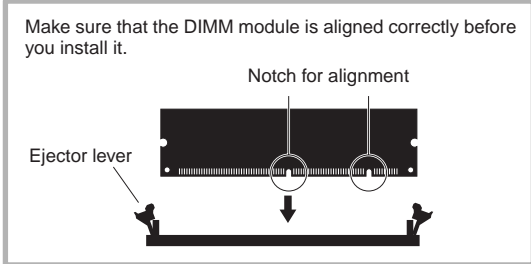

4-1 Press the ejector levers to the outside of the socket.

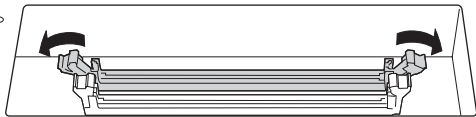

4-2 Insert the DIMM vertically in the socket. Press the DIMM in firmly until it “snaps” or locks in place.

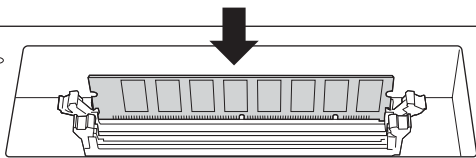

Confirm whether or not both the levers are firmly locked.

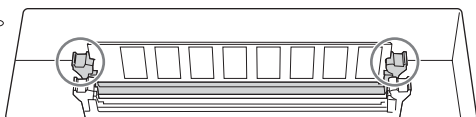

5 Re-install the cover you removed in step 3, in reverse order.

6 Check that the installed DIMMs are functioning properly.

Set the MOTIF XS right-side up, and connect the power cord to the rear-panel AC IN jack and an AC outlet. Turn on the power, go to the Sampling display by pressing the [INTEGRATED SAMPLING] button, and press the [F6] Rec button then [SF6] INFO button (page 165). If the DIMMs have been installed properly, the appropriate available memory size is indicated in the display.

NOTE NOTE If the DIMMs have not been installed properly, the MOTIF XS may freeze when you press the [INTEGRATED SAMPLING] button. If this occurs, turn the power off, perform the instructions above again, and make sure to install the DIMMs firmly in step 4.

Removing DIMMs

1 Press the ejector lever until the DIMM unlocks.

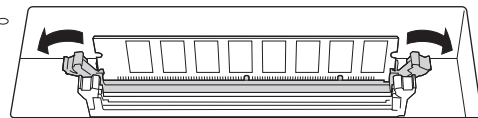

2 Pull the DIMM vertically out of the socket.

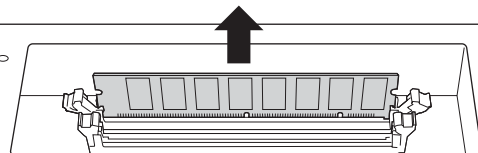

Specifications

Keyboards	MOTIF XS8	88 keys, Balanced Hammer Effect Keyboard (Initial Touch/Aftertouch)	
	MOTIF XS7	76 keys, FSX Keyboard (Initial Touch/Aftertouch)	
	MOTIF XS6	61 keys, FSX Keyboard (Initial Touch/Aftertouch)	
Tone Generator block	Tone Generator	AWM2, with Expanded Articulation	
	Polyphony	128 notes	
	Multi Timbral Capacity	16 Parts (internal), Audio Input Parts (A/D, mLAN*) *1 stereo Part	
	Wave	355MB (when converted to 16-bit linear format), 2,670 waveforms	
	Voice	Preset: 1,024 Normal Voices + 64 Drum Kits GM: 128 Normal Voices + 1 Drum Kit User: 128 x 3 (selected and copied from Preset bank), Normal Voice + 32 Drum Kits	
	Performance	User: 128 x 3 (up to 4 Parts)	
	Filter	18 types	
	Effect System	Reverb x 9 types, Chorus x 22 types, Insertion (A, B) x 53 types x 8 Parts (up to 16 units), Vocoder x 1 (uses both Insertion Effect A and B blocks), Master Effect x 9 types (Preset settings for parameters of each effect type are provided as templates; total 320) Master EQ (5 bands), Part EQ (3 bands, stereo)	
	Sampling block	Samples	Up to 1,024 Waveforms (Multi Samples) Up to 128 Key Banks per Waveform Up to 4,096 Key Banks
Sampling Sources		Analog input L/R, Stereo output (Resampling) mLAN (available on the MOTIF XS6 and 7 when the mLAN16E2 has been installed)	
A/D Conversion		24-bit, 64x oversampling	
D/A Conversion		24-bit, 128x oversampling	
Sample Data Bits		16	
Sampling Frequency		44.1kHz, 22.05kHz, 11.025kHz, 5.5125kHz (Stereo/Mono) Sampling Frequency via mLAN (when the mLAN16E2 has been installed): 44.1kHz (fixed)	
Sampling Memory		Optionally installed, expandable to 1GB (512MB DIMM x 2 slots) *DIMMs are not installed to the instrument when shipped from the factory.	
Sample Length		Mono: 32 MB Stereo: 64 MB	
Sampling Time		44.1kHz: 6 min. 20 sec. 22.05kHz: 12 min. 40 sec. 11.025kHz: 25 min. 20 sec. 5.0125kHz: 55 min. 40 sec. *Mono/Stereo	
Sample Format		Original format, WAV, AIFF	
Sequencer block		Note Capacity	Approx. 130,000 notes
		Note Resolution	480 ppq (parts per quarter note)
		Maximum Polyphony	124 notes
	Tempo (BPM)	5 – 300	
	Recording type	Real time replace Real time overdub (with the exception of the Pattern Chain) Real time punch in/out (Song only)	
	Tracks	Pattern: 16 Phrase tracks Pattern Chain: Pattern track, Tempo track, Scene track Song: 16 sequence tracks (Loop on/off can be set for each track), Tempo track, Scene track	
	Patterns	64 Patterns (x 16 sections), Measures: 256 maximum Mixing Voices: 16 Voices per Pattern and up to 256 Voices for all Patterns Mixing Templates: 32 for all Songs and Patterns	
	Phrases	User Phrases: 256 per Pattern	
	Songs	64 Songs Mixing Voices: 16 Voices per Song and up to 256 Voices for all Songs Mixing Templates: 32 for all Songs and Patterns	
	Arpeggio	Preset: 6,633 types User: 256 types *MIDI Sync, MIDI transmit/receive channel, Velocity Limit, and Note Limit can be set.	

Specifications

Sequencer block	Scene Memory	5 per Song
	Sequence Format	Original format, SMF format 0, 1 (Format 1 load only)
Others	Master	User: 128 *8 Zones (Master keyboard settings), Assignable Knob/Slider settings, Program Change Table
	Sequence Software compatible with the Remote Control function	For Windows [®] : Cubase 4, SONAR 5.2 For Macintosh [®] : Cubase 4, Logic 7.2, Digital Performer 5.1 *Functions to be controlled differ depending on the software.
	Controllers	Pitch Bend wheel, Modulation wheel, Ribbon Controller, Assignable Control Sliders x 8, Assignable Knobs x 8, Assignable Function buttons x 2, Data dial
	Display	320 x 240 dot, 5.7 inch graphic color backlit LCD
	Connectors	OUTPUT L/MONO, R (standard phone jack) ASSIGNABLE OUTPUT L, R (standard phone jack) A/D INPUT L, R (standard phone jack) DIGITAL OUT PHONES (standard stereo phone jack) FOOT CONTROLLER 1, 2 FOOT SWITCH x 2 (SUSTAIN, ASSIGNABLE) MIDI IN/OUT/THRU USB (TO HOST, TO DEVICE) AC IN ETHERNET mLAN (MOTIF XS8 only)
	Power Consumption	30W
	Dimensions, Weight	MOTIF XS8: 1,457 (W) x 466 (D) x 168 (H) mm, 28.6 kg MOTIF XS7: 1,252 (W) x 391 (D) x 122 (H) mm, 17.0 kg MOTIF XS6: 1,045 (W) x 391 (D) x 122 (H) mm, 14.8 kg
	Accessories	AC Power cord, Media (disc) x 1, Owner's Manual (this book), Data List

*Specifications and descriptions in this owner's manual are for information purposes only. Yamaha Corp. reserves the right to change or modify products or specifications at any time without prior notice. Since specifications, equipment or options may not be the same in every locale, please check with your Yamaha dealer.

Index

Symbols

.AIF	273, 274
.MID	273, 274
.WAV	273, 274
.XOA	273, 274
.XOE	274
.XOG	273, 274
.XOP	273, 274
.XOS	273, 274
.XOV	273, 274
.XOW	273, 274

Numerics

1/4 Shift	99
1/4 tone	99
1/8 tone	99
1st-on	106
2 Band	126

A

A Mod	125
A. Function 1/2	256
A. Function 1/2 Control No.	147
A. Function 1/2 Mode	100, 145
A/D	234
A/D INPUT jacks	18, 40
AC IN (AC Power Cord Socket)	16, 19
Accent Phrase	64
Accent Start Quantize	103, 157
Accent Vel Threshold	103, 157
Accuracy	174
AEG (Amplitude EG)	94, 123, 139, 157
AF1/2	25, 92
Aftertouch	78
AI driver	44
AIFF	273
All	273
All Arpeggio	273, 274
All Parameters	133, 159, 236, 258
All Pattern	273, 274
All Song	273, 274
All Sound Off	78
All Track	188, 190
All Voice	273
All Waveform	273, 274
all without system	273
Alternate Group	130
Alternate Pan	123, 132
Amplitude	57, 122, 131
Amplitude EG	132
Append Pattern	227
Append Phrase	224
Apply	217, 249
Arabic 1/2/3	99
ARP Category	206
ARP Common Switch	145
ARP FX	90, 100, 145, 181
ARP Main	101, 128, 154, 235
ARP MIDI Out Switch	264
ARP No.	206
ARP Other	102, 128, 156, 235
ARP Sync Quantize Value	145
ARP Transmit Ch	264
ARP1 – ARP5	92, 95, 102, 138, 141, 155, 252
Arpeggio	93, 95, 138, 139, 188, 189, 219
Hold on/off	136
Performance	135
play	24
playback on/off	136
Arpeggio Block	62

Arpeggio Category	62
[ARPEGGIO ON/OFF] button	13
Arpeggio playback	
Pattern	66
Performance	66
Voice Play	65
Arpeggio Sub Category	62
Arpeggio Switch	39
Arpeggio Type	
create	66
Drum Voice	65
name	62
non-note events	65
Normal Voice	64
AS1/2	25, 92
ASSIGN 1/2	90
Assign 1/2 Control No.	147
Assign 1/2 Value	100, 145
Assign L&R Gain	263
Assign Mode	130
Assign Settings	92
ASSIGNABLE FUNCTION [1] / [2] buttons	12, 67
ASSIGNABLE OUT L and R jacks	18
ATTACK	90
Attack Level	116, 120, 123
Attack Time	115, 120, 123, 132
Audio	232
Audio channel	46
Audio In	147, 234
Audio In/Out	263
Audio Input block	59
Audio Recording	242
Audio track	61
Audition	162, 167, 169, 170, 172, 246, 248
Auto Load	262

B

Band Elimination Filter	118
Band Pass Filter	117
BANK	140
Bank	93, 95, 99, 102, 138, 151, 155, 232, 238
Bank buttons	14
Bank LSB	256
Bank MSB	256
Bank Select	268
Basic Receive Ch	267
BEAT	193, 215
Beat	182, 187, 210, 219, 270
Beat Stretch	203
beat1 – 3	249
BEF (Band Elimination Filter)	118
BEF12	118
BEF6	118
Boost 12	126
Boost 18	126
Boost 6	126
BPF (Band Pass Filter)	117
BPF1 – 10 Gain	110
BPF12D	117
BPF6	118
BPFw	118
Break 1 – 16	217
Break Point 1 – 4	121, 124
Breath	104
Breath Controller Control No.	147
Brightness	77
Bulk	134, 160, 238, 258
Bulk Dump Interval	269

C

Cancel	217
CAT (Channel Aftertouch)	78, 193
CATEGORY	140
Category	92, 95, 102, 109, 137, 138, 149, 155, 231, 267
Category Search	24
[CATEGORY SEARCH] button	15
Center Key	115, 117, 119, 121, 122, 124
Ch After Touch	256
Chain	183, 185, 211, 213
Chain Edit	214
Chain Number	185
Chain Record	214
Change Timing	101, 154
Channel Aftertouch (CAT)	78
Channel number	52
CHAR	82
character input	82
CHO SEND	129
Cho Send	232
CHORUS	90
Chorus	71, 109, 129, 149, 150, 235, 260
Chorus Category/Type	108, 149
Chorus Pan	108, 149
Chorus Return	108, 149
Chorus Send	108, 130, 145, 148, 152, 266
CHORUS TO REVERB	108, 149
Clear	212
Clear All	194
Clear Pattern	228
Clear Pattern Chain	228
Clear Phrase	225
Clear Sample Voice	226
Clear Song	207
Clear Track	205, 226
Click	188, 220, 270
CLOCK	193, 215
Clock	200, 202
Clock Out	268
Clock Shift	184
Coarse	114, 131
Coarse Tune	170
Com LFO	105
Combination Type Filter	118
Common	258
Common Edit	96, 127, 141, 229, 253
Master	254
Mixing	233
Mixing Voice	241
Performance	143
Voice	98, 128
[COMMON EDIT] button	15
Common Parameters	133, 159, 236
Common Switch	139
Compare function	97, 142, 233, 240
Compressor	72
Confirm	166, 246
Confirm Password	262
Connect	107, 128, 148, 149, 234, 266
Connection	
external MIDI instruments	83
LAN	86
MTR	84
USB storage device	85
Control	256, 264, 267
Control Change (CC)	77
Control Depth	106
Control Dest	106
Control Function	92, 138
Control Knob No.	257
Control Slider No.	257

- Control Sliders13, 68, 137, 180
 function 91
 Control Sliders 1 – 8252
 Controller Assign264
 Controller Block67
 Controller Reset269
 Controller Set104
 Convert Pitch174
 Convert to Song215
 Convert Type206
 Copy 134, 160, 172, 176, 212, 215, 237, 241, 265
 Copy Event201
 Copy Part237
 Copy Pattern227
 Copy Pattern Chain227
 Copy Performance237
 Copy Performance Parameters141
 Copy Phrase206, 223
 Copy Sample Voice .206, 207, 212, 223, 225, 228
 Copy Song207
 Copy Track204, 226
 Copy Voice237
 Create Continuous Data202
 Create Measure203
 Create Roll199
 Crescendo198
 Ctrl Asgn147, 234
 Ctrl Set104, 128
 Cubase49, 52, 267
 Current Password262
 Current Pattern Phrase212
 Current Performance160
 Current settings271
 Current Voice134
 Currently edited Part237
 Cursor buttons14, 81
 Curve202
 CUTOFF90
 Cutoff118, 131
 Cutoff Key Follow119
 Cutoff Velocity Sens118, 131
 Cycle107
- D**
- Data Decrement77
 Data dial14, 81
 Data Entry LSB77
 Data Entry MSB77
 Data Increment77
 Data indicator210
 Data Range202
 Data status182
 Data Type205, 237, 238
 Data type of the destination160
 Data type of the destination Voice134
 Data type of the source160
 Data type of the source Voice134
 Data type to be cleared205, 226
 Data Type to be copied204, 226
 DAW (digital audio workstation)47
 DAW Settings267
 DAW Type267
 [DEC/NO] button14, 81
 DECAY90
 Decay 1 Level116, 120, 123, 132
 Decay 1 Time115, 120, 123, 132
 Decay 2 Level116, 120, 123
 Decay 2 Time115, 120, 123, 132
 Delay71, 106, 125
 Delay Tempo113
 Delay Tempo Sync113
 Delete173, 177, 194, 241, 276
 Delete All177
 Delete Measure204
 Delete range204
 Demo data21
- Demo Song
 load21
 play21
 Depth104
 Depth Offset 1 – 8106
 Description261
 Destination104
 Destination Key Bank172, 173
 Destination Location215
 Destination Measure225
 Destination Mixing Voice241
 Destination Parts238
 Destination Pattern227, 228
 Destination Phrase223, 224, 225
 Destination Song207, 215, 225
 Destination Song and Track204
 Destination Track225, 226
 Detune152
 Device272, 275, 278
 Device Number268
 DHCP Client261
 Dial Function53
 DIGITAL OUT connector18
 Digital Performer52
 DIMM79, 295
 Dir275
 direct155
 Direction201
 Directory275
 Directory (Dir)272
 Display169, 248
 Distance119
 Distortion71
 Divide Drum Track205, 226
 DNS1/2261
 Domain261
 down200
 down&up200
 DRAM79
 Drum Key57, 134, 165, 245
 Drum Voice56
 Drum Voice Edit127
 Dry Level148, 153, 266
 Dry/Wet Balance110
 Dual BEF118
 Dual BPF118
 Dual HPF118
 Dual LPF118
 Dual Type Filter118
 Duplication symbol162
- E**
- [E] Indicator91, 97, 138, 142, 233, 240, 254
 each-on106
 Edit231
 Edit Buffer79
 Edit Recall134, 159
 Effect93, 107, 128, 138, 149, 232, 234
 Effect Block68
 Effect Bypass260
 EFFECT BYPASS [INSERTION] button13
 EFFECT BYPASS [SYSTEM] button13
 Effect Category70
 Effect connection
 Mixing70
 Performance69
 Voice69
 Effect Parameters73, 109, 146, 149, 150, 267
 Effect Type70
 Effect Unit Settings160
 Effects93, 138
 EG (Envelope Generator)138, 139, 157, 235
 EG Depth116, 120
 EG Depth Vel Curve116
 EG Depth Vel Sens116, 120
 EG Depth Vel Sens Curve120
- EG Time Key Follow116, 121, 124
 EG Time Segment116
 EG Time Velocity Sens116, 121, 124
 EG Time Velocity Sens Segment121, 124
 EG/EQ93, 94
 Element57
 on/off97, 240
 solo97, 240
 Element Edit96, 112, 241
 Element EQ68
 Element Group113
 Element Out 1 – 8108
 Element Parameters 1 – 8133
 Element Switch93, 104, 112, 129
 Element Switch 1 – 8106
 Elm LFO125
 End185
 end185
 End Point169, 247
 End Step199
 End Velocity199
 EQ95, 126, 132, 158, 236
 EQ graph95
 EQ HIGH90
 EQ LOW90
 EQ MID90
 EQ MID F90
 EQ MID Q90
 EQ Type126
 2 Band126
 PEQ126
 Equal99
 Erase220
 Erase Event201
 ETHERNET connector16, 86
 Event and Parameters193
 Event Jobs200, 223
 Event List display192, 193, 221
 Event Type194, 201, 202, 203, 215, 216
 Exchange Phrase224
 Exchange Track205, 226
 [EXIT] button14
 Expanded Articulation (XA)56, 113
 Ext184, 211
 Ext Bank Select256
 Ext Prog Change256
 Ext Switch (External Switch)255
 Extension272
 Extensions for Steinberg DAW48
 Extract177
 Extract Event201
- F**
- F Mod125
 [F1] – [F6] (Function) buttons14, 81
 Factory Set22, 269
 Fade In Time106, 125
 Fade In/Out174
 Fade Out Time106
 Fade Type174
 Favorite Category88
 FEG (Filter EG)94, 119, 139, 157
 File272, 275, 276
 procedure276
 File list275
 File Name272
 File Save278
 File Server261
 File Server Account261
 File Sharing87
 File size272
 File type273
 File Type Setting275
 Filter57, 94, 117, 131, 139, 158
 Filter (MIDI Filter)270
 Fine114, 131, 174

- Fine Scaling Sens 114
 Fine Tune 170
 fingered 100, 152
 Fixed Velocity 260
 Flanger 71
 Flash ROM 79
 folder 272
 Foot Controller 1/2 256
 Foot Controller 1/2 Control No. 147
 FOOT CONTROLLER jacks 18
 Foot Switch 256
 Foot Switch Control No. 147
 FOOT SWITCH jacks 18
 Formant Offset 110
 Formant Shift 110
 Format 273, 276, 278
 [▶▶] (Forward) button 14
 Frequency 146, 158, 162, 165, 244
 Front Panel 10
 fulltime 100, 152
 FXBypass 260
- G**
- Gain 119, 146, 158
 GAIN knob 18, 39, 40
 Gate Switch 110
 GATE TIME 90
 Gate Time 197
 Gate Time Rate 102, 103, 155, 156, 184
 Gateway 261
 General 98, 128, 143, 233, 259
 Get Name 255
 Get Phrase from Song 225
 Glide 199
 Glide Time 199
 GM 92
 GM Voice 92
 Graph 105
 Grid 200
 Group [A] – [H] buttons 14
- H**
- Half Damper Switch 123
 Half Damper Time 124
 Half Sampling Frequency 175
 High Frequency 126, 144
 High Gain 126, 144
 High Pass Filter 117
 HOLD 140
 Hold 95, 101, 106, 154
 Hold Level 115, 120
 Hold Time 115, 120
 Host 277
 Host Name 260
 HPF (High Pass Filter) 117
 HPF Cutoff 119, 131
 HPF Freq 110
 HPF Key Follow 119
 HPF Output Level 110
 HPF12 117
 HPF24D 117
- I**
- I/O 263
 IEEE1394 cable 44
 [INC/YES] button 14, 81
 Indian 99
 INFO 138
 INFO (Information) 53, 92, 93, 138, 165, 172, 182, 211, 240, 252, 259
 Init 133, 159, 236, 258
 Initial Level 123
 Initialize selected Parts to GM 237
 Initialize the settings of the waveform assigned to the selected Key 134
 Initialize the settings of the waveforms assigned to the selected Elements 133
 Initialize Type 258
 Input Source 164, 244
 Ins A 109, 129, 149, 234, 267
 Ins B 109, 129, 149, 234, 267
 Ins Effect Output 114, 130
 Ins Effect Sw 188, 219
 Ins FX Sw 232
 Ins L 109
 Ins Switch (Insertion Effect Switch) 234
 Insert 194, 216
 Insert Event window 192, 193, 216, 221
 Inserting location 216
 Insertion A/B 69, 108, 148, 266
 INSERTION CONNECT 108, 148, 266
 Insertion Effect 68, 230
 Insertion point 204
 Inst Input Level 110
 Installing Optional Hardware 293
 Int 184, 211
 Int Bank Select 255
 Int Prog Change 256
 Int Switch (Internal Switch) 255
 Internal Memory 79
 Interval 217
 Interval diagram 217
 IP Address 261
- J**
- Job
 Master 257
 Mixing 236
 Mixing Voice 240
 Pattern 222
 Performance 159
 Sampling 171
 Song 195
 Voice 133
- K**
- KBD 82, 162, 172
 Keep Original Phrase 227, 228
 Key 129, 162, 166, 169, 246
 Key Assign Mode 100
 Key Bank 161, 173, 174, 175, 176
 Key Bank number 162
 Key Bank to be deleted 173
 Key Edit 127, 129
 Key Mode 101, 155
 Key On Delay 113
 Key On Reset 105, 125
 Key On Start Switch 141
 Key Parameters 134
 Key Range 170, 245
 Keybank 165, 172, 244
 Keybank Jobs 162
 Keyboard 12, 67
 Keyboard MIDI transmit channel 91
 Keyboard Octave setting 91
 Keyboard Start 210, 214, 219
 Keyboard Transmit Ch 268
 Kirmberger 99
 Knob 256
 Knob Control Assign 100, 145
 Knob Ctrl Assign 255
 Knob Functions/Values 52
 Knobs 12, 26, 68, 136, 180
 Function 90
 Knobs 1 – 8 252
 KnobSlider 257
- L**
- L&R Gain 263
 LAN connection 86
 Layer 29
 LCD Contrast Control 16, 20
 LCD Display 14
 Length 174, 210, 212, 219
 Level 122, 131, 145, 170
 level 166, 246
 Level 1 – 16 107
 Level Key Follow 122
 LEVEL METER 52
 Level Meter 166, 246
 Level Velocity Sens 122
 Level Velocity Sens Curve 122
 Level Velocity Sens Offset 122
 Level/MEF 145
 Level/Pan 122
 LFO (Low Frequency Oscillator) 58
 LFO Phase Offset 107
 LIST 82
 Load 273, 275, 280
 a AIFF file 284
 a Pattern 283
 a Performance 282
 a Sample Voice 283
 a SMF file 285
 a Song 283
 a specific type 280
 a Voice 280
 a WAV file 284
 a Waveform 281
 all user data 280
 all voice 280
 Load File 280
 Load Mixing 271
 Local Control 269
 Location 182
 Lo-Fi 72
 Logic 52
 Loop 103, 156, 182, 185, 219
 Loop Point 169, 247
 Loop-Remix 175
 Low Frequency 126, 144
 Low Frequency Oscillator (OSC) 58
 Low Gain 126, 144
 Low Pass Filter 117
 Lower Ch 258
 Lowest Key 176
 LP=ST 169, 248
 LPF (Low Pass Filter) 117
 LPF12+BPF6 118
 LPF12+HPF12 118
 LPF18 117
 LPF18s 117
 LPF24A 117
 LPF24D 117
 LPF6+HPF6 118
- M**
- Main Category 143
 Main Category 1/2 93, 98
 manual 166, 246
 Master Edit 253
 Master Effect 68
 [MASTER EFFECT] button 13
 Master EQ 68
 Master Job 257
 Master Name 251, 252
 Master Number 251
 Master Play 251
 Master Store 254
 MASTER VOLUME 12, 20
 MasterEQ 146, 234, 264
 MasterFX 146, 234, 264
 Maximum Polyphony 59

- MEAS193, 215
 Meas182, 187
 meas (measure)246
 Measure141, 169, 176, 193, 207,
210, 213, 219, 243, 245, 248, 249
 Measure Jobs203
 Measure number182
 Mega Voice62
 Mega Voice Arpeggio62
 Memory254
 Memory location275
 Memory Structure80
 Meter169, 176, 248, 249
 Meter of measures to be inserted204
 Metronome Settings270
 Mic Gate Threshold110
 Mic Level110
 Mic/Line263
 Micro Tuning99, 265
 Micro Tuning Copy265
 Micro Tuning List99
 Micro Tuning Name265
 Micro Tuning No.265
 Mid Frequency144
 Mid Gain144
 MIDI76, 267
 MIDI channel76
 MIDI event76
 MIDI Filter270
 MIDI IN/OUT259, 268
 MIDI IN/OUT/THRU connectors18, 83
 MIDI interface44
 MIDI Out Channel157
 MIDI Out Switch157
 MIDI Send257
 MIDI Settings267
 MIDI Sync268
 MIDI track61
 Misc72
 Mix238
 Mix Phrase224
 Mix Track205, 226
 Mixing33, 58, 229
 Insertion Effect230
 setup230
 structure229
 Mixing Edit233
 Mixing Job236
 Mixing Play231
 Mixing Setup181
 Mixing Store233
 Mixing Template238
 Mixing Voice230
 Mixing Voice Edit239
 Mixing Voice Job240
 Mixing Voice Store240
 Mixing Voice to be deleted241
 MIXV (Mixing Voice)188
 mLAN17
 mLAN (IEEE1394) connector 1, 217, 44
 mLAN expansion board cover17
 mLAN Gain263
 mLAN Monitor Setup263
 mLAN16E217, 294
 MMC (MIDI Machine Control)85, 268
 Mode251, 252, 254, 270
 select55
 table54
 MODE buttons14, 20
 Modify Control Data203
 Modify Gate Time198
 Modify Velocity197
 Modulation Wheel256
 Modulation wheel12, 67
 Mono/Poly93, 99, 152
 Mono/Poly Mode93
 Mono/Stereo147, 265
 MOTIF XS Editor274
 Mount273, 276, 277
 Move173
 MTC (MIDI Time Code)84, 268
 MTC Start Offset268
 multi100, 130
 [MULTI PART CONTROL] button13
 Mute182, 187, 210, 219, 231
 [MUTE] button15
 MW (Modulation Wheel)25, 92
- N**
- Name93, 98, 128, 138, 143, 254
 Naming82
 Network260
 Network Information259
 Network Settings86
 New Dir276
 New Password262
 New settings271
 No.212
 Noise Input Level110
 Non-Registered Parameter Number (NRPN)79
 normal 01 – 16217
 Normal Voice56
 Edit96
 Normalize173
 Normalize Play Effect205, 226
 Note76, 78, 177, 199, 255
 Note Jobs196, 223
 Note Limit101, 114, 152, 154
 Note Limit High255
 NOTE LIMIT LO-HI139
 Note Limit Low255
 Note Shift99, 152, 184, 259
 NRPN (Non-Registered Parameter Number)77
 NUM81, 169, 248
 Number151, 232
 Number [1] – [16] buttons14
 number input81
 Number of measures to be inserted204
 Number of Times201, 202, 215
- O**
- OCT RANGE90
 Octave92, 138, 177, 251, 255, 260
 OCTAVE [UP] and [DOWN] buttons14
 Octave Range103, 156
 Offset198, 203
 Offset 1 – 4121, 125
 one shot105, 170
 Optimize Memory177
 Original Notes Root206
 Original Pattern227, 228
 Original Phrase224
 Oscillator57, 112, 129
 Other100, 128, 145, 153, 235, 254, 271
 Other Jobs177
 Out129, 184
 Output147, 152, 234, 235, 265
 OUTPUT L/MONO and R jacks18, 19
 Output Level110
 Output Octave Shift102, 155
 Output Select130, 148, 153, 266
 Overdub Recording191
- P**
- P Mod125
 Page List53
 Page Select53
 PageHold131
 PAN90
 Pan99, 122, 131, 145, 147, 152, 170, 188,
219, 232, 256, 257, 265
 Param169, 170
 Param. with Voice151
 PART139
 Part160, 165, 231, 232, 245
 adjusting volume34
 mute135, 142, 233
 on/off135, 142, 233
 select151
 solo135, 142, 233
 Part 1 – 16231, 232, 234
 Part 1 – 4138
 Part Edit141, 229
 Mixing235
 Performance151
 Part EQ68, 144
 Part number237
 Part Parameters159, 236
 Part Switch151
 Password262
 Setting262
 PAT (Polyphonic Aftertouch)78, 193
 Patch211, 212
 Path273
 Pattern207, 274
 create212
 defined60
 Pattern Chain60, 209, 213
 edit214, 216
 Pattern Edit220
 Pattern Job222
 Pattern Jobs227
 Pattern name210, 211, 219
 Pattern number140, 210, 237
 Pattern Play208
 Pattern Record218
 Pattern Scene209
 Pattern Store218
 Pattern to be cleared228
 PB Range199
 PB Range Lower99, 153
 PB Range Upper99, 153
 PDC Name261
 PEG (Pitch EG)115
 PEQ126
 Perf237, 238
 Performance160, 274
 defined58
 Initialize29
 select135
 Store142
 Performance Bank137
 Performance Category143
 [PERFORMANCE CONTROL] button15
 Performance Copy160
 Performance Edit141
 Performance Job159
 Performance name137
 Performance Number137, 238
 Performance number238
 Performance Play display137
 Performance Play Mode135
 Performance Record31, 61, 140
 Phase105
 Phaser71
 PHONES (Headphone) jack18, 19
 Phrase60, 225
 Phrase Jobs223
 Phrase Name212
 Phrase to be exchanged224
 Phrase1 – 4249
 57, 114, 174
 pitch 01 – 16217
 Pitch Bend76, 256
 Pitch Bend Range93
 Pitch Bend wheel12, 67
 Pitch Key Follow115
 Pitch Velocity Sens114, 131
 Play93, 138, 210, 211, 259

- [▶] (Play) button 14
 - Play Effect (Play FX) 61
 - Play FX 183, 211
 - Play Mode 98, 105, 128, 170
 - Polyphonic Aftertouch (PAT) 78
 - Porta 93, 144
 - Portamento 93
 - apply to Voice 94
 - Portamento Common 144
 - Portamento Legato Slope 100
 - Portamento Mode 93, 100, 152
 - Portamento Part 1 – 4 144
 - Portamento Part Sw 152
 - Portamento Switch 93, 100
 - Portamento Time 93, 100, 152
 - Portamento Time Mode 100
 - Portamento Time Offset 144
 - Power On Auto Factory Set 269
 - Power On Mode 262
 - Power Supply 19
 - POWER switch 16, 19
 - Preset 109, 146, 149, 150, 256, 267
 - Program 93, 138, 252, 255
 - [PROGRAM] button 15
 - Program Change 256, 268
 - Program Change (PC) 76
 - Program number 251
 - punch 187
 - Punch In/Out 188, 191, 246
 - PureMajor 99
 - PureMinor 99
 - Put Phrase to Song 225
 - Put Track to Arpeggio 206, 227
- ## Q
- Q 126, 144, 147, 158
 - Quantize 183, 188, 196, 197, 219, 271
 - QUANTIZE STRENGTH 90
 - Quantize Strength 103, 156
 - QUANTIZE VALUE 90
 - Quantize Value 102, 156
 - Quick 270
 - quick 249
 - Quick Setup 270
- ## R
- Random 114
 - Random Pan 123, 132
 - Random SFX 64, 103, 157
 - Random SFX Key On Control 103, 157
 - Random SFX Velocity Offset 103, 157
 - Random Speed 106
 - Range 206, 207, 227
 - Rate 197, 198, 203
 - Ratio 173, 174
 - RB (Ribbon Controller) 25, 92
 - RcvSwitch (Receive Switch) 158, 236
 - Realtime Recording 33, 186
 - Rear Panel 16
 - Rec 162, 164, 244
 - REC TR 187, 219
 - Recall 134, 159, 241
 - Recall Buffer 79
 - Receive Bulk 269
 - Receive Channel 235
 - Receive Note Off 130
 - [●] (Record) button 14
 - Record Gain 166, 245
 - Record Monitor 166, 245
 - Record Next 164, 244
 - Record Part 188, 219
 - Record Slice 248
 - Record Trim 247
 - Record Type 187, 219
 - Recordable Size 165
 - Recordable Time 162, 165, 166, 169, 170, 245, 246, 248, 249
 - Recording 189
 - 1-16 tracks 189
 - All Track setting 190
 - Arpeggio playback to Pattern 32
 - Audio 242
 - Melody and Arpeggio playback to Song 31
 - Pattern 218
 - Pattern Chain 214
 - Scene Track 190
 - Song 186
 - Tempo Track 190
 - Recording Count 270
 - Recording Type 164, 244
 - Registered Parameter Number (RPN) 78
 - Rehearsal 191
 - RELEASE 90
 - Release Level 116, 120
 - Release Time 115, 120, 123
 - Remix 211, 217
 - Remote 267
 - Remote Control
 - function 51
 - mode 52
 - set up 51
 - [REMOTE ON/OFF] button 13
 - Rename 177, 276
 - replace 219
 - Replace Recording 189
 - resample 164
 - Reset 269
 - RESONANCE 90
 - Resonance 119, 131
 - Resonance Velocity Sens 119
 - REV SEND 129
 - Rev Send 232
 - REVERB 90
 - Reverb 70, 109, 129, 150, 235, 260
 - Reverb Pan 108, 150
 - Reverb Return 108, 150
 - Reverb Send 108, 130, 145, 148, 152, 266
 - Reverb Type 108, 149
 - reverse 170
 - reverse 01 – 16 217
 - [◀◀] (Reverse) button 14
 - REV-X 73
 - Ribbon Controller 12, 67, 256
 - Ribbon Controller Control No. 147
 - Ribbon Mode 100, 145
 - RPN (Registered Parameter Number) 78
- ## S
- Sample 161
 - Sample Size 162
 - Sample Voice 274
 - sample+note 244
 - Sampling
 - procedure 40, 163
 - setup 39
 - Sampling Block 59
 - Sampling Edit 167, 250
 - Sampling FINISHED display 167, 246
 - Sampling Job 171, 250
 - Sampling Main display 162, 243
 - Sampling mode 161, 242
 - Sampling Record 163, 244
 - Sampling RECORDING display 167, 246
 - Sampling Setup display 164, 244
 - Save 273, 275, 278
 - a specific type 278
 - all user data 278
 - sample of a Voice 279
 - SMF 279
 - Scale 121, 124
 - Scaling Pan 123
 - Scene Track 60, 190
 - Scene1 – Scene5 182, 188, 189, 211, 219, 252
 - Section 60, 140, 207, 210, 213, 215, 219, 237
 - Section Length 140
 - Security 261
 - Select 263
 - [SELECTED PART CONTROL] button 12
 - Sens 176, 249
 - Separate Chord 200
 - SEQ TRANSPORT buttons 14
 - Sequence data bar 182
 - Sequence tracks 1 – 16 59
 - Sequencer Block 59
 - Sequencer Control 268
 - Sequencer Mode 140
 - Sequencer Settings 269
 - Set 106
 - Set All 194, 197, 198, 203
 - Setting Values 215
 - Setup 187, 188, 219
 - Setup Number 271
 - [SF1] – [SF5] (Sub Function) buttons 14, 81
 - Shape 146
 - Sharing Point 277
 - Shift Clock 200
 - single 100, 130
 - single timbre 56
 - skip 185
 - Slice 176, 242, 248
 - Slice Type 250
 - slice+seq 244
 - Slider 256
 - Slope 107
 - SMF (Standard MIDI File) 273
 - SMPL (Sample Voice) 188
 - Solo 182, 187, 210, 219, 231
 - [SOLO] button 15
 - SONAR 52
 - Song 33, 207, 215, 274
 - defined 59
 - select 21
 - Song Chain 60, 180, 185
 - Song Edit 192
 - Song Event Chase 271
 - Song Job 195
 - Song Jobs 207
 - Song name 181, 185, 187
 - Song number 140, 181, 185, 237
 - Song Play 178
 - Song Position Line 182
 - Song Record 186
 - Song Scene 179
 - Song Store 186
 - Song Track 59
 - sort 155
 - Sort Chord 200
 - sort+direct 155
 - Source 104
 - Source Key Bank 172, 173
 - Source Measure 225
 - Source Mixing Voice 241
 - Source Part 160
 - Source Pattern 206, 227
 - Source Phrase 206, 212, 223, 225
 - Source Range 215
 - Source Song 207, 225
 - Source Song and Track 204
 - Source Track 225, 226
 - Specifications 297
 - Speed 105, 125
 - Split 30
 - Split Pattern 228
 - Split Phrase 224
 - Split Point 258
 - Split Point Measure 225
 - Split Song to Pattern 207
 - Splitpoint Measure 228
 - Standby 165, 166, 245
 - Start 166, 185, 246

- Start Point 169, 247
 Start Step 199
 Start Velocity 199
 Stereo to Mono 175
 Stereo/Mono 162, 164, 244
 Stop 167
 stop 185
 [■] (Stop) button 14
 Store
 Master 254
 Mixing 233
 Mixing Voice 240
 Pattern 218
 Performance 142
 Song 186
 Voice 97
 Strength 197
 Studio Connections 50
 Studio Manager 50
 SUB CATEGORY 140
 Sub Category 95, 102, 143, 155
 Sub Category 1/2 98
 Sub Divide 176, 249
 Subnet Mask 261
 SUSTAIN 90
 Sustain 256
 Sustain Pedal 260
 SW 140
 SWING 90
 Swing 103, 156, 183
 Swing Rate 197
 Switch 95, 101, 146, 154, 264
 Sync Quantize Value 140
 System Effect 68
 System Exclusive 79
 System settings 259
- T**
- Tech 72
 Template 107, 238
 Template Mix 238
 Template Performance 238
 TEMPO 90
 Tempo 95, 101, 140, 154, 169, 176, 182, 187,
 210, 214, 219, 247, 249
 Tempo Change 215
 Tempo Hold 271
 Tempo Speed 105
 Tempo Sync 105
 Tempo Track 60, 190
 Thin Out 202
 thru 155
 thru+direct 155
 Time Signature 140, 215
 Time signature 182, 187, 210, 213, 219
 Time-Stretch 173
 Tone Generator block 56
 [■] (Top) button 14
 TR 193
 Track 33, 165, 169, 183, 184, 201, 205, 206,
 207, 211, 212, 226, 243, 244, 245
 mute 33
 solo 33
 Track and location 201
 Track and range 196, 197, 198, 199, 200, 201, 202, 203
 [TRACK] button 15
 Track Jobs 204, 226
 Track Mute 215
 Track number 182, 183, 187, 210, 219
 Track Sel 194
 Track Status 141
 Track type 187, 210, 219
 TrackView 181, 183
 Trans 182, 210, 213
 Transmit 255
 Transmit CH 92
 Transmit Ch 137
 Transmit Channel 252, 255
 Transmit Switch 255
 Transpose 27, 177, 198, 199, 255, 260
 Tremolo & Rotary 71
 Trigger Level 166, 246
 Trigger Mode 103, 156, 166, 246
 Trim 168, 169, 247, 249
 Troubleshooting 288
 Tune 27, 114, 259
 Tuning 265
 Tuning Number 99
 Tuning Offset 265
 Tuning Root 99
 Tx Switch 255
 TxCh 184, 211
 TYPE 140
 Type 175, 176, 200, 217, 270
 Arpeggio 95, 102, 155
 Effect 109, 149, 150, 267
 EQ 126
 File 275
 Filter 117
 Loop-Remix 176
 Master Effect 146
 Recording 164, 244
 Slice 249
 Vocoder 110
 Type diagram 217
- U**
- Undo/Redo 196, 223
 Unit Multiply 102, 156
 UNITMULTIPLY 90
 up 200
 up&down 200
 Upper Ch 258
 USB 16
 USB storage device 85
 USB TO DEVICE connector 16, 85
 USB TO HOST connector 16, 43
 USB-MIDI driver 43
 Used/Total 165
 User 107
 User Arpeggio 80
 User Memory 79, 80
 User Phrase 80
 User Voice 80
 Utility 259
- V**
- Vallot&Yng 99
 Value of the selected event type 216
 Variation 176, 217
 Vce Edit 232
 VCM (Virtual Circuitry Modeling) 72
 VCM Auto Wah 73
 VCM Compressor 376 72
 VCM Equalizer 501 73
 VCM Flanger 73
 VCM Pedal Wah 73
 VCM Phaser Mono 73
 VCM Phaser Stereo 73
 VCM Touch Wah 73
 Vel Cross Fade 114
 Vel Sens Depth 153
 VELOCITY 90
 Velocity 162, 166, 169, 170, 184, 245
 Velocity Curve 260
 Velocity Limit 95, 101, 114, 152, 154
 Velocity Mode 102, 155
 Velocity Offset (Random SFX) 157
 Velocity Range 198
 Velocity Rate 102, 103, 155, 156
 Velocity Sens 131
 Velocity Sens Depth Offset 153
- ViewFilter 194, 215, 221
 Vocoder 72
 structure 111
 use 111
 Vocoder Attack 110
 Vocoder Release 110
 Voice 138, 151, 160, 165, 184, 185,
 188, 211, 219, 235, 237, 245, 263, 274
 defined 56
 select 88
 Store 97
 Voice as source 134
 Voice Bank 92, 139, 140
 Voice Element Pan 152
 Voice Job 133
 Voice Name 92, 138, 139, 140, 182, 187, 219
 Voice Number 92, 139, 140
 Voice Play display 91
 Voice Play mode 88
 Voice Type 93
 Voice with ARP 154, 189
 VoiceAudio 265
 Volume 98, 145, 147, 152, 188, 219, 232,
 257, 259, 265, 270
 Volume Label 278
 Volume/Express 256
- W**
- Wah 72
 WAV 273, 274
 Wave 105, 125
 Wave Bank 113, 130
 Wave Category 113, 130
 Wave Memory 250
 Wave Number 113, 130
 Waveform
 161, 162, 165, 166, 169, 177, 244, 245, 274
 Waveform as destination 176
 Waveform as source 176
 Waveform Jobs 176
 Werckmeister 99
 Width 119
 WINS 261
 Without Program Change 215
- X**
- XA Control 112
- Z**
- Zone 258
 Zone Edit 253, 255
 Zone Switch 252, 254
 Zoom In 169, 183, 248
 Zoom Out 169, 183, 248

About the accessory disk

SPECIAL NOTICE

- The software included in the accessory disk and the copyrights thereof are under exclusive ownership by Steinberg Media Technologies GmbH.
- Use of the software and this manual is governed by the license agreement which the purchaser fully agrees to upon breaking the seal of the software packaging. (Please read carefully the Software Licensing Agreement at the end of this manual before installing the application.)
- Copying of the software or reproduction of this manual in whole or in part by any means is expressly forbidden without the written consent of the manufacturer.
- Yamaha makes no representations or warranties with regard to the use of the software and documentation and cannot be held responsible for the results of the use of this manual and the software.
- This disk is NOT for audio/visual purpose. Do not attempt to play the disk on an audio/visual CD/DVD player. Doing so may result in irreparable damage to your player.
- For information about the minimum system requirements and latest information of the software in the disk, check the web site below.
<<http://www.yamahasyth.com/>>
- Note that Yamaha does not offer technical support for the DAW software in the accessory disk.

About the DAW software in the accessory disk

The accessory disk contains DAW software both for Windows and Macintosh.

- NOTE**
- Make sure to install DAW software under the "Administrator" account.
 - In order to have continuous use of the DAW software in the accessory disk, including support and other benefits, you will need to register the software and activate your software license by starting it while the computer is connected to the Internet. Click the "Register Now" button shown when the software is started, then fill in all required fields for registration. If you do not register the software, you will be unable to use it after a limited period of time expires.
 - If you are using a Macintosh computer, double-click the "****.pkg" file to start installation.

For information about the minimum system requirements and latest information on the software in the disk, check the web site below.

<<http://www.yamahasyth.com/>>

About software support

Support for the DAW software in the accessory disk is provided by Steinberg on its website at the following address.
<http://www.steinberg.net>

You can visit the Steinberg site also via the Help menu of the included DAW software. (The Help menu also includes the PDF manual and other information on the software.)

ATTENTION

SOFTWARE LICENSE AGREEMENT

PLEASE READ THIS SOFTWARE LICENSE AGREEMENT ("AGREEMENT") CAREFULLY BEFORE USING THIS SOFTWARE. YOU ARE ONLY PERMITTED TO USE THIS SOFTWARE PURSUANT TO THE TERMS AND CONDITIONS OF THIS AGREEMENT. THIS AGREEMENT IS BETWEEN YOU (AS AN INDIVIDUAL OR LEGAL ENTITY) AND YAMAHA CORPORATION ("YAMAHA").

BY BREAKING THE SEAL OF THIS PACKAGE YOU ARE AGREEING TO BE BOUND BY THE TERMS OF THIS LICENSE. IF YOU DO NOT AGREE WITH THE TERMS, DO NOT INSTALL, COPY, OR OTHERWISE USE THIS SOFTWARE.

THIS AGREEMENT PROVIDES YOUR USE-CONDITIONS ABOUT THE "DAW" SOFTWARE OF STEINBERG MEDIA TECHNOLOGIES GMBH ("STEINBERG") WHICH IS BUNDLED WITH THIS PRODUCT. SINCE THE END-USER SOFTWARE LICENSE AGREEMENT (EUSLA) SHOWED ON YOUR PC-DISPLAY IN YOUR INSTALLING THE "DAW" SOFTWARE IS REPLACED BY THIS AGREEMENT, YOU SHOULD DISREGARD THE EUSLA. THAT IS, IN THE INSTALLING PROCESS, YOU SHOULD SELECT "AGREE" WITH THE EUSLA, WITHOUT YOUR JUDGMENT THERETO, SO AS TO PROCEED TO THE NEXT PAGE.

1. GRANT OF LICENSE AND COPYRIGHT

Yamaha hereby grants you the right to use one copy of the software program(s) and data ("SOFTWARE") accompanying this Agreement. The term SOFTWARE shall encompass any updates to the accompanying software and data. The SOFTWARE is owned by STEINBERG, and is protected by relevant copyright laws and all applicable treaty provisions. Yamaha has acquired the sublicense right to license you to use the SOFTWARE. While you are entitled to claim ownership of the data created with the use of SOFTWARE, the SOFTWARE will continue to be protected under relevant copyrights.

- **You may** use the SOFTWARE on a **single computer**.
- **You may** make one copy of the SOFTWARE in machine-readable form for backup purposes only, if the SOFTWARE is on media where such backup copy is permitted. On the backup copy, you must reproduce Yamaha's copyright notice and any other proprietary legends that were on the original copy of the SOFTWARE.
- **You may** permanently transfer to a third party all your rights in the SOFTWARE only when you transfer this product together, provided that you do not retain any copies and the recipient reads and agrees to the terms of this Agreement.

2. RESTRICTIONS

- **You may not** engage in reverse engineering, disassembly, decompilation or otherwise deriving a source code form of the SOFTWARE by any method whatsoever.
- **You may not** reproduce, modify, change, rent, lease, or distribute the SOFTWARE in whole or in part, or create derivative works of the SOFTWARE.
- **You may not** electronically transmit the SOFTWARE from one computer to another or share the SOFTWARE in a network with other computers.
- **You may not** use the SOFTWARE to distribute illegal data or data that violates public policy.
- **You may not** initiate services based on the use of the SOFTWARE without permission by Yamaha Corporation.

Copyrighted data, including but not limited to MIDI data for songs, obtained by means of the SOFTWARE, are subject to the following restrictions which you must observe.

- Data received by means of the SOFTWARE may not be used for any commercial purposes without permission of the copyright owner.
- Data received by means of the SOFTWARE may not be duplicated, transferred, or distributed, or played back or performed for listeners in public without permission of the copyright owner.
- The encryption of data received by means of the SOFTWARE may not be removed nor may the electronic watermark be modified without permission of the copyright owner.

3. TERMINATION

This Agreement becomes effective on the day that you receive the SOFTWARE and remains effective until terminated. If any copyright law or provisions of this Agreement is violated, the Agreement shall terminate automatically and immediately without notice from Yamaha. Upon such termination, you must immediately destroy the licensed SOFTWARE, any accompanying written documents and all copies thereof.

4. LIMITED WARRANTY ON MEDIA

As to SOFTWARE sold on tangible media, Yamaha warrants that the tangible media on which the SOFTWARE is recorded will be free from defects in materials and workmanship under normal use for a period of fourteen (14) days from the date of receipt, as evidenced by a copy of the receipt. Yamaha's entire liability and your exclusive remedy will be replacement of the defective media if it is returned to Yamaha or an authorized Yamaha dealer within fourteen days with a copy of the receipt. Yamaha is not responsible for replacing media damaged by accident, abuse or misapplication. TO THE FULLEST EXTENT PERMITTED BY LAW, YAMAHA EXPRESSLY DISCLAIMS ANY IMPLIED WARRANTIES ON THE TANGIBLE MEDIA, INCLUDING THE IMPLIED WARRANTIES OF MERCHANTABILITY AND FITNESS FOR A PARTICULAR PURPOSE.

5. DISCLAIMER OF WARRANTY ON SOFTWARE

You expressly acknowledge and agree that use of the SOFTWARE is at your sole risk. The SOFTWARE and related documentation are provided "AS IS" and without warranty of any kind. NOTWITHSTANDING ANY OTHER PROVISION OF THIS AGREEMENT, YAMAHA EXPRESSLY DISCLAIMS ALL WARRANTIES AS TO THE SOFTWARE, EXPRESS, AND IMPLIED, INCLUDING BUT NOT LIMITED TO THE IMPLIED WARRANTIES OF MERCHANTABILITY, FITNESS FOR A PARTICULAR PURPOSE AND NON-INFRINGEMENT OF THIRD PARTY RIGHTS. SPECIFICALLY, BUT WITHOUT LIMITING THE FOREGOING, YAMAHA DOES NOT WARRANT THAT THE SOFTWARE WILL MEET YOUR REQUIREMENTS, THAT THE OPERATION OF THE SOFTWARE WILL BE UNINTERRUPTED OR ERROR-FREE, OR THAT DEFECTS IN THE SOFTWARE WILL BE CORRECTED.

6. LIMITATION OF LIABILITY

YAMAHA'S ENTIRE OBLIGATION HEREUNDER SHALL BE TO PERMIT USE OF THE SOFTWARE UNDER THE TERMS HEREOF. IN NO EVENT SHALL YAMAHA BE LIABLE TO YOU OR ANY OTHER PERSON FOR ANY DAMAGES, INCLUDING, WITHOUT LIMITATION, ANY DIRECT, INDIRECT, INCIDENTAL OR CONSEQUENTIAL DAMAGES, EXPENSES, LOST PROFITS, LOST DATA OR OTHER DAMAGES ARISING OUT OF THE USE, MISUSE OR INABILITY TO USE THE SOFTWARE, EVEN IF YAMAHA OR AN AUTHORIZED DEALER HAS BEEN ADVISED OF THE POSSIBILITY OF SUCH DAMAGES. In no event shall Yamaha's total liability to you for all damages, losses and causes of action (whether in contract, tort or otherwise) exceed the amount paid for the SOFTWARE.

7. GENERAL

This Agreement shall be interpreted according to and governed by Japanese law without reference to principles of conflict of laws. Any dispute or procedure shall be heard before the Tokyo District Court in Japan. If for any reason a court of competent jurisdiction finds any portion of this Agreement to be unenforceable, the remainder of this Agreement shall continue in full force and effect.

8. COMPLETE AGREEMENT

This Agreement constitutes the entire agreement between the parties with respect to use of the SOFTWARE and any accompanying written materials and supersedes all prior or contemporaneous understandings or agreements, written or oral, regarding the subject matter of this Agreement. No amendment or revision of this Agreement will be binding unless in writing and signed by a fully authorized representative of Yamaha.

GNU GENERAL PUBLIC LICENSE

Version 2, June 1991

Copyright © 1989, 1991 Free Software Foundation, Inc., 51 Franklin Street, Fifth Floor, Boston, MA 02110-1301 USA
Everyone is permitted to copy and distribute verbatim copies of this license document, but changing it is not allowed.

Preamble

The licenses for most software are designed to take away your freedom to share and change it. By contrast, the GNU General Public License is intended to guarantee your freedom to share and change free software—to make sure the software is free for all its users. This General Public License applies to most of the Free Software Foundation's software and to any other program whose authors commit to using it. (Some other Free Software Foundation software is covered by the GNU Lesser General Public License instead.) You can apply it to your programs, too.

When we speak of free software, we are referring to freedom, not price. Our General Public Licenses are designed to make sure that you have the freedom to distribute copies of free software (and charge for this service if you wish), that you receive source code or can get it if you want it, that you can change the software or use pieces of it in new free programs; and that you know you can do these things.

To protect your rights, we need to make restrictions that forbid anyone to deny you these rights or to ask you to surrender the rights. These restrictions translate to certain responsibilities for you if you distribute copies of the software, or if you modify it.

For example, if you distribute copies of such a program, whether gratis or for a fee, you must give the recipients all the rights that you have. You must make sure that they, too, receive or can get the source code. And you must show them these terms so they know their rights.

We protect your rights with two steps: (1) copyright the software, and (2) offer you this license which gives you legal permission to copy, distribute and/or modify the software.

Also, for each author's protection and ours, we want to make certain that everyone understands that there is no warranty for this free software. If the software is modified by someone else and passed on, we want its recipients to know that what they have is not the original, so that any problems introduced by others will not reflect on the original authors' reputations.

Finally, any free program is threatened constantly by software patents. We wish to avoid the danger that redistributors of a free program will individually obtain patent licenses, in effect making the program proprietary. To prevent this, we have made it clear that any patent must be licensed for everyone's free use or not licensed at all.

The precise terms and conditions for copying, distribution and modification follow.

GNU GENERAL PUBLIC LICENSE TERMS AND CONDITIONS FOR COPYING, DISTRIBUTION AND MODIFICATION

0. This License applies to any program or other work which contains a notice placed by the copyright holder saying it may be distributed under the terms of this General Public License. The "Program", below, refers to any such program or work, and a "work based on the Program" means either the Program or any derivative work under copyright law: that is to say, a work containing the Program or a portion of it, either verbatim or with modifications and/or translated into another language. (Hereinafter, translation is included without limitation in the term "modification".) Each licensee is addressed as "you".

Activities other than copying, distribution and modification are not covered by this License; they are outside its scope. The act of running the Program is not restricted, and the output from the Program is covered only if its contents constitute a work based on the Program (independent of having been made by running the Program). Whether that is true depends on what the Program does.

1. You may copy and distribute verbatim copies of the Program's source code as you receive it, in any medium, provided that you conspicuously and appropriately publish on each copy an appropriate copyright notice and disclaimer of warranty; keep intact all the notices that refer to this License and to the absence of any warranty; and give any other recipients of the Program a copy of this License along with the Program.

You may charge a fee for the physical act of transferring a copy, and you may at your option offer warranty protection in exchange for a fee.

2. You may modify your copy or copies of the Program or any portion of it, thus forming a work based on the Program, and copy and distribute such modifications or work under the terms of Section 1 above, provided that you also meet all of these conditions:

- a)** You must cause the modified files to carry prominent notices stating that you changed the files and the date of any change.
- b)** You must cause any work that you distribute or publish, that in whole or in part contains or is derived from the Program or any part thereof, to be licensed as a whole at no charge to all third parties under the terms of this License.
- c)** If the modified program normally reads commands interactively when run, you must cause it, when started running for such interactive use in the most ordinary way, to print or display an announcement including an appropriate copyright notice and a notice that there is no warranty (or else, saying that you provide a warranty) and that users may redistribute the program under these conditions, and telling the user how to view a copy of this License. (Exception: if the Program itself is interactive but does not normally print such an announcement, your work based on the Program is not required to print an announcement.)

These requirements apply to the modified work as a whole. If identifiable sections of that work are not derived from the Program, and can be reasonably considered independent and separate works in themselves, then this License, and its terms, do not apply to those sections when you distribute them as separate works. But when you distribute the same sections as part of a whole which is a work based on the Program, the distribution of the whole must be on the terms of this License, whose permissions for other licensees extend to the entire whole, and thus to each and every part regardless of who wrote it.

Thus, it is not the intent of this section to claim rights or contest your rights to work written entirely by you; rather, the intent is to exercise the right to control the distribution of derivative or collective works based on the Program.

In addition, mere aggregation of another work not based on the Program with the Program (or with a work based on the Program) on a volume of a storage or distribution medium does not bring the other work under the scope of this License.

- 3.** You may copy and distribute the Program (or a work based on it, under Section 2) in object code or executable form under the terms of Sections 1 and 2 above provided that you also do one of the following:
 - a)** Accompany it with the complete corresponding machine-readable source code, which must be distributed under the terms of Sections 1 and 2 above on a medium customarily used for software interchange; or,
 - b)** Accompany it with a written offer, valid for at least three years, to give any third party, for a charge no more than your cost of physically performing source distribution, a complete machine-readable copy of the corresponding source code, to be distributed under the terms of Sections 1 and 2 above on a medium customarily used for software interchange; or,
 - c)** Accompany it with the information you received as to the offer to distribute corresponding source code. (This alternative is allowed only for noncommercial distribution and only if you received the program in object code or executable form with such an offer, in accord with Subsection b above.)

The source code for a work means the preferred form of the work for making modifications to it. For an executable work, complete source code means all the source code for all modules it contains, plus any associated interface definition files, plus the scripts used to control compilation and installation of the executable. However, as a special exception, the source code distributed need not include anything that is normally distributed (in either source or binary form) with the major components (compiler, kernel, and so on) of the operating system on which the executable runs, unless that component itself accompanies the executable.

If distribution of executable or object code is made by offering access to copy from a designated place, then offering equivalent access to copy the source code from the same place counts as distribution of the source code, even though third parties are not compelled to copy the source along with the object code.

- 4.** You may not copy, modify, sublicense, or distribute the Program except as expressly provided under this License. Any attempt otherwise to copy, modify, sublicense or distribute the Program is void, and will automatically terminate your rights under this License. However, parties who have received copies, or rights, from you under this License will not have their licenses terminated so long as such parties remain in full compliance.

5. You are not required to accept this License, since you have not signed it. However, nothing else grants you permission to modify or distribute the Program or its derivative works. These actions are prohibited by law if you do not accept this License. Therefore, by modifying or distributing the Program (or any work based on the Program), you indicate your acceptance of this License to do so, and all its terms and conditions for copying, distributing or modifying the Program or works based on it.
6. Each time you redistribute the Program (or any work based on the Program), the recipient automatically receives a license from the original licensor to copy, distribute or modify the Program subject to these terms and conditions. You may not impose any further restrictions on the recipients' exercise of the rights granted herein. You are not responsible for enforcing compliance by third parties to this License.
7. If, as a consequence of a court judgment or allegation of patent infringement or for any other reason (not limited to patent issues), conditions are imposed on you (whether by court order, agreement or otherwise) that contradict the conditions of this License, they do not excuse you from the conditions of this License. If you cannot distribute so as to satisfy simultaneously your obligations under this License and any other pertinent obligations, then as a consequence you may not distribute the Program at all. For example, if a patent license would not permit royalty-free redistribution of the Program by all those who receive copies directly or indirectly through you, then the only way you could satisfy both it and this License would be to refrain entirely from distribution of the Program.

If any portion of this section is held invalid or unenforceable under any particular circumstance, the balance of the section is intended to apply and the section as a whole is intended to apply in other circumstances.

It is not the purpose of this section to induce you to infringe any patents or other property right claims or to contest validity of any such claims; this section has the sole purpose of protecting the integrity of the free software distribution system, which is implemented by public license practices. Many people have made generous contributions to the wide range of software distributed through that system in reliance on consistent application of that system; it is up to the author/donor to decide if he or she is willing to distribute software through any other system and a licensee cannot impose that choice.

This section is intended to make thoroughly clear what is believed to be a consequence of the rest of this License.

8. If the distribution and/or use of the Program is restricted in certain countries either by patents or by copyrighted interfaces, the original copyright holder who places the Program under this License may add an explicit geographical distribution limitation excluding those countries, so that distribution is permitted only in or among countries not thus excluded. In such case, this License incorporates the limitation as if written in the body of this License.
9. The Free Software Foundation may publish revised and/or new versions of the General Public License from time to time. Such new versions will be similar in spirit to the present version, but may differ in detail to address new problems or concerns.

Each version is given a distinguishing version number. If the Program specifies a version number of this License which applies to it and "any later version", you have the option of following the terms and conditions either of that version or of any later version published by the Free Software Foundation. If the Program does not specify a version number of this License, you may choose any version ever published by the Free Software Foundation.
10. If you wish to incorporate parts of the Program into other free programs whose distribution conditions are different, write to the author to ask for permission. For software which is copyrighted by the Free Software Foundation, write to the Free Software Foundation; we sometimes make exceptions for this. Our decision will be guided by the two goals of preserving the free status of all derivatives of our free software and of promoting the sharing and reuse of software generally.

NO WARRANTY

11. BECAUSE THE PROGRAM IS LICENSED FREE OF CHARGE, THERE IS NO WARRANTY FOR THE PROGRAM, TO THE EXTENT PERMITTED BY APPLICABLE LAW. EXCEPT WHEN OTHERWISE STATED IN WRITING THE COPYRIGHT HOLDERS AND/OR OTHER PARTIES PROVIDE THE PROGRAM "AS IS" WITHOUT WARRANTY OF ANY KIND, EITHER EXPRESSED OR IMPLIED, INCLUDING, BUT NOT LIMITED TO, THE IMPLIED WARRANTIES OF MERCHANTABILITY AND FITNESS FOR A PARTICULAR PURPOSE. THE ENTIRE RISK AS TO THE QUALITY AND PERFORMANCE OF THE PROGRAM IS WITH YOU. SHOULD THE PROGRAM PROVE DEFECTIVE, YOU ASSUME THE COST OF ALL NECESSARY SERVICING, REPAIR OR CORRECTION.

12. IN NO EVENT UNLESS REQUIRED BY APPLICABLE LAW OR AGREED TO IN WRITING WILL ANY COPYRIGHT HOLDER, OR ANY OTHER PARTY WHO MAY MODIFY AND/OR REDISTRIBUTE THE PROGRAM AS PERMITTED ABOVE, BE LIABLE TO YOU FOR DAMAGES, INCLUDING ANY GENERAL, SPECIAL, INCIDENTAL OR CONSEQUENTIAL DAMAGES ARISING OUT OF THE USE OR INABILITY TO USE THE PROGRAM (INCLUDING BUT NOT LIMITED TO LOSS OF DATA OR DATA BEING RENDERED INACCURATE OR LOSSES SUSTAINED BY YOU OR THIRD PARTIES OR A FAILURE OF THE PROGRAM TO OPERATE WITH ANY OTHER PROGRAMS), EVEN IF SUCH HOLDER OR OTHER PARTY HAS BEEN ADVISED OF THE POSSIBILITY OF SUCH DAMAGES.

END OF TERMS AND CONDITIONS

How to Apply These Terms to Your New Programs

If you develop a new program, and you want it to be of the greatest possible use to the public, the best way to achieve this is to make it free software which everyone can redistribute and change under these terms.

To do so, attach the following notices to the program. It is safest to attach them to the start of each source file to most effectively convey the exclusion of warranty; and each file should have at least the "copyright" line and a pointer to where the full notice is found.

```
<one line to give the program's name and a brief idea of what it does.>
Copyright © <year> <name of author>
```

```
This program is free software; you can redistribute it and/or modify it
under the terms of the GNU General Public License as published by the
Free Software Foundation; either version 2 of the License, or (at
your option) any later version.
```

```
This program is distributed in the hope that it will be useful, but
WITHOUT ANY WARRANTY; without even the implied warranty of
MERCHANTABILITY or FITNESS FOR A PARTICULAR PURPOSE. See
the GNU General Public License for more details.
```

```
You should have received a copy of the GNU General Public License
along with this program; if not, write to the Free Software Foundation,
Inc., 51 Franklin Street, Fifth Floor, Boston, MA 02110-1301 USA.
```

Also add information on how to contact you by electronic and paper mail.

If the program is interactive, make it output a short notice like this when it starts in an interactive mode:

```
Gnomovision version 69, Copyright © year name of author
Gnomovision comes with ABSOLUTELY NO WARRANTY; for details
type 'show w'. This is free software, and you are welcome to
redistribute it under certain conditions; type 'show c' for details.
```

The hypothetical commands 'show w' and 'show c' should show the appropriate parts of the General Public License. Of course, the commands you use may be called something other than 'show w' and 'show c'; they could even be mouse-clicks or menu items—whatever suits your program.

You should also get your employer (if you work as a programmer) or your school, if any, to sign a "copyright disclaimer" for the program, if necessary. Here is a sample; alter the names:

```
Yoyodyne, Inc., hereby disclaims all copyright interest in the program
'Gnomovision' (which makes passes at compilers) written by James
Hacker.
```

```
<signature of Ty Coon>, 1 April 1989
Ty Coon, President of Vice
```

This General Public License does not permit incorporating your program into proprietary programs. If your program is a subroutine library, you may consider it more useful to permit linking proprietary applications with the library. If this is what you want to do, use the GNU Lesser General Public License instead of this License.

GNU LESSER GENERAL PUBLIC LICENSE

Version 2.1, February 1999

Copyright © 1991, 1999 Free Software Foundation, Inc., 51 Franklin Street, Fifth Floor, Boston, MA 02110-1301 USA
Everyone is permitted to copy and distribute verbatim copies of this license document, but changing it is not allowed.

[This is the first released version of the Lesser GPL.

It also counts as the successor of the GNU Library Public License, version 2, hence the version number 2.1.]

Preamble

The licenses for most software are designed to take away your freedom to share and change it. By contrast, the GNU General Public Licenses are intended to guarantee your freedom to share and change free software—to make sure the software is free for all its users.

This license, the Lesser General Public License, applies to some specially designated software packages—typically libraries—of the Free Software Foundation and other authors who decide to use it. You can use it too, but we suggest you first think carefully about whether this license or the ordinary General Public License is the better strategy to use in any particular case, based on the explanations below.

When we speak of free software, we are referring to freedom of use, not price. Our General Public Licenses are designed to make sure that you have the freedom to distribute copies of free software (and charge for this service if you wish); that you receive source code or can get it if you want it; that you can change the software and use pieces of it in new free programs; and that you are informed that you can do these things.

To protect your rights, we need to make restrictions that forbid distributors to deny you these rights or to ask you to surrender these rights. These restrictions translate to certain responsibilities for you if you distribute copies of the library or if you modify it.

For example, if you distribute copies of the library, whether gratis or for a fee, you must give the recipients all the rights that we gave you. You must make sure that they, too, receive or can get the source code. If you link other code with the library, you must provide complete object files to the recipients, so that they can relink them with the library after making changes to the library and recompiling it. And you must show them these terms so they know their rights.

We protect your rights with a two-step method: (1) we copyright the library, and (2) we offer you this license, which gives you legal permission to copy, distribute and/or modify the library.

To protect each distributor, we want to make it very clear that there is no warranty for the free library. Also, if the library is modified by someone else and passed on, the recipients should know that what they have is not the original version, so that the original author's reputation will not be affected by problems that might be introduced by others.

Finally, software patents pose a constant threat to the existence of any free program. We wish to make sure that a company cannot effectively restrict the users of a free program by obtaining a restrictive license from a patent holder. Therefore, we insist that any patent license obtained for a version of the library must be consistent with the full freedom of use specified in this license.

Most GNU software, including some libraries, is covered by the ordinary GNU General Public License. This license, the GNU Lesser General Public License, applies to certain designated libraries, and is quite different from the ordinary General Public License. We use this license for certain libraries in order to permit linking those libraries into non-free programs.

When a program is linked with a library, whether statically or using a shared library, the combination of the two is legally speaking a combined work, a derivative of the original library. The ordinary General Public License therefore permits such linking only if the entire combination fits its criteria of freedom. The Lesser General Public License permits more lax criteria for linking other code with the library.

We call this license the “Lesser” General Public License because it does Less to protect the user's freedom than the ordinary General Public License. It also provides other free software developers Less of an advantage over competing non-free programs. These disadvantages are the reason we use the ordinary General Public License for many libraries. However, the Lesser license provides advantages in certain special circumstances.

For example, on rare occasions, there may be a special need to encourage the widest possible use of a certain library, so that it becomes a de-facto standard. To achieve this, non-free programs must be allowed to use the library. A more frequent case is that a free library does the same job as widely used non-free libraries. In this case, there is little to gain by limiting the free library to free software only, so we use the Lesser General Public License.

In other cases, permission to use a particular library in non-free programs enables a greater number of people to use a large body of free software. For example, permission to use the GNU C Library in non-free programs enables many more people to use the whole GNU operating system, as well as its variant, the GNU/Linux operating system.

Although the Lesser General Public License is Less protective of the users' freedom, it does ensure that the user of a program that is linked with the Library has the freedom and the wherewithal to run that program using a modified version of the Library.

The precise terms and conditions for copying, distribution and modification follow. Pay close attention to the difference between a “work based on the library” and a “work that uses the library”. The former contains code derived from the library, whereas the latter must be combined with the library in order to run.

GNU LESSER GENERAL PUBLIC LICENSE TERMS AND CONDITIONS FOR COPYING, DISTRIBUTION AND MODIFICATION

0. This License Agreement applies to any software library or other program which contains a notice placed by the copyright holder or other authorized party saying it may be distributed under the terms of this Lesser General Public License (also called “this License”). Each licensee is addressed as “you”.

A “library” means a collection of software functions and/or data prepared so as to be conveniently linked with application programs (which use some of those functions and data) to form executables.

The “Library”, below, refers to any such software library or work which has been distributed under these terms. A “work based on the Library” means either the Library or any derivative work under copyright law: that is to say, a work containing the Library or a portion of it, either verbatim or with modifications and/or translated straightforwardly into another language. (Hereinafter, translation is included without limitation in the term “modification”.)

“Source code” for a work means the preferred form of the work for making modifications to it. For a library, complete source code means all the source code for all modules it contains, plus any associated interface definition files, plus the scripts used to control compilation and installation of the library.

Activities other than copying, distribution and modification are not covered by this License; they are outside its scope. The act of running a program using the Library is not restricted, and output from such a program is covered only if its contents constitute a work based on the Library (independent of the use of the Library in a tool for writing it). Whether that is true depends on what the Library does and what the program that uses the Library does.

1. You may copy and distribute verbatim copies of the Library's complete source code as you receive it, in any medium, provided that you conspicuously and appropriately publish on each copy an appropriate copyright notice and disclaimer of warranty; keep intact all the notices that refer to this License and to the absence of any warranty; and distribute a copy of this License along with the Library.

You may charge a fee for the physical act of transferring a copy, and you may at your option offer warranty protection in exchange for a fee.

2. You may modify your copy or copies of the Library or any portion of it, thus forming a work based on the Library, and copy and distribute such modifications or work under the terms of Section 1 above, provided that you also meet all of these conditions:

- The modified work must itself be a software library.
- You must cause the files modified to carry prominent notices stating that you changed the files and the date of any change.
- You must cause the whole of the work to be licensed at no charge to all third parties under the terms of this License.
- If a facility in the modified Library refers to a function or a table of data to be supplied by an application program that uses the facility, other than as an argument passed when the facility is invoked, then you must make a good faith effort to ensure that, in the event an application does not supply such function or table, the facility still operates, and performs whatever part of its purpose remains meaningful.

(For example, a function in a library to compute square roots has a purpose that is entirely well-defined independent of the application. Therefore, Subsection 2d requires that any application-supplied function or table used by this function must be optional: if the

application does not supply it, the square root function must still compute square roots.)

These requirements apply to the modified work as a whole. If identifiable sections of that work are not derived from the Library, and can be reasonably considered independent and separate works in themselves, then this License, and its terms, do not apply to those sections when you distribute them as separate works. But when you distribute the same sections as part of a whole which is a work based on the Library, the distribution of the whole must be on the terms of this License, whose permissions for other licensees extend to the entire whole, and thus to each and every part regardless of who wrote it.

Thus, it is not the intent of this section to claim rights or contest your rights to work written entirely by you; rather, the intent is to exercise the right to control the distribution of derivative or collective works based on the Library.

In addition, mere aggregation of another work not based on the Library with the Library (or with a work based on the Library) on a volume of a storage or distribution medium does not bring the other work under the scope of this License.

3. You may opt to apply the terms of the ordinary GNU General Public License instead of this License to a given copy of the Library. To do this, you must alter all the notices that refer to this License, so that they refer to the ordinary GNU General Public License, version 2, instead of to this License. (If a newer version than version 2 of the ordinary GNU General Public License has appeared, then you can specify that version instead if you wish.) Do not make any other change in these notices.

Once this change is made in a given copy, it is irreversible for that copy, so the ordinary GNU General Public License applies to all subsequent copies and derivative works made from that copy.

This option is useful when you wish to copy part of the code of the Library into a program that is not a library.

4. You may copy and distribute the Library (or a portion or derivative of it, under Section 2) in object code or executable form under the terms of Sections 1 and 2 above provided that you accompany it with the complete corresponding machine-readable source code, which must be distributed under the terms of Sections 1 and 2 above on a medium customarily used for software interchange.

If distribution of object code is made by offering access to copy from a designated place, then offering equivalent access to copy the source code from the same place satisfies the requirement to distribute the source code, even though third parties are not compelled to copy the source along with the object code.

5. A program that contains no derivative of any portion of the Library, but is designed to work with the Library by being compiled or linked with it, is called a "work that uses the Library". Such a work, in isolation, is not a derivative work of the Library, and therefore falls outside the scope of this License.

However, linking a "work that uses the Library" with the Library creates an executable that is a derivative of the Library (because it contains portions of the Library), rather than a "work that uses the library". The executable is therefore covered by this License. Section 6 states terms for distribution of such executables.

When a "work that uses the Library" uses material from a header file that is part of the Library, the object code for the work may be a derivative work of the Library even though the source code is not. Whether this is true is especially significant if the work can be linked without the Library, or if the work is itself a library. The threshold for this to be true is not precisely defined by law.

If such an object file uses only numerical parameters, data structure layouts and accessors, and small macros and small inline functions (ten lines or less in length), then the use of the object file is unrestricted, regardless of whether it is legally a derivative work. (Executables containing this object code plus portions of the Library will still fall under Section 6.)

Otherwise, if the work is a derivative of the Library, you may distribute the object code for the work under the terms of Section 6. Any executables containing that work also fall under Section 6, whether or not they are linked directly with the Library itself.

6. As an exception to the Sections above, you may also combine or link a "work that uses the Library" with the Library to produce a work containing portions of the Library, and distribute that work under terms of your choice, provided that the terms permit modification of the work for the customer's own use and reverse engineering for debugging such modifications.

You must give prominent notice with each copy of the work that the Library is used in it and that the Library and its use are covered by this License. You must supply a copy of this License. If the work during execution displays copyright notices, you must include the copyright notice for the Library among them, as well as a reference directing the user to the copy of this License. Also, you must do one of these things:

- a) Accompany the work with the complete corresponding machine-readable source code for the Library including whatever changes were used in the work (which must be distributed under Sections 1 and 2 above); and, if the work is an executable linked with the Library, with the complete machine-readable "work that uses the Library", as object code and/or source code, so that the user can modify the Library and then relink to produce a modified executable containing the modified Library. (It is understood that the user who changes the contents of definitions files in the Library will not necessarily be able to recompile the application to use the modified definitions.)
- b) Use a suitable shared library mechanism for linking with the Library. A suitable mechanism is one that (1) uses at run time a copy of the library already present on the user's computer system, rather than copying library functions into the executable, and (2) will operate properly with a modified version of the library, if the user installs one, as long as the modified version is interface-compatible with the version that the work was made with.
- c) Accompany the work with a written offer, valid for at least three years, to give the same user the materials specified in Subsection 6a, above, for a charge no more than the cost of performing this distribution.
- d) If distribution of the work is made by offering access to copy from a designated place, offer equivalent access to copy the above specified materials from the same place.
- e) Verify that the user has already received a copy of these materials or that you have already sent this user a copy.

For an executable, the required form of the "work that uses the Library" must include any data and utility programs needed for reproducing the executable from it. However, as a special exception, the materials to be distributed need not include anything that is normally distributed (in either source or binary form) with the major components (compiler, kernel, and so on) of the operating system on which the executable runs, unless that component itself accompanies the executable.

It may happen that this requirement contradicts the license restrictions of other proprietary libraries that do not normally accompany the operating system. Such a contradiction means you cannot use both them and the Library together in an executable that you distribute.

7. You may place library facilities that are a work based on the Library side-by-side in a single library together with other library facilities not covered by this License, and distribute such a combined library, provided that the separate distribution of the work based on the Library and of the other library facilities is otherwise permitted, and provided that you do these two things:
 - a) Accompany the combined library with a copy of the same work based on the Library, uncombined with any other library facilities. This must be distributed under the terms of the Sections above.
 - b) Give prominent notice with the combined library of the fact that part of it is a work based on the Library, and explaining where to find the accompanying uncombined form of the same work.
8. You may not copy, modify, sublicense, link with, or distribute the Library except as expressly provided under this License. Any attempt otherwise to copy, modify, sublicense, link with, or distribute the Library is void, and will automatically terminate your rights under this License. However, parties who have received copies, or rights, from you under this License will not have their licenses terminated so long as such parties remain in full compliance.
9. You are not required to accept this License, since you have not signed it. However, nothing else grants you permission to modify or distribute the Library or its derivative works. These actions are prohibited by law if you do not accept this License. Therefore, by modifying or distributing the Library (or any work based on the Library), you indicate your acceptance of this License to do so, and all its terms and conditions for copying, distributing or modifying the Library or works based on it.
10. Each time you redistribute the Library (or any work based on the Library), the recipient automatically receives a license from the original licensor to copy, distribute, link with or modify the Library subject to these terms and conditions. You may not impose any further restrictions on the recipients' exercise of the rights granted herein. You are not responsible for enforcing compliance by third parties with this License.
11. If, as a consequence of a court judgment or allegation of patent infringement or for any other reason (not limited to patent issues), conditions are imposed on you (whether by court order, agreement or otherwise) that contradict the conditions of this License, they do not excuse you from the conditions of this License. If you cannot distribute so as to satisfy simultaneously your obligations under this License and any other pertinent obligations, then as a consequence you may not distribute the Library at all. For example, if a patent license would not permit royalty-free redistribution of the Library by all those who receive

copies directly or indirectly through you, then the only way you could satisfy both it and this License would be to refrain entirely from distribution of the Library.

If any portion of this section is held invalid or unenforceable under any particular circumstance, the balance of the section is intended to apply, and the section as a whole is intended to apply in other circumstances.

It is not the purpose of this section to induce you to infringe any patents or other property right claims or to contest validity of any such claims; this section has the sole purpose of protecting the integrity of the free software distribution system which is implemented by public license practices. Many people have made generous contributions to the wide range of software distributed through that system in reliance on consistent application of that system; it is up to the author/donor to decide if he or she is willing to distribute software through any other system and a licensee cannot impose that choice.

This section is intended to make thoroughly clear what is believed to be a consequence of the rest of this License.

12. If the distribution and/or use of the Library is restricted in certain countries either by patents or by copyrighted interfaces, the original copyright holder who places the Library under this License may add an explicit geographical distribution limitation excluding those countries, so that distribution is permitted only in or among countries not thus excluded. In such case, this License incorporates the limitation as if written in the body of this License.

13. The Free Software Foundation may publish revised and/or new versions of the Lesser General Public License from time to time. Such new versions will be similar in spirit to the present version, but may differ in detail to address new problems or concerns.

Each version is given a distinguishing version number. If the Library specifies a version number of this License which applies to it and "any later version", you have the option of following the terms and conditions either of that version or of any later version published by the Free Software Foundation. If the Library does not specify a license version number, you may choose any version ever published by the Free Software Foundation.

14. If you wish to incorporate parts of the Library into other free programs whose distribution conditions are incompatible with these, write to the author to ask for permission. For software which is copyrighted by the Free Software Foundation, write to the Free Software Foundation; we sometimes make exceptions for this. Our decision will be guided by the two goals of preserving the free status of all derivatives of our free software and of promoting the sharing and reuse of software generally.

NO WARRANTY

15. BECAUSE THE LIBRARY IS LICENSED FREE OF CHARGE, THERE IS NO WARRANTY FOR THE LIBRARY, TO THE EXTENT PERMITTED BY APPLICABLE LAW. EXCEPT WHEN OTHERWISE STATED IN WRITING THE COPYRIGHT HOLDERS AND/OR OTHER PARTIES PROVIDE THE LIBRARY "AS IS" WITHOUT WARRANTY OF ANY KIND, EITHER EXPRESSED OR IMPLIED, INCLUDING, BUT NOT LIMITED TO, THE IMPLIED WARRANTIES OF MERCHANTABILITY AND FITNESS FOR A PARTICULAR PURPOSE. THE ENTIRE RISK AS TO THE QUALITY AND PERFORMANCE OF THE LIBRARY IS WITH YOU. SHOULD THE LIBRARY PROVE DEFECTIVE, YOU ASSUME THE COST OF ALL NECESSARY SERVICING, REPAIR OR CORRECTION.

16. IN NO EVENT UNLESS REQUIRED BY APPLICABLE LAW OR AGREED TO IN WRITING WILL ANY COPYRIGHT HOLDER, OR ANY OTHER PARTY WHO MAY MODIFY AND/OR REDISTRIBUTE THE LIBRARY AS PERMITTED ABOVE, BE LIABLE TO YOU FOR DAMAGES, INCLUDING ANY GENERAL, SPECIAL, INCIDENTAL OR CONSEQUENTIAL DAMAGES ARISING OUT OF THE USE OR INABILITY TO USE THE LIBRARY (INCLUDING BUT NOT LIMITED TO LOSS OF DATA OR DATA BEING RENDERED INACCURATE OR LOSSES SUSTAINED BY YOU OR THIRD PARTIES OR A FAILURE OF THE LIBRARY TO OPERATE WITH ANY OTHER SOFTWARE), EVEN IF SUCH HOLDER OR OTHER PARTY HAS BEEN ADVISED OF THE POSSIBILITY OF SUCH DAMAGES.

END OF TERMS AND CONDITIONS

How to Apply These Terms to Your New Libraries

If you develop a new library, and you want it to be of the greatest possible use to the public, we recommend making it free software that everyone can redistribute and change. You can do so by permitting redistribution under these terms (or, alternatively, under the terms of the ordinary General Public License).

To apply these terms, attach the following notices to the library. It is safest to attach them to the start of each source file to most effectively convey the exclusion of warranty; and each file should have at least the "copyright" line and a pointer to where the full notice is found.

<one line to give the library's name and a brief idea of what it does.>
Copyright © <year> <name of author>

This library is free software; you can redistribute it and/or modify it under the terms of the GNU Lesser General Public License as published by the Free Software Foundation; either version 2.1 of the License, or (at your option) any later version.

This library is distributed in the hope that it will be useful, but WITHOUT ANY WARRANTY; without even the implied warranty of MERCHANTABILITY or FITNESS FOR A PARTICULAR PURPOSE. See the GNU Lesser General Public License for more details.

You should have received a copy of the GNU Lesser General Public License along with this library; if not, write to the Free Software Foundation, Inc., 51 Franklin Street, Fifth Floor, Boston, MA 02110-1301 USA

Also add information on how to contact you by electronic and paper mail.

You should also get your employer (if you work as a programmer) or your school, if any, to sign a "copyright disclaimer" for the library, if necessary. Here is a sample; alter the names:

Yoyodyne, Inc., hereby disclaims all copyright interest in the library 'Frob' (a library for tweaking knobs) written by James Random Hacker.

<signature of Ty Coon>, 1 April 1990
Ty Coon, President of Vice

That's all there is to it!

expat

Copyright © 1998, 1999, 2000 Thai Open Source Software Center Ltd and Clark Cooper
Copyright © 2001, 2002, 2003 Expat maintainers.

Permission is hereby granted, free of charge, to any person obtaining a copy of this software and associated documentation files (the "Software"), to deal in the Software without restriction, including without limitation the rights to use, copy, modify, merge, publish, distribute, sublicense, and/or sell copies of the Software, and to permit persons to whom the Software is furnished to do so, subject to the following conditions:

The above copyright notice and this permission notice shall be included in all copies or substantial portions of the Software.

THE SOFTWARE IS PROVIDED "AS IS", WITHOUT WARRANTY OF ANY KIND, EXPRESS OR IMPLIED, INCLUDING BUT NOT LIMITED TO THE WARRANTIES OF MERCHANTABILITY, FITNESS FOR A PARTICULAR PURPOSE AND NONINFRINGEMENT. IN NO EVENT SHALL THE AUTHORS OR COPYRIGHT HOLDERS BE LIABLE FOR ANY CLAIM, DAMAGES OR OTHER LIABILITY, WHETHER IN AN ACTION OF CONTRACT, TORT OR OTHERWISE, ARISING FROM, OUT OF OR IN CONNECTION WITH THE SOFTWARE OR THE USE OR OTHER DEALINGS IN THE SOFTWARE.

freetype

The FreeType Project LICENSE

2002-Apr-11
Copyright 1996-2002 by David Turner, Robert Wilhelm, and Werner Lemberg

Introduction

The FreeType Project is distributed in several archive packages; some of them may contain, in addition to the FreeType font engine, various tools and contributions which rely on, or relate to, the FreeType Project.

This license applies to all files found in such packages, and which do not fall under their own explicit license. The license affects thus the FreeType font engine, the test programs, documentation and makefiles, at the very least.

This license was inspired by the BSD, Artistic, and IJG (Independent JPEG Group) licenses, which all encourage inclusion and use of free software in

commercial and freeware products alike. As a consequence, its main points are that:

- We don't promise that this software works. However, we will be interested in any kind of bug reports. ('as is' distribution)
- You can use this software for whatever you want, in parts or full form, without having to pay us. ('royalty-free' usage)
- You may not pretend that you wrote this software. If you use it, or only parts of it, in a program, you must acknowledge somewhere in your documentation that you have used the FreeType code. ('credits')

We specifically permit and encourage the inclusion of this software, with or without modifications, in commercial products. We disclaim all warranties covering The FreeType Project and assume no liability related to The FreeType Project.

Finally, many people asked us for a preferred form for a credit/disclaimer to use in compliance with this license. We thus encourage you to use the following text:

Portions of this software are copyright © 1996-2002 The FreeType Project (www.freetype.org). All rights reserved.

Legal Terms

0. Definitions

Throughout this license, the terms 'package', 'FreeType Project', and 'FreeType archive' refer to the set of files originally distributed by the authors (David Turner, Robert Wilhelm, and Werner Lemberg) as the 'FreeType Project', be they named as alpha, beta or final release.

'You' refers to the licensee, or person using the project, where 'using' is a generic term including compiling the project's source code as well as linking it to form a 'program' or 'executable'. This program is referred to as 'a program using the FreeType engine'.

This license applies to all files distributed in the original FreeType Project, including all source code, binaries and documentation, unless otherwise stated in the file in its original, unmodified form as distributed in the original archive. If you are unsure whether or not a particular file is covered by this license, you must contact us to verify this.

The FreeType Project is copyright © 1996-2000 by David Turner, Robert Wilhelm, and Werner Lemberg. All rights reserved except as specified below.

1. No Warranty

THE FREETYPE PROJECT IS PROVIDED 'AS IS' WITHOUT WARRANTY OF ANY KIND, EITHER EXPRESS OR IMPLIED, INCLUDING, BUT NOT LIMITED TO, WARRANTIES OF MERCHANTABILITY AND FITNESS FOR A PARTICULAR PURPOSE. IN NO EVENT WILL ANY OF THE AUTHORS OR COPYRIGHT HOLDERS BE LIABLE FOR ANY DAMAGES CAUSED BY THE USE OR THE INABILITY TO USE, OF THE FREETYPE PROJECT.

2. Redistribution

This license grants a worldwide, royalty-free, perpetual and irrevocable right and license to use, execute, perform, compile, display, copy, create derivative works of, distribute and sublicense the FreeType Project (in both source and object code forms) and derivative works thereof for any purpose; and to authorize others to exercise some or all of the rights granted herein, subject to the following conditions:

- Redistribution of source code must retain this license file ('FTL.TXT') unaltered; any additions, deletions or changes to the original files must be clearly indicated in accompanying documentation. The copyright notices of the unaltered, original files must be preserved in all copies of source files.
- Redistribution in binary form must provide a disclaimer that states that the software is based in part of the work of the FreeType Team, in the distribution documentation. We also encourage you to put an URL to the FreeType web page in your documentation, though this isn't mandatory.

These conditions apply to any software derived from or based on the FreeType Project, not just the unmodified files. If you use our work, you must acknowledge us. However, no fee need be paid to us.

3. Advertising

Neither the FreeType authors and contributors nor you shall use the name of the other for commercial, advertising, or promotional purposes without specific prior written permission.

We suggest, but do not require, that you use one or more of the following phrases to refer to this software in your documentation or advertising materials: 'FreeType Project', 'FreeType Engine', 'FreeType library', or 'FreeType Distribution'.

As you have not signed this license, you are not required to accept it. However, as the FreeType Project is copyrighted material, only this license, or another one contracted with the authors, grants you the right to use, distribute, and modify it. Therefore, by using, distributing, or modifying the FreeType Project, you indicate that you understand and accept all the terms of this license.

4. Contacts

There are two mailing lists related to FreeType:

- freetype@freetype.org
Discusses general use and applications of FreeType, as well as future and wanted additions to the library and distribution.
If you are looking for support, start in this list if you haven't found anything to help you in the documentation.
- devel@freetype.org
Discusses bugs, as well as engine internals, design issues, specific licenses, porting, etc.
- http://www.freetype.org
Holds the current FreeType web page, which will allow you to download our latest development version and read online documentation.

You can also contact us individually at:

David Turner <david.turner@freetype.org>
Robert Wilhelm <robert.wilhelm@freetype.org>
Werner Lemberg <werner.lemberg@freetype.org>

glibc

This file contains the copying permission notices for various files in the GNU C Library distribution that have copyright owners other than the Free Software Foundation. These notices all require that a copy of the notice be included in the accompanying documentation and be distributed with binary distributions of the code, so be sure to include this file along with any binary distributions derived from the GNU C Library.

All code incorporated from 4.4 BSD is distributed under the following license:

Copyright © 1991 Regents of the University of California.
All rights reserved.

Redistribution and use in source and binary forms, with or without modification, are permitted provided that the following conditions are met:

1. Redistributions of source code must retain the above copyright notice, this list of conditions and the following disclaimer.
2. Redistributions in binary form must reproduce the above copyright notice, this list of conditions and the following disclaimer in the documentation and/or other materials provided with the distribution.
3. [This condition was removed.]
4. Neither the name of the University nor the names of its contributors may be used to endorse or promote products derived from this software without specific prior written permission.

THIS SOFTWARE IS PROVIDED BY THE REGENTS AND CONTRIBUTORS "AS IS" AND ANY EXPRESS OR IMPLIED WARRANTIES, INCLUDING, BUT NOT LIMITED TO, THE IMPLIED WARRANTIES OF MERCHANTABILITY AND FITNESS FOR A PARTICULAR PURPOSE ARE DISCLAIMED. IN NO EVENT SHALL THE REGENTS OR CONTRIBUTORS BE LIABLE FOR ANY DIRECT, INDIRECT, INCIDENTAL, SPECIAL, EXEMPLARY, OR CONSEQUENTIAL DAMAGES (INCLUDING, BUT NOT LIMITED TO, PROCUREMENT OF SUBSTITUTE GOODS OR SERVICES; LOSS OF USE, DATA, OR PROFITS; OR BUSINESS INTERRUPTION) HOWEVER CAUSED AND ON ANY THEORY OF LIABILITY, WHETHER IN CONTRACT, STRICT LIABILITY, OR TORT (INCLUDING NEGLIGENCE OR OTHERWISE) ARISING IN ANY WAY OUT OF THE USE OF THIS SOFTWARE, EVEN IF ADVISED OF THE POSSIBILITY OF SUCH DAMAGE.

The DNS resolver code, taken from BIND 4.9.5, is copyrighted both by UC Berkeley and by Digital Equipment Corporation. The DEC portions are under the following license:

Portions Copyright © 1993 by Digital Equipment Corporation.

Permission to use, copy, modify, and distribute this software for any purpose with or without fee is hereby granted, provided that the above copyright notice and this permission notice appear in all copies, and that the name of Digital Equipment Corporation not be used in advertising or publicity pertaining to distribution of the document or software without specific, written prior permission.

THE SOFTWARE IS PROVIDED "AS IS" AND DIGITAL EQUIPMENT CORP. DISCLAIMS ALL WARRANTIES WITH REGARD TO THIS SOFTWARE, INCLUDING ALL IMPLIED WARRANTIES OF MERCHANTABILITY AND FITNESS. IN NO EVENT SHALL DIGITAL EQUIPMENT CORPORATION BE LIABLE FOR ANY SPECIAL, DIRECT, INDIRECT, OR CONSEQUENTIAL DAMAGES OR ANY DAMAGES WHATSOEVER RESULTING FROM LOSS OF USE, DATA OR PROFITS, WHETHER IN AN ACTION OF CONTRACT, NEGLIGENCE OR OTHER TORTIOUS ACTION, ARISING OUT OF OR IN CONNECTION WITH THE USE OR PERFORMANCE OF THIS SOFTWARE.

The Sun RPC support (from rpcsrc-4.0) is covered by the following license:

Copyright © 1984, Sun Microsystems, Inc.

Sun RPC is a product of Sun Microsystems, Inc. and is provided for unrestricted use provided that this legend is included on all tape media and as a part of the software program in whole or part. Users may copy or

modify Sun RPC without charge, but are not authorized to license or distribute it to anyone else except as part of a product or program developed by the user.

SUN RPC IS PROVIDED AS IS WITH NO WARRANTIES OF ANY KIND INCLUDING THE WARRANTIES OF DESIGN, MERCHANTABILITY AND FITNESS FOR A PARTICULAR PURPOSE, OR ARISING FROM A COURSE OF DEALING, USAGE OR TRADE PRACTICE.

Sun RPC is provided with no support and without any obligation on the part of Sun Microsystems, Inc. to assist in its use, correction, modification or enhancement.

SUN MICROSYSTEMS, INC. SHALL HAVE NO LIABILITY WITH RESPECT TO THE INFRINGEMENT OF COPYRIGHTS, TRADE SECRETS OR ANY PATENTS BY SUN RPC OR ANY PART THEREOF.

In no event will Sun Microsystems, Inc. be liable for any lost revenue or profits or other special, indirect and consequential damages, even if Sun has been advised of the possibility of such damages.

The following CMU license covers some of the support code for Mach, derived from Mach 3.0:

Mach Operating System
Copyright © 1991, 1990, 1989 Carnegie Mellon University
All Rights Reserved.

Permission to use, copy, modify and distribute this software and its documentation is hereby granted, provided that both the copyright notice and this permission notice appear in all copies of the software, derivative works or modified versions, and any portions thereof, and that both notices appear in supporting documentation.

CARNEGIE MELLON ALLOWS FREE USE OF THIS SOFTWARE IN ITS "AS IS" CONDITION. CARNEGIE MELLON DISCLAIMS ANY LIABILITY OF ANY KIND FOR ANY DAMAGES WHATSOEVER RESULTING FROM THE USE OF THIS SOFTWARE.

Carnegie Mellon requests users of this software to return to

Software Distribution Coordinator
School of Computer Science
Carnegie Mellon University
Pittsburgh, PA 15213-3890

or Software.Distribution@CS.CMU.EDU any improvements or extensions that they make and grant Carnegie Mellon the rights to redistribute these changes.

The file `if_ppp.h` is under the following CMU license:

Redistribution and use in source and binary forms, with or without modification, are permitted provided that the following conditions are met:

1. Redistributions of source code must retain the above copyright notice, this list of conditions and the following disclaimer.
2. Redistributions in binary form must reproduce the above copyright notice, this list of conditions and the following disclaimer in the documentation and/or other materials provided with the distribution.
3. Neither the name of the University nor the names of its contributors may be used to endorse or promote products derived from this software without specific prior written permission.

THIS SOFTWARE IS PROVIDED BY CARNEGIE MELLON UNIVERSITY AND CONTRIBUTORS "AS IS" AND ANY EXPRESS OR IMPLIED WARRANTIES, INCLUDING, BUT NOT LIMITED TO, THE IMPLIED WARRANTIES OF MERCHANTABILITY AND FITNESS FOR A PARTICULAR PURPOSE ARE DISCLAIMED.

IN NO EVENT SHALL THE UNIVERSITY OR CONTRIBUTORS BE LIABLE FOR ANY DIRECT, INDIRECT, INCIDENTAL, SPECIAL, EXEMPLARY, OR CONSEQUENTIAL DAMAGES (INCLUDING, BUT NOT LIMITED TO, PROCUREMENT OF SUBSTITUTE GOODS OR SERVICES; LOSS OF USE, DATA, OR PROFITS; OR BUSINESS INTERRUPTION) HOWEVER CAUSED AND ON ANY THEORY OF LIABILITY, WHETHER IN CONTRACT, STRICT LIABILITY, OR TORT (INCLUDING NEGLIGENCE OR OTHERWISE) ARISING IN ANY WAY OUT OF THE USE OF THIS SOFTWARE, EVEN IF ADVISED OF THE POSSIBILITY OF SUCH DAMAGE.

The following license covers the files from Intel's "Highly Optimized Mathematical Functions for Itanium" collection:

Intel License Agreement

Copyright © 2000, Intel Corporation
All rights reserved.

Redistribution and use in source and binary forms, with or without modification, are permitted provided that the following conditions are met:

- * Redistributions of source code must retain the above copyright notice, this list of conditions and the following disclaimer.
- * Redistributions in binary form must reproduce the above copyright notice, this list of conditions and the following disclaimer in the documentation and/or other materials provided with the distribution.
- * The name of Intel Corporation may not be used to endorse or promote products derived from this software without specific prior written permission.

THIS SOFTWARE IS PROVIDED BY THE COPYRIGHT HOLDERS AND CONTRIBUTORS "AS IS" AND ANY EXPRESS OR IMPLIED WARRANTIES, INCLUDING, BUT NOT LIMITED TO, THE IMPLIED WARRANTIES OF MERCHANTABILITY AND FITNESS FOR A PARTICULAR PURPOSE ARE DISCLAIMED. IN NO EVENT SHALL INTEL OR CONTRIBUTORS BE LIABLE FOR ANY DIRECT, INDIRECT, INCIDENTAL, SPECIAL, EXEMPLARY, OR CONSEQUENTIAL DAMAGES (INCLUDING, BUT NOT LIMITED TO, PROCUREMENT OF SUBSTITUTE GOODS OR SERVICES; LOSS OF USE, DATA, OR PROFITS; OR BUSINESS INTERRUPTION) HOWEVER CAUSED AND ON ANY THEORY OF LIABILITY, WHETHER IN CONTRACT, STRICT LIABILITY, OR TORT (INCLUDING NEGLIGENCE OR OTHERWISE) ARISING IN ANY WAY OUT OF THE USE OF THIS SOFTWARE, EVEN IF ADVISED OF THE POSSIBILITY OF SUCH DAMAGE.

The files `inet/getnameinfo.c` and `sysdeps/posix/getaddrinfo.c` are copyright © by Craig Metz and are distributed under the following license:

The Inner Net License, Version 2.00

The author(s) grant permission for redistribution and use in source and binary forms, with or without modification, of the software and documentation provided that the following conditions are met:

0. If you receive a version of the software that is specifically labelled as not being for redistribution (check the version message and/or README), you are not permitted to redistribute that version of the software in any way or form.
1. All terms of the all other applicable copyrights and licenses must be followed.
2. Redistributions of source code must retain the authors' copyright notice(s), this list of conditions, and the following disclaimer.
3. Redistributions in binary form must reproduce the authors' copyright notice(s), this list of conditions, and the following disclaimer in the documentation and/or other materials provided with the distribution.
4. [The copyright holder has authorized the removal of this clause.]
5. Neither the name(s) of the author(s) nor the names of its contributors may be used to endorse or promote products derived from this software without specific prior written permission.

THIS SOFTWARE IS PROVIDED BY ITS AUTHORS AND CONTRIBUTORS "AS IS" AND ANY EXPRESS OR IMPLIED WARRANTIES, INCLUDING, BUT NOT LIMITED TO, THE IMPLIED WARRANTIES OF MERCHANTABILITY AND FITNESS FOR A PARTICULAR PURPOSE ARE DISCLAIMED. IN NO EVENT SHALL THE AUTHORS OR CONTRIBUTORS BE LIABLE FOR ANY DIRECT, INDIRECT, INCIDENTAL, SPECIAL, EXEMPLARY, OR CONSEQUENTIAL DAMAGES (INCLUDING, BUT NOT LIMITED TO, PROCUREMENT OF SUBSTITUTE GOODS OR SERVICES; LOSS OF USE, DATA, OR PROFITS; OR BUSINESS INTERRUPTION) HOWEVER CAUSED AND ON ANY THEORY OF LIABILITY, WHETHER IN CONTRACT, STRICT LIABILITY, OR TORT (INCLUDING NEGLIGENCE OR OTHERWISE) ARISING IN ANY WAY OUT OF THE USE OF THIS SOFTWARE, EVEN IF ADVISED OF THE POSSIBILITY OF SUCH DAMAGE.

If these license terms cause you a real problem, contact the author.

libcap

Unless otherwise *explicitly* stated, the following text describes the licensed conditions under which the contents of this libcap release may be used and distributed:

Redistribution and use in source and binary forms of libcap, with or without modification, are permitted provided that the following conditions are met:

1. Redistributions of source code must retain any existing copyright notice, and this entire permission notice in its entirety, including the disclaimer of warranties.
2. Redistributions in binary form must reproduce all prior and current copyright notices, this list of conditions, and the following disclaimer in the documentation and/or other materials provided with the distribution.
3. The name of any author may not be used to endorse or promote products derived from this software without their specific prior written permission.

ALTERNATIVELY, this product may be distributed under the terms of the GNU General Public License, in which case the provisions of the GNU GPL are required INSTEAD OF the above restrictions. (This clause is necessary due to a potential conflict between the GNU GPL and the restrictions contained in a BSD-style copyright.)

THIS SOFTWARE IS PROVIDED "AS IS" AND ANY EXPRESS OR IMPLIED WARRANTIES, INCLUDING, BUT NOT LIMITED TO, THE IMPLIED WARRANTIES OF MERCHANTABILITY AND FITNESS FOR A PARTICULAR PURPOSE ARE DISCLAIMED.

IN NO EVENT SHALL THE AUTHOR(S) BE LIABLE FOR ANY DIRECT, INDIRECT, INCIDENTAL, SPECIAL, EXEMPLARY, OR CONSEQUENTIAL DAMAGES (INCLUDING, BUT NOT LIMITED TO, PROCUREMENT OF SUBSTITUTE GOODS OR SERVICES; LOSS OF USE, DATA, OR PROFITS; OR BUSINESS INTERRUPTION) HOWEVER CAUSED AND ON ANY THEORY OF LIABILITY, WHETHER IN CONTRACT, STRICT LIABILITY, OR TORT (INCLUDING NEGLIGENCE OR OTHERWISE) ARISING IN ANY WAY

OUT OF THE USE OF THIS SOFTWARE, EVEN IF ADVISED OF THE POSSIBILITY OF SUCH DAMAGE.

libjpeg

The authors make NO WARRANTY or representation, either express or implied, with respect to this software, its quality, accuracy, merchantability, or fitness for a particular purpose. This software is provided "AS IS", and you, its user, assume the entire risk as to its quality and accuracy.

This software is copyright © 1991-1998, Thomas G. Lane.
All Rights Reserved except as specified below.

Permission is hereby granted to use, copy, modify, and distribute this software (or portions thereof) for any purpose, without fee, subject to these conditions:

- (1) If any part of the source code for this software is distributed, then this README file must be included, with this copyright and no-warranty notice unaltered; and any additions, deletions, or changes to the original files must be clearly indicated in accompanying documentation.
- (2) If only executable code is distributed, then the accompanying documentation must state that "this software is based in part on the work of the Independent JPEG Group".
- (3) Permission for use of this software is granted only if the user accepts full responsibility for any undesirable consequences; the authors accept NO LIABILITY for damages of any kind.

These conditions apply to any software derived from or based on the IJG code, not just to the unmodified library. If you use our work, you ought to acknowledge us.

Permission is NOT granted for the use of any IJG author's name or company name in advertising or publicity relating to this software or products derived from it. This software may be referred to only as "the Independent JPEG Group's software".

We specifically permit and encourage the use of this software as the basis of commercial products, provided that all warranty or liability claims are assumed by the product vendor.

ansi2knr.c is included in this distribution by permission of L. Peter Deutsch, sole proprietor of its copyright holder, Aladdin Enterprises of Menlo Park, CA.

ansi2knr.c is NOT covered by the above copyright and conditions, but instead by the usual distribution terms of the Free Software Foundation; principally, that you must include source code if you redistribute it. (See the file ansi2knr.c for full details.) However, since ansi2knr.c is not needed as part of any program generated from the IJG code, this does not limit you more than the foregoing paragraphs do.

The Unix configuration script "configure" was produced with GNU Autoconf. It is copyright by the Free Software Foundation but is freely distributable. The same holds for its supporting scripts (config.guess, config.sub, ltconfig, ltmain.sh). Another support script, install-sh, is copyright by M.I.T. but is also freely distributable.

It appears that the arithmetic coding option of the JPEG spec is covered by patents owned by IBM, AT&T, and Mitsubishi. Hence arithmetic coding cannot legally be used without obtaining one or more licenses. For this reason, support for arithmetic coding has been removed from the free JPEG software.

(Since arithmetic coding provides only a marginal gain over the unpatented Huffman mode, it is unlikely that very many implementations will support it.) So far as we are aware, there are no patent restrictions on the remaining code.

The IJG distribution formerly included code to read and write GIF files. To avoid entanglement with the Unisys LZW patent, GIF reading support has been removed altogether, and the GIF writer has been simplified to produce "uncompressed GIFs". This technique does not use the LZW algorithm; the resulting GIF files are larger than usual, but are readable by all standard GIF decoders.

We are required to state that "The Graphics Interchange Format © is the Copyright property of CompuServe Incorporated. GIF(sm) is a Service Mark property of CompuServe Incorporated."

libmng

COPYRIGHT NOTICE:

Copyright © 2000 Gerard Juyn (gerard@libmng.com)
[You may insert additional notices after this sentence if you modify this source]

For the purposes of this copyright and license, "Contributing Authors" is defined as the following set of individuals:
Gerard Juyn

The MNG Library is supplied "AS IS". The Contributing Authors disclaim all warranties, expressed or implied, including, without limitation, the warranties of merchantability and of fitness for any purpose. The Contributing Authors assume no liability for direct, indirect, incidental, special, exemplary, or consequential damages, which may result from the use of the MNG Library, even if advised of the possibility of such damage.

Permission is hereby granted to use, copy, modify, and distribute this source code, or portions hereof, for any purpose, without fee, subject to the following restrictions:

1. The origin of this source code must not be misrepresented; you must not claim that you wrote the original software.
2. Altered versions must be plainly marked as such and must not be misrepresented as being the original source.
3. This Copyright notice may not be removed or altered from any source or altered source distribution.

The Contributing Authors specifically permit, without fee, and encourage the use of this source code as a component to supporting the MNG and JNG file format in commercial products. If you use this source code in a product, acknowledgment would be highly appreciated.

Parts of this software have been adapted from the libpng package. Although this library supports all features from the PNG specification (as MNG descends from it) it does not require the libpng package. It does require the zlib library and optionally the IJG jpeg library, and/or the "little-cms" library by Marti Maria (depending on the inclusion of support for JNG and Full-Color-Management respectively).

This library's function is primarily to read and display MNG animations. It is not meant as a full-featured image-editing component! It does however offer creation and editing functionality at the chunk level. (future modifications may include some more support for creation and or editing)

libncurses

Copyright © 1998-2003, 2004 Free Software Foundation, Inc.

Permission is hereby granted, free of charge, to any person obtaining a copy of this software and associated documentation files (the "Software"), to deal in the Software without restriction, including without limitation the rights to use, copy, modify, merge, publish, distribute, distribute with modifications, sublicense, and/or sell copies of the Software, and to permit persons to whom the Software is furnished to do so, subject to the following conditions:

The above copyright notice and this permission notice shall be included in all copies or substantial portions of the Software.

THE SOFTWARE IS PROVIDED "AS IS", WITHOUT WARRANTY OF ANY KIND, EXPRESS OR IMPLIED, INCLUDING BUT NOT LIMITED TO THE WARRANTIES OF MERCHANTABILITY, FITNESS FOR A PARTICULAR PURPOSE AND NONINFRINGEMENT. IN NO EVENT SHALL THE ABOVE COPYRIGHT HOLDERS BE LIABLE FOR ANY CLAIM, DAMAGES OR OTHER LIABILITY, WHETHER IN AN ACTION OF CONTRACT, TORT OR OTHERWISE, ARISING FROM, OUT OF OR IN CONNECTION WITH THE SOFTWARE OR THE USE OR OTHER DEALINGS IN THE SOFTWARE.

Except as contained in this notice, the name(s) of the above copyright holders shall not be used in advertising or otherwise to promote the sale, use or other dealings in this Software without prior written authorization.

libpng

This copy of the libpng notices is provided for your convenience. In case of any discrepancy between this copy and the notices in the file png.h that is included in the libpng distribution, the latter shall prevail.

COPYRIGHT NOTICE, DISCLAIMER, and LICENSE:

If you modify libpng you may insert additional notices immediately following this sentence.

libpng version 1.2.6, August 15, 2004, is Copyright © 2004 Glenn Randers-Pehrson, and is distributed according to the same disclaimer and license as libpng-1.2.5 with the following individual added to the list of Contributing Authors
Cosmin Truta

libpng versions 1.0.7, July 1, 2000, through 1.2.5 - October 3, 2002, are Copyright © 2000-2002 Glenn Randers-Pehrson, and are distributed according to the same disclaimer and license as libpng-1.0.6 with the following individuals added to the list of Contributing Authors
Simon-Pierre Cadieux
Eric S. Raymond
Gilles Vollant

and with the following additions to the disclaimer:

There is no warranty against interference with your enjoyment of the library or against infringement. There is no warranty that our efforts or the library will fulfill any of your particular purposes or needs. This library is provided with all faults, and the entire risk of satisfactory quality, performance, accuracy, and effort is with the user.

libpng versions 0.97, January 1998, through 1.0.6, March 20, 2000, are Copyright © 1998, 1999 Glenn Randers-Pehrson, and are distributed according to the same disclaimer and license as libpng-0.96, with the following individuals added to the list of Contributing Authors:

Tom Lane
Glenn Randers-Pehrson
Willem van Schaik

libpng versions 0.89, June 1996, through 0.96, May 1997, are Copyright © 1996, 1997 Andreas Dilger
Distributed according to the same disclaimer and license as libpng-0.88, with the following individuals added to the list of Contributing Authors:

John Bowler
Kevin Bracey
Sam Bushell
Magnus Holmgren
Greg Roelofs
Tom Tanner

libpng versions 0.5, May 1995, through 0.88, January 1996, are Copyright © 1995, 1996 Guy Eric Schalnat, Group 42, Inc.

For the purposes of this copyright and license, "Contributing Authors" is defined as the following set of individuals:

Andreas Dilger
Dave Martindale
Guy Eric Schalnat
Paul Schmidt
Tim Wegner

The PNG Reference Library is supplied "AS IS". The Contributing Authors and Group 42, Inc. disclaim all warranties, expressed or implied, including, without limitation, the warranties of merchantability and of fitness for any purpose. The Contributing Authors and Group 42, Inc. assume no liability for direct, indirect, incidental, special, exemplary, or consequential damages, which may result from the use of the PNG Reference Library, even if advised of the possibility of such damage.

Permission is hereby granted to use, copy, modify, and distribute this source code, or portions hereof, for any purpose, without fee, subject to the following restrictions:

1. The origin of this source code must not be misrepresented.
2. Altered versions must be plainly marked as such and must not be misrepresented as being the original source.
3. This Copyright notice may not be removed or altered from any source or altered source distribution.

The Contributing Authors and Group 42, Inc. specifically permit, without fee, and encourage the use of this source code as a component to supporting the PNG file format in commercial products. If you use this source code in a product, acknowledgment is not required but would be appreciated.

A "png_get_copyright" function is available, for convenient use in "about" boxes and the like:

```
printf("%s",png_get_copyright(NULL));
```

Also, the PNG logo (in PNG format, of course) is supplied in the files "pngbar.png" and "pngbar.jpg" (88x31) and "pngnow.png" (98x31).

libpng is OSI Certified Open Source Software. OSI Certified Open Source is a certification mark of the Open Source Initiative.

Glenn Randers-Pehrson
glennrp@users.sourceforge.net
August 15, 2004

libuuid

Copyright © 1996, 1997, 1998, 1999 Theodore Ts'o.
Copyright 1999 Andreas Dilger

Redistribution and use in source and binary forms, with or without modification, are permitted provided that the following conditions are met:

1. Redistributions of source code must retain the above copyright notice, and the entire permission notice in its entirety, including the disclaimer of warranties.
2. Redistributions in binary form must reproduce the above copyright notice, this list of conditions and the following disclaimer in the documentation and/or other materials provided with the distribution.
3. The name of the author may not be used to endorse or promote products derived from this software without specific prior written permission.

THIS SOFTWARE IS PROVIDED "AS IS" AND ANY EXPRESS OR IMPLIED WARRANTIES, INCLUDING, BUT NOT LIMITED TO, THE IMPLIED WARRANTIES OF MERCHANTABILITY AND FITNESS FOR A PARTICULAR

PURPOSE, ALL OF WHICH ARE HEREBY DISCLAIMED. IN NO EVENT SHALL THE AUTHOR BE LIABLE FOR ANY DIRECT, INDIRECT, INCIDENTAL, SPECIAL, EXEMPLARY, OR CONSEQUENTIAL DAMAGES (INCLUDING, BUT NOT LIMITED TO, PROCUREMENT OF SUBSTITUTE GOODS OR SERVICES; LOSS OF USE, DATA, OR PROFITS; OR BUSINESS INTERRUPTION) HOWEVER CAUSED AND ON ANY THEORY OF LIABILITY, WHETHER IN CONTRACT, STRICT LIABILITY, OR TORT (INCLUDING NEGLIGENCE OR OTHERWISE) ARISING IN ANY WAY OUT OF THE USE OF THIS SOFTWARE, EVEN IF NOT ADVISED OF THE POSSIBILITY OF SUCH DAMAGE.

libwrap

Copyright 1995 by Wietse Venema. All rights reserved. Some individual files may be covered by other copyrights.

This material was originally written and compiled by Wietse Venema at Eindhoven University of Technology, The Netherlands, in 1990, 1991, 1992, 1993, 1994 and 1995.

Redistribution and use in source and binary forms, with or without modification, are permitted provided that this entire copyright notice is duplicated in all such copies.

This software is provided "as is" and without any expressed or implied warranties, including, without limitation, the implied warranties of merchantability and fitness for any particular purpose.

libxml

Except where otherwise noted in the source code (e.g. the files hash.c, list.c and the trio files, which are covered by a similar licence but with different Copyright notices) all the files are:

Copyright © 1998-2003 Daniel Veillard. All Rights Reserved.

Permission is hereby granted, free of charge, to any person obtaining a copy of this software and associated documentation files (the "Software"), to deal in the Software without restriction, including without limitation the rights to use, copy, modify, merge, publish, distribute, sublicense, and/or sell copies of the Software, and to permit persons to whom the Software is furnished to do so, subject to the following conditions:

The above copyright notice and this permission notice shall be included in all copies or substantial portions of the Software.

THE SOFTWARE IS PROVIDED "AS IS", WITHOUT WARRANTY OF ANY KIND, EXPRESS OR IMPLIED, INCLUDING BUT NOT LIMITED TO THE WARRANTIES OF MERCHANTABILITY, FITNESS FOR A PARTICULAR PURPOSE AND NONINFRINGEMENT. IN NO EVENT SHALL THE DANIEL VEILLARD BE LIABLE FOR ANY CLAIM, DAMAGES OR OTHER LIABILITY, WHETHER IN AN ACTION OF CONTRACT, TORT OR OTHERWISE, ARISING FROM, OUT OF OR IN CONNECTION WITH THE SOFTWARE OR THE USE OR OTHER DEALINGS IN THE SOFTWARE.

Except as contained in this notice, the name of Daniel Veillard shall not be used in advertising or otherwise to promote the sale, use or other dealings in this Software without prior written authorization from him.

Copyright © 1998 Bjorn Reese and Daniel Stenberg.
Copyright © 2000 Bjorn Reese and Daniel Veillard.
Copyright © 2000 Bjorn Reese and Daniel Stenberg.
Copyright © 2000 Gary Pennington and Daniel Veillard.
Copyright © 2001 Bjorn Reese and Daniel Stenberg.

Permission to use, copy, modify, and distribute this software for any purpose with or without fee is hereby granted, provided that the above copyright notice and this permission notice appear in all copies.

THIS SOFTWARE IS PROVIDED "AS IS" AND WITHOUT ANY EXPRESS OR IMPLIED WARRANTIES, INCLUDING, WITHOUT LIMITATION, THE IMPLIED WARRANTIES OF MERCHANTABILITY AND FITNESS FOR A PARTICULAR PURPOSE. THE AUTHORS AND CONTRIBUTORS ACCEPT NO RESPONSIBILITY IN ANY CONCEIVABLE MANNER.

netkit-inetd

Most of the files, fall under the following copyright, and are distributable under the terms of the BSD license (/usr/share/common-licenses/BSD):

Copyright © 1983, 1991 The Regents of the University of California.
All rights reserved.

Some of the RPC code, is copyrighted by Sun Microsystems, and is provided under the following terms:

Sun RPC is a product of Sun Microsystems, Inc. and is provided for unrestricted use provided that this legend is included on all tape media and as a part of the software program in whole or part. Users may copy or modify Sun RPC without charge, but are not authorized to license or distribute it to anyone else except as part of a product or program

developed by the user or with the express written consent of Sun Microsystems, Inc.

SUN RPC IS PROVIDED AS IS WITH NO WARRANTIES OF ANY KIND INCLUDING THE WARRANTIES OF DESIGN, MERCHANTABILITY AND FITNESS FOR A PARTICULAR PURPOSE, OR ARISING FROM A COURSE OF DEALING, USAGE OR TRADE PRACTICE.

Sun RPC is provided with no support and without any obligation on the part of Sun Microsystems, Inc. to assist in its use, correction, modification or enhancement.

SUN MICROSYSTEMS, INC. SHALL HAVE NO LIABILITY WITH RESPECT TO THE INFRINGEMENT OF COPYRIGHTS, TRADE SECRETS OR ANY PATENTS BY SUN RPC OR ANY PART THEREOF.

In no event will Sun Microsystems, Inc. be liable for any lost revenue or profits or other special, indirect and consequential damages, even if Sun has been advised of the possibility of such damages.

Sun Microsystems, Inc.
2550 Garcia Avenue
Mountain View, California 94043

pam

Unless otherwise *explicitly* stated the following text describes the licensed conditions under which the contents of this Linux-PAM release may be distributed:

Redistribution and use in source and binary forms of Linux-PAM, with or without modification, are permitted provided that the following conditions are met:

1. Redistributions of source code must retain any existing copyright notice, and this entire permission notice in its entirety, including the disclaimer of warranties.
2. Redistributions in binary form must reproduce all prior and current copyright notices, this list of conditions, and the following disclaimer in the documentation and/or other materials provided with the distribution.
3. The name of any author may not be used to endorse or promote products derived from this software without their specific prior written permission.

ALTERNATIVELY, this product may be distributed under the terms of the GNU General Public License, in which case the provisions of the GNU GPL are required INSTEAD OF the above restrictions. (This clause is necessary due to a potential conflict between the GNU GPL and the restrictions contained in a BSD-style copyright.)

THIS SOFTWARE IS PROVIDED "AS IS" AND ANY EXPRESS OR IMPLIED WARRANTIES, INCLUDING, BUT NOT LIMITED TO, THE IMPLIED WARRANTIES OF MERCHANTABILITY AND FITNESS FOR A PARTICULAR PURPOSE ARE DISCLAIMED. IN NO EVENT SHALL THE AUTHOR(S) BE LIABLE FOR ANY DIRECT, INDIRECT, INCIDENTAL, SPECIAL, EXEMPLARY, OR CONSEQUENTIAL DAMAGES (INCLUDING, BUT NOT LIMITED TO, PROCUREMENT OF SUBSTITUTE GOODS OR SERVICES; LOSS OF USE, DATA, OR PROFITS; OR BUSINESS INTERRUPTION) HOWEVER CAUSED AND ON ANY THEORY OF LIABILITY, WHETHER IN CONTRACT, STRICT LIABILITY, OR TORT (INCLUDING NEGLIGENCE OR OTHERWISE) ARISING IN ANY WAY OUT OF THE USE OF THIS SOFTWARE, EVEN IF ADVISED OF THE POSSIBILITY OF SUCH DAMAGE.

portmap

Author:
Wietse Venema (wietse@wzv.win.tue.nl), dept. of Mathematics and Computing Science, Eindhoven University of Technology, The Netherlands.

Some Components:
Copyright © 1990 The Regents of the University of California.
All rights reserved.

Redistribution and use in source and binary forms, with or without modification, are permitted provided that the following conditions are met:

1. Redistributions of source code must retain the above copyright notice, this list of conditions and the following disclaimer.
2. Redistributions in binary form must reproduce the above copyright notice, this list of conditions and the following disclaimer in the documentation and/or other materials provided with the distribution.
3. All advertising materials mentioning features or use of this software must display the following acknowledgement:

This product includes software developed by the University of California, Berkeley and its contributors.

4. Neither the name of the University nor the names of its contributors may be used to endorse or promote products derived from this software without specific prior written permission.

THIS SOFTWARE IS PROVIDED BY THE REGENTS AND CONTRIBUTORS "AS IS" AND ANY EXPRESS OR IMPLIED WARRANTIES, INCLUDING, BUT NOT LIMITED TO, THE IMPLIED WARRANTIES OF MERCHANTABILITY

AND FITNESS FOR A PARTICULAR PURPOSE ARE DISCLAIMED. IN NO EVENT SHALL THE REGENTS OR CONTRIBUTORS BE LIABLE FOR ANY DIRECT, INDIRECT, INCIDENTAL, SPECIAL, EXEMPLARY, OR CONSEQUENTIAL DAMAGES (INCLUDING, BUT NOT LIMITED TO, PROCUREMENT OF SUBSTITUTE GOODS OR SERVICES; LOSS OF USE, DATA, OR PROFITS; OR BUSINESS INTERRUPTION) HOWEVER CAUSED AND ON ANY THEORY OF LIABILITY, WHETHER IN CONTRACT, STRICT LIABILITY, OR TORT (INCLUDING NEGLIGENCE OR OTHERWISE) ARISING IN ANY WAY OUT OF THE USE OF THIS SOFTWARE, EVEN IF ADVISED OF THE POSSIBILITY OF SUCH DAMAGE.

Some of the RPC code, is copyrighted by Sun Microsystems, and is provided under the following terms:

Sun RPC is a product of Sun Microsystems, Inc. and is provided for unrestricted use provided that this legend is included on all tape media and as a part of the software program in whole or part. Users may copy or modify Sun RPC without charge, but are not authorized to license or distribute it to anyone else except as part of a product or program developed by the user or with the express written consent of Sun Microsystems, Inc.

SUN RPC IS PROVIDED AS IS WITH NO WARRANTIES OF ANY KIND INCLUDING THE WARRANTIES OF DESIGN, MERCHANTABILITY AND FITNESS FOR A PARTICULAR PURPOSE, OR ARISING FROM A COURSE OF DEALING, USAGE OR TRADE PRACTICE.

Sun RPC is provided with no support and without any obligation on the part of Sun Microsystems, Inc. to assist in its use, correction, modification or enhancement.

SUN MICROSYSTEMS, INC. SHALL HAVE NO LIABILITY WITH RESPECT TO THE INFRINGEMENT OF COPYRIGHTS, TRADE SECRETS OR ANY PATENTS BY SUN RPC OR ANY PART THEREOF.

In no event will Sun Microsystems, Inc. be liable for any lost revenue or profits or other special, indirect and consequential damages, even if Sun has been advised of the possibility of such damages.

Sun Microsystems, Inc.
2550 Garcia Avenue
Mountain View, California 94043

shadow

This software is copyright 1988 - 1994, Julianne Frances Haugh.
All rights reserved.

Redistribution and use in source and binary forms, with or without modification, are permitted provided that the following conditions are met:

1. Redistributions of source code must retain the above copyright notice, this list of conditions and the following disclaimer.
2. Redistributions in binary form must reproduce the above copyright notice, this list of conditions and the following disclaimer in the documentation and/or other materials provided with the distribution.
3. Neither the name of Julianne F. Haugh nor the names of its contributors may be used to endorse or promote products derived from this software without specific prior written permission.

THIS SOFTWARE IS PROVIDED BY JULIE HAUGH AND CONTRIBUTORS "AS IS" AND ANY EXPRESS OR IMPLIED WARRANTIES, INCLUDING, BUT NOT LIMITED TO, THE IMPLIED WARRANTIES OF MERCHANTABILITY AND FITNESS FOR A PARTICULAR PURPOSE ARE DISCLAIMED. IN NO EVENT SHALL JULIE HAUGH OR CONTRIBUTORS BE LIABLE FOR ANY DIRECT, INDIRECT, INCIDENTAL, SPECIAL, EXEMPLARY, OR CONSEQUENTIAL DAMAGES (INCLUDING, BUT NOT LIMITED TO, PROCUREMENT OF SUBSTITUTE GOODS OR SERVICES; LOSS OF USE, DATA, OR PROFITS; OR BUSINESS INTERRUPTION) HOWEVER CAUSED AND ON ANY THEORY OF LIABILITY, WHETHER IN CONTRACT, STRICT LIABILITY, OR TORT (INCLUDING NEGLIGENCE OR OTHERWISE) ARISING IN ANY WAY OUT OF THE USE OF THIS SOFTWARE, EVEN IF ADVISED OF THE POSSIBILITY OF SUCH DAMAGE.

This source code is currently archived on ftp.uu.net in the comp.sources.misc portion of the USENET archives. You may also contact the author, Julianne F. Haugh, at jfh@tab.com if you have any questions regarding this package.

THIS SOFTWARE IS BEING DISTRIBUTED AS-IS. THE AUTHORS DISCLAIM ALL LIABILITY FOR ANY CONSEQUENCES OF USE. THE USER IS SOLELY RESPONSIBLE FOR THE MAINTENANCE OF THIS SOFTWARE PACKAGE. THE AUTHORS ARE UNDER NO OBLIGATION TO PROVIDE MODIFICATIONS OR IMPROVEMENTS. THE USER IS ENCOURAGED TO TAKE ANY AND ALL STEPS NEEDED TO PROTECT AGAINST ACCIDENTAL LOSS OF INFORMATION OR MACHINE RESOURCES.

Source files: login_access.c, login_desrpc.c, login_krb.c are derived from the logdaemon-5.0 package, which is under the following license:

Copyright 1995 by Wietse Venema. All rights reserved. Individual files may be covered by other copyrights (as noted in the file itself.)

This material was originally written and compiled by Wietse Venema at Eindhoven University of Technology, The Netherlands, in 1990, 1991, 1992, 1993, 1994 and 1995.

Redistribution and use in source and binary forms are permitted provided that this entire copyright notice is duplicated in all such copies.

This software is provided "as is" and without any expressed or implied warranties, including, without limitation, the implied warranties of merchantability and fitness for any particular purpose.

sudo

Sudo is distributed under the following BSD-style license:

Copyright © 1994-1996, 1998-2003 Todd C. Miller
<Todd.Miller@courtesan.com>
All rights reserved.

Redistribution and use in source and binary forms, with or without modification, are permitted provided that the following conditions are met:

1. Redistributions of source code must retain the above copyright notice, this list of conditions and the following disclaimer.
2. Redistributions in binary form must reproduce the above copyright notice, this list of conditions and the following disclaimer in the documentation and/or other materials provided with the distribution.
3. The name of the author may not be used to endorse or promote products derived from this software without specific prior written permission from the author.
4. Products derived from this software may not be called "Sudo" nor may "Sudo" appear in their names without specific prior written permission from the author.

THIS SOFTWARE IS PROVIDED "AS IS" AND ANY EXPRESS OR IMPLIED WARRANTIES, INCLUDING, BUT NOT LIMITED TO, THE IMPLIED WARRANTIES OF MERCHANTABILITY AND FITNESS FOR A PARTICULAR PURPOSE ARE DISCLAIMED. IN NO EVENT SHALL THE AUTHOR BE LIABLE FOR ANY DIRECT, INDIRECT, INCIDENTAL, SPECIAL, EXEMPLARY, OR CONSEQUENTIAL DAMAGES (INCLUDING, BUT NOT LIMITED TO, PROCUREMENT OF SUBSTITUTE GOODS OR SERVICES; LOSS OF USE, DATA, OR PROFITS; OR BUSINESS INTERRUPTION) HOWEVER CAUSED AND ON ANY THEORY OF LIABILITY, WHETHER IN CONTRACT, STRICT LIABILITY, OR TORT (INCLUDING NEGLIGENCE OR OTHERWISE) ARISING IN ANY WAY OUT OF THE USE OF THIS SOFTWARE, EVEN IF ADVISED OF THE POSSIBILITY OF SUCH DAMAGE.

Sponsored in part by the Defense Advanced Research Projects Agency (DARPA) and Air Force Research Laboratory, Air Force Materiel Command, USAF, under agreement number F39502-99-1-0512.

Additionally, lsearch.c, fnmatch.c, getcwd.c, snprintf.c, strcasecmp.c and fnmatch.3 bear the following UCB license:

Copyright © 1987, 1989, 1990, 1991, 1993, 1994
The Regents of the University of California. All rights reserved.

Redistribution and use in source and binary forms, with or without modification, are permitted provided that the following conditions are met:

1. Redistributions of source code must retain the above copyright notice, this list of conditions and the following disclaimer.
2. Redistributions in binary form must reproduce the above copyright notice, this list of conditions and the following disclaimer in the documentation and/or other materials provided with the distribution.
3. Neither the name of the University nor the names of its contributors may be used to endorse or promote products derived from this software without specific prior written permission.

THIS SOFTWARE IS PROVIDED BY THE REGENTS AND CONTRIBUTORS "AS IS" AND ANY EXPRESS OR IMPLIED WARRANTIES, INCLUDING, BUT NOT LIMITED TO, THE IMPLIED WARRANTIES OF MERCHANTABILITY AND FITNESS FOR A PARTICULAR PURPOSE ARE DISCLAIMED. IN NO EVENT SHALL THE REGENTS OR CONTRIBUTORS BE LIABLE FOR ANY DIRECT, INDIRECT, INCIDENTAL, SPECIAL, EXEMPLARY, OR CONSEQUENTIAL DAMAGES (INCLUDING, BUT NOT LIMITED TO, PROCUREMENT OF SUBSTITUTE GOODS OR SERVICES; LOSS OF USE, DATA, OR PROFITS; OR BUSINESS INTERRUPTION) HOWEVER CAUSED AND ON ANY THEORY OF LIABILITY, WHETHER IN CONTRACT, STRICT LIABILITY, OR TORT (INCLUDING NEGLIGENCE OR OTHERWISE) ARISING IN ANY WAY OUT OF THE USE OF THIS SOFTWARE, EVEN IF ADVISED OF THE POSSIBILITY OF SUCH DAMAGE.

zlib

Copyright notice:
© 1995-2003 Jean-loup Gailly and Mark Adler

This software is provided 'as-is', without any express or implied warranty. In no event will the authors be held liable for any damages arising from the use of this software.

Permission is granted to anyone to use this software for any purpose, including commercial applications, and to alter it and redistribute it freely, subject to the following restrictions:

1. The origin of this software must not be misrepresented; you must not claim that you wrote the original software. If you use this software in a product, an acknowledgment in the product documentation would be appreciated but is not required.
2. Altered source versions must be plainly marked as such, and must not be misrepresented as being the original software.
3. This notice may not be removed or altered from any source distribution.

Jean-loup Gailly
jloup@gzip.org

Mark Adler
madler@alummi.caltech.edu

If you use the zlib library in a product, we would appreciate *not* receiving lengthy legal documents to sign. The sources are provided for free but without warranty of any kind. The library has been entirely written by Jean-loup Gailly and Mark Adler; it does not include third-party code.

If you redistribute modified sources, we would appreciate that you include in the file ChangeLog history information documenting your changes. Please read the FAQ for more information on the distribution of modified source versions.

Note on source code distribution

For three years after the final factory shipment, you may request from Yamaha the source code for any portions of the product which are licensed under the GNU General Public License by writing to the following address:

MP business unit PA•DMI Division, YAMAHA Corporation
10-1 Nakazawa-cho, Naka-ku, Hamamatsu, 430-8650, JAPAN

The source code will be provided at no charge; however, we may require you to reimburse Yamaha for the cost of delivering the source code to you.

- Note that we shall bear no responsibility whatsoever for any damage arising from changes (additions/ deletions) made to the software for this product by a third party other than Yamaha (or party authorized by Yamaha).
- Note that re-use of source code released to the public domain by Yamaha is unguaranteed, and Yamaha shall not bear any responsibility whatsoever for the source code.
- The source code can be downloaded from the following address:
<http://www.yamahasynt.com/download/source/motifxs/>

FCC INFORMATION (U.S.A.)

1. IMPORTANT NOTICE: DO NOT MODIFY THIS UNIT!

This product, when installed as indicated in the instructions contained in this manual, meets FCC requirements. Modifications not expressly approved by Yamaha may void your authority, granted by the FCC, to use the product.

2. IMPORTANT: When connecting this product to accessories and/or another product use only high quality shielded cables. Cable/s supplied with this product MUST be used. Follow all installation instructions. Failure to follow instructions could void your FCC authorization to use this product in the USA.

3. NOTE: This product has been tested and found to comply with the requirements listed in FCC Regulations, Part 15 for Class "B" digital devices. Compliance with these requirements provides a reasonable level of assurance that your use of this product in a residential environment will not result in harmful interference with other electronic devices. This equipment generates/uses radio frequencies and, if not installed and used according to the instructions found in the users manual, may cause interference harmful to the operation of other electronic devices. Compliance with FCC regulations does

not guarantee that interference will not occur in all installations. If this product is found to be the source of interference, which can be determined by turning the unit "OFF" and "ON", please try to eliminate the problem by using one of the following measures:

Relocate either this product or the device that is being affected by the interference.

Utilize power outlets that are on different branch (circuit breaker or fuse) circuits or install AC line filter/s.

In the case of radio or TV interference, relocate/reorient the antenna. If the antenna lead-in is 300 ohm ribbon lead, change the lead-in to co-axial type cable.

If these corrective measures do not produce satisfactory results, please contact the local retailer authorized to distribute this type of product. If you can not locate the appropriate retailer, please contact Yamaha Corporation of America, Electronic Service Division, 6600 Orangethorpe Ave, Buena Park, CA90620

The above statements apply ONLY to those products distributed by Yamaha Corporation of America or its subsidiaries.

* This applies only to products distributed by YAMAHA CORPORATION OF AMERICA.

(class B)

COMPLIANCE INFORMATION STATEMENT (DECLARATION OF CONFORMITY PROCEDURE)

Responsible Party : Yamaha Corporation of America

Address : 6600 Orangethorpe Ave.,
Buena Park, Calif. 90620

Telephone : 714-522-9011

Type of Equipment : Music Production Synthesizer

Model Name : MOTIF XS8, MOTIF XS7, MOTIF XS6

This device complies with Part 15 of the FCC Rules.

Operation is subject to the following two conditions:

- 1) this device may not cause harmful interference, and
- 2) this device must accept any interference received including interference that may cause undesired operation.

See user manual instructions if interference to radio reception is suspected.

* This applies only to products distributed by
YAMAHA CORPORATION OF AMERICA.

(FCC DoC)

IMPORTANT NOTICE FOR THE UNITED KINGDOM

Connecting the Plug and Cord

WARNING: THIS APPARATUS MUST BE EARTHED

IMPORTANT. The wires in this mains lead are coloured in accordance with the following code:

GREEN-AND-YELLOW	: EARTH
BLUE	: NEUTRAL
BROWN	: LIVE

As the colours of the wires in the mains lead of this apparatus may not correspond with the coloured markings identifying the terminals in your plug proceed as follows:

The wire which is coloured GREEN-and-YELLOW must be connected to the terminal in the plug which is marked by the letter E or by the safety earth symbol  or colored GREEN or GREEN-and-YELLOW.

The wire which is coloured BLUE must be connected to the terminal which is marked with the letter N or coloured BLACK.

The wire which is coloured BROWN must be connected to the terminal which is marked with the letter L or coloured RED.

• This applies only to products distributed by Yamaha-Kemble Music (U.K.) Ltd. (3 wires)

This product contains a high intensity lamp that contains a small amount of mercury. Disposal of this material may be regulated due to environmental considerations. For disposal information in the United States, refer to the Electronic Industries Alliance web site:
www.eiae.org

* This applies only to products distributed by
YAMAHA CORPORATION OF AMERICA.

(mercury)

For details of products, please contact your nearest Yamaha representative or the authorized distributor listed below.

Pour plus de détails sur les produits, veuillez-vous adresser à Yamaha ou au distributeur le plus proche de vous figurant dans la liste suivante.

Die Einzelheiten zu Produkten sind bei Ihrer unten aufgeführten Niederlassung und bei Yamaha Vertragshändlern in den jeweiligen Bestimmungsländern erhältlich.

Para detalles sobre productos, contacte su tienda Yamaha más cercana o el distribuidor autorizado que se lista debajo.

NORTH AMERICA

CANADA

Yamaha Canada Music Ltd.
135 Milner Avenue, Scarborough, Ontario,
M1S 3R1, Canada
Tel: 416-298-1311

U.S.A.

Yamaha Corporation of America
6600 Orangethorpe Ave., Buena Park, Calif. 90620,
U.S.A.
Tel: 714-522-9011

CENTRAL & SOUTH AMERICA

MEXICO

Yamaha de México S.A. de C.V.
Calz. Javier Rojo Gómez #1149,
Col. Guadalupe del Moral
C.P. 09300, México, D.F., México
Tel: 55-5804-0600

BRAZIL

Yamaha Musical do Brasil Ltda.
Rua Joaquim Floriano, 913 - 4º andar, Itaim Bibi,
CEP 04534-013 Sao Paulo, SP. BRAZIL
Tel: 011-3704-1377

ARGENTINA

Yamaha Music Latin America, S.A.
Sucursal de Argentina
Olga Cossettini 1553, Piso 4 Norte
Madero Este-C1107CEK
Buenos Aires, Argentina
Tel: 011-4119-7000

PANAMA AND OTHER LATIN AMERICAN COUNTRIES/ CARIBBEAN COUNTRIES

Yamaha Music Latin America, S.A.
Torre Banco General, Piso 7, Urbanización Marbella,
Calle 47 y Aquilino de la Guardia,
Ciudad de Panamá, Panamá
Tel: +507-269-5311

EUROPE

THE UNITED KINGDOM

Yamaha Music U.K. Ltd.
Sherbourne Drive, Tilbrook, Milton Keynes,
MK7 8BL, England
Tel: 01908-366700

IRELAND

Danfay Ltd.
61D, Sallynoggin Road, Dun Laoghaire, Co. Dublin
Tel: 01-2859177

GERMANY

Yamaha Music Central Europe GmbH
Siemensstraße 22-34, 25462 Rellingen, Germany
Tel: 04101-3030

SWITZERLAND/LIECHTENSTEIN

Yamaha Music Central Europe GmbH,
Branch Switzerland
Seefeldstrasse 94, 8008 Zürich, Switzerland
Tel: 01-383 3990

AUSTRIA

Yamaha Music Central Europe GmbH,
Branch Austria
Schleiergasse 20, A-1100 Wien, Austria
Tel: 01-60203900

CZECH REPUBLIC/SLOVAKIA/ HUNGARY/SLOVENIA

Yamaha Music Central Europe GmbH,
Branch Austria, CEE Department
Schleiergasse 20, A-1100 Wien, Austria
Tel: 01-602039025

POLAND

Yamaha Music Central Europe GmbH
Sp.z o.o. Oddział w Polsce
ul. 17 Stycznia 56, PL-02-146 Warszawa, Poland
Tel: 022-868-07-57

THE NETHERLANDS/ BELGIUM/LUXEMBOURG

Yamaha Music Central Europe GmbH,
Branch Benelux
Clarissenhof 5-b, 4133 AB Vianen, The Netherlands
Tel: 0347-358 040

FRANCE

Yamaha Musique France
BP 70-77312 Marne-la-Vallée Cedex 2, France
Tel: 01-64-61-4000

ITALY

Yamaha Musica Italia S.P.A.
Combo Division
Viale Italia 88, 20020 Lainate (Milano), Italy
Tel: 02-935-771

SPAIN/PORTUGAL

Yamaha Música Ibérica, S.A.
Ctra. de la Coruna km. 17, 200, 28230
Las Rozas (Madrid), Spain
Tel: 91-639-8888

GREECE

Philippos Nakas S.A. The Music House
147 Skiathou Street, 112-55 Athens, Greece
Tel: 01-228 2160

SWEDEN

Yamaha Scandinavia AB
J. A. Wettergrens Gata 1, Box 30053
S-400 43 Göteborg, Sweden
Tel: 031 89 34 00

DENMARK

YS Copenhagen Liaison Office
Generatorvej 6A, DK-2730 Herlev, Denmark
Tel: 44 92 49 00

FINLAND

F-Musiikki Oy
Kluuvikatu 6, P.O. Box 260,
SF-00101 Helsinki, Finland
Tel: 09 618511

NORWAY

Norsk filial av Yamaha Scandinavia AB
Grini Næringspark 1, N-1345 Østerås, Norway
Tel: 67 16 77 70

ICELAND

Skifan HF
Skeifan 17 P.O. Box 8120, IS-128 Reykjavik, Iceland
Tel: 525 5000

RUSSIA

Yamaha Music (Russia)
Office 4015, entrance 2, 21/5 Kuznetskii
Most street, Moscow, 107996, Russia
Tel: 495 626 0660

OTHER EUROPEAN COUNTRIES

Yamaha Music Central Europe GmbH
Siemensstraße 22-34, 25462 Rellingen, Germany
Tel: +49-4101-3030

AFRICA

Yamaha Corporation,
Asia-Pacific Music Marketing Group
Nakazawa-cho 10-1, Naka-ku, Hamamatsu,
Japan 430-8650
Tel: +81-53-460-2312

MIDDLE EAST

TURKEY/CYPRUS

Yamaha Music Central Europe GmbH
Siemensstraße 22-34, 25462 Rellingen, Germany
Tel: 04101-3030

OTHER COUNTRIES

Yamaha Music Gulf FZE
LOB 16-513, P.O.Box 17328, Jubel Ali,
Dubai, United Arab Emirates
Tel: +971-4-881-5868

ASIA

THE PEOPLE'S REPUBLIC OF CHINA

Yamaha Music & Electronics (China) Co.,Ltd.
2F, Yunhedasha, 1818 Xinzha-lu, Jingan-qu,
Shanghai, China
Tel: 021-6247-2211

HONG KONG

Tom Lee Music Co., Ltd.
11/F., Silvercord Tower 1, 30 Canton Road,
Tsimshatsui, Kowloon, Hong Kong
Tel: 2737-7688

INDIA

Yamaha Music India Pvt. Ltd.
5F Ambience Corporate Tower Ambience Mall Complex
Ambience Island, NH-8, Gurgaon-122001, Haryana, India
Tel: 0124-466-5551

INDONESIA

PT. Yamaha Music Indonesia (Distributor)
PT. Nusantik
Gedung Yamaha Music Center, Jalan Jend. Gatot
Subroto Kav. 4, Jakarta 12930, Indonesia
Tel: 21-520-2577

KOREA

Yamaha Music Korea Ltd.
8F, 9F, Dongsung Bldg. 158-9 Samsung-Dong,
Kangnam-Gu, Seoul, Korea
Tel: 080-004-0022

MALAYSIA

Yamaha Music Malaysia, Sdn., Bhd.
Lot 8, Jalan Perbandaran, 47301 Kelana Jaya,
Petaling Jaya, Selangor, Malaysia
Tel: 3-78030900

PHILIPPINES

Yupangco Music Corporation
339 Gil J. Puyat Avenue, P.O. Box 885 MCPO,
Makati, Metro Manila, Philippines
Tel: 819-7551

SINGAPORE

Yamaha Music Asia Pte., Ltd.
#03-11 A-Z Building
140 Paya Lebar Road, Singapore 409015
Tel: 747-4374

TAIWAN

Yamaha KHS Music Co., Ltd.
3F, #6, Sec.2, Nan Jing E. Rd. Taipei.
Taiwan 104, R.O.C.
Tel: 02-2511-8688

THAILAND

Siam Music Yamaha Co., Ltd.
4, 6, 15 and 16th floor, Siam Motors Building,
891/1 Rama 1 Road, Wangmai,
Pathumwan, Bangkok 10330, Thailand
Tel: 02-215-2626

OTHER ASIAN COUNTRIES

Yamaha Corporation,
Asia-Pacific Music Marketing Group
Nakazawa-cho 10-1, Naka-ku, Hamamatsu,
Japan 430-8650
Tel: +81-53-460-2317

OCEANIA

AUSTRALIA

Yamaha Music Australia Pty. Ltd.
Level 1, 99 Queensbridge Street, Southbank,
Victoria 3006, Australia
Tel: 3-9693-5111

NEW ZEALAND

Music Works LTD
P.O.BOX 6246 Wellesley, Auckland 4680,
New Zealand
Tel: 9-634-0099

COUNTRIES AND TRUST TERRITORIES IN PACIFIC OCEAN

Yamaha Corporation,
Asia-Pacific Music Marketing Group
Nakazawa-cho 10-1, Naka-ku, Hamamatsu,
Japan 430-8650
Tel: +81-53-460-2312

HEAD OFFICE Yamaha Corporation, Pro Audio & Digital Musical Instrument Division
Nakazawa-cho 10-1, Naka-ku, Hamamatsu, Japan 430-8650
Tel: +81-53-460-2445



Yamaha Web Site (English only)
<http://www.yamahasyth.com/>

Yamaha Manual Library
<http://www.yamaha.co.jp/manual/>

U.R.G., Pro Audio & Digital Musical Instrument Division, Yamaha Corporation
© 2007 Yamaha Corporation

WG97440 811MWDH68.2-05E0
Printed in Japan