

YAMAHA
PORTATONE

PSR-530

Owner's Manual

SPECIAL MESSAGE SECTION

This product utilizes batteries or an external power supply (adapter). DO NOT connect this product to any power supply or adapter other than one described in the manual, on the name plate, or specifically recommended by Yamaha.

This product should be used only with the components supplied or; a cart, rack, or stand that is recommended by Yamaha. If a cart, etc., is used, please observe all safety markings and instructions that accompany the accessory product.

SPECIFICATIONS SUBJECT TO CHANGE:

The information contained in this manual is believed to be correct at the time of printing. However, Yamaha reserves the right to change or modify any of the specifications without notice or obligation to update existing units.

This product, either alone or in combination with an amplifier and headphones or speaker/s, may be capable of producing sound levels that could cause permanent hearing loss. DO NOT operate for long periods of time at a high volume level or at a level that is uncomfortable. If you experience any hearing loss or ringing in the ears, you should consult an audiologist.

IMPORTANT: The louder the sound, the shorter the time period before damage occurs.

NOTICE:

Service charges incurred due to a lack of knowledge relating to how a function or effect works (when the unit is operating as designed) are not covered by the manufacturer's warranty, and are therefore the owners responsibility. Please study this manual carefully and consult your dealer before requesting service.

ENVIRONMENTAL ISSUES:

Yamaha strives to produce products that are both user safe and environmentally friendly. We sincerely believe that our products and the production methods used to produce them, meet these goals. In keeping with both the letter and the spirit of the law, we want you to be aware of the following:

Battery Notice:

This product MAY contain a small non-rechargeable battery which (if applicable) is soldered in place. The average life span of this type of

battery is approximately five years. When replacement becomes necessary, contact a qualified service representative to perform the replacement.

This product may also use "household" type batteries. Some of these may be rechargeable. Make sure that the battery being charged is a rechargeable type and that the charger is intended for the battery being charged.

When installing batteries, do not mix batteries with new, or with batteries of a different type. Batteries MUST be installed correctly. Mismatches or incorrect installation may result in overheating and battery case rupture.

Warning:

Do not attempt to disassemble, or incinerate any battery. Keep all batteries away from children. Dispose of used batteries promptly and as regulated by the laws in your area. Note: Check with any retailer of household type batteries in your area for battery disposal information.

Disposal Notice:

Should this product become damaged beyond repair, or for some reason its useful life is considered to be at an end, please observe all local, state, and federal regulations that relate to the disposal of products that contain lead, batteries, plastics, etc. If your dealer is unable to assist you, please contact Yamaha directly.

NAME PLATE LOCATION:

The name plate is located on the bottom of the product. The model number, serial number, power requirements, etc., are located on this plate. You should record the model number, serial number, and the date of purchase in the spaces provided below and retain this manual as a permanent record of your purchase.

Model

Serial No.

Purchase Date

PLEASE KEEP THIS MANUAL

92-BP

FCC INFORMATION (U.S.A.)

IMPORTANT NOTICE: DO NOT MODIFY THIS UNIT!

This product, when installed as indicated in the instructions contained in this manual, meets FCC requirements. Modifications not expressly approved by Yamaha may void your authority, granted by the FCC, to use the product.

IMPORTANT:

When connecting this product to accessories and/or another product use only high quality shielded cables. Cable/s supplied with this product MUST be used. Follow all installation instructions. Failure to follow instructions could void your FCC authorization to use this product in the USA.

NOTE:

This product has been tested and found to comply with the requirements listed in FCC Regulations, Part 15 for Class "B" digital devices. Compliance with these requirements provides a reasonable level of assurance that your use of this product in a residential environment will not result in harmful interference with other electronic devices. This equipment generates/uses radio frequencies and, if not installed and used according to

the instructions found in the users manual, may cause interference harmful to the operation of other electronic devices. Compliance with FCC regulations does not guarantee that interference will not occur in all installations. If this product is found to be the source of interference, which can be determined by turning the unit "OFF" and "ON", please try to eliminate the problem by using one of the following measures:

- Relocate either this product or the device that is being affected by the interference.
- Utilize power outlets that are on different branch (circuit breaker or fuse) circuits or install AC line filter/s.
- In the case of radio or TV interference, relocate/reorient the antenna. If the antenna lead-in is 300 ohm ribbon lead, change the lead-in to co-axial type cable.

If these corrective measures do not produce satisfactory results, please contact the local retailer authorized to distribute this type of product. If you can not locate the appropriate retailer, please contact Yamaha Corporation of America, Electronic Service Division, 6600 Orangethorpe Ave, Buena Park, CA90620

• This applies only to products distributed by Yamaha Corporation of America.

PRECAUTIONS

PLEASE READ CAREFULLY BEFORE PROCEEDING

* Please keep these precautions in a safe place for future reference.



WARNING

Always follow the basic precautions listed below to avoid the possibility of serious injury or even death from electrical shock, short-circuiting, damages, fire or other hazards. These precautions include, but are not limited to, the following:

- Do not open the instrument or attempt to disassemble the internal parts or modify them in any way. The instrument contains no user-serviceable parts. If it should appear to be malfunctioning, discontinue use immediately and have it inspected by qualified Yamaha service personnel.
- Do not expose the instrument to rain, use it near water or in damp or wet conditions, or place containers on it containing liquids which might spill into any openings.
- If the AC adaptor cord or plug becomes frayed or damaged, or if there is a sudden loss of sound during use of the instrument, or if any unusual smells or smoke should appear to be caused by it, immediately turn off the power switch, disconnect the adaptor plug from the outlet, and have the instrument inspected by qualified Yamaha service personnel.
- Use the specified adaptor (PA-6 or an equivalent recommended by Yamaha) only. Using the wrong adaptor can result in damage to the instrument or overheating.
- Before cleaning the instrument, always remove the electric plug from the outlet. Never insert or remove an electric plug with wet hands.
- Check the electric plug periodically and remove any dirt or dust which may have accumulated on it.



CAUTION

Always follow the basic precautions listed below to avoid the possibility of physical injury to you or others, or damage to the instrument or other property. These precautions include, but are not limited to, the following:

- Do not place the AC adaptor cord near heat sources such as heaters or radiators, and do not excessively bend or otherwise damage the cord, place heavy objects on it, or place it in a position where anyone could walk on, trip over, or roll anything over it.
- When removing the electric plug from the instrument or an outlet, always hold the plug itself and not the cord.
- Do not connect the instrument to an electrical outlet using a multiple-connector. Doing so can result in lower sound quality, or possibly cause overheating in the outlet.
- Unplug the AC power adaptor when not using the instrument, or during electrical storms.
- Always make sure all batteries are inserted in conformity with the +/- polarity markings. Failure to do so might result in overheating, fire, or battery fluid leakage.
- Always replace all batteries at the same time. Do not use new batteries together with old ones. Also, do not mix battery types, such as alkaline batteries with manganese batteries, or batteries from different makers, or different types of batteries from the same maker, since this can cause overheating, fire, or battery fluid leakage.
- Do not dispose of batteries in fire.
- Do not attempt to recharge batteries that are not intended to be charged.
- If the instrument is not to be in use for a long time, remove the batteries from it, in order to prevent possible fluid leakage from the battery.
- Keep batteries away from children.
- Before connecting the instrument to other electronic components, turn off the power for all components. Before turning the power on or off for all components, set all volume levels to minimum.
- Do not expose the instrument to excessive dust or vibrations, or extreme cold or heat (such as in direct sunlight, near a heater, or in a car during the day) to prevent the possibility of panel disfiguration or damage to the internal components.
- Do not use the instrument near other electrical products such as televisions, radios, or speakers, since this might cause interference which can affect proper operation of the other products.
- Do not place the instrument in an unstable position where it might accidentally fall over.
- Before moving the instrument, remove all connected adaptor and other cables.
- When cleaning the instrument, use a soft, dry cloth. Do not use paint thinners, solvents, cleaning fluids, or chemical-impregnated wiping cloths. Also, do not place vinyl or plastic objects on the instrument, since this might discolor the panel or keyboard.
- Do not rest your weight on, or place heavy objects on the instrument, and do not use excessive force on the buttons, switches or connectors.
- Use only the stand specified for the instrument. When attaching the stand, use the provided screws only. Failure to do so could cause damage to the internal components or result in the instrument falling over.
- Do not operate the instrument for a long period of time at a high or uncomfortable volume level, since this can cause permanent hearing loss. If you experience any hearing loss or ringing in the ears, consult a physician.

■ SAVING USER DATA

- Save all data to an external device such as the Yamaha MIDI Data Filer MDF2, in order to help prevent the loss of important data due to a malfunction or user operating error.

Yamaha cannot be held responsible for damage caused by improper use or modifications to the instrument, or data that is lost or destroyed.

Always turn the power off when the instrument is not in use.

Make sure to discard used batteries according to local regulations.

..... Congratulations!

You are the proud owner of a fine electronic keyboard. The Yamaha PSR-530 PortaTone combines the most advanced tone generation technology with state-of-the-art digital electronics and features to give you stunning sound quality with maximum musical enjoyment. A large graphic display and easy-to-use interface also greatly enhance the operability of this advanced instrument.

In order to make the most of your PortaTone's features and extensive performance potential, we urge you to read the manual thoroughly while trying out the various features described. Keep the manual in a safe place for later reference.

..... Important Features



Touch-sensitive 61-key keyboard for a wide range of dynamic musical expression.



An outstanding range of 200 panel voices and 12 drum kits, plus a full set of 480 XG voices.



Voice set feature automatically selects the appropriate voice parameter settings for the panel voices.



Advanced auto-accompaniment technology gives you 100 fully-orchestrated accompaniment "styles" to back up what you play on the keyboard.



Virtual Arranger feature lets you add chord progressions to any of the auto-accompaniment styles for more musical, refined accompaniment.



One Touch Setting feature automatically selects appropriate voice, effect, and other settings for the selected accompaniment style — all you have to do is select a style and play.



Large multi-function LCD display panel makes it easy to select and edit parameters.



Registration Memory saves your favorite panel settings for instant recall when needed.



Digital effects add depth and ambience to your sound.



Minus-one and Repeat functions are ideal for learning new songs and polishing your keyboard technique.



Song recording feature lets you record four melody tracks with an accompaniment track.



Create original accompaniment styles with the User Style feature.



Multi Pads record and play short rhythmic and melodic sequences that can be used to add impact and variety to your performances.



Optional Yamaha Music Cartridges can be plugged in for enjoyable automated performance, keyboard practice, and extra accompaniment styles.

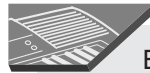

Built-in amplifier and speaker system delivers top-quality sound without the need for external equipment.



A range of MIDI functions for expanded musical enjoyment (General MIDI System Level 1 and Yamaha XG compatible).



GM System Level 1

“GM System Level 1” is an addition to the MIDI standard which ensures that any GM-compatible music data can be accurately played by any GM-compatible tone generator, regardless of manufacturer. The GM mark is affixed to all software and hardware products that support the “GM System Level 1”.

PSR-530 supports GM System Level 1.

XG XG

XG is a new MIDI format created by Yamaha which significantly improves and expands upon the “GM System Level 1” standard by providing a greater variety of high-quality voices plus considerably enhanced effect operation while being fully compatible with GM.

PSR-530 supports the XG format.

◆ Packing List

- PSR-530

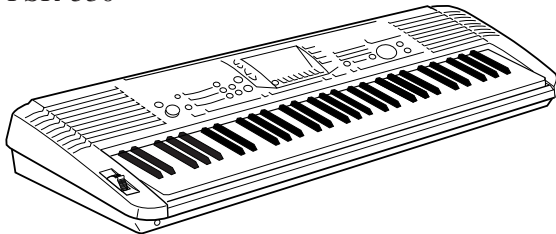

- Music Cartridge



- Music Stand

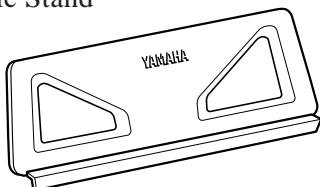

- Owner's manual

Contents

Panel Controls	6
The Music Stand	7
Basic Display Operation	8
The Display Icons	8
The Menus	10
Shortcuts	11
Setting Up	12
Power Supply	12
Using An Optional AC Power Adaptor	12
Using Batteries	12
Connections	13
The PHONES Jack	13
SUSTAIN Jack	13
The AUX OUT R and L/L+R Jacks	13
MIDI IN/OUT and TO HOST Connectors	13
The Demonstration	14
Playing the PSR-530	16
The PSR-530 Voices	16
A Word About the “R1”, “R2”, and “L” Voices	16
Selecting & Playing Voices	17
Keyboard Percussion	19
The Dual Voice Mode	19
The Split Voice Mode	20
Changing the SPLIT VOICE Split Point	21
Auto Accompaniment	22
Using Auto Accompaniment	22
The Synchro Stop Function	26
Using Virtual Arranger	27
Accompaniment Track Muting	27
Muting Individual Tracks	28
Accompaniment Volume Control	28
Changing the Accompaniment Split Point	29
Interaction Between the AUTO ACCOMPANIMENT and SPLIT VOICE Split Points	30
The Auto Accompaniment Fingering Modes	30
The Stop Accompaniment Function	34
One Touch Setting	34
Digital Effects	36
Reverb	36
Turning the Reverb Effect On or Off	36
Selecting a Reverb Type	37
Reverb Return Level	38
Chorus	38
Turning the Chorus Effect On or Off	38
Selecting a Chorus Effect	39
Chorus Return Level	39
DSP	40
Turning the DSP Effect On or Off	41
Selecting a DSP Effect	41
DSP Return Level	42
Harmony	42
Turning the Harmony Effect On or Off	43
Selecting a Harmony Type	43
Adjusting the Harmony Volume	44
The Pitch Bend Wheel	45
Setting the Pitch Bend Range	45
Transpose	46
Setting Transposition	46
Registration Memory	47
Registering the Panel Settings	47
Recall the Registered Panel Settings	48
The Accompaniment Freeze Function	48
The Multi Pads	49
Selecting a MULTI PAD Set	49
Playing the MULTI PADS	50
Turning the CHORD MATCH Function On/Off	51
Song Playback	52
Song Playback Procedure	52
Song Volume Control	53
Play from a Specified Measure	54
Minus-one Practice	55
Minus-one Track Assignment	55
Repeat Play	57



Song Recording 58

Song Recording Procedure 59
 About the Recording with
 the Digital Effects Applied 62
Clearing Song Data 63
 Clearing an Entire Song 63
 Clearing Selected Melody Tracks 63

Style Recording 64

Style Recording Procedure 64
 Drum Cancel 68
 Quantize 69
Clearing User Style Data 70
 Clearing an Entire Style 70
 Clearing Selected Style Tracks 70

Multi Pad Recording 71

MUTI PAD Recording Procedure 71
Clearing MULTI PAD Data 74
 Clearing an Entire Pad Set 74
 Clearing Selected MULTI PADS 74

Using Music Cartridges 75

 Inserting a Music Cartridge 75
 Music Cartridge Handling Precautions 75
Cartridge Songs 76
 Cartridge Song Playback 76
Cartridge Accompaniment Styles 77

Revoicing 78

Revoicing the R1, R2, and L Voices 78
Revoicing a Style 80
Revoicing a User Song 81

Overall Functions 83

 Touch Sensitivity 84
 Pitch Bend Range 84
 Master Tuning 84
 Scale Tuning 84
 Song Transpose 85
 Metronome 85
 Split Voice Split Point 85
 Accompaniment Split Point 85
 Fingering Mode 85
 Voice Set 85

MIDI Functions 86

What's MIDI? 86
 MIDI Terminal/TO HOST Terminal 88
What You Can Do with MIDI 88
Connecting to a Personal Computer
(TO HOST Terminal/HOST SELECT Switch) 90
 Connect using the PSR-530 MIDI terminals 90
 Connect using the TO HOST terminal 91
The PSR-530 MIDI Functions 92
 Transmit Channel & Transmit Track 92
 Receive Channel & Receive Mode 93
 Local Control 94
 Clock 94
 Bulk Data Send 95
 Initial Data Send 95

Appendix

PSR-530 Display MENU/SUB MENU Structure 96
Data Backup & Initialization 98
 Data Backup 98
 Data Initialization 98
Voice List 99
 Maximum Polyphony 99
Drum Kit List 104
About Digital Effects (Reverb/Chorus/DSP) 106
 When DSP type Is
 Selected as a System Effect 106
 When DSP type Is
 Selected as a Insertion Effect 107
Troubleshooting 109
MIDI Data Format 110
MIDI Implementation Chart 122
Specifications 124
Index 125

Panel Controls

Top Panel Controls

- 1 STAND BY/ON Switch page 14
- 2 MASTER VOLUME Control page 14
- 3 DEMO Button page 14
- 4 TEMPO Buttons page 23
- 5 TRANSPOSE Buttons page 46
- 6 ACCOMPANIMENT/SONG VOLUME Buttons pages 28, 53
- 7 AUTO ACCOMPANIMENT SECTION
 - AUTO ACCOMPANIMENT ON/OFF Button page 23
 - SYNC STOP Button page 26
 - SYNC START Button page 24
 - INTRO Button page 24
 - MAIN/AUTO FILL A & B Buttons page 24
 - ENDING Button page 26
- 8 RECORD Button pages 59, 65, 71
- 9 START/STOP Button pages 15, 24, 26
- 10 DIGITAL EFFECT SECTION
 - REVERB Button page 36
 - CHORUS Button page 38
 - DSP Button page 41
 - VARIATION Button page 41
 - HARMONY Button page 43
- 11 DISPLAY & RELATED CONTROLS
 - DISPLAY page 8
 - MENU Buttons page 10
 - SUB MENU Buttons page 10
 - VOICE Button page 10
 - STYLE Button page 10
 - SONG Button page 10
 - CARTRIDGE Button page 10
 - REVOICE Button page 78
 - TRACK Buttons pages 19, 20, 28, 60, 79
- 12 REGISTRATION MEMORY SECTION
 - MEMORY Button page 48
 - 1, 2, 3, 4 Buttons page 48
 - FREEZE Button page 48
- 13 ONE TOUCH SETTING Button page 35
- 14 NUMBER Buttons page 17
- 15 + and - Buttons pages 15, 17
- 16 Data Dial page 18

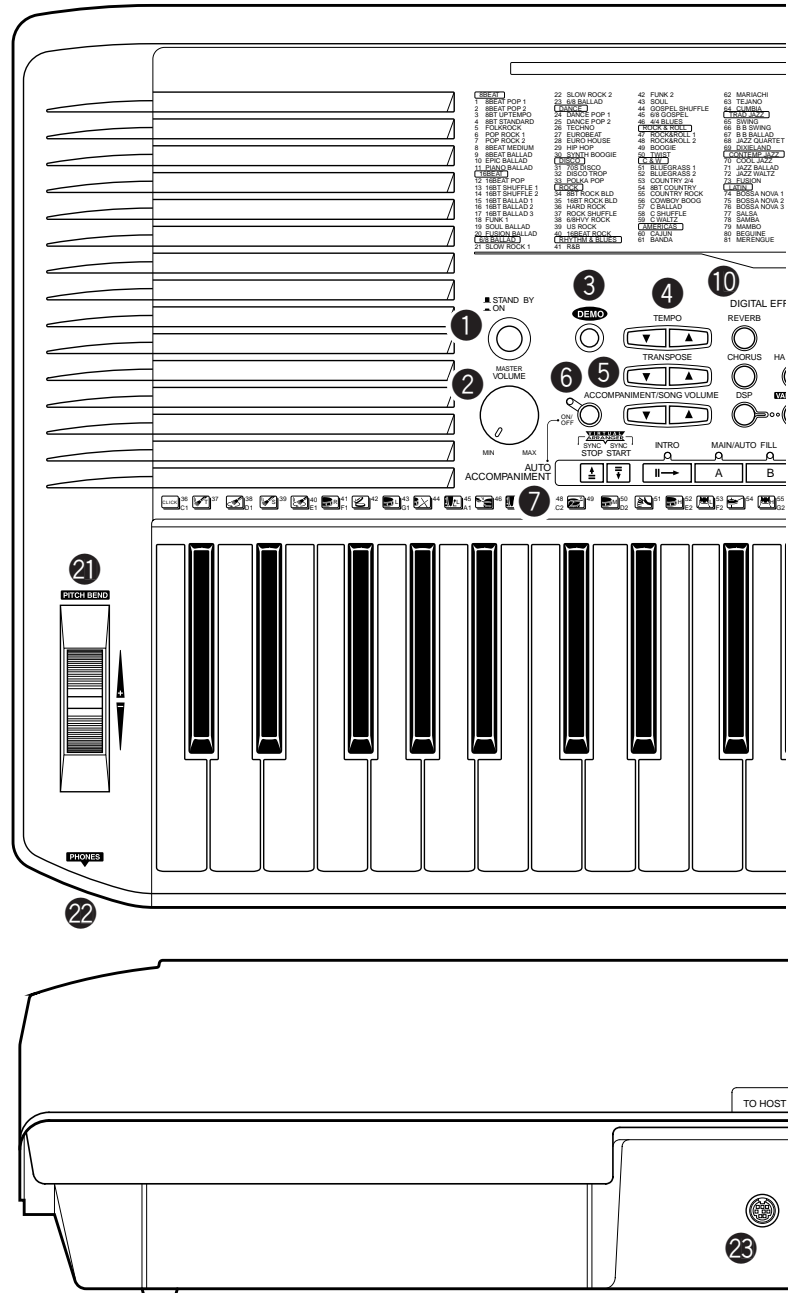

- 17 MUSIC CARTRIDGE Slot page 75
- 18 KEYBOARD SECTION
 - DUAL VOICE Button page 19
 - SPLIT VOICE Button page 20
- 19 MULTI PAD SECTION
 - STOP Button page 50
 - 1, 2, 3, 4 Buttons pages 50, 72
- 20 Keyboard page 18
- 21 PITCH BEND Wheel page 45
- 22 PHONES Jack page 13

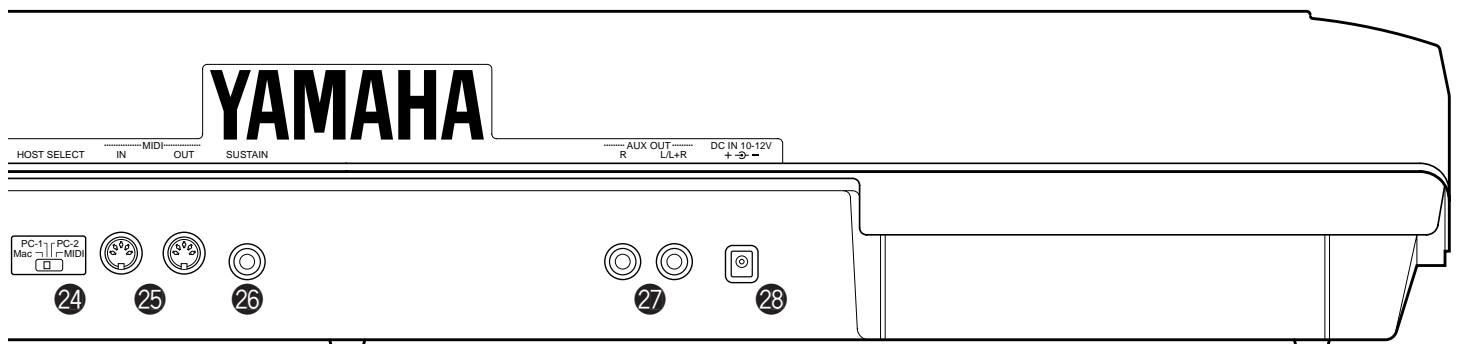
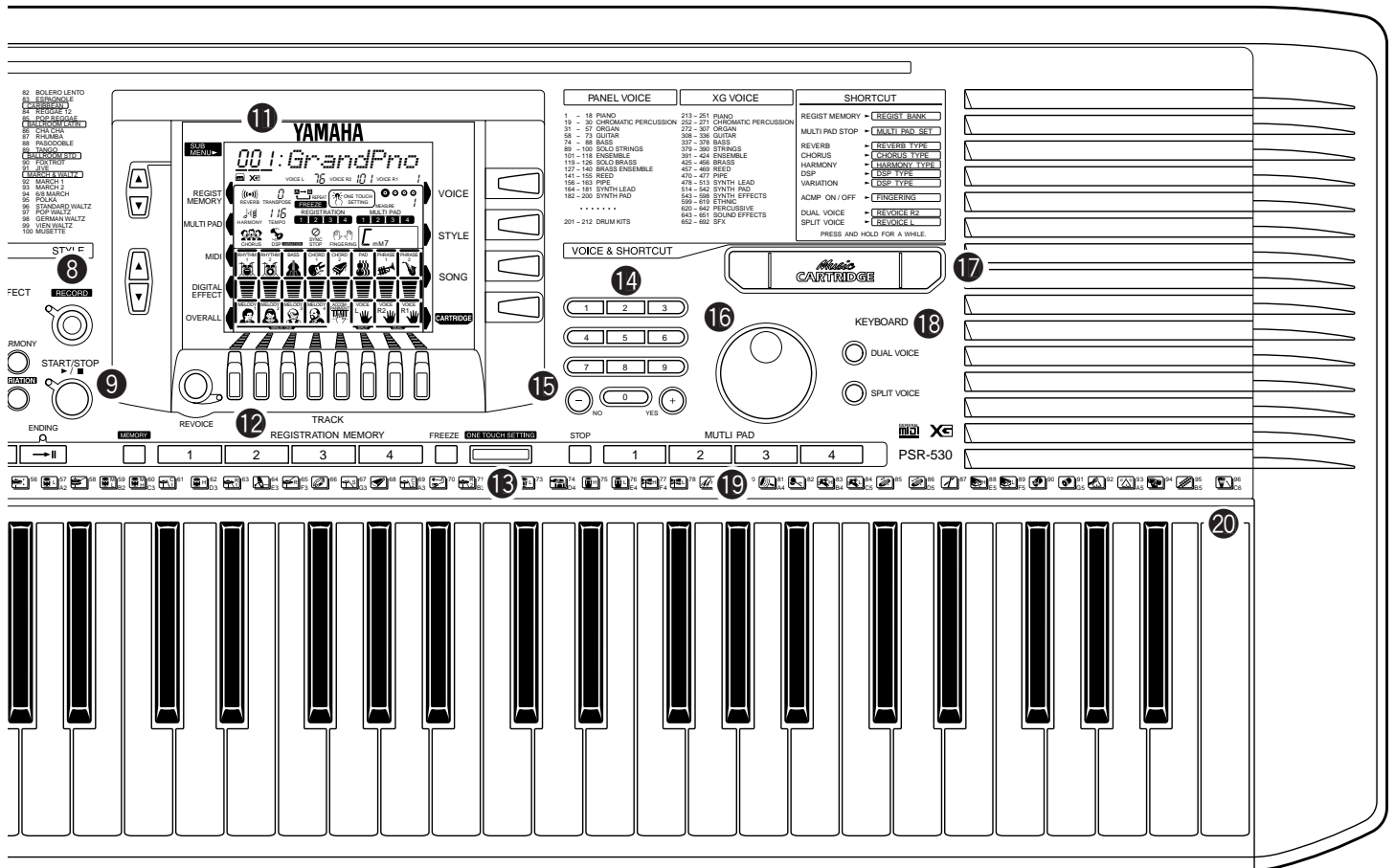

■ Rear Panel Controls

- 23 TO HOST Connector page 88
- 24 HOST SELECT Switch page 90
- 25 MIDI IN and OUT Connectors page 88
- 26 SUSTAIN Jack page 13
- 27 AUX OUT R, L/L+R Jacks page 13
- 28 DC IN 10-12V Jack page 12

◆ The Music Stand

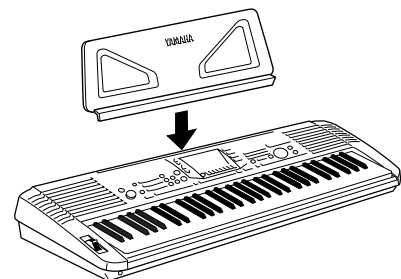

The PSR-530 is supplied with a music stand that can be attached to the instrument by inserting it into the slot at the rear of the control panel.

Basic Display Operation

The PSR-530 LCD panel is a large multi-function type that simultaneously displays and provides access to a number of important parameters. Basic operation of the display as well as the MENU and SUB MENU buttons, and the meaning of the icons which appear in the display, are summarized briefly below.

The Display Icons



CART (Cartridge)

Appears when a Music Cartridge song or style is selected (page 76).



XG

Appears when one of the PSR-530's XG voices is selected (page 16).

VOICE L 76 VOICE R2 101 VOICE R1 1

VOICE L, VOICE R2, and VOICE R1

The currently selected L (Left-hand), R2 (Right-hand 2) and R1 (Right-hand 1) voice numbers are displayed in these display locations (page 16).



REVERB

Appears when the REVERB effect is turned on (page 36).



HARMONY

Appears when the HARMONY effect is turned on (page 43).



CHORUS

Appears when the CHORUS effect is turned on (page 38).



TRANSPOSE

The current transpose value (page 46).



TEMPO

Shows the current tempo of accompaniment/song playback (page 23).



DSP

Appears when the DSP effect is turned on (page 41).



DSP VARIATION

Appears when the DSP effect variation is turned on (page 41).

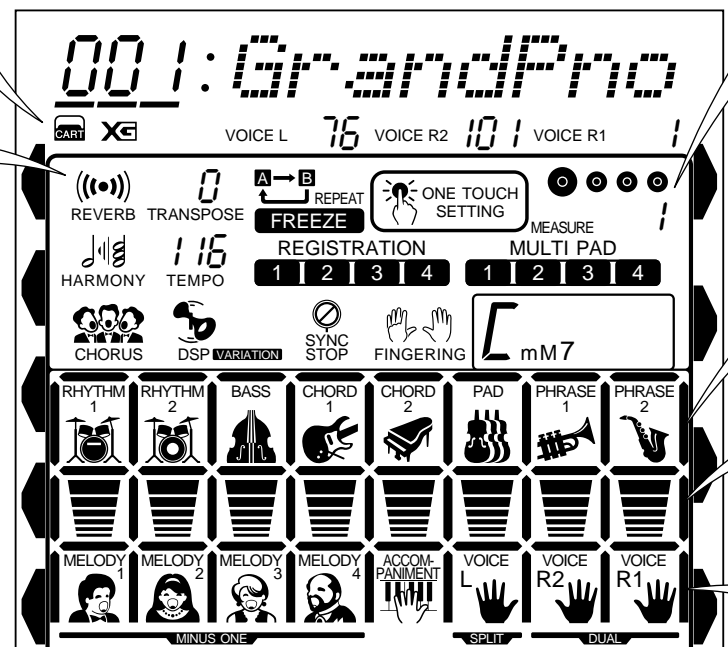



REPEAT

Indicates the “A” and “B” repeat points when programming a repeat section, and whether REPEAT PLAY is on or off (page 57).



ONE TOUCH SETTING

Appears when the ONE TOUCH SETTING feature is engaged (page 34).



REGISTRATION 1 ... 4 (Registration Memory)

Indicates the currently selected REGISTRATION MEMORY or ONE TOUCH SETTING number (page 47).



FREEZE

Appears when the REGISTRATION MEMORY “FREEZE” function is on (page 48).



MULTI PAD 1 ... 4

Indicates the currently playing MULTI PAD number (page 50).



BEAT

Flashes at the current tempo and indicates the current beat during accompaniment and song playback. (page 25)



MEASURE

Indicates the current measure number during song recording and playback (page 54).



SYNC STOP

Appears when the AUTO ACCOMPANIMENT SYNC STOP function is engaged (page 26).



FINGERING

Shows the currently selected fingering mode (page 30).



CHORD

Displays the current chord name during AUTO ACCOMPANIMENT playback or SONG recording/playback (page 25).

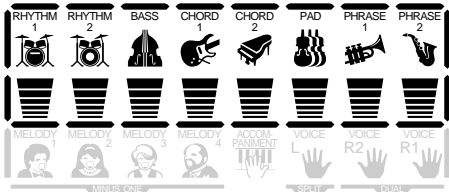

ACCOMPANIMENT TRACKS

The top row of 8 icons light to indicate which of the 8 possible accompaniment tracks are being used for accompaniment playback. They are also used to specify tracks when using the REVOICE function (page 27).



VOLUME

These icons show the volume (actually velocity) of each accompaniment track during accompaniment playback, the volume of the melody and accompaniment tracks during song playback, and the volume of the R1, R2 and L voices (page 16).

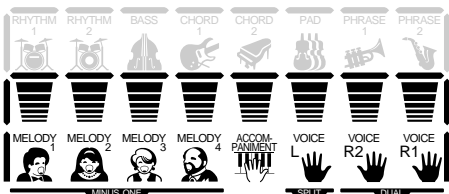

MELODY TRACKS 1 ... 4, ACCOMPANIMENT TRACK

These icons indicate the playback on/off status of each song track, and are used to specify tracks for song recording (page 60). They are also used to specify tracks when using the REVOICE function (page 81).

VOICE L, VOICE R2, VOICE R1

These icons indicate the on/off status of the L, R2, and R1 voices when the DUAL VOICE and/or SPLIT VOICE functions are used (page 16). They are also used to specify tracks when using the REVOICE function (page 79).

The Menu

The buttons to the right of the display directly select one of the PSR-530's four main function menus: VOICE, STYLE, SONG, and CARTRIDGE. The currently selected menu is indicated by a triangular indicator in the display next to the menu list printed immediately to the right of the display panel. In addition to the menus and functions which are available directly via the PSR-530 panel controls, there is also a range of important "background" functions which can be selected via the MENU and SUB MENU [▲] and [▼] buttons.

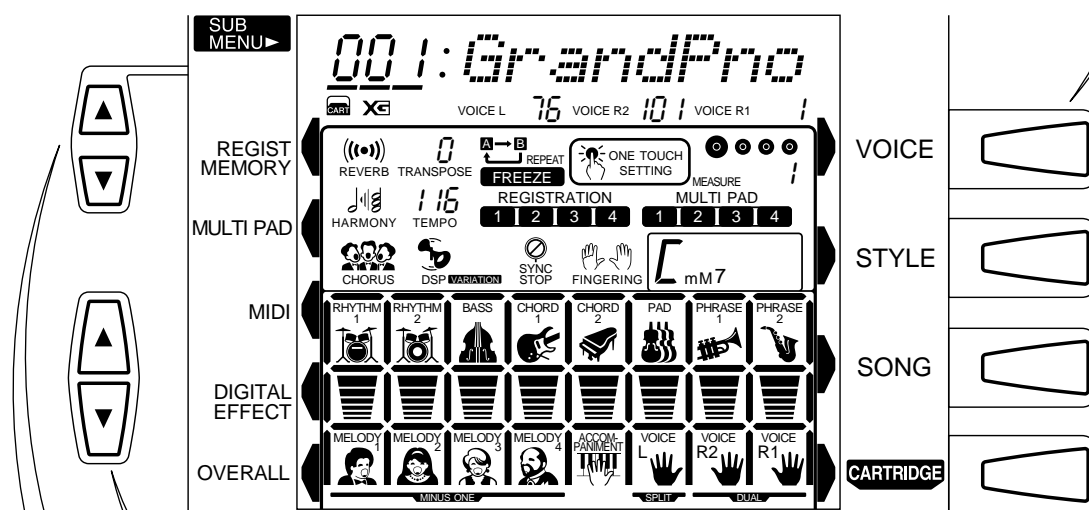

The MENU [▲] and [▼] buttons are used to select the menu: REGISTRATION MEMORY, MULTI PAD, MIDI, DIGITAL EFFECT, or OVERALL. The currently selected MENU category is indicated by a triangular indicator in the display next to the menu list printed immediately to the left of the display panel. All of the listed menu categories can be selected by pressing either the MENU [▲] or [▼] button as many times as necessary until the triangular indicator in the display appears next to the name of the desired category. Once a MENU has been selected, the SUB MENU [▲] and [▼] buttons can be used to select the desired function. The SUB MENU functions will be described in detail in the appropriate chapters throughout this manual.

Shortcuts

To make operation as easy and as efficient as possible, the PSR-530 features a number of “shortcuts” which allow you to jump directly to certain functions without having to use the MENU and SUB MENU buttons. All of these shortcuts work in the same way: press and hold a panel button for a few seconds to go to the related function. For example, if you press and hold the [REVERB] button for a few seconds, you will go directly to the REVERB type selection function. The shortcut buttons and the functions they access are listed on the PSR-530 panel, near the upper left corner of the display. The shortcuts will also be described where appropriate throughout this manual.

REVERB



:Reverb

Setting Up

This section contains information about setting up your PSR-530 and preparing to play. Be sure to go through this section carefully before using your PSR-530.

Power Supply

Although the PSR-530 will run either from an optional AC adaptor or batteries, Yamaha recommends use of the more environmentally safe AC adaptor. Follow the instructions below according to the power source you intend to use.

CAUTION

- *Never interrupt the power supply (e.g. remove the batteries or unplug the AC adaptor) during any PSR-530 record operation! Doing so can result in a loss of data.*

Using An Optional AC Power Adaptor

- 1 Plug an optional Yamaha PA-6 Power Adaptor into a wall AC outlet.
- 2 Then plug the DC output cable from the PA-6 into the **DC IN 10-12V** jack on the rear panel of the PSR-530. The internal batteries are automatically disconnected when an AC Power Adaptor is used.

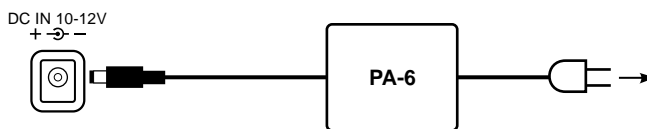

When turning the power OFF, simply reverse the procedure.

WARNING

- *Use ONLY a Yamaha PA-6 AC Power Adaptor (or other adaptor specifically recommended by Yamaha) to power your instrument from the AC mains. The use of other adaptors may result in irreparable damage to both the adaptor and the PSR-530.*
- *Unplug the AC Power Adaptor when not using the PSR-530, or during electrical storms.*

Using Batteries

For battery operation the PSR-530 requires six 1.5V SUM-1, “D” size, R-20 or equivalent batteries.

When the batteries need to be replaced “LoBattery” may appear on top of the display, the volume may be reduced, the sound may be distorted, and other problems may occur. When this happens, turn the power off and replace the batteries.

Replace the batteries as follows:

- 1 Open the battery compartment cover located on the instrument’s bottom panel.
- 2 Insert the six new batteries, being careful to follow the polarity markings on the inside of the compartment.
- 3 Replace the compartment cover, making sure that it locks firmly in place.

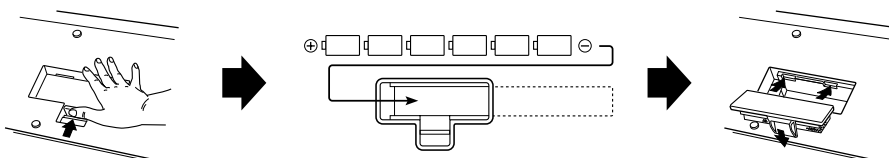

CAUTION

- *When the batteries run down, replace them with a complete set of six new batteries. NEVER mix old and new batteries.*
- *Do not use different kinds of batteries (e.g. alkaline and manganese) at the same time.*
- *If the instrument is not to be in use for a long time, remove the batteries from it, in order to prevent possible fluid leakage from the battery.*
- *Plugging or unplugging the AC power adaptor while the batteries are installed will reset the PSR-530 to the defaults.*

Connections

The PHONES Jack

A standard pair of stereo headphones can be plugged in here for private practice or late-night playing. The internal stereo speaker system is automatically shut off when a pair of headphones is plugged into the **PHONES** jack.

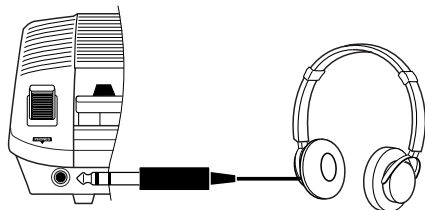

SUSTAIN Jack

An optional Yamaha FC4 or FC5 footswitch can be plugged into the rear-panel **SUSTAIN** jack for sustain control. The footswitch functions like the damper pedal on a piano — press for sustain, release for normal sound.

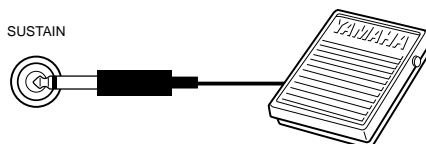

NOTE

- Be sure that you do not press the footswitch while turning the power on. If you do, the ON/OFF status of the footswitch will be reversed.
- Some voices may sound continuously or have a long decay after the notes have been released while the sustain pedal (footswitch) is held.

The AUX OUT R and L/L+R Jacks

The rear-panel **AUX OUT R** and **L/L+R** jacks deliver the output of the PSR-530 for connection to a keyboard amplifier, stereo sound system, a mixing console, or tape recorder. If you will be connecting the PSR-530 to a monaural sound system, use only the **L/L+R** jack. When a plug is inserted into the **L/L+R** jack only, the left- and right-channel signals are combined and delivered via the **L/L+R** jack so you don't lose any of the PSR-530 sound.

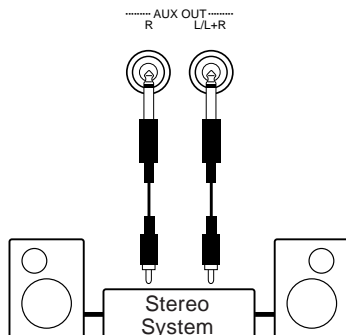

MIDI IN/OUT and TO HOST Connectors

See page 88.

The Demonstration

Once you've set up your PSR-530, try listening to the pre-programmed demonstration songs. A total of 12 demo songs are provided.

1 Switch ON

Turn the power ON by pressing the [STAND BY/ON] switch.



CAUTION

• Even when the switch is in the "STAND BY" position, electricity is still flowing to the instrument at the minimum level. When you are not using the PSR-530 for a long time, make sure you unplug the AC power adaptor from the wall AC outlet, and/or remove the batteries from the instrument.

2 Set an Initial Volume Level

Turn the [MASTER VOLUME] control up (clockwise) about a quarter-turn from its minimum position. You can re-adjust the [MASTER VOLUME] control for the most comfortable overall volume level after playback begins.

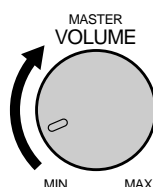

NOTE

• If you play the PSR-530 with the volume at its maximum level when the batteries are used, the life of the batteries will be shorter.

3 Press the [DEMO] Button

Press the [DEMO] button to start demo playback. The PSR-530 SONG menu will automatically be selected and the number and name of the first demo song will appear on the top line of the display. The demo will begin playing automatically. The demo songs will play in sequence, and the sequence will repeat until stopped.



01: Peter Gun

NOTE

• You can play along on the PSR-530 keyboard while the demonstration is playing.
• The volume icons will move in response to the data in each track while the demonstration plays.

4 Skip to the Beginning Of a Different Demo Song

While the demonstration is playing you can select any of the demo songs by using the [-] and [+] buttons. Playback will skip to the beginning of the selected song.

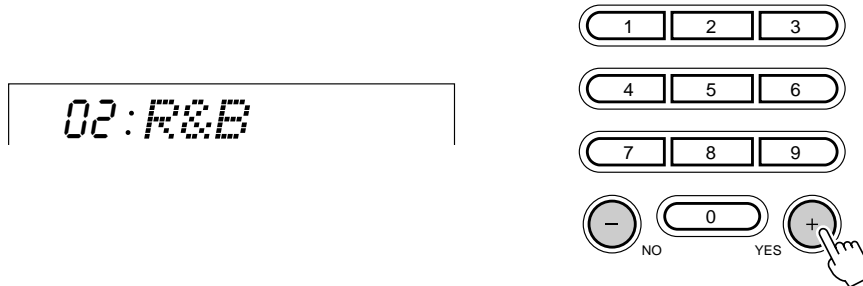

5 Stop When Done

Press the [DEMO] button or the [START/STOP] button to stop demo playback.

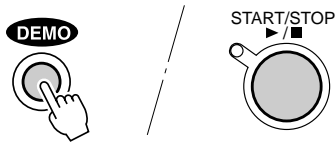

NOTE

- Demo playback can be re-started after it has been stopped by pressing the [START/STOP] button. In this case the selected demo song will play through to the end and then playback will stop automatically.
- Since playing the demo automatically selects the SONG menu, the SONG menu will remain active when demo playback is stopped. To select and play voices after stopping the demo, for example, you will have to press the [VOICE] button to go to the VOICE menu. The same applies for other menus.

Playing the PSR-530

The PSR-530 Voices

The PSR-530 actually includes two voice sets: the “panel” voices and percussion kits, and the XG voices. The panel voices include 200 “pitched” voices (voice numbers 1 through 200) and 12 percussion kits (numbers 201 through 212), while the XG voice set includes 480 voices (voice numbers 213 through 692).

Panel voices	1 ... 200
Panel drum kits	201 ... 212
XG voices	213 ... 692

See the “Voice List” on page 99.

A Word About the “R1”, “R2”, and “L” Voices

The PSR-530 allows up to three voices to be selected at the same time: “R1” (Right-hand 1), “R2”, (Right-hand 2) and “L” (Left-hand). Only the “R1” voice is used when you’re playing a single voice over the entire range of the keyboard. When you’re using the DUAL VOICE and/or SPLIT VOICE modes (described on pages 19 and 20), however, the “R2” and/or “L” voice will be used as well. The numbers of the currently selected R1, R2, and L voices are all shown on the display panel.

VOICE L 76 VOICE R2 101 VOICE R1 1

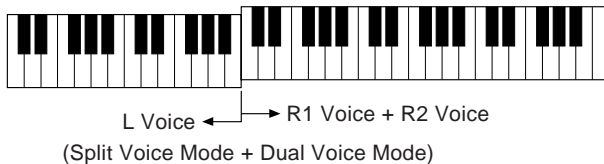
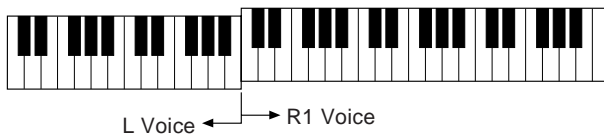

The R2 and L voices will be discussed in more detail in the DUAL VOICE and SPLIT VOICE sections. For now we’ll describe how to select and play the main R1 voice.

Selecting & Playing Voices

Here's how you can select and play the panel voices.

1 Select the VOICE Menu

Press the [VOICE] button so that the triangular indicator appears in the display next to "VOICE" to the right of the display. The number and name of the currently selected "R1" voice appears on the top line of the display panel when the VOICE menu is selected.



2 Select a Panel Voice

The PSR-530 voices can be selected by using the [-] and [+] buttons, the number buttons, the data dial, or the [VOICE] button.

● The [-] and [+] Buttons

When the VOICE menu is selected these buttons step up or down through the PSR-530's voices. Press either button briefly to step to the next voice in the corresponding direction, or hold the button to scroll rapidly through the voices in the corresponding direction.

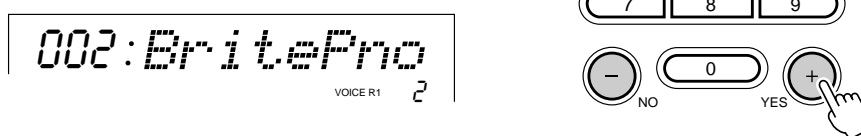

● The Number Buttons

The number buttons can be used to directly enter the number of the desired voice, thereby immediately selecting that voice without having to step through a number of other voices. To select voice number 109 (TremoloStrs), for example, press the [1], [0], and [9] number buttons in sequence.



Playing the PSR-530

One- or two-digit voice numbers can be entered without leading zeros. To select voice number “23” (SteelDrums), for example, simply press the [2] button and then the [3] button. The bars below the voice number on the display will flash for a few seconds, and then disappear when the selected voice number has been recognized by the PSR-530.

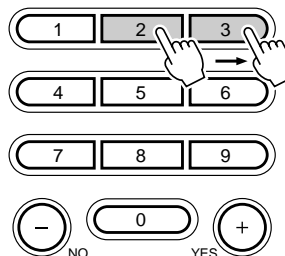

One- or two-digit voice numbers can also be entered with leading zeroes: e.g. “023” can be entered as “023” by pressing the [0], [2], and [3] buttons. In this case the specified voice number will be immediately recognized by the PSR-530.

● The Data Dial

Simply rotate the dial clockwise to increment the voice number, or counter-clockwise to decrement the voice number.

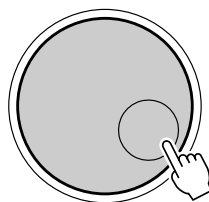

● The [VOICE] Button

Pressing the [VOICE] button increments the voice number. Press briefly to increment by one, or hold for continuous incrementing.

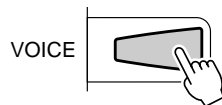

3 Play & Adjust Volume

You can now play the selected voice on the PSR-530 keyboard. Use the [MASTER VOLUME] control to adjust the overall volume level.

If the Voice Set function (page 85) is turned “on”, whenever a panel voice is selected appropriate “R2” and “L” voices (i.e. DUAL VOICE and SPLIT VOICE modes) as well as digital effects, etc., will be automatically selected at the same time.

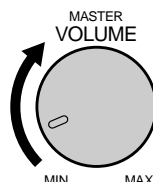

NOTE

- The PSR-530's XG voices are selected in the same way as the panel voices, as described above.
- When a XG voice is selected the XG icon will appear below the voice number.
- Refer to page 99 for a complete list of the panel and XG voices.

◆ Keyboard Percussion

When one of the 12 panel DRUM KIT voices are selected (voice numbers 201 through 212) you can play different drums and percussion instruments on the keyboard. The drums and percussion instruments played by the various keys are marked by symbols above the keys.



● The Drum Kits

201	Standard Kit1	207	Dance Kit
202	Standard Kit2	208	Jazz Kit
203	Room Kit	209	Brush Kit
204	Rock Kit	210	Classic Kit
205	Electronic Kit	211	SFX Kit 1
206	Analog Kit	212	SFX Kit 2

NOTE

- The HARMONY effect (page 42) cannot be turned on while a drum kit is selected for the "R1" voice, and will automatically be turned off if a drum kit is selected while HARMONY is on.
- The TRANSPOSE parameter (page 46) has no effect on the drum kit voices.
- See page 104 for a complete listing of the keyboard percussion drum instrument assignments.

The Dual Voice Mode

When the DUAL VOICE mode is engaged you can play two voices (the R1 and R2 voices) simultaneously across the entire keyboard.

The DUAL VOICE mode is turned on and off by pressing the [DUAL VOICE] button. When the DUAL VOICE mode is turned on both R1 and R2 icons in the display will light. Press the [DUAL VOICE] button a second time to turn the DUAL VOICE mode off: the R2 icon in the display will go out leaving only the R1 icon lit.

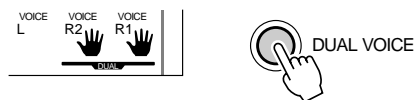

The R2 TRACK button below the display can also be used to turn the R2 voice on or off, only when a frame appears around the voice icons, or in the Song mode including the Demo song playback.

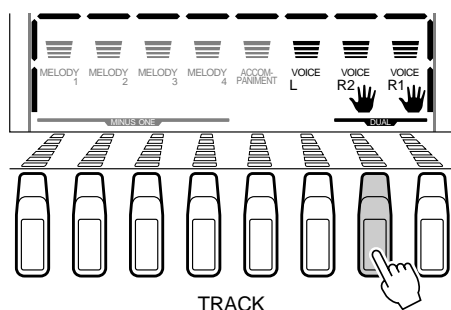

NOTE

- The R1/R2 voice settings can be changed as required by using the REVOICE function, described on page 78.
- The R1 voice cannot be turned off.
- The DUAL VOICE mode can be used at the same time as the SPLIT VOICE mode, described below. In this case the L voice is played on the left-hand section of the keyboard while both the R1 and R2 voices are played on the right-hand section of the keyboard. See the "The Split Voice Mode" section, below, for more information.

The Split Voice Mode

The SPLIT VOICE mode lets you play different voices with the left and right hands. You could, for example, play bass with the left hand (the L voice) while playing piano with the right (the R1 or R1 and R2 voices). The “split point” is initially set at B2 (note number 59), but it can be set at any key on the keyboard.

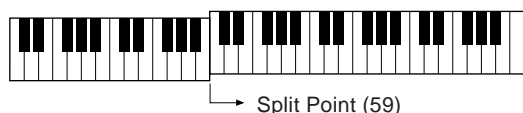

The SPLIT VOICE mode is engaged by pressing the [SPLIT VOICE] button. When turned on, the L icon in the display will light in addition to the R1 or R1 and R2 icons. Press the [SPLIT VOICE] button a second time to disengage the SPLIT VOICE mode: the L icon will go out leaving only the R voice.

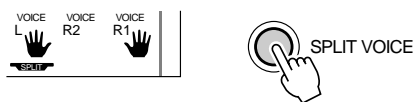

The L TRACK button below the display can also be used to turn the L voice on or off, only when a frame appears around the voice icons, or in the Song mode including the Demo song playback.

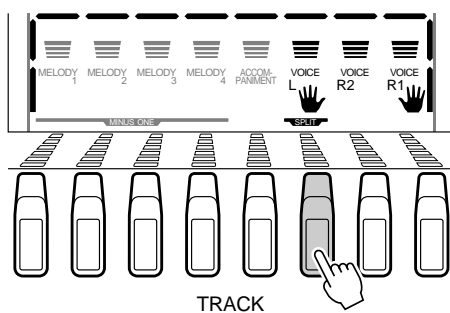

NOTE

- The L/R1/R2 voice settings can be changed as required by using the RE-VOICE function, described on page 78.
- The split point can be changed as required as described below.
- The SPLIT VOICE mode can be used at the same time as the DUAL VOICE mode, described above. In this case the L voice is played on the left-hand section of the keyboard while both the R1 and R2 voices are played on the right-hand section of the keyboard. See the “The Dual Voice Mode” section, above, for more information.

Changing the SPLIT VOICE Split Point

The SPLIT VOICE split point can be set to any key on the PSR-530 keyboard to match your individual playing requirements.

1 Select the SPLIT VOICE Split Point Function

Use the MENU [▲] and [▼] buttons to the left of the display to move the triangular indicator next to “OVERALL” on the left side of the display.

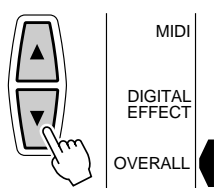

Then use the SUB MENU [▲] and [▼] buttons to select the “S.Split” function from within the OVERALL menu. The MIDI note number corresponding to the current split point will appear to the left of “S.Split” on the top line of the display.

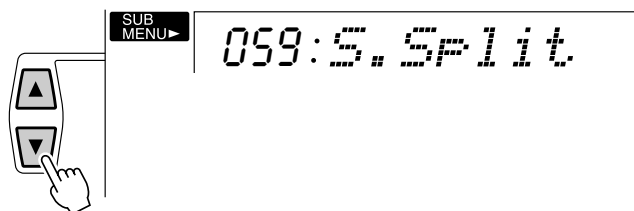

2 Set As Required

Simply press the key you want to assign as the split point. The key number of the key you press will appear to the left of “S.Split” on the top line of the display. You can also use the [-] and [+] buttons, number buttons, or data dial to enter the split point key number. The lowest key on the keyboard (C1) is key number “36”, middle C (C3) is “60”, and the highest key (C5) is 96. The split point can be set at any key number from 0 through 127, allowing the split point to be set outside the range of the PSR-530 keyboard for MIDI applications.

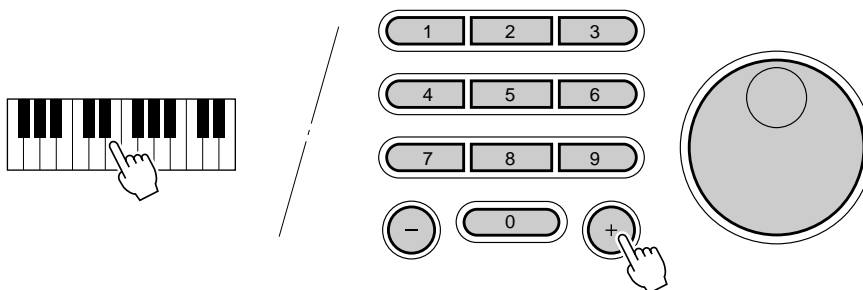

NOTE

- The split point key becomes the highest key in the left-hand section of the keyboard.
- The default split point (59) can be instantly recalled by pressing the [-] and [+] buttons at the same time.
- For the relationship between the SPLIT VOICE split point and the AUTO ACCOMPANIMENT split point, see page 30.
- When setting the split point, that is, the sub menu “S.Split” is shown on the display, pressing the key on the keyboard doesn’t either produce notes or detect chords in the accompaniment section, but only designates the split point.

Auto Accompaniment

The PSR-530 has 100 different accompaniment “styles” that can be used to provide fully-orchestrated or rhythm-only accompaniment. The PSR-530’s sophisticated AUTO ACCOMPANIMENT system can provide automated bass and chord backing that is perfectly matched to the selected accompaniment style.

When Auto-Accompaniment is turned on, the specified left-hand section of the keyboard becomes the “auto accompaniment” section, and chords played in this section are automatically detected and used as a basis for fully automatic accompaniment with the selected style.

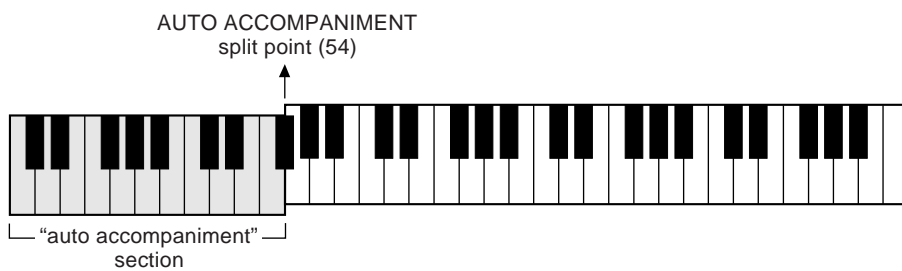

Using Auto Accompaniment

1 Select the Style Menu

Press the [STYLE] button to select the STYLE menu (the triangular indicator will appear next to “STYLE” to the right of the display). The number and name of the currently selected style will appear on the top line of the display, and the accompaniment track and volume icons in the display will appear framed.

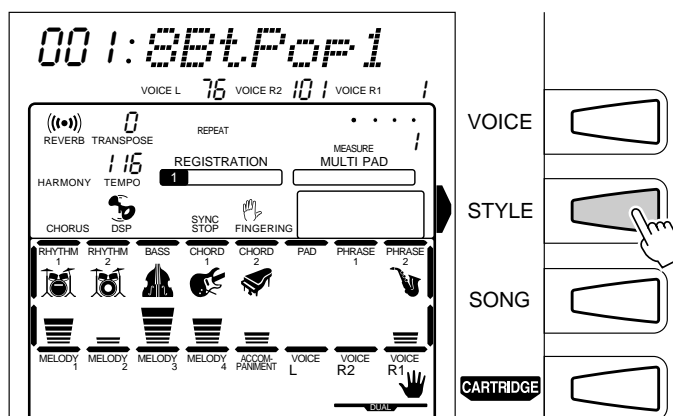

2 Select a Style

The PSR-530 has 100 styles that can be selected by using the [-] and [+] buttons, the number buttons, the data dial, or the [STYLE] button (these controls function in the same way as for voice selection — see page 17). The styles are listed in the STYLE list printed at the top of the instrument's control panel.

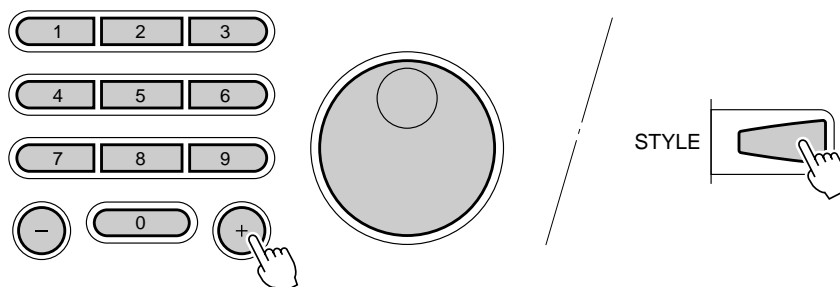

NOTE

- See page 77 for details on selecting cartridge styles.

3 Turn AUTO ACCOMPANIMENT On

Press the AUTO ACCOMPANIMENT [ON/OFF] so that its indicator lights.

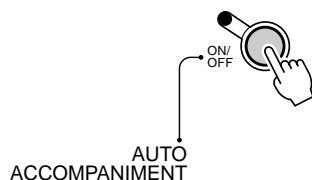

NOTE

- If **AUTO ACCOMPANIMENT** is off, only rhythm (drums and percussion) accompaniment will be produced.

4 Set the Tempo

When you select a different style while the accompaniment is not playing, the “default” tempo for that style is also selected, and the tempo is displayed immediately above “TEMPO” in the display in quarter-note beats per minute. If the accompaniment is playing, the same tempo is maintained even if you select a different style.

You can change the tempo to any value between 32 and 280 beats per minute, however, by using the TEMPO [▼] and [▲] buttons. Press either button briefly to decrement or increment the tempo value by one, or hold the button for continuous decrementing or incrementing.



When either of the TEMPO buttons is pressed the current tempo value will appear on the top line of the display for a few seconds — during this time the [-] and [+] buttons, number buttons, or data dial can also be used to set the tempo. The default tempo for the selected style can be recalled at any time by pressing both the TEMPO [▼] and [▲] buttons simultaneously (or by pressing the [-] and [+] buttons simultaneously while the tempo value is showing on the top line of the display).

5 Start the Accompaniment

There are several ways to start the accompaniment:

● Straight start

Press the [START/STOP] button. The rhythm will begin playing immediately without bass and chord accompaniment. The currently selected MAIN [A] or [B] section will play.

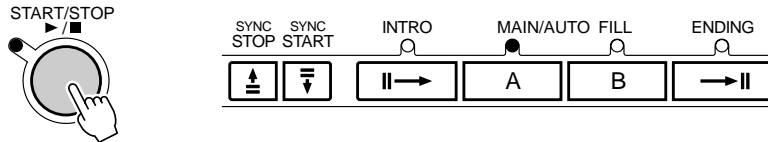

NOTE

- It is possible to select the MAIN A or B section prior to a straight start — refer to “7. Select the MAIN A and B Sections as Required,” below.

● Start with an introduction followed by the MAIN A section

Press the [INTRO] button so that its indicator lights, press the MAIN/AUTO FILL [A] button (not necessary if its indicator is already flashing), then press [START/STOP].

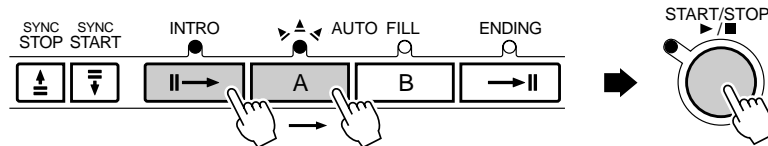

● Start with an introduction followed by the MAIN B section

Press the [INTRO] button so that its indicator lights, press the MAIN/AUTO FILL [B] button (not necessary if its indicator is already flashing), then press [START/STOP].

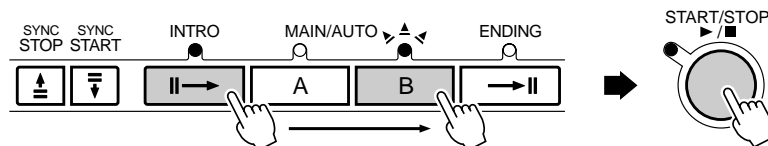

● Synchronized start

Any of the above start types can be synchronized to the first note or chord played on the left-hand section of the keyboard (i.e. keys to the left of and including the split-point key — normally 54) by first pressing the [SYNC START] button.

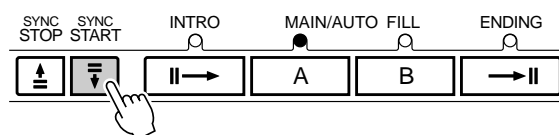

NOTE

- If you press the [SYNC START] button while the accompaniment is playing, the accompaniment will stop and the synchro start mode will be engaged.
- The [INTRO] button can be used to select the INTRO section even while the accompaniment is playing.
- The accompaniment split point can be changed via the “Accompaniment Split Point” function in the OVERALL menu — see page 29.

Pressing the [SYNC START] button alone causes a straight start to occur when the first note or chord is played. Press the [SYNC START] button and then the appropriate [INTRO] and [MAIN/AUTO FILL] buttons for a synchronized introduction start. The BEAT indicator will flash at the current tempo when a synchronized start mode has been selected. The synchro start mode can be disengaged prior to actually starting the accompaniment by pressing the [SYNC START] button a second time.

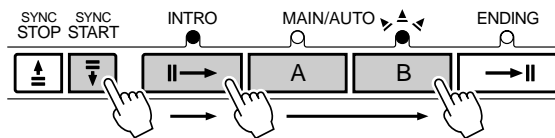

NOTE

- When the AUTO ACCOMPANIMENT split point and SPLIT VOICE split point are set at different keys, the L voice can be played between the AUTO ACCOMPANIMENT split point and SPLIT VOICE split point when the AUTO ACCOMPANIMENT function is on.
- When the AUTO ACCOMPANIMENT split point and SPLIT VOICE split point are set to the same key, the L voice can be played anywhere to the left of the AUTO ACCOMPANIMENT split point and SPLIT VOICE split point while AUTO ACCOMPANIMENT is not playing.

6 Play On the Auto-accompaniment Section Of the Keyboard

As soon as you play any chord that the PSR-530 can “recognize” on the left-hand section of the keyboard, the PSR-530 will automatically begin to play the chord along with the selected rhythm and an appropriate bass line. The name of the current chord will appear on the display. The accompaniment will continue playing even if you release the keys (unless the Synchro Stop function is engaged — page 26).

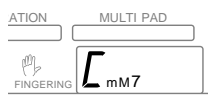

NOTE

- The PSR-530 has several fingering modes which allow you to play chords in different ways. See “The Auto Accompaniment Fingering Modes” on page 30 for details.

● The Beat Indicator

The four dots of the BEAT indicator provide a visual indication of the selected tempo as shown below.

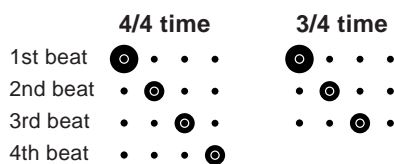

7 Select the MAIN A and B Sections as Required

The MAIN A and MAIN B sections can be selected at any time during playback by pressing the corresponding button. Whenever you press the MAIN/AUTO FILL [A] or [B] button during playback, the PSR-530 will generate an appropriate “fill-in” (one of four types: AA, AB, BA, and BB) which will smoothly connect the current section to the selected section — even if it is the same section. For example, if you press the MAIN/AUTO FILL [A] button while the MAIN A section is playing, a fill-in will be produced, then the MAIN A section will continue playing. When you select a different section, the fill-in will begin immediately and the new section will actually begin playing from the top of the next measure unless the MAIN/AUTO FILL [A] or [B] button is pressed during

NOTE

- The MAIN A section is automatically selected whenever the PSR-530 power is initially turned on.
- The indicator of the destination section (MAIN A or B) will flash while the corresponding fill-in is playing. During this time you can change the destination section by pressing the appropriate MAIN/AUTO FILL [A] or [B] button.

the last half beat of the measure, in which case the fill-in will begin from the first beat of the next measure.

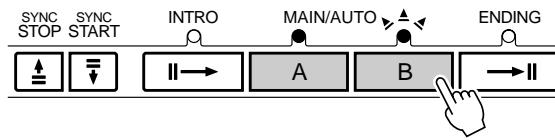

8 Stop the Accompaniment

The accompaniment can be stopped at any time by pressing the [START/STOP] button. Press the [ENDING] button if you want to go to the ending section and then stop.

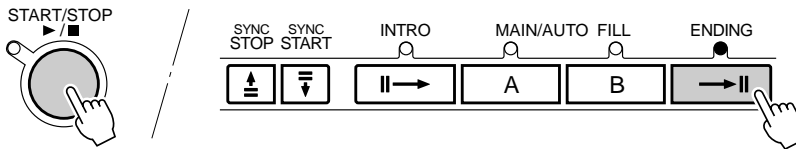

NOTE

- The ending will begin playing immediately when you press the [ENDING] button while the accompaniment is playing the first beat of the measure. The ending will begin playing from the next measure when you press the button while the accompaniment is playing the second or larger numbered beat.
- If you press the [INTRO] button while the ending is playing, the intro section will begin playing after the ending is finished.
- Some INTRO and ENDING sections have their own chord progressions which play in the current accompaniment key.
- If the MAIN/AUTO FILL [A] or [B] button is pressed while the ENDING section is playing, an appropriate fill-in will be played, followed by a return to the MAIN A or B section.
- The accompaniment volume can be adjusted independently of the keyboard volume via the ACCOMPANIMENT/SONG VOLUME [▼] and [▲] buttons (page 28).
- Pressing the [ENDING] button during the Ending playback decelerate its tempo (ritardando).

◆ The Synchro Stop Function

When the Synchro Stop function is engaged, accompaniment playback will stop completely when all keys in the auto-accompaniment section of the keyboard are released. Accompaniment playback will start again as soon as a chord is played. The BEAT indicators in the display will flash while the accompaniment is stopped.

The Synchro Stop function is engaged by pressing the [SYNC STOP] button so that the SYNC STOP icon in the display appears. Press the [SYNC STOP] button again so that the icon disappears to turn the Synchro Stop function off.



NOTE

- The Synchro Stop function can not be turned on when the FULL KEYBOARD AUTO ACCOMPANIMENT fingering mode is selected. The Synchro Stop function will be automatically turned off if the FULL KEYBOARD fingering mode is selected while the Synchro Stop function is on.

Using Virtual Arranger

Simply pressing chords causes the Auto Accompaniment automatically plays the slightly different chord variations and becomes livelier and more melodic when you turn on the Virtual Arranger function while the Auto Accompaniment is active.

1 Select the Style Menu

Press the [STYLE] button to select the STYLE menu (the triangular indicator will appear next to “STYLE” to the right of the display).

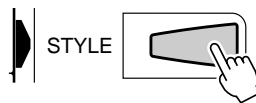

2 Select the Virtual Arranger Function

Use the SUB MENU [▲] and [▼] buttons to select the “VirtArng” function. The current on/off status will be shown at the top left of the display.

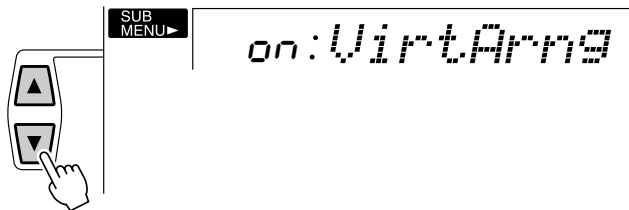

Then use the [-] and [+] buttons or the Dial to select “on” or “off.”

NOTE

- Simultaneously pressing the [SYNC STOP] and [SYNC START] buttons causes the Virtual Arranger to switch between off and on. The current on/off status will be shown at the top left of the display. (The on/off display will return to its original condition after a few seconds.)

Accompaniment Track Muting

The PSR-530 has eight accompaniment tracks — RHYTHM 1, RHYTHM 2, BASS, CHORD 1, CHORD 2, PAD, PHRASE 1, and PHRASE 2 — that you can control to modify the “orchestration” and therefore the overall sound of the accompaniment. When a style is selected the icons corresponding to the tracks which contain data for any section of that style will light.

● What's in the Tracks

RHYTHM 1 & 2	These are the main rhythm tracks. The RHYTHM tracks produce the drum and percussion sounds.
BASS	The BASS track always plays a bass line, but the voice will change to fit the selected style ... acoustic bass, synth bass, tuba, etc.
CHORD 1 & 2	These tracks provide the rhythmic chordal accompaniment required by each style. You'll find guitar, piano, and other chordal instruments here.
PAD	This track plays long chords where necessary, using sustained instruments such as strings, organ, choir.
PHRASE 1 & 2	This is where the musical embellishments reside. The PHRASE tracks are used for punchy brass stabs, arpeggiated chords, and other extras that make the accompaniment more interesting.

NOTE

- Individual track voices, volume, and other parameters can be changed by using the REVOICE function — page 80.

Muting Individual Tracks

Individual accompaniment tracks can be turned OFF (muted) or ON by using the **TRACK** buttons corresponding to the target tracks. The track icon will disappear when a track is muted.

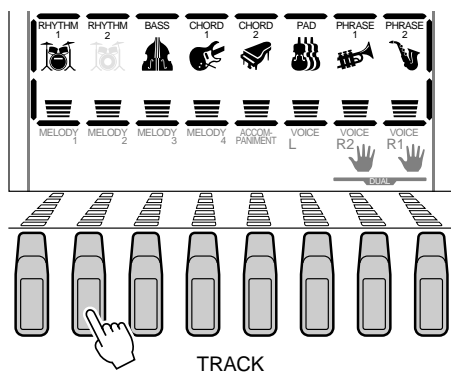

Accompaniment Volume Control

When the **STYLE** menu is selected (i.e. the accompaniment track and volume icons are framed) the volume of the accompaniment in relation to the keyboard can be adjusted for the best overall balance by using the **ACCOMPANIMENT/SONG VOLUME** [▼] and [▲] buttons. When either button is pressed the current accompaniment volume setting will appear on the top line of the display for a few seconds. The accompaniment volume range is from “0” (no sound) to “127” (maximum volume). The default setting is “100”. Press the **ACCOMPANIMENT/SONG VOLUME** [▼] button to decrease the volume or the [▲] button to increase the volume. Pressing briefly to single step, or hold for continuous decrementing/incrementing.

ACCOMPANIMENT/SONG VOLUME

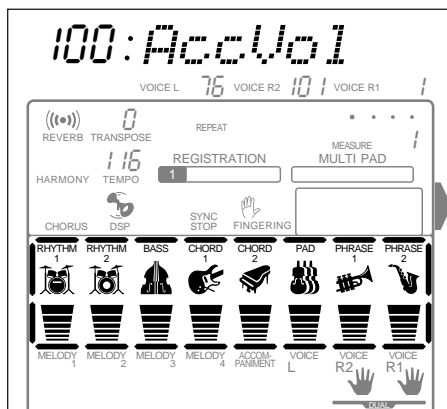
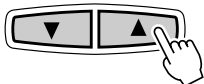

While the accompaniment volume setting appears on the top line of the display the [-] and [+] buttons, number buttons, or data dial can also be used to set the accompaniment volume.

Changing the Accompaniment Split Point

The AUTO ACCOMPANIMENT split point can be set to any key on the PSR-530 keyboard to match your individual playing requirements.

1 Select the Accompaniment Split Point Function

Use the MENU [▲] and [▼] buttons to the left of the display to move the triangular indicator next to “OVERALL” on the left side of the display.

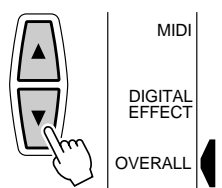

Then use the SUB MENU [▲] and [▼] buttons to select the “AccSpPnt” function from within the OVERALL menu. The MIDI note number corresponding to the current split point will appear to the left of “AccSpPnt” on the top line of the display.

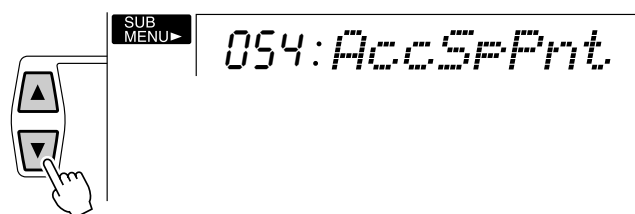

2 Set As Required

Simply press the key you want to assign as the split point. The key number of the key you press will appear to the left of “AccSpPnt” on the top line of the display. You can also use the [-] and [+] buttons, number buttons, or data dial to enter the split point key number. The lowest key on the keyboard (C1) is key number “36”, middle C (C3) is “60”, and the highest key (C5) is 96. The split point can be set at any key number from 0 through 127, allowing the split point to be set outside the range of the PSR-530 keyboard for MIDI applications.

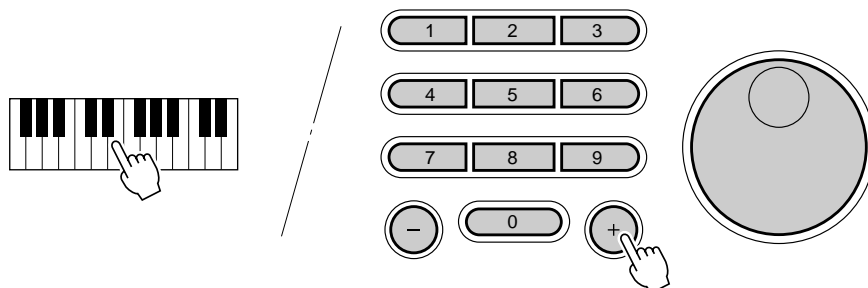

NOTE

- The split point key becomes the highest key in the Auto Accompaniment section of the keyboard.
- The default split point (54) can be instantly recalled by pressing the [-] and [+] buttons at the same time.
- When setting the split point, that is, the sub menu “AccSpPnt” is shown on the display, pressing the key on the keyboard doesn’t either produce notes or detect chords in the accompaniment section, but only designates the split point.

◆ Interaction Between the AUTO ACCOMPANIMENT and SPLIT VOICE Split Points

The SPLIT VOICE split point (page 21) and AUTO ACCOMPANIMENT split point can be independently specified, with the following limitations. The SPLIT VOICE split point cannot be set at a lower key than the AUTO ACCOMPANIMENT split point (if you attempt to do this the AUTO ACCOMPANIMENT split point will be set to the same key as the SPLIT VOICE split point). Conversely, the AUTO ACCOMPANIMENT split point cannot be set at a higher key than the SPLIT VOICE split point (if you attempt to do this the SPLIT VOICE split point will be set to the same key as the AUTO ACCOMPANIMENT split point).

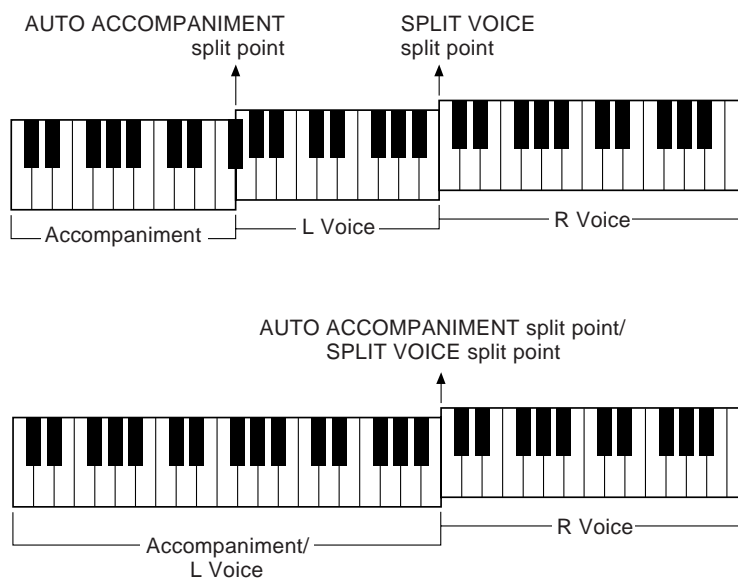

The Auto Accompaniment Fingering Modes

The PSR-530 AUTO ACCOMPANIMENT feature has five different fingering modes which can be selected as follows.

1 Select the Fingering Mode Function

Use the MENU [▲] and [▼] buttons to the left of the display to move the triangular indicator next to "OVERALL" on the left side of the display.

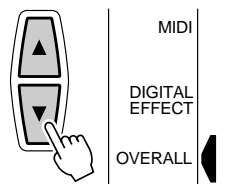

Shortcut

- You can jump directly to the "FngrngMd" function by pressing and holding the AUTO ACCOMPANIMENT [ON/OFF] button for a few seconds.

Then use the SUB MENU [▲] and [▼] buttons to select the “FngrngMd” function from within the OVERALL menu. The abbreviated name of the current fingering mode will appear to the left of “FngrngMd” on the top line of the display.

SF : FngrngMd

2 Select the Required Fingering Mode

Use the [-] and [+] buttons or data dial to select the desired fingering mode:

SF	Single Finger
F1	Fingered 1
F2	Fingered 2
FuL	Full Keyboard
MuL	Multi-finger

● SF: The SINGLE FINGER Mode



SF : FngrngMd

Single-finger accompaniment makes it simple to produce beautifully orchestrated accompaniment using major, seventh, minor and minor-seventh chords by pressing a minimum number of keys on the AUTO ACCOMPANIMENT section of the keyboard. The abbreviated chord fingerings described below are used:

C



- For a major chord, press the root key only.

Cm

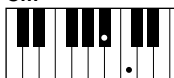

- For a minor chord, simultaneously press the root key and a black key to its left.

C7

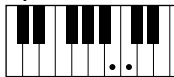

- For a seventh chord, simultaneously press the root key and a white key to its left.

Cm7

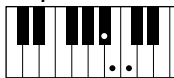

- For a minor-seventh chord, simultaneously press the root key and both a white and black key to its left.

● F1: The FINGERED 1 Mode



F1 : Fingered 1 Mode

The Fingered 1 mode lets you finger your own chords on the AUTO ACCOMPANIMENT section of the keyboard (i.e. all keys to the left of and including the split-point key — normally 54) while the PSR-530 supplies appropriately orchestrated rhythm, bass, and chord accompaniment in the selected style.

The FINGERED 1 mode recognizes the following chords:

Chord Name/[Abbreviation]	Normal Voicing	Chord (C)	Display
Major [M]	1 - 3 - 5	C	C
Add ninth [(9)]	1 - 2 - 3 - 5	C(9)	C(9)
Sixth [6]	1 - (3) - 5 - 6	C6	C6
Sixth ninth [6(9)]	1 - 2 - 3 - (5) - 6	C6(9)	C6(9)
Major seventh [M7]	1 - 3 - (5) - 7 or 1 - (3) - 5 - 7	CM7	CM7
Major seventh ninth [M7(9)]	1 - 2 - 3 - (5) - 7	CM7(9)	CM7(9)
Major seventh add sharp eleventh [M7(#11)]	1 - (2) - 3 - #4 - 5 - 7 or 1 - 2 - 3 - #4 - (5) - 7	CM7(#11)	CM7(#11)
Flatted fifth [(b5)]	1 - 3 - b5	C(b5)	C(b5)
Major seventh flatted fifth [M7b5]	1 - 3 - b5 - 7	CM7b5	CM7b5
Suspended fourth [sus4]	1 - 4 - 5	Csus4	Csus4
Augmented [aug]	1 - 3 - #5	Caug	Caug
Major seventh augmented [M7aug]	1 - (3) - #5 - 7	CM7aug	CM7aug
Minor [m]	1 - b3 - 5	Cm	Cm
Minor add ninth [m(9)]	1 - 2 - b3 - 5	Cm(9)	Cm(9)
Minor sixth [m6]	1 - b3 - 5 - 6	Cm6	Cm6
Minor seventh [m7]	1 - b3 - (5) - b7	Cm7	Cm7
Minor seventh ninth [m7(9)]	1 - 2 - b3 - (5) - b7	Cm7(9)	Cm7(9)
Minor seventh add eleventh [m7(11)]	1 - (2) - b3 - 4 - 5 - (b7)	Cm7(11)	Cm7(11)
Minor major seventh [mM7]	1 - b3 - (5) - 7	CmM7	CmM7
Minor major seventh ninth [mM7(9)]	1 - 2 - b3 - (5) - 7	CmM7(9)	CmM7(9)
Minor seventh flatted fifth [m7b5]	1 - b3 - b5 - b7	Cm7b5	Cm7b5
Minor major seventh flatted fifth [mM7b5]	1 - b3 - b5 - 7	CmM7b5	CmM7b5
Diminished [dim]	1 - b3 - b5	Cdim	Cdim
Diminished seventh [dim7]	1 - b3 - b5 - 6	Cdim7	Cdim7
Seventh [7]	1 - 3 - (5) - b7 or 1 - (3) - 5 - b7	C7	C7
Seventh flatted ninth [7(b9)]	1 - b2 - 3 - (5) - b7	C7(b9)	C7(b9)
Seventh add flatted thirteenth [7(b13)]	1 - 3 - 5 - b6 - b7	C7(b13)	C7(b13)
Seventh ninth [7(9)]	1 - 2 - 3 - (5) - b7	C7(9)	C7(9)
Seventh add sharp eleventh [7(#11)]	1 - (2) - 3 - #4 - 5 - b7 or 1 - 2 - 3 - #4 - (5) - b7	C7(#11)	C7(#11)
Seventh add thirteenth [7(13)]	1 - 3 - (5) - 6 - b7	C7(13)	C7(13)
Seventh sharp ninth [7(#9)]	1 - #2 - 3 - (5) - b7	C7(#9)	C7(#9)
Seventh flatted fifth [7b5]	1 - 3 - b5 - b7	C7b5	C7b5
Seventh augmented [7aug]	1 - 3 - #5 - b7	C7aug	C7aug
Seventh suspended fourth [7sus4]	1 - 4 - (5) - b7	C7sus4	C7sus4
One plus two plus five [1+2+5]	1 - 2 - 5	C1+2+5	C

NOTE

- Notes in parentheses can be omitted.
- If you play any three adjacent keys (including black keys), the chord sound will be cancelled and only the rhythm instruments will continue playing (CHORD CANCEL function).
- Playing a single key or two same root keys in the adjacent octaves produces accompaniment based only on the root.
- A perfect fifth (1 + 5) produces accompaniment based only on the root and fifth which can be used with both major and minor chords.
- The chord fingerings listed are all in "root" position, but other inversions can be used — with the following exceptions:
m7, m7b5, 6, m6, sus4, aug, dim7, 7b5, 6(9), m7(11), 1+2+5.
- Inversion of the 7sus4 chord are not recognized if the 5th is omitted.
- The AUTO ACCOMPANIMENT will sometimes not change when related chords are played in sequence (e.g. some minor chords followed by the minor seventh).
- Two-note fingerings will produce a chord based on the previously played chord.

Example for “C” chords

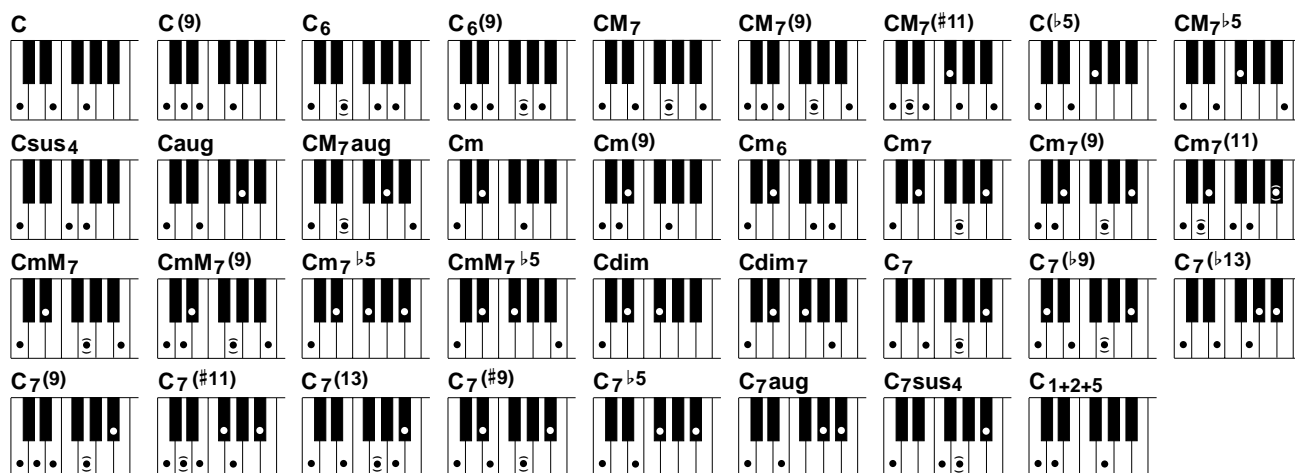

● F2: The FINGERED 2 Mode



F2 : F n g r n g h d

This is essentially the same as the FINGERED 1 mode, described above, except that the FINGERED 2 mode additionally allows you to specify the lowest note of each chord — simply, the lowest note played in the AUTO ACCOMPANIMENT section of the keyboard is used as the accompaniment bass note. This means you can specify “on-bass” chords in which the main bass note for the chord is not the root of the chord. For a C major chord, for example, you could use E (the third) or G (the fifth) as the bass note rather than C.

C



C on E



C on G



● FuL: The FULL KEYBOARD Mode



FuL : F n g r n g h d

When the FULL KEYBOARD mode is selected, the PSR-530 will automatically create appropriate accompaniment while you play just about anything using both hands, anywhere on the keyboard. You do not have to worry about specifying the accompaniment chords. The name of the detected chord will appear in the display.

NOTE

- When the FULL KEYBOARD mode is selected, the split point setting (see page 29) for the auto accompaniment will be ignored.
- Chord detection occurs at approximately 8th-note intervals. Extremely short chords — less than an 8th note in length — may not be detected.

● MuL: The MULTI-FINGER Mode



MuL: Fingered Mode

This is the default accompaniment mode. The MULTI-FINGER mode automatically detects SINGLE FINGER or FINGERED 1 chord fingerings, so you can use either type of fingering without having to switch fingering modes.

NOTE

- If you want to play minor, seventh or minor seventh chords using the SINGLE FINGER operation in the MULTI-FINGER Mode, always press the closest white/black key(s) to the root of the chord.

◆ The Stop Accompaniment Function

While the SINGLE FINGER, FINGERED 1, FINGERED 2, or MULTI-FINGER mode is selected chords played in the AUTO ACCOMPANIMENT section of the keyboard are also detected and played by the PSR-530 Auto Accompaniment system when the accompaniment is stopped (except when the FULL KEYBOARD mode is engaged). In this case the bass note and chord voices are selected automatically.

NOTE

- When the AUTO ACCOMPANIMENT split point and SPLIT VOICE split point are set to the same key, the L voice and the automatically selected bass note will sound.

One Touch Setting

The PSR-530's 100 internal styles each have four recommended "panel setups" that can be instantly selected via the [ONE TOUCH SETTING] and REGISTRATION MEMORY [1] ... [4] buttons. The One Touch Setting feature automatically sets the following parameters:

● One Touch Setting Parameter List

- R1 Voice
(Voice number, volume, octave, pan, reverb level, chorus send level, DSP send level)
- Dual Voice ON/OFF
- R2 Voice
(Voice number, volume, octave, pan, reverb level, chorus send level, DSP send level)
- Split Voice ON/OFF
- L Voice
(Voice number, volume, octave, pan, reverb level, chorus send level, DSP send level)
- Split Point : Split Voice=59
: Auto Accompaniment=54
- Auto Accompaniment=ON
- Main A/B section
- Accompaniment Track data
(Style parameters=default, Track ON/OFF)
- Synchro start=ON
- Accompaniment volume=100
- Harmony ON/OFF, type, volume
- Reverb ON/OFF
- Chorus ON/OFF
- DSP ON/OFF, type, variation ON/OFF
- Multi Pad Set number
- Chord Match ON/OFF=Default (Multi Pad1...4)

1 Select a Style

Select the STYLE menu and select an accompaniment style as described on page 22.

2 Press the [ONE TOUCH SETTING] Button

Press the [ONE TOUCH SETTING] button. The ONE TOUCH SETTING and REGIST [1] icons will appear in the display, and the ONE TOUCH SETTING type 1 panel settings will be recalled. At the same, AUTO ACCOMPANIMENT will automatically be turned on if it was off, and the SYNC START mode will be engaged.

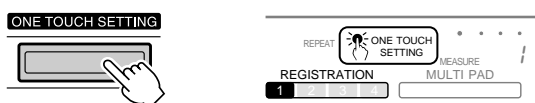

3 Select a ONE TOUCH SETTING Type, as Required

If you want to select a different REGISTRATION MEMORY, use the REGISTRATION MEMORY buttons to select the desired ONE TOUCH SETTING type. The corresponding number will appear in the display, and all setting will change according to the recalled data.

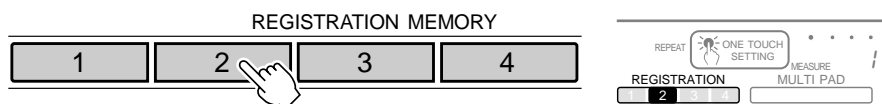

4 Turn ONE TOUCH SETTING Off When Done

Press the [ONE TOUCH SETTING] button so that the ONE TOUCH SETTING icon in the display disappears to turn the ONE TOUCH SETTING feature off.

NOTE

- "No OTS" will appear on the display if an optional cartridge style which has no ONE TOUCH SETTING data is selected.

Digital Effects

With the digital effects built into the PSR-530 you can add ambiance and depth to your music in a variety of ways—such as adding reverb that makes you sound like you are playing in a concert hall or adding harmony notes for a full, rich sound.

Digital Effects

REVERB Button



You can create a reverb effect that makes you sound like you are playing in places like a concert hall, or live in a club.

CHORUS Button



You can add a chorus effect that makes your playing sound as though multiple parts were being played together at the same time.

DSP Button



In addition to the reverb and chorus types, the effects usually used to a specific part, such as the distortion and tremolo, can be selected.

HARMONY Button



You can add a variety of harmony notes to the R1 voice, or to your playing in the right-hand section, as well as adding an tremolo or other effect.

NOTE

- For details about using Digital Effects (Reverb, Chorus, DSP) see page 106.

Reverb

The PSR-530 has 12 digital reverb effects that simulate the natural reverberation of a range of acoustic environments. See “The Digital Effect List” on page 108. There’s also an “Off” setting:

Turning the Reverb Effect On or Off

Press the **[REVERB]** button so that the REVERB icon appears in the display to turn the selected REVERB effect on. Press **[REVERB]** a second time so that the REVERB icon disappears to turn the REVERB effect off.

REVERB



The REVERB effect applies only to the R1. Reverb can be turned completely off by selecting the “off” reverb type as described below.

NOTE

- The REVERB effect will be turned on or off according to the selected R1 panel voice.

Selecting a Reverb Type

1 Select the Digital Effect “Reverb” Function

Use the MENU [▲] and [▼] buttons to move the triangular indicator in the display next to “DIGITAL EFFECT”.

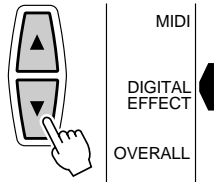

Shortcut

- You can also jump directly to the DIGITAL EFFECT REVERB TYPE function by pressing and holding the [REVERB] button for a few seconds.

Then use the SUB MENU [▲] and [▼] buttons to select “Reverb”. After a few seconds the name of the currently selected REVERB type will appear on top line of the display.

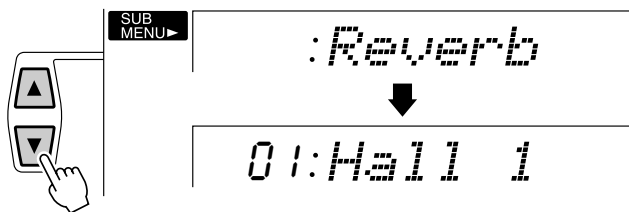

2 Select a Reverb Effect

Use the [-] and [+] buttons, number buttons, or data dial to select the desired REVERB effect (the name of the selected REVERB effect will appear on the top line of the display). Select “OFF” if you want no REVERB effect on any part of the PSR-530 sound.

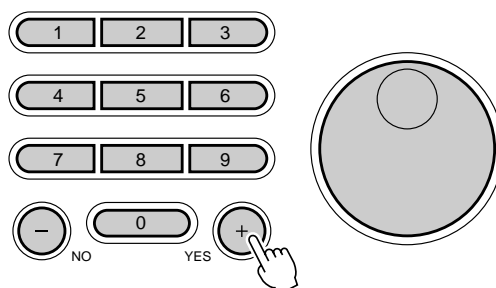

NOTE

- When you select a different Style, the appropriate Reverb type will be selected accordingly. Some of the Styles contain Reverb types which cannot be selected on the PSR-530. In this case “- :XG Rev.” will be displayed when you select the SUB MENU Reverb of the DIGITAL EFFECT.
- If you don't want to apply the Reverb effect to Styles or Songs, select “13: OFF” from the Reverb types, or set the Reverb Return Level to its minimum. In this case no Reverb is applied to the entire system. If you use the Revoice function, you can set the Reverb Send Level for each track of the Style/ User Song independently (see page 78).

Reverb Return Level

The RevRtnLv (Reverb Return Level) parameter sets the amount of reverb effect returned from the reverb effect stage, thus making it possible to adjust the degree of reverb effect applied to the overall sound.

1 Select the Digital Effect “RevRtnLv” Function

Use the MENU [▲] and [▼] buttons to move the triangular indicator in the display next to “DIGITAL EFFECT”, then use the SUB MENU [▲] and [▼] buttons to select “RevRtnLv”.

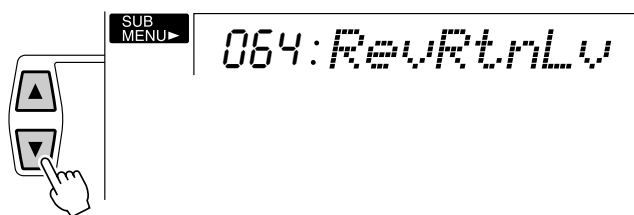

2 Set the Reverb Return Level

Use the [-] and [+] buttons, number buttons, or data dial to set the desired reverb return level (the current return level value appears to the left of “RevRtnLv” on the display). The range is from “0” to “127”. The higher the value the greater the return level.

Chorus

The PSR-530’s 9 chorus effects can be used to give your sound extra life and animation. See “The Digital Effect List” on page 108.

Turning the Chorus Effect On or Off

Press the [CHORUS] button so that the CHORUS icon appears in the display to turn the selected chorus effect on. Press [CHORUS] a second time so that the CHORUS icon disappears to turn the CHORUS effect off.



NOTE

- The CHORUS effect will be turned on or off according to the selected R1 panel voice.

The CHORUS effect applies only to the R1. Chorus can be turned completely off by selecting the “Off” chorus type as described below.

Selecting a Chorus Effect

1 Select the Digital Effect “Chorus” Function

Use the MENU [▲] and [▼] buttons to move the triangular indicator in the display next to “DIGITAL EFFECT”.

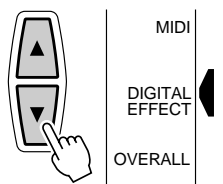

Then use the SUB MENU [▲] and [▼] buttons to select “Chorus”. After a few seconds the name of the currently selected chorus effect will appear on the top line of the display.

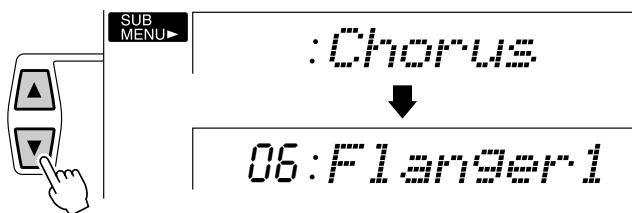

Shortcut

- You can also jump directly to the DIGITAL EFFECT Chorus function by pressing and holding the [CHORUS] button for a few seconds.

NOTE

- When you select a different Style, the appropriate Chorus type will be selected accordingly. Some of the Styles contain Chorus types which cannot be selected on the PSR-530. In this case “:XG Cho.” will be displayed when you select the SUB MENU Chorus of the DIGITAL EFFECT.
- If you don't want to apply the Chorus effect to Styles or Songs, select “10: OFF” from the Chorus types, or set the Chorus Return Level to its minimum. In this case no Chorus is applied to the entire system. If you use the Revoice function, you can set the Chorus Send Level for each track of the Style/User Song independently (see page 78).

2 Select a Chorus Effect

Use the [-] and [+] buttons, number buttons, or data dial to select the desired chorus effect (the name of the selected chorus effect will appear on the top line of the display). Select “Off” if you want no chorus effect on any part of the PSR-530 sound.

Chorus Return Level

The ChoRtnLv (Chorus Return Level) parameter sets the amount of chorus effect returned from the chorus effect stage, thus making it possible to adjust the degree of chorus effect applied to the overall sound.

1 Select the Digital Effect “ChoRtnLv” Function

Use the MENU [▲] and [▼] buttons to move the triangular indicator in the display next to “DIGITAL EFFECT”, then use the SUB MENU [▲] and [▼] buttons to select “ChoRtnLv”.

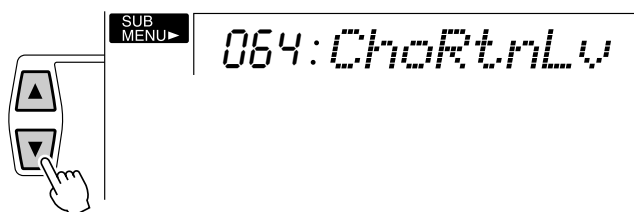

2 Set the Chorus Return Level

Use the [-] and [+] buttons, number buttons, or data dial to set the desired chorus return level (the current return level value appears to the left of “ChoRtnLv” on the display). The range is from “0” to “127”. The higher the value the greater the return level.

DSP

The PSR-530 features an extensive range of 45 DSP (Digital Signal Processor) effects. There are two types of digital effects, system effects and insertion effects. The illustration below will give you an idea of how DSP effects work, centering on the mixer. See “The Digital Effect List” on page 108.

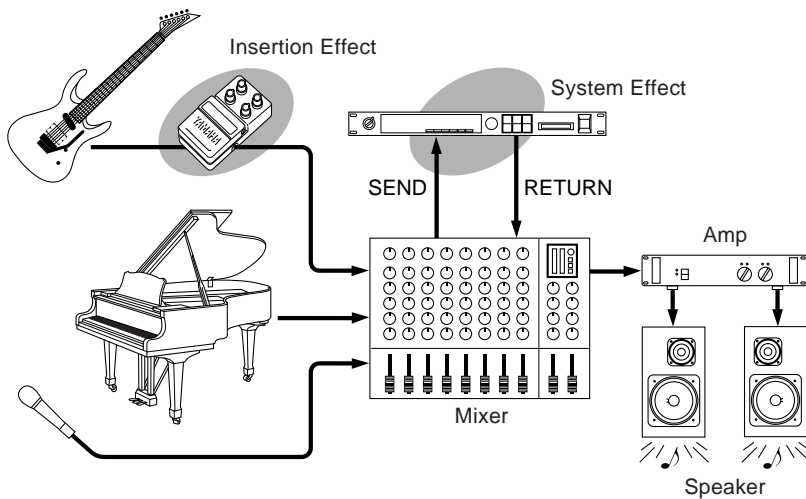

- **System Effect:**

Applies to all of the parts input to the mixer. You can set the Effect Send Level and Effect Return Level. The System Effect includes Reverb and Chorus types.

- **Insertion Effect:**

Applies only to a designated part before inputting the signal to the mixer. You can effectively use the digital effects by applying the effect to the specific part. With the Insertion Effect, you can only designate the Effect Send Level. The Insertion Effect includes Distortion and Tremolo.

NOTE

- DSP send level cannot be modified for some Insertion effects. In this case the display shows “- -”, indicating that it’s not accessible.

Turning the DSP Effect On or Off

Press the [DSP] button so that the DSP icon appears in the display to turn the selected DSP effect on. Press [DSP] a second time so that the DSP icon disappears to turn the DSP effect off.



The DSP effect applies to the R1, R2 and L. The DSP effect can be turned completely off by selecting the “Off” DSP type as described below.

NOTE

- The DSP effect and variation settings may change according to the selected R1 panel voice.

Selecting a DSP Effect

1 Select the Digital Effect “DSP” Function

Use the MENU [▲] and [▼] buttons to move the triangular indicator in the display next to “DIGITAL EFFECT”.

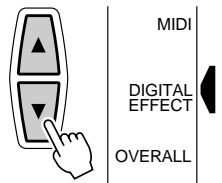

Shortcut

- You can also jump directly to the DIGITAL EFFECT DSP function by pressing and holding the [DSP] button for a few seconds.

Then use the SUB MENU [▲] and [▼] buttons to select “DSP”. After a few seconds the name of the currently selected DSP effect will appear on the top line of the display.

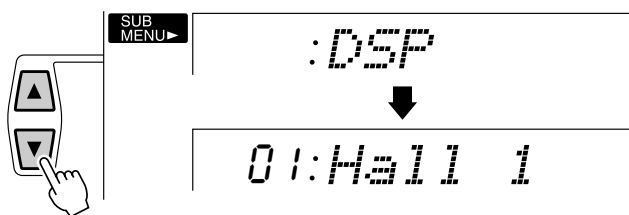

2 Select a DSP Effect

Use the [-] and [+] buttons, number buttons, or data dial to select the desired DSP effect (the name of the selected DSP effect will appear on the top line of the display). Select “Off” if you want no DSP effect on any part of the PSR-530 sound.

Each DSP effect has its own variation. Turn the [DSP VARIATION] button ON to activate each variation.



DSP Return Level

The DspRtnLv (DSP Return Level) parameter sets the amount of DSP effect returned from the DSP effect stage, thus making it possible to adjust the degree of DSP effect applied to the overall sound.

1 Select the Digital Effect “DspRtnLv” Function

Use the MENU [▲] and [▼] buttons to move the triangular indicator in the display next to “DIGITAL EFFECT”, then use the SUB MENU [▲] and [▼] buttons to select “DspRtnLv”.

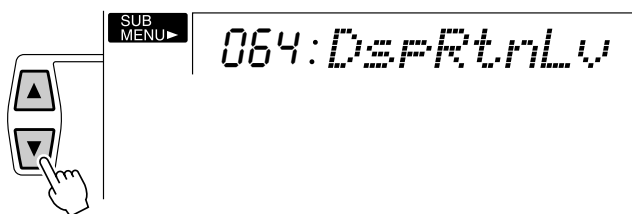

2 Set the DSP Return Level

Use the [-] and [+] buttons, number buttons, or data dial to set the desired DSP return level (the current return level value appears to the left of “DspRtnLv” on the display). The range is from “0” to “127”. The higher the value the greater the return level.

Harmony

When HARMONY is on, playing single notes or chords on the right-hand section of the keyboard produces automatic harmony matched to the accompaniment chords (AUTO ACCOMPANIMENT must be on). Harmony is applied to the R1 voice. When chords are played the harmony is based on the last note played (i.e. last-note priority).

The PSR-530 has 16 different harmony types, as listed below.

No.	Type	Description
1	Duet	This harmony type produces a duophonic melody with the second voice below the melody line.
2	Trio	This harmony type generates two voices in addition to the melody voice.
3	4 Part	Three harmony notes are generated to produce a four-note chord.
4	4 Part Jazz	Similar to the preceding type, but depending on the chords played this type will sometimes produce a more colorful sound.
5	Country	Similar to Duet, but the second voice is above the melody line.
6	Octave	One note is added an octave below the melody.
7	Tremolo	The note(s) pressed and held is(are) repeatedly played at the preset tempo.
8	Tremolo Duet	Combination of Tremolo and Duet; produces a duophonic melody with two voices played alternately.

No.	Type	Description
9	Tremolo Octave	Combination of Tremolo and Octave; produces a duophonic melody with two voices played alternately (the second voice is an octave below the melody).
10	Strumming	This type adds arpeggiated pattern to the melody.
11	Trio Delay	Two notes slightly below the melody are added to create three parts. Additional notes are delayed slightly.
12	Vibraphone & Jazz Guitar	Two voices, Vibraphone and Jazz Guitar, below the melody are added to create three parts.
13	Trumpet & Sax	Two voices, Trumpet and Saxophone, below the melody are added to create three parts.
14	Back Vocal	“Vocal” voice is added to the melody to get a vocal part in the background.
15	Strings	“Strings” voice is added to the melody to create an orchestral atmosphere.
16	Forest	“Twitterings” of a bird are added to the melody to create an effect as if you were playing outside.

NOTE

- The Harmonies except for the types 6,7 and 9 are applied to the R1 voice according to the chords detected in the Accompaniment section.

Turning the Harmony Effect On or Off

Press the [HARMONY] button so that the HARMONY icon appears in the display to turn the selected HARMONY effect on. Press [HARMONY] a second time so that the HARMONY icon disappears to turn the HARMONY effect off.

HARMONY



NOTE

- HARMONY can not be turned on when a drum kit is selected for the R1 voice.
- HARMONY can not be turned on when the FULL KEYBOARD AUTO ACCOMPANIMENT fingering mode is selected even if AUTO ACCOMPANIMENT is on. HARMONY will be automatically turned off if the FULL KEYBOARD fingering mode is selected while the HARMONY effect is on.
- When the Voice Set function is ON (Page 85), the HARMONY effect settings may change according to the selected R1 panel voice.

Selecting a Harmony Type

1 Select the Digital Effect “Harmony” Function

Use the MENU [▲] and [▼] buttons to move the triangular indicator in the display next to “DIGITAL EFFECT”.

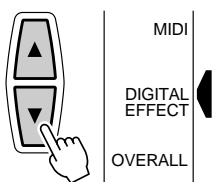

Then use the SUB MENU [▲] and [▼] buttons to select “Harmony”. After a few seconds the name of the currently selected HARMONY type will appear on top line of the display.

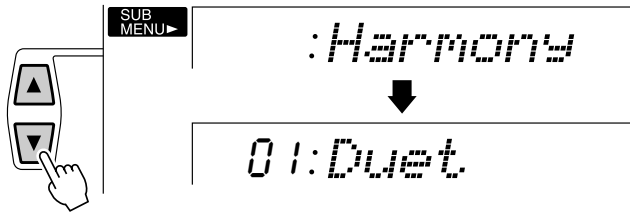

Shortcut

- You can also jump directly to the DIGITAL EFFECT HARMONY TYPE function by pressing and holding the [HARMONY] button for a few seconds.

2 Select a Harmony Type

Use the [-] and [+] buttons, number buttons, or data dial to select the desired HARMONY type (the name of the selected HARMONY type will appear on the top line of the display).

Adjusting the Harmony Volume

The volume of the harmony sound in relation to the keyboard sound can be adjusted for HARMONY types 1 through 10 as follows (HARMONY types 11 through 22 are not affected):

1 Select the Digital Effect “HarmVol” Function

Use the MENU [▲] and [▼] buttons to move the triangular indicator in the display next to “DIGITAL EFFECT”, then use the SUB MENU [▲] and [▼] buttons to select “HarmVol”. The current harmony volume setting will appear to the left of “HarmVol” on the display.

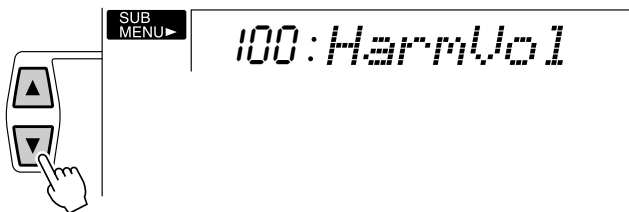

2 Adjust the Harmony Volume

Use the [-] and [+] buttons, number buttons, or data dial to adjust the harmony volume as required. The range is from “0” to “127” — “0” is minimum (no sound) and “127” is maximum volume.

NOTE

- When the Voice Set function is ON (page 85), the Harmony Volume may change according to the selected R1 panel voice.

The Pitch Bend Wheel

Use the PSR-530 pitch bend wheel to bend notes up (roll the wheel away from you) or down (roll the wheel toward you) while playing the keyboard. The pitch bend wheel is self-centering and will automatically return to normal pitch when released.

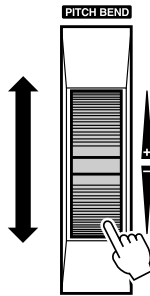

Setting the Pitch Bend Range

The maximum pitch bend range can be set via the PITCH BEND RANGE function in the OVERALL function group. Use the MENU [▲] and [▼] buttons to move the triangular indicator in the display next to “OVERALL”.

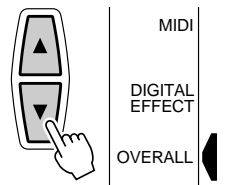

Then use the SUB MENU [▲] and [▼] buttons to select “PBRange”. The current pitch bend range setting will appear to the left of the function name on the top line of the display. Use the [-] and [+] buttons, number buttons, or data dial to set the pitch bend range from “01” to “12” as required. Each increment corresponds to one semitone.

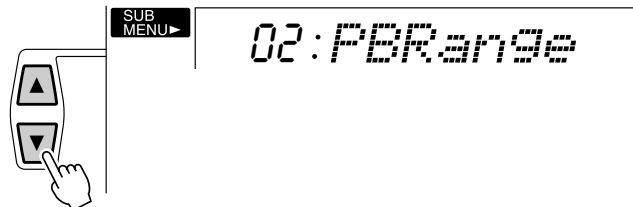

A setting of “02”, for example, will result in a maximum pitch bend range of plus and minus a whole note.

NOTE

- When the Voice Set function is ON (page 85), the Pitch Bend Range will be changed according to the selected R1 panel voice.
- The default pitch bend range can be instantly recalled by pressing the [+] and [-] buttons simultaneously.

Transpose

This functions allow the overall pitch of the PSR-530 to be transposed up or down by a maximum of one octave in semitone increments.

Setting Transposition

Use the TRANSPOSE [▼] and [▲] buttons to set the desired degree of transposition. Press either button briefly to decrement or increment by one, or hold for continuous decrementing or incrementing. The current transpose value will appear on the top line of the display for a few seconds whenever one of the TRANSPOSE buttons is pressed — during this time the [-] and [+] buttons, number buttons, or data dial can also be used to set the transpose value (the transpose value also appears continuously above “TRANSPOSE” in the display).

NOTE

- Press the TRANSPOSE [▼] and [▲] buttons simultaneously to instantly reset the transpose value to “0”.
- The new TRANSPOSE value will take effect from the next key played.

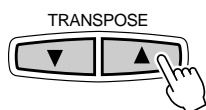

The transpose range is from -12 to +12. Each step corresponds to one semitone, allowing a maximum upward or downward transposition of 1-octave. A setting of “0” produces the normal pitch.

Registration Memory

The PSR-530 Registration Memory feature can be used to memorize 128 complete control-panel setups (32 banks, 4 setups each) that you can recall whenever needed.

Registering the Panel Settings

1 Set Up the Controls as Required

Make the desired control settings. The following settings are memorized by the Registration Memory function:

● Data Stored By the Registration Memory

VOICE PARAMETERS

- R1 Voice (Voice number, volume, octave, pan, reverb send level, chorus send level, DSP send level)
- Dual Voice ON/OFF
- R2 Voice (Voice number, volume, octave, pan, reverb send level, chorus send level, DSP send level)
- Split Voice ON/OFF
- L Voice (Voice number, volume, octave, pan, reverb send level, chorus send level, DSP send level)
- Split Point (Split Voice)
- Touch Sensitivity
- Reverb ON/OFF
- Chorus ON/OFF
- DSP ON/OFF, variation ON/OFF
- DSP type
- Harmony ON/OFF, type, volume
- Pitch bend range
- Scale Tuning

ACCOMPANIMENT PARAMETERS

- Auto Accompaniment ON/OFF
- Style number
- Fingering mode
- Tempo
- Split point (Auto Accompaniment)
- Accompaniment volume
- Track data (Track ON/OFF, voice, volume, pan, reverb send level, chorus send level)
- Accompaniment section (Main A/B)
- Multi Pad Set number
- Chord Match ON/OFF (Multi Pad1...4)
- Transpose
- Reverb type
- Chorus type

2 Select a Registration Bank (if necessary)

Any of the eight Registration Memory banks can be selected via the REGISTRATION MEMORY menu. Use the MENU [▲] and [▼] buttons to move the triangular indicator next to “REGISTRATION MEMORY “ in the menu list to the left of the display — the currently selected registration bank number and name will appear on the top line of the display. Then use the [-] and [+] buttons, number buttons, or data dial to select the desired bank (1 through 32).

Shortcut

- Press and hold the REGISTRATION MEMORY [MEMORY] button for a few seconds to go directly to the REGISTRATION BANK display.

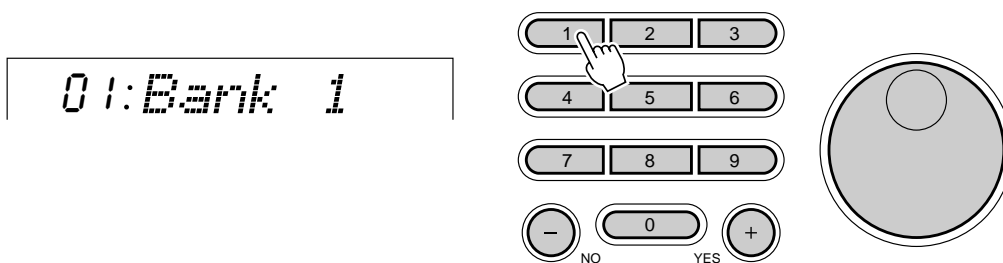

3 Register the Settings

While holding the [MEMORY] button, press one of the REGISTRATION MEMORY buttons — [1] through [4]. Any data that was previously in the selected location is erased and replaced by the new settings. The corresponding REGISTRATION MEMORY number will appear below “REGISTRATION” in the display.

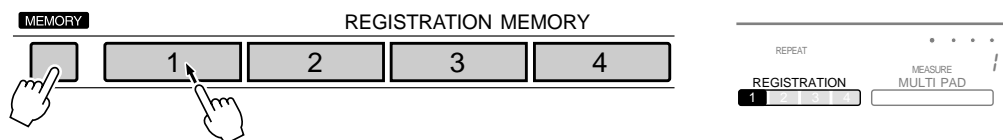

NOTE

- The REGISTRATION MEMORY contents will be retained even after turning the power off. See page 98 for the details.

Recall the Registered Panel Settings

Simply select the appropriate bank as described above, then press the desired REGISTRATION MEMORY button at any time to recall the memorized settings. The corresponding Registration Memory number will appear below “REGISTRATION” in the display, and the appropriate setting changes will appear in the display.

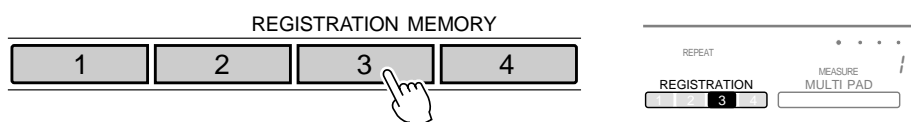

NOTE

- REGISTRATION MEMORY data cannot be recalled when the ONE TOUCH SETTING feature is on.
- No REGISTRATION MEMORY indicator will be showing when the PSR-530 is initially turned on or when a bank is selected prior to actually selecting a REGISTRATION MEMORY number.

The Accompaniment Freeze Function

When the FREEZE function is engaged, the accompaniment parameters listed above will not be changed when a REGISTRATION MEMORY is recalled. This allows you to recall different REGISTRATION MEMORY settings while using Auto Accompaniment, without suddenly disturbing the flow of the accompaniment. The FREEZE function is turned on and off by pressing the [FREEZE] button. The “FREEZE” icon appears in the display when it is turned on.

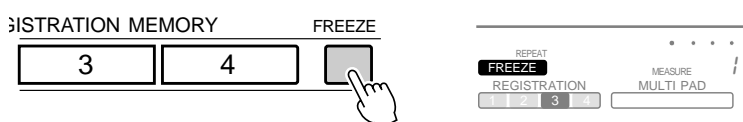

NOTE

- FREEZE remains on even if a different registration bank is selected.
- The Freeze function will automatically be turned on when one of the following modes, Song, Record or Style Revoice, is engaged.

The Multi Pads

The PSR-530 MULTI PADS can be used to play a number of short pre-recorded rhythmic and melodic sequences that can be used to add impact and variety to your keyboard performances. You can also record your own MULTI PAD phrases as described in “MULTI PAD Recording” on page 71.

Some pad phrases simply play back as programmed, while others are “chord match” types which, if the CHORD MATCH function is turned on, are automatically transposed to match chords played using the PSR-530 Auto Accompaniment feature.

Selecting a MULTI PAD Set

The PSR-530 has 36 multi pad sets, each containing a complete set of 4 MULTI PAD phrases — 144 phrases in all. Before using the MULTI PADS, select the MULTI PAD set containing the phrases you want to use as follows:

1 Select the Multi Pad Function

To select a multi pad set first use the MENU [▲] and [▼] buttons to select the MULTI PAD function so that the triangular indicator in the display appears next to “MULTI PAD” to the left of the display.

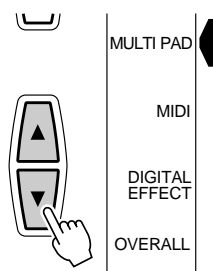

2 Select a Multi Pad Set Number

If necessary use the SUB MENU [▲] and [▼] buttons so that the name of the currently selected MULTI PAD set appears on the display (see list on page 50), then use the [-] and [+], number buttons, or data dial to select the MULTI PAD set you want to use.

01: Fanfare 1

Shortcut

- Press and hold the MULTI PAD [STOP] button for a few seconds to go directly to the MULTI PAD SET display.

Playing the MULTI PADS

Simply tap any of the MULTI PADS at any time to play back the corresponding phrase at the currently set tempo. MULTI PAD playback begins as soon as the button is pressed. You can even play two, three, or four MULTI PADS at the same time. Also, you can create “retriggered sample” effects by repeatedly pressing a pad before its contents are completely played back.

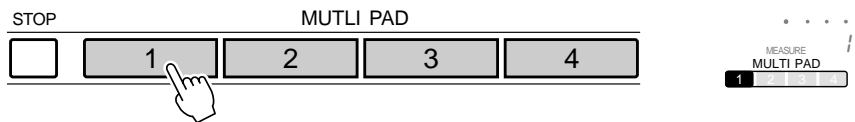

The MULTI PAD voices are independent from the voices you have currently selected for keyboard performance. You could, for example, play piano on the keyboard while a MULTI PAD plays a brass chord stab.

When the CHORD MATCH function (see page 51) for a pad is turned on, the corresponding phrase will be automatically transposed to match chords played using the PSR-530 Auto-accompaniment feature.

MULTI PAD playback can be terminated by pressing the MULTI PAD [STOP] button.

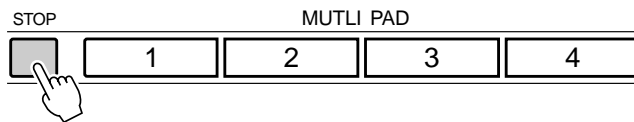

● The Multi Pad Sets

Set	Chord Match				Set	Chord Match			
	Pad 1	Pad 2	Pad 3	Pad 4		Pad 1	Pad 2	Pad 3	Pad 4
1 Fanfare1	○	○	○	—	19 Classic	○	○	○	○
2 Fanfare2	○	○	○	—	20 Jingle	○	○	○	○
3 Brassy1	○	○	○	○	21 Horror SE	—	—	—	—
4 Brassy2	○	○	○	○	22 Racing SE	—	—	—	—
5 Synth Brass	○	○	○	○	23 Stormy SE	—	—	—	—
6 Guitar Play1	○	○	○	○	24 Water SE	—	—	—	—
7 Guitar Play2	○	○	○	○	25 Dog SE	—	—	—	—
8 Guitar Play3	○	○	○	○	26 Haha SE	—	—	—	—
9 Guitar Play4	○	○	○	○	27 Rock Kit	—	—	—	—
10 Techno Synth1	○	○	○	○	28 Techno Kit	—	—	—	—
11 Techno Synth2	○	○	○	○	29 Analog Kit	—	—	—	—
12 Arpeggio	○	○	○	○	30 Tom Flam	—	—	—	—
13 Crystal	○	○	○	○	31 Latin Percussion1	—	—	—	—
14 Twinkle	○	○	○	○	32 Latin Percussion2	—	—	—	—
15 Magical	○	○	○	○	33 Timbales	—	—	—	—
16 Piano Sequence	○	○	○	○	34 Analog Sequence	—	—	—	—
17 Banjo Sequence	○	○	○	○	35 Conga Sequence	—	—	—	—
18 Gothic	○	○	○	○	36 Techno Sequence	—	—	—	—

Turning the CHORD MATCH Function On/Off

The CHORD MATCH function can be individually turned on or off for each of the MULTI PADS, as described below.

NOTE

- The chord match function has no effect with pads that contain percussion phrases.

1 Select the MULTI PAD Function

Use the MENU [▲] and [▼] buttons to select the MULTI PAD function so that the triangular indicator in the display appears next to “MULTI PAD” to the left of the display.

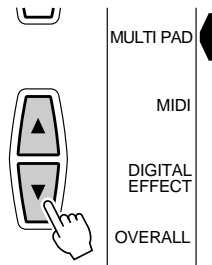

2 Select a CHORD MATCH Function

Use the SUB MENU [▲] and [▼] buttons to select “Pad1Chd”, “Pad2Chd”, “Pad3Chd”, or “Pad4Chd”, depending on the pad for which you want to turn the CHORD MATCH function on or off.

NOTE

- The chord match on/off status depends on the selected Multi Pad.

on: Pad1Chd

3 Turn the CHORD MATCH Function On or Off

Use the [-] and [+] buttons or data dial to turn the CHORD MATCH function for the selected pad “on” or “off” as required.

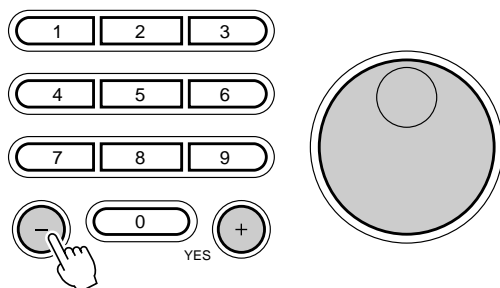

NOTE

- The CHORD MATCH ON/OFF setting is re-stored to its original status whenever a preset MULTI PAD set is selected.
- When the CHORD MATCH ON/OFF status of a user MULTI PAD (see page 71) set is changed, the new status is recorded with the MULTI PAD data.

Song Playback

Use the following procedure to play back the PSR-530's internal demonstration songs as well as songs you record yourself (see "Song Recording", page 58).

Song Playback Procedure

1 Select the Song Menu

Press the [SONG] button to select the SONG menu (the triangular indicator will appear next to "SONG" to the right of the display). The number and name of the currently selected song will appear on the top line of the display, and the song track and volume icons near the bottom of the display will appear framed.

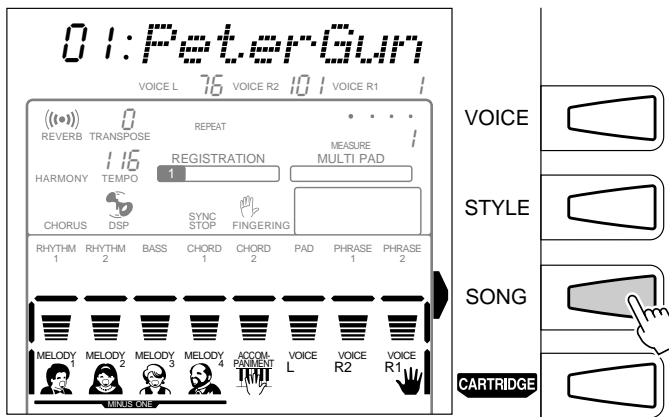

2 Select a SONG Number

If necessary, use the [-] and [+] buttons, the number buttons, or the data dial to select the SONG number you want to play. The SONG number can also be incremented by pressing the [SONG] button: press briefly to increment by one, or hold for continuous incrementing.

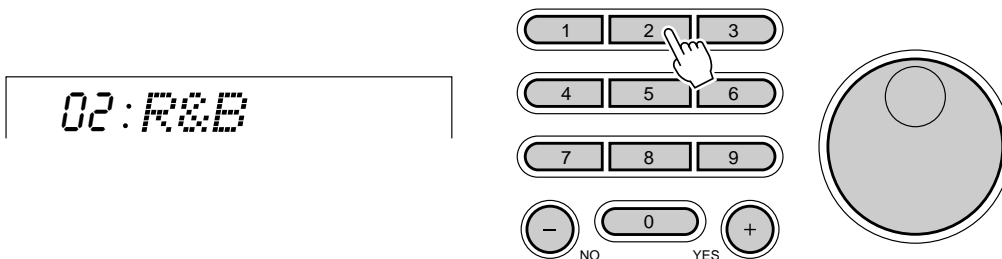

3 Start Playback

Playback will begin as soon as the [START/STOP] button is pressed. You can turn the MELODY and ACCOMPANIMENT tracks on and off during playback as required by using the TRACK buttons.



NOTE

- You can also start playback from any specified measure (see page 54).

4 Play Along If You Like

Play along on the keyboard if you like. You can also change the tempo during playback.

5 Stop Playback

SONG playback will stop automatically when the entire SONG has been played back. You can also stop playback at any time by pressing the [START/STOP] button.

Song Volume Control

When the SONG menu is selected (i.e. the song track and volume icons near the bottom of the display are framed) the volume of SONG playback in relation to the keyboard can be adjusted for the best overall balance by using the ACCOMPANIMENT/SONG VOLUME [▼] and [▲] buttons. When either button is pressed the current song volume setting will appear on the top line of the display for a few seconds. The song volume range is from “0” (no sound) to “127” (maximum volume). The default setting is “100”. Press the ACCOMPANIMENT/SONG VOLUME [▼] button to decrease the volume or the [▲] button to increase the volume. Pressing briefly to single step, or hold for continuous decrementing/incrementing.

While the song volume setting appears on the top line of the display the [-] and [+] buttons, number buttons, or data dial can also be used to set the song volume.

ACCOMPANIMENT/SONG VOLUME

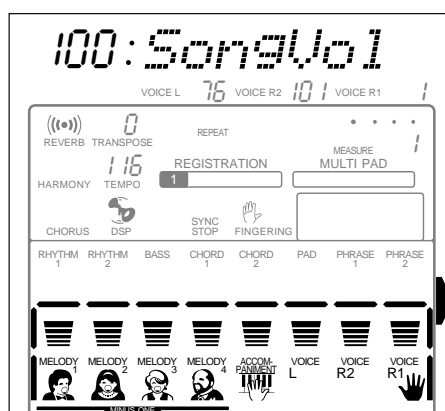

Play from a Specified Measure

You can start SONG playback from any specified measure, as long as the specified measure is within the range of measures that has already been recorded:

1 Select the Measure Parameter

While the SONG menu is selected, but no playback or recording is in progress, use the SUB MENU [▲] and [▼] buttons to select the “Measure” parameter in the display. The current measure number will appear to the left of “Measure” on the top line of the display (the current measure number is also continuously displayed next to “MEASURE” in the display).

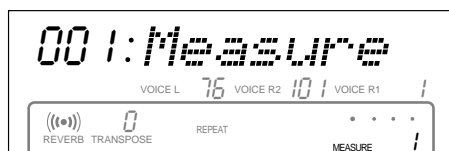

2 Enter the Desired Measure Number

Use the [-] and [+] buttons, number buttons, or data dial to enter the desired measure number.

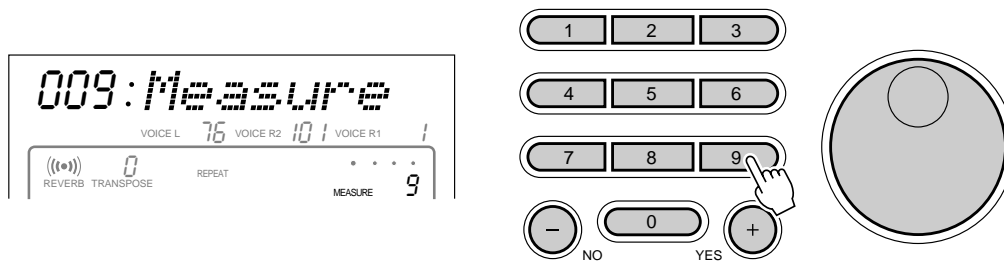

NOTE

- You can move the measure number for playback back and forth even during the song playback.

3 Start Playback

You can now start playback from the specified measure number by pressing the [START/STOP] button.



Minus-one Practice

Minus-one playback lets you turn off specific parts of a song so you can practice them on the PSR-530 keyboard while the other parts play automatically. Any of the PSR-530's four MELODY tracks and/or the ACCOMPANIMENT track can be turned on or off as required. Individual SONG tracks can be turned OFF (muted) or ON by using the **TRACK** buttons corresponding to the target MELODY or ACCOMPANIMENT tracks. The track icon will disappear when a track is muted.

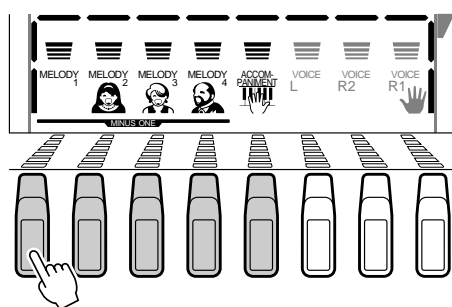

Minus-one Track Assignment

Many of the PSR-530 demonstration songs, and songs provided on Music Cartridges (see “Using Music Cartridges”, page 75) have more than 4 channels — as many as 16, in fact. This function lets you assign any of the song's channels to the PSR-530's MELODY tracks so they can be turned on or off for minus-one practice.

1 Select the MinusOne Parameter

While the SONG menu is selected, but no recording is in progress, use the SUB MENU [▲] and [▼] buttons to select the “MinusOne” parameter in the display. After a few seconds “MinusOne” will change to “MinusCh”, the number of the current minus-one channel will appear to the left of “MinusCh”, and a frame will appear around the MELODY 1 song track icon.

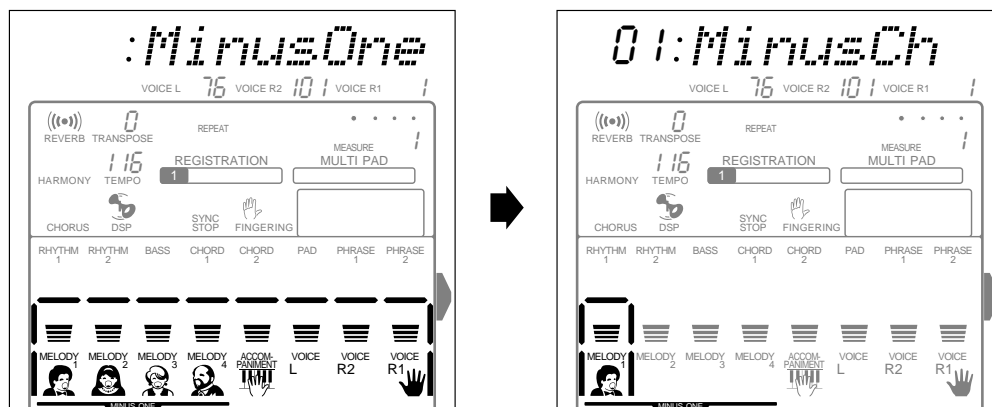

2 Select a MELODY Track

Use the **TRACK** buttons to select the song MELODY track (1...4) to which a minus-one channel is to be assigned. A frame will appear around the selected track icon.

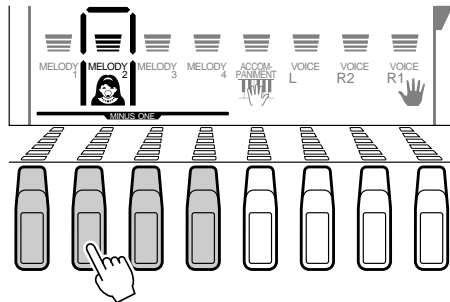

3 Assign a Channel to the Selected Track

Use the [-] and [+] buttons, number buttons, or data dial to assign the desired minus-one channel (1...16) to the selected MELODY track. The number of the assigned channel will appear to the left of “MinusCh” on the top line of the display.

05:MinusCh

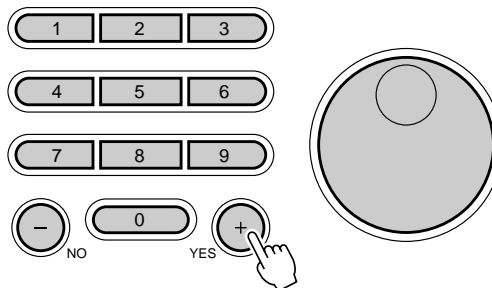

NOTE

- Press the [-] and [+] buttons simultaneously to recall the song's initial channel assignment for the selected track.
- Minus-one channel assignments do not apply to songs you record yourself.
- If a selected song includes minus-one channel settings, those channels will automatically be assigned to the appropriate tracks.

Repeat Play

This function allows you to specify any section of a song — internal or cartridge — for continuous repeat playback.

1 Select the A-b Repeat Parameter

While the SONG menu is selected, but no recording is in progress, use the SUB MENU [▲] and [▼] buttons to select the “A-b Repeat” parameter in the display. The MAIN/AUTO FILL [A] and [B] button indicators will flash.



2 Start Playback

Press the [START/STOP] button to start song playback.



3 Specify the Repeat “A” and “B” Points

While the song is playing, press the MAIN/AUTO FILL [A] button at the beginning of the section to be repeated (the [A] button indicator will light continuously, and the “A” repeat icon will appear in the display), then press the MAIN/AUTO FILL [B] button at the end of the section to be repeated (the [B] button indicator will light continuously, and the “B” repeat icon will appear in the display). Repeat playback will begin automatically from the A point as soon as the B point has been specified, and will continue until either the MAIN/AUTO FILL [A] button is pressed again to cancel the repeat function, or until song playback is stopped.

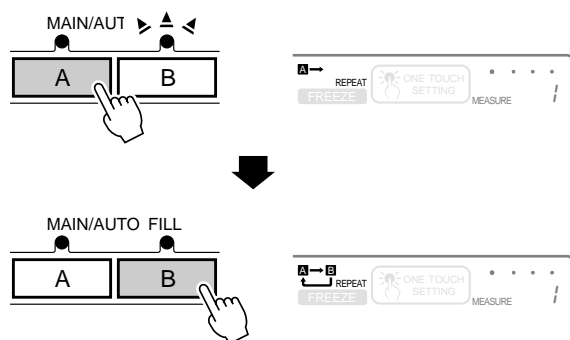

NOTE

- If only the “A” repeat point is specified, repeat playback will occur between the “A” point and the end of the song.
- If the MAIN/AUTO FILL [B] button is pressed during repeat playback, the previously specified “B” point will be cancelled and a new “B” point can be specified as required.
- Repeat playback will continue even if a different menu is selected during repeat playback.
- Repeat playback will be cancelled if a different SONG number selected or the record mode is engaged or the revoice mode is engaged.

Song Recording

The PSR-530 SONG tracks allows you to record and play back complete songs including chord sequences created using the AUTO ACCOMPANIMENT feature and a melody lines you play on the keyboard. The SONG tracks include one ACCOMPANIMENT track and four MELODY tracks.

The PSR-530 can retain up to 4 complete songs in internal memory, and these can be selected and played back as described in the preceding section.

NOTE

- Material recorded on the SONG tracks will be retained even after turning the power off. See page 98 for the details.
- The recorded data will be lost if the power is turned off, the AC adaptor is unplugged, or the batteries fail during recording.
- The Shortcut functions are not available when one of the Record modes is engaged.

● The SONG MELODY tracks record the following operations and data:

- Note on/off.
- Velocity.
- R1 and R2 voice number, volume, octave, pan, reverb send level, chorus send level, DSP send level.
- Dual voice on/off.
- Reverb on/off.
- Reverb type.
- Chorus on/off.
- Chorus type.
- DSP on/off, variation on/off.
- Harmony on/off, type.**
- Sustain pedal on/off.
- Pitch bend, pitch bend range.

NOTE

- Up to approximately 4500 notes can be recorded in the PSR-530 MELODY tracks.
- Only harmony applied to the last track recorded will be included in the recorded song data (see page 42 for details on the HARMONY effect).

● The SONG ACCOMPANIMENT track records the following operations and data:

- Section changes.
- Style number.*
- Accompaniment track changes* (8 tracks: track on/off, voice number, volume, pan, reverb send level, chorus send level, DSP send level).
- Accompaniment volume.*
- Chord changes, timing.
- Reverb type.
- Chorus type.
- Tempo and time signature (common to the ACCOMPANIMENT and MELODY tracks).*

NOTE

- Up to approximately 3500 chords can be recorded in the ACCOMPANIMENT track, when the Virtual Arranger is OFF.

* Recorded only at the beginning of a song; changes cannot be made during recording.

** Recorded only at the beginning of a song; changes cannot be made during recording. Only one melody track can be recorded with harmony. The harmony data for the last track recorded with harmony will be retained (last priority).

Song Recording Procedure

1 Set Up to Record

Before recording set up the PSR-530 as required: e.g. select the required voice(s), effects, accompaniment style, accompaniment fingering mode, etc.

2 Engage the Record Ready Mode

Press the **[RECORD]** button to engage the record-ready mode. The **[RECORD]** button indicator will light, and the **SONG**, **STYLE**, and **MULTI PAD [1] ... [4]** icons will flash, indicating that you must select one of the corresponding record modes.

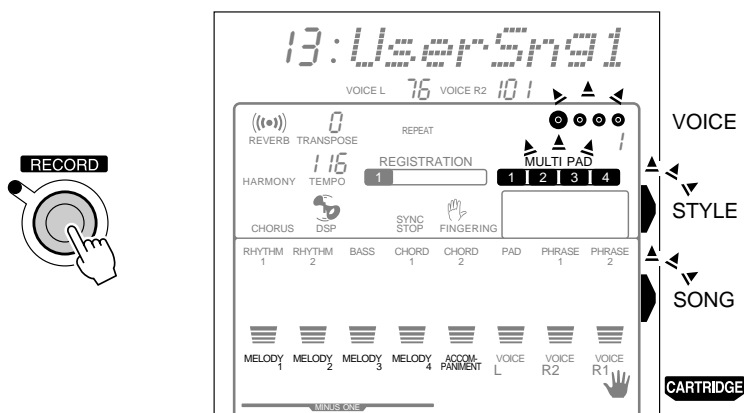

3 Select the SONG Record Mode

Press the **[SONG]** button to select the **SONG** record mode. The **SONG** menu will automatically be selected and a **SONG** number will appear on the top line of the display. The beat indicator dots will flash at the currently set tempo, indicating that the record ready (synchro-start) mode is engaged. Also, the frame surrounding the **SONG** **MELODY** and **ACCOMPANIMENT** track icons will flash, indicating that a **MELODY** and/or **ACCOMPANIMENT** track must be selected before recording can begin.

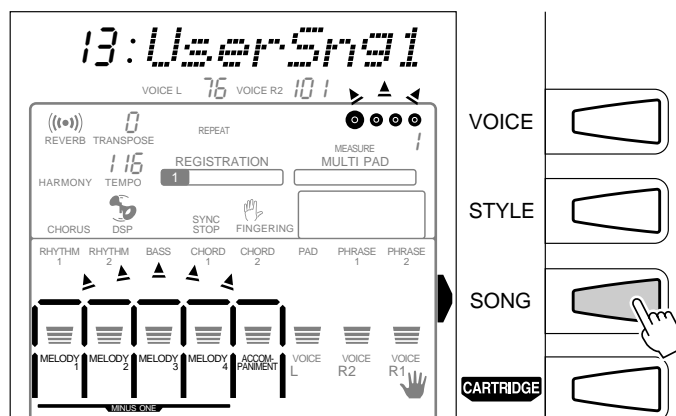

NOTE

- If the **[RECORD]** button is pressed while a demonstration song or cartridge song is selected, the lowest-numbered user song which does not contain any recorded data will automatically be selected. If other user songs already contain data, however, user song number 13 will be selected.
- The following panel setting changes will occur when the record ready mode is engaged:
 - The measure number will be reset to "1".
 - If the Metronome function is on (page 85), the metronome will sound at the current tempo.
 - The **REGISTRATION MEMORY FREEZE** function will be turned on (it cannot be turned off while the record mode is engaged).
 - The **SYNCHRO STOP** function will be turned off.

4 If Necessary, Select a User Song Number

If the desired user song is not already selected, use the [-] and [+] buttons, number buttons, or data dial to select as required.

5 Select the Track(s) to be Recorded

Use the **TRACK** buttons to select a SONG MELODY track to record (only one MELODY track can be recorded at a time). A frame appears continuously around the icon of the MELODY track selected for recording.

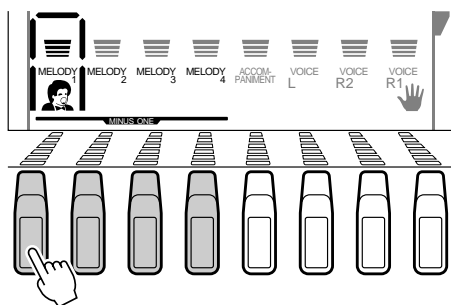

The ACCOMPANIMENT track can be recorded alone or at the same time as one MELODY track. If you intend to record accompaniment use the appropriate **TRACK** button to select the ACCOMPANIMENT track (a frame will appear continuously around the ACCOMPANIMENT track icon).

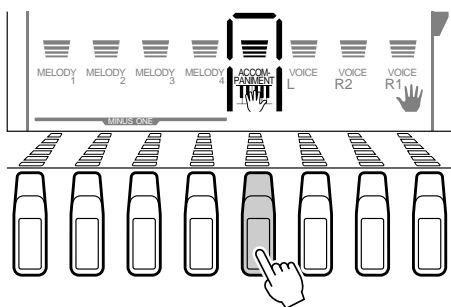

NOTE

- The R1 and R2 voices can be simultaneously recorded on a single track. The L voice cannot be recorded.
- If you start recording without selecting a specific track while the panel AUTO ACCOMPANIMENT button is on, the MELODY 1 and ACCOMP tracks will automatically be selected for recording.

NOTE

- The panel AUTO ACCOMPANIMENT [ON/OFF] button is automatically turned off when the ACCOMPANIMENT track is turned off.
- AUTO ACCOMPANIMENT will automatically be turned on if it is off when the ACCOMPANIMENT track is selected for recording. Conversely, the ACCOMPANIMENT track will automatically be selected for recording if the AUTO ACCOMPANIMENT [ON/OFF] button is turned on.
- AUTO ACCOMPANIMENT cannot be turned on or off during recording.

6 Record

Recording will begin as soon as you play a note on the keyboard or press the [START/STOP] button, and the BEAT indicator dots will begin to indicate the current beat as in the Auto Accompaniment mode. The MEASURE parameter will also show the current measure number during recording.

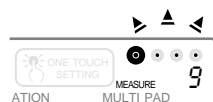
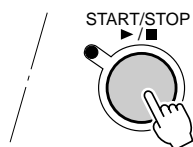

NOTE

- Before actually starting to record you can try playing the PSR-530 the way it is set up by using the "Rehearsal Mode": press the [SYNC START] button to temporarily disengage the record ready mode, rehearse as necessary, then press the [SYNC START] button again to return to the record ready mode.
- Whenever you record using a SONG, any previously recorded material in the same track will be erased.
- If the SONG memory becomes full while recording, "FULL" will appear on the display and recording will stop (the "Rehearsal Mode" will be engaged).

- If you start recording by pressing the [START/STOP] button, nothing will be recording on a MELODY track until you begin playing on the keyboard. Only rhythm accompaniment will be recorded on the ACCOMPANIMENT track until you play a chord in the auto accompaniment section of the keyboard.
- During recording you can use the TRACK buttons to turn playback of previously-recorded MELODY tracks or the ACCOMPANIMENT track on or off as required.

7 Stop Recording

Stop recording by pressing the [START/STOP] button. If you press the [ENDING] button while recording the ACCOMPANIMENT track, recording will stop automatically after the ending section has finished. When recording is stopped the MEASURE number on the display will return to "1" and the record-ready mode will be engaged.

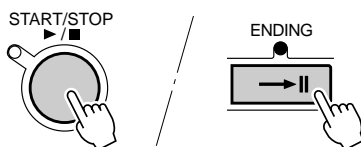

NOTE

- You can also press the [SYNC START] button to stop recording and return to the record ready mode.

8 Record Additional Tracks as Required

By repeating steps 5 through 7, above, you can select and record additional tracks as required.

● Recording from the Middle of the Song

It is possible to initiate recording from the middle of the song. If you want to change the latter half of the song (track), select the Measure number (page 54) from which you want to record and start recording.

017:Measure

NOTE

- While the record ready mode is engaged you can press the [VOICE] button to go to the VOICE menu and change the R1 voice as required. The R2 voice, however, cannot be changed (If the Voice Set function is on — page 85 — the R2 voice will automatically be changed when an R1 panel voice is selected). The record-ready mode must be disengaged in order to change the R2 voice and other settings.
- When you select one of the Accompaniment tracks for recording, the display shows "--:Measure" indicating that recording from the middle of the song is not possible.

9 Exit From the Record Mode

When you're finished recording a song, press the [RECORD] button so that its indicator goes out to exit from the record mode. The recorded user song can now be played back in the same way as the demonstration songs (page 52).



NOTE

- Many types of data recorded in user songs can be re-written ("revoiced") as described on page 81.

◆ About the Recording with the Digital Effects Applied

You can use three Digital Effects, Reverb, Chorus and DSP, at one time. However, two or more types from the same group cannot be selected at the same time. Be aware the following facts especially when recording a song with the different effects applied to the different tracks.

A The Reverb type and Chorus type effects can be set and recorded independently for each track. However, only the latest settings (one each) will be effective if several effects are used in a song (the latest setting priority).

[EX.] While the panel REVERB button is turned on:

1. Select the Hall 1 (Reverb) for the Accompaniment track, and record the Accompaniment track for ten measures from the beginning.
2. Start recording on the Melody 1 track with the Hall 1 (Reverb) selected from the beginning and then change the effect type to Room 1 (Reverb) respectively from the fifth measure through the end.

When you play back the song recorded with the above condition, the first four measures will be played back with the Hall 1 applied to both the Accompaniment and Melody 1 tracks, and the rest six measures, from fifth through the end, with the Room 1 applied to both tracks. The effect types set for the Accompaniment track are replaced with the latest settings. Only the Send Levels for each track remains the same.

B The DSP type effects can be set and recorded only for the Melody tracks regardless of the current effect, insertion or System. Only the latest setting will be effective if several types are used in a song (the latest setting priority).

[EX.]

1. Turn on the panel DSP button, and start recording on the Melody 1 track with the Distortion (DSP No.42 Hard) selected for ten measures from the beginning.
2. Turn off the panel DSP button, and start recording on the Melody 2 track without any effect from the beginning. Then turn on the panel DSP button again at the fifth measure, and continue recording to the end with the Rotary Speaker1 (DSP No.28 Rotary1) selected.

When you play back the song recorded with the above condition, the first four measures will be played back with the Distortion applied only to the Melody 1 track, and the rest six measures, from fifth through the end, with the Rotary Speaker applied only to the Melody 2 track. The DSP type set for the Melody 1 track is taken over by the one set for the Melody 2 track.

Clearing Song Data

This function makes it possible to clear unneeded data from the PSR-530 SONG memory.

Clearing an Entire Song

While the SONG record-ready or rehearsal mode is engaged use the SUB MENU [▲] and [▼] buttons to select the “SongClr?” function, then press the [+] (YES) button: “Sure?” will appear on the display. Press the [+] (YES) button a second time to actually clear the currently selected user song (the demonstration songs and cartridge songs cannot be cleared). Press [-] (NO) if you want to abort the clear operation.

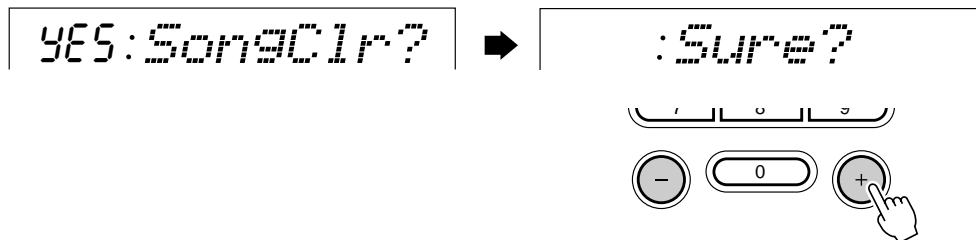

Clearing Selected Melody Tracks

While the SONG record-ready or rehearsal mode is engaged use the SUB MENU [▲] and [▼] buttons to select the “TrkClr?” function. The SONG tracks icons corresponding to MELODY tracks which contain data will flash (the ACCOMPANIMENT track cannot be cleared — neither can tracks in demonstration or cartridge songs). Use the **TRACK** buttons to select track you want to clear (frame will appear continuously around the selected track.) Once the desired track has been selected, “Sure?” will appear on the display. Press the [+] (YES) button to actually clear the currently selected track. Press [-] (NO) if you want to abort the clear operation.

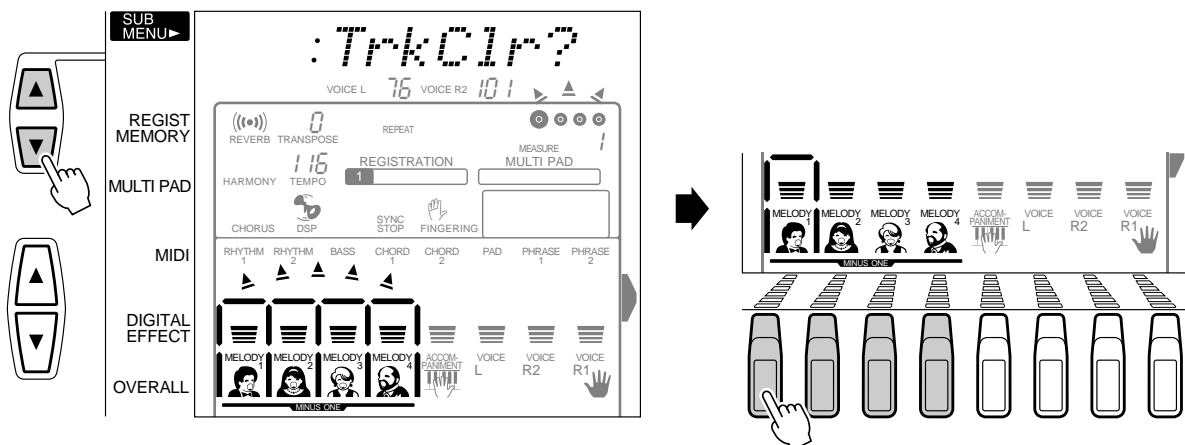

Style Recording

The PSR-530 lets you record up to three original “user styles” which can be used for auto-accompaniment in the same way as the preset styles. The user styles are recorded as style numbers 101, 102, and 103, and each style can be recorded with the full complement of 8 tracks (RHYTHM 1, RHYTHM 2, BASS, CHORD 1, CHORD 2, PAD, PHRASE 1, PHRASE 2) and 5 sections (INTRO, MAIN A, MAIN B, ENDING, FILL).

NOTE

- Material recorded on the STYLE tracks will be retained even after turning the power off. See page 98 for the details.
- The recorded data will be lost if the power is turned off, the AC adaptor is unplugged, or the batteries fail during recording.
- The REGISTRATION MEMORY cannot be recalled during style recording.
- The Shortcut functions are not available when one of the Record modes is engaged.

● The STYLE tracks record the following operations and data:

- Note on/off.
- Velocity.
- Voice number (drum kit number)*
- Pitch bend.

Only one event of the item marked with * can be recorded for each track of the sections.

NOTE

- Up to approximately 1,980 notes for a section (totally ca. 3,960 notes) can be recorded in the PSR-530 STYLE tracks.

Style Recording Procedure

1 Select a Style To Begin With

Select a style from one of the 100 presets that is close to the type of style you want to create.

NOTE

- If none of the preset styles is appropriate, select one that has the same time signature and number of measures as the one you want to create, then use the “All Clear” function (page 70) to clear all preset data before entering your own.
- If you select a blank user style to begin with (101 ... 103), the style will be in 4/4 time and all sections except FILL will be 2 measures long. FILL will be 1 measure long.

2 Engage the Record Ready Mode

Press the **[RECORD]** button to engage the record-ready mode. The **[RECORD]** button indicator will light, and the **SONG**, **STYLE**, and **MULTI PAD [1] ... [4]** icons will flash, indicating that you must select one of the corresponding record modes.

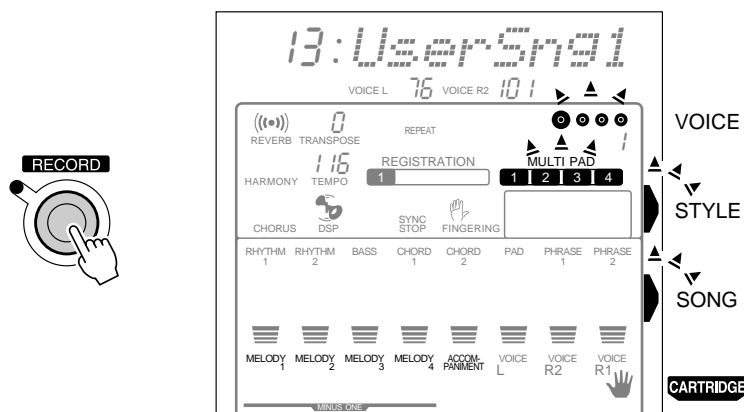

3 Select the STYLE Record mode

Press the **[STYLE]** button to select the STYLE record mode. The STYLE menu will automatically be selected and a user style number will appear on the top line of the display. The beat indicator dots will flash at the currently set tempo, indicating that the record ready (synchro-start) mode is engaged. Also, the frame surrounding the style track icons and the auto-accompaniment section button (INTRO, MAIN A, MAIN B, and ENDING) indicators will flash, indicating that a section and track must be selected before recording can begin.

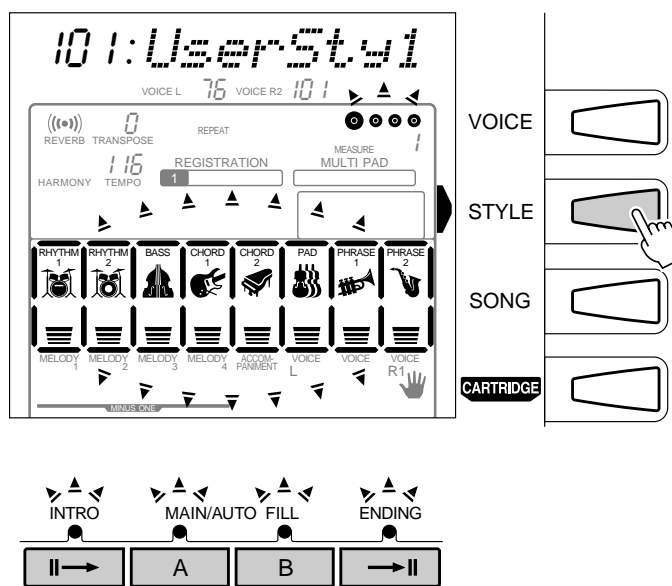

NOTE

- The icons of tracks which already contain data will appear continuously rather than flashing when the STYLE record mode is selected.
- If the STYLE record mode is selected while a preset style or cartridge style is selected, the lowest-numbered user style which does not contain any recorded data will automatically be selected. If all user styles already contain data, however, user style number 101 will be selected.
- If the STYLE record mode is selected while a user style is selected, that user style will be selected for recording.
- The following panel setting changes will occur when the STYLE record mode is engaged:
 - The measure number will be reset to "1".
 - If the Metronome function is on (page 85), the metronome will sound at the current tempo.
 - The SYNCHRO STOP function will be turned off.

4 If Necessary, Select a User Style Number

If the desired user style is not already selected, use the [-] and [+] buttons, number buttons, or data dial to select as required.

5 Select a Section to Record

Press the auto-accompaniment section button corresponding to the section you want to record. Press the MAIN A or MAIN B button twice to record a FILL. The indicator of the selected section button will light continuously and the others will go out. (The MAIN A or MAIN B indicator will flash when you designate FILL recording.)

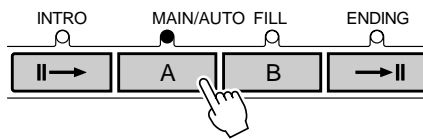

In this case the RHYTHM 1 track will automatically be selected for recording as the default.

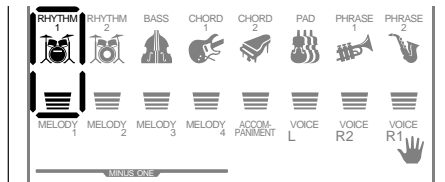

NOTE

- If you don't specifically select a section, the MAIN A section will automatically be selected for recording.
- Although the preset FILL sections have 4 variations (refer to page 25), user-style FILL sections can have only 1. When using a preset style as a basis for a user style, the AA FILL variation is used.

6 Select a Track to Record

When using a preset style as a basis for a user style, the BASS, CHORD 1, CHORD 2, PAD, PHRASE 1, and PHRASE 2 tracks must be cleared before they can be selected for recording (see page 70). The RHYTHM 1 and RHYTHM 2 tracks can be “overdubbed” — i.e. new notes can be added without erasing the original data.

Use the **TRACK** buttons to select the style track you want to record. A frame appears continuously around the icon of the track selected for recording, and the frames surrounding the remaining tracks will disappear.

NOTE

- Only one track can be recorded at a time.
- If you don't specifically select a track, the RHYTHM 1 track will automatically be selected when you start recording.

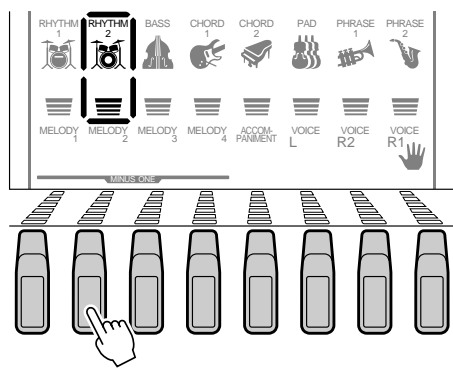

7 Select a Voice, If Necessary

If necessary, select a voice for the track to be recorded by pressing the [VOICE] button and selecting in the normal way.

NOTE

- The Registration Memory buttons will be disabled in the style record mode.

8 Record

Recording will begin as soon as you play a note on the keyboard or press the [START/STOP] button. The BEAT indicator dots will begin to indicate the current beat, and the MEASURE parameter will show the current measure number during recording.



The style will repeat continuously when recording is started, so you can continue to add (“overdub”) notes until the current track is complete. The style should be recorded based on a CM7 chord (C Major Seven) in order for it to function properly when used for auto-accompaniment.

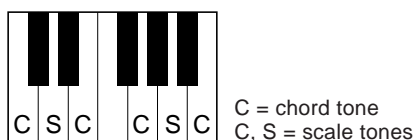

Observe the following rules when recording the MAIN and FILL sections:

- Use only the CM7 scale tones when recording the BASS, and PHRASE tracks (i.e. C, D, E, G, A, and B).
- Use only the chord tones when recording the CHORD and PAD tracks (i.e. C, E, G, and B).

Any appropriate chord or chord progression can be used for the INTRO and ENDING sections.

NOTE

- Before actually starting to record you can try playing the PSR-530 the way it is set up by using the “Rehearsal Mode”: press the [SYNC START] button to temporarily disengage the record ready mode, rehearse as necessary, then press the [SYNC START] button again to return to the record ready mode.
- If the memory becomes full while recording, “Full” will appear on the display and recording will stop (the rehearsal mode will be engaged).
- Even though you can start recording with the user style memory space thoroughly consumed, “Full” will be shown on the display and the recording will forcibly be stopped. In this case, first exit from the record mode, next select the unnecessary user style, and then enter the record mode again and execute the Clear function (see page 70) to secure the free space to record.
- For recording the RHYTHM 1/2 tracks, the instrument symbols printed on the front edge of the panel show you the instrument assignments to each key. See Keyboard Percussion on page 19 for playing each drum/percussion sound.

9 Stop Recording

Stop recording by pressing the [START/STOP] button. When recording is stopped the MEASURE number on the display will return to “1”.



NOTE

- You can also press the [SYNC START] button to stop recording and return to the record ready mode.

10 Record Additional Sections & Tracks as Required

By repeating steps 5 through 9, above, you can select and record additional sections and tracks as required.

11 Exit From the Record Mode

When you're finished recording a style, press the **[RECORD]** button so that its indicator goes out to exit from the record mode. The recorded user style can now be used in the same way as the preset styles (page 22).



NOTE

- The voice data in specific user style tracks can be "revoiced" in the same way as the preset styles, as described on page 80. This, however, does not actually rewrite the user style data. In order to actually change the user style data first use the revoice function, then immediately engage and disengage the style record mode without recording any data.

Drum Cancel

This function makes it possible to erase specific drum instruments from the RHYTHM 1 and RHYTHM 2 tracks.

While recording either the RHYTHM 1 or RHYTHM 2 track, use the SUB MENU **[▲]** and **[▼]** buttons to select the "Cancel".

:Cancel

Then press the key on the key board corresponding to the instrument you want to cancel.

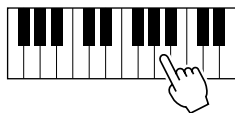

Quantize

Quantization can be used to align notes to the nearest specified beat to tighten up loose timing.

- 1 With the style record ready mode (or rehearsal mode) engaged and the target style and its section selected, use the SUB MENU [▲] and [▼] buttons to select the “YES:Quantiz?”.

YES:Quantiz?

- 2 Press the [+] (YES) button to engage the quantize function (or [-] to abort). The current quantize value will appear to the left of “Quantize” on the top line of the display. Use the [-] and [+] buttons, or data dial to select the desired quantize value (see the chart below). When the quantize function is executed, all notes in the target track will be aligned with the nearest note of the corresponding value.

4:Quantize

Quantize Value	Note
4	Quarter note
6	Quarter note triplet
8	Eighth note
12	Eighth note triplet
16	Sixteenth note
24	Sixteenth note triplet
32	Thirty-second note

One measure of 8th notes before quantization



After quantization



- 3 Press the SUB MENU [▼] button once so that “: Execute?” appears on the display. Then press the [+] (YES) button to execute the quantize function, or the [-] (NO) button to cancel.

:Execute?

Clearing User Style Data

This function makes it possible to clear unneeded data from the PSR-530 User Style tracks.

Clearing an Entire Style

While the STYLE record-ready or rehearsal mode is engaged use the SUB MENU [▲] and [▼] buttons to select the “All Clr?” function, then press the [+] (YES) button: “Sure?” will appear on the display. Press the [+] (YES) button a second time to actually clear the currently selected user style (the preset styles and cartridge styles cannot be cleared). Press [-] (NO) if you want to abort the clear operation.

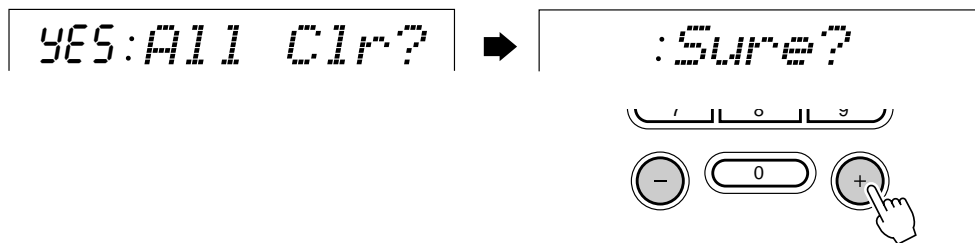

Clearing Selected Style Tracks

While the STYLE record-ready or rehearsal mode is engaged and a section is selected, use the SUB MENU [▲] and [▼] buttons to select the “TrkClr” function. The style track icons corresponding to tracks which contain data will flash. Use the TRACK buttons to select track(s) you want to clear (frames will appear continuously around the selected tracks).

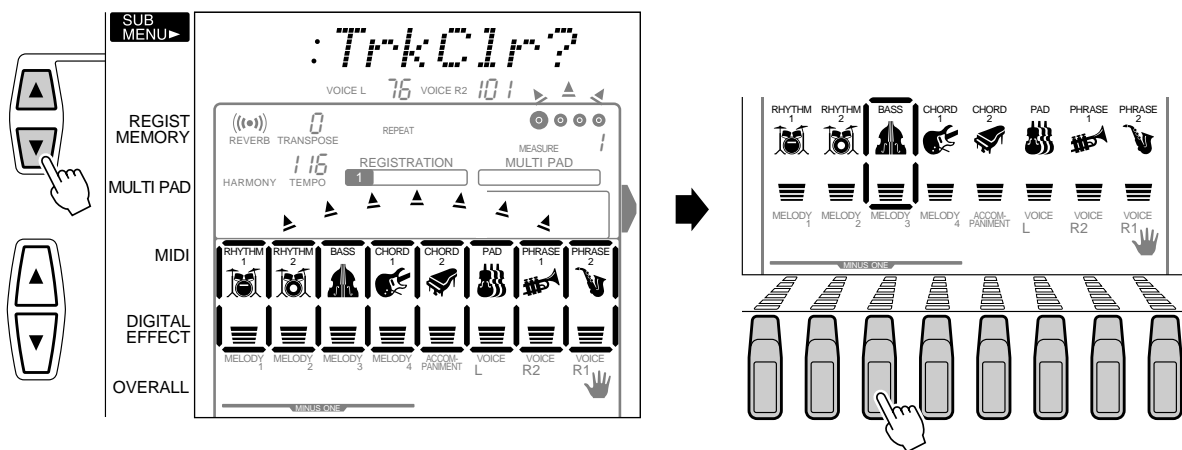

Once the desired tracks have been selected, “Sure?” will appear on the display. Press the [+] (YES) button to actually clear the currently selected track(s). Press [-] (NO) if you want to abort the clear operation.

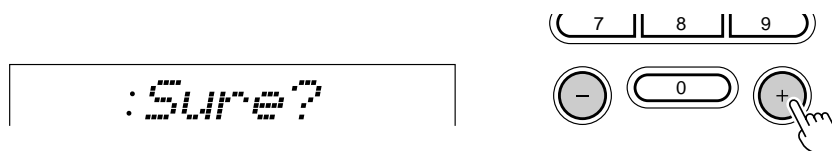

Multi Pad Recording

In addition to the preset MULTI PAD sets, the PSR-530 has 4 user-recordable sets that you can use to store your own creations.

NOTE

- Material recorded in the MULTI PADS will be retained even after turning the power off. See page 98 for the details.
- The recorded data will be lost if the power is turned off, the AC adaptor is unplugged, or the batteries fail during recording.
- The Shortcut functions are not available when one of the Record modes is engaged.

● The MULTI PADS record the following operations and data:

- Note on/off.
- Velocity.
- R1 voice (voice number, volume, reverb send level, chorus send level, octave, pan).
- Chord match on/off (pad 1...4).
- Pitch bend, pitch bend range.
- Sustain on/off.

NOTE

- Up to approximately 100 notes for each pad can be recorded in the PSR-530 MULTI PADS.

MULTI PAD Recording Procedure

1 Engage the Record Ready Mode

Press the [RECORD] button to engage the record-ready mode. The [RECORD] button indicator will light, and the SONG, STYLE, and MULTI PAD [1] ... [4] icons will flash, indicating that you must select one of the corresponding record modes.

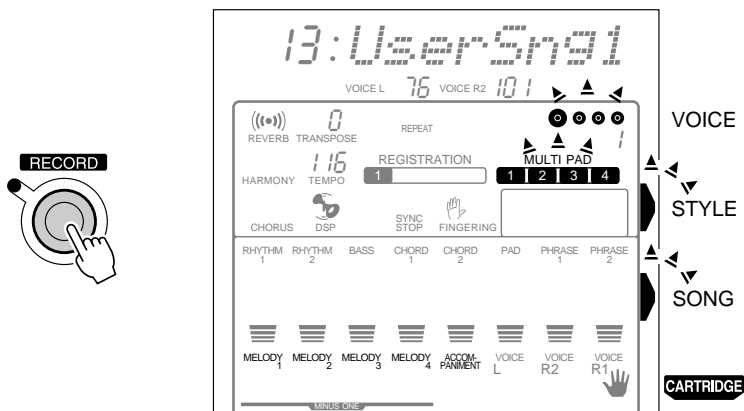

2 Select the MULTI PAD Record Mode

Press any MULTI PAD button ([1] ... [4]) to select the MULTI PAD record mode (the MULTI PAD button you press will be selected for recording). The MULTI PAD menu will automatically be selected and a user pad set number will appear on the top line of the display. The beat indicator dots will flash at the currently set tempo, indicating that the record ready (synchro-start) mode is engaged.

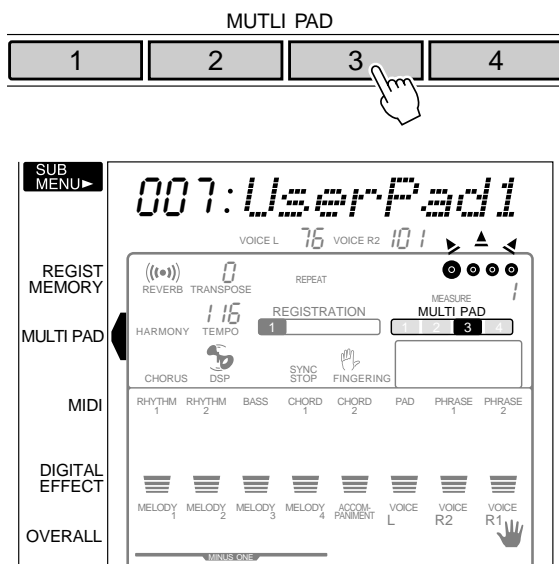

NOTE

- If the [RECORD] button is pressed while a preset pad set is selected, the lowest-numbered user pad set which does not contain any recorded data will automatically be selected. If other user pad sets already contain data, however, user pad number 1 will be selected.
- The DSP effect cannot be turned on during MULTI PAD recording or the MULTI PAD record standby mode. If the DSP effect is on when the MULTI PAD record mode is engaged, it will automatically be turned off.
- If the Metronome function is on (page 85), the metronome will sound at the current tempo.

3 If Necessary, Select a User Pad Set Number

If the desired user pad set is not already selected, use the [-] and [+] buttons, the number buttons, or the data dial to select as required.



4 If Necessary, Select a MULTI PAD to Record

If the MULTI PAD you pressed in step 2, above, is not the one you want to record, you can select any other pad at this point simply pressing the appropriate MULTI PAD button. The selected MULTI PAD icon will appear in the display.

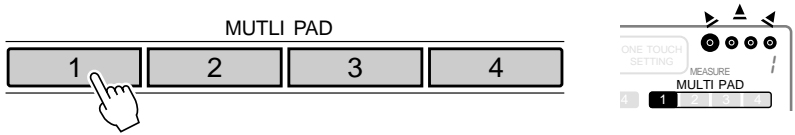

5 Specify Chord Match if Required

If you record a MULTI PAD with a pitched voice, the Chord Match function (see page 51) can be specified for that pad by using the SUB MENU buttons to select the Chord Match function for the corresponding pad (“Pad1Chd” ... “Pad4Chd”) while in the record standby or rehearsal mode, and then using the [+] button to turn it “On” or “Off” as you like.

NOTE

- The Chord Match on/off status can be changed in the SUB MENU “MULTI PAD” even after exiting the recording mode.

on: Pad1Chd

6 Record

Recording will begin as soon as you play a note on the keyboard or press the [START/STOP] button, and the BEAT indicator dots will begin to indicate the current beat as in the Auto Accompaniment mode. If you are recording a Chord Match phrase, be sure to base your phrase on a CM7 chord to ensure proper Chord Match operation. See page 67 for more details on recording around a CM7 chord.

NOTE

- Before actually starting to record you can try playing the PSR-530 the way it is set up by using the “Rehearsal Mode”: press the [SYNC START] button to temporarily disengage the record ready mode, rehearse as necessary, then press the [SYNC START] button again to return to the record ready mode.
- Whenever you record a MULTI PAD, any previously recorded material in the same MULTI PAD will be erased.
- If the memory becomes full while recording, “Full” will appear on the display and re-recording will stop (the record-ready mode will be engaged).



7 Stop Recording

Stop recording by pressing the [START/STOP] button.



8 Record Additional Pads as Required

By repeating steps 3 through 7, above, you can select and record additional pads as required.

9 Exit From the Record Mode

When you’re finished recording pads, press the [RECORD] button so that its indicator goes out to exit from the record mode. The recorded user pads can now be played back in the same way as the preset pads (page 49).



Clearing MULTI PAD Data

This function makes it possible to clear unneeded data from the PSR-530 MULTI PADS.

Clearing an Entire Pad Set

While the MULTI PAD record-ready or rehearsal mode is engaged use the SUB MENU [▲] and [▼] buttons to select the “BankClr” function, then press the [+] (YES) button: “Sure?” will appear on the display. Press the [+] (YES) button a second time to actually clear the currently selected pad set (the preset pad sets cannot be cleared). Press [-] (NO) if you want to abort the clear operation.

NOTE

- “- - -: PadClr?” will be shown on the display if all the pads for the selected set are cleared.

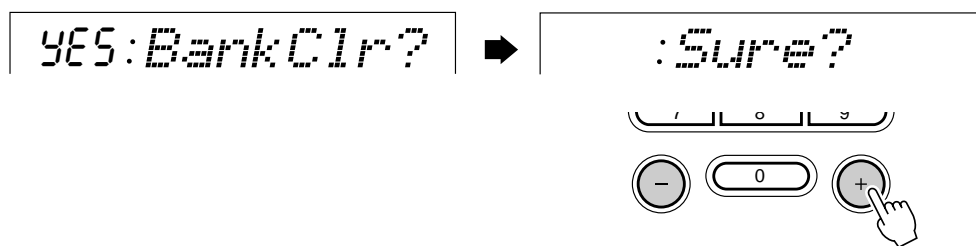

Clearing Selected MULTI PADS

While the MULTI PAD record-ready or rehearsal mode is engaged use the SUB MENU [▲] and [▼] buttons to select the “PadClr” function. The MULTI PAD icons corresponding to pads which contain data will flash (preset pad set data cannot be cleared).

NOTE

- If the pad you selected has already been cleared, “- - -: PadClr?” will appear on the display.

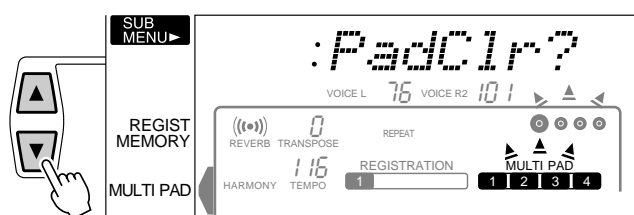

Use the **MULTI PAD** buttons to select the pad you want to clear (the icon corresponding to the selected pad will flash). “Sure?” will appear on the display. Press the [+] (YES) button to actually clear the currently selected pad. Press [-] (NO) if you want to abort the clear operation.

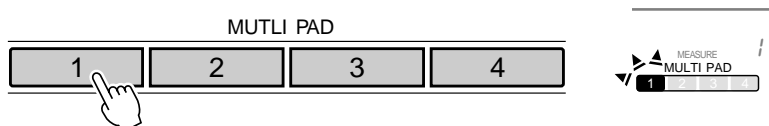

Using Music Cartridges

The PSR-530 features a cartridge slot which accepts pre-programmed Yamaha Music Cartridges containing style and/or song data. One sample Music Cartridge containing song data is supplied with the PSR-530. Others are available from your Yamaha dealer.

◆ Inserting a Music Cartridge

With the power OFF, insert the Music Cartridge into the cartridge slot as shown, and press down firmly until the Cartridge is seated properly (as shown in the illustration). The Cartridge is shaped so that it will only fit in the slot one way - don't try to force it in the wrong way. Turn the power back ON again after inserting.

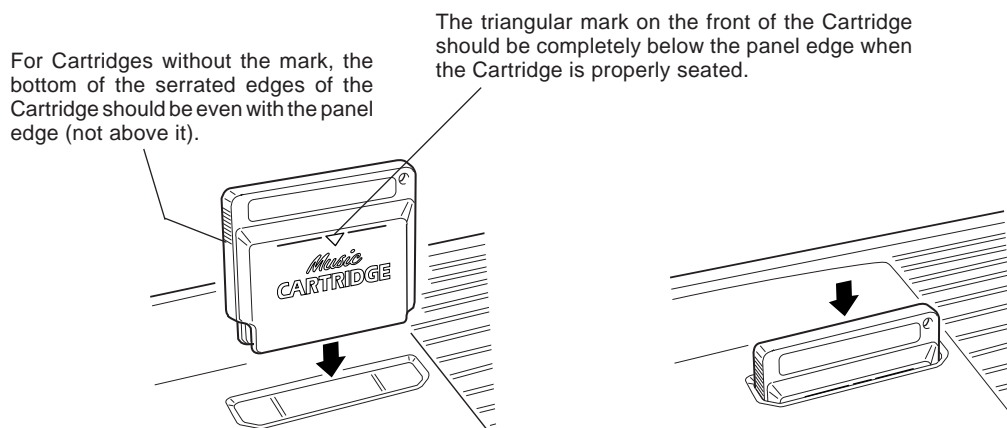

◆ Music Cartridge Handling Precautions

- Do not leave Music Cartridges in locations which are subject to excessive heat or humidity.
- Do not drop Music Cartridges or subject them to strong shock.
- Do not disassemble Music Cartridges.
- Do not directly touch the Music Cartridge's electrical contacts. Persistently touching it may cause to break electrical contacts or generate static electricity. Static electric charges can cause loss of data and unreliable operation.
- Do not insert objects or cartridges other than Yamaha Music Cartridges in the PortaTone cartridge slot. Doing so can result in serious damage to the instrument.
- **Never attempt to insert or remove a cartridge when the STANDBY/ON switch is ON. Doing so can result in loss of the PSR-530 memory data (song data/registration memory data) or complete lack of control.**
- The Music Cartridge data may not be selected or played back correctly, if the electrical contacts on the Music Cartridge are affected with dust. If this happens, insert and remove the Music Cartridge several times. This may solve the problem. If the problem still happens, wipe and clean the electrical contacts on the Music Cartridge with a dry soft cloth.

NOTE

- Be sure to insert the Music Cartridge when you recall the registration settings based on the cartridge data or playback the song based on the cartridge data. Otherwise, "No Cart (Cartridge)" will appear on the display.

Cartridge Songs

Using Yamaha Music Cartridges (the one supplied with the PSR-530 includes 7 songs, others are available from your Yamaha dealer), the PSR-530 will let you enjoy listening to automated performances, or function as your “private music tutor,” allowing you to practice various parts of a piece while the others are played automatically.

NOTE

- The included music cartridge is made exclusively for the PSR-530. The data on the cartridge may not be played back properly with the other models.

Cartridge Song Playback

1 Select the Cartridge Menu

Press the [CARTRIDGE] button to select the CARTRIDGE menu (the triangular indicator will appear next to “CARTRIDGE” to the right of the display). The number and name of the currently selected cartridge song will appear on the top line of the display, the CART icon will appear in the upper left corner of the display, and the song track and volume icons near the bottom of the display will appear framed. The [START/STOP] indicator will flash.

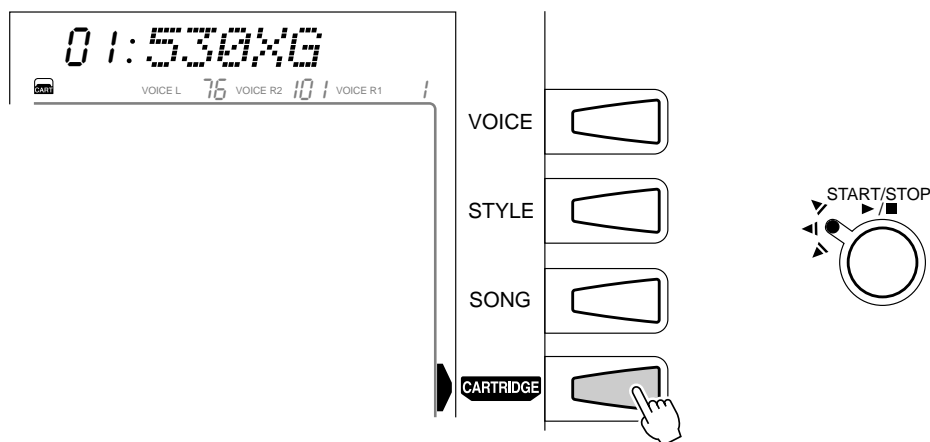

NOTE

- Cartridge song numbers can also be selected from the SONG menu as follows: press and hold the number [3] button until the cartridge icon appears in the display, then enter the number of the cartridge song you want to select via the number buttons in the normal way.
- The cartridge songs can also be selected from the SONG menu by using the [-] and [+] buttons or data dial to go beyond the highest or lowest internal song numbers — e.g. pressing the [+] button while internal song number 16 is selected will select cartridge song number 1 (the cartridge icon will appear).

2 Select a Cartridge Song Number

Use the [-] and [+] buttons, number buttons, or data dial to select the cartridge song number you want to play. The song number can also be incremented by pressing the [CARTRIDGE] button: press briefly to increment by one, or hold for continuous incrementing.

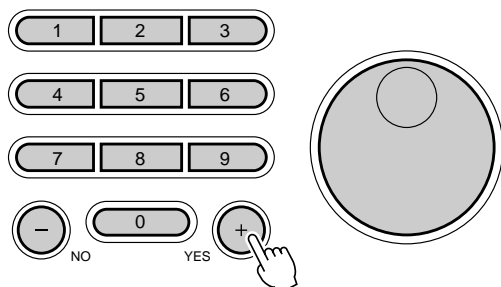

3 Start Playback

Playback will begin as soon as the [START/STOP] button is pressed. You can turn the MELODY and ACCOMPANIMENT tracks on and off during playback as required by using the TRACK buttons.



NOTE

- Playback can be started from any measure — page 54.
- The playback tempo can be changed freely as required.
- Cartridge song data cannot be revoiced.
- You may not be able to play back the cartridge songs properly just after turning the power on since it takes a while for the PSR-530 to read the cartridge data.

Cartridge Accompaniment Styles

Optional Style Music Cartridges provides extra accompaniment styles that can be used in the same way as the internal accompaniment styles after pressing the [STYLE] button to select the STYLE menu.

Cartridges which contain both song and style data require a slightly different style selection procedure: Press and hold the number [3] button until the cartridge icon appears to the left of the style name in the display, then enter the number of the cartridge style you want to select via the number buttons or data dial in the normal way. The cartridge styles can also be selected by using the [-] and [+] buttons or data dial to go beyond the highest or lowest internal style numbers — e.g. pressing the [+] button while internal style number 100 is selected will select cartridge style number 01 (the cartridge icon will appear).

The cartridge styles are used in exactly the same way as the internal accompaniment styles (page 22).

NOTE

- Some cartridge styles, for example, have A and B intro and ending sections as well as A and B main sections. In such a case, if the [INTRO] and MAIN/AUTO FILL [A] buttons are pressed in order to start the accompaniment with an introduction and then go to the main A section, the intro A section will play. If the [INTRO] and MAIN/AUTO FILL [B] buttons are pressed, the intro B section will play. A similar situation applies to endings: if the main A or B section is playing and the [ENDING] button is pressed, the ending A or B section will play accordingly.
- You may not be able to select the cartridge styles just after turning the power on since it takes a while for the PSR-530 to read the cartridge style data.

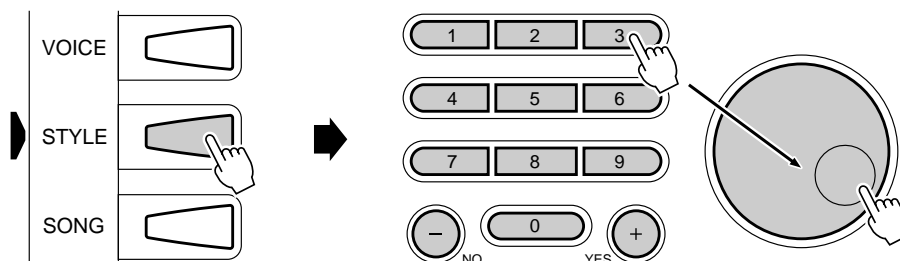

Revoicing

The PSR-530 REVOICE function lets you change the following parameters for the R1, R2 and L voices, the AUTO ACCOMPANIMENT tracks, and the user SONG tracks.

● Revoice Parameters

Parameter	Display	Range	Comments
Voice	Voice Name	1 ... 692	Assigns a voice number to the specified PSR-530 voice or track.
Volume	<i>Volume</i>	0 ... 127	Sets the volume of the specified PSR-530 voice or track.
Octave	<i>Octave</i>	-2 ... 2	Shifts the pitch of the specified voice or track up or down by one or two octaves. A setting of "0" produces normal pitch.
Pan	<i>Pan</i>	-7 ... 7	Positions the sound of the specified voice or track from left to right in the stereo sound field. "-7" is full left, "7" is full right, "0" is center, and all other settings are corresponding positions in between.
Reverb Send Level	<i>RevSndLv</i>	0 ... 127	Sets the reverb send level for the specified voice or track, and thus the amount of reverb effect applied to that voice or track.
Chorus Send Level	<i>ChoSndLv</i>	0 ... 127	Sets the chorus send level for the specified voice or track, and thus the amount of chorus effect applied to that voice or track.
DSP Send Level	<i>DspSndLv</i>	0 ... 127	Sets the DSP send level for the specified voice or track, and thus the amount of DSP effect applied to that voice or track.

Revoicing the R1, R2, and L Voices

1 Select the VOICE REVOICE Mode

While the VOICE menu is selected, press the [REVOICE] button (actually, the order here is not important: you can also press the [VOICE] button after pressing the [REVOICE] button). The [REVOICE] button indicator will light and a frame will appear around the R1 voice icon in the display (i.e. the R1 voice is initially selected for revoicing).

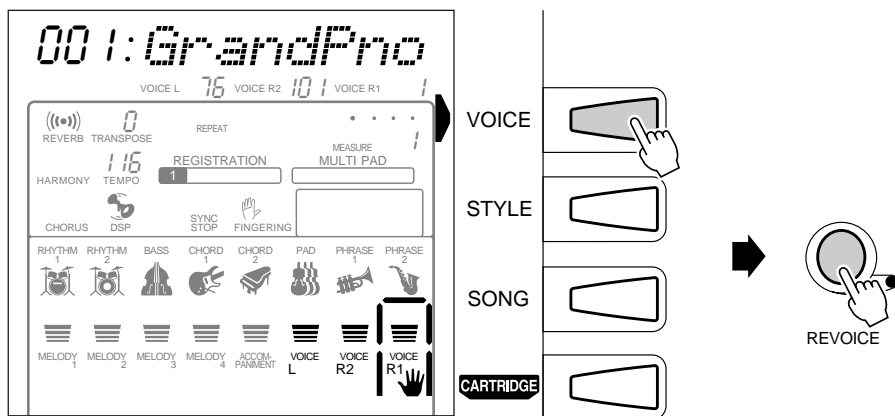

NOTE

- The VOICE REVOICE mode will automatically be selected if the [REVOICE] button is pressed while any menu other than STYLE or SONG is selected.
- The VOICE REVOICE mode cannot be selected while one of the record modes is engaged.

2 If Necessary Select a Voice to Revoice

Use the three rightmost **TRACK** buttons to select the voice you want to revoice: L, R2, or R1. A frame will appear around the icon of the selected voice.

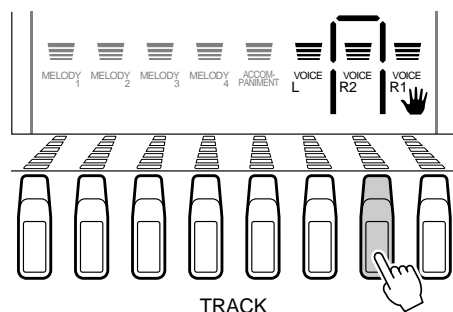

NOTE

- The **TRACK** button below the selected voice can be used to turn the voice on or off. Make sure that the voice is turned on if you want to monitor the sound while revoicing (the R1 voice cannot be turned off).

3 Select and Edit the Revoice Parameters

Use the **SUB MENU** [**▲**] and [**▼**] buttons to select the desired parameter. The name of the selected parameter will appear on the top line of the display to the right of the parameter's current value. Use the [**-**] and [**+**] buttons, the number buttons, or the data dial to set the parameter's value as required. Refer to the "Revoice Parameters" chart on page 78.

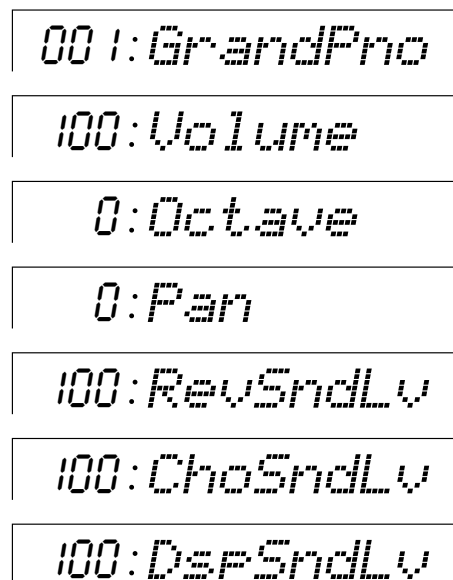

Shortcut

- You can jump directly to the **REVOICE R2 VOICE** display by pressing and holding the [**DUAL VOICE**] button for a few seconds.
- You can jump directly to the **REVOICE L VOICE** display by pressing and holding the [**SPLIT VOICE**] button for a few seconds.

NOTE

- Minus settings for the **Octave** and **Pan** parameters can be directly entered by pressing the appropriate number button while holding the [**-**] button.
- When the **DSP** type is set as **insertion**, the **DSP depth** parameter cannot be changed.
- The **REVOICE** mode will automatically be exited if the **MENU** [**▲**] and [**▼**] buttons are used to select any of the menus to the left of the display, or if the [**CARTRIDGE**] button is pressed.
- Save any revoice settings you want to keep to the **PSR-530 REGISTRATION MEMORY** (page 47). The revoice settings are temporary and will be lost if the power is turned off, a different R1 panel voice is selected while the **Voice Set** function is on, or a **REGISTRATION MEMORY** is recalled.

4 Repeat as Required and Exit When Done

Repeat steps 2 and 3, above, to revoice the voices as required, then press the [**REVOICE**] button so that its indicator goes out to exit from the **REVOICE** mode.



REVOICE

Revoicing a Style

1 Select the STYLE REVOICE Mode

While the STYLE menu and the style you want to revoice are selected, press the [REVOICE] button (actually, the order here is not important: you can also press the [STYLE] button after pressing the [REVOICE] button). The [REVOICE] button indicator will light and a frame will appear around the RHYTHM 1 track icon in the display (i.e. the RHYTHM 1 track is initially selected for revoicing).

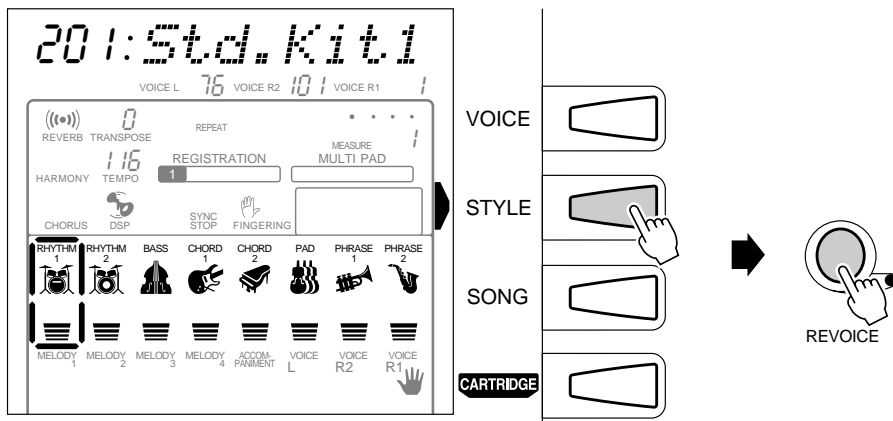

NOTE

- The **STYLE REVOICE** mode can even be selected by pressing the [REVOICE] button while an accompaniment is playing.
- The **STYLE REVOICE** mode cannot be selected while one of the record modes is engaged.
- The **STYLE REVOICE** mode cannot be selected while a song or voice is being revoiced during song playback.
- The Registration Memory Freeze function will automatically be turned on when entering the Style Revoice Mode.

2 Select the Section(s) to be Revoiced

Press **INTRO**, **MAIN A/B** or **ENDING** button(s) to select the section(s).

NOTE

- Style revoicing affects all sections of the selected style.

3 If Necessary Select a Track to Revoice

Use the **TRACK** buttons to select the accompaniment track you want to revoice: RHYTHM 1, RHYTHM 2, BASS, CHORD 1, CHORD 2, PAD, PHRASE 1, or PHRASE 2. A frame will appear around the icon of the selected track.

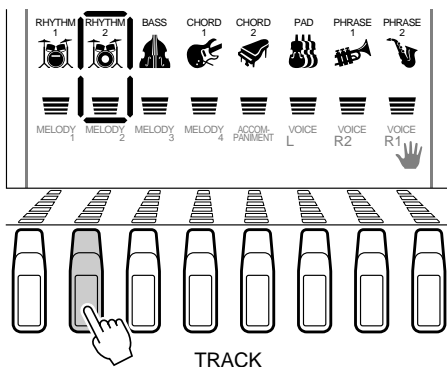

NOTE

- The **TRACK** button below the selected track can be used to turn the track on or off. Make sure that the track is turned on if you want to monitor the sound while revoicing.
- Only drum kits (voice numbers 127 ... 136) can be selected for the RHYTHM 1 track.
- Any voice can be selected for the RHYTHM 2 track, but please note that the RHYTHM 2 track is not affected by the AUTO ACCOMPANIMENT feature.
- The **OCTAVE** parameter and the **DSP** send level cannot be edited in the **STYLE REVOICE** mode.

4 Select and Edit the Revoice Parameters

Use the SUB MENU [▲] and [▼] buttons to select the desired parameter. The name of the selected parameter will appear on the top line of the display to the right of the parameter's current value. Use the [-] and [+] buttons, the number buttons, or the data dial to set the parameter's value as required. Refer to the "Revoice Parameters" chart on page 78.

NOTE

- "- - -" will appear on the top line of the display if you select an accompaniment track which contains no data for revoicing, and revoicing will not be possible.
- Minus settings for the Octave and Pan parameters can be directly entered by pressing the appropriate number button while holding the [-] button.
- When a voice (especially bass voices) used for a Style is changed from the XG Voice to the Panel Voice using the Revoice function, the octave played for the voice may change.
- The REVOICE mode will automatically be exited if the MENU [▲] and [▼] buttons are used to select any of the menus to the left of the display, or if the [CARTRIDGE] button is pressed.
- Save any revoice settings you want to keep to the PSR-530 REGISTRATION MEMORY (page 47). The revoice settings are temporary and will be lost if the power is turned off, a different style is selected, or a REGISTRATION MEMORY is recalled.

5 Repeat as Required and Exit When Done

Repeat steps 2 and 4, above, to revoice the tracks as required, then press the [REVOICE] button so that its indicator goes out to exit from the REVOICE mode.



Revoicing a User Song

1 Select the SONG REVOICE Mode

While the SONG menu and the user song you want to revoice are selected, press the [REVOICE] button (actually, the order here is not important: you can also press the [SONG] button after pressing the [REVOICE] button). The [REVOICE] button indicator will light and a frame will appear around the MELODY 1 track icon in the display (i.e. the MELODY 1 track is initially selected for revoicing).

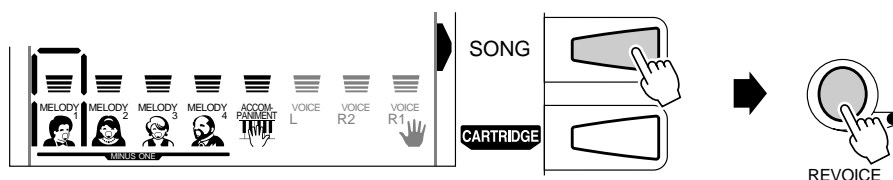

NOTE

- Revoicing a user song actually rewrites the recorded song data, so the original data will be lost.
- The pre-programmed internal songs and cartridge songs cannot be revoiced.
- The SONG REVOICE mode cannot be selected while one of the record modes is engaged.
- The SONG REVOICE mode cannot be selected while a style or voice is being revoiced during accompaniment style playback.

2 If Necessary Select a Track to Revoice

Use the **TRACK** buttons to select the SONG track you want to revoice: MELODY 1 ... MELODY 4, or ACCOMP. A frame will appear around the icon of the selected track.

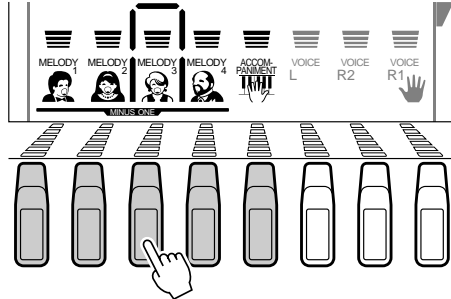

NOTE

- The **TRACK** button below the selected track can be used to turn the track on or off. Make sure that the track is turned on if you want to monitor the sound while revoicing.
- The revoicing cannot be executed when the memory space is almost full with the user songs.
- When you revoice the user song data during its playback and exit from the **REVOICE** mode, the song will automatically be stopped.

3 Select and Edit the Revoice Parameters

Use the **SUB MENU** [▲] and [▼] buttons to select the desired parameter. The name of the selected parameter will appear on the top line of the display to the right of the parameter's current value.

100: RevSndLv

Use the [-] and [+] buttons, the number buttons, or the data dial to set the parameter's value as required. Refer to the "Revoice Parameters" chart on page 78.

70: RevSndLv

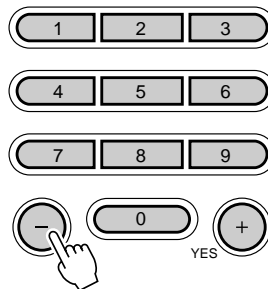

NOTE

- "- - -" will appear on the top line of the display if you select a song track which contains no data for revoicing, and revoicing will not be possible.
- Only the Volume parameter can be revoiced for the **ACCOMPANIMENT** track. If you attempt to change any other parameter "- - -" will appear on the top line of the display and revoicing will not be possible.
- If the R1 and R2 voices have been recorded to a single track, only the R1 voice can be revoiced.
- Minus settings for the Octave and Pan parameters can be directly entered by pressing the appropriate number button while holding the [-] button.
- Only one song revoice parameter can be recorded per track. If you revoice a song while playing back the song, only the last-entered data will be recorded.

4 Repeat as Required and Exit When Done

Repeat steps 2 and 3, above, to revoice the tracks as required, then press the **[REVOICE]** button so that its indicator goes out to exit from the **REVOICE** mode.



NOTE

- The **REVOICE** mode will automatically be exited if the **MENU** [▲] and [▼] buttons are used to select any of the menus to the left of the display, or if the **[CARTRIDGE]** button is pressed.
- Since revoicing a user song actually rewrites the song data, the revoiced song will remain in memory as long as a working set of batteries is installed in the PSR-530, or the AC adapter is connected.

Overall Functions

Some of the functions in the OVERALL function group have already been described in appropriate sections of this manual. Others will be introduced for the first time in this section. Refer to the chart below for the page numbers on which each function is described. The chart also lists the full name of each function, the abbreviated name which appears on the display, and the available settings or range of settings. Ranges are indicated by two or more values separated by ellipsis (...).

Function	Display	Settings	Page
Touch Sensitivity	<i>TouchSns</i>	0 ... 127	84
Pitch Bend Range	<i>PBRnge</i>	01 ... 12	45
Master Tuning	<i>Tuning</i>	-50 ... +50	84
Scale Tuning Note	<i>SC.Note</i>	C ... b	84
Scale Tuning	<i>SC.Tune</i>	-64 ... 63	84
Song Transpose	<i>SongTrns</i>	-12 ... +12	85
Metronome	<i>Metronom</i>	oFF, on	85
Split Voice Split Point	<i>S.Split</i>	0 ... 127	21
Accompaniment Split Point	<i>AccSPnt</i>	0 ... 127	29
Fingering Mode	<i>FngrngMd</i>	SF, F1, F2, FuL, MuL	30
Voice Set	<i>VoiceSet</i>	oFF, on	85

To access an OVERALL function first use the MENU [▲] and [▼] buttons to move the triangular indicator in the display next to “OVERALL”.

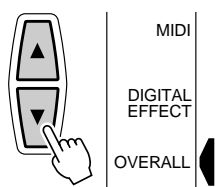

Then use the SUB MENU [▲] and [▼] buttons to select the desired function from within the OVERALL menu. When a function is selected the current setting will appear to the left of the function name on the top line of the display. Once the function has been selected, use the [-] and [+] buttons or data dial (or number buttons, where applicable) to set the function as required.

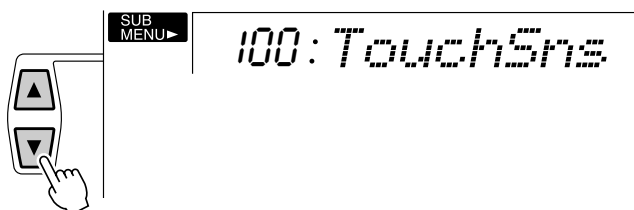

Touch Sensitivity

This function sets the keyboard touch sensitivity. The range is from “0” to “127”. The higher the value the higher the sensitivity. When the touch sensitivity value is set to “0”, “oFF” appears in the display and the same volume is produced no matter how hard you play the keys. — this setting can produce a more realistic effect with voices that normally do not have touch response: e.g. organ and harpsichord.

100: TouchSns

Pitch Bend Range

See page 45.

Master Tuning

The Tuning function sets the overall pitch of the PSR-530 over a ± 100 cent range (from -100 to $+100$) in 1-cent increments. Since 1 cent is 1/100th of a semitone, the total tuning range is from a semitone below normal pitch to a semitone above normal pitch.

000: Tuning

NOTE

- The “normal” tuning value (“0”) can be recalled by simultaneously pressing the [-] and [+] buttons.
- Minus values can be entered by using the number buttons while holding the [-] button.

Scale Tuning

Scale tuning allows each individual note of the octave to be tuned over range from -64 to $+63$ cents in 1-cent increments (1 cent = 1/100th of a semitone). This makes it possible to produce subtle tuning variations, or tune the instrument to totally different scales (e.g. classic or Arabic scales).

First use the SC.Note function to select the note to be tuned. The range is from C to b: C, $d\flat$, d, $E\flat$, E, F, $G\flat$, G, $A\flat$, A, $b\flat$, b.

C: SC. Note

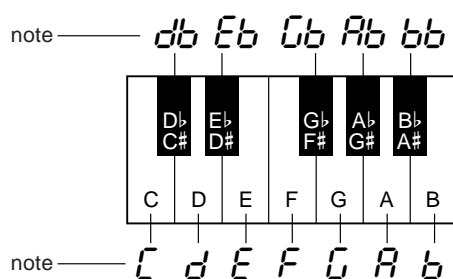

NOTE

- The scale tuning settings are common to each octave on the keyboard.
- The Accompaniment and Multi Pad sound is affected by Scale Tuning.
- The “normal” tuning value (“0”) can be recalled by simultaneously pressing the [-] and [+] buttons.
- Minus values can be entered by using the number buttons while holding the [-] button.

Then use the SC.Tune function to tune the selected note as required.

-50: SC. Tune

Song Transpose

This function allows you to transpose only the song to be played back. That means you can play along with your desired song (Minus-one function) in the desired key without affecting your performance.

02 : SongTrns

NOTE

- Since the Transpose function (page 46) sets the overall transpose value, if it is changed, the Song Transpose value will be changed by the same amount at the same time.
- The "normal" transpose value ("00") can be recalled by simultaneously pressing the [-] and [+] buttons.
- Minus values can be entered by using the number buttons while holding the [-] button.
- The Song Transpose value is automatically set to "00" when the record mode is engaged.

Metronome

When turned "on" the PSR-530 metronome will sound during AUTO ACCOMPANIMENT playback as well as SONG playback and recording.

on : Metronom

Split Voice Split Point

See page 21.

Accompaniment Split Point

See page 29.

Fingering Mode

See page 30.

Voice Set

The VOICE SET feature brings out the best in each individual voice by automatically setting a range of important voice-related parameters whenever an R1 panel voice (voice numbers 1 ... 200) is selected. The parameters that may be set by the VOICE SET feature are listed below. This function lets you turn VOICE SET on or off, as required.

on : VoiceSet

NOTE

- The Voice Set function is on by default when the power is initially turned on.

● Voice Set parameter list

- R1 Voice (Volume, Pan)
- R2 Voice (Voice number, volume, octave, pan, reverb send level, chorus send level, DSP send level)
- DSP return level
- Harmony type, volume
- Pitch Bend Range

The parameter below is set whether or not the voice set function is on or off.

- R1 Voice (Octave, reverb send level, chorus send level, DSP send level)
- Reverb ON/OFF
- Chorus ON/OFF
- DSP ON/OFF, variation ON/OFF
- DSP type

MIDI Functions

In the rear panel of your PSR-530, there are MIDI terminals (MIDI IN, MIDI OUT), a TO HOST terminal, and a HOST SELECT switch. By using the MIDI functions you can expand your musical possibilities. This section explains what MIDI is, and what it can do, as well as how you can use MIDI on your PSR-530.

What's MIDI?

No doubt you have heard the terms “acoustic instrument” and “digital instrument.” In the world today, these are the two main categories of instruments. Let's consider an acoustic piano and a classical guitar as representative acoustic instruments. They are easy to understand. With the piano, you strike a key, and a hammer inside hits some strings and plays a note. With the guitar, you directly pluck a string and the note sounds. But how does a digital instrument go about playing a note?

● Acoustic guitar note production

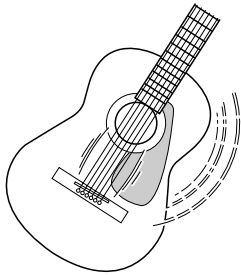

Pluck a string and the body resonates the sound.

● Digital instrument note production

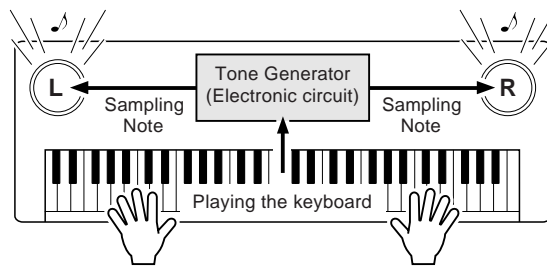

Based on playing information from the keyboard, a sampling note stored in the tone generator is played through the speakers.

As shown in the illustration above, in an electronic instrument the sampling note (previously recorded note) stored in the tone generator section (electronic circuit) is played based on information received from the keyboard. So then what is the information from the keyboard that becomes the basis for note production?

For example, let's say you play a “C” quarter note using the grand piano sound on the PSR-530 keyboard. Unlike an acoustic instrument that puts out a resonated note, the electronic instrument puts out information from the keyboard such as “with what voice,” “with which key,” “about how strong,” “when was it pressed,” and “when was it released.” Then each piece of information is changed into a number value and sent to the tone generator. Using these numbers as a basis, the tone generator plays the stored sampling note.

Example of Keyboard Information

Voice number (with what voice)	01 (grand piano)
Note number (with which key)	60 (C3)
Note on (when was it pressed) and note off (when was it released)	Timing expressed numerically (quarter note)
Velocity (about how strong)	120 (strong)

MIDI is an acronym that stands for Musical Instrument Digital Interface, which allows electronic musical instruments to communicate with each other, by sending and receiving compatible Note, Control Change, Program Change and various other types of MIDI data, or messages.

The PSR-530 can control a MIDI device by transmitting note related data and various types of controller data. The PSR-530 can be controlled by the incoming MIDI messages which automatically determine tone generator mode, select MIDI channels, voices and effects, change parameter values and of course play the voices specified for the various parts.

MIDI messages can be divided into two groups: Channel messages and System messages. Below is an explanation of the various types of MIDI messages which the PSR-530 can receive/transmit.

● Channel Messages

The PSR-530 is an electronic instrument that can handle 16 channels. This is usually expressed as “it can play 16 instruments at the same time.” Channel messages transmit information such as Note ON/OFF, Program Change, for each of the 16 channels.

Message Name	PSR-530 Operation/Panel Setting
Note ON/OFF	Messages which are generated when the keyboard is played. Each message includes a specific note number which corresponds to the key which is pressed, plus a velocity value based on how hard the key is struck.
Program Change	Voice setting (control change bank select MSB/LSB setting)
Control Change	Revoice setting(volume, pan pot, etc.)

● System Messages

This is data that is used in common by the entire MIDI system. System messages include messages like Exclusive Messages that transmit data unique to each instrument manufacturer and Realtime Messages that control the MIDI device.

Message Name	PSR-530 Operation/Panel Setting
Exclusive Message	Reverb/chorus/DSP settings, etc.
Realtime Messages	Clock setting Start/stop operation

The messages transmitted/received by the PSR-530 are shown in the MIDI Data Format and MIDI Implementation Chart on pages 110 and 122.

◆ MIDI Terminal/TO HOST Terminal

In order to exchange MIDI data between multiple devices, each device must be connected by a cable.

There are two ways to connect: from the MIDI terminals of the PSR-530 to the MIDI terminals of an external device using a MIDI cable, or from the TO HOST port of the PSR-530 to the serial port of a personal computer using a special cable.

If you connect from the PSR-530 TO HOST terminal to a personal computer, the PSR-530 will be used as a MIDI interface device, meaning that a specialized MIDI interface device is not necessary.

In the rear panel of the PSR-530, there are two kinds of terminals, the MIDI terminals and the TO HOST terminal.

- **MIDI IN** Receives MIDI data from another MIDI device.
- **MIDI OUT** Transmits the PSR-530's keyboard information as MIDI data to another MIDI device.
- **TO HOST** Transmits and receives MIDI data to and from a personal computer.

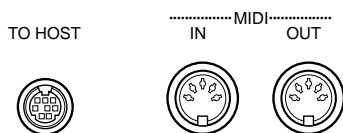

NOTE

- When using the TO HOST terminal to connect to a personal computer using Windows, a Yamaha MIDI driver must be installed in the personal computer. The Yamaha MIDI driver can be obtained at Yamaha's home page on the World Wide Web, <<http://www.yamaha.co.jp/english/xg/>>.
- Special MIDI cables (sold separately) must be used for connecting to MIDI devices. They can be bought at music stores, etc.
- Never use MIDI cables longer than about 15 meters. Cables longer than this can pick up noise which can cause data errors.

What You Can Do with MIDI

- Remotely play another PSR-530



Bulk send/receive (page 95).

- Save/load song and registration memory data to/from the MDF2

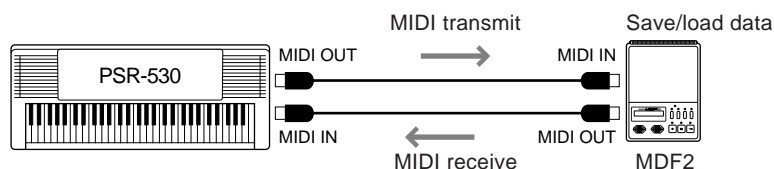

Bulk send/receive (page 95).

- Use the PSR-530 as a multi tone generator (playing 16 channels at one time).

Receive mode for all channels set to "normal."



MIDI receive settings (page 93).

- Play music from another keyboard (no tone generator) using the PSR-530 XG tone generator.



MIDI receive settings (page 93).

Clock settings (page 94).

- Record performance data (1-16 channels) using the PSR-530 Auto Accompaniment and Multi Pad features on an external sequencer (such as a personal computer). After recording, edit the data with the sequencer, then play it again on the PSR-530 (playback).

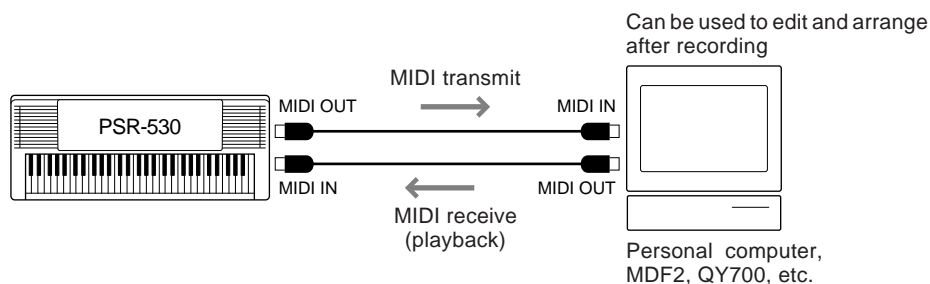

MIDI transmit setting (page 92).

Initial send (page 95).

NOTE

- When using a personal computer, special software (sequencer software) is needed.

Connecting to a Personal Computer

(TO HOST Terminal/HOST SELECT Switch)

You can enjoy using personal computer music software when you connect your PSR-530's TO HOST terminal or MIDI terminals to a personal computer.

There are two ways to connect.

- Connect using the PSR-530 MIDI terminals.
- Connect using the TO HOST terminal.

■ Connect using the PSR-530 MIDI terminals

Using a MIDI interface device installed in the personal computer, connect the MIDI terminals of the personal computer and the PSR-530.

For the connection cable, use a special MIDI cable.

- When the computer has a MIDI interface installed, connect the MIDI OUT terminal of the personal computer to the MIDI IN terminal of the PSR-530. Set the HOST SELECT switch to "MIDI."

Computer (sequencer software)

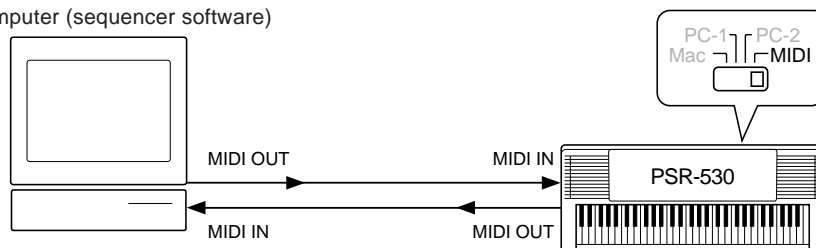

- When using a MIDI interface with a Macintosh series computer, connect the RS-422 terminal of the computer (modem or printer terminal) to the MIDI interface, then connect the MIDI OUT terminal on the MIDI interface to the MIDI IN terminal of the PSR-530, as show in the diagram below.

Set the HOST SELECT switch on the PSR-530 to "MIDI."

Computer (sequencer software)

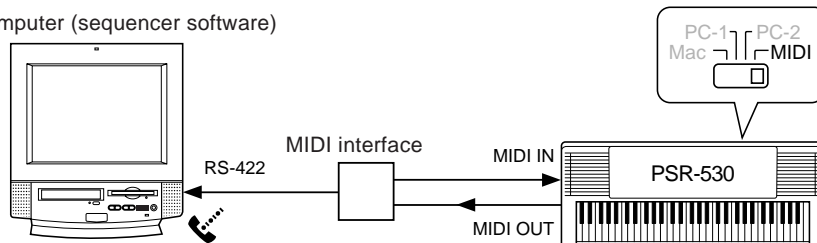

- When the HOST SELECT switch is set in the "MIDI" position, input and output in the TO HOST switch is ignored.
- When using a Macintosh series computer, set the MIDI interface clock setting in the application software to match the setting of the MIDI interface you are using. For details, carefully read the owner's manual for the software you are using.

■ Connect using the TO HOST terminal

Connect the serial port of the personal computer (RS-232C terminal or RS-422 terminal) to the TO HOST terminal of the PSR-530.

For the connection cable, use the cable below (sold separately) that matches the personal computer type.

Macintosh Series

Connect the RS-422 terminal (modem or printer terminal) on the computer to the TO HOST terminal on the PSR-530 using a serial cable (system peripheral cable, 8 bit). Set the PSR-530 HOST SELECT switch in the "MAC" position.

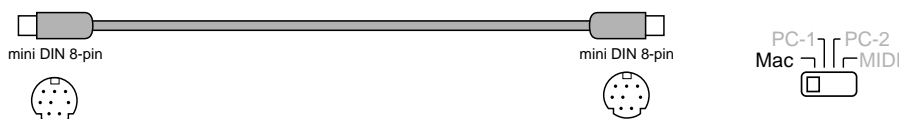

- Set the MIDI interface clock in the sequencer software you are using to 1 MHz. For details, carefully read the owner's manual for the software you are using.

IBM-PC/AT Series

Connect the RS-232C terminal on the computer to the TO HOST terminal on the PSR-530 using a serial cable (D-SUB 9P → MINI DIN 8P cross cable). Set the PSR-530 HOST SELECT switch in the "PC-2" position.

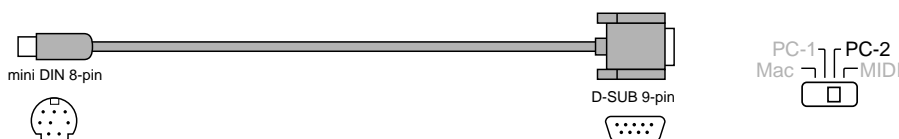

- When using a D-SUB 25P → MINI DIN 8P cross cable, connect using a D-SUB 9P plug adaptor on the computer side of the cable.



For details about the necessary MIDI settings for computer and sequence software you are using, see the owner's manuals for each of them.

Macintosh is a registered trademark of Apple Computer, Inc.
IBM PC/AT is a trademark of International Business Machines Corp.

Other company names and product names, etc. in this manual are registered trademarks or trademarks of those companies.

NOTE

• If you connect from the PSR-530 TO HOST terminal to a personal computer, the PSR-530 will be used as a MIDI interface device, meaning that a specialized MIDI interface device is not necessary.

• When the HOST SELECT switch is set to "MAC," "PC-1," or "PC-2," don't use the MIDI IN/OUT terminals. (MIDI data cannot be sent or received through the MIDI terminals).

• "Host is Offline!!" will be shown on the display, when the Host Select switch is set appropriately and the serial cable is connected to the PSR-530 TO HOST but not to the PC's serial port (or the cable is properly connected to the PC which is currently turned off).

The PSR-530 MIDI Functions

The PSR-530 has the following MIDI functions.

Function	Display	Settings	Page
Transmit Channel	<i>Tr. Ch</i>	<i>1 ... 16</i>	92
Transmit Track	<i>Tr. Trk</i>	<i>r 1, r 2, L, H 1, H 2, H 3, r H 2, r H 1, bRS, CH 1, CH 2, P 3d, PH 1, PH 2, S 1, S 1d, S 2, S 2d, S 3, S 3d, S 4, S 4d, oFF</i>	93
Receive Channel	<i>Rcv. Ch</i>	<i>1 ... 16</i>	93
Receive Mode	<i>Rcv. Mod</i>	<i>nor, oFF, rE</i>	94
Local Control	<i>Local</i>	<i>oFF, on</i>	94
External Clock	<i>ExtClock</i>	<i>oFF, on</i>	94
Bulk Data Send	<i>BlkSnd?</i>	None	95
Initial Data Send	<i>InitSnd?</i>	None	95

To access a MIDI function first use the MENU [▲] and [▼] buttons to move the triangular indicator in the display next to “MIDI”, then use the SUB MENU [▲] and [▼] buttons to select the desired function from within the MIDI menu. When a function is selected the current setting will appear on the top line of the display. Once the function has been selected, use the [-] and [+] buttons or data dial (or number buttons, where applicable) to set the function as required.

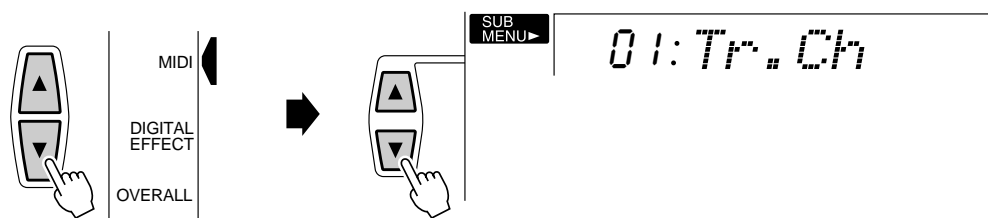

Transmit Channel & Transmit Track

The PSR-530 can simultaneously transmit data on all 16 MIDI channels. The Transmit Channel and Transmit Track functions determine what PSR-530 data is transmitted via which MIDI channels.

● Transmit Channel

The “Tr.Ch” function selects a MIDI channel to which a PSR-530 track can be assigned via the Transmit Track function, below. First select a transmit channel, then the transmit track for that channel. Different tracks can be assigned to each of the 16 MIDI channels. Any of the standard MIDI channels - 1 through 16 — can be specified.

01: Tr. Ch

● Transmit Track

The “Tr.Trk” function selects the track to be transmitted via the transmit channel specified by the Transmit Channel function, above. The available settings are as follows:

r 1: Tr. Trk

r 1	R1 keyboard voice.
r 2	R2 keyboard voice
L	L keyboard voice.
H 1	Harmony note 1.
H 2	Harmony note 2.
H 3	Harmony note 3.
r H 2	Auto accompaniment rhythm 2 track data.
r H 1	Auto accompaniment rhythm 1 track data.
b R 5	Auto accompaniment bass track data.
[H 1	Auto accompaniment chord 1 track data.
[H 2	Auto accompaniment chord 2 track data.
P 2 d	Auto accompaniment pad track data.
P H 1	Auto accompaniment phrase 1 track data.
P H 2	Auto accompaniment phrase 2 track data.
S 1	User song melody track 1 data (R1 voice).
S 1 d	User song melody track 1 data (R2 voice).
S 2	User song melody track 2 data (R1 voice).
S 2 d	User song melody track 2 data (R2 voice).
S 3	User song melody track 3 data (R1 voice).
S 3 d	User song melody track 3 data (R2 voice).
S 4	User song melody track 4 data (R1 voice).
S 4 d	User song melody track 4 data (R2 voice).
o F F	No data transmitted.

NOTE

- The initial default channel/track settings are:
 Channel 1 = R1 voice
 Channel 2 = L voice
 Channel 3 = Bass / Track3
 Channel 4 = Chord1 / Track4
 Channel 5 = Chord2 / Track5
 Channel 6 = Pad / Track6
 Channel 7 = Phrase1 / Track7
 Channel 8 = Phrase2 / Track8
 Channel 9 = Rhythm2 / Track2
 Channel 10 = Rhythm1 / Track1
 Channel 11 = R2 voice
 Channel 12 = Harmony1
 Channel 13 = Harmony2
 Channel 14 = Harmony3
 Channel 15 = Off
 Channel 16 = Off
- When a track is assigned to more than one MIDI channel, the data from that track is transmitted via the lowest-numbered channel.
- To avoid MIDI loops which can cause operational errors, check the PSR-530 Local Control setting (page 94), and the MIDI THRU settings of any external MIDI devices.
- MIDI transmit track settings will be retained even after turning the power off. See page 98 for the details.

■ Receive Channel & Receive Mode

The PSR-530 can simultaneously receive data on all 16 MIDI channels, allowing it to function as a 16-channel multi-timbral tone generator. The Receive Channel and Receive Mode functions determine how each channel will respond to received MIDI data.

● Receive Channel

The “Rcv.Ch” function selects a MIDI channel to which a receive mode is to be assigned via the Receive Mode function, below. First select a receive channel, then the receive mode for that channel. Any of the standard MIDI channels — 1 through 16 — can be specified.

0 1: Rcv. Ch

● Receive Mode

The “Rcv.Mod” function specifies the receive mode for the channel selected via the Receive Channel function, above. The receive mode settings are as follows:

`nor : Rcv. Mod`

<code>nor</code>	“Normal”. Received MIDI data is sent directly to the PSR-530 tone generator. If all channels are set to “nor”, the PSR-530 functions as a 16-channel multi-timbral tone generator.
<code>oFF</code>	No MIDI data is received on channels set to “oFF”.
<code>rE</code>	“Remote”. Received MIDI data is handled in the same way as data generated by the PSR-530’s own keyboard. In other words, a remote keyboard could be used to control the PSR-530 AUTO ACCOMPANIMENT functions, etc.

NOTE

- MIDI receive mode settings will be retained even after turning the power off. See page 98 for the details.
- The initial default setting for all channels is “nor.”
- In the Record mode, the Receive mode settings cannot be set.

■ Local Control

“Local Control” refers to the fact that, normally, the PSR-530 keyboard controls the internal tone generator, allowing the internal voices to be played directly from the keyboard. This situation is “Local Control on” since the internal tone generator is controlled locally by its own keyboard. Local control can be turned off, however, so that the keyboard does not play the internal voices, but the appropriate MIDI information is still transmitted via the MIDI OUT connector when notes are played on the keyboard. At the same time, the internal tone generator can respond to MIDI information received on channels set to the “nor” (normal) mode via the MIDI IN connector. This means that while an external MIDI sequencer, for example, plays the PSR-530 internal voices, an external tone generator can be played from the PSR-530 keyboard. The default Local Control setting is “on”.

`on : Local`

■ Clock

Reception of an external MIDI clock signal can be enabled or disabled as required. When disabled (“off”), all of the time-based functions (Auto Accompaniment, SONG recording and playback, etc.) are controlled by its own internal clock. When MIDI clock reception is enabled (“on”), however, all timing is controlled by an external MIDI clock signal received via the MIDI IN terminal (in this case the PSR-530 TEMPO setting has no effect). The default setting is “off”.

`oFF : Ext. Clock`

NOTE

- Clock is “off” be default when the power is initially turned on.
- When Clock is turned “on”, AUTO ACCOMPANIMENT playback cannot be started via the panel [START/STOP] button, or started via the synchro start function. Also, the MULTI PAD playback cannot be initiated by pressing the MULT PADS.
- When External Clock is turned “On”, “EC” will appear on the TEMPO display, and tempo cannot be changed with the panel button.

Bulk Data Send

This function causes the contents of the registration, user song, user style and user pad memory to be transmitted via the MIDI OUT connector. This data can be saved to memory or disk via a MIDI sequence recorder or MIDI data recorder, and then reloaded when required. The bulk data can also be sent directly to a second PSR-530.

To send the bulk data select the “BlkSnd?” function, then press the [+] (YES) button. “Sure?” will appear on the display. Press [+] (YES) again to begin transmission of the bulk data. “BkSnd:Rg” (registration data), “BkSnd:Sg” (user song data), “BkSnd:Pd” (user pad data) and then “BkSnd:Cs” (user style data) will appear on the display during transmission. “End” will appear on the display briefly when the transmission has finished.

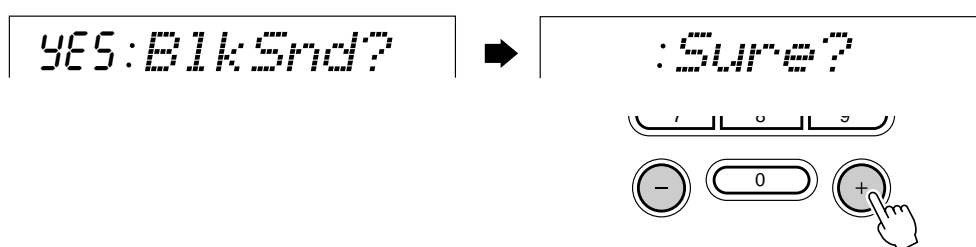

NOTE

- A bulk dump transmission can be stopped at any time by pressing the [-] (NO) button.
- No other operations can be performed during bulk dump transmission.
- During Style/Song/Multi Pad playback or in one of the Record modes, the display shows “- -: BlkSnd” indicating that you cannot execute the Bulk Data send operation.

Receiving Bulk Data

The PSR-530 will automatically receive compatible bulk data from an external MIDI device as long as no auto accompaniment, multi pad, or song recording/playback operation is in progress. “BkRcv” will appear on the display during reception, then “End” will appear briefly when all data has been received.

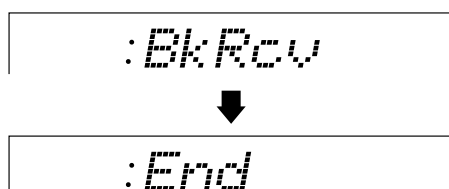

NOTE

- No other operations can be performed during bulk dump reception.
- If an error is encountered during bulk data reception, “Blk Err” will appear on the display, and registration, user song, user style and user pad memory will be cleared.
- When a bulk dump is received, the received data replaces any data that was previously in the PSR-530 memory.
- The bulk receive messages are rejected during playback/recording.

Initial Data Send



Transmits all current panel settings to a second PSR-530 or a MIDI data storage device. To send the initial data, select the “InitSnd?” function. Press the [+] (YES) to begin transmission of the initial data.







NOTE

- During Style/Song/Multi Pad playback or in one of the Record modes, the display shows “- -: InitSnd?” indicating that you cannot execute the initial data send operation.

If you want to have the song play back with the panel settings used for recording, execute the Initial Data Send function before recording the performance on the PSR-530 to an external sequencer.

MENU	SUB MENU	FUNCTION	PAGE
VOICE	<i>ex</i> GrandPno (R1 voice name)	R1 voice selection.	17
STYLE	<i>ex</i> 8BtPop1 (Style name)	Accompaniment style selection.	22
	VirtArng*	Virtual Arranger on/off selection.	27
	Quantiz?*	Quantize.	69
	AllClr?*	User style clear (All).	70
	TrkClr?*	User style clear (Track).	70
	Cancel*	Drum cancel.	68
SONG	<i>ex</i> PeterGun (Song name)	Song selection.	52
	Measure	Measure from which to start playback.	54
	MinusCh [MinusOne] *	Minus-one channel setting.	55
	A-b:Repeat *	Repeat playback setting.	57
	SongClr?*	Song clear.	63
	TrkClr?*	Track clear.	63
CARTRIDGE	<i>ex</i> 530XG (Song name)	Cartridge song selection.	76
REGISTRATION MEMORY	Bank 1 (Bank name)	Registration bank selection.	47
	 REGISTRATION MEMORY Button		
MULTI PAD	<i>ex</i> Fanfare1 (Multi Pad set name)	Multi Pad set selection.	49
	 MULTI PAD STOP Button		
	Pad1Chd	Chord match on/off selection (pad 1).	51
	Pad2Chd	Chord match on/off selection (pad 2).	51
	Pad3Chd	Chord match on/off selection (pad 3).	51
	Pad4Chd	Chord match on/off selection (pad 4).	51
	BankClr?*	Bank clear.	74
PadClr?*	Pad clear.	74	
MIDI	Tr. Ch	Transmit channel selection.	92
	Tr. Trk	Transmit track selection.	93
	Rcv. Ch	Receive channel selection.	93
	Rcv. Mod	Receive mode selection.	94
	Local	Local on/off selection.	94
	ExtClock	External/internal clock selection.	94
	BlkSnd?	Bulk dump transmission.	95
	InitSnd?	Initial panel setting transmission.	95

MENU	SUB MENU	FUNCTION	PAGE
------	----------	----------	------

MENU	SUB MENU	FUNCTION	PAGE
DIGITAL EFFECT	<i>ex</i> Hall 1 [Reverb] (Reverb type name)	Reverb type selection.	37
		 REVERB Button	
	RevRtnLv	Reverb return level setting.	38
	<i>ex</i> Chorus1 [Chorus] (Chorus type name)	Chorus type selection.	39
		 CHORUS Button	
	ChoRtnLv	Chorus return level setting.	39
	<i>ex</i> Hall 1 [DSP] (DSP type name)	DSP type selection.	41
		 DSP Button	
	DspRtnLv	DSP return level setting.	42
<i>ex</i> Duet [Harmony] (Harmony type name)	Harmony type selection.	43	
	 HARMONY Button		
HarmVol	Harmony volume setting.	44	

MENU	SUB MENU	FUNCTION	PAGE
OVERALL	TouchSns	Touch sensitivity setting.	84
	PBRange	Pitch bend range setting.	45
	Tuning	Overall tuning.	84
	SC.Note	Scale tuning (note) setting.	84
	SC.Tune	Scale tuning (tune) setting.	84
	SongTrns	Song transpose setting.	85
	Metronom	Metronome on/off selection.	85
	S.Split	Split mode split point selection.	21
	AccSpPnt	Auto accompaniment split point selection.	29
	FngrngMd  AUTO ACCOMPANIMENT	Fingering mode selection.	30
		ON/OFF Button	
	VoiceSet	Voice set on/off selection.	85

- Sub-menu items with a “ * ” appear only when the record mode is engaged.
- Sub-menu items with a “ ☆ ” appear only when the record mode is not engaged.
- Sub-menu items with “  ” have shortcut access (press and hold the specified button for a few seconds to jump directly to the associated sub-menu function). In addition to the shortcuts listed above, the [DUAL VOICE] button can be held to jump to the R2 voice revoice function, and the [SPLIT VOICE] button can be held to jump to the L voice revoice function.

Data Backup & Initialization

Data Backup

Except for the data listed below, all PSR-530 panel settings are reset to their initial settings whenever the power is turned on.

- Registration Memory
- User Song Data
- User Style Data
- User Pad Data
- MIDI Transmit Settings
- MIDI Receive Settings

The data listed above can be backed up — i.e. retained in memory — as long as a working set of batteries is installed and you keep the following Off/On procedure.

- 1** Turn the power OFF by pressing the [STAND BY/ON] switch.
- 2** Unplug the DC output cable of the PA-6 from the DC IN 10-12V jack on the rear panel of the PSR-530.
- 3** Then unplug the PA-6 Power Adaptor from the wall AC outlet.

When turning the power ON, simply reverse the procedure.

Data Initialization

All data can be initialized and restored to the factory preset condition by turning on the power while holding the highest (rightmost) white key on the keyboard. “CLr:Back up” will appear briefly on the display.

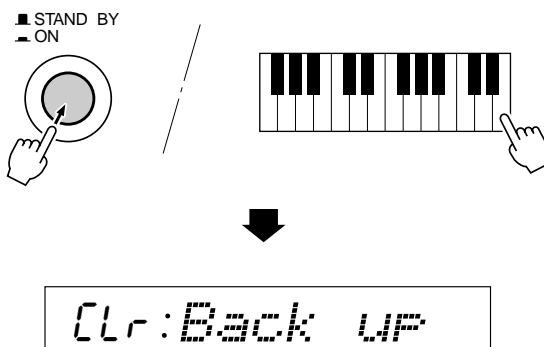

CAUTION

- All registration and song memory data, plus the other settings listed above, will be erased and/or changed when the data initialization procedure is carried out.
- Carrying out the data initialization procedure will usually restore normal operation if the PSR-530 freezes or begins to act erratically for any reason.

Voice List

Maximum Polyphony

The PSR-530 has 32-note maximum polyphony. This means that it play a maximum of up to 32 notes at once, regardless of what functions are used. Auto Accompaniment uses a number of the available notes, so when Auto Accompaniment is used the total number of notes that can be played on the keyboard is correspondingly reduced. The same applies to the Dual Voice, Split Voice, Multi Pad, and Song functions.

NOTE

- The Voice List includes MIDI program change numbers for each voice. Use these program change numbers when playing the PSR-530 via MIDI from an external device.
- Some voices may sound continuously or have a long decay after the notes have been released while the sustain pedal (footswitch) is held.

[Panel Voice List]

Voice Number	Bank Select		MIDI Program Change Number	Voice Name
	MSB	LSB		
Piano				
1	0	112	0	Grand Piano
2	0	112	1	BrightPiano
3	0	112	3	Honky Tonk
4	0	112	2	Midi Grand
5	0	113	2	CP 80
6	0	114	4	Galaxy EP
7	0	112	5	DX Modern
8	0	112	4	Funk EP
9	0	115	5	Modern EP
10	0	113	5	Hyper Tines
11	0	116	5	New Tines
12	0	114	5	Venus EP
13	0	113	4	Tremolo EP
14	0	114	2	Rock Piano
15	0	112	7	Clavi
16	0	113	7	Wah Clavi
17	0	112	6	Harpsichord
18	0	113	6	GrandHarpsi
Chromatic Percussion				
19	0	112	11	Vibraphone
20	0	113	11	Jazz Vibes
21	0	112	12	Marimba
22	0	112	13	Xylophone
23	0	112	114	Steel Drums
24	0	112	8	Celesta
25	0	112	9	Glocken
26	0	112	10	Music Box
27	0	112	14	TubularBells
28	0	112	108	Kalimba
29	0	112	47	Timpani
30	0	112	15	Dulcimer
Organ				
31	0	112	16	Jazz Organ1
32	0	113	16	Jazz Organ2
33	0	112	17	Click Organ
34	0	113	17	Dance Organ
35	0	115	16	Drawbar Org
36	0	115	17	Mellow Draw
37	0	116	16	Bright Draw
38	0	112	18	Rock Organ1
39	0	113	18	Rock Organ2
40	0	114	18	Purple Org
41	0	116	17	60's Organ
42	0	117	17	Blues Organ
43	0	117	16	16+1 Organ
44	0	118	16	16+2 Organ
45	0	119	16	16+4 Organ
46	0	118	17	Elec.Organ
Guitar				
47	0	114	16	TheatreOrg1
48	0	114	17	TheatreOrg2
49	0	112	19	Pipe Organ
50	0	113	19	ChapelOrgan
51	0	112	20	Reed Organ
52	0	113	21	Trad. Accrd
53	0	112	21	Musette
54	0	112	23	Tango Accrd
55	0	113	23	Bandoneon
56	0	114	21	Soft Accrd
57	0	112	22	Harmonica
Bass				
58	0	112	24	Classic Gtr
59	0	113	24	Spanish Gtr
60	0	112	25	Folk Guitar
61	0	113	25	12StrGuitar
62	0	112	26	Jazz Guitar
63	0	113	26	Octave Gtr
64	0	114	26	HawaiianGtr
65	0	112	27	CleanGuitar
66	0	113	27	Tremolo Gtr
67	0	114	27	Slap Guitar
68	0	113	28	Funk Guitar
69	0	112	28	MutedGuitar
70	0	113	29	FeedbackGtr
71	0	112	29	Overdrive
72	0	112	30	Distortion
73	0	115	27	PedalSteel
Solo Strings				
74	0	112	32	Aco.Bass
75	0	114	32	Bass&Cymbal
76	0	112	33	FingerBass
77	0	112	34	Pick Bass
78	0	112	35	Fretless
79	0	113	35	Jaco Bass
80	0	119	17	Organ Bass
81	0	112	36	Slap Bass
82	0	112	37	Funk Bass
83	0	113	36	Fusion Bass
84	0	112	38	Synth Bass
85	0	112	39	Analog Bass
86	0	113	39	Dance Bass
87	0	113	38	Hi Q Bass
88	0	114	38	Rave Bass
Solo Strings				
89	0	112	40	Solo Violin
90	0	113	40	Soft Violin
91	0	112	110	Fiddle
92	0	112	41	Viola

Voice List

Voice Number	Bank Select		MIDI Program Change Number	Voice Name
	MSB	LSB		
93	0	112	42	Cello
94	0	112	43	Contrabass
95	0	112	46	Harp
96	0	113	46	Hackbrett
97	0	112	106	Shamisen
98	0	112	107	Koto
99	0	112	104	Sitar
100	0	112	105	Banjo
Ensemble				
101	0	112	48	Strings
102	0	113	48	OrchStrings
103	0	114	48	Symphon. Str
104	0	113	49	SlowStrings
105	0	114	49	Str.Quartet
106	0	115	48	ConcertoStr
107	0	115	49	MarcatoStrs
108	0	112	49	ChamberStrs
109	0	112	44	TremoloStrs
110	0	112	45	PizzStrings
111	0	112	50	Syn Strings
112	0	112	51	Analog Strs
113	0	112	52	Choir
114	0	112	54	Air Choir
115	0	113	52	Vocal Ensbl
116	0	112	53	Vox Humana
117	0	113	53	Gothic Vox
118	0	112	55	Orch.Hit
Solo Brass				
119	0	112	56	SoloTrumpet
120	0	114	56	SoftTrumpet
121	0	113	56	Flugel Horn
122	0	112	59	Muted Trp
123	0	112	57	Trombone
124	0	114	57	MelTrombone
125	0	112	60	French Horn
126	0	112	58	Tuba
Brass Ensemble				
127	0	113	61	BigBandBrs
128	0	112	61	BrasSection
129	0	116	61	MellowBrass
130	0	117	61	Small Brass
131	0	118	61	Pop Brass
132	0	119	61	MellowHorns
133	0	113	59	BallroomBrs
134	0	114	61	Full Horns
135	0	115	61	High Brass
136	0	113	57	Trb.Section
137	0	112	62	Synth Brass
138	0	112	63	Analog Brs
139	0	113	62	Jump Brass
140	0	114	62	TechnoBrass
Reed				
141	0	112	64	Soprano Sax
142	0	112	65	Alto Sax
143	0	113	65	BreathyAlto
144	0	112	66	Tenor Sax
145	0	114	66	BreathTenor
146	0	112	67	BaritoneSax
147	0	116	66	Sax Section
148	0	112	71	Clarinet
149	0	113	71	MelClarinet
150	0	113	66	WoodwindEns
151	0	115	66	Brass Combo
152	0	112	68	Oboe
153	0	112	69	EnglishHorn

Voice Number	Bank Select		MIDI Program Change Number	Voice Name
	MSB	LSB		
154	0	112	70	Bassoon
155	0	112	109	Bagpipe
Pipe				
156	0	112	73	Flute
157	0	112	75	Pan Flute
158	0	112	72	Piccolo
159	0	113	73	EthnicFlute
160	0	112	77	Shakuhachi
161	0	112	78	Whistle
162	0	112	74	Recorder
163	0	112	79	Ocarina
Synth Lead				
164	0	112	80	Square Lead
165	0	112	81	Saw.Lead
166	0	113	81	Big Lead
167	0	112	98	Stardust
168	0	114	81	Blaster
169	0	115	81	Analogon
170	0	113	80	Vintage Ld
171	0	113	98	Sun Bell
172	0	112	83	Aero Lead
173	0	116	81	Fire Wire
174	0	114	80	Mini Lead
175	0	115	80	Vinylead
176	0	117	81	Warp
177	0	116	80	Hi Bias
178	0	117	80	Meta Wood
179	0	118	80	Tiny Lead
180	0	118	81	Sub Aqua
181	0	119	81	Fargo
Synth Pad				
182	0	113	94	Insomnia
183	0	112	90	Krypton
184	0	113	99	Cyber Pad
185	0	112	95	Wave 2001
186	0	112	94	Equinox
187	0	114	88	Stargate
188	0	112	92	DX Pad
189	0	112	93	Loch Ness
190	0	112	88	Fantasia
191	0	115	88	Golden Age
192	0	112	91	Xenon Pad
193	0	112	89	Area 51
194	0	112	99	Atmosphere
195	0	113	89	Dark Moon
196	0	115	94	Ionosphere
197	0	113	93	Phase IV
198	0	113	88	Symbiont
199	0	114	94	Solaris
200	0	113	95	Transform
Drum Kits				
201	127	0	0	Std.Kit1
202	127	0	1	Std.Kit2
203	127	0	8	Room Kit
204	127	0	16	Rock Kit
205	127	0	24	Electro Kit
206	127	0	25	Analog Kit
207	127	0	27	Dance Kit
208	127	0	32	Jazz Kit
209	127	0	40	Brush Kit
210	127	0	48	Classic Kit
211	126	0	0	SFX Kit1
212	126	0	1	SFX Kit2

[XG Voice List]

Voice Number	Bank Select		MIDI Program Change Number	Voice Name	Voice Number	Bank Select		MIDI Program Change Number	Voice Name	Voice Number	Bank Select		MIDI Program Change Number	Voice Name
	MSB	LSB				MSB	LSB				MSB	LSB		
Piano					273	0	32	16	DetDrwOr	335	0	65	31	GtFeedbk
213	0	0	0	GrandPno	274	0	33	16	60sDrOr1	336	0	66	31	GtrHrmo2
214	0	1	0	GrndPnoK	275	0	34	16	60sDrOr2	Bass				
215	0	18	0	MelloGrP	276	0	35	16	70sDrOr1	337	0	0	32	Aco.Bass
216	0	40	0	PianoStr	277	0	36	16	DrawOrg2	338	0	40	32	JazzRrthm
217	0	41	0	Dream	278	0	37	16	60sDrOr3	339	0	45	32	VXUprght
218	0	0	1	BritePno	279	0	38	16	EvenBar	340	0	0	33	FngrBass
219	0	1	1	BritPnoK	280	0	40	16	16+2'2/3	341	0	18	33	FingrDrk
220	0	0	2	E.Grand	281	0	64	16	Organ Ba	342	0	27	33	FlangeBa
221	0	1	2	EIGrPnoK	282	0	65	16	70sDrOr2	343	0	40	33	Ba&DstEG
222	0	32	2	Det.CP80	283	0	66	16	CheezOrg	344	0	43	33	FngrSlap
223	0	40	2	EIGrPno1	284	0	67	16	DrawOrg3	345	0	45	33	FngBass2
224	0	41	2	EIGrPno2	285	0	0	17	PercOrgn	346	0	65	33	ModAlem
225	0	0	3	HnkyTonk	286	0	24	17	70sPcOr1	347	0	0	34	PickBass
226	0	1	3	HnkyTnkK	287	0	32	17	DetPrcOr	348	0	28	34	MutePkBa
227	0	0	4	E.Piano1	288	0	33	17	LiteOrg	349	0	0	35	Fretless
228	0	1	4	Ei.Pno1K	289	0	37	17	PercOrg2	350	0	32	35	Fretles2
229	0	18	4	MelloEP1	290	0	0	18	RockOrgn	351	0	33	35	Fretles3
230	0	32	4	Chor.EP1	291	0	64	18	RotaryOR	352	0	34	35	Fretles4
231	0	40	4	HardEI.P	292	0	65	18	SloRotar	353	0	96	35	SynFretl
232	0	45	4	VX EI.P1	293	0	66	18	FstRotar	354	0	97	35	Smooth
233	0	64	4	60sEI.P	294	0	0	19	ChrchOrg	355	0	0	36	SlapBas1
234	0	0	5	E.Piano2	295	0	32	19	ChurOrg3	356	0	27	36	ResoSlap
235	0	1	5	Ei.Pno2K	296	0	35	19	ChurOrg2	357	0	32	36	PunchThm
236	0	32	5	Chor.EP2	297	0	40	19	NotreDam	358	0	0	37	SlapBas2
237	0	33	5	DX Hard	298	0	64	19	OrgFlute	359	0	43	37	VeloSlap
238	0	34	5	DXLegend	299	0	65	19	TrmOrgFl	360	0	0	38	SynBass1
239	0	40	5	DX Phase	300	0	0	20	ReedOrgn	361	0	18	38	SynBa1Dk
240	0	41	5	DX+Analg	301	0	40	20	Puff Org	362	0	20	38	FastResB
241	0	42	5	DXKotoEP	302	0	0	21	Acordion	363	0	24	38	AcidBass
242	0	45	5	VX EI.P2	303	0	32	21	AccordIt	364	0	35	38	Clv Bass
243	0	0	6	Harpsi.	304	0	0	22	Harmnica	365	0	40	38	TeknoBa
244	0	1	6	Harpsi.K	305	0	32	22	Harmo 2	366	0	64	38	Oscar
245	0	25	6	Harpsi.2	306	0	0	23	TangoAcd	367	0	65	38	SqrBass
246	0	35	6	Harpsi.3	307	0	64	23	TngoAcd2	368	0	66	38	RubberBa
247	0	0	7	Clavi.	Guitar					369	0	96	38	Hammer
248	0	1	7	Clavi. K	308	0	0	24	NylonGtr	370	0	0	39	SynBass2
249	0	27	7	ClaviWah	309	0	16	24	NylonGt2	371	0	6	39	MelloSB1
250	0	64	7	PulseClv	310	0	25	24	NylonGt3	372	0	12	39	Seq Bass
251	0	65	7	PierceCl	311	0	43	24	VelGtHrm	373	0	18	39	ClkSynBa
Chromatic Percussion					312	0	96	24	Ukulele	374	0	19	39	SynBa2Dk
252	0	0	8	Celesta	313	0	0	25	SteelGtr	375	0	32	39	SmthBa 2
253	0	0	9	Glocken	314	0	16	25	SteelGt2	376	0	40	39	ModulrBa
254	0	0	10	MusicBox	315	0	35	25	12StrGtr	377	0	41	39	DX Bass
255	0	64	10	Orgel	316	0	40	25	Nyln&Stl	378	0	64	39	X WireBa
256	0	0	11	Vibes	317	0	41	25	Stl&Body	Strings				
257	0	1	11	VibesK	318	0	96	25	Mandolin	379	0	0	40	Violin
258	0	45	11	HardVibe	319	0	0	26	Jazz Gtr	380	0	8	40	SlowVln
259	0	0	12	Marimba	320	0	18	26	MelloGtr	381	0	0	41	Viola
260	0	1	12	MarimbaK	321	0	32	26	JazzAmp	382	0	0	42	Cello
261	0	64	12	SineMrmb	322	0	0	27	CleanGtr	383	0	0	43	Contrabs
262	0	97	12	Balafon2	323	0	32	27	ChorusGt	384	0	0	44	Trem.Str
263	0	98	12	Log Drum	324	0	0	28	Mute.Gtr	385	0	8	44	SlowTrStr
264	0	0	13	Xylophon	325	0	40	28	FunkGtr1	386	0	40	44	Susp Str
265	0	0	14	TubulBel	326	0	41	28	MuteStlG	387	0	0	45	Pizz.Str
266	0	96	14	ChrchBel	327	0	43	28	FunkGtr2	388	0	0	46	Harp
267	0	97	14	Carillon	328	0	45	28	Jazz Man	389	0	40	46	YangChin
268	0	0	15	Dulcimer	329	0	0	29	Ovrdrive	390	0	0	47	Timpani
269	0	35	15	Dulcimr2	330	0	43	29	Gt.Pinch	Ensemble				
270	0	96	15	Cimbalom	331	0	0	30	Dist.Gtr	391	0	0	48	Strings1
271	0	97	15	Santur	332	0	40	30	FeedbkGt	392	0	3	48	S.Strngs
Organ					333	0	41	30	FeedbkGt2	393	0	8	48	SlowStr
272	0	0	16	DrawOrgn	334	0	0	31	GtrHarmo	394	0	24	48	ArcoStr

Voice List

Voice Number	Bank Select		MIDI Program Change Number	Voice Name	Voice Number	Bank Select		MIDI Program Change Number	Voice Name	Voice Number	Bank Select		MIDI Program Change Number	Voice Name
	MSB	LSB				MSB	LSB				MSB	LSB		
395	0	35	48	60sStrng	Reed					516	0	0	89	Warm Pad
396	0	40	48	Orchestr	457	0	0	64	SprnoSax	517	0	16	89	ThickPad
397	0	41	48	Orchstr2	458	0	0	65	Alto Sax	518	0	17	89	Soft Pad
398	0	42	48	TremOrch	459	0	40	65	Sax Sect	519	0	18	89	SinePad
399	0	45	48	VeloStr	460	0	43	65	HyprAlto	520	0	64	89	Horn Pad
400	0	0	49	Strings2	461	0	0	66	TenorSax	521	0	65	89	RotarStr
401	0	3	49	S.SlwStr	462	0	40	66	BrthTnSx	522	0	0	90	PolySyPd
402	0	8	49	LegatoSt	463	0	41	66	SoftTenr	523	0	64	90	PolyPd80
403	0	40	49	Warm Str	464	0	64	66	TnrSax 2	524	0	65	90	ClickPad
404	0	41	49	Kingdom	465	0	0	67	Bari.Sax	525	0	66	90	Ana Pad
405	0	64	49	70s Str	466	0	0	68	Oboe	526	0	67	90	SquarPad
406	0	65	49	Str Ens3	467	0	0	69	Eng.Horn	527	0	0	91	ChoirPad
407	0	0	50	Syn.Str1	468	0	0	70	Bassoon	528	0	64	91	Heaven2
408	0	27	50	ResoStr	469	0	0	71	Clarinet	529	0	66	91	ltopia
409	0	64	50	Syn Str4	Pipe					530	0	67	91	CC Pad
410	0	65	50	SS Str	470	0	0	72	Piccolo	531	0	0	92	BowedPad
411	0	0	51	Syn.Str2	471	0	0	73	Flute	532	0	64	92	Glacier
412	0	0	52	ChoirAah	472	0	0	74	Recorder	533	0	65	92	GlassPad
413	0	3	52	S.Choir	473	0	0	75	PanFlute	534	0	0	93	MetalPad
414	0	16	52	Ch.Aahs2	474	0	0	76	Bottle	535	0	64	93	Tine Pad
415	0	32	52	MelChoir	475	0	0	77	Shakhchi	536	0	65	93	Pan Pad
416	0	40	52	ChoirStr	476	0	0	78	Whistle	537	0	0	94	Halo Pad
417	0	0	53	VoiceOoh	477	0	0	79	Ocarina	538	0	0	95	SweepPad
418	0	0	54	SynVoice	Synth Lead					539	0	20	95	Shwimmer
419	0	40	54	SynVox2	478	0	0	80	SquareLd	540	0	27	95	Converge
420	0	41	54	Choral	479	0	6	80	Square 2	541	0	64	95	PolarPad
421	0	64	54	AnaVoice	480	0	8	80	LMSquare	542	0	66	95	Celstial
422	0	0	55	Orch.Hit	481	0	18	80	Hollow	Synth Effects				
423	0	35	55	OrchHit2	482	0	19	80	Shmoog	543	0	0	96	Rain
424	0	64	55	Impact	483	0	64	80	Mellow	544	0	45	96	ClaviPad
Brass					484	0	65	80	SoloSine	545	0	64	96	HrmoRain
425	0	0	56	Trumpet	485	0	66	80	SineLead	546	0	65	96	AfrcnWnd
426	0	16	56	Trumpet2	486	0	0	81	Saw.Lead	547	0	66	96	Caribbean
427	0	17	56	BriteTrp	487	0	6	81	Saw 2	548	0	0	97	SoundTrk
428	0	32	56	WarmTrp	488	0	8	81	ThickSaw	549	0	27	97	Prologue
429	0	0	57	Trombone	489	0	18	81	DynaSaw	550	0	64	97	Ancestrl
430	0	18	57	Trmbone2	490	0	19	81	DigiSaw	551	0	0	98	Crystal
431	0	0	58	Tuba	491	0	20	81	Big Lead	552	0	12	98	SynDrCmp
432	0	16	58	Tuba 2	492	0	24	81	HeavySyn	553	0	14	98	Popcorn
433	0	0	59	Mute.Trp	493	0	25	81	WaspySyn	554	0	18	98	TinyBell
434	0	0	60	Fr.Horn	494	0	40	81	PulseSaw	555	0	35	98	RndGlock
435	0	6	60	FrHrSolo	495	0	41	81	Dr. Lead	556	0	40	98	GlockChi
436	0	32	60	FrHorn2	496	0	45	81	VeloLead	557	0	41	98	ClearBel
437	0	37	60	HornOrch	497	0	96	81	Seq Ana	558	0	42	98	ChorBell
438	0	0	61	BrasSect	498	0	0	82	CalioPld	559	0	64	98	SynMalet
439	0	35	61	Tp&TbSec	499	0	65	82	Pure Pad	560	0	65	98	SftCryst
440	0	40	61	BrssSec2	500	0	0	83	Chiff Ld	561	0	66	98	LoudGlok
441	0	41	61	HiBrass	501	0	64	83	Rubby	562	0	67	98	XmasBell
442	0	42	61	MelloBrs	502	0	0	84	CharanLd	563	0	68	98	VibeBell
443	0	0	62	SynBras1	503	0	64	84	DistLead	564	0	69	98	DigiBell
444	0	12	62	QuackBr	504	0	65	84	WireLead	565	0	70	98	AirBells
445	0	20	62	RezSynBr	505	0	0	85	Voice Ld	566	0	71	98	BellHarp
446	0	24	62	PolyBrss	506	0	24	85	SynthAah	567	0	72	98	Gamelmba
447	0	27	62	SynBras3	507	0	64	85	VoxLead	568	0	0	99	Atmosphr
448	0	32	62	JumpBrss	508	0	0	86	Fifth Ld	569	0	18	99	WarmAtms
449	0	45	62	AnaVelBr	509	0	35	86	Big Five	570	0	19	99	HollwRls
450	0	64	62	AnaBrss1	510	0	0	87	Bass &Ld	571	0	40	99	NylonEP
451	0	0	63	SynBras2	511	0	16	87	Big&Low	572	0	64	99	NylnHarp
452	0	18	63	Soft Brs	512	0	64	87	Fat&Prky	573	0	65	99	Harp Vox
453	0	40	63	SynBrss4	513	0	65	87	SoftWurl	574	0	66	99	AtmosPad
454	0	41	63	ChoirBrs	Synth Pad					575	0	67	99	Planet
455	0	45	63	VelBrss2	514	0	0	88	NewAgePd	576	0	0	100	Bright
456	0	64	63	AnaBrss2	515	0	64	88	Fantasy2	577	0	64	100	FantaBel

Voice Number	Bank Select		MIDI Program Change Number	Voice Name	Voice Number	Bank Select		MIDI Program Change Number	Voice Name
	MSB	LSB				MSB	LSB		
578	0	96	100	Smokey	639	0	0	118	Syn.Drum
579	0	0	101	Goblins	640	0	64	118	Ana Tom
580	0	64	101	GobSyn	641	0	65	118	ElecPerc
581	0	65	101	50sSciFi	642	0	0	119	RevCymb1
582	0	66	101	Ring Pad	Sound Effects				
583	0	67	101	Ritual	643	0	0	120	FretNoiz
584	0	68	101	ToHeaven	644	0	0	121	BrthNoiz
585	0	70	101	Night	645	0	0	122	Seashore
586	0	71	101	Glisten	646	0	0	123	Tweet
587	0	96	101	BelChoir	647	0	0	124	Telephone
588	0	0	102	Echoes	648	0	0	125	Helicptr
589	0	8	102	EchoPad2	649	0	0	126	Applause
590	0	14	102	Echo Pan	650	0	0	127	Gunshot
591	0	64	102	EchoBell	SFX				
592	0	65	102	Big Pan	651	64	0	0	CuttngNz
593	0	66	102	SynPiano	652	64	0	1	CttngNz2
594	0	67	102	Creation	653	64	0	3	Str Slap
595	0	68	102	Stardust	654	64	0	16	Fl.KClik
596	0	69	102	Reso Pan	655	64	0	32	Rain
597	0	0	103	Sci-Fi	656	64	0	33	Thunder
598	0	64	103	Starz	657	64	0	34	Wind
Ethnic					658	64	0	35	Stream
599	0	0	104	Sitar	659	64	0	36	Bubble
600	0	32	104	DetSitar	660	64	0	37	Feed
601	0	35	104	Sitar 2	661	64	0	48	Dog
602	0	96	104	Tambra	662	64	0	49	Horse
603	0	97	104	Tamboura	663	64	0	50	Bird 2
604	0	0	105	Banjo	664	64	0	54	Ghost
605	0	28	105	MuteBnjo	665	64	0	55	Maou
606	0	96	105	Rabab	666	64	0	64	Tel.Dial
607	0	97	105	Gopichnt	667	64	0	65	DoorSqek
608	0	98	105	Oud	668	64	0	66	Door Slam
609	0	0	106	Shamisen	669	64	0	67	Scratch
610	0	0	107	Koto	670	64	0	68	Scratch 2
611	0	96	107	T. Koto	671	64	0	69	WindChm
612	0	97	107	Kanoon	672	64	0	70	Telphon2
613	0	0	108	Kalimba	673	64	0	80	CarEngin
614	0	0	109	Bagpipe	674	64	0	81	Car Stop
615	0	0	110	Fiddle	675	64	0	82	Car Pass
616	0	0	111	Shanai	676	64	0	83	CarCrash
617	0	64	111	Shanai2	677	64	0	84	Siren
618	0	96	111	Pungi	678	64	0	85	Train
619	0	97	111	Hichriki	679	64	0	86	Jetplane
Percussive					680	64	0	87	Starship
620	0	0	112	TnklBell	681	64	0	88	Burst
621	0	96	112	Bonang	682	64	0	89	Coaster
622	0	97	112	Gender	683	64	0	90	SbMarine
623	0	98	112	Gamelan	684	64	0	96	Laughing
624	0	99	112	S.Gamlan	685	64	0	97	Scream
625	0	100	112	Rama Cym	686	64	0	98	Punch
626	0	101	112	AsianBel	687	64	0	99	Heart
627	0	0	113	Agogo	688	64	0	100	FootStep
628	0	0	114	SteelDrm	689	64	0	112	MchinGun
629	0	97	114	GlasPerc	690	64	0	113	LaserGun
630	0	98	114	ThaiBell	691	64	0	114	Xplosion
631	0	0	115	WoodBlok	692	64	0	115	FireWork
632	0	96	115	Castanet					
633	0	0	116	TaikoDrm					
634	0	96	116	Gr.Cassa					
635	0	0	117	MelodTom					
636	0	64	117	Mel Tom2					
637	0	65	117	Real Tom					
638	0	66	117	Rock Tom					

Drum Kit List

- “<—” indicates that the drum kit is the same as “Standard Kit1”.
- Each percussion voice uses one note.
- The note numbers and note names printed on the keyboard are one octave higher than the MIDI note numbers and note names shown in the list. For example, the note number and note name, #36 and C1, on the keyboard correspond to the MIDI note number and note name, #24 and C0, shown in the list.
- Voices with the same Alternate Note Number (*1 ... 4) cannot be played simultaneously.

Voice #	201	202	203	204	205	206
Bank MSB#	127	127	127	127	127	127
Bank LSB#	0	0	0	0	0	0
Program Change#	0	1	8	16	24	25
MIDI	Standard Kit 1	Standard Kit 2	Room Kit	Rock Kit	Electronic Kit	Analog Kit
Note#	Note					
13	C#-1 *3	Surdo Mute	<—	<—	<—	<—
14	D-1 *3	Surdo Open	<—	<—	<—	<—
15	D#-1	Hi Q	<—	<—	<—	<—
16	E-1	Whip Slap	<—	<—	<—	<—
17	F-1 *4	Scratch Push	<—	<—	<—	<—
18	F#-1 *4	Scratch Pull	<—	<—	<—	<—
19	G-1	Finger Snap	<—	<—	<—	<—
20	G#-1	Click Noise	<—	<—	<—	<—
21	A-1	Metronome Click	<—	<—	<—	<—
22	A#-1	Metronome Bell	<—	<—	<—	<—
23	B-1	Seq Click L	<—	<—	<—	<—
24	C0	Seq Click H	<—	<—	<—	<—
25	C#0	Brush Tap	<—	<—	<—	<—
26	D0	Brush Swirl L	<—	<—	<—	<—
27	D#0	Brush Slap	<—	<—	<—	<—
28	E0	Brush Swirl H	<—	<—	Reverse Cymbal	Reverse Cymbal
29	F0	Snare Roll	Snare Roll 2	<—	<—	<—
30	F#0	Castanet	<—	<—	Hi Q	Hi Q
31	G0	Snare L	Snare L 2	<—	SD Rock M	Snare M
32	G#0	Sticks	<—	<—	<—	SD Rock H
33	A0	Bass Drum L	<—	<—	Bass Drum M	Bass Drum H 4
34	A#0	Open Rim Shot	Open Rim Shot 2	<—	<—	Bass Drum M
35	B0	Bass Drum M	Bass Drum M 2	<—	Bass Drum H 3	<—
36	C1	Bass Drum H	Bass Drum H 2	BD Room	BD Rock	BD Rock
37	C#1	Side Stick	<—	<—	BD Gate	BD Gate
38	D1	Snare M	Snare M 2	SD Room L	SD Rock	SD Rock L
39	D#1	Hand Clap	<—	<—	<—	SD Rock H
40	E1	Snare H	Snare H 2	SD Room H	SD Rock Rim	SD Rock H
41	F1	Floor Tom L	<—	Room Tom 1	Rock Tom 1	E Tom 1
42	F#1 *1	Hi-Hat Closed	<—	<—	<—	Analog Snare L
43	G1	Floor Tom H	<—	Room Tom 2	Rock Tom 2	E Tom 1
44	G#1 *1	Hi-Hat Pedal	<—	<—	<—	Analog HH Closed 1
45	A1	Low Tom	<—	Room Tom 3	Rock Tom 3	E Tom 2
46	A#1 *1	Hi-Hat Open	<—	<—	<—	Analog HH Closed 2
47	B1	Mid Tom L	<—	Room Tom 4	Rock Tom 4	E Tom 3
48	C2	Mid Tom H	<—	Room Tom 5	Rock Tom 5	E Tom 4
49	C#2	Crash Cymbal 1	<—	<—	<—	E Tom 5
50	D2	High Tom	<—	Room Tom 6	Rock Tom 6	E Tom 6
51	D#2	Ride Cymbal 1	<—	<—	<—	Analog Cymbal
52	E2	Chinese Cymbal	<—	<—	<—	Analog Tom 6
53	F2	Ride Cymbal Cup	<—	<—	<—	<—
54	F#2	Tambourine	<—	<—	<—	<—
55	G2	Splash Cymbal	<—	<—	<—	<—
56	G#2	Cowbell	<—	<—	<—	<—
57	A2	Crash Cymbal 2	<—	<—	<—	Analog Cowbell
58	A#2	Vibraslap	<—	<—	<—	<—
59	B2	Ride Cymbal 2	<—	<—	<—	<—
60	C3	Bongo H	<—	<—	<—	<—
61	C#3	Bongo L	<—	<—	<—	<—
62	D3	Conga H Mute	<—	<—	<—	<—
63	D#3	Conga H Open	<—	<—	<—	Analog Conga H
64	E3	Conga L	<—	<—	<—	Analog Conga M
65	F3	Timbale H	<—	<—	<—	Analog Conga L
66	F#3	Timbale L	<—	<—	<—	<—
67	G3	Agogo H	<—	<—	<—	<—
68	G#3	Agogo L	<—	<—	<—	<—
69	A3	Cabasa	<—	<—	<—	<—
70	A#3	Maracas	<—	<—	<—	<—
71	B3	Samba Whistle H	<—	<—	<—	Analog Maracas
72	C4	Samba Whistle L	<—	<—	<—	<—
73	C#4	Guiro Short	<—	<—	<—	<—
74	D4	Guiro Long	<—	<—	<—	<—
75	D#4	Claves	<—	<—	<—	<—
76	E4	Wood Block H	<—	<—	<—	Analog Claves
77	F4	Wood Block L	<—	<—	<—	<—
78	F#4	Cuica Mute	<—	<—	<—	<—
79	G4	Cuica Open	<—	<—	Scratch Push	Scratch Push
80	G#4 *2	Triangle Mute	<—	<—	Scratch Pull	Scratch Pull
81	A4 *2	Triangle Open	<—	<—	<—	<—
82	A#4	Shaker	<—	<—	<—	<—
83	B4	Jingle Bell	<—	<—	<—	<—
84	C5	Bell Tree	<—	<—	<—	<—
85	C#5					
86	D5					
87	D#5					
88	E5					
89	F5					
90	F#5					
91	G5					

Voice #	207	208	209	210	211	212
Bank MSB#	127	127	127	127	126	126
Bank LSB#	0	0	0	0	0	0
Program Change#	27	32	40	48	0	1
MIDI	Dance Kit	Jazz Kit	Brush Kit	Classic Kit	SFX 1	SFX 2
Note#	Note					
13	C#-1 *3	<---	<---	<---	<---	
14	D-1 *3	<---	<---	<---	<---	
15	D#-1	<---	<---	<---	<---	
16	E-1	<---	<---	<---	<---	
17	F-1 *4	<---	<---	<---	<---	
18	F#-1 *4	<---	<---	<---	<---	
19	G-1	<---	<---	<---	<---	
20	G#-1	<---	<---	<---	<---	
21	A-1	<---	<---	<---	<---	
22	A#-1	<---	<---	<---	<---	
23	B-1	<---	<---	<---	<---	
24	C0	<---	<---	<---	<---	
25	C#0	<---	<---	<---	<---	
26	D0	<---	<---	<---	<---	
27	D#0	<---	<---	<---	<---	
28	E0	Reverse Cymbal	<---	<---	<---	
29	F0	<---	<---	<---	<---	
30	F#0	Hi Q	<---	<---	<---	
31	G0	AnSD Snappy	<---	Brush Slap L	<---	
32	G#0	<---	<---	<---	<---	
33	A0	AnBD Dance-1	<---	<---	Bass Drum L2	
34	A#0	AnSD OpenRim	<---	<---	<---	
35	B0	AnBD Dance-2	<---	<---	Gran Casa	
36	C1	AnBD Dance-3	BD Jazz	BD Soft	Gran Casa Mute	Guitar Cutting Noise
37	C#1	Analog Side Stick	<---	<---	<---	Guitar Cutting Noise 2
38	D1	AnSD Q	SD Jazz L	Brush Slap	Marching Sn M	Door Creaking
39	D#1	<---	<---	<---	<---	Door Slam
40	E1	AnSD Ana+Acoustic	SD Jazz H	Brush Tap	Marching Sn H	Scratch
41	F1	Analog Tom 1	Jazz Tom 1	Brush Tom 1	Jazz Tom 1	Scratch 2
42	F#1 *1	AnHH Closed-3	<---	<---	<---	Windchime
43	G1	Analog Tom 2	Jazz Tom 2	Brush Tom 2	Jazz Tom 2	Telephone Ring2
44	G#1 *1	Analog HH Closed 2	<---	<---	<---	
45	A1	Analog Tom 3	Jazz Tom 3	Brush Tom 3	Jazz Tom 3	
46	A#1 *1	AnHH Open-2	<---	<---	<---	
47	B1	Analog Tom 4	Jazz Tom 4	Brush Tom 4	Jazz Tom 4	
48	C2	Analog Tom 5	Jazz Tom 5	Brush Tom 5	Jazz Tom 5	
49	C#2	Analog Cymbal	<---	<---	Hand Cym.Open L	
50	D2	Analog Tom 6	Jazz Tom 6	Brush Tom 6	Jazz Tom 6	
51	D#2	<---	<---	<---	Hand Cym.Closed L	
52	E2	<---	<---	<---	<---	FL.Key Click
53	F2	<---	<---	<---	<---	Engine Start
54	F#2	<---	<---	<---	<---	Tire Screech
55	G2	<---	<---	<---	<---	Car Passing
56	G#2	Analog Cowbell	<---	<---	<---	Crash
57	A2	<---	<---	<---	Hand Cym.Open H	Siren
58	A#2	<---	<---	<---	<---	Train
59	B2	<---	<---	<---	Hand Cym.Closed H	Jetplane
60	C3	<---	<---	<---	<---	Starship
61	C#3	<---	<---	<---	<---	Burst Noise
62	D3	Analog Conga H	<---	<---	<---	Coaster
63	D#3	Analog Conga M	<---	<---	<---	SvMarine
64	E3	Analog Conga L	<---	<---	<---	
65	F3	<---	<---	<---	<---	
66	F#3	<---	<---	<---	<---	
67	G3	<---	<---	<---	<---	
68	G#3	<---	<---	<---	<---	Rain
69	A3	<---	<---	<---	<---	Thunder
70	A#3	Analog Maracas	<---	<---	<---	Wind
71	B3	<---	<---	<---	<---	Stream
72	C4	<---	<---	<---	<---	Bubble
73	C#4	<---	<---	<---	<---	Feed
74	D4	<---	<---	<---	<---	
75	D#4	Analog Claves	<---	<---	<---	
76	E4	<---	<---	<---	<---	
77	F4	<---	<---	<---	<---	
78	F#4	Scratch Push	<---	<---	<---	
79	G4	Scratch Pull	<---	<---	<---	
80	G#4 *2	<---	<---	<---	<---	
81	A4 *2	<---	<---	<---	<---	
82	A#4	<---	<---	<---	<---	
83	B4	<---	<---	<---	<---	
84	C5	<---	<---	<---	<---	Dog
85	C#5	<---	<---	<---	<---	Horse Gallop
86	D5	<---	<---	<---	<---	Bird 2
87	D#5	<---	<---	<---	<---	Explosion
88	E5	<---	<---	<---	<---	FireWork
89	F5	<---	<---	<---	<---	
90	F#5	<---	<---	<---	<---	Ghost
91	G5	<---	<---	<---	<---	Maou

About Digital Effects (Reverb/Chorus/DSP)

There are three types of digital effects installed in the PSR-530: the reverb effect (system effect), the chorus effect (system effect) and the DSP effect (can be set as either as a system effect or insertion effect).

There are basically two ways to use the effects: with the DSP effect set as a system effect or as an insertion effect. Each different way will be explained here.

Although not all the effect settings cannot be made by operating the PSR-530 panel manually, some of them may be accessible through MIDI.

When DSP type Is Selected as a System Effect

- The three PSR-530 effects will be connected as shown below.
- The signal will enter reverb/chorus/DSP according to the send level set for each, and the signal with the effect applied will be output according to the return level that is set. The reverb/chorus/DSP send levels are set for each part (track) with the Revoice mode. The reverb/chorus/DSP return levels value are set in common for all the parts.
- The stereo panning is available for each of the reverb, chorus and DSP at the output for their signals. Using MIDI, the panning position for the effect can be set (page 115).
- If a "Send Chorus to Reverb" (page 115) signal is transmitted to the PSR-530 from an external MIDI device, a signal can be sent from the chorus to the reverb (connected in series). Also, if a "Send Variation (DSP) to Reverb" (page 116) signal is transmitted, a signal can be sent from the DSP to the reverb and in the same way if a "Send Variation (DSP) to Chorus" signal (page 116) is transmitted a signal can be sent from DSP to the chorus. If these signals are used, the three effects can be connected in series, or used separately, and a lot of different effects can be produced.

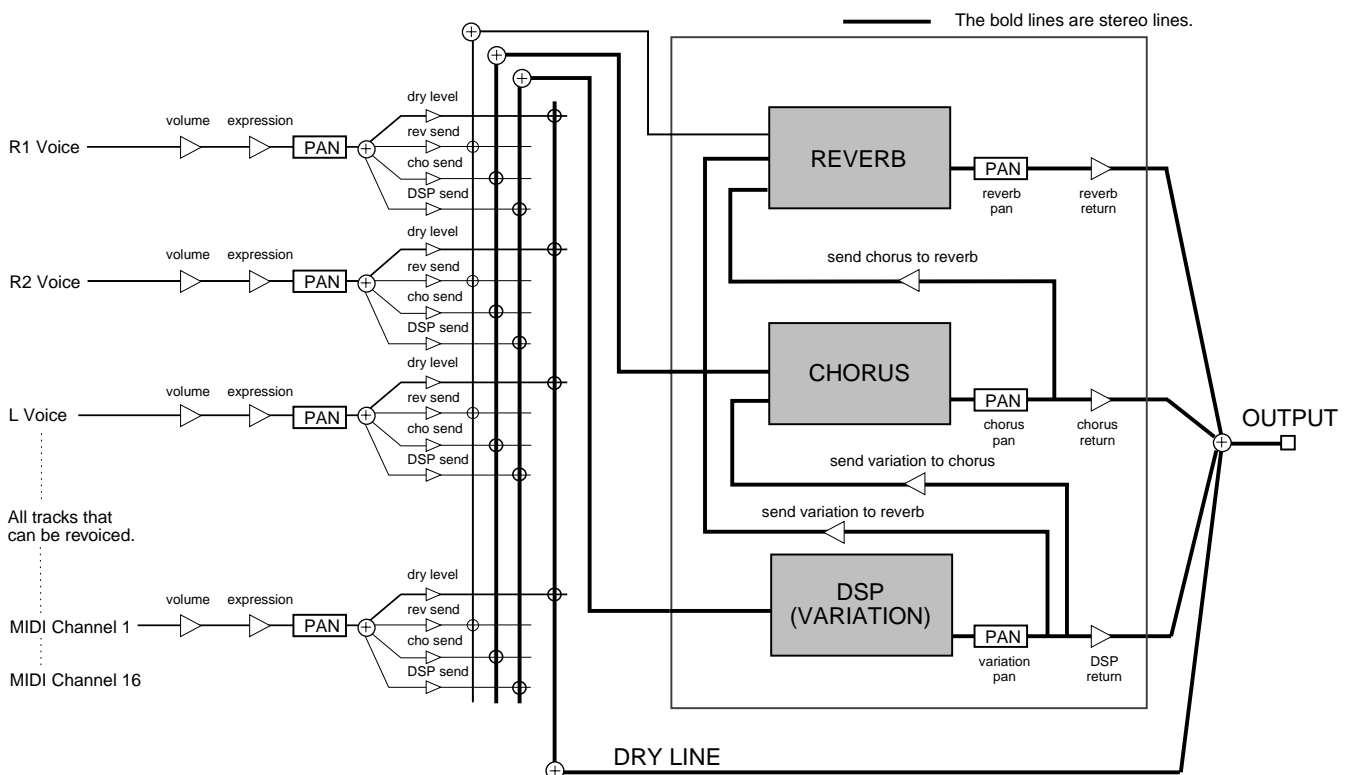

When DSP type Is Selected as an Insertion Effect

- The three PSR-530 effects will be connected as shown below.
- The signal will enter reverb and chorus according to the send level set for each, and the signal with the effect applied will be output according to the return level that is set. The reverb and chorus send levels are set for each part (track) with the Revoice mode. The reverb and chorus return level value is set in common for all the parts.
- The stereo panning is available for each of the reverb and chorus at the output for their signals. Using MIDI, the panning position for the effect can be set (page 115).
- If a "Send Chorus to Reverb" (page 115) signal is transmitted to the PSR-530 from an external MIDI device, a signal can be sent from the chorus to the reverb (connected in series).
- The signal will enter DSP with the Dry/Wet (send level) that is set, and a signal with the effect applied will be output. The DSP Dry/Wet (send level) is set for only R1 voice with the Revoice mode. The DSP return level cannot be set.

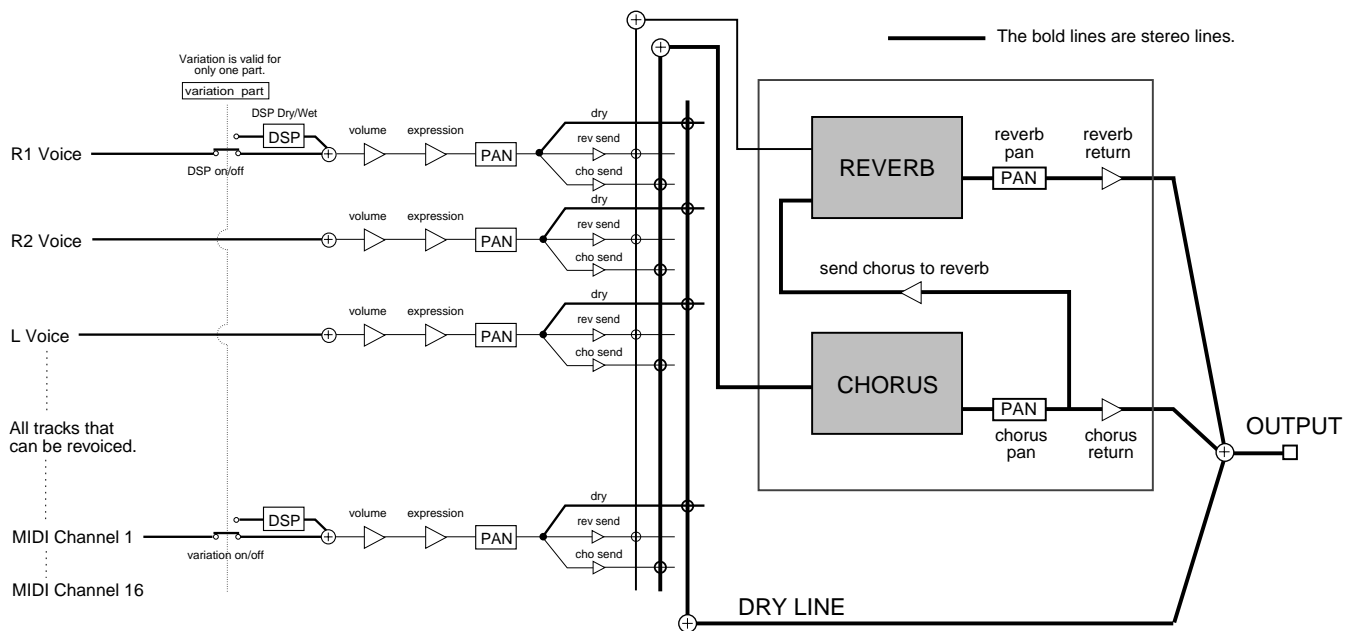

About Digital Effects (Reverb/Chorus/DSP)

The Digital Effect List

No.	Effect Type		Features
REVERB			
01~04	Hall1~4	System	Concert hall reverb.
05~08	Room1~4	System	Small room reverb.
09, 10	Stage1, 2	System	Reverb for solo instruments.
11, 12	Plate1, 2	System	Simulated steel plate reverb.
13	OFF	—	No effect.
CHORUS			
01~05	Chorus1~5	System	Conventional chorus program with rich, warm chorusing.
06~09	Flanger1~4	System	Pronounced three-phase modulation with a slight metallic sound.
10	OFF	—	No effect.
DSP			
01~04	Hall1~4	System	Concert hall reverb.
05~08	Room1~4	System	Small room reverb.
09, 10	Stage1, 2	System	Reverb for solo instruments.
11, 12	Plate1, 2	System	Simulated steel plate reverb.
13, 14	Early Reflection1, 2	System	Early reflections only.
15	Gate Reverb	System	Gated reverb effect, in which the reverberation is quickly cut off for special effects.
16	Reverse Gate	System	Similar to Gate Reverb, but with a reverse increase in reverb.
17~21	Chorus1~5	System	Conventional chorus program with rich, warm chorusing.
22~25	Flanger1~4	System	Pronounced three-phase modulation with slight metallic sound.
26	Symphonic	System	Exceptionally rich & deep chorusing.
27	Phaser	System	Pronounced, metallic modulation with periodic phase change.
28~32	Rotary Speaker 1~5	Insertion	Rotary speaker simulation.
33, 34	Tremolo 1, 2	Insertion	Rich Tremolo effect with both volume and pitch modulation.
35	Guitar Tremolo	Insertion	Simulated electric guitar tremolo.
36	Auto Pan	Insertion	Several panning effects that automatically shift the sound position (left, right, front, back).
37	Auto Wah	Insertion	Repeating filter sweep "wah" effect.
38	Delay L, C, R	System	Three independent delays, for the left, right and center stereo positions.
39	Delay L, R	System	Initial delay for each stereo channel, and two separate feedback delays.
40	Echo	System	Stereo delay, with independent Feedback Level controls for each channel.
41	Cross Delay	System	Complex effect that sends the delayed repeats "bouncing" between the left and right channels.
42	Distortion Hard	Insertion	Hard-edge distortion.
43	Distortion Soft	Insertion	This type is not so hard compared with Distortion Hard.
44	EQ Disco	Insertion	Discotype equalizer program to boost high and low frequencies.
45	EQ Telephone	Insertion	Equalizer program which eliminates higher and lower frequencies to simulate the sounds through telephone.
46	OFF	—	No effect.

Troubleshooting

Something not working as it should? In many cases what appears to be a malfunction can be traced to a simple error that can be remedied immediately. Before assuming that your PSR-530 is faulty, please check the following points.

PROBLEM	POSSIBLE CAUSE/SOLUTION
The speakers produce a “pop” sound whenever the power is turned ON or OFF.	This is normal and is no cause for alarm.
The volume is reduced or the sound is distorted.	The batteries probably need to be replaced. Either replace all six batteries, or use an AC power adaptor.
The registration memory doesn’t work properly.	
Recorded song data will not play back properly.	
The display goes bland and all panel controls are reset.	
No sound when the keyboard is played.	The R1/R2/L voice volume settings could be set too low. Make sure the voice volumes are set at appropriate levels (pages 14, 79).
	The Local Control function could be turned off. Make sure Local Control is turned on (page 94).
Not all simultaneously-played notes sound.	You are probably exceeding the maximum polyphony of the PSR-530. The PSR-530 can play up to 32 notes at the same time — including split, dual, auto-accompaniment, song, and multi pad notes. Notes exceeding this limit will not sound.
Auto Accompaniment seems to “skip” when the keyboard is played.	
Auto Accompaniment doesn’t sound when started.	The MIDI Clock mode may be set to “on”. Make sure it is turned “off” (page 94).
Auto accompaniment won’t function properly. No lower keyboard sound.	Make sure that all accompaniment tracks are turned on, and that they are all set to appropriate volume levels.
	Make sure you are using fingerings recognized by the selected fingering mode, and are playing in the Auto Accompaniment section of the keyboard.
	Are you sure you’re playing in the Auto-Accompaniment section of the keyboard? Make sure that the Auto Accompaniment split point is set appropriately (page 29).
	Are you playing chords that the PSR-530 can recognize (see chord types on page 30)?
The Harmony function will not turn on.	Harmony cannot be turned on when the FULL KEYBOARD fingering mode is selected or if a percussion kit voice is selected. Select an appropriate fingering mode or voice.
Certain notes sound at the wrong pitch.	Make sure that the scale tuning value for those notes is set to “0” (page 84).
A cartridge style or song cannot be selected or will not play properly.	Make sure that an appropriate Yamaha Music Cartridge is properly plugged into the cartridge slot (page 75), or the cartridge contacts are dirty. Try re-inserting the cartridge. If the contacts are dirty removing and inserting the cartridge several times will sometimes solve the problem. If this doesn’t work, try wiping the cartridge connectors carefully with a soft, dry cloth.
Operation of the sustain pedal is reversed.	Sustain pedal operation will be reversed if you turn on the power or plug in the pedal while pressing the pedal. For normal operation turn off the power then turn it back on while the pedal is not pressed.
Individual registration or song memory data transmitted via bulk dump from an external sequencer or other device is not received by the PSR-530.	Transmit the data with no more than a 2-second break between blocks, or transmit as entirely separate data.

MIDI Data Format

Many MIDI messages listed in the MIDI Data Format are expressed in decimal numbers, binary numbers and hexadecimal numbers. Hexadecimal numbers may include the letter "H" as a suffix. Also, "n" can freely be defined as any whole number.

To enter data/values, refer to the table below.

Decimal	Hexadecimal	Binary	Decimal	Hexadecimal	Binary
0	00	0000 0000	64	40	0100 0000
1	01	0000 0001	65	41	0100 0001
2	02	0000 0010	66	42	0100 0010
3	03	0000 0011	67	43	0100 0011
4	04	0000 0100	68	44	0100 0100
5	05	0000 0101	69	45	0100 0101
6	06	0000 0110	70	46	0100 0110
7	07	0000 0111	71	47	0100 0111
8	08	0000 1000	72	48	0100 1000
9	09	0000 1001	73	49	0100 1001
10	0A	0000 1010	74	4A	0100 1010
11	0B	0000 1011	75	4B	0100 1011
12	0C	0000 1100	76	4C	0100 1100
13	0D	0000 1101	77	4D	0100 1101
14	0E	0000 1110	78	4E	0100 1110
15	0F	0000 1111	79	4F	0100 1111
16	10	0001 0000	80	50	0101 0000
17	11	0001 0001	81	51	0101 0001
18	12	0001 0010	82	52	0101 0010
19	13	0001 0011	83	53	0101 0011
20	14	0001 0100	84	54	0101 0100
21	15	0001 0101	85	55	0101 0101
22	16	0001 0110	86	56	0101 0110
23	17	0001 0111	87	57	0101 0111
24	18	0001 1000	88	58	0101 1000
25	19	0001 1001	89	59	0101 1001
26	1A	0001 1010	90	5A	0101 1010
27	1B	0001 1011	91	5B	0101 1011
28	1C	0001 1100	92	5C	0101 1100
29	1D	0001 1101	93	5D	0101 1101
30	1E	0001 1110	94	5E	0101 1110
31	1F	0001 1111	95	5F	0101 1111
32	20	0010 0000	96	60	0110 0000
33	21	0010 0001	97	61	0110 0001
34	22	0010 0010	98	62	0110 0010
35	23	0010 0011	99	63	0110 0011
36	24	0010 0100	100	64	0110 0100
37	25	0010 0101	101	65	0110 0101
38	26	0010 0110	102	66	0110 0110
39	27	0010 0111	103	67	0110 0111
40	28	0010 1000	104	68	0110 1000
41	29	0010 1001	105	69	0110 1001
42	2A	0010 1010	106	6A	0110 1010
43	2B	0010 1011	107	6B	0110 1011
44	2C	0010 1100	108	6C	0110 1100
45	2D	0010 1101	109	6D	0110 1101
46	2E	0010 1110	110	6E	0110 1110
47	2F	0010 1111	111	6F	0110 1111
48	30	0011 0000	112	70	0111 0000
49	31	0011 0001	113	71	0111 0001
50	32	0011 0010	114	72	0111 0010
51	33	0011 0011	115	73	0111 0011
52	34	0011 0100	116	74	0111 0100
53	35	0011 0101	117	75	0111 0101
54	36	0011 0110	118	76	0111 0110
55	37	0011 0111	119	77	0111 0111
56	38	0011 1000	120	78	0111 1000
57	39	0011 1001	121	79	0111 1001
58	3A	0011 1010	122	7A	0111 1010
59	3B	0011 1011	123	7B	0111 1011
60	3C	0011 1100	124	7C	0111 1100
61	3D	0011 1101	125	7D	0111 1101
62	3E	0011 1110	126	7E	0111 1110
63	3F	0011 1111	127	7F	0111 1111

- Except the table above, for example 144-159 (decimal)/9nH/1001 0000-1001 1111 (binary) displays the Note On Message for each channel (1-16). 176-191/BnH/1011 0000-1011 1111 displays the Control Change Message for each channel (1-16). 192-207/CnH/1100 0000-1100 1111 displays the Program Change Message for each channel (1-16). 240/FOH/1111 0000 denotes the start of a System Exclusive Message. 247/F7H/1111 0111 denotes the end of a System Exclusive Message.
- aaH (hexadecimal)/0aaaaaaa (binary) denotes the data address. The address contains High, Mid, and Low.
- bbH/0bbbbbbb denotes the byte count.
- ccH/0ccccccc denotes the check sum.
- ddH/0ddddddd denotes the data/value.

(1) TRANSMIT FLOW

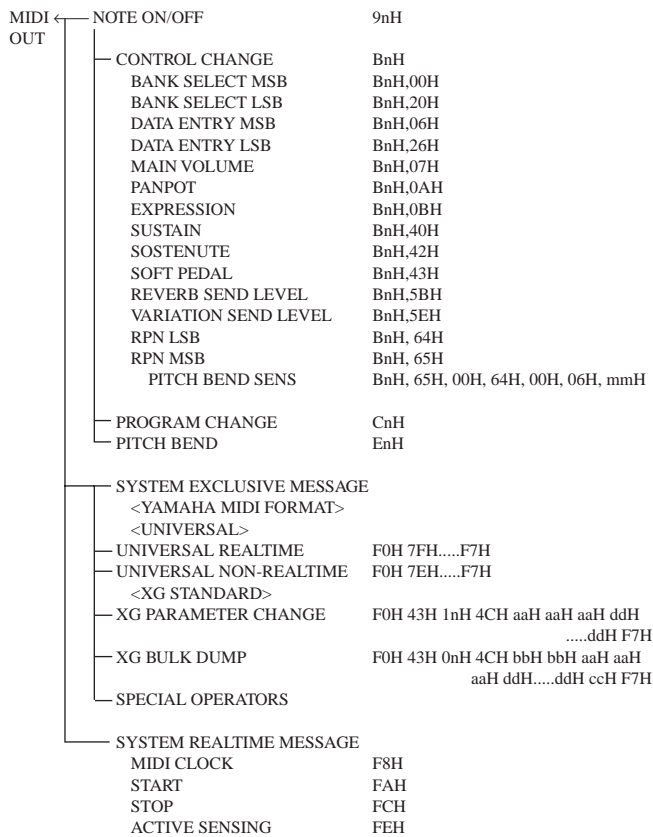

(2) RECEIVE FLOW

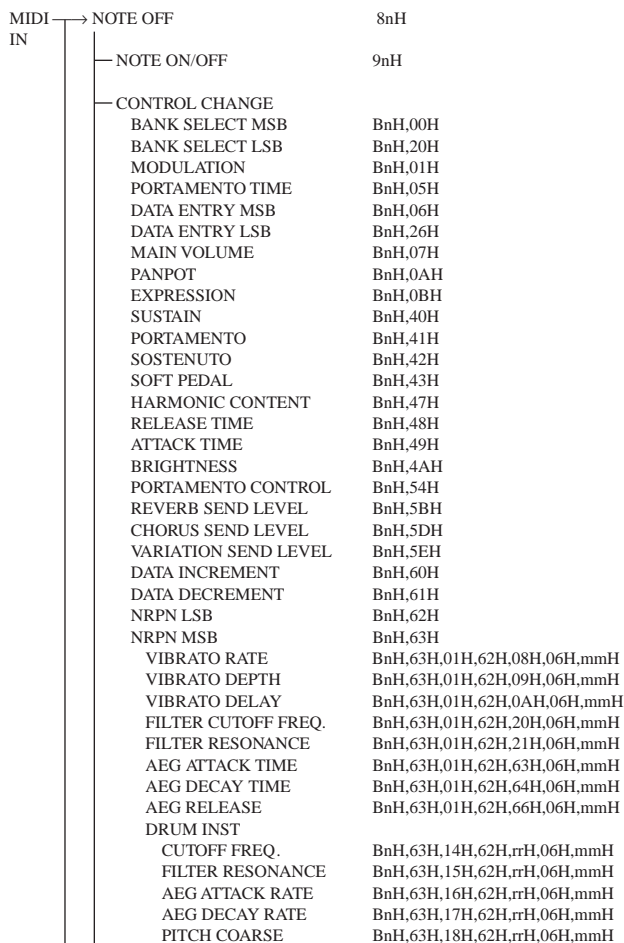

PITCH FINE	BnH,63H,19H,62H,rrH,06H,mmH
LEVEL	BnH,63H,1AH,62H,rrH,06H,mmH
PANPOT	BnH,63H,1CH,62H,rrH,06H,mmH
REVERB SEND	BnH,63H,1DH,62H,rrH,06H,mmH
CHORUS SEND	BnH,63H,1EH,62H,rrH,06H,mmH
VARIATION SEND	BnH,63H,1FH,62H,rrH,06H,mmH
RPN LSB	BnH,64H
RPN MSB	BnH,65H
PITCH BEND SENS.	BnH,65H,00H,64H,00H,06H,mmH
FINE TUNING	BnH,65H,00H,64H,01H,06H,mmH, 26H,IIIH
COARSE TUNING	BnH,65H,00H,64H,02H,06H,mmH
NULL	BnH,65H,7FH,64H,7FH
ALL SOUND OFF	BnH,78H,00H
RESET ALL CONTROLLERS	BnH,79H,00H
ALL NOTES OFF	BnH,7BH
OMNI OFF	BnH,7CH
OMNI ON	BnH,7DH
MONO	BnH,7EH
POLY	BnH,7FH
PROGRAM CHANGE	CnH
CHANNEL AFTER TOUCH	DnH
PITCH BEND CHANGE	EnH
SYSTEM EXCLUSIVE MESSAGE	
<YAMAHA MIDI FORMAT>	
<UNIVERSAL>	
UNIVERSAL REALTIME	FOH 7FH.....F7H
UNIVERSAL NON-REALTIME	FOH 4EH.....F7H
<XG STANDARD>	
XG PARAMETER CHANGE	FOH 43H 1nH 4CH aaH aaH aaH ddHddH F7H
XG BULK DUMP	FOH 43H 0nH 4CH bbH bbH aaH aaH aaH ddH.....ddH ccH F7H
PARAMETER REQUEST	FOH 43H 3nH 4CH aaH aaH aaH F7H
DUMP REQUEST	FOH 43H 2nH 4CH aaH aaH aaH F7H
SPECIAL OPERATORS	
Others	
SYSTEM REALTIME MESSAGE	
MIDI CLOCK	F8H
START	FAH
STOP	FCH
ACTIVE SENSING	FEH

(3) TRANSMIT/RECEIVE DATA

(3-1) CHANNEL VOICE MESSAGES

(3-1-1) NOTE OFF (Recive only)

STATUS	1000nnnn (8nH)	n = 0 - 15 VOICE CHANNEL NUMBER
NOTE NUMBER	0kkkkkkk	k = 0 (C-2) - 127 (G8)
VELOCITY	0vvvvvvv	v: ignored

(3-1-2) NOTE ON/OFF

STATUS	1001nnnn (9nH)	n = 0 - 15 VOICE CHANNEL NUMBER
NOTE NUMBER	0kkkkkkk	k = 0 (C-2) - 127 (G8)
VELOCITY	0vvvvvvv	(v ≠ 0) NOTE ON (v = 0) NOTE OFF
	00000000	

(3-1-3) PROGRAM CHANGE

STATUS	1100nnnn (CnH)	n = 0 - 15 VOICE CHANNEL NUMBER
PROGRAM NUMBER	0ppppppp	p = 0 - 127

* PROGRAM NUMBER: XG DRUM VOICE number correspondence

P = 0	Standard Kit
P = 1	Standard2 Kit
P = 8	Room Kit
P = 16	Rock Kit
P = 24	Elctrnic Kit
P = 25	Analog Kit
P = 27	Dance Kit
P = 32	Jazz Kit
P = 40	Brush Kit
P = 48	Classic Kit

* PROGRAM NUMBER: XG SFX KIT number correspondence

P = 1	SFX1 Kit
P = 2	SFX2 Kit

When DRUM VOICE is selected and program change data for a different DRUM VOICE is received, the currently selected DRUM VOICE will be replaced with the new DRUM VOICE.

(3-1-4) CHANNEL AFTER TOUCH (Recive only)

STATUS	1101nnnn (DnH)	n = 0 - 15 VOICE CHANNEL NUMBER
VALUE	0vvvvvvv	v = 0 - 127 AFTER TOUCH VALUE

(3-1-5) PITCH BEND CHANGE

STATUS	1110nnnn (EnH)	n = 0 - 15 VOICE CHANNEL NUMBER
LSB	0vvvvvvv	PITCH BEND CHANGE LSB
MSB	0vvvvvvv	PITCH BEND CHANGE MSB

(3-1-6) CONTROL CHANGE

STATUS	1011nnnn (BnH)	n = 0 - 15 VOICE CHANNEL NUMBER
CONTROL NUMBER	0ccccccc	
CONTROL VALUE	0vvvvvvv	

* Transmit CONTROL NUMBER.

c = 0	BANK SELECT MSB	; v = 0:XG NORMAL, 64:SFX NORMAL, 126:XG SFX KIT, 127:XG DRUM	
c = 32	BANK SELECT LSB	; v = 0 - 127	*3
c = 6	DATA ENTRY MSB	; v = 0 - 127	*1
c = 38	DATA ENTRY LSB	; v = 0 - 127	*1
c = 7	MAIN VOLUME	; v = 0 - 127	
c = 10	PANPOT	; v = 0 - 127	
c = 11	EXPRESSION	; v = 0 - 127	
c = 64	SUSTAIN	; v = 0-63:OFF , 64-127:ON	*2
c = 66	SOSTENUTO	; v = 0-63:OFF , 64-127:ON	*2
c = 67	SOFT PEDAL	; v = 0-63:OFF , 64-127:ON	*2
c = 91	REVERB SEND LEVEL	; v = 0 - 127	
c = 94	VARIATION SEND LEVEL	; v = 0 - 127	

* Receive CONTROL NUMBER.

c = 0	BANK SELECT MSB	; v = 0:XG NORMAL, 64:SFX NORMAL, 126:XG SFX KIT, 127:XG DRUM	
c = 32	BANK SELECT LSB	; v = 0 - 127	*3
c = 1	MODULATION	; v = 0 - 127	*2
c = 5	PORTAMENTO TIME	; v = 0 - 127	*2
c = 6	DATA ENTRY MSB	; v = 0 - 127	*1
c = 38	DATA ENTRY LSB	; v = 0 - 127	*1
c = 7	MAIN VOLUME	; v = 0 - 127	
c = 10	PANPOT	; v = 0 - 127	
c = 11	EXPRESSION	; v = 0 - 127	
c = 64	SUSTAIN	; v = 0-63:OFF , 64-127:ON	*2
c = 65	PORTAMENTO	; v = 0-63:OFF , 64-127:ON	*2
c = 66	SOSTENUTO	; v = 0-63:OFF , 64-127:ON	*2
c = 67	SOFT PEDAL	; v = 0-63:OFF , 64-127:ON	*2
c = 71	HARMONIC CONTENT	; v = 0:-64 - 64:0 - 127:+63	*2
c = 72	RELEASE TIME	; v = 0:-64 - 64:0 - 127:+63	*2
c = 73	ATTACK TIME	; v = 0:-64 - 64:0 - 127:+63	*2
c = 74	BRIGHTNESS	; v = 0:-64 - 64:0 - 127:+63	*2
c = 84	PORTAMENT CONTROL	; v = 0 - 127	*2
c = 91	REVERB SEND LEVEL	; v = 0 - 127	
c = 93	CHORUS SEND LEVEL	; v = 0 - 127	
c = 94	VARIATION SEND LEVEL	; v = 0 - 127	
		(When only Connection = 1[System])	
c = 96	DATA INCREMENT	; v = 127	*1
c = 97	DATA DECREMENT	; v = 127	*1

*1 Only when setting the appointed parameter with RPN, NRPn.

*2 Does not effect Rhythm Voice.

*3 MSB=0, anything other than 63 is 0.

• Until a PROGRAM CHANGE message is received, the BANK SELECT operation will be suspended. When a Voice, including VOICE BANK, is changed, set the BANK SELECT and Program Change Message, and transmit in the following order, BANK SELECT MSB, LSB, PROGRAM CHANGE.

• MODULATION controls the Vibrato Depth.

• PORTAMENTO TIME controls the Pitch Change Speed when the Portamento Switch = ON. 0 being the shortest time, and 127 being the longest.

• PANPOT changes the value for the melody voice and rhythm voice in relation to the preset value.

• Portamento time is fixed to 0 when the PORTAMENTO CONTROL is used.

• HARMONIC CONTENT applies adjustment to the resonance value that is set by the voice. This parameter specifies relative change with the value of 64 producing 0 adjustment. As values get higher the sound becomes increasingly eccentric. Note that for some voices the effective parameter range is narrower than the legal parameter range.

• RELEASE TIME applies adjustment to the envelope release time set by the voice. This parameter specifies relative change with the value of 64 producing 0 adjustment.

MIDI Data Format

- **ATTACK TIME** applies adjustment to the envelope attack time set by the voice. This parameter specifies relative change with the value of 64 producing 0 adjustment.
- **BRIGHTNESS** applies adjustment to the cut-off frequency set by the voice. This parameter specifies relative change with the value of 64 producing 0 adjustment. Lower voices produce a softer sound. For some voices the effective parameter range is narrower than the legal parameter range.

(3-2) CHANNEL MODE MESSAGES

STATUS 1011nnnn (BnH) n = 0 - 15 VOICE CHANNEL NUMBER
 CONTROL NUMBER 0ccccccc c = CONTROL NUMBER
 CONTROL VALUE 0vvvvvvv v = DATA VALUE

(3-2-1) ALL SOUND OFF (Recive only)

(CONTROL NUMBER = 78H , DATA VALUE = 0)

Switches off all sound from the channel. Does not reset Note On and Hold On conditions established by Channel Messages.

(3-2-2) RESET ALL CONTROLLERS (Recive only)

(CONTROL NUMBER = 79H , DATA VALUE = 0)

Resets controllers as follows.

PITCH BEND CHANGE 0 (Center)
 AFTER TOUCH 0 (min.)
 MODULATION 0 (min.)
 EXPRESSION 127 (max.)
 SUSTAIN 0 (off)
 SOSTENUTO 0 (off)
 SOFT PEDAL 0 (off)
 NRPN Sets number to null. (Internal data remains unchanged)
 RPN Sets number to null. (Internal data remains unchanged)
 PORTAMENT CONTROL Resets portamento source note number
 PORTAMENTO 0 (off)

(3-2-3) ALL NOTES OFF (Recive only)

(CONTROL NUMBER = 7BH , DATA VALUE = 0)

Switches off all of the channel's "on" notes. However, any notes being held by SUSTAIN or SOSTENUTO continue to sound until SUSTAIN/SOSTENUTO goes off.

(3-2-4) OMNI OFF (Recive only) (CONTROL NUMBER = 7CH , DATA VALUE = 0)

Same processing as for All Notes Off.

(3-2-5) OMNI ON (Recive only) (CONTROL NUMBER = 7DH , DATA VALUE = 0)

Same processing as for All Notes Off. Omni On is not executed.

(3-2-6) MONO (Recive only) (CONTROL NUMBER = 7EH , DATA VALUE = 0-16)

Same processing as for All Notes Off. If the 3rd byte is in a range of 0-16 the corresponding channel will be changed to Mode 4 (m=1).

(3-2-7) POLY (Recive only) (CONTROL NUMBER = 7FH , DATA VALUE = 0)

Same processing as for All Sounds Off and the corresponding channel will be changed to Mode 3.

(3-3) REGISTERED PARAMETER NUMBER (RPN)

STATUS 1011nnnn (BnH) n = 0 - 15 VOICE CHANNEL NUMBER
 RPN LSB 01100100 (64H)
 RPN LSB NUMBER 0ppppppp p = RPN LSB (refer to the list below)
 RPN MSB 01100101 (65H)
 RPN MSB NUMBER 0qqqqqqq q = RPN MSB (refer to the list below)
 DATA ENTRY MSB 00000110 (06H)
 DATA VALUE 0mmmmmmm m = Data Value
 DATA ENTRY LSB 00100110 (26H)
 DATA VALUE 0lllllll l = Data Value

First appoints the parameter for RPN MSB/LSB, then sets the parameter value for data entry MSB/LSB.

RPN	D.ENTRY	LSB MSB	MSB LSB	PARAMETER NAME	DATA RANGE
00H 00H	mmH —			PITCH BEND SENSITIVITY	00H - 18H (0 - 24 semitones)
01H 00H	mmH llH			FINE TUNE	{mmH,llH} = {00H,00H} - {40H,00H} - {7FH,7FH} (-8192*100/8192) - 0 - (+8192*100/8192)
02H 00H	mmH —			COARSE TUNE	28H - 40H - 58H (-24 - 0 - +24 semitones)
7FH 7FH	— —			NULL	

Clears the current RPN number setting. Does not change the internal parameter settings.

(3-4) NON-REGISTERED PARAMETER NUMBER (NRPN) (Recive only)

STATUS 1011nnnn (BnH) n = 0 - 15 VOICE CHANNEL NUMBER
 NRPN LSB 01100010 (62H)
 NRPN LSB NUMBER 0ppppppp p = NRPN LSB (refer to the list below)
 NRPN MSB 01100011 (63H)
 NRPN MSB NUMBER 0qqqqqqq q = NRPN MSB (refer to the list below)
 DATA ENTRY MSB 00000110 (06H)
 DATA VALUE 0mmmmmmm m = Data Value

First appoints the parameter for NRPN MSB/LSB, then sets the parameter value for data entry MSB/LSB.

NRPN	D.ENTRY	MSB LSB	MSB LSB	PARAMETER NAME	DATA RANGE
01H 08H	mmH —			VIBRATO RATE	00H - 40H - 7FH (-64 - 0 - +63)
01H 09H	mmH —			VIBRATO DEPTH	00H - 40H - 7FH (-64 - 0 - +63)
01H 0AH	mmH —			VIBRATO DELAY	00H - 40H - 7FH (-64 - 0 - +63)
01H 20H	mmH —			FILTER CUTOFF FREQUENCY	00H - 40H - 7FH (-64 - 0 - +63)
01H 21H	mmH —			FILTER RESONANCE	00H - 40H - 7FH (-64 - 0 - +63)
01H 63H	mmH —			EG ATTACK TIME	00H - 40H - 7FH (-64 - 0 - +63)
01H 64H	mmH —			EG DECAY TIME	00H - 40H - 7FH (-64 - 0 - +63)
01H 66H	mmH —			EG RELEASE	00H - 40H - 7FH (-64 - 0 - +63)
14H rrH	mmH —			DRUM FILTER CUTOFF FREQ.	00H - 40H - 7FH (-64 - 0 - +63)
15H rrH	mmH —			DRUM FILTER RESONANCE	00H - 40H - 7FH (-64 - 0 - +63)
16H rrH	mmH —			DRUM AEG ATTACK RATE	00H - 40H - 7FH (-64 - 0 - +63)
17H rrH	mmH —			DRUM AEG DECAY RATE	00H - 40H - 7FH (-64 - 0 - +63)
18H rrH	mmH —			DRUM PITCH COARSE	00H - 40H - 7FH (-64 - 0 - +63)
19H rrH	mmH —			DRUM PITCH FINE	00H - 40H - 7FH (-64 - 0 - +63)
1AH rrH	mmH —			DRUM LEVEL	00H - 7FH (0 - max.)
1CH rrH	mmH —			DRUM PANPOT	00H ,01H - 40H - 7FH (random,left - center - right)
1DH rrH	mmH —			DRUM REVERB SEND LEVEL	00H - 7FH (0 - max.)
1EH rrH	mmH —			DRUM CHORUS SEND LEVEL	00H - 7FH (0 - max.)
1FH rrH	mmH —			DRUM VARIATION SEND LEVEL	00H - 7FH (0 - max.)

The MSG14H-1FH (for drums) message is accepted as long as the channel is set with a drum voice.
 rrH : drum instrument note number

(3-5) SYSTEM REALTIME MESSAGES

(3-5-1) MIDI CLOCK

STATUS 11111000 (F8H)

Transmission: 96 clocks per measure are transmitted.

Reception: If the instrument's clock is set to external, after FAH is received from the external device the instrument's clock will sync with the 96 beats per measure received from the external device.

Decides whether the internal clock, or Timing Clocks received via the MIDI IN will be used.

(3-5-2) START

STATUS 11111010 (FAH)

Transmission: Transmitted when instrument's Auto accompaniment or Song playback is started.

Reception: Depending upon the condition, Auto accompaniment, Song Playback, or Song Rec will start. FAH can only be received when External Clock is ON.

(3-5-3) STOP

STATUS 11111100 (FCH)

Transmission: Transmitted when instrument's Rhythm or Song playback is stopped.

Reception: Depending upon the condition, Rhythm, Song Playback, or Song Rec will stop.

(3-5-4) ACTIVE SENSING

STATUS 11111110 (FEH)

Transmission: Transmitted approximately once every 200msec.

Reception: Sensing is started once this Code is received. If Status or Data is not received within 400ms, the MIDI Receive Buffer will be cleared, and all notes, including those being sustained, will be cut OFF. Also, all control values will be reset to their factory defaults.

(3-6) SYSTEM EXCLUSIVE MESSAGE

(3-6-1) YAMAHA MIDI FORMAT

(3-6-1-1) SECTION CONTROL

binary	hexadecimal	Exclusive status
11110000	F0	YAMAHA ID
01000011	43	Style
01111110	7E	Style
00000000	00	Switch No.
0sssssss	SS	Switch No.
		00H : INTRO A
		01H-07H : INTRO B
		08H : MAIN A
		09H-0FH : MAIN B
		10H : FILL IN AA
		11H-17H : FILL IN BB
		18H : FILL IN AB
		19H-1FH : FILL IN BA
		20H : ENDING A
		21H-27H : ENDING B
0ddddd	DD	Switch On/Off : 00H (Off),7FH (On)
11110111	F7	End of Exclusive

When an ON code is received, the appointed section will be changed.

(3-6-1-2) TEMPO CONTROL

binary	hexadecimal	
11110000	F0	Exclusive status
01000011	43	YAMAHA ID
01111110	7E	Style
00000000	01	
0ttttttt	TT	Tempo4
0ttttttt	TT	Tempo3
0ttttttt	TT	Tempo2
0ttttttt	TT	Tempo1
11110111	F7	End of Exclusive

The internal clock will be set to the received Tempo value.

Tempo Meta Event is a large data block (24-bit), it is divided into 4 groups with 7-bits going into each of the Tempos 1-4 (4 receives the remaining 3 bits).

(3-6-2) UNIVERSAL SYSTEM EXCLUSIVE

(3-6-2-1) UNIVERSAL REALTIME MESSAGE

(3-6-2-1-1) MIDI MASTER VOLUME (Recive only)

binary	hexadecimal	
11110000	F0	Exclusive status
01111110	7F	Universal Realtime
01111111	7F	ID of target Device
00001001	04	Sub-ID #1=Device Control Message
00000001	01	Sub-ID #2=Master Volume
0sssssss	SS	Volume LSB
0ttttttt	TT	Volume MSB
11110111	F7	End of Exclusive
or		
11110000	F0	Exclusive status
01111110	7F	Universal Realtime
0xxxxxxx	XN	When N is received N=0-F, whichever is received. When N is transmitted N always=0. X = don't care
00001001	04	Sub-ID #1=Device Control Message
00000001	01	Sub-ID #2=Master Volume
0sssssss	SS	Volume LSB
0ttttttt	TT	Volume MSB
11110111	F7	End of Exclusive

The volume for all channels will be changed simultaneously.

The TT value is used as the MIDI Master Volume value. (the ss value is ignored.)

(3-6-2-2) UNIVERSAL NON REALTIME MESSAGE

(3-6-2-2-1) GENERAL MIDI SYSTEM ON

binary	hexadecimal	
11110000	F0	Exclusive status
01111110	7E	Universal Non-Realtime
01111111	7F	ID of target Device
00001001	09	Sub-ID #1=General MIDI Message
00000001	01	Sub-ID #2=General MIDI On
11110111	F7	End of Exclusive
or		
11110000	F0	Exclusive status
01111110	7E	Universal Non-Realtime
0xxxxxxx	XN	When N is received N=0-F, whichever is received. When N is transmitted N always=0. X = don't care
00001001	09	Sub-ID #1=General MIDI Message
00000001	01	Sub-ID #2=General MIDI On
11110111	F7	End of Exclusive

Depending upon the received ON message, the System Mode will be changed to XG. Except MIDI Master Tuning, all control data be reset to default values.

This message requires approximately 50ms to execute, so sufficient time should be allowed before the next message is sent.

The bank select message for the channel 10 and the NRPN messages are not received in the GM mode.

(3-6-3) XG STANDARD

(3-6-3-1) XG PARAMETER CHANGE

(3-6-3-1-1) XG SYSTEM ON

binary	hexadecimal	
11110000	F0	Exclusive status
01000011	43	YAMAHA ID
0001nnnn	1N	Device Number
01001100	4C	Model ID
00000000	00	Address High
00000000	00	Address Mid
01111110	7E	Address Low
00000000	00	Data
11110111	F7	End of Exclusive

Depending upon the received ON message, the SYSTEM MODE will be changed to XG. Controllers will be reset, all values of Multi Part and Effect, and All System values denoted by "XG" data within All System will be reset to default values in the table. This message requires approximately 50ms to execute, so sufficient time should be allowed before the next message is sent.

(3-6-3-1-2) XG PARAMETER CHANGE

binary	hexadecimal	
11110000	F0	Exclusive status
01000011	43	YAMAHA ID
0001nnnn	1N	Device Number
01001100	4C	Model ID
0aaaaaaa	AA	Address High
0aaaaaaa	AA	Address Mid
0aaaaaaa	AA	Address Low
0ddddd	DD	Data
11110111	F7	End of Exclusive

For parameters with data size of 2 or 4, transmit the appropriate number of data bytes. For more information on Address and Parameters, refer to < Table 1-2 > ~ < Table 1-6 > (pages 115 ~ 118).

The 4 data types listed below are transmitted and received.

(These are transmitted only after a Parameter change request is received.)

XG System Data
Multi Effect Data
Multi Part Data
Drums Setup Data

(3-6-3-2) XG BULK DUMP

binary	hexadecimal	
11110000	F0	Exclusive status
01000011	43	YAMAHA ID
0000nnnn	0N	Device Number
01001100	4C	Model ID
0bbbbbbb	BB	ByteCount
0bbbbbbb	BB	ByteCount
0aaaaaaa	AA	Address High
0aaaaaaa	AA	Address Mid
0aaaaaaa	AA	Address Low
0ddddd	DD	Data
0ccccc	CC	Check sum
11110111	F7	End of Exclusive

For more information on Address and Byte Count, refer to < Table 1-2 > ~ < Table 1-6 > (pages 115 ~ 118).

The Check Sum value is set such that the sum of Byte Count, Address, Data, and Check Sum has value zero in its seven least significant bits.

If the top of the block is appointed to the Address the XG Bulk Dump, Bulk Request will be received.

The Block is a unit that consists of the data, arranged in the list, as the Total Size.

The 5 data types listed below are transmitted and received.

(These are transmitted only after a Bulk Dump request is received.)

System Data
Multi Effect Data (Individual effect unit)
Multi Part Data (Individual part unit)
Drums Setup Data (Individual note unit)
System Information (Individual only)

(3-6-3-3) XG PARAMETER REQUEST (Recive only)

binary	hexadecimal	
11110000	F0	Exclusive status
01000011	43	YAMAHA ID
0011nnnn	3n	Device Number
01001100	4C	Model ID
0aaaaaaa	AA	Address High
0aaaaaaa	AA	Address Mid
0aaaaaaa	AA	Address Low
11110111	F7	End of Exclusive

For more information on Address and Byte Count refer to < Table 1-2 > ~ < Table 1-6 > (pages 115 ~ 118).

The 4 data types listed below are received.

System Data
Multi Effect Data
Multi Part Data
Drums Setup Data

(3-6-3-4) XG DUMP REQUEST (Recive only)

binary	hexadecimal	
11110000	F0	Exclusive status
01000011	43	YAMAHA ID
0010nnnn	2n	Device Number
01001100	4C	Model ID
0aaaaaaa	AA	Address High
0aaaaaaa	AA	Address Mid
0aaaaaaa	AA	Address Low
11110111	F7	End of Exclusive

For more information on Address and Byte Count refer to < Table 1-2 > ~ < Table 1-6 > (pages 115 ~ 118).

MIDI Data Format

The 5 data types listed below are received.

- System Data
- Multi Effect Data (Individual module unit)
- Multi Part Data (Individual part unit)
- Drums Setup Data (Individual note unit)
- System Information

(3-6-4) SPECIAL OPERATORS

(3-6-4-1) VOLUME ,EXPRESSION AND PAN REALTIME CONTROL OFF

binary	hexadecimal	Exclusive status
11110000	F0	Exclusive status
01000011	43	YAMAHA ID
01110011	73	Clavinova ID
01000101	45	CVP-98/96/94/92 ID
00010001	11	Sub ID
0000nnnn	0N	N = MIDI Channel
01001001	45	Volume and Expression Realtime Control Off
0vvvvvvv	VV	Value VV: 00H=on, 7FH=off
11110111	F7	End of Exclusive

When "On" is received, subsequent volume, expression, and PAN changes are only valid after the reception of the next key on. Normal operation resumes when "Off" is received.

(3-6-5) Others

(3-6-5-1) MIDI MASTER TUNING (Recive only)

binary	hexadecimal	Exclusive status
11110000	F0	Exclusive status
01000011	43	YAMAHA ID
0001nnnn	1N	When N is received N=0-F, whichever is received.
00100111	27	Model ID
00110000	30	Sub ID
00000000	00	
00000000	00	
0mmmmmmm	MM	Master Tune MSB
0lllllll	LL	Master Tune LSB
0ccccccc	CC	don't care
11110111	F7	End of Exclusive

Changes tuning of all channels.

MM, LL values are used to define the MIDI Master Tuning value.

T = M-128

T : Tuning value (-100cent - +100cent)

M : A single byte value (28-228) consists of bytes 0-3 of MM = MSB, bytes 0-3 of LL = LSB.

In this setting, GM System ON, XG System ON will not be reset.

(3-6-5-2) Bulk Dump

User Song, User Style

binary	hexadecimal	Exclusive status
11110000	F0	Exclusive status
01000011	43	YAMAHA ID
01110011	73	Clavinova ID
01001011	4B	Model ID (PSR-530)
00110000	06	Bulk ID
0kkkkkkk	KK	Bulk No. (0AH;User Song, 07H;User Style)
0000llll	0L	Data Length
0000llll	0L	Data Length
0000llll	0L	Data Length
0000llll	0L	Data Length
0000llll	0L	Data Length
0000llll	0L	Data Length (Date Length=LLLLL HByte)
0ddddd	DD	Bulk Data
:	:	
0ccccccc	CC	Check Sum
11110111	F7	End of Exclusive

Multi Pad, Registration Memory

binary	hexadecimal	Exclusive status
11110000	F0	Exclusive status
01000011	43	YAMAHA ID
01110011	73	Clavinova ID
01001011	4B	Model ID (PSR-530)
00110000	06	Bulk ID
0kkkkkkk	KK	Bulk No.(08H;Multi Pad, 09H;Registration Memory)
0000llll	0L	Data Length
0000llll	0L	Data Length
0000llll	0L	Data Length
0000llll	0L	Data Length (Date Length=LLLLL HByte)
0ddddd	DD	Bulk Data
:	:	
0ccccccc	CC	Check Sum
11110111	F7	End of Exclusive

Bulk data cannot be sent when:

- in the Record Modes (Song, Style, Pad).
- song playback.
- accompaniment playback.
- multi pad playback.
- changing the registration number.

Bulk data cannot be received when:

- in the Record Modes (Song, Style, Pad).
- a frame appears around the voice icons and an user song is selected.
- song playback.
- accompaniment playback.
- multi pad playback.
- changing the registration number.

< Table 1-1> Parmeter Basic Address

	Parameter Change Address	Description
SYSTEM	(H) (M) (L) 00 00 00	System
	00 00 7D	Drum Setup Reset
	00 00 7E	XG System On
	00 00 7F	All Parameter Reset
INFORMATION	01 00 00	System Information
EFFECT 1	02 01 00	Effect1 (Reverb,Chorus,Variation)
MULTI PART	08 00 00	Multi Part 1
	:	
	08 0F 00	Multi Part 16
	08 10 00	Reserved
:	:	:
DRUM	30 0B 00	Drum Setup 1
	31 0B 00	Drum Setup 2
	:	
	3n 0B 00	note number 13
	3n 0C 00	note number 14
	:	
3n 5B 00	note number 91	

< Table 1-2 > MIDI Parameter Change table (SYSTEM) (With XG, GM On, it will not reset.)

Address (H)	Size (H)	Data (H)	Parameter Name	Description	Default Value (H)
00 00 00	4	0000	Master Tune	-102.4..+102.3[cent]	00 04 00 00 (0400) (With XG, GM On, it will not reset.)
01		..07FF		1st bit3-0 -> bit15-12	
02				2nd bit3-0 -> bit11-8	
03				3rd bit3-0 -> bit7-4	
04	1	00..7F	Master Volume	0..127	7F
05	1		Not Used		
06	1	28..58	Transpose	-24..+24[semitones]	40
7D	n		Drum Setup Reset	n=Drum Setup Number	
7E	00		XG System On	00=XG Sytem on	
7F	00		All Parameter Reset	00=on (receive only)	
TOTAL SIZE 6					

< Table 1-3 > MIDI Parameter table (System information) (Transmitted by Dump Request. Not received. Bulk Dump Only)

Address (H)	Size (H)	Data (H)	Parameter Name	Description
01 00 00	E	20..7F	Model Name	32..127 (ASCII)
		:		
		0D		
	1	00		
	1	00		
TOTAL SIZE 10 (Transmitted by Dump Request. Not received. Bulk Dump Only)				

< Table 1-4 > MIDI Parameter Change table (EFFECT 1)

Address (H)	Size (H)	Data (H)	Parameter Name	Description	Default Value (H)
02 01 00	2	00..7F	Reverb Type MSB	Refer to the Effect Type List	01 (=HALL1)
		00..7F	Reverb Type LSB	: basic type	00
02	1	00..7F	Reverb Parameter 1	Refer to the Effect Parameter List	Depend on Reverb type
03	1	00..7F	Reverb Parameter 2	Refer to the Effect Parameter List	Depend on Reverb type
04	1	00..7F	Reverb Parameter 3	Refer to the Effect Parameter List	Depend on Reverb type
05	1	00..7F	Reverb Parameter 4	Refer to the Effect Parameter List	Depend on Reverb type
06	1	00..7F	Reverb Parameter 5	Refer to the Effect Parameter List	Depend on Reverb type
07	1	00..7F	Reverb Parameter 6	Refer to the Effect Parameter List	Depend on Reverb type
08	1	00..7F	Reverb Parameter 7	Refer to the Effect Parameter List	Depend on Reverb type
09	1	00..7F	Reverb Parameter 8	Refer to the Effect Parameter List	Depend on Reverb type
0A	1	00..7F	Reverb Parameter 9	Refer to the Effect Parameter List	Depend on Reverb type
0B	1	00..7F	Reverb Parameter 10	Refer to the Effect Parameter List	Depend on Reverb type
0C	1	00..7F	Reverb Return	-∞..0..+6dB (0..96..127)	60
0D	1	01..7F	Reverb Pan	L63..C..R63 (1..64..127)	40
TOTAL SIZE 0E					
02 01 10	1	00..7F	Reverb Parameter 11	Refer to the Effect Parameter List	Depend on Reverb type
	1	00..7F	Reverb Parameter 12	Refer to the Effect Parameter List	Depend on Reverb type
	1	00..7F	Reverb Parameter 13	Refer to the Effect Parameter List	Depend on Reverb type
	1	00..7F	Reverb Parameter 14	Refer to the Effect Parameter List	Depend on Reverb type
	1	00..7F	Reverb Parameter 15	Refer to the Effect Parameter List	Depend on Reverb type
	1	00..7F	Reverb Parameter 16	Refer to the Effect Parameter List	Depend on Reverb type
TOTAL SIZE 6					
02 01 20	2	00..7F	Chorus Type MSB	Refer to the Effect Type List	00
		00..7F	Chorus Type LSB	: basic type	
	1	00..7F	Chorus Parameter 1	Refer to the Effect Parameter List	Depend on Chorus Type
	1	00..7F	Chorus Parameter 2	Refer to the Effect Parameter List	Depend on Chorus Type
	1	00..7F	Chorus Parameter 3	Refer to the Effect Parameter List	Depend on Chorus Type
	1	00..7F	Chorus Parameter 4	Refer to the Effect Parameter List	Depend on Chorus Type
	1	00..7F	Chorus Parameter 5	Refer to the Effect Parameter List	Depend on Chorus Type
	1	00..7F	Chorus Parameter 6	Refer to the Effect Parameter List	Depend on Chorus Type
	1	00..7F	Chorus Parameter 7	Refer to the Effect Parameter List	Depend on Chorus Type
	1	00..7F	Chorus Parameter 8	Refer to the Effect Parameter List	Depend on Chorus Type
	1	00..7F	Chorus Parameter 9	Refer to the Effect Parameter List	Depend on Chorus Type
2A	1	00..7F	Chorus Parameter 10	Refer to the Effect Parameter List	Depend on Chorus Type
2B	1	00..7F	Chorus Return	-∞..0..+6dB (0..96..127)	60
2C	1	00..7F	Chorus Return	-∞..0..+6dB (0..96..127)	60
2D	1	01..7F	Chorus Pan	L63..C..R63 (1..64..127)	40
2E	1	00..7F	Send Chorus To Reverb	-∞..0..+6dB (0..96..127)	00
TOTAL SIZE 0F					

MIDI Data Format

Address (H)	Size (H)	Data (H)	Parameter Name	Description	Default Value (H)
02 01	30 1	00..7F	Chorus Parameter 11	Refer to the Effect Parameter List	Depend on Chorus Type
	31 1	00..7F	Chorus Parameter 12	Refer to the Effect Parameter List	Depend on Chorus Type
	32 1	00..7F	Chorus Parameter 13	Refer to the Effect Parameter List	Depend on Chorus Type
	33 1	00..7F	Chorus Parameter 14	Refer to the Effect Parameter List	Depend on Chorus Type
	34 1	00..7F	Chorus Parameter 15	Refer to the Effect Parameter List	Depend on Chorus Type
	35 1	00..7F	Chorus Parameter 16	Refer to the Effect Parameter List	Depend on Chorus Type
TOTAL SIZE 6					
02 01	40 2	00..7F	Variation Type MSB	Refer to the Effect Type List	
		00..7F	Variation Type LSB	: basic type	00
	42 2	00..7F	Vari. Param. 1 MSB	Refer to the Effect Parameter List	Depend on Vari. Type
		00..7F	Vari. Param. 1 LSB	Refer to the Effect Parameter List	Depend on Vari. Type
	44 2	00..7F	Vari. Param. 2 MSB	Refer to the Effect Parameter List	Depend on Vari. Type
		00..7F	Vari. Param. 2 LSB	Refer to the Effect Parameter List	Depend on Vari. Type
	46 2	00..7F	Vari. Param. 3 MSB	Refer to the Effect Parameter List	Depend on Vari. Type
		00..7F	Vari. Param. 3 LSB	Refer to the Effect Parameter List	Depend on Vari. Type
	48 2	00..7F	Vari. Param. 4 MSB	Refer to the Effect Parameter List	Depend on Vari. Type
		00..7F	Vari. Param. 4 LSB	Refer to the Effect Parameter List	Depend on Vari. Type
	4A 2	00..7F	Vari. Param. 5 MSB	Refer to the Effect Parameter List	Depend on Vari. Type
		00..7F	Vari. Param. 5 LSB	Refer to the Effect Parameter List	Depend on Vari. Type
	4C 2	00..7F	Vari. Param. 6 MSB	Refer to the Effect Parameter List	Depend on Vari. Type
		00..7F	Vari. Param. 6 LSB	Refer to the Effect Parameter List	Depend on Vari. Type
	4E 2	00..7F	Vari. Param. 7 MSB	Refer to the Effect Parameter List	Depend on Vari. Type
		00..7F	Vari. Param. 7 LSB	Refer to the Effect Parameter List	Depend on Vari. Type
	50 2	00..7F	Vari. Param. 8 MSB	Refer to the Effect Parameter List	Depend on Vari. Type
		00..7F	Vari. Param. 8 LSB	Refer to the Effect Parameter List	Depend on Vari. Type
	52 2	00..7F	Vari. Param. 9 MSB	Refer to the Effect Parameter List	Depend on Vari. Type
		00..7F	Vari. Param. 9 LSB	Refer to the Effect Parameter List	Depend on Vari. Type
	54 2	00..7F	Vari. Param. 10 MSB	Refer to the Effect Parameter List	Depend on Vari. Type
		00..7F	Vari. Param. 10 LSB	Refer to the Effect Parameter List	Depend on Vari. Type
	56 1	00..7F	Variation Return	-∞..0..+6dB (0..96..127)	60
	57 1	01..7F	Variation Pan	L63..C..R63 (1..64..127)	40
	58 1	00..7F	Send Vari. To Reverb	-∞..0..+6dB (0..96..127)	00
	59 1	00..7F	Send Vari. To Chorus	-∞..0..+6dB (0..96..127)	00
	5A 1	00..01	Variation Connection	0:insertion,1:system	00
	5B 1	00..1F	Variation Part	part1..32 (0..31),off (127)	7F
	5C 1	01..7F	MW Vari. Ctrl Depth	-63..+63	40
	5D 1	01..7F	PB Vari. Ctrl Depth	-63..+63	40
	5E 1	01..7F	CAT Vari. Ctrl Depth	-63..+63	40
	5F 1	01..7F	Not Used		
	60 1	01..7F	Not Used		
TOTAL SIZE 21					
02 01	70 1	00..7F	Variation Parameter 11	option Parameter	Depend on Variation Type
	71 1	00..7F	Variation Parameter 12	option Parameter	Depend on Variation Type
	72 1	00..7F	Variation Parameter 13	option Parameter	Depend on Variation Type
	73 1	00..7F	Variation Parameter 14	option Parameter	Depend on Variation Type
	74 1	00..7F	Variation Parameter 15	option Parameter	Depend on Variation Type
	75 1	00..7F	Variation Parameter 16	option Parameter	Depend on Variation Type
TOTAL SIZE 6					

< Table 1-5 > MIDI Parameter Change table (MULTI PART)

Address (H)	Size (H)	Data (H)	Parameter Name	Description	Default Value (H)
08	nn 00	1 00..20	Element Reserve	0..32	0 (Part10),2 (Others)
	nn 01	1 00..7F	Bank Select MSB	0..127	7F (Part10),00 (Others)
	nn 02	1 00..7F	Bank Select LSB	0..127	00
	nn 03	1 00..7F	Program Number	1..128	00
	nn 04	1 00..0F, 7F	Rcv Channel	0..16;1..16,127;off	Part No.
	nn 05	1 00..01	Mono/Poly Mode	0:mono,1:poly	01
	nn 06	1 00..02	Same Note Number Key On Assign	0:single 1:multi 2:inst (for DRUM)	00
	nn 07	1 00..02	Part Mode	0:normal 1:drum,drumS1..2	00 (Except Part 10.) 02 (Part10)
	nn 08	1 28..58	Note Shift	-24..+24[semitones]	40
	nn 09	2 00..FF	Detune	-12.8..+12.7[Hz]	08 00
	nn 0A			1st bit3..0 -> bit7..4 2nd bit3..0 -> bit3..0	(80)
	nn 0B	1 00..7F	Volume	0..127	64
	nn 0C	1 00..7F	Velocity Sense Depth	0..127	40
	nn 0D	1 00..7F	Velocity Sense Offset	0..127	40
	nn 0E	1 00..7F	Pan	0:random L63..C..R63 (1..64..127)	40

Address (H)	Size (H)	Data (H)	Parameter Name	Description	Default Value (H)
nn 0F	1	00..7F	Note Limit Low	C-2..G8	00
nn 10	1	00..7F	Note Limit High	C-2..G8	7F
nn 11	1	00..7F	Dry Level	0..127	7F
nn 12	1	00..7F	Chorus Send	0..127	00
nn 13	1	00..7F	Reverb Send	0..127	28
nn 14	1	00..7F	Variation Send	0..127	00
nn 15	1	00..7F	Vibrato Rate	-64..+63	40
nn 16	1	00..7F	Vibrato Depth	-64..+63	40
nn 17	1	00..7F	Vibrato Delay	-64..+63	40
nn 18	1	00..7F	Filter Cutoff Freq.	-64..+63	40
nn 19	1	00..7F	Filter Resonance	-64..+63	40
nn 1A	1	00..7F	EG Attack Time	-64..+63	40
nn 1B	1	00..7F	EG Decay Time	-64..+63	40
nn 1C	1	00..7F	EG Release Time	-64..+63	40
nn 1D	1	28..58	MW Pitch Control	-24..+24[semitones]	40
nn 1E	1	00..7F	MW Filter Control	-9600..+9450[cent]	40
nn 1F	1	00..7F	MW Amp. Control	-100..+100[%]	40
nn 20	1	00..7F	MW LFO PMod Depth	0..127	0A
nn 21	1	00..7F	MW LFO FMod Depth	0..127	00
nn 22	1	00..7F	MW LFO AMod Depth	0..127	00
nn 23	1	28..58	Bend Pitch Control	-24..+24[semitones]	42
nn 24	1	00..7F	Bend Filter Control	-9600..+9450[cent]	40
nn 25	1	00..7F	Bend Amp. Control	-100..+100[%]	40
nn 26	1	00..7F	Bend LFO PMod Depth	0..127	00
nn 27	1	00..7F	Bend LFO FMod Depth	0..127	00
nn 28	1	00..7F	Bend LFO AMod Depth	0..127	00
TOTAL SIZE 29					
nn 30			Not Used		
:			:		
nn 40			Not Used		
nn 41	1	00..7F	Scale Tuning C	-64..+63[cent]	40
nn 42	1	00..7F	Scale Tuning C#	-64..+63[cent]	40
nn 43	1	00..7F	Scale Tuning D	-64..+63[cent]	40
nn 44	1	00..7F	Scale Tuning D#	-64..+63[cent]	40
nn 45	1	00..7F	Scale Tuning E	-64..+63[cent]	40
nn 46	1	00..7F	Scale Tuning F	-64..+63[cent]	40
nn 47	1	00..7F	Scale Tuning F#	-64..+63[cent]	40
nn 48	1	00..7F	Scale Tuning G	-64..+63[cent]	40
nn 49	1	00..7F	Scale Tuning G#	-64..+63[cent]	40
nn 4A	1	00..7F	Scale Tuning A	-64..+63[cent]	40
nn 4B	1	00..7F	Scale Tuning A#	-64..+63[cent]	40
nn 4C	1	00..7F	Scale Tuning B	-64..+63[cent]	40
nn 4D	1	28..58	CAT Pitch Control	-24..+24[semitones]	40
nn 4E	1	00..7F	CAT Filter Control	-9600..+9450[cent]	40
nn 4F	1	00..7F	CAT Amplitude Control	-100..+100[%]	40
nn 50	1	00..7F	CAT LFO PMod Depth	0..127	00
nn 51	1	00..7F	CAT LFO FMod Depth	0..127	00
nn 52	1	00..7F	CAT LFO AMod Depth	0..127	00
nn 53			Not Used		
:			:		
66			Not Used		
nn 67	1	00..01	Portamento Switch	off/on	00
nn 68	1	00..7F	Portamento Time	0..127	00
nn 69			Not Used		
:			:		
6E			Not Used		
TOTAL SIZE 3F					

nn = PartNumber

If there is a Drum Voice assigned to the Part, the following parameters are ineffective.

- Bank Select LSB
- Amp EG
- Portamento
- Soft Pedal
- Mono/Poly
- Scale Tuning

MIDI Data Format

< Table 1-6 > MIDI Parameter Change table (DRUM SETUP)

Address (H)	Size (H)	Data (H)	Parameter Name	Description	Default Value (H)
3n rr 00	1	00..7F	Pitch Coarse	-64..+63	40
3n rr 01	1	00..7F	Pitch Fine	-64..+63[cent]	40
3n rr 02	1	00..7F	Level	0..127	Depend on the Note
3n rr 03	1	00..7F	Alternate Group	0:off,1..127	Depend on the Note
3n rr 04	1	00..7F	Pan	0:random L63..C..R63 (1..64..127)	Depend on the Note
3n rr 05	1	00..7F	Reverb Send Level	0..127	Depend on the Note
3n rr 06	1	00..7F	Chorus Send Level	0..127	Depend on the Note
3n rr 07	1	00..7F	Variation Send Level	0..127	7F
3n rr 08	1	00..01	Key Assign	0:single,1:multi	00
3n rr 09	1	00..01	Rcv Note Off	off/on	Depend on the Note
3n rr 0A	1	00..01	Rcv Note On	off/on	01
3n rr 0B	1	00..7F	Filter Cutoff Freq.	-64..63	40
3n rr 0C	1	00..7F	Filter Resonance	-64..63	40
3n rr 0D	1	00..7F	EG Attack Rate	-64..63	40
3n rr 0E	1	00..7F	EG Decay1 Rate	-64..63	40
3n rr 0F	1	00..7F	EG Decay2 Rate	-64..63	40

TOTAL SIZE 10

n:Drum Setup Number (0 - 1)

rr:note number (0DH - 5BH)

If XG SYSTEM ON and/or GM On message is received, all Drum Setup Parameter will be reset to default values.

According to the Drum Setup Reset message, individual Drum Setup Parameters can be reset to default values.

< Table 1-7 > Effect Type List

	XG ESSENTIAL EFFECT
	Same as LSB=0
	XG OPTION EFFECT

* If the received value does not contain an effect type in the TYPE LSB, the LSB will be directed to TYPE 0.

* Panel Effects are based on the "[Number] Effect Name".

* Using an external sequencer, capable of editing and transmitting the system exclusive messages and parameter changes, allows you to select the reverb, chorus and DSP effect types which are not accessible from the PSR-530 panel operation. When one of the effects is selected by the external sequencer, "XG Rev.," "XG Cho.," or "XG Eff.," will be shown on the display.

REVERB TYPE

TYPE MSB	TYPE LSB											
	00	01	02	03..07	08	09..15	16	17	18	19	20	21..
000	NO EFFECT											
001	[1]HALL1	HALL2					[2]HALL2	[3]HALL3	[4]HALL4			
002	ROOM1	ROOM2	ROOM3				[5]ROOM1	[6]ROOM2	[7]ROOM3	[8]ROOM4		
003	STAGE1	STAGE2					[9]STAGE1	[10]STAGE2				
004	PLATE						[11]PLATE1	[12]PLATE2				
005..015	NO EFFECT											
016	WHITE ROOM											
017	TUNNEL											
018	CANYON											
019	BASEMENT											
020..127	NO EFFECT											

CHORUS TYPE

TYPE MSB	TYPE LSB											
	00	01	02	03..07	08	09..15	16	17	18	19	20	21..
000	NO EFFECT											
001..064	NO EFFECT											
065	CHORUS1	CHORUS2	[5]CHORUS5		CHORUS4							
066	CELESTE1	[4]CHORUS4	CELESTE3		[2]CHORUS2		[3]CHORUS3	[1]CHORUS1				
067	FLANGER 1	[9]FLANGER 4			[6]FLANGER1		[7]FLANGER2	[8]FLANGER3				
068..127	NO EFFECT											

DSP TYPE (0 — 63)

TYPE MSB	TYPE LSB												
00	01	02	03...07	08	09...15	16	17	18	19	20	21...		
000	NO EFFECT												
001	[1]HALL1	HALL2				[2]HALL2	[3]HALL3	[4]HALL4					
002	ROOM1	ROOM2	ROOM3			[5]ROOM1	[6]ROOM2	[7]ROOM3	[8]ROOM4				
003	STAGE1	STAGE2				[9]STAGE1	[10]STAGE2						
004	PLATE					[11]PLATE1	[12]PLATE2						
005	"DELAY L,C,R"					[38]Delay LCR							
006	"[39]DELAY L,R"												
007	[40]ECHO												
008	[41]CROSS DELAY												
009	[13]ER1	[14]ER2											
010	[15]GATE REVERB												
011	[16]REVERS GATE												
012...019	NO EFFECT or THRU												
020	KARAOKE 1	KARAOKE 2	KARAOKE 3										
021...063	NO EFFECT or THRU*												

DSP TYPE (64 — 127)

TYPE MSB	TYPE LSB												
064	01	02	03...07	08	09...15	16	17	18	19	20	21...		
064	THRU												
065	CHORUS1	CHORUS2	[21]CHORUS5	CHORUS4									
066	CELESTE1	[20]CHORUS4	CELESTE3	[18]CHORUS2		[19]CHORUS3	[17]CHORUS1	[32]Rotary Sp5					
067	FLANGER 1	[25]FLANGER 4		[22]FLANGER1		[23]FLANGER2	[24]FLANGER3						
068	SYMPHONIC					[26]Symphonic							
069	ROTARY SP.					[28]Rotary Sp1							
070	TREMOLO					[33]Tremolo1	[31]Rotary Sp4						
071	AUTO PAN					[36]AutoPan	[29]Rotary Sp2	[30]Rotary Sp3	[34]Tremolo2	[35]Gr Tremolo			
072	[27]PHASER			PHASER 2									
073	DISTORTION												
074	OVER DRIVE												
075	AMP SIM.												
076	3BAND EQ					[42]DIST.HARD	[43]DIST.SOFT						
077	2BAND EQ					[44]EQ DISCO	[45]EQ TEL						
078	AUTO WAH					[37]Auto Wah							
079...127	THRU												

< Table 1-8 > Effect Parameter List

HALL1,HALL2, ROOM1,ROOM2,ROOM3, STAGE1,STAGE2, PLATE (reverb, variation block)

No.	Parameter	Value
1	Reverb Time	0.3 — 30.0s
2	Diffusion	0 — 10
3	Initial Delay	0 — 63
4	HPF Cutoff	Thru — 8.0kHz
5	LPF Cutoff	1.0k — Thru
6		34-60
7		
8		
9		
10	Dry/Wet	D63 > W — D=W — D<W63
11	Rev Delay	0 — 63
12	Density	0 — 3
13	Er/Rev Balance	E63 > R — E=R — E<R63
14		1-127
15	Feedback Level	-63 — +63
16		1-127

WHITE ROOM, TUNNEL, CANYON, BASEMENT (reverb)

No.	Parameter	Value
1	Reverb Time	0.3 — 30.0s
2	Diffusion	0 — 10
3	Initial Delay	0 — 63
4	HPF Cutoff	Thru — 8.0kHz
5	LPF Cutoff	1.0k — Thru
6	Width	0.5 — 10.2m
7	Height	0.5 — 20.2m
8	Depth	0.5 — 30.2m
9	Wall Vary	0 — 30
10	Dry/Wet	D63 > W — D=W — D<W63
11	Rev Delay	0 — 63
12	Density	0 — 3
13	Er/Rev Balance	E63 > R — E=R — E<R63
14		1-127
15	Feedback Level	-63 — +63
16		1-127

MIDI Data Format

DELAY L,C,R (variation block)

No.	Parameter	Value	Value
1	Lch Delay	0.1 — 715.0ms	1-7150
2	Rch Delay	0.1 — 715.0ms	1-7150
3	Cch Delay	0.1 — 715.0ms	1-7150
4	Feedback Delay	0.1 — 715.0ms	1-7150
5	Feedback Level	-63 — +63	1-127
6	Cch Level	0 — 127	0-127
7	High Damp	0.1 — 1.0	1-10
8			
9			
10	Dry/Wet	D63 > W — D=W — D<W63	1-127
11			
12			
13	EQ Low Frequency	50Hz — 2.0kHz	8-40
14	EQ Low Gain	-12 — +12dB	52-76
15	EQ High Frequency	500Hz — 16.0kHz	28-58
16	EQ High Gain	-12 — +12dB	52-76

GATE REVERB, REVERSE GATE (variation block)

No.	Parameter	Value	Value
1	Type	"TypeA,TypeB"	0-1
2	Room Size	0.1 — 7.0	0-44
3	Diffusion	0 — 10	0-10
4	Initial Delay	0 — 63	0-63
5	Feedback Level	-63 — +63	1-127
6	HPF Cutoff	Thru — 8.0kHz	0-52
7	LPF Cutoff	1.0k — Thru	34-60
8			
9			
10	Dry/Wet	D63 > W — D=W — D<W63	1-127
11	Liveness	0 — 10	0-10
12	Density	0 — 3	0-3
13	High Damp	0.1 — 1.0	1-10
14			
15			
16			

DELAY L,R (variation block)

No.	Parameter	Value	Value
1	Lch Delay	0.1 — 715.0ms	1-7150
2	Rch Delay	0.1 — 715.0ms	1-7150
3	Feedback Delay 1	0.1 — 715.0ms	1-7150
4	Feedback Delay 2	0.1 — 715.0ms	1-7150
5	Feedback Level	-63 — +63	1-127
6	High Damp	0.1 — 1.0	1-10
7			
8			
9			
10	Dry/Wet	D63 > W — D=W — D<W63	1-127
11			
12			
13	EQ Low Frequency	50Hz — 2.0kHz	8-40
14	EQ Low Gain	-12 — +12dB	52-76
15	EQ High Frequency	500Hz — 16.0kHz	28-58
16	EQ High Gain	-12 — +12dB	52-76

KARAOKE1,2,3 (variation block)

No.	Parameter	Value	Value
1	Delay Time	0 — 127	0-127
2	Feedback Level	-63 — +63	1-127
3	HPF Cutoff	Thru — 8.0kHz	0-52
4	LPF Cutoff	1.0k — Thru	34-60
5			
6			
7			
8			
9			
10	Dry/Wet	D63 > W — D=W — D<W63	1-127
11			
12			
13			
14			
15			
16			

ECHO (variation block)

No.	Parameter	Value	Value
1	Lch Delay1	0.1 — 355.0ms	1-3550
2	Lch Feedback Level	-63 — +63	1-127
3	Rch Delay1	0.1 — 355.0ms	1-3550
4	Rch Feedback Level	-63 — +63	1-127
5	High Damp	0.1 — 1.0	1-10
6	Lch Delay2	0.1 — 355.0ms	1-3550
7	Rch Delay2	0.1 — 355.0ms	1-3550
8	Delay2 Level	0 — 127	0-127
9			
10	Dry/Wet	D63 > W — D=W — D<W63	1-127
11			
12			
13	EQ Low Frequency	50Hz — 2.0kHz	8-40
14	EQ Low Gain	-12 — +12dB	52-76
15	EQ High Frequency	500Hz — 16.0kHz	28-58
16	EQ High Gain	-12 — +12dB	52-76

CHORUS1,2,3,4, CELESTE1,2,3,4 (chorus, variation block)

No.	Parameter	Value	Value
1	LFO Frequency	0.00Hz — 39.7Hz	0-127
2	LFO Depth	0 — 127	0-127
3	Feedback Level	-63 — +63	1-127
4	Delay Offset	0 — 127	0-127
5			
6	EQ Low Frequency	50Hz — 2.0kHz	8-40
7	EQ Low Gain	-12 — +12dB	52-76
8	EQ High Frequency	500Hz — 16.0kHz	28-58
9	EQ High Gain	-12 — +12dB	52-76
10	Dry/Wet	D63 > W — D=W — D<W63	1-127
11			
12			
13			
14			
15	Input Mode	mono/stereo	0-1
16			

CROSS DELAY (variation block)

No.	Parameter	Value	Value
1	L -> R Delay	0.1 — 355.0ms	1-3550
2	R -> L Delay	0.1 — 355.0ms	1-3550
3	Feedback Level	-63 — +63	1-127
4	Input Select	"L,R,L&R"	0-2
5	High Damp	0.1 — 1.0	1-10
6			
7			
8			
9			
10	Dry/Wet	D63 > W — D=W — D<W63	1-127
11			
12			
13	EQ Low Frequency	50Hz — 2.0kHz	8-40
14	EQ Low Gain	-12 — +12dB	52-76
15	EQ High Frequency	500Hz — 16.0kHz	28-58
16	EQ High Gain	-12 — +12dB	52-76

FLANGER1,2,3 (chorus, variation block)

No.	Parameter	Value	Value
1	LFO Frequency	0.00Hz — 39.7Hz	0-127
2	LFO Depth	0 — 127	0-127
3	Feedback Level	-63 — +63	1-127
4	Delay Offset	0 — 63	0-63
5			
6	EQ Low Frequency	50Hz — 2.0kHz	8-40
7	EQ Low Gain	-12 — +12dB	52-76
8	EQ High Frequency	500Hz — 16.0kHz	28-58
9	EQ High Gain	-12 — +12dB	52-76
10	Dry/Wet	D63 > W — D=W — D<W63	1-127
11			
12			
13			
14	LFO Phase Difference	-180 — +180deg(resolution=3deg.)	4-124
15			
16			

EARLY REF1,EARLY REF2(variation block)

No.	Parameter	Value	Value
1	Type	"S-H, L-H, Rdm, Rvs, Plt, Spr"	0-5
2	Room Size	0.1 — 7.0	0-44
3	Diffusion	0 — 10	0-10
4	Initial Delay	0 — 63	0-63
5	Feedback Level	-63 — +63	1-127
6	HPF Cutoff	Thru — 8.0kHz	0-52
7	LPF Cutoff	1.0k — Thru	34-60
8			
9			
10	Dry/Wet	D63 > W — D=W — D<W63	1-127
11	Liveness	0 — 10	0-10
12	Density	0 — 3	0-3
13	High Damp	0.1 — 1.0	1-10
14			
15			
16			

SYMPHONIC (variation block)

No.	Parameter	Value	Value
1	LFO Frequency	0.00Hz — 39.7Hz	0-127
2	LFO Depth	0 — 127	0-127
3	Delay Offset	0 — 127	0-127
4			
5			
6	EQ Low Frequency	50Hz — 2.0kHz	8-40
7	EQ Low Gain	-12 — +12dB	52-76
8	EQ High Frequency	500Hz — 16.0kHz	28-58
9	EQ High Gain	-12 — +12dB	52-76
10	Dry/Wet	D63 > W — D=W — D<W63	1-127
11			
12			
13			
14			
15			
16			

ROTARY SPEAKER (variation block)

No.	Parameter	Value
1	LFO Frequency	0.00Hz — 39.7Hz
2	LFO Depth	0 — 127
3		
4		
5		
6	EQ Low Frequency	50Hz — 2.0kHz
7	EQ Low Gain	-12 — +12dB
8	EQ High Frequency	500Hz — 16.0kHz
9	EQ High Gain	-12 — +12dB
10	Dry/Wet	D63 > W — D=W — D<W63
11		
12		
13		
14		
15		
16		

AMP SIMULATOR (variation block)

No.	Parameter	Value
1	Drive	0 — 127
2	AMP Type	"Off, Stack, Combo, Tube"
3	LPF Cutoff	1.0k — Thru
4	Output Level	0 — 127
5		
6		
7		
8		
9		
10	Dry/Wet	D63 > W — D=W — D<W63
11	Edge(Clip Curve)	0 — 127
12		
13		
14		
15		
16		

TREMOLO (variation block)

No.	Parameter	Value
1	LFO Frequency	0.00Hz — 39.7Hz
2	AM Depth	0 — 127
3	PM Depth	0 — 127
4		
5		
6	EQ Low Frequency	50Hz — 2.0kHz
7	EQ Low Gain	-12 — +12dB
8	EQ High Frequency	500Hz — 16.0kHz
9	EQ High Gain	-12 — +12dB
10		
11		
12		
13		
14	LFO Phase Difference	-180 — +180deg(resolution=3deg.)
15	Input Mode	mono/stereo
16		

3BAND EQ(MONO) (variation block)

No.	Parameter	Value
1	EQ Low Gain	-12 — +12dB
2	EQ Mid Frequency	100Hz — 10.0kHz
3	EQ Mid Gain	-12 — +12dB
4	EQ Mid Width	1.0 — 12.0
5	EQ High Gain	-12 — +12dB
6	EQ Low Frequency	50Hz — 2.0kHz
7	EQ High Frequency	500Hz — 16.0kHz
8		
9		
10		
11		
12		
13		
14		
15		
16		

AUTO PAN (variation block)

No.	Parameter	Value
1	LFO Frequency	0.00Hz — 39.7Hz
2	L/R Depth	0 — 127
3	F/R Depth	0 — 127
4	PAN Direction	"L <-> R, L -> R, L <- R, Lturn, Rturn, L/R"
5		
6	EQ Low Frequency	50Hz — 2.0kHz
7	EQ Low Gain	-12 — +12dB
8	EQ High Frequency	500Hz — 16.0kHz
9	EQ High Gain	-12 — +12dB
10		
11		
12		
13		
14		
15		
16		

2BAND EQ(STEREO) (variation block)

No.	Parameter	Value
1	EQ Low Frequency	50Hz — 2.0kHz
2	EQ Low Gain	-12 — +12dB
3	EQ High Frequency	500Hz — 16.0kHz
4	EQ High Gain	-12 — +12dB
5		
6		
7		
8		
9		
10		
11		
12		
13		
14		
15		
16		

PHASER 1,2 (variation block)

No.	Parameter	Value
1	LFO Frequency	0.00Hz — 39.7Hz
2	LFO Depth	0 — 127
3	Phase Shift Offset	0 — 127
4	Feedback Level	-63 — +63
5		
6	EQ Low Frequency	50Hz — 2.0kHz
7	EQ Low Gain	-12 — +12dB
8	EQ High Frequency	500Hz — 16.0kHz
9	EQ High Gain	-12 — +12dB
10	Dry/Wet	D63 > W — D=W — D<W63
11	Stage	6 — 10(phaser1) / 3 — 5(phaser2)
12	Diffusion	mono/stereo
13	LFO Phase Difference	-180 — +180deg.(resolution=3deg.)
14		
15		
16		

AUTO WAH (variation block)

No.	Parameter	Value
1	LFO Frequency	0.00Hz — 39.7Hz
2	LFO Depth	0 — 127
3	Cutoff Frequency Offset	0 — 127
4	Resonance	1.0 — 12.0
5		
6	EQ Low Frequency	50Hz — 2.0kHz
7	EQ Low Gain	-12 — +12dB
8	EQ High Frequency	500Hz — 16.0kHz
9	EQ High Gain	-12 — +12dB
10	Dry/Wet	D63 > W — D=W — D<W63
11		
12		
13		
14		
15		
16		

DISTORTION, OVERDRIVE (variation block)

No.	Parameter	Value
1	Drive	0 — 127
2	EQ Low Frequency	50Hz — 2.0kHz
3	EQ Low Gain	-12 — +12dB
4	LPF Cutoff	1.0k — Thru
5	Output Level	0 — 127
6		
7	EQ Mid Frequency	100Hz — 10.0kHz
8	EQ Mid Gain	-12 — +12dB
9	EQ Mid Width	1.0 — 12.0
10	Dry/Wet	D63 > W — D=W — D<W63
11	Edge(Clip Curve)	0 — 127
12		
13		
14		
15		
16		

MIDI Implementation Chart

[Portable Keyboard]
Model: PSR-530

MIDI Implementation Chart

Date: 1997. 4. 14
Version: 1.0

Function	Transmitted	Recognized	Remarks
Basic Channel Default Changed	1~16 CH (*1) 1~16 CH (*1)	1~16 CH (*2) 1~16 CH (*2)	
Mode Messages Default Altered	Mode 3 X *****	Mode 3 X X	
Note Number : True voice	0~127 *****	0~127 0~127	
Velocity Note on Note off	O 9nH, v=1~127 X 9nH, v=0	O 9nH, v=1~127 X	
After key's Touch Ch's	X X	X O	
Pitch Bender	O	O	
Control Change	0, 32 O 1 X (*3) 5 X 7, 10, 11 O 6, 38 X (*3) 64, 65 O 66, 67 X 71 — 74 X (*3) 84 X (*3) 91, 93, 94 O 96, 97 X 98, 99 X (*3) 100, 101 O 120 X 121 X	O O O O O O O O O O O O O O O O O O O O	Bank select Modulation Portament time Data entry Sound controller Portament control Effect depth RPN increment, decrement NRPN LSB, MSB RPN LSB, MSB All sound off Reset all controllers
Program Change : True #	O 0~127 *****	O 0~127	
System Exclusive	O	O	
System : Song Position : Song Select Common : Tune	X X X	X X X	
System : Clock Real Time : Commands	O O	O O	
Aux : Local ON/OFF : All Notes Off Messages: Active Sense : Reset	X X O X	X O 123~127 O X	

Mode 1 : OMNI ON, POLY
Mode 3 : OMNI OFF, POLY

Mode 2 : OMNI ON, MONO
Mode 4 : OMNI OFF, MONO

O : Yes
X : No

* 1 The tracks for each channel can be selected on the panel. See page 92 for more information.

* 2 Incoming MIDI messages control the PSR-530 as 16 channel multi timbral tone generator when initially shipped (factory set). The MIDI messages don't affect the panel controls including the Panel Voice selection since they are directly sent to the tone generator of the PSR-530. However, the following MIDI messages affects the panel controls such as Panel Voice, Style, Multi Pad and Song settings:

- MIDI MASTER TUNE, MASTER TUNE (XG System Parameter).
- TRANSPOSE (XG System Parameter).
- System Exclusive Messages related to the REVERB, CHORUS and DSP EFFECT settings.

Also, the MIDI messages affect the panel settings when one of the following MIDI reception modes is selected. These modes can be selected on the panel (see page 94).

rE (Remote): The Note On/Off messages received at the designated Remote (receive) channel are processed the same as the notes normally played on the keyboard.

In this mode, only the following channel messages will be recognized:

- Note On/Off
- Control Changes
 - Bank Select (R1 voice only)
 - Modulation
 - Volume
 - Expression
 - Sustain
 - Sostenute
 - Soft Pedal
 - All Notes Off
- Program Change (R1 voice only)
- Pitch Bend

Off: The MIDI channel messages will not be received at the designated channel.

* 3 Though these messages will not output by playing the keyboard and changing the panel settings, they may be included in the Song or Style data and output.

Specifications

Keyboards

- 61 standard-size keys (C1 — C6) with touch response.

Display

- Large multi-function LCD display

Setup

- Stand by/ON
- Master Volume : MIN — MAX

Control & Number Buttons

- MENU ▲▼, VOICE, STYLE, SONG, CARTRIDGE, SUB MENU ▲▼, [1] — [0], [+], [-] (YES), [-] (NO)

Cartridge Slot

Demo

- 12 Songs

Voice

- 200 Panel Voices +12 Drum Kits + 480 XG Voices
- Polyphony : 32
- Voice Set
- R1/R2/L Voices
- Revoice : Volume, Octave, Pan, Reverb Send Level, Chorus Send Level, DSP Send Level
- Split Voice Mode
- Dual Voice Mode

Auto Accompaniment

- 100 Styles
- Auto Accompaniment ON/OFF
- Accompaniment Track : RHYTHM1/2, BASS, CHORD1/2, PAD, PHRASE1/2
- Accompaniment Track Settings : ON/OFF
- Accompaniment Control : SYNC START, SYNC STOP, START/STOP, INTRO, MAIN A/B (AUTO FILL), ENDING
- Beat Indicator
- Virtual Arranger ON/OFF
- Accompaniment Volume
- Revoice : Volume, Pan, Reverb Send Level, Chorus Send Level
- Virtual Arranger

One Touch Setting

Overall Controls

- Tempo : 32 — 280
- Pitch Bend Range
- Transpose
- Touch Sensitivity
- Master Tuning
- Scale Tuning
- Song Transpose
- Metronome
- Split Voice Split Point
- Accompaniment Split Point
- Fingering Mode : SINGLE FINGER/FINGERED 1/FINGERED 2/ FULL KEYBOARD/MULTI-FINGER
- Voice Set

Digital Effect

- Reverb : 13 types
- Chorus : 10 types
- DSP (system/insertion) : 46 types
- Harmony : 16 types

Registration Memory

- 32 Regist Bank : 1 — 4
- Accompaniment Freeze

Multi Pads

- 36 Multi Pad Sets
- 4 Pads + STOP
- Chord Match

Song

- Song Volume
- Minus One Practice (Minus One Channel Setting)
- Repeat Play
- Revoice (User song only) : Volume, Octave, Pan, Reverb Send Level, Chorus Send Level, DSP Send Level

Song Recording

- User Song : 4 Songs
- Recording Tracks : ACCOMPANIMENT, MELODY 1 — 4
- Song Clear, Track Clear

Style Recording

- User Style : 3 Styles
- Recording Tracks : 5 Sections x 8 Tracks
- Drum Cancel
- Quantize
- All Clear, Track Clear

Multi Pad Recording

- User Pad : 4 Pad Sets
- Chord Match
- Pad Clear, Bank Clear

MIDI

- Transmit Settings
- Receive Settings
- Local Control
- Clock
- Bulk Data Send/Receive
- Initial Data Send

Auxiliary Jacks

- DC IN 10-12V, PHONES, SUSTAIN, AUX OUT R, L/L+R, MIDI IN/OUT, TO HOST

Amplifiers

- 6 W + 6 W (when using PA-6 power adaptor)
- 4 W + 4 W (when using batteries)

Speakers

- 12cm (4-3/4") x 2

Power Consumption

- 22 W (when using PA-6 AC power adaptor)

Batteries

- Six SUM-1, "D" size, R-20 or equivalent batteries

Rated Voltage

- DC 10-12V

Dimensions (W x D x H)

- 952 x 387 x 147 mm

Weight

- 8.0 kg (13 lbs.) excluding batteries

Supplied Accessories

- Music Cartridge
- Music Stand
- Owner's Manual

Optional Accessories

- Headphones : HPE-150
- AC Power Adaptor : PA-6
- Foot Switch : FC4, FC5
- Keyboard Stand : L-6
- Music Cartridge

* Specifications subject to change without notice.

Index

A	AC power adaptor	12		Minus-one practice	55
	Accompaniment styles, cartridge	77		Multi pad set selection	49
	Accompaniment tracks, song	58		Multi Pads, playing	50
	Auto accompaniment	22		Multi-finger fingering mode	34
	Auto accompaniment on/off	23		Music cartridges, handling	75
	Auto Fill	25		Music stand	7
B	Bank, registration	47	O	One touch setting	34
	Batteries	12		Overall functions	83
	Beat indicator	25	P	Panel controls	6
	Bulk data receive	95		Phones jack	13
	Bulk data send	95		Pitch Bend	45
C	Cartridge accompaniment styles	77		Polyphony	99
	Cartridge song playback	76		Power supply	12
	Chord Match function	51		Precautions	1
	Chord types, auto accompaniment	32	R	R1, R2, & L voices	16
	Chorus	38		Receive channel & mode	93
	Clock	94		Record Ready Mode	59, 65, 71
	Connectors	13		Registration memory	47
	Contents	4		Rehearsal mode	61, 67, 73
D	Data Dial	18		Repeat play	57
	Demonstration playback	14		Reverb	36
	Digital Effect	36		Revoicing	78
	Display operation	8	S	Scale tuning	84
	Drum kit list	104		Shortcuts	11
	DSP	40		Single Finger fingering mode	31
	Dual voice mode	19		Song clear	63
E	Effects	36		Song playback	52
	Ending, accompaniment	26		Song playback, cartridge	76
F	Features	2		Song recording	58
	Fill-in	25		Song, revoice	81
	Fingered 1 fingering mode	32		Specifications	124
	Fingered 2 fingering mode	33		Split point, auto accompaniment	29
	Fingering modes, accompaniment	31		Split point, split voice	21
	Freeze (Accompaniment Freeze function)	48		Split voice mode	20
	Full Keyboard fingering mode	33		Start modes, accompaniment	24
G	GM System Level 1	3		Stop Accompaniment function	34
H	Harmony	42		Style selection	22
I	Icons	8		Style, revoice	80
	Initial data send	95		Sustain jack	13
	Initialization (data backup)	98		Synchro Stop function	26
	Insertion Effect	40, 107		Synchronized start	24
	Intro, accompaniment	24		System Effect	40, 106
K	Keyboard percussion	19	T	Tempo, accompaniment	23
L	Local control	94		To Host	88
M	Main A & Main B sections	25		Touch sensitivity	84
	Master tuning	84		Track assignment, minus-one	55
	Measure, song play from specified	54		Track muting, accompaniment	27
	Melody tracks, clearing	63		Transmit channel & track	92
	Melody tracks, song	58		Transposition	46
	Menu structure	96		Troubleshooting	109
	Menus	10	V	Virtual Arranger	27
	Metronome	85		Voice list	99
	MIDI connectors	88		Voice set	85
	MIDI data format	110		Voice, revoice	80
	MIDI functions	92		Voices, about the	16
	MIDI implementation chart	122		Voices, selecting & playing	17
				Volume control, accompaniment	28
				Volume control, song	53
				Volume, harmony	44
			X	XG	3, 16

Limited Warranty

90 DAYS LABOR

1 YEAR PARTS

Yamaha Corporation of America, hereafter referred to as Yamaha, warrants to the original consumer of a product included in the categories listed below, that the product will be free of defects in materials and/or workmanship for the periods indicated. This warranty is applicable to all models included in the following series of products:

PSR SERIES OF PORTATONE ELECTRONIC KEYBOARDS

If during the first 90 days that immediately follows the purchase date, your new Yamaha product covered by this warranty is found to have a defect in material and/or workmanship, Yamaha and/or its authorized representative will repair such defect without charge for parts or labor.

If parts should be required after this 90 day period but within the one year period that immediately follows the purchase date, Yamaha will, subject to the terms of this warranty, supply these parts without charge. However, charges for labor, and/or any miscellaneous expenses incurred are the consumers responsibility. Yamaha reserves the right to utilize reconditioned parts in repairing these products and/or to use reconditioned units as warranty replacements.

THIS WARRANTY IS THE ONLY EXPRESS WARRANTY WHICH YAMAHA MAKES IN CONNECTION WITH THESE PRODUCTS. ANY IMPLIED WARRANTY APPLICABLE TO THE PRODUCT, INCLUDING THE WARRANTY OF MERCHANT ABILITY IS LIMITED TO THE DURATION OF THE EXPRESS WARRANTY. YAMAHA EXCLUDES AND SHALL NOT BE LIABLE IN ANY EVENT FOR INCIDENTAL OR CONSEQUENTIAL DAMAGES.

Some states do not allow limitations that relate to implied warranties and/or the exclusion of incidental or consequential damages. Therefore, these limitations and exclusions may not apply to you.

This warranty gives you specific legal rights. You may also have other rights which vary from state to state.

CONSUMERS RESPONSIBILITIES

If warranty service should be required, it is necessary that the consumer assume certain responsibilities:

1. Contact the Customer Service Department of the retailer selling the product, or any retail outlet authorized by Yamaha to sell the product for assistance. You may also contact Yamaha directly at the address provided below.
2. Deliver the unit to be serviced under warranty to: the retailer selling the product, an authorized service center, or to Yamaha with an explanation of the problem. Please be prepared to provide proof purchase date (sales receipt, credit card copy, etc.) when requesting service and/or parts under warranty.
3. Shipping and/or insurance costs are the consumers responsibility.* Units shipped for service should be packed securely.

*Repaired units will be returned PREPAID if warranty service is required within the first 90 days.

IMPORTANT: Do NOT ship anything to ANY location without prior authorization. A Return Authorization (RA) will be issued that has a tracking number assigned that will expedite the servicing of your unit and provide a tracking system if needed.

4. Your owners manual contains important safety and operating instructions. It is your responsibility to be aware of the contents of this manual and to follow all safety precautions.

EXCLUSIONS

This warranty does not apply to units whose trade name, trademark, and/or ID numbers have been altered, defaced, exchanged removed, or to failures and/or damages that may occur as a result of:

1. Neglect, abuse, abnormal strain, modification or exposure to extremes in temperature or humidity.
2. Improper repair or maintenance by any person who is not a service representative of a retail outlet authorized by Yamaha to sell the product, an authorized service center, or an authorized service representative of Yamaha.
3. This warranty is applicable only to units sold by retailers authorized by Yamaha to sell these products in the U.S.A., the District of Columbia, and Puerto Rico. This warranty is not applicable in other possessions or territories of the U.S.A. or in any other country.

Please record the model and serial number of the product you have purchased in the spaces provided below.

Model _____ Serial # _____ Sales Slip # _____

Purchased from _____ Date _____
(Retailer)

YAMAHA CORPORATION OF AMERICA
Electronic Service Division
6600 Orangethorpe Avenue
Buena Park, CA 90620

KEEP THIS DOCUMENT FOR YOUR RECORDS. DO NOT MAIL!

For details of products, please contact your nearest Yamaha or the authorized distributor listed below.

Pour plus de détails sur les produits, veuillez-vous adresser à Yamaha ou au distributeur le plus proche de vous figurant dans la liste suivante.

Die Einzelheiten zu Produkten sind bei Ihrer unten aufgeführten Niederlassung und bei Yamaha Vertragshändlern in den jeweiligen Bestimmungsländern erhältlich.

Para detalles sobre productos, contacte su tienda Yamaha más cercana o el distribuidor autorizado que se lista debajo.

NORTH AMERICA

CANADA

Yamaha Canada Music Ltd.
135 Milner Avenue, Scarborough, Ontario,
M1S 3R1, Canada
Tel: 416-298-1311

U.S.A.

Yamaha Corporation of America
6600 Orangethorpe Ave., Buena Park, Calif. 90620,
U.S.A.
Tel: 714-522-9011

CENTRAL & SOUTH AMERICA

MEXICO

**Yamaha de Mexico S.A. De C.V.,
Departamento de ventas**
Javier Rojo Gomez No.1149, Col. Gpe Del
Moral, Deleg. Iztapalapa, 09300 Mexico, D.F.
Tel: 686-00-33

BRAZIL

Yamaha Musical do Brasil LTDA.
Av. Rebouças 2636, São Paulo, Brasil
Tel: 011-853-1377

ARGENTINA

Yamaha Music Argentina S.A.
Viamonte 1145 Piso2-B 1053,
Buenos Aires, Argentina
Tel: 1-371-7021

PANAMA AND OTHER LATIN AMERICAN COUNTRIES/ CARIBBEAN COUNTRIES

Yamaha de Panama S.A.
Torre Banco General, Piso 7, Urbanización Marbella,
Calle 47 y Aquilino de la Guardia,
Ciudad de Panamá, Panamá
Tel: 507-269-5311

EUROPE

THE UNITED KINGDOM

Yamaha-Kemble Music (U.K.) Ltd.
Sherbourne Drive, Tilbrook, Milton Keynes,
MK7 8BL, England
Tel: 01908-366700

IRELAND

Danfay Ltd.
61D, Sallynoggin Road, Dun Laoghaire, Co. Dublin
Tel: 01-2859177

GERMANY/SWITZERLAND

Yamaha Europa GmbH.
Siemensstraße 22-34, 25462 Rellingen,
F.R. of Germany
Tel: 04101-3030

AUSTRIA

Yamaha Music Austria
Schleiergasse 20, A-1100 Wien Austria
Tel: 01-60203900

THE NETHERLANDS

Yamaha Music Nederland
Kanaalweg 18G, 3526KL, Utrecht, The Netherlands
Tel: 030-2828411

BELGIUM

Yamaha Music Belgium
Keibergh Imperiastraat 8, 1930 Zaventem, Belgium
Tel: 02-7258220

FRANCE

**Yamaha Musique France,
Division Claviers**
BP 70-77312 Marne-la-Vallée Cedex 2, France
Tel: 01-64-61-4000

ITALY

**Yamaha Musica Italia S.P.A.,
Home Keyboard Division**
Viale Italia 88, 20020 Lainate (Milano), Italy
Tel: 02-935-771

SPAIN

Yamaha-Hazen Electronica Musical, S.A.
Jorge Juan 30, 28001, Madrid, Spain
Tel: 91-577-7270

PORTUGAL

Valentim de Carvalho CI SA
Estrada de Porto Salvo, Paço de Arcos 2780 Oeiras,
Portugal
Tel: 01-443-3398/4030/1823

GREECE

Philippe Nakas S.A.
Navarinou Street 13, P.Code 10680, Athens, Greece
Tel: 01-364-7111

SWEDEN

Yamaha Scandinavia AB
J. A. Wettergrens Gata 1
Box 30053
S-400 43 Göteborg, Sweden
Tel: 031 89 34 00

DENMARK

YS Copenhagen Liaison Office
Generatorvej 8B
DK-2730 Herlev, Denmark
Tel: 44 92 49 00

FINLAND

Warner Music Finland OY/Fazer Music
Aleksanterinkatu 11, P.O. Box 260
SF-00101 Helsinki, Finland
Tel: 0435 011

NORWAY

Norsk filial av Yamaha Scandinavia AB
Grini Næringspark 1
N-1345 Østerås, Norway
Tel: 67 16 77 70

ICELAND

Skifan HF
Skeifan 17 P.O. Box 8120
IS-128 Reykjavik, Iceland
Tel: 525 5000

OTHER EUROPEAN COUNTRIES

Yamaha Europa GmbH.
Siemensstraße 22-34, 25462 Rellingen, F.R. of
Germany
Tel: 04101-3030

AFRICA

**Yamaha Corporation,
International Marketing Division**
Nakazawa-cho 10-1, Hamamatsu, Japan 430-8650
Tel: 053-460-2312

MIDDLE EAST

TURKEY/CYPRUS

Yamaha Europa GmbH.
Siemensstraße 22-34, 25462 Rellingen,
F.R. of Germany
Tel: 04101-3030

OTHER COUNTRIES

**Yamaha Corporation,
International Marketing Division**
Nakazawa-cho 10-1, Hamamatsu, Japan 430-8650
Tel: 053-460-2312

ASIA

HONG KONG

Tom Lee Music Co., Ltd.
11/F., Silvercord Tower 1, 30 Canton Road,
Tsimshatsui, Kowloon, Hong Kong
Tel: 2737-7688

INDONESIA

**PT. Yamaha Music Indonesia (Distributor)
PT. Nusantik**
Gedung Yamaha Music Center, Jalan Jend. Gatot
Subroto Kav. 4, Jakarta 12930, Indonesia
Tel: 21-520-2577

KOREA

Cosmos Corporation
#131-31, Neung-Dong, Sungdong-Ku, Seoul
Korea
Tel: 02-466-0021~5

MALAYSIA

Yamaha Music Malaysia, Sdn., Bhd.
16-28, Jalan SS 2/72, Petaling Jaya, Selangor,
Malaysia
Tel: 3-717-8977

PHILIPPINES

Yupangco Music Corporation
339 Gil J. Puyat Avenue, P.O. Box 885 MCPO,
Makati, Metro Manila, Philippines
Tel: 819-7551

SINGAPORE

Yamaha Music Asia Pte., Ltd.
Blk 202 Hougang, Street 21 #02-01,
Singapore 530202
Tel: 747-4374

TAIWAN

Yamaha KHS Music Co., Ltd.
10F, 150, Tun-Hwa Northroad,
Taipei, Taiwan, R.O.C.
Tel: 02-2713-8999

THAILAND

Siam Music Yamaha Co., Ltd.
121/60-61 RS Tower 17th Floor,
Ratchadaphisek RD., Dindaeng,
Bangkok 10320, Thailand
Tel: 02-641-2951

THE PEOPLE'S REPUBLIC OF CHINA AND OTHER ASIAN COUNTRIES

**Yamaha Corporation,
International Marketing Division**
Nakazawa-cho 10-1, Hamamatsu, Japan 430-8650
Tel: 053-460-2317

OCEANIA

AUSTRALIA

Yamaha Music Australia Pty. Ltd.
17-33 Market Street, South Melbourne, Vic. 3205,
Australia
Tel: 3-699-2388

NEW ZEALAND

Music Houses of N.Z. Ltd.
146/148 Captain Springs Road, Te Papapa,
Auckland, New Zealand
Tel: 9-634-0099

COUNTRIES AND TRUST TERRITORIES IN PACIFIC OCEAN

**Yamaha Corporation,
International Marketing Division**
Nakazawa-cho 10-1, Hamamatsu, Japan 430-8650
Tel: 053-460-2317

HEAD OFFICE Yamaha Corporation, Electronic Musical Instrument Division
Nakazawa-cho 10-1, Hamamatsu, Japan 430-8650
Tel: 053-460-3273

