



DIGITAL KEYBOARD

PSR-E433

Setting Up

Quick Guide

Reference

Appendix

Owner's Manual



EN

SPECIAL MESSAGE SECTION

This product utilizes batteries or an external power supply (adapter). DO NOT connect this product to any power supply or adapter other than one described in the manual, on the name plate, or specifically recommended by Yamaha.

WARNING: Do not place this product in a position where anyone could walk on, trip over, or roll anything over power or connecting cords of any kind. The use of an extension cord is not recommended! If you must use an extension cord, the minimum wire size for a 25' cord (or less) is 18 AWG. NOTE: The smaller the AWG number, the larger the current handling capacity. For longer extension cords, consult a local electrician.

This product should be used only with the components supplied or; a cart, rack, or stand that is recommended by Yamaha. If a cart, etc., is used, please observe all safety markings and instructions that accompany the accessory product.

SPECIFICATIONS SUBJECT TO CHANGE:

The information contained in this manual is believed to be correct at the time of printing. However, Yamaha reserves the right to change or modify any of the specifications without notice or obligation to update existing units.

This product, either alone or in combination with an amplifier and headphones or speaker/s, may be capable of producing sound levels that could cause permanent hearing loss. DO NOT operate for long periods of time at a high volume level or at a level that is uncomfortable. If you experience any hearing loss or ringing in the ears, you should consult an audiologist.

IMPORTANT: The louder the sound, the shorter the time period before damage occurs.

Some Yamaha products may have benches and / or accessory mounting fixtures that are either supplied with the product or as optional accessories. Some of these items are designed to be dealer assembled or installed. Please make sure that benches are stable and any optional fixtures (where applicable) are well secured BEFORE using.

Benches supplied by Yamaha are designed for seating only. No other uses are recommended.

NOTICE:

Service charges incurred due to a lack of knowledge relating to how a function or effect works (when the unit is operating as designed) are not covered by the manufacturer's warranty, and are therefore the owners responsibility. Please study this manual carefully and consult your dealer before requesting service.

ENVIRONMENTAL ISSUES:

Yamaha strives to produce products that are both user safe and environmentally friendly. We sincerely believe that our products and the production methods used to produce them, meet these goals. In keeping with both the letter and the spirit of the law, we want you to be aware of the following:

Battery Notice:

This product MAY contain a small non-rechargeable battery which (if applicable) is soldered in place. The average life span of this type of battery is approximately five years. When replacement becomes necessary, contact a qualified service representative to perform the replacement.

This product may also use "household" type batteries. Some of these may be rechargeable. Make sure that the battery being charged is a rechargeable type and that the charger is intended for the battery being charged.

When installing batteries, never mix old batteries with new ones, and never mix different types of batteries. Batteries MUST be installed correctly. Mismatches or incorrect installation may result in overheating and battery case rupture.

Warning:

Do not attempt to disassemble, or incinerate any battery. Keep all batteries away from children. Dispose of used batteries promptly and as regulated by the laws in your area. Note: Check with any retailer of household type batteries in your area for battery disposal information.

Disposal Notice:

Should this product become damaged beyond repair, or for some reason its useful life is considered to be at an end, please observe all local, state, and federal regulations that relate to the disposal of products that contain lead, batteries, plastics, etc. If your dealer is unable to assist you, please contact Yamaha directly.

NAME PLATE LOCATION:

The name plate is located on the bottom of the product. The model number, serial number, power requirements, etc., are located on this plate. You should record the model number, serial number, and the date of purchase in the spaces provided below and retain this manual as a permanent record of your purchase.

Model

Serial No.

Purchase Date

PLEASE KEEP THIS MANUAL

92-BP (bottom)

FCC INFORMATION (U.S.A.)

1. IMPORTANT NOTICE: DO NOT MODIFY THIS UNIT!

This product, when installed as indicated in the instructions contained in this manual, meets FCC requirements. Modifications not expressly approved by Yamaha may void your authority, granted by the FCC, to use the product.

2. IMPORTANT:

When connecting this product to accessories and/or another product use only high quality shielded cables. Cable/s supplied with this product MUST be used. Follow all installation instructions. Failure to follow instructions could void your FCC authorization to use this product in the USA.

3. NOTE:

This product has been tested and found to comply with the requirements listed in FCC Regulations, Part 15 for Class "B" digital devices. Compliance with these requirements provides a reasonable level of assurance that your use of this product in a residential environment will not result in harmful interference with other electronic devices. This equipment generates/uses radio frequencies and, if not installed and used according to the instructions found in the users manual, may cause interference harmful to the operation of other electronic devices. Compliance with FCC regulations does

not guarantee that interference will not occur in all installations. If this product is found to be the source of interference, which can be determined by turning the unit "OFF" and "ON", please try to eliminate the problem by using one of the following measures:

Relocate either this product or the device that is being affected by the interference.

Utilize power outlets that are on different branch (circuit breaker or fuse) circuits or install AC line filter/s.

In the case of radio or TV interference, relocate/reorient the antenna. If the antenna lead-in is 300 ohm ribbon lead, change the lead-in to co-axial type cable.

If these corrective measures do not produce satisfactory results, please contact the local retailer authorized to distribute this type of product. If you can not locate the appropriate retailer, please contact Yamaha Corporation of America, Electronic Service Division, 6600 Orangethorpe Ave, Buena Park, CA90620

The above statements apply ONLY to those products distributed by Yamaha Corporation of America or its subsidiaries.

* This applies only to products distributed by YAMAHA CORPORATION OF AMERICA.

(class B)

OBSERVERA!

Apparaten kopplas inte ur växelströmskällan (nätet) så länge som den är ansluten till vägguttaget, även om själva apparaten har stängts av.

ADVARSSEL: Netspændingen til dette apparat er IKKE afbrudt, så længe netledningen sidder i en stikkontakt, som er tændt — også selvom der er slukket på apparatets afbryder.

VAROITUS: Laitteen toisiopiiriin kytketty käyttökytin ei irroita koko laitetta verkosta.

(standby)

Entsorgung leerer Batterien (nur innerhalb Deutschlands)

Leisten Sie einen Beitrag zum Umweltschutz. Verbrauchte Batterien oder Akkumulatoren dürfen nicht in den Hausmüll. Sie können bei einer Sammelstelle für Altbatterien bzw. Sondermüll abgegeben werden. Informieren Sie sich bei Ihrer Kommune.

(battery)

The name plate of this product may be found on the bottom of the unit. The serial number of this product may be found on or near the name plate. You should note this serial number in the space provided below and retain this manual as a permanent record of your purchase to aid identification in the event of theft.

Model No. _____

Serial No. _____

(bottom)

COMPLIANCE INFORMATION STATEMENT (DECLARATION OF CONFORMITY PROCEDURE)

Responsible Party : Yamaha Corporation of America
Address : 6600 Orangethorpe Ave., Buena Park,
Calif. 90620
Telephone : 714-522-9011
Type of Equipment : Digital Keyboard
Model Name : PSR-E433

This device complies with Part 15 of the FCC Rules.
Operation is subject to the following two conditions:
1) this device may not cause harmful interference, and
2) this device must accept any interference received including interference that may cause undesired operation.
See user manual instructions if interference to radio reception is suspected.

* This applies only to products distributed by
YAMAHA CORPORATION OF AMERICA.

(FCC DoC)

Information for Users on Collection and Disposal of Old Equipment and used Batteries



These symbols on the products, packaging, and/or accompanying documents mean that used electrical and electronic products and batteries should not be mixed with general household waste.
For proper treatment, recovery and recycling of old products and used batteries, please take them to applicable collection points, in accordance with your national legislation and the Directives 2002/96/EC and 2006/66/EC.



By disposing of these products and batteries correctly, you will help to save valuable resources and prevent any potential negative effects on human health and the environment which could otherwise arise from inappropriate waste handling.



For more information about collection and recycling of old products and batteries, please contact your local municipality, your waste disposal service or the point of sale where you purchased the items.

[For business users in the European Union]

If you wish to discard electrical and electronic equipment, please contact your dealer or supplier for further information.



[Information on Disposal in other Countries outside the European Union]

These symbols are only valid in the European Union. If you wish to discard these items, please contact your local authorities or dealer and ask for the correct method of disposal.

Cd

Note for the battery symbol (bottom two symbol examples):

This symbol might be used in combination with a chemical symbol. In this case it complies with the requirement set by the Directive for the chemical involved.

(weee_battery_eu_en)

Table of Contents

Special Features	5
Compatible Format and Functions	8
About the Manuals	9
Included Accessories	9

Setting Up

Panel Controls and Terminals	10
Setting Up	12
Power Requirements	12
Connecting Headphones or External Audio Equipment	13
Connecting a Footswitch to the SUSTAIN jack	13
Basic Operations	14
Turning the Power On/Off	14
Auto Power Off Function	14
Selecting Operations	14
Display Items	15

Quick Guide

Try Playing a Variety of Instrument Voices	16
Selecting a Main Voice	16
Playing the "Grand Piano"	16
Layering a Dual Voice	16
Playing a Split Voice in the Left Hand area	17
Using the Metronome	18
Adding Harmony	19
Creating Arpeggios	20
Triggering the Arpeggio	20
Changing the Arpeggio Type	20
Creating Original Sounds via the Knobs	21
Selecting a Knob Effect Combination	21
Applying the Filter to the Main Voice	21
Playing Styles	22
Using the Music Database	22
Playing with Patterns Like a DJ!	23
Playing Songs	24
Listening to a Demo Song	24
Selecting and Playing Back a Song	24
Song Fast Forward, Fast Reverse, and Pause	25
A-B Repeat	25
Turning Each Track On/Off	25
Using the Song Lesson Feature	26
Three Types of Song Lesson	26
Practicing with Song Lesson	26
Making Practice Perfect—Repeat & Learn	27
Recording Your Performance	28
Track Structure of a Song	28
Quick Recording	28
Recording to a Specified Track	29
Clearing a User Song	30
Clearing a Specified Track from a User Song	30
Memorizing Your Favorite Panel Settings	31
Memorizing Panel Settings to the Registration Memory	31
Recalling Panel Settings from the Registration Memory	31
Backup Parameters and Initialization	32
Backup Parameters	32
Initialization	32

Reference

Handy Performance Features	33
Selecting a Reverb Type	33
Selecting a Chorus Type	33
Pitch Controls—Transpose	34
Pitch Controls—Tuning	34
Pitch Controls—the PITCH BEND wheel	34
Calling up Optimum Panel Settings	34
Changing the Touch Sensitivity of the Keyboard	35
Selecting an EQ Setting for the Best Sound	35
Voice Settings	36
Selecting a Dual Voice	36
Selecting a Split Voice	36
Voice Editing	36
Parameters Assigned to the Knobs	37
Arpeggio Settings	39
Synchronizing an Arpeggio to Song/Style/Pattern	39
Playback—Arpeggio Quantize	39
Holding the Arpeggio Playback via the Footswitch	39
Styles (Auto Accompaniment) and Patterns	40
Style Variations—Sections	40
Synchro Stop	41
Pattern Variations—Sections	42
Changing the Tempo	42
Tap Start	42
Adjusting the Volume of the Style or Pattern	42
Setting the Split Point	43
Playing Chords Without Style Playback	43
Chord Types for Style Playback	44
Looking Up Chords Using the Chord Dictionary	45
Song Settings	46
BGM (Background Music) Playback	46
Random Song Playback	46
Tempo Setting of the Song	47
Tap Start	47
Song Volume	47
Melody Voice Setting of the Preset Song	47
The Functions	48
Basic Procedure in the Function Display	48
USB Flash Memory Operations	51
Connecting a USB Flash Memory	52
Formatting a USB Flash Memory	53
Saving User Data to a USB Flash Memory	54
Saving a User Song as SMF to a USB Flash Memory	55
Loading User Data from a USB Flash Memory	56
Loading a Style File	57
Deleting a User File in the USB Flash Memory	58
Deleting a SMF File in the USB Flash Memory	58
Exiting from a File Control display	59

Appendix

Troubleshooting	60
Specifications	61
Index	62

Special Features

Creating New Sounds

► Page 21

By adjusting just two knobs you can add varying degrees of distortion, sweetness, or other characteristics to a sound to change it subtly or drastically. Parameters that can be assigned to the knobs include effect, filter, envelope generator and more. You can create new sounds in real time!

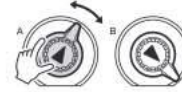

.....

Arpeggio Function

► Page 20

Similar to the arpeggio functions provided on some synthesizers, this function automatically produces arpeggios (broken chords) when you simply play the appropriate notes on the keyboard. A variety of arpeggios can be produced by changing your fingering or the arpeggio type.



.....

Play a Variety of Instrument Voices

► Page 16

The instrument voice that sounds when you play the keyboard can be changed to violin, flute, harp, or any of an extensive range of voices. You can change the mood of a song written for piano, for example, by using violin to play it instead. Experience a whole new world of musical variety.



.....

Play Along with Styles

► Page 22

Want to play with full accompaniment? Try the auto-accompaniment Styles. The accompaniment styles provide the equivalent of a full backing band covering a wide variety of styles from waltzes to 8-beat to euro-trance ... and much more. Select a style that matches the music you want to play, or experiment with new styles to expand your musical horizons.



.....

Try playing like a DJ by using the Patterns!

► Page 23

The Pattern function lets you perform like a DJ. The Track Control lets you enjoy various instrument combinations, and the Knobs let you control the tempo and create various sounds.

The appropriate panel settings for each Pattern are pre-programmed to Registration Memory. Refer to page 34.



.....

PRECAUTIONS

PLEASE READ CAREFULLY BEFORE PROCEEDING

Please keep this manual in a safe and handy place for future reference.



WARNING

Always follow the basic precautions listed below to avoid the possibility of serious injury or even death from electrical shock, short-circuiting, damages, fire or other hazards. These precautions include, but are not limited to, the following:

Power supply/AC power adaptor

- ❑ Do not place the power cord near heat sources such as heaters or radiators. Also, do not excessively bend or otherwise damage the cord, or place heavy objects on it.
- ❑ Only use the voltage specified as correct for the instrument. The required voltage is printed on the name plate of the instrument.
- ❑ Use the specified adaptor (page 61) only. Using the wrong adaptor can result in damage to the instrument or overheating.
- ❑ Check the electric plug periodically and remove any dirt or dust which may have accumulated on it.

Do not open

- ❑ This instrument contains no user-serviceable parts. Do not open the instrument or attempt to disassemble or modify the internal components in any way. If it should appear to be malfunctioning, discontinue use immediately and have it inspected by qualified Yamaha service personnel.

Water warning

- ❑ Do not expose the instrument to rain, use it near water or in damp or wet conditions, place on it any containers (such as vases, bottles or glasses) containing liquids which might spill into any openings. If any liquid such as water seeps into the instrument, turn off the power immediately and unplug the power cord from the AC outlet. Then have the instrument inspected by qualified Yamaha service personnel.
- ❑ Never insert or remove an electric plug with wet hands.

Fire warning

- ❑ Do not put burning items, such as candles, on the unit. A burning item may fall over and cause a fire.

Battery

- ❑ Follow the precautions below. Failure to do so might result in explosion, fire, overheating or battery fluid leakage.
 - Do not tamper with or disassemble batteries.
 - Do not dispose of batteries in fire.
 - Do not attempt to recharge batteries that are not designed to be charged.
 - Keep the batteries separate from metallic objects such as necklaces, hairpins, coins, and keys.
 - Use the specified battery type (page 12) only.
 - Use new batteries, all of which are the same type, same model, and made by the same manufacturer.
 - Always make sure all batteries are inserted in conformity with the +/- polarity markings.
 - When the batteries run out, or if the instrument is not to be used for a long time, remove the batteries from the instrument.
 - When using Ni-MH batteries, follow the instructions that came with the batteries. Use only the specified charger device when charging.
- ❑ Keep batteries away from small children who might accidentally swallow them.
- ❑ If the batteries do leak, avoid contact with the leaked fluid. If the battery fluid should come in contact with your eyes, mouth, or skin, wash immediately with water and consult a doctor. Battery fluid is corrosive and may possibly cause loss of sight or chemical burns.

If you notice any abnormality

- ❑ When one of the following problems occur, immediately turn off the power switch and disconnect the electric plug from the outlet. (If you are using batteries, remove all batteries from the instrument.) Then have the device inspected by Yamaha service personnel.
 - The power cord or plug becomes frayed or damaged.
 - It emits unusual smells or smoke.
 - Some object has been dropped into the instrument.
 - There is a sudden loss of sound during use of the instrument.

CAUTION

Always follow the basic precautions listed below to avoid the possibility of physical injury to you or others, or damage to the instrument or other property. These precautions include, but are not limited to, the following:

Power supply/AC power adaptor

- ❑ Do not connect the instrument to an electrical outlet using a multiple-connector. Doing so can result in lower sound quality, or possibly cause overheating in the outlet.
- ❑ When removing the electric plug from the instrument or an outlet, always hold the plug itself and not the cord. Pulling by the cord can damage it.
- ❑ Remove the electric plug from the outlet when the instrument is not to be used for extended periods of time, or during electrical storms.

Location

- ❑ Do not place the instrument in an unstable position where it might accidentally fall over.
- ❑ Before moving the instrument, remove all connected cables, to prevent damage to the cables or injury to anyone who might trip over them.
- ❑ When setting up the product, make sure that the AC outlet you are using is easily accessible. If some trouble or malfunction occurs, immediately turn off the power switch and disconnect the plug from the outlet. Even when the power switch is turned off, electricity is still flowing to the product at the minimum level. When you are not using the product for a long time, make sure to unplug the power cord from the wall AC outlet.
- ❑ Use only the stand specified for the instrument. When attaching the stand or rack, use the provided screws only. Failure to do so could cause damage to the internal components or result in the instrument falling over.

Connections

- ❑ Before connecting the instrument to other electronic components, turn off the power for all components. Before turning the power on or off for all components, set all volume levels to minimum.
- ❑ Be sure to set the volumes of all components at their minimum levels and gradually raise the volume controls while playing the instrument to set the desired listening level.

Handling caution

- ❑ Do not insert a finger or hand in any gaps on the instrument.
- ❑ Never insert or drop paper, metallic, or other objects into the gaps on the panel or keyboard. This could cause physical injury to you or others, damage to the instrument or other property, or operational failure.
- ❑ Do not rest your weight on, or place heavy objects on the instrument, and do not use excessive force on the buttons, switches or connectors.
- ❑ Do not use the instrument/device or headphones for a long period of time at a high or uncomfortable volume level, since this can cause permanent hearing loss. If you experience any hearing loss or ringing in the ears, consult a physician.

Yamaha cannot be held responsible for damage caused by improper use or modifications to the instrument, or data that is lost or destroyed.

Always turn the power off when the instrument is not in use.

Even when the [] (Standby/On) switch is in standby status (display is off), electricity is still flowing to the instrument at the minimum level.

When you are not using the instrument for a long time, make sure you unplug the power cord from the wall AC outlet.

Make sure to discard used batteries according to local regulations.

NOTICE

To avoid the possibility of malfunction/ damage to the product, damage to data, or damage to other property, follow the notices below.

❑ Handling and Maintenance

- ❑ Do not use the instrument in the vicinity of a TV, radio, stereo equipment, mobile phone, or other electric devices. Otherwise, the instrument, TV, or radio may generate noise.
- ❑ Do not expose the instrument to excessive dust or vibrations, or extreme cold or heat (such as in direct sunlight, near a heater, or in a car during the day) to prevent the possibility of panel disfiguration, damage to the internal components or unstable operation. (Verified operating temperature range: 5°C/40°F, or 41°C/104°F)
- ❑ Do not place vinyl, plastic or rubber objects on the instrument, since this might discolor the panel or keyboard.

❑ Saving data

- ❑ Some data items (page 32) are automatically saved as backup data in the internal memory even if you turn the power off. Saved data may be lost due to malfunction or incorrect operation. Save important data to external device such as a USB flash memory (page 51).

Information

❑ About copyrights

- ❑ Copying of the commercially available musical data including but not limited to MIDI data and/or audio data is strictly prohibited except for your personal use.
- ❑ This product incorporates and bundles computer programs and contents in which Yamaha owns copyrights or with respect to which it has license to use others' copyrights. Such copyrighted materials include, without limitation, all computer software, stylefiles, MIDI files, WAVedata, musical scores and sound recordings. Any unauthorized use of such programs and contents outside of personal use is not permitted under relevant laws. Any violation of copyright has legal consequences. **DO NOT MAKE, DISTRIBUTE OR USE ILLEGAL COPIES.**

❑ About functions/data bundled with the instrument

- ❑ Some of the preset songs have been edited for length or arrangement, and may not be exactly the same as the original.

❑ About this manual

- ❑ The illustrations and LCD screens as shown in this manual are for instructional purposes only, and may appear somewhat different from those on your instrument.
- ❑ The company names and product names in this manual are the trademarks or registered trademarks of their respective companies.

DMI-5 2/2

Compatible Format and Functions



GM System Level 1

GM System Level 1 is an addition to the MIDI standard which ensures that any GM-compatible music data can be accurately played by any GM-compatible tone generator, regardless of manufacturer. The GM mark is affixed to all software and hardware products that support GM System Level.



XGlite

As its name implies, XGlite is a simplified version of Yamaha's high-quality XG tone generation format. Naturally, you can play back any XG song data using an XGlite tone generator. However, keep in mind that some songs may play back differently compared to the original data, due to the reduced set of control parameters and effects.



USB

USB is an abbreviation for Universal Serial Bus. It is a serial interface for connecting a computer with peripheral Devices. It allows hot swapping (connecting peripheral devices while the power to the computer is on).



STYLE FILE

The Style File Format is Yamaha's original style file format which uses a unique conversion system to provide high-quality automatic accompaniment based on a wide range of chord types.

About the Manuals

This instrument has the following documents and instructional materials.

□ Included Documents



Owner's Manual (this book)

- Setting Up Please read this section first.
- Quick Guide This section explains how to use the basic functions. Refer to this section while playing the instrument.
- Reference This section explains how to make detailed settings for the various functions of the instrument.
- Appendix This section includes troubleshooting information and specifications.



Data List

Contains various important preset content lists such as those of Voices, Styles, Patterns and Effects.

□ Online Materials (from Yamaha Manual Library)



MIDI Reference

Contains MIDI related information such as MIDI Data Format and the MIDI Implementation Chart.



MIDI Basics (only in English, French, German and Spanish)

Contains basic explanations about MIDI.



Computer-related Operations

Includes instructions on connecting this instrument to a computer, and operations related to transferring song data.

To obtain these manuals, access the Yamaha Manual Library, enter PSR-E433or MIDI Basicsto the Model Name box, then click [SEARCH].

Yamaha Manual Library <http://www.yamaha.co.jp/manual/>

□ Online Materials (for Yamaha Online members)



Song Book (only in English, French, German and Spanish)

Contains music scores for the preset Songs (excluding the Demo Songs) of this instrument. After completing the user registration at the website below, you can download this Song Book free of charge.

Yamaha Online Member <https://member.yamaha.com/myproduct/regist/>

You will need the PRODUCT ID on the sheet (Online Member Product Registration) packaged with this manual in order to fill out the User Registration form.

Included Accessories

- Owner's Manual (this book)
- Data List
- AC Power Adaptor *1
- Music Rest
- Online Member Product Registration *2

*1: May not be included depending on your particular locale. Check with your Yamaha dealer.

*2: The PRODUCT ID on the sheet will be needed when you fill out the User Registration form.

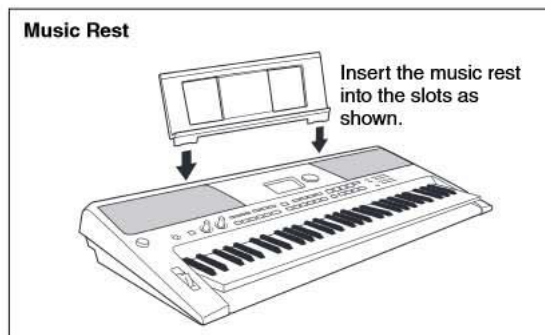

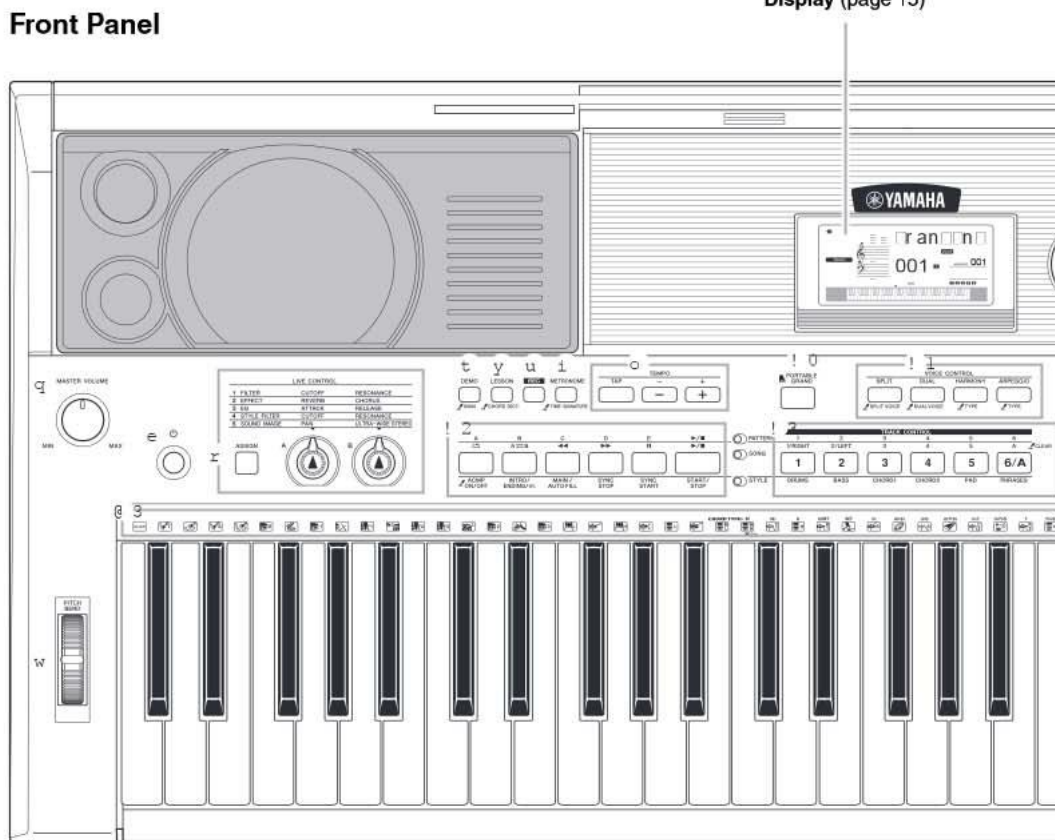

Front Panel

q	[MASTER VOLUME] control	Page 14	!	1	VOICE CONTROL section	
w	PITCH BEND wheel	Page 34			[SPLIT] button	Page 17
e	[] (Standby/On) switch	Page 14			[DUAL] button	Page 16
r	LIVE CONTROL section				[HARMONY] button	Page 19
	[ASSIGN] button	Page 21			[ARPEGGIO] button	Page 20
	[A] and [B] knobs	Page 21	!	2	Playback Control buttons	
t	[DEMO] button	Page 24			• When the [PATTERN] lamp is turned on:	
y	[LESSON] button	Page 26			Pages 23 and 42
u	[REC] button	Page 28			• When the [SONG] lamp is turned on:	
i	[METRONOME] button	Page 18			Page 25
o	TEMPO section				• When the [STYLE] lamp is turned on:	
	[TAP] button	Page 42			Pages 22, 40, and 41
	[-] and [+] buttons	Page 42				
!	o [PORTABLE GRAND] button	Page 16				

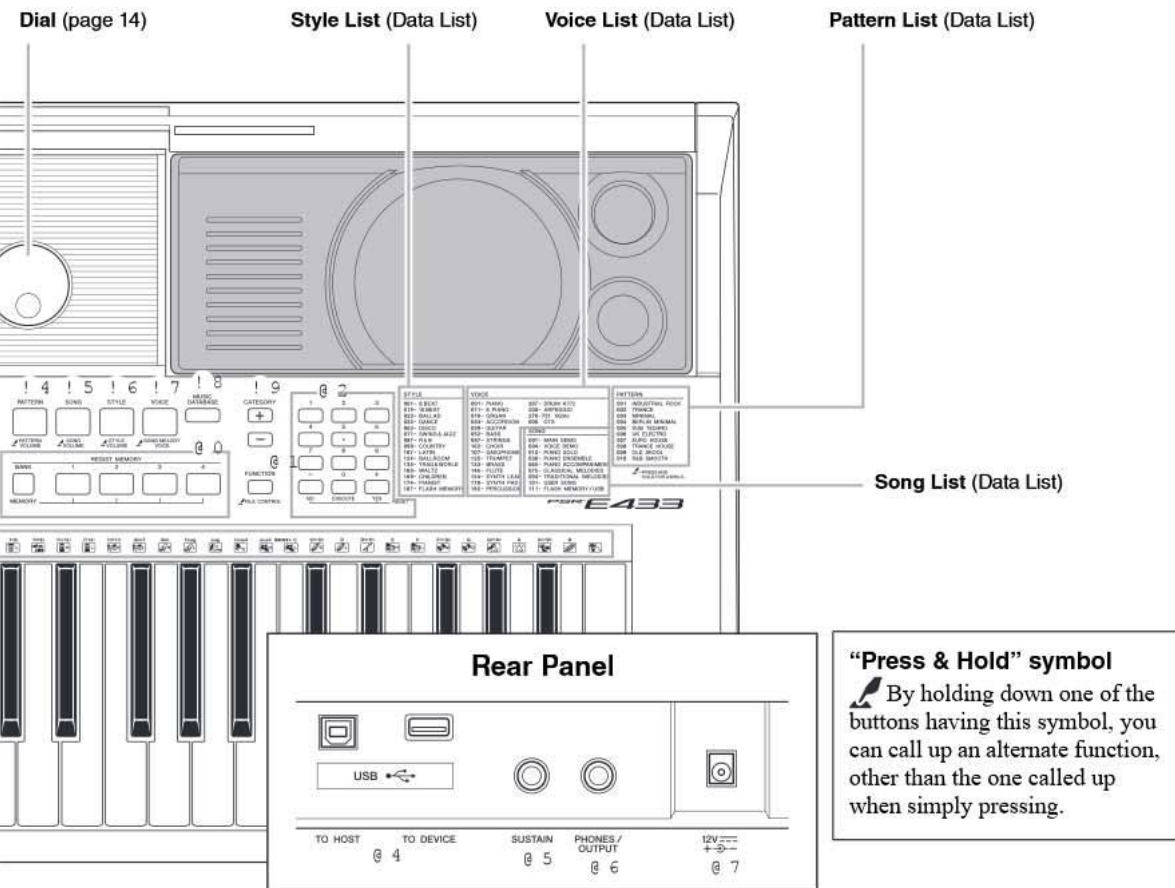

- ! 3 [TRACK CONTROL] buttons
 - When the [PATTERN] lamp is turned on:Page 23
 - When the [SONG] lamp is turned on:Page 25
 - When the [STYLE] lamp is turned on:Page 41
- ! 4 [PATTERN] buttonPage 23
- ! 5 [SONG] buttonPage 24
- ! 6 [STYLE] buttonPage 22
- ! 7 [VOICE] buttonPage 16
- ! 8 [MUSIC DATABASE] buttonPage 22
- ! 9 [CATEGORY] buttonsPage 14
- @ 0 [REGIST MEMORY] buttonsPage 31
- @ 1 [FUNCTION] buttonPage 48

- @ 2 Number buttons [1]–[9], [-/NO], [0/EXECUTE] and [+ /YES] buttonsPage 14
- @ 3 Drum illustrations for the Drum Kit....Page 16
 - Each of these indicates the drum or percussion instrument assigned to the corresponding key for “Standard Kit 1.”

Rear Panel

- @ 4 USB terminals
 - USB TO HOST terminal*Page 50
 - USB TO DEVICE terminalPage 51
- @ 5 SUSTAIN jackPage 13
- @ 6 PHONES/OUTPUT jackPage 13
- @ 7 Power supply jackPage 12

* For connecting to a computer. For details, refer to “Computer-related Operations” (page 9). When connecting, use an AB type USB cable of less than 3 meters. USB 3.0 cables cannot be used.

Power Requirements

Although the instrument will run either from an optional AC adaptor or batteries, Yamaha recommends use of an AC adaptor whenever possible. An AC adaptor is more environmentally friendly than batteries and does not deplete resources.

Using an AC Power Adaptor

- 1 Make sure that the power of the instrument is off (display is blank, except for notation staff).

⚠ WARNING

□ Use the specified adaptor (page 61) only. Using the wrong adaptor can result in damage to the instrument or overheating.

- 2 Connect the AC adaptor to the power supply jack.
- 3 Plug the AC adaptor into an AC outlet.

⚠ CAUTION

□ When setting up the product, make sure that the AC outlet you are using is easily accessible. If some trouble or malfunction occurs, immediately turn off the power switch and disconnect the plug from the outlet. Even when the power switch is turned off, electricity is still flowing to the product at the minimum level. When you are not using the product for a long time, make sure to unplug the power cord from the wall AC outlet.

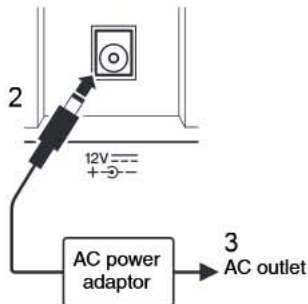

Using Batteries

This instrument requires six AA size, Alkaline (LR6)/Manganese (R6) batteries, or rechargeable nickel-metal hydride batteries (rechargeable Ni-MH batteries). The Alkaline batteries or rechargeable Ni-MH batteries are recommended for this instrument, since other types may result in poorer battery performance.

⚠ WARNING

□ When using Ni-MH batteries, follow the instructions that came with the batteries. Use only the specified charger device when charging.

□ Installing the batteries

- 1 Make sure that the power of the instrument is off (display is blank, except for notation staff).
- 2 Open the battery compartment cover located on the instrument's bottom panel.

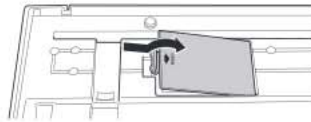

- 3 Insert the six new batteries, being careful to follow the polarity markings on the inside of the compartment.

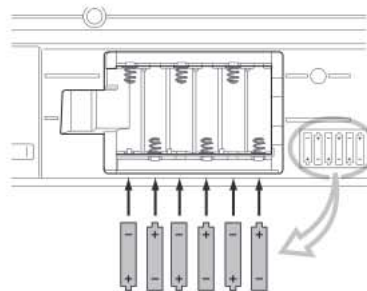

- 4 Replace the compartment cover, making sure that it locks firmly in place.

NOTICE

□ Connecting or disconnecting the power adaptor with batteries installed may turn the power off, resulting in loss of data being recorded or transferred at the time.

When battery power becomes too low for proper operation, the volume may be reduced, the sound may be distorted, and other problems may occur. When this happens, make sure to replace all batteries with new ones or already-recharged ones.

NOTE

- This instrument cannot charge the batteries. Use only the specified charger device when charging.
- Power will be automatically drawn from the AC adaptor if an AC adaptor is connected while batteries are installed in the instrument.

□ Setting the battery type

After installing the new batteries then turning the power on, make sure to set the Battery Type to Rechargeable type or not. For details, refer to page 50.

NOTICE

- Failure to set the Battery Type may shorten the amount of the battery life. Make sure to set the Battery Type correctly.



□ Checking the power status on the display

□ Power source on the display

You can confirm the power source at the left corner of the display.



Only one of these is shown.



When  is shown, the power is supplied from the AC power adaptor. When  is shown, the power is supplied from the batteries. When the AC power adaptor is connected with the batteries installed, the power is supplied from the AC power adaptor and the  indication is shown.

□ Remaining battery power indication

You can confirm the approximate amount of remaining battery power at the top left of the display.

	Indicates that the power will be turned off immediately. When rechargeable batteries are used, this icon flashes before the power is turned off.
	Indicates that remaining power is insufficient for operation. Before the power runs out, replace all the batteries with new ones, or fully recharged ones (when using rechargeable types). Note that the instrument may not work properly, including unusually soft volume and poor sound quality when remaining power becomes low.
	Indicates that the remaining power is sufficient.

Connecting Headphones or External Audio Equipment

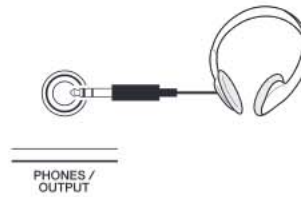

Any pair of stereo headphones with a 1/4" stereo phone plug can be plugged in here for convenient monitoring. The speakers are automatically shut off when a plug is inserted into this jack.

The PHONES/OUTPUT jack also functions as an external output. You can connect the PHONES/OUTPUT jack to a keyboard amplifier, stereo system, mixer, tape recorder, or other line-level audio device to send the instrument's output signal to that device.

⚠ CAUTION

- Do not use the instrument/device or headphones for a long period of time at a high or uncomfortable volume level, since this can cause permanent hearing loss. If you experience any hearing loss or ringing in the ears, consult a physician.
- Before connecting the instrument to other electronic components, set all volume levels to the minimum, then turn off the power for all components.

NOTICE

- When the instrument's sound is output to an external device, first turn on the power to the instrument, then to the external device. Reverse this order when you turn the power off.

Connecting a Footswitch to the SUSTAIN jack

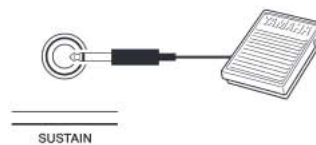

You can produce a natural sustain as you play by pressing an optional Footswitch plugged into the [SUSTAIN] jack.

NOTE

- The sustain function does not affect split voices (page 17).
- Make sure that the footswitch plug is properly connected to the SUSTAIN jack before turning on the power.
- Do not press the footswitch while turning the power on. Doing this changes the recognized polarity of the footswitch, resulting in reversed footswitch operation.

Turning the Power On/Off

Turn down the MASTER VOLUME control to [MIN] then press the [⏻] (Standby/On) switch to turn on the power. While playing the keyboard, adjust the MASTER VOLUME control. To turn off the power, press the [⏻] (Standby/On) switch again for a second.

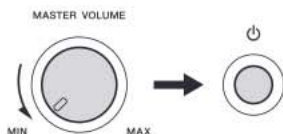

CAUTION

When using a power adaptor, even when the power is off, a small amount of electricity is still being consumed by the instrument. When you are not using the instrument for a long time, make sure to unplug the AC power adaptor from the wall AC outlet.

Auto Power Off Function

To prevent unnecessary power consumption, this instrument features an Auto Power Off function that automatically turns the power off if the instrument is not operated for a specified period of time. The amount of time that will elapse before the power is automatically turned off is set by default to 30 minutes.

To disable the Auto Power Off function:

Turn off the power, then press the [⏻] (Standby/On) switch to turn on the power while holding down the lowest key.



To set the time that elapses before Auto Power Off is executed:

Press the [FUNCTION] button, press the CATEGORY [+/-] button several times until [Auto Power Off] appears then select the desired value.

Settings: OFF, 5, 10, 15, 30, 60, 120
Default value: 30

NOTE

Generally, the data and settings are maintained even when the power is turned off. For details, see page 32.

NOTICE

Depending on the instrument status, the power may not turn off automatically, even after the elapse of the specified period of time. Always turn off the power manually when the instrument is not in use.

When the instrument is not operated for a specified period of time while connected to an external device such as an amplifier, speaker or computer, make sure to follow the instructions in the Owner's Manual to turn off the power to the instrument and the connected devices, in order to protect the devices from damage. If you do not want the power to turn off automatically when a device is connected, disable Auto Power Off.

Selecting Operations

Before operating the instrument, it may be helpful to familiarize yourself with the basic controls below that are used to select items and change values.

Dial

Rotate the dial clockwise to increase the value, or counter-clockwise to decrease the value.

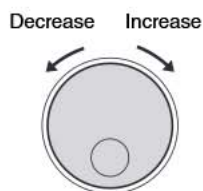

Number buttons

Use the Number buttons to directly enter an item or value. For numbers that start with one or two zeroes, the first zeroes can be omitted.

Example: Selecting Voice 003, Bright Piano.

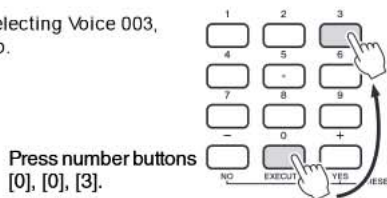

[-] and [+] buttons

Press the [+] button briefly to increase the value by 1, or press the [-] button briefly to decrease the value by 1. Press and hold either button to continuously increase or decrease the value in the corresponding direction.

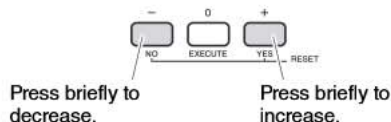

CATEGORY buttons

Use these buttons to jump to the first Voice, Style, or Song in the next or previous Category, and call up the next or previous Function sequentially.



Display Items

The display shows all the current settings of the Song, Style Pattern, Voice and other related functions.

Power source status
Indicates the source from which this instrument obtains power, AC power adaptor or batteries. (Page 13)



USB connection status
Appears when USB flash memory is connected to this instrument. (Page 51)

USB

Notation
Normally this indicates the notes you play. When the Song Lesson function is used, this indicates the current notes and chord of playback. When the Dictionary function is used, this indicates the notes of the chord you specify.







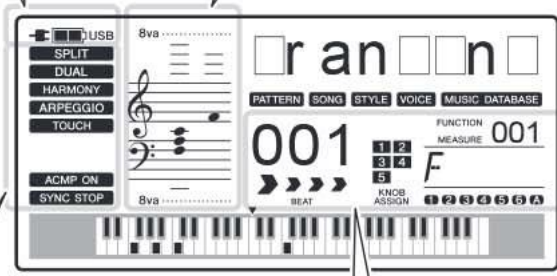

NOTE

- Any notes occurring below or above the staff are indicated by [8va]
- For a few specific chords, not all notes may be shown, due to space limitations in the display.

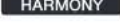

On/off status
This area indicates the on/off status of each function. Each indication is shown when the corresponding function is turned on.

-  Page 17
-  Page 16
-  Page 19
-  Page 20
-  Page 35
-  Page 22
-  Page 41

Beat
Indicates the current beat of playback. (Page 24)



Knob assignment
Indicates the parameters currently assigned to the Knobs. (Page 21)



FUNCTION and MEASURE
Indicates the Function number when the [FUNCTION] button is pressed, or the current Measure number during playback of a Song, Style or Pattern.



Chord
Indicates the chord which is being played on the keyboard (Page 22) or specified via Song playback.



Track status
Indicates the on/off status of the current Song, Style or Pattern. (Pages 23, 28, 41)



Try Playing a Variety of Instrument Voices

In addition to piano, organ, and other “standard” keyboard instruments, this instrument has a large range of voices that includes guitar, bass, strings, sax, trumpet, drums and percussion, and even sound effects—giving you a wide variety of musical sounds.

Selecting a Main Voice

1 Press the [VOICE] button.

The Voice number and name will be shown.

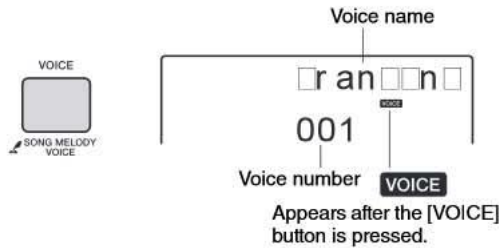

2 Use the dial to select the desired Voice.

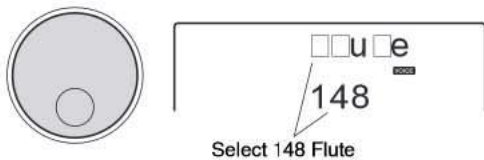

3 Play the keyboard.

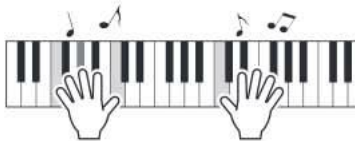

Preset Voice Types

001–206	Instrument Voices.
207–229 (Drum Kit)	Various drum and percussion sounds are assigned to individual keys. Details on assigning instruments to keys are provided in the Drum Kit List of the separate Data List.
230–269	Used for arpeggio performance (page 20).

Playing the [Grand Piano]

When you want to reset various settings to default and simply play a Piano sound, press the [PORTABLE GRAND] button.



The Voice number is set to 001 Grand Piano and all the settings such as Dual and Split are turned off automatically, with exception of the Touch Sensitivity (page 35).

Layering a Dual Voice

In addition to the Main Voice, you can layer a different Voice over the entire keyboard as a [Dual Voice].

1 Press the [DUAL] button to turn Dual on.

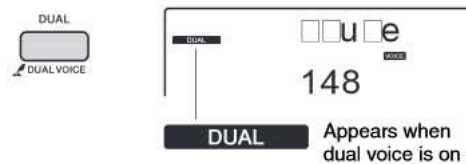

2 Press the [DUAL] button again to exit from Dual.

Although turning on Dual will select a Dual Voice suitable for the current Main Voice, you can easily select a different Dual Voice (page 36).

Playing a Split Voice in the Left Hand area

By dividing the keyboard into the two separate areas, you can play a different Voice between the Left hand and Right hand areas.

1 Press the [SPLIT] button to turn on Split.

The keyboard is divided into the Left hand and Right hand areas.

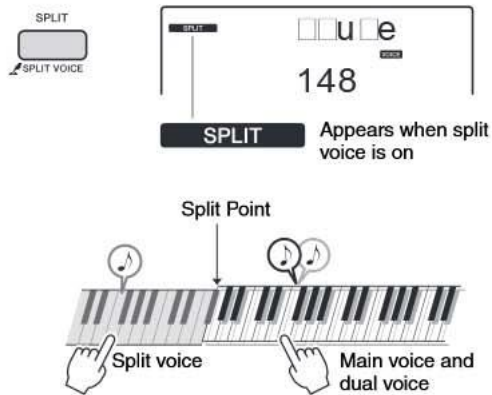

You can play a Split Voice on the Left hand area of the keyboard while playing a Main Voice and Dual Voice on the Right hand area of the keyboard.

The highest key for the Left hand area is referred to as the Split Point which can be changed from the default F#2 key. For details, refer to page 36.

2 Press the [SPLIT] button again to exit from Split.

You can easily select a different Split Voice (page 36).

Using the Metronome

The instrument features a built-in metronome (a device that keeps an accurate tempo), convenient for practicing.

- 1 Press the [METRONOME] button to start the metronome.



- 2 Press the [METRONOME] button again to stop the metronome.

Adjusting the Metronome Tempo

Press the TEMPO [TAP] button to call up the Tempo value, then use the TEMPO [-] and [+] buttons to adjust the Tempo value.

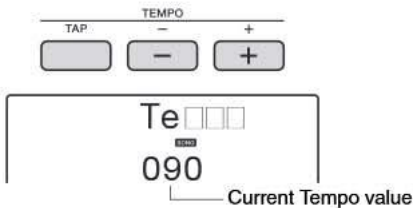

The dial and the Number buttons can also be used to set the Tempo.

Setting the Time Signature

Here, we'll set a time signature of 5/8 as an example.

- 1 Hold down the [METRONOME] button for longer than a second to call up "TimeSigN" (Time Signature Numerator).

The number of beats per measure is shown on the display.

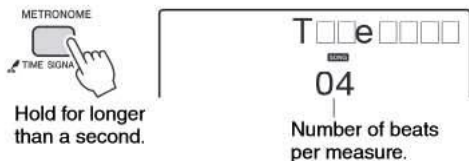

- 2 Rotate the dial to select the number of beats per measure.

A chime will sound on the first beat of each measure while the other beats will click. If 0 is selected, all beats will simply click with no chime. Select 5 for this example.

NOTE

This parameter cannot be set during playback of a Style, Song or Pattern.

- 3 Press the CATEGORY [+] button to call up "TimeSigD" (Time Signature Denominator).

The length of one beat is shown on the display.



- 4 Rotate the dial to select the length of one beat, from 2nd, 4th, 8th and 16th note.

Select 08 (8th note) for this example.

- 5 Confirm the setting by playing the Metronome.

Setting the Metronome Volume

- 1 Press the [FUNCTION] button.



- 2 Press the CATEGORY [+] or [-] buttons repeatedly until "MtrVol" appears.



- 3 Rotate the dial to set the Metronome Volume.

Adding Harmony

You can add harmony notes to the Main Voice.

1 Press the [HARMONY] button to turn Harmony on.

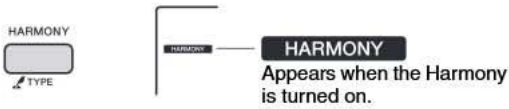

Although turning on the Harmony will select a Harmony Type suitable for the current Main Voice, you can select a different Harmony Type.

2 Hold down the [HARMONY] button for longer than a second until “HarmType” appears on the display.

After HarmType is shown for a few seconds, the current Harmony Type appears.

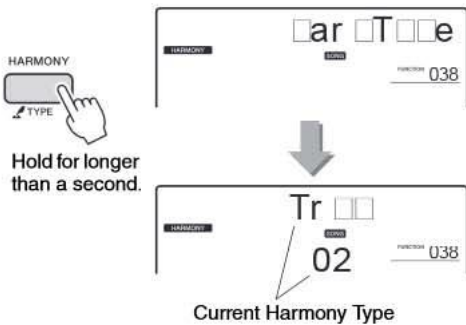

3 Rotate the dial to select the desired Harmony Type.

For details, refer to the separate Data List. The effect and operation differs depending on the Harmony Type. Refer to the section below.

How to sound each Harmony Type

Harmony type 01 to 05

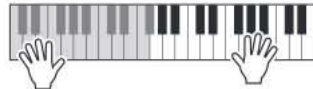

Press the right-hand keys while playing chords in the auto accompaniment range of the keyboard when the Auto Accompaniment is on (page 22).

Harmony type 06 to 12 (Trill)



Hold down two keys.

Harmony type 13 to 19 (Tremolo)



Keep holding down the keys.

Harmony type 20 to 26 (Echo)



You can adjust the Harmony Volume in the Function Settings (page 49).

Creating Arpeggios

The Arpeggio function lets you create arpeggios (broken chords) by simply pressing the notes of the chord. For example, you could play the notes of a triad—the root, third, and fifth—to trigger interesting phrases. This feature can be used for music production as well as performance.

Triggering the Arpeggio

- 1 Press the [ARPEGGIO] button to turn on the Arpeggio function.



NOTE

Selecting a Voice number between 230 and 269 will turn on Arpeggio automatically.

- 2 Press a note or notes to trigger Arpeggio.

The Arpeggio phrase differs depending on the number of pressed notes and the area of the keyboard.

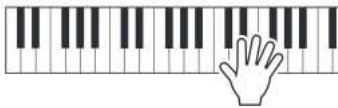

When Split is on, Arpeggio is applied only to the Split Voice. When Split is off, Arpeggio is applied to the Main and Dual Voices. Arpeggio cannot be applied to the Split and Main/Dual Voices simultaneously.

For instructions on selecting a Split Voice, refer to page 36.

Note that selecting one of the Main Voices 260–269 will call up the appropriate Split Voice.

NOTE

When you select a Voice between 260 and 269, play a key to the left of the Split Point, since Arpeggio is applied only to the Split Voice.

When an optional Footswitch (page 13) connected to the SUSTAIN jack is pressed, the Arpeggio will continue to play after the note is released (page 39).

- 3 To turn off the Arpeggio, press the [ARPEGGIO] button again.

Changing the Arpeggio Type

The most suitable Arpeggio Type is automatically selected when you select a Main Voice, but you can easily select any other Arpeggio Type.

- 1 Hold down the ARPEGGIO [TYPE] button for longer than a second.

In the display, [ARP Type] appears for a few seconds, followed by the current Arpeggio Type appears.

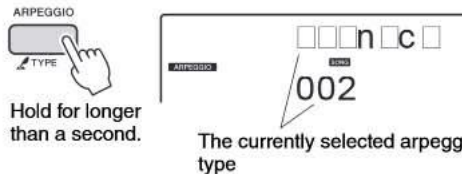

Hold for longer than a second.

The currently selected arpeggio type

- 2 Rotate the dial to select the desired Arpeggio type

An Arpeggio Type List is provided in the separate Data List.

Creating Original Sounds via the Knobs

The two knobs located in the lower left area of the panel can be used to add variations to the sound being played, transforming the sound in a variety of musical ways. Select the desired pre-programmed effect combination printed above the Knobs, then rotate the Knobs to enjoy the sound.

Selecting a Knob Effect Combination

Repeatedly press the [ASSIGN] button to sequentially select the five effect combinations provided: (1) (2) (3) (4) (5) (1) etc. The current combination is shown in the display.

LIVE CONTROL		
1 FILTER	CUTOFF	RESONANCE
2 EFFECT	REVERB	CHORUS
3 EG	ATTACK	RELEASE
4 STYLE FILTER	CUTOFF	RESONANCE
5 SOUND IMAGE	PAN	ULTRA-WIDE STEREO

ASSIGN

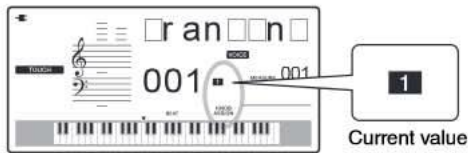

(1)(3) affect the Main and Dual Voices only, (4) affects only playback of Style and Pattern, and (5) affects the entire sound of this instrument. For details about each Knob effect, refer to page 37.

Only selecting a Knob effect combination will not affect the sound even if the Knob arrow is not at the initial position. After operating the Knob, the selected effect is applied to the sound.

Applying the Filter to the Main Voice

- 1 Select the desired Main Voice.**
Here, select [164 SquareLd] (Square-wave Lead) as a synth-lead type Voice.
- 2 Press the [ASSIGN] button several times until (1) (Filter) appears in the display.**
- 3 Rotate Knob B all the way to the right (maximum), then play the keyboard with your right hand while operating Knob A with your left.**

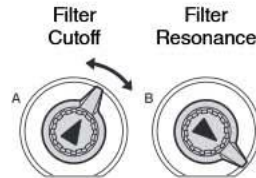

NOTICE

- Selecting a different Voice will replace the settings (except for ULTRA-WIDE STEREO; page 37) created via the Knobs with the default settings of the new Voice. If you create a sound with the Knobs that you wish to keep, make sure to memorize the settings to Registration Memory (page 31) before selecting a different Voice.

NOTE

- Rotating a Knob to the right while the volume is set to a high level may result in distortion. If this occurs, reduce the volume level.
- The settings for the ULTRA-WIDE STEREO and the Pan via the Knob cannot be memorized to Registration Memory.

Playing Styles

This instrument includes the **Auto Accompaniment** feature that plays appropriate “Styles” (rhythm + bass + chord accompaniment). You can select from a huge variety of Styles covering a wide range of musical genres.

1 Press the [STYLE] button, then use the dial to select the desired Style.

The Style List is provided on the front panel, or in the Data List (page 9).

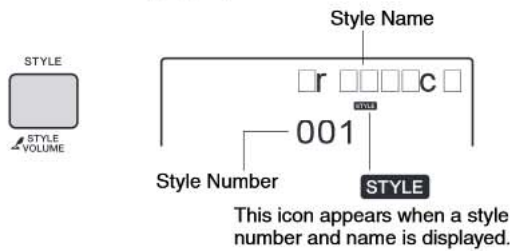

2 Press the [ACMP ON/OFF] button to turn on the Auto Accompaniment.



With this operation, the area of the keyboard to the left of the Split Point (54: F#2) becomes the **Auto Accompaniment range** and is used only for specifying the chords.

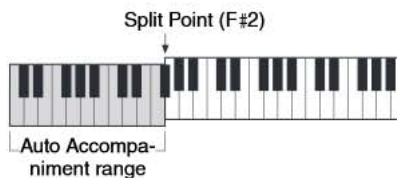

3 Press the [SYNC START] button to turn Synchro Start on.

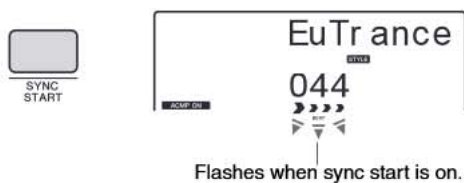

4 Play a chord in the Auto Accompaniment range to start playback.

Play a melody with the right hand and chords with the left hand.

For information about chords, refer to **Chord List** (page 44) or use the **Chord Dictionary** function (page 45).

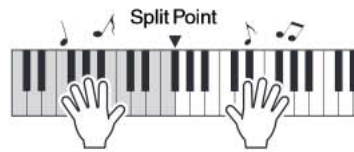

5 Press the [START/STOP] button to stop playback.



You can add intro, ending and rhythm variations to Style playback by using **Sections**. For details, refer to page 40.

Using the Music Database

If you have difficulty finding and selecting the desired Style and Voice, use this feature. From the Music Database, just selecting the favorite music genre calls up the ideal settings.

1 Press the [MUSIC DATABASE] button.

Both the Auto Accompaniment and Synchro Start are automatically turned on.

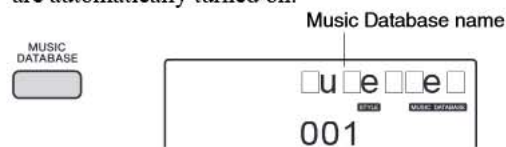

2 Use the dial to select the desired Music Database.

This operation calls up the panel settings such as Voice and Style that are registered to the selected Music Database. The Music Database List is provided in the Data List (page 9).

3 Play the keyboard as described in Steps 4–5 above.

Playing with Patterns Like a DJ!

Using the Pattern playback functions, try out the cool DJ-like performance features—changing keys in the left-hand area of the keyboard and rotating the Knobs for dynamic sound variations.

1 Press the [PATTERN] button, then use the dial to select the desired Pattern.

The ACMP is turned on, and the keyboard is divided into the accompaniment area (page 22) and melody area.



2 Press the [START/STOP] button or press any key to left of the Split Point (page 43) to start Pattern playback.

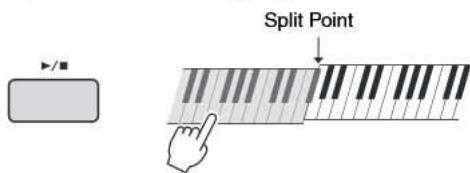

During Pattern playback, enjoy creating sound variations via the following operations.

Turning on/off individual tracks via the [TRACK CONTROL] buttons

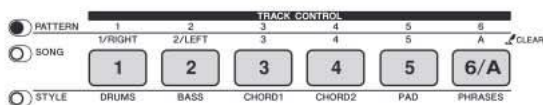

1 2 3 4 5 6 — On/off status is shown in the display (page 15)

NOTE

Up to two Track buttons can be pressed simultaneously for turning on or off.

Changing the Pattern Section via the [A]–[E] buttons

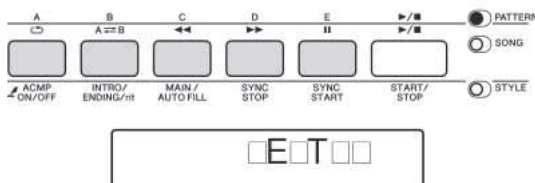

Transposing playback by pressing any note to the left of the Split Point (page 43)

Unlike with the Styles, only the Root can be specified; the Chord Type cannot be specified.

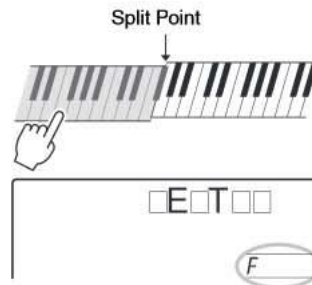

Changing the sound via the Knobs

Press the [ASSIGN] button several times to select [4] STYLE FILTER then rotate the Knobs A and B.

LIVE CONTROL		
1. FILTER	CUTOFF	RESONANCE
2. EFFECT	REVERB	CHORUS
3. EG	ATTACK	RELEASE
4. STYLE FILTER	CUTOFF	RESONANCE
5. SOUND IMAGE	PAN	ULTRA-WIDE STEREO



Applying the Arpeggio to the right-hand area

Press the [ARPEGGIO] button to turn it on, then press the notes in the right-hand area of the keyboard.



NOTE

When you select a Voice between 260 and 269, play a key to the left of the Split Point, since Arpeggio is applied only to the Split Voice.

3 Press the [START/STOP] button to stop playback.



Playing Songs

You can simply enjoy listening to the internal Songs, or use them with just about any of the functions, such as Lesson.

□ Song Category

The Songs are organized by category as listed below.

SONG

- 001- MAIN DEMO ————— • Gives you an idea of the advanced capabilities of this instrument.
- 004- VOICE DEMO ————— • Demonstrates many useful Voices of this instrument.
- 012- PIANO SOLO ————— • These piano solo pieces are ideally suited for the Song Lesson.
- 038- PIANO ENSEMBLE ————— • These piano ensemble pieces are also well suited for the Song Lesson.
- 065- PIANO ACCOMPANIMENT — • When you need to practice backing (accompaniment) patterns, these songs are ideal for that purpose.
- 075- CLASSICAL MELODIES — • Includes famous classical music pieces.
- 094- TRADITIONAL MELODIES — • Includes traditional Songs from around the world.
- 101- USER SONG ————— • Songs you record yourself.
- 111- FLASH MEMORY / USB — • Songs transferred from a computer (refer to “Computer-related operations”—page 9) and Songs in the USB flash memory (page 53).

Listening to a Demo Song

Press the [DEMO] button to play Songs in sequence. Playback will repeat continuously, starting again from the first Song (001).



To stop playback, press the [DEMO/BGM] button.

Selecting and Playing Back a Song

1 Press the [SONG] button, then use the dial to select the desired Song.

Refer to the Song List in the Data List (page 9).

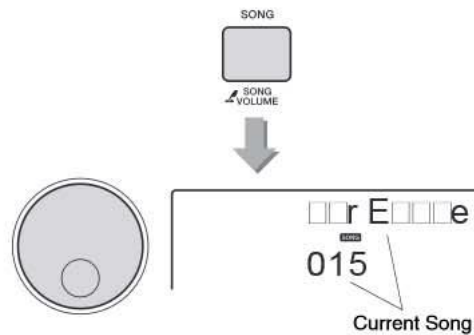

2 Press the [▶/■] (Start/Stop) button to start playback.

To stop playback, press the [▶/■] (Start/Stop) button again.

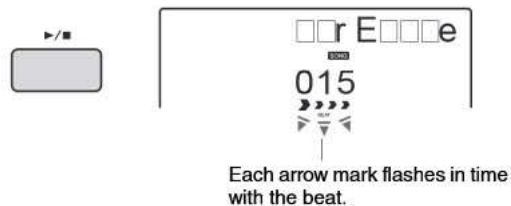

Song Fast Forward, Fast Reverse, and Pause

Like the transport controls on an audio player, this instrument lets you fast forward [▶▶] (Fast Forward), rewind [◀◀] (Fast Reverse) and pause [⏸] (PAUSE) playback of the Song.

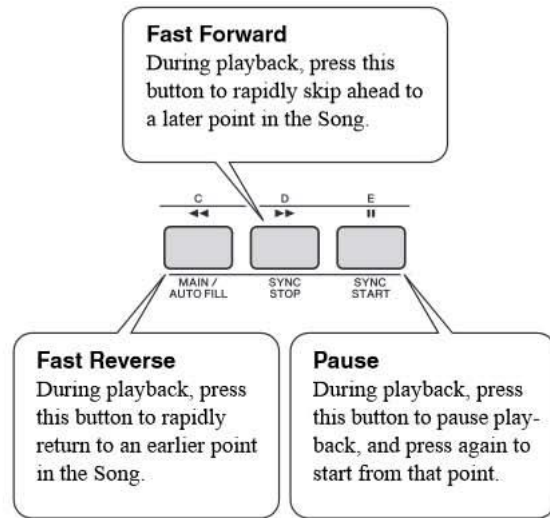

NOTE

When the A-B repeat is specified, the Fast Reverse and Fast Forward will only work within the range between A and B.

A-B Repeat

You can play back only a specific section of a Song repeatedly by setting the A point (start point) and B point (end point) in one-measure increments.



- 1 Start playback of the Song (page 24).
- 2 When playback reaches to the point you want to specify as the start point, press the [A=B] (A-B REPEAT) button to set the A point.



- 3 When playback reaches to the point you want to specify as the end point, press the [A=B] (A-B REPEAT) button again to set the B point.

The specified A-B section of the song will now play repeatedly.

- 4 To cancel repeat playback, press the [A=B] (A-B REPEAT) button.

To stop playback, press the [START/STOP] button.

NOTE

If you want to set the start point A at the top of the Song, press the [A=B] (A-B REPEAT) button before starting playback.

Turning Each Track On/Off

Each track of a Song plays a different part melody, percussion, accompaniment, etc. Each of the tracks can be muted so that you can play the muted part yourself. Pressing the desired Track button repeatedly will toggle the on/off status.

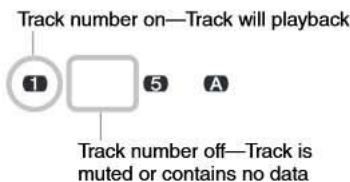
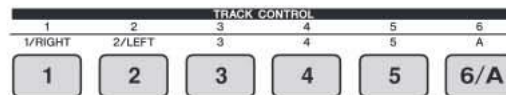

NOTE

Up to two Track buttons can be pressed simultaneously for turning on or off.

Using the Song Lesson Feature

You can use the selected Song for a left-hand, right-hand, or both-hands lesson. Try practicing with these three Song Lesson types while referring to the music scores in the Song Book (page 9).

Three Types of Song Lesson

Lesson 1—Listen

In this Lesson, you need not play the keyboard. The model melody/chords of the part you selected will sound. Listen to it carefully and remember it well.



Lesson 2—Timing

In this mode, simply concentrate on playing the notes with the correct timing. Even if you play wrong notes, the correct notes shown in the display will sound.



Lesson 3—Waiting

In this Lesson, try playing the correct notes shown on the display. The Song pauses until you play the right note, and playback tempo will change to match the speed at which you are playing at.

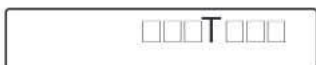

NOTE

- If you want to keep a steady playback tempo is maintained during Lesson 3. Waiting, set the Your Tempo parameter (page 50) to OFF.

Practicing with Song Lesson

1 Select the desired Song for your lesson (page 24).

NOTE

- The Song Lesson can be applied also to the Songs (SMF format 0 only) transferred from a computer (page 24), but cannot be applied to the User Songs.

2 Turn off the part you want to practice.

For the right-hand lesson, press the [1/RIGHT] button to turn off the right-hand part. For the left-hand lesson, press the [2/LEFT] button to turn off the left-hand part. For the lesson using both hands, turn off both the parts.



Pressing the [1/RIGHT] and [2/LEFT] buttons repeatedly will toggle the on/off status of each part, which can be shown on the display.

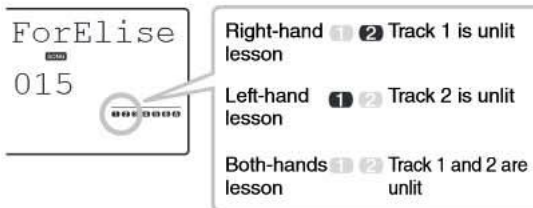

NOTE

- Song numbers 075-100 only support the right-hand lesson.

3 Press the [LESSON] button to start playback of the Song Lesson.

After starting playback, pressing the [LESSON] button repeatedly will change the Lesson number from 1: LISTEN □ 2: TIMING □ 3: WAITING □ off □ 1 □. Press this button until the desired number is shown on the display.

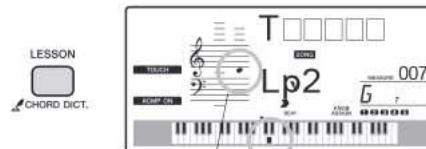

The notation and key positions you should play are shown.

To stop Lesson playback, press the [START/STOP] button.

Even during playback, you can change the Lesson number by pressing the [LESSON] button.

4 When Lesson playback reaches to the end, check your evaluation Grade on the display.

□2 Timing□ and □3 Waiting□ will evaluate your performance in four levels: OK, Good, Very Good, or Excellent.

See How You've Done

Excellent ~~~~~~
 Very Good ~~~~~~
 Good ~~~~~~
 OK ~~~~~~

When the lesson song has played all the way through your performance will be evaluated in 4 levels: OK, Good, Very Good, or Excellent. "Excellent!" is the highest evaluation.

After the evaluation display has appeared, the lesson will start again from the beginning.

Making Practice Perfect □ Repeat & Learn

If you want to practice a specific section in which you made a mistake or you have difficulty with use the Repeat & Learn function.

Press the [↶] (REPEAT & LEARN) button during a Lesson playback.



The Song location will move back four measures, a one-measure count will play, then Song playback will start again. Playback of the four measures will repeat with a one-measure count-in.

To exit from this status, press this button again.

NOTE

□ You can change the amount of measures the Repeat & Learn function jumps back by pressing a number button [1]□[9] during repeat playback.

Recording Your Performance

You can record up to 10 of your performances as User Songs. The recorded User Songs can be played back on the instrument.

Track Structure of a Song

1 Melody Tracks [1]–[5]

The melody performance in the right-hand area of the keyboard will be recorded.

2 Accompaniment Track [A]

The chord progression (for the Style) or the key change (for the Pattern) will be recorded.

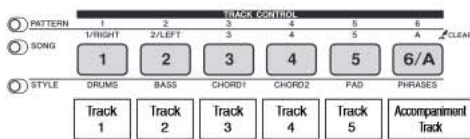

Quick Recording

The operation is useful when you record a new Song from scratch.

- 1 Make the desired settings including the Main Voice selection.**
- 2 Make the desired settings of your performance.**
 - If you want to record only the melody performance, press the [SONG] button.
 - If you want to record the performance using a Style, press the [Style] button.
 - If you want to record the performance using a Pattern, press the [Pattern] button.
- 3 Press the [REC] button to enter the Record Ready mode.**

If a User Song was not selected beforehand, this operation selects the lowest-numbered unrecorded User Song (from 101 to 110) as Recording target.

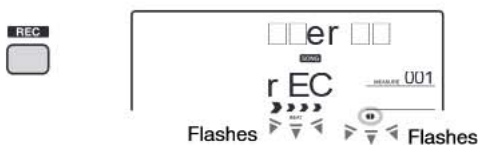

To exit from this status, press the [REC] button again.

NOTE

- The ACMP on/off status cannot be changed after the [REC] button is pressed.

4 Start recording.

- When you press the [SONG] button in Step 2, play any note to start recording.
- When you select a Style in Step 2, play a chord in the Auto Accompaniment area to start recording with Style playback, or press the [START/STOP] button to start recording only with playback of the Rhythm part of a Style.
- When you select a Pattern in Step 2, play a key in the Accompaniment area or press the [START/STOP] button to start recording with Pattern playback.

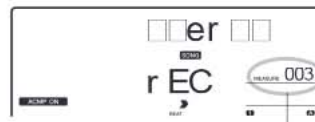

Current measure number

The current measure will be shown on the display while recording.

5 Press the [START/STOP] or [REC] button to stop recording.

When using a Style, you can stop recording also by pressing the [ENDING] button then waiting until playback ends.



After recording finishes, [Writing!] appears indicating that the recorded data will be stored, then the recorded track numbers in the display will light.

NOTICE

- Never attempt to turn the power off when [Writing!] is shown in the display. Doing so can damage the flash memory and result in a loss of data.

6 To play back the recorded Song, press the [START/STOP] button.

Recording to a Specified Track

The operation here is useful especially when you want to record the additional performances to an already recorded Song.

- 1 Press the [SONG] button, then select the desired User Song (101–110) as the recording target.



- 2 While holding down the [REC] button, press the desired Track button to enter the Record Ready mode.

- If you want to record only the melody: While holding down the [REC] button, press one of the [1] [5] buttons.

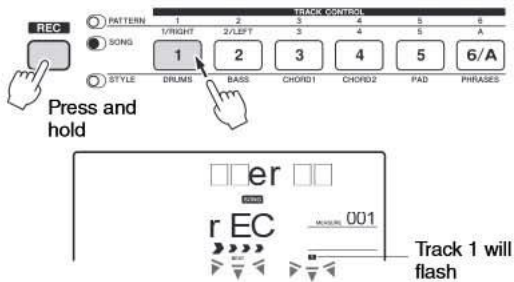

- If you want to record only the Style playback:

Press the [STYLE] button, select the desired Style, then simultaneously hold down the [REC] button and press the [6/A] button. ACMP is automatically turned on.

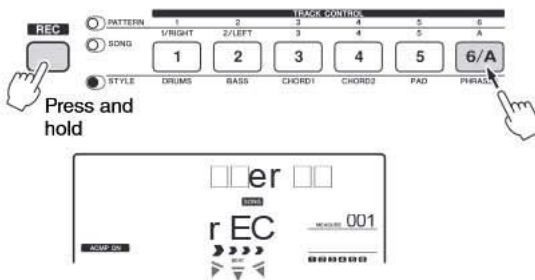

- If you want to record only the Pattern playback:

Press the [Pattern] button, then select the desired Pattern. While holding down the [REC] button, press the [6/A] button. ACMP is automatically turned on.

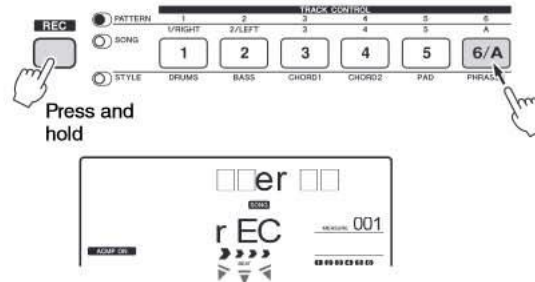

- 3 Same as in Steps 4 to 6 (page 28) in “Quick Recording.”

NOTE

- If the memory becomes full while recording, an alert message will appear and recording will stop automatically. In this case, delete unnecessary data by using the Clear functions (page 30), then execute the recording again.

Limitations while recording

- The on/off status of ACMP cannot be changed.
- Playback cannot be changed between Style and Pattern.
- The Pattern number can be changed while the Style number cannot.
- When you use a Style/Pattern, the following parameters cannot be changed: Reverb Type, Chorus Type, Time Signature, Style number and Style/Pattern Volume.
- Performance with a Split Voice cannot be recorded.

Clearing a User Song

You can clear all tracks of a User Song.

- 1 Press the [SONG] button, then select the User Song (101–110) to be cleared.
- 2 While holding down the track [A] button, press the track [1] button for longer than a second.

A confirmation message will appear on the display.

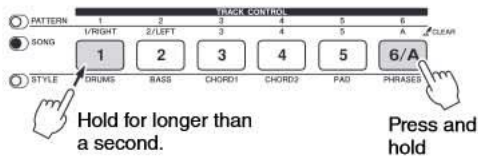

- 3 Press the [+] button.
A confirmation message will appear on the display. To cancel this operation, press the [-] button.
- 4 Press the [+] button to clear the Song.
A clear-in-progress message will appear briefly on the display.

Clearing a Specified Track from a User Song

This lets you clear individual tracks from a User Song.

- 1 Press the [SONG] button, then select the desired User Song (101–110).
- 2 From [1]–[5] and [A], press the Track button to be cleared for longer than a second.

A confirmation message will appear on the display.

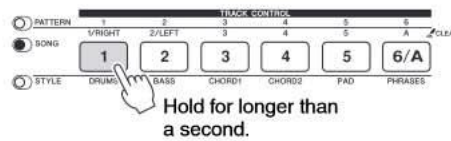

- 3 Press the [+] button.
A confirmation message will appear on the display. To cancel this operation, press the [-] button.
- 4 Press the [+] button to clear the track.
A clear-in-progress message will appear briefly on the display.

Memorizing Your Favorite Panel Settings

This instrument has a Registration Memory feature that lets you memorize your favorite settings for easy recall whenever they're needed. Up to 32 complete setups can be saved (eight banks of four setups each).

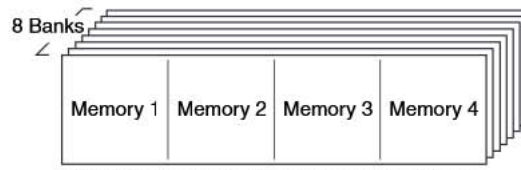

Up to 32 presets (eight banks of four each) can be memorized.

Memorizing Panel Settings to the Registration Memory

- 1 Make the desired settings such as those for Voice, Style, and Pattern.
- 2 Press and release the [MEMORY/BANK] button to call up a Bank number on the display.



- 3 Use the dial or the [1]–[8] number buttons to select a Bank number.

NOTE

Data cannot be saved to the Registration Memory during Song playback.

- 4 While holding down the [MEMORY/BANK] button, press one of the [1]–[4] buttons to memorize the current panel settings.

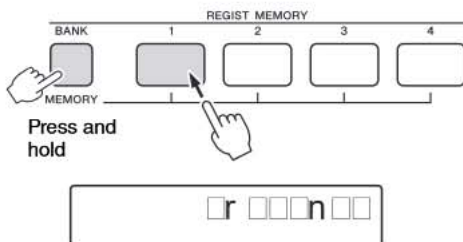

NOTICE

- If you select a Registration Memory number that already contains data, the previous data is deleted and overwritten by the new data.
- Do not turn off the power while memorizing settings to the Registration Memory, otherwise the data may be damaged or lost.

NOTE

□ Appropriate panel settings for each Pattern are pre-programmed to Banks 1–3. For details, refer to page 34.

Recalling Panel Settings from the Registration Memory

- 1 Press and release the [MEMORY/BANK] button to call up a Bank number on the display.
- 2 Use the dial or the [1]–[8] number buttons to select a Bank number.
- 3 Press one of the [1]–[4] buttons to call up the panel settings you memorized. The recalled REGIST MEMORY number appears in the display for a few seconds.

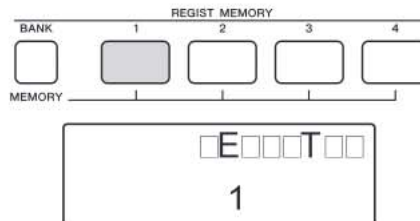

IMPORTANT

□ When recalling the panel settings from the Registration Memory, make sure to press the same button [STYLE] or [PATTERN] corresponding to the mode used when you memorize the panel settings. This is necessary since the mode status (Style or Pattern) is not memorized to the Registration Memory, meaning that it cannot be called up even if you press the REGISTRATION MEMORY button.

Parameters that can be memorized to Registration Memory

- **Style settings***
Style number, ACMP on/off, Style volume, Track on/off
- **Pattern settings****
Pattern number, Pattern volume, Section, Track on/off
- **Voice settings**
Main Voice settings: Voice number and all settings of the related Functions
Dual Voice settings: Dual on/off and all settings of the related Functions
Split Voice settings: Split on/off and all settings of the related Functions
- **Effect settings**
Reverb Type, Chorus Type
- **Arpeggio settings**
Arpeggio on/off and all settings of the related Functions
- **Harmony settings**
Harmony on/off and all settings of the related Functions
- **Other settings**
Transpose, Pitch Bend Range, Knob Effect Combination number, Split Point, Tempo

* Available only when a Style is selected.

** Available only when a Pattern is selected.

Backup Parameters and Initialization

Backup Parameters

The following data will be maintained even if the power is turned off and can be transferred then saved to a computer via Musicsoft Downloader as a single Backup file. For instructions, refer to **Computer-related Operations** (page 9).

- User Song data (page 28)
- Style data transferred from a computer and loaded to Style numbers 187–191 (page 57)
- Registration Memory data (page 31)
- Function Settings (page 48):
 - Tuning, Split Point, Touch Sensitivity, Style Volume, Song Volume, Pattern Volume, Metronome Volume, Grade, Demo Group, Demo Play, Demo Cancel, Master EQ type, Your Tempo on/off, Auto Power Off setting, Battery Select, Language

In addition to the Backup data above, all the Style data (including data that have not been loaded) and all the Song data will be maintained even if you turn off the power.

To initialize Backup data, execute **Backup Clear** explained below.

To initialize data (excluding Backup data) transferred from a computer, execute **Flash Clear** explained below.

Initialization

This function erases the Backup data described above and Song/Style data, then restores all the default factory settings. As required, execute one of the following two procedures.

Backup Clear

This operation initializes the backup data. While holding down the highest white key on the keyboard, press the [] (Standby/On) switch to turn the power on.

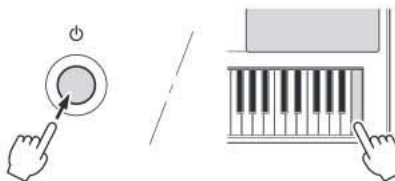

Flash Clear

This operation deletes all the Songs and Styles that have been transferred from a computer. Note that Style data loaded to Style numbers 187–191 will be maintained.

While simultaneously holding the highest white key and the three highest black keys, press the [] (Standby/On) switch to turn the power on.

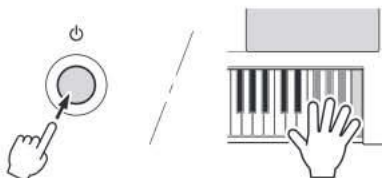

NOTICE

- Keep in mind that this operation also deletes the data you have purchased. Be sure to save the important data to a computer via Musicsoft Downloader (MSD) software. For details, refer to **Computer-related Operations** (page 9).

Selecting a Reverb Type

The Reverb effect lets you play with a rich concert hall type ambience.

Although selecting a Style or Song will call up the optimum Reverb type for the entire sound, you can select a different Reverb type manually.

1 Press the [FUNCTION] button.



2 Use the CATEGORY [+] and [-] buttons to call up “Reverb” (Function 034).

After [Reverb] is shown for a few seconds, the current Reverb Type is shown.

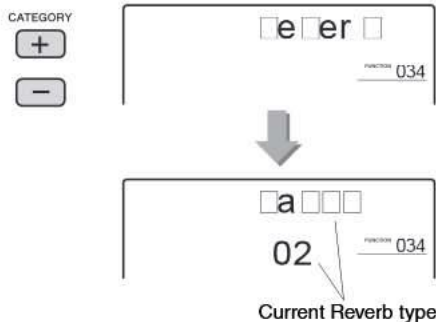

NOTE

Some Songs and Styles use Reverb Types which cannot be selected via panel operation. If such a Song or Style is played back, [--] is shown on the display.

3 Rotate the dial to select a Reverb type.

Play the keyboard to check the sound. For information about the available Reverb types, refer to the Effect Type List in the Data List (page 9).

Adjusting the Reverb depth

You can adjust the Reverb depth applied to the Main, Dual, and Split Voices individually via the same operations above. Regarding the item in Step 2, refer to the Function List on page 48.

Selecting a Chorus Type

The Chorus effect creates a thick sound that is similar to many of the same Voices being played in unison.

Although selecting a Style or Song will call up the optimum Chorus type for the entire sound, you can select a different Chorus type manually.

1 Press the [FUNCTION] button.



2 Use the CATEGORY [+] and [-] buttons to call up “Chorus” (Function 035).

After [Chorus] is shown for a few seconds, the current Chorus Type is shown.

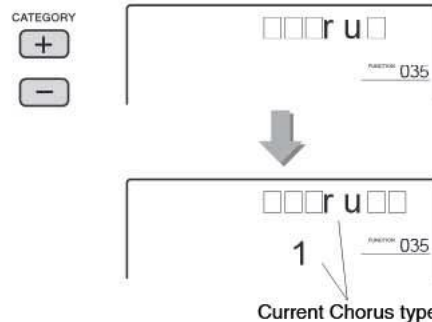

NOTE

Some Songs and Styles use Chorus Types which cannot be selected via panel operation. If such a Song or Style is played back, [--] is shown on the display.

3 Rotate the dial to select a Chorus type.

Play the keyboard to check the sound. For information about the available Chorus types, refer to the Effect Type List in the Data List (page 9).

Adjusting the Chorus depth

You can adjust the Chorus depth applied to the Main, Dual, and Split Voices individually via the same operations above. Regarding the item in Step 2, refer to the Function List on page 48.

Pitch Controls—Transpose

The overall pitch of the instrument (except for the Drum Kit Voices) can be shifted up or down by a maximum of 1 octave in semitone increments.

1 Press the [FUNCTION] button.



2 Use the CATEGORY [+] and [-] buttons to call up “Transpos” (Function 004).



3 Use the dial to set the Transpose value between -12 and +12.

Pitch Controls—Tuning

The overall tuning of the instrument (except for the Drum Kit Voices) can be shifted up or down between 427 Hz and 453 Hz in approximately 0.2Hz increments. The default value is 440.0 Hz.

1 Press the [FUNCTION] button.



2 Use the CATEGORY [+] and [-] buttons to call up “Tuning.”

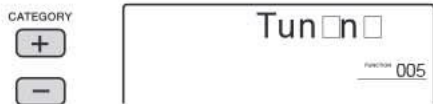

3 Use the dial to set the Tuning value.



Pitch Controls—the PITCH BEND wheel

The PITCH BEND wheel can be used to add smooth pitch variations to notes you play on the keyboard. Roll the wheel upward to raise the pitch, or downward to lower the pitch.

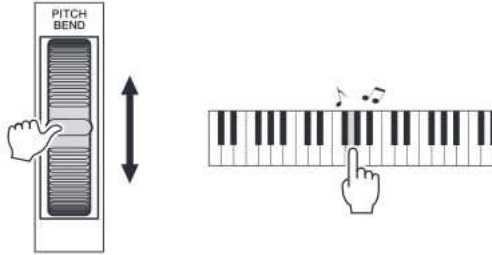

You can change the amount of pitch bend produced by the wheel. Refer to □Pitch Bend Range□ in the Function List (page 48).

Calling up Optimum Panel Settings

You can call up optimum panel settings that are ideal and stylistically appropriate for the current Song, Style or Pattern□ with a single touch. If you don't know what settings are best with a selected Voice, for example, use the following functions.

□ **To call up the settings for a Song or Style (One Touch Setting):**

Select Voice number □000 OTS.□ In this status, selecting a Style or Song will call up the optimum panel settings matching the current Song or Style.

□ **To call up the settings for a Pattern:**

Press the [PATTERN] button, then use the Registration Memory function (page 31). As listed below, the panel settings appropriate for each Pattern are provided by default.

Bank #	Memory #	Pattern #	Bank #	Memory #	Pattern #
1	1	001	2	2	006
1	2	002	2	3	007
1	3	003	2	4	008
1	4	004	3	1	009
2	1	005	3	2	010

The above settings are erased when you memorize your panel settings. To restore them, execute the Initializing operation (page 32).

Changing the Touch Sensitivity of the Keyboard

The keyboard of this instrument is equipped with a Touch Response feature that lets you dynamically and expressively control the level of the Voices according to your playing strength.

1 Press the [FUNCTION] button.



2 Press the CATEGORY [+] or [-] button several times until “TouchSns” (Function 008) appears.

TouchSns is shown in the display for a few seconds, and the current Touch Sensitivity is shown.

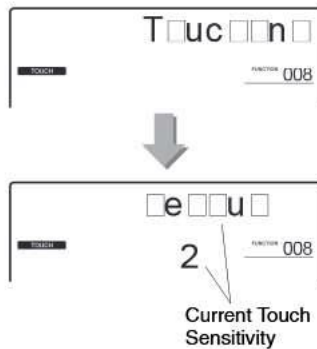

3 Use the dial to select a Touch Sensitivity setting between 1 and 4.

When Boost is selected, higher values produce greater (easier) volume variation in response to keyboard dynamics i.e. greater sensitivity. When 4(off) is selected, all notes will be played at the same volume no matter how strongly or softly you play the keys.

NOTE

The initial default Touch Sensitivity value is 2.

Selecting an EQ Setting for the Best Sound

Five different master equalizer (EQ) settings are provided to give you the best possible sound when listening through different reproduction systems—the instrument's internal speakers, headphones, or an external speaker system.

1 Press the [FUNCTION] button.



2 Press the CATEGORY [+] or [-] button several times until “MasterEQ” (Function 036) appears.

MasterEQ is shown in the display for a few seconds, and the current Master EQ type appears.

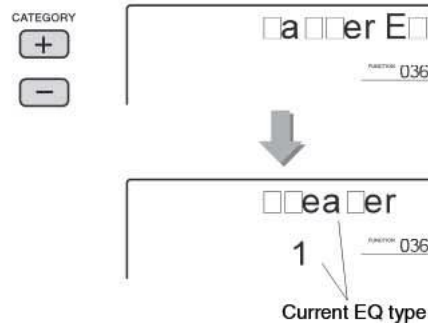

3 Use the dial to select the desired Master EQ type.

Settings 1 and 2 are best for listening via the instrument's built-in speakers, setting 3 is for headphones, and settings 4 and 5 are ideal for listening via external speakers.

NOTE

Boost produces a more punchy sound but may produce distortion depending on the Voice and Style, compared to the other Master EQ types.

Voice Settings

Selecting a Dual Voice

- 1 Hold down the [DUAL] button for longer than a second to call up “D.Voice.”

[D.VOICE] is shown for a few seconds, then the current Dual Voice appears.

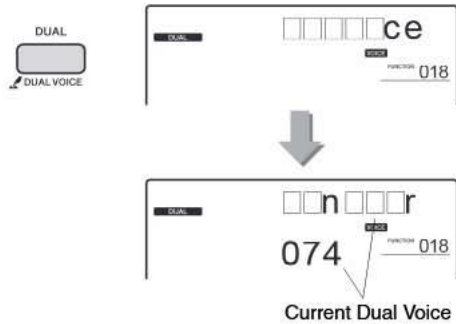

- 2 Rotate the dial to select the desired Dual Voice.

Selecting a Split Voice

- 1 Hold down the [SPLIT] button for longer than a second to call up “S.Voice.”

[S.VOICE] is shown for a few seconds, then the current Split Voice appears.

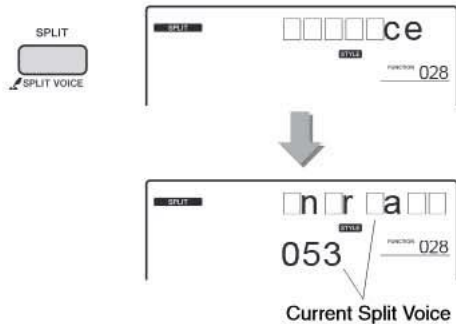

- 2 Rotate the dial to select the desired Split Voice.

Voice Editing

For each of the Main, Dual and Split Voices, you can edit the parameters such as volume, octave and depth of the Reverb and Chorus, allowing you to create new, custom sounds that best suit your musical needs.

- 1 Press the [FUNCTION] button.



- 2 Use the CATEGORY [+] and [-] buttons to call up the desired item.

Main Voice parameters are indicated as [M.*****], Dual Voice parameters as [D.*****], and Split Voice parameters as [S.*****]. For information about each parameter, refer to the Function List on page 48.



- 3 Rotate the dial to set the value.

Check the sound by playing the keyboard.

- 4 Repeat Steps 2–3 above to edit various parameters.

- 5 If necessary, memorize the settings to the Registration Memory (page 31).

The Voice-related settings are reset when a different Voice is selected. If you want to store the created sound for future recall, memorize the settings to the Registration Memory.

Parameters Assigned to the Knobs

This section describes each of the parameters which can be assigned to the Knobs (page 21).

Z FILTER

Filter effects shape the sound by allowing only a specified range of frequencies to pass and/or by producing a resonance peak at the filter's **Cutoff** frequency. Filter effects can be used to create a range of synthesizer-like sounds.

NOTE

- These effects are applied only to the Main/Dual Voices played on the keyboard.
- Filter effects can sometimes cause distortion in the bass frequencies.

□ Knob A: CUTOFF

Adjusts the filter's cutoff frequency, and therefore the brightness of the sound. Turning the Knob to the left makes the sound more muffled or darker, while turning the Knob A to the right makes the sound brighter.

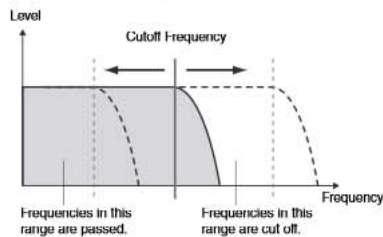

□ Knob B: RESONANCE

Adjusts the amount of Resonance applied at the filter's cutoff frequency. Turning the Knob to the right will increase the Resonance to emphasize the frequencies at the cutoff frequency, and thus **strengthens** the perceived effect of the filter.

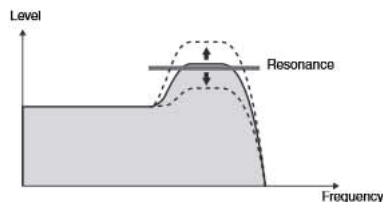

X EFFECT

□ Knob A: REVERB

Reproduces the acoustic ambience of a concert hall or club. Turning the Knob to the right will increase the Reverb depth.

□ Knob B: CHORUS

Produces a layered **multi-instrument** effect. Turning the Knob to the right will increase the Chorus depth.

NOTE

- These effects are applied only to the Main/Dual Voices played on the keyboard.

C EG (Envelope Generator)

Envelope Generator effects determine how the level of the sound varies over time. You can make the attack faster for a more percussive sound or slower for a violin-like sound, for example. Or you can lengthen or shorten the sustain to best match the music you're playing.

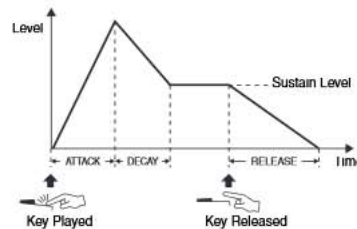

□ Knob A: ATTACK

Adjusts the Attack Time (the amount of time it takes the sound to reach maximum level when a key is played). Turning the Knob to the right will increase the Attack Time, thus slowing down the attack rate.

□ Knob B: RELEASE

Adjusts the Release Time (the amount of time it takes for the sound to decay to silence after a key is released). Turning the Knob to the right will increase the Release Time, thus making a longer sustain.

NOTE

- These effects are applied only to the Main/Dual Voices played on the keyboard.

V STYLE FILTER

Same as **Z FILTER**. These effects are applied only to Style or Pattern playback.

b SOUND IMAGE

□ Knob A: PAN

Moves the stereo pan position of the entire sound rightward or leftward according to the Knob position.

□ Knob B: ULTRA-WIDE STEREO

Lets you play the keyboard with a spacious, dynamic sound effect that gives you the sensation of hearing the sound outside of the speakers. By changing the wide effect type in the Function settings (page 49), you can enjoy different sound variations.

The chart below lists some interesting ways to use the various effects that can be assigned to the knobs.

Some Ideas for Using the Knobs

Number/Effect		Try This
Z	FILTER	Select a synth-type lead or pad voice (see the Voice List of the separate Data List). Turn Knob B all the way up and operate Knob A while playing for some spacey, floating 1980's effects.
X	EFFECT	Select a voice that sounds as though it already has reverb and chorus effects applied, and turn Knob A and Knob B all the way down to hear the □direct□ sound of the voice. You can then turn the Knob A and Knob B settings up to add extra impact and richness to the voice.
C	EG	Select a piano voice, and turn Knob B all the way up and Knob A to about the 3 o'clock position. This should give you a majestic, organ-like sound. The attack time is quite long so play the keys and hold them to let the sound come in fully. Ideal for slow pieces.
V	STYLE FILTER	Select style 44, Euro Trance. Turn accompaniment on and start style playback (page 22). Set Knob B to about 3 o'clock, and Knob A to about 8 o'clock. The overall sound of the style should be a bit muffled, with the drums emphasized for solid rhythmic impact.
b	SOUND IMAGE	Rotate the Knobs during Style playback to create a shifting sound effect, as if the performance members were concentrated at the center of the stage center and alternately moving to fill the entire stage. This also lets you create various sounds from simulated mono to wider stereo, even when playing only a single Voice (Grand Piano, Octave Strings, etc.).

Arpeggio Settings

Synchronizing an Arpeggio to Song/Style/Pattern Playback—Arpeggio Quantize

When you play the keyboard to trigger an Arpeggio (page 20) along with Song/Style/Pattern playback, you'll need to play the notes with correct timing to keep the Arpeggio in synchronization with the other playback tracks. However, your actual timing may be slightly ahead of or behind the beat (or both). The [Arpeggio Quantize] function of this instrument will correct any slight imperfections in the timing (according to settings below), and then play back the Arpeggio appropriately.

- Synchronizing at the quarter notes
- Synchronizing at the 8th notes
- No synchronization with Style or Song playback

Although the Arpeggio Quantize value is pre-programmed for each Arpeggio Type, you can change the value manually.

1 Press the [FUNCTION] button.



2 Use the CATEGORY [+] and [-] buttons to call up “Quantize” (Function 042).

After [Quantize] is shown for a few seconds, the current Arpeggio Quantize value is shown.

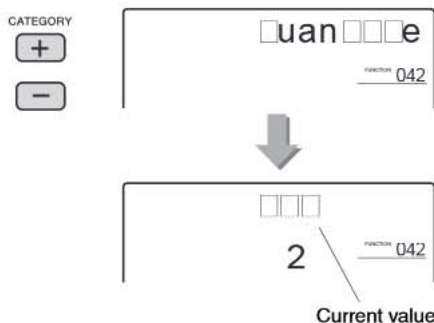

3 Rotate the dial to select a value from “OFF,” “1/8” and “1/16.”

- 1/8 Synchronizing at the quarter notes
- 1/16 Synchronizing at the 8th notes
- OFF No synchronization with Style or Song playback

Holding the Arpeggio Playback via the Footswitch

You can set the instrument so that Arpeggio playback continues even after the note has been released, by pressing the footswitch connected to the SUSTAIN jack.

1 Press the [FUNCTION] button.



2 Use the CATEGORY [+] and [-] buttons to call up “PdI Func” (Function 043).

After [PdI Func] is shown for a few seconds, the current setting is shown.

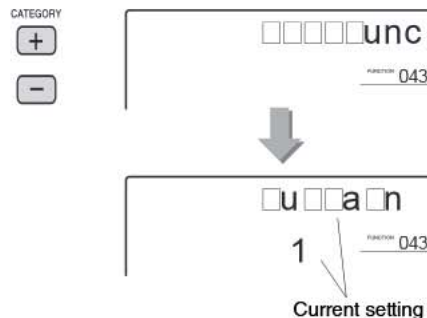

3 Rotate the dial to select “Arp Hold.”

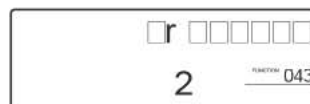

If you want to restore the footswitch function to sustain, select [Sustain]. If you want to use both hold and sustain functions, select [Hold+Sus].

4 Try playing Arpeggio with the footswitch.

Press the notes to trigger the Arpeggio, then press the footswitch. Even if you release the notes, Arpeggio playback will continue. To stop Arpeggio playback, release the footswitch.

Styles (Auto Accompaniment) and Patterns

Style Variations—Sections

Each Style consists of **Sections** that allow you to vary the arrangement of the accompaniment to match the song you are playing.

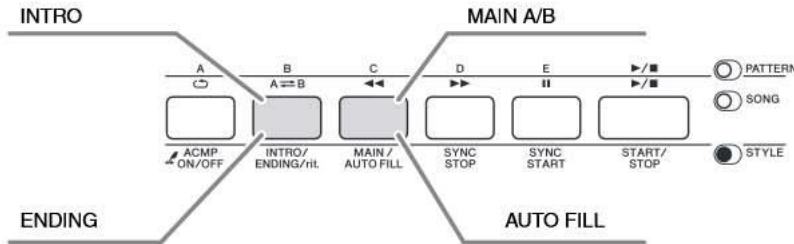

INTRO

This is used for the beginning of the Song. When the Intro finishes, Style playback shifts to the Main section. The length of the Intro (in measures) differs depending on the selected Style.

MAIN

This is used for playing the main part of the Song. Playback of the Main section repeats indefinitely until another Section's button is pressed. There are two variations (A and B), and the Style playback sound changes harmonically in response on the chords you play with your left hand.

AUTO FILL

This is automatically added before changing to Main A or B.

ENDING

This is used for the ending of the Song. When the Ending finishes, the Style playback stops automatically. The length of the Ending (in measures) differs depending on the selected Style.

Reference

- 1 Press the **[STYLE]** button, then rotate the dial to select a Style.
- 2 Press the **[ACMP ON/OFF]** button to turn ACMP on.

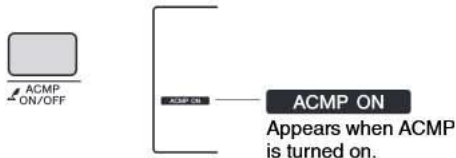

- 3 Press the **[SYNC START]** button to turn Synchro Start on.



- Synchro Start

When the Synchro Start is on, Style playback will begin as soon as you play a chord in the accompaniment range of the keyboard. To turn off the Synchro Start, press the **[SYNC START]** button.

- 4 Press the **[MAIN/AUTO FILL]** button to select Main A or Main B.



5 Press the [INTRO/ENDING/rit.] button.



Now, you're ready to start Style playback from the Intro section.

6 Play a chord with your left hand to start playback of the Intro.

For this example, play a C major chord (as shown below). For information on how to enter chords, see [Chords] on page 44.

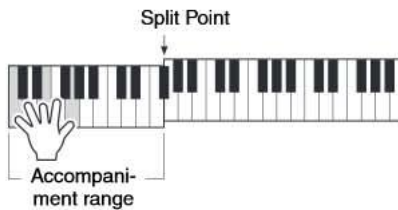

7 After the Intro finishes, play the keyboard according to the progression of the Song you are playing.

Play chords with your left hand while playing melodies with your right hand, and press the [MAIN/AUTO FILL] button as necessary. The Section will change to Fill-in then Main A or B.



8 Press the [INTRO/ENDING/rit.] button.



The Section switches to the Ending. When the Ending is finished, Style playback stops automatically. You can have the Ending gradually slow down (ritardando) by pressing the [INTRO/ENDING/rit.] button again while the Ending is playing back.

Synchro Stop

When you press the [SYNC/STOP] button to turn on this function, the Style will only play while pressing chords in the Accompaniment range of the keyboard. Releasing all the notes will stop Style playback. This makes it easy to add rhythmic breaks as you perform, simply by releasing your hand from the Accompaniment range of the keyboard.

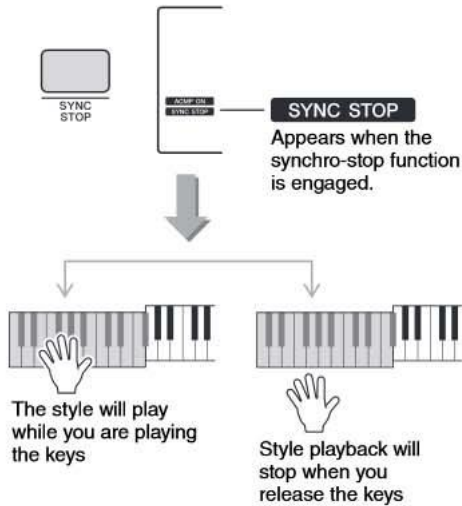

Turning on/off each Track via the [TRACK CONTROL] button

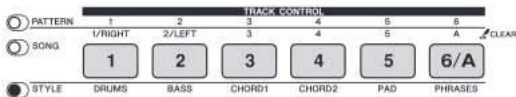

1 2 3 4 5 6 — On/off status is shown in the display (page 15)

NOTE

Up to two Track buttons can be pressed simultaneously for turning Tracks on or off.

Pattern Variations—Sections

Like the Styles, each Pattern features several Sections, allowing you to add dynamic variations to the performance. Five Sections (A-E) are provided.

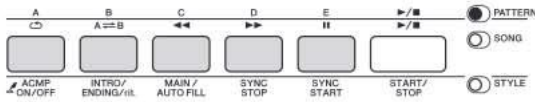

Unlike the Styles, however, Patterns do not have the Sections dedicated to the beginning or ending of the Song, such as Intro and Ending. All Sections A-E will play back repeatedly until stopped manually.

Changing the Tempo

A Style or Pattern can be played at any tempo you desire—fast or slow.

- 1 Press the [TEMPO/TAP] button to call up the Tempo value in the display.

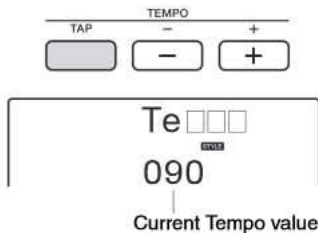

- 2 Rotate the dial to set a tempo from 011 to 280.

Press the [+] and [-] buttons simultaneously to instantly reset the value to the default tempo of the current Style, Pattern or Song. You can change the tempo during playback by pressing the [TEMPO/TAP] button just twice at the required tempo.

NOTE

The above operation applies also to Song or Arpeggio playback tempo.

Tap Start

You can start play back of the Style, Style or Song by simply tapping the [TEMPO/TAP] button at the required tempo—four times for time signatures in 4 (4/4, etc.), and three times for time signatures in 3 (3/4, etc.).



Adjusting the Volume of the Style or Pattern

You can adjust the volume balance between Style or Pattern playback and keyboard performance.

- 1 Press the [FUNCTION] button.



- 2 Use the CATEGORY [+] and [-] buttons to call up “StyleVol” (Function 001) or “PatrVol” (Function 003).



- 3 Rotate the dial to set the volume between 000 and 127.

Setting the Split Point

The point on the keyboard that separates the left-hand range and the right-hand range of the keyboard is called the **Split Point**.

When a Style is selected and ACMP is on, the notes played to the left of the Split Point are used to specify the chord for Style playback. When a Pattern is selected, the note played to the left of the Split Point is used to specify the key for Pattern playback. When the Split function is on, the notes played to the left of the Split Point are used to play the Split Voice.

The initial default Split Point is key number 54 (the F#2 key), but you can change it to another key.

1 Press the [FUNCTION] button.



2 Use the CATEGORY [+] and [-] buttons to call up “SplitPnt” (Function 007).

You can call up this display also by pressing the [STYLE] then holding the [ACMP] button for longer than a second.

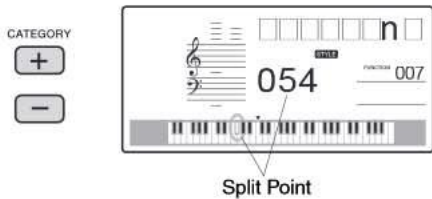

3 Rotate the dial to set the Split Point between 036 (C1) and 096 (C6).

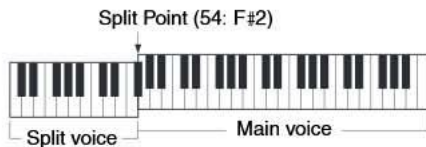

NOTE #

- The Split Point set here is applied common to the Style, Pattern and Voice.
- During the Lesson playback, the Split Point cannot be changed.

Playing Chords Without Style Playback

If you press the [STYLE] button, press the [ACMP ON/OFF] button to turn ACMP on (the ACMP ON icon appears), and play the chord in the Left hand range of the keyboard (with SYNC START off), the chord sound will be heard without Style playback. This is referred to as **Stop Accompaniment**. The specified chord will be shown in the display, and affects the Harmony function (page 19).

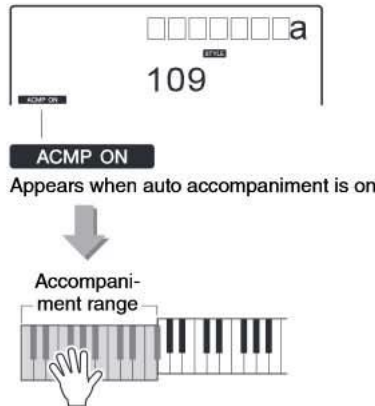

Chord Types for Style Playback

For users who are new to chords, this chart features common chords. Since there are many useful chords and many different ways to use them musically, refer to commercially available chord books for further details.

□ indicates the root note.

Major	Minor	Seventh	Minor Seventh	Major Seventh
C 	Cm 	C7 	Cm7 	CM7
D 	Dm 	D7 	Dm7 	DM7
E 	Em 	E7 	Em7 	EM7
F 	Fm 	F7 	Fm7 	FM7
G 	Gm 	G7 	Gm7 	GM7
A 	Am 	A7 	Am7 	AM7
B 	Bm 	B7 	Bm7 	BM7

- Inversions can be used as well as in □ root □ position □ with the following exceptions: m7, m7♭5, 6, m6, sus4, aug, dim7, 7♭5, 6(9), sus2
- Inversion of the 7sus4 and m7(11) chords are not recognized if the notes are omitted.
- When playing a chord which cannot be recognized by this instrument, nothing is shown on the display. In such a case, only the rhythm and bass parts will be played.

Easy Chords

This method lets you easily play chords in the accompaniment range of the keyboard using only one, two, or three fingers.

For root "C"



To play a major chord
Press the root note (□) of the chord.



To play a minor chord
Press the root note together with the nearest black key to the left of it.



To play a seventh chord
Press the root note together with the nearest white key to the left of it.



To play a minor seventh chord
Press the root note together with the nearest white and black keys to the left of it (three keys altogether).

Looking Up Chords Using the Chord Dictionary

The Dictionary function is useful when you know the name of a certain chord and want to quickly learn how to play it.

1 Press and hold the [CHORD DICT] button for longer than a second to call up "Dict."



Hold for longer than a second.

This operation will divide the entire keyboard into the three ranges as illustrated below.

- The range to the right of [ROOT] ▶ □
Lets you specify the Chord Root, but produces no sound.
- The range between [CHORD TYPE] ▶ □ and [ROOT] ▶ □
Lets you specify the Chord Type, but produces no sound.
- The range to the left of [CHORD TYPE] ▶ □
Lets you play and confirm the Chord specified in the above two ranges.

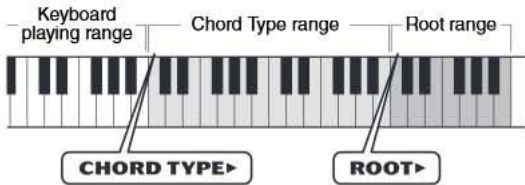

2 As an example, learn how to play a GM7 (G major seventh) chord.

- 2-1. Press the [G] key in the section to the right of [ROOT] ▶ □ so that the [G] is shown as the root note.

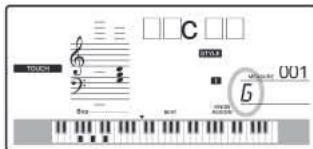
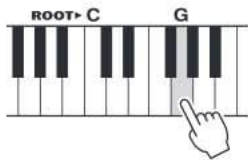

- 2-2. Press the key labeled [M7] in the section between [CHORD TYPE] ▶ □ and [ROOT]. □ The notes you should play for the specified chord (root note and chord type) are conveniently shown in the display, both as notation and in the keyboard diagram.

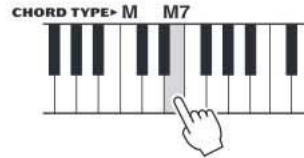

Notation of chord Chord name (root and type)

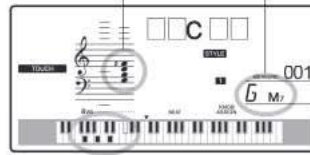

Individual notes of chord (keyboard)

To call up possible inversions of the chord, press the [+]/[-] buttons.

NOTE

□ About major chords. Simple major chords are usually indicated only by the root note. For example, [C] refers to C major. However, when specifying major chords here, make sure to select [M] (major) after pressing the root note.

3 Following the notation and keyboard diagram in the display, try playing a chord in the range to the left of "CHORD TYPE ▶."

When you've played the chord properly, a bell sound signals your success and the chord name in the display flashes.

Specifying only the key for Pattern playback

Note that you only need to specify only the root note for Pattern playback, unlike Style playback for which you also need to specify the Chord Type.

BGM (Background Music) Playback

With the default setting, pressing the [DEMO/BGM] button will play back only a few of the internal Songs repeatedly. This setting can be changed so that, for example, all internal Songs are played, or all Songs transferred to the instrument from a computer are played back, letting you use the instrument as a background music source. Five playback group settings are provided. Simply select the one that suits your needs.

1 Hold down the [DEMO/BGM] button for longer than a second.

␣DemoGrp␣ is shown in the display for a few seconds, followed by the current repeat playback target.



2 Rotate the dial to select a repeat playback group from the table below.

Demo	Preset Songs 001–003
Preset	All preset Songs
User	All User Songs
Download	All Songs transferred from a computer
USB	All Songs (MIDI files) in the connected USB flash memory

3 Press the [DEMO] button to start playback.

To stop playback, press the [DEMO] button again.

Random Song Playback

The order of Song repeat playback via the [DEMO/BGM] button can be changed between the numerical order and random order.

1 Press the [FUNCTION] button.



2 Press the CATEGORY [+] and [-] buttons several times to call up “PlayMode” (Function 059).

␣PlayMode␣ is shown for a few seconds, followed by the current playback mode, ␣Normal␣ or ␣Random␣.



When the DemoGrp is set to ␣Demo␣, this parameter cannot be set.

3 Rotate the dial to select “Random.”

To return to the numerical order, select ␣Normal␣.

4 Press the [DEMO] button to start playback.

To stop playback, press the [DEMO] button again.

Tempo Setting of the Song

This operation is same as that of the Style and Pattern.
Refer to page 42.

Tap Start

This operation is same as that of the Style and Pattern.
Refer to page 42.

Song Volume

- 1 Press the [FUNCTION] button.



- 2 Press the CATEGORY [+] and [-] buttons several times to call up "SongVol."

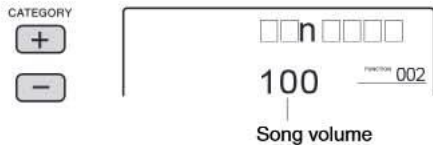

- 3 Rotate the dial to set the Song volume between 000 and 127.

NOTE

□ Song volume can be adjusted while a Song is selected.

Melody Voice Setting of the Pre-set Song

You can change the Melody Voice of the current Pre-set Song temporarily to any other desired Voice.

- 1 Press the [SONG] button, select the desired Pre-set Song, then start playback.



- 2 Press the [VOICE] button, then rotate the dial to select the desired Voice.



- 3 Hold down the [VOICE] button for longer than a second.

After □SONG MELODY VOICE□ is shown for a few seconds, the Melody Voice of the Song will be changed to that selected in Step 2.



Hold for longer than a second.

The Functions

The “Functions” provide access to a range of detailed instrument parameters such as Tuning, Split Point, Voices and Effects. Take a look at the Function List (pages 48–50). When you find the desired Function you want to change, follow the instructions below.

Basic Procedure in the Function Display

1 Find the desired item in the Function List on pages 48–50.

2 Press the [FUNCTION] button.



3 Press the CATEGORY [+] and [-] buttons several times until the desired item appears.

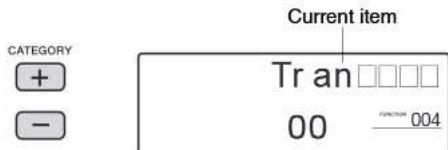

4 Use the dial, the [+] and [-] buttons, or the [0]–[9] number buttons to set the value of the selected function.

To restore the default value, press the [+] and [-] buttons simultaneously. In the sole case of the MIDI Initial Send function, pressing the [+] button executes the function while pressing [-] cancels it.

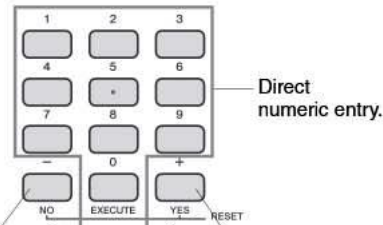
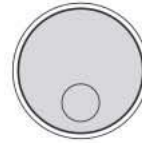

- Decrement value by 1.
 - Cancel
 - Increment value by 1.
 - Execute
- Press simultaneously to recall the default setting.

Some Function settings are maintained even if you turn off the power, and can be transferred to the computer as Backup Data (page 32).

Function List

Function Number	Function	Display	Range/Settings	Default Value	Description
Volume					
001	Style Volume	StyleVol	000–127	100	Refer to page 42.
002	Song Volume	SongVol	000–127	100	Refer to page 47.
003	Pattern Volume	PatrnVol	000–127	100	Refer to page 42.
Overall					
004	Transpose	Transpos	-12–12	0	Refer to page 34.
005	Tuning	Tuning	427Hz–453Hz (in approximately 0.2Hz increments)	440.0Hz	Refer to page 34.
006	Pitch Bend Range	PBRange	01–12	2	Sets the range over which you can control pitch by using the PITCH BEND wheel (page 34), in semitone increments.
007	Split Point	SplitPnt	036–096 (C1–C6)	54 (F#2)	Refer to page 43.
008	Touch Sensitivity	Touchsns	1 (Soft), 2 (Medium), 3 (Hard), 4 (Off)	2 (Medium)	Refer to page 35.
Main Voice (page 16)					
009	Volume	M.Volume	000–127	*	Determines the volume of the Main Voice.
010	Octave	M.Octave	-2 – +2	*	Determines the octave range for the Main Voice.

Function Number	Function	Display	Range/Settings	Default Value	Description
011	Pan	M.Pan	000 (left)–64 (center)–127 (right)	*	Determines the stereo pan position of the Main Voice. The value "0" results in the sound being panned full left; the value "127" results in the sound being panned full right.
012	Reverb Depth	M.Reverb	000–127	*	Determines how much of the Main Voice's signal is sent to the Reverb effect.
013	Chorus Depth	M.Chorus	000–127	*	Determines how much of the Main Voice's signal is sent to the Chorus effect.
014	Attack Time	M.Attack	000–127	64	Determines how fast the volume of the Main Voice reaches the Attack level when the note is pressed. The larger the value, the faster the attack rate. The smaller the value, the slower the attack rate.
015	Release Time	M.Releas	000–127	64	Determines how fast the volume of the Main Voice falls to 0 when the note is released. The larger the value, the longer the sustain. The smaller the value, the shorter the sustain.
016	Filter Cutoff	M.Cutoff	000–127	64	Determines the Filter Cutoff Frequency (page 37) of the Main Voice.
017	Filter Resonance	M.Reso.	000–127	64	Determines the Filter Resonance (page 37) of the Main Voice.
Dual Voice (page 16)					
018	Dual Voice	D.Voice	001–731	*	Selects a Dual Voice.
019	Volume	D.Volume	000–127	*	Determines the volume of the Dual Voice.
020	Octave	D.Octave	-2 +2	*	Determines the octave range for the Dual Voice.
021	Pan	D.Pan	000 (left)–64 (center)–127 (right)	*	Determines the stereo pan position of the Dual Voice. A value of "0" results in the sound being panned full left; a value of "127" results in the sound being panned full right.
022	Reverb Depth	D.Reverb	000–127	*	Determines how much of the Dual Voice's signal is sent to the Reverb effect.
023	Chorus Depth	D.Chorus	000–127	*	Determines how much of the Dual Voice's signal is sent to the Chorus effect.
024	Attack Time	D.Attack	000–127	64	Determines how fast the volume of the Dual Voice reaches the Attack level when the note is pressed. The larger the value, the faster the attack rate. The smaller the value, the slower the attack rate.
025	Release Time	D.Releas	000–127	64	Determines how fast the volume of the Dual Voice falls to 0 when the note is released. The larger the value, the longer the sustain. The smaller the value, the shorter the sustain.
026	Filter Cutoff	D.Cutoff	000–127	64	Determines the Filter Cutoff Frequency (page 37) of the Dual Voice.
027	Filter Resonance	D.Reso.	000–127	64	Determines the Filter Resonance (page 37) of the Dual Voice.
Split Voice (page 17)					
028	Split Voice	S.Voice	001–731	53 (FngrBass)	Selects a Split Voice.
029	Volume	S.Volume	000–127	*	Determines the volume of the Split Voice.
030	Octave	S.Octave	-2 +2	*	Determines the octave range for the Split Voice.
031	Pan	S.Pan	000 (left)–64 (center)–127 (right)	*	Determines the stereo pan position of the Split Voice. A value of "0" results in the sound being panned full left; a value of "127" results in the sound being panned full right.
032	Reverb Depth	S.Reverb	000–127	*	Determines how much of the Split Voice's signal is sent to the Reverb effect.
033	Chorus Depth	S.Chorus	000–127	*	Determines how much of the Split Voice's signal is sent to the Chorus effect.
Effects					
034	Reverb Type	Reverb	01–10	**	Refer to page 33.
035	Chorus Type	Chorus	01–05	**	Refer to page 33.
036	Master EQ Type	MasterEQ	Speaker, Boost, Headphone, Line Out1, Line Out2	1 (Speaker)	Refer to page 35.
037	Wide Type	Wide	1–3	2 (Wide2)	Determines the Ultra-Wide Stereo type. Higher values produce a greater Wide effect.
Harmony (page 19)					
038	Harmony Type	HarmType	01–26	*	Determines the Harmony type.
039	Harmony Volume	HarmVol	000–127	*	Determines the volume of the Harmony effect
Arpeggio (page 20)					
040	Arpeggio Type	ARP Type	001–150	*	Determines the Arpeggio type.
041	Arpeggio Velocity	ARP velo	1(Original), 2(Thru)	*	When "Thru" is selected, the velocities of Arpeggio playback are determined by your playing strength. When "Original" is selected, the velocities of Arpeggio playback are determined by the original setting regardless of your playing strength.
042	Arpeggio Quantize	Quantize	1(OFF), 2(1/8), 3(1/16)	*	Refer to page 39.

Function Number	Function	Display	Range/Settings	Default Value	Description
043	Pedal Function	PdlFunc	1 (Sustain) / 2 (Arp Hold) / 3 (Hold+Sus)	*	Refer to page 39.
Computer (USB TO HOST terminal)**					
044	PC mode	PC mode	OFF/PC1/PC2	OFF	Optimizes the MIDI settings when you connect to a computer
MIDI**					
045	Local Control	Local	ON/OFF	ON	Determines whether the instrument's keyboard controls the internal tone generator (ON) or not (OFF). When you record your keyboard performance to the application software on the computer via MIDI, set this parameter to OFF.
046	External Clock	ExtClock	ON/OFF	OFF	Determines whether the instrument synchronizes to the internal clock (OFF) or an external clock (ON). When you record your keyboard performance to the application software on the computer via MIDI, set this parameter to ON.
047	Keyboard Out	KbdOut	ON/OFF	ON	Determines whether MIDI messages generated via keyboard performance are transmitted (ON) or not (OFF) from the USB TO HOST terminal.
048	Style Out	StyleOut	ON/OFF	OFF	Determines whether MIDI messages generated via Style playback are transmitted (ON) or not (OFF) from the USB TO HOST terminal.
049	Song Out	SongOut	ON/OFF	OFF	Determines whether MIDI messages generated via Song playback are transmitted (ON) or not (OFF) from the USB TO HOST terminal.
050	Initial Send	InitSend	YES/NO	-	Lets you send the data of the panel settings to a computer. Press [+] to send, or press [-] to cancel. This operation should be done immediately after starting the Recording operation on the computer.
Metronome (page 18)					
051	Time Signature Numerator	TimesignN	00-60	**	Determines the time signature of the Metronome.
052	Time Signature Denominator	TimesignD	Half note, Quarter note, Eighth note, Sixteenth note	**	Determines the length of each metronome beat.
053	Metronome Volume	MtrVol	000-127	100	Determines the volume of the Metronome.
Lesson (page 26)					
054	Lesson Track (R)	R-Part	GuideTrack1-16, OFF	1	Determines the guide track number for your right hand lesson. The setting is only effective for Songs in SMF format 0 transferred from a computer.
055	Lesson Track (L)	L-Part	GuideTrack1-16, OFF	2	Determines the guide track number for your left hand lesson. The setting is only effective for Songs in SMF format 0 transferred from a computer.
056	Grade	Grade	ON/OFF	ON	Determines whether the Grade function is on or off.
057	Your Tempo	YourTemp	ON/OFF	ON	This parameter is for Lesson 3 "Waiting." When set to ON, playback tempo will change to match the speed at which you are playing. When set to OFF, playback tempo will be maintained regardless of the speed at which you are playing.
Demo (page 24)					
058	Demo Group	DemoGrip	1 (Demo) / 2 (Preset) / 3 (User) / 4 (Download) / 5 (USB)	1 (Demo)	Refer to page 46.
059	Demo Play Mode	PlayMode	1 (Normal) / 2 (Random)	1 (Normal)	Refer to page 46.
060	Demo Cancel	D-Cancel	ON/OFF	OFF	Determines whether Demo cancel is enabled or not. When this is set to ON, the Demo Song will not play, even if the [DEMO/BGM] button is pressed.
Auto Power Off (page 14)					
061	Auto Power Off Time	AutoOff	OFF, 5/10/15/30/60/120 (min.)	30 minutes	Specifies the time that will elapse before the instrument's power is automatically turned off.
Battery (page 12)					
062	Battery Type	Battery Type	1 (Alkaline battery) / 2 (Rechargeable battery)	1 (Alkaline battery)	Selects the type of batteries you have installed to this instrument.
Language (page 53)					
063	Language	Language	English/Japanese	English	Determines the display language for the Song file names, lyrics and certain display messages.

* The appropriate value is automatically set for each Voice combination.

** The appropriate value is automatically set for each Song, Style or Pattern.

*** For details, refer to [Computer-related Operations] (page 9).

USB Flash Memory Operations

By connecting the USB flash memory device to the [USB TO DEVICE] terminal, you can save the data created on this instrument, such as User Song and parameter settings. The saved data can be recalled to this instrument again for the future use.

IMPORTANT

- It is recommended to use the Power Adaptor when executing USB flash memory operations, since battery power may not be reliable enough to last through these crucial operations. When you try executing certain functions, the Use Adaptor indication may appear and the selected function cannot be executed.

Precautions when using the [USB TO DEVICE] terminal

This instrument features a built-in [USB TO DEVICE] terminal. When connecting a USB device to the terminal, be sure to handle the USB device with care. Follow the important precautions below.

NOTE

- For more information about the handling of USB devices, refer to the owner's manual of the USB device.

Compatible USB devices

The instrument does not necessarily support all commercially available USB devices. Yamaha cannot guarantee operation of USB devices that you purchase. Before purchasing a USB device for use with this instrument, check the following web page:

<http://download.yamaha.com/>

NOTE

- Other USB devices such as a computer keyboard or mouse cannot be used.

Connecting USB flash memory

- When connecting a USB device to the [USB TO DEVICE] terminal, make sure that the connector on the device is appropriate and that it is connected in the proper direction.
- When connecting a USB cable, make sure that the length is less than 3 meters.
- Though the instrument supports the USB 1.1 standard, you can connect and use a USB 2.0 storage device with the instrument. However, note that the transfer speed is that of USB 1.1.

Using USB Flash Memory

By connecting the instrument to a USB flash memory, you can save data you've created to the connected device, as well as read data from the connected device.

- The number of USB flash memory to be used
Only one USB flash memory device can be connected to the [USB TO DEVICE] terminal.

Formatting USB flash memory

When a USB flash memory is connected, a message may appear prompting you to format the device. If so, execute the Format operation (page 53).

NOTICE

- The format operation overwrites any previously existing data. Make sure that the USB flash memory you are formatting does not contain important data.

To protect your data (write-protect)

To prevent important data from being inadvertently erased, apply the write-protect provided with the particular USB flash memory. If you are saving data to the USB flash memory, make sure to disable write-protect.

Connecting/removing USB storage device

Before removing the USB flash memory from the [USB TO DEVICE] terminal, make sure that the instrument is not accessing data (such as in the Save and Delete operations).

NOTICE

- Avoid frequently connecting/disconnecting the USB flash memory too often. Doing so may result in the operation of the instrument freezing or hanging up. While the instrument is accessing data (such as during Save, Delete, Load and Format operations) or is mounting the USB storage device (shortly after the connection), do NOT unplug the USB flash memory, and do NOT turn the power off. Doing so may corrupt the data on either or both devices.

Connecting a USB Flash Memory

- 1 Connect a USB flash memory to the **USB TO DEVICE** terminal, being careful to insert it with the proper orientation.

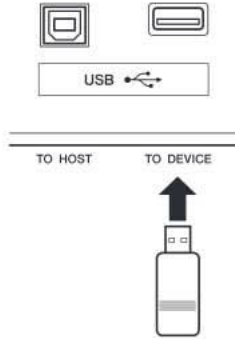

- 2 Wait until “USB” appears on the left corner of the display.

The **USB** indication confirms that the connected USB flash memory has been mounted or recognized.

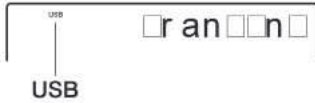

- If “UnFormat” followed by “Format?” appears:
This indicates that the connected USB flash memory has not been formatted, and cannot be mounted or recognized. Execute the Format operation by following the instructions starting with Step 2 on page 53.

- 3 Hold down the **[FILE CONTROL]** button to call up the File Control display.



- 4 Rotate the dial to call up the desired **File Control** function, then execute it.

For details, refer to the table below.

Display	File Control function	Page
Format?	Formatting a USB Flash Memory	53
Save USR	Saving User Data to a USB Flash Memory	54
Save SMF	Saving a User Song as SMF to a USB Flash Memory	55
Load USR	Loading User Data from a USB Flash Memory	56
Load STY	Loading a Style File	57
Del USR	Deleting a User File in a USB Flash Memory	58
Del SMF	Deleting a SMF File in a USB Flash Memory	58
Exit?	Exiting from a File Control display	59

Messages may appear on the display during File Control procedures to aid in smooth operation. Refer to the Message List on page 59 for details.

NOTE

□ No sound will be produced if the keyboard is played while the file control display is showing, and only buttons related to File Control operations will be active.

NOTE

The File Control display cannot be called up in the following situations.

- During playback of Style, Pattern, or Song
- When **USB** does not appear even if you have connected a USB flash memory to the **[USB TO DEVICE]** terminal.

Formatting a USB Flash Memory

The Format operation lets you prepare commercially available USB flash memory for use with this instrument is called [Format].

- 1 Hold the [FILE CONTROL] button for longer than a second to call up the File Control display.
- 2 Use the CATEGORY [+] and [-] buttons to call up "Format?"



- 3 Press the [0/EXECUTE] button. A confirmation message will appear. To cancel the operation, press the [-/NO] button.

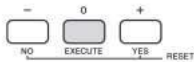

- 4 Press the [0/EXECUTE] button again or the [+ /YES] button to execute the Format operation.

After a while, a message indicating completion of the operation appears, and the [USER FILES] folder will be created on the root directory in the USB flash memory.

NOTICE

- The Format operation cannot be cancelled during execution. Never turn off the power or disconnect the USB flash memory during the operation. Doing so may result in data loss.

- 5 Press the [FILE CONTROL] button to exit from the File Control display.



Recognizable file location in the USB flash memory for Song playback (page 24)

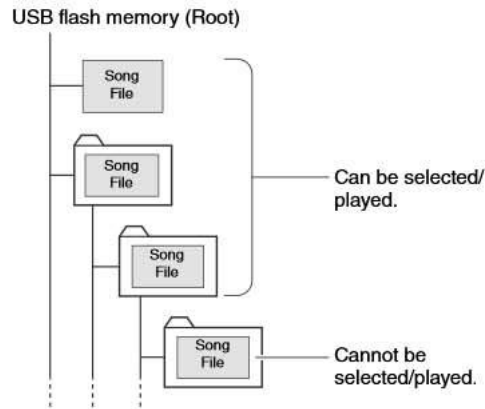

IMPORTANT

- In order to play data copied to a USB flash memory from a computer or other device, the data must be stored either in the USB flash memory's root directory or a first-level/second-level folder in the root directory. Data stored in third-level folders created inside a second-level folder cannot be selected and played by this instrument.

NOTE

- If playback of an external Song (created via a different instrument or computer) produces the distorted sound, decrease the Song Volume (page 47) to reduce the distortion then adjust the Master Volume (page 14).

Song title display language

File names containing Japanese katakana characters will be properly displayed if the instrument's display language is set to [Japanese]. All display information other than file names will be displayed in English even if [Japanese] is selected. Kanji characters cannot be displayed. The display language can be set via the Language function (page 50).

Saving User Data to a USB Flash Memory

The following data created on this instrument comprise the User Data.

- All 10 User Songs
- Styles which have been transferred from a computer then loaded to Style numbers 187-191.
- All the Registration Memory settings

The User Data can be saved as a single User File (.usr) to a USB flash memory.

NOTE

- The extension (.usr) of the User File will not be shown on the display of this instrument. Confirm the extension on the computer display when connecting the USB flash memory to a computer.

- 1 Hold the [FILE CONTROL] button for longer than a second to call up the File Control display.
- 2 Use the CATEGORY [+] and [-] buttons to call up "Save USR."



- 3 Press the [0/EXECUTE] button. As the target file name, USER*** (***: number) appears on the display. If desired, rotate the dial to select a different file name from USER001-USER100.



- 4 Press the [0/EXECUTE] button again. A confirmation message will appear. To cancel the operation, press the [-/NO] button.

Overwriting existing files

If a file that already contains data is selected as the target user file, an overwrite confirmation message will appear.

- 5 Press the [0/EXECUTE] button again, or the [+ /YES] button to execute the Save operation.

After a while, a message indicating completion of the operation appears, and a User file (.usr) will be saved in a USER FILES folder which will automatically be created on the USB flash memory.

NOTICE

- The Save operation cannot be cancelled during execution. Never turn off the power or disconnect the USB flash memory during the operation. Doing so may result in data loss.

NOTE

- The amount of time required for this operation may vary depending on the condition of the USB flash memory.

- 6 Press the [FILE CONTROL] button to exit from the File Control display.



NOTE

- If you want to recall the User file (.usr) to this instrument again, execute the Load operation (page 56).

Saving a User Song as SMF to a USB Flash Memory

A User Song can be converted to SMF (Standard MIDI File) format 0 and saved to a USB flash memory.

SMF (Standard MIDI File) format

With this format, various events via the keyboard performance such as note on/off and Voice selection will be recorded as MIDI data. The SMF Format 0 and Format 1 are available. A large number of MIDI devices are compatible with SMF Format 0, and most commercially available Song file (MIDI file) is provided in SMF Format 0.

- 1 Hold the [FILE CONTROL] button for longer than a second to call up the File Control display.
- 2 Use the CATEGORY [+] and [-] buttons to call up "Save SMF."



- 3 Press the [0/EXECUTE] button. As the target User Song, [USER**] (**: number 1-10) appears on the display. If desired, rotate the dial to select a different User Song from [USER01] [USER10] then press the [0/EXECUTE] button.



- 4 Press the [0/EXECUTE] button again. As the target file name on the USB flash memory, [SONG***] (***: number 1-100) appears on the display. If desired, rotate the dial to select the different file.



- 5 Press the [0/EXECUTE] button again. A confirmation message will appear. To cancel the operation, press the [-/NO] button.

Overwriting existing files

If a file that already contains data is selected, an overwrite confirmation message will appear.

- 6 Press the [0/EXECUTE] button again, or the [+ /YES] button to execute the Save operation.

After a while, a message indicating completion of the operation appears, and a User Song will be saved as the SMF format 0 in a [USER FILES] folder which will automatically be created on the USB flash memory.

NOTICE

- The Save operation cannot be cancelled during execution. Never turn off the power or disconnect the USB flash memory during the operation. Doing so may result in data loss.

NOTE

- The amount of time required for this operation may vary depending on the condition of the USB flash memory.

- 7 Press the [FILE CONTROL] button to exit from the File Control display.



Loading User Data from a USB Flash Memory

A User data (page 54) saved as a User file (.usr) to the USB flash memory can be loaded to this instrument.

NOTICE

□ Loading a User file will overwrite and erase the existing data, including all 10 User Songs, Style data loaded to the Style numbers 187–191, and all the Registration Memory settings. Save important data you want to keep to a separate USB flash memory before loading a User file.

- 1 Hold the [FILE CONTROL] button for longer than a second to call up the File Control display.
- 2 Use the CATEGORY [+] and [-] buttons to call up “Load USR.”



- 3 Press the [0/EXECUTE] button.
 - USER*** (***: number) appears on the display as the User file name in the USB flash memory.
 - As desired, rotate the dial to select a different User file.



Note that the User file should be saved in the USERFILES folder on the USB flash memory. Files saved outside this folder cannot be recognized.

- 4 Press the [0/EXECUTE] button again. A confirmation message will appear. To cancel the operation, press the [-/NO] button.
- 5 Press the [0/EXECUTE] button again, or the [+ /YES] button to execute the Load operation. After a while, a message indicating completion of the operation appears.

NOTICE

□ The Load operation cannot be cancelled during execution. Never turn off the power or disconnect the USB flash memory during the operation. Doing so may result in data loss.

- 6 Press the [FILE CONTROL] button to exit from the File Control display.
- 7 Check the loaded data by calling up the User Song, one of the Styles 187–191, and Registration Memory settings.

Loading a Style File

Style data created on another instrument or a computer can be loaded to the Style numbers 187–191, and you can play them like the internal preset Styles. The following two Load operations are available.

- Loading of a Style file (.sty) saved on the root directory on the USB flash memory
- Loading of a Style file (.sty) transferred from a computer via the Musicsoft Downloader and stored in the internal memory of this instrument

NOTE

For instructions on transferring a Style file from a computer via the Musicsoft Downloader, refer to *Computer-related Operations* (page 9). After data transfer, load the Style data to one of the Style numbers 187–191 to enable playback.

NOTICE

Loading a Style file will overwrite and erase the existing data of the destination number. Save important data you want to keep to a separate USB flash memory before loading.

- 1 Hold the [FILE CONTROL] button for longer than a second to call up the File Control display.**
- 2 Use the CATEGORY [+] and [-] buttons to call up “Load STY.”**



- 3 Press the [0/EXECUTE] button.**
A name of a Style file in the USB flash memory or internal memory of this instrument will appear on the display. As desired, rotate the dial to select a different Style file.



- 4 Press the [0/EXECUTE] button again.**
As the Load destination, [Load To? ***] (***: 187–191) appears on the display. If desired, rotate the dial to select a different number.



- 5 Press the [0/EXECUTE] button again.**
A confirmation message will appear. To cancel the operation, press the [-/NO] button.
- 6 Press the [0/EXECUTE] button again, or the [+ /YES] button to execute the Load operation.**
After a while, a message indicating completion of the operation appears.

NOTICE

The Load operation cannot be cancelled during execution. Never turn off the power or disconnect the USB flash memory during the operation. Doing so may result in data loss.

- 7 Press the [STYLE] button, rotate the dial to select a Style from 187–191, then try playing it back.**

Reference

Deleting a User File in the USB Flash Memory

User Files (.usr) in the root directory of the USB flash memory can be deleted.

IMPORTANT
 □ The User file (.usr) to be deleted should have been saved in the root directory of the USB flash memory. Files outside this folder cannot be recognized.

- 1 Hold the [FILE CONTROL] button for longer than a second to call up the File Control display.
- 2 Use the CATEGORY [+] and [-] buttons to call up “Del USR.”



- 3 Press the [0/EXECUTE] button.
 As a User file name in the USB flash memory, [USER****] (****: number) appears on the display. As desired, rotate the dial to select a different User file.



- 4 Press the [0/EXECUTE] button again.
 A confirmation message will appear. To cancel the operation, press the [-/NO] button.

- 5 Press the [0/EXECUTE] button again, or the [+ /YES] button to execute the Delete operation.

After a while, a message indicating completion of the operation appears.

NOTICE
 □ The Delete operation cannot be cancelled during execution. Never turn off the power or disconnect the USB flash memory during the operation. Doing so may result in data loss.

- 6 Press the [FILE CONTROL] button to exit from the File Control display.

Deleting a SMF File in the USB Flash Memory

You can delete a SMF file that has been saved in the USB flash memory via the Save SMF operation (page 55).

IMPORTANT
 □ The SMF file (.usr) to be deleted should have been saved in the root directory of the USB flash memory. Files outside this folder cannot be recognized. This operation can be applied only to file names with the [SONG***] (***: number) format.

- 1 Hold the [FILE CONTROL] button for longer than a second to call up the File Control display.
- 2 Use the CATEGORY [+] and [-] buttons to call up “Del SMF.”

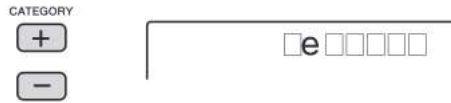

- 3 Press the [0/EXECUTE] button.
 As a SMF file name in the USB flash memory, [SONG***] (***: number) appears on the display. As desired, rotate the dial to select a different SMF file.



- 4 Press the [0/EXECUTE] button again.
 A confirmation message will appear. To cancel the operation, press the [-/NO] button.

- 5 Press the [0/EXECUTE] button again, or the [+ /YES] button to execute the Delete operation.

After a while, a message indicating completion of the operation appears.

NOTICE
 □ The Delete operation cannot be cancelled during execution. Never turn off the power or disconnect the USB flash memory during the operation. Doing so may result in data loss.

- 6 Press the [FILE CONTROL] button to exit from the File Control display.

Exiting from a File Control display

To exit from the File Control display, press the [VOICE], [STYLE], [PATTERN], [SONG], [FUNCTION], or [GRAND PIANO] button.

You can also exit from the File Control function mode as follows:

- 1 Use the CATEGORY [+] and [-] buttons to call up “Exit?.”



- 2 Press the [0/EXECUTE] button to exit from the File Control display.

Message	Comment
Can't Use	Indicates that the file control function is currently unavailable since the media is being accessed.
Comple.	Indicates the specified job completion such as data saving and transmission.
Data Err	Displayed when the user song contains illegal data.
Disk Ful	Displayed when saving data cannot be executed since the media memory becomes full.
Error	Displayed when a file error or operational error occurs.
File Ful	Indicates that SMF songs cannot be displayed since the total number of files exceeds the capacity.
no data	There is no data to save in the flash memory.
no file	There is no file to load or delete from the media.
 Our	Communication with the USB device has been shut down because of the overcurrent to the USB device. Disconnect the device from the [USB TO DEVICE] terminal, then turn on the power of the instrument.
Protect	Displayed when trying to save or delete data on a protected media, or format a protected media. Set protect to off and try again.
UnFormat	Displayed when connecting an unformatted media.
UseAdpt	USB flash memory save, delete, and format operations cannot be performed when the instrument is being powered from battery. Use an AC adaptor.

Troubleshooting

Problem	Possible Cause and Solution
When the instrument is turned on or off, a popping sound is temporarily produced.	This is normal and indicates that the instrument is receiving electrical power.
When using a mobile phone, noise is produced	Using a mobile phone in close proximity to the instrument may produce interference. To prevent this, turn off the mobile phone or use it further away from the instrument
The instrument is automatically turned off even if no operation is done.	This is normal. This occurs due to the Auto Power Off function (page 14).
The volume is too soft. The sound quality is poor. The Style/Pattern/Song/Arpeggio stops unexpectedly or will not play. The recorded data of the song, etc. does not play correctly. The LCD display suddenly goes dark, and all panel settings are reset.	The batteries are low or dead. Replace all six batteries with completely new ones or completely recharged ones, or use the AC power adaptor.
No sound is produced even when the keyboard is played, or a Song, Style, or Pattern is being played back.	Check whether a set of headphones or an audio cable is connected to the PHONES/OUTPUT, or not. When such a connection is made, no sound is output from the speaker of this instrument. Check the on/off status of the Local Control (page 50). Normally, set this parameter to ON.
The footswitch (for sustain) seems to produce the opposite effect. For example, pressing the footswitch cuts off the sound and releasing it sustains the sounds.	The polarity of the footswitch is reversed. Make sure that the footswitch plug is properly connected to the SUSTAIN jack before turning on the power.
No sound is produced even when playing keys in the right hand area of the keyboard, although chords played in the left hand area are recognized.	Check whether or not the Dictionary function (page 45) is used. When used, this is normal.
Not all of the Voices seem to sound, or the sound seems to be cut off, when playing the keyboard, Arpeggio, Style or Pattern or Song.	You have exceeded 32 simultaneous notes, which is the maximum polyphony (the maximum amount of notes that can be played simultaneously) of this instrument. If the Main, Dual, and Split Voices are being used along with playback of Arpeggio, Style, Pattern or Song, some notes/sounds may be omitted (or "stolen").
The sound of the Voice changes from note to note.	This is normal. The tone generation method uses multiple recordings (samples) of an instrument across the range of the keyboard; thus, the actual sound of the Voice may be slightly different from note to note.
The keyboard performance and playback of Style/Pattern/Song produces an unexpected or inappropriate sound, and cannot be restored to the normal status.	Using the Knobs can produce dramatic changes in the sound, but may also produce unexpected or undesired sounds. If you want to restore the original, normal sound before being changed by the Knobs, change the Voice, Style, Pattern or Song, or press the [PORTABLE GRAND] button to reset the panel settings.
The Style, Pattern or Song does not start even when the [START/STOP] button is pressed. The Arpeggio does not start even when the note is pressed with the Arpeggio turned on.	Check the on/off status of the External Clock (page 50). Normally, set this parameter to OFF.
The volume of the Style, Pattern or Song is too low.	Check the volume setting in the Functions (pages 42 and 47).
The chords played in the left hand area cannot be recognized even when the ACMP is turned on.	Check the Split Point setting (page 43). Set this to the appropriate value.
Style parts other than the Rhythm part produce no sound.	Check the on/off status of the ACMP (page 22). Make sure to turn ACMP on.
The Styles numbered 174–186 produce no rhythm drum sound even when the [START/STOP] button is pressed.	This is normal. Style numbers 174–186 have no rhythm parts, so no rhythm will play. When one of these Styles is selected, turn ACMP on, then specify the chord in the left hand area to play Style parts other than the Rhythm part.
The ACMP indicator does not appear on the display when the [ACMP ON/OFF] button is pressed.	Check the on/off status of the [STYLE] lamp. When using a Style, press the [STYLE] button to turn on the [STYLE] lamp.

Specifications

Size/Weight	Dimensions (W x D x H)		946 mm x 405 mm x 140 mm (37-1/4" x 15-15/16" x 5-1/2")
	Weight		6.8 kg (15lbs 0oz.) (not including batteries)
Keyboard	Number of Keys		61
	Touch Response		Yes
Other Controllers	Pitch Bend		Yes
	Control Knobs		Yes
Display	Display		LCD display
	Language		English
Voices	Tone Generation	Tone Generating Technology	AWM Stereo Sampling
	Polyphony	Number of Polyphony (Max.)	32
	Preset	Number of Voices	206 + 462 XGlite + 23 Drum/SFX Kits + 40 Arpeggio
	Compatibility		GM, XGlite
Effects	Types	Reverb	9 types
		Chorus	4 types
		Master EQ	5 types
		Harmony	26 types
		Ultra-Wide Stereo	3 types
	Functions	Dual	Yes
		Split	Yes
Accompaniment Styles	Preset	Number of Preset Styles	186
		Fingering	Multi finger
		Style Control	ACMP ON/OFF, INTRO/ENDING/rit., MAIN/AUTO FILL, SYNC START, SYNC STOP, START/STOP, TRACK ON/OFF
	User Styles		5
	Other Features	Music Database	305
		One Touch Setting (OTS)	Yes
	Pattern	Preset	Preset Pattern
Section			5
Recording/Playback	Preset	Number of Preset Songs	100
		Number of Songs	10
	Recording	Number of Tracks	6 (5 Melody + 1 Style/Pattern)
		Data Capacity	Approx. 19,000 notes (when only "melody" tracks are recorded) Approx. 5,500 chords (when only "chord" tracks are recorded)
Compatible Data Format	Playback		SMF
	Recording		Original File Format (SMF conversion function)
Function	Lesson/Guide		[1 LISTENING, 2 TIMING, 3 WAITING], [Repeat & Learn], [Chord Dictionary]
	Registration	Number of Buttons	4 (x 8 banks)
		Metronome	Yes
	Overall	Tempo Range	11 – 280
		Transpose	-12 to 0, 0 to +12
		Tuning	427.0 – 440.0 – 453.0 Hz
	Miscellaneous	Portable Grand Button	Yes
Memory/Connectivity	Memory	Internal Memory	Approx. 1.54MB
		External Storage Device	USB flash memory
	Connectivity	DC IN	DC IN 12V
		Headphones/Output	[PHONES/OUTPUT] x 1
		Sustain Pedal	[SUSTAIN] x 1
		USB TO DEVICE	Yes
USB TO HOST	Yes		
Amplifiers/Speakers	Amplifiers		2.5W + 2.5W
	Speakers		12cmx2 + 3cmx2
Power Supply	Power Supply	Adaptor	• Adaptor: Users within U.S or Europe: PA-150 or an equivalent recommended by Yamaha Others: PA-5D, PA-150 or an equivalent
		Batteries	Six "AA" size alkaline (LR6), manganese (H6) or Ni-MH rechargeable batteries
	Power Consumption		• 16W (PA-150)
	Auto Power Off Function		Yes
Accessories	Included Accessories		<ul style="list-style-type: none"> • Owner's Manual • Data List • AC Power Adaptor PA-150 or an equivalent • May not be included depending on your particular area. Please check with your Yamaha dealer. • Music Rest • Online Member Product Registration
	Optional Accessories		<ul style="list-style-type: none"> • AC Power Adaptor Users within U.S or Europe: PA-150 or an equivalent recommended by Yamaha • Others: PA-5D, PA-150 or an equivalent • Keyboard Stand (L-2C) • Stereo Headphones (HPE-150/HPE-30) • Footswitch (FC4/FC5)

* Specifications and descriptions in this owner's manual are for information purposes only. Yamaha Corp. reserves the right to change or modify products or specifications at any time without prior notice. Since specifications, equipment or options may not be the same in every locale, please check with your Yamaha dealer.

A

AC Power Adaptor 9, 12
 Accessories 9
 ACMP 22, 23, 40
 Arpeggio 20, 39
 Arpeggio Quantize 39, 49
 Arpeggio Type 20, 49
 Arpeggio Velocity 49
 ATTACK 37
 Attack Time 37, 49
 Auto Accompaniment 40
 Auto Accompaniment range 22
 AUTO FILL 40
 Auto Power Off 14
 Auto Power Off Time 50

B

Backup 32
 Backup Clear 32
 Backup Parameters 32
 Battery 12
 Battery Type 13, 50
 Beat 15
 BGM Playback 46

C

Can't Use 59
 Chord 15, 43
 Chord Dictionary 45
 CHORUS 37
 Chorus Depth 33, 49
 Chorus Type 33, 49
 Complet. 59
 Computer-related Operations 9
 CUTOFF 37

D

Data Err 59
 Del SMF 58
 Del USR 58
 Demo Cancel 32, 50
 Demo Group 32, 50
 Demo Play Mode 50
 Demo Song 24
 Disk Ful 59
 Display 15
 Dual Voice 16, 36, 49

E

EFFECT 37, 38
 EG 38
 EG (Envelope Generator) 37
 ENDING 40
 Envelope Generator 37
 EQ Setting 35
 EQ Type 35
 Error 59
 Excellent 27
 Exit? 59
 External Clock 50

F

Fast Forward 25
 Fast Reverse 25
 File Control 59
 File Ful 59
 FILTER 37, 38
 Filter 21
 Filter Cutoff 21, 49
 Filter Resonance 21, 49
 Flash Clear 32
 Footswitch 13, 39
 Format 53
 Function 48
 Function List 48

G

GM System Level 1 8
 Grade 27, 50

H

Harmony 19
 Harmony Type 19, 49
 Harmony Volume 49
 Headphone 13

I

Initial Send 50
 Initialization 32
 INTRO 40

K

Keyboard Out 50
 Knob 21, 37
 Knob assignment 15

L

Language 50
 Lesson 26
 Lesson Track 50
 Listen 26
 Load STY 57
 Load USR 56
 Local Control 50

M

MAIN 40
 Main 16
 Main Voice 16
 Master EQ Type 32, 49
 MASTER VOLUME 14
 MEASURE 15
 Melody Voice 47
 Metronome 18, 50
 Metronome Volume 18
 MIDI Basics 9
 MIDI Reference 9
 Music Database 22
 Music Rest 9

N

no data 59
 no file 59
 Notation 15

O

Octave 48, 49
 OK 27
 One Touch Setting 34

P

PAN 37
 Pan 49
 Pattern 23, 40
 Pattern Volume 32, 42, 48
 Pause 25
 PC mode 50
 Pedal Function 50
 PITCH BEND 34
 Pitch Bend Range 34, 48
 Pitch Controls 34
 Power 14
 Power Requirements 12
 Power source 13
 Preset Song 47
 Protect 59

R	
Random	46
Recording	28
Registration Memory	31
RELEASE	37
Release Time	37, 49
Repeat	25
Repeat & Learn	27
RESONANCE	37
REVERB	37
Reverb Depth	33, 49
Reverb Type	33, 49
S	
Save SMF	55
Save USR	54
Section	23, 40, 42
SMF (Standard MIDI File)	55
Song	24
Song Book	9
Song Category	24
Song Out	50
Song title display language	53
Song Volume	32, 47, 48
SOUND IMAGE	37, 38
Split Point	23, 43, 48
Split Voice	17, 36, 49
Style	22, 40
STYLE FILE	8
Style File	57
STYLE FILTER	23, 37, 38
Style Out	50
Style Volume	42, 48
Sustain	39
SYNC START	22
Synchro Start	40
Synchro Stop	41
T	
Tap Start	42
Tempo	18, 42
Time Signature	18, 50
Timing	26
Touch Sensitivity	35, 48
Track	28
TRACK CONTROL	23, 41
Track On/Off	25
Transpose	23, 34, 48
Troubleshooting	60
Tuning	34, 48
U	
ULTRA-WIDE STEREO	37
UnFormat	59
USB	8
USB Flash Memory	51
USB TO DEVICE	51
USB TO HOST	11
UseAdpt	59
User Song	28
V	
Very Good	27
Volume	48, 49
Volume of the Pattern	42
Volume of the Style	42
W	
Waiting	26
Wide Type	49
X	
XGlite	8
Y	
Your Tempo	50



YAMAHA LIMITED 1-YEAR WARRANTY ON PORTABLE KEYBOARDS

(NP, NPV, PSRE, EZ, DGX230, DGX530, YPG AND YPT SERIES)

Thank you for selecting a Yamaha product. Yamaha products are designed and manufactured to provide a high level of defect-free performance. Yamaha Corporation of America ("Yamaha") is proud of the experience and craftsmanship that goes into each and every Yamaha product. Yamaha sells its products through a network of reputable, specially authorized dealers and is pleased to offer you, the Original Owner, the following Limited Warranty, which applies only to products that have been (1) directly purchased from Yamaha's authorized dealers in the fifty states of the USA and District of Columbia (the "Warranted Area") and (2) used exclusively in the Warranted Area. Yamaha suggests that you read the Limited Warranty thoroughly, and invites you to contact your authorized Yamaha dealer or Yamaha Customer Service if you have any questions.

Coverage: Yamaha will, at its option, repair or replace the product covered by this warranty if it becomes defective, malfunctions or otherwise fails to conform with this warranty under normal use and service during the term of this warranty, without charge for labor or materials. Repairs may be performed using new or refurbished parts that meet or exceed Yamaha specifications for new parts. If Yamaha elects to replace the product, the replacement may be a reconditioned unit. You will be responsible for any installation or removal charges and for any initial shipping charges if the product(s) must be shipped for warranty service. However, Yamaha will pay the return shipping charges to any destination within the USA if the repairs are covered by the warranty. This warranty does not cover (a) damage, deterioration or malfunction resulting from accident, negligence, misuse, abuse, improper installation or operation or failure to follow instructions according to the Owner's Manual for this product; any shipment of the product (claims must be presented to the carrier); repair or attempted repair by anyone other than Yamaha or an authorized Yamaha Service Center; (b) any unit which has been altered or on which the serial number has been defaced, modified or removed; (c) normal wear and any periodic maintenance; (d) deterioration due to perspiration, corrosive atmosphere or other external causes such as extremes in temperature or humidity; (e) damages attributable to power line surge or related electrical abnormalities, lightning damage or acts of God; or (f) RFI/EMI (Interference/noise) caused by improper grounding or the improper use of either certified or uncertified equipment, if applicable. Any evidence of alteration, erasing or forgery of proof-of-purchase documents will cause this warranty to be void. This warranty covers only the Original Owner and is not transferable.

In Order to Obtain Warranty Service: Warranty service will only be provided for defective products within the Warranted Area. Contact your local authorized Yamaha dealer who will advise you of the procedures to be followed. If this is not successful, contact Yamaha at the address, telephone number or website shown below. Yamaha may request that you send the defective product to a local authorized Yamaha Servicer or authorize return of the defective product to Yamaha for repair. If you are uncertain as to whether a dealer has been authorized by Yamaha, please contact Yamaha's Service Department at the number shown below, or check Yamaha's website at www.Yamaha.com. Product(s) shipped for service should be packed securely and must be accompanied by a detailed explanation of the problem(s) requiring service, together with the original or a machine reproduction of the bill of sale or other dated, proof-of-purchase document describing the product, as evidence of warranty coverage. Should any product submitted for warranty service be found ineligible therefore, an estimate of repair cost will be furnished and the repair will be accomplished only if requested by you and upon receipt of payment or acceptable arrangement for payment.

Limitation of Implied Warranties and Exclusion of Damages: ANY IMPLIED WARRANTIES, INCLUDING WARRANTIES OF MERCHANTABILITY AND FITNESS FOR A PARTICULAR PURPOSE SHALL BE LIMITED IN DURATION TO THE APPLICABLE PERIOD OF TIME SET FORTH ABOVE. YAMAHA SHALL NOT BE RESPONSIBLE FOR INCIDENTAL OR CONSEQUENTIAL DAMAGES OR FOR DAMAGES BASED UPON INCONVENIENCE, LOSS OF USE, DAMAGE TO ANY OTHER EQUIPMENT OR OTHER ITEMS AT THE SITE OF USE OR INTERRUPTION OF PERFORMANCES OR ANY CONSEQUENCES. YAMAHA'S LIABILITY FOR ANY DEFECTIVE PRODUCT IS LIMITED TO REPAIR OR REPLACEMENT OF THE PRODUCT, AT YAMAHA'S OPTION. SOME STATES DO NOT ALLOW LIMITATIONS ON HOW LONG AN IMPLIED WARRANTY LASTS OR THE EXCLUSION OR LIMITATION OF INCIDENTAL OR CONSEQUENTIAL DAMAGES, SO THE ABOVE LIMITATION OR EXCLUSION MAY NOT APPLY TO YOU. This Warranty gives you specific legal rights, and you may also have other rights which vary from state to state. This is the only express warranty applicable to the product specified herein; Yamaha neither assumes nor authorizes anyone to assume for it any other express warranty.

If you have any questions about service received or if you need assistance in locating an authorized Yamaha Servicer, please contact:



CUSTOMER SERVICE

Yamaha Corporation of America

6600 Orangethorpe Avenue, Buena Park, California 90620-1373

Telephone: 800-854-1569

www.yamaha.com

Do not return any product to the above address without a written Return Authorization issued by YAMAHA.

©2012 Yamaha Corporation of America.

Important Notice: Guarantee Information for customers in European Economic Area (EEA) and Switzerland

Important Notice: Guarantee Information for customers in EEA* and Switzerland For detailed guarantee information about this Yamaha product, and Pan-EEA* and Switzerland warranty service, please either visit the website address below (Printable file is available at our website) or contact the Yamaha representative office for your country. * EEA: European Economic Area	English
Wichtiger Hinweis: Garantie-Information für Kunden in der EWR* und der Schweiz Für nähere Garantie-Information über dieses Produkt von Yamaha, sowie über den Pan-EWR*- und Schweizer Garantieservice, besuchen Sie bitte entweder die folgende angegebene Internetadresse (eine druckfähige Version befindet sich auch auf unserer Webseite), oder wenden Sie sich an den für Ihr Land zuständigen Yamahavertrieb. *EWR: Europäischer Wirtschaftsraum	Deutsch
Remarque importante: Informations de garantie pour les clients de l'EEE et la Suisse Pour des informations plus détaillées sur la garantie de ce produit Yamaha et sur le service de garantie applicable dans l'ensemble de l'EEE ainsi qu'en Suisse, consultez notre site Web à l'adresse ci-dessous (le fichier imprimable est disponible sur notre site Web) ou contactez directement Yamaha dans votre pays de résidence. * EEE : Espace Economique Européen	Français
Belangrijke mededeling: Garantie-informatie voor klanten in de EER* en Zwitserland Voor gedetailleerde garantie-informatie over dit Yamaha-product en de garantieservice in heel de EER* en Zwitserland, gaat u naar de onderstaande website (u vindt een afdrukbare versie op onze website) of neemt u contact op met de vertegenwoordiging van Yamaha in uw land. * EER: Europese Economische Ruimte	Nederlands
Aviso importante: Información sobre la garantía para los clientes del EEE* y Suiza Para una información detallada sobre este producto Yamaha y sobre el soporte de garantía en la zona EEE* y Suiza, visite la dirección web que se incluye más abajo (la versión del archivo para imprimir está disponible en nuestro sitio web) o póngase en contacto con el representante de Yamaha en su país. * EEE: Espacio Económico Europeo	Español
Aviso importante: Informazioni sulla garanzia per i clienti residenti nell'EEA* e in Svizzera Per informazioni dettagliate sulla garanzia relativa a questo prodotto Yamaha e l'assistenza in garanzia nei paesi EEA* e in Svizzera, potete consultare il sito Web all'indirizzo riportato di seguito (è disponibile il file in formato stampabile) oppure contattare l'ufficio di rappresentanza locale della Yamaha. * EEA: Area Economica Europea	Italiano
Aviso importante: Informações sobre as garantias para clientes da AEE* e da Suíça Para obter uma informação pormenorizada sobre este produto da Yamaha e sobre o serviço de garantia na AEE* e na Suíça, visite o site a seguir (o arquivo para impressão está disponível no nosso site) ou entre em contato com o escritório de representação da Yamaha no seu país. * AEE: Área Económica Europeia	Portugués
Σημαντική σημείωση: Πληροφορίες εγγύησης για τους πελάτες στον ΕΟΧ* και Ελλάδα Για λεπτομερείς πληροφορίες εγγύησης σχετικά με το προϊόν προϊόν της Yamaha και την κάλυψη εγγύησης, σε όλες τις χώρες του ΕΟΧ και την Ελλάδα, επισκεφτείτε την παρακάτω ιστοσελίδα (Εκτυπώσιμη μορφή είναι διαθέσιμη στην ιστοσελίδα μας) ή απευθυνθείτε στην αντιπροσωπεία της Yamaha στη χώρα σας. * ΕΟΧ: Ευρωπαϊκός Οικονομικός Χώρος	Ελληνικά
Viktigt: Garantierinformation för kunder i EES-området* och Schweiz För detaljerad information om denna Yamaha-produkt samt garantierinformation i hela EES-området* och Schweiz kan du antingen besöka nedanstående webbadress (en utskriftsvänlig fil finns på webbplatsen) eller kontakta Yamahas officiella representant i ditt land. * EES: Europeiska Ekonomiska Samarbetsområdet	Svenska
Viktig merknad: Garantierinformasjon for kunder i EØS* og Sveits Detaljert garantierinformasjon om dette Yamaha-produktet og garantierinformasjon for hele EØS-området* og Sveits kan fås enten ved å besøke nettstedene nedenfor (utskriftsversjon finnes på våre nettsider) eller kontakte kontakttakk Yamaha-kontoret i landet der du bor. *EØS: Det europeiske økonomiske samarbeidsområdet	Norsk
Vigtig oplysning: Garantiplysninger til kunder i EØO* og Schweiz De kan finde detaljerede garantiplysninger om dette Yamaha-produkt og garantierinformation for EØO* (og Schweiz) ved at besøge det websted, der er angivet nedenfor (der findes en fil, som kan udskrives, på vores websted), eller ved at kontakte Yamahas nationale repræsentationskontor i det land, hvor De bor. * EØO: Det Europæiske Økonomiske Område	Dansk

<http://europe.yamaha.com/warranty/>

URL_4

Tärkeä ilmoitus: Taku tiedot Euroopan talousalueen (ETA)* ja Sveitsin asiakkaille Tämän Yamaha-tuotteen sekä ETA-alueen ja Sveitsin takuuta koskevat yksityiskohtaiset tiedot saatte alla olevasta netti-sivustosta. (Tulostettava tiedosto saatavissa sivustollamme.) Voitte myös ottaa yhteyttä paikalliseen Yamaha-edustajaan. *ETA: Euroopan talousalue	Suomi
Ważne: Warunki gwarancyjne obowiązujące w EOG* i Szwajcarii Aby dowiedzieć się więcej na temat warunków gwarancyjnych tego produktu firmy Yamaha i serwisu gwarancyjnego w całym EOG* i Szwajcarii, należy odwiedzić wskazaną poniżej stronę internetową (plik gotowy do wydruku znajduje się na naszej stronie internetowej) lub skontaktować się z przedstawicielstwem firmy Yamaha w swoim kraju. * EOG — Europejski Obszar Gospodarczy	Polski
Důležité oznámení: Záruční informace pro zákazníky v EHS* a ve Švýcarsku Podrobné záruční informace o tomto produktu Yamaha a záručním servisu v celém EHS* a ve Švýcarsku naleznete na níže uvedené webové adrese (soubor k tisku je dostupný na našich webových stránkách) nebo se můžete obrátit na zástupce firmy Yamaha ve své zemi. * EHS: Evropský hospodářský prostor	Česky
Fontos figyelmeztetés: Garancia-információk az EGT* területén és Svájcban élő vásárlók számára A jelen Yamaha termékre vonatkozó részletes garancia-információk, valamint az EGT*-re és Svájcra kiterjedő garanciális szolgáltatás tekintetében keressék fel webhelyünket az alábbi címen (a webhelyen nyomtatható lájlt is talál), vagy pedig lépjen kapcsolatba az országában működő Yamaha képviselői iróddal. * EGT: Európai Gazdasági Térség	Magyar
Oluline märkus: Garantiteave Euroopa Majanduspiirkonna (EMP)* ja Šveitsi klientidele Täpsemat teabes saameks selle Yamaha toote garantii ning kogu Euroopa Majanduspiirkonna ja Šveitsi garantiteeninduse kohta, külastage palun veebisaiti alljärgneval aadressil (meie saidil on saadaval printitav fail) või pöörduge Teie regiooni Yamaha esinduse poole. * EMP: Euroopa Majanduspiirkond	Eesti keel
Svarīgs paziņojums: garantijas informācija klientiem EEZ* un Šveicē Lai saņemtu detalizētu garantijas informāciju par šo Yamaha produktu, kā arī garantijas apkaļpošanu EEZ* un Šveicē, lūdzu, apmeklēt zemāk norādīto līmekļa vietnes adresi (līmekļa vietnē ir pieejams drukājams fails) vai sazināties ar jūsu valstī apkalpojošo Yamaha pārstāvniecību. * EEZ: Eiropas Ekonomikas zona	Latviešu
Dēmiesto: informācija dēl garantijas prīkājams EEE* ir Šveicarijōje Jei reikia šāsamios informācijas apie šį „Yamaha“ produktą ir jo techninę priežiūrą visoje EEE* ir Šveicarijōje, apsilankykite mūsų svetainėje toliau nurodytu adresu (svetainėje yra spausdinamas failas) arba kreipkitės į „Yamaha“ atstovybę savo šalyje. *EEE – Europos ekonominė erdvė	Lietuvių kalba
Dôležitě upozornenie: informácie o záruke pre zákazníkov v EHP* a Švajčiarsku Podrobné informácie o záruke týkajúcej sa tohto produktu od spoločnosti Yamaha a garancionom servise v EHP* a Švajčiarsku nájdete na webovej stránke uvedenej nižšie (na našej webovej stránke je k dispozícii súbor na tlač) alebo sa obráťte na zástupcu spoločnosti Yamaha vo svojej krajine. * EHP: Európsky hospodársky priestor	Slovenčina
Pomembno obvestilo: informacije o záruke pro zákazníkov v EHP* in Švici Za podrobnejše informacije o tem Yamahinem izdelku ter garancijskem servisu v celotnem EGP in Švici, obiščite spletno mesto, ki je navedeno spodaj (natisljiva datoteka je na voljo na našem spletnem mestu), ali se obrnite na Yamahinega predstavnika v svoji državi. * EGP: Evropski gospodarski prostor	Slovensčina
Важно съобщение: Информация за гаранцията за клиенти в ЕИП* и Швейцария За подробна информация за гаранцията за този продукт на Yamaha и гаранционото обслужване в паневропейската зона на ЕИП* и Швейцария или посетете посочения по-долу уеб сайт (на нашия уеб сайт има файл за печат), или се свържете с представителния офис на Yamaha в вашата страна. * ЕИП: Европейско икономическо пространство	Български език
Notificare importantă: Informații despre garanție pentru clienții din SEE* și Elveția Pentru informații detaliate privind acest produs Yamaha și serviciul de garanție Pan-SEE* și Elveția, vizitați site-ul la adresa de mai jos (fișierul imprimabil este disponibil pe site-ul nostru) sau contactați biroul reprezentanței Yamaha din țara dumneavoastră. * SEE: Spațiul Economic European	Limba română

For details of products, please contact your nearest Yamaha representative or the authorized distributor listed below.

NORTH AMERICA

CANADA

Yamaha Canada Music Ltd.
135 Milner Avenue, Scarborough, Ontario,
M1S 3R1, Canada
Tel: 416-298-1311

U.S.A.

Yamaha Corporation of America
6600 Orangethorpe Ave., Buena Park, Calif. 90620,
U.S.A.
Tel: 714-522-9011

CENTRAL & SOUTH AMERICA

MEXICO

Yamaha de México S.A. de C.V.
Calz. Javier Rojo Gómez #1149,
Col. Guadalupe del Moral
C.P. 09300, México, D.F., México
Tel: 55-5804-0600

BRAZIL

Yamaha Musical do Brasil Ltda.
Rua Joaquin Floriano, 913 - 4 Andar, Itaim Bibi,
CEP 04534-013 Sao Paulo, SP. BRAZIL
Tel: 011-3704-1377

ARGENTINA

Yamaha Music Latin America, S.A.
Sucursal de Argentina
Olga Cossetini 1553, Piso 4 Norte
Madero Este-C1107CEK
Buenos Aires, Argentina
Tel: 011-4119-7000

PANAMA AND OTHER LATIN AMERICAN COUNTRIES/ CARIBBEAN COUNTRIES

Yamaha Music Latin America, S.A.
Torre Banco General, Piso 7, Urbanización Marbella,
Calle 47 y Aquilino de la Guardia,
Ciudad de Panamá Panamá
Tel: +507-269-5311

EUROPE

THE UNITED KINGDOM/IRELAND

Yamaha Music Europe GmbH (UK)
Sherbourne Drive, Tilbrook, Milton Keynes,
MK7 8BL, England
Tel: 01908-366700

GERMANY

Yamaha Music Europe GmbH
Siemensstraße 22-34, 25462 Rellingen, Germany
Tel: 04101-3030

SWITZERLAND/LIECHTENSTEIN

Yamaha Music Europe GmbH
Branch Switzerland in Zürich
Seefeldstrasse 94, 8008 Zürich, Switzerland
Tel: 044-387-8080

AUSTRIA

Yamaha Music Europe GmbH Branch Austria
Schleiergasse 20, A-1100 Wien, Austria
Tel: 01-60203900

CZECH REPUBLIC/HUNGARY/ ROMANIA/SLOVAKIA/SLOVENIA

Yamaha Music Europe GmbH
Branch Austria (Central Eastern Europe Office)
Schleiergasse 20, A-1100 Wien, Austria
Tel: 01-602039025

POLAND/LITHUANIA/LATVIA/ESTONIA

Yamaha Music Europe GmbH
Branch Sp. z o.o. Oddział w Polsce
ul. 17 Stycznia 56, PL-02-146 Warszawa, Poland
Tel: 022-500-2925

BULGARIA

Dinacord Bulgaria LTD.
Bul. Iskarsko Schose 7 Targovskii Zentar Evropa
1528 Sofia, Bulgaria
Tel: 02-978-20-25

MALTA

Olimpus Music Ltd.
The Emporium, Level 3, St. Louis Street Msida
MSD06
Tel: 02133-2144

THE NETHERLANDS/ BELGIUM/LUXEMBOURG

Yamaha Music Europe Branch Benelux
Clarissenhof 5-b, 4133 AB Vianen, The Netherlands
Tel: 0347-358 040

FRANCE

Yamaha Music Europe
7 rue Ambroise Croizat, Zone d'activités Pariest,
77183 Croissy-Beaubourg, France
Tel: 01-64-61-4000

ITALY

Yamaha Music Europe GmbH, Branch Italy
Viale Italia 88, 20020 Lainate (Milano), Italy
Tel: 02-935-771

SPAIN/PORTUGAL

Yamaha Music Europe GmbH Iberica, Sucursal
en España
Ctra. de la Coruna km. 17, 200, 28230
Las Rozas (Madrid), Spain
Tel: 91-639-8888

GREECE

Philippos Nakas S.A. The Music House
147 Skiathou Street, 112-55 Athens, Greece
Tel: 01-228 2160

SWEDEN

Yamaha Music Europe GmbH Germany filial
Scandinavia
J. A. Wettergrens Gata 1, Box 30053
S-400 43 Göteborg, Sweden
Tel: 031 89 34 00

DENMARK

Yamaha Music Europe GmbH, Tyskland filial
Denmark
Generatorvej 6A, DK-2730 Herlev, Denmark
Tel: 44 92 49 00

FINLAND

F-Musiikki Oy
Kluuvikatu 6, P.O. Box 260,
SF-00101 Helsinki, Finland
Tel: 09 618511

NORWAY

Yamaha Music Europe GmbH Germany -
Norwegian Branch
Grini Næringspark 1, N-1345 Osterås, Norway
Tel: 67 16 77 70

ICELAND

Skeifan HF
Skeifan 17 P.O. Box 8120, IS-128 Reykjavik, Iceland
Tel: 525 5000

RUSSIA

Yamaha Music (Russia)
Room 37, bld. 7, Kievskaya street, Moscow,
121059, Russia
Tel: 495 626 5005

OTHER EUROPEAN COUNTRIES

Yamaha Music Europe GmbH
Siemensstraße 22-34, 25462 Rellingen, Germany
Tel: +49-4101-3030

AFRICA

Yamaha Corporation,
Asia-Pacific Sales & Marketing Group
Nakazawa-cho 10-1, Naka-ku, Hamamatsu,
Japan 430-8650
Tel: +81-53-460-2313

MIDDLE EAST

TURKEY/CYPRUS

Yamaha Music Europe GmbH
Siemensstraße 22-34, 25462 Rellingen, Germany
Tel: 04101-3030

OTHER COUNTRIES

Yamaha Music Gulf FZE
LOB 16-513, P.O.Box 17328, Jubel Ali,
Dubai, United Arab Emirates
Tel: +971-4-881-5868

ASIA

THE PEOPLE'S REPUBLIC OF CHINA

Yamaha Music & Electronics (China) Co., Ltd.
2F, Yunhedasha, 1818 Xinzha-lu, Jingan-qu,
Shanghai, China
Tel: 021-6247-2211

HONG KONG

Tom Lee Music Co., Ltd.
11/F., Silvercord Tower 1, 30 Canton Road,
Tsimshatsui, Kowloon, Hong Kong
Tel: 2737-7688

INDIA

Yamaha Music India Pvt. Ltd.
Spazedge building, Ground Floor, Tower A, Sector
47, Gurgaon- Sohna Road, Gurgaon, Haryana, India
Tel: 0124-485-3300

INDONESIA

PT. Yamaha Musik Indonesia (Distributor)
PT. Nusantik
Gedung Yamaha Music Center, Jalan Jend. Gatot
Subroto Kav. 4, Jakarta 12930, Indonesia
Tel: 021-520-2577

KOREA

Yamaha Music Korea Ltd.
8F, 9F, Dongsung Bldg. 158-9 Samsung-Dong,
Kangnam-Gu, Seoul, Korea
Tel: 02-3467-3300

MALAYSIA

Yamaha Music (Malaysia) Sdn., Bhd.
Lot 8, Jalan Perbandaran, 47301 Kelana Jaya,
Petaling Jaya, Selangor, Malaysia
Tel: 03-78030900

PHILIPPINES

Yupangco Music Corporation
339 Gil J. Puyat Avenue, P.O. Box 885 MCPO,
Makati, Metro Manila, Philippines
Tel: 819-7551

SINGAPORE

Yamaha Music (Asia) PRIVATE LIMITED
Blk 202 Hougang Street 21, #02-00,
Singapore 530202, Singapore
Tel: 6747-4374

TAIWAN

Yamaha KHS Music Co., Ltd.
3F, #6, Sec.2, Nan Jing E. Rd. Taipei.
Taiwan 104, R.O.C.
Tel: 02-2511-8688

THAILAND

Siam Music Yamaha Co., Ltd.
4, 6, 15 and 16th floor, Siam Motors Building,
891/1 Rama 1 Road, Wangmai,
Pathumwan, Bangkok 10330, Thailand
Tel: 02-215-2622

OTHER ASIAN COUNTRIES

Yamaha Corporation,
Asia-Pacific Sales & Marketing Group
Nakazawa-cho 10-1, Naka-ku, Hamamatsu,
Japan 430-8650
Tel: +81-53-460-2313

OCEANIA

AUSTRALIA

Yamaha Music Australia Pty. Ltd.
Level 1, 99 Queensbridge Street, Southbank,
Victoria 3006, Australia
Tel: 3-9693-5111

NEW ZEALAND

Music Works LTD
P.O. BOX 6246 Wellesley, Auckland 4680,
New Zealand
Tel: 9-634-0099

COUNTRIES AND TRUST

TERRITORIES IN PACIFIC OCEAN

Yamaha Corporation,
Asia-Pacific Sales & Marketing Group
Nakazawa-cho 10-1, Naka-ku, Hamamatsu,
Japan 430-8650
Tel: +81-53-460-2313

MEMO



Yamaha Global Site
<http://www.yamaha.com/>

Yamaha Manual Library
<http://www.yamaha.co.jp/manual/>

U.R.G., Digital Musical Instruments Division
□ 2012 Yamaha Corporation

202POTY*.*-01A0
Printed in China

WZ60270