

DIGITAL KEYBOARD**PSR-E453**
PSR-EW400**Owner's Manual****Setting Up****Quick Guide****Reference****Appendix**

Thank you for purchasing this Yamaha Digital Keyboard!

We recommend that you read this manual carefully so that you can fully take advantage of the advanced and convenient functions of the instrument. We also recommend that you keep this manual in a safe and handy place for future reference.

Before using the instrument, be sure to read "PRECAUTIONS" on pages 5–7.

SPECIAL MESSAGE SECTION

This product utilizes batteries or an external power supply (adapter). DO NOT connect this product to any power supply or adapter other than one described in the manual, on the name plate, or specifically recommended by Yamaha.

WARNING: Do not place this product in a position where anyone could walk on, trip over, or roll anything over power or connecting cords of any kind. The use of an extension cord is not recommended! If you must use an extension cord, the minimum wire size for a 25' cord (or less) is 18 AWG. NOTE: The smaller the AWG number, the larger the current handling capacity. For longer extension cords, consult a local electrician.

This product should be used only with the components supplied or; a cart, rack, or stand that is recommended by Yamaha. If a cart, etc., is used, please observe all safety markings and instructions that accompany the accessory product.

SPECIFICATIONS SUBJECT TO CHANGE:

The information contained in this manual is believed to be correct at the time of printing. However, Yamaha reserves the right to change or modify any of the specifications without notice or obligation to update existing units.

This product, either alone or in combination with an amplifier and headphones or speaker/s, may be capable of producing sound levels that could cause permanent hearing loss. DO NOT operate for long periods of time at a high volume level or at a level that is uncomfortable. If you experience any hearing loss or ringing in the ears, you should consult an audiologist.

IMPORTANT: The louder the sound, the shorter the time period before damage occurs.

Some Yamaha products may have benches and / or accessory mounting fixtures that are either supplied with the product or as optional accessories. Some of these items are designed to be dealer assembled or installed. Please make sure that benches are stable and any optional fixtures (where applicable) are well secured BEFORE using.

Benches supplied by Yamaha are designed for seating only. No other uses are recommended.

NOTICE:

Service charges incurred due to a lack of knowledge relating to how a function or effect works (when the unit is operating as designed) are not covered by the manufacturer's warranty, and are therefore the owners responsibility. Please study this manual carefully and consult your dealer before requesting service.

ENVIRONMENTAL ISSUES:

Yamaha strives to produce products that are both user safe and environmentally friendly. We sincerely believe that our products and the production methods used to produce them, meet these goals. In keeping with both the letter and the spirit of the law, we want you to be aware of the following:

Battery Notice:

This product MAY contain a small non-rechargeable battery which (if applicable) is soldered in place. The average life span of this type of battery is approximately five years. When replacement becomes necessary, contact a qualified service representative to perform the replacement.

This product may also use "household" type batteries. Some of these may be rechargeable. Make sure that the battery being charged is a rechargeable type and that the charger is intended for the battery being charged.

When installing batteries, never mix old batteries with new ones, and never mix different types of batteries. Batteries MUST be installed correctly. Mismatches or incorrect installation may result in overheating and battery case rupture.

Warning:

Do not attempt to disassemble, or incinerate any battery. Keep all batteries away from children. Dispose of used batteries promptly and as regulated by the laws in your area. Note: Check with any retailer of household type batteries in your area for battery disposal information.

Disposal Notice:

Should this product become damaged beyond repair, or for some reason its useful life is considered to be at an end, please observe all local, state, and federal regulations that relate to the disposal of products that contain lead, batteries, plastics, etc. If your dealer is unable to assist you, please contact Yamaha directly.

NAME PLATE LOCATION:

The name plate is located on the bottom of the product. The model number, serial number, power requirements, etc., are located on this plate. You should record the model number, serial number, and the date of purchase in the spaces provided below and retain this manual as a permanent record of your purchase.

Model

Serial No.

Purchase Date

PLEASE KEEP THIS MANUAL

92-BP (bottom)

COMPLIANCE INFORMATION STATEMENT (DECLARATION OF CONFORMITY PROCEDURE)

Responsible Party : Yamaha Corporation of America
Address : 6600 Orangethorpe Ave., Buena Park, Calif.
90620
Telephone : 714-522-9011
Type of Equipment : Digital Keyboard
Model Name : PSR-E453/PSR-EW400

This device complies with Part 15 of the FCC Rules.

Operation is subject to the following two conditions:

- 1) this device may not cause harmful interference, and
- 2) this device must accept any interference received including interference that may cause undesired operation.

See user manual instructions if interference to radio reception is suspected.

* This applies only to products distributed by
YAMAHA CORPORATION OF AMERICA.

(FCC DoC)

FCC INFORMATION (U.S.A.)

1. IMPORTANT NOTICE: DO NOT MODIFY THIS UNIT!

This product, when installed as indicated in the instructions contained in this manual, meets FCC requirements. Modifications not expressly approved by Yamaha may void your authority, granted by the FCC, to use the product.

2. IMPORTANT: When connecting this product to accessories and/or another product use only high quality shielded cables. Cable/s supplied with this product **MUST** be used. Follow all installation instructions. Failure to follow instructions could void your FCC authorization to use this product in the USA.

3. NOTE: This product has been tested and found to comply with the requirements listed in FCC Regulations, Part 15 for Class "B" digital devices. Compliance with these requirements provides a reasonable level of assurance that your use of this product in a residential environment will not result in harmful interference with other electronic devices. This equipment generates/uses radio frequencies and, if not installed and used according to the instructions found in the users manual, may cause interference harmful to the operation of other electronic devices. Compliance with FCC regulations does

not guarantee that interference will not occur in all installations. If this product is found to be the source of interference, which can be determined by turning the unit "OFF" and "ON", please try to eliminate the problem by using one of the following measures:

Relocate either this product or the device that is being affected by the interference.

Utilize power outlets that are on different branch (circuit breaker or fuse) circuits or install AC line filter/s.

In the case of radio or TV interference, relocate/reorient the antenna. If the antenna lead-in is 300 ohm ribbon lead, change the lead-in to co-axial type cable.

If these corrective measures do not produce satisfactory results, please contact the local retailer authorized to distribute this type of product. If you can not locate the appropriate retailer, please contact Yamaha Corporation of America, Electronic Service Division, 6600 Orangethorpe Ave, Buena Park, CA90620

The above statements apply **ONLY** to those products distributed by Yamaha Corporation of America or its subsidiaries.

* This applies only to products distributed by YAMAHA CORPORATION OF AMERICA.

(class B)

The model number, serial number, power requirements, etc., may be found on or near the name plate, which is at the bottom of the unit. You should note this serial number in the space provided below and retain this manual as a permanent record of your purchase to aid identification in the event of theft.

Model No.

Serial No.

(bottom_en_01)

For AC adaptor

This device complies with Part 15 of the FCC Rules. Operation is subject to the following two conditions: (1) this device may not cause harmful interference, and (2) this device must accept any interference received, including interference that may cause undesired operation.

(foc_sengen_C)

CAN ICES-3 (B)/NMB-3(B)

- This applies only to products distributed by Yamaha Canada Music Ltd.
- Ceci ne s'applique qu'aux produits distribués par Yamaha Canada Musique Ltée. (can_b_01)

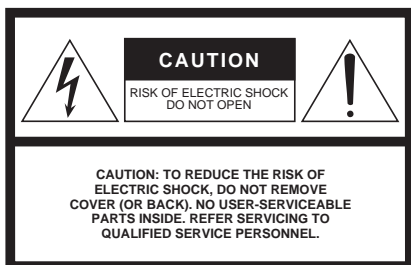

Explanation of Graphical Symbols



The lightning flash with arrowhead symbol within an equilateral triangle is intended to alert the user to the presence of uninsulated “dangerous voltage” within the product’s enclosure that may be of sufficient magnitude to constitute a risk of electric shock to persons.



The exclamation point within an equilateral triangle is intended to alert the user to the presence of important operating and maintenance (servicing) instructions in the literature accompanying the product.

IMPORTANT SAFETY INSTRUCTIONS

- 1 Read these instructions.
- 2 Keep these instructions.
- 3 Heed all warnings.
- 4 Follow all instructions.
- 5 Do not use this apparatus near water.
- 6 Clean only with dry cloth.
- 7 Do not block any ventilation openings. Install in accordance with the manufacturer’s instructions.
- 8 Do not install near any heat sources such as radiators, heat registers, stoves, or other apparatus (including amplifiers) that produce heat.
- 9 Do not defeat the safety purpose of the polarized or grounding-type plug. A polarized plug has two blades with one wider than the other. A grounding type plug has two blades and a third grounding prong. The wide blade or the third prong are provided for your safety. If the provided plug does not fit into your outlet, consult an electrician for replacement of the obsolete outlet.
- 10 Protect the power cord from being walked on or pinched particularly at plugs, convenience receptacles, and the point where they exit from the apparatus.
- 11 Only use attachments/accessories specified by the manufacturer.
- 12 Use only with the cart, stand, tripod, bracket, or table specified by the manufacturer, or sold with the apparatus. When a cart is used, use caution when moving the cart/apparatus combination to avoid injury from tip-over.
- 13 Unplug this apparatus during lightning storms or when unused for long periods of time.
- 14 Refer all servicing to qualified service personnel. Servicing is required when the apparatus has been damaged in any way, such as power-supply cord or plug is damaged, liquid has been spilled or objects have fallen into the apparatus, the apparatus has been exposed to rain or moisture, does not operate normally, or has been dropped.



WARNING

TO REDUCE THE RISK OF FIRE OR ELECTRIC SHOCK, DO NOT EXPOSE THIS APPARATUS TO RAIN OR MOISTURE.

(UL60065_03)

PRECAUTIONS

PLEASE READ CAREFULLY BEFORE PROCEEDING

Please keep this manual in a safe and handy place for future reference.

For AC adaptor



WARNING

- This AC adaptor is designed for use with only Yamaha electronic instruments. Do not use for any other purpose.
- Indoor use only. Do not use in any wet environments.



CAUTION

- When setting up, make sure that the AC outlet is easily accessible. If some trouble or malfunction occurs, immediately turn off the power switch of the instrument and disconnect the AC adaptor from the outlet. When the AC adaptor is connected to the AC outlet, keep in mind that electricity is flowing at the minimum level, even if the power switch is turned off. When you are not using the instrument for a long time, make sure to unplug the power cord from the wall AC outlet.

For PSR-E453/PSR-EW400



WARNING

Always follow the basic precautions listed below to avoid the possibility of serious injury or even death from electrical shock, short-circuiting, damages, fire or other hazards. These precautions include, but are not limited to, the following:

Power supply/AC adaptor

- Do not place the power cord near heat sources such as heaters or radiators. Also, do not excessively bend or otherwise damage the cord, or place heavy objects on it.
- Only use the voltage specified as correct for the instrument. The required voltage is printed on the name plate of the instrument.
- Use the specified adaptor (page 72) only. Using the wrong adaptor can result in damage to the instrument or overheating.
- Check the electric plug periodically and remove any dirt or dust which may have accumulated on it.

Do not open

- This instrument contains no user-serviceable parts. Do not open the instrument or attempt to disassemble or modify the internal components in any way. If it should appear to be malfunctioning, discontinue use immediately and have it inspected by qualified Yamaha service personnel.

Water warning

- Do not expose the instrument to rain, use it near water or in damp or wet conditions, or place on it any containers (such as vases, bottles or glasses) containing liquids which might spill into any openings. If any liquid such as water seeps into the instrument, turn off the power immediately and unplug the power cord from the AC outlet. Then have the instrument inspected by qualified Yamaha service personnel.
- Never insert or remove an electric plug with wet hands.

Fire warning

- Do not put burning items, such as candles, on the unit. A burning item may fall over and cause a fire.

Battery

- Follow the precautions below. Failure to do so might result in explosion, fire, overheating or battery fluid leakage.
 - Do not tamper with or disassemble batteries.
 - Do not dispose of batteries in fire.
 - Do not attempt to recharge batteries that are not designed to be charged.
 - Keep the batteries separate from metallic objects such as necklaces, hairpins, coins, and keys.
 - Use the specified battery type (page 72) only.
 - Use new batteries, all of which are the same type, same model, and made by the same manufacturer.
 - Always make sure all batteries are inserted in conformity with the +/- polarity markings.
 - When the batteries run out, or if the instrument is not to be used for a long time, remove the batteries from the instrument.
 - When using Ni-MH batteries, follow the instructions that came with the batteries. Use only the specified charger device when charging.

- Keep batteries away from small children who might accidentally swallow them.
- If the batteries do leak, avoid contact with the leaked fluid. If the battery fluid should come in contact with your eyes, mouth, or skin, wash immediately with water and consult a doctor. Battery fluid is corrosive and may possibly cause loss of sight or chemical burns.

If you notice any abnormality

- When one of the following problems occur, immediately turn off the power switch and disconnect the electric plug from the outlet. (If you are using batteries, remove all batteries from the instrument.) Then have the device inspected by Yamaha service personnel.
 - The power cord or plug becomes frayed or damaged.
 - It emits unusual smells or smoke.
 - Some object has been dropped into the instrument.
 - There is a sudden loss of sound during use of the instrument.



CAUTION

Always follow the basic precautions listed below to avoid the possibility of physical injury to you or others, or damage to the instrument or other property. These precautions include, but are not limited to, the following:

Power supply/AC adaptor

- Do not connect the instrument to an electrical outlet using a multiple-connector. Doing so can result in lower sound quality, or possibly cause overheating in the outlet.
- When removing the electric plug from the instrument or an outlet, always hold the plug itself and not the cord. Pulling by the cord can damage it.
- Remove the electric plug from the outlet when the instrument is not to be used for extended periods of time, or during electrical storms.

Location

- Do not place the instrument in an unstable position where it might accidentally fall over.
- Before moving the instrument, remove all connected cables, to prevent damage to the cables or injury to anyone who might trip over them.

- When setting up the product, make sure that the AC outlet you are using is easily accessible. If some trouble or malfunction occurs, immediately turn off the power switch and disconnect the plug from the outlet. Even when the power switch is turned off, electricity is still flowing to the product at the minimum level. When you are not using the product for a long time, make sure to unplug the power cord from the wall AC outlet.
- Use only the stand specified for the instrument. When attaching it, use the provided screws only. Failure to do so could cause damage to the internal components or result in the instrument falling over.

Connections

- Before connecting the instrument to other electronic components, turn off the power for all components. Before turning the power on or off for all components, set all volume levels to minimum.
- Be sure to set the volumes of all components at their minimum levels and gradually raise the volume controls while playing the instrument to set the desired listening level.

Handling caution

- Do not insert a finger or hand in any gaps on the instrument.
- Never insert or drop paper, metallic, or other objects into the gaps on the panel or keyboard. This could cause physical injury to you or others, damage to the instrument or other property, or operational failure.

- Do not rest your weight on, or place heavy objects on the instrument, and do not use excessive force on the buttons, switches or connectors.
- Do not use the instrument/device or headphones for a long period of time at a high or uncomfortable volume level, since this can cause permanent hearing loss. If you experience any hearing loss or ringing in the ears, consult a physician.

Yamaha cannot be held responsible for damage caused by improper use or modifications to the instrument, or data that is lost or destroyed.

Always turn the power off when the instrument is not in use.

Even when the [] (Standby/On) switch is in standby status (display is off), electricity is still flowing to the instrument at the minimum level.

When you are not using the instrument for a long time, make sure you unplug the power cord from the wall AC outlet.

Make sure to discard used batteries according to local regulations.

DMI-5 3/3

NOTICE

To avoid the possibility of malfunction/ damage to the product, damage to data, or damage to other property, follow the notices below.

■ Handling

- Do not use the instrument in the vicinity of a TV, radio, stereo equipment, mobile phone, or other electric devices. Otherwise, the instrument, TV, or radio may generate noise. When you use the instrument along with an application on your iPad, iPhone or iPod touch, we recommend that you set "Airplane Mode" to "ON" on that device in order to avoid noise caused by communication.
- Do not expose the instrument to excessive dust or vibrations, or extreme cold or heat (such as in direct sunlight, near a heater, or in a car during the day) to prevent the possibility of panel discoloration, damage to the internal components or unstable operation. (Verified operating temperature range: 5° – 40°C, or 41° – 104°F.)
- Do not place vinyl, plastic or rubber objects on the instrument, since this might discolor the panel or keyboard.

■ Maintenance

- When cleaning the instrument, use a soft cloth. Do not use paint thinners, solvents, alcohol, cleaning fluids, or chemical-impregnated wiping cloths.

■ Saving data

- Some of the data of this instrument (page 39) are retained when the power is turned off. However, the saved data may be lost due to some failure, an operation mistake, etc. Save your important data onto USB flash drive/an external device such as a computer (pages 36, 64). Before using a USB flash drive, make sure to refer to page 62.
- To protect against data loss through USB flash drive damage, we recommend that you save your important data onto spare USB flash drive or an external device such as a computer as backup data.

Information

■ About copyrights

- Copying of the commercially available musical data including but not limited to MIDI data and/or audio data is strictly prohibited except for your personal use.
- This product incorporates and bundles contents in which Yamaha owns copyrights or with respect to which Yamaha has license to use others' copyrights. Due to copyright laws and other relevant laws, you are NOT allowed to distribute media in which these contents are saved or recorded and remain virtually the same or very similar to those in the product.
 - * The contents described above include a computer program, Accompaniment Style data, MIDI data, WAVE data, voice recording data, a score, score data, etc.
 - * You are allowed to distribute medium in which your performance or music production using these contents is recorded, and the permission of Yamaha Corporation is not required in such cases.

■ About functions/data bundled with the instrument

- Some of the preset songs and the songs that can be downloaded from the Yamaha website have been edited for length or arrangement, and may not be exactly the same as the original.

■ About this manual

- The illustrations and LCD screens as shown in this manual are for instructional purposes only, and may appear somewhat different from those on your instrument.
- Windows is a registered trademark of Microsoft® Corporation in the United States and other countries.
- iPhone, iPad and iPod touch are trademarks of Apple Inc., registered in the U.S. and other countries.
- The company names and product names in this manual are the trademarks or registered trademarks of their respective companies.

Table of Contents

| | |
|---------------------------------------|----|
| Special Features | 8 |
| Compatible Format and Functions | 10 |
| Included Accessories | 10 |
| About the Manuals | 11 |

Setting Up

| | |
|---|-----------|
| Panel Controls and Terminals | 12 |
| Setting Up | 14 |
| Power Requirements | 14 |
| Turning the Power On/Off | 16 |
| Adjusting the Master Volume | 16 |
| Connecting Headphones or an External Device | 16 |
| Using a Pedal (Sustain) | 17 |
| Using a Keyboard Stand | 17 |

Quick Guide

| | |
|---|-----------|
| Basic Operation and Display Items | 18 |
| Basic Operation | 18 |
| Display Items | 19 |
| Try Playing a Variety of Instrument Voices | 20 |
| Selecting a Main Voice | 20 |
| Playing the "Grand Piano" | 20 |
| Layering a Dual Voice | 21 |
| Playing a Split Voice in the Left Hand area | 21 |
| Using the Metronome | 22 |
| Adding Harmony | 23 |
| Creating Arpeggios | 24 |
| Triggering Arpeggios | 24 |
| Changing the Arpeggio Type | 24 |
| Creating Original Sounds via the Knobs | 25 |
| Assigning Functions to the Knobs | 25 |
| Using the Knobs | 25 |

| | |
|---|-----------|
| Playing Styles | 26 |
| Using the Music Database | 26 |
| Playing with Patterns Like a DJ! | 27 |
| Playing Songs | 28 |
| Listening to a Demo Song | 28 |
| Selecting and Playing Back a Song | 28 |
| Song Fast Forward, Fast Reverse, and Pause | 29 |
| Playing a Specified Section of a Song Repeatedly (A-B Repeat) | 29 |
| Turning Each Track On/Off | 29 |
| Using the Song Lesson Feature | 30 |
| Making Practice Perfect—Repeat & Learn | 31 |
| Recording Your Performance | 32 |
| Track Structure of a Song | 32 |
| Quick Recording | 32 |
| Recording to a Specified Track | 33 |
| Clearing a User Song | 34 |
| Clearing a Specified Track from a User Song | 34 |
| Memorizing Your Favorite Settings (Registration Memory) | 35 |
| Memorizing Panel Settings to the Registration Memory | 35 |
| Recalling Panel Settings from the Registration Memory | 35 |
| Connecting to Other Devices | 36 |
| Playing an External Audio Device with the Built-in Speakers | 36 |
| Connecting to a Computer | 36 |
| Connecting to an iPhone/iPad | 37 |
| Using the Melody Suppressor | 37 |
| Using an External Stereo System for Playback (OUTPUT [L/L+R]/[R] jacks) (PSR-EW400) | 38 |
| Speaker Mute On/Off Setting (PSR-EW400) | 38 |
| Backup and Initialization | 39 |
| Backup Parameters | 39 |
| Initializing the Instrument | 39 |

Special Features

Play a Variety of Instrument Voices

► Page 20

The instrument voice that sounds when you play the keyboard can be changed to violin, flute, harp, or any of an extensive range of voices.



Arpeggio Function

► Page 24

Similar to the arpeggio functions provided on some synthesizers, this function automatically produces arpeggios (broken chords) when you simply play the appropriate notes on the keyboard.



Play Audio via an External Device

► Page 36

By connecting an external audio device such as an iPhone/iPad or a device such as a computer, you can play the audio sound of that external device through this instrument.

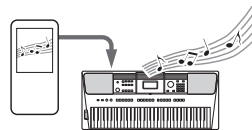

Reference

| | |
|---|-----------|
| Handy Performance Features | 40 |
| Selecting a Reverb Type | 40 |
| Selecting a Chorus Type | 40 |
| Pitch Controls—Transpose | 41 |
| Pitch Controls—Fine Tuning | 41 |
| Pitch Controls—the [PITCH BEND] wheel | 41 |
| Calling Up Optimum Panel Settings—One Touch Setting (OTS) | 41 |
| Changing the Touch Response of the Keyboard | 42 |
| Selecting an EQ Setting for the Best Sound | 42 |
| Scale Tuning | 43 |
| Selecting a Scale | 43 |
| Setting the Base Note for Each Scale | 43 |
| Tuning Each Note to Create an Original Scale | 44 |
| Voice Settings | 45 |
| Selecting a Dual Voice | 45 |
| Selecting a Split Voice | 45 |
| Voice Editing | 45 |
| Parameters Assigned to the Knobs | 46 |
| Adding DSP Effects | 48 |
| Arpeggio Settings | 49 |
| Synchronizing an Arpeggio to Song/Style/Pattern Playback—Arpeggio Quantize | 49 |
| Holding the Arpeggio Playback via the Footswitch | 49 |
| Style and Pattern Settings | 50 |
| Style Variations—Sections | 50 |
| Style Synchro Stop | 51 |
| Turning Each Style Track On/Off | 51 |
| Pattern Variations—Sections | 52 |
| Pattern Retrigger Function | 52 |
| Changing the Tempo | 52 |
| Tap Start | 52 |

| | |
|---|-----------|
| Adjusting the Volume of the Style or Pattern | 53 |
| Setting the Split Point | 53 |
| Playing Chords Without Style Playback (Stop Accompaniment) | 53 |
| Chord Types for Style Playback | 54 |
| Looking Up Chords Using the Chord Dictionary | 55 |
| Song Settings | 56 |
| BGM (Background Music) Playback | 56 |
| Random Song Playback | 56 |
| Tempo Setting of the Song | 57 |
| Tap Start | 57 |
| Song Volume | 57 |
| Melody Voice Setting of the Preset Song | 57 |
| The Functions | 58 |
| Basic Procedure in the Function Display | 58 |
| USB Flash Drive Operations | 62 |
| Connecting a USB Flash Drive | 63 |
| Formatting a USB Flash Drive | 64 |
| Saving User Data to a USB Flash Drive | 64 |
| Saving a User Song as SMF to a USB Flash Drive | 65 |
| Loading User Data from a USB Flash Drive | 66 |
| Loading a Style File | 67 |
| Deleting a User File in the USB Flash Drive | 68 |
| Deleting an SMF File in the USB Flash Drive | 68 |
| Exiting from a File Control Display | 69 |
| Message List | 69 |

Appendix

| | |
|-----------------------|----|
| Troubleshooting | 70 |
| Specifications | 71 |
| Index | 73 |

Play Along with Styles

► Page 26

The auto-accompaniment Styles provide the equivalent of a full backing band covering a wide variety of music genres. Select a Style that matches the music you want to play, or experiment with new Styles to expand your musical horizons.



Create New Sounds

► Page 25

By simply adjusting two knobs you can enhance the sound of your performance with dynamic effect processing, such as adding distortion or applying luscious reverb. The functions that can be assigned to the knobs include filter, DSP effect, etc.



Try playing like a DJ by using the Patterns!

► Page 27

The Pattern function lets you perform like a DJ. Use the Track Control to try out various instrument combinations, and play with the Knobs to create various new sounds.



Compatible Format and Functions



GM System Level 1

“GM System Level 1” is an addition to the MIDI standard which ensures that any GM-compatible music data can be accurately played by any GM-compatible tone generator, regardless of manufacturer. The GM mark is affixed to all software and hardware products that support GM System Level.



XGlite

As its name implies, “XGlite” is a simplified version of Yamaha’s high-quality XG tone generation format. Naturally, you can play back any XG song data using an XGlite tone generator. However, keep in mind that some songs may play back differently compared to the original data, due to the reduced set of control parameters and effects.



USB

USB is an abbreviation for Universal Serial Bus. It is a serial interface for connecting a computer with peripheral Devices. It allows “hot swapping” (connecting peripheral devices while the power to the computer is on).



STYLE FILE FORMAT (SFF)

The Style File Format is Yamaha’s original style file format which uses a unique conversion system to provide high-quality automatic accompaniment based on a wide range of chord types.

Included Accessories

- Owner’s Manual (this book)
- Data List
- AC adaptor*¹
- Power cord (PSR-EW400)
- Music rest
- Online Member Product Registration*²

*1:May not be included depending on your area. Check with your Yamaha dealer.

*2:The PRODUCT ID on the sheet will be needed when you fill out the User Registration form.

Attaching the Music Rest

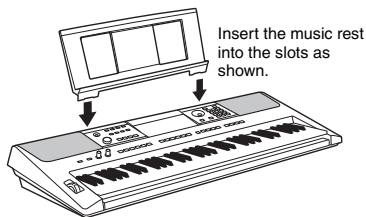

About the Manuals

This instrument has the following documents and instructional materials.

NOTE

- The illustrations and displays as shown in this manual are based on the PSR-E453.
- Please note that the PSR-EW400 and PSR-E453 have different numbers of keys: the PSR-EW400 has 76 keys, and the PSR-E453 has 61 keys.

■ Included Documents



Owner's Manual (this book)

- **Setting Up** Please read this section first.
- **Quick Guide** This section explains how to use the basic functions.
- **Reference** This section explains how to make detailed settings for the various functions of the instrument.
- **Appendix** This section includes troubleshooting and specifications.



Data List

Contains various important preset content lists such as those of Voices, Styles, Patterns and Effects.

■ Online Materials (PDF)



MIDI Reference

Contains MIDI-related information for this instrument.



MIDI Basics (only in English, French, German and Spanish)

Contains basic explanations about MIDI.



Computer-related Operations

Includes instructions on connecting this instrument to a computer, and operations related to transmitting/receiving the data.



iPhone/iPad Connection Manual

Explains how to connect the instrument to smart devices, such as iPhone, iPad, etc.

To obtain these materials, access the Yamaha Downloads website, then enter the model name for searching the desired files.

Yamaha Downloads <http://download.yamaha.com/>

Downloading the Song Book/Song Data



Song Book (only in English, French, German, Spanish and Japanese)

Contains music scores for the preset Songs (excluding the Demo Songs) of this instrument and the optional Songs.



Song Data

Contains the data of 70 Songs that can be played back with this instrument and/or used for the Song Lesson (page 30).

After completing the user registration at the website below, you can download the Song Book and the Song Data free of charge.

Yamaha Online Member <https://member.yamaha.com/>

You will need the PRODUCT ID on the sheet ("Online Member Product Registration") packaged with this manual in order to fill out the User Registration form.

NOTE

- The downloaded Song data can be played back by transferring data from the computer to the instrument or saving data to the USB flash drive (page 28).

Panel Controls and Terminals

Front Panel

The illustration is of the PSR-E453.

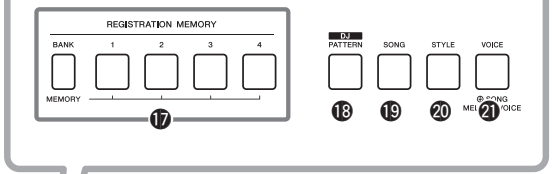
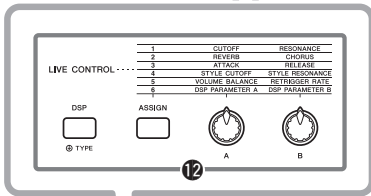
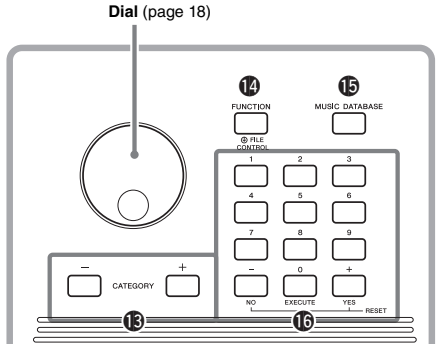
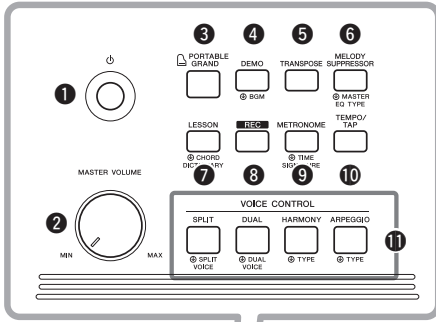

Display (page 19)

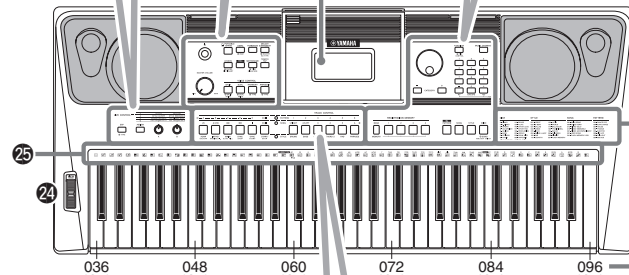

- Voice List (Data List)
- Style List (Data List)
- Song List (Data List)
- Pattern List (Data List)

As illustrated, each note of the keyboard has a specific note number and name (e.g., 036/C1), which is used in making various settings, such as Split Point (page 53).

PSR-E453: 036 (C1) – 096 (C6)
PSR-EW400: 028 (E0) – 103 (G6)

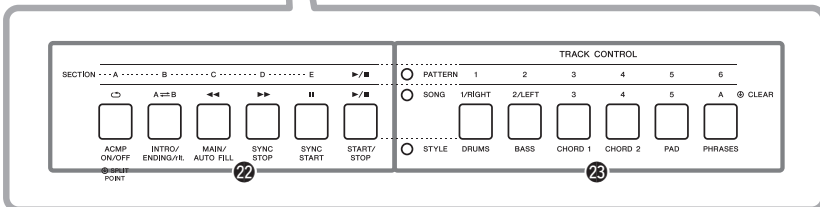

- 1 [⏻] (Standby/On) switchPage 16
- 2 [MASTER VOLUME] controlPage 16
- 3 [PORTABLE GRAND] buttonPage 20
- 4 [DEMO] buttonPage 28
- 5 [TRANPOSE] buttonPage 41
- 6 [MELODY SUPPRESSOR] button.....Page 37
- 7 [LESSON] buttonPage 30
- 8 [REC] buttonPage 32
- 9 [METRONOME] buttonPage 22
- 10 [TEMPO/TAP] buttonPage 52
- 11 VOICE CONTROL section
 - [SPLIT] buttonPage 21
 - [DUAL] buttonPage 21
 - [HARMONY] buttonPage 23
 - [ARPEGGIO] buttonPage 24
- 12 LIVE CONTROL section
 - [ASSIGN] buttonPage 25
 - [A] and [B] knobsPage 25
 - [DSP] buttonPage 48
- 13 CATEGORY buttonsPage 18
- 14 [FUNCTION] buttonPage 58
- 15 [MUSIC DATABASE] buttonPage 26
- 16 Number buttons [1]–[9], [-/NO], [0/EXECUTE] and [+ /YES] buttonsPage 18
- 17 REGISTRATION MEMORY buttons
 - [BANK/MEMORY] buttonsPage 35
 - [1]–[4] buttonsPage 35
- 18 [PATTERN] buttonPage 27
- 19 [SONG] buttonPage 28
- 20 [STYLE] buttonPage 26
- 21 [VOICE] buttonPage 20
- 22 PATTERN/SONG/STYLE Control buttons
 - When the [PATTERN] lamp is on:Pages 27 and 52
 - When the [SONG] lamp is on:Page 29
 - When the [STYLE] lamp is on:Pages 26, 50, and 51
- 23 TRACK CONTROL buttons
 - When the [PATTERN] lamp is on:Page 27
 - When the [SONG] lamp is on:Pages 29, 32
 - When the [STYLE] lamp is on:Page 51
- 24 [PITCH BEND] wheelPage 41
- 25 Drum illustrations for the Drum Kit.....Page 20

These indicate the drum or percussion instrument assigned to the corresponding keys (in the case of “Standard Kit 1,” shown in the Drum/SFX Kit List of the separate Data List).

Rear Panel

PSR-E453

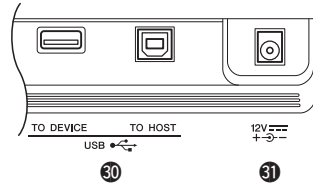
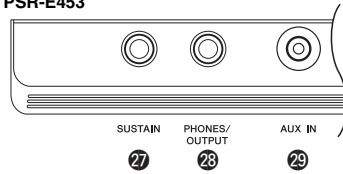

PSR-EW400

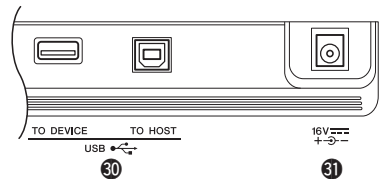
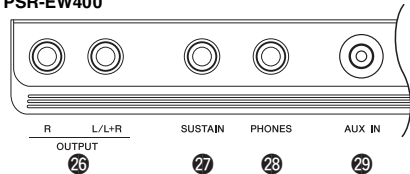

- 26 OUTPUT [L/L+R]/[R] jacks (PSR-EW400)Page 38
- 27 [SUSTAIN] jackPage 17
- 28 [PHONES/OUTPUT] jack (PSR-E453), [PHONES] jack (PSR-EW400)Page 16
- 29 [AUX IN] jackPage 36
- 30 [USB TO DEVICE] terminalPage 62
- 31 [USB TO HOST] terminalPage 36
- 31 DC IN jackPage 14

Setting Up

Power Requirements

Although the instrument will run either from an AC adaptor or batteries, Yamaha recommends use of an AC adaptor whenever possible. An AC adaptor is more environmentally friendly than batteries and does not deplete resources.

NOTICE

- You should use an AC adaptor when executing USB flash drive operations, since battery power may not be reliable enough to last through these crucial operations.

Using an AC Adaptor

Connect the AC adaptor in the order shown in the illustration.

PSR-E453

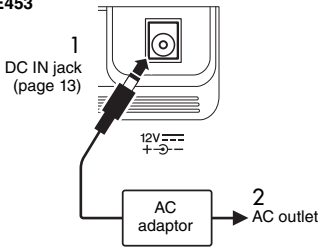

PSR-EW400

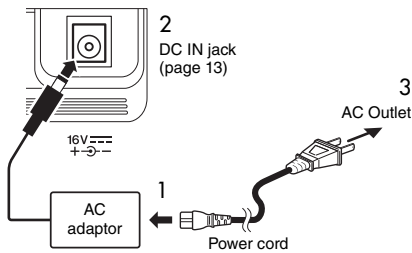

The shape of the plug differs depending on your area.

WARNING

- Use the specified AC adaptor (page 72) only. Using the wrong AC adaptor can result in damage to the instrument or overheating.

WARNING

- When using the AC adaptor with a removable plug, make sure to keep the plug attached to the AC adaptor. Using the plug alone can cause electric shock or fire.
- Never touch the metallic section when attaching the plug. To avoid electric shock, short circuit or damage, also be careful that there is no dust between the AC adaptor and plug.

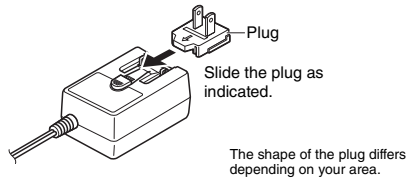

CAUTION

- When setting up the product, make sure that the AC outlet you are using is easily accessible. If some trouble or malfunction occurs, immediately turn the power off and disconnect the plug from the outlet.

NOTE

- Follow this procedure in reverse order when disconnecting the AC adaptor.

Using Batteries

This instrument requires the following batteries.

- **PSR-E453:** Six "AA" size alkaline (LR6), manganese (R6) or Ni-MH rechargeable batteries.
- **PSR-EW400:** Six "D" size alkaline (LR20), manganese (R20) or Ni-MH rechargeable batteries.

The Alkaline batteries or rechargeable Ni-MH batteries are recommended for this instrument, since other types may result in poorer battery performance.

NOTICE

- When using Ni-MH batteries, follow the instructions that came with the batteries.

- 1 Make sure that the power of the instrument is off.
- 2 Open the battery compartment cover located on the instrument's bottom panel.

PSR-E453

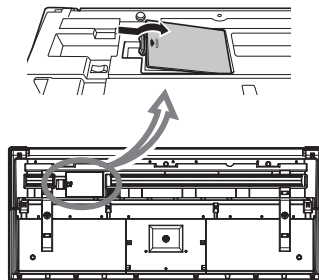

PSR-EW400

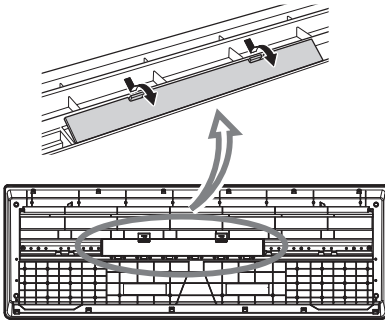

3 Insert the six new batteries, putting them in the correct direction according to the illustration.

PSR-E453

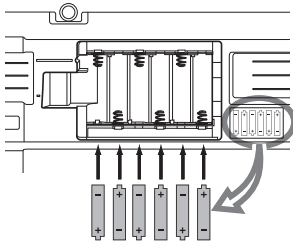

PSR-EW400

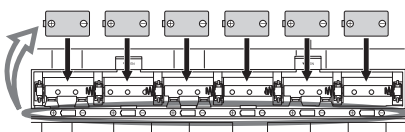

4 Replace the compartment cover, making sure that it locks firmly in place.

NOTICE

- **Connecting or disconnecting the AC adaptor with batteries installed may turn the power off, resulting in loss of data being recorded or transferred at the time.**
- **Make sure to set the battery type correctly (page 15).**
- **When battery power becomes too low for proper operation, the volume may be reduced, the sound may be distorted, and other problems may occur. When this happens, make sure to replace all batteries with new ones or already-recharged ones.**

NOTE

- **This instrument cannot charge the batteries. Use only the specified charger device when charging.**
- **Power will be automatically drawn from the AC adaptor if an AC adaptor is connected while batteries are installed in the instrument.**

■ Setting the battery type

Depending on the battery type to be used, you may need to change the battery type setting on this instrument. To change the setting, first turn on the power to the instrument, then choose the battery type you would like to use. Alkaline (and manganese) batteries are chosen by default. For details, refer to page 61, Function 068 (PSR-E453)/Function 069 (PSR-EW400).

NOTICE

- **Failure to set the battery type may shorten the amount of the battery life. Make sure to set the battery type correctly.**

■ Checking the power status

You can confirm the power source at the left corner of the display.

Only one of these is shown.



: The power is supplied from the AC adaptor.

: The power is supplied from the batteries.

NOTE

- **When the AC adaptor is plugged in to the AC outlet, the battery icon does not appear even when batteries are inserted. In this case, the power is supplied from the AC adaptor.**

Remaining battery power indication

| | |
|--|---|
| | Indicates that the power will be turned off immediately. When rechargeable batteries are used, this icon flashes before the power is turned off. |
| | Indicates that remaining power is insufficient for operation. Before the power runs out, replace all the batteries with new ones, or fully recharged ones (when using rechargeable types). Note that the instrument may not work properly, including unusually soft volume and poor sound quality when remaining power becomes low. |
| | Indicates that the remaining power is sufficient. |

Turning the Power On/Off

- 1 Turn down the [MASTER VOLUME] control to "MIN."

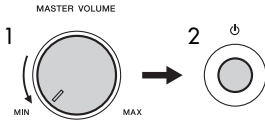

- 2 Press the [⏻] (Standby/On) switch to turn the power on.
Adjust the volume as desired while playing the keyboard.
- 3 Press and hold the [⏻] (Standby/On) switch for about a second to turn the power off.

CAUTION

- Even when the power is off, a small amount of electricity is still being consumed by the instrument. When you are not using the instrument for a long time, make sure to unplug the AC adaptor from the wall AC outlet.

NOTICE

- Press only the [⏻] (Standby/On) switch when turning the power on. Any other operations such as pressing keys, buttons or the pedal are not allowed. Doing so may cause the instrument to malfunction.

Setting the Auto Power Off function

To prevent unnecessary power consumption, this instrument features an Auto Power Off function that automatically turns the power off if the instrument is not operated for a specified period of time. The amount of time that elapses before the power is automatically turned off is 30 minutes by default; however, you can change the setting. For details, refer to page 61, Function 067 (PSR-E453)/Function 068 (PSR-EW400).

Disabling Auto Power Off (simple method)

Turn the power on while holding down the lowest key on the keyboard. Then the instrument starts up with the Auto Power Off function disabled.

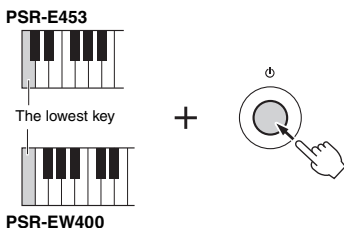

NOTICE

- When the instrument is not operated for a specified period of time while connected to an external device such as an amplifier, speaker or computer, make sure to follow the instructions in the Owner's Manual to turn off the power to the instrument and the connected devices, in order to protect the devices from damage. If you do not want the power to turn off automatically when a device is connected, disable Auto Power Off.

NOTE

- Generally, the data and settings are maintained even when the power is turned off. For details, see page 39.

Adjusting the Master Volume

To adjust the volume of the entire keyboard sound, use the [MASTER VOLUME] control while playing the keyboard.

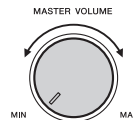

CAUTION

- Do not use the instrument for a long period of time at a high or uncomfortable volume level, since this can cause permanent hearing loss.

Connecting Headphones or an External Device

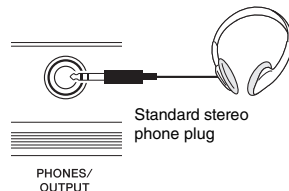

Connecting Headphones

Connect a pair of headphones to the [PHONES/OUTPUT]/[PHONES] jack on the rear panel.

The built-in speakers are automatically shut off when a plug is inserted into this jack.

Connecting an External Device

- **PSR-E453:** This jack also functions as an external output. By connecting to a computer, keyboard amplifier, recorder, or other audio device, you can

output the audio signal of this instrument to that external device. The speakers of this instrument are automatically shut off when a plug is inserted into this jack.

- **PSR-EW400:** When connecting an external speaker, refer to page 38.

⚠ CAUTION

- *Do not use the headphones for a long period of time at a high or uncomfortable volume level, since this can cause permanent hearing loss.*
- *Before connecting the instrument to other electronic components, turn off the power of all the components. Also, before turning any components on or off, make sure to set all volume levels to minimum. Otherwise, damage to the components or electrical shock may occur.*

NOTICE

- *To avoid possible damage to the external device, first turn on the power to the instrument, then to the external device. When turning off the power, do so in reverse order: first turn off the power to the external device, then to the instrument.*

Using a Pedal (Sustain)

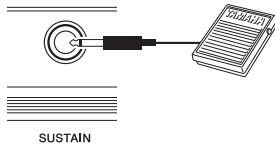

You can produce a natural sustain as you play by pressing a footswitch (FC5 or FC4A; sold separately) plugged into the [SUSTAIN] jack.

NOTE

- *Plug or unplug the footswitch while the power is off. Also, do not press the footswitch when turning the power on. Doing so changes the polarity of the footswitch, resulting in reversed operation.*
- *The sustain function does not affect Split Voices (page 21).*
- *Some Voices may sound continuously or have a long decay after the notes have been released while the footswitch is held.*

Using a Keyboard Stand

The following keyboard stands (sold separately) can be used.

- **PSR-E453:** L-2C
- **PSR-EW400:** L-6

When using L-6 Keyboard Stand (PSR-EW400)

The exterior size of PSR-EW400 is beyond the limits as described in the L-6 Assembly Instructions. However, we have determined through tests that the stand can be safely used for the instrument. When setting the instrument, place it on the center of the stand as shown in the illustration.

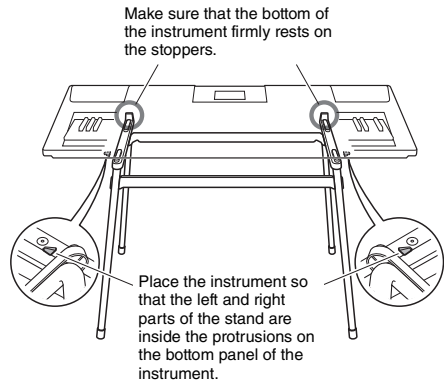

⚠ CAUTION

- *Do not place the instrument in an unstable position where it might accidentally slip down. This could cause physical injury to you or others, as well as damage to the instrument or other property.*

Basic Operation and Display Items

Basic Operation

This instrument features four basic functions: Voice, Style, Pattern and Song. To use this instrument, select a basic function first, and then make various settings.

3 Start a function or play the keyboard.

2 Select an item or value.

1 Select a basic function.

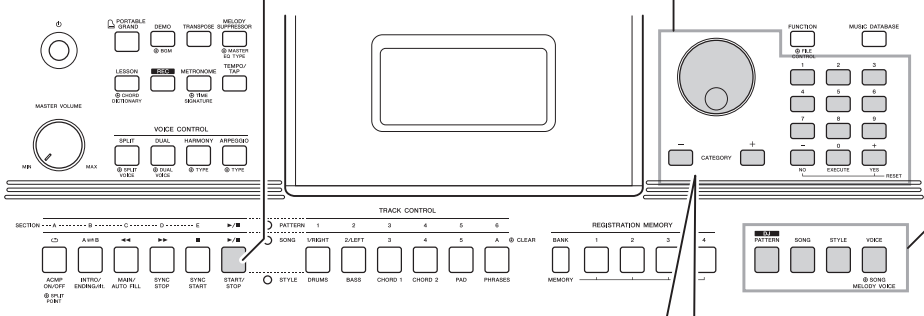

Quick Guide

Number buttons [0]–[9]

Use these buttons to directly enter the desired Style/Voice number etc, or a parameter value.

Example:
Selecting Voice 003, Bright Piano.

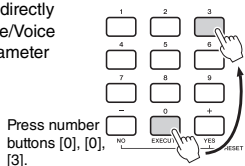

Dial

Rotate the dial clockwise to increase the value of the selected item, or counter-clockwise to decrease its value.

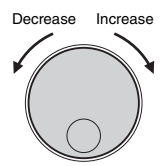

[+]/[YES], [-]/[NO] buttons

Press the [+]/[YES] button briefly to increase the value by 1, or press the [-]/[NO] button briefly to decrease the value by 1. Press and hold either button to continuously increase or decrease the value in the corresponding direction.

Pressing both buttons simultaneously lets you reset a parameter to the default value.

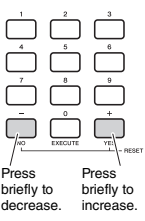

CATEGORY [+], [-] buttons

When selecting a Voice, Style, Pattern, Song, etc., you can use these buttons to jump to the first item in the next or previous category. These buttons can also be used to select function items sequentially after pressing the [FUNCTION] button.

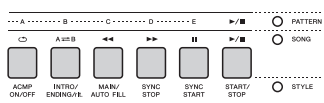
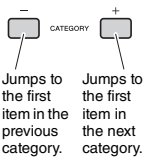

Depending on the basic function selected in step 1, you can use the different functions as printed on the panel. Song functions are printed above the buttons, Pattern functions are printed further above, and Style functions are printed below.

The "Press & Hold" Symbol



Buttons having this indication can be used to call up an alternate function when the relevant button is pressed and held. Hold down this button until the function calls up.

In most procedures described throughout this manual, the dial is used for selecting items or changing values. Note however, that in most cases in which the dial can be used to change values, the [+]/[YES] and [-]/[NO] buttons can also be used.

Display Items

The display shows all the current settings of the Song, Style Pattern, Voice and other related functions.

Power source status

Indicates the source from which this instrument obtains power, AC adaptor or batteries (page 15).



USB connection status

Appears when USB flash drive is connected to this instrument (page 63).

USB

Notation

Normally this indicates the notes you play. When the Song Lesson function is used, this indicates the current notes and chord of playback. When the Dictionary function is used, this indicates the notes of the chord you specify.



NOTE 1

- Any notes occurring below or above the staff are indicated by "8va."
- For a few specific chords, not all notes may be shown, due to space limitations in the display.

The illustration is of the PSR-E453.

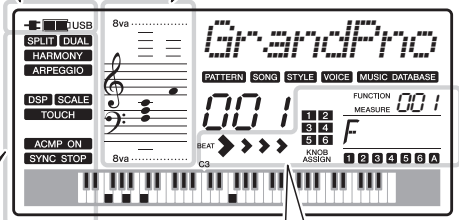

On/off status

This area indicates the on/off status of each function. Each indication is shown when the corresponding function is turned on.

- SPLIT** page 21
- DUAL** page 21
- HARMONY** page 23
- ARPEGGIO** page 24
- DSP** page 48
- SCALE** page 43
- TOUCH** page 42
- ACMP ON** page 26
- SYNC STOP** page 51

Beat

Indicates the current beat of playback (page 28).



Knob assignment

Indicates the parameters currently assigned to the knobs (page 25).



FUNCTION and MEASURE

Indicates the Function number when the [FUNCTION] button is pressed, or the current Measure number during playback of a Song, Style or Pattern.



Chord

Indicates the chord which is being played in the Auto Accompaniment range (page 26) or specified via Song playback.



Track status

Indicates the on/off status of the current Song, Style or Pattern (pages 27, 29, 32, 51).



Quick Guide

Try Playing a Variety of Instrument Voices

This instrument features various instrumental Voices including piano. Not only can you play just one single Voice (Main Voice), but you can also layer a different Voice (Dual Voice) to the Main Voice, or play a different Voice (Split Voice) in the left-hand area of the keyboard from the right-hand area.

Selecting a Main Voice

1 Press the [VOICE] button.

The Voice number and name will be shown.
For a list of available Voices, refer to the Voice List in the separate Data List.

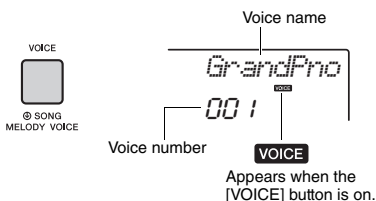

NOTE

- Voice number 001 on the PSR-EW400 is "Live! Grand Piano."

2 Use the dial to select the desired Voice.

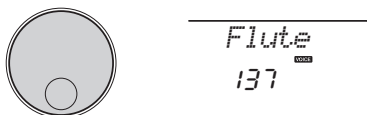

3 Play the keyboard.



Preset Voice Types

| | |
|---------------------------|--|
| 001–237 | Instrument Voices. |
| 238–261 (Drum/SFX Kit) | Various drum/percussion or SFX sounds are assigned to individual keys. Details on assigning instruments to keys are provided in the Drum/SFX Kit List of the separate Data List. |
| 262–301 | Used for Arpeggio performance (page 24). |
| 302–758 | XGlite Voices. |
| 000 | Selecting this automatically calls up the most suitable Voice and panel setups for the current Style, Song or Pattern. This function is called OTS (page 41). |

Playing the "Grand Piano"

When you want to reset various settings to default and simply play a Piano sound, press the [PORTABLE GRAND] button.



The Voice for the entire keyboard will be set to 001 "Grand Piano" (PSR-E453)/ or "Live! Grand Piano" (PSR-EW400).

Layering a Dual Voice

In addition to the Main Voice, you can layer a different Voice over the entire keyboard as a “Dual Voice.”

- 1 Press the [DUAL] button to turn Dual on.

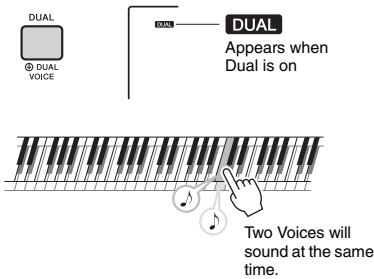

- 2 Press the [DUAL] button again to exit from Dual.

Although turning on Dual will select a Dual Voice suitable for the current Main Voice, you can also select a different Dual Voice (page 45).

Playing a Split Voice in the Left Hand area

By dividing the keyboard into the two separate areas, you can play a different Voice between the Left hand and Right hand areas.

- 1 Press the [SPLIT] button to turn Split on.

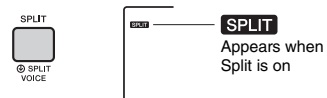

The keyboard is divided into left and right hand area at the Split Point. You can play a Split Voice on the left hand area while playing a Main Voice and Dual Voice on the right hand area of the keyboard.

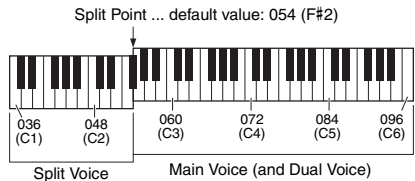

The Split Voice (page 45) and the Split Point can be changed as desired (page 53).

- 2 Press the [SPLIT] button again to exit from Split.

Using the Metronome

This instrument features a built-in metronome which can be used when practicing.

- 1 Press the [METRONOME] button to start the metronome.



- 2 Press the [METRONOME] button again to stop the metronome.

Adjusting the Metronome Tempo

This operation lets you adjust not only the metronome tempo, but also the tempo of Style, Song and Pattern.

- 1 Press the [TEMPO/TAP] button to call up "Tempo."

The current tempo is shown on the display.

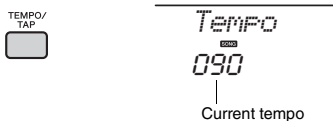

- 2 Adjust the tempo by rotating the dial.

Setting the Time Signature

Here, we'll set a time signature of 6/8 as an example.

- 1 Hold down the [METRONOME] button for longer than a second to call up "TimeSig" (Time Signature Numerator).

The number of beats per measure is shown on the display.

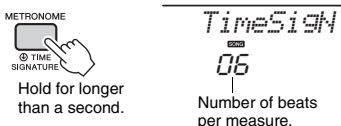

- 2 Rotate the dial to select the number of beats per measure.

A chime will sound on the first beat of each measure while a click sounds the other beats. If "0" is selected, a click sounds for all beats with no chime accent. Select 6 for this example.

NOTE

- This parameter cannot be set during playback of a Style, Song or Pattern.

- 3 Press the CATEGORY [+] button once to call up "TimeSig" (Time Signature Denominator).

The length of one beat is shown on the display.

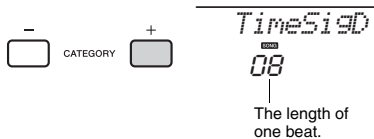

- 4 Rotate the dial to select the length of one beat, from 2nd, 4th, 8th and 16th note. Select "08" (8th note) for this example.

- 5 Confirm the setting by playing the Metronome.

Setting the Metronome Volume

- 1 Press the [FUNCTION] button.



- 2 Use the CATEGORY [+] and [-] buttons to call up "MtrVol" (Function 061).

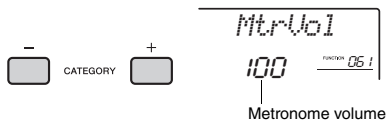

- 3 Rotate the dial to set the volume.

Adding Harmony

You can add effects such as Harmony, Tremolo and Echo to the Main Voice. For a list of the effects, refer to the Harmony Type List in the separate Data List.

1 Press the [HARMONY] button to turn Harmony on.



Although turning on the Harmony will select a Harmony type suitable for the current Main Voice, you can select a different Harmony type as described in the following steps.

2 Hold down the [HARMONY] button for longer than a second until "HarmType" (Function 042) appears on the display.

After a few seconds, the current Harmony type appears.

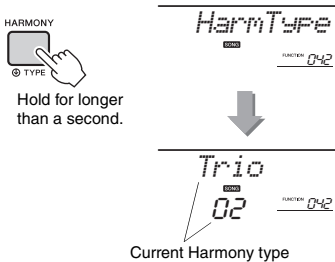

3 Rotate the dial to select the desired Harmony type.

The operation differs depending on the Harmony type. Try playing the keyboard by referring to "How to sound each Harmony Type" at right, and the Harmony Type List.

4 Press the [HARMONY] button again to turn Harmony off.

Playing each Harmony Type

- Harmony type 01 to 05



Press the right-hand keys while playing chords in the Auto Accompaniment area of the keyboard when ACMP is on (page 26).

- Harmony type 06 to 12 (Trill)



Hold down two keys.

- Harmony type 13 to 19 (Tremolo)



Keep holding down the keys.

- Harmony type 20 to 26 (Echo)



Play the keys.

Adjusting the Harmony Volume

You can adjust the Harmony volume in the Function Settings (page 60, Function 043).

Creating Arpeggios

The Arpeggio function lets you create arpeggios (broken chords) by simply pressing the notes of the chord. For example, you could play the notes of a triad—the root, third, and fifth—to trigger interesting phrases. This feature can be used for music production as well as performance.

Triggering Arpeggios

- 1 Press the [ARPEGGIO] button to turn on the Arpeggio function.



NOTE

- Selecting a Voice number between 262 and 301 will turn on Arpeggio automatically.

- 2 Press a note or notes to trigger Arpeggio.

The Arpeggio phrase differs depending on the number of pressed notes and the area of the keyboard.



When Split (page 21) is on, Arpeggio is applied only to the Split Voice. When Split is off, Arpeggio is applied to the Main and Dual Voices. Arpeggio cannot be applied to the Split and Main/Dual Voices simultaneously.

NOTE

- Selecting a Voice number between 292 and 301 will turn on Split automatically, as well as Arpeggio. When one of those Voices is selected, Arpeggio is applied only to the Split Voice and is triggered only by playing a key to the left of the Split Point.
- By assigning the Arpeggio Hold function to the foot-switch, the Arpeggio will continue to play after the note is released (page 49).

- 3 To turn off the Arpeggio function, press the [ARPEGGIO] button again.

Changing the Arpeggio Type

The most suitable Arpeggio type is automatically selected when you select a Main Voice, but you can also select any other Arpeggio type. For a list of available Arpeggios, refer to the Arpeggio List in the separate Data List.

- 1 Hold down the [ARPEGGIO] button for longer than a second to call up “ARP Type” (Function 044).

After a few seconds, the current Arpeggio type appears.

ARPEGGIO



Hold for longer than a second.



Current Arpeggio type

- 2 Rotate the dial to select the desired Arpeggio type.

NOTE

- When playing one of the Arpeggio types 117 to 150, select a Drum Kit (Voice No.238–261) as the Main Voice.

Creating Original Sounds via the Knobs

The two knobs can be used to add variations to the sound being played, transforming the sound in a variety of musical ways. Select the desired pre-programmed function combination printed above the knobs, then rotate the knobs, to enjoy the sound.

Assigning Functions to the Knobs

Repeatedly press the [ASSIGN] button to sequentially assign the function combinations provided: (1) → (2) → (3) → (4) → (5) → (6) → (1) ... etc. The current combination is shown in the display.

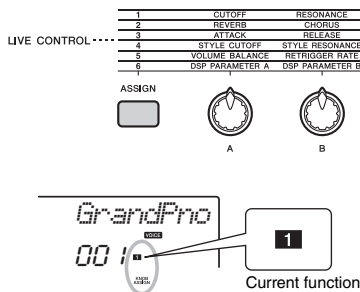

The target differs depending on the selected number.

| Function | Target |
|------------------------------------|---|
| 1 Filter (Cutoff, Resonance) | Main Voice and Dual Voice |
| 2 Effect (Reverb, Chorus) | |
| 3 EG (Attack, Release) | |
| 4 Style Filter (Cutoff, Resonance) | Style (page 26) or Pattern (page 27) |
| 5 Volume Balance/Pattern Retrigger | Knob A: Audio input from the external device, and Style/Pattern/Song Knob B: Pattern |
| 6 DSP | The DSP part selected in the Function Settings (page 60, Function 041). |

For details about each function, refer to page 46.

NOTE

- Only selecting a function combination will not affect the sound even if the knob arrow is not at the center position. The selected function only works when the knob is moved.

Using the Knobs

Here is an example of how to use the knobs. For some other ideas for using the knobs, refer to page 47.

- Select the desired Main Voice (page 20).**
Here, select "Voice No.156 SquareLd" (Square Lead) as a synth-lead type Voice.
- Press the [ASSIGN] button several times until 1 appears in the display.**
- Rotate knob B all the way to the right (maximum), then play the keyboard with your right hand while operating the knob A with your left.**

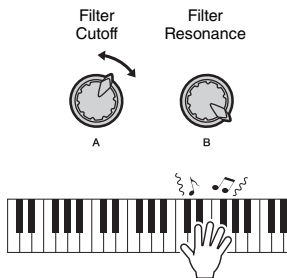

NOTICE

- After selecting 1, 2 or 3 by pressing the [ASSIGN] button, changing the Voice will replace the settings created via the knobs with the default settings of the new Voice.
If you want to keep the settings you have created, make sure to memorize it to Registration Memory (page 35) before selecting a different Voice.

NOTE

- Rotating a knob to the right while the volume is set to a high level may result in distortion. If this occurs, reduce the volume level.

Playing Styles

This instrument includes an Auto Accompaniment feature that plays appropriate “Styles” (rhythm + bass + chord accompaniment). You can select from a huge variety of Styles covering a wide range of musical genres.

- 1 Press the [STYLE] button, then use the dial to select the desired Style.

For the Style List, refer to the separate Data List.

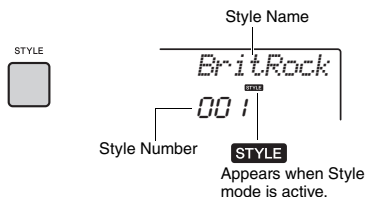

- 2 Press the [ACMP ON/OFF] button to turn on the Auto Accompaniment (ACMP).

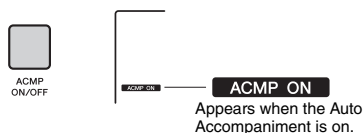

With this operation, the area of the keyboard to the left of the Split Point becomes the “Auto Accompaniment area” and is used only for specifying the chords. The rhythm part as well as the bass and chord accompaniment play back when you play chords.

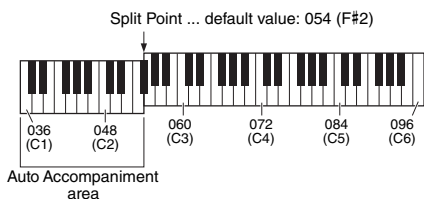

The Split Point can be changed as desired (page 53).

- 3 Press the [SYNC START] button to turn Synchro Start on.

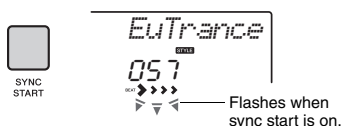

This puts the Style playback in “standby” and Style starts playing back when you play the keyboard.

- 4 Play a chord in the Auto Accompaniment area to start playback.

Play a melody with the right hand and chords with the left hand.

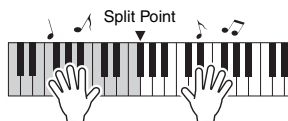

NOTE

- For information about how to play chords, refer to pages 54 and 55.

- 5 Press the [START/STOP] button to stop playback.



You can easily add variations to your performance by changing the section of the Style. For details, refer to page 50.

Using the Music Database

With this function, you can easily call up suitable panel settings such as Voice and Style simply by selecting your desired music genre.

- 1 Press the [MUSIC DATABASE] button.

Both the ACMP and Synchro Start are automatically turned on.

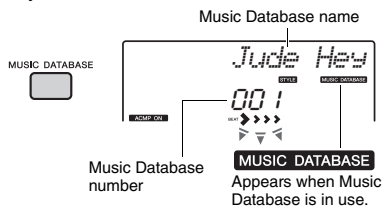

- 2 Rotate the dial to select the desired Music Database.

This operation calls up panel settings, such as for Voice and Style, that are registered to the selected Music Database. For the Music Database List, refer to the separate Data List.

- 3 Play the keyboard as described in steps 4–5 of the previous section.

Playing with Patterns Like a DJ!

The **Pattern** playback function lets you repeatedly play various rhythm patterns, and is particularly effective in dance music styles, such as Hip Hop, House, etc. Try out the cool DJ-like performance features—changing keys in the left-hand area of the keyboard and rotating the knobs for dynamic sound variations.

- Press the **[PATTERN]** button, then use the dial to select the desired **Pattern**. ACMP is automatically turned on, and the keyboard is divided into the Auto Accompaniment area (page 26) and melody area.

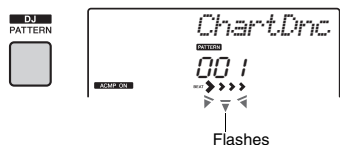

- Press the **[START/STOP]** button to start **Pattern** playback. You can also start playback by pressing any note in the Auto Accompaniment area.



During Pattern playback, enjoy creating sound variations via the following operations.

- Turning on/off individual tracks via the **[TRACK CONTROL]** buttons

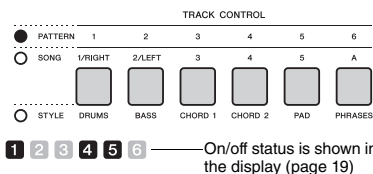

NOTE

Up to two track buttons can be pressed simultaneously for turning on or off.

- Changing the Section via the **[A]–[E]** buttons

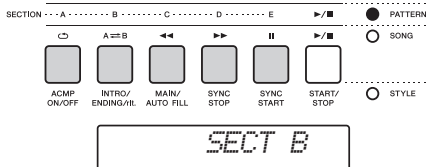

- Using the **Retrigger** function
Pattern Retrigger is a function which repeats the first part of the current Pattern, for a rhythmic break effect. For details, refer to page 52.
- Transposing playback by pressing any note in the Auto Accompaniment area.**

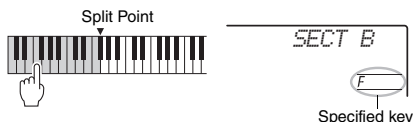

- Changing the sound via the **Knobs**
Press the **[ASSIGN]** button several times to select "4 STYLE CUTOFF/STYLE RESONANCE" then rotate the knobs A and B.

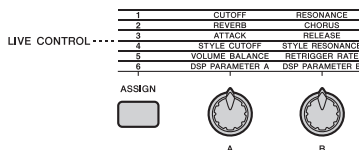

- Playing **Arpeggios** in the right-hand area
Press the **[ARPEGGIO]** button to turn it on, then press the notes in the right-hand area of the keyboard.



NOTE

When you select a Voice between 292 and 301, Arpeggio is applied only to the Split Voice. Playing a key to the left of the Split Point turns Arpeggio on as well as specifies the key for Pattern playback.

- Press the **[START/STOP]** button to stop playback.

Playing Songs

You can simply enjoy listening to the internal Songs, or use them with just about any of the functions, such as Lesson.

● Song Category

The Songs are organized by category as listed below.

SONG

- 001 - MAIN DEMO ————— Gives you an idea of the advanced capabilities of this instrument.
- 004 - VOICE DEMO ————— Demonstrates many useful Voices of this instrument.
- 012 - PIANO SOLO ————— These piano solo pieces are ideally suited for the Song Lesson.
- 016 - PIANO ENSEMBLE ————— These piano ensemble pieces are also well suited for the Song Lesson.
- 021 - PIANO ACCOMPANIMENT ————— These songs are ideal for when you want to practice backing (accompaniment) patterns.
- 031 - USER SONG ————— Songs you record yourself (page 32).
- 041 - FLASH MEMORY/USB ————— FLASH MEMORY: Songs transferred from a computer (page 36).
————— USB: Songs in the USB flash drive (page 62).

NOTE

- In addition to the 30 preset Songs in this instrument, you can enjoy extra Songs downloadable from the Yamaha website. For details, refer to page 11.
- For instructions on transferring Songs from a computer to this instrument, refer to the online PDF manual (page 11) "Computer-related Operations."
The numbers are generally assigned to the Songs in the following sequence: Songs transferred from a computer, Songs in the USB flash drive. When you transfer a Song from a computer while the USB flash drive is connected to the instrument, the transferred Song will be inserted before the first USB Song number, moving all USB Song numbers later in sequence.

Listening to a Demo Song

Press the [DEMO] button to play Demo Songs 001–003 in sequence. Playback will repeat continuously, starting again from the first Song (001).



To stop playback, press the [DEMO] or [▶/■] (Start/Stop) button.

Selecting and Playing Back a Song

1 Press the [SONG] button, then rotate the dial to select the desired Song.

For a list of available Songs, refer to the Song List in the separate Data List.

You can select User Songs, Songs transferred from a computer, and Songs in the USB flash drive in the same way as above.

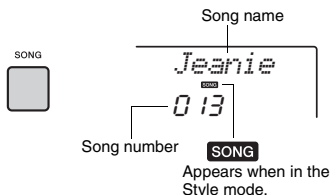

2 Press the [▶/■] (Start/Stop) button to start playback.

To stop playback, press the [▶/■] (Start/Stop) button again.

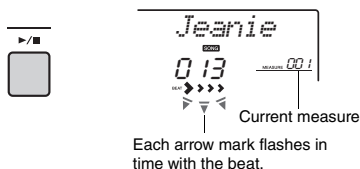

NOTE

- External MIDI Songs containing the Portamento Control and Scale Tune settings may not be played correctly.

NOTE

- If playback of a Song in the USB flash drive or a Song transferred from a computer produces the distorted sound, decrease the Song volume (page 57) to reduce the distortion, and then adjust the master volume (page 16).

Song Fast Forward, Fast Reverse, and Pause

[▶▶] Fast Forward
During playback, press this button to rapidly skip ahead to a later point in the Song.

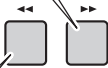

[◀◀] Fast Reverse
During playback, press this button to rapidly return to an earlier point in the Song.

[||] Pause
During playback, press this button to pause playback, and press again to start from that point.

NOTE

- When the A-B repeat is specified, the Fast Reverse and Fast Forward will only work within the range between A and B.
- The [◀◀], [▶▶] and [||] buttons cannot be used for Demo Song playback started by using the [DEMO] button.

Playing a Specified Section of a Song Repeatedly (A-B Repeat)

You can play back only a specific section of a Song repeatedly by setting the A point (start point) and B point (end point) in one-measure increments.



- 1 Start playback of the Song (page 28).
- 2 When playback reaches to the point you want to specify as the start point, press the [A⇌B] (A-B REPEAT) button to set the A point.



- 3 When playback reaches to the point you want to specify as the end point, press the [A⇌B] (A-B REPEAT) button again to set the B point.

The specified A-B section of the Song will now play repeatedly.

- 4 To cancel repeat playback, press the [A⇌B] (A-B REPEAT) button again.

To stop playback, press the [▶/■] (Start/Stop) button.

NOTE

- If you want to set start point "A" to the top of the Song, press the [A⇌B] (A-B REPEAT) button before starting playback.
- If you want to set end point "B" to the end of the Song, specify only the A point and play back the Song to the end.

Turning Each Track On/Off

Each "track" of a Song plays a different part—melody, percussion, accompaniment, etc. Each of the tracks can be muted so that you can play the muted part yourself. Pressing the desired Track button repeatedly will toggle the on/off status.

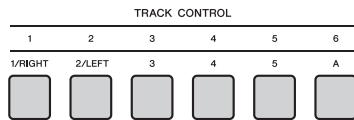

Track number on—Track will be played back



Track number off—Track is muted or contains no data

NOTE

- Up to two Track buttons can be pressed simultaneously for turning on or off.

Using the Song Lesson Feature

You can use the selected Song for a left-hand, right-hand, or both-hands lesson. Try practicing with these three Song Lesson types while referring to the music scores in the Song Book downloaded from the website (page 11).

Lesson Types

- **Lesson 1 (LISTEN):** You do not need to play the keyboard. The model melody/chords of the selected part will sound. Listen to it carefully and remember it as best as you can.
- **Lesson 2 (TIMING):** Simply concentrate on playing the notes with the correct timing. Even if you play wrong notes, the correct notes will sound.
- **Lesson 3 (WAITING):** Try playing the correct notes shown on the display. The Song pauses until you play the right note, and playback tempo will change to match the speed at which you are playing.

NOTE

- If you want to maintain a steady playback tempo during Lesson 3, change the parameter in the Function Settings (page 61, Function 064).

1 Select the desired Song for your lesson (page 28).

NOTE

- The Song Lesson can be applied to Songs transferred from a computer, and Songs in USB flash drive. However, some of the Lesson functions may not be applied to some Songs due to the structure of the Song data.
- The Song Lesson cannot be applied to the User Songs and the Songs other than SMF format 0.

2 Turn off the part you want to practice.

For the right-hand lesson, press the [1/RIGHT] button to turn off the right-hand part. For the left-hand lesson, press the [2/LEFT] button to turn off the left-hand part. For lessons using both hands, turn off both parts.

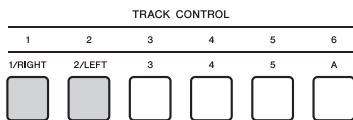

Pressing one of the TRACK CONTROL buttons repeatedly will toggle the on/off status of each part, which can be shown on the display.

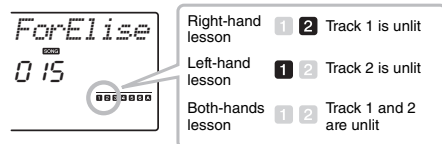

3 Press the [LESSON] button to start playback of the Song.

Pressing the [LESSON] button repeatedly will change the lesson number from 1: LISTEN → 2: TIMING → 3: WAITING → off → 1.... Press this

button until the desired number is shown on the display.



The notation and key positions you should play are shown.

In lesson 2, both-hands lesson is indicated as "LR2," right-hand lesson is indicated as "R2" and left-hand lesson is indicated as "L2."

To stop the lesson, press the [▶/■] (Start/Stop) button.

Even during playback, you can change the lesson number by pressing the [LESSON] button.

4 When Song playback reaches to the end, check your evaluation Grade on the display.

In lesson 2 (TIMING) and 3 (WAITING), when the Song reaches to the end, your performance will be evaluated in four levels: "Excellent!," "Very Good!," "Good," "OK." "Excellent!" is the highest evaluation.

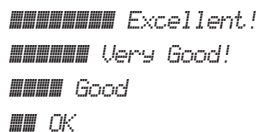

After the evaluation display is shown, the lesson will start again from the beginning.

Making Practice Perfect— Repeat & Learn

If you want to practice a specific section in which you made a mistake or you have difficulty with, use the Repeat & Learn function.

Press the [↺] (REPEAT & LEARN) button during a lesson.



The Song position will move back four measures, a one-measure count will play, then Song playback will start again. Playback of the four measures will repeat with a one-measure count-in.

To exit from this status, press this button again.

NOTE

- You can change the amount of measures the Repeat & Learn function jumps back by pressing a number button [1]–[9] during repeat playback.

Recording Your Performance

You can record up to 10 of your performances to the instrument as User Songs. The recorded User Songs can be played back in the same way as the preset Songs.

NOTE

- This instrument records your performance and save it in an original format. If you want MIDI data, convert it to SMF by saving it to the connected USB flash drive (page 65).

Track Structure of a Song

A Song can be recorded to the six tracks. You can record without specifying tracks, but you can also record each track one by one (e.g., only the right-hand part or the left-hand part) to create a complete piece which may be difficult to play at once.

● **Melody Tracks [1/RIGHT]–[5]**

The melody performance will be recorded.

● **Accompaniment Track [A]**

The chord progression (for the Style) or the key change (for the Pattern) will be recorded.

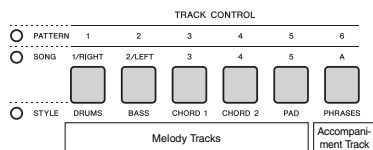

Track 1 will be selected as recording target of the melody, and the Track A will be selected as recording target of the accompaniment part (the chord progression for the Style or the key change for the Pattern) automatically. If a User Song was selected beforehand, recording data will overwrite Tracks 1 and A of the selected Song.

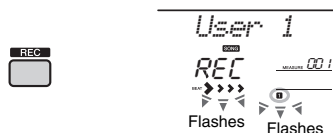

NOTE

- The ACMP on/off status cannot be changed after the [REC] button is pressed.

To exit from this status, press the [REC] button again.

4 Start recording.

- When you press the [SONG] button in step 2, play any note to start recording.
- When you select a Style in step 2, play a chord in the Auto Accompaniment area to start recording with Style playback, or press the [START/STOP] button to start recording only with playback of the Rhythm part of a Style.
- When you select a Pattern in step 2, play a key in the Accompaniment area or press the [START/STOP] button to start recording with Pattern playback.

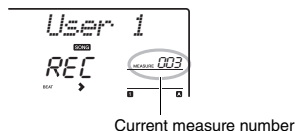

The current measure will be shown on the display while recording.

5 Press the [▶/■] (Start/Stop) or [REC] button to stop recording.

When using a Style, you can stop recording also by pressing the [INTRO/ENDING/rit.] button, and then waiting until playback ends.

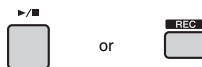

Quick Recording

This section explains how to record without specifying a track. This is useful when you record a new Song from scratch.

1 Make the desired settings including the Main Voice selection.

2 Make the desired settings of your performance.

- If you want to record only the melody performance, press the [SONG] button.
- If you want to record the performance using a Style, press the [STYLE] button.
- If you want to record the performance using a Pattern, press the [PATTERN] button.

3 Press the [REC] button to enter the Record Ready mode.

This operation selects the lowest-numbered unrecorded User Song from 031–040 (User 1–10) as the recording target.

After recording finishes, "Writing!" appears indicating that the recorded data is being stored, and then the recorded track numbers in the display will light.

NOTICE

- Never attempt to turn the power off when "Writing!" is shown in the display. Doing so can result in a loss of data.

6 To play back the recorded Song, press the [▶/■] (Start/Stop) button.

NOTE

- When recording Pattern playback with Retrigger Note that the beat indicator in the display, metronome and Arpeggio playback are not synchronized with playback of the recorded Song.

Limitations while recording

- The on/off status of ACMP cannot be changed.
- Playback cannot be changed between Style and Pattern.
- The Pattern number can be changed while the Style number cannot.
- When you use a Style/Pattern, the following parameters cannot be changed: Reverb Type, Chorus Type, Time Signature, Style number and Style/Pattern Volume.
- Performance with a Split Voice cannot be recorded.
- The audio input from an external device (playback sound on the connected computer or audio device) cannot be recorded.

Recording to a Specified Track

This section explains how to record to a specified track. This is useful when you want to record the additional performances to an already recorded Song, or re-record only one track of an already recorded Song.

1 Press the [SONG] button, and then select the desired User Song from 031–040 (User 1–10) as the recording target.

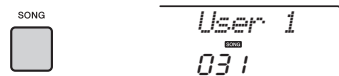

2 While holding down the [REC] button, press the desired Track button to enter the Record Ready mode.

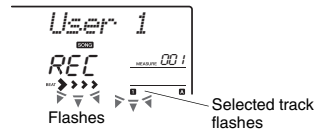

- If you want to record only the melody: While holding down the [REC] button, press one of the [1/RIGHT]–[5] buttons.

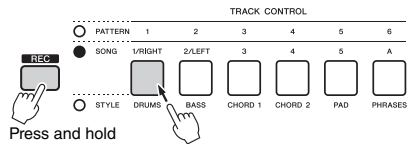

- If you want to record only the Style playback:

Press the [STYLE] button, select the desired Style, then simultaneously hold down the [REC] button and press the [A] button. ACMP is automatically turned on.

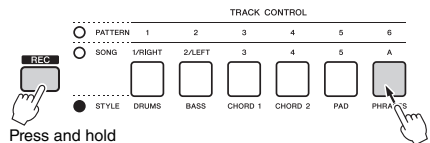

- If you want to record only the Pattern playback:
Press the [PATTERN] button, then select the desired Pattern. While holding down the [REC] button, press the [A] button. ACMP is automatically turned on.

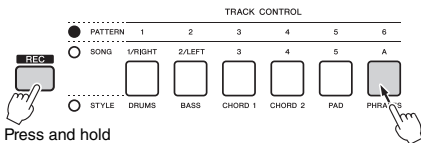

3 Same as in steps 4 to 6 (page 32) in “Quick Recording.”

NOTE

• If the memory becomes full while recording, an alert message will appear and recording will stop automatically. In this case, delete unnecessary data by using the Clear functions (below), then execute the recording again.

Clearing a User Song

You can clear all tracks of a User Song.

- 1 Press the [SONG] button, then select the User Song from 031–040 (User 1–10) to be cleared.
- 2 Hold down the track [1/RIGHT] and [A] buttons simultaneously for longer than a second.

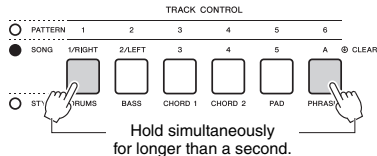

A confirmation message will appear on the display.



- 3 Press the [+ / YES] button.
A confirmation message will appear on the display. To cancel this operation, press the [-] button.

4 Press the [+ / YES] button to clear the Song.

A clear-in-progress message will appear briefly on the display.

Clearing a Specified Track from a User Song

This lets you clear individual tracks from a User Song.

- 1 Press the [SONG] button, and then select the desired User Song from 031–040 (User 1–10).
- 2 From [1/RIGHT]–[5] and [A], press the Track button to be cleared for longer than a second.

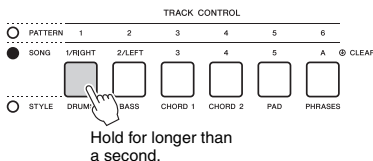

A confirmation message will appear on the display.



- 3 Press the [+ / YES] button.
A confirmation message will appear on the display. To cancel this operation, press the [-] button.
- 4 Press the [+ / YES] button to clear the track.
A clear-in-progress message will appear briefly on the display.

Memorizing Your Favorite Settings (Registration Memory)

The Registration Memory function allows you to save (or “register”) panel settings such as Voice and Style to a Registration Memory button, and then instantly recall your custom panel settings by simply pressing a single button. The registered settings for four Registration Memory buttons will be saved as a single Bank.

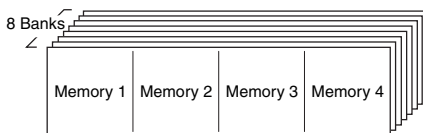

Up to 32 settings (eight banks of four each) can be memorized.

Memorizing Panel Settings to the Registration Memory

- 1 Make the desired settings, such as those for Voice, Style, and Pattern.

NOTE

- Data cannot be saved to the Registration Memory during Song playback.

- 2 Press the REGISTRATION MEMORY [BANK/MEMORY] button to call up a Bank number on the display.

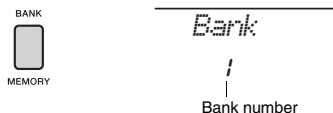

- 3 Use the dial or the [1]–[8] number buttons to select a Bank number.

- 4 While holding down the [BANK/MEMORY] button, press one of the [1]–[4] buttons to memorize the current panel settings.

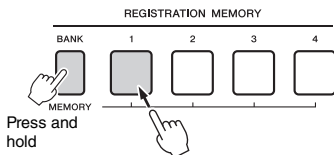

A “Writing!” message appears indicating that the panel settings will be stored.

NOTICE

- If you select a Registration Memory number that already contains data, the previous data is deleted and overwritten by the new data.
- Never attempt to turn the power off when “Writing!” is shown in the display. Doing so can result in a loss of data.

Recalling Panel Settings from the Registration Memory

- 1 Press and release the [BANK/MEMORY] button to call up a Bank number on the display.
- 2 Use the dial or the [1]–[8] number buttons to select a Bank number.
- 3 Press one of the REGISTRATION MEMORY [1]–[4] buttons to call up the panel settings you memorized.

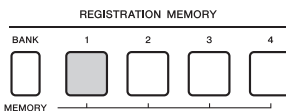

The recalled Registration Memory number appears in the display for a few seconds.

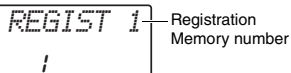

NOTE

- When the [SONG] lamp is lit, the Style or Pattern settings will not be recalled even if you press the REGISTRATION MEMORY button to which the Style or Pattern settings are memorized. To recall Style/Pattern settings, make sure to press the [STYLE] or [PATTERN] button beforehand.

Parameters that can be memorized to Registration Memory

- **Style settings:** Style number, ACMP on/off, Style volume, Track on/off, Main section A/B, Tempo
- **Pattern settings:** Pattern number, Pattern volume, Section, Track on/off, Tempo
- **Voice settings:**
 - **Main Voice settings:** Voice number and all settings of the related Functions (page 58)
 - **Dual Voice settings:** Dual on/off and all settings of the related Functions
 - **Split Voice settings:** Split on/off and all settings of the related Functions
- **Effect settings:** Reverb Type, Chorus Type
- **Arpeggio settings:** Arpeggio on/off and all settings of the related Functions
- **Harmony settings:** Harmony on/off and all settings of the related Functions
- **DSP:** Parameter values of Knobs A/B and settings of the related Functions
- **Other settings:** Transpose, Pitch Bend Range, Knob Effect Combination number, Split Point, Scale Tune

Connecting to Other Devices

⚠ CAUTION

- Before connecting the instrument to external devices, turn off the power of all the devices. Also, before turning the power on or off, make sure to set all volume levels to minimum. Otherwise, damage to the devices or electrical shock may occur.

Playing an External Audio Device with the Built-in Speakers

By connecting an audio device such as a portable music player to the instrument's [AUX IN] jack, you can output the sound of the audio device through the built-in speakers of this instrument. This lets you play the keyboard along with the playback of your audio player.

NOTICE

- To avoid damage to the devices, first turn on the power to the external device, and then to the instrument. When turning off the power, first turn off the power to the instrument, and then to the external device.

1 Connect the headphone jack of an audio device to the instrument's [AUX IN] jack by using an audio cable.

Audio device (portable music player, etc.)

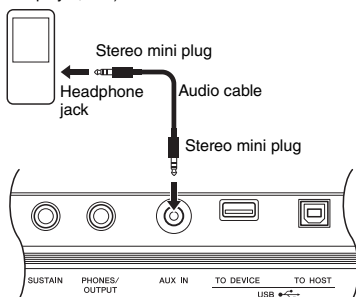

NOTE

- If you are using a computer or a smart device such as an iPhone/iPad, you can also connect it to the [USB TO HOST] terminal (see "Connecting to a Computer," at right).

2 Turn on the audio device, and then this instrument.

3 Start play back of the connected audio device.

The sound of the audio device is output through the speakers of this instrument.

4 Adjust the volume balance between the audio device and this instrument.

Adjust the audio playback volume on the audio device, then adjust the entire volume by rotating the [MASTER VOLUME] control of the instrument.

NOTE

- If you want to adjust the volume balance between the audio input from the external device and Song/Style/Pattern, use the [ASSIGN] button to select Function number 5, then turn Knob A (page 46). The audio input volume from the [AUX IN] jack can also be adjusted in the Function Settings (page 58, Function 004). If you increase the volume to more than 50, the audio device sound may be distorted.

5 Play the keyboard along with the sound of audio device.

NOTE

- You can cancel or lower the volume of the melody part of audio playback. For details, refer to page 37.

6 After finishing the performance, stop playback of the audio device.

Connecting to a Computer

Connecting the [USB TO HOST] terminal of this instrument and the computer via a USB cable allows you to transmit/receive MIDI and Audio data to/from the computer. For details on using a computer with this instrument, refer to the online PDF manual (page 11) "Computer-related Operations."

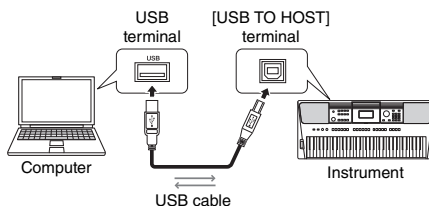

Files that can be transferred from a computer to this instrument (and vice versa).

- Song file: .mid (SMF format 0/1)
 - Style file: .sty
 - Backup file: PSR-E453.BUP* (PSR-E453)/PSREW400.BUP* (PSR-EW400)
- * Backup parameters (page 39) can be transferred and saved to a computer via Musicsoft Downloader as a single file.

NOTE

- Up to 256 Song files can be transferred to this instrument.
- If you transfer a Style file from the computer to this instrument, you need to load it to this instrument for Style playback. For details, refer to "Loading a Style File" (page 67).

NOTICE

- Use an AB type USB cable of less than 3 meters. USB 3.0 cables cannot be used.
- If you are using a DAW (digital audio workstation) with this instrument, set the Audio Loop Back (page 60) to OFF. Otherwise, a loud sound may occur, depending on the settings of the computer or the application software.

NOTE

- The volume can be adjusted on the computer, and also by using the instrument's [MASTER VOLUME] control. If you want to adjust the volume balance between the audio input from the external device and Song/Style/Pattern, use the [ASSIGN] button to select Function number 5, then turn Knob A (page 46).
The audio input volume from the [USB TO HOST] terminal can also be adjusted in the Function Settings (page 58, Function 005).

Connecting to an iPhone/iPad

You can use a smart device, such as an iPhone or iPad, with the instrument for a variety of musical purposes by connecting it to the instrument's [USB TO HOST] terminal. For details on connections, refer to the online PDF manual (page 11) "iPhone/iPad Connection Manual." For information about the compatible smart devices and application tools, access the following page:

<http://www.yamaha.com/kbdapps/>

NOTICE

- If you are using a DAW (digital audio workstation) with this instrument, set the Audio Loop Back (page 60) to OFF. Otherwise, a loud sound may occur, depending on the settings of the computer or the application software.

NOTE

- The volume can be adjusted on the smart device, and also by using the instrument's [MASTER VOLUME] control. If you want to adjust the volume balance between the audio input from the external device and Song/Style/Pattern, use the [ASSIGN] button to select Function number 5, then turn Knob A (page 46).
The audio input volume from the [USB TO HOST] terminal can also be adjusted in the Function Settings (page 58, Function 005).

Using the Melody Suppressor

When you output the audio sound of an external audio device or a computer connected to the [AUX IN] jack or the [USB TO HOST] terminal through this instrument, you can cancel or lower the volume of the melody part of audio playback. You can use the function to practice the melody part along with the audio playback.

- 1 Play back audio on the connected external device.
- 2 Press the [MELODY SUPPRESSOR] button to turn it on.



NOTE

- Depending on the particular music source, the melody or vocal sound may not be cancelled as expected even when if the Melody Suppressor is turned on. In such a case, try adjusting the pan position to be cancelled in the Function Settings (page 59, Function 039).
- When the instrument is connected to the [USB TO HOST] terminal, and Audio Loop Back (page 60, Function 058) is set to OFF, the Melody Suppressor function cannot be used.

- 3 Press the [MELODY SUPPRESSOR] button again to turn it off.

Using an External Stereo System for Playback (OUTPUT [L/L+R]/[R] jacks) (PSR-EW400)

You can connect a stereo system to amplify the instrument's sound by using the OUTPUT [L/L+R]/[R] jacks.

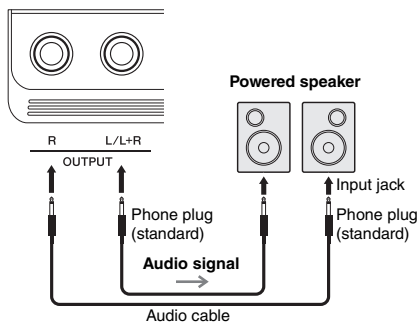

You can use the instrument's [MASTER VOLUME] dial to adjust the volume of the sound output to the external device.

NOTE

- Use audio cables and adaptor plugs having no (zero) resistance.

NOTE

- Use only the [L/L+R] jack for connection with a monaural device.

NOTICE

- To avoid possible damage, first turn on the power to the instrument, then to the external device. When turning off the power, first turn off the power to the external device, then to the instrument. Since this instrument's power may automatically be turned off due to the Auto Power Off function (page 16), turn off the power to the external device, or disable Auto Power Off when you do not intend to operate the instrument.

NOTICE

- Do not route the output from the OUTPUT jacks to the [AUX IN] jack. If you make this connection, the signal input at the [AUX IN] jack is output from the [OUTPUT] jacks and then back again, creating a feedback loop that could make normal performance impossible, and may even damage the equipment.

Speaker Mute On/Off Setting (PSR-EW400)

You can set whether the sound of this instrument is always output from its built-in speaker or not.

- 1 Press the [FUNCTION] button.



- 2 Use the CATEGORY [+] and [-] buttons to call up "SP Mute" (Function 067).

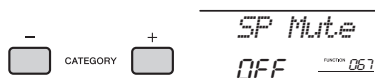

- 3 Use the dial to select the desired setting.

When Speaker Mute set to "ON," the Speaker sound is off. You can only hear the instrument sound via the headphones or an external device connected to the [OUTPUT] jacks.

When Speaker Mute set to "OFF," the speaker sound is always on as long as headphones are not connected.

Backup and Initialization

Backup Parameters

The following Backup parameters will be maintained even if the power is turned off.

Backup parameters

- User Songs (page 32)
- Style data transferred from a computer and loaded to Style numbers 221–230 (page 67)
- Registration Memory (page 35)
- FUNCTION Settings: (page 58)
 - Tuning, Split Point, Touch Response, Style Volume, Song Volume, Pattern Volume, Metronome Volume, Demo Group, Demo Play Mode, Master EQ type, Audio Loop Back on/off, Your Tempo on/off, Auto Power Off Time, Battery Type, Language

In addition to the Backup parameters above, all the data (including Style data that have not been loaded) transferred from the connected computer will be maintained even if you turn off the power.

Initializing the Instrument

You can erase the backup parameters described above, and then restores all the default factory settings.

You can initialize the instrument via the following two methods.

Backup Clear

This operation initializes the backup parameters. While holding down the highest white key, press the [⏻] (Standby/On) switch to turn the power on.

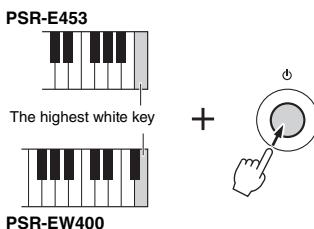

Flash Clear

This operation deletes all the Songs and Styles that have been transferred from a computer. Note that Style data loaded to Style numbers 221–230 will be maintained. While simultaneously holding the highest white key and the three highest black keys, press the [⏻] (Standby/On) switch to turn the power on.

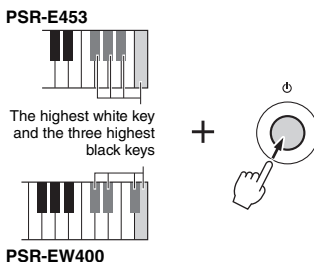

NOTICE

- *Keep in mind that this operation also deletes the data you have purchased. Be sure to save important data to a computer. For details, refer to the online PDF manual (page 11) "Computer-related Operations."*

Handy Performance Features

Selecting a Reverb Type

The Reverb effect lets you play with a rich concert hall type ambience.

Although selecting a Style or Song will call up the optimum Reverb type for the entire sound, you can select a different Reverb type manually.

1 Press the [FUNCTION] button.



2 Use the CATEGORY [+] and [-] buttons to call up “Reverb” (Function 036).

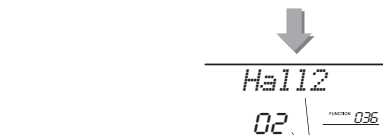
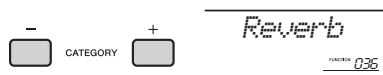

Current Reverb type

NOTE

- Some Songs and Styles use Reverb Types which cannot be selected via panel operation. If such a Song or Style is played back, “- - -” is shown on the display.

3 Rotate the dial to select a Reverb type.

Play the keyboard to check the sound. For information about the available Reverb types, refer to the Effect Type List in the separate Data List.

Adjusting the Reverb depth

You can adjust the Reverb depth applied to the Main, Dual, and Split Voices individually via the same operations above. Regarding the item in step 2, refer to the Function List on page 59.

Selecting a Chorus Type

The Chorus effect creates a thick sound that sounds like many of the same Voices being played in unison.

Although selecting a Style or Song will call up the optimum Chorus type for the entire sound, you can select a different Chorus type manually.

1 Press the [FUNCTION] button.



2 Use the CATEGORY [+] and [-] buttons to call up “Chorus” (Function 037).

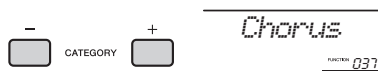

Current Chorus type

NOTE

- Some Songs and Styles use Chorus Types which cannot be selected via panel operation. If such a Song or Style is played back, “- - -” is shown on the display.

3 Rotate the dial to select a Chorus type.

Play the keyboard to check the sound. For information about the available Chorus types, refer to the Effect Type List in the separate Data List.

Adjusting the Chorus depth

You can adjust the Chorus depth applied to the Main, Dual, and Split Voices individually via the same operations above. Regarding the item in step 2, refer to the Function List on page 59.

Pitch Controls—Transpose

The overall pitch of the instrument (except for the Drum Kit Voices) can be shifted up or down by a maximum of 1 octave in semitone increments.

- 1 Press the [TRANPOSE] button to call up “Transpose” (Function 006).



- 2 Use the dial to set the Transpose value between -12 and +12.

Pitch Controls—Fine Tuning

The overall tuning of the instrument (except for the Drum Kit Voices) can be shifted up or down between 427.0 Hz and 453.0 Hz in approximately 0.2 Hz increments. The default value is 440.0 Hz.

- 1 Press the [FUNCTION] button.



- 2 Use the CATEGORY [+] and [-] buttons to call up “Tuning” (Function 007).



- 3 Use the dial to set the Tuning value.

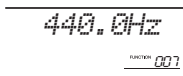

Pitch Controls—the [PITCH BEND] wheel

The [PITCH BEND] wheel can be used to add smooth pitch variations to notes you play on the keyboard. Roll the wheel upward to raise the pitch, or downward to lower the pitch.

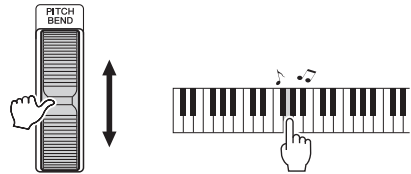

You can change the amount of pitch bend produced by the wheel in the Function Settings (page 58, Function 008).

Calling Up Optimum Panel Settings—One Touch Setting (OTS)

Select a Song, Style or Pattern by pressing the [SONG], [STYLE] or [PATTERN] button, then select Voice number 000 OTS (page 20). This lets you automatically call up the optimum panel settings such as Voice and tempo for the current Song, Style or Pattern.

Changing the Touch Response of the Keyboard

The keyboard of this instrument is equipped with a Touch Response feature that lets you dynamically and expressively control the level of the Voices according to your playing strength.

1 Press the [FUNCTION] button.



2 Use the CATEGORY [+] and [-] buttons to call up “TouchRes” (Function 010).

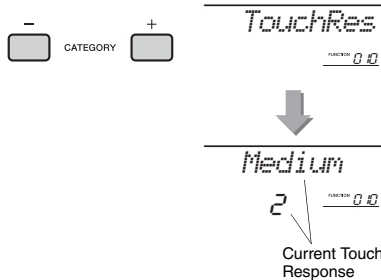

3 Use the dial to select a Touch Response setting between 1 and 4.

Touch Response

| | | |
|---|--------|--|
| 1 | Soft | Allows maximum loudness to be produced with relatively light key pressure. |
| 2 | Medium | Produces a fairly “standard” keyboard response. |
| 3 | Hard | Requires that the keys be played quite hard to produce maximum loudness. |
| 4 | Fixed | All notes are produced at the same volume no matter how hard the keyboard is played. |

Selecting an EQ Setting for the Best Sound

Six different master equalizer (EQ) settings give you the best possible sound when listening through different reproduction systems—the instrument’s internal speakers, headphones, or an external speaker system.

1 Hold down the [MELODY SUPPRESSOR] button for longer than a second to call up “Master EQ” (Function 038).

After a few seconds, the current Master EQ type appears.

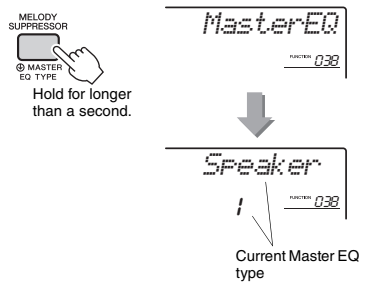

2 Rotate the dial to select the desired Master EQ type.

Master EQ types

| | | |
|---|-----------|---|
| 1 | Speaker | Optimum for listening via the instrument’s built-in speakers. |
| 2 | Headphone | Optimum for headphones, or for listening via external speakers. |
| 3 | Boost | Features more powerful sound. Depending on the selected Voice and Style, etc., the sound may be more subject to distortion than other EQ types. |
| 4 | Piano | Optimum for piano solo performance. |
| 5 | Bright | Lowers the mid range for a brighter sound. |
| 6 | Mild | Lowers the high range for a softer sound. |

Scale Tuning

By default, the scale of this keyboard is set to Equal Temperament — the same tuning as with any acoustic piano. However, the setting can be changed to any other scale according to the music genre or music style you want to play.

Selecting a Scale

You can select a desired scale among the various preset scales.

- 1 Press the [FUNCTION] button.



- 2 Use the CATEGORY [+] or [-] button to call up “Scale” (Function 048).

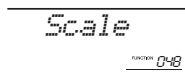

Current scale

- 3 Rotate the dial to select a scale.

The default setting is “1 Equal.”

Preset Scale types

| | |
|---|----------------|
| 1 | Equal |
| 2 | Pure Major |
| 3 | Pure Minor |
| 4 | Bayat (Arabic) |
| 5 | Rast (Arabic) |

Setting the Base Note for Each Scale

Please make sure to specify the appropriate base note, if you select a scale other than Equal Temperament, or create an original scale via Scale Tune function.

- 1 Press the [FUNCTION] button.



- 2 Use the CATEGORY [+] or [-] button to call up “BaseNote” (Function 049).

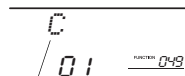
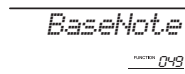

Current base note

- 3 Rotate the dial to select a base note from C, C#, D, E \flat , E, F, F#, G, A \flat , A, B \flat and B.

The default setting is “C.”

Tuning Each Note to Create an Original Scale

You can tune the individual notes in cents (a “cent” is 1/100th of a semitone) to create your original scale.

1 Press the [FUNCTION] button.



2 Use the CATEGORY [+] and [-] buttons to call up “TuneNote” (Function 050).

After a few seconds, the current note appears.

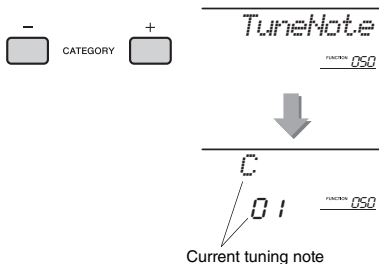

3 Rotate the dial to select the note to be tuned from C, C#, D, Eb, E, F, F#, G, Ab, A, Bb, B.

4 Press the CATEGORY [+] button to call up “Tune” (Function 051).

After a few seconds, the tuning value of the note selected in step 3 appears.

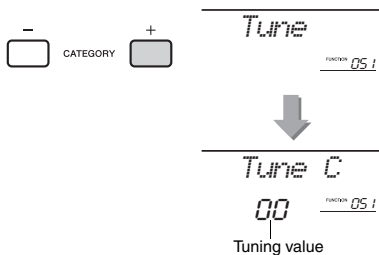

5 Rotate the dial to tune the note over a range of -64 to +63.

The setting can be reset to the initial default value by pressing the [+ / YES] and [- / NO] buttons simultaneously.

6 Repeat steps 2–5 as desired.

7 Memorize the settings here to the Registration Memory as desired (page 35).

NOTE

- When pressing the [+ / YES] and [- / NO] buttons simultaneously after recalling an original scale memorized to Registration Memory, the scale will return to the original scale registered to Registration Memory, not to the default tune value.
- When calling up “Scale” (Function 048) after using individual note scale tuning, “(Edited)” will be shown in the display. However, the edited scale settings will be erased by calling up another scale. For this reason, the edited settings should be memorized to the Registration Memory.

Voice Settings

Selecting a Dual Voice

- 1 Hold down the [DUAL] button for longer than a second to call up “D.Voice” (Function 020).

After a few seconds, the current Dual Voice appears.

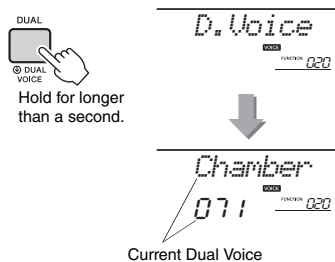

- 2 Rotate the dial to select the desired Dual Voice.

Selecting a Split Voice

- 1 Hold down the [SPLIT] button for longer than a second to call up “S.Voice” (Function 030).

After a few seconds, the current Split Voice appears.

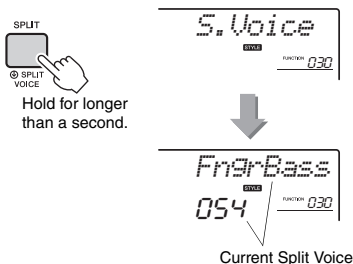

- 2 Rotate the dial to select the desired Split Voice.

Voice Editing

For each of the Main, Dual and Split Voices, you can edit the parameters such as volume, octave and depth of the Reverb and Chorus, allowing you to create new, custom sounds that best suit your musical needs.

- 1 Press the [FUNCTION] button.



- 2 Use the CATEGORY [+ and -] buttons to call up the desired item.

Voice parameters are indicated as below.

- Main Voice parameters: M.***** (Function 011–019)
- Dual Voice parameters: D.***** (Function 020–029)
- Split Voice parameters: S.***** (Function 030–035)

For details on each parameter, refer to the Function List on page 59.

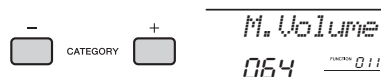

- 3 Rotate the dial to set the value.

Check the sound by playing the keyboard.

- 4 Repeat steps 2–3 above to edit various parameters.

- 5 If necessary, memorize the settings to the Registration Memory (page 35).

The Voice-related settings are reset when a different Voice is selected. If you want to store the created sound for future recall, memorize the settings to the Registration Memory.

Parameters Assigned to the Knobs

This section describes each of the parameters which can be assigned to the Knobs (page 25).

1 Filter

Filter effects shape the sound by allowing only a specified range of frequencies to pass and/or by producing a resonance peak at the filter's "cutoff" frequency. Filter effects can be used to create a range of synthesizer-like sounds.

NOTE

- These effects are applied only to the Main/Dual Voices played on the keyboard.
- Filter effects can sometimes cause distortion in the bass frequencies.

● Knob A: CUTOFF

Adjusts the filter's cutoff frequency, and therefore the brightness of the sound. Turning the knob to the left makes the sound more muffled or darker, while turning the knob A to the right makes the sound brighter.

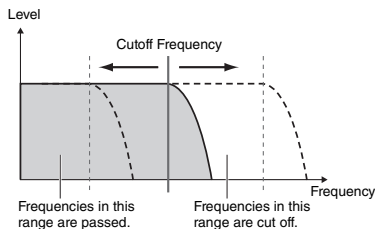

● Knob B: RESONANCE

Adjusts the amount of Resonance applied at the filter's cutoff frequency. Turning the knob to the right will increase the Resonance to emphasize the frequencies at the cutoff frequency, and thus "strengthen" the perceived effect of the filter.

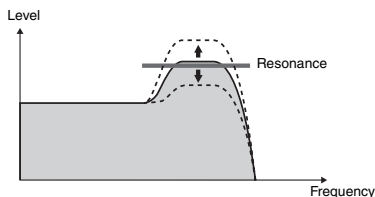

2 Effect

● Knob A: REVERB

Reproduces the acoustic ambience of a concert hall or club. Turning the knob to the right increases the Reverb depth.

● Knob B: CHORUS

Produces a layered "multi-instrument" effect. Turning the knob to the right increases the Chorus depth.

NOTE

- These effects are applied only to the Main/Dual Voices played on the keyboard.

3 EG (Envelope Generator)

Envelope Generator effects determine how the level of the sound varies over time. You can make the attack faster for a more percussive sound or slower for a violin-like sound, for example. Or you can lengthen or shorten the sustain to best match the music you're playing.

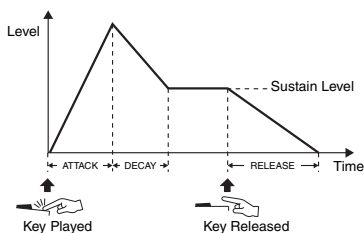

● Knob A: ATTACK

Adjusts the Attack Time (the amount of time it takes the sound to reach maximum level when a key is played). Turning the knob to the right increases the Attack Time, thus slowing down the attack rate.

● Knob B: RELEASE

Adjusts the Release Time (the amount of time it takes for the sound to decay to silence after a key is released). Turning the knob to the right increases the Release Time, thus making a longer sustain.

NOTE

- These effects are applied only to the Main/Dual Voices played on the keyboard.

4 Style Filter

Same as 1. These effects are applied only to Style or Pattern playback.

5 Volume Balance/Pattern Retrigger

● Knob A: VOLUME BALANCE

Adjusts the volume balance between the audio playback volume from the connected audio device (page 36) or the computer (page 36) and the Song/Style/Pattern. Turning the knob to the left decreases the external audio volume, while turning it to the right decreases the instrument volume.

Even when there is no audio input from an external device, the volume of Song, Style and Pattern can be adjusted by using the knob. The volume of Voices played on the keyboard cannot be adjusted.

[NOTE]

- When the instrument is connected to the [USB TO HOST] terminal, and Audio Loop Back (page 60, Function 058) is set to OFF, you cannot adjust the volume of audio playback input from the external device.

● Knob B: RETRIGGER RATE

Adjusts the Retrigger Rate (the length of the part to be repeated) of the Pattern Retrigger function (page 52). Turning this knob to the right decreases it, and turning the knob to the left increases it.

[NOTE]

- When setting the tempo of the Pattern playback to more than 200, turning the knob to the right cannot change the length to be repeated.

6 DSP

● Knob A/B: DSP PARAMETER A/B

With the digital effects built into the instrument, you can add DSP effects to your keyboard performance and the playback sound of Style, etc. (page 48). Each effect has two parameters which are assigned to Knobs A and B. By turning the knobs in real-time, you can alter the music in various dynamic ways, such as changing the rotating speed (slow/fast) of the rotary speaker or changing the degree of the Distortion.

The chart below lists some interesting ways to use the various effects that can be assigned to the knobs.

Some Ideas for Using the Knobs

| Number/Effect | | Try This |
|---------------|--------------------------------------|--|
| 1 | Filter | Select "143 Gemini" (a synth-lead type Voice) or "170 Noise" (page 20). Turning Knobs A or B while playing gives you the dynamic filter-sweep effects of an analog synthesizer. |
| 2 | Effect | Select the Voice "008 CP80." Turn Knobs A and B all the way down to hear the direct, unprocessed sound of the Voice. As you turn Knob B toward the right, a Chorus effect with modulation is gradually applied to the sound. Turning Knob A to the right adds a Reverb effect that makes you sound like you are playing in a concert hall. |
| 3 | EG | Select the Voice "173 RSAnPad." Turning Knob A all the way down makes the attack faster, and lets you hear the crisp, clear sound of the original Voice. Turning Knob B all the way down shortens the amount of time for the sound to decay to silence after a key is released. These knobs let you finely adjust the Voice to create the appropriate sound for the particular song you're playing. |
| 4 | Style Filter | Select the Style, "057 EuTrance." Turn on the [ACMP ON/OFF] button and start Style playback (page 26). Set Knob B to about 3 o'clock, and Knob A to about 8 o'clock. The overall sound of the style should be a bit muffled compared to the original, with the drums emphasized for solid rhythmic impact. |
| 5 | Volume Balance/ Pattern Retrigger | Knob A: Connect an audio device or a computer (page 36), then turn this knob while playing audio on the external device. You can adjust the volume balance between the performance on this instrument and the audio input. Knob B: Select the Section C of the Pattern "002 FrenchDJ" and start Pattern playback. Turn this knob to the right while holding down the Section button C, and you can progressively shorten the Retrigger rate like a DJ would in performance. |
| 6 | DSP | Select the Voice, "019 Cool!Org." Press the [DSP] button to turn the DSP on, then set the DSP type (Function 040) to "01 RotarySp," and the DSP part (Function 041) to "1 Keyboard" (page 60). Adjust the effect depth by turning Knob B while playing the keyboard, then use Knob A to change the rotating speed of the rotary speaker. When you move it slowly, you can create gradual speed changes like on a real rotary speaker. |

Adding DSP Effects

DSP is term of abbreviated form of Digital Signal Processor. DSP effects are applied only to a specified part as described below.

Parts to which DSP effects are applied

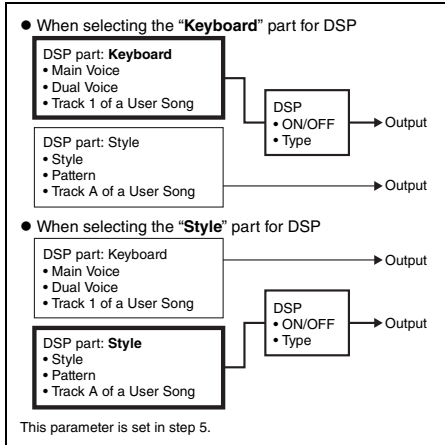

1 Press the [DSP] button to turn DSP on.



Although turning on DSP will select a DSP type suitable for the current panel setting, you can select a different DSP type as described in the following steps.

2 Hold down the [DSP] button for longer than a second to call up "DSP Type" (Function 040).

After a few seconds, the current DSP type appears.

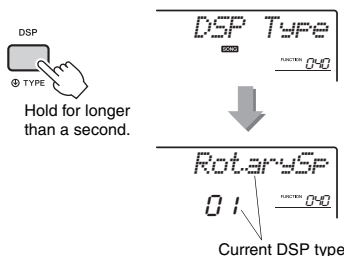

3 Rotate the dial to select a DSP type.

For information about the available DSP types, refer to the Effect Type List in the Data List.

4 Press the CATEGORY [+] button once to call up "DSP Part" (Function 041).

After a few seconds, the current part to which the DSP effects are applied appears.

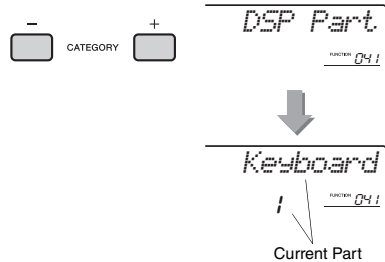

5 Rotate the dial to select a part to which the DSP effects are applied.

Refer to the chart of "Parts to which DSP effects are applied" (see left), and select "Keyboard" or "Style."

6 Press the [ASSIGN] button several times to assign Function 6 to the knobs (page 25).

7 Turn the knobs while playing the part selected in step 5 to see how the DSP effects change.

8 Press the [DSP] button again to turn DSP off.

Limitations when recording a Song

- DSP effects can be recorded only to Tracks 1 and A.
- The DSP type and part cannot be changed while recording.
- When recording to an existing User Song, if the part to which the DSP effects are applied differs from the recording tracks, DSP related setting data (DSP part, type, parameter A/B) will not be recorded or overwritten.
- The DSP effects may not be applied as expected when a User Song is being played back. This is because the DSP effects are affected by the data recorded to the User Song.

Arpeggio Settings

Synchronizing an Arpeggio to Song/Style/Pattern Playback— Arpeggio Quantize

When you play the keyboard to trigger an Arpeggio (page 24) along with Song/Style/Pattern playback, you'll need to play the notes with correct timing to keep the Arpeggio in synchronization with the other playback tracks. However, your actual timing may be slightly ahead of or behind the beat (or both). The "Arpeggio Quantize" function of this instrument will correct any slight imperfections in the timing (according to settings below), and then play back the Arpeggio appropriately.

- Synchronizing to quarter notes
- Synchronizing to 8th notes
- No synchronization

Although the Arpeggio Quantize value is pre-programmed for each Arpeggio Type, you can change the value manually.

1 Press the [FUNCTION] button.



2 Use the CATEGORY [+] and [-] buttons to call up "Quantize" (Function 046).

After a few seconds, the current Arpeggio Quantize value appears.

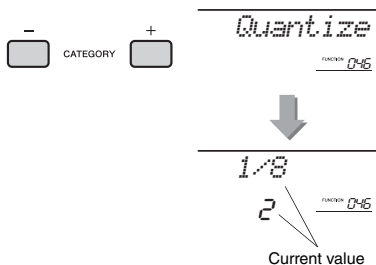

3 Rotate the dial to select a value from "OFF," "1/8" and "1/16."

- 1/8 Synchronizing to quarter notes
- 1/16 Synchronizing to 8th notes
- OFF No synchronization

Holding the Arpeggio Playback via the Footswitch

You can set the instrument so that Arpeggio playback continues even after the note has been released, by pressing the footswitch connected to the [SUSTAIN] jack.

1 Press the [FUNCTION] button.



2 Use the CATEGORY [+] and [-] buttons to call up "Pd1 Func" (Function 047).

After a few seconds, the current pedal setting appears.

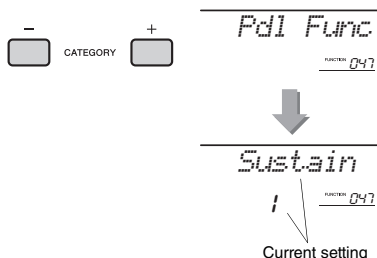

3 Rotate the dial to select "Arp Hold."

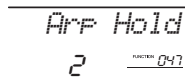

If you want to restore the footswitch function to sustain, select "Sustain." If you want to use both hold and sustain functions, select "Hold+Sus."

4 Try playing Arpeggio with the footswitch.

Press the notes to trigger the Arpeggio, then press the footswitch. Even if you release the notes, Arpeggio playback will continue. To stop Arpeggio playback, release the footswitch.

Style and Pattern Settings

Style Variations—Sections

Each Style consists of “Sections” that allow you to vary the arrangement of the accompaniment to match the song you are playing.

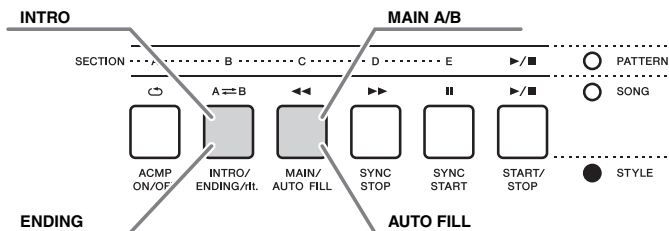

INTRO

This is used for the beginning of the Song. When the Intro finishes, Style playback shifts to the Main section. The length of the Intro (in measures) differs depending on the selected Style.

MAIN

This is used for playing the main part of the Song. Playback of the Main section repeats indefinitely until another Section’s button is pressed. There are two variations (A and B), and the Style playback sound changes harmonically in response on the chords you play with your left hand.

AUTO FILL

This is automatically added before changing to Main A or B.

ENDING

This is used for the ending of the Song. When the Ending finishes, the Style playback stops automatically. The length of the Ending (in measures) differs depending on the selected Style.

1 Press the [STYLE] button, then rotate the dial to select a Style.

2 Press the [ACMP ON/OFF] button to turn ACMP on.



3 Press the [SYNC START] button to turn Synchro Start on.



To turn off Synchro Start, press the [SYNC START] button.

● Synchro Start

When Synchro Start is on, Style playback will begin as soon as you play a chord in the Auto Accompaniment area of the keyboard.

4 Press the [MAIN/AUTO FILL] button to select Main A or Main B.

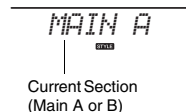

5 Press the [INTRO/ENDING/rit.] button.

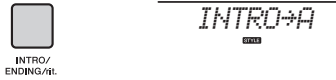

Now, you're ready to start Style playback of the Intro and then the Main A (or B) section.

6 Play a chord with your left hand to start playback of the Intro.

For information on how to play chords, see "Chords" on page 54.

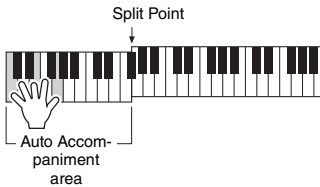

7 After the Intro finishes, play the keyboard according to the progression of the Song you are playing.

Play chords with your left hand while playing melodies with your right hand, and press the [MAIN/AUTO FILL] button as necessary. The Section will change to Fill-in then Main A or B.



8 Press the [INTRO/ENDING/rit.] button.



The Section switches to the Ending. When the Ending is finished, Style playback stops automatically. You can have the Ending gradually slow down (ritardando) by pressing the [INTRO/ENDING/rit.] button again while the Ending is playing back.

NOTE

- Style numbers 196, 208–220 have no rhythm parts, so no rhythm will play. When one of these Styles is selected, turn ACMP on, then specify the chord in the left hand area to play Style parts other than the Rhythm part.

Style Synchro Stop

When you press the [SYNC STOP] button to turn on this function, the Style will only play while pressing chords in the Auto Accompaniment area of the keyboard. Releasing all the notes will stop Style playback.

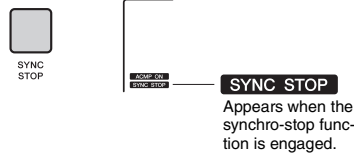

Appears when the synchro-stop function is engaged.

NOTE

- This function can be used when ACMP is turned on.

Turning Each Style Track On/Off

As printed on the front panel, a Style consists of six tracks. Turn on/off each track via the TRACK CONTROL buttons. Each of the tracks can be muted so that you can play the muted part yourself. Pressing the desired Track button repeatedly will toggle the on/off status.

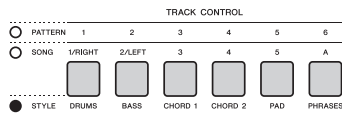

1 2 3 4 5 6 — On/off status is shown in the display (page 19)

NOTE

- Up to two Track buttons can be pressed simultaneously for turning Tracks on or off.

Pattern Variations—Sections

Like the Styles, each Pattern features several Sections, allowing you to add dynamic variations to the performance. Five Sections (A–E) are provided.

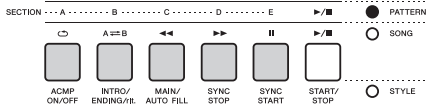

Unlike the Styles, however, Patterns do not have the Sections dedicated to the beginning or ending of the Song, such as Intro and Ending. All Sections A–E will play back repeatedly until stopped manually.

Pattern Retrigger Function

This function restarts Pattern playback from the beginning.

- 1 Press the [PATTERN] button, then rotate the dial to select the desired Pattern.
- 2 Press the [START/STOP] button or press any key in the Auto Accompaniment area to start Pattern playback (page 27).
- 3 By pressing the button of the currently playing Section, you can restart playback from the beginning. Holding down the button lets loop-play only the top portion of the Section.

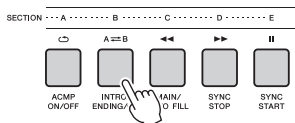

The top portion length (Retrigger Rate) can be changed by using the knob (page 47).

NOTE

- When recording Pattern playback with the Retrigger function, note that the beat indicator in the display, metronome and Arpeggio playback is not synchronized with playback of the recorded Song.

Changing the Tempo

A Style or Pattern can be played at any tempo you desire—fast or slow.

- 1 Press the [TEMPO/TAP] button to call up the Tempo value in the display.

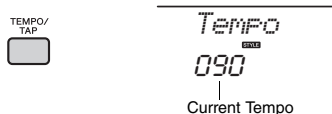

- 2 Rotate the dial to set a tempo from 011 to 280.

Pressing the [+ / YES] and [- / NO] buttons simultaneously can instantly reset the value to the default tempo of the current Style or Pattern. You can change the tempo during playback by pressing the [TEMPO/TAP] button just twice at the required tempo.

NOTE

- The above operation applies also to Song or Arpeggio playback tempo.

Tap Start

You can start play back of the Style, Pattern or Song by simply tapping the [TEMPO/TAP] button at the required tempo—four times for time signatures in 4 (4/4, etc.), and three times for time signatures in 3 (3/4, etc.).

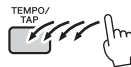

NOTE

- Tap tempo setting range: 32–280

Adjusting the Volume of the Style or Pattern

You can adjust the volume balance between Style or Pattern playback and your keyboard performance.

1 Press the [FUNCTION] button.



2 Use the CATEGORY [+] and [-] buttons to call up “StyleVol” (Function 001) or “PatrnVol” (Function 003).

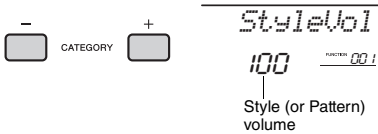

3 Rotate the dial to set the volume between 000 and 127.

Setting the Split Point

The point on the keyboard that separates the left-hand area and the right-hand area of the keyboard is called the “Split Point.” The left-hand area is used to specify the chord for Style playback, to specify the key for Pattern playback, or to play the Split Voice. The default Split Point is key number 054 (the F#2 key), but you can change it to another key.

1 Press the [FUNCTION] button.



2 Use the CATEGORY [+] and [-] buttons to call up “SplitPnt” (Function 009).

You can call up this display also by pressing the [STYLE] then holding the [ACMP] button for longer than a second.

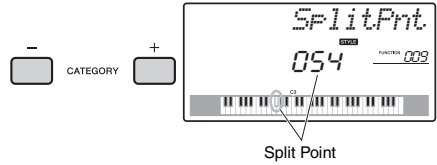

3 Rotate the dial to set the Split Point between 036 (C1) and 096 (C6) (on the PSR-E453) or 028 (E0) and 103 (G6) (on the PSR-EW400).

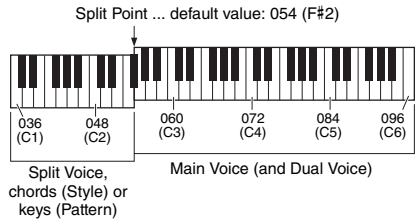

NOTE

- During the Lesson playback, the Split Point cannot be changed.

Playing Chords Without Style Playback (Stop Accompaniment)

If you press the [STYLE] button, press the [ACMP ON/OFF] button to turn ACMP on (the ACMP ON icon appears), and play the chord in the Auto Accompaniment area of the keyboard (with SYNC START off), the chord sound will be heard without Style playback. This is referred to as “Stop Accompaniment.” The specified chord will be shown in the display, and affects the Harmony function (page 23).

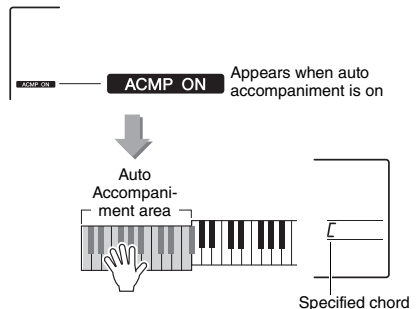

Chord Types for Style Playback

For users who are new to chords, this chart features common chords. Since there are many useful chords and many different ways to use them musically, refer to commercially available chord books for further details.

★ indicates the root note.

| Major | Minor | Seventh | Minor Seventh | Major Seventh |
|--------------|---------------|---------------|----------------|----------------|
| C | Cm | C7 | Cm7 | CM7 |
| D | Dm | D7 | Dm7 | DM7 |
| E | Em | E7 | Em7 | EM7 |
| F | Fm | F7 | Fm7 | FM7 |
| G | Gm | G7 | Gm7 | GM7 |
| A | Am | A7 | Am7 | AM7 |
| B | Bm | B7 | Bm7 | BM7 |

- Inversions can be used as well as in "root" position—with the following exceptions: m7, m7♭5, m7(11), 6, m6, sus4, aug, dim7, 7♭5, 6(9), sus2
- Inversion of the 7sus4 chords are not recognized if the notes are omitted.
- When playing a chord which cannot be recognized by this instrument, nothing is shown on the display. In such a case, only the rhythm and bass parts will be played.

Easy Chords

This method lets you easily play chords in the Auto Accompaniment area of the keyboard using only one, two, or three fingers.

For root "C"



To play a major chord
Press the root note (★) of the chord.



To play a minor chord
Press the root note together with the nearest black key to the left of it.



To play a seventh chord
Press the root note together with the nearest white key to the left of it.



To play a minor seventh chord
Press the root note together with the nearest white and black keys to the left of it (three keys altogether).

Looking Up Chords Using the Chord Dictionary

The Dictionary function is useful when you know the name of a certain chord and want to quickly learn how to play it.

1 Press and hold the [LESSON] button for longer than a second to call up "Dict."

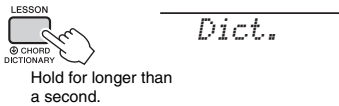

This operation will divide the entire keyboard into the three ranges as illustrated below.

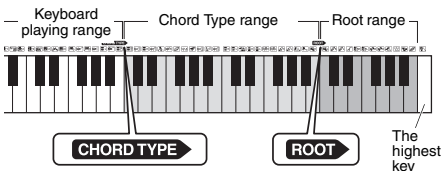

- The range to the right of "ROOT": Lets you specify the chord root, but produces no sound.
- The range between "CHORD TYPE" and "ROOT": Lets you specify the chord type, but produces no sound.
- The range to the left of "CHORD TYPE": Lets you play and confirm the chord specified in the above two ranges.

2 As an example, learn how to play a GM7 (G major seventh) chord.

2-1. Press the "G" key in the section to the right of "ROOT" so that the "G" is shown as the root note.

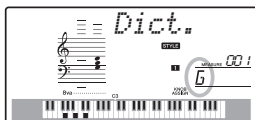
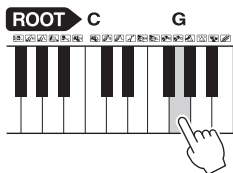

2-2. Press the key labeled "M7" in the section between "CHORD TYPE" and "ROOT." The notes you should play for the specified chord (root note and chord type) are conveniently shown in the display, both as notation and in the keyboard diagram.

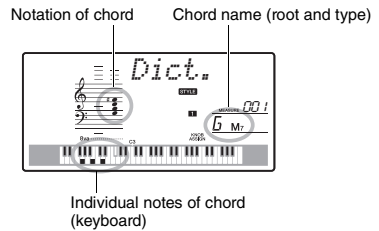
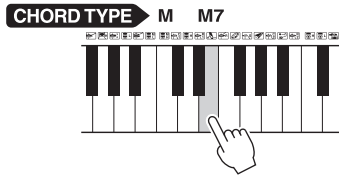

To call up possible inversions of the chord, press the [+ / YES] or [- / NO] button.

NOTE

- About major chords: Simple major chords are usually indicated only by the root note. For example, "C" refers to C major. However, when specifying major chords here, make sure to press the key of "M" (major) after pressing the root note.

3 Following the notation and keyboard diagram in the display, try playing a chord in the range to the left of "CHORD TYPE."

When you've played the chord properly, a bell sound signals your success and the chord name in the display flashes.

Specifying only the key for Pattern playback

Note that you need to specify only the root note for Pattern playback, unlike Style playback for which you also need to specify the chord type.

Song Settings

BGM (Background Music) Playback

With the default setting, pressing the [DEMO] button will play back only a few of the internal Songs repeatedly. This setting can be changed so that, for example, all internal Songs are played, or all Songs transferred to the instrument from a computer are played back, letting you use the instrument as a background music source. Five playback group settings are provided. Simply select the one that suits your needs.

1 Hold down the [DEMO] button for longer than a second to call up “DemoGrp.”

After a few seconds, the current repeat playback group appears.

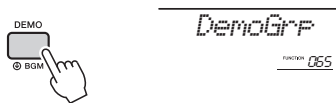

Hold for longer than a second.

2 Rotate the dial to select a repeat playback group from the table below.

| | |
|----------|---|
| Demo | Preset Songs 001–003 |
| Preset | All preset Songs |
| User | All User Songs |
| Download | All Songs transferred from a computer |
| USB | All Songs (MIDI files) in the connected USB flash drive |

[NOTE]

- When User Songs, Download Songs and USB Songs data do not exist, Demo Songs are played back.

3 Press the [DEMO] button to start playback.

To stop playback, press the [DEMO] button again.

Random Song Playback

The order of Song repeat playback via the [DEMO] button can be changed between the numerical order and random order.

1 Press the [FUNCTION] button.



2 Use the CATEGORY [+/-] buttons to call up “PlayMode” (Function 066).

After a few seconds, the current playback mode appears.

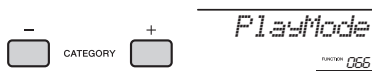

When the DemoGrp is set to “Demo,” this parameter cannot be set.

3 Rotate the dial to select “Random.”

To return to the numerical order, select “Normal.”

4 Press the [DEMO] button to start playback.

To stop playback, press the [DEMO] button again.

Tempo Setting of the Song

This operation is same as that of the Style and Pattern. Refer to page 52.

Tap Start

This operation is same as that of the Style and Pattern. Refer to page 52.

Song Volume

- 1 Press the [FUNCTION] button.



- 2 Use the CATEGORY [+] and [-] buttons to call up “SongVol” (Function 002).

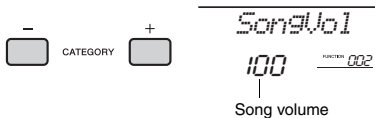

- 3 Rotate the dial to set the Song volume between 000 and 127.

NOTE

- Song volume can be adjusted while in the Song mode.

Melody Voice Setting of the Preset Song

You can change the Melody Voice of the current Preset Song temporarily to any other desired Voice.

- 1 Press the [SONG] button, select the desired Preset Song, then start playback (page 28).
- 2 Press the [VOICE] button, then rotate the dial to select the desired Voice.

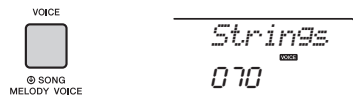

- 3 Hold down the [VOICE] button for longer than a second to call up “SONG MELODY VOICE.”

After a few seconds, the Melody Voice of the Song will be changed to that selected in step 2.

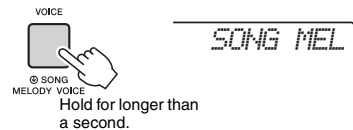

NOTE

- Selecting another Song will cancel the changed Melody Voice.
- You cannot change the Melody Voice of a User Song.

The Functions

The “Functions” provide access to a range of detailed instrument parameters such as Tuning, Split Point, Voices and Effects. Find the desired item in the Function List on pages 58–61, then follow the instructions below.

Basic Procedure in the Function Display

1 Press the [FUNCTION] button.



2 Press the CATEGORY [+] or [-] button several times until the desired item appears.

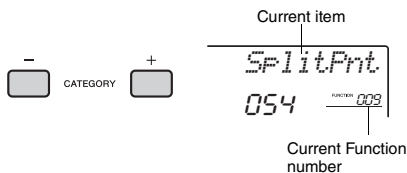

3 Use the dial, the [+ /YES] and [- /NO] buttons, or the [0]–[9] number buttons to set the value of the selected function.

To restore the default value, press the [+ /YES] and [- /NO] buttons simultaneously. In the sole case of the MIDI Initial Send function (Function 057), pressing the [+ /YES] button executes the function while pressing [- /NO] cancels it.

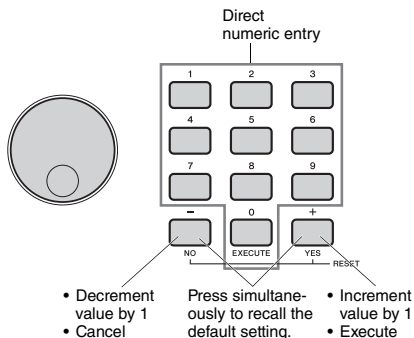

Some Function settings are maintained even if you turn off the power, and can be transferred to a computer as Backup Data (page 39).

NOTE 4

- To exit from a Function display, press the [VOICE], [STYLE], [SONG] or [PATTERN] button.

Function List

| Function Number | | Function | Display | Range/Settings | Default Value | Description |
|-----------------|-----------|----------------------------|-----------------|--|---------------|--|
| PSR-E453 | PSR-EW400 | | | | | |
| Volume | | | | | | |
| 001 | 001 | Style Volume | <i>StylVcl</i> | 000–127 | 100 | Refer to page 53. |
| 002 | 002 | Song Volume | <i>SongVol</i> | 000–127 | 100 | Refer to page 57. |
| 003 | 003 | Pattern Volume | <i>PatrVcl</i> | 000–127 | 100 | Refer to page 53. |
| 004 | 004 | [AUX IN] Audio Volume | <i>AuxInVol</i> | 000–127 | 50 | Adjusts the volume of audio playback, input from the [AUX IN] jack (page 36). |
| 005 | 005 | [USB TO HOST] Audio Volume | <i>USBInVol</i> | 000–127 | 100 | Adjusts the volume of audio playback, input from the [USB TO HOST] terminal (page 36, 37). |
| Overall | | | | | | |
| 006 | 006 | Transpose | <i>Transpos</i> | -12–12 | 00 | Refer to page 41. |
| 007 | 007 | Tuning | <i>Tuning</i> | 427.0Hz–453.0Hz | 440.0Hz | Refer to page 41. |
| 008 | 008 | Pitch Bend Range | <i>PBRang</i> | 01–12 | 02 | Sets the range over which you can control pitch by using the [PITCH BEND] wheel (page 41), in semitone increments. |
| 009 | 009 | Split Point | <i>SplitPnt</i> | 036–096 (C1–C6, PSR-E453)/ 028–103 (E0–G6, PSR-EW400) | 054 (F#2) | Refer to page 53. |
| 010 | 010 | Touch Response | <i>TouchRes</i> | 1 (Soft), 2 (Medium), 3 (Hard), 4 (Fixed) | 2 (Medium) | Refer to page 42. |

| Function Number | | Function | Display | Range/Settings | Default Value | Description |
|------------------------------|-----------|-------------------|------------------|--|----------------|--|
| PSR-E453 | PSR-EW400 | | | | | |
| Main Voice (page 20) | | | | | | |
| 011 | 011 | Volume | <i>M.VoIume</i> | 000–127 | * | Determines the volume of the Main Voice. |
| 012 | 012 | Octave | <i>M.Octave</i> | -2 +2 | * | Determines the octave range for the Main Voice. |
| 013 | 013 | Pan | <i>M.Pan</i> | 000 (left)–064 (center)–127 (right) | * | Determines the stereo pan position of the Main Voice. The value "0" results in the sound being panned full left; the value "127" results in the sound being panned full right. |
| 014 | 014 | Reverb Depth | <i>M.Reverb</i> | 000–127 | * | Determines how much of the Main Voice's signal is sent to the Reverb effect. |
| 015 | 015 | Chorus Depth | <i>M.Chorus</i> | 000–127 | * | Determines how much of the Main Voice's signal is sent to the Chorus effect. |
| 016 | 016 | Attack Time | <i>M.Attack</i> | 000–127 | 064 | Determines how fast the volume of the Main Voice reaches the Attack level when the note is pressed. The larger the value, the slower the attack rate. The smaller the value, the faster the attack rate. |
| 017 | 017 | Release Time | <i>M.Release</i> | 000–127 | 064 | Determines how fast the volume of the Main Voice falls to 0 when the note is released. The larger the value, the longer the sustain. The smaller the value, the shorter the sustain. |
| 018 | 018 | Filter Cutoff | <i>M.Cutoff</i> | 000–127 | 064 | Determines the Filter Cutoff Frequency (page 46) of the Main Voice. |
| 019 | 019 | Filter Resonance | <i>M.Reso.</i> | 000–127 | 064 | Determines the Filter Resonance (page 46) of the Main Voice. |
| Dual Voice (page 21) | | | | | | |
| 020 | 020 | Dual Voice | <i>D.Voice</i> | 001–758 | * | Selects a Dual Voice. |
| 021 | 021 | Volume | <i>D.VoIume</i> | 000–127 | * | Determines the volume of the Dual Voice. |
| 022 | 022 | Octave | <i>D.Octave</i> | -2 +2 | * | Determines the octave range for the Dual Voice. |
| 023 | 023 | Pan | <i>D.Pan</i> | 000 (left)–064 (center)–127 (right) | * | Determines the stereo pan position of the Dual Voice. A value of "0" results in the sound being panned full left; a value of "127" results in the sound being panned full right. |
| 024 | 024 | Reverb Depth | <i>D.Reverb</i> | 000–127 | * | Determines how much of the Dual Voice's signal is sent to the Reverb effect. |
| 025 | 025 | Chorus Depth | <i>D.Chorus</i> | 000–127 | * | Determines how much of the Dual Voice's signal is sent to the Chorus effect. |
| 026 | 026 | Attack Time | <i>D.Attack</i> | 000–127 | 064 | Determines how fast the volume of the Dual Voice reaches the Attack level when the note is pressed. The larger the value, the slower the attack rate. The smaller the value, the faster the attack rate. |
| 027 | 027 | Release Time | <i>D.Release</i> | 000–127 | 064 | Determines how fast the volume of the Dual Voice falls to 0 when the note is released. The larger the value, the longer the sustain. The smaller the value, the shorter the sustain. |
| 028 | 028 | Filter Cutoff | <i>D.Cutoff</i> | 000–127 | 064 | Determines the Filter Cutoff Frequency (page 46) of the Dual Voice. |
| 029 | 029 | Filter Resonance | <i>D.Reso.</i> | 000–127 | 064 | Determines the Filter Resonance (page 46) of the Dual Voice. |
| Split Voice (page 21) | | | | | | |
| 030 | 030 | Split Voice | <i>S.Voice</i> | 001–758 | 054 (Fng/Bass) | Selects a Split Voice. |
| 031 | 031 | Volume | <i>S.VoIume</i> | 000–127 | 080 | Determines the volume of the Split Voice. |
| 032 | 032 | Octave | <i>S.Octave</i> | -2 +2 | -1 | Determines the octave range for the Split Voice. |
| 033 | 033 | Pan | <i>S.Pan</i> | 000 (left)–064 (center)–127 (right) | 064 | Determines the stereo pan position of the Split Voice. A value of "0" results in the sound being panned full left; a value of "127" results in the sound being panned full right. |
| 034 | 034 | Reverb Depth | <i>S.Reverb</i> | 000–127 | 008 | Determines how much of the Split Voice's signal is sent to the Reverb effect. |
| 035 | 035 | Chorus Depth | <i>S.Chorus</i> | 000–127 | 000 | Determines how much of the Split Voice's signal is sent to the Chorus effect. |
| Effects | | | | | | |
| 036 | 036 | Reverb Type | <i>Reverb</i> | 01–10 | ** | Refer to page 40. |
| 037 | 037 | Chorus Type | <i>Chorus</i> | 1–6 | ** | Refer to page 40. |
| 038 | 038 | Master EQ Type | <i>MasterEQ</i> | 1 (Speaker), 2 (Headphone), 3 (Boost), 4 (Piano), 5 (Bright), 6 (Mild) | 1 (Speaker) | Refer to page 42. |
| 039 | 039 | Melody Suppressor | <i>SUPPRPan</i> | L63, L62...L02, L01, C, R01, R02...R62, R63 | C | Determines the pan position to be cancelled when the Melody Suppressor (page 37) is turned on. |

| Function Number | | Function | Display | Range/Settings | Default Value | Description |
|-------------------------------|-----------|-------------------|---------------------|---|--------------------------------|---|
| PSR-E453 | PSR-EW400 | | | | | |
| DSP (page 48) | | | | | | |
| 040 | 040 | DSP Type | <i>DSP Type</i> | 01–10 | 01 | Refer to page 48. |
| 041 | 041 | DSP Part | <i>DSP Part</i> | 1 (Keyboard) 2 (Style) | 1 (Keyboard) | |
| Harmony (page 23) | | | | | | |
| 042 | 042 | Harmony Type | <i>Harmony Type</i> | 01–26 | * | Determines the Harmony type. |
| 043 | 043 | Harmony Volume | <i>Harmony Vol</i> | 000–127 | * | Determines the volume of the Harmony effect. |
| Arpeggio (page 24) | | | | | | |
| 044 | 044 | Arpeggio Type | <i>ARP Type</i> | 001–150 | * | Determines the Arpeggio type. |
| 045 | 045 | Arpeggio Velocity | <i>ARP Velo</i> | 1 (Original), 2 (Thru) | Depending on the Arpeggio type | When "Thru" is selected, the velocities of Arpeggio playback are determined by your playing strength. When "Original" is selected, the velocities of Arpeggio playback are determined by the original setting regardless of your playing strength. |
| 046 | 046 | Arpeggio Quantize | <i>Quantize</i> | 1 (OFF), 2 (1/8), 3 (1/16) | Depending on the Arpeggio type | Refer to page 49. |
| 047 | 047 | Pedal Function | <i>Pd1 Func</i> | 1 (Sustain) / 2 (Arp Hold) / 3 (Hold+Sus) | * | Refer to page 49. |
| Scale Tuning (page 43) | | | | | | |
| 048 | 048 | Scale | <i>Scale</i> | 1 (Equal), 2 (Pure Maj), 3 (Pure min), 4 (Bayat), 5 (Rast) | 1 (Equal) | Refer to page 43. |
| 049 | 049 | Base Note | <i>Base Note</i> | 01 (C), 02 (C#), 03 (D), 04 (E ^b), 05 (E), 06 (F), 07 (F#), 08 (G), 09 (A ^b), 10 (A), 11 (B ^b), 12 (B) | 01 (C) | Refer to page 43. |
| 050 | 050 | Tuning Note | <i>Tune Note</i> | 01 (C), 02 (C#), 03 (D), 04 (E ^b), 05 (E), 06 (F), 07 (F#), 08 (G), 09 (A ^b), 10 (A), 11 (B ^b), 12 (B) | 01 (C) | Refer to page 44. |
| 051 | 051 | Tuning | <i>Tune</i> | -64–63 | Depending on the Scale | |
| MIDI | | | | | | |
| 052 | 052 | Local Control | <i>Local</i> | ON/OFF | ON | Determines whether the instrument's keyboard controls the internal tone generator (ON) or not (OFF). When you record your keyboard performance to application software on a computer via MIDI, set this parameter to OFF. |
| 053 | 053 | External Clock | <i>ExtClock</i> | ON/OFF | OFF | Determines whether the instrument synchronizes to the internal clock (OFF) or an external clock (ON). When you record your keyboard performance to application software on a computer via MIDI, set this parameter to ON. |
| 054 | 054 | Keyboard Out | <i>KbdOut</i> | ON/OFF | ON | Determines whether MIDI messages generated via keyboard performance are transmitted (ON) or not (OFF) from the [USB TO HOST] terminal. |
| 055 | 055 | Style Out | <i>StyleOut</i> | ON/OFF | OFF | Determines whether MIDI messages generated via Style playback are transmitted (ON) or not (OFF) from the [USB TO HOST] terminal. |
| 056 | 056 | Song Out | <i>SongOut</i> | ON/OFF | OFF | Determines whether MIDI messages generated via Song playback are transmitted (ON) or not (OFF) from the [USB TO HOST] terminal. |
| 057 | 057 | Initial Send | <i>InitSend</i> | YES/NO | - | Lets you send the data of the panel settings to a computer. Press [+]/YES to send, or press [-]/NO to cancel. This operation should be done immediately after starting the Recording operation on a computer. |
| Audio (page 36) | | | | | | |
| 058 | 058 | Audio Loop Back | <i>LoopBack</i> | ON/OFF | ON | Determines whether Audio sound input from the [USB TO HOST] terminal is returned to the computer or not with the performance played on the instrument. If you want to output only the sound played on this instrument to the computer, set this parameter to OFF. |

| Function Number | | Function | Display | Range/Settings | Default Value | Description |
|---------------------------------|-----------|----------------------------|--------------------|---|---------------|--|
| PSR-E453 | PSR-EW400 | | | | | |
| Metronome (page 22) | | | | | | |
| 059 | 059 | Time Signature Numerator | <i>Timesign</i> | 00–60 | ** | Determines the time signature of the Metronome. |
| 060 | 060 | Time Signature Denominator | <i>TimesignD</i> | Half note, Quarter note, Eighth note, Sixteenth note | ** | Determines the length of each metronome beat. |
| 061 | 061 | Metronome Volume | <i>MtrVol</i> | 000–127 | 100 | Determines the volume of the Metronome. |
| Lesson (page 30) | | | | | | |
| 062 | 062 | Lesson Track (R) | <i>R-Part</i> | 01–16, OFF | 01 | Determines the guide track number for your right hand lesson. The setting is only effective for Songs in SMF format 0, in USB flash drive or transferred from a computer. |
| 063 | 063 | Lesson Track (L) | <i>L-Part</i> | 01–16, OFF | 02 | Determines the guide track number for your left hand lesson. The setting is only effective for Songs in SMF format 0, in USB flash drive or transferred from a computer. |
| 064 | 064 | Your Tempo | <i>YourTemp</i> | ON/OFF | ON | This parameter is for Lesson 3 (WAITING). When set to ON, playback tempo will change to match the speed at which you are playing. When set to OFF, playback tempo will be maintained regardless of the speed at which you are playing. |
| Demo (page 28) | | | | | | |
| 065 | 065 | Demo Group | <i>DemoGrp</i> | 1 (Demo) / 2 (Preset) / 3 (User) / 4 (Download) / 5 (USB) | 1 (Demo) | Refer to page 56. |
| 066 | 066 | Demo Play Mode | <i>PlayMode</i> | 1 (Normal) / 2 (Random) | 1 (Normal) | Refer to page 56. |
| Speaker Mute (page 38) | | | | | | |
| – | 067 | Speaker Mute | <i>SP Mute</i> | ON/OFF | OFF | Refer to page 38. |
| Auto Power Off (page 16) | | | | | | |
| 067 | 068 | Auto Power Off Time | <i>AutoOff</i> | OFF, 5/10/15/30/60/120 (min.) | 30 minutes | Specifies the time that will elapse before the instrument's power is automatically turned off. |
| Battery (page 14) | | | | | | |
| 068 | 069 | Battery Type | <i>BatteryType</i> | 1 (Alkaline) / 2 (Ni-MH) | 1 (Alkaline) | Selects the type of batteries you have installed to this instrument. |
| Language (page 63) | | | | | | |
| 069 | 070 | Language | <i>Language</i> | English/Japanese | English | Determines the language for the Song file names. Determines the language for the name of the files in the USB flash drive or the files loaded from a computer. |

* The appropriate value is automatically set for each Voice.

** The appropriate value is automatically set for each Song, Style or Pattern.

NOTE

- The settings of "MIDI" and "Audio" is useful when an external device such as a computer is connected to the [USB TO HOST] terminal (page 36).

USB Flash Drive Operations

By connecting the USB flash drive (sold separately) to the [USB TO DEVICE] terminal, you can save the data created on this instrument, such as User Song and parameter settings. The saved data can be recalled to this instrument again for the future use.

IMPORTANT

- You should use an AC adaptor when executing USB flash drive operations, since battery power may not be reliable enough to last through these crucial operations. When you try executing certain functions, the "UseAdpt" indication may appear and the selected function cannot be executed.

Precautions when using the [USB TO DEVICE] terminal

This instrument features a built-in [USB TO DEVICE] terminal. When connecting a USB device to the terminal, be sure to handle the USB device with care. Follow the important precautions below.

NOTE

- For more information about the handling of USB devices, refer to the owner's manual of the USB device.

● Compatible USB devices

- USB flash drive

Other USB devices such as a USB hub, computer keyboard or mouse cannot be used.

The instrument does not necessarily support all commercially available USB devices. Yamaha cannot guarantee operation of USB devices that you purchase. Before purchasing a USB device for use with this instrument, please visit the following web page:

<http://download.yamaha.com/>

Although USB devices 1.1 to 3.0 can be used on this instrument, the amount of time for saving to or loading from the USB device may differ depending on the type of data or the status of the instrument.

NOTE

- The rating of the [USB TO DEVICE] terminal is a maximum of 5V/500mA. Do not connect USB devices having a rating above this, since this can cause damage to the instrument itself.

● Connecting a USB device

- When connecting a USB device to the [USB TO DEVICE] terminal, make sure that the connector on the device is appropriate and that it is connected in the proper direction.

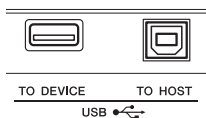

NOTICE

- Avoid connecting or disconnecting the USB device while executing playback/recording and file management operations (such as Save, Delete and Format), or when accessing the USB device. Failure to observe this may result in "freezing" of the operation of the instrument or corruption of the USB device and the data.
- When connecting then disconnecting the USB device (and vice versa), make sure to wait a few seconds between the two operations.

NOTE

- When connecting a USB cable, make sure that the length is less than 3 meters. Do not connect an extension cable.

Using a USB Flash Drive

By connecting the instrument to a USB flash drive, you can save data you've created to the connected device, as well as read data from the connected device.

● Number of USB flash drives that can be used

Only one USB flash drive can be connected to the [USB TO DEVICE] terminal.

● Formatting a USB flash drive

You should format the USB flash drive only with this instrument (page 64). A USB flash drive formatted on another device may not operate properly.

NOTICE

- The format operation overwrites any previously existing data. Make sure that the USB flash drive you are formatting does not contain important data.

● To protect your data (write-protect)

To prevent important data from being inadvertently erased, apply the write-protect provided with each USB flash drive. If you are saving data to the USB flash drive, make sure to disable write-protect.

● Turning off the instrument

When turning off the instrument, make sure that the instrument is NOT accessing the USB flash drive by playback/recording or file management (such as during Save, Delete and Format operations). Failure to do so may corrupt the USB flash drive and the data.

Connecting a USB Flash Drive

NOTE

- Before using a USB flash drive, be sure to read "Precautions when using the [USB TO DEVICE] terminal" on page 62.
- Messages may appear on the display during File Control procedures to aid in smooth operation. Refer to the Message List on page 69 for details.

1 Connect a USB flash drive to the [USB TO DEVICE] terminal, and wait until "USB" appears on the left corner of the display.

The "USB" indication confirms that the connected USB flash drive has been mounted or recognized.

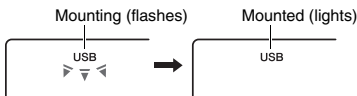

2 Hold down the [FUNCTION] button for longer than a second to call up the File Control display.

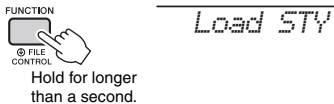

● If "UnFormat" followed by "Format?" appears:

This indicates that the connected USB flash drive requires formatting. Execute the Format operation by following the instructions starting with step 2 on page 64.

NOTE

The File Control display cannot be called up in the following situations.

- During playback of Style, Pattern, or Song
- When "USB" does not appear even if you have connected a USB flash drive to the [USB TO DEVICE] terminal.

NOTE

- No sound will be produced if the keyboard is played while the File Control display is showing, and only buttons related to File Control operations will be active.

3 Use the CATEGORY [+] and [-] buttons to call up the desired File Control function, then execute it.

For details, refer to the table on the right.

File Control Display List

| Display | File Control function | Page |
|----------|--|------|
| Load STY | Loading a Style File | 67 |
| Load USR | Loading User Data from a USB Flash Drive | 66 |
| Save SMF | Saving a User Song as SMF to a USB Flash Drive | 65 |
| Save USR | Saving User Data to a USB Flash Drive | 64 |
| Del SMF | Deleting a SMF File in a USB Flash Drive | 68 |
| Del USR | Deleting a User File in a USB Flash Drive | 68 |
| Format? | Formatting a USB Flash Drive | 64 |
| Exit? | Exiting from a File Control Display | 69 |

NOTE

- You can also exit from a File Control display only by pressing the [FUNCTION] button.

Recognizable file location in the USB flash drive for Song playback (page 28)

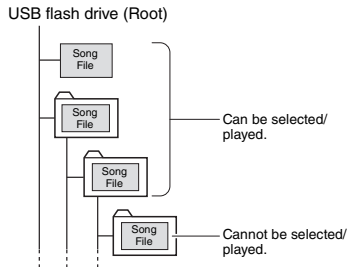

IMPORTANT

- If you manage the Song files in the USB flash drive by using a computer, etc., make sure to store the data either in the USB flash drive's root directory or a first-level/second-level folder in the root directory. Data stored in third-level folders created inside a second-level folder cannot be selected and played by this instrument.

Song title display language

File names containing Japanese katakana characters will be properly displayed if the instrument's display language is set to "Japanese." All display information other than file names will be displayed in English even if "Japanese" is selected. For details, refer to page 61 Function 069 (PSR-E453)/Function 070 (PSR-EW400).

Formatting a USB Flash Drive

The Format operation lets you prepare commercially available USB flash drive for use with this instrument.

NOTICE

- The format operation overwrites any previously existing data. Make sure that the USB flash drive you are formatting does not contain important data.

1 Hold the [FUNCTION] button for longer than a second to call up the File Control display.

2 Use the CATEGORY [+] and [-] buttons to call up “Format?”



3 Press the [0/EXECUTE] button.

A confirmation message will appear. To cancel the operation, press the [-/NO] button.



4 Press the [0/EXECUTE] button again or the [+ /YES] button to execute the Format operation.

After a while, a message indicating completion of the operation appears, and the “USER FILES” folder will be created in the USB flash drive.

NOTICE

- The Format operation cannot be cancelled during execution. Never turn off the power or disconnect the USB flash drive during the operation. Doing so may result in data loss.

5 Press the [FUNCTION] button to exit from the File Control display.

Saving User Data to a USB Flash Drive

The following data created on this instrument comprise the “User Data.”

- All 10 User Songs (page 32)
- Styles which have been transferred from a computer then loaded to Style numbers 221–230 (page 67).
- All the Registration Memory settings (page 35)

The User Data can be saved as a single “User File” (.usr) to a USB flash drive.

NOTE

- The extension (.usr) of the User File will not be shown on the display of this instrument. Confirm the extension on the computer display when connecting the USB flash drive to a computer.

1 Hold the [FUNCTION] button for longer than a second to call up the File Control display.

2 Use the CATEGORY [+] and [-] buttons to call up “Save USR.”



3 Press the [0/EXECUTE] button.

As the target file name, “USER****” (****: number) appears on the display. If desired, rotate the dial to select a different file name from “USER001”–“USER100.”



4 Press the [0/EXECUTE] button again.

A confirmation message will appear. To cancel the operation, press the [-/NO] button.

Overwriting existing files

If a file that already contains data is selected as the target user file, an overwrite confirmation message will appear.

5 Press the [0/EXECUTE] button again, or the [+ /YES] button to execute the Save operation.

After a while, a message indicating completion of the operation appears, and a User file (.usr) will be saved in a "USER FILES" folder which will automatically be created on the USB flash drive.

NOTICE

- The Save operation cannot be cancelled during execution. Never turn off the power or disconnect the USB flash drive during the operation. Doing so may result in data loss.

NOTE

- The amount of time required for this operation may vary depending on the condition of the USB flash drive.

6 Press the [FUNCTION] button to exit from the File Control display.

NOTE

- If you want to recall the User file (.usr) to this instrument again, execute the Load operation (page 66).

Saving a User Song as SMF to a USB Flash Drive

A User Song can be converted to SMF (Standard MIDI File) format 0 and saved to a USB flash drive.

SMF (Standard MIDI File) format

With this format, various events via the keyboard performance such as note on/off and Voice selection will be recorded as MIDI data. The SMF Format 0 and Format 1 are available. A large number of MIDI devices are compatible with SMF Format 0, and most commercially available Song files (MIDI files) are provided in SMF Format 0.

NOTE

- Patterns recorded to a User Song cannot be converted to SMF.
- The DSP effect (page 48) cannot be converted to SMF format.

1 Hold the [FUNCTION] button for longer than a second to call up the File Control display.

2 Use the CATEGORY [+] and [-] buttons to call up "Save SMF."

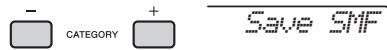

3 Press the [0/EXECUTE] button.

As the target User Song, "USER**" (**: number 1–10) appears on the display. If desired, rotate the dial to select a different User Song from "USER01"–"USER10" then press the [0/EXECUTE] button.

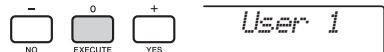

4 Press the [0/EXECUTE] button again.

As the target file name on the USB flash drive, "SONG***" (***: number 1–100) appears on the display. If desired, rotate the dial to select the different file.



5 Press the [0/EXECUTE] button again.

A confirmation message will appear. To cancel the operation, press the [-/NO] button.

Overwriting existing files

If a file that already contains data is selected, an overwrite confirmation message will appear.

6 Press the [0/EXECUTE] button again, or the [+ /YES] button to execute the Save operation.

After a while, a message indicating completion of the operation appears, and a User Song will be saved as the SMF format 0 in a "USER FILES" folder which will automatically be created on the USB flash drive.

NOTICE

- The Save operation cannot be cancelled during execution. Never turn off the power or disconnect the USB flash drive during the operation. Doing so may result in data loss.

NOTE

- The amount of time required for this operation may vary depending on the condition of the USB flash drive.
- If a Pattern has been recorded to the User Song, the Save operation cannot be executed by pressing the [0/EXECUTE] button or the [+ /YES] button, and "Can'tUse" appears on the display.

7 Press the [FUNCTION] button to exit from the File Control display.

Loading User Data from a USB Flash Drive

A User data (page 64) saved as a User file (.usr) to the USB flash drive can be loaded to this instrument.

NOTICE

- Loading a User file will overwrite and erase the existing data, including all 10 User Songs, Style data loaded to the Style numbers 221–230, and all the Registration Memory settings. Save important data you want to keep to a separate USB flash drive before loading a User file.

IMPORTANT

- Note that User files should be saved in the "USER FILES" folder on the USB flash drive. Files saved outside this folder cannot be recognized.

1 Hold the [FUNCTION] button for longer than a second to call up the File Control display.

2 Use the CATEGORY [+] and [-] buttons to call up "Load USR."



3 Press the [0/EXECUTE] button.

"USER***" (***: number) appears on the display as the User file name in the USB flash drive. As desired, rotate the dial to select a different User file.



4 Press the [0/EXECUTE] button again.

A confirmation message will appear. To cancel the operation, press the [-/NO] button.

5 Press the [0/EXECUTE] button again, or the [+ /YES] button to execute the Load operation.

After a while, a message indicating completion of the operation appears.

NOTICE

- The Load operation cannot be cancelled during execution. Never turn off the power or disconnect the USB flash drive during the operation. Doing so may result in data loss.

- 6 Press the [FUNCTION] button to exit from the File Control display.
- 7 Check the loaded data by calling up the User Song, one of the Styles 221–230, and Registration Memory settings.

Loading a Style File

Style data created on another instrument or a computer can be loaded to the Style numbers 221–230, and you can play them like the internal preset Styles. The following two Load operations are available.

- Loading of a Style file (.sty) saved on the root directory on the USB flash drive
- Loading of a Style file (.sty) transferred from a computer via the Musicsoft Downloader and stored in the internal memory of this instrument

NOTE

- For instructions on transferring a Style file from a computer via the Musicsoft Downloader, refer to the online PDF manual (page 11) “Computer-related Operations.” After data transfer, load the Style data to one of the Style numbers 221–230 to enable playback.

NOTICE

- Loading a Style file will overwrite and erase the existing data of the destination number. Save important data you want to keep to a separate USB flash drive before loading.

- 1 Hold the [FUNCTION] button for longer than a second to call up the File Control display.
- 2 Use the CATEGORY [+] and [-] buttons to call up “Load STY.”

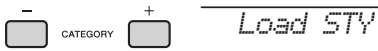

- 3 Press the [0/EXECUTE] button. The name of a Style file in the USB flash drive or internal memory of this instrument will appear on the display. If desired, rotate the dial to select a different Style file.

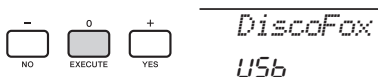

- 4 Press the [0/EXECUTE] button again. As the Load destination, “Load To? ****” (***: 221–230) appears on the display. If desired, rotate the dial to select a different number.



- 5 Press the [0/EXECUTE] button again. A confirmation message will appear. To cancel the operation, press the [-/NO] button.
- 6 Press the [0/EXECUTE] button again, or the [+ /YES] button to execute the Load operation. After a while, a message indicating completion of the operation appears.

NOTICE

- The Load operation cannot be cancelled during execution. Never turn off the power or disconnect the USB flash drive during the operation. Doing so may result in data loss.

- 7 Press the [STYLE] button, rotate the dial to select a Style from 221–230, and then try playing it back.

Deleting a User File in the USB Flash Drive

User Files (.usr) in the root directory of the USB flash drive can be deleted.

IMPORTANT

- Only User files (.usr) saved in the "USER FILES" folder on the USB flash drive can be deleted. Files outside this folder cannot be recognized.

- 1 Hold the [FUNCTION] button for longer than a second to call up the File Control display.
- 2 Use the CATEGORY [+] and [-] buttons to call up "Del USR."



- 3 Press the [0/EXECUTE] button. User file names in the USB flash drive appear on the display as "USER*****" (****: number). If desired, rotate the dial to select a different User file.



- 4 Press the [0/EXECUTE] button again. A confirmation message will appear. To cancel the operation, press the [-/NO] button.
- 5 Press the [0/EXECUTE] button again, or the [+ /YES] button to execute the Delete operation. After a while, a message indicating completion of the operation appears.

NOTICE

- The Delete operation cannot be cancelled during execution. Never turn off the power or disconnect the USB flash drive during the operation. Doing so may result in data loss.

- 6 Press the [FUNCTION] button to exit from the File Control display.

Deleting an SMF File in the USB Flash Drive

You can delete a SMF file that has been saved in the USB flash drive via the Save SMF operation (page 65).

IMPORTANT

- Only SMF files (.mid) saved in the "USER FILES" folder on the USB flash drive can be deleted. Files outside this folder cannot be recognized. This operation applies only to file names with the "SONG****" (****: 001-100) format.

- 1 Hold the [FUNCTION] button for longer than a second to call up the File Control display.
- 2 Use the CATEGORY [+] and [-] buttons to call up "Del SMF."

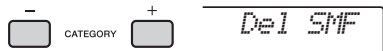

- 3 Press the [0/EXECUTE] button. SMF file names in the USB flash drive appear on the display as "SONG*****" (****: number). If desired, rotate the dial to select a different SMF file.

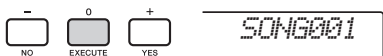

- 4 Press the [0/EXECUTE] button again. A confirmation message will appear. To cancel the operation, press the [-/NO] button.
- 5 Press the [0/EXECUTE] button again, or the [+ /YES] button to execute the Delete operation. After a while, a message indicating completion of the operation appears.

NOTICE

- The Delete operation cannot be cancelled during execution. Never turn off the power or disconnect the USB flash drive during the operation. Doing so may result in data loss.

- 6 Press the [FUNCTION] button to exit from the File Control display.

Exiting from a File Control Display

To exit from the File Control display, press the [FUNCTION], [VOICE], [STYLE], [SONG] or [PATTERN] button.

You can also exit from the File Control function mode as follows:

1 Use the CATEGORY [+] and [-] buttons to call up “Exit?”

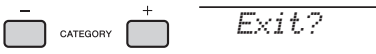

2 Press the [0/EXECUTE] button to exit from the File Control display.



Message List

| Message | Comment |
|---------------|---|
| Can'tUse | <ul style="list-style-type: none"> Indicates that the file control function is currently unavailable since the USB flash drive is being accessed. Displayed when attempting to save a User Song recorded Pattern as SMF format 0. |
| Comple. | Indicates the specified job completion such as data saving and transmission. |
| Data Err | Displayed when the user song contains illegal data. |
| Disk Ful | Displayed when saving data cannot be executed since the memory becomes full. Delete any unnecessary data or use another USB flash drive. |
| Error | Displayed when a file error or operational error occurs. |
| File Ful | Displayed when saving data cannot be executed since the total number of files exceeds the capacity. Delete the unnecessary data or use another USB flash drive. |
| no data | There is no data in the memory. |
| no file | There is no file in the memory. |
| Ovr (Flashes) | Communication with the USB flash drive has been shut down because of overcurrent to the USB flash drive. Disconnect the USB flash drive from the [USB TO DEVICE] terminal, then turn on the power of the instrument. |
| Protect | Displayed when trying to save or delete data on a protected USB flash drive, or formatting a protected USB flash drive. Set protect to off and try again. |
| UnFormat | Displayed when connecting an unformatted USB flash drive. |
| UseAdpt | USB flash drive save, delete, and format operations cannot be performed when the instrument is being powered from battery. Use an AC adaptor. |

Troubleshooting

| Problem | Possible Cause and Solution |
|---|--|
| When the instrument is turned on or off, a popping sound is temporarily produced. | This is normal and indicates that the instrument is receiving electrical power. |
| When the instrument is turned on, power is turned off suddenly and unexpectedly. | This is normal. If an AC adaptor other than the one specified is used, power may be turned off suddenly and unexpectedly. |
| When using a mobile phone, noise is produced | Using a mobile phone in close proximity to the instrument may produce interference. To prevent this, turn off the mobile phone or use it further away from the instrument |
| The instrument is automatically turned off even if no operation is done. | This is normal. This occurs due to the Auto Power Off function (page 16). |
| <ul style="list-style-type: none"> • The volume is too soft. • The sound quality is poor. • The Style/Pattern/Song/Arpeggio stops unexpectedly or will not play. • The recorded data of the song, etc. does not play correctly. • The LCD display suddenly goes dark, and all panel settings are reset. • The instrument turns off when a USB flash drive is connected. | The batteries are low or dead. Replace all six batteries with completely new ones or completely recharged ones, or use the AC adaptor. |
| No sound is produced even when the keyboard is played, or a Song, Style, or Pattern is being played back. | Check whether a set of headphones or an audio cable is connected to the [PHONES/OUTPUT], or not. When such a connection is made, no sound is output from the speaker of this instrument. |
| | (PSR-EW400) Check the on/off status of the Speaker Mute setting (page 38). Make sure to set to OFF. |
| | Check the on/off status of the Local Control (page 61). Normally, set this parameter to ON. |
| The footswitch (for sustain) seems to produce the opposite effect. For example, pressing the footswitch cuts off the sound and releasing it sustains the sounds. | The polarity of the footswitch is reversed. Make sure that the footswitch plug is properly connected to the SUSTAIN jack before turning on the power. |
| No sound is produced even when playing keys in the right hand area of the keyboard, although chords played in the left hand area are recognized. | Check whether or not the Dictionary function (page 55) is used. When used, this is normal. |
| Not all of the Voices seem to sound, or the sound seems to be cut off, when playing the keyboard, Arpeggio, Style or Pattern or Song. | You have exceeded 48 simultaneous notes, which is the maximum polyphony (the maximum amount of notes that can be played simultaneously) of this instrument. If the Main, Dual, and Split Voices are being used along with playback of Arpeggio, Style, Pattern or Song, some notes/sounds may be omitted (or "stolen"). |
| The sound of the Voice changes from note to note. | This is normal. The tone generation method uses multiple recordings (samples) of an instrument across the range of the keyboard; thus, the actual sound of the Voice may be slightly different from note to note. |
| The keyboard performance and playback of Style/Pattern/Song produces an unexpected or inappropriate sound, and cannot be restored to the normal status. | Using the Knobs can produce dramatic changes in the sound, but may also produce unexpected or undesired sounds. If you want to restore the original, normal sound before being changed by the Knobs, press the [DSP] button to turn DSP off, change the Voice, Style, Pattern or Song, or press the [PORTABLE GRAND] button to reset the panel settings. |
| The Style, Pattern or Song does not start even when the [START/STOP] button is pressed. The Arpeggio does not start even when the note is pressed with the Arpeggio turned on. | Check the on/off status of the External Clock (page 61). Normally, set this parameter to OFF. |
| The volume of the Style, Pattern or Song is too low. | Check the volume setting in the Functions (pages 53 and 57). |
| The chords played in the left hand area cannot be recognized even when ACMP is turned on. | Check the Split Point setting (page 53). Set this to an appropriate value. |
| Style parts other than the Rhythm part produce no sound. | Check the on/off status of the ACMP (page 26). Make sure to turn ACMP on. |
| The ACMP indicator does not appear on the display when the [ACMP ON/OFF] button is pressed. | Check the on/off status of the [STYLE] lamp. When using a Style, press the [STYLE] button to turn on the [STYLE] lamp. |

Refer to the "Message List" on page 69 as required.

Specifications

| | | PSR-E453 | | PSR-EW400 | | |
|---------------------------------|-------------------------|---|---|---|---|--|
| Product Name | | Digital Keyboard | | | | |
| Size/Weight | Dimensions (W x D x H) | 946 mm x 405 mm x 140 mm (37-1/4" x 15-15/16" x 5-1/2") | | 1178 mm x 412 mm x 138 mm (46-3/8" x 16-1/4" x 5-7/16") | | |
| | Weight | 6.6 kg (14 lbs 9 oz.) (not including batteries) | | 8.4 kg (18 lbs 8 oz.) (not including batteries) | | |
| Control Interface | Keyboard | Number of Keys | 61 | | | |
| | | Touch Response | Soft, Medium, Hard, Fixed | | | |
| | Other Controllers | Pitch Bend Wheel | Yes | | | |
| | | Knobs | Yes | | | |
| | Display | Type | LCD (Liquid Crystal Display) | | | |
| Language | | English | | | | |
| Panel | Language | English | | | | |
| Voices | Tone Generation | AWM Stereo Sampling | | | | |
| | Polyphony | 48 | | | | |
| | Preset | Number of Voices | 237 panel Voices + 24 Drum/SFX kits + 40 Arpeggio + 457 XGlite Voices | | Live! Grand Piano + 236 panel Voices + 24 Drum/SFX kits + 40 Arpeggio + 457 XGlite Voices | |
| | | Compatibility | GM, XGlite | | | |
| Effects | Types | Reverb | 9 types | | | |
| | | Chorus | 5 types | | | |
| | | Master EQ | 6 types | | | |
| | | Harmony | 26 types | | | |
| | | DSP | 10 types | | | |
| | Functions | Dual | Yes | | | |
| | | Split | Yes | | | |
| | | Arpeggio | 150 types | | | |
| | | Melody Suppressor | Yes | | | |
| | | Compatibility | Style File Format (SFF) | | | |
| Accompaniment Styles | Preset | Number of Styles | 220 | | | |
| | | Fingering | Multi finger | | | |
| | | Style Control | ACMP ON/OFF, SYNC START, SYNC STOP, START/STOP, INTRO/ENDING/rit., MAIN/AUTO FILL, TRACK ON/OFF | | | |
| | External Styles | 10 | | | | |
| | Other Features | Music Database | 378 | | | |
| One Touch Setting (OTS) | | Yes | | | | |
| Compatibility | Style File Format (SFF) | | | | | |
| Patterns | Preset | Number of Patterns | 25 | | | |
| | | Number of Sections | 5 | | | |
| | Recording | 6 (5 Melody + 1 Style/Pattern) | | | | |
| Songs (MIDI) | Preset | Number of Preset Songs | 30 | | | |
| | | Number of Songs | 10 | | | |
| | Recording | Number of Tracks | 6 (5 Melody + 1 Style/Pattern) | | | |
| | | Data Capacity | Approx. 19,000 notes (when only "melody" tracks are recorded) | | | |
| Format | Playback | SMF (Formats 0 & 1) | | | | |
| | Recording | Original File Format (SMF 0 conversion function) | | | | |
| Functions | Lesson/Guide | Lesson 1 – 3 (Listening, Timing, Waiting), Repeat & Learn, Chord Dictionary | | | | |
| | USB Audio (USB TO HOST) | 44.1 kHz, 16 bit, stereo | | | | |
| | Registration Memory | Number of Buttons | 4 (x 8 banks) | | | |
| | | Metronome | Yes | | | |
| | Overall Controls | Tempo Range | 11 – 280 | | | |
| | | Transpose | -12 to 0, 0 to +12 | | | |
| | | Tuning | 427.0 – 440.0 – 453.0 Hz (approx. 0.2Hz increments) | | | |
| | Miscellaneous | Scale Type | 5 types | | | |
| PIANO Button | | Yes (Portable Grand Button) | | | | |
| Storage and Connectivity | Storage | Internal Memory | Approx. 1.29 MB | | | |
| | | External Drives | USB flash drive | | | |
| | Connectivity | USB TO HOST, USB TO DEVICE, DC IN 12V, Headphones/Output, Sustain Pedal, AUX IN (Stereo-mini) | | USB TO HOST, USB TO DEVICE, DC IN 16V, Headphones, Sustain Pedal, AUX IN (Stereo-mini), OUTPUT (L/L+R, R) | | |
| Amplifiers/ Speakers | Amplifiers | 6 W + 6 W (When using PA-150 AC adaptor) | | 12 W + 12 W (When using PA-300C AC adaptor) | | |
| | Speakers | 12 cm x 2 | | | | |

Specifications

| | | | | |
|---|-------------------|--|--|---|
| Power Supply | Power Supply | Adaptor | PA-150 or an equivalent recommended by Yamaha | PA-300C or an equivalent recommended by Yamaha |
| | | Batteries | Six "AA" size alkaline (LR6), manganese (R6) or Ni-MH rechargeable batteries | Six "D" size alkaline (LR20), manganese (R20) or Ni-MH rechargeable batteries |
| | Power Consumption | | 8 W (When using PA-150 AC adaptor) | 11 W (When using PA-300C AC adaptor) |
| | Auto Power Off | | Yes | |
| Included Accessories | | <ul style="list-style-type: none"> • Owner's Manual • Data List • AC adaptor* (PA-150 or an equivalent recommended by Yamaha) * May not be included depending on your area. Check with your Yamaha dealer. • Music Rest • Online Member Product Registration | <ul style="list-style-type: none"> • Owner's Manual • Data List • AC adaptor* (PA-300C or an equivalent recommended by Yamaha), power cord* * May not be included depending on your area. Check with your Yamaha dealer. • Music Rest • Online Member Product Registration | |
| Separately Sold Accessories (May not be available depending on your area.) | | <ul style="list-style-type: none"> • AC adaptor: PA-150 or an equivalent recommended by Yamaha • Keyboard Stand: L-2C • Headphones: HPH-150/HPH-100/HPH-50 • Footswitch: FC4A/FC5 • Wireless MIDI adaptor: UD-BT01 | <ul style="list-style-type: none"> • AC adaptor: PA-300C or an equivalent recommended by Yamaha • Keyboard Stand: L-6 • Headphones: HPH-150/HPH-100/HPH-50 • Footswitch: FC4A/FC5 • Wireless MIDI adaptor: UD-BT01 | |

* The contents of this manual apply to the latest specifications as of the publishing date. To obtain the latest manual, access the Yamaha website then download the manual file. Since specifications, equipment or separately sold accessories may not be the same in every locale, please check with your Yamaha dealer.

Index

| | | | |
|-------------------------------------|--------|--|--|
| A | | | |
| A-B Repeat | 29 | | |
| AC Adaptor | 14 | | |
| Accessories | 10 | | |
| ACMP | 26 | | |
| Arpeggio | 24, 49 | | |
| Arpeggio Quantize | 49 | | |
| Arpeggio Type | 24 | | |
| Arpeggio Velocity | 60 | | |
| Attack | 46, 59 | | |
| Audio Device | 36 | | |
| Audio Loop Back | 60 | | |
| Auto Accompaniment | 26 | | |
| Auto Accompaniment area | 26 | | |
| Auto Power Off | 16, 61 | | |
| AUX IN | 36 | | |
| B | | | |
| Backup | 39 | | |
| Backup Clear | 39 | | |
| Base Note | 43 | | |
| Battery | 14 | | |
| Battery Type | 15, 61 | | |
| BGM (Background Music) | 56 | | |
| C | | | |
| Chord Dictionary | 55 | | |
| Chord Type | 54 | | |
| Chorus | 46, 59 | | |
| Chorus Type | 40 | | |
| Computer | 36 | | |
| Computer-related Operations | 11 | | |
| Connection | 36 | | |
| Cutoff | 46, 59 | | |
| D | | | |
| Data List | 11 | | |
| Del SMF | 68 | | |
| Del USR | 68 | | |
| Demo Song | 28 | | |
| Display | 19 | | |
| DSP | 47, 48 | | |
| DSP Part | 48 | | |
| DSP Type | 48 | | |
| Dual Voice | 21, 45 | | |
| E | | | |
| EG (Envelope Generator) | 46 | | |
| Ending | 50 | | |
| EQ (Equalizer) | 42 | | |
| External Clock | 60 | | |
| F | | | |
| Fast Forward | 29 | | |
| Fast Reverse | 29 | | |
| File Control Display | 63 | | |
| Fill | 50 | | |
| Filter | 46, 59 | | |
| Fine Tuning | 41 | | |
| Flash Clear | 39 | | |
| Footswitch | 17, 49 | | |
| Formatting | 64 | | |
| Function | 58 | | |
| H | | | |
| Harmony | 23 | | |
| Harmony Type | 60 | | |
| Headphones | 16 | | |
| I | | | |
| Initial Send | 60 | | |
| Initialization | 39 | | |
| Intro | 50 | | |
| iPhone/iPad | 37 | | |
| iPhone/iPad Connection Manual | 11 | | |
| K | | | |
| Keyboard Out | 60 | | |
| Keyboard Stand | 17 | | |
| Knob | 25, 46 | | |
| L | | | |
| Language | 61 | | |
| Lesson | 30, 61 | | |
| Load STY | 67 | | |
| Load USR | 65 | | |
| Local Control | 60 | | |
| M | | | |
| Main | 50 | | |
| Main Voice | 20 | | |
| Master Volume | 16 | | |
| Melody Suppressor | 37, 59 | | |
| Melody Voice | 57 | | |
| Message List | 69 | | |
| Metronome | 22 | | |
| MIDI | 60 | | |
| MIDI Basics | 11 | | |
| MIDI Reference | 11 | | |
| Music Database | 26 | | |
| Music Rest | 10 | | |
| O | | | |
| Octave | 59 | | |
| One Touch Setting (OTS) | 41 | | |
| Output | 38 | | |
| P | | | |
| Pan | 59 | | |
| Pattern | 27, 50 | | |
| Pattern Retrigger | 47, 52 | | |
| Pause | 29 | | |
| Pedal | 17, 49 | | |
| Pitch | 41 | | |
| Pitch Bend Range | 58 | | |
| Power | 16 | | |
| R | | | |
| Random | 56 | | |
| Recording | 32 | | |
| Registration Memory | 35 | | |
| Release | 46, 59 | | |
| Repeat | 29, 31 | | |
| Resonance | 46, 59 | | |
| Retrigger Rate | 47 | | |
| Reverb | 46, 59 | | |
| Reverb Type | 40 | | |
| S | | | |
| Save SMF | 65 | | |
| Save USR | 64 | | |
| Scale | 43 | | |
| Section | 50, 52 | | |
| Song | 28, 56 | | |
| Song Book | 11 | | |
| Song Out | 60 | | |
| Speaker | 16, 38 | | |
| Specifications | 71 | | |
| Split Point | 53 | | |
| Split Voice | 21, 45 | | |
| Stop Accompaniment | 53 | | |
| Style | 26, 50 | | |
| Style Out | 60 | | |
| Sustain | 17 | | |
| Syncho Stop | 51 | | |

T

Tap Start52, 57
Tempo22, 52, 57
Time Signature22
Touch Response42
Track29, 32, 51
Transpose41
Troubleshooting70
Tuning44

U

USB Flash Drive62
USB TO DEVICE62
USB TO HOST36

V

Voice20, 45
Volume16
Volume (AUX IN)58
Volume (Harmony)60
Volume (Metronome)22
Volume (Pattern)53
Volume (Song)57
Volume (Style)53
Volume (USB TO HOST)58
Volume (Voice)59
Volume Balance46

Y

Your Tempo61

MEMO

OBSERVERA!

Apparaten kopplas inte ur växelströmskällan (nätet) så länge som den är ansluten till vägguttaget, även om själva apparaten har stängts av.

ADVARSEL: Netspændingen til dette apparat er IKKE afbrudt, så længe netledningen sidder i en stikkontakt, som er tændt — også selvom der er slukket på apparatets afbryder.

VAROITUS: Laitteen toisiopiiriin kytketty käyttökytin ei irroita koko laitetta verkosta.

(standby)

Entsorgung leerer Batterien (nur innerhalb Deutschlands)

Leisten Sie einen Beitrag zum Umweltschutz. Verbrauchte Batterien oder Akkumulatoren dürfen nicht in den Hausmüll. Sie können bei einer Sammelstelle für Altbatterien bzw. Sondermüll abgegeben werden. Informieren Sie sich bei Ihrer Kommune.

(battery)

Information for Users on Collection and Disposal of Old Equipment and used Batteries



These symbols on the products, packaging, and/or accompanying documents mean that used electrical and electronic products and batteries should not be mixed with general household waste.

For proper treatment, recovery and recycling of old products and used batteries, please take them to applicable collection points, in accordance with your national legislation and the Directives 2002/96/EC and 2006/66/EC.



By disposing of these products and batteries correctly, you will help to save valuable resources and prevent any potential negative effects on human health and the environment which could otherwise arise from inappropriate waste handling.



For more information about collection and recycling of old products and batteries, please contact your local municipality, your waste disposal service or the point of sale where you purchased the items.

[For business users in the European Union]

If you wish to discard electrical and electronic equipment, please contact your dealer or supplier for further information.

[Information on Disposal in other Countries outside the European Union]

These symbols are only valid in the European Union. If you wish to discard these items, please contact your local authorities or dealer and ask for the correct method of disposal.



Note for the battery symbol (bottom two symbol examples):

This symbol might be used in combination with a chemical symbol. In this case it complies with the requirement set by the Directive for the chemical involved.

Cd

(weee_battery_eu_en_01)



YAMAHA

LIMITED 1-YEAR WARRANTY ON PORTABLE KEYBOARDS

(NP, NPV, PSRE, PSREW, EZ, DGX230, DGX530, YPG AND YPT SERIES)

Thank you for selecting a Yamaha product. Yamaha products are designed and manufactured to provide a high level of defect-free performance. Yamaha Corporation of America ("Yamaha") is proud of the experience and craftsmanship that goes into each and every Yamaha product. Yamaha sells its products through a network of reputable, specially authorized dealers and is pleased to offer you, the Original Owner, the following Limited Warranty, which applies only to products that have been (1) directly purchased from Yamaha's authorized dealers in the fifty states of the USA and District of Columbia (the "Warranted Area") and (2) used exclusively in the Warranted Area. Yamaha suggests that you read the Limited Warranty thoroughly, and invites you to contact your authorized Yamaha dealer or Yamaha Customer Service if you have any questions.

Coverage: Yamaha will, at its option, repair or replace the product covered by this warranty if it becomes defective, malfunctions or otherwise fails to conform with this warranty under normal use and service during the term of this warranty, without charge for labor or materials. Repairs may be performed using new or refurbished parts that meet or exceed Yamaha specifications for new parts. If Yamaha elects to replace the product, the replacement may be a reconditioned unit. You will be responsible for any installation or removal charges and for any initial shipping charges if the product(s) must be shipped for warranty service. However, Yamaha will pay the return shipping charges to any destination within the USA if the repairs are covered by the warranty. This warranty does not cover (a) damage, deterioration or malfunction resulting from accident, negligence, misuse, abuse, improper installation or operation or failure to follow instructions according to the Owner's Manual for this product; any shipment of the product (claims must be presented to the carrier); repair or attempted repair by anyone other than Yamaha or an authorized Yamaha Service Center; (b) any unit which has been altered or on which the serial number has been defaced, modified or removed; (c) normal wear and any periodic maintenance; (d) deterioration due to perspiration, corrosive atmosphere or other external causes such as extremes in temperature or humidity; (e) damages attributable to power line surge or related electrical abnormalities, lightning damage or acts of God; or (f) RFI/EMI (Interference/noise) caused by improper grounding or the improper use of either certified or uncertified equipment, if applicable. Any evidence of alteration, erasing or forgery of proof-of-purchase documents will cause this warranty to be void. This warranty covers only the Original Owner and is not transferable.

In Order to Obtain Warranty Service: Warranty service will only be provided for defective products within the Warranted Area. Contact your local authorized Yamaha dealer who will advise you of the procedures to be followed. If this is not successful, contact Yamaha at the address, telephone number or website shown below. Yamaha may request that you send the defective product to a local authorized Yamaha Servicer or authorize return of the defective product to Yamaha for repair. If you are uncertain as to whether a dealer has been authorized by Yamaha, please contact Yamaha's Service Department at the number shown below, or check Yamaha's website at www.Yamaha.com. Product(s) shipped for service should be packed securely and must be accompanied by a detailed explanation of the problem(s) requiring service, together with the original or a machine reproduction of the bill of sale or other dated, proof-of-purchase document describing the product, as evidence of warranty coverage. Should any product submitted for warranty service be found ineligible therefore, an estimate of repair cost will be furnished and the repair will be accomplished only if requested by you and upon receipt of payment or acceptable arrangement for payment.

Limitation of Implied Warranties and Exclusion of Damages: ANY IMPLIED WARRANTIES, INCLUDING WARRANTIES OF MERCHANTABILITY AND FITNESS FOR A PARTICULAR PURPOSE SHALL BE LIMITED IN DURATION TO THE APPLICABLE PERIOD OF TIME SET FORTH ABOVE. YAMAHA SHALL NOT BE RESPONSIBLE FOR INCIDENTAL OR CONSEQUENTIAL DAMAGES OR FOR DAMAGES BASED UPON INCONVENIENCE, LOSS OF USE, DAMAGE TO ANY OTHER EQUIPMENT OR OTHER ITEMS AT THE SITE OF USE OR INTERRUPTION OF PERFORMANCES OR ANY CONSEQUENCES. YAMAHA'S LIABILITY FOR ANY DEFECTIVE PRODUCT IS LIMITED TO REPAIR OR REPLACEMENT OF THE PRODUCT, AT YAMAHA'S OPTION. SOME STATES DO NOT ALLOW LIMITATIONS ON HOW LONG AN IMPLIED WARRANTY LASTS OR THE EXCLUSION OR LIMITATION OF INCIDENTAL OR CONSEQUENTIAL DAMAGES, SO THE ABOVE LIMITATION OR EXCLUSION MAY NOT APPLY TO YOU. This Warranty gives you specific legal rights, and you may also have other rights which vary from state to state. This is the only express warranty applicable to the product specified herein; Yamaha neither assumes nor authorizes anyone to assume for it any other express warranty.

If you have any questions about service received or if you need assistance in locating an authorized Yamaha Servicer, please contact:



YAMAHA

CUSTOMER SERVICE

Yamaha Corporation of America

6600 Orangethorpe Avenue, Buena Park, California 90620-1373

Telephone: 800-854-1569

www.yamaha.com

Do not return any product to the above address without a written Return Authorization issued by YAMAHA.

© 2015 Yamaha Corporation of America.

Important Notice: Guarantee Information for customers in European Economic Area (EEA) and Switzerland

| | |
|---|-------------------|
| Important Notice: Guarantee Information for customers in EEA* and Switzerland For detailed guarantee information on this Yamaha product, and Pan-EEA and Switzerland warranty service, please either visit the website www.yamaha.com . Printable file is available at our website) or contact the Yamaha representative office for your country. * EEA: European Economic Area | English |
| Wichtiger Hinweis: Garantie-Information für Kunden in der EWR* und der Schweiz Für nähere Garantie-Information über dieses Produkt von Yamaha, sowie über den Pan-EEA* und Schweizer Garantieservice, besuchen Sie bitte entweder die folgende angegebene Internetadresse (eine druckfähige Version befindet sich auch auf unserer Webseite), oder wenden Sie sich an den für Ihr Land zuständigen Yamaha-Vertrieb. *EWR: Europäischer Wirtschaftsraum | Deutsch |
| Remarque importante: Informations de garantie pour les clients de l'EEE et la Suisse Pour des informations plus détaillées sur la garantie de ce produit Yamaha et sur le service de garantie applicable dans l'ensemble de l'EEE ainsi qu'en Suisse, consultez notre site Web à l'adresse ci-dessous (le fichier imprimable est disponible sur notre site Web) ou contactez directement Yamaha dans votre pays de résidence. * EEE: Espace Economique Européen | Français |
| Belangrijke mededeling: Garantie-informatie voor klanten in de EER* en Zwitserland Voor gedetailleerde garantie-informatie over dit Yamaha-product en de garantieservice in heel de EER* en Zwitserland, gaat u naar de website www.yamaha.com (er vindt een afdrukbare versie op onze website) of neemt u contact op met de vertegenwoordiging van Yamaha in uw land. * EER: Europees Economisch Ruimte | Nederlands |
| Aviso importante: información sobre la garantía para los clientes de la EEA* y Suiza Para una información detallada sobre este producto Yamaha y sobre el servicio de garantía en la zona EEA* y Suiza, visite la dirección web que se incluye más abajo (la versión del archivo para imprimir está disponible en nuestro sitio web) o póngase en contacto con el representante de Yamaha en su país. * EEE: Espacio Económico Europeo | Español |
| Avviso importante: informazioni sulla garanzia per i clienti residenti nell'EEA* e in Svizzera Per informazioni dettagliate sulla garanzia relativa a questo prodotto Yamaha e l'assistenza in garanzia nei paesi EEA* e in Svizzera, potete consultare il sito Web all'indirizzo riportato di seguito (è disponibile il file in formato stampabile) oppure contattate l'ufficio di rappresentanza locale della Yamaha. * EEA: Area Economica Europea | Italiano |
| Aviso importante: informações sobre as garantias para clientes da AEE* e da Suíça Para obter uma informação pormenorizada sobre este produto da Yamaha e sobre o serviço de garantia na AEE* e na Suíça, visite o site a seguir (o arquivo para impressão está disponível no nosso site) ou entre em contato com o escritório de representação da Yamaha no seu país. * AEE: Área Económica Europeia | Português |
| Ārīvērtīgu informāciju: Garantijas informācija par šīs mašīnas klientiem Eiropas Ekonomiskajā telpā (EET) un Šveicē Ārīvērtīgu informāciju par šīs mašīnas garantijas pakalpojumiem Eiropas Ekonomiskajā telpā (EET) un Šveicē, lūdzam apmeklēt mājaslapu www.yamaha.com (tur ir pieejama drukājama versija) vai sazināties ar Yamaha pārstāvniecību jūsu valstī. * EET: Eiropas Ekonomiskā telpa | Latviešu |
| Επισημάνσεις: Πληροφορίες εγγύησης για τους πελάτες της ΕΕΑ* και της Ελβετίας Για περισσότερες πληροφορίες σχετικά με το παρόν προϊόν της Yamaha και την κάλυψη των εγγυήσεων, παρακαλούμε να επισκεφθείτε την ιστοσελίδα www.yamaha.com (υπάρχει διαθέσιμη εκτύπωση του αρχείου) ή να επικοινωνήσετε με τον αντιπρόσωπο της Yamaha στο έδαφος σας. * ΕΕΑ: Ευρωπαϊκή Οικονομική Ένωση | Ελληνικά |
| Viktigt: Garantierinformation for kunder i EES-området* och Schweiz För detaljerad information om denna Yamaha-produkt samt garantier och service i hela EES-området* och Schweiz kan du antingen besöka nedanstående webbadress (en utskriftsvänlig fil finns på webbplatsen) eller kontakta Yamahas officiella representant i ditt land. * EES: Europeiska Ekonomiska Samarbetsområdet | Svenska |
| Viktig merknad: Garantierinformasjon for kunder i EØS-området* og Sveits Detaljert garantierinformasjon om dette Yamaha-produktet og garantier og service for hele EØS-området* og Sveits kan fås enten ved å besøke nedstående elektroniske adresse (en utskriftsvennlig fil finnes på nettstedet) eller kontakte Yamahas-kontoret i landet der du bor. *EØS: Det europeiske økonomiske samarbeidsområdet | Norsk |
| Viktig oplysning: Garantieroplysninger til kunder i EØO* og Schweiz De kan finne detaljerte garantieroplysninger om dette Yamaha-produktet og den felle garantieroplysning for EØO* (og Sveits) ved å besøke det webstedet, der er angitt nedenfor (der finnes en fil som kan utskrives, på vores website), eller ved å kontakte Yamahas nationale representantkontor i det land, hvor De bor. * EØO: Det Europæiske Økonomiske Område | Dansk |

| | |
|--|-----------------------|
| Tärkeä huomio: Taku tiedot Euroopan talousalueen (ETA*) ja Sveitsin asiakkaille Tämä Yamaha-tuote on saatavilla ETA-alueella ja Sveitsin alueella koskettavien yksityiskohtaisten tietojen saattamiseksi, olemme lisänneet verkkosivustollamme sekä ETA-alueella ja Sveitsin alueella koskettavien yksityiskohtaisten tietojen saattamiseksi, olemme lisänneet verkkosivustollamme. *ETA: Euroopan talousalue. | Suomi |
| Ważne: Warunki gwarancji obowiązujące w EOG* i Szwajcarii Aby dowiedzieć się więcej na temat warunków gwarancji tego produktu firmy Yamaha i serwisu gwarancyjnego w całym EOG* i Szwajcarii, należy odwiedzić wskazaną stronę internetową (plik pobory do wydruku znajduje się na naszej stronie internetowej) lub skontaktować się z przedstawicielstwem firmy Yamaha w swoim kraju. * EOG – Europejski Obszar Gospodarczy | Polski |
| Důležité oznámení: Zaruční informace pro zákazníky v EHS* a ve Švýcarsku Podrobné zaruční informace o tomto produktu Yamaha a zaručeném servisu v celém EHS* a ve Švýcarsku naleznete na níže uvedené webové adrese (soubor k tisku je dostupný na našich webových stránkách) nebo se můžete obrátit na zástupce firmy Yamaha ve své zemi. * EHS: Evropský hospodářský prostor | Česky |
| Fontos figyelemzés: Garancia-információk az EGT* területén és Svájcban élő vásárlók számára A jelen Yamaha terméknek vonatkozó részletes garancia-információk, valamint az EGT*-re és Svájcra kiterjedő garanciális szolgáltatás feltételeinek keretében a Webnyomtatványra az alábbi címen (a Webnyomtatványt itt is találja), vagy pedig telefon kapcsolatba az országában működő Yamaha képviselővel. * EGT: Európai Gazdasági Térség | Magyar |
| Östämärke: Garanti villkor för kunder i EGP* och i Schweiz För detaljerad information om denna Yamaha-produkt och den gemensamma garantieroplysningen för EGP* (och Schweiz) kan du antingen besöka nedanstående webbadress (en utskriftsvänlig fil finns på webbplatsen) eller kontakta Yamahas officiella representant i ditt land. * EGP: Europeiska Ekonomiska Samarbetsområdet | Esti keel |
| Östämärke: Garanti villkor för kunder i EGP* och i Schweiz För detaljerad information om denna Yamaha-produkt och den gemensamma garantieroplysningen för EGP* (och Schweiz) kan du antingen besöka nedanstående webbadress (en utskriftsvänlig fil finns på webbplatsen) eller kontakta Yamahas officiella representant i ditt land. * EGP: Europeiska Ekonomiska Samarbetsområdet | Latviešu |
| Lietauvi kalba Dėl išsames informacijos apie šį „Yamaha“ produktą ir jo techninę priežiūrą visose EEE* ir Šveicarijoje, apsilankykite mūsų svetainėje (toliau nurodytu adresu (svetainėje yra spausdinamas failas) arba kreipkitės į „Yamaha“ atstovą savo šalyje. *EEE – Europos ekonominė erdvė | Lietuvių kalba |
| Dobrá informácia: Informácia o záruke pre zákazníkov v EHP* a Švajčiarsku Podrobné informácie o tomto produkte Yamaha a o zaručenom servise v EHP* a Švajčiarsku nájdete na nižšie uvedenej webovej stránke (súbory na stiahnutie sú dostupné na našich webových stránkach) alebo sa obráťte na zástupcu spoločnosti Yamaha vo svojej krajine. * EHP: Európsky hospodársky priestor | Slovenčina |
| Pomebno obvestilo: Informacije o tem Yamahinem izdelku ter garancijskem servisu v celotnem EGP in Švici, obiščite spletno mesto, ki je navedeno spodaj (matljajiva datoteka je na voljo na našem spletnem mestu), ali se obrnite na Yamahinega predstavnika v svoji državi. * EGP: Evropski gospodarski prostor | Slovenščina |
| Важно съобщение: Информация за гаранцията за клиентите в ЕПТ* и Швейцария За подробна информация за гаранцията за този продукт на Yamaha и гаранционното обслужване в пазарнообслужваната зона на ЕПТ* и Швейцария или посетете посочения почтов ящик (на нашия уеб сайт има файл за печат), или се свържете с представителния офис на Yamaha във вашата страна. * ЕПТ: Европейско икономично пространство | Български език |
| Notificarea importantă: Informații despre garanție pentru clienții din SEE* și Elveția Pentru informații detaliate privind acest produs Yamaha și serviciul de garanție Pan-SEE* și Elveția, vizitați site-ul la adresa de mai jos (fișierul imprimabil este disponibil pe site-ul nostru) sau contactați biroul reprezentanților Yamaha din țara dumneavoastră. *SEE: Spațiul Economic European | Limba română |

<http://europe.yamaha.com/warranty/>

For details of products, please contact your nearest Yamaha representative or the authorized distributor listed below.

NORTH AMERICA

CANADA

Yamaha Canada Music Ltd.
135 Milner Avenue, Toronto, Ontario M1S 3R1,
Canada
Tel: +1-416-298-1311

U.S.A.

Yamaha Corporation of America
6600 Orangehorpe Avenue, Buena Park, CA 90620,
U.S.A.
Tel: +1-714-522-9011

CENTRAL & SOUTH AMERICA

MEXICO

Yamaha de México, S.A. de C.V.
Av. Insurgentes Sur 1647 Piso 9, Col. San José
Insurgentes, Delegación Benito Juárez, México,
D.F., C.P. 03900
Tel: +52-55-5804-0600

BRAZIL

Yamaha Musical do Brasil Ltda.
Rua Fidêncio Ramos, 302 - Cj 52 e 54 - Torre B -
Vila Olímpia - CEP 04551-010 - São Paulo/SP,
Brazil
Tel: +55-11-3704-1377

ARGENTINA

**Yamaha Music Latin America, S.A.,
Sucursal Argentina**
Olga Cossettini 1553, Piso 4 Norte,
Madero Este-C1107CEK,
Buenos Aires, Argentina
Tel: +51-11-4119-7000

VENEZUELA

Yamaha Musical de Venezuela, C.A.
AV. Manzanares, C.C. Manzanares Plaza,
Piso 4, Oficina 0401, Baruta, Caracas, Venezuela
Tel: +58-212-943-1877

PANAMA AND OTHER LATIN AMERICAN COUNTRIES/ CARIBBEAN COUNTRIES/

Yamaha Music Latin America, S.A.
Edif. Torre Banco General, F7, Urb. Marbella,
Calle 47 y Aquilino de la Guardia, Panama,
P.O.Box 0825-05863, Panama, Rep.de Panama
Tel: +507-269-5311

EUROPE

THE UNITED KINGDOM/IRELAND

Yamaha Music Europe GmbH (UK)
Sherbourne Drive, Tilbrook, Milton Keynes,
MK7 8BL, U.K.
Tel: +44-1908-366700

GERMANY

Yamaha Music Europe GmbH
Siemensstrasse 22-34, 25462 Rellingen, Germany
Tel: +49-4101-303-0

SWITZERLAND/LIECHTENSTEIN

**Yamaha Music Europe GmbH, Rellingen,
Branch Switzerland in Zürich**
Seefeldstrasse 94, 8008 Zürich, Switzerland
Tel: +41-44-387-8080

AUSTRIA

Yamaha Music Europe GmbH, Branch Austria
Schleiergasse 20, 1100 Wien, Austria
Tel: +43-1-60203900

CZECH REPUBLIC/HUNGARY/ ROMANIA/SLOVAKIA/SLOVENIA

Yamaha Music Europe GmbH, Branch Austria
Schleiergasse 20, 1100 Wien, Austria
Tel: +43-1-60203900

POLAND/LITHUANIA/LATVIA/ ESTONIA

Yamaha Music Europe GmbH
Sp.z o.o. Oddział w Polsce
ul. Wrotkowa 14, 02-553 Warszawa, Poland
Tel: +48-22-880-08-88

BULGARIA

Dinacord Bulgaria LTD.
Bul.Ikarsko Schose 7 Targoviski Zentar Ewropa
1528 Sofia, Bulgaria
Tel: +359-2-978-20-25

MALTA

Olimpus Music Ltd.
Valletta Road, Mosta MST9010, Malta
Tel: +356-2133-2093

NETHERLANDS/BELGIUM/ LUXEMBOURG

Yamaha Music Europe, Branch Benelux
Clarissenhof 5b, 4133 AB Vianen, The Netherlands
Tel: +31-347-358040

FRANCE

Yamaha Music Europe
7 rue Ambroise Croizat, Zone d'activités de Pariest,
77183 Croissy-Beaubourg, France
Tel: +33-1-6461-4000

ITALY

Yamaha Music Europe GmbH, Branch Italy
Viale Italia 88, 20020, Lainate (Milano), Italy
Tel: +39-02-93577-1

SPAIN/PORTUGAL

**Yamaha Music Europe GmbH Ibérica, Sucursal
en España**
Ctra. de la Coruna km. 17,200, 28231
Las Rozas de Madrid, Spain
Tel: +34-91-639-88-88

GREECE

Philippou Nakas S.A. The Music House
19th km. Loof. Lavriou 190 02 Peania - Attiki,
Greece
Tel: +30-210-6686260

SWEDEN

**Yamaha Music Europe GmbH Germany filial
Scandinavia**
JA Wettergsgata 1, 400 43 Göteborg, Sweden
Tel: +46-31-89-34-00

DENMARK

**Yamaha Music Denmark,
Filial of Yamaha Music Europe GmbH, Tyskland**
Generatorvej 8C, ST. TH., 2860 Søborg, Denmark
Tel: +45-44-92-49-40

FINLAND

F-Musikkii Oy
Anttaksentie 4
FI-01510 Vantaa, Finland
Tel: +358 (0)96185111

NORWAY

**Yamaha Music Europe GmbH 0825-
Norwegian Branch**
Grimi Næringspark 1, 1332 Østerås, Norway
Tel: +47-6716-7800

ICELAND

Hjódærahusid Ehf.
Sidumula 20
IS-108 Reykjavik, Iceland
Tel: +354-525-5050

CROATIA

Euro Unit D.O.O.
Skakovce 73
40305 Nedelisce
Tel: +385-40829400

RUSSIA

Yamaha Music (Russia) LLC.
Room 37, entrance 7, bld. 7, Kievskaya street,
Moscow, 121059, Russia
Tel: +7-495-626-5005

OTHER EUROPEAN COUNTRIES

Yamaha Music Europe GmbH
Siemensstrasse 22-34, 25462 Rellingen, Germany
Tel: +49-4101-303-0

AFRICA

Yamaha Music Gulf FZE
JAFZA-16, Office 512, P.O.Box 17328,
Jebel Ali FZE, Dubai, UAE
Tel: +971-4-801-1500

MIDDLE EAST

TURKEY

Yamaha Music Europe GmbH
Merkezi Almanya Türkiye Istanbul Şubesi
Musik Meydan Sokak, Spring Giz Plaza Bagimsiz
Böl. No:3, Sarıyer Istanbul, Turkey
Tel: +90-212-999-8010

CYPRUS

Nakas Music Cyprus Ltd.
Nikis Ave 2k
1086 Nicosia
Tel: +357-22-511080

Major Music Center

21 Ali Riza Ave. Ortakoy
P.O.Box 475 Nicosia, Cyprus
Tel: (392) 227 9213

OTHER COUNTRIES

Yamaha Music Gulf FZE
JAFZA-16, Office 512, P.O.Box 17328,
Jebel Ali FZE, Dubai, UAE
Tel: +971-4-801-1500

ASIA

THE PEOPLE'S REPUBLIC OF CHINA

Yamaha Music & Electronics (China) Co. Ltd.
2F, Yunhedasha, 1818 Xinzha-lu, Jingan-qu,
Shanghai, China
Tel: +86-400-051-7700

HONG KONG

Tom Lee Music Co., Ltd.
11/F, Silvercreek Tower 1, 30 Canton Road,
Tsimshatsui, Kowloon, Hong Kong
Tel: +852-2737-7688

INDIA

Yamaha Music India Private Limited
Spazedge Building, Ground Floor, Tower A,
Sector-47, Gurgaon- Sohna Road, Gurgaon-122002,
Haryana, India
Tel: +91-124-485-3300

INDONESIA

PT. Yamaha Musik Indonesia (Distributor)
Yamaha Music Center Bldg. Jalan Jend. Gatot
Subroto Kav. 4, Jakarta 12930, Indonesia
Tel: +62-21-520-2577

KOREA

Yamaha Music Korea Ltd.
8F, Dongsung Bldg. 21, Teheran-ro 87-gil,
Gangnam-gu, Seoul, 135-880, Korea
Tel: +82-2-3467-3300

MALAYSIA

Yamaha Music (Malaysia) Sdn. Bhd.
No.8, Jalan Perbandaran, Kelana Jaya, 47301
Petaling Jaya, Selangor, Malaysia
Tel: +60-3-78039000

SINGAPORE

Yamaha Music (Asia) Private Limited
Block 202 Hougang Street 21, #02-00,
Singapore 530202, Singapore
Tel: +65-6740-9200

TAIWAN

Yamaha Music & Electronics Taiwan Co., Ltd.
2F, No.1, Yundang Rd. Bangiao Dist.
New Taipei City 22063, Taiwan, R.O.C.
Tel: +886-2-7741-8888

THAILAND

Siam Music Yamaha Co., Ltd.
3, 4, 15, 16th Fl., Siam Motors Building,
891/1 Rama 1 Road, Wangmai,
Pathumwan, Bangkok 10330, Thailand
Tel: +66-2215-2622

VIETNAM

Yamaha Music Vietnam Company Limited
15th Floor, Nam A Bank Tower, 201-203 Cach
Mang Thang Tam St., Ward 4, Dist.3,
Ho Chi Minh City, Vietnam
Tel: +84-8-3818-1122

OTHER ASIAN COUNTRIES

<http://asia.yamaha.com>

OCEANIA

AUSTRALIA

Yamaha Music Australia Pty. Ltd.
Level 1, 99 Queensbridge Street, Southbank,
VIC 3006, Australia
Tel: +61-3-9693-5111

NEW ZEALAND

Music Works LTD
P.O.BOX 6246 Wellesley, Auckland 4680,
New Zealand
Tel: +64-9-634-0099

COUNTRIES AND TRUST

TERRITORIES IN PACIFIC OCEAN

<http://asia.yamaha.com>

Yamaha Global Site
<http://www.yamaha.com/>

Yamaha Downloads
<http://download.yamaha.com/>

Manual Development Department
© 2016 Yamaha Corporation

Published 03/2016 POAP-A0
Printed in China

ZT18040



ZT18040