



DIGITAL MIXING CONSOLE

---

**QL5**

**QL1**

# Owner's Manual

Keep This Manual For Future Reference.

# Contents

## **PRECAUTIONS..... 5**

## **Introduction ..... 8**

Accessories.....	8
About utility software.....	8
About firmware updates.....	8
About the Owner's Manual.....	8
Conventions in this manual.....	8

## **An overview of the QL series..... 9**

Features.....	9
About the models.....	10

## **Controls and functions ..... 11**

Top panel.....	11
Front panel.....	15
Rear panel.....	16

## **Touch screen..... 18**

Basic touch screen operations.....	18
On-screen user interface.....	18
Viewing the touch screen.....	20
Using the tool buttons.....	21

## **Basic operation of the QL series.... 22**

Controlling selected channels (Selected Channel section).....	22
Using the top panel (Channel Strip section).....	22
Assigning a name.....	23
Using libraries.....	24
Initializing settings.....	28
Copying and pasting settings.....	28
Comparing two sets of settings.....	29

## **Connection..... 30**

About network connections.....	30
Connecting to I/O devices.....	30
Audio input/output connections.....	32
Installing an optional card.....	33

## **Quick Guide ..... 34**

Connecting the devices.....	34
Setting the input channels.....	35
Sending an input channel signal to the STEREO bus.....	36
Applying EQ/dynamics.....	36
Setting the output channels.....	37
Using GEQ.....	37
Using Automixer.....	38
Applying effects.....	38
Changing the patch settings.....	40
Grouping and linking.....	41
Using talkback.....	41
Routing the oscillator to an output channel.....	42
Using scene memories.....	42
Recording and playing audio using a USB flash drive.....	43
Saving and loading the unit settings.....	44

## **Other functions ..... 45**

Adjusting the brightness of the touch screen, lamps, and other indicators.....	45
Setting the date and time of the internal clock.....	45
Initializing the unit to factory default settings...	46
Adjusting the faders (Calibration function).....	46

## **Troubleshooting ..... 48**

## **Attaching the RK1 rackmount kit (sold separately)..... 50**

## **General specifications ..... 51**

## **Dimensional Diagrams..... 52**

## **Index ..... 53**

## **Block Diagram ..... End of Manual**

## **Level Diagram ..... End of Manual**

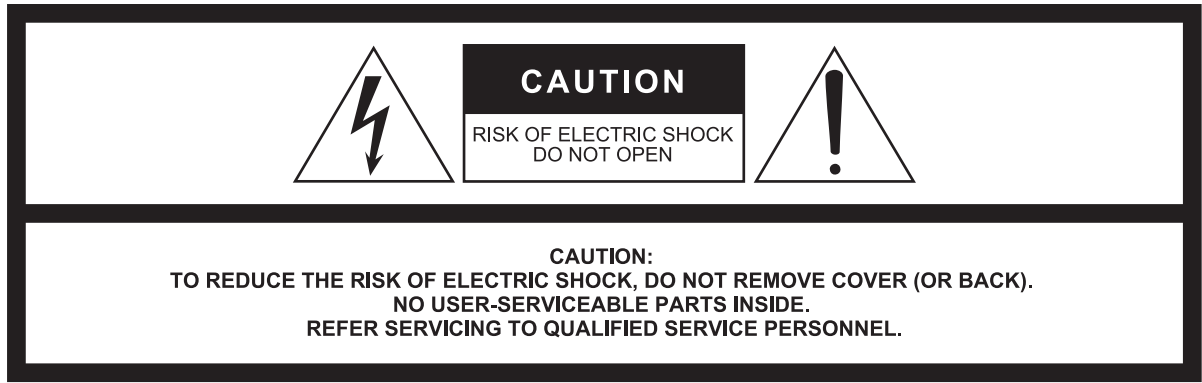

The above warning is located on the rear/side of the unit.  
L'avertissement ci-dessus est situé sur le arrière/côté de l'appareil.

## Explanation of Graphical Symbols Explication des symboles



The lightning flash with arrowhead symbol within an equilateral triangle is intended to alert the user to the presence of uninsulated “dangerous voltage” within the product’s enclosure that may be of sufficient magnitude to constitute a risk of electric shock to persons. L'éclair avec une flèche à l'intérieur d'un triangle équilatéral est destiné à attirer l'attention de l'utilisateur sur la présence d'une « tension dangereuse » non isolée à l'intérieur de l'appareil, pouvant être suffisamment élevée pour constituer un risque d'électrocution.



The exclamation point within an equilateral triangle is intended to alert the user to the presence of important operating and maintenance (servicing) instructions in the literature accompanying the product. Le point d'exclamation à l'intérieur d'un triangle équilatéral est destiné à attirer l'attention de l'utilisateur sur la présence d'instructions importantes sur l'emploi ou la maintenance (réparation) de l'appareil dans la documentation fournie.

## IMPORTANT SAFETY INSTRUCTIONS

- 1 Read these instructions.
- 2 Keep these instructions.
- 3 Heed all warnings.
- 4 Follow all instructions.
- 5 Do not use this apparatus near water.
- 6 Clean only with dry cloth.
- 7 Do not block any ventilation openings. Install in accordance with the manufacturer's instructions.
- 8 Do not install near any heat sources such as radiators, heat registers, stoves, or other apparatus (including amplifiers) that produce heat.
- 9 Do not defeat the safety purpose of the polarized or grounding-type plug. A polarized plug has two blades with one wider than the other. A grounding type plug has two blades and a third grounding prong. The wide blade or the third prong are provided for your safety. If the provided plug does not fit into your outlet, consult an electrician for replacement of the obsolete outlet.
- 10 Protect the power cord from being walked on or pinched particularly at plugs, convenience receptacles, and the point where they exit from the apparatus.
- 11 Only use attachments/accessories specified by the manufacturer.
- 12 Use only with the cart, stand, tripod, bracket, or table specified by the manufacturer, or sold with the apparatus. When a cart is used, use caution when moving the cart/apparatus combination to avoid injury from tip-over.
- 13 Unplug this apparatus during lightning storms or when unused for long periods of time.
- 14 Refer all servicing to qualified service personnel. Servicing is required when the apparatus has been damaged in any way, such as power-supply cord or plug is damaged, liquid has been spilled or objects have fallen into the apparatus, the apparatus has been exposed to rain or moisture, does not operate normally, or has been dropped.



### WARNING

TO REDUCE THE RISK OF FIRE OR ELECTRIC SHOCK, DO NOT EXPOSE THIS APPARATUS TO RAIN OR MOISTURE.

(UL60065\_03)

## PRÉCAUTIONS CONCERNANT LA SÉCURITÉ

- 1 Lire ces instructions.
- 2 Conserver ces instructions.
- 3 Tenir compte de tous les avertissements.
- 4 Suivre toutes les instructions.
- 5 Ne pas utiliser ce produit à proximité d'eau.
- 6 Nettoyer uniquement avec un chiffon propre et sec.
- 7 Ne pas bloquer les orifices de ventilation. Installer l'appareil conformément aux instructions du fabricant.
- 8 Ne pas installer l'appareil à proximité d'une source de chaleur comme un radiateur, une bouche de chaleur, un poêle ou tout autre appareil (y compris un amplificateur) produisant de la chaleur.
- 9 Ne pas modifier le système de sécurité de la fiche polarisée ou de la fiche de terre. Une fiche polarisée dispose de deux broches dont une est plus large que l'autre. Une fiche de terre dispose de deux broches et d'une troisième pour le raccordement à la terre. Cette broche plus large ou cette troisième broche est destinée à assurer la sécurité de l'utilisateur. Si la fiche équipant l'appareil n'est pas compatible avec les prises de courant disponibles, faire remplacer les prises par un électricien.
- 10 Acheminer les cordons d'alimentation de sorte qu'ils ne soient pas piétinés ni coincés, en faisant tout spécialement attention aux fiches, prises de courant et au point de sortie de l'appareil.
- 11 Utiliser exclusivement les fixations et accessoires spécifiés par le fabricant.
- 12 Utiliser exclusivement le chariot, le stand, le trépied, le support ou la table recommandés par le fabricant ou vendus avec cet appareil. Si l'appareil est posé sur un chariot, déplacer le chariot avec précaution pour éviter tout risque de chute et de blessure.
- 13 Débrancher l'appareil en cas d'orage ou lorsqu'il doit rester hors service pendant une période prolongée.
- 14 Confier toute réparation à un personnel qualifié. Faire réparer l'appareil s'il a subi tout dommage, par exemple si la fiche ou le cordon d'alimentation est endommagé, si du liquide a coulé ou des objets sont tombés à l'intérieur de l'appareil, si l'appareil a été exposé à la pluie ou à de l'humidité, si l'appareil ne fonctionne pas normalement ou est tombé.

### AVERTISSEMENT

POUR RÉDUIRE LES RISQUES D'INCENDIE OU DE DÉCHARGE ÉLECTRIQUE, N'EXPOSEZ PAS CET APPAREIL À LA PLUIE OU À L'HUMIDITÉ.

(UL60065\_03)

# FCC INFORMATION (U.S.A.)

## 1. IMPORTANT NOTICE: DO NOT MODIFY THIS UNIT!

This product, when installed as indicated in the instructions contained in this manual, meets FCC requirements. Modifications not expressly approved by Yamaha may void your authority, granted by the FCC, to use the product.

**2. IMPORTANT:** When connecting this product to accessories and/or another product use only high quality shielded cables. Cable/s supplied with this product **MUST** be used. Follow all installation instructions. Failure to follow instructions could void your FCC authorization to use this product in the USA.

**3. NOTE:** This product has been tested and found to comply with the requirements listed in FCC Regulations, Part 15 for Class "B" digital devices. Compliance with these requirements provides a reasonable level of assurance that your use of this product in a residential environment will not result in harmful interference with other electronic devices. This equipment generates/uses radio frequencies and, if not installed and used according to the instructions found in the users manual, may cause interference harmful to the operation of other electronic devices. Compliance with FCC regulations does

not guarantee that interference will not occur in all installations. If this product is found to be the source of interference, which can be determined by turning the unit "OFF" and "ON," please try to eliminate the problem by using one of the following measures:

Relocate either this product or the device that is being affected by the interference.

Utilize power outlets that are on different branch (circuit breaker or fuse) circuits or install AC line filter/s.

In the case of radio or TV interference, relocate/reorient the antenna. If the antenna lead-in is 300 ohm ribbon lead, change the lead-in to co-axial type cable.

If these corrective measures do not produce satisfactory results, please contact the local retailer authorized to distribute this type of product. If you can not locate the appropriate retailer, please contact Yamaha Corporation of America, Electronic Service Division, 6600 Orangethorpe Ave, Buena Park, CA90620

The above statements apply **ONLY** to those products distributed by Yamaha Corporation of America or its subsidiaries.

\* This applies only to products distributed by YAMAHA CORPORATION OF AMERICA.

(class B)

## ADVARSEL!

Lithiumbatteri—Eksplosionsfare ved fejlagtig håndtering. Udskiftning må kun ske med batteri af samme fabrikat og type. Levér det brugte batteri tilbage til leverandoren.

## VARNING

Explosionsfara vid felaktigt batteribyte. Använd samma batterityp eller en ekvivalent typ som rekommenderas av apparattillverkaren. Kassera använt batteri enligt fabrikantens instruktion.

## VAROITUS

Paristo voi räjähtää, jos se on virheellisesti asennettu. Vaihda paristo ainoastaan laitevalmistajan suosittelemaan tyyppiin. Hävitä käytetty paristo valmistajan ohjeiden mukaisesti.

(lithium caution)

## NEDERLAND / THE NETHERLANDS

- Dit apparaat bevat een lithium batterij voor geheugen back-up.
- This apparatus contains a lithium battery for memory back-up.
- Raadpleeg uw leverancier over de verwijdering van de batterij op het moment dat u het apparaat aan het einde van de levensduur of gelieve dan contact op te nemen met de vertegenwoordiging van Yamaha in uw land.
- For the removal of the battery at the moment of the disposal at the end of life please consult your retailer or Yamaha representative office in your country.
- Gooi de batterij niet weg, maar lever hem in als KCA.
- Do not throw away the battery. Instead, hand it in as small chemical waste.

(lithium disposal)

This product contains a battery that contains perchlorate material. Perchlorate Material—special handling may apply, See [www.dtsc.ca.gov/hazardouswaste/perchlorate](http://www.dtsc.ca.gov/hazardouswaste/perchlorate).

\* This applies only to products distributed by YAMAHA CORPORATION OF AMERICA.

(Perchlorate)

## COMPLIANCE INFORMATION STATEMENT (DECLARATION OF CONFORMITY PROCEDURE)

Responsible Party: Yamaha Corporation of America

Address: 6600 Orangethorpe Ave., Buena Park, Calif. 90620

Telephone: 714-522-9011

Type of Equipment: Digital Mixing Console

Model Name: QL5/QL1

This device complies with Part 15 of the FCC Rules.

Operation is subject to the following two conditions:

- 1) this device may not cause harmful interference, and
- 2) this device must accept any interference received including interference that may cause undesired operation.

See user manual instructions if interference to radio reception is suspected.

\* This applies only to products distributed by YAMAHA CORPORATION OF AMERICA.

(FCC DoC)

## IMPORTANT NOTICE FOR THE UNITED KINGDOM Connecting the Plug and Cord

**WARNING:** THIS APPARATUS MUST BE EARTHED

IMPORTANT. The wires in this mains lead are coloured in accordance with the following code:

GREEN-AND-YELLOW : EARTH

BLUE : NEUTRAL

BROWN : LIVE

As the colours of the wires in the mains lead of this apparatus may not correspond with the coloured markings identifying the terminals in your plug proceed as follows:

The wire which is coloured GREEN-and-YELLOW must be connected to the terminal in the plug which is marked by the letter E or by the safety earth symbol  or colored GREEN or GREEN-and-YELLOW.

The wire which is coloured BLUE must be connected to the terminal which is marked with the letter N or coloured BLACK.

The wire which is coloured BROWN must be connected to the terminal which is marked with the letter L or coloured RED.

(3 wires)

이 기기는 가정용(B급) 전자파적합기기로서 주로 가정에서 사용하는 것을 목적으로 하며, 모든 지역에서 사용할 수 있습니다.

(class b korea)

# PRECAUTIONS

## PLEASE READ CAREFULLY BEFORE PROCEEDING

Please keep this manual in a safe place for future reference.



### WARNING

Always follow the basic precautions listed below to avoid the possibility of serious injury or even death from electrical shock, short-circuiting, damages, fire or other hazards. These precautions include, but are not limited to, the following:

#### Power supply/power cord

- Do not place the power cord near heat sources such as heaters or radiators, and do not excessively bend or otherwise damage the cord, place heavy objects on it, or place it in a position where anyone could walk on, trip over, or roll anything over it.
- Only use the voltage specified as correct for the device. The required voltage is printed on the name plate of the device.
- Use only the supplied power cord/plug.  
If you intend to use the device in an area other than in the one you purchased, the included power cord may not be compatible. Please check with your Yamaha dealer.
- Check the electric plug periodically and remove any dirt or dust which may have accumulated on it.
- Be sure to connect to an appropriate outlet with a protective grounding connection. Improper grounding can result in electrical shock, damage to the device(s), or even fire.

#### Do not open

- This device contains no user-serviceable parts. Do not open the device or attempt to disassemble the internal parts or modify them in any way. If it should appear to be malfunctioning, discontinue use immediately and have it inspected by qualified Yamaha service personnel.

#### Water warning

- Do not expose the device to rain, use it near water or in damp or wet conditions, or place on it any containers (such as vases, bottles or glasses) containing liquids which might spill into any openings. If any liquid such as water seeps into the device, turn off the power immediately and unplug the power cord from the AC outlet. Then have the device inspected by qualified Yamaha service personnel.
- Never insert or remove an electric plug with wet hands.

#### Fire warning

- Do not put burning items, such as candles, on the unit.  
A burning item may fall over and cause a fire.

#### If you notice any abnormality

- When one of the following problems occur, immediately turn off the power switch and disconnect the electric plug from the outlet. Then have the device inspected by Yamaha service personnel.
  - The power cord or plug becomes frayed or damaged.
  - It emits unusual smells or smoke.
  - Some object has been dropped into the device.
  - There is a sudden loss of sound during use of the device.
- If this device should be dropped or damaged, immediately turn off the power switch, disconnect the electric plug from the outlet, and have the device inspected by qualified Yamaha service personnel.



### CAUTION

Always follow the basic precautions listed below to avoid the possibility of physical injury to you or others, or damage to the device or other property. These precautions include, but are not limited to, the following:

#### Power supply/power cord

- When removing the electric plug from the device or an outlet, always hold the plug itself and not the cord. Pulling by the cord can damage it.
- Remove the electric plug from the outlet when the device is not to be used for extended periods of time, or during electrical storms.

#### Location

- Do not place the device in an unstable position where it might accidentally fall over.
- Do not block the vents. This device has ventilation holes at the rear/sides to prevent the internal temperature from becoming too high. In particular, do not place the device on its side or upside down. Inadequate ventilation can result in overheating, possibly causing damage to the device(s), or even fire.
- Keep device away from the reach of children.
- Do not place the device in a location where it may come into contact with corrosive gases or salt air. Doing so may result in malfunction.
- Avoid being near the device during a disaster, such as an earthquake. Since the device may turn over or fall and cause injury, stay away from the device quickly and move to a safe place.
- Before moving the device, remove all connected cables.
- When setting up the device, make sure that the AC outlet you are using is easily accessible. If some trouble or malfunction occurs, immediately turn off the power switch and disconnect the plug from the outlet. Even when the power switch is turned off, electricity is still flowing to the product at the minimum level. When you are not using the product for a long time, make sure to unplug the power cord from the wall AC outlet.
- When setting up the device, make sure that the power switch can be easily turned ON/OFF. If some trouble or malfunction occurs, immediately turn off the power switch and disconnect the plug from the AC outlet.
- When transporting or moving the device, always use two or more people. Attempting to lift the device by yourself may damage your back, result in other injury, or cause damage to the device itself.

## Connections

---

- Before connecting the device to other devices, turn off the power for all devices. Before turning the power on or off for all devices, set all volume levels to minimum.

## Maintenance

---

- Remove the power plug from the AC outlet when cleaning the device.

## Handling caution

---

- Do not insert your fingers or hands in any gaps or openings on the device (vents).
- Avoid inserting or dropping foreign objects (paper, plastic, metal, etc.) into any gaps or openings on the device (vents) If this happens, turn off the power immediately and unplug the power cord from the AC outlet. Then have the device inspected by qualified Yamaha service personnel.
- Do not rest your weight on the device or place heavy objects on it, and avoid use excessive force on the buttons, switches or connectors.
- Do not use headphones for a long period of time at a high or uncomfortable volume level, since this can cause permanent hearing loss. If you experience any hearing loss or ringing in the ears, consult a physician.

## Backup battery

---

- Do not replace the backup battery by yourself. Doing so may cause an explosion and/or damage to the device(s).  
If the backup battery power is fully depleted, have qualified Yamaha service personnel replace the battery.

Yamaha cannot be held responsible for damage caused by improper use or modifications to the device, or data that is lost or destroyed.

# NOTICE

To avoid the possibility of malfunction/damage to the product, damage to data, or damage to other property, follow the notices below.

## Handling and Maintenance

- Do not use the device in the vicinity of a TV, radio, stereo equipment, mobile phone, or other electric devices. Otherwise, the device, TV, or radio may generate noise.
- Do not expose the device to excessive dust or vibration, or extreme cold or heat (such as in direct sunlight, near a heater, or in a car during the day), in order to prevent the possibility of panel disfiguration, unstable operation, or damage to the internal components.
- Do not place vinyl, plastic or rubber objects on the device, since this might discolor the panel.
- When cleaning the device, use a dry and soft cloth. Do not use paint thinners, solvents, cleaning fluids, or chemical-impregnated wiping cloths.
- Condensation can occur in the device due to rapid, drastic changes in ambient temperature—when the device is moved from one location to another, or air conditioning is turned on or off, for example. Using the device while condensation is present can cause damage. If there is reason to believe that condensation might have occurred, leave the device for several hours without turning on the power until the condensation has completely dried out.
- Avoid setting all equalizer controls and faders to their maximum. Depending on the condition of the connected devices, doing so may cause feedback and may damage the speakers.
- Do not apply oil, grease, or contact cleaner to the faders. Doing so may cause problems with electrical contact or fader motion.
- When turning on the AC power in your audio system, always turn on the power amplifier/the device LAST, to avoid speaker damage. When turning the power off, the power amplifier/the device should be turned off FIRST for the same reason.
- The rubber feet included in this package can be attached to the speaker to prevent slippage when it is to be used on a slippery surface.
- Always turn the power off when the device is not in use.

## Saving data

- This device has a built-in backup battery that maintains internal clock data even when the device's power is switched off. However, the backup battery will eventually become depleted, and when that happens the internal clock data will be reset. Replace the backup battery before it becomes fully depleted. When the backup battery is running low, the LCD display indicates "Low Battery" when you start up the system. In this case, contact your Yamaha dealer and have qualified Yamaha service personnel replace the backup battery. The average life of the backup battery is approximately five years, depending on operating conditions.

## Connectors

- XLR-type connectors are wired as follows (IEC60268 standard): pin 1: ground, pin 2: hot (+), and pin 3: cold (-).

# Information

## About copyrights

- Copying of the commercially available musical data including but not limited to MIDI data and/or audio data is strictly prohibited except for your personal use.

## About this manual

- The illustrations and LCD screens as shown in this manual are for instructional purposes only, and may appear somewhat different from those on your device.
- Windows is a registered trademark of Microsoft® Corporation in the United States and other countries.
- Apple, Mac, Macintosh and iPad are trademarks of Apple Inc., registered in the U.S. and other countries.
- The bitmap fonts used in this instrument have been provided by and are the property of Ricoh Co., Ltd.
- MPEG Layer-3 audio coding technology licensed from Fraunhofer IIS and Thomson. 
- The company names and product names in this manual are the trademarks or registered trademarks of their respective companies.

### Information for Users on Collection and Disposal of Old Equipment



This symbol on the products, packaging, and/or accompanying documents means that used electrical and electronic products should not be mixed with general household waste.

For proper treatment, recovery and recycling of old products, please take them to applicable collection points, in accordance with your national legislation and the Directives 2002/96/EC.

By disposing of these products correctly, you will help to save valuable resources and prevent any potential negative effects on human health and the environment which could otherwise arise from inappropriate waste handling.

For more information about collection and recycling of old products, please contact your local municipality, your waste disposal service or the point of sale where you purchased the items.

#### [For business users in the European Union]

If you wish to discard electrical and electronic equipment, please contact your dealer or supplier for further information.

#### [Information on Disposal in other Countries outside the European Union]

This symbol is only valid in the European Union. If you wish to discard these items, please contact your local authorities or dealer and ask for the correct method of disposal.

(weee\_eu\_en\_01)

# Introduction

Thank you for choosing a Yamaha QL series QL5/QL1 Digital Mixing Console. To take full advantage of the superior features and performance offered by your QL series console, and to enjoy years of trouble-free use, please read this owner's manual carefully before operating your console. After you have read the manual, keep it in a safe place.

## Accessories

- AC power cord
- Owner's Manual (this document)
- Dante Virtual Soundcard license code
- Dust cover (QL5 only)

## About utility software

QL series products can be used with a variety of utility software. Information about downloading, installing and setting up the software applications is available on the Yamaha Pro Audio website. In addition, refer to the installation guide that comes with each downloaded application.

<http://www.yamahaproaudio.com/>

### • QL Editor

This software application enables you to set up and operate the unit from a connected computer. You can also use the application to back up console settings or set console parameters without connecting the unit.

### • Console File Converter

This software application enables you to convert between Yamaha PM5D, M7CL, LS9, CL and QL series setting files.

### • QL StageMix

This software application enables you to control the unit remotely from an iPad on a WiFi network.

#### NOTE

iOS applications may not be supported in your area. Please check with your Yamaha dealer.

## About firmware updates

This product enables you to update the unit firmware to improve the operation, add functions, and correct possible malfunctions. The following two types of firmware are available for the unit.

- Console firmware
- Dante module firmware

You must update each type of firmware separately. Details on updating the firmware are available on the following website. For information about updating and setting up the unit, please refer to the firmware update guide available on the website.

<http://www.yamahaproaudio.com/>

## About the Owner's Manual

### Owner's Manual (this document)

This book primarily explains panel controls and functions and basic operation of the QL series. In this manual, most explanations refer to the QL5.

### Reference Manual (PDF format; downloadable from the website)

This book primarily explains details about functions, effects parameters, and MIDI.

The Reference Manual is an electronic file in PDF format. Use PDF viewing software such as Adobe® Reader® to read this manual. You can download the latest Adobe Reader application from the website listed below.

<http://www.adobe.com/>

### Help file (XML file; downloadable from the website)

You can read this Help file on the unit's screen. Load the file on the unit, then press the Help button on the display to view related sections.

You can download the Reference Manual and Help file from the following website.

<http://www.yamahaproaudio.com/>

## Conventions in this manual

In this manual, switch-type controllers on the panel are called "keys." Control knobs on the panel are called "knobs." Some knobs rotate from a minimum value to a maximum value, while others rotate endlessly.

Virtual buttons displayed on the screen are called "buttons," and virtual knobs are called "knobs."

Controls located on the panel are enclosed in square brackets [ ] (e.g., [CUE] key) to distinguish them from virtual buttons and knobs displayed on screen. For some controls, the name of the section is given before the [ ] (e.g., SCENE MEMORY [STORE] key).



# An overview of the QL series

## Features

QL series digital mixing consoles create high-quality, refined, live-sound environments. These consoles carry forward the digital evolution of a broad array of advanced concepts that helps to make the consoles easy and intuitive to use. The built-in effect processor and an optional I/O devices can accommodate the most demanding situations at the highest level of quality, while retaining the flexibility necessary to configure a system that meets your needs.

### User interface friendly to newcomers but familiar to seasoned users

The Selected Channel section located to the right of the display lets you use the knobs to control the main parameters (gain, EQ, dynamics threshold, etc.) for a particular channel. This section can be operated much like a module in an analog mixer.

The display is a touch screen. You can turn functions on or off or select items simply by touching buttons or knobs on the screen. You can use the [TOUCH AND TURN] knob to adjust the parameters of the selected knob.

Groups of channels routed to the top-panel faders can be selected and switched easily in a “Fader Bank.” The Fader Bank holds input and output channel banks, as well as custom fader banks. The custom fader banks enable you to select various combinations of channels, regardless of channel types. Each channel strip offers easy visual identification. The channel name appears on a display, and an indicator shows the channel color. You can adjust the brightness of each indicator across a broad range to accommodate dimly-lit environments.

Mix parameter settings, including gain and phantom power for input channels, can be stored and recalled as “scenes.” All faders on the panel are moving faders. When you recall a scene, the recorded fader locations will be reproduced immediately.

### Flexible system configuration with Dante

The Ethernet-compatible Dante audio network protocol facilitates connecting QL series consoles to external devices, such as the Rio3224-D I/O device. A connected I/O device that has been assigned a unique unit ID will automatically be recognized and will facilitate patching functions.

Using an I/O rack, you can configure a redundant network to defend against unforeseen difficulties that can arise in large-scale Dante networks. If multiple QL units share the same I/O device, the gain compensation function will maintain network audio streams at a constant level to help you enjoy the benefits of a large-scale sound system.

The Dante Virtual Soundcard software enables you to carry out multi-channel recording to DAW software installed on a computer. Consequently, no other audio interface is needed.

### Integration of mixer and I/O device with port-to-port functionality

Direct “port-to-port” patching functionality between input ports and output ports allows direct routing of QL analog inputs and outputs to/from external Dante devices without passing through the mixing channels.

Further, you can remotely control the head amps from other CL series and QL series consoles, allowing QL series consoles to be used as remote I/O devices. You can use recall safe in the port to port function to remove a head amp from scene recall in QL series consoles so that it is controlled only from another CL series or QL series console.

### Ultra-realistic digital reproduction of analog sound by PREMIUM RACK

The QL series features PREMIUM RACK, which employs VCM technology. This technology models analog circuitry on a component level to faithfully reproduce amazing analog sounds. PREMIUM RACK creates authentic sounds by modeling and faithfully capturing the sonic characteristics of analog circuitry fine-tuned to be faithful to the original sound. The QL’s PREMIUM RACK includes six models, including a Portico 5033 EQ/Portico 5043 Compressor by Rupert Neve Designs, a U76 Compressor, an Opt-2A Leveling Amplifier, etc.

### Sonic flexibility from versatile effects and GEQ rack

Independent of the PREMIUM RACK, high-quality multi-effect processors are built into your QL series console, with up to eight available simultaneously. Effects such as reverb, delay, multiband compression, and various modulation effects can be routed via internal buses or inserted into the desired channel.

In addition to the effects, the QL series features a GEQ rack. This includes a 31-band graphic EQ, a Flex15GEQ, and an Automixer function—each of which can be inserted into any channel or bus. The Flex15GEQ allows you to adjust the gain for any 15 of the 31 bands. Automixer allows you to reduce noise and maintain feedback margins, by automating the gain distribution for multiple microphones, freeing the operator from making constant fader adjustments. To use effects or the graphic EQ, you mount them in virtual racks displayed on the touch screen. The currently-mounted modules can be seen at a glance, and you can switch modules and change input/output patching in an intuitive manner.

## I/O card and processing card expansion

The rear panel provides two slots in which separately sold mini-YGDAI cards can be installed. You can add inputs and outputs by installing AD cards, DA cards, or digital I/O cards in these slots. You can also expand processing or effects by installing a DSP card.

## Cascade connections in the digital domain

You can cascade a second QL series unit or another digital mixer, such as the Yamaha CL series, M7CL, PM5D or LS9, connected via a digital I/O card installed in a slot or a Dante connector. (Cascade connections via a Dante connector are possible only between QL series consoles.) You can cascade any of the MIX, MATRIX, STEREO (L/R), MONO, and CUE (L/R) buses.

## Recorder function useful for sound checks and mix recording

The QL series features a USB memory recorder function that enables you to record output from STEREO or MIX buses onto a USB flash drive. It also enables you to play audio files that reside on a USB flash drive by assigning the files to input channels or monitor outputs. The MP3 format (MPEG-1 Audio Layer-3) is supported for recording. For playback, MP3, WMA (Windows Media Audio), and MPEG-4 AAC (Advanced Audio Coding) formats are supported. This function can be useful if you want to record certain bus mix outputs or play music for a sound check through speakers.

## Security functions at user or system level

Functionality can be restricted for users other than the administrator at three levels of security: administrator, guest, and user. Passwords can be specified for the administrator and for users to help prevent important settings from being changed accidentally.

Information specific to each user (user level, system settings, and user-defined key/knob settings) can be stored on the unit or on a USB flash drive as a “user authentication key.” By loading your own user authentication key, you can instantly reconfigure the unit for your own ideal operating environment.

## Help file downloadable to the unit

You can download from the website a Help file that explains the parameters and messages displayed on the screen. Once you load the Help file, it will be stored inside the unit so that you can use the Help function at any time.

## About the models

The QL series is available in two models: QL5 and QL1. Model differences are shown in the table below.

	Analog inputs	Analog outputs	Monaural input channels	Channel strips
QL5	32	16	64	Block A/B: 32 Master section: 2
QL1	16	8	32	Block A/B: 16 Master section: 2

### • QL5

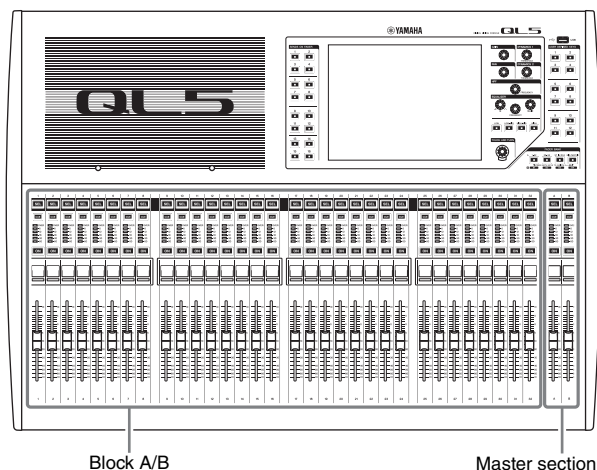

### • QL1

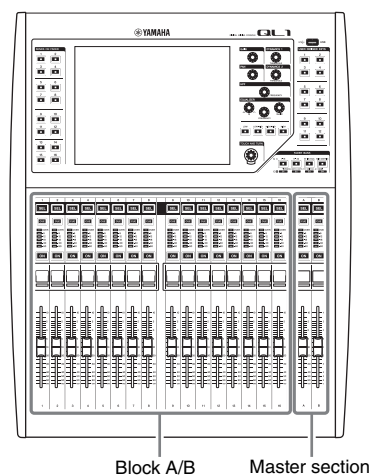

# Controls and functions

## Top panel

The top panel of the QL series is divided into the following sections.

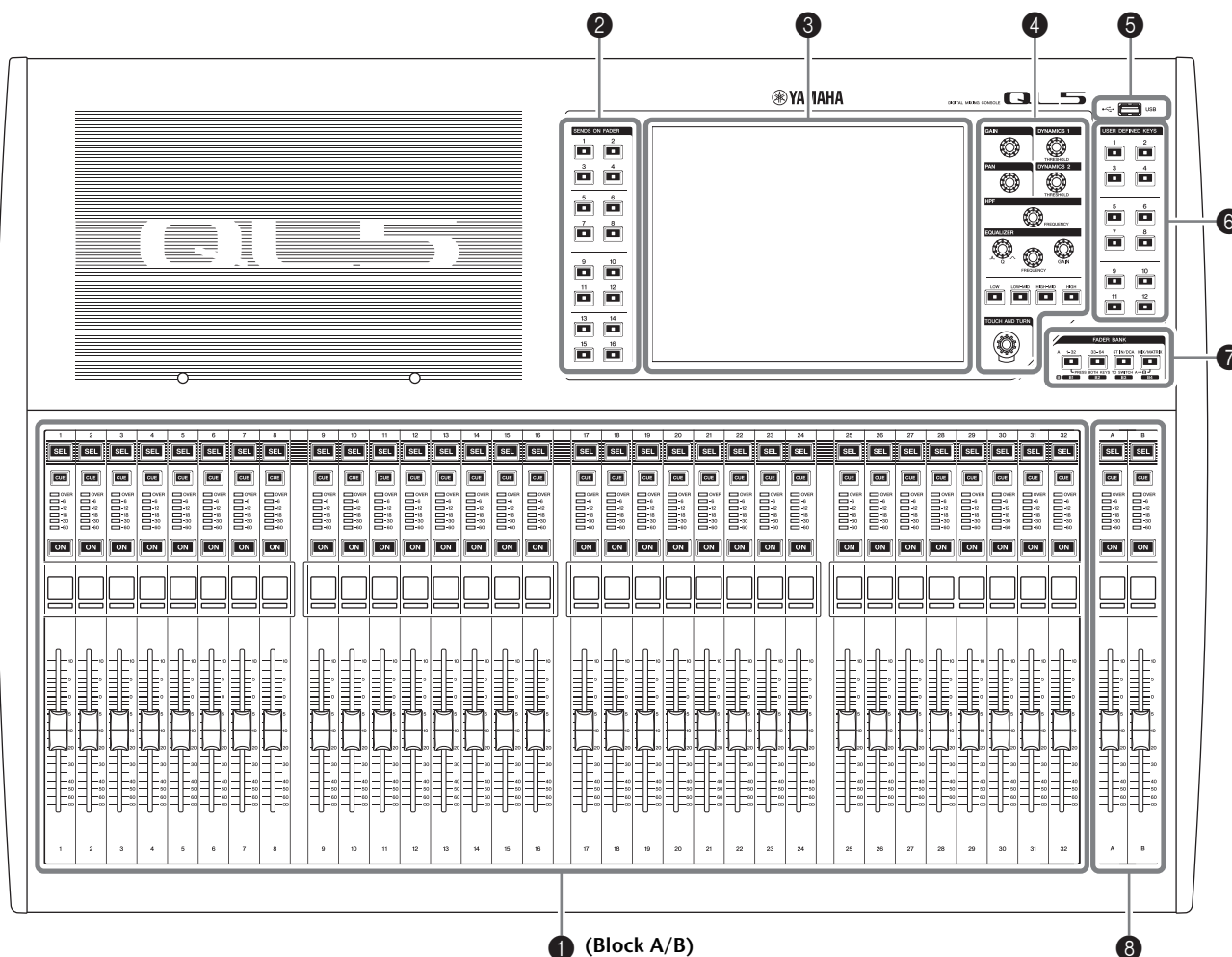

- ❶ Channel Strip section → page 12
- ❷ SENDS ON FADER section → page 12
- ❸ Display section → page 13
- ❹ Selected Channel section → page 13
- ❺ USB connector → page 15
- ❻ USER DEFINED KEYS section → page 14
- ❼ FADER BANK section → page 14
- ❽ Master section → page 14

### NOTE

This illustration shows the top panel of the QL5.

## Channel Strip section

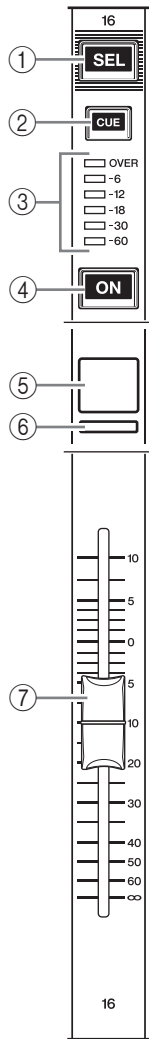

① **[SEL] key**

Selects the channel that will be controlled in the Channel Strip section and on the touch screen. When a channel is selected, the key LED will light. If you control an ST IN channel in the Channel Strip section, the L channel will be routed to an odd-numbered channel, and the R channel will be routed to the adjacent even-numbered channel. If you control the custom fader bank, and if you assign L/R channels, the selected object of control will alternate between the L and R channels each time you press the [SEL] key.

**NOTE**

If you assign either the L or R channel, this key will simply select the channel.

② **[CUE] key**

Selects the channel to be cue-monitored. If cue is on, the LED will light.

③ **Meter LEDs**

Indicate the channel level.

④ **[ON] key**

Switches the channel on or off. If a channel is on, the key LED will light. In SENDS ON FADER mode, this is an on/off switch for signals sent from each channel to the currently-selected MIX/MATRIX bus.

⑤ **Channel name display**

Indicates the channel name, fader value, etc. You can set the display so that it will indicate only the channel name. The information to be shown can be specified in the USER SETUP screen PREFERENCE tab.



⑥ **Channel color indicator**

Lights in the channel color specified on the PATCH/NAME screen. You can select the channel color from nine options, including OFF.

⑦ **Fader**

Adjusts the input/output level of the channel. In SENDS ON FADER mode, this fader adjusts the send level of the signal from each channel to the currently-selected MIX/MATRIX bus.

## SENDS ON FADER section

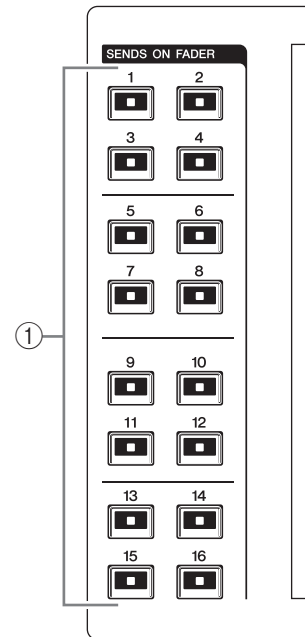

① **MIX/MATRIX buses [1]–[16]**

For selecting the MIX/MATRIX buses whose send levels will be adjusted in the Selected Channel section. The LED of the key corresponding to the currently selected bus will light (or flash, in the case of a MATRIX bus).

In SENDS ON FADER mode, these keys select a MIX/MATRIX bus as the send-destination. In this case, the LED of the key corresponding to the currently selected bus will flash, and the LED of keys corresponding to selectable buses will light. For MATRIX buses, the [9]–[16] keys will be dark and cannot be selected.

## Display section

This is a touch screen that you can operate by touching the surface of the screen. You can touch your finger to the screen to select menus or set parameters. Please note that you cannot operate the unit by touching multiple points simultaneously.



### NOTICE

Never use a sharp or pointed object such as your fingernail to operate the touch panel. Doing so may damage the screen and render the touch functions inoperable.

### NOTE

If the touch screen becomes dirty, wipe it with a soft dry cloth.

## Selected Channel section

This section enables you to set the mix parameters for the currently-selected channel.

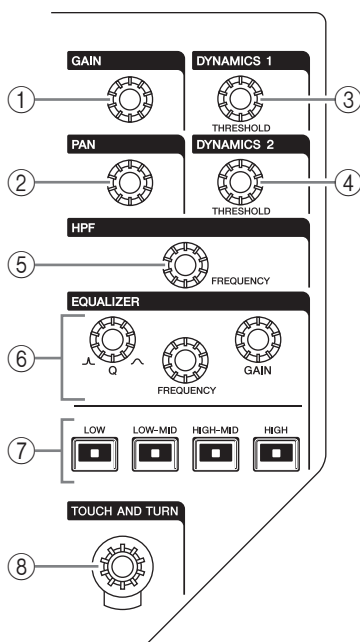

### ① [GAIN] knob

Adjusts the head amp's analog gain for an input channel.  
 Alternately, it adjusts the digital gain if GAIN KNOB FUNCTION is set to DIGITAL GAIN in the PREFERENCE tab of the USER SETUP screen.  
 This knob has no effect for other types of channels.

### NOTE

- The PAD will be switched on or off internally when the HA analog gain is adjusted between +17dB and +18dB. Keep in mind that noise may be generated when using phantom power if there is a difference between the hot and cold output impedance of an external device connected to the INPUT connector.

### ② [PAN] knob

When a monaural channel is selected, this knob adjusts the panning of the signal sent to the STEREO bus.  
 When a stereo channel is selected, this knob adjusts the PAN or left/right balance, whichever is selected.

### ③ [DYNAMICS 1] knob

### ④ [DYNAMICS 2] knob

Adjust the THRESHOLD parameter of the gate, compressor, etc.  
 The [DYNAMICS 2] knob has no effect if the MIX, MATRIX, STEREO, or MONO channel is selected.

### ⑤ [HPF] knob

Adjusts the HPF cutoff frequency for an input channel. It has no effect on other types of channels.

### ⑥ EQ [Q], EQ [FREQUENCY], EQ [GAIN] knobs

For each band of the four-band EQ, these knobs adjust the Q, center frequency (cutoff frequency), and gain.

Press the EQ [Q] and EQ [GAIN] knobs simultaneously to reset the GAIN setting for each band to the default value (0.0dB).

### ⑦ EQ [LOW] key/EQ [LOW-MID] key/EQ [HIGH-MID] key/EQ [HIGH] key

These keys select an EQ band that is controlled by the knobs located above the keys. Press and turn the EQ [Q] knob to switch between SHELIVING, HPF (OUT only), and LPF.

### ⑧ [TOUCH AND TURN] knob

You can press a desired knob in the touch screen and then use this knob to operate it. The LED below this knob indicates the color of the knob selected on the touch screen.

## USER DEFINED KEYS section

### USER DEFINED keys [1]–[12]

Execute functions as assigned by the user (scene changes, switching the talkback or internal oscillator on/off, etc.). Make these assignments in the USER SETUP screen.

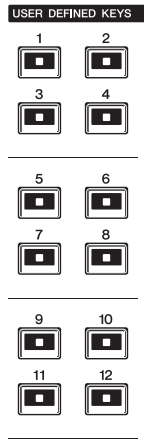

## FADER BANK section

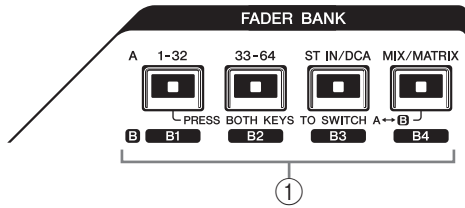

### ① Bank Select keys [1–32]/[33–64]/[STIN/DCA]/[MIX/MATRIX]

These keys switch the channel faders controlled in the Channel Strip section.

Press the [1–32] key and [MIX/MATRIX] key simultaneously to switch between fader bank A and custom fader bank B.

For details on the custom fader banks, refer to page 22.

## Master section

This section is similar to the Channel Strip section, and enables you to control the principal parameters of the assigned channels. When the unit is in the default state, STEREO/MONO channels are assigned.

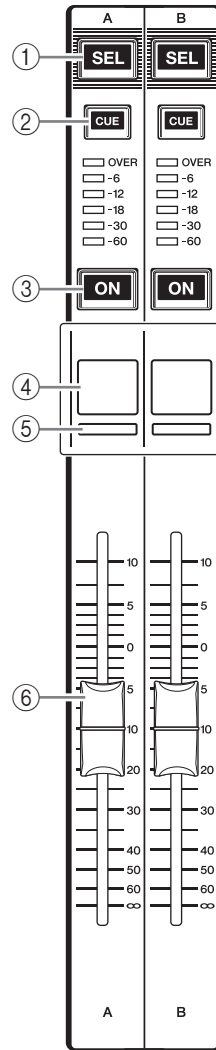

### ① [SEL] key

Selects the channel you wish to control. Pressing this key will cause the channel LED to light up, and you will be able to control the channel in both the Selected Channel section and on the touch screen. If the STEREO bus has been assigned, the selected object of control will alternate between the L and R channels each time you press the [SEL] key.

### ② [CUE] key

Selects the channel to be cue-monitored. If cue is on, the LED will light.

### ③ [ON] key

Switches the channel on or off. If a channel is on, the key LED will light. If MONITOR has been assigned, this key switches the monitor output on or off.

### ④ Channel name display

### ⑤ Channel color indicator

Same as that in the Channel Strip section.

⑥ **Fader**

Adjusts the output level of the channel.  
If MONITOR has been assigned, this fader adjusts the monitor output level.

**USB connector**

You can connect a USB flash drive to the USB connector to record or play audio files, and to save or load internal data.

The Help file displayed on the unit screen is also loaded from a connected USB flash drive.

You can also save “User authentication key” data on a USB flash drive. This determines the user level and limits the functionality to which each user has access.

**NOTE**

Operation is guaranteed only for a connection with a USB flash drive.

**■ USB flash drive capacities and formats**

The operation of USB flash drives with capacities of up to 32GB has been verified.

(However, this does not guarantee operation of all USB flash drives.)

The FAT16 and FAT32 formats are supported.

**■ Prevention of accidental erasure**

Some USB flash drives have a write-protect setting that lets you prevent data from being erased accidentally. If your flash drive contains important data, it is a good idea to use the write-protect setting to prevent accidental erasure.

On the other hand, you will need to make sure that your USB flash drive's write-protect setting is turned off before you save data onto it.

**NOTICE**

An ACCESS indicator appears in the function access area while data is being accessed (saved, loaded, or deleted). Do not disconnect the USB flash drive or power-off the QL unit while this indicator is shown. Doing so may damage your flash drive, or may damage the data in the QL unit or on your media device.

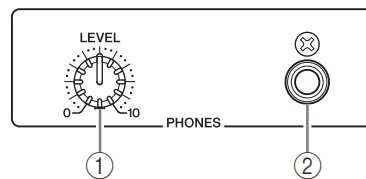
**Front panel**① **PHONES LEVEL knob**

Adjusts the level of the signal output from the PHONES OUT jack.

② **PHONES Out (headphone output) jack**

Lets you monitor the MONITOR OUT or CUE signal.

# Rear panel

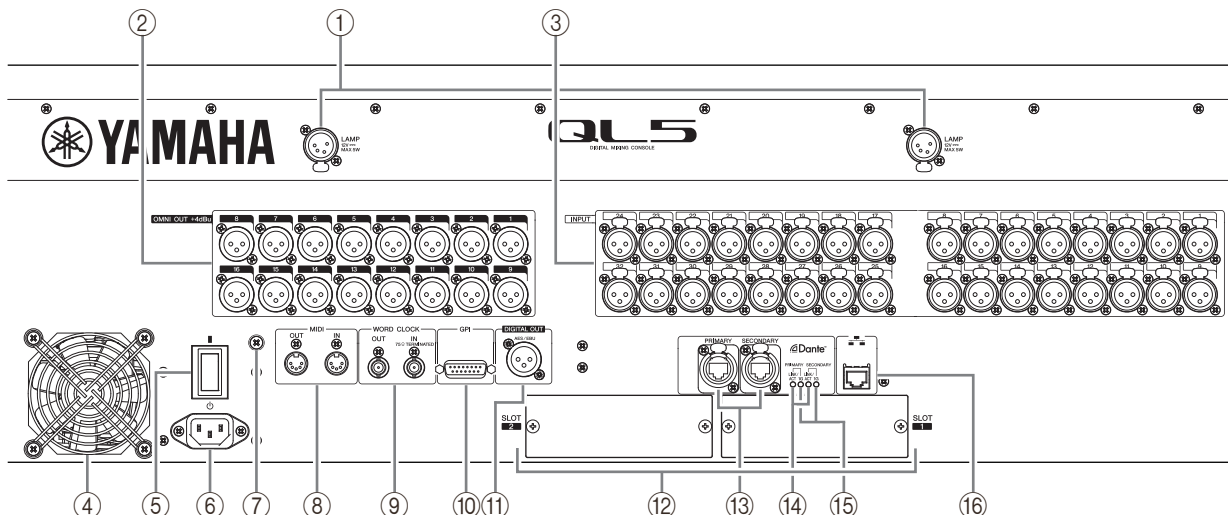

**① LAMP connectors**

Four-pin female XLR output jacks that supply power to separately-sold gooseneck lamps (such as the Yamaha LA1L). (The QL5 includes these connectors at two locations. The QL1 includes one.)

**② OMNI OUT jacks**

XLR-3-32 male output jacks for outputting analog audio signals. (The QL5 has 16 of these jacks. The QL1 has 8.) These jacks are used mainly to output the signals of MIX channels or MATRIX channels. The nominal output level is +4dBu.

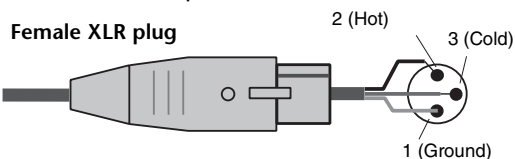

**NOTE**

- The nominal output level of the OMNI OUT jacks is +4dBu (maximum level +24dBu), but if necessary, this can be changed to -2dBu (maximum level +18dBu) by setting an internal switch (a fee will be charged). For details, contact a Yamaha service center listed at the end of the owner's manual.

**③ INPUT jacks**

Balanced XLR-3-31 female input jacks for inputting analog audio signals from line level devices or microphones. (The QL5 has 32 of these jacks, and the QL1 has 16.) The input level range is from -62dBu to +10dBu.

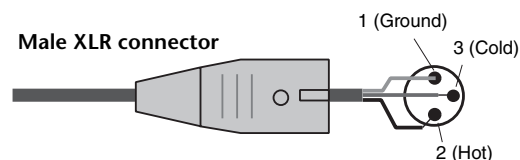

**④ Exhaust port**

The QL series consoles have cooling fans. Please be sure that you do not block the air intakes or exhaust vents.

**⑤ / / ⏻ (Power Switch)**

This switch turns the power on/off (|/⏻).

**⚠ Caution**

- Rapidly turning the unit on and off in succession can cause it to malfunction. After turning the unit off, wait for at least 6 seconds before turning it on again.
- Even when the power switch is turned off, a small amount of current is flowing through the unit. If you plan not to use the unit for a long period of time, remove the power cable from the AC outlet.

**⑥ AC IN connector**

Connect the supplied AC power cord here. First connect the AC power cable to the QL unit, then insert the power cable plug into an AC power outlet.

Insert the cable plug all the way until it locks in securely. The supplied AC power cable features a V-lock mechanism via a latch, which prevents the power cable from coming off accidentally.

**⚠ Caution**

**Be sure to turn the power off before connecting or disconnecting the power cable.**

To disconnect the power cable, remove it while pressing the latch on the plug.

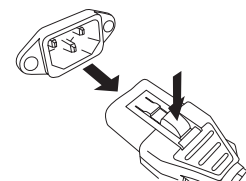

**⑦ Grounding screw**

The supplied AC power cable is a 3-wire type. Therefore, if the AC outlet used is properly grounded, the QL will be grounded as well. Also, grounding this screw may effectively eliminate noise such as hum and interference.



**⑧ MIDI IN/OUT connectors**

Used to transmit and receive MIDI messages to and from external MIDI devices. The MIDI IN connector receives messages from an external device, and the MIDI OUT connector transmits messages from the QL unit.

These are used mainly to record QL parameter operations or scene/library selections on an external device, or to control QL parameters from an external device.

**⑨ WORD CLOCK IN/OUT connectors**

BNC connectors used to transmit and receive word clock signals to and from an external device. The WORD CLOCK IN connector features internal 75-ohm termination.

**⑩ GPI connector**

D-sub 15-pin female connector that allows communication (5-in, 5-out) with a GPI-equipped external device.

**⑪ DIGITAL OUT connector**

An AES/EBU (XLR-3-32 male) jack that outputs the digital audio signal of a desired channel in AES/EBU format. This is used mainly to output the signal of the STEREO/MONO channel.

**⑫ SLOT 1–2**

Allow for the installation of separately-sold DSP cards, or mini-YGDAI I/O cards to expand the number of input/output ports.

**⑬ Dante PRIMARY/SECONDARY connectors**

Used to connect to other Dante audio network devices, such as an Rio3224-D I/O device. Use standard Ethernet cables with Neutrik etherCON CAT5e compatible RJ-45 plugs.

**NOTE**

Use STP (shielded twisted pair) cable to prevent electromagnetic interference. Make sure that the metal parts of the plugs are electrically connected to the STP cable shield by conductive tape or comparable means.

**⑭ LINK/ACT indicators**

These indicators show the communication status of the PRIMARY and SECONDARY connectors. They flash rapidly if the Ethernet cables are connected properly.

**⑮ 1G Indicators**

These indicators light when the Dante network is functioning as Giga-bit Ethernet.

**⑯ NETWORK connector**

This RJ-45 connector allows the QL unit to be connected to a computer via an Ethernet cable (CAT5e or higher recommended). This connector is used mainly to control mix parameters or to edit scene memories and libraries from the dedicated "QL Editor" application program or the "QL StageMix" iPad application.

**NOTE**

Use STP (shielded twisted pair) cable to prevent electromagnetic interference. Make sure that the metal parts of the plugs are electrically connected to the STP cable shield by conductive tape or comparable means.

# Touch screen

## Basic touch screen operations

This section explains the basic procedures you can perform on the QL's touch screen.

### Pressing the touch screen

You will mainly use this operation to switch screens and pages, to select parameters to be operated, and to turn buttons on/off. Certain buttons let you specify a number based on the area of the button itself that you touch.

#### NOTE

Typically, you will press a top panel key once, but in certain cases you can access special functions by rapidly pressing a key twice in succession.

### Multiple selection (specifying a range)

While pressing your finger on the touch panel, move it in the left or right direction to specify a range within a character string. You will use this technique primarily when assigning a name to a scene or library.



For the channel select buttons, you can select multiple buttons by moving your finger across the touch screen while continuing to press down.

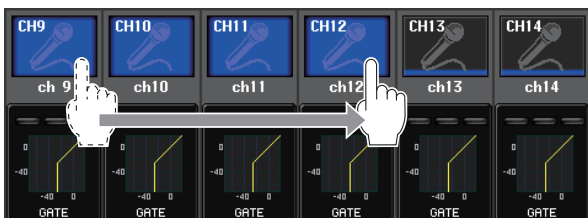

#### NOTE

This makes it easy to select a range of buttons to be turned on or off together.

### Using the knobs on the top panel

The knobs on the top panel are rotated to change the value of the corresponding parameter. Also, by pressing a knob, you can recall a specific screen.

For certain parameters, you can adjust the value in finer steps (greater detail) by simultaneously holding down the knob and rotating it.

### Using the [TOUCH AND TURN] knob

The [TOUCH AND TURN] knob is used to operate the knobs selected for operation in the touch screen.

Press the touch screen to select the knob you want to operate. When you press a knob, a highlight outline is displayed around that knob. Turn the [TOUCH AND TURN] knob to adjust the value for the corresponding parameter.

#### NOTE

Pressing certain knobs a second time while the outline is displayed will open a screen in which you can make additional detailed settings.

## On-screen user interface

The section below explains various user interface components that appear in the touch screen, and how to use them. Examples of screens appearing on the touch screen are shown below.

### USER DEFINED KEY SETUP window

Displayed when selecting items from a list, such as a list of USER DEFINED keys.

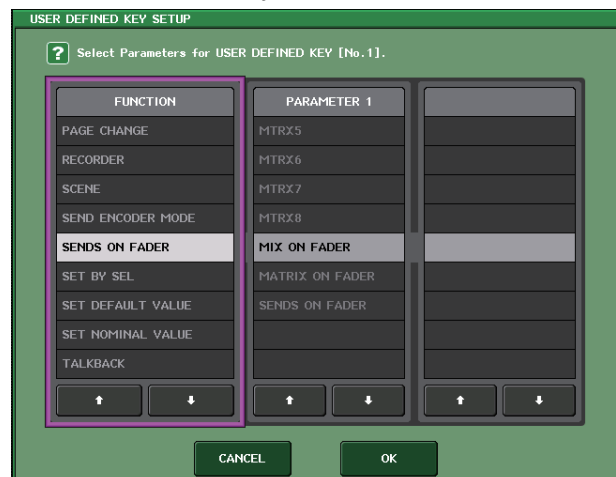

The constantly highlighted item in the center is the selected item. Press the  $\uparrow/\downarrow$  located below the list to scroll the list upward or downward.

#### NOTE

- You can also scroll the list up or down by using the [TOUCH AND TURN] knob.
- If there is more than one list in the screen, your operations will apply to the list enclosed in a white frame.

## Keyboard window

Displayed when you need to assign a name or comment to a scene or library, or when you need to assign a channel name. Press characters in the window to enter the desired characters.



## HPF/EQ window

When you press a button or field for a specific parameter in a screen, a window showing detailed parameters or lists will appear.



If there are tabs in the window, you can press a tab to switch pages.

Some windows show several buttons called “tool buttons” at the top of the window. You can use these tool buttons to recall or copy/paste library data.

Press the “X” (close) button to close the window and return to the previous screen.

## Dialog boxes

Dialog boxes similar to the following enable you to confirm operations you just performed. Press the OK button to execute the operation. The operation will be canceled if you press the CANCEL button.

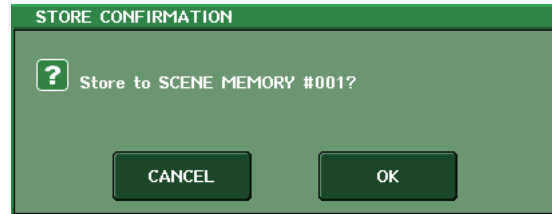

## Tabs

Tabs enable you to switch between multiple pages. Each tab indicates its page name.

## Buttons

Buttons are used to execute specific functions, to switch parameters on or off, or to select one of multiple choices. Buttons that perform on/off operations appear in solid colors while they are turned on, and are dark (ghosted) when turned off.



When you press a button that has the following symbol, a separate window will open, allowing you to make detailed settings.



## Faders/Knobs

Faders and knobs on screen move in tandem when you operate the top panel faders and knobs. The current value appears immediately below the fader or knob. For display knobs that can be operated by the panel [TOUCH AND TURN] knob, pressing the display knob just once causes a highlight outline to appear around the knob. This frame indicates that the knob has been selected for operation.

# Viewing the touch screen

The touch screen of the QL series is broadly divided into two areas.



## Function access area

### ① Selected channel

This shows the number, name, icon, and channel color of the channel that is currently selected for operation. Pressing the minus indication here will switch to the preceding channel, and pressing the plus indication will switch to the next channel.

### ② Time

This shows the current time.

### ③ Status Indicator

This shows the current status. Normally it indicates the name of the user who is currently logged in (i.e., is authenticated and able to operate the system). The following table shows the displayed content and the corresponding status.

Indication	Status
OSC	Oscillator enabled
TALKBACK	Talkback enabled
CUE	Cue monitor on*
ACCESS	Accessing internal memory or USB memory
PATCHING	Now performing Dante patching
ALT	ALTERNATE mode enabled
PLAY	Playing an audio file
REC	Recording an audio file

\* The type of signal being cue-monitored (IN/OUT/DCA/KEY IN/EFFECT) is shown in the upper part of the cue meter.

### NOTICE

An ACCESS indicator appears in the function access area while data is being accessed (saved, loaded, or deleted). Do not disconnect the USB flash drive or power-off the QL

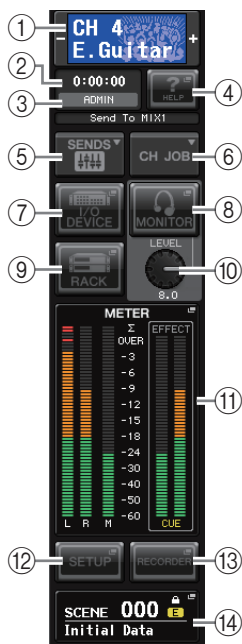

unit while this indicator is shown. Doing so may damage your flash drive, or may damage the data in the QL unit or on your media device.

### ④ HELP

Pressing this button will show on-line help in the main area. To view the on-line Help, first you must load the Help file into the QL series console from a USB flash drive.

### ⑤ SENDS ON FADER

Press this button to switch to SENDS ON FADER mode, where you can use the faders of the top panel to adjust the MIX/MATRIX send level. During this time, the function access area will switch to a screen that enables you to select the send-destination MIX/MATRIX bus.

### ⑥ CH JOB (Channel Job)

Press this button to display the CH JOB menu, which you can make settings for channel grouping and linking, and then select the function to operate.

### ⑦ I/O DEVICE

When you press this button, the I/O DEVICE screen will appear in the main area, allowing you to make I/O device settings and external head amp settings.

### ⑧ MONITOR

When you press this button, the MONITOR screen will appear in the main area, allowing you to edit the monitor or oscillator settings.

### ⑨ RACK

When you press this button, the VIRTUAL RACK screen will appear in the main area, allowing you to edit the GEQ or effect settings.

### ⑩ MONITOR LEVEL KNOB

This control adjusts the monitor level.

### ⑪ METER

Displays the level of the STEREO bus (L/R), MONO bus (M), and cue signal (CUE). When you press this field, the METER screen will appear in the main area. If you press the CUE meter area when the cue monitor is on, the cue monitor will be canceled.

### ⑫ SETUP

When you press this button, the SETUP screen will appear in the main area, allowing you to make basic system settings and user-specific settings.

### ⑬ RECORDER

When you press this button, the recorder screen will appear in the main area; here you can operate and make settings for the recorder function (USB/Nuendo Live) which allows you to record and play back audio files.

### ⑭ SCENE

This indicates the number and name of the scene that was last stored or recalled. An "R" symbol is displayed for read-only scenes, and a lock icon is displayed for write-protected scenes. If you edit the parameters from their last stored or recalled state, an "E" symbol will appear in the lower right. When you press this field, the SCENE LIST screen will appear in the main area, allowing you to store or recall scenes. In PREVIEW mode, this field is shown in red.

When you press a button (7–10, 12–14) to access the corresponding screen, the button will be highlighted. In this state, pressing the button once again will return either to the most recently recalled SELECTED CHANNEL VIEW screen or the OVERVIEW screen.

## Main area

The contents of the main area will depend on the currently selected function. Mixing operations will involve mainly the following two types of screens.

### SELECTED CHANNEL VIEW screen

This screen shows all mix parameters of the currently selected channel. To access this screen, press one of the knobs of the “Selected Channel section” (see page 13).



### OVERVIEW screen

The main parameters for 8 channels are displayed. This screen appears when you press a USER DEFINED key to which OVERVIEW is assigned.



## Using the tool buttons

The title bar at the top of some windows contains tool buttons that provide additional functions. You can use these buttons to recall related libraries, or to copy the parameters of a channel to a different channel.

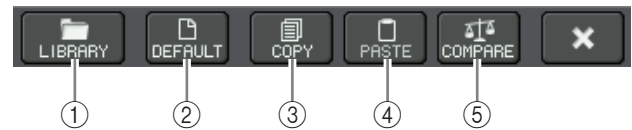

### 1 LIBRARY button

This button opens the library associated with the current window (EQ, dynamics, GEQ, effect, or premium libraries).

### 2 DEFAULT button

This button restores the currently selected channel (EQ/dynamics) or rack (effect/premium rack) to the default state.

#### NOTE

The GEQ does not have this button; the FLAT button in the GEQ EDIT window will return the parameters to the default state.

### 3 COPY button

This button copies the settings of the currently selected channel (EQ/dynamics) or rack (GEQ/effect/premium rack). The copied settings are copied to buffer memory (a memory area for temporary storage).

### 4 PASTE button

This button pastes the settings copied to buffer memory into the currently selected channel (EQ/dynamics) or rack (GEQ/effect/premium rack).

### 5 COMPARE button

This button exchanges the settings copied to buffer memory with the settings of the currently selected channel (EQ/dynamics) or rack (GEQ/effect/premium rack).

For some windows, a variety of tool buttons also appear.

# Basic operation of the QL series

This section explains the basic operations of the QL series.

QL series operations are divided into two main categories. In general, you will operate the QL series for mixing using a combination of these operations.

- **Controlling selected channels (Selected Channel section)**
- **Using the faders on the top panel (Channel Strip section)**

## Controlling selected channels (Selected Channel section)

The Selected Channel section located at the right of the display corresponds to a channel module of a conventional analog mixer, and allows you to manually adjust all the major parameters of the currently selected channel. Operations in this section will affect the channel that was most recently selected by its [SEL] key.

- 1. Press the appropriate Bank Select key (in the FADER BANK section) of the bank containing the channel that you want to control.**  
Select one of the preset or custom fader banks in the Channel Strip section.
- 2. Press the [SEL] key to select the target channel.**
- 3. Press one of the knobs in the Selected Channel section.**  
The SELECTED CHANNEL VIEW screen for the selected channel will appear. You can view the actual setting values on screen.
- 4. Use the knobs of the Selected Channel section and the buttons in the SELECTED CHANNEL VIEW screen to edit the parameters of the selected channel.**  
Even if a different screen is selected, the currently-selected channel can be set using the knobs of the Selected Channel section. In this case, a mini window indicating the value of that parameter will appear on screen when you operate a knob.

## Using the top panel (Channel Strip section)

The Channel Strip section of the top panel enables you to control the level, CUE, and other parameters for the selected channels.

- 1. Use the Bank Select keys located in the Fader Bank section to select the channels or DCA groups that you want to control.**
- 2. Use the controls of the Channel Strip section.**  
Each channel's display indicates the currently assigned channel information.

## Custom fader bank settings

The B1, B2, B3, and B4 keys in the Fader Bank section enable you to assign and recall a bank with your own assortment of the channels or DCA groups. These banks are called "custom fader banks." Since the custom fader banks enable you to assign a combination of different types of channels, you can control different types of channels as a group.

- 1. In the function access area, press the SETUP button.**
- 2. Press the USER SETUP button in the upper left of the SETUP screen.**
- 3. Press the CUSTOM FADER tab near the bottom of the USER SETUP screen.**  
The CUSTOM FADER BANK/MASTER FADER page will appear.
- 4. Select the custom fader bank you want to set.**  
The channel strip is divided into 1–16, 17–24 (QL5 only), and Master, from the left side of the console.
- 5. Press the Fader select button you want to set, then press the [SEL] key for the channel that you want to assign to that fader.**

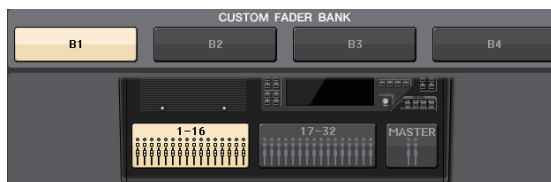

You can also select a channel in the display. Press the button below the desired number to display the CH SELECT screen. Use the list in the left column to select the desired channel group, then use the buttons in the right column to select channels.

6. To assign channels to other faders, repeat step 5.
7. When you have finished, press the X symbol in the upper right corner of the screen, and press the SETUP button again to return to the SELECT CHANNEL VIEW screen.

## Adjusting the send level to a MIX bus or MATRIX bus (SENDS ON FADER mode)

Each fader on the top panel enables you to adjust the level of the corresponding channel, as well as the send level of the signal routed from each channel to the specified MIX/MATRIX bus (SENDS ON FADER mode).

1. Press the key for the MIX/MATRIX bus to be used to adjust the SENDS ON FADER section.

The LED of the selected key will light.

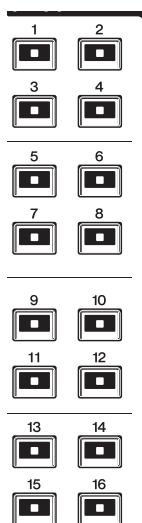

2. Press the same key of the SENDS ON FADER section once again.

The QL will switch to SENDS ON FADER mode. The key will change from lit to flashing, and the LEDs of the other keys in the SENDS ON FADER section will light. The faders in the Channel Strip section will change to indicate the send level of the signals that are routed from each channel to the currently selected MIX/MATRIX bus.

### NOTE

- If the function for switching between MIX 1–16 and MATRIX 1–8 is assigned to a USER DEFINED key, you can switch between the two areas.
- Alternatively, press a SEND LEVEL knob in the Selected Channel section to display the SELECTED CHANNEL VIEW window, from which you can select a MIX/MATRIX bus.
- You can also select a MIX/MATRIX bus by using the Bank Select key [MIX/MATRIX] in the Fader Bank section.
- If you press the currently selected MIX/MATRIX bus select button again, cue monitoring will be turned on for the related MIX/MATRIX channel. This method is convenient if you want to monitor the signal that is being sent to the selected MIX/MATRIX bus.

3. Press the Bank Select key in the Fader Bank section, including the input channel being operated, and use the fader to adjust the send level to the selected MIX/MATRIX bus.

4. Repeat steps 1–3 to adjust the send level for other MIX/MATRIX buses in the same way.
5. When you've finished setting the MIX/MATRIX send levels, press the key that is flashing in the SENDS ON FADER section.

The function access area display will return to its prior state, and the unit will return to normal mode.

### NOTE

You can also use the buttons in the function access area to switch and select buses.

- ① ON FADER switch button  
Pressing this button repeatedly will switch between MIX and MATRIX.
- ② MIX/MATRIX bus select buttons  
These buttons enable you to select the destination MIX/MATRIX buses. Two buses that are paired in stereo are represented by one button.



## Assigning a name

On the QL series, you can assign a name to each input channel, output channel, DCA group, and MUTE group, and assign a title to scene and library data when saving it.

To assign a name, you will use the keyboard window that is shown in the main area.

1. Call up the keyboard window (from a naming-relevant operation).

Below is an example of how to assign a name to a channel.

The box shows the characters you have entered and a cursor that indicates the current position.



## 2. Press the keyboard window in the touch screen to enter the desired characters.

While entering characters, you can use the following buttons in the keyboard window.

- **COPY button**  
Copies the string of characters that are selected (highlighted) in the text box.
- **CUT button**  
Deletes and copies the string of characters that are selected (highlighted) in the text box.
- **PASTE button**  
Inserts the string of characters copied by COPY or CUT at the cursor location (or overwrites the currently selected range of characters).
- **CLEAR button**  
Erases all characters that were entered in the text input box.
- **INS button**  
Inserts a space (blank) at the cursor position.
- **DEL button**  
Deletes the character at the right of the cursor (or the string of characters selected in the text box).
- **BS (Backspace) button**  
Deletes the character at the left of the cursor (or the string of characters selected in the text box).
- **TAB button**  
Switches to the next item that can be selected. For example in the SCENE STORE window you can use this button to switch between two text input boxes, and in the PATCH/NAME window you can use this to switch channels.
- **SHIFT LOCK button**  
Switches between uppercase and lowercase alphabetical characters. You can enter uppercase characters and symbols while this button is on, and lowercase characters and numerals while this button is off.
- **ENTER button**  
Finalizes the name you entered.

## 3. When you've entered the name, press the STORE button or the ENTER button.

The name you entered will be applied.

### NOTE

- The basic procedure is the same in the windows that let you assign names to channels or other types of library data. When you enter a name for a channel, your input will be reflected immediately without pressing the ENTER button.
- Press in the text entry box to move the input position. If you select a region of characters you've entered in the box and then enter a new character, the newly entered character will overwrite the selected region.

## Using libraries

You can use libraries to store (save) or recall (load) the settings of the currently selected channel (EQ/dynamics) or rack (GEQ/effect/premium rack). The method of operation is essentially the same for each library.

The following libraries are provided.

- Input channel library
- Output channel library
- Input EQ library
- Output EQ library
- Dynamics library
- GEQ library
- Effect library
- Dante input patch library
- Premium Rack library

### NOTE

Premium Rack library features a library for each Premium Rack type.

## ■ Recalling settings from a library

### 1. Access a window that contains tool buttons.

To select a display page: For a channel library, first display the SELECTED CHANNEL VIEW screen and then proceed to Step 3.

[SELECTED CHANNEL VIEW screen]

Press a knob in the Selected Channel section.





**[HPF/EQ screen]/[DYNAMICS 1/2 screen]**  
 In the SELECTED CHANNEL VIEW screen or the OVERVIEW screen, press any knob in the appropriate field for EQ or Dynamics 1/2. (In the SELECTED CHANNEL VIEW screen, press any knob twice; in the OVERVIEW screen, press the area once.)



- ① EQ field
- ② Dynamics 1/2 field

**[VIRTUAL RACK screen]**  
 In the VIRTUAL RACK window that appears when you press the RACK button in the function access area, press a rack container in which a GEQ/effect/Premium Rack is already mounted.



- ① RACK button
- ② RACK container

**2. Select the channel (EQ/dynamics) or rack (GEQ/effect/Premium Rack) for which you want to recall settings.**

The method of selecting a channel/rack will depend on the type of window that is currently displayed.

**[HPF/EQ window (1ch)]**

**[DYNAMICS 1/2 window (1ch)]**

Use the panel [SEL] keys or the channel select button in the function access area to select a channel.



**[HPF/EQ window (8ch)]**

**[DYNAMICS 1/2 window (8ch)]**

In addition to using the panel [SEL] keys or the channel select button in the function access area, you can also select a channel by pressing the channel number/channel name buttons in the window.



If you use the channel number/channel name buttons in the 8ch (8-channel) window, you can select multiple channels by selecting a region. In this case, the same library data will be recalled to all of the selected channels.

**[VIRTUAL RACK screen]**

Use the rack select tabs at the bottom of the window to select a rack.



**NOTE**

You cannot select a rack select tab of a rack in which no GEQ, effect, or Premium Rack is mounted.

**3. Press the LIBRARY button.**

The screen for the selected library appears.



**① CURRENT TYPE (Only for output channel library)**

This field displays the type of channel selected via the [SEL] key.

**② List**

This shows the settings that are saved in the library. The highlighted line indicates the data that is selected for operations. Read-only data is indicated by an "R" symbol.

**NOTE**

The right side of the list displays information regarding the relevant setting data (such as the type of output channels, dynamics type or effect type being used). The dynamics library also displays symbols indicating whether the data can be recalled into Dynamics 1 and/or Dynamics 2.

**4. Rotate the [TOUCH AND TURN] knob to move the highlight line up or down to select a library item you want to recall.**

In some cases, the data selected as the recall-source cannot be recalled into the currently selected channel/rack. Each library has the following limitations.

**• Channel library**

If the type of channel selected via the [SEL] key is different from the one selected in the list in the output channel library, "CONFLICT" appears to the right of CURRENT TYPE. You can recall the data even if "CONFLICT" appears, although the data would include different parameters. Parameters that do not exist in the library will be set to the default value.

**• Dynamics library**

The dynamics library contains three types of data: Dynamics 1 and Dynamics 2 for input channels, and Dynamics 1 for output channels. Recall is not possible if you've selected a type that is not supported by the corresponding dynamics processor.

**• GEQ library**

The GEQ library holds two types of data: 31BandGEQ or Flex15GEQ. You cannot recall the 31BandGEQ library data into the Flex15GEQ library if the data contains the gain settings for 16 or more bands.

**• Effect library**

Effect library items that use effect types "HQ.Pitch" or "Freeze" can be recalled only to effect racks 1, 3, 5 or 7. They cannot be recalled if any other rack is selected.

**5. Press the RECALL button.**

The selected data will be loaded into the channel (EQ/dynamics) or rack (GEQ/effect/Premium Rack) you selected in step 2.

**NOTE**

- If you recall channel library data to a channel that is linked to another channel, the link setting of the channel to which data was recalled will be canceled.
- If you select a library number that cannot be recalled, it will not be possible to press the RECALL button.

## ■ Storing settings in a library

1. Access a window that contains tool buttons.
2. Select the channel (EQ/dynamics) or rack (GEQ/effect/Premium Rack) whose settings you want to store.

### NOTE

You can select only one channel or rack as the source for storing. If multiple channels are selected in the dynamics or EQ window, you will not be able to perform the Store operation.

3. Press the **LIBRARY** button.  
The screen for the selected library appears.

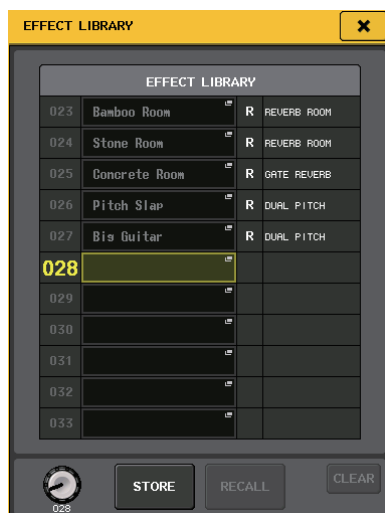

4. Turn the [TOUCH AND TURN] knob to select the store-destination library number.

### NOTE

You cannot store to a library number that contains read-only data (indicated by an R symbol).

5. When you've selected the store-destination, press the **STORE** button.  
The LIBRARY STORE window will appear, allowing you to assign a name to the data. For details on entering text, refer to "Assigning a name" (see page 23).
6. When you've assigned a title to the settings, press the **STORE** button in the keyboard window.  
A dialog box will ask you to confirm the Store operation.
7. Press the **OK** button to execute the Store operation.  
The current settings will be stored to the library number you selected in step 4. If you decide to cancel the Store operation, press the **CANCEL** button instead of the **OK** button.

### NOTE

- Even after you have stored the settings, you can edit the title of the settings by pressing the data title in the list to access the LIBRARY TITLE EDIT window. However, you can't edit the title of a read-only library item (indicated by an R symbol).

- Be aware that if you store settings to a location that already contains data, the existing data will be overwritten. (Read-only data cannot be overwritten.)

## ■ Erasing settings from a library

1. Access a window that contains tool buttons.
2. Press the **LIBRARY** button.  
The screen for the selected library appears.



3. Turn the [TOUCH AND TURN] knob to select the library number that you want to clear.

### NOTE

You can't clear read-only data (data indicated by an "R" symbol).

4. Press the **CLEAR** button.  
A dialog box will ask you to confirm the Clear operation.
5. Press the **OK** button to execute the Clear operation.  
The data you selected in step 3 will be cleared. If you decide to cancel the Clear operation, press the **CANCEL** button instead of the **OK** button.

## Initializing settings

Here's how you can return the EQ/dynamics settings of the currently selected channel or the effect settings of a rack to their initial state. GEQ settings can be initialized using the FLAT button in the screen.

1. Access a window that contains tool buttons.
2. Select the channel (EQ/dynamics) or rack (effect/Premium Rack) whose settings you want to initialize.
3. Press the DEFAULT button.  
A dialog box will ask you to confirm the Initialize operation.
4. Press the OK button to execute the Initialize operation.  
The EQ/dynamics settings of the channel you selected in step 2 or the effect/processor settings of the rack will be initialized. If you decide to cancel the initialization, press the CANCEL button instead of the OK button.

### NOTE

In the case of EQ/dynamics, you can use the channel number/channel name buttons in the 8ch/ALL window to select a range of channels and initialize them simultaneously.

## Copying and pasting settings

Here's how you can copy the EQ/dynamics settings of the currently selected channel or the GEQ/effect/premium rack settings of the currently selected rack to buffer memory, and then paste them to a different channel or rack. Copy/paste is limited to the following combinations.

- Between input channel EQ settings
- Between output channel EQ settings
- Between dynamics processors for which the paste-destination has the same type (GATE, DUCKING, COMPRESSOR, EXPANDER, COMPANDER-H, COMPANDER-S, or DE-ESSER) as the copy-source
- Between effects/GEQ mounted in a rack
- Between the same processors mounted in a premium rack

### NOTE

Only 31BandGEQ settings that use less than fifteen bands can be copied to a Flex15GEQ.

1. Access a window that contains tool buttons.
2. Select the channel (EQ/dynamics) or rack (GEQ/effect/premium rack) whose settings you want to copy.

3. Press the COPY button.

The current settings will be copied to buffer memory.

### NOTE

- Be aware that if you copy other settings before you paste, the buffer memory will be overwritten.
- You can select only one channel or rack as the copy-source. If multiple channels are selected in the 8ch/ALL window, you won't be able to press the COPY button.

4. Select the paste-destination channel or rack.

### NOTE

If you're pasting EQ/dynamics settings, you can use the 8ch/ALL window to select multiple channels as the paste-destination. In this case, the same content will be pasted to all selected channels.

5. Press the PASTE button.

The settings of the channel (EQ/dynamics) or the rack (GEQ/effect/premium rack) you selected in step 2 will be pasted.

### NOTE

- Be aware that when you paste, the settings will overwrite the paste-destination.
- If nothing has been copied to the buffer memory, the PASTE button cannot be used (is ghosted).
- Of the two types of GEQ, using the tool buttons in a rack where a Flex15GEQ is selected will cause rack settings A and B to be copied/pasted individually.
- You cannot paste effect settings that use effect types "HQ.Pitch" or "Freeze" to racks 2, 4, 6 or 8.

## Comparing two sets of settings

You can use the COMPARE button to switch between the settings copied to the buffer memory and the settings of the currently selected channel (EQ/dynamics) or rack (GEQ/effect/premium rack).

This is convenient when you want to copy an interim result of your editing, and then compare it with subsequent edits.

1. Access a window that contains tool buttons.
2. Select a channel (EQ/dynamics) or rack (GEQ/effect/premium rack).
3. Press the COPY button to copy the current settings to the buffer memory.

This will be the first version of your settings.

### NOTE

Be aware that if you copy other settings before you compare, the buffer memory will be overwritten.

4. Edit the settings of the currently selected channel (EQ/dynamics) or rack (GEQ/effect/premium rack).
- This will be the second version of your settings.

### NOTE

After you copy the first set of settings to the buffer memory, you can initialize the channel or rack and edit the second set of settings from an initialized (blank slate) state if desired.

5. To compare the first set of settings with the current settings (the second set), press the COMPARE button.

You will return to the first version of your settings. At this time, the second version of your settings will be copied to buffer memory.

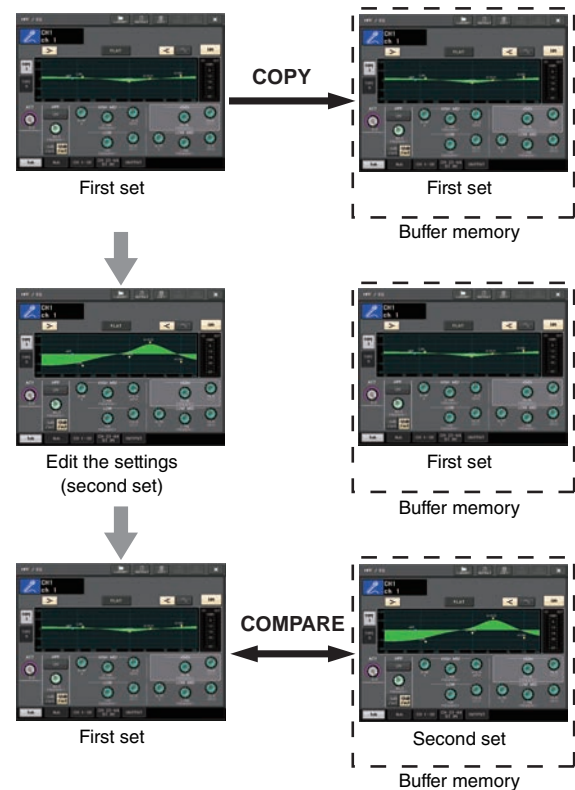

6. You can press the COMPARE button repeatedly to compare the first and second sets of settings.

Each time you press the COMPARE button, the current settings will be exchanged with the settings copied to the buffer memory. Unlike the Paste operation, this operation lets you return to the previous settings at any time as long as the buffer memory has not been overwritten.

### NOTE

- The settings copied to buffer memory can also be used by the Paste operation.
- If you operate the tool buttons for a rack in which Flex15GEQ (of the two types of GEQ) is selected, the rack's A and B settings will be individually exchanged with the buffer memory.

# Connection

## About network connections

### About Dante

This product features Dante technology as a protocol to transmit audio signals. Dante is a network protocol developed by Audinate. It is designed to deliver multi-channel audio signals at various sampling and bit rates, as well as device control signals over a Giga-bit Ethernet (GbE) network. Dante also offers the following benefits:

- It transmits up to 512 in/512 out, for a total 1024 channels (in theory) of audio over a GbE network. (The QL series features QL5: 64 in/64 out, QL1: 32 in/32 out with a 24/32-bit resolution.)
  - Dante-enabled devices will automatically configure their network interfaces and find each other on the network. You can label Dante devices and their audio channels with descriptive names that make sense to you.
  - Dante uses high accuracy network synchronization standards to achieve sample-accurate playback with extremely low latency and jitter. Five types of latency are offered by the QL series: 0.25 msec, 0.5 msec, 1.0 msec, 2.0 msec, and 5.0 msec.
  - A primary circuit and a secondary circuit provide redundancy in the event of a problem.
  - Connecting a Dante-enabled device to a computer using an Ethernet connection enables you to directly input or output audio signals without using any audio interface devices.
  - Audio can be transferred over distances up to 100 meters\* between devices using CAT5e network cables.
- \* Maximum practical distance may vary according to the cable used.

Visit the Audinate website for more details on Dante.

<http://www.audinate.com/>

More information on Dante is also posted on the Yamaha Pro Audio website:

<http://www.yamahaproaudio.com/>

#### NOTE

Please do not use the EEE function (\*) of network switches in a Dante network.

Although power management should be negotiated automatically in switches that support EEE, some switches do not perform the negotiation properly. This may cause EEE to be enabled in Dante networks when it is not appropriate, resulting in poor synchronization performance and occasional dropouts.

Therefore we strongly recommend that:

- If you use managed switches, ensure that they allow EEE to be disabled. Make sure that EEE is disabled on all ports used for real-time Dante traffic.
- If you use unmanaged switches, make sure to not use network switches that support the EEE function, since EEE operation cannot be disabled in these switches.

\* EEE (Energy Efficient Ethernet) is a technology that reduces switch power consumption during periods of low network traffic. It is also known as Green Ethernet and IEEE802.3az.

### About Dante Controller

Dante Controller is a software application that allows configuration and audio routing of Dante networks. Use this application if you wish to set up complicated signal routings on a Dante network. More information is posted on the following website.

<http://www.yamahaproaudio.com/>

## Connecting to I/O devices

This section explains how to connect the QL series to I/O devices (such as Rio3224-D) in a daisy chain network and in a star network (redundant network). Before connecting I/O devices, first perform "Setting up the Dante network" (see page 34) and then turn off the power to the QL series console.

### Daisy chain network

A daisy chain is a wiring scheme in which multiple devices are connected together in sequence. With this method, networking is simple and requires no network switches. This connection method is suitable for a simple system with a small number of devices.

However, if a large number of devices are connected in this way, the latency value must be increased. Also, if a connection is broken in a daisy chain network, the signal flow is interrupted at that point and no signal will be transferred beyond that point.

### ■ Connecting QL series consoles and I/O devices

Use the Dante connectors on the QL series console and I/O devices to connect them as follows.

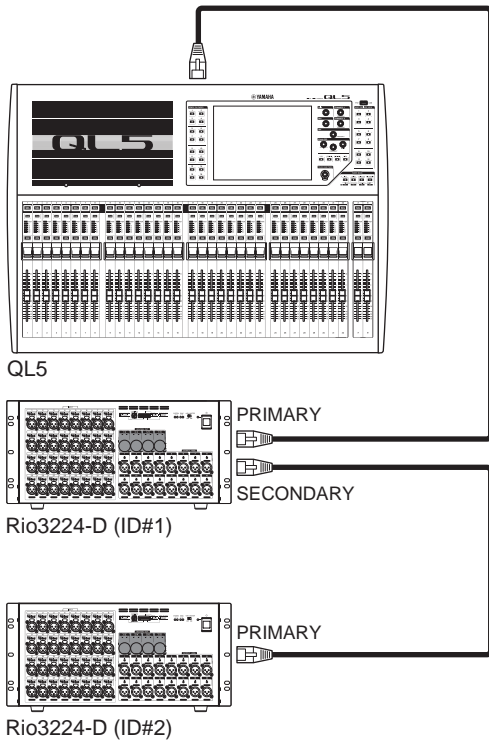

### ■ Setting rotary switches and DIP switches on the I/O devices

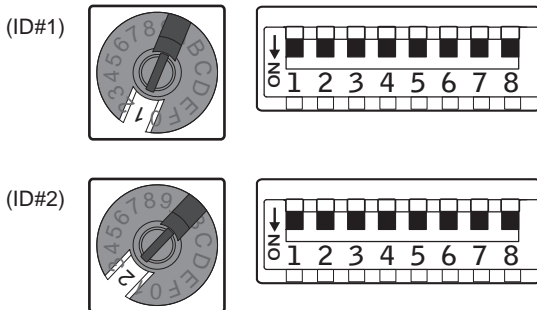

### Star network (redundant network)

In a star network, each device is connected to a central switch. Using a GbE-compatible network switch enables you to configure a wide-band, large-scale network. We recommend a network switch that gives you the ability to control and monitor the network (such as QoS, the ability to assign priority to data flows - e.g., clock synchronization or audio transmission on certain data circuits).

With this topology, it is common to configure a redundant network so that communication can continue without affecting the audio even if an unexpected network problem should occur.

#### About redundant networks

A redundant network consists of two circuits, a primary circuit and a secondary circuit. Normally, the network operates on the primary circuit. However, if the primary connection is broken, the secondary circuit will automatically take over communications. Therefore,

using a redundant network with a star topology is better for increasing communication stability compared to a daisy chain network.

### ■ Connecting QL series consoles and I/O devices

Use the Dante connectors on the QL series console and I/O devices to connect them as follows.

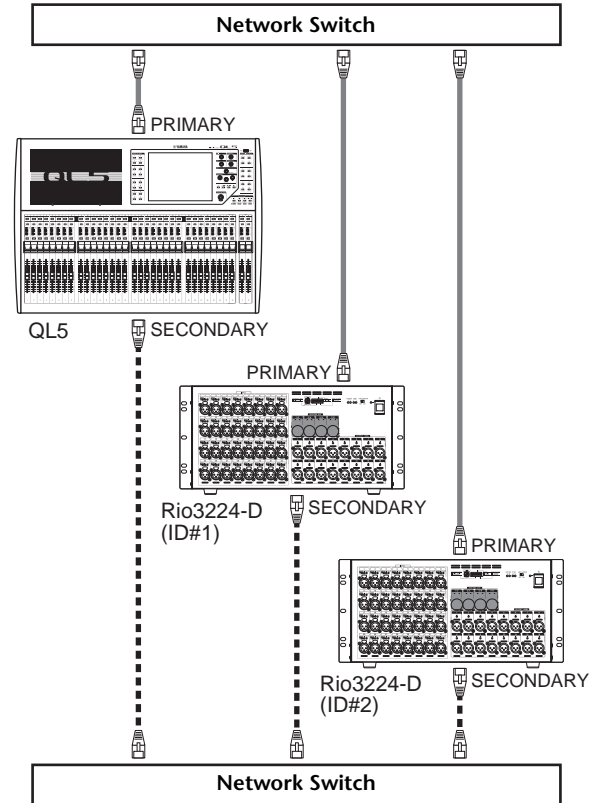

### ■ Setting rotary switches and DIP switches on the I/O devices

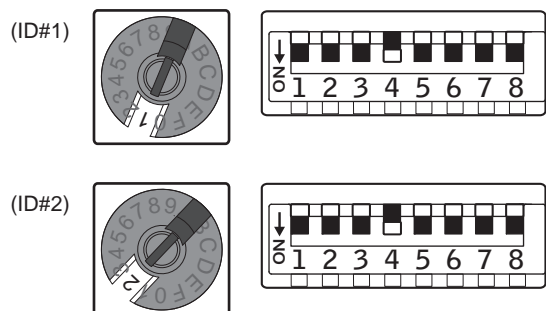

# Audio input/output connections

## Analog input connections

INPUT jacks on the console and I/O devices are used mainly to connect microphones or monaural line-level devices.

QL series

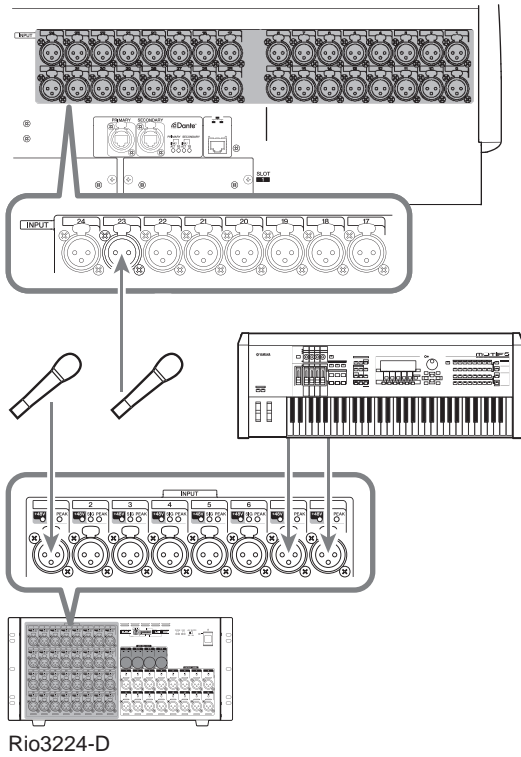

## Analog output connections

To the OMNI OUT jacks on the QL series and the OUTPUT jacks on I/O devices, you can patch the output signals from output channels [MIX, MATRIX, STEREO (L/R), MONO (C)], monitor signals (MONITOR OUT L/R/C channels), and the direct out signals of the input channels. For information about patches, refer to “Patching the mixer output to the I/O device” (see page 35) in the Quick Guide section.

The console’s front panel has a PHONES OUT jack for monitoring, and this jack always lets you monitor the signal that is selected as the monitoring source. By assigning the MONITOR OUT L/R/C channels to the desired output jacks, you can also monitor the same signal through external speakers.

QL series

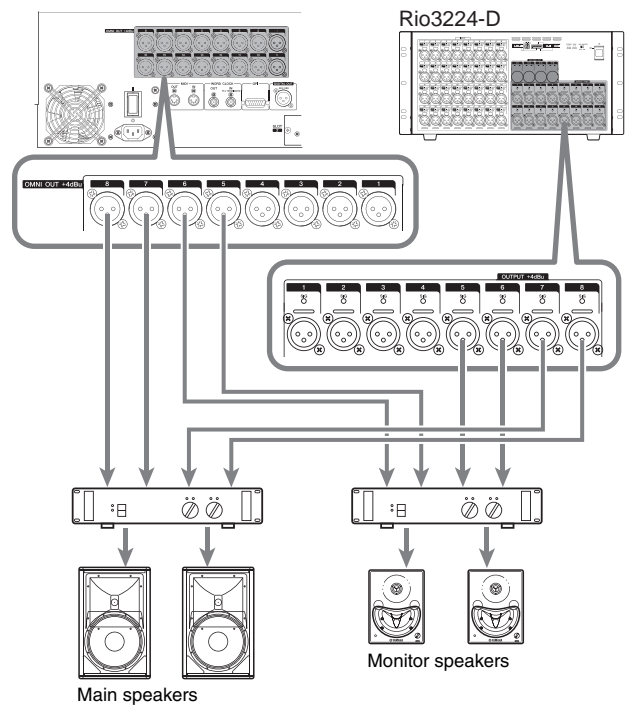



## Port-to-port function

The port-to-port function enables direct patching between input ports and output ports. With this function, the QL analog inputs and outputs can be directly routed to/from external Dante devices without passing through the mixing channels. If both a monitor console and I/O device are required on the side of a stage, a single QL series console can achieve both functions, reducing the necessary equipment. In addition, by setting the QL series as a remote I/O device as well as a monitor console, the FOH console can share and remotely control the head amps.

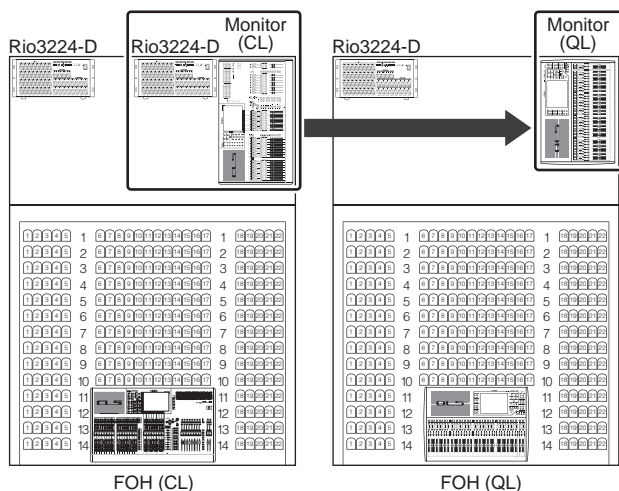

## Digital input/output connections

Use the DIGITAL OUT jack to send the QL's internal signals to an external digital audio device. When the QL is in the default state, the output signal of the STEREO channel is patched to the DIGITAL OUT jack, which enables you to record the main mix onto a CD recorder or other device.

You can connect this jack to the AES/EBU jack on an I/O device, such as Rio3224-D. Also, by installing separately sold mini-YGDAI I/O cards in slots 1–2, you can add input/output jacks to the QL or connect speaker processor units.

## Installing an optional card

Before you install I/O cards in slots 1–2, you must check the Yamaha website to determine whether the card is compatible with the QL series, and to verify the total number of Yamaha or third-party cards that can be installed in combination with that card.

<http://www.yamahaproaudio.com/>

Follow the steps below to install an optional mini-YGDAI card.

### 1. Make sure that the power is turned off.

#### ⚠ Caution

Before connecting a separately sold mini-YGDAI I/O card to the QL, make sure to turn off the power switch of the console's power supply. Otherwise, malfunctions or electric shock may occur.

### 2. Loosen the screws that fasten the slot, and remove the slot cover.

Keep the cover and fixing screws in a safe place for future use.

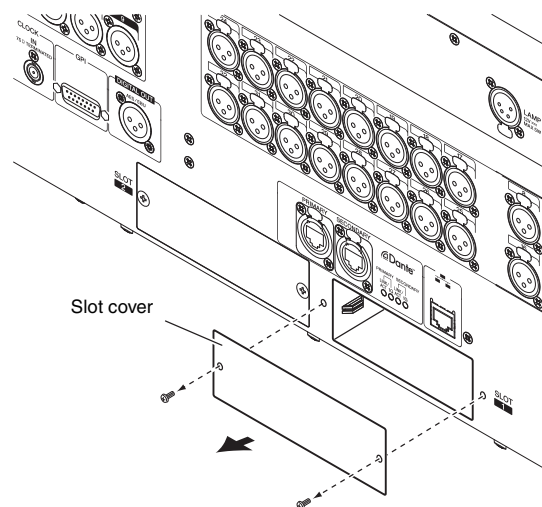

### 3. Align both edges of the card with the guide rails inside the slot, and insert the card into the slot.

Push the card all the way into the slot so that the connector at the end of the card is correctly inserted into the connector inside the slot.

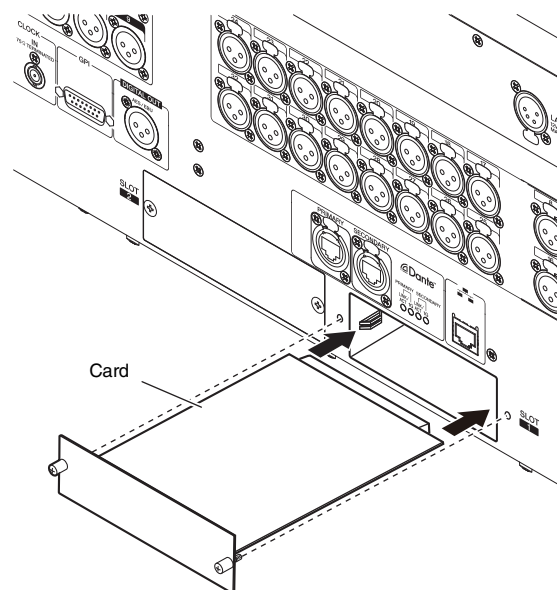

#### NOTE

When installing a card, carefully align both edges of the card with the guide rails in the slot of the device.

### 4. Fasten the card using the screws attached to the card.

Be aware that damage or malfunctions may occur if the card is not fastened.

# Quick Guide

This section explains the general procedures in a mixing work flow. The example below is based on a system in which one QL5, one I/O device, an amplifier and speakers are connected. If there are multiple methods to achieve the same result, this section describes the simplest method.

For details on the functions and their parameters, refer to the Reference Manual.

## Connecting the devices

### Setting up the Dante network

1. Press the **SETUP** button in the touch screen.



2. Press the **DANTE SETUP** button in the SETUP screen.

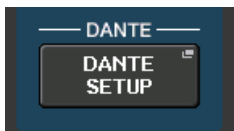

3. Press the **SETUP** tab in the lower part of the DANTE SETUP screen.



4. Set **CONSOLE ID** to #1, and **SECONDARY PORT** to **DAISY CHAIN**.



#### NOTE

Before changing the settings, first disconnect all connections with I/O devices. Otherwise, communication with I/O devices will not be performed correctly.

If changes have been made, press the **APPLY** button. When a confirmation dialog appears, press the **OK** button.



Wait approximately 30 seconds for the buttons that have been changed to switch from red to white for the settings to be applied.



5. Set **BIT** to 24, and **LATENCY** to 0.25.

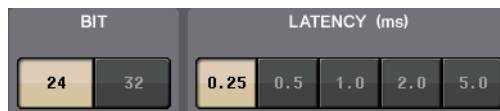

### Connecting an I/O device

1. Make sure that power to all devices to be connected is turned off. Then, use an Ethernet cable to connect the Dante **PRIMARY** connector on the QL to the Dante **PRIMARY** connector on the I/O device.

2. Set the ID of the I/O device.

#### NOTE

If there is one I/O device, set the I/O device's ID to "1."  
If you plan to use multiple devices, you must assign a unique ID number to each device.

3. Turn on the power in this order: 1) the I/O device, 2) the QL series, and 3) the amplifier.

4. Press the **SETUP** button, **DANTE SETUP** button, and **DEVICE MOUNT** tab in the touch screen.



5. Mount the I/O device.

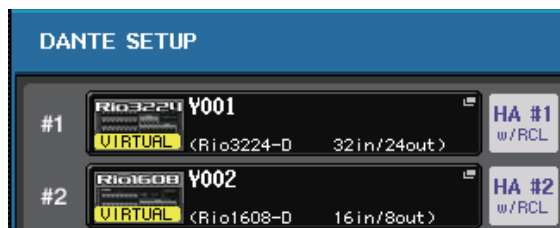

#### NOTE

I/O devices other than the Rio3224-D must be mounted. For more details, refer to the Reference Manual pdf document.

6. Connect a mic or instrument to the I/O device.

### Setting the word clock

1. Press the **SETUP** button and then **WORD CLOCK/SLOT SETUP** button in the touch screen.





2. Select **INT 48k** or **INT 44.1k**.





3. Press the **X** symbol to close the screen.

## Patching the input port

1. Press the I/O DEVICE button in the touch screen.
2. Press the DANTE PATCH tab in the upper part of the I/O DEVICE screen. 
3. Press the DANTE INPUT PATCH button in the I/O DEVICE screen. 
4. Press the AUTO SETUP button. 
5. When a confirmation dialog appears, press the OK button.
6. Press the X symbol to close the screen.

## Patching the mixer output to the I/O device

1. Press the I/O DEVICE button and then the Rio tab in the touch screen. 
2. Press the OUTPUT display of the I/O device that is the output destination. 
3. Press the OUTPUT1 button in the OUTPUT PATCH screen. 
4. In PORT SELECT, select the output channels you want to output to the rack.

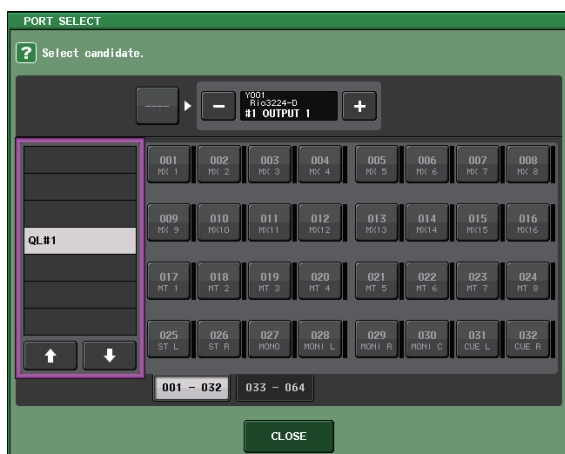

5. Press the CLOSE button.
6. In the same way, set OUTPUT 2 and subsequent outputs, if necessary.

## Setting the input channels

### Phantom power on/off

1. Press the [SEL] key for the channel that you want to adjust in the Channel Strip section.
2. Press the GAIN knob in the SELECTED CHANNEL VIEW screen.



3. For the microphone to be used, press the +48V button in the GAIN/PATCH popup window, if necessary.

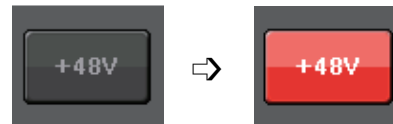

### NOTE

- The phantom power master switch on the I/O device must be turned on first.
- Make sure that phantom power is turned OFF unless it is needed.
- When turning phantom power ON, make sure that no equipment other than phantom-powered devices such as condenser microphones are connected to the corresponding INPUT connectors. Applying phantom power to a device that does not require phantom power can damage the connected device.
- Do not connect or disconnect a device to an INPUT while phantom power is applied. Doing so can damage the connected device and/or the unit itself.
- To prevent possible damage to speakers, make sure that power amplifiers and/or powered speakers are turned OFF when switching phantom power ON or OFF. We also recommend setting all digital mixing console output controls to minimum when turning phantom power ON or OFF. Sudden high level peaks caused by the switching operation can damage equipment as well as the hearing of those present.

### Adjusting the analog gain

1. Press the [SEL] key for the channel that you want to adjust in the Channel Strip section.
2. Press the [CUE] key of the same channel.
3. While checking the sound level through the headphones and meters, adjust the channel [GAIN] knob of the Selected Channel section.

### NOTE

Adjust the gain level as high as possible without allowing the OVER segment of the channel strip level meter to light at the highest input level.

- Adjust the gain level for other channels in the same way, by pressing their [SEL] and [CUE] keys, and then rotating the [GAIN] knobs.
- After adjustment is complete, switch the [CUE] key off (the key LED turns off).

## Sending an input channel signal to the STEREO bus

- Press the [SEL] key of the input channel you want to control.
- Press one of the knobs in the Selected Channel section, to return to the SELECTED CHANNEL VIEW screen.
- In the TO ST PAN/BALANCE field, press the ST button to turn it on (lights in pink).
- In the top panel, press the [ON] key of the corresponding input channel to turn it on.
- In the Master section, turn on the [ON] key of the STEREO channel, and raise the STEREO channel fader to 0dB.
- Raise the fader of the currently selected input channel to an appropriate volume.

In this state, you should hear sound from the speaker system patched to the STEREO channel. If you don't hear sound, check whether the L/R meters are moving in the METER field of the function access area.

**If the L/R meters are moving:**  
It may be that the STEREO channel is not correctly patched to the output jacks that are connected to your speaker system. Check the output port patching.

**If the L/R meters are not moving:**

Make sure that signals are being routed correctly to the patched input channels.

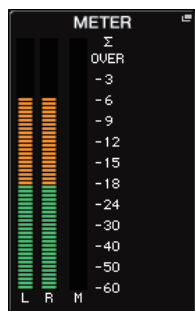

- To adjust the pan/balance of the signal sent from the input channel to the STEREO bus, rotate the [PAN] knob of the Selected Channel section.

## Applying EQ/dynamics

### Applying EQ

- Press the [SEL] key of the channel that you want to control.
- Press any one of the knobs in the Selected Channel section, to return to the SELECTED CHANNEL VIEW screen.
- Adjust EQ of the EQ parameter field in the Selected Channel section.
- To make fine adjustments to EQ settings, press the EQ parameter field in the touch screen.



- Edit the EQ type and filter type in the HPF/EQ window.



## Applying dynamics

1. Press the [SEL] key of the channel that you want to control.
2. Press any one of the knobs in the Selected Channel section, to return to the SELECTED CHANNEL VIEW screen.
3. Press the ON button for DYNAMICS 1 in the touch screen.



4. Press any one of the DYNAMICS 1 knobs twice.
5. Edit the dynamics type and parameters in the DYNAMICS window.  
Use the [TOUCH AND TURN] knob to operate the parameters.

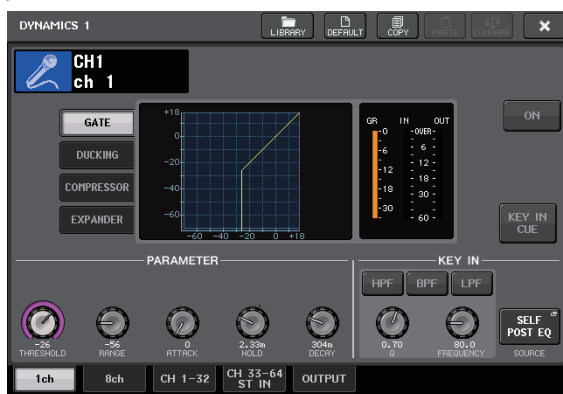

6. Edit the DYNAMICS 2 parameters in the same way.

## Setting the output channels

1. Use the Bank Select key of the Fader Bank section to select the output channel bank.
2. Press the [SEL] key for the output channel that you want to operate in the Channel Strip section.
3. Press any one of the knobs in the Selected Channel section.
4. Edit the EQ and dynamics parameters in the same way as for the input channels.

## Using GEQ

1. Press the RACK button in the touch screen.



2. Press the GEQ tab.



3. Press the INPUT PATCH button for GEQ1.



4. Select an input source in the left column of the CH SELECT window, and then select a channel in the right column.



5. Press the CLOSE button.
6. Press the corresponding GEQ rack container to open the GEQ EDIT screen.

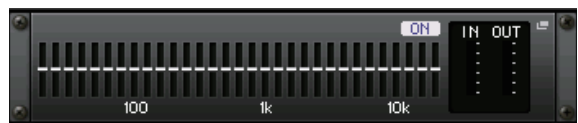

7. Press the FADER ASSIGN button.
8. Adjust using the faders.  
(For QL1, press the FADER ASSIGN field to select the region to operate.)
9. Perform the same operations for other GEQs as desired.

### NOTE

The graphic EQ of the GEQ rack is for output channels. To use GEQ for input channels, mount a graphic EQ in the EFFECT RACK.

## Using Automixer

1. Press the RACK button in the touch screen.
2. Press the GEQ tab.
3. Press the rack mount button in the VIRTUAL RACK screen.



4. Press the 8ch Automixer button in the RACK MOUNTER screen.



5. Press the INPUT PATCH button for GEQ1.
6. Select an input source in the left column of the CH SELECT window, and then select a channel in the right column.
7. Press any one of the knobs in the Selected Channel section, to return to the SELECTED CHANNEL VIEW screen.
8. Press a [SEL] key on the top panel to select a channel.
9. Press the popup button in the INSERT field in the SELECTED CHANNEL VIEW screen.



10. Press the INSERT field farthest to the right for the post fader in the INSERT/DIRECT OUT 1ch screen.

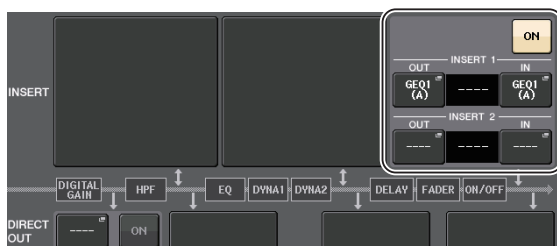

11. Repeat steps 5 to 10 to set 8 channels.
12. Press the RACK button.

13. Press the rack container in which you mounted Automixer.
14. Making sure no one is speaking into any microphones, adjust the head amp gain (or fader) until the level indicator remains green.
15. If necessary, operate the weight control to adjust uniform sensitivity between input channels.

## Applying effects

### Using EFFECT RACK with send/return

1. Press the RACK button in the touch screen.



2. Press the EFFECT tab.



3. Modify the INPUT CH/OUTPUT CH patch settings, if necessary.



4. Press the center rack container to open the EFFECT EDIT screen.



5. Press the effect type field.



- Select an effect you want to use from the EFFECT TYPE window.

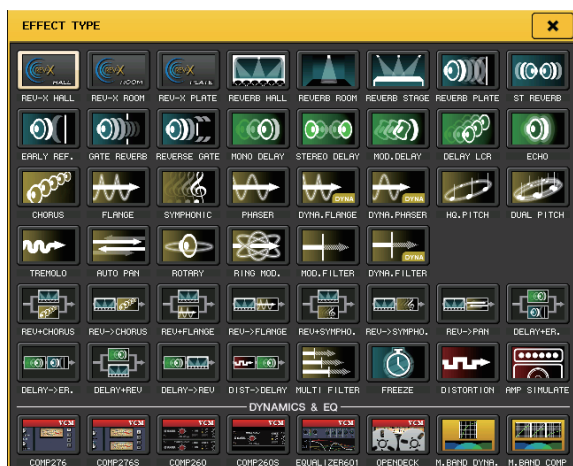

- In the Fader Bank section, press the Bank Select key for the Effect Send channel selected in step 3.
- Press the [SEL] key for the channel used for Effect Send in the Channel Strip section.
- Use the faders to control effect sends.
- In the Fader Bank section, press the Bank Select key for the Effect Return channel selected in step 3
- Press the [SEL] key for the channel used for Effect Return in the Channel Strip section.
- Adjust the effect return level using the fader.
- If necessary, press the RACK button, then the rack container in the EFFECT tab, and then set the effect parameters as desired.



## Inserting PREMIUM RACK processors

- Press the RACK button in the touch screen.



- Press the PREMIUM tab.



- Press the rack icon in the middle to open the PREMIUM RACK MOUNTER window.



- Select a processor you want to use from the MODULE SELECT area, then press the OK button.

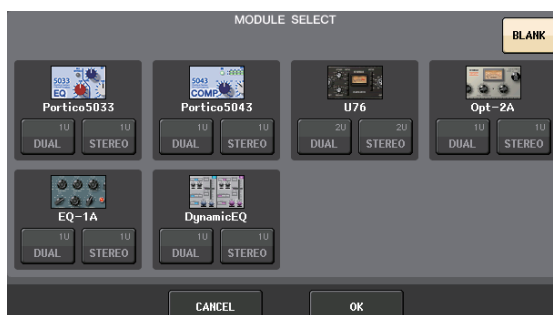

- Press the INPUT PATCH button.



- Select an input source in the left column of the CH SELECT window, and then select a channel in the right column.

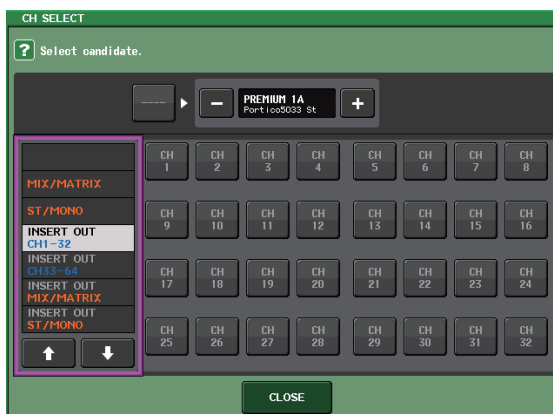

- Press the CLOSE button.

8. In the Channel Strip section, select the bank that includes the channel for the premium rack you want to use.
9. Press the [SEL] key of the channel for the premium rack you want to use.
10. Press the RACK EDIT button in the INSERT field in the SELECTED CHANNEL VIEW screen.



11. Adjust the parameters in the PREMIUM RACK window.

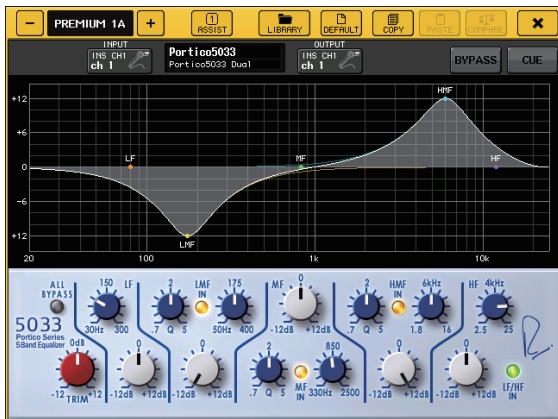

## Changing the patch settings

### Setting up INSERT or DIRECT OUT

1. Select the bank that contains the channel for which you want to set up INSERT or DIRECT OUT in the Channel Strip section.
2. Press the [SEL] key of the channel for which you want to change the patching.
3. Press the popup button in the DIRECT OUT field in the SELECTED CHANNEL VIEW screen.



4. Assign OUT and IN for INSERT or DIRECT OUT.

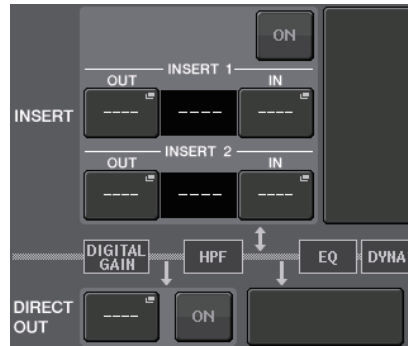

5. Press the ON button to enable it.



6. Modify the INSERT or DIRECT OUT point by pressing it, if necessary.

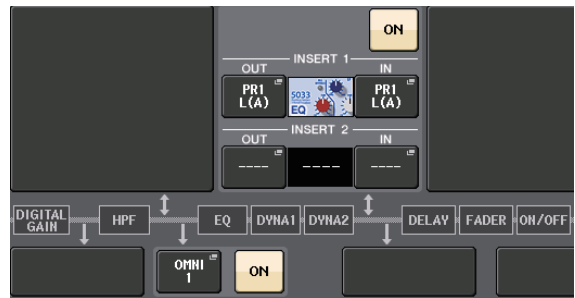

### Changing the signal output to each output port

1. Press the SETUP button in the touch screen.



2. Press the OUTPUT PORT button in SYSTEM SETUP.

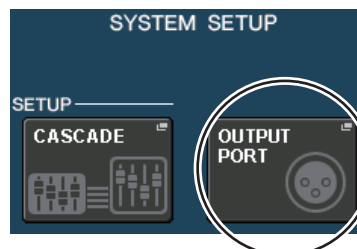

3. Select the OUTPUT PORT tab you want to change.





4. Press the output channel select button to select the output channel for which you want to change the port.



## Grouping and linking

### Creating a channel link

1. Press the CH JOB button in the touch screen.



2. Press the CH LINK button.



3. Select the bank that contains the channels you want to link in the Channel Strip section.
4. While pressing and holding down the [SEL] key of one channel, press the [SEL] key of the other channel that you want to link.
5. To release the link, press and hold down the [SEL] key for one of the linked channels, and press the [SEL] key for the other channel.

**NOTE**

You can also set or release a channel link in the display.

### Setting a DCA or MUTE group

1. Press the [SEL] key of the channel that you want to control.

2. Press the DCA tab or MUTE tab in the SELECTED CHANNEL VIEW screen.



3. Press a group number button.

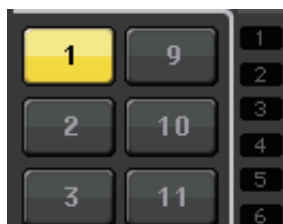

4. To assign other channels to a group, select the channel, then press DCA or MUTE group numbers in the same way.

## Using talkback

1. Plug the microphone to use for talkback into the INPUT jack on the rear panel.

2. Press the MONITOR button in the touch screen.



3. Press the TALKBACK ASSIGN field in the TALKBACK area.

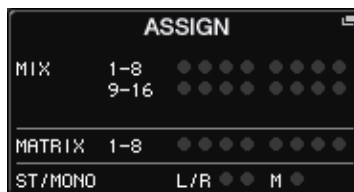

4. In the ASSIGN field in the TALKBACK screen, select a bus to which you want to send the talkback signal.

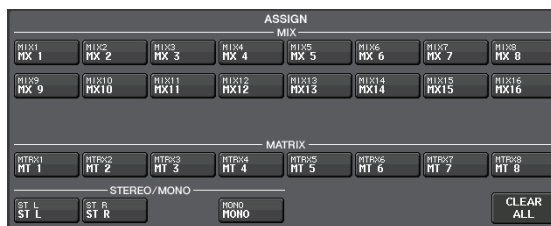

5. Press the TALKBACK ON button.



6. Press the INPUT TO TALKBACK button to select an input. Press the A.GAIN knob to enable it, then, while observing the meter, use the knob to adjust the level.



## Routing the oscillator to an output channel

1. Press the MONITOR button in the touch screen.



2. Press the OSCILLATOR display button.



3. Set the MODE, LEVEL, and FREQ (frequency) parameters in the OSCILLATOR screen.



4. Press the desired OUTPUT tab to select the output destination.

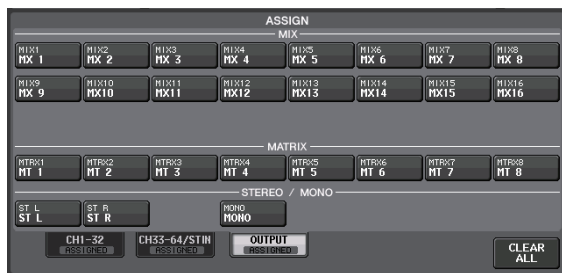

5. Return to the previous screen, then press the OUTPUT button in the OSCILLATOR field.



## Using scene memories

### Storing a scene

1. Press the SCENE field in the function access area.



2. Turn the [TOUCH AND TURN] knob to select the store-destination scene number.

3. Press the STORE button in the SCENE LIST screen.



4. Enter the scene name and comments in the SCENE STORE screen.

5. Press the STORE button in the SCENE STORE screen.



6. Press the OK button in the STORE CONFIRMATION dialog box to execute the Store operation.

### Recalling a scene

1. Press the SCENE field in the function access area.

2. Turn the [TOUCH AND TURN] knob to select the scene number to recall.

3. Press the RECALL button in the SCENE LIST screen.



#### NOTE

Scene 000 is a read-only scene that restores the mix parameters to their default state. Be aware that when scene number 000 is recalled, the input patch, output patch, internal effect, and HA (Head Amp) settings will also return to their default state.

## Recording and playing audio using a USB flash drive

### Recording to USB flash drive

1. Connect a USB flash drive to the USB connector of the QL unit.
2. Press the RECORDER button in the touch screen.

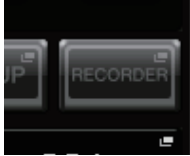

3. Press the USB tab.



4. Press the REC RATE button to switch the recording bit rate for an MP3 file.

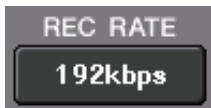

5. In the RECORDER INPUT area, select a recording source channel and set the recording level.



6. Press the REC button to arm recording.

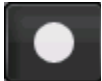

7. Press the PLAY button to start recording.



8. When you have finished recording, press the STOP button.



### Playing audio files from a USB flash drive

1. Connect a USB flash drive that contains audio files to the QL unit.
2. Press the RECORDER button in the touch screen.



3. In the PLAYBACK OUT area, select a channel from which you want to play audio files.



4. Select an audio file to play from the list.

NO.	FILE NAME	ARTIST	TIME
	[SONG]		
001	SONG001.MP3	Artist	00:00:13
002	SONG002.MP3	Artist	00:00:07

5. Press the Play button.



6. Adjust the gain using the PLAYBACK OUT GAIN knob, then in the Channel Strip section use the faders for the channels selected in the PLAYBACK OUT area to adjust the volume level.

## Saving and loading the unit settings

### Saving the unit settings to a USB flash drive

1. Connect a USB flash drive to the USB connector of the QL unit.
2. Press the SETUP button in the touch screen.



3. Press the SAVE/LOAD button.

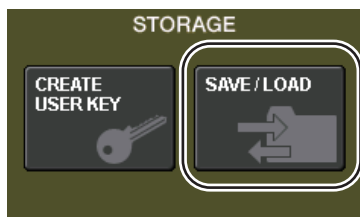

4. If necessary, press the directory icon and change the directory.

To move to the next higher level, press the arrow button in the PATH field.

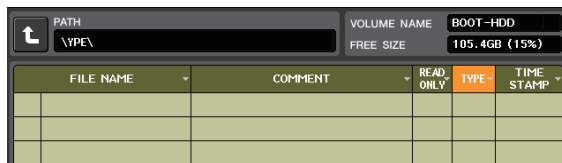

5. Press the SAVE button.



6. In the SAVE SELECT screen, select the data to be saved, the data type, and the save destination, and then press the SAVE button.



7. Enter the data name and comments, then press the SAVE button.

### Loading the unit settings from a USB flash drive

1. Press the SETUP button in the touch screen.
2. Press the SAVE/LOAD button.
3. To select the file that you want to load, press the name of the desired file in the file list, or rotate the [TOUCH AND TURN] knob.
4. Press the LOAD button.
5. In the LOAD SELECT screen, select the data to load, the data type, and the load destination.



6. Press the LOAD button to load the selected file.

### Formatting a USB flash drive on the QL unit

1. Connect a USB flash drive (that you want to format) to the QL unit.
2. In the SAVE/LOAD screen, press the FORMAT button.
3. Enter a name in the VOLUME NAME field, and then press the FORMAT button.
4. When a confirmation dialog appears, press the OK button.

# Other functions

## Adjusting the brightness of the touch screen, lamps, and other indicators

This operation lets you adjust the brightness of the touch screen, top panel LEDs, channel name displays, and lamps connected to the rear panel LAMP connectors.

1. In the function access area, press the **SETUP** button.
2. In the field located in the bottom row of the **SETUP** screen, press the **BANK A** or **BANK B** button.  
You can save two different brightness settings in bank A and B, and switch between them if desired.



3. Use the [TOUCH AND TURN] knob to set the following parameters.

### CONTRAST field

- **NAME**  
This knob adjusts the contrast of the characters of the channel name displays on the top panel.

### BRIGHTNESS field

- **NAME**  
This knob adjusts the brightness of the channel name displays on the top panel.
- **CH COLOR**  
This knob sets the brightness balance of the channel color indicator and the channel name display on the top panel.
- **SCREEN**  
This knob adjusts the brightness of the touch screen.  
If you have set the brightness to lower than level 2, the QL will start up next time with a brightness setting of 2 so that you will be able to see the screen.
- **PANEL**  
This knob adjusts the brightness of the top panel LEDs.
- **LAMP**  
This knob adjusts the brightness of the lamps connected to the rear panel LAMP jacks.

4. If desired, switch between banks A/B and make settings for the other bank in the same way.  
Now you can switch between the BANK A and BANK B buttons to change the brightness of the touch screen, LCD, channel name displays, and lamps in a single operation. You can also assign this parameter to a USER DEFINED key (see the Reference Manual), and press that key to switch between banks A and B.

## Setting the date and time of the internal clock

This section explains how to set the date and time of the clock built into the QL unit, and how to select a date and time display format. The date and time you specify here are used for the time stamp used when saving a scene.

1. In the function access area, press the **SETUP** button.
2. Press the **DATE/TIME** button at the lower part of the **SETUP** screen.  
The **DATE/TIME** display appears.

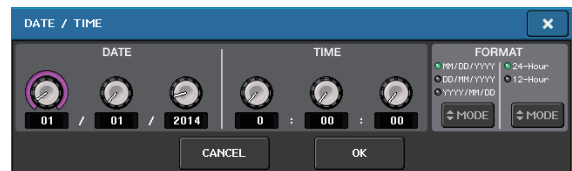

- **DATE**  
This field specifies the date of the internal clock.
  - **TIME**  
This field specifies the time of the internal clock.
  - **DISPLAY FORMAT**  
This field specifies the format in which the date and time of the internal clock are displayed.  
**Date**  
MM/DD/YYYY (Month/Day/Year)  
DD/MM/YYYY (Day/Month/Year)  
YYYY/MM/DD (Year/Month/Day)  
**Time**  
24Hours (hours shown in the range of 0–23)  
12Hours (hours shown from 0am–11 am, and 0pm–11pm)
3. In the **FORMAT** field, press the **MODE** buttons several times to select the desired format for date and time display.
  4. Use the [TOUCH AND TURN] knob to set the current date and time.
  5. When you have finished making settings, press the **OK** button.  
The date, time, and display format you specified will be finalized, and the window will close. If you press the **CANCEL** button or the **X** symbol instead of the **OK** button, your changes will be discarded and the window will close.

## Initializing the unit to factory default settings

If an error occurs in the QL's internal memory, or if you forget the password and cannot operate the unit, you can use the following procedure to initialize the internal memory. Use caution when performing the following steps.

### NOTICE

When you initialize the internal memory, all content that had been saved in memory will be lost.

1. Press and hold the [SEL] key for Fader B in the Master section on the panel while turning the power on.

After the opening screen, the startup menu screen will appear.

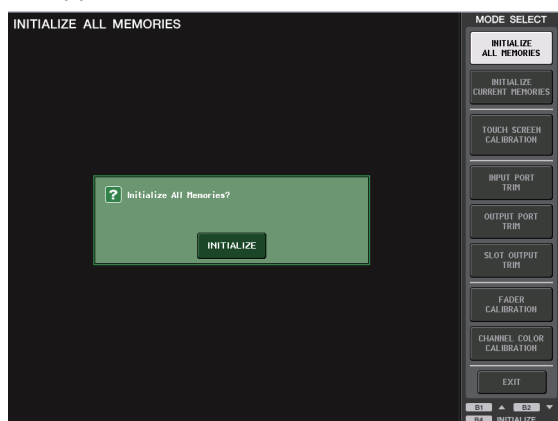

2. On the startup menu screen, select the initialization method.
  - **INITIALIZE ALL MEMORIES**  
The entire memory including scene memories and libraries will be returned to their initial settings, except DANTE SETUP.
  - **INITIALIZE CURRENT MEMORIES**  
The entire memory, excluding scene memories and libraries, will be returned to its initial settings, except DANTE SETUP.
3. Press the INITIALIZE button in the dialog box to confirm initialization.
4. Press the OK button in the confirmation dialog box.  
The Initialization operation starts.

### NOTE

Do not press any buttons until initialization is complete.

5. A message indicates that the initialization process is complete. Press the EXIT button.  
The console will start up in normal operating mode.

### NOTE

Alternatively, you can continue operation by selecting a different menu instead of pressing the EXIT button.

## Adjusting the faders (Calibration function)

Depending on the environment in which you use the console, discrepancies may occur in the motion of the motor faders. You can use the Calibration function to correct these discrepancies. With this operation, the specified faders in the channel strip section and Master section will be semi-automatically calibrated.

### NOTE

For information about adjusting the input gain or the detection point of the touch screen, refer to the Reference Manual.

1. Press and hold the [SEL] key for Fader B in the Master section on the panel while turning the power on.

After the opening screen, the startup menu screen will appear.

This window will also appear if a problem is detected in the fader settings while the QL is starting up.

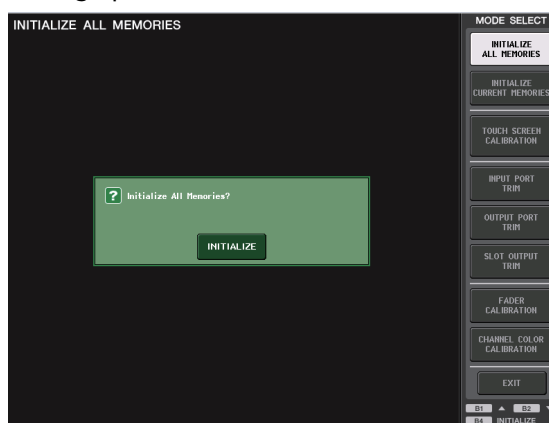

2. Press the FADER CALIBRATION button.  
The FADER CALIBRATION MODE screen will appear, where you can adjust the faders.
3. Press a [SEL] key to specify the faders that you want to calibrate.  
Faders for which a problem was detected at start-up will already be selected.
4. Press the START button.
5. Press the OK button in the dialog box.  
The fader specified in step 3 moves to  $-\infty$  (all the way down).
6. If the fader position is not correct, move it manually to  $-\infty$  (all the way down).
7. After you adjust the fader position, press the [NEXT] button.  
The process will proceed to the next fader position.

- 8. Repeat steps 6 to 7 to adjust the fader position to 20dB, 0dB, and +10dB (all the way up), in order.**

When adjustment to the +10dB position is complete, calibration starts.

- 9. When calibration has been completed, press the APPLY button.**

The calibration settings will be saved in internal memory. If the RESTART button appears, calibration has failed. Press the RESTART button to execute calibration once again.

- 10. Press the EXIT button.**

The console will start up in normal operating mode.

**NOTE**

Alternatively, you can continue operation by selecting a different menu instead of pressing the EXIT button.

# Troubleshooting

A FAQ section is available on the Yamaha Pro Audio site.  
<http://www.yamahaproaudio.com/>

## Power does not turn on; panel LEDs and the LCD display do not light.

- Is the QL's power switch turned on?
- Is the power cable connected to a proper AC outlet?
- Is the power cable plug inserted all the way - has it clicked and locked in securely?
- ➔ **If the power still does not turn on, contact your Yamaha dealer.**

## The unit is not receiving an input signal.

- Did you correctly set the UNIT ID and the DIP switches on the I/O device connected to the QL before turning on the power to the devices?
- Is the DANTE SETUP for the unit appropriate?
- Are the source devices delivering an appropriate signal?
- Is the SIG indicator on the I/O device lit?
- If a phantom-powered microphone is connected to the QL unit, are the I/O device's +48V MASTER switch, QL's +48V MASTER ON/OFF switch, and +48V button of each channel set to on?
- Is the GAIN of the internal head amp, external head amp, or I/O device set to an appropriate level?
- Is the input port patched to an input channel?
- Is the [ON] key indicator of the input channel lit?
- Is the fader of the input channel raised?
- Are EQ's attenuators raised?
- Could the insert be turned on even though it has not been specified correctly?
- If you are using an optional I/O card, is it installed correctly?

## Sound is not output from headphones or the MONITOR OUT jacks.

- Is the [PHONES] knob or monitor level set to an appropriate volume?
- Is the monitor fader set to an appropriate level?
- Has the monitoring source been selected?
- Could the DIMMER be applied?
- ➔ **Press the MONITOR button, then check the MONITOR area on the display.**

## The sound level is too low.

- Is the GAIN or digital gain on the head amplifier, external head amp device or I/O device set to an appropriate level?
- Is the fader of the input channel raised?
- Could the EQ gain be turned down excessively?
- Are EQ's attenuators raised?
- Could the GATE/COMP threshold or ratio setting be set to an extreme value?
- Is the fader of the output channel raised?
- Try using the various screens of the METER function to check the levels.

- Is the DCA fader assigned to that channel raised?
- Could MUTE MASTER be turned on for the channel assigned to a MUTE group?

## Sound is distorted.

- Is the word clock set correctly?
- Is the GAIN of the internal head amp, external head amp, or I/O device set to an appropriate level?
- Was Gain Compensation turned on when analog gain is not appropriate? Or, was the analog gain raised to an extreme while the Gain Compensation is turned on?
- ➔ **First turn the Gain Compensation function off, set the analog gain to an appropriate level, and then turn Gain Compensation back on.**
- Could the digital gain be set to an extremely high setting?
- Could the fader of the input channel be raised too high?
- Could the STEREO channel fader be raised too high?
- Could the EQ gain be set to an extremely high setting?
- Is the latency set too low on the DANTE SETUP screen?

## Sound is output even though it is not patched to an output channel.

- Could you have assigned an input channel to direct out?
- Could you have assigned an output channel as the insert out?

## The volume of a specific channel rises and falls.

- Could DYNAMICS 1/2 be set to ducking or to an extreme parameter value?

## Operating a fader does not control the level as you expect.

- Could the function access area indicate MIX/MTRX ON FADER? And could SENDS ON FADER mode be engaged?

## Only the sound of a specific channel is heard from the MONITOR OUT or PHONES jack.

- Could a [CUE] key be on?

## Noise occurs from an externally connected recorder or other device.

- Is the word clock set correctly?
- Could the input signal be unsynchronized?
- Could the oscillator or talkback be turned on?

## High frequency range is attenuated.

- Could emphasis be applied? This problem will occur if the input signal status does not match the emphasis data.
- Could EQ be applied?



### **There is insufficient headroom, especially when EQ boost is applied.**

- Use the EQ attenuator function to lower the level.

### **An input signal is being input, but there is no monitor output.**

- Could the DIMMER be applied?
- Could the MONITOR CH be assigned even though its output port has not been connected to an external device?

### **Signal is delayed.**

- Check whether the delay setting for each INPUT channel and OUTPUT PORT is set correctly.

### **Rotating a MIX knob does not change the send level to the MIX bus.**

- Is the TO MIX SEND ON/OFF button turned on?
- Is the MIX [ON] key turned on?
- Is the MIX bus set to VARI type?
- If the send point is set to POST, could the fader have been lowered?

### **Cannot save scene memory or various library data.**

- Are you attempting to save the data to a read-only scene/library or a protected scene?
- Could user level restrictions have been specified?

### **Cannot save to a USB flash drive.**

- Could the USB flash drive be protected?
- Does the USB flash drive have enough free capacity to save the data?
- When formatting the USB flash drive, format it in FAT32 or FAT16 format.
- Could the recorder be playing back?

### **Cannot transmit or receive MIDI data.**

- Is the MIDI PORT selected correctly?
- Are the transmission and reception modes and channels selected correctly?
- Has an event corresponding to the particular Program Change message been specified?

### **When you recall a scene, some channels/parameters are not updated.**

- Could that channel or parameter be set to Recall Safe?
- Could FOCUS be set in such a way that the channels or parameters will not be updated?
- Could user level restrictions have been specified?

### **You turn on a CUE button in the EFFECT EDIT screen, but it is automatically defeated.**

- This is defeated automatically when you switch screens in the display.

### **When you recall a scene, it takes a certain amount of time for the faders to stop.**

- Could you have specified a fade time?

### **The panel LEDs or LCD display are too dark/too bright.**

- This can be adjusted in the SETUP screen.

### **Signal level of a specific frequency is low.**

- Could the EQ gain be turned down excessively?
- Routing a signal through a GEQ or EFFECT will delay it relative to other signals. If this signal is mixed with another signal that is routed via a different signal path, a comb filtering effect will cause the level of a specific frequency to be decreased.

### **Cannot control an I/O device.**

- Are the rotary switch and DIP switches on the I/O devices set correctly?
- Does the channel being controlled match the channel on the I/O device?

### **Cannot control the QL unit from QL Editor.**

- Is the computer connected to the unit's Network jack correctly?
- Is the network setting on the QL unit specified correctly?
- For details on settings, refer to the QL Editor installation guide posted on our website.

### **Cannot control the QL unit from StageMix.**

- Is the WiFi setting in QL StageMix set correctly?
- Is the unit's Network jack on the QL unit connected to the WiFi access point correctly?
- Is the network setting on the QL unit specified correctly?
- Refer to the QL StageMix Owner's Manual on our website.

### **In the LCD display, there are some black points (unlit) or white points (always lit).**

- Unfortunately, this is a common characteristic of TFT-LCDs. This is not a malfunction.

### **In the channel name display, because of the response speed of the GR meter display on each channel's voice input and output, the indication may be weak or different than expected.**

- This is a common characteristic of LCDs and not a malfunction. Depending on the input source, this phenomenon may be more pronounced.

# Attaching the RK1 rackmount kit (sold separately)

You can attach the optional RK-1 rackmount kit to the QL5 and QL1 and mount it in a rack or an installed system.

1. Make sure that the power is turned off.
2. Remove screws "A" and detach the side pads.

**NOTE**

Keep the side pad screws together with the pads you removed.

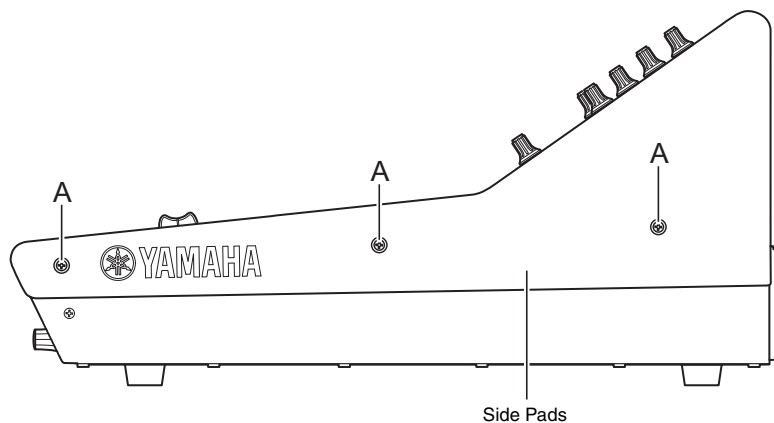

3. Use the screws included with RK1 to install the hardware. Tighten the screws at the locations indicated by the arrows.

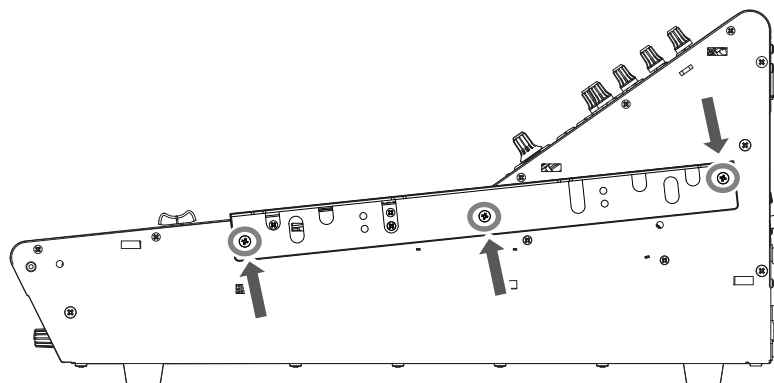

4. Attach the hardware to the other side in the same way.

**NOTICE**

When attaching the RK1 rackmount kit, you must turn off the power switch on the unit and use the screws that are included with the RK1. Otherwise, malfunctions or electric shock may occur.

# General specifications

Sampling Frequency	Internal Clock	44.1kHz 48kHz	
	External Clock	44.1kHz +4.1667%, +0.1%, -0.1%, -4.0%	±200ppm
		48kHz +4.1667%, +0.1%, -0.1%, -4.0%	±200ppm
Signal Delays	Less than 2.5ms, INPUT to OMNI OUT, Fs= 48kHz		
Fader	100mm motorized, Resolution=1024steps, +10dB to -138dB, -∞dB all faders		
Frequency Response	+0.5, -1.5dB 20Hz-20kHz, refer to +4dBu output @1kHz, INPUT to OMNI OUT		
Total Harmonic Distortion <sup>*3</sup>	Less than 0.05% 20Hz-20kHz@+4dBu into 600Ω, INPUT to OMNI OUT, Input Gain= Min.		
Hum & Noise <sup>*4</sup>	-128dBu typ., Equivalent Input Noise, Input Gain= Max., -88dBu, Residual output noise, ST master off		
Dynamic Range	112dB typ., DA Converter, 108dB typ., INPUT to OMNI OUT, Input Gain= Min.		
Crosstalk @ 1kHz	-100dB <sup>*1</sup> , adjacent INPUT/OMNI OUT channels, Input Gain= Min.		
Dimensions (W x H x D) and Net Weight	QL5: 828.4mm x 272mm x 563mm, 21.8kg QL1: 468mm x 272mm x 562mm, 14.7kg		
Power Requirements (in watts)	QL5: 200W, QL1: 135W		
Power Requirements (in volts, Hz)	100-240V 50/60Hz		
Temperature Range	Operating temperature range: 0-40°C Storage temperature range: -20-60°C		
Included Accessories	Owner's Manual, dust cover (QL5 only), power cord		
Optional Accessories	Rackmount kit RK1, Mini-YGDAL cards <sup>*2</sup> , Gooseneck Lamp LA1L		

\*1. A 22kHz, 30dB/Oct filter is used to measure crosstalk.

\*2. For more information about Mini-YGDAL card support, refer to the Yamaha pro audio website.  
<http://www.yamahaproaudio.com/>

\*3. An 80kHz, 18dB/Oct filter is used to measure total harmonic distortion.

\*4. An A-Weight filter is used to measure hum & noise.

## European Models

Inrush Current based on EN 55103-1:2009

5A (on initial switch-on)

3A (after a supply interruption of 5s)

Conforms to Environments: E1, E2, E3 and E4

Specifications and descriptions in this owner's manual are for information purposes only. Yamaha Corp. reserves the right to change or modify products or specifications at any time without prior notice. Since specifications, equipment or options may not be the same in every locale, please check with your Yamaha dealer.

# Dimensional Diagrams

QL5

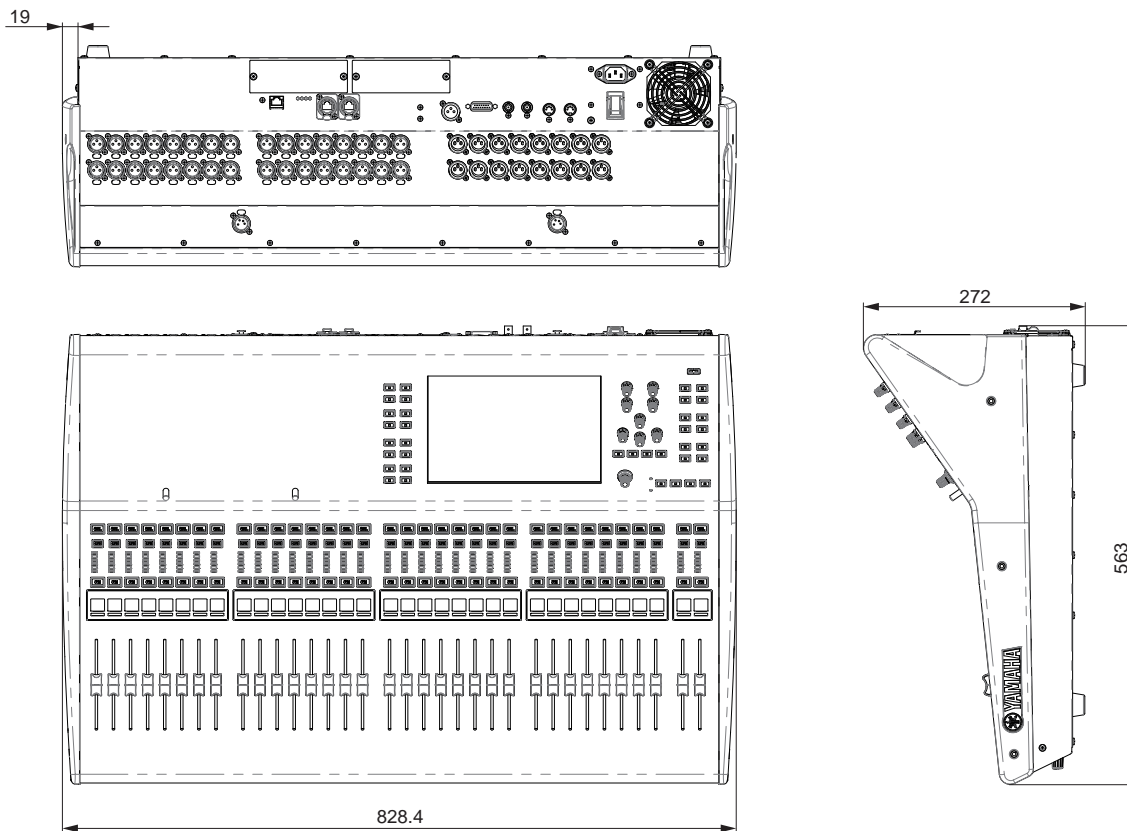

QL1

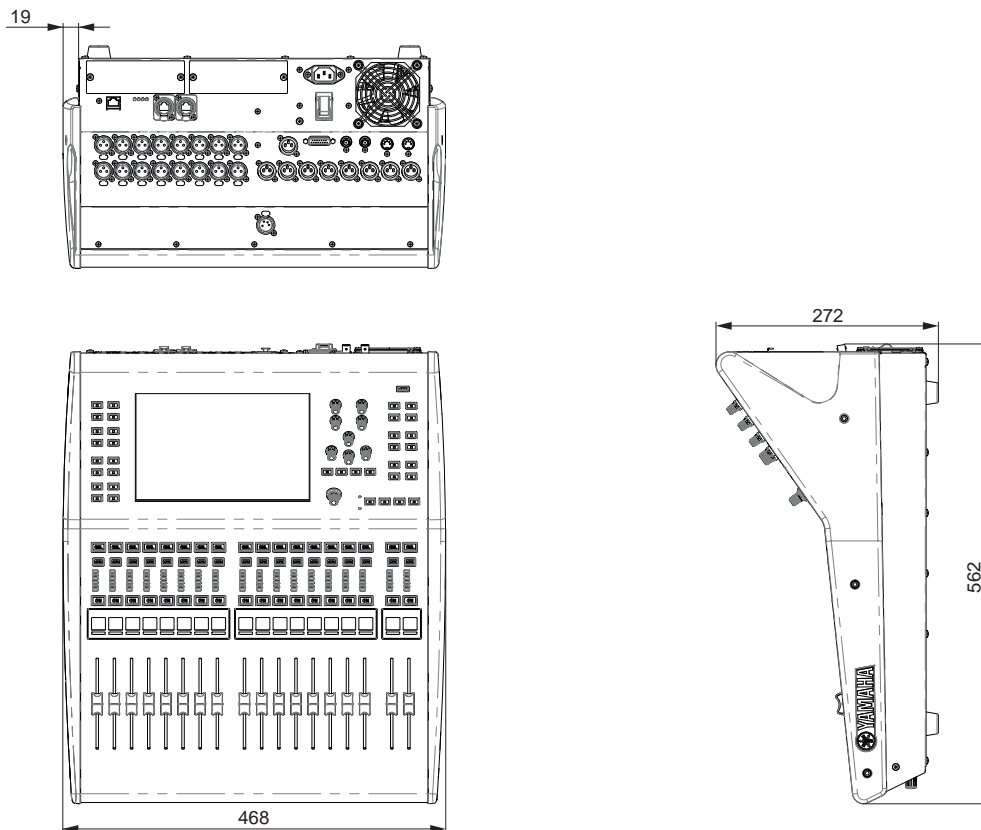

Units: mm

# Index

## A

- About Dante Controller ..... 30
- Analog gain ..... 35
- Automixer ..... 38

## B

- Buttons ..... 19

## C

- Calibrating the faders ..... 46
- Channel link ..... 41
- Copy/Paste (library) ..... 28
- Custom fader bank ..... 22

## D

- Dante ..... 9, 30, 34
  - INPUT PATCH ..... 35
  - OUTPUT PATCH ..... 35
- DCA group ..... 41
- Dialog boxes ..... 19
- DIRECT OUT ..... 40
- Dynamics ..... 36

## E

- EFFECT RACK ..... 38
- Effect rack ..... 38
- Effects ..... 38
- EQ ..... 36

## F

- Factory set ..... 46
- Faders/Knobs ..... 19
- Front panel ..... 15
- Function access area ..... 20

## G

- GEQ (Graphic EQ) ..... 37
- GEQ rack ..... 37
- Grouping ..... 41

## H

- Help ..... 20

## I

- I/O devices ..... 30
- Input port ..... 35
- INSERT ..... 40

## K

- Keyboard window ..... 19

## L

- Lamp ..... 45
- Libraries ..... 24
- Link ..... 41

## M

- Main area ..... 21
- MIX/MATRIX buses ..... 23
- MUTE group ..... 41

## O

- Optional I/O cards ..... 33
- Oscillator ..... 42

## P

- Patch ..... 40
- PREMIUM RACK ..... 9, 39

## R

- Rear panel ..... 16
- Recorder ..... 43
- Redundant network ..... 31

## S

- Scene memory ..... 42
- Selected Channel section ..... 13
- SENDS ON FADER mode ..... 23
- STEREO bus ..... 36

## T

- Tabs ..... 19
- Talkback ..... 41
- Tool buttons ..... 21
- Top panel
  - Channel Strip section ..... 12
  - Display section ..... 13
  - Master section ..... 14
  - Selected Channel section ..... 13
  - USB connector ..... 15
  - USER DEFINED KEYS section ..... 14
- TOUCH AND TURN knob ..... 18
- Touch screen ..... 18

## U

- USB flash drive ..... 43
  - Format ..... 44
  - Load (unit settings) ..... 44
  - Save (unit settings) ..... 44

## W

- Word clock ..... 34

# Important Notice: Guarantee Information for customers in European Economic Area (EEA) and Switzerland

<b>Important Notice: Guarantee Information for customers in EEA* and Switzerland</b> For detailed guarantee information about this Yamaha product, and Pan-EEA* and Switzerland warranty service, please either visit the website address below (Printable file is available at our website) or contact the Yamaha representative office for your country. * EEA: European Economic Area	<b>English</b>
<b>Wichtiger Hinweis: Garantie-Information für Kunden in der EWR* und der Schweiz</b> Für nähere Garantie-Information über dieses Produkt von Yamaha, sowie über den Pan-EWR*- und Schweizer Garantieservice, besuchen Sie bitte entweder die folgend angegebene Internetadresse (eine druckfähige Version befindet sich auch auf unserer Webseite), oder wenden Sie sich an den für Ihr Land zuständigen Yamaha-Vertrieb. *EWR: Europäischer Wirtschaftsraum	<b>Deutsch</b>
<b>Remarque importante: informations de garantie pour les clients de l'EEE et la Suisse</b> Pour des informations plus détaillées sur la garantie de ce produit Yamaha et sur le service de garantie applicable dans l'ensemble de l'EEE ainsi qu'en Suisse, consultez notre site Web à l'adresse ci-dessous (le fichier imprimable est disponible sur notre site Web) ou contactez directement Yamaha dans votre pays de résidence. * EEE : Espace Economique Européen	<b>Français</b>
<b>Belangrijke mededeling: Garantie-informatie voor klanten in de EER* en Zwitserland</b> Voor gedetailleerde garantie-informatie over dit Yamaha-product en de garantieservice in heel de EER* en Zwitserland, gaat u naar de onderstaande website (u vindt een afdrukbaar bestand op onze website) of neemt u contact op met de vertegenwoordiging van Yamaha in uw land. * EER: Europese Economische Ruimte	<b>Nederlands</b>
<b>Aviso importante: información sobre la garantía para los clientes del EEE* y Suiza</b> Para una información detallada sobre este producto Yamaha y sobre el soporte de garantía en la zona EEE* y Suiza, visite la dirección web que se incluye más abajo (la versión del archivo para imprimir esta disponible en nuestro sitio web) o póngase en contacto con el representante de Yamaha en su país. * EEE: Espacio Económico Europeo	<b>Español</b>
<b>Avviso importante: informazioni sulla garanzia per i clienti residenti nell'EEA* e in Svizzera</b> Per informazioni dettagliate sulla garanzia relativa a questo prodotto Yamaha e l'assistenza in garanzia nei paesi EEA* e in Svizzera, potete consultare il sito Web all'indirizzo riportato di seguito (è disponibile il file in formato stampabile) oppure contattare l'ufficio di rappresentanza locale della Yamaha. * EEA: Area Economica Europea	<b>Italiano</b>
<b>Aviso importante: informações sobre as garantias para clientes da AEE* e da Suíça</b> Para obter uma informação pormenorizada sobre este produto da Yamaha e sobre o serviço de garantia na AEE* e na Suíça, visite o site a seguir (o arquivo para impressão está disponível no nosso site) ou entre em contato com o escritório de representação da Yamaha no seu país. * AEE: Área Económica Européia	<b>Português</b>
<b>Σημαντική σημείωση: Πληροφορίες εγγύησης για τους πελάτες στον EOX* και Ελβετία</b> Για λεπτομερείς πληροφορίες εγγύησης σχετικά με το προϊόν προϊόν της Yamaha και την κάλυψη εγγύησης σε όλες τις χώρες του EOX και την Ελβετία, επισκεφτείτε την παρακάτω ιστοσελίδα (Εκτυπώσιμη μορφή είναι διαθέσιμη στην ιστοσελίδα μας) ή απευθυνθείτε στην αντιπροσωπεία της Yamaha στη χώρα σας. * EOX: Ευρωπαϊκός Οικονομικός Χώρος	<b>Ελληνικά</b>
<b>Viktigt: Garantiinformation för kunder i EES-området* och Schweiz</b> För detaljerad information om denna Yamahaprodukt samt garantiservice i hela EES-området* och Schweiz kan du antingen besöka nedanstående webbadress (en utskriftsvänlig fil finns på webbplatsen) eller kontakta Yamahas officiella representant i ditt land. * EES: Europeiska Ekonomiska Samarbetsområdet	<b>Svenska</b>
<b>Viktig merknad: Garantiinformasjon for kunder i EØS* og Sveits</b> Detaljert garantiinformasjon om dette Yamaha-produktet og garantiservice for hele EØS-området* og Sveits kan fås enten ved å besøke nettadressen nedenfor (utskriftsversjon finnes på våre nettsider) eller kontakte kontakke Yamaha-kontoret i landet der du bor. *EØS: Det europeiske økonomiske samarbeidsområdet	<b>Norsk</b>
<b>Vigtig oplysning: Garantioplysninger til kunder i EØ* og Schweiz</b> De kan finde detaljerede garantioplysninger om dette Yamaha-produkt og den fælles garantiserviceordning for EØ* (og Schweiz) ved at besøge det websted, der er angivet nedenfor (der findes en fil, som kan udskrives, på vores websted), eller ved at kontakte Yamahas nationale repræsentationskontor i det land, hvor De bor. * EØ: Det Europæiske Økonomiske Område	<b>Dansk</b>
<b>Tärkeä ilmoitus: Takuutiedot Euroopan talousalueen (ETA)* ja Sveitsin asiakkaille</b> Tämän Yamaha-tuotteen sekä ETA-alueen ja Sveitsin takuuta koskevat yksityiskohtaiset tiedot saatte alla olevasta nettiosoitteesta. (Tulostettava tiedosto saatavissa sivustollamme.) Voitte myös ottaa yhteyttä paikalliseen Yamaha-edustajaan. *ETA: Euroopan talousalue	<b>Suomi</b>
<b>Ważne: Warunki gwarancyjne obowiązujące w EOG* i Szwajcarii</b> Aby dowiedzieć się więcej na temat warunków gwarancyjnych tego produktu firmy Yamaha i serwisu gwarancyjnego w całym EOG* i Szwajcarii, należy odwiedzić wskazaną poniżej stronę internetową (Plik gotowy do wydruku znajduje się na naszej stronie internetowej) lub skontaktować się z przedstawicielstwem firmy Yamaha w swoim kraju. * EOG — Europejski Obszar Gospodarczy	<b>Polski</b>
<b>Důležité oznámení: Záruční informace pro zákazníky v EHS* a ve Švýcarsku</b> Podrobné záruční informace o tomto produktu Yamaha a záručním servisu v celém EHS* a ve Švýcarsku naleznete na níže uvedené webové adrese (soubor k tisku je dostupný na našich webových stránkách) nebo se můžete obrátit na zastoupení firmy Yamaha ve své zemi. * EHS: Evropský hospodářský prostor	<b>Česky</b>
<b>Fontos figyelmeztetés: Garancia-információk az EGT* területén és Svájcban élő vásárlók számára</b> A jelen Yamaha termékre vonatkozó részletes garancia-információk, valamint az EGT*-re és Svájcra kiterjedő garanciális szolgáltatás tekintetében keresse fel webhelyünket az alábbi címen (a webhelyen nyomtatható fájl is található), vagy pedig lépjen kapcsolatba az országában működő Yamaha képviselői irodával. * EGT: Európai Gazdasági Térség	<b>Magyar</b>
<b>Oluline märkus: Garantiiteave Euroopa Majanduspiirkonna (EMP)* ja Šveitsi klientidele</b> Täpsema teabe saamiseks selle Yamaha toote garantii ning kogu Euroopa Majanduspiirkonna ja Šveitsi garantiiteeninduse kohta, külastage palun veebisaiti alljärgneval aadressil (meie saidil on saadaval printitav fail) või pöörduge Teie regiooni Yamaha esinduse poole. * EMP: Euroopa Majanduspiirkond	<b>Eesti keel</b>
<b>Svarīgs paziņojums: garantijas informācija klientiem EEZ* un Šveicē</b> Lai saņemtu detalizētu garantijas informāciju par šo Yamaha produktu, kā arī garantijas apkalpošanu EEZ* un Šveicē, lūdzu, apmeklējiet zemāk norādīto tīmekļa vietnes adresi (tīmekļa vietnē ir pieejams drukājams fails) vai sazinieties ar jūsu valsti apkalpojošo Yamaha pārstāvniecību. * EEZ: Eiropas Ekonomikas zona	<b>Latviešu</b>
<b>Dėmesio: informacija dėl garantijos pirkėjams EEE* ir Šveicarijoje</b> Jei reikia išsamios informacijos apie šį „Yamaha“ produktą ir jo techninę priežiūrą visoje EEE* ir Šveicarijoje, apsilankykite mūsų svetainėje toliau nurodytu adresu (svetainėje yra spausdintinas failas) arba kreipkitės į „Yamaha“ atstovybę savo šaliai. *EEE – Europos ekonominė erdvė	<b>Lietuvių kalba</b>
<b>Dôležité upozornenie: Informácie o záruke pre zákazníkov v EHP* a Švajčiarsku</b> Podrobné informácie o záruke týkajúce sa tohto produktu od spoločnosti Yamaha a garančnom servise v EHP* a Švajčiarsku nájdete na webovej stránke uvedenej nižšie (na našej webovej stránke je k dispozícii súbor na tlač) alebo sa obráťte na zástupcu spoločnosti Yamaha vo svojej krajine. * EHP: Európsky hospodársky priestor	<b>Slovenčina</b>
<b>Pomembno obvestilo: Informacije o garanciji za kupce v EGP* in Švici</b> Za podrobnejše informacije o tem Yamahinem izdelku ter garancijskem servisu v celotnem EGP in Švici, obiščite spletno mesto, ki je navedeno spodaj (natisljiva datoteka je na voljo na našem spletnem mestu), ali se obrnite na Yamahinega predstavnika v svoji državi. * EGP: Evropski gospodarski prostor	<b>Slovenščina</b>
<b>Важно съобщение: Информация за гаранцията за клиенти в ЕИП* и Швейцария</b> За подробна информация за гаранцията за този продукт на Yamaha и гаранционното обслужване в паневропейската зона на ЕИП* и Швейцария или посетете посочения по-долу уеб сайт (на нашия уеб сайт има файл за печат), или се свържете с представителния офис на Yamaha във вашата страна. * ЕИП: Европейско икономическо пространство	<b>Български език</b>
<b>Notificare importantă: Informații despre garanție pentru clienții din SEE* și Elveția</b> Pentru informații detaliate privind acest produs Yamaha și serviciul de garanție Pan-SEE* și Elveția, vizitați site-ul la adresa de mai jos (fișierul imprimabil este disponibil pe site-ul nostru) sau contactați biroul reprezentanței Yamaha din țara dumneavoastră. * SEE: Spațiul Economic European	<b>Limba română</b>

<http://europe.yamaha.com/warranty/>

# Block Diagram

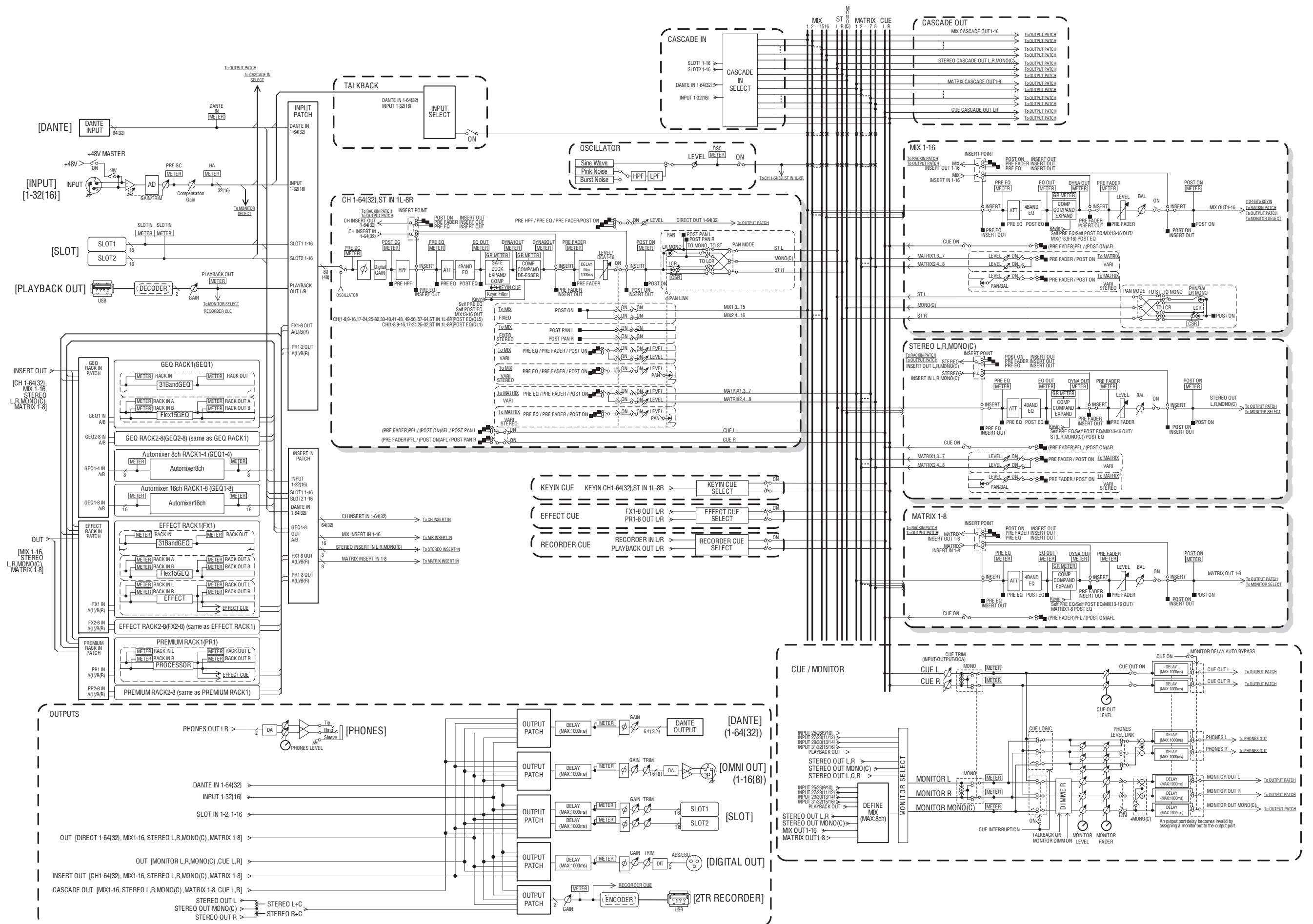

# Level Diagram

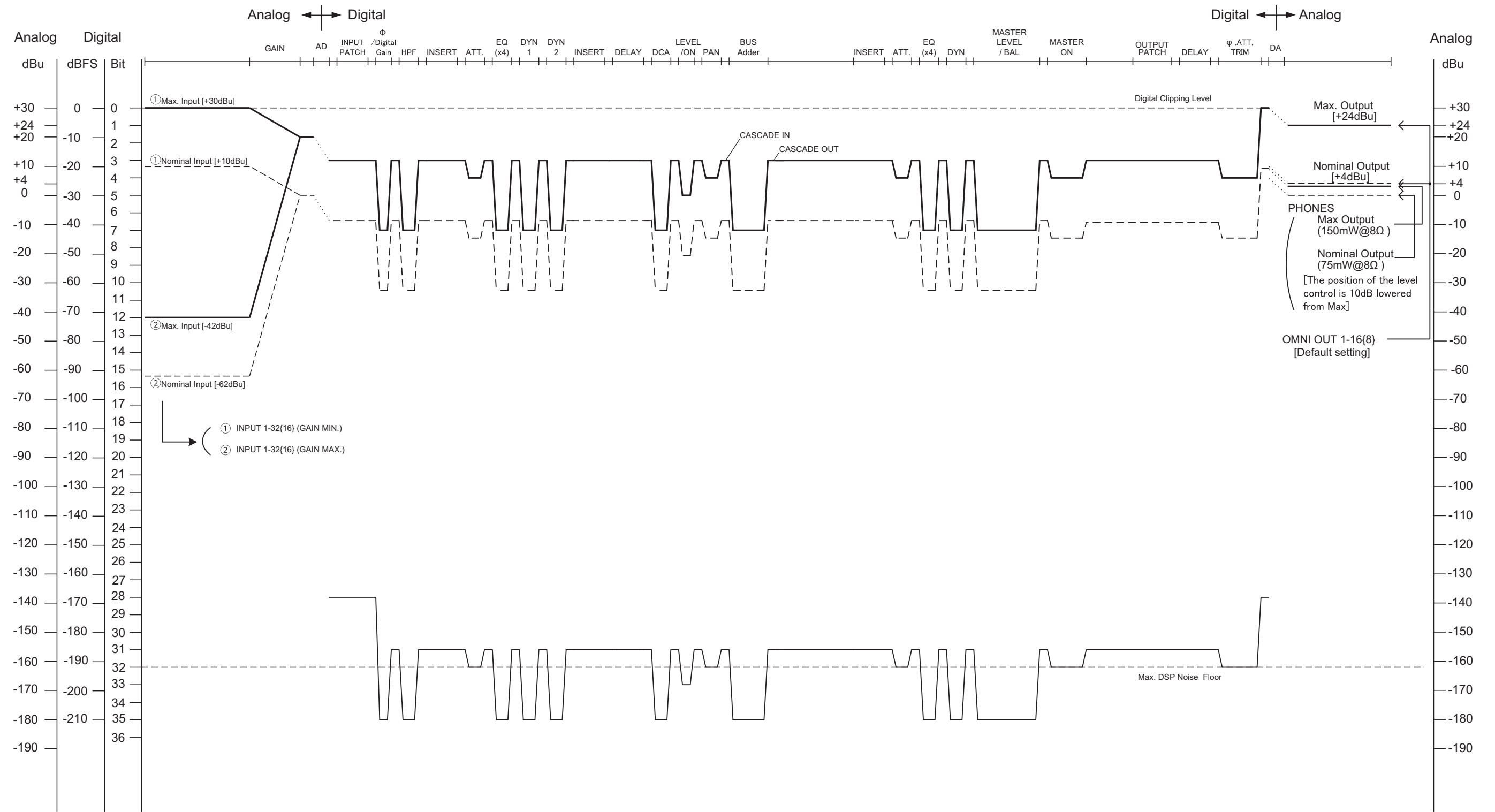

[0dBu = 0.775Vrms]  
 [0dBFS = Full Scale]



For details of products, please contact your nearest Yamaha representative or the authorized distributor listed below.

Pour plus de détails sur les produits, veuillez-vous adresser à Yamaha ou au distributeur le plus proche de vous figurant dans la liste suivante.

Die Einzelheiten zu Produkten sind bei Ihrer unten aufgeführten Niederlassung und bei Yamaha Vertragshändlern in den jeweiligen Bestimmungsländern erhältlich.

Para detalles sobre productos, contacte su tienda Yamaha más cercana o el distribuidor autorizado que se lista debajo.

## NORTH AMERICA

### CANADA

**Yamaha Canada Music Ltd.**  
135 Milner Avenue, Toronto, Ontario,  
M1S 3R1, Canada  
Tel: 416-298-1311

### U.S.A.

**Yamaha Corporation of America**  
6600 Orangethorpe Avenue, Buena Park, CA 90620,  
U.S.A.  
Tel: 714-522-9011

## CENTRAL & SOUTH AMERICA

### MEXICO

**Yamaha de México, S.A. de C.V.**  
Av. Insurgentes Sur 1647 Piso 9, Col. San José  
Insurgentes, Delegación Benito Juárez, México,  
D.F., C.P. 03900  
Tel: 55-5804-0600

### BRAZIL

**Yamaha Musical do Brasil Ltda.**  
Rua Joaquim Floriano, 913 - 4º andar, Itaim Bibi,  
CEP 04534-013 São Paulo, SP. BRAZIL  
Tel: 011-3704-1377

### ARGENTINA

**Yamaha Music Latin America, S.A.,  
Sucursal Argentina**  
Olga Cossettini 1553, Piso 4 Norte,  
Madero Este-C1107CEK  
Buenos Aires, Argentina  
Tel: 011-4119-7000

### VENEZUELA

**Yamaha Music Latin America, S.A.,  
Sucursal Venezuela**  
C.C. Manzanares Plaza P4  
Ofic. 0401- Manzanares-Baruta  
Caracas Venezuela  
Tel: 58-212-943-1877

### PANAMA AND OTHER LATIN AMERICAN COUNTRIES/ CARIBBEAN COUNTRIES

**Yamaha Music Latin America, S.A.**  
Torre Banco General, Piso No.7, Marbella,  
Calle 47 y Aquilino de la Guardia,  
Ciudad de Panamá, República de Panamá  
Tel: +507-269-5311

## EUROPE

### THE UNITED KINGDOM/IRELAND

**Yamaha Music Europe GmbH (UK)**  
Sherbourne Drive, Tilbrook, Milton Keynes,  
MK7 8BL, U.K.  
Tel: 01908-366700

### GERMANY

**Yamaha Music Europe GmbH**  
Siemensstraße 22-34, 25462 Rellingen, Germany  
Tel: 04101-3030

### SWITZERLAND/LIECHTENSTEIN

**Yamaha Music Europe GmbH  
Branch Switzerland in Zürich**  
Seefeldstrasse 94, 8008 Zürich, Switzerland  
Tel: 044-387-8080

### AUSTRIA/BULGARIA

**Yamaha Music Europe GmbH Branch Austria**  
Schleiergasse 20, A-1100 Wien, Austria  
Tel: 01-60203900

### CZECH REPUBLIC/HUNGARY/ ROMANIA/SLOVAKIA/SLOVENIA

**Yamaha Music Europe GmbH  
Branch Austria (Central Eastern Europe Office)**  
Schleiergasse 20, A-1100 Wien, Austria  
Tel: 01-60203900

### POLAND/LITHUANIA/LATVIA/ESTONIA

**Yamaha Music Europe GmbH  
Branch Poland Office**  
ul. Wrotkowa 14 02-553 Warsaw, Poland  
Tel: 022-500-2925

### MALTA

**Olimpus Music Ltd.**  
The Emporium, Level 3, St. Louis Street Msida  
MSD06  
Tel: 02133-2144

### NETHERLANDS/BELGIUM/ LUXEMBOURG

**Yamaha Music Europe Branch Benelux**  
Clarissenhof 5-b, 4133 AB Vianen, Netherlands  
Tel: 0347-358 040

### FRANCE

**Yamaha Music Europe**  
7 rue Ambroise Croizat, Zone d'activites Pariest,  
77183 Croissy-Beaubourg, France  
Tel: 01-64-61-4000

### ITALY

**Yamaha Music Europe GmbH, Branch Italy**  
Viale Italia 88, 20020 Lainate (Milano), Italy  
Tel: 02-935-771

### SPAIN/PORTUGAL

**Yamaha Music Europe GmbH Ibérica, Sucursal  
en España**  
Ctra. de la Coruna km. 17,200, 28231  
Las Rozas (Madrid), Spain  
Tel: +34-91-639-88-88

### GREECE

**Philippos Nakas S.A. The Music House**  
147 Skiathou Street, 112-55 Athens, Greece  
Tel: 01-228 2160

### SWEDEN/FINLAND/ICELAND

**Yamaha Music Europe GmbH Germany filial  
Scandinavia**  
J. A. Wettergrensgata 1, Box 30053  
S-400 43 Göteborg, Sweden  
Tel: +46 31 89 34 00

### DENMARK

**Yamaha Music Europe GmbH, Tyskland – filial  
Denmark**  
Generatorvej 6A, DK-2730 Herlev, Denmark  
Tel: 44 92 49 00

### NORWAY

**Yamaha Music Europe GmbH Germany -  
Norwegian Branch**  
Grini Næringspark 1, N-1361 Østerås, Norway  
Tel: 67 16 78 00

### RUSSIA

**Yamaha Music (Russia) LLC.**  
Room 37, bld. 7, Kievskaya street, Moscow,  
121059, Russia  
Tel: 495 626 5005

### OTHER EUROPEAN COUNTRIES

**Yamaha Music Europe GmbH**  
Siemensstraße 22-34, 25462 Rellingen, Germany  
Tel: +49-4101-3030

## AFRICA

**Yamaha Music Gulf FZE**  
Office JAFZA 16-512, P.O.Box 17328,  
Jebel Ali - Dubai, UAE  
Tel: +971-4-881-5868

## MIDDLE EAST

### TURKEY

**Yamaha Music Europe GmbH**  
Merkezi Almanya Türkiye İstanbul Şubesi  
Maslak Meydan Sokak No:5 Spring Giz Plaza  
Bağımsız Böl. No:3, 34398 Şişli İstanbul  
Tel: +90-212-999-8010

### CYPRUS

**Yamaha Music Europe GmbH**  
Siemensstraße 22-34, 25462 Rellingen, Germany  
Tel: 04101-3030

### OTHER COUNTRIES

**Yamaha Music Gulf FZE**  
Office JAFZA 16-512, P.O.Box 17328,  
Jebel Ali - Dubai, U.A.E  
Tel: +971-4-881-5868

## ASIA

### THE PEOPLE'S REPUBLIC OF CHINA

**Yamaha Music & Electronics (China) Co.,Ltd.**  
2F, Yunhedasha, 1818 Xinzha-lu, Jingan-qu,  
Shanghai, China  
Tel: 021-6247-2211

### INDIA

**Yamaha Music India Pvt. Ltd.**  
Spazedge building, Ground Floor, Tower A, Sector  
47, Gurgaon- Sohna Road, Gurgaon, Haryana, India  
Tel: 0124-485-3300

### INDONESIA

**PT. Yamaha Musik Indonesia (Distributor)**  
Yamaha Music Center Bldg. Jalan Jend. Gatot  
Subroto Kav. 4, Jakarta 12930, Indonesia  
Tel: 021-520-2577

### KOREA

**Yamaha Music Korea Ltd.**  
8F, 9F, Dongsung Bldg. 158-9 Samsung-Dong,  
Kangnam-Gu, Seoul, Korea  
Tel: 02-3467-3300

### MALAYSIA

**Yamaha Music (Malaysia) Sdn., Bhd.**  
No.8, Jalan Perbandaran, Kelana Jaya, 47301  
Petaling Jaya, Selangor, Malaysia  
Tel: 03-78030900

### SINGAPORE

**Yamaha Music (Asia) Private Limited**  
Block 202 Hougang Street 21, #02-00,  
Singapore 530202, Singapore  
Tel: 65-6747-4374

### TAIWAN

**Yamaha Music & Electronics Taiwan Co.,Ltd.**  
3F, No.6, Section 2 Nan-Jing East Road, Taipei,  
Taiwan R.O.C.  
Tel: 02-2511-8688

### THAILAND

**Siam Music Yamaha Co., Ltd.**  
3, 4, 15 and 16th floor, Siam Motors Building,  
891/1 Rama 1 Road, Wangmai,  
Pathumwan, Bangkok 10330, Thailand  
Tel: 02-215-2622

### VIETNAM

**Yamaha Music Vietnam Company Limited**  
15th Floor, Nam A Bank Tower, 201-203 Cach  
Mang Thang Tam St., Ward 4, Dist.3,  
Ho Chi Minh City, Vietnam  
Tel: +84-8-3818-1122

### OTHER ASIAN COUNTRIES

**Yamaha Corporation  
Sales & Marketing Division**  
Nakazawa-cho 10-1, Naka-ku, Hamamatsu,  
Japan 430-8650  
Tel: +81-53-460-2312

## OCEANIA

### AUSTRALIA

**Yamaha Music Australia Pty. Ltd.**  
Level 1, 99 Queensbridge Street, Southbank,  
Victoria 3006, Australia  
Tel: 3-9693-5111

### COUNTRIES AND TRUST

### TERRITORIES IN PACIFIC OCEAN

**Yamaha Corporation  
Sales & Marketing Division**  
Nakazawa-cho 10-1, Naka-ku, Hamamatsu,  
Japan 430-8650  
Tel: +81-53-460-2312



Yamaha Pro Audio Global Web Site  
<http://www.yamahaproaudio.com/>  
Yamaha Manual Library  
<http://www.yamaha.co.jp/manual/>

C.S.G., PA Development Division  
© 2014 Yamaha Corporation

405MATO-B0  
Printed in Japan

ZH99130