



# R-S201

---

Receiver

OWNER'S MANUAL

# IMPORTANT SAFETY INSTRUCTIONS

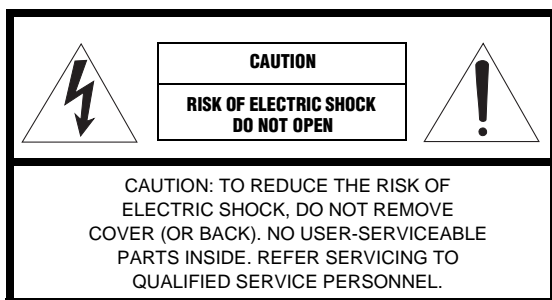

## • Explanation of Graphical Symbols



The lightning flash with arrowhead symbol, within an equilateral triangle, is intended to alert you to the presence of uninsulated “dangerous voltage” within the product’s enclosure that may be of sufficient magnitude to constitute a risk of electric shock to persons.



The exclamation point within an equilateral triangle is intended to alert you to the presence of important operating and maintenance (servicing) instructions in the literature accompanying the appliance.

## IMPORTANT

Please record the serial number of this unit in the space below.

MODEL:

Serial No.:

The serial number is located on the rear of the unit. Retain this Owner’s Manual in a safe place for future reference.

- 1 Read these instructions.
- 2 Keep these instructions.
- 3 Heed all warnings.
- 4 Follow all instructions.
- 5 Do not use this apparatus near water.
- 6 Clean only with dry cloth.
- 7 Do not block any ventilation openings. Install in accordance with the manufacturer’s instructions.
- 8 Do not install near any heat sources such as radiators, heat registers, stoves, or other apparatus (including amplifiers) that produce heat.
- 9 Do not defeat the safety purpose of the polarized or grounding-type plug. A polarized plug has two blades with one wider than the other. A grounding type plug has two blades and a third grounding prong. The wide blade or the third prong are provided for your safety. If the provided plug does not fit into your outlet, consult an electrician for replacement of the obsolete outlet.
- 10 Protect the power cord from being walked on or pinched particularly at plugs, convenience receptacles, and the point where they exit from the apparatus.
- 11 Only use attachments/accessories specified by the manufacturer.
- 12 Use only with the cart, stand, tripod, bracket, or table specified by the manufacturer, or sold with the apparatus. When a cart is used, use caution when moving the cart/apparatus combination to avoid injury from tip-over.
- 13 Unplug this apparatus during lightning storms or when unused for long periods of time.
- 14 Refer all servicing to qualified service personnel. Servicing is required when the apparatus has been damaged in any way, such as power-supply cord or plug is damaged, liquid has been spilled or objects have fallen into the apparatus, the apparatus has been exposed to rain or moisture, does not operate normally, or has been dropped.



## We Want You Listening For A Lifetime

Yamaha and the Electronic Industries Association’s Consumer Electronics Group want you to get the most out of your equipment by playing it at a safe level. One that lets the sound come through loud and clear without annoying blaring or distortion – and, most importantly, without affecting your sensitive hearing. Since hearing damage from loud sounds is often undetectable until it is too late, Yamaha and the Electronic Industries Association’s Consumer Electronics Group recommend you to avoid prolonged exposure from excessive volume levels.



**FCC INFORMATION (for US customers)**

**1 IMPORTANT NOTICE: DO NOT MODIFY THIS UNIT!**

This product, when installed as indicated in the instructions contained in this manual, meets FCC requirements. Modifications not expressly approved by Yamaha may void your authority, granted by the FCC, to use the product.

**2 IMPORTANT:** When connecting this product to accessories and/or another product use only high quality shielded cables. Cable/s supplied with this product **MUST** be used. Follow all installation instructions. Failure to follow instructions could void your FCC authorization to use this product in the USA.

**3 NOTE:** This product has been tested and found to comply with the requirements listed in FCC Regulations, Part 15 for Class "B" digital devices. Compliance with these requirements provides a reasonable level of assurance that your use of this product in a residential environment will not result in harmful interference with other electronic devices.

This equipment generates/uses radio frequencies and, if not installed and used according to the instructions found in the users manual, may cause interference harmful to the operation of other electronic devices.

Compliance with FCC regulations does not guarantee that interference will not occur in all installations. If this product is found to be the source of interference, which can be determined by turning the unit "OFF" and "ON", please try to eliminate the problem by using one of the following measures:

Relocate either this product or the device that is being affected by the interference.

Utilize power outlets that are on different branch (circuit breaker or fuse) circuits or install AC line filter/s.

In the case of radio or TV interference, relocate/reorient the antenna. If the antenna lead-in is 300 ohm ribbon lead, change the lead-in to coaxial type cable.

If these corrective measures do not produce satisfactory results, please contact the local retailer authorized to distribute this type of product. If you can not locate the appropriate retailer, please contact Yamaha Corporation of America A/V Division, 6600 Orangethorpe Avenue, Buena Park, CA 90620, USA.

The above statements apply **ONLY** to those products distributed by Yamaha Corporation of America or its subsidiaries.

**FOR CANADIAN CUSTOMERS**

To prevent electric shock, match wide blade of plug to wide slot and fully insert.  
CAN ICES-3 (B)/NMB-3(B)

# CAUTION: READ THIS BEFORE OPERATING YOUR UNIT.

- 1 To assure the finest performance, please read this manual carefully. Keep it in a safe place for future reference.
- 2 Install this sound system in a well ventilated, cool, dry, clean place - away from direct sunlight, heat sources, vibration, dust, moisture, and/or cold. For proper ventilation, allow the following minimum clearances around this unit.  
Top: 30 cm (11-3/4 in)  
Rear: 20 cm (7-7/8 in)  
Sides: 20 cm (7-7/8 in)
- 3 Locate this unit away from other electrical appliances, motors, or transformers to avoid humming sounds.
- 4 Do not expose this unit to sudden temperature changes from cold to hot, and do not locate this unit in an environment with high humidity (i.e. a room with a humidifier) to prevent condensation inside this unit, which may cause an electrical shock, fire, damage to this unit, and/or personal injury.
- 5 Avoid installing this unit where foreign object may fall onto this unit and/or this unit may be exposed to liquid dripping or splashing. On the top of this unit, do not place:
  - Other components, as they may cause damage and/or discoloration on the surface of this unit.
  - Burning objects (i.e. candles), as they may cause fire, damage to this unit, and/or personal injury.
  - Containers with liquid in them, as they may fall and liquid may cause electrical shock to the user and/or damage to this unit.
- 6 Do not cover this unit with a newspaper, tablecloth, curtain, etc. in order not to obstruct heat radiation. If the temperature inside this unit rises, it may cause fire, damage to this unit, and/or personal injury.
- 7 Do not plug in this unit to an AC wall outlet until all connections are complete.
- 8 Do not operate this unit upside-down. It may overheat, possibly causing damage.
- 9 Do not use force on switches, knobs and/or cords.
- 10 When disconnecting the power cable from the AC wall outlet, grasp the plug; do not pull the cable.
- 11 Do not clean this unit with chemical solvents; this might damage the finish. Use a clean, dry cloth.
- 12 Only voltage specified on this unit must be used. Using this unit with a higher voltage than specified is dangerous and may cause fire, damage to this unit, and/or personal injury. Yamaha will not be held responsible for any damage resulting from use of this unit with a voltage other than specified.
- 13 To prevent damage by lightning, keep the power cable and outdoor antennas disconnected from an AC wall outlet or this unit during a lightning storm.
- 14 Do not attempt to modify or fix this unit. Contact qualified Yamaha service personnel when any service is needed. The cabinet should never be opened for any reasons.
- 15 When not planning to use this unit for long periods of time (i.e. vacation), disconnect the AC power plug from the AC wall outlet.
- 16 Be sure to read the “TROUBLESHOOTING” section on common operating errors before concluding that this unit is faulty.
- 17 Before moving this unit, press  $\phi$  (power) to set this unit to standby mode, and then disconnect the AC power plug from the AC wall outlet.
- 18 Condensation will form when the surrounding temperature changes suddenly. Disconnect the power cable from the outlet, then leave this unit alone.
- 19 When using this unit for a long time, this unit may become warm. Turn the power off, then leave this unit alone for cooling.
- 20 Install this unit near the AC wall outlet and where the AC power plug can be reached easily.
- 21 The batteries shall not be exposed to excessive heat such as sunshine, fire or the like.
- 22 Excessive sound pressure from earphones and headphones can cause hearing loss.

This unit is not disconnected from the AC power source as long as it is connected to the AC wall outlet, even if this unit itself is turned off by  $\phi$ . This state is called the standby mode. In this state, this unit is designed to consume a very small quantity of power.

## WARNING

TO REDUCE THE RISK OF FIRE OR ELECTRIC SHOCK, DO NOT EXPOSE THIS UNIT TO RAIN OR MOISTURE.



This label is required to be attached to a product of which the temperature of the top cover may be hot during operation.

# CONTENTS

## INTRODUCTION

<b>USEFUL FEATURES</b> .....	<b>1</b>
<b>SUPPLIED ACCESSORIES</b> .....	<b>1</b>
<b>CONTROLS AND FUNCTIONS</b> .....	<b>2</b>
Front panel .....	2
Front panel display .....	4
Rear panel .....	5
Remote control .....	6
Using the remote control .....	8

## PREPARATION

<b>CONNECTIONS</b> .....	<b>9</b>
Connecting speakers and source components .....	9
Connecting the FM and AM antennas .....	11
Connecting power cable .....	11

## BASIC OPERATION

<b>PLAYBACK</b> .....	<b>12</b>
Playing a source .....	12
Using the sleep timer .....	13
<b>FM/AM TUNING</b> .....	<b>14</b>
Using preset functions .....	14
Receiving Radio Data System information (Only for Europe model) .....	18

## ADVANCED OPERATION

<b>SETTING THE OPTION MENU FOR EACH INPUT SOURCE</b> .....	<b>19</b>
Option menu items .....	19

## ADDITIONAL INFORMATION

<b>TROUBLESHOOTING</b> .....	<b>20</b>
<b>SPECIFICATIONS</b> .....	<b>23</b>

### ■ About this manual

-  indicates a tip for your operation.
- The instructions in this manual describe the operation of this unit with the supplied remote control. You can also use the buttons or knobs on the front panel if they have the same or similar names as those on the remote control.

## USEFUL FEATURES

This unit allows you to:

- ◆ Listen to FM and AM radio stations (see page 14)
- ◆ Use the remote control of this unit to operate a Yamaha CD player (see page 7)
- ◆ Save power by using the AUTO POWER STANDBY function (see page 19)

## SUPPLIED ACCESSORIES

Please check that you received all of the following parts.

Remote control

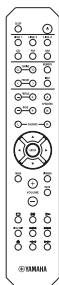

Indoor FM antennas

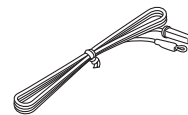
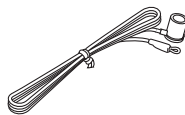

\* One of the above is supplied depending on the region of purchase.

AM loop antenna



Batteries (x2)  
(AA, R6, UM-3)

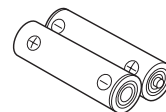

# INTRODUCTION

## CONTROLS AND FUNCTIONS

### Front panel

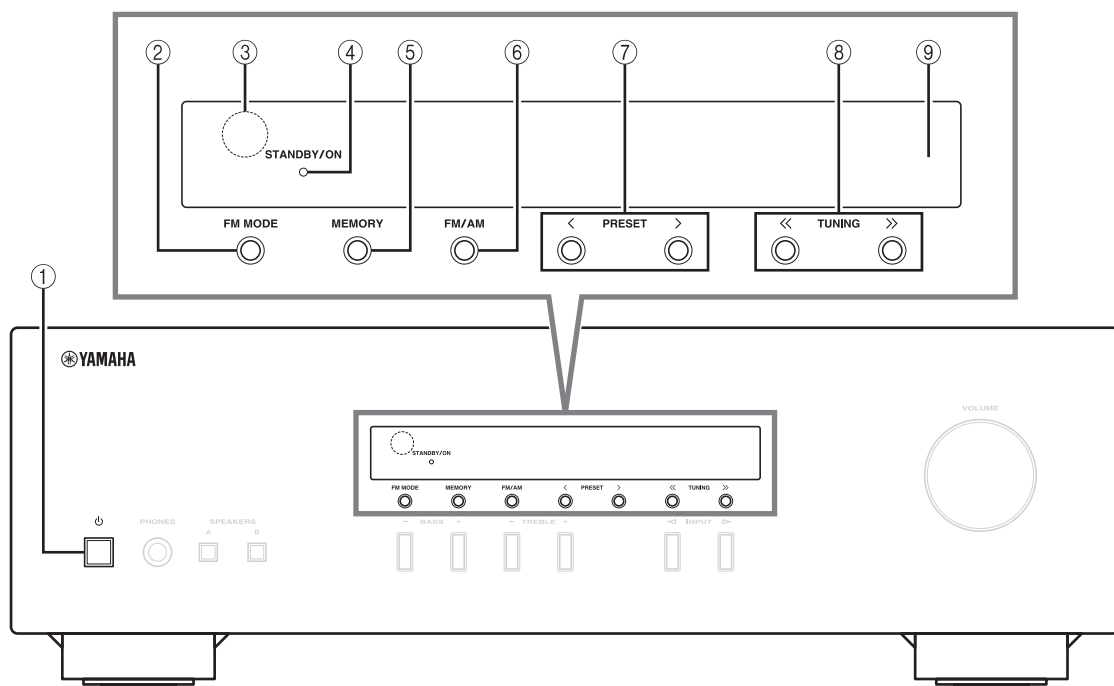

#### ① **⏻ (power)**

Turns this unit on, or sets it to standby mode.

#### **Note**

This unit consumes a small amount of power even when in standby mode.

#### ② **FM MODE**

Changes the FM radio wave reception mode (stereo or monaural) when TUNER is selected as the input source (see page 14).

#### ③ **Remote control sensor**

Receives infrared signals from the remote control.

#### ④ **STANDBY/ON indicator**

Indicator	Status
Brightly lit	The power of this unit is "on".
Dimly lit	This unit is in "standby" mode.
Off	The power of this unit is "off". To turn off this unit, disconnect the power cable from an AC wall outlet.

#### ⑤ **MEMORY**

Stores the current FM/AM station as a preset when TUNER is selected as the input source (see page 15).

#### ⑥ **FM/AM**

Sets the FM/AM tuner band to FM or AM when TUNER is selected as the input source (see page 14).

#### ⑦ **PRESET </>**

Selects a preset FM/AM station when TUNER is selected as the input source (see page 16).

#### ⑧ **TUNING <</>**

Selects the tuning frequency when TUNER is selected as the input source (see page 14).

#### ⑨ **Front panel display**

Shows information about the operational status of this unit.

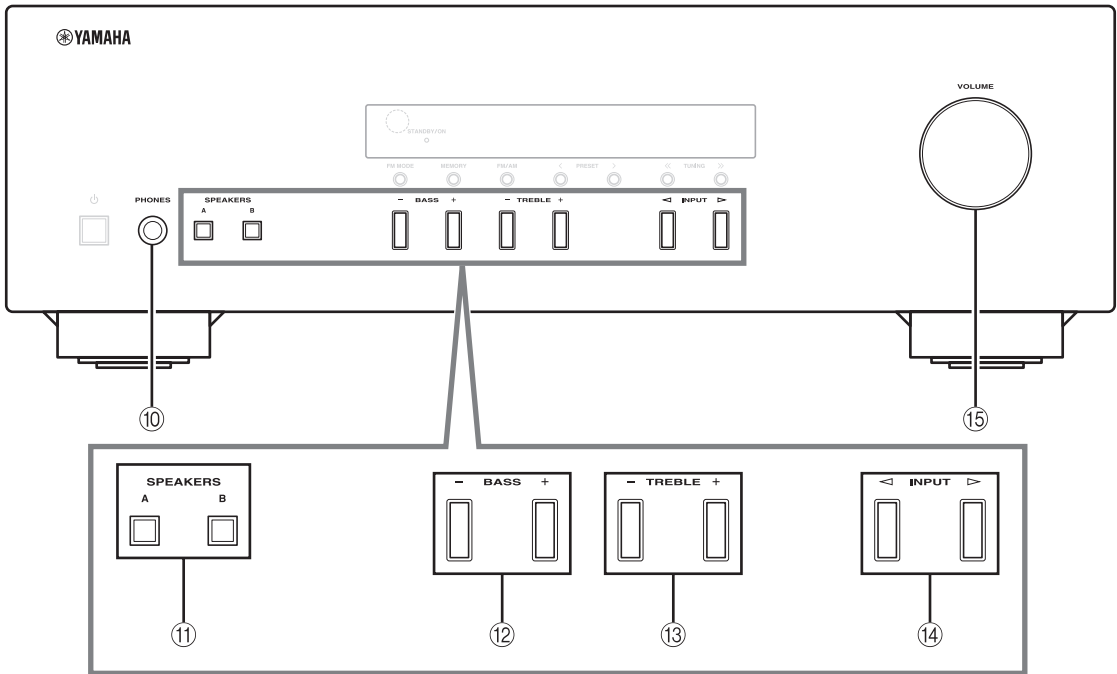

⑩ **PHONES jack**

Outputs audio to your headphones for private listening.

**Note**

Press SPEAKERS A/B so that the SP A/B indicators (see page 4) turn off before you connect your headphones to the PHONES jack.

⑪ **SPEAKERS A/B**

Turns on or off the speaker set connected to the SPEAKERS A and/or SPEAKERS B terminals on the rear panel each time the corresponding button is pressed (see page 12).

⑫ **BASS +/-**

Increases or decreases the low frequency response.  
Control range: -10 dB to +10 dB

⑬ **TREBLE +/-**

Increases or decreases the high frequency response.  
Control range: -10 dB to +10 dB

⑭ **INPUT </>**

Selects the input source you want to listen to.

⑮ **VOLUME control**

Increases or decreases the sound output level.

## Front panel display

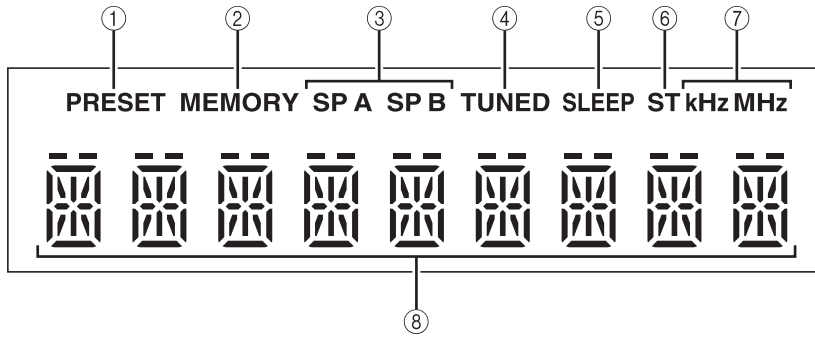

### ① PRESET indicator

Indicator	Status
lights up	Recalling a preset radio station.
	Searching an FM/AM station manually to register as a preset.
blinks	Scanning for FM stations automatically to register as presets.

### ② MEMORY indicator

Indicator	Status
lights up	Registering an FM/AM station as a preset has been completed.
blinks	Searching an FM/AM station manually to register as a preset.
	Scanning for FM stations automatically to register as presets.

### ③ SP (SPEAKERS) A/B indicators

Light up according to the set of speakers selected. Both indicators light up when both sets of speakers are selected.

### ④ TUNED indicator

Lights up when this unit is tuned in to an FM or AM station with a strong signal.

### ⑤ SLEEP indicator

Lights up when the sleep timer is turned on (see page 13).

### ⑥ ST indicator

Lights up when this unit is in stereo mode and tuning in an FM station with a stereo broadcast.

### ⑦ kHz/MHz indicators

Lights up according to the current broadcast frequency.  
kHz: AM  
MHz: FM

### ⑧ Multi-information display

Shows information when adjusting or changing settings.

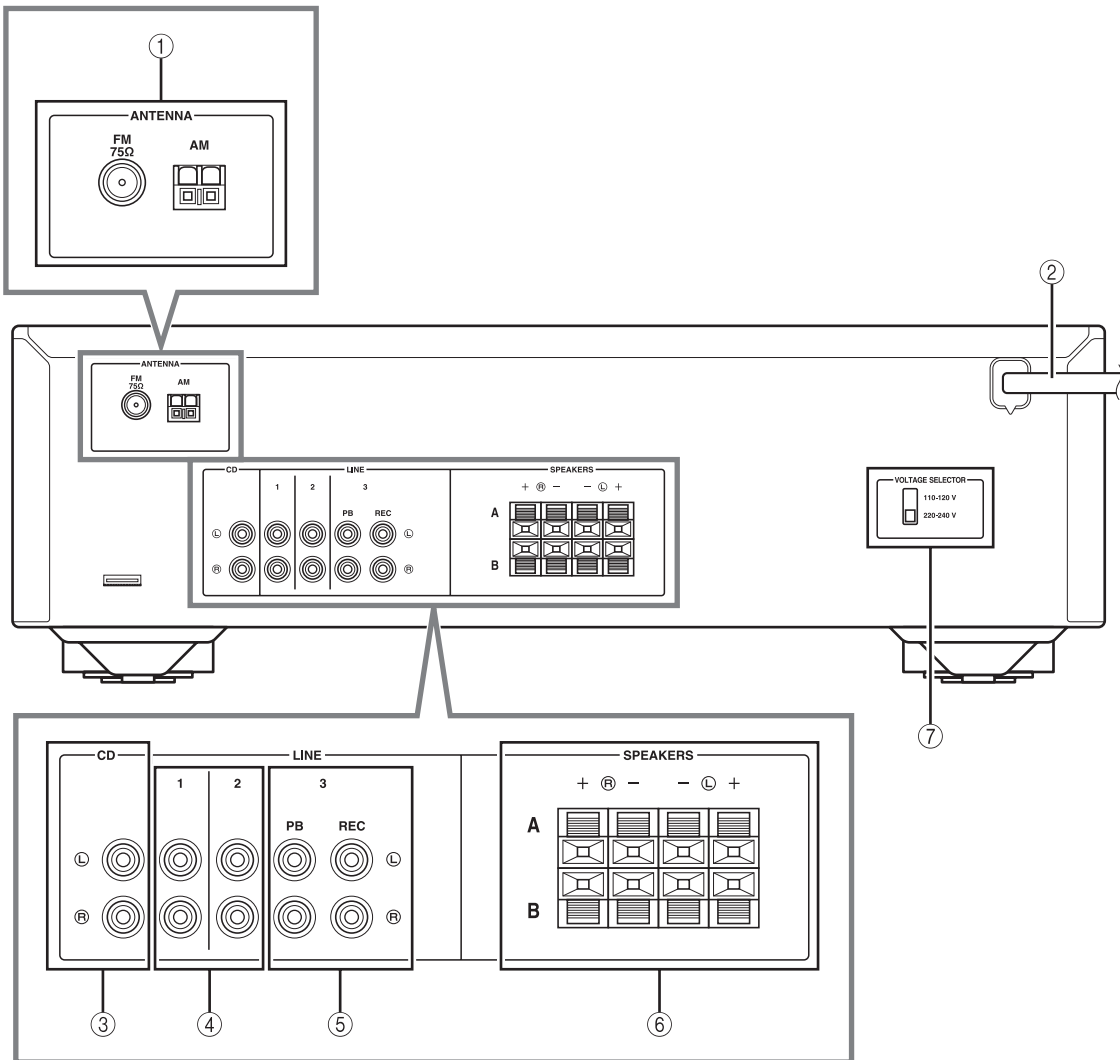

## Rear panel

① **ANTENNA terminals**

Used to connect FM and AM antennas (see page 11).

② **Power cable**

For connecting this unit to an AC wall outlet (see page 11).

③ **CD jacks**

Used to connect a CD player (see page 9).

④ **LINE 1-2 jacks**

Used to connect audio components (see page 9).

⑤ **LINE 3 jacks****PB (Playback) jacks**

Used to connect to audio output jacks of an audio component.

**REC (Recording) jacks**

Used to connect to audio input jacks of an audio component.

⑥ **SPEAKERS terminals**

Used to connect speakers (see page 9).

⑦ **VOLTAGE SELECTOR (Only for General model)**

## Remote control

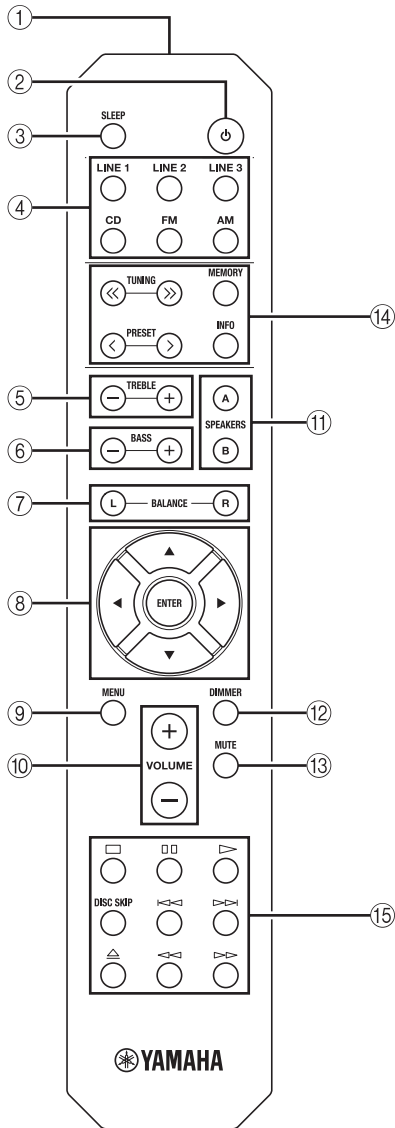

### Common controls

The following parts and controls can be used no matter which input source is selected.

- ① **Infrared signal transmitter**  
Sends infrared signals.
- ② **Power**  
Turns this unit on, or sets it to standby mode.
- ③ **SLEEP**  
Sets the sleep timer (see page 13).

### ④ Input selector buttons

Select the input source you want to listen to.



- The input source names correspond to the names of the connection jacks on the rear panel.
- To select TUNER as the input source using the remote control, press FM or AM.

### ⑤ TREBLE +/-

Increases or decreases the high frequency response.  
Control range: -10 dB to +10 dB

### ⑥ BASS +/-

Increases or decreases the low frequency response.  
Control range: -10 dB to +10 dB

### ⑦ BALANCE L/R

Adjusts the sound output balance of the left and right speakers to compensate for sound imbalances.  
Control range:

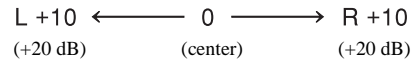

The opposite side of channel is muted.

The opposite side of channel is muted.

### ⑧ $\Delta / \nabla / \triangleleft / \triangleright / \text{ENTER}$

Selects and confirms items in the Option menu (see page 19).

### ⑨ MENU

Turns the Option menu on and off (see page 19).

### ⑩ VOLUME +/-

Increases or decreases the sound output level.

### ⑪ SPEAKERS A/B

Turns on or off the speaker set connected to the SPEAKERS A and/or SPEAKERS B terminals on the rear panel each time the corresponding button is pressed (see page 12).

### ⑫ DIMMER

Select the brightness level of the front panel display from 3 levels by pressing this button repeatedly.



- This setting is retained even if you turn off this unit.
- The default setting is the brightest.

### ⑬ MUTE

Mutes the sound output. Press again to restore the sound output to the previous volume level.

## ■ FM/AM controls

The following buttons can be used when TUNER is selected as the input source.

### ⑭ TUNING <</>>

Selects the tuning frequency (see page 14).

### PRESET </>

Selects a preset FM/AM station (see page 16).

### MEMORY

Stores the current FM/AM station as a preset (see page 15).

### INFO









Only for Europe model:

Switches information shown on the front panel display (see page 18).

## ■ Yamaha CD player controls

The following buttons can be used to control a Yamaha CD player.

### ⑮ Yamaha CD player control buttons

	Stops playback
	Pauses playback
	Starts playback
DISC SKIP	Skips to the next disc in a CD changer
	Skips backward
	Skips forward
	Ejects the disc
	Rewinds playback
	Fast-forwards playback

### Note

Even when using a Yamaha CD player, certain components and features may not be available. Refer to your component's owner's manual for more information.

## Using the remote control

### ■ Installing batteries

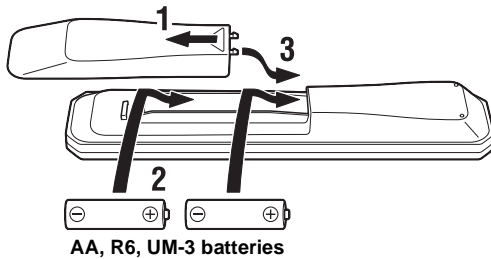

### ■ Operation range

Point the remote control at the remote control sensor on this unit and remain within the operating range shown below.

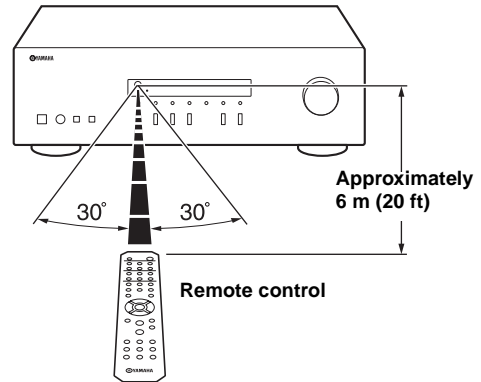

### ■ Notes on remote control and batteries

- The area between the remote control and this unit must be clear of large obstacles.
- Be careful not to spill water or other liquids on the remote control.
- Be careful not to drop the remote control.
- Do not leave or store the remote control in the following conditions:
  - places of high humidity, such as near a bathroom
  - places of high temperatures, such as near a heater or stove
  - places of extremely low temperatures
  - dusty places
- Change all batteries if you notice the operation range of the remote control narrows.
- If the batteries run out, immediately remove them from the remote control to prevent an explosion or acid leak.
- If you find leaking batteries, discard the batteries immediately, taking care not to touch the leaked material. If the leaked material comes into contact with your skin or gets into your eyes or mouth, rinse it away immediately and consult a doctor. Clean the battery compartment thoroughly before installing new batteries.
- Do not use old batteries together with new ones. This may shorten the life of the new batteries or cause old batteries to leak.
- Do not use different types of batteries (such as alkaline and manganese batteries) together. Batteries that look the same may have a different specification.
- Before inserting new batteries, wipe the battery compartment clean.
- Dispose of batteries according to your regional regulations.
- Keep the batteries in a location out of reach of children.  
Batteries can be dangerous if a child were to put in his or her mouth.
- If you plan not to use this unit for a long period of time, remove the batteries from this unit. Otherwise, the batteries will wear out, possibly resulting in a leakage of battery liquid that may damage this unit.

# PREPARATION

## CONNECTIONS

### Connecting speakers and source components

Make sure to connect L (left) to L, R (right) to R, “+” to “+” and “-” to “-”. If the connections are faulty, no sound will be heard from the speakers, and if the polarity of the speaker connections is incorrect, the sound will be unnatural and lack bass. Refer to the owner’s manual for each of your components.

Make sure to use RCA cables to connect audio components.

#### CAUTION

- Do not connect this unit or other components to the main power until all connections between components are complete.
- Do not let bare speaker wires touch each other or any metal part of this unit. This could damage this unit and/or the speakers.

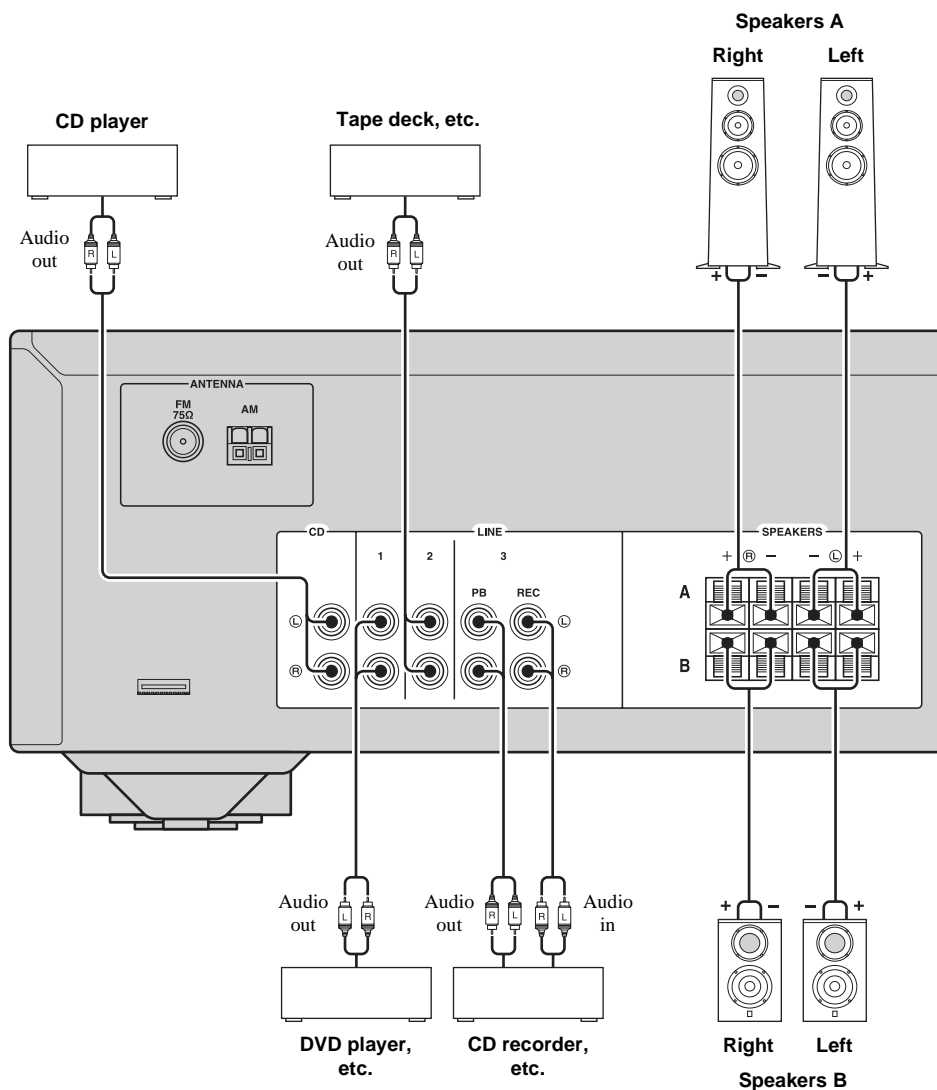

**REC jacks**

- The REC jacks output audio signals of the currently selected input (except when LINE 3 is selected).
- Volume level, tone control and balance settings do not affect the REC jacks.

**Connecting speaker cables**

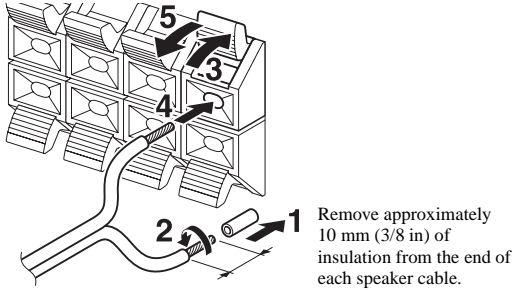

**Note**

When inserting speaker cables into the speaker terminals, insert only the bare speaker wire. If insulated cable is inserted, the connection may be poor and sound may not be heard.

**CAUTION**

Speaker impedance must be set as shown below.

Speaker connection	Speaker impedance
SPEAKERS A or SPEAKERS B	8 Ω or higher
SPEAKERS A and SPEAKERS B	16 Ω or higher (except for North America model)
Bi-wiring	8 Ω or higher

**Bi-wire connection**

Bi-wire connection separates the woofer from the combined midrange and tweeter section. A bi-wire compatible speaker has four binding post terminals. These two sets of terminals allow the speaker to be split into two independent sections. With these connections, the mid and high frequency drivers are connected to one set of terminals and the low frequency driver to another set of terminals.

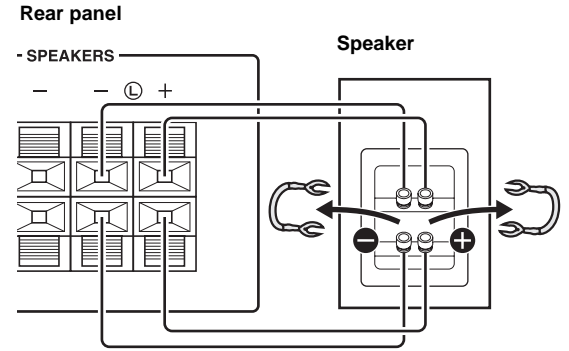

Connect the other speaker to the other set of terminals in the same way.

**Note**

When making bi-wire connections, remove the shorting bridges or cables on the speaker.



To use the bi-wire connections, press SPEAKERS A and SPEAKERS B so that both SP A and B light up on the front panel display.

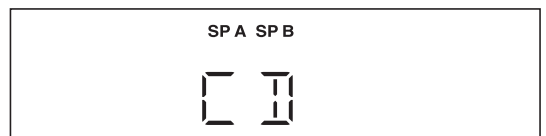
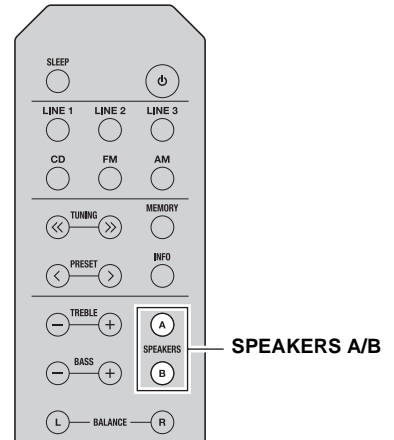

## Connecting the FM and AM antennas

Indoor antennas for receiving FM and AM broadcasts are included with this unit. In general, these antennas should provide sufficient signal strength. Connect each antenna correctly to the designated terminals.

### Note

If you experience poor reception quality, install an outdoor antenna. Consult the nearest authorized Yamaha dealer or service center about outdoor antennas.

#### Outdoor FM antenna

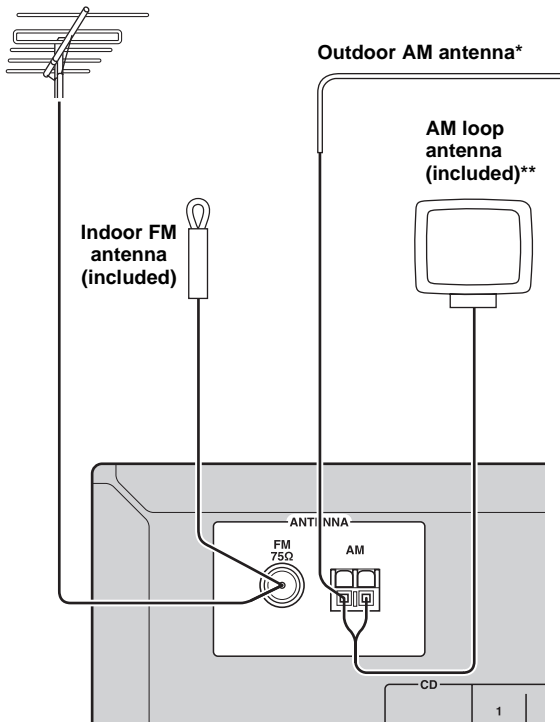

#### \*Outdoor AM antenna

Use 5 to 10 m of vinyl-covered wire extended outdoors from a window.

#### \*\*AM loop antenna (included)

- The AM loop antenna should always be connected, even if an outdoor AM antenna is connected to this unit.
- The AM loop antenna should be placed away from this unit.
- The wires of the AM antenna have no polarity.

#### ■ Assembling the supplied AM loop antenna

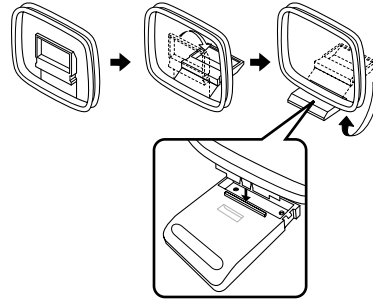

#### ■ Connecting the wire of the AM loop antenna

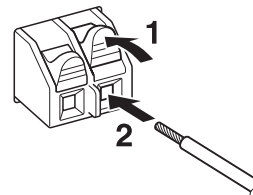

## Connecting power cable

Plug the power cable into an AC wall outlet after all other connections are complete.

### CAUTION

Only for General model:

Before connecting the power cable, make sure you set **VOLTAGE SELECTOR** of this unit according to your local voltage. Improper setting of **VOLTAGE SELECTOR** may cause fire and damage to this unit.

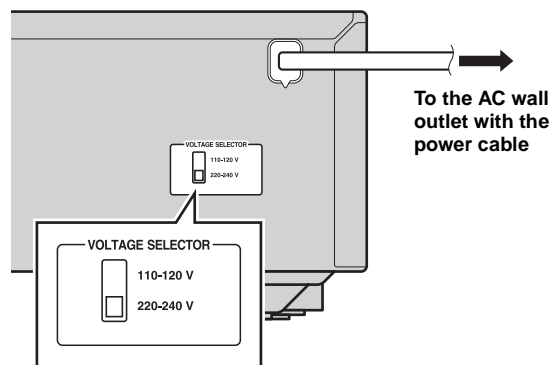

# BASIC OPERATION

## PLAYBACK

### Playing a source

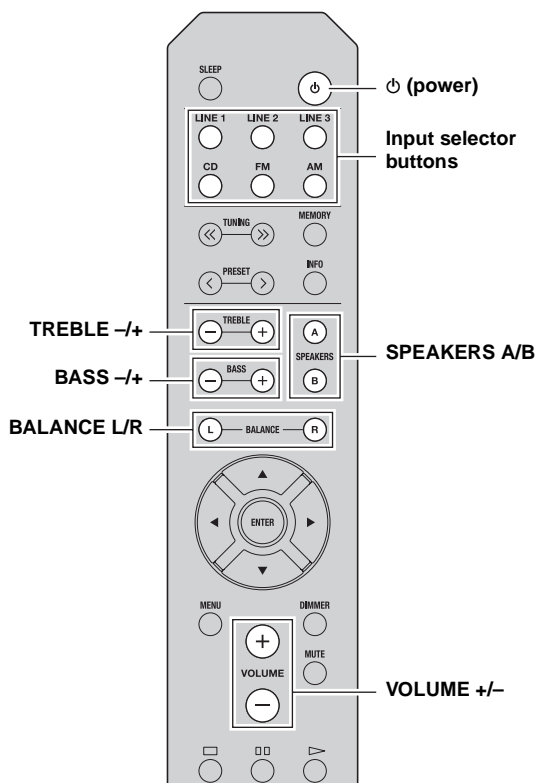

**1** Press **⏻** (power) to turn on this unit.

**2** Press one of the Input selector buttons to select the desired input source.

**3** Press **SPEAKERS A** and/or **SPEAKERS B** to select desired speaker(s).

#### Notes

- When one set of speakers is connected using bi-wire connections, or when using two sets of speakers simultaneously (A and B), make sure SP A and SP B are displayed on the front panel display.
- When listening with headphones, turn off the speakers.

**4** Play the source.

**5** Press **VOLUME +/-** to adjust the sound output level.



You can adjust the tonal quality by using **BASS -/+** and **TREBLE -/+**, and the left/right sound balance of speakers by using **BALANCE L/R** (see page 6).

**6** When finished listening, press **⏻** (power) to set this unit to standby mode.

Press **⏻** (power) to turn this unit on again.



- You can also use the buttons or knobs on the front panel if they have the same or similar names as those on the remote control.
- For recording, see page 5.



## Using the sleep timer

Use this feature to automatically set this unit to standby mode after a certain amount of time. The sleep timer is useful when you are going to sleep while this unit is playing or recording a source.

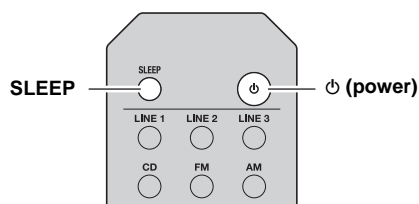

**Press SLEEP repeatedly to set the amount of time before this unit is set to standby mode.**

Each time you press SLEEP, the front panel display changes cyclically as shown below.

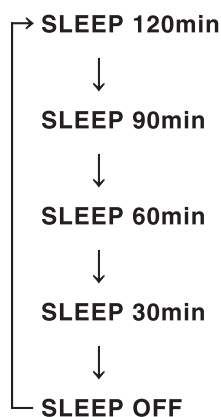

The SLEEP indicator blinks while setting the amount of time for the sleep timer.



If the sleep timer is set, the SLEEP indicator on the front panel display lights up.



To cancel the sleep timer, do one of the following:

- Select "SLEEP OFF".
- Set this unit to standby mode.

# FM/AM TUNING

## Notes

- The radio frequencies differ depending on the country or region where this unit is being used. Front panel display illustrations shown in this section are based on Europe model.
- Only for Asia and General models:  
Be sure to set the tuner frequency step according to the frequency spacing in your area before you tune into a radio station (see page 19).

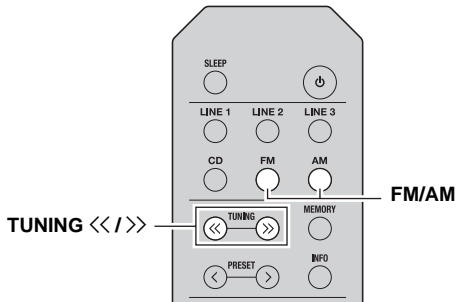

**1 Press FM/AM to select TUNER as the input source and select the band.**

**2 Press and hold TUNING <</>> to begin tuning.**

Press >> to tune in to a higher frequency.

Press << to tune in to a lower frequency.

When this unit tunes in to a station, the TUNED indicator lights up on the front panel display.

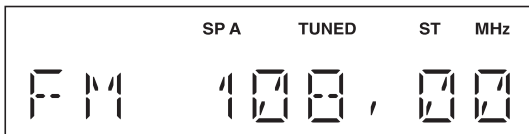

## Note

If the tuning search does not stop at the desired station because the station signals are weak, press TUNING <</>> repeatedly to tune in to the desired station.



You can also use the buttons on the front panel if they have the same or similar names as those on the remote control.

## Improving FM reception

If the signal from the station is weak and the sound quality is not good, set the FM band reception mode to monaural mode to improve reception.

### Front panel

Press FM MODE, and then make sure the ST indicator is turned off (see page 4).

### Remote control

Enter FM MODE from the Option menu to select MONO (monaural mode) (see page 19).

## Using preset functions

You can register up to 40 radio stations as presets. Once you have registered stations, you can easily tune in to them by recalling the presets.

### Presetting stations automatically (FM stations only)

You can automatically register FM stations that have strong signals.

## Notes

- If a station is registered to a preset number that already has a station registered to it, the previously registered station is overwritten.
- If the station you want to store is weak in signal strength, press TUNING <</>> repeatedly to tune in to the desired station.
- Only for Europe model:  
Only Radio Data System broadcasting stations can be preset automatically.



FM stations registered as presets using the automatic preset registration feature will be heard in stereo.

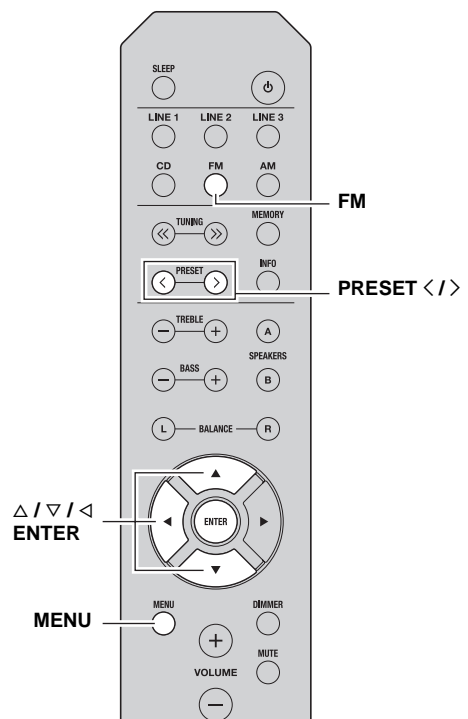

**1 Press FM to select TUNER as the input source.**

**2 Press MENU to enter the Option menu.**  
The Option menu for TUNER is displayed (see page 19).

**3 Press  $\Delta$  /  $\nabla$  to select "AUTO PRESET", and then press ENTER.**

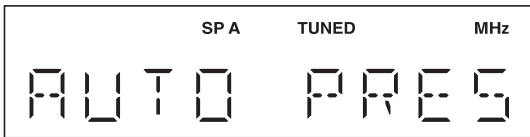

This unit starts scanning the FM band about 3 seconds later from the lowest frequency upwards.



- Before scanning begins, you can specify the first preset number to be used by pressing PRESET </> or  $\Delta$ / $\nabla$ .
- To cancel scanning, press  $\triangleleft$ .

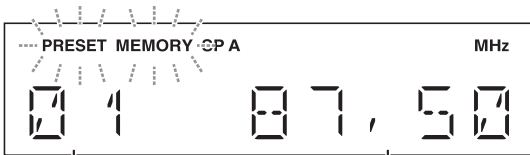

Preset number

Frequency

When a station to preset is found, information is displayed on the front panel display as shown in the illustration above.

When scanning is complete, "FINISH" is displayed, and then the display returns to the Option menu. To return the display to the original state, press MENU.

**■ Presetting stations manually**

You can manually register the desired radio stations.

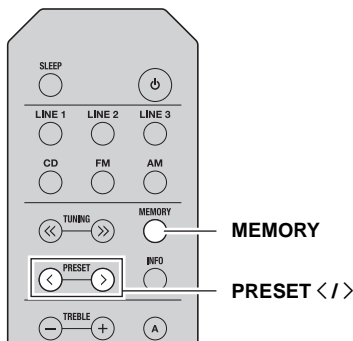

**1 Tune in to the desired FM/AM station.**  
See page 14 for tuning instructions.

**2 Press MEMORY.**  
"MANUAL PRESET" is displayed briefly on the front panel display, and then the preset number to which the station will be registered is displayed.

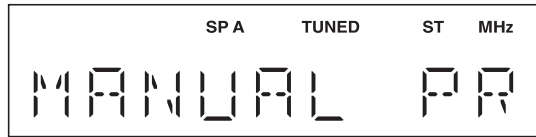

By holding down MEMORY for more than 2 seconds, you can skip the following steps and automatically register the selected station to an empty preset number (i.e., the preset number following the last preset number used).

**3 Press PRESET </> to select the preset number to which the station will be registered.**

When you select a preset number to which no station is registered, "EMPTY" is displayed. When you select a preset number to which a station has already been registered, the frequency of the station is displayed.

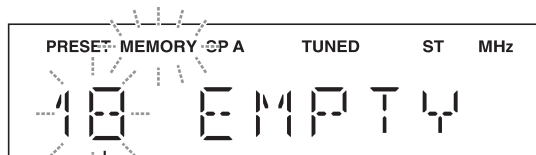

Preset number

**4 Press MEMORY.**

When registration is complete, the display returns to the original state.



- To cancel registration, switch input or band or do not perform any operations for about 30 seconds.
- You can also preset stations manually by pressing buttons on the front panel with the same names as remote control.

■ **Recalling a preset station**

You can recall preset stations that were registered by presetting automatically or manually.

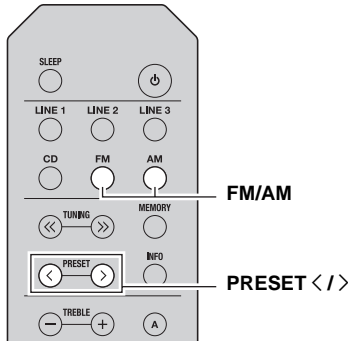

**1 Press FM/AM to select TUNER as the input source.**

**2 Press PRESET </> to select a preset number.**



- Preset numbers to which no stations are registered are skipped.
- If this unit does not have any preset stations, “NO PRESET” is displayed.
- If the station signals that you want to recall are weak, try tuning in to a station manually.
- You can also recall a preset station by pressing PRESET </> on the front panel.

■ **Clearing a preset station**

Follow the steps below to clear a preset station.

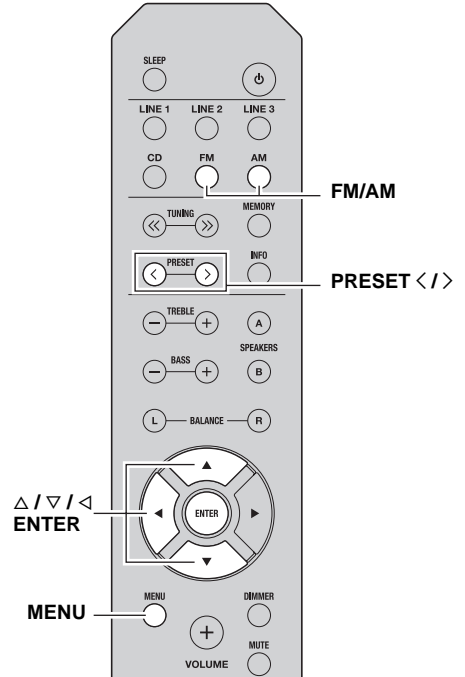

**1 Press FM/AM to select TUNER as the input source.**

**2 Press MENU to enter the Option menu.**

The Option menu for TUNER is displayed (see page 19).

**3 Press  $\Delta / \nabla$  to select “CLEAR PRESET”, and then press ENTER.**

**4 Select the desired preset station number by pressing  $\Delta / \nabla$  repeatedly.**

The selected preset number blinks on the front panel display.

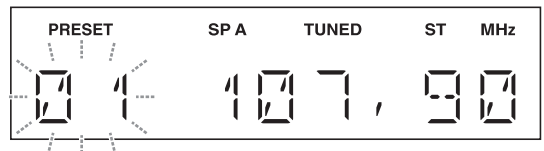

- You can also use PRESET </> instead.
- To cancel clearing the preset station, press  $\triangleleft$  or leave this unit without any operations for about 30 seconds.

**5 Press ENTER again to confirm.**

“CLEARED” is displayed on the front panel display. Then, another preset station is shown on the front panel display. When there is no more preset station, “NO PRESET” is displayed, and then the display returns to the Option menu. To return the display to the original state, press MENU.

**■ Clearing all preset stations**

Follow the steps below to clear all preset stations.

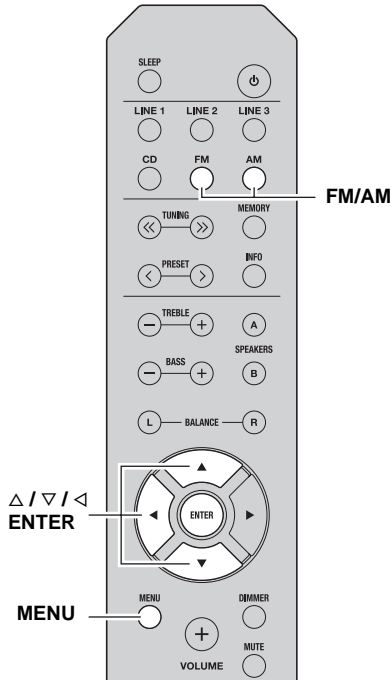
**1 Press FM/AM to select TUNER as the input source.****2 Press MENU to enter the Option menu.**

The Option menu for TUNER is displayed (see page 19).

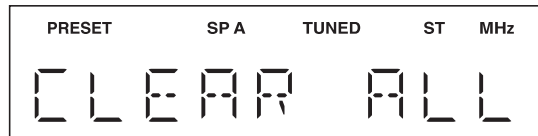
**3 Press  $\Delta$  /  $\nabla$  to select “CLEAR ALL PRESET”, and then press ENTER.**

To cancel the operation and return to the Option menu, press  $\triangleleft$ .

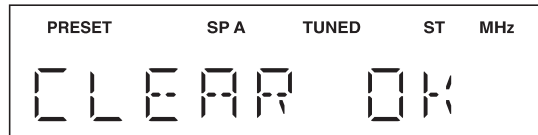
**4 Press  $\Delta$  /  $\nabla$  to select “CLEAR OK”, and then press ENTER.**

To cancel without clearing the presets, select “CLEAR NO”.

When all presets have been cleared, “CLEARED” is displayed, and then the display returns to the Option menu.

To return the display to the original state, press MENU.

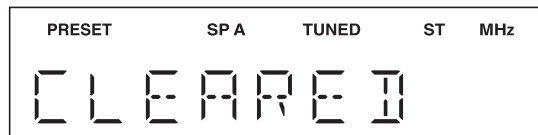

## Receiving Radio Data System information (Only for Europe model)

Radio Data System is a data transmission system used by FM stations in many countries.

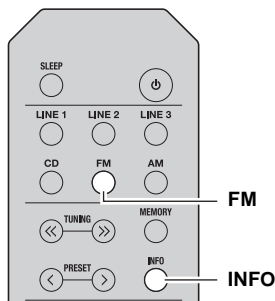

- 1** Press FM to select TUNER as the input source.
- 2** Tune in to the desired Radio Data System broadcasting station.
- 3** Press INFO repeatedly to select the desired Radio Data System display mode.

Choice	Description
Frequency	This unit displays the frequency of the current station.
Program Service	Default setting. This unit displays the name of the Radio Data System program currently being received.
Program Type	This unit displays the type of the Radio Data System program currently being received.
Radio Text	This unit displays about the Radio Data System program currently being received.
Clock Time	This unit displays the current time being received.

When you select Program Type, the following program types can be displayed.

Program type	Description
NEWS	News
AFFAIRS	Current affairs
INFO	General information
SPORT	Sport
EDUCATE	Education
DRAMA	Drama
CULTURE	Culture
SCIENCE	Science
VARIED	Light entertainment
POP M	Popular music
ROCK M	Rock music
EASY M	Middle-of-the-road music (easy listening)
LIGHT M	Light classics
CLASSICS	Serious classics
OTHER M	Other music

# ADVANCED OPERATION

## SETTING THE OPTION MENU FOR EACH INPUT SOURCE

The Option menu allows you to configure various settings for each input source and recall those settings automatically when an input source is selected.

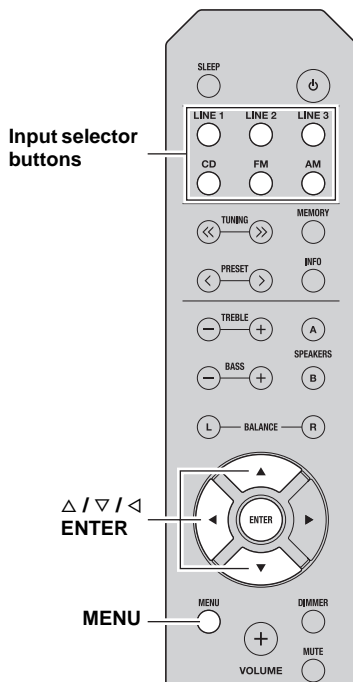

- 1 Press one of the Input selector buttons to select the desired input source.
- 2 Press MENU.
- 3 Press  $\Delta$  /  $\nabla$  to select the desired menu item, and then press ENTER.
- 4 Press  $\Delta$  /  $\nabla$  to change the settings.
  - For certain menu items, you must press ENTER to save the new setting.
  - To return to the screen where you can select menu items, press  $\triangleleft$ .
- 5 To exit the Option menu, press MENU.

### Option menu items

Available menu items vary depending on the selected input source.

Menu item	Description
<b>MAX VOL</b>	Sets the maximum volume level so that the volume will not be accidentally increased above a certain level. Adjustable range: 01 to 99, MAX*
<b>INITIAL VOLUME (INIT VOL)</b>	Sets the volume at the time this unit is turned on. When this parameter is set to "OFF", the volume level used when this unit was set to standby is applied. Adjustable range: OFF*, MUTE, 01 to 99, MAX
<b>TUNER STEP (TUNER STP)</b> Only for Asia and General models	Sets tuner frequency step. Choices: AM10/FM100, AM9/FM50*
<b>FM MODE</b>	Changes the FM radio wave reception mode (see page 14). Choices: STEREO*, MONO
<b>AUTO PRESET (A, PREST)</b>	Automatically detects FM radio stations and registers them as preset stations (see page 14).
<b>CLEAR PRESET (C, PREST)</b>	Clears a selected preset station (see page 16).
<b>CLEAR ALL PRESET (C,A, PREST)</b>	Clears all preset stations (see page 17).
<b>AUTO POWER STANDBY (AUTO STBY)</b>	Sets this unit to standby mode automatically if no operation is performed in the specified time. Choices: OFF/2H/4H/8H*/12H

The default settings are marked with "\*".

# ADDITIONAL INFORMATION

## TROUBLESHOOTING

Refer to the chart below if this unit does not function properly. If the problem you are experiencing is not listed below or if the instructions below do not help, set this unit to standby mode, disconnect the power cable, and then contact the nearest authorized Yamaha dealer or service center.

### ■ General

Problem	Cause	Remedy	See page
<b>This unit fails to turn on.</b>	The power cable is not connected or the plug is not completely inserted.	Connect the power cable firmly.	—
	The impedance setting of the connected speaker is too small.	Use speaker(s) with proper speaker impedance.	10
	The protection circuitry has been activated because of a short circuit, etc.	Check that the speaker wires are not touching each other and then turn the power of this unit back on.	9
	This unit has been exposed to a strong external electric shock (such as lightning or strong static electricity).	Set this unit to standby mode, disconnect the power cable, plug it back in after 30 seconds, then use it normally.	—
<b>No sound</b>	Incorrect input or output cable connections.	Connect the cables properly. If the problem persists, the cables may be defective.	9
	No appropriate input source has been selected.	Select an appropriate input source by pressing one of the Input selector buttons on the remote control (INPUT <◁ / ▷ or FM/AM on the front panel).	12
	The SPEAKERS A/B switches are not set properly.	Turn on the corresponding SPEAKERS A or SPEAKERS B.	12
	Speaker connections are not secure.	Secure the connections.	9
	Output has been muted.	Deactivate the mute function.	6
	The MAX VOL or INITIAL VOLUME setting is set too low.	Set the setting to a higher value.	19
	The component corresponding to the selected input source is turned off or is not playing.	Turn the component on and make sure it is playing.	—
<b>The sound suddenly goes off.</b>	The protection circuitry has been activated because of a short circuit, etc.	Check that the speaker wires are not touching each other and then turn the power of this unit back on.	9
	This unit has become too hot.	Make sure the openings on the top panel are not blocked.	—
	The AUTO POWER STANDBY or SLEEP function has set this unit to standby mode.	Change the AUTO POWER STANDBY setting to a longer setting or OFF from the Option menu by pressing MENU.	19
<b>Only the speaker on one side can be heard.</b>	Incorrect cable connections.	Connect the cables properly. If the problem persists, the cables may be defective.	9
	Incorrect setting for the BALANCE L/R setting.	Set the BALANCE L/R setting to the appropriate position.	6
<b>There is a lack of bass and no ambience.</b>	The + and – wires are connected in reverse at the amplifier or the speakers.	Connect the speaker wires to the correct + and – phase.	9
<b>A “humming” sound can be heard.</b>	Incorrect cable connections.	Connect the audio plugs firmly. If the problem persists, the cables may be defective.	9
<b>The volume level cannot be increased, or the sound is distorted.</b>	The component connected to the LINE 3 PB/REC jacks of this unit is turned off.	Turn on the power of the component.	—



Problem	Cause	Remedy	See page
<b>The sound is degraded when listening with headphones connected to a CD player connected to this unit.</b>	This unit has been set to standby mode.	Turn on the power of this unit.	12
<b>The remote control does not work nor function properly.</b>	Wrong distance or angle.	The remote control will function within a maximum range of 6 m (20 ft) and no more than 30 degrees off-axis from the front panel.	8
	Direct sunlight or lighting (from an inverter type of fluorescent lamp, etc.) is striking the remote control sensor of this unit.	Reposition this unit.	—
	The batteries are weak.	Replace all batteries.	8
<b>Your CD player cannot be operated with the remote control.</b>	The remote control does not support the CD player.	Refer to the owner's manual supplied with the CD player.	—
<b>"OVER HEAT" appears on the front panel display.</b>	This unit has become too hot.	Make sure the openings on the top panel are not blocked.	—
<b>"CHECK SP" appears on the front panel display.</b>	Speaker cables got shorted out.	Twist bare wires of speaker cables firmly, and then connect to this unit and speakers properly.	—

■ **Tuner**

Problem		Cause	Remedy	See page
FM	<b>FM stereo reception is noisy.</b>	The particular characteristics of the FM stereo broadcasts being received may cause this problem when the transmitter is too far away or the antenna input is poor.	Check the antenna connections. Try using a high-quality directional FM antenna.	11
			Switch to monaural mode.	14
	<b>There is distortion, and clear reception cannot be obtained even with a good FM antenna.</b>	There is multipath interference.	Adjust the antenna position to eliminate the multipath interference.	—
	<b>The desired station cannot be tuned in automatically.</b>	The signal is too weak.	Try using a high-quality directional FM antenna. Try tuning manually.	11 14
<b>FM/AM</b>	<b>“NO PRESET” is displayed.</b>	No preset stations are registered.	Register stations you want to listen to as preset stations before operation.	14
AM	<b>The desired station cannot be tuned in automatically.</b>	The signal is weak or the antenna connections are loose.	Tighten the AM loop antenna connections and orient it for the best reception. Try tuning manually.	— 14
	<b>Automatic station preset does not work.</b>	Automatic station preset is not available for AM stations.	Use manual station preset.	15
	<b>There are continuous crackling and hissing noises.</b>	The noises may result from lightning, fluorescent lamps, motors, thermostats or other electrical equipment.	Try using an outdoor antenna and a earth ground. This will help somewhat, but it is difficult to eliminate all noise.	—
	<b>There are buzzing and whining noises.</b>	A TV set is being used nearby.	Move this unit away from the TV set.	—

# SPECIFICATIONS

## AUDIO SECTION

- Minimum RMS output power  
(8  $\Omega$ , 40 Hz to 20 kHz, 0.2% THD)  
[North America, General, Australia and Europe models] ..... 100 W + 100 W  
[Asia model] ..... 85 W + 85 W
- Input sensitivity/Input impedance (1 kHz, 100 W/8  $\Omega$ )  
CD, etc. .... 500 mV/47 k $\Omega$
- Output level/Output impedance  
CD, etc. (Input 1 kHz, 500 mV)  
REC ..... 500 mV/2.2 k $\Omega$   
CD, etc. (Input 1 kHz, 500 mV, 8  $\Omega$ )  
PHONES ..... 470 mV/470  $\Omega$
- Frequency response  
CD, etc. (20 Hz to 20 kHz) ..... 0  $\pm$  0.5 dB  
CD, etc. (10 Hz to 100 kHz) ..... 0  $\pm$  3.0 dB
- Total harmonic distortion  
CD, etc. to SPEAKERS  
(20 Hz to 20 kHz, 50 W, 8  $\Omega$ ) ..... 0.2% or less
- Signal to noise ratio (IHF-A network)  
CD, etc. (500 mV input shorted) ..... 100 dB or more
- Residual noise (IHF-A network) ..... 70  $\mu$ V
- Tone control characteristics  
BASS  
Boost/Cut (50 Hz) .....  $\pm$  10 dB  
TREBLE  
Boost/Cut (20 kHz) .....  $\pm$  10 dB

## FM SECTION

- Tuning range  
[North America model] ..... 87.5 to 107.9 MHz  
[Asia and General models] ..... 87.5 to 107.9 MHz/87.50 to 108.00 MHz  
[Australia and Europe models] ..... 87.50 to 108.00 MHz
- 50 dB quieting sensitivity (IHF, 1 kHz, 100% MOD.)  
Mono ..... 3.0  $\mu$ V (20.8 dBf)
- Signal to noise ratio (IHF)  
Mono/Stereo ..... 72 dB/70 dB
- Harmonic distortion (1 kHz)  
Mono/Stereo ..... 0.3%/0.5%
- Antenna Input ..... 75  $\Omega$ , unbalanced

## AM SECTION

- Tuning range  
[North America model] ..... 530 to 1710 kHz  
[Asia and General models] ..... 530 to 1710 kHz/531 to 1611 kHz  
[Australia and Europe models] ..... 531 to 1611 kHz

## GENERAL

- Power supply  
[North America model] ..... AC 120 V, 60 Hz  
[General model] ..... AC 110-120/220-240 V, 50/60 Hz  
[Australia model] ..... AC 240 V, 50 Hz  
[Europe model] ..... AC 230 V, 50 Hz  
[Asia model] ..... AC 220-240 V, 50/60 Hz
- Power consumption  
[North America, General, Australia and Europe models] ..... 175 W  
[Asia model] ..... 140 W
- Standby power consumption  
[North America, Australia, Europe and Asia models] ..... 0.5 W or less
- Dimensions (W  $\times$  H  $\times$  D) ..... 435  $\times$  141  $\times$  322 mm  
(17'1/8"  $\times$  5'1/2"  $\times$  12'5/8")
- Weight ..... 6.7 kg (14.8 lbs)

\* Specifications are subject to change without notice.

