



AVENTAGE

AV Receiver

RX-A850

RX-A750

Owner's Manual

Read the supplied booklet "Safety Brochure" before using the unit.

English

CONTENTS

Accessories	5
-------------------	---

FEATURES 6

What you can do with the unit	6
-------------------------------------	---

Useful applications	8
---------------------------	---

Part names and functions	9
--------------------------------	---

Front panel (RX-A850)	9
-----------------------------	---

Front panel (RX-A750)	10
-----------------------------	----

Front display (indicators)	11
----------------------------------	----

Rear panel (RX-A850)	12
----------------------------	----

Rear panel (RX-A750)	13
----------------------------	----

Remote control	14
----------------------	----

PREPARATIONS 15

General setup procedure	15
-------------------------------	----

1 Placing speakers	16
--------------------------	----

2 Connecting speakers	20
-----------------------------	----

Connecting front speakers that support bi-amp connections	22
---	----

Input/output jacks and cables	23
-------------------------------------	----

3 Connecting a TV	24
-------------------------	----

4 Connecting playback devices	26
-------------------------------------	----

Connecting video devices (such as BD/DVD players)	26
---	----

Connecting audio devices (such as CD players)	29
---	----

Connecting to the jacks on the front panel	29
--	----

5 Connecting the FM/AM antennas	30
---------------------------------------	----

6 Connecting a network cable or preparing the wireless antenna	31
---	----

Connecting the network cable	31
------------------------------------	----

Preparing the wireless antenna	31
--------------------------------------	----

7 Connecting other devices	32
----------------------------------	----

Connecting an external power amplifier	32
--	----

Connecting a device compatible with the trigger function	32
--	----

8 Connecting the power cable	33
------------------------------------	----

9 Selecting an on-screen menu language	34
--	----

10 Optimizing the speaker settings automatically (YPAO)	35
---	----

Measuring at one listening position (single measure)	37
--	----

Measuring at multiple listening positions (multi measure) (RX-A850 only)	38
--	----

Checking the measurement results	40
--	----

Reloading the previous YPAO adjustments	40
---	----

Error messages	41
----------------------	----

Warning messages	42
------------------------	----

11 Connecting to a network device wirelessly	43
--	----

Selecting the connection method	43
---------------------------------------	----

Connecting the unit to a wireless network	44
---	----

Connecting a mobile device to the unit directly (Wireless Direct)	50
---	----

PLAYBACK 52

Basic playback procedure	52
--------------------------------	----

Selecting an HDMI output jack	52
-------------------------------------	----

Selecting the input source and favorite settings with one touch	
---	--

(SCENE)	53
---------------	----

Configuring scene assignments	53
-------------------------------------	----

Selecting the sound mode	54
--------------------------------	----

Enjoying stereoscopic sound fields (CINEMA DSP 3D)	55
--	----

Enjoying unprocessed playback	58
-------------------------------------	----

Enjoying pure high fidelity sound (Pure Direct)	59
---	----

Enjoying compressed music with enhanced sound (Compressed Music Enhancer)	59
---	----

Listening to FM/AM radio	60
Setting the frequency steps	60
Selecting a frequency for reception	61
Registering favorite radio stations (presets)	61
Radio Data System tuning	62
Operating the radio on the TV	63
Playing back music via Bluetooth	65
Playing back <i>Bluetooth</i> device music on the unit	65
Playing back iPod music	66
Connecting an iPod	66
Playback of iPod content	66
Playing back music stored on a USB storage device	69
Connecting a USB storage device	69
Playback of USB storage device contents	69
Playing back music stored on media servers (PCs/NAS)	72
Media sharing setup	72
Playback of PC music contents	73
Listening to Internet radio	76
Playback of Internet radio	76
Registering favorite Internet radio stations (bookmarks)	78
Playing back music with AirPlay	79
Playback of iTunes/iPod music contents	79
Playing back music in multiple rooms (multi-zone)	81
Preparing Zone2	81
Controlling Zone2	84
Controlling the unit from a web browser (web control)	86
Viewing the current status	89
Switching information on the front display	89
Viewing the status information on the TV	89
Configuring playback settings for different playback sources (Option menu)	90
Option menu items	90

CONFIGURATIONS

93

Configuring input sources (Input menu)	93
Input menu items	93
Configuring the SCENE function (Scene menu)	95
Scene menu items	96
Configuring sound programs/surround decoders (DSP Program menu)	97
DSP Program menu items	98
Configuring various functions (Setup menu)	100
Setup menu items	101
Speaker (Manual Setup)	103
Sound	107
Video	109
HDMI	110
Network	111
Bluetooth	113
Multi Zone	114
Function	115
ECO	116
Language	117
Viewing information about the unit (Information menu)	117
Types of information	118
Configuring the system settings (ADVANCED SETUP menu)	119
ADVANCED SETUP menu items	119
Changing the speaker impedance setting (SP IMP.)	120
Selecting the remote control ID (REMOTE ID)	120
Changing the FM/AM tuning frequency setting (TU)	120
Switching the video signal type (TV FORMAT)	120
Removing the limitation on HDMI video output (MON.CHK)	121
Selecting the HDMI 4K signal format (4K MODE)	121
Restoring the default settings (INIT)	121
Updating the firmware (UPDATE)	122
Checking the firmware version (VERSION)	122
Updating the unit's firmware via the network	123

Frequently asked questions	124
Troubleshooting	125
Power, system and remote control	125
Audio	126
Video	128
FM/AM radio	128
<i>Bluetooth</i>	129
USB and network	130
Error indications on the front display	132
Ideal speaker layout	133
Glossary	134
Audio information	134
HDMI and video information	136
Network information	136
Yamaha technologies	136
Supported devices and file formats	137
Video signal flow	138
Information on HDMI	139
HDMI Control	139
Audio Return Channel (ARC)	140
HDMI signal compatibility	141
Dolby Atmos (RX-A850 only)	142
Reference diagram (rear panel)	145
Trademarks	146
Specifications	147
Index	151

Accessories

Check that the following accessories are supplied with the product.

Remote control

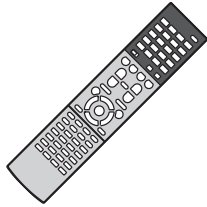

Batteries (AAA, R03, UM-4) (x2)

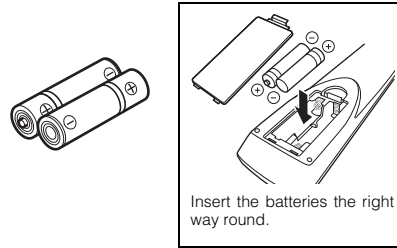

AM antenna



FM antenna

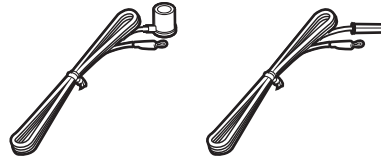

*One of the above is supplied depending on the region of purchase.

YPAO microphone

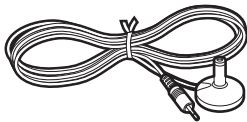

Power cable



*The supplied power cable varies depending on the region of purchase.

CD-ROM (Owner's Manual)

Easy Setup Guide

Safety Brochure

Operating range of the remote control

- Point the remote control at the remote control sensor on the unit and remain within the operating range shown below.

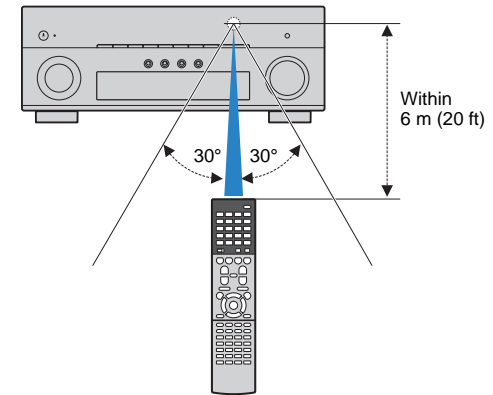

- The illustrations of the main unit and remote control used in this manual are of the RX-A850 (U.S.A. model), unless otherwise specified.

- In this manual, illustrations of English menu screens are used as examples.

- (RX-A850 [China, Korea, U.K. and Europe models] only)
For information on how to control external devices with the remote control, refer to "Supplement for Remote Control" on the supplied CD-ROM.

- Some features are not available in certain regions.

- Due to product improvements, specifications and appearance are subject to change without notice.

- This manual explains operations using the supplied remote control.

- This manual describes all the "iPod" and "iPhone" as the "iPod". "iPod" refers to both "iPod" and "iPhone" unless otherwise specified.

- indicates precautions for use of the unit and its feature limitations.

- indicates supplementary explanations for better use.

FEATURES

What you can do with the unit

Wide variety of supported content

- **Bluetooth** ➔ p.65
- **iPod/iPhone** ➔ p.66
- **USB** ➔ p.69
- **Media server (PC/NAS)** ➔ p.72
- **Internet radio** ➔ p.76
- **AirPlay** ➔ p.79

Supports 2- to 7.1-channel (plus presence) speaker system. Allows you to enjoy your favorite acoustic spaces in various styles.

- **Automatically optimizing the speaker settings to suit your room (YPAO)** ➔ p.35
- **Reproducing stereo or multichannel sounds with the sound fields like actual movie theaters and concert halls (CINEMA DSP)** ➔ p.55
- **Enjoying compressed music with enhanced sound (Compressed Music Enhancer)** ➔ p.59
- **Playing back music in multiple rooms (multi-zone)** ➔ p.81

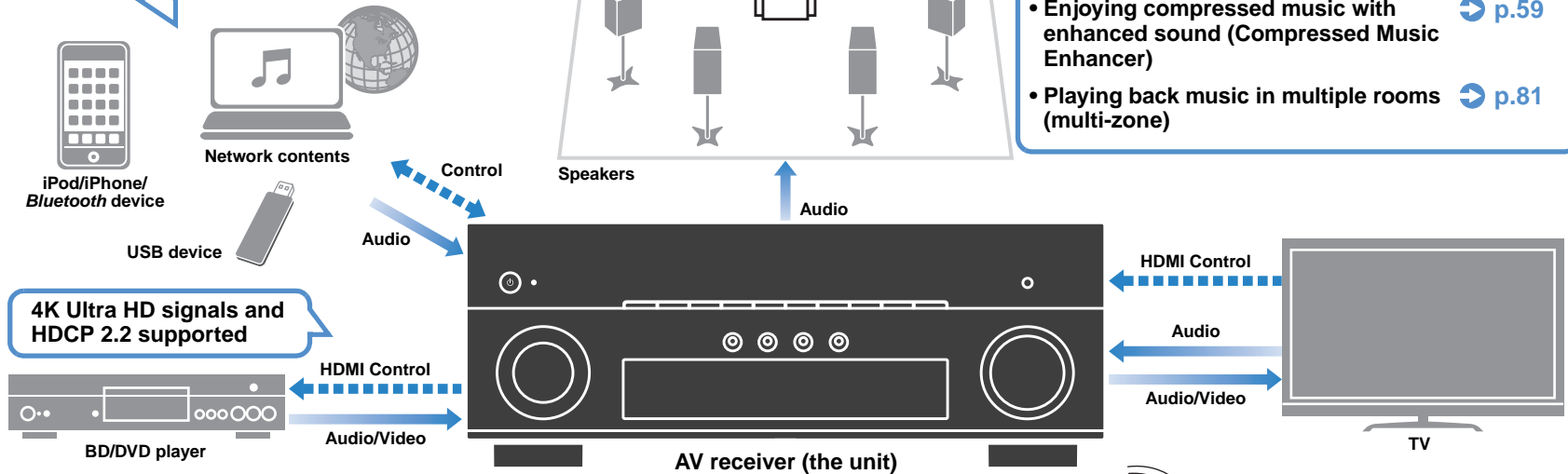

4K Ultra HD signals and HDCP 2.2 supported

Playback of Dolby Atmos contents supported (RX-A850 only)

➔ p.142

Change the input source and favorite settings with one touch (SCENE)

➔ p.53

Sequential operation of a TV, AV receiver, and BD/DVD player (HDMI Control)

➔ p.139

TV remote control

Full of useful functions!

❑ Connecting various devices (p.26)

A number of HDMI jacks and various input/output jacks on the unit allow you to connect video devices (such as BD/DVD players), audio devices (such as CD players), game consoles, camcorders, and other devices.

❑ Playing back TV audio in surround sound with a single HDMI cable connection (Audio Return Channel: ARC) (p.24)

When using an ARC-compatible TV, you only need one HDMI cable to enable video output to the TV, audio input from the TV, and the transmission of HDMI Control signals.

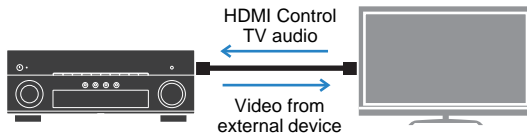

❑ Various wireless connection methods (p.43)

The unit supports the Wi-Fi feature that allows the unit to connect to your wireless router (access point) without a network cable connection. In addition, Wireless Direct enables connecting a mobile device to the unit directly without router.



❑ Creating 3-dimensional sound fields (p.55)

Connecting presence speakers allows you to create a natural 3-dimensional sound field in your own room (CINEMA DSP 3D). Even when no presence speakers are connected, the Virtual Presence Speaker (VPS) function produces 3D surround sound. In addition, the unit creates Virtual Surround Back Speaker (VSBS) using the surround speakers to add a sense of depth to the rear sound field even when no surround back speakers are connected.

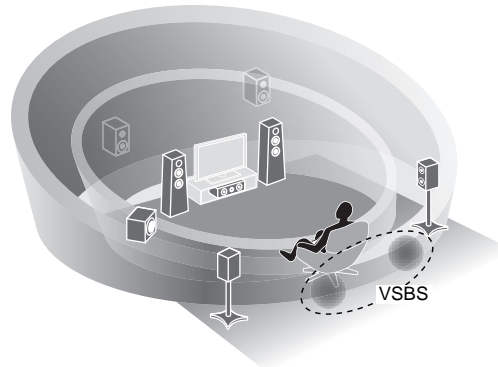

❑ Surround playback with 5 speakers placed in front (p.57)

If you have surround speakers but there is no space to place them in the rear of your room, you can place them in the front and enjoy multichannel surround sound with the 5 speakers placed in the front (Virtual CINEMA FRONT).

❑ Low power consumption (p.116)

The ECO mode (power saving function) reduces the unit's power consumption.

Useful tips

The combination of video/audio input jacks does not match an external device...

Use "Audio In" in the "Input" menu to change the combination of video/audio input jacks so that it matches the output jack(s) of your external device (p.27).

Video and audio are not synchronized...

Use "Lipsync" in the "Setup" menu to adjust the delay between video and audio output (p.107).

I want to hear audio from the TV speakers...

Use "Audio Output" in the "Setup" menu to select the output destination of signals input into the unit (p.111). Your TV speakers may be selected as an output destination.

I want to get more bass sounds...

Set "Extra Bass" in the "Option" menu to "On" to enjoy enhanced bass sounds (p.92).

I want to change the on-screen menu language...

Use "Language" in the "Setup" menu to select a language from English, Japanese, French, German, Spanish, Russian, Italian and Chinese (p.34).

I want to update the firmware...

Use "UPDATE" in the "ADVANCED SETUP" menu to update the unit's firmware (p.122). If the unit is connected to the Internet, a message will be displayed on the TV when a firmware update is available (p.123).

Many other settings are available that let you to customize the unit. For details, see the following pages.

- Input settings (p.93)
- SCENE settings (p.96)
- Sound program and surround decoder settings (p.98)
- Various function settings (p.101)
- Information view (such as audio signal and video signal) (p.118)
- System settings (p.119)

Useful applications

■ AV CONTROLLER



"AV CONTROLLER" will turn your smartphone/tablet into a Wi-Fi enabled remote control for your Yamaha network products. This application provides you the flexibility to control the available inputs, volume, mute, power commands and playback source.

Functions

- Power on/off and volume adjustment
- Input, scene and sound mode selection
- DSP Parameter adjustment
- Playback control (including music selection for some sources)



- For details, search for "AV CONTROLLER" on the App Store or Google Play.

■ AV SETUP GUIDE (for tablet)



"AV SETUP GUIDE" is an application that assists you with cable connections between AV receiver and source devices as well as AV receiver setup. This application guides you through the various settings such as speaker connections, TV and video/audio device connections and selecting the speaker system.

Functions

- Connection guide (speakers, TV and video/audio devices)
- Setup guide (YPAO settings and various setup assistance with illustrations)
- Viewing owner's manual



- For details, search for "AV SETUP GUIDE" on the App Store or Google Play.

Part names and functions

Front panel (RX-A850)

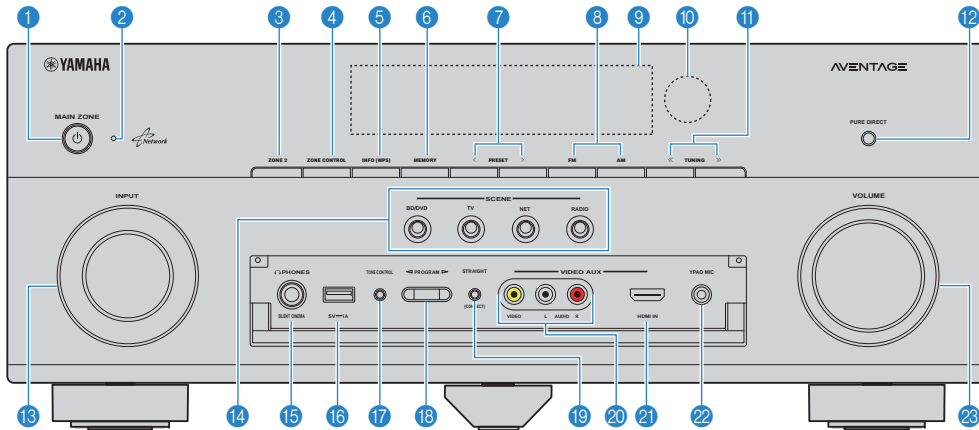

- 1 MAIN ZONE** key
Turns on/off (standby) the unit.
- 2 Standby indicator**
Lights up when the unit is in standby mode under any of the following conditions.
 - HDMI Control is enabled (p.110)
 - Standby Through is enabled (p.111)
 - Network Standby is enabled (p.112)
 - An iPod is being charged (p.66)
- 3 ZONE 2 key**
Enables/disables the audio output to Zone2 (p.84).
- 4 ZONE CONTROL key**
Changes the zone (main zone or the Zone2) that is controlled by the keys and knobs on the front panel (p.84).
- 5 INFO (WPS) key**
Selects the information displayed on the front display (p.89). Enters the wireless network connection setup (WPS push button configuration) by holding down for 3 seconds (p.46).
- 6 MEMORY key**
Registers FM/AM radio stations as preset stations (p.61).
- 7 PRESET keys**
Select a preset FM/AM radio station (p.62).
- 8 FM and AM keys**
Switch between FM and AM (p.61).
- 9 Front display**
Displays information (p.11).
- 10 Remote control sensor**
Receives remote control signals (p.5).
- 11 TUNING keys**
Select the radio frequency (p.61).
- 12 PURE DIRECT key**
Enables/disables Pure Direct (p.59).
- 13 INPUT knob**
Selects an input source.
- 14 SCENE keys**
Select the registered input source, sound program, and various settings with one touch. Also, turns on the unit when it is in standby mode (p.53).
- 15 PHONES jack**
For connecting headphones.
- 16 USB jack**
For connecting a USB storage device (p.69) or an iPod (p.66).

Opening the front panel door

- To use controls or jacks behind the front panel door, gently press the bottom of the door to open it. Keep the door closed when not using controls or jacks behind the front panel door.

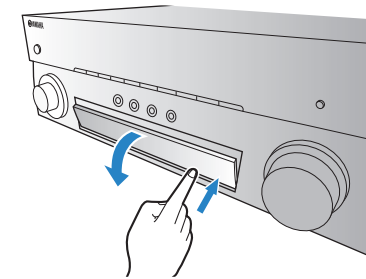

- 17 TONE CONTROL key**
Adjusts the high-frequency range and low-frequency range of output sounds (p.91).
- 18 PROGRAM keys**
Select a sound program or a surround decoder (p.54).
- 19 STRAIGHT key**
Enables/disables the straight decode mode (p.58).
- 20 VIDEO AUX (VIDEO/AUDIO) jacks**
For connecting a device, such as a camcorder and a game console (p.30).
- 21 VIDEO AUX (HDMI IN) jack**
For connecting a device, such as a camcorder and a game console (p.29).
- 22 YPAO MIC jack**
For connecting the supplied YPAO microphone (p.35).
- 23 VOLUME knob**
Adjusts the volume.

Front panel (RX-A750)

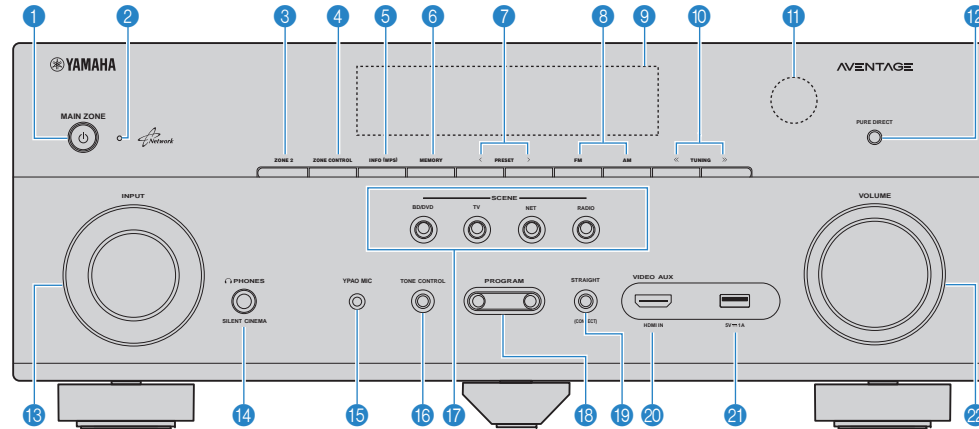

1 MAIN ZONE key

Turns on/off (standby) the unit.

2 Standby indicator

Lights up when the unit is in standby mode under any of the following conditions.

- HDMI Control is enabled (p.110)
- Standby Through is enabled (p.111)
- Network Standby is enabled (p.112)
- An iPod is being charged (p.66)

3 ZONE 2 key

Enables/disables the audio output to Zone2 (p.84).

4 ZONE CONTROL key

Changes the zone (main zone or the Zone2) that is controlled by the keys and knobs on the front panel (p.84).

5 INFO (WPS) key

Selects the information displayed on the front display (p.89).
Enters the wireless network connection setup (WPS push button configuration) by holding down for 3 seconds (p.46).

6 MEMORY key

Registers FM/AM radio stations as preset stations (p.61).

7 PRESET keys

Select a preset FM/AM radio station (p.62).

8 FM and AM keys

Switch between FM and AM (p.61).

9 Front display

Displays information (p.11).

10 TUNING keys

Select the radio frequency (p.61).

11 Remote control sensor

Receives remote control signals (p.5).

12 PURE DIRECT key

Enables/disables Pure Direct (p.59).

13 INPUT knob

Selects an input source.

14 PHONES jack

For connecting headphones.

15 YPAO MIC jack

For connecting the supplied YPAO microphone (p.35).

16 TONE CONTROL key

Adjusts the high-frequency range and low-frequency range of output sounds (p.91).

17 SCENE keys

Select the registered input source, sound program, and various settings with one touch. Also, turns on the unit when it is in standby mode (p.53).

18 PROGRAM keys

Select a sound program or a surround decoder (p.54).

19 STRAIGHT key

Enables/disables the straight decode mode (p.58).

20 VIDEO AUX (HDMI IN) jack

For connecting a device, such as a camcorder and a game console (p.29).

21 USB jack

For connecting a USB storage device (p.69) or an iPod (p.66).

22 VOLUME knob

Adjusts the volume.

Front display (indicators)

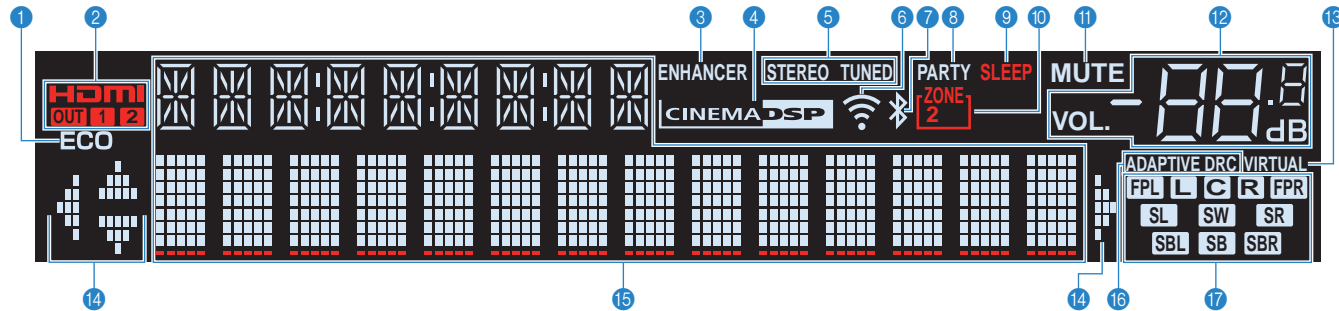

- 1 ECO**
Lights up when the unit is in the eco mode (p.116).
- 2 HDMI**
Lights up when HDMI signals are being input or output.
OUT1/OUT2 (RX-A850 only)
Indicates the HDMI OUT jacks currently outputting an HDMI signal.
OUT (RX-A750 only)
Lights up when HDMI signals are being output.
- 3 ENHANCER**
Lights up when Compressed Music Enhancer (p.59) is working.
- 4 CINEMA DSP**
Lights up when CINEMA DSP or CINEMA DSP 3D (p.55) is working.
- 5 STEREO**
Lights up when the unit is receiving a stereo FM radio signal.
TUNED
Lights up when the unit is receiving an FM/AM radio station signal.
- 6 Signal strength indicator**
Indicates the strength of the wireless network signal (p.43).
- 7 Bluetooth indicator**
Lights up when the unit is connecting to a *Bluetooth* device (p.65).
- 8 PARTY**
Lights up when the unit is in the party mode. (p.85)
- 9 SLEEP**
Lights up when the sleep timer is on.
- 10 ZONE2**
Lights up when audio output to Zone2 is enabled (p.84).
- 11 MUTE**
Blinks when audio is muted.
- 12 Volume indicator**
Indicates the current volume.
- 13 VIRTUAL**
Lights up when the Virtual Presence Speaker (VPS) or Virtual Surround Back Speaker (VSBS) (p.55), or the virtual surround processing (p.57) is working.
- 14 Cursor indicators**
Indicate the remote control cursor keys currently operational.
- 15 Information display**
Displays the current status (such as input name and sound mode name). You can switch the information by pressing INFO (p.89).
- 16 ADAPTIVE DRC**
Lights up when Adaptive DRC (p.91) is working.
- 17 Speaker indicators**
Indicate speaker terminals from which signals are output.
L Front speaker (L)
R Front speaker (R)
C Center speaker
SL Surround speaker (L)
SR Surround speaker (R)
SBL Surround back speaker (L)
SBR Surround back speaker (R)
SB Surround back speaker
FPL Presence speaker (L)
FPR Presence speaker (R)
SW Subwoofer

Rear panel (RX-A850)

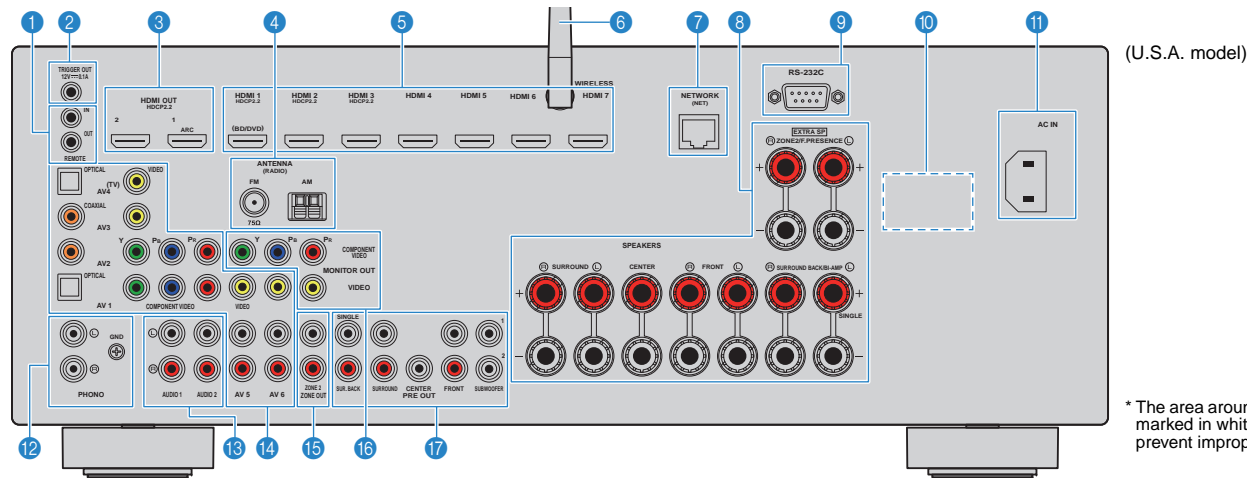

* The area around the video/audio output jacks is marked in white on the actual product to prevent improper connections.

1 REMOTE IN/OUT jacks

For connecting to an infrared signal receiver/emitter that allows you to operate the unit and other devices from another room (p.83).

2 TRIGGER OUT jack

For connecting to a device that supports the trigger function (p.32).

3 HDMI OUT 1–2 jacks

For connecting to HDMI-compatible TVs and outputting video/audio signals (p.24). When using ARC, TV audio signal can also be input through the HDMI OUT 1 jack.

4 ANTENNA jacks

For connecting to FM and AM antennas (p.30).

5 HDMI 1–7 jacks

For connecting to HDMI-compatible playback devices and inputting video/audio signals (p.26).

6 Wireless antenna

For connecting to a network device wirelessly (p.43).

7 NETWORK jack

For connecting to a network with a network cable (p.31).

8 SPEAKERS terminals

For connecting to speakers (p.20).

9 RS-232C terminal

This is a control expansion terminal for custom installation. Consult your dealer for details.

10 VOLTAGE SELECTOR

(General model only)
Selects the switch position according to your local voltage (p.33).

11 AC IN jack

For connecting the supplied power cable (p.33).

12 PHONO jacks

For connecting to a turntable (p.29).

13 AUDIO 1–2 jacks

For connecting to audio playback devices and inputting audio signals (p.29).

14 AV 1–6 jacks

For connecting to video/audio playback devices and inputting video/audio signals (p.26).

15 ZONE2 OUT jacks

For connecting to the external amplifier used in Zone2 and for outputting audio (p.82).

16 MONITOR OUT jacks COMPONENT VIDEO jacks

For connecting to a TV that supports component video and outputting video signals (p.24).

VIDEO jack

For connecting to a TV that supports composite video and outputting video signals (p.25).

17 PRE OUT jacks

For connecting to a subwoofer with built-in amplifier or to an external power amplifier (p.32).

Rear panel (RX-A750)

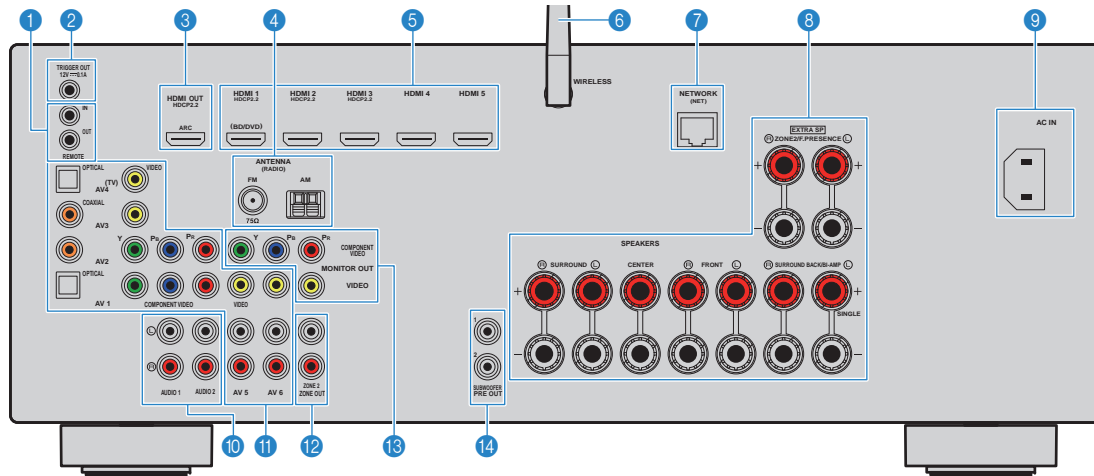

* The area around the video/audio output jacks is marked in white on the actual product to prevent improper connections.

1 REMOTE IN/OUT jacks

For connecting to an infrared signal receiver/emitter that allows you to operate the unit and other devices from another room (p.83).

2 TRIGGER OUT jack

For connecting to a device that supports the trigger function (p.32).

3 HDMI OUT jacks

For connecting to HDMI-compatible TVs and outputting video/audio signals (p.24). When using ARC, TV audio signal can also be input through the HDMI OUT 1 jack.

4 ANTENNA jacks

For connecting to FM and AM antennas (p.30).

5 HDMI 1–5 jacks

For connecting to HDMI-compatible playback devices and inputting video/audio signals (p.26).

6 Wireless antenna

For connecting to a network device wirelessly (p.43).

7 NETWORK jack

For connecting to a network with a network cable (p.31).

8 SPEAKERS terminals

For connecting to speakers (p.20).

9 AC IN jack

For connecting the supplied power cable (p.33).

10 AUDIO 1–2 jacks

For connecting to audio playback devices and inputting audio signals (p.29).

11 AV 1–6 jacks

For connecting to video/audio playback devices and inputting video/audio signals (p.26).

12 ZONE 2 OUT jacks

For connecting to the external amplifier used in Zone2 and for outputting audio (p.82).

13 MONITOR OUT jacks COMPONENT VIDEO jacks

For connecting to a TV that supports component video and outputting video signals (p.24).

VIDEO jack

For connecting to a TV that supports composite video and outputting video signals (p.25).

14 SUBWOOFER PRE OUT 1–2 jacks

For connecting to a subwoofer with built-in amplifier (p.22).

Remote control

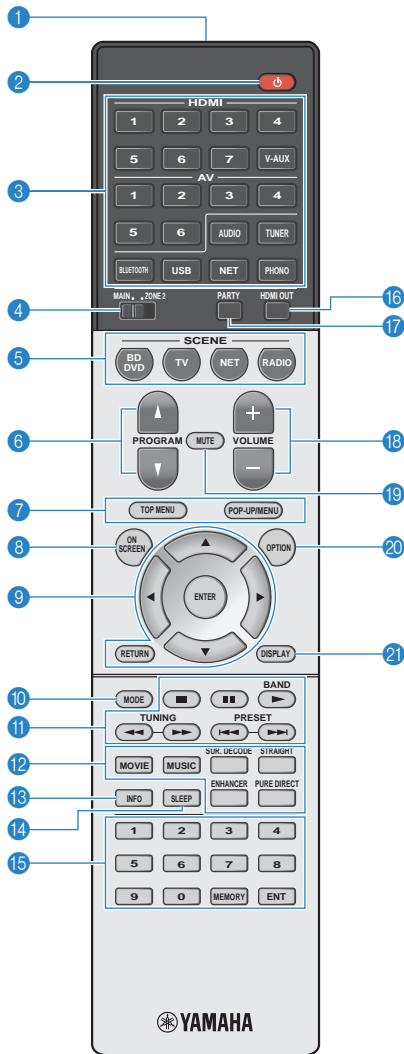

(RX-A850 U.S.A. model)

1 Remote control signal transmitter

Transmits infrared signals.

2 (receiver power) key

Turns on/off (standby) the unit.

3 Input selection keys

Select an input source for playback.

HDMI 1-7 (RX-A850) HDMI 1-7 jacks

HDMI 1-5 (RX-A750) HDMI 1-5 jacks

V-AUX VIDEO AUX jack (on the front panel)

AV 1-6 AV 1-6 jacks

AUDIO AUDIO 1-2 jacks (press repeatedly to select "AUDIO1" or "AUDIO2")

TUNER FM/AM radio

BLUETOOTH Bluetooth connection (the unit as a Bluetooth receiver)

USB USB jack (on the front panel)

NET NETWORK sources (press repeatedly to select a desired network source)

PHONO (RX-A850 only)
PHONO jacks

4 MAIN/ZONE2 switch

Changes the zone (main zone or Zone2) that is controlled by the remote control (p.84).

5 SCENE keys

Select the registered input source, sound program, and various settings with one touch. Also, turns on the unit when it is in standby mode (p.53).

6 PROGRAM keys

Select a sound program (p.54).

7 External device operation keys

Displays menus for the HDMI Control-compatible playback device (p.139).

8 ON SCREEN key

Displays the on-screen menu on the TV.

9 Menu operation keys

Cursor keys Select a menu or a parameter.

ENTER Confirms a selected item.

RETURN Returns to the previous screen.

10 MODE key

Switches the iPod operation modes (p.68).

11 Radio keys

Operate the FM/AM radio when "TUNER" is selected as the input source (p.61).

BAND Switches between FM and AM radio.

PRESET Select a preset station.

TUNING Select the radio frequency.

External device operation keys

Let you perform playback operations when "USB" or "NET" is selected as the input source, or control playback of the HDMI Control-compatible playback device (p.139).

12 Sound mode keys

Select a sound mode (p.54).

13 INFO key

Selects the information displayed on the front display (p.89).

14 SLEEP key

Switches the unit to standby mode automatically after a specified period of time has elapsed (sleep timer). Press repeatedly to set the time (120 min, 90 min, 60 min, 30 min, off).

15 Numeric keys

Let you enter numerical values, such as radio frequencies.

MEMORY key

Registers FM/AM radio stations as presets (p.61).

16 HDMI OUT key

(RX-A850)

Selects HDMI OUT jacks to be used for video/audio output (p.52). (RX-A750)

Enables/disables video/audio output from the HDMI OUT jack (p.52).

17 PARTY key

Turns on/off the party mode (p.85).

18 VOLUME keys

Adjust the volume.

19 MUTE key

Mutes the audio output.

20 OPTION key

Displays the option menu (p.90).

21 DISPLAY key

Displays status information on the TV (p.89).



- (RX-A850 [China, Korea, U.K. and Europe models] only)
For information on the keys other than those above, refer to "Supplement for Remote Control" on the supplied CD-ROM.

PREPARATIONS

General setup procedure

- 1 Placing speakers (p.16)** Select the speaker layout for the number of speakers that you are using and place them in your room.
- 2 Connecting speakers (p.20)** Connect the speakers to the unit.
- 3 Connecting a TV (p.24)** Connect a TV to the unit.
- 4 Connecting playback devices (p.26)** Connect video devices (such as BD/DVD players) and audio devices (such as CD players) to the unit.
- 5 Connecting the FM/AM antennas (p.30)** Connect the supplied FM/AM antennas to the unit.
- 6 Connecting a network cable or preparing the wireless antenna (p.31)** Connect the unit to a router (access point) with a network cable, or prepare the wireless antenna for establishing a wireless network connection.
- 7 Connecting other devices (p.32)** Connect external devices, such as an external power amplifier (RX-A850 only) and a device compatible with the trigger function.
- 8 Connecting the power cable (p.33)** After all the connections are complete, plug in the power cable.
- 9 Selecting an on-screen menu language (p.34)** Select the desired on-screen menu language (default: English).
- 10 Optimizing the speaker settings automatically (YPAO) (p.35)** Optimize the speaker settings, such as volume balance and acoustic parameters, to suit your room (YPAO).
- 11 Connecting to a network device wirelessly (p.43)** Connect the unit to a wireless router (access point) or a mobile device by establishing a wireless connection.

This completes all the preparations. Enjoy playing movies, music, radio and other content with the unit!

1 Placing speakers

Select the speaker layout for the number of speakers that you are using and place the speakers and subwoofer (with built-in amplifier) in your room. This section describes the representative speaker layout examples.

Caution

- Under its default settings, the unit is configured for 8-ohm speakers. When connecting 6-ohm speakers, set the unit's speaker impedance to "6 Ω MIN". In this case, you can also use 4-ohm speakers as the front speakers. For details, see "Setting the speaker impedance" (p.19).

Speaker type	Abbr.	Function	Speaker system (the number of channels)									
			7.1+2	7.1	7.1	6.1	5.1	Front 5.1	4.1	3.1	2.1	
Front (L)	FL	Produce front left/right channel sounds (stereo sounds).	●	●	●	●	●	●	●	●	●	●
Front (R)	FR		●	●	●	●	●	●	●	●	●	●
Center	C	Produces center channel sounds (such as movie dialogue and vocals).	●	●	●	●	●	●			●	
Surround (L)	SL	Produce surround left/right channel sounds. Surround speakers also produce surround back channel sounds when no surround back speakers are connected.	●	●	●	●	●	○*1	●			
Surround (R)	SR		●	●	●	●	●	○*1	●			
Surround back (L)	SBL	Produce surround back left/right channel sounds.	●	●								
Surround back (R)	SBR		●	●								
Surround back	SB	Produces sounds mixed from surround back left/right channel sounds.				●						
Presence (L)	FPL	Produce CINEMA DSP effect sounds. In combination with CINEMA DSP 3D (p.55), the presence speakers create a natural 3-dimensional sound field in your room.	●		●			○*2				
Presence (R)	FPR		●		●			○*2				
Subwoofer	SW	Produces LFE (low-frequency effect) channel sounds and reinforces the bass parts of other channels. This channel is counted as "0.1". You can connect 2 subwoofers (with built-in amplifier) to the unit.	●	●	●	●	●	●	●	●	●	●

If you use five speakers in the front side, use two of them as front surround speakers (*1) or presence speakers (*2). We recommend using them as front surround speakers for enjoying unprocessed playback (p.58) or presence speakers for enjoying stereoscopic sound fields (p.55).



- For information on the ideal speaker layout, see "Ideal speaker layout" (p.133).
- If you have seven speakers, use two of them as surround back speakers or presence speakers. To reinforce the rear left/right sounds, use them as surround back speakers. To create a natural 3-dimensional sound field, use them as presence speakers.
- Two subwoofers connected to the unit output the same sounds.

About Dolby Atmos® (RX-A850 only)

- The unit supports the surround technology "Dolby Atmos". To get the most from Dolby Atmos contents on the unit, refer to "Dolby Atmos (RX-A850 only)" (p.142) to lay out the speakers and configure the settings.

7.1+2-channel system

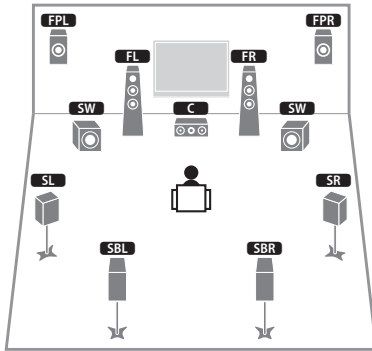

- The surround back speakers and presence speakers do not produce sounds simultaneously. The unit automatically changes the speakers to be used, depending on the selected CINEMA DSP (p.55).

7.1-channel system (using presence speakers)

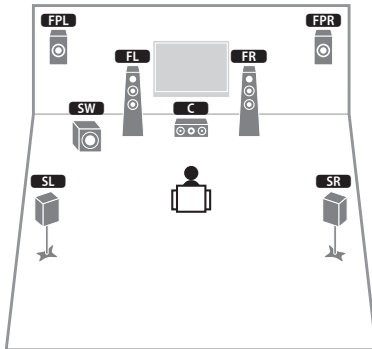

This speaker system uses the front presence speakers to produce a natural 3-dimensional sound field, and also creates Virtual Surround Back Speaker (VSBS) using the surround speakers to add a sense of depth to the rear sound field. This system is suited for enjoying not only 5.1-channel but also for 7.1-channel contents.

7.1-channel system (using surround back speakers)

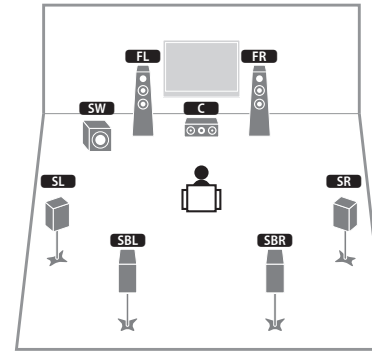

This speaker system creates Virtual Presence Speaker (VPS) using the front, center and surround speakers to produce a 3-dimensional sound field, and also allows you to enjoy extended surround sounds using the surround back speakers.

6.1-channel system

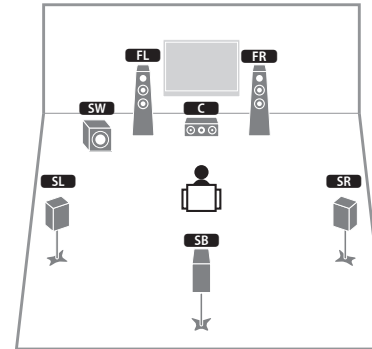

This speaker system creates Virtual Presence Speaker (VPS) using the front, center and surround speakers to produce a 3-dimensional sound field, and also allows you to enjoy extended surround sounds using the surround back speaker.

5.1-channel system

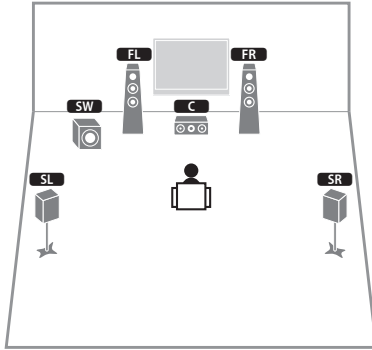

This speaker system creates Virtual Presence Speaker (VPS) using the front, center and surround speakers to produce a 3-dimensional sound field, and also creates Virtual Surround Back Speaker (VSBS) using the surround speakers to add a sense of depth to the rear sound field. This system is suited for enjoying not only 5.1-channel but also for 7.1-channel contents.

Front 5.1-channel system (using presence speakers)

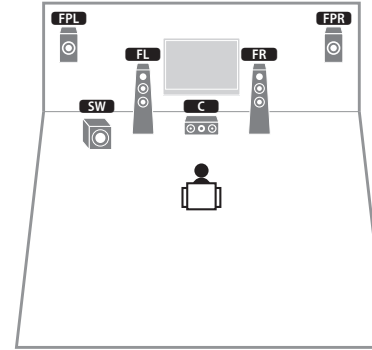

This speaker system uses the front presence speakers to produce a natural 3-dimensional sound field, and creates the virtual surround speakers using the front speakers to allow you to enjoy multichannel surround sound (Virtual CINEMA DSP).

Front 5.1-channel system (using surround speakers)

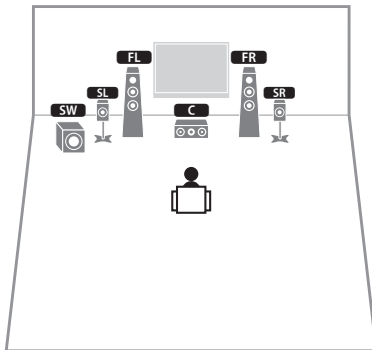

Even when surround speakers are placed in the front side, the unit creates the virtual surround speakers in the rear side to allow you to enjoy multichannel surround sound (Virtual CINEMA FRONT) when "Layout (Surround)" (p.104) in the "Setup" menu is set to "Front".

4.1-channel system

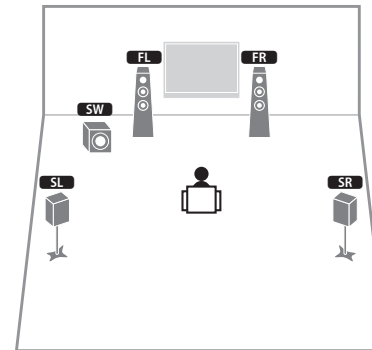

- You can enjoy surround sound even without the center speaker (front 4.1-channel system).

2.1-channel system

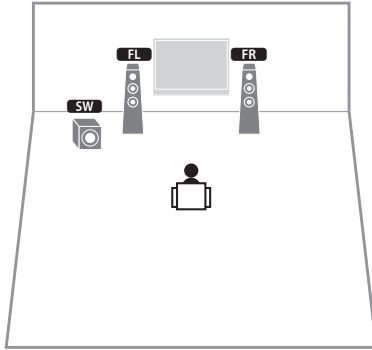

Even when no surround speakers are connected, the unit creates the virtual surround speakers using the front speakers to allow you to enjoy multichannel surround sound (Virtual CINEMA DSP).



- Add the center speaker to configure a 3.1-channel system.

■ Setting the speaker impedance

Under its default settings, the unit is configured for 8-ohm speakers. When using a 6-ohm speaker for any channel, set the speaker impedance to “6 Ω MIN”. In this case, you can also use 4-ohm speakers as the front speakers.

- 1 Before connecting speakers, connect the power cable to an AC wall outlet.
- 2 While holding down STRAIGHT on the front panel, press MAIN ZONE ⏻.

(RX-A850)

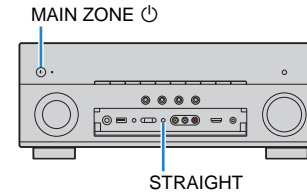

(RX-A750)

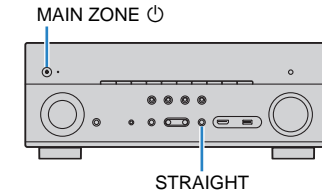

- 3 Check that “SP IMP.” is displayed on the front display.



- 4 Press STRAIGHT to select “6 Ω MIN”.
- 5 Press MAIN ZONE ⏻ to set the unit to standby mode and remove the power cable from the AC wall outlet.

You are now ready to connect the speakers.

2 Connecting speakers

Connect the speakers placed in your room to the unit. The following diagrams provide connections for 7.1+2-, 7.1-, and 6.1-channel systems as examples. For other systems, connect speakers while referring to the connection diagram for the 6.1-channel system.

Caution

- Remove the unit's power cable from an AC wall outlet and turn off the subwoofer before connecting the speakers.
- Ensure that the core wires of the speaker cable do not touch one another or come into contact with the unit's metal parts. Doing so may damage the unit or the speakers. If the speaker cables short circuit, "Check SP Wires" will appear on the front display when the unit is turned on.

- The illustrations of the unit (rear) used in this section are of the RX-A850.

Cables required for connection (commercially available)

Speaker cables (x the number of speakers)



Audio pin cable (two for connecting two subwoofers)



7.1+2-channel system

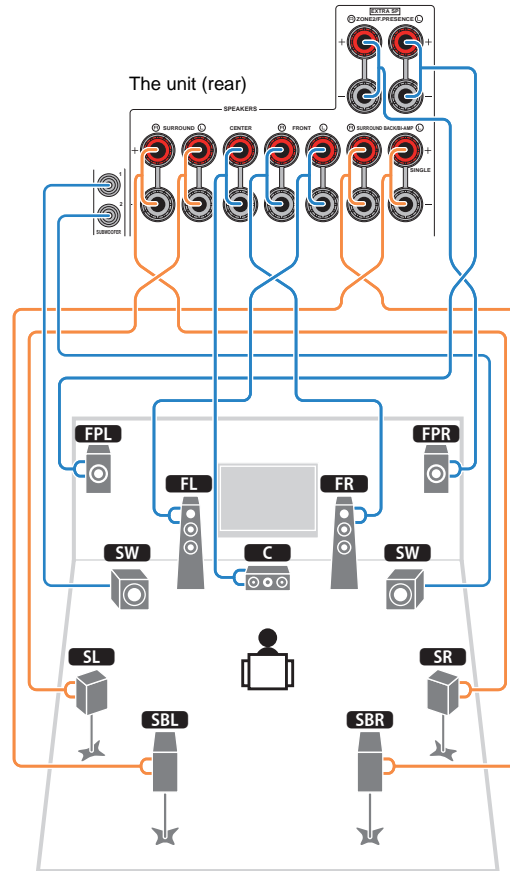

7.1-channel system (using surround back speakers)

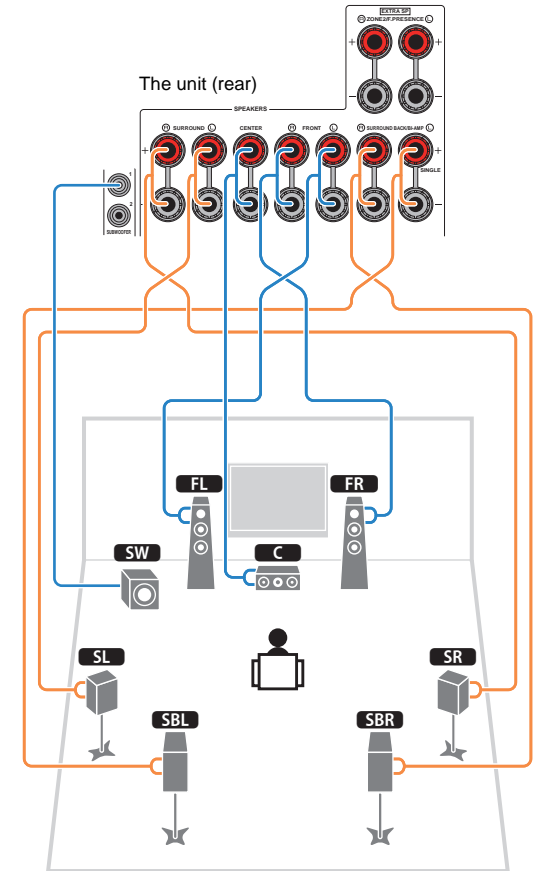

7.1-channel system (using presence speakers)

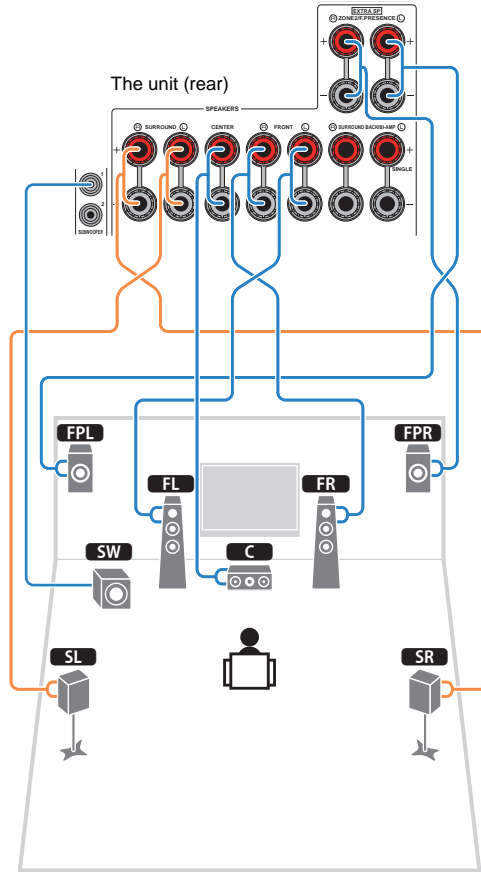

6.1-channel system

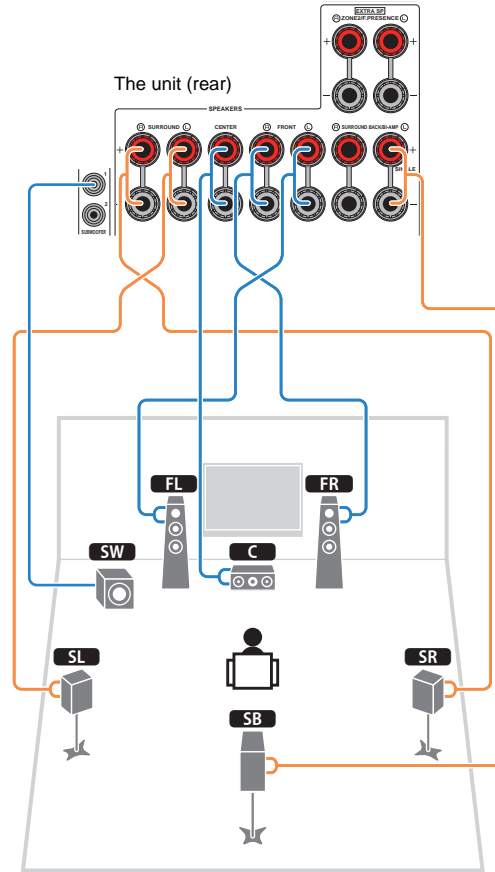

When using only one surround back speaker, connect it to the SINGLE jack (L side).

■ Connecting speaker cables

Speaker cables have two wires. One is for connecting the negative (-) terminal of the unit and the speaker, and the other is for the positive (+) terminal. If the wires are colored to prevent confusion, connect the black wire to the negative and the other wire to the positive terminal.

- ① Remove approximately 10 mm (3/8") of insulation from the ends of the speaker cable and twist the bare wires of the cable firmly together.
- ② Loosen the speaker terminal.
- ③ Insert the bare wires of the cable into the gap on the side (upper right or bottom left) of the terminal.
- ④ Tighten the terminal.

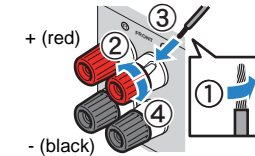

Using a banana plug

(U.S.A., Canada, China, Australia and General models only)

- ① Tighten the speaker terminal.
- ② Insert a banana plug into the end of the terminal.

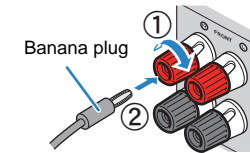

■ Connecting the subwoofer

Use an audio pin cable to connect the subwoofer.

Audio pin cable

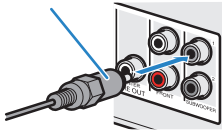

Connecting front speakers that support bi-amp connections

When using front speakers that support bi-amp connections, connect them to the FRONT jacks and SURROUND BACK/BI-AMP jacks.

To enable the bi-amp function, set "Power Amp Assign" (p.103) in the "Setup" menu to "5ch BI-AMP" after connecting the power cable to an AC wall outlet.

Caution

- Before making bi-amp connections, remove any brackets or cables that connect a woofer with a tweeter. Refer to the instruction manual of the speakers for details. If you are not making bi-amp connections, make sure that the brackets or cables are connected before connecting the speaker cables.
- Surround back speakers cannot be used during bi-amp connections.

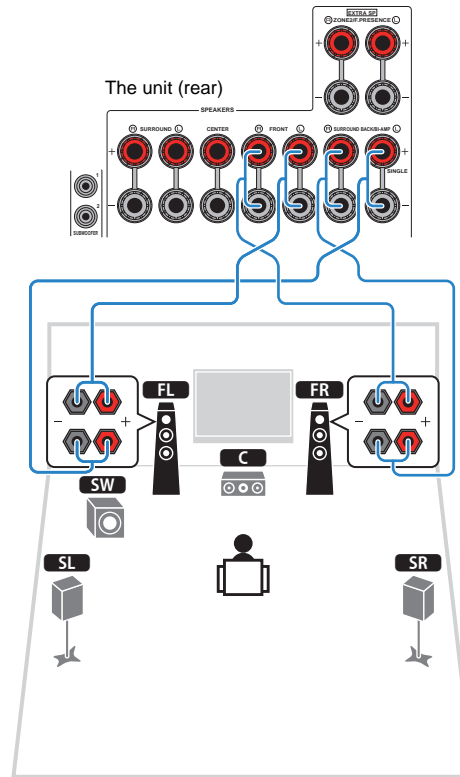

- The FRONT jacks and SURROUND BACK/BI-AMP jacks output the same signals.

Input/output jacks and cables

Video/audio jacks

HDMI jacks

Transmit digital video and digital sound through a single jack. Use an HDMI cable.



HDMI cable

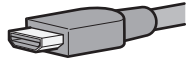

- Use a 19-pin HDMI cable with the HDMI logo. We recommend using a cable less than 5.0 m (16.4 ft) long to prevent signal quality degradation.



- The unit's HDMI jacks support the HDMI Control, Audio Return Channel (ARC), and 3D and 4K Ultra HD video transmission features.
- Use high speed HDMI cables to enjoy 3D or 4K Ultra HD videos.

Video jacks

COMPONENT VIDEO jacks

Transmit video signals separated into three components: luminance (Y), chrominance blue (Pb), and chrominance red (Pr). Use a component video cable with three plugs.

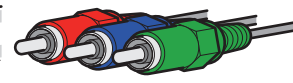
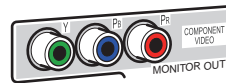

Component video cable

VIDEO jacks

Transmit analog video signals. Use a video pin cable.

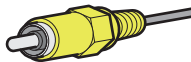
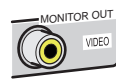

Video pin cable

Audio jacks

OPTICAL jacks

Transmit digital audio signals. Use a digital optical cable. Remove the tip protector (if available) before using the cable.



Digital optical cable

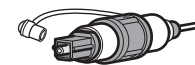

COAXIAL jacks

Transmit digital audio signals. Use a digital coaxial cable.



Digital coaxial cable

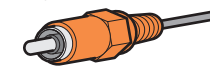

AUDIO jacks

Transmit analog stereo audio signals. Use a stereo pin cable (RCA cable).



Stereo pin cable

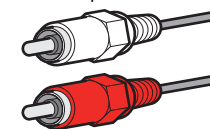

3 Connecting a TV

Connect a TV to the unit so that video input to the unit can be output to the TV. You can also enjoy playback of TV audio on the unit. To maximize the performance of the unit, we recommend connecting a TV with an HDMI cable.

HDMI connection

Connect the TV to the unit with an HDMI cable and a digital optical cable.



- (RX-A850 only)
You can connect another TV or a projector by using the HDMI OUT 2 jack (p.25).

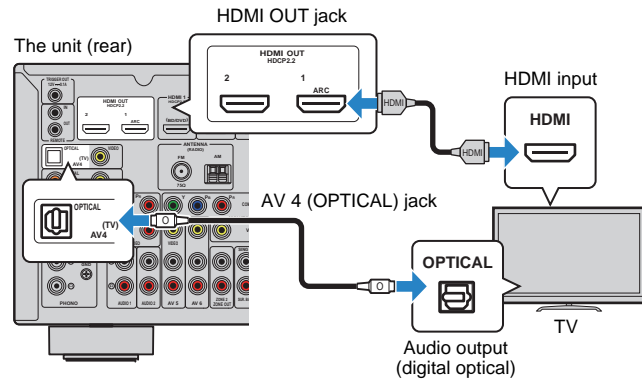

- You do not make a digital optical cable connection between the TV and the unit in the following cases:
 - If your TV supports Audio Return Channel (ARC)
 - If you will receive TV broadcasts only from the set-top box
- If you connect a TV that supports HDMI Control to the unit with an HDMI cable, you can control the unit's power and volume with the TV's remote control.

To use HDMI Control and ARC, you need to configure the HDMI settings on the unit. For details on the settings, see "Information on HDMI" (p.139).

About Audio Return Channel (ARC)

- ARC allows audio signals to travel both ways. If you connect a TV that supports ARC to the unit with a single HDMI cable, you can output video/audio to the TV or input TV audio to the unit.
- When using ARC, connect a TV with an HDMI cable that supports ARC.

Component/composite video connection

When connecting any video device with a component video cable, connect the TV to the MONITOR OUT (COMPONENT VIDEO) jacks.

When connecting any video device with a video pin cable, connect the TV to the MONITOR OUT (VIDEO) jack.



- If you connect your TV to the unit with a cable other than HDMI, video input to the unit via HDMI cannot be output to the TV.
- Operations with TV screen are available only when your TV is connected to the unit via HDMI.



- If you will receive TV broadcasts only from the set-top box, you do not need to make an audio cable connection between the TV and the unit.

COMPONENT VIDEO connection (with a component video cable)

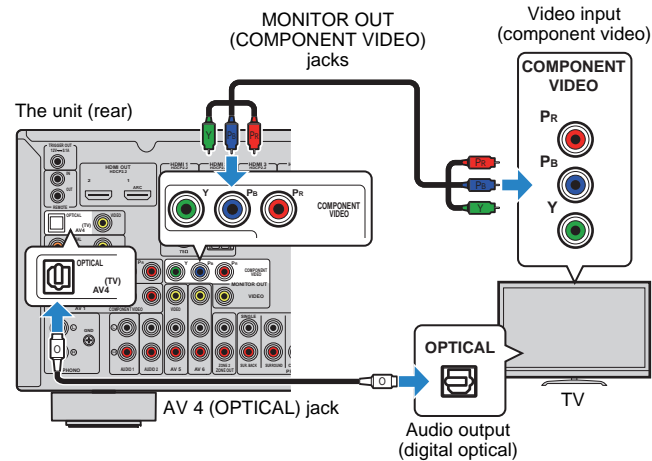

❑ VIDEO (composite video) connection (with a video pin cable)

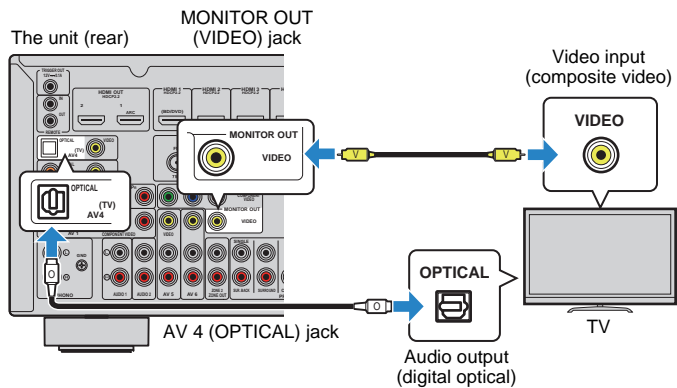

■ Connecting another TV or a projector

(RX-A850 only)

The unit has two HDMI output jacks. If you connect another TV or a projector to the unit with an HDMI cable, you can switch the TV (or projector) to be used for watching videos with the remote control (p.52).

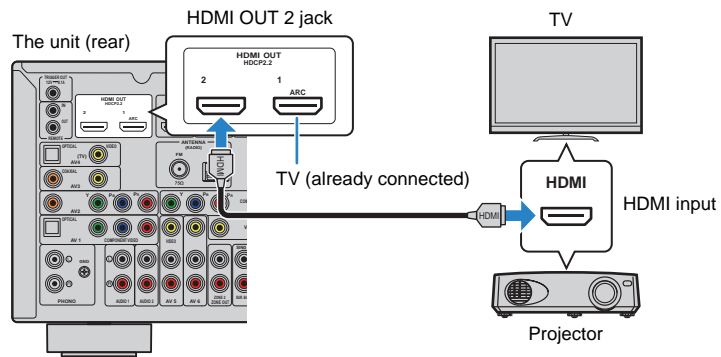

- HDMI Control is not available on the HDMI OUT 2 jack.

4 Connecting playback devices

The unit is equipped with a variety of input jacks including HDMI input jacks to allow you to connect different types of playback devices. For information on how to connect an iPod or a USB storage device, see the following pages.

- Connecting an iPod (p.66)
- Connecting a USB storage device (p.69)

Connecting video devices (such as BD/DVD players)

Connect video devices such as BD/DVD players, set-top boxes (STBs) and game consoles to the unit. Depending on the video/audio output jacks available on your video device, choose one of the following connections. We recommend using an HDMI connection if the video device has an HDMI output jack.



- If the combination of video/audio input jacks available on the unit does not match your video device, change its combination according to the output jacks of your device (p.27).

HDMI connection

Connect a video device to the unit with an HDMI cable.

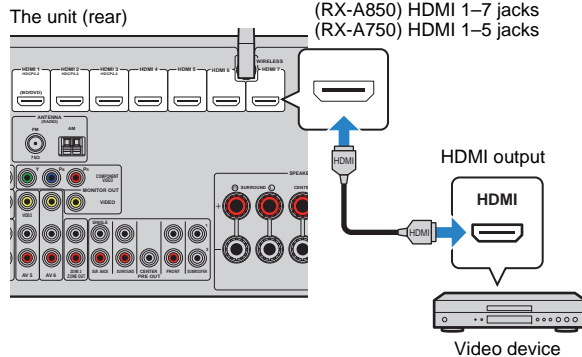

If you select the input source by pressing HDMI 1-7 (RX-A850) or HDMI 1-5 (RX-A750), the video/audio played back on the video device will be output from the unit.



- To watch videos input to the HDMI jacks, you need to connect your TV to the HDMI OUT jack of the unit (p.24).
- If your video device supports HDCP 2.2, connect the device to the HDMI 1-3 jacks.

Component video connection

Connect a video device to the unit with a component video cable and an audio cable (digital optical or digital coaxial). Choose a set of input jacks (on the unit) depending on the audio output jacks available on your video device.

Output jacks on video device		Input jacks on the unit
Video	Audio	
Component video	Digital optical	AV 1 (COMPONENT VIDEO + OPTICAL)
	Digital coaxial	AV 2 (COMPONENT VIDEO + COAXIAL)

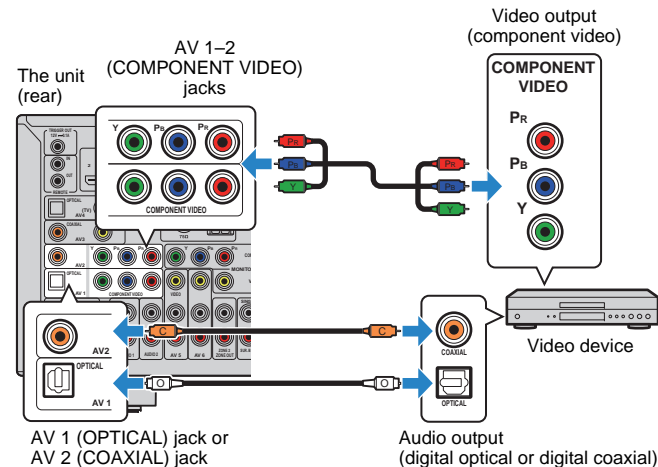

If you select the input source by pressing AV 1-2, the video/audio played back on the video device will be output from the unit.



- The component video signals (other than 480i/576i signals) input to AV 1-2 jacks of the unit can be output from the MONITOR OUT (COMPONENT VIDEO) jacks only. To watch those videos, you need to connect your TV to the MONITOR OUT (COMPONENT VIDEO) jacks of the unit (p.24). For details, refer to "Video signal flow" (p.138).

■ Composite video connection

Connect a video device to the unit with a video pin cable and an audio cable (digital coaxial, digital optical, or stereo pin cable). Choose a set of input jacks (on the unit) depending on the audio output jacks available on your video device.

Output jacks on video device		Input jacks on the unit
Video	Audio	
Composite video	Digital coaxial	AV 3 (VIDEO + COAXIAL)
	Digital optical	AV 4 (VIDEO + OPTICAL)
	Analog stereo	AV 5-6 (VIDEO + AUDIO)

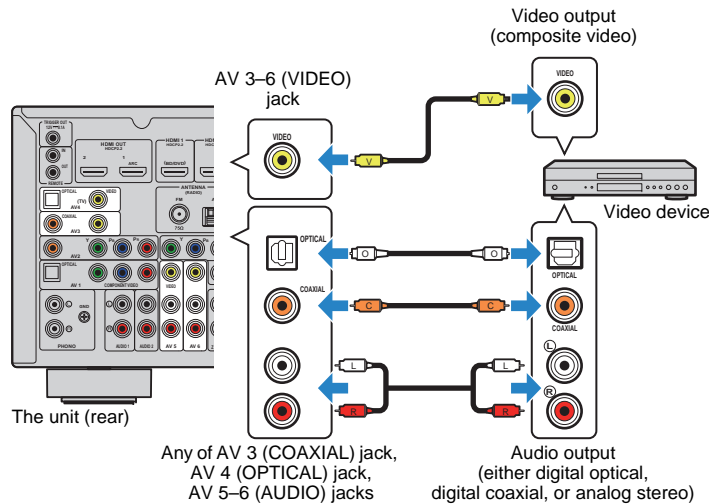

If you select the input source by pressing AV 3-6, the video/audio played back on the video device will be output from the unit.



- To watch videos input to the AV 3-6 (VIDEO) jacks, you need to connect your TV to the HDMI OUT jack (p.24) or to the MONITOR OUT (VIDEO) jack (p.25) of the unit. For details, refer to "Video signal flow" (p.138).

■ Changing the combination of video/audio input jacks

If the combination of video/audio input jacks available on the unit does not match your video device, change its combination according to the output jacks of your device. You can connect a video device that has the following video/audio output jacks.

Output jacks on video device		Input jacks on the unit	
Video	Audio	Video	Audio
HDMI	Digital optical	(RX-A850) HDMI 1-7 (RX-A750) HDMI 1-5	AV 1 (OPTICAL) AV 4 (OPTICAL)
	Digital coaxial	(RX-A850) HDMI 1-7 (RX-A750) HDMI 1-5	AV 2-3 (COAXIAL)
	Analog stereo	(RX-A850) HDMI 1-7 (RX-A750) HDMI 1-5	AV 5-6 (AUDIO) AUDIO 1-2
Component video	Analog stereo	AV 1-2 (COMPONENT VIDEO)	AV 5-6 (AUDIO) AUDIO 1-2

□ Necessary setting

For example, if you have connected a video device to AV 2 (COMPONENT VIDEO) and AV 5 (AUDIO) jacks of the unit, change the combination setting as follows.

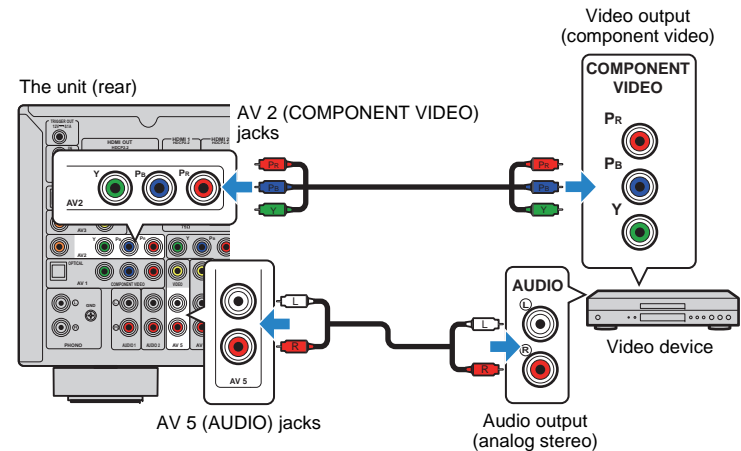



• The following operation is available only when your TV is connected to the unit via HDMI.

- 1 After connecting external devices (such as a TV and playback devices) and power cable of the unit, turn on the unit.
- 2 Press AV 2 to select “AV 2” (video input jack to be used) as the input source.

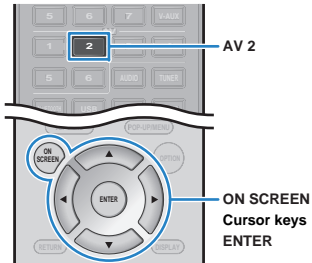

- 3 Press ON SCREEN.
- 4 Use the cursor keys to select “Input” and press ENTER.
- 5 Use the cursor keys (◀/▶) to select “AV2” (video input jack to be used) and press the cursor key (△).

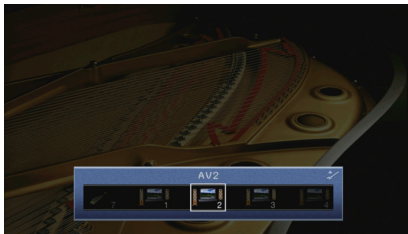

- 6 Use the cursor keys to select “Audio In” and press ENTER.
- 7 Use the cursor keys to select “AV5” (audio input jack to be used).

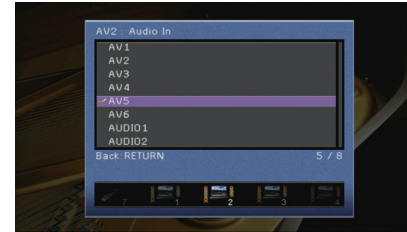

- 8 Press ON SCREEN.

This completes the necessary settings.

If you select “AV 2” as the input source by pressing AV 2, the video/audio played back on the video device will be output from the unit.

Connecting audio devices (such as CD players)

Connect audio devices such as CD players, MD players, and a turntable to the unit. Depending on the audio output jacks available on your audio device, choose one of the following connections.

Audio output jacks on audio device	Audio output jacks on the unit
Digital optical	AV 1 (OPTICAL) AV 4 (OPTICAL)
Digital coaxial	AV 2-3 (COAXIAL)
Analog stereo	AV 5-6 (AUDIO) AUDIO 1-2
Turntable (PHONO)	PHONO*

* RX-A850 only

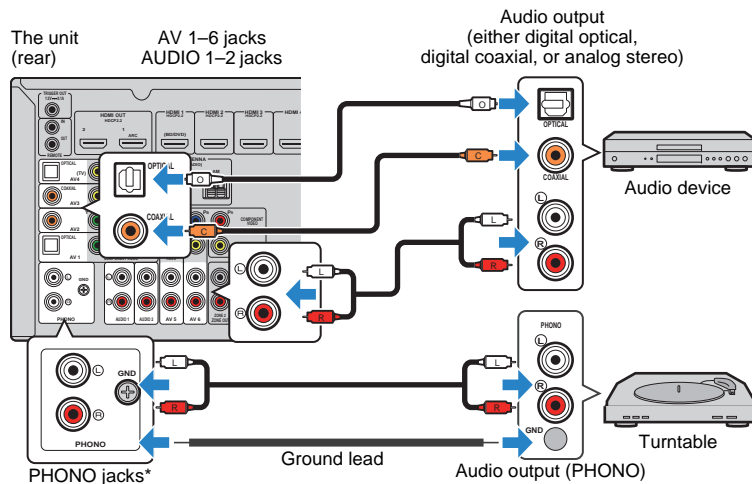

If you select the input source by pressing AV 1-6, AUDIO or PHONO*, the audio played back on the audio device will be output from the unit.

When connecting a turntable

(RX-A850 only)

- The PHONO jack of the unit is compatible with an MM cartridge. To connect a turntable with a low-output MC cartridge, use a boosting transformer.
- Connecting the turntable to the GND terminal of the unit may reduce noise in the signal.

Connecting to the jacks on the front panel

Use the VIDEO AUX jack to temporarily connect a playback device to the unit.

Use the USB jack to connect an iPod or a USB storage device. For details, see “Connecting an iPod” (p.66) or “Connecting a USB storage device” (p.69).

Before making a connection, stop playback on the device and turn down the volume on the unit.

□ HDMI connection

Connect an HDMI-compatible device (such as game consoles and camcorders) to the unit with an HDMI cable.

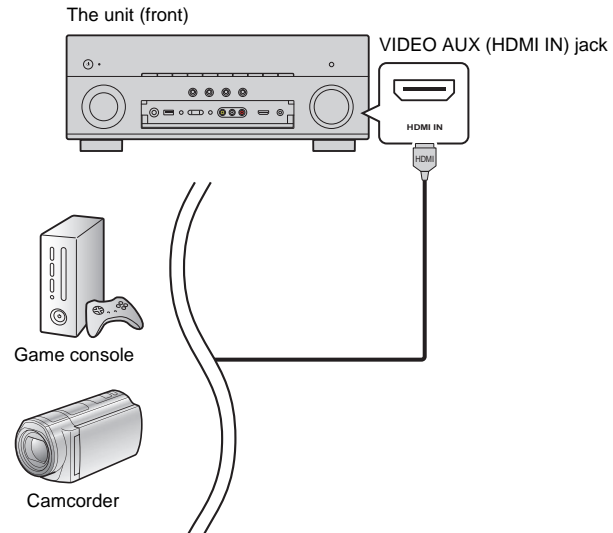

If you select “V-AUX” as the input source by pressing V-AUX, the video/audio played back on the device will be output from the unit.



- To watch videos input to the VIDEO AUX (HDMI IN) jack, you need to connect your TV to the HDMI OUT jack of the unit (p.24).
- You need to prepare an HDMI cable that match the output jacks on your device.

❑ Composite video/analog stereo connection

(RX-A850 only)

Connect a playback device (such as game consoles and camcorders) to the unit with a video pin cable and a stereo pin cable.

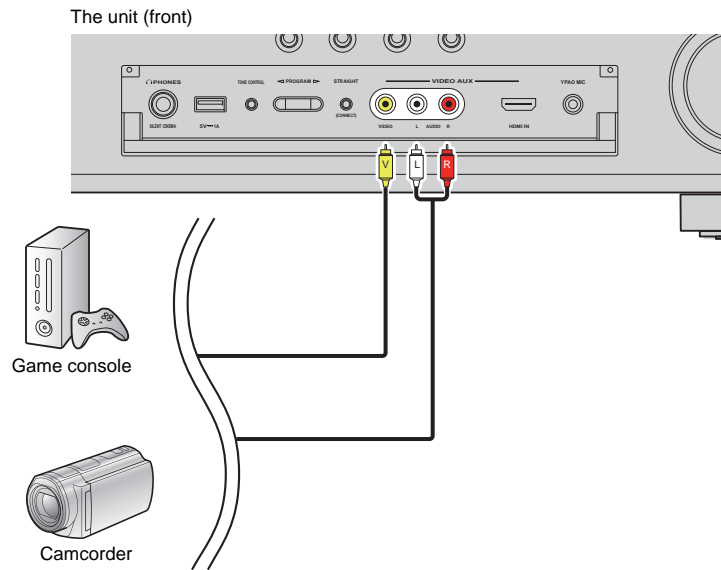

If you select "V-AUX" as the input source by pressing V-AUX, the video/audio played back on the device will be output from the unit.



- If you connect video devices to both the VIDEO AUX (HDMI IN) jack and VIDEO AUX (VIDEO/AUDIO) jacks, the unit outputs video/audio input through the VIDEO AUX (HDMI IN) jack.

5 Connecting the FM/AM antennas

Connect the supplied FM/AM antennas to the unit. Fix the end of the FM antenna to a wall, and place the AM antenna on a flat surface.

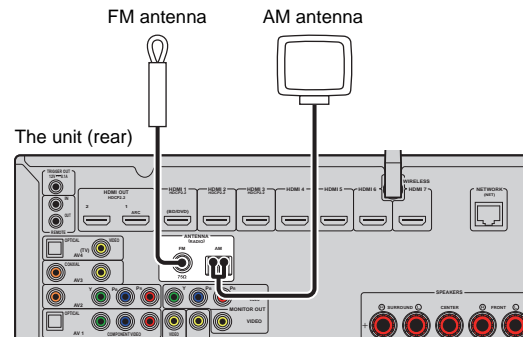

Assembling and connecting the AM antenna

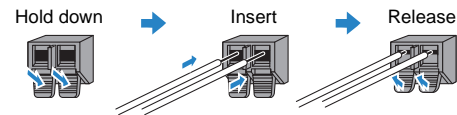
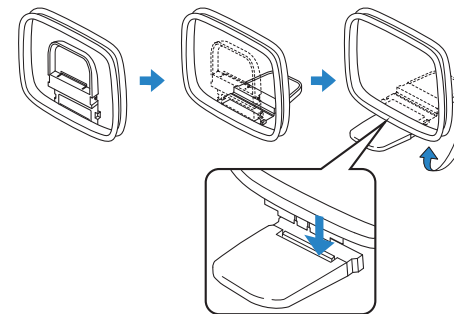

- Unwind only the length of cable needed from the AM antenna unit.
- The wires of the AM antenna have no polarity.

6 Connecting a network cable or preparing the wireless antenna

Connect the unit to a router (access point) with a network cable, or prepare the wireless antenna for establishing a wireless network connection.

You can enjoy Internet radio or music files stored on media servers, such as PCs and Network Attached Storage (NAS), on the unit.

Connecting the network cable

Connect the unit to your router with a commercially-available STP network cable (CAT-5 or higher straight cable).

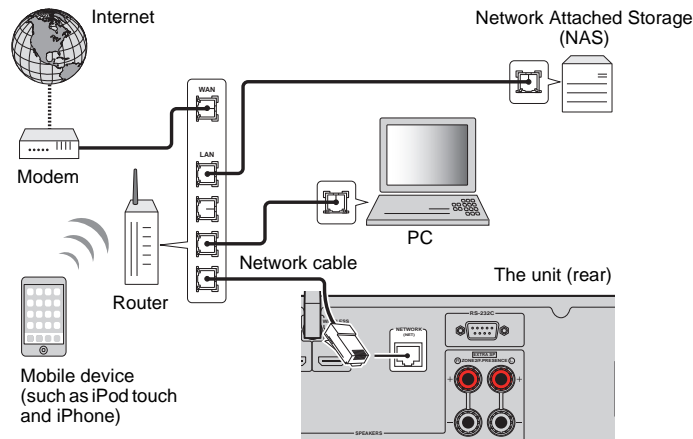

- If you want to use a wired (network cable) connection when a wireless connection has been made, set "Network Connection" (p.111) in the "Setup" menu to "Wired".
- If you are using a router that supports DHCP, you do not need to configure any network settings for the unit, as the network parameters (such as the IP address) will be assigned automatically to it. You only need to configure the network settings if your router does not support DHCP or if you want to configure the network parameters manually (p.112).
- You can check whether the network parameters (such as IP address) are properly assigned to the unit in "Network" (p.118) in the "Information" menu.



- Some security software installed on your PC or the firewall settings of network devices (such as a router) may block the access of the unit to the network devices or the Internet. In these cases, configure the security software or firewall settings appropriately.
- Each server must be connected to the same subnet as the unit.
- To use the service via the Internet, broadband connection is strongly recommended.

Preparing the wireless antenna

If you want to establish a wireless network connection, stand the wireless antenna up straight.

For information on how to connect the unit to a network device wirelessly, see "Connecting to a network device wirelessly" (p.43).

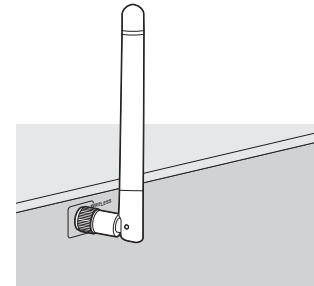

- Do not apply excessive force on the antenna. Doing so may damage it.

7 Connecting other devices

Connecting an external power amplifier

(RX-A850 only)

When connecting an external power amplifier (pre-main amplifier) to enhance speaker output, connect the input jacks of the power amplifier to the PRE OUT jacks of the unit. The same channel signals are output from the PRE OUT jacks as from their corresponding SPEAKERS terminals.

Caution

- To prevent the generation of loud noises or abnormal sounds, make sure the followings before making connections.
 - Remove the power cable of the unit and turn off the external power amplifier before connecting them.
 - When using the PRE OUT jacks, do not connect speakers to the corresponding SPEAKERS terminals.
 - When using an external amplifier that does not have the volume control bypass, do not connect other devices (except the unit) to the amplifier.

The unit (rear)

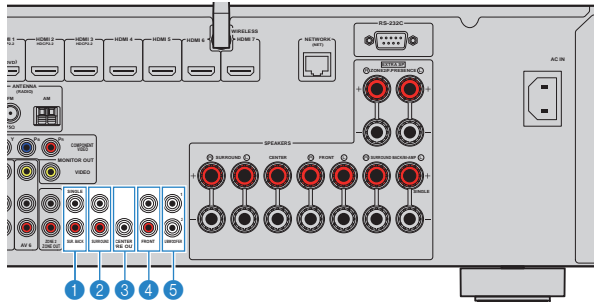

- 1 SUR. BACK jacks**
Output surround back channel sounds. When using only one external amplifier for the surround back channel, connect it to the SINGLE jack (L side).
- 2 SURROUND jacks**
Output surround channel sounds.
- 3 CENTER jack**
Outputs center channel sounds.
- 4 FRONT jacks**
Output front channel sounds.
- 5 SUBWOOFER1-2 jacks**
For connecting a subwoofer with built-in amplifier. When 2 subwoofers are connected, the same sound is output from them.

Connecting a device compatible with the trigger function

The trigger function can control an external device in conjunction with operating the unit (such as powering on/off and input selection). If you have a Yamaha subwoofer that supports a system connection or a device with a trigger input jack, you can use the trigger function by connecting the external device to the TRIGGER OUT jack with a monaural mini-plug cable.

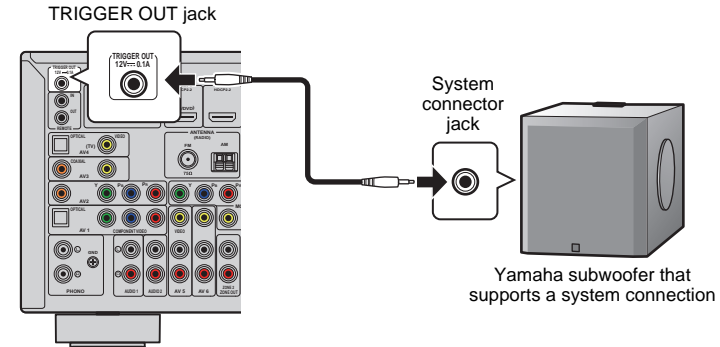

The unit (rear)



- You can configure the trigger function settings in "Trigger Output" (p.115) in the "Setup" menu.

8 Connecting the power cable

Before connecting the power cable (RX-A850 [General model] only)

Set the switch position of VOLTAGE SELECTOR according to your local voltage. Voltages are AC 110–120/220–240 V, 50/60 Hz.



- Make sure you set VOLTAGE SELECTOR of the unit BEFORE plugging the power cable into an AC wall outlet. Improper setting of VOLTAGE SELECTOR may cause damage to the unit and create a potential fire hazard.

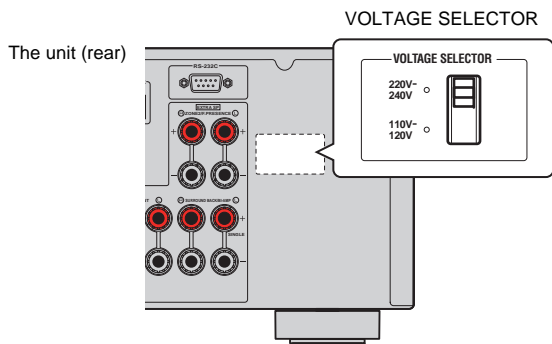

After all the connections are complete, plug in the power cable.

The unit (rear)

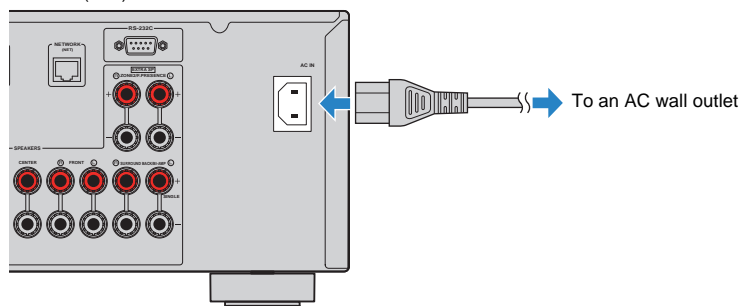

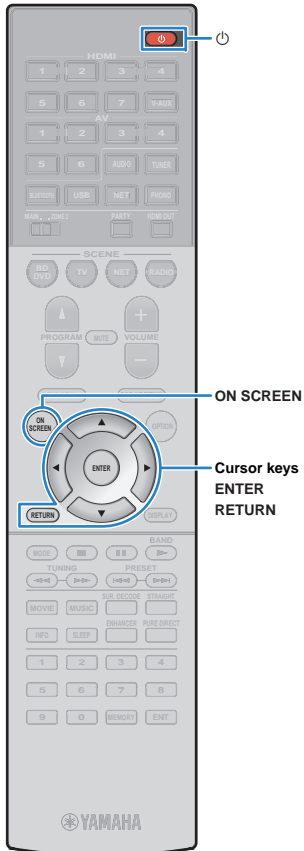

9 Selecting an on-screen menu language

Select the desired on-screen menu language from English (default), Japanese, French, German, Spanish, Russian, Italian and Chinese.

- 1 Press (receiver power) to turn on the unit.
- 2 Turn on the TV and switch the TV input to display video from the unit (HDMI OUT jack).
 - If you turn on the unit for the first time, the message regarding the network setup appears. For now, press RETURN and proceed to Step 3.
- 3 Press ON SCREEN.
- 4 Use the cursor keys to select “Setup” and press ENTER.

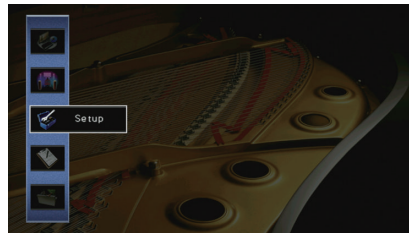

- 5 Use the cursor keys (</>) to select “Language” and the cursor keys (Δ/∇) to select the desired language.

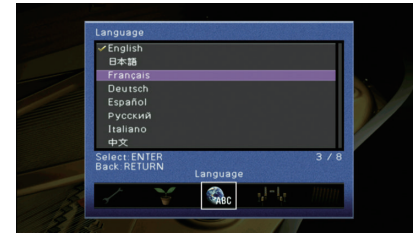

- 6 To confirm the setting, press ENTER.
- 7 To exit from the menu, press ON SCREEN.



• The information on the front display is provided in English only.

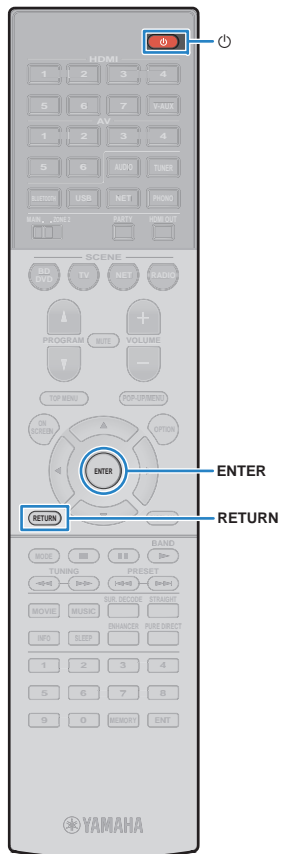

10 Optimizing the speaker settings automatically (YPAO)

The Yamaha Parametric room Acoustic Optimizer (YPAO) function detects speaker connections, measures the distances from them to your listening position(s), and then automatically optimizes the speaker settings, such as volume balance and acoustic parameters, to suit your room.



The YPAO function of the unit adopts the YPAO-R.S.C. (Reflected Sound Control) technology that enables to create natural sound fields like a room specifically designed for acoustic perfection.



- Note the following regarding YPAO measurement.
 - Test tones are output at high volume and may surprise or frighten small children.
 - Test tone volume cannot be adjusted.
 - Keep the room as quiet as possible
 - Stay in a corner of the room behind the listening position so that you do not become an obstacle between speakers and the YPAO microphone.
 - Do not connect headphones.

1 Press (receiver power) to turn on the unit.

2 Turn on the TV and switch the TV input to display video from the unit (HDMI OUT jack).



- If you turn on the unit for the first time, the message regarding the network setup appears. For now, press RETURN and proceed to Step 3.

3 Turn on the subwoofer and set the volume to half. If the crossover frequency is adjustable, set it to maximum.

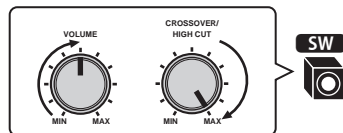

- If you are using bi-amp connection or Zone2 speakers, set "Power Amp Assign" (p.103) in the "Setup" menu to the appropriate setting before starting YPAO.
- If you want to use the surround speakers for the front 5.1-channel system (Virtual CINEMA FRONT) (p.18), set "Layout (Surround)" (p.104) in the "Setup" menu to "Front".

4 Place the YPAO microphone at your listening position and connect it to the YPAO MIC jack on the front panel.



- Place the YPAO microphone at your listening position (same height as your ears). We recommend the use of a tripod as a microphone stand. You can use the tripod screws to stabilize the microphone.

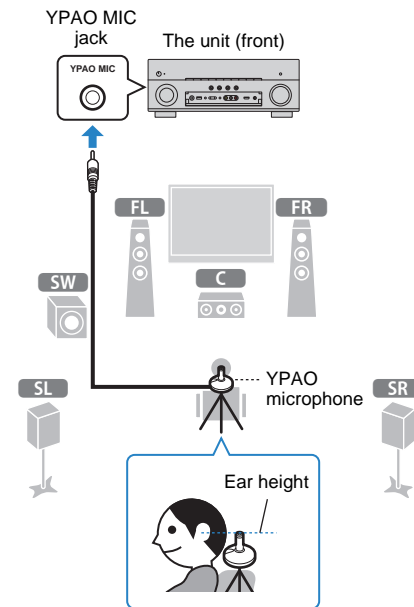

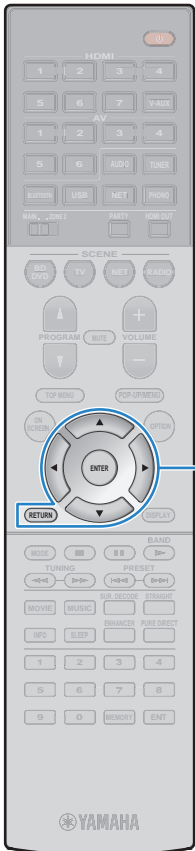

Cursor keys
ENTER
RETURN

(RX-A750)

The following screen appears on the TV.



This completes the preparations.

See "Measuring at one listening position (single measure)" (p.37) to start the measurement.

(RX-A850)

The following screen appears on the TV.



Proceed to Step 5.



- To cancel the operation, disconnect the YPAO microphone before starting the measurement.
- To configure the power amplifier assignment setting, press RETURN and select "Manual Setup" (p.103).

5 (RX-A850 only)

If desired, change the measuring method (multi/single).

- ① Use the cursor keys to select "Multi Position" and press ENTER.
- ② Use the cursor keys to select a setting and then press ENTER.



Settings

Yes	Select this option if you will have several listening positions or if you want others to enjoy surround sound. You can take measurements at up to 8 different positions in the room. The speaker settings will be optimized to suit the area defined by those positions (multi measure).
No (default)	Select this option if your listening position will always be fixed. Take the measurements at only one position. The speaker settings will be optimized to suit that position (single measure).



- If you perform the multi measure, the speaker settings will be optimized for you to enjoy surround sound in a wider space.
- If you perform the multi measure, first place the YPAO microphone at the listening position you will be seated most frequently.



Cursor keys
ENTER
RETURN

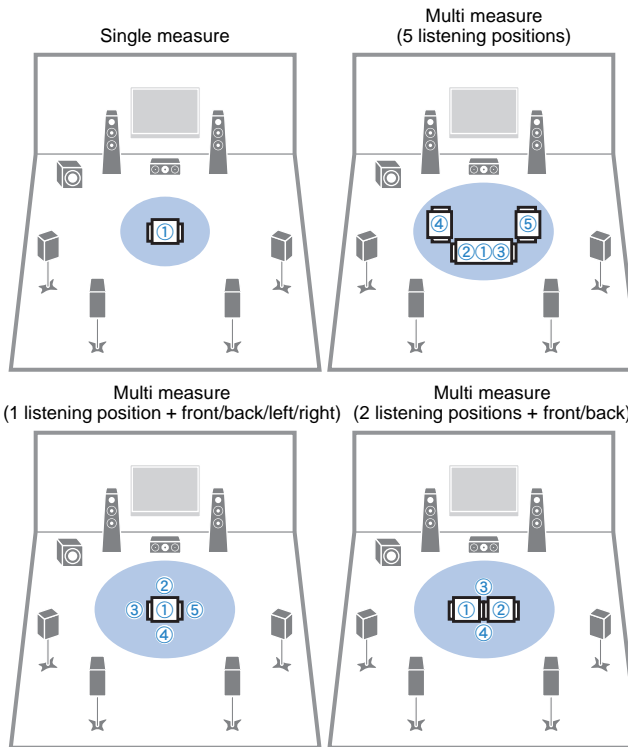

This completes the preparations. See the following page to start the measurement.

When “Multi Position” is set to “Yes”:

“Measuring at multiple listening positions (multi measure) (RX-A850 only)” (p.38)

When “Multi Position” is set to “No”:

“Measuring at one listening position (single measure)” (p.37)

Measuring at one listening position (single measure)

Follow the procedure below for measurement. It takes about 3 minutes to perform the measurement.

1 To start the measurement, use the cursor keys to select “Measure” and press ENTER.

The measurement will start in 10 seconds. Press ENTER again to start the measurement immediately.



- To cancel the measurement temporarily, press RETURN.

The following screen appears on the TV when the measurement finishes.



- If any error message (such as E-1) or warning message (such as W-1) appears, see “Error messages” (p.41) or “Warning messages” (p.42).



- To check the measurement results, select “Result”. For details, see “Checking the measurement results” (p.40).

2 Use the cursor keys to select “Save/Cancel” and press ENTER.

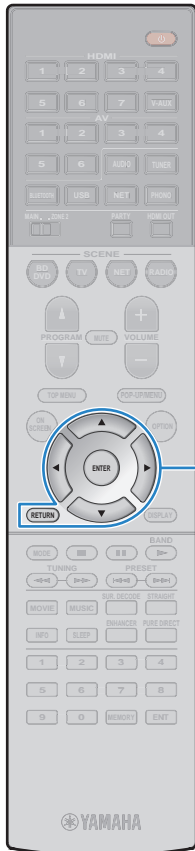

Cursor keys
ENTER
RETURN

3 To save the measurement results, use the cursor keys (</>) to select “SAVE” and press ENTER.

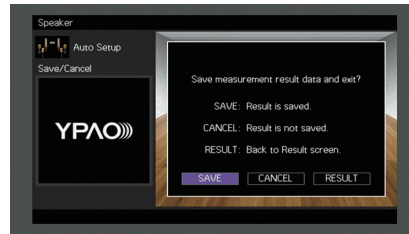

The adjusted speaker settings are applied.



- To finish the measurement without saving the result, select “CANCEL”.

4 Use the cursor keys (</>) to select “YES” or “NO” to enable/disable YPAO Volume and press ENTER.

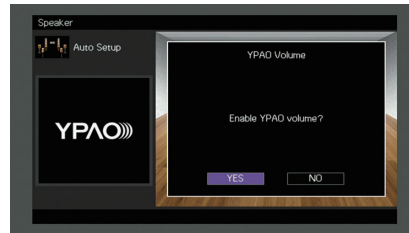

- If YPAO Volume is enabled, the high- and low-frequency levels are automatically adjusted according to the volume so that you can enjoy natural sounds even at low volume.
- You can also enable/disable YPAO Volume in “YPAO Volume” (p.91) in the “Option” menu.

5 Disconnect the YPAO microphone from the unit.

This completes optimization of the speaker settings.

Caution

- The YPAO microphone is sensitive to heat, so should not be placed anywhere where it could be exposed to direct sunlight or high temperatures (such as on top of AV equipment).

Measuring at multiple listening positions (multi measure) (RX-A850 only)

When “Multi Position” is set to “Yes”, follow the procedure below for measurement. It takes about 10 minutes to measure 8 listening positions.



- If any error message (such as E-1) or warning message (such as W-1) appears, see “Error messages” (p.41) or “Warning messages” (p.42).

1 To start the measurement, use the cursor keys to select “Measure” and press ENTER.

The measurement will start in 10 seconds. Press ENTER again to start the measurement immediately.



- To cancel the measurement temporarily, press RETURN.

The following screen appears on the TV when the measurement at the first position finishes.

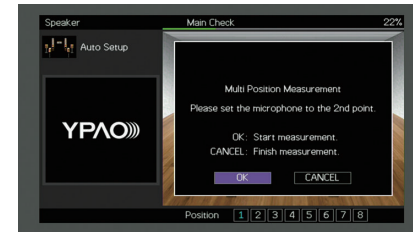

2 Move the YPAO microphone to the next listening position and press ENTER.

Repeat Step 2 until measurements at all listening positions (up to 8) have been taken.

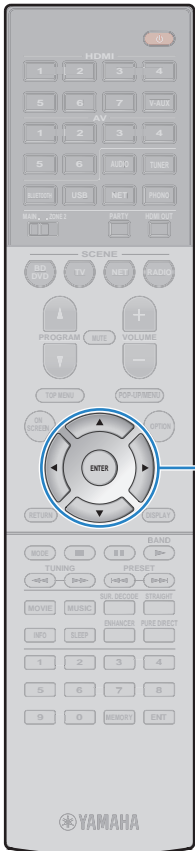

Cursor keys
ENTER

3 When the measurements at the positions you want to measure are completed, use the cursor keys to select “CANCEL” and press ENTER.

When you have taken measurements at 8 listening positions, the following screen appears automatically.



- To check the measurement results, select “Result”. For details, see “Checking the measurement results” (p.40).

4 Use the cursor keys to select “Save/Cancel” and press ENTER.

5 To save the measurement result, use the cursor keys to select “SAVE” and press ENTER.



The adjusted speaker settings are applied.



- To finish the measurement without saving the result, select “CANCEL”.

6 Use the cursor keys (<|/>) to select “YES” or “NO” to enable/disable YPAO Volume and press ENTER.

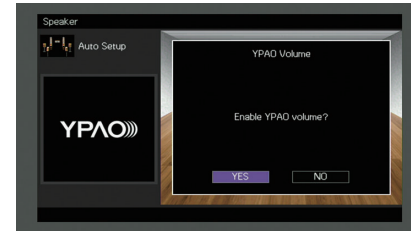

- If YPAO Volume is enabled, the high- and low-frequency levels are automatically adjusted according to the volume so that you can enjoy natural sounds even at low volume.
- You can also enable/disable YPAO Volume in “YPAO Volume” (p.91) in the “Option” menu.

7 Disconnect the YPAO microphone from the unit.

This completes optimization of the speaker settings.

Caution

- The YPAO microphone is sensitive to heat, so should not be placed anywhere where it could be exposed to direct sunlight or high temperatures (such as on top of AV equipment).

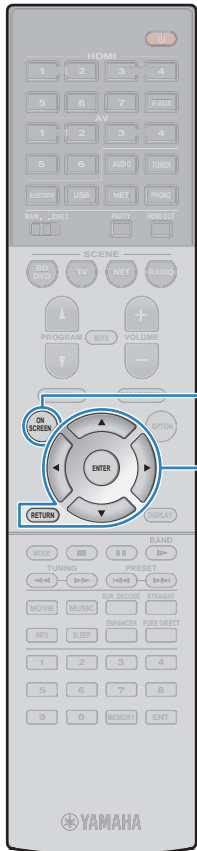

ON SCREEN
 Cursor keys
 ENTER
 RETURN

Checking the measurement results

You can check the YPAO measurement results.

- 1 After the measurement, use the cursor keys to select “Result” and press ENTER.



- You can also select “Result” from “Auto Setup” (p.101) in the “Setup” menu, which displays the previous measurement results.

The following screen appears.



- 1 Measurement result items
- 2 Measurement result details
- 3 The number of measured positions (when multi measure is performed) * RX-A850 only

- 2 Use the cursor keys to select an item.

Wiring	Polarity of each speaker Reverse: The speaker cable may be connected with the reverse polarity (+/-).
Size	Size of each speaker (cross-over frequency of the subwoofer) Large: The speaker can reproduce low-frequency signals effectively. Small: The speaker cannot reproduce low-frequency signals effectively.
Distance	Distance from the listening position to each speaker
Level	Output level adjustment for each speaker

- 3 To finish checking the results and return to the previous screen, press RETURN.

Reloading the previous YPAO adjustments

When the speaker settings you have configured manually are not suitable, follow the procedure below to discard the manual settings and reload the previous YPAO adjustments.

- 1 In the “Setup” menu, select “Speaker”, “Auto Setup”, and then “Result” (p.100).
- 2 Use the cursor keys to select “Setup Reload” and press ENTER.

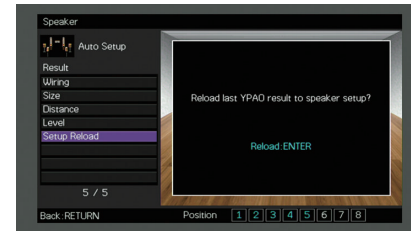

- 3 To exit from the menu, press ON SCREEN.

Error messages

If any error message is displayed during the measurement, resolve the problem and perform YPAO again.

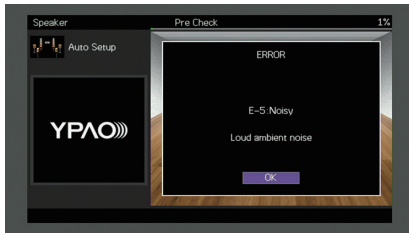

Error message	Cause	Remedy
E-1: No Front SP	Front speakers are not detected.	
E-2: No Sur. SP	One of the surround speakers cannot be detected.	Follow the on-screen instructions to exit YPAO, turn off the unit, and then check the speaker connections.
E-3: No F.PRNS SP	One of the presence speakers cannot be detected.	
E-4: SBR → SBL	A surround back speaker is connected to the R side only.	When using only one surround back speaker, you need to connect it to the SINGLE jack (L side). Follow the on-screen instructions to exit YPAO, turn off the unit, and then reconnect the speaker.
E-5: Noisy	The noise is too loud.	Keep the room quiet and follow the on-screen instructions to start the measurement again. If you select "PROCEED", YPAO takes the measurement again and ignores any noise detected.
E-6: Check Sur.	Surround back speakers are connected, but no surround speakers are connected.	Surround speakers need to be connected in order to use surround back speakers. Follow the on-screen instructions to exit YPAO, turn off the unit, and then reconnect the speakers.
E-7: No MIC	The YPAO microphone has been removed.	Connect the YPAO microphone to the YPAO MIC jack firmly and follow the on-screen instructions to start the measurement again.
E-8: No Signal	The YPAO microphone cannot detect test tones.	Connect the YPAO microphone to the YPAO MIC jack firmly and follow the on-screen instructions to start the measurement again. If this error occurs repeatedly, contact the nearest authorized Yamaha dealer or service center.
E-9: User Cancel	The measurement has been canceled.	Follow the on-screen instructions to start the measurement again. To cancel the measurement, select "EXIT".
E-10: Internal Error	An internal error has occurred.	Follow the on-screen instructions to exit YPAO, turn off and on the unit. If this error occurs repeatedly, contact the nearest authorized Yamaha dealer or service center.

Warning messages

If a warning message is displayed after the measurement, you can still save the measurement results by following on-screen instructions. However, we recommend you perform YPAO again in order to use the unit with the optimal speaker settings.

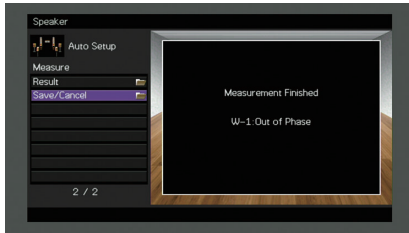

Warning message	Cause	Remedy
W-1: Out of Phase	A speaker cable may be connected with the reverse polarity (+/-).	Select "Wiring" in "Result" (p.40) and check the cable connections (+/-) of the speaker identified by "Reverse". If the speaker is connected incorrectly: Turn off the unit and then reconnect the speaker cable. If the speaker is connected correctly: Depending on the type of speakers or room environment, this message may appear even if the speakers are connected correctly. In this case, you can ignore the message.
W-2: Over Distance	A speaker is placed more than 24 m (80 ft) from the listening position.	Select "Distance" in "Result" (p.40) and move the speaker identified by ">24.00m (>80.0ft)" within 24 m (80 ft) of the listening position.
W-3: Level Error	There are significant volume differences between the speakers.	Check the usage environment and cable connections (+/-) of each speaker, and the volume of the subwoofer. We recommend using the same speakers or speakers with specifications that are as similar as possible.

11 Connecting to a network device wirelessly

Connect the unit to a wireless router (access point) or a mobile device by establishing a wireless connection.

Selecting the connection method

Select a connection method according to your network environment.

■ Connecting with a wireless router (access point)

Connect the unit to a wireless router (access point).

You can enjoy Internet radio, AirPlay, or music files stored on media servers (PC/NAS) on the unit.

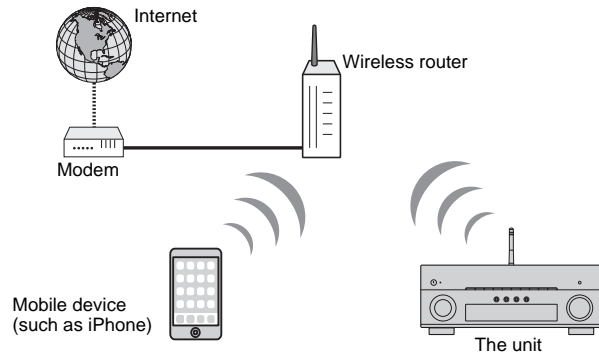

For details on connection, see “Connecting the unit to a wireless network” (p.44).



- You cannot use the wireless network connection simultaneously with the wired (network cable) connection (p.31) or Wireless Direct (p.50).
- If the unit and the wireless router (access point) are too far apart, the unit may not connect to a wireless router (access point). In such case, place them close to each other.

■ Connecting without a wireless router (access point)

Connect a mobile device to the unit directly.

You can use the application for smartphone / tablet “AV CONTROLLER” to control the unit from mobiles devices or enjoy music files stored on mobiles devices on the unit.

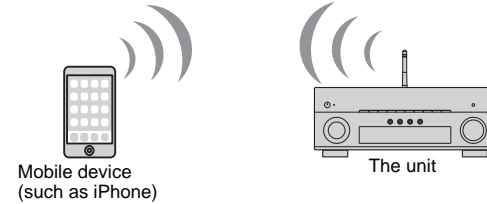

For details on connection, see “Connecting a mobile device to the unit directly (Wireless Direct)” (p.50).



- You cannot use Wireless Direct simultaneously with the wired (network cable) connection (p.31) or the wireless network connection (p.44).
- When Wireless Direct is enabled, the following functions are not available.
 - Internet radio
 - Network services
 - Playback of music stored on media servers (PC/NAS)



- For details on “AV CONTROLLER”, visit the Yamaha website.

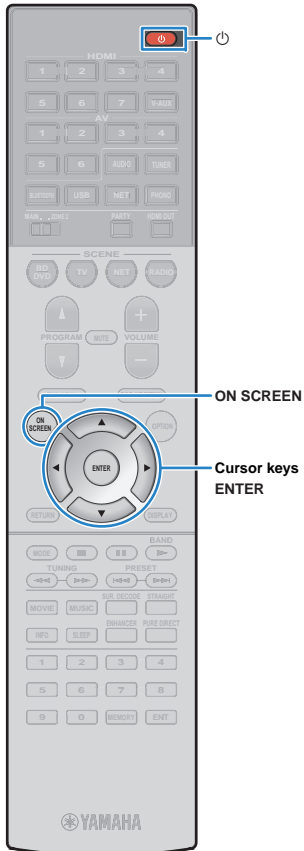

Connecting the unit to a wireless network

There are several methods to connect the unit to a wireless network.
Select a connection method according to your environment.

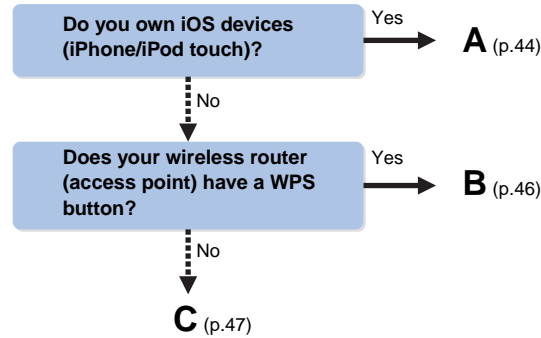

■ A: Sharing the iOS device setting

You can easily setup a wireless connection by applying the connection settings on iOS devices (iPhone/iPod touch).
Before proceeding, confirm that your iOS device is connected to a wireless router.

- 1 Press (receiver power) to turn on the unit.
- 2 Turn on the TV and switch the TV input to display video from the unit (HDMI OUT jack).
- Operations with TV screen are available only when your TV is connected to the unit via HDMI.
- 3 Press ON SCREEN.
- 4 Use the cursor keys to select “Setup” and press ENTER.
- 5 Use the cursor keys (</>) to select “Network”.

- 6 Use the cursor keys (Δ/▽) to select “Network Connection” and press ENTER.
- 7 Use the cursor keys (Δ/▽) and ENTER to check “Wireless (Wi-Fi)” and select “OK”.

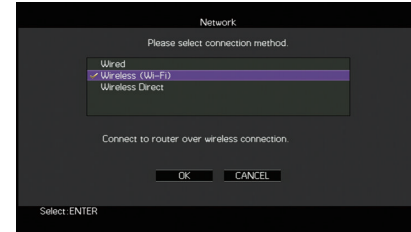

• The checkmark indicates the current setting.

- 8 Use the cursor keys (Δ/▽) and ENTER to check “Share Wi-Fi Settings (iOS)” and select “NEXT”.

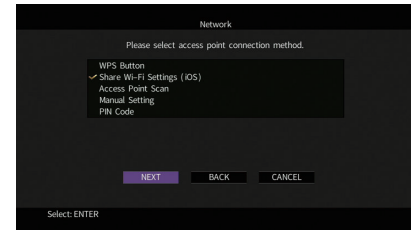



Cursor keys
ENTER

9 Use the cursor keys (△/▽) and ENTER to select the desired connection method and select “NEXT”.

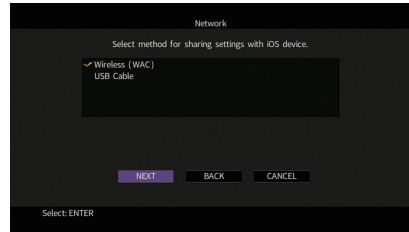

The following connection methods are available.

Wireless (WAC)

You can apply the connection settings on the iOS device to the unit using a wireless connection. For details, see “Sharing the iOS device setting wirelessly”. (You need iOS device with iOS 7 or later.)

USB Cable

You can apply the connection settings on the iOS device to the unit using a USB cable. For details, see “Sharing the iOS device setting using a USB cable”. (You need iOS device with iOS 5 or later.)

Sharing the iOS device setting wirelessly

If you select “Wireless (WAC)” as the connection method, perform the network setting sharing operation on your iOS device. (The following procedure is a setup example for iOS 8.)

1 On the iOS device, select the unit as the AirPlay speaker in the Wi-Fi screen.

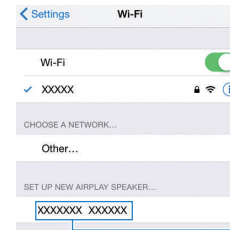

The name of the unit

2 Check the network currently selected and tap “Next”.



Tap here to start setup

The network currently selected

When the sharing process finishes, the unit is automatically connected to the selected network (access point).

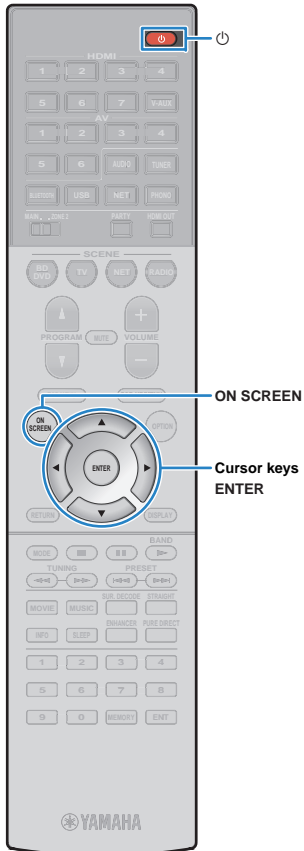

☐ **Sharing the iOS device setting using a USB cable**

If you select “USB Cable” as the connection method, follow the procedure below to share the iOS device setting with the unit.

1 Connect the iOS device to the USB jack, and disable the screen lock on the iOS device.

The unit (front)

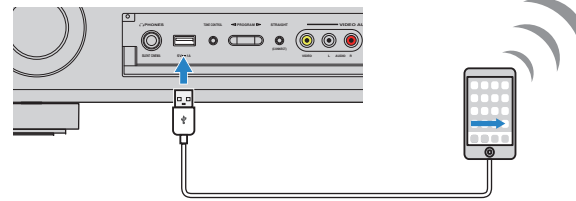

2 Use the cursor keys (</>) to select “NEXT” and press ENTER.

3 Tap “Allow” in the message appeared on the iOS device.

When the connection process finishes, “Completed” appears on the TV screen.

4 To exit from the menu, press ON SCREEN.

■ B: Using the WPS push button configuration

You can easily set up a wireless connection with one push of the WPS button.



- This configuration does not work if the security method of your wireless router (access point) is WEP. In this case, use other connection method.

1 Press ⏻ (receiver power) to turn on the unit.

2 Hold down INFO (WPS) on the front panel for 3 seconds.

“Press WPS button on Access Point” appears on the front display.

3 Push the WPS button on the wireless router (access point).

When the connection process finishes, “Completed” appears on the front display.

If “Not connected” appears, repeat from Step 1 or try another connection method.

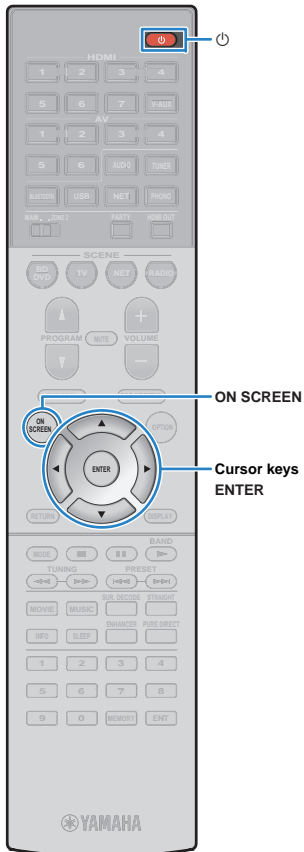

C: Using other connection methods

If your wireless router (access point) does not support WPS push button configuration method, follow the procedure below to configure the wireless network settings.

- 1 Press **⏻** (receiver power) to turn on the unit.
- 2 Turn on the TV and switch the TV input to display video from the unit (HDMI OUT jack).



• Operations with TV screen are available only when your TV is connected to the unit via HDMI.

- 3 Press **ON SCREEN**.
- 4 Use the cursor keys to select “Setup” and press **ENTER**.
- 5 Use the cursor keys (**◀/▶**) to select “Network”.
- 6 Use the cursor keys (**△/▽**) to select “Network Connection” and press **ENTER**.
- 7 Use the cursor keys (**△/▽**) and **ENTER** to check “Wireless (Wi-Fi)” and select “OK”.

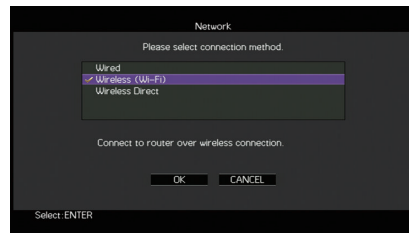

• The checkmark indicates the current setting.

8 Use the cursor keys (**△/▽**) and **ENTER** to select the desired connection method and select “NEXT”.

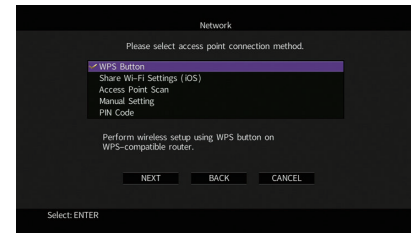

The following connection methods are available.

WPS Button	You can set up a wireless connection with the WPS button while viewing the TV screen. Follow the instructions displayed on the TV screen.
Share Wi-Fi Settings (iOS)	See “Sharing the iOS device setting” (p.44).
Access Point Scan	You can set up a wireless connection by searching for an access point. For details on settings, see “Searching for an access point” (p.48).
Manual Setting	You can set up a wireless connection by entering the required information (such as SSID) manually. For details on settings, see “Setting up the wireless connection manually” (p.48).
PIN Code	You can set up a wireless connection by entering the unit’s PIN code into the wireless router (access point). The method is available if the wireless router (access point) supports the WPS PIN code method. For details on settings, see “Using the PIN code” (p.49).

About WPS

WPS (Wi-Fi Protected Setup) is a standard established by the Wi-Fi Alliance, which allows easy establishment of a wireless home network.

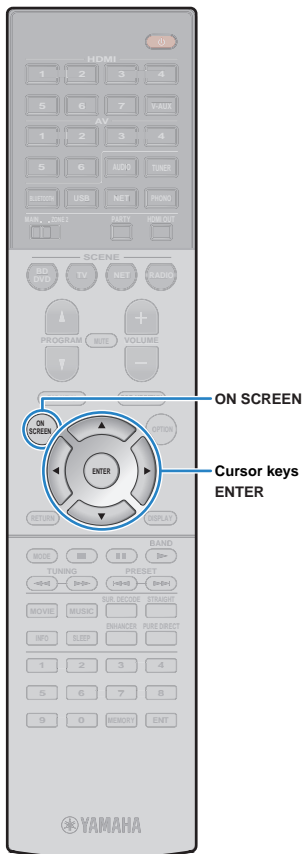

❑ Searching for an access point

If you select “Access Point Scan” as the connection method, the unit starts searching for access points. After a while, the list of available access points appears on the TV screen.

- 1 Use the cursor keys and ENTER to check the desired access point and select “NEXT”.

The wireless connection setting screen appears on the TV.

- 2 Use the cursor keys and ENTER to enter the security key and select “NEXT”.



- 3 Use the cursor keys (◀/▶) to select “CONNECT” and press ENTER to start the connection process.

When the connection process finishes, “Completed” appears on the TV screen.

If “Not connected” appears, repeat from Step 1 or try another connection method.

- 4 To exit from the menu, press ON SCREEN.

❑ Setting up the wireless connection manually

If you select “Manual Setting” as the connection method, the wireless connection setting screen appears on the TV.

You need to setup the SSID (network name), encryption method and security key for your network.

- 1 Use the cursor keys and ENTER to enter the SSID of the access point and select “NEXT”.



- 2 Use the cursor keys (Δ/▽) and ENTER to check the security method of the access point and select “NEXT”.

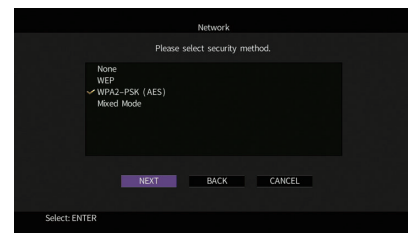

Settings

None, WEP, WPA2-PSK (AES), Mixed Mode

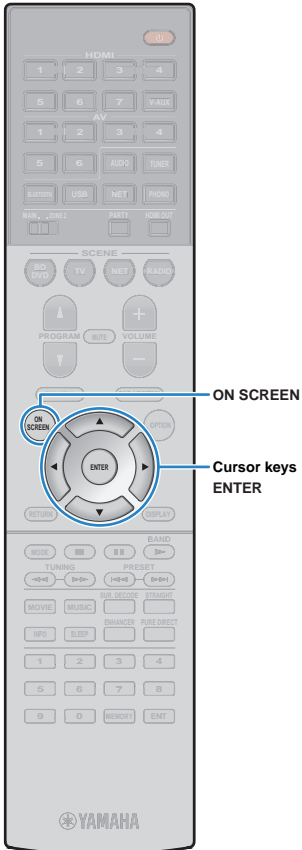

3 Use the cursor keys and ENTER to enter the security key and select “NEXT”.

If you select “None” in Step 2, this setting is not available. Proceed to Step 4.

If you select “WEP”, enter either 5 or 13 character string, or 10 or 26 hexadecimal digits.

If you select other method, enter either 8 to 63 character string, or 64 hexadecimal digits.



4 Use the cursor keys (</>) to select “CONNECT” and press ENTER to start the connection process.

When the connection process finishes, “Completed” appears on the TV screen.

If “Not connected” appears, check that all the information is entered correctly, and repeat from Step 1.

5 To exit from the menu, press ON SCREEN.

Using the PIN code

If you select “PIN Code” as the connection method, the list of available access points appears on the TV screen.

1 Use the cursor keys and ENTER to check the desired access point and select “NEXT”.

The PIN code of the unit appears on the TV screen.

2 Enter the unit’s PIN code into the wireless router (access point).

For details on settings, refer to the instruction manual of the wireless router (access point).

3 Use the cursor keys (</>) to select “CONNECT” and press ENTER to start the connection process.

When the connection process finishes, “Completed” appears on the TV screen.

If “Not connected” appears, repeat from Step 1 or try another connection method.

4 To exit from the menu, press ON SCREEN.

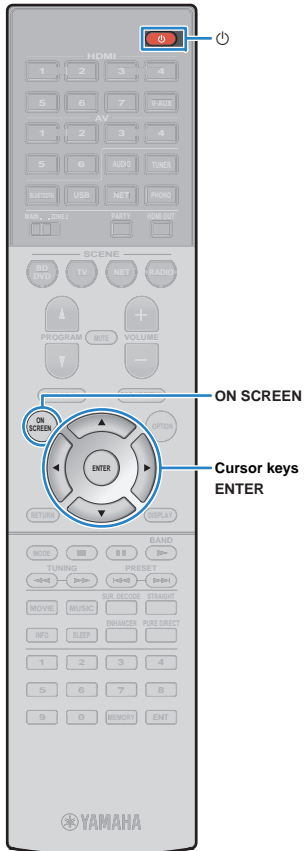

Connecting a mobile device to the unit directly (Wireless Direct)

Follow the procedure below to connect a mobile device to the unit directly.



- Wireless Direct connection may be insecure since the communication is not strongly encrypted. The unit may operate by playback operation on wireless devices connected to the unit without permission.

- 1 Press (receiver power) to turn on the unit.
- 2 Turn on the TV and switch the TV input to display video from the unit (HDMI OUT jack).



- Operations with TV screen are available only when your TV is connected to the unit via HDMI.

- 3 Press ON SCREEN.
- 4 Use the cursor keys to select “Setup” and press ENTER.
- 5 Use the cursor keys (</>) to select “Network”.
- 6 Use the cursor keys (Δ/▽) to select “Network Connection” and press ENTER.

- 7 Use the cursor keys (Δ/▽) and ENTER to check “Wireless Direct” and select “OK”.

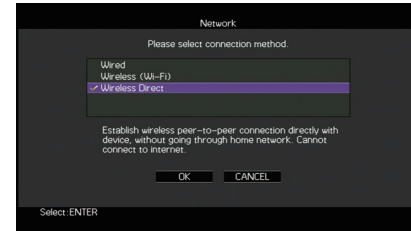

- The checkmark indicates the current setting.

- 8 Use the cursor keys (Δ/▽) and ENTER to check the desired security method and select “NEXT”.

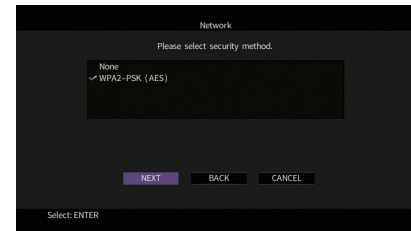

Settings

None, WPA2-PSK (AES)



- If you select “None”, the connection may be insecure since the communication is not encrypted.

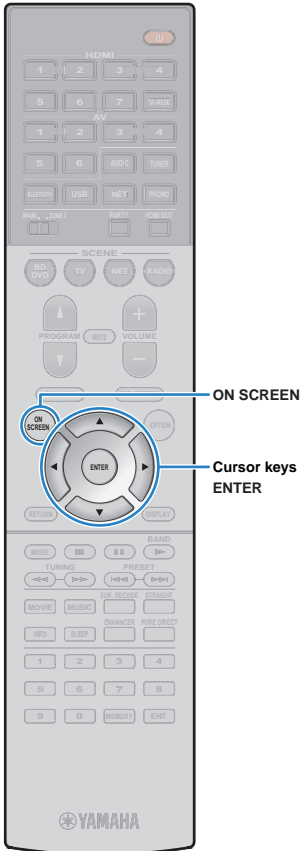

9 Use the cursor keys and ENTER to enter the security key and select “NEXT”.

If you select “None” in Step 8, this setting is not available. Proceed to Step 10.

Otherwise, enter either 8 to 63 character string, or 64 hexadecimal digits.

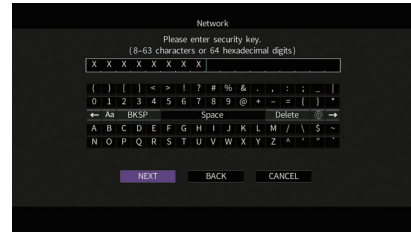

10 Use the cursor keys (</>) to select “OK” and press ENTER to save the setting.

The settings made appear on the TV screen.

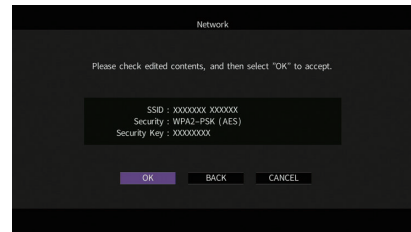

The SSID and security key information is required for setup of a mobile device.

11 Configure the Wi-Fi settings of a mobile device.

For details on settings of your mobile device, refer to the instruction manual of the mobile device.

- ① Enable the Wi-Fi function on the mobile device.
- ② Select the SSID displayed in Step 10 from the list of available access points.
- ③ When you are prompted for a password, enter the security key displayed in Step 10.

12 To exit from the menu, press ON SCREEN.

PLAYBACK

Basic playback procedure

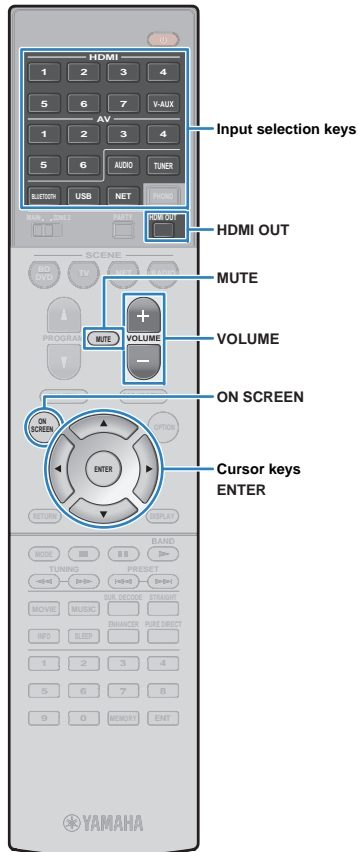

- 1 Turn on the external devices (such as a TV or BD/DVD player) connected to the unit.
- 2 Use the input selection keys to select an input source.
- 3 Start playback on the external device or select a radio station.

Refer to the instruction manual for the external device.

For details on the following operations, see the corresponding pages.

- Listening to FM/AM radio (p.60)
- Playing back music via *Bluetooth* (p.65)
- Playing back iPod music (p.66)
- Playing back music stored on a USB storage device (p.69)
- Playing back music stored on media servers (PCs/NAS) (p.72)
- Listening to Internet radio (p.76)
- Playing back music with AirPlay (p.79)

- 4 Press **VOLUME** to adjust the volume.



- To mute the audio output, press MUTE. Press MUTE again to unmute.
- To adjust the treble/bass settings, use the "Option" menu or TONE CONTROL on the front panel (p.91).

On-screen input selection

- 1 Press ON SCREEN.
- 2 Use the cursor keys to select "Input" and press ENTER.
- 3 Use the cursor keys to select the desired input source and press ENTER.

Selecting an HDMI output jack

- 1 Press **HDMI OUT** to select an HDMI OUT jack.

Each time you press the key, the HDMI OUT jack to be used for signal output changes.



	(RX-A850 only)
HDMI OUT 1+2	Outputs the same signal at both the HDMI OUT 1 and HDMI OUT 2 jacks.
HDMI OUT 1	Output the signals at the HDMI OUT 1 (RX-A850) or HDMI OUT (RX-A750) jack.
HDMI OUT 2	(RX-A850 only) Output the signals at the HDMI OUT 2 jack.
HDMI OUT Off	Does not output the signals at the HDMI OUT jacks.



(RX-A850 only)

- You can also select an HDMI output jack by selecting a scene (p.53).
- When "HDMI OUT 1+2" is selected, the unit outputs video signals at the highest resolution supported by both TVs (or projectors) connected to the unit. (For example, if you have connected a 1080p TV to the HDMI OUT 1 jack and a 720p TV to the HDMI OUT 2 jack, the unit outputs 720p video signals.)

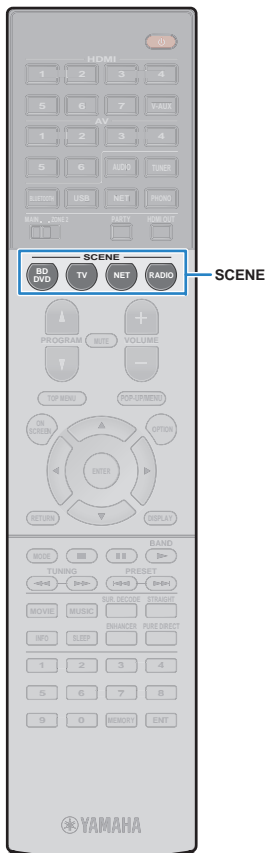

Selecting the input source and favorite settings with one touch (SCENE)

The SCENE function allows you to select the assigned input source, sound program, Compressed Music Enhancer on/off, and HDMI output jack (RX-A850 only) with just one touch.

1 Press SCENE.

The input source and settings registered to the corresponding scene are selected. The unit turns on automatically when it is in standby mode.

By default, the following settings are registered for each scene.

SCENE	BD DVD	TV	NET	RADIO
Input	HDMI 1	AV 4	NET RADIO	TUNER
Sound program	MOVIE (Sci-Fi)	STRAIGHT	MUSIC (7ch Stereo)	MUSIC (7ch Stereo)
Compressed Music Enhancer	Off	On	On	On
HDMI output jack (RX-A850 only)	HDMI OUT 1+2	HDMI OUT 1+2	HDMI OUT 1+2	HDMI OUT 1+2

Configuring scene assignments

1 Perform the following operations to prepare the settings you want to assign to a scene.

- Select an input source (p.52)
- Select a sound program (p.54)
- Enable/disable Compressed Music Enhancer (p.59)
- (RX-A850 only)
Selecting an HDMI output jack (p.52)

2 Hold down the desired SCENE key until “SET Complete” appears on the front display.



- You can also configure scene assignments in the “Scene” menu (p.95).
- The SCENE link playback function allows you to start playback of an external device connected to the unit via HDMI. To enable SCENE link playback, specify the device type in “Device Control” (p.96) in the “Scene” menu.
- (RX-A850 [China, Korea, U.K. and Europe models] only)
To control your playback device after selecting a scene with the remote control of the unit, change the external device assigned to the SCENE keys. For details, refer to “Supplement for Remote Control” in the supplied CD-ROM.

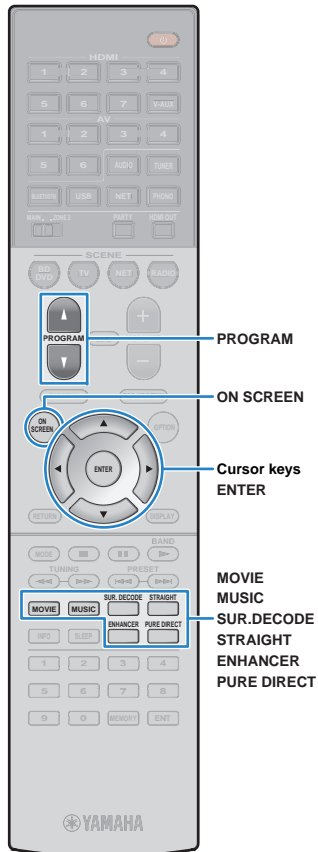

Selecting the sound mode

The unit is equipped with a variety of sound programs and surround decoders that allow you to enjoy playback sources with your favorite sound mode (such as sound field effect or stereo playback).

❑ Selecting a sound program suitable for movies

- Press MOVIE repeatedly.

This mode lets you enjoy sound field effects optimized for viewing video sources, such as movies, TV programs, and games (p.55).

❑ Selecting a sound program suitable for music or stereo playback

- Press MUSIC repeatedly.

This mode lets you enjoy sound field effects optimized for listening music sources or stereo playback (p.56).

❑ Selecting a surround decoder

- Press SUR.DECODE repeatedly.

This mode lets you enjoy unprocessed multichannel playback from 2-channel sources (p.58).

❑ Switching to the straight decode mode

- Press STRAIGHT.

This mode lets you enjoy unprocessed sounds in original channels (p.58).

❑ Switching to the Pure Direct mode

- Press PURE DIRECT.

This mode lets you enjoy pure high fidelity sound by reducing the electrical noise from other circuitry (p.59).

❑ Enabling Compressed Music Enhancer

- Press ENHANCER.

This mode lets you enjoy compressed music with additional depth and breadth (p.59).



On-screen sound program/surround decoder selection

- ① Press ON SCREEN.
- ② Use the cursor keys to select "DSP Program" and press ENTER.
- ③ Use the cursor keys to select a sound program/surround decoder and press ENTER.



- You can also switch the sound programs and surround decoder by pressing PROGRAM.
- You can change the settings of the surround programs and surround decoders in the "DSP Program" menu (p.97).
- The sound mode can be applied separately to each input source.
- When you play back audio signals with a sampling rate of higher than 96 kHz, the straight decode mode (p.58) is automatically selected.
- You can check which speakers are currently outputting sound by looking at the speaker indicators on the unit's front panel (p.11) or at the "Audio Signal" screen in the "Information" menu (p.117).

Enjoying stereoscopic sound fields (CINEMA DSP 3D)



The unit is equipped with a variety of sound programs that utilize Yamaha's original DSP technology (CINEMA DSP 3D). It allows you to easily create sound fields like actual movie theaters or concert halls in your room and enjoy natural stereoscopic sound fields.

Sound program category



- To use the conventional CINEMA DSP, set "CINEMA DSP 3D Mode" (p.108) in the "Setup" menu to "Off".
- We recommend using presence speakers in order to experience the full effect of the stereoscopic sound fields. However, even when no presence speakers are connected, the unit creates Virtual Presence Speaker (VPS) using the front, center, and surround speakers to produce stereoscopic sound fields.
- If a multichannel source (6.1 channels or more) is input when no surround back speakers are connected, the unit creates Virtual Surround Back Speaker (VSBS) using the surround speakers to add a sense of depth to the rear sound field.
- When VPS or VSBS is working, "VIRTUAL" lights up in the front display.

■ Sound programs suitable for movies (MOVIE)

The following sound programs are optimized for viewing video sources, such as movies, TV programs, and games.

□ MOVIE THEATER

Standard	This program creates a sound field that emphasizes the surround feeling without disturbing the original acoustic positioning of multichannel audio, such as Dolby Digital and DTS. Its design is based on the concept of the ideal movie theater, in which the audience is surrounded by beautiful reverberations from the left, right, and rear.
Spectacle	This program delivers the scale and grandeur of spectacular movie productions. It delivers an expansive sound space to match the cinemascope wide-screen, and boasts a broad dynamic range, providing everything from small delicate sounds to powerful loud booms.
Sci-Fi	This program clearly reproduces the finely elaborated sound design of the latest Sci-Fi and SFX movies. You can enjoy a variety of cinematographically created virtual spaces reproduced with clear separation between dialogue, sound effects, and background music.
Adventure	This program is ideal for reproducing the sound design of action and adventure movies precisely. The sound field restrains reverberations, but puts emphasis on reproducing a sensation of expansiveness on both sides, powerful space expanded widely to the left and right. The restrained depth creates a clear and powerful space, while also maintaining the articulation of the sounds and the separation of the channels.
Drama	This program features stable reverberations that match a wide range of movie genres, from serious dramas to musicals and comedies. The reverberations are modest, but suitably stereophonic. The sound effects and background music are reproduced with a gentle echo that does not impinge on the articulation of the dialogue. You'll never get tired listening for long periods.
Mono Movie	This program reproduces monaural video sources, such as classic movies, in an atmosphere of a good old movie theater. The program creates a pleasant space with depth, by adding breadth and the appropriate reverberation to the original audio.

❑ ENTERTAINMENT

Sports	This program allows listeners to enjoy the rich vividness of sport broadcasts and light entertainment programs. In sports broadcasts, the commentators' voices are positioned clearly at the center, while the atmosphere inside the stadium is realistically conveyed by the peripheral delivery of the sounds of the fans in a suitable space.
Action Game	This program is suitable for action games, such as car racing and fighting games. The reality of, and emphasis on, various effects makes the player feel like they are right in the middle of the action, allowing for greater concentration. Use this program in combination with Compressed Music Enhancer for a more dynamic and strong sound field.
Roleplaying Game	This program is suitable for role-playing and adventure games. This program adds depth to the sound field for natural and realistic reproduction of background music, special effects, and dialogue from a wide variety of scenes. Use this program in combination with Compressed Music Enhancer for a clearer and more spatial sound field.
Music Video	This program allows you to enjoy videos of pop, rock, and jazz concerts, as if you were there yourself. Immerse yourself in the hot concert atmosphere thanks to the vividness of the singers and solos on stage, a presence sound field that emphasizes the beat of rhythm instruments, and a surround sound field that reproduces the space of a big live hall.

■ Sound programs suitable for music/stereo playback (MUSIC)

The following sound programs are optimized for listening to music sources.

You can also select stereo playback.

❑ CLASSICAL

Hall in Munich	This program simulates a Munich concert hall with approximately 2,500 seats that uses stylish wood for the interior finishing. Fine, beautiful reverberations spread richly, creating a calming atmosphere. The listener's virtual seat is at the center left of the arena.
Hall in Vienna	This program simulates a 1,700-seat, middle-sized concert hall with a shoebox shape that is traditional in Vienna. Pillars and ornate carvings create extremely complex reverberations from all around the audience, producing a very full, rich sound.
Chamber	This program creates a relatively wide space with a high ceiling, like an audience hall in a palace. It offers pleasant reverberations that are suitable for courtly music and chamber music.

❑ LIVE/CLUB

Cellar Club	This program simulates an intimate concert venue with a low ceiling and homey atmosphere. A realistic, live sound field delivers powerful sounds that make you feel as if you are sitting in the front row in front of a small stage.
The Roxy Theatre	This program creates the sound field of a 460-seat rock music concert venue in Los Angeles. The listener's virtual seat is at the center left of the hall.
The Bottom Line	This program creates the sound field at stage front in The Bottom Line, a famous New York jazz club once. The floor can seat 300 people to the left and right in a sound field offering real and vibrant sound.

❑ STEREO

2ch Stereo	Use this program to mix down multichannel sources to 2 channels. When multichannel signals are input, they are down mixed to 2 channels and output from the front speakers (this program does not utilize CINEMA DSP).
7ch Stereo	Use this program to output sound from all speakers. When you play back multichannel sources, the unit mixes down the source to 2 channels, and then outputs the sound from all speakers. This program creates a larger sound field and is ideal for background music at parties.



- CINEMA DSP 3D (p.55) and Virtual CINEMA DSP (p.57) do not work when "2ch Stereo" or "7ch Stereo" is selected.

■ Enjoying sound field effects without surround speakers (Virtual CINEMA DSP)

If you select one of the sound programs (except 2ch Stereo and 7ch Stereo) when no surround speakers are connected, the unit utilizes Yamaha's original virtual surround technology to reproduce up to 7-channel surround sound and enable you to enjoy the well-oriented sound field only with the front-side speakers. We recommend using presence speakers in order to enjoy more effective stereoscopic sound field.



- When Virtual CINEMA DSP is working, "VIRTUAL" lights up in the front display.

■ Enjoying surround sound with 5 speakers placed in front (Virtual CINEMA FRONT)

If you have surround speakers but there is no space to place them in the rear of your room, you can place them in the front (p.18) and enjoy multichannel surround sound using Virtual CINEMA FRONT.

When "Layout (Surround)" (p.104) in the "Setup" menu is set to "Front", the unit creates the virtual surround speakers in the rear side to allow you to enjoy multichannel surround sound with the 5 speakers placed in the front.



- When Virtual CINEMA FRONT is working, "VIRTUAL" lights up in the front display.

■ Enjoying surround sound with headphones (SILENT CINEMA)

SILENT™
CINEMA

You can enjoy surround or sound field effects, like a multichannel speaker system, with stereo headphones by connecting the headphones to the PHONES jack and selecting a sound program or a surround decoder.



Enjoying unprocessed playback

You can play back input sources without any sound field effect processing.

■ Playing back in original channels (straight decode)

When the straight decode mode is enabled, the unit produces stereo sound from the front speakers for 2-channel sources such as CDs, and produces unprocessed multichannel sounds for multichannel sources.

1 Press STRAIGHT.

Each time you press the key, the straight decode mode is enabled or disabled.



- To enable 6.1/7.1-channel playback from 5.1-channel sources when surround back speakers are used, select a surround decoder (p.58).
- If “Layout (Surround)” (p.104) in the “Setup” menu is set to “Front”, Virtual CINEMA FRONT (p.57) works when multichannel source is played back.

■ Playing back 2-channel sources in multichannel (surround decoder)

The surround decoder enables unprocessed multichannel playback from 2-channel or multichannel sources.



- Speakers that produce sounds will change depending on your speaker system and the selected decode type (p.98).
- For details on each decoder, see “Glossary” (p.134).

1 Press SUR.DECODE to select a surround decoder.

Each time you press the key, the surround decoder changes.



	(RX-A850 only) Use the Dolby Surround decoder suitable for all sources. A real acoustic space (including overhead) will be created especially when object-based audio (such as Dolby Atmos content) is played.
Surround	
PLIIx Movie	Use the Dolby Pro Logic IIx decoder (or Dolby Pro Logic II decoder) suitable for movies. Sounds will be output from the surround/surround back speakers even when 2-channel source is input.
PLII Movie	
PLIIx Music	Use the Dolby Pro Logic IIx decoder (or Dolby Pro Logic II decoder) suitable for music. Sounds will be output from the surround/surround back speakers even when 2-channel source is input.
PLII Music	
PLIIx Game	Use the Dolby Pro Logic IIx decoder (or Dolby Pro Logic II decoder) suitable for games. Sounds will be output from the surround/surround back speakers even when 2-channel source is input.
PLII Game	
Neo:6 Cinema	Uses the DTS Neo:6 decoder (or DTS-ES Matrix decoder) suitable for movies. Sounds will be output from the surround/surround back speakers.
Neo:6 Music	Uses the DTS Neo:6 decoder (or DTS-ES Matrix decoder) suitable for music. Sounds will be output from the surround/surround back speakers.



- You cannot select the Dolby Pro Logic IIx decoders when headphones are connected or when “Surround Back” in the “Setup” menu is set to “None”.
- (RX-A850 only)
When the Dolby Surround decoder is selected, virtual surround processing (such as Virtual CINEMA FRONT) (p.57), YPAO Volume (p.91) or Compressed Music Enhancer (p.59) does not work. Also, audio outputs from the HDMI OUT and ZONE OUT jacks are disabled.
- (RX-A850 only)
If the Dolby Surround decoder is selected when only one surround back speaker is used, no sound is output from the surround back speaker (except when a Dolby Atmos content is played).

Enjoying pure high fidelity sound (Pure Direct)

When the Pure Direct mode is enabled, the unit plays back the selected source with the least circuitry in order to reduce the electrical noise from other circuitry (such as the front display). It allows you to enjoy Hi-Fi sound quality.

1 Press PURE DIRECT.

Each time you press the key, the Pure Direct mode is enabled or disabled.



- When the Pure Direct mode is enabled, the following functions are not available.
 - Some settings for the speakers or sound programs
 - Operating the on-screen menu and some items in the “Option” menu
 - Using the multi-zone function
 - Viewing information on the front display (when not in operation)

Enjoying compressed music with enhanced sound (Compressed Music Enhancer)

compressed music ENHANCER

Compressed Music Enhancer adds depth and breadth to the sound, allowing you to enjoy a dynamic sound close to the original sound before it was compressed. This function can be used along with any other sound modes.

1 Press ENHANCER.

Each time you press the key, Compressed Music Enhancer is enabled or disabled.

“ENHANCER” lights up



- Compressed Music Enhancer does not work on signals whose sampling rate is over 48 kHz.



- You can also use “Enhancer” (p.92) in the “Option” menu to enable/disable Compressed Music Enhancer.

Listening to FM/AM radio

You can tune into a radio station by specifying its frequency or selecting from registered radio stations.



- The radio frequencies differ depending on the country or region where the unit is being used. The explanation of this section uses a display with frequencies used in U.K. and Europe models.
- If you cannot obtain good reception on the radio, adjust the direction of the FM/AM antennas.

Setting the frequency steps

(Asia and General models only)

At the factory, the frequency step setting is set to 50 kHz for FM and 9 kHz for AM. Depending on your country or region, set the frequency steps to 100 kHz for FM and 10 kHz for AM.

- 1 Set the unit to standby mode.**
- 2 When holding down STRAIGHT on the front panel, press MAIN ZONE .**

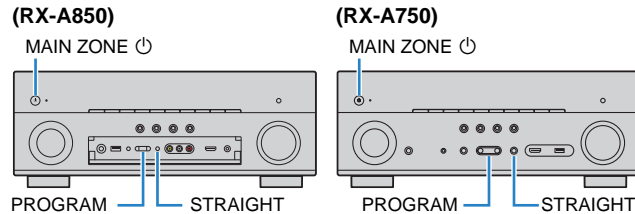

- 3 Press PROGRAM repeatedly to select “TU”.**



- 4 Press STRAIGHT to select “FM100/AM10”.**

- 5 Press MAIN ZONE  to set the unit to standby mode and turn it on again.**

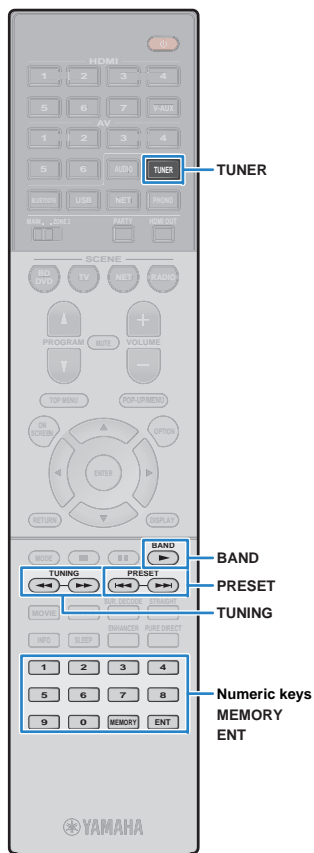

Selecting a frequency for reception

- 1 Press **TUNER** to select “TUNER” as the input source.
- 2 Press **BAND** to select a band (FM or AM).



- 3 Use the following keys to set a frequency.

TUNING: Increase/decrease the frequency. Hold down the key for about a second to search stations automatically.

Numeric keys: Enter a frequency directly. For example, to select 98.50 MHz, press “9”, “8”, “5” and “0” (or ENT).



“TUNED” lights up when a signal is received from a radio station.

“STEREO” also lights up when a stereo signal is received.



- “Wrong Station!” appears when you enter a frequency that is out of reception range.



- You can switch between “Stereo” (stereo) and “Mono” (monaural) for FM radio reception in “FM Mode” (p.92) in the “Option” menu. When the signal reception for an FM radio station is unstable, switching to monaural may improve it.

Registering favorite radio stations (presets)

You can register up to 40 radio stations as presets. Once you have registered stations, you can easily tune into them by selecting their preset numbers.



- You can automatically register FM radio stations that have strong signals by using “Auto Preset” (p.64).

Registering a radio station

Select a radio station manually and register it to a preset number.

- 1 Follow “Selecting a frequency for reception” (p.61) to tune into the desired radio station.
- 2 Hold down **MEMORY** for more than 2 seconds.

The first time that you do register a station, the selected radio station will be registered to the preset number “01”. Thereafter, each radio station you select will be registered to the next empty (unused) preset number after the most recently registered number.



Preset number



- To select a preset number for registering, press **MEMORY** once after tuning into the desired radio station, press **PRESET** to select a preset number, and then press **MEMORY** again.



“Empty” (not in use) or the frequency currently registered

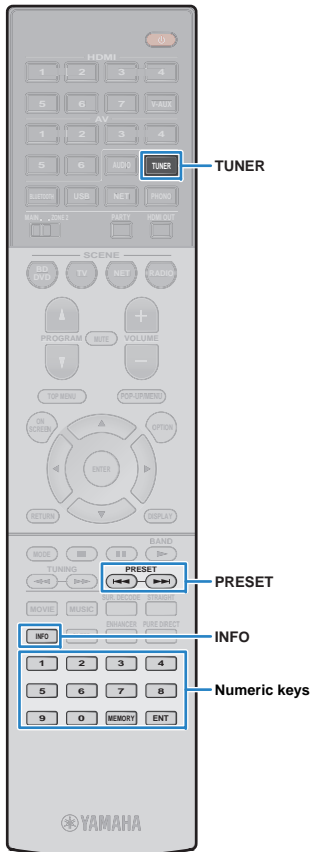

■ Selecting a preset station

Tune into a registered radio station by selecting its preset number.

- 1 Press **TUNER** to select “TUNER” as the input source.
- 2 Press **PRESET** repeatedly to select the desired radio station.

You can also enter a preset number (01 to 40) directly by using the numeric keys after pressing PRESET once.



- “No Presets” appears when no radio stations are registered.
- “Wrong Num.” appears when an invalid number is entered.
- “Empty” appears when a preset number not in use is entered.



- To clear preset stations, use “Clear Preset” or “Clear All Preset” (p.64).

Radio Data System tuning

(U.K. and Europe models only)

Radio Data System is a data transmission system used by FM stations in many countries. The unit can receive various types of Radio Data System data, such as “Program Service”, “Program Type,” “Radio Text” and “Clock Time”, when it is tuned into a Radio Data System broadcasting station.

■ Displaying the Radio Data System information

- 1 Tune into the desired Radio Data System broadcasting station.



- We recommend using “Auto Preset” to tune into the Radio Data System broadcasting stations (p.64).

- 2 Press **INFO**.
Each time you press the key, the displayed item changes.



Item name

About 3 seconds later, the corresponding information for the displayed item appears.



Information

Program Service	Program service name
Program Type	Current program type
Radio Text	Information on the current program
Clock Time	Current time
DSP Program	Sound mode name
Audio Decoder	Decoder name
Frequency	Frequency

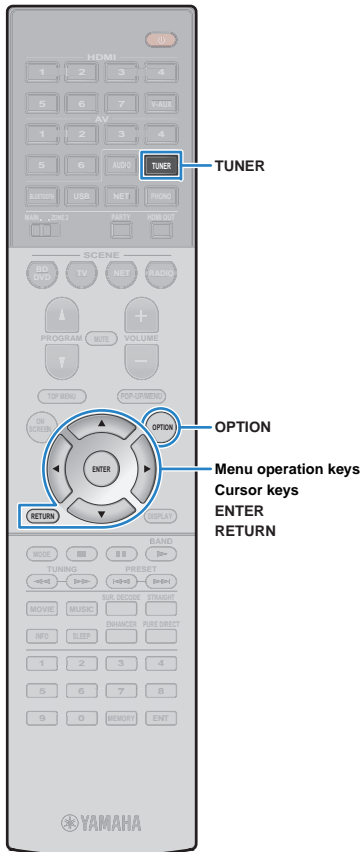

- “Program Service”, “Program Type”, “Radio Text”, and “Clock Time” are not displayed if the radio station does not provide the Radio Data System service.

■ Receiving traffic information automatically

When “TUNER” is selected as the input source, the unit automatically receives traffic information. To enable this function, follow the procedure below to set the traffic information station.

- 1 When “TUNER” is selected as the input source, press **OPTION**.
- 2 Use the cursor keys to select “Traffic Program” (TrafficProgram) and press **ENTER**.

The traffic information station search will start in 5 seconds. Press **ENTER** again to start the search immediately.



- To search upward/downward from the current frequency, press the cursor keys (Δ/∇) while “READY” is displayed.
- To cancel the search, press **RETURN**.
- Texts in parentheses denote indicators on the front display.

The following screen appears for about 3 seconds when the search finishes.



Traffic information station (frequency)



- “TP Not Found” appears for about 3 seconds when no traffic information stations are found.

Operating the radio on the TV

You can view the radio information or select a radio station on the TV.

- 1 Press **TUNER** to select “TUNER” as the input source.

The playback screen is displayed on the TV.

■ Playback screen

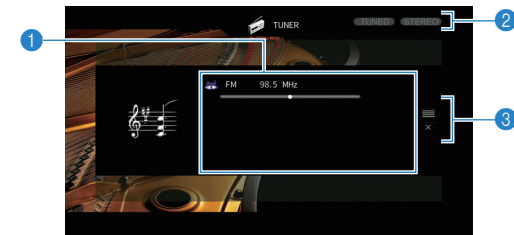

- 1 **Radio station information**

Displays the information of the selected radio station such as the selected band (FM/AM) and frequency.

(U.K. and Europe models only)

When tuning into a Radio Data System broadcasting station (p.62), the Radio Data System information (“Program Service”, “Program Type,” “Radio Text” and “Clock Time”) is also displayed.

- 2 **TUNED/STEREO indicators**

“TUNED” lights up when a signal is received from a radio station.

“STEREO” lights up when a stereo signal is received.

- 3 **Operation menu**

Press the cursor key (\triangleright) and then use the cursor keys (Δ/∇) to select an item. Press **ENTER** to confirm the selection.

Menu	Function
Browse	Moves to the browse screen (preset station list).
Screen Off	Closes the screen display and shows the background. Press one of the menu operation keys to redisplay it.



Menu operation keys
Cursor keys
ENTER

Browse screen



1 Preset station list

Displays the list of preset stations. Use the cursor keys to select a preset station and press ENTER to tune into it.

2 Preset number

3 Operation menu

Press the cursor key (▷) and then use the cursor keys (△/▽) to select an item. Press ENTER to confirm the selection.

Menu	Submenu	Function
Utility	Memory	Registers the current station to the preset number selected in the list.
	Auto Preset	Automatically registers FM radio stations with strong signals (up to 40 stations).
	Clear Preset	Clear the preset station selected in the list.
	Clear All Preset	Clear all the preset stations.
1 Page Up		Moves to the previous/next page of the list.
1 Page Down		
Now Playing		Moves to the playback screen.
Screen Off		Closes the screen display and shows the background. Press one of the menu operation keys to redisplay it.



- (U.K. and Europe models only)
Only Radio Data System broadcasting stations are stored automatically by "Auto Preset".

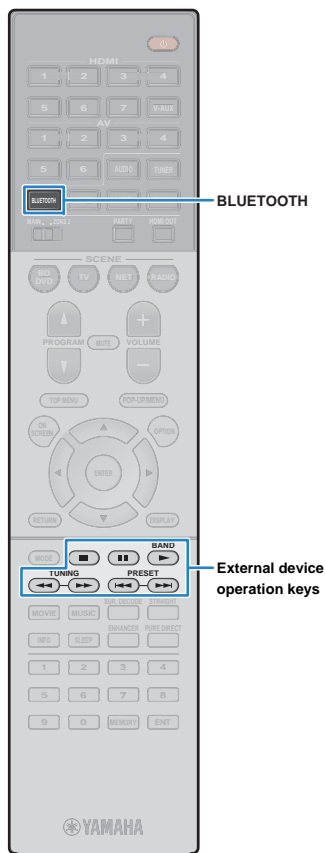

Playing back music via *Bluetooth*

You can play back music files stored on a *Bluetooth* device (such as smartphones) on the unit.

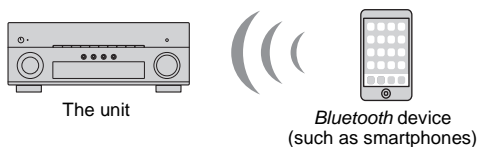

- To use the *Bluetooth* function, set “Bluetooth” (p.113) in the “Setup” menu to “On”.



- For details on supported *Bluetooth* devices, see “Supported devices and file formats” (p.137).

Playing back *Bluetooth* device music on the unit

Follow the procedure below to establish a *Bluetooth* connection between a *Bluetooth* device (such as smartphones) and the unit, and play back music stored the *Bluetooth* device on the unit.



- The unit does not support video playback via *Bluetooth*.

1 Press BLUETOOTH to select “Bluetooth” as the input source.

2 On the *Bluetooth* device, select the unit (network name of the unit) from the available device list.

A connection between the *Bluetooth* device and the unit will be made.

If the pass key is required, enter the number “0000”.

3 On the *Bluetooth* device, select a song and start playback.

The playback screen (artist name, album name and song title) is displayed on the TV.



- “Not found” appears when no *Bluetooth* devices are detected.



- If the unit detects the *Bluetooth* device previously connected, the unit automatically connects to the *Bluetooth* device after Step 1. To establish another *Bluetooth* connection, first terminate the current *Bluetooth* connection.
- To terminate the *Bluetooth* connection, perform one of the following operations.
 - Perform the disconnect operation on the *Bluetooth* device.
 - Select an input source other than “Bluetooth” on the unit.
 - Select “Disconnect” in “Audio Receive” (p.102) in the “Setup” menu.
- You can use the external device operation keys (▶, ■, ■, ◀, ▶▶) on the remote control to control playback.

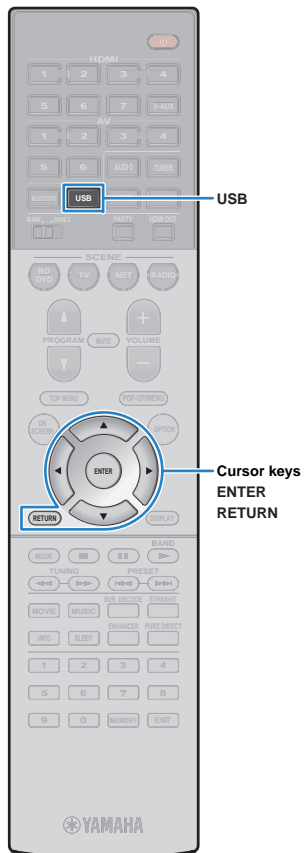

Playing back iPod music

You can play back iPod music on the unit using a USB cable supplied with the iPod.



- For details on playable iPod devices, see “Supported devices and file formats” (p.137).



- The unit does not support a USB connection for iPad. To play back iPad music on the unit, use AirPlay (p.79).

Connecting an iPod

Connect your iPod to the unit with the USB cable supplied with the iPod.

- 1 Connect the USB cable to the iPod.
- 2 Connect the USB cable to the USB jack.

The unit (front)

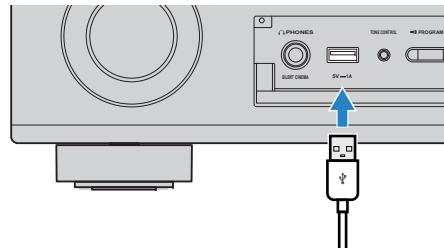

- The iPod charges while it is connected to the unit. If you set the unit to standby mode while the iPod is charging, the iPod continues to charge up to 4 hours. If “Network Standby” (p.112) in the “Setup” menu is set to “On”, it continues to charge without limit.



- Disconnect the iPod from the USB jack when it is not in use.

Playback of iPod content

Follow the procedure below to operate the iPod contents and start playback.

You can control the iPod with the menu displayed on the TV screen.

- 1 Press **USB** to select “USB” as the input source.

The browse screen is displayed on the TV.

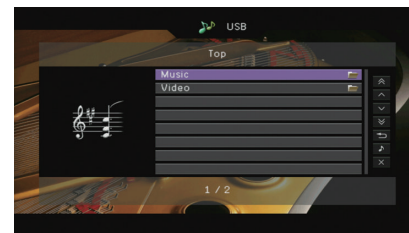

- If playback is ongoing on your iPod, the playback screen is displayed.

- 2 Use the cursor keys to select an item and press **ENTER**.

If a song is selected, playback starts and the playback screen is displayed.

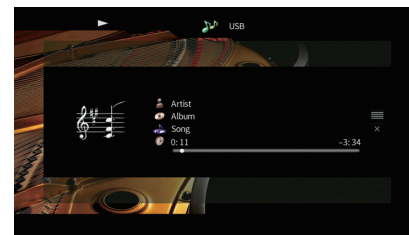

- To return to the previous screen, press **RETURN**.
- To operate the iPod manually to select content or control playback, switch to the simple play mode (p.68).



Browse screen

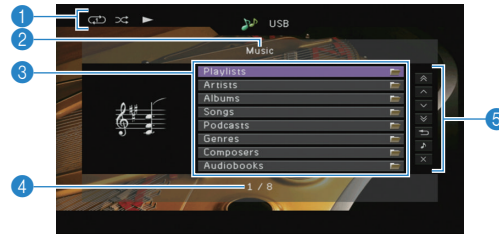

- 1 Status indicators**
Display the current shuffle/repeat settings (p.68) and playback status (such as play/pause).
- 2 List name**
Displays the list of iPod content. Use the cursor keys to select an item and press ENTER to confirm the selection.
- 3 Contents list**
Displays the list of iPod content. Use the cursor keys to select an item and press ENTER to confirm the selection.
- 4 Item number/total**
- 5 Operation menu**
Press the cursor key (▷) and then use the cursor keys (△/▽) to select an item. Press ENTER to confirm the selection.

Menu	Function
1 Page Up	Moves to the previous/next page of the list.
1 Page Down	
10 Pages Up	Moves 10 pages forward/backward.
10 Pages Down	
Return	Returns to the higher-level list.
Now Playing	Moves to the playback screen.
Screen Off	Closes the screen display and shows the background. Press one of the menu operation keys to redisplay it.

Playback screen

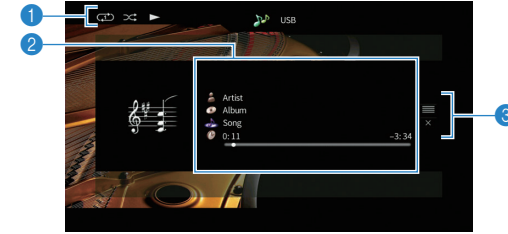

- 1 Status indicators**
Display the current shuffle/repeat settings (p.68) and playback status (such as play/pause).
- 2 Playback information**
Displays the artist name, album name, song title, and elapsed/remaining time.
Use the cursor keys to select scrollable information.
- 3 Operation menu**
Press the cursor key (▷) and then use the cursor keys (△/▽) to select an item. Press ENTER to confirm the selection.

Menu	Function
Browse	Moves to the browse screen.
Screen Off	Closes the screen display and shows the background. Press one of the menu operation keys to redisplay it.



- You can use the external device operation keys on the remote control to control playback.

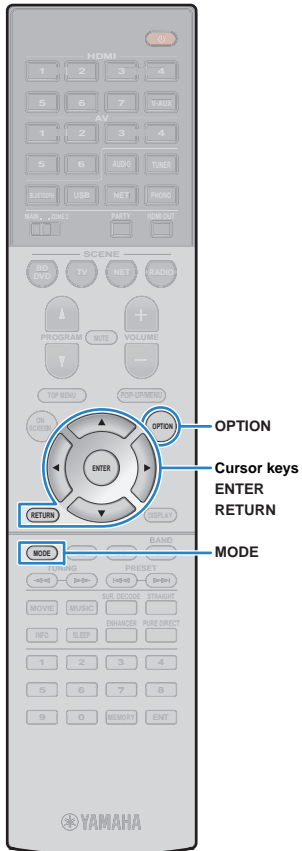

■ Operating the iPod itself (simple play)

1 Press MODE to switch to the simple play mode.

The TV menu screen turns off and iPod operations are enabled.

To display the TV menu screen, press MODE again.

2 Operate your iPod itself to start playback.

■ Shuffle/repeat settings

You can configure the shuffle/repeat settings of your iPod.



- During simple play, configure the shuffle/repeat settings directly on your iPod or press MODE to display the TV menu screen and then follow the procedure below.

1 When “USB” is selected as the input source, press OPTION.

2 Use the cursor keys to select “Shuffle” (Shuffle) or “Repeat” (Repeat) and press ENTER.



- To return to the previous screen during menu operations, press RETURN.
- Texts in parentheses denote indicators on the front display.

3 Use the cursor keys (</>) to select a setting.

Item	Setting	Function
Shuffle (Shuffle)	Off (Off)	Turns off the shuffle function.
	Songs (Songs)	Plays back songs in random order. “∞” appears in the TV screen.
	Albums (Albums)	Plays back albums in random order. “∞” appears in the TV screen.
Repeat (Repeat)	Off (Off)	Turns off the repeat function.
	One (One)	Plays back the current song repeatedly. “1” appears in the TV screen.
	All (All)	Plays back all songs repeatedly. “∞” appears in the TV screen.

4 To exit from the menu, press OPTION.



Playing back music stored on a USB storage device

You can play back music files stored on a USB storage device on the unit.

The unit supports USB mass storage class devices (FAT16 or FAT32 format).



- For details on playable file formats, see “Supported devices and file formats” (p.137).

Connecting a USB storage device

1 Connect the USB storage device to the USB jack.

The unit (front)

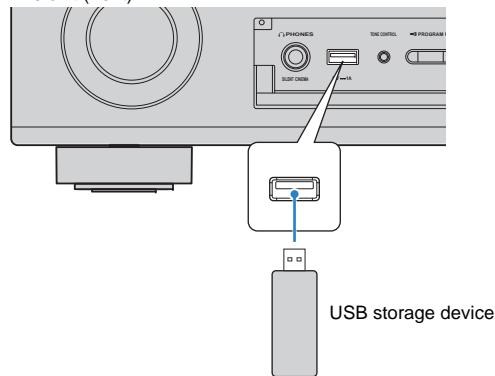

USB storage device



- If the USB storage device contains many files, it may take time to load the them. In this case, “Loading...” appears in the front display.



- Stop playback of the USB storage device before disconnect it from the USB jack.
- Connect a USB storage device directly to the USB jack of the unit. Do not use extension cables.

Playback of USB storage device contents

Follow the procedure below to operate the USB storage device contents and start playback.

You can control the USB memory device with the menu displayed on the TV screen.

1 Press USB to select “USB” as the input source.

The browse screen is displayed on the TV.



- If playback is ongoing on your USB storage device, the playback screen is displayed.

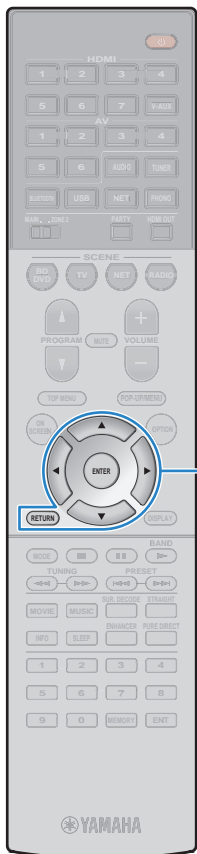

2 Use the cursor keys to select an item and press ENTER.

If a song is selected, playback starts and the playback screen is displayed.



- To return to the previous screen, press RETURN.
- Files not supported by the unit cannot be selected.
- If the unit detects a series of unsupported files (such as images and hidden files) during playback, playback stops automatically.

■ Browse screen



1 Status indicators

Display the current shuffle/repeat settings (p.71) and playback status (such as play/pause).

2 List name

3 Contents list

Displays the list of USB storage device contents. Use the cursor keys to select an item and press ENTER to confirm the selection.

4 Item number/total

5 Operation menu

Press the cursor key (▷) and then use the cursor keys (△/▽) to select an item. Press ENTER to confirm the selection.

Menu	Function
1 Page Up	Moves to the previous/next page of the list.
1 Page Down	
10 Pages Up	Moves 10 pages forward/backward.
10 Pages Down	
Return	Returns to the higher-level list.
Now Playing	Moves to the playback screen.
Screen Off	Closes the screen display and shows the background. Press one of the menu operation keys to redisplay it.

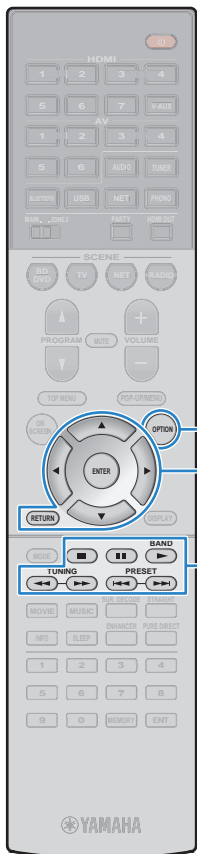

OPTION
Menu operation keys
 Cursor keys
 ENTER
 RETURN

External device operation keys

■ Playback screen

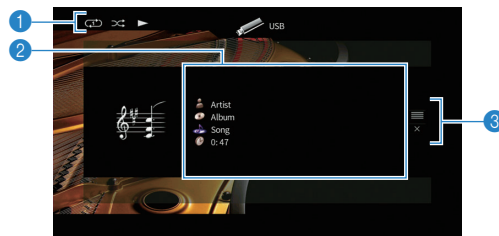

- 1 Status indicators**
 Display the current shuffle/repeat settings (p.71) and playback status (such as play/pause).
- 2 Playback information**
 Displays the artist name, album name, song title, and elapsed time. Use the cursor keys to select scrollable information.
- 3 Operation menu**
 Press the cursor key (▷) and then use the cursor keys (△/▽) to select an item. Press ENTER to confirm the selection.

Menu	Function
Browse	Moves to the browse screen.
Screen Off	Closes the screen display and shows the background. Press one of the menu operation keys to redisplay it.

-  You can use the external device operation keys (▶, ■, ■■, ◀, ▶▶) on the remote control to control playback.

■ Shuffle/repeat settings

You can configure the shuffle/repeat settings for playback of USB storage device contents.

- 1** When “USB” is selected as the input source, press **OPTION**.
- 2** Use the cursor keys to select “Shuffle” (Shuffle) or “Repeat” (Repeat) and press **ENTER**.



- To return to the previous screen during menu operations, press RETURN.
- Texts in parentheses denote indicators on the front display.

- 3** Use the cursor keys (</>) to select a setting.

Item	Setting	Function
Shuffle (Shuffle)	Off (Off)	Turns off the shuffle function.
	On (On)	Plays back songs in the current album (folder) in random order. “∞” appears on the TV screen.
Repeat (Repeat)	Off (Off)	Turns off the repeat function.
	One (One)	Plays back the current song repeatedly. “1” appears on the TV screen.
	All (All)	Plays back all songs in the current album (folder) repeatedly. “∞” appears on the TV screen.

- 4** To exit from the menu, press **OPTION**.

Playing back music stored on media servers (PCs/NAS)

You can play back music files stored on your PC or DLNA-compatible NAS on the unit.



- To use this function, the unit and your PC must be connected to the same router (p.31). You can check whether the network parameters (such as the IP address) are properly assigned to the unit in "Network" (p.118) in the "Information" menu.
- The audio may be interrupted while using the wireless network connection. In this case, use the wired network connection.



- For details on playable file formats, see "Supported devices and file formats" (p.137).

Media sharing setup

To play back music files stored on your PC or DLNA-compatible NAS, first you need to configure the media sharing setting on each music server.

■ For a PC with Windows Media Player installed

□ For Windows Media Player 12

- 1 Start Windows Media Player 12 on your PC.**
- 2 Select "Stream", then "Turn on media streaming".**
- 3 Click "Turn on media streaming".**
- 4 Select "Allowed" from the drop-down list next to the unit's model name.**
- 5 Click "OK" to exit.**

□ For Windows Media Player 11

- 1 Start Windows Media Player 11 on your PC.**
- 2 Select "Library", then "Media Sharing".**
- 3 Check the "Share my media to" box, select the unit's icon, and click "Allow".**
- 4 Click "OK" to exit.**



- For details on media sharing settings, refer to Windows Media Player help.

■ For a PC or a NAS with other DLNA server software installed

Refer to the instruction manual for the device or software and configure the media sharing settings.

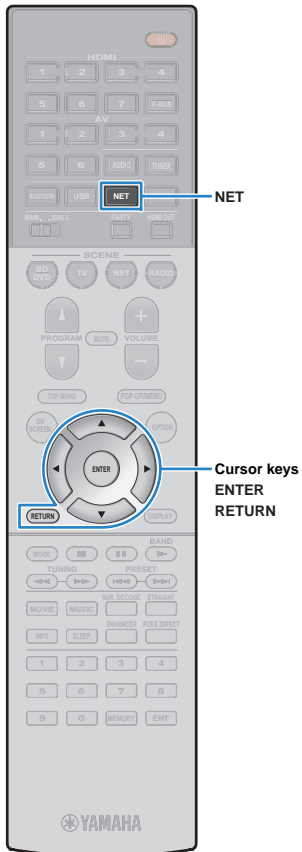

Playback of PC music contents

Follow the procedure below to operate the PC music contents and start playback.

You can control the PC/NAS with the menu displayed on the TV screen.

1 Press NET repeatedly to select “SERVER” as the input source.

The browse screen is displayed on the TV.

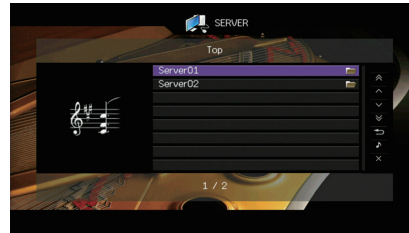

- If playback of a music file selected from the unit is ongoing on your PC, the playback screen is displayed.

2 Use the cursor keys to select a music server and press ENTER.

3 Use the cursor keys to select an item and press ENTER.

If a song is selected, playback starts and the playback screen is displayed.

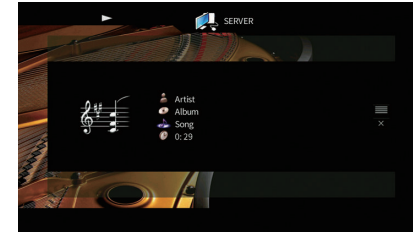

- To return to the previous screen, press RETURN.
- Files not supported by the unit cannot be selected.
- If the unit detects a series of unsupported files (such as images and hidden files) during playback, playback stops automatically.



Browse screen



- 1 Status indicators**
Display the current shuffle/repeat settings (p.75) and playback status (such as play/pause).
- 2 List name**
- 3 Contents list**
Displays the list of PC content. Use the cursor keys to select an item and press ENTER to confirm the selection.
- 4 Item number/total**
- 5 Operation menu**
Press the cursor key (▷) and then use the cursor keys (△/▽) to select an item. Press ENTER to confirm the selection.

Menu	Function
1 Page Up	Moves to the previous/next page of the list.
1 Page Down	
10 Pages Up	Moves 10 pages forward/backward.
10 Pages Down	
Return	Returns to the higher-level list.
Now Playing	Moves to the playback screen.
Screen Off	Closes the screen display and shows the background. Press one of the menu operation keys to redisplay it.

Playback screen

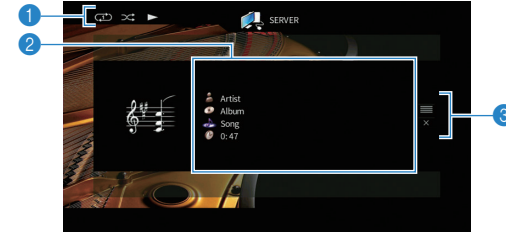

- 1 Status indicators**
Display the current shuffle/repeat settings (p.75) and playback status (such as play/pause).
- 2 Playback information**
Displays the artist name, album name, song title, and elapsed time. Use the cursor keys to select scrollable information.
- 3 Operation menu**
Press the cursor key (▷) and then use the cursor keys (△/▽) to select an item. Press ENTER to confirm the selection.

Menu	Function
Browse	Moves to the browse screen.
Screen Off	Closes the screen display and shows the background. Press one of the menu operation keys to redisplay it.



- You can use the external device operation keys on the remote control to control playback (some functions may not work depending on the PC/NAS).
- You can also use a DLNA-compatible Digital Media Controller (DMC) to control playback. For details, see "DMC Control" (p.95).

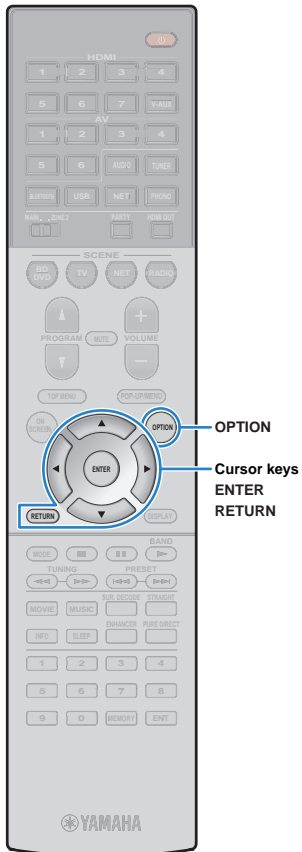

■ Shuffle/repeat settings



You can configure the shuffle/repeat settings for the playback of PC music content.

- 1 When “SERVER” is selected as the input source, press **OPTION**.
- 2 Use the cursor keys to select “Shuffle” (Shuffle) or “Repeat” (Repeat) and press **ENTER**.



- To return to the previous screen during menu operations, press **RETURN**.
- Text in parentheses denotes indicators on the front display.

- 3 Use the cursor keys (</>) to select a setting.

Item	Setting	Function
Shuffle (Shuffle)	Off (Off)	Turns off the shuffle function.
	On (On)	Plays back songs in the current album (folder) in random order. “  ” appears on the TV screen.
Repeat (Repeat)	Off (Off)	Turns off the repeat function.
	One (One)	Plays back the current song repeatedly. “  ” appears on the TV screen.
	All (All)	Plays back all songs in the current album (folder) repeatedly. “  ” appears on the TV screen.

- 4 To exit from the menu, press **OPTION**.

Listening to Internet radio

You can listen to Internet radio stations from all over the world.



- To use this function, the unit must be connected to the Internet (p.31). You can check whether the network parameters (such as the IP address) are properly assigned to the unit in "Network" (p.118) in the "Information" menu.
- You may not be able to receive some Internet radio stations.
- The unit uses the vTuner Internet radio station database service.
- This service may be discontinued without notice.

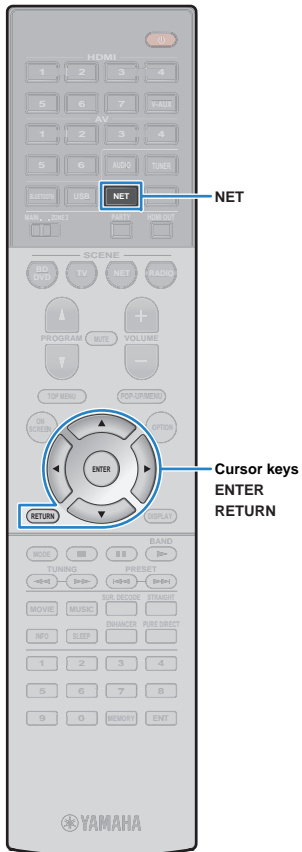

Playback of Internet radio

- 1 Press NET repeatedly to select "NET RADIO" as the input source.**

The browse screen is displayed on the TV.



- 2 Use the cursor keys to select an item and press ENTER.**

If an Internet radio station is selected, playback starts and the playback screen is displayed.

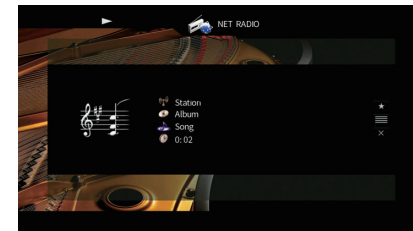

- To return to the previous screen, press RETURN.



Menu operation keys
Cursor keys
ENTER

External device operation keys

Browse screen



1 Playback indicator

2 List name

3 Contents list

Displays the list of Internet radio content. Use the cursor keys to select an item and press ENTER to confirm the selection.

4 Item number/total

5 Operation menu

Press the cursor key (▷) and then use the cursor keys (Δ/▽) to select an item. Press ENTER to confirm the selection.

Menu	Function
Bookmark On (Bookmark Off)	Adds/removes the station selected in the list to/from the "Bookmarks" folder (p.78).
1 Page Up	Moves to the previous/next page of the list.
1 Page Down	Moves to the previous/next page of the list.
10 Pages Up	Moves 10 pages forward/backward.
10 Pages Down	Moves 10 pages forward/backward.
Return	Returns to the higher-level list.
Now Playing	Moves to the playback screen.
Screen Off	Closes the screen display and shows the background. Press one of the menu operation keys to redisplay it.

Playback screen

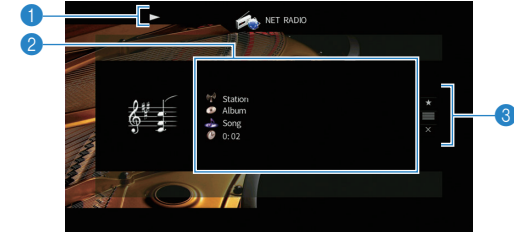

1 Playback indicator

2 Playback information

Displays the station name, album name, song title, and elapsed time. Use the cursor keys (Δ/▽) to select scrollable information.

3 Operation menu

Press the cursor key (▷) and then use the cursor keys (Δ/▽) to select an item. Press ENTER to confirm the selection.

Menu	Function
Bookmark On	Adds the current station to the "Bookmarks" folder (p.78).
Browse	Moves to the browse screen.
Screen Off	Closes the screen display and shows the background. Press one of the menu operation keys to redisplay it.



- You can use the external device operation key (■) on the remote control to stop playback.
- Some information may not be available depending on the station.



Cursor keys
ENTER

Registering favorite Internet radio stations (bookmarks)

By registering your favorite Internet radio stations to “Bookmarks”, you can quickly access to them from the “Bookmarks” folder in the browse screen.

■ Registering the station on the browse/playback screen

1 Select the desired Internet radio station in the browse screen or start playback of it to display the playback screen.

2 Press the cursor key (▷) to select “Bookmark On” and press ENTER.

The selected station is added to the “Bookmarks” folder.



- To remove stations from the “Bookmarks” folder, select the station in the “Bookmarks” folder and then “Bookmark Off”.

■ Registering the station on the vTuner website

1 Select any of Internet radio stations on the unit.

This operation is necessary to register the radio station for the first time.

2 Check the vTuner ID of the unit.

You can find the vTuner ID in “Network” (p.118) in the “Information” menu.

3 Access the vTuner website (<http://yradio.vtuner.com/>) with the web browser on your PC and enter the vTuner ID.

You can switch the language.



Enter the vTuner ID in this area.



- To use this feature, you need to create your personal account. Create your account using your e-mail address.

4 Register your favorite radio stations.

Click the “Add” icon (♥+) next to the station name.



- To remove the station from the “Bookmarks” folder, select “Bookmarks” in the Home screen, and then click the “Remove” icon (♥-) next to the station name.

Playing back music with AirPlay

The AirPlay function allows you to play back iTunes/iPod music on the unit via network.

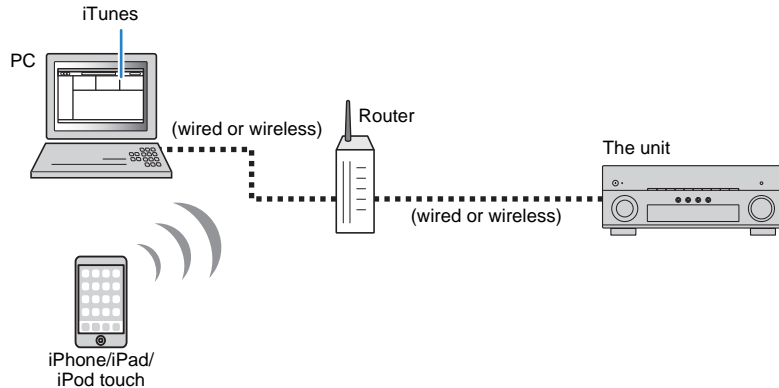

- To use this function, the unit and your PC or iPod must be connected to the same router. You can check whether the network parameters (such as the IP address) are properly assigned to the unit in "Network" (p.118) in the "Information" menu.
- When using a multiple SSID router, access to the unit might be restricted depending on the SSID to connect. Connect the iPod to the SSID which can access the unit.



- For details on supported iPod devices, see "Supported devices and file formats" (p.137).
- You can restrict access to the unit using the AirPlay password (p.88).

Playback of iTunes/iPod music contents

Follow the procedure below to play back iTunes/iPod music contents on the unit.

1 Turn on the unit, and start iTunes on the PC or display the playback screen on the iPod.

If the iTunes/iPod recognizes the unit, the AirPlay icon () appears.

iTunes (example)

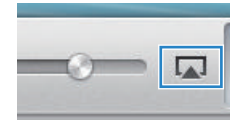

iPod iOS7/iOS8 (example)

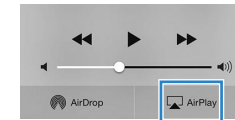

iPod iOS6 (example)

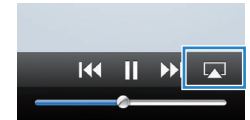

- If the icon does not appear, check whether the unit and PC/iPod are connected to the router properly.

2 On the iTunes/iPod, click (tap) the AirPlay icon and select the unit (network name of the unit) as the audio output device.

iTunes (example)

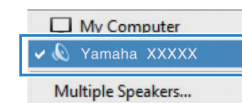

iPod (example)



Network name of the unit

3 Select a song and start playback.

The unit automatically selects "AirPlay" as the input source and starts playback. The playback screen is displayed on the TV.



- The playback screen is available only when your TV is connected to the unit via HDMI.



Menu operation keys
Cursor keys
ENTER

External device
operation keys



- You can turn on the unit automatically when starting playback on iTunes or iPod by setting "Network Standby" (p.112) in the "Setup" menu to "On".
- You can edit the network name (the unit's name on the network) displayed on iTunes/iPod in "Network Name" (p.113) in the "Setup" menu.
- If you select the other input source on the unit during playback, playback on the iTunes/iPod stops automatically.
- You can adjust the unit's volume from the iTunes/iPod during playback. To disable volume controls from iTunes/iPod, set "Volume Interlock" (p.95) in the "Input" menu to "Off".

Caution

- When you use iTunes/iPod controls to adjust volume, the volume may be unexpectedly loud. This could result in damage to the unit or speakers. If the volume suddenly increases during playback, stop playback on the iTunes/iPod immediately.

Playback screen

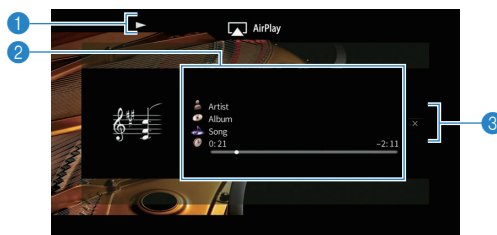

1 Playback indicator

2 Playback information

Displays the artist name, album name, song title, and elapsed/remaining time.

Use the cursor keys (Δ/∇) to select scrollable information.

3 Operation menu

Press the cursor key (\triangleright) to select an item. Press ENTER to confirm the selection.

Menu	Function
Screen Off	Closes the screen display and shows the background. Press one of the menu operation keys to redisplay it.



- You can use the external device operation keys (\blacktriangleright , \blacksquare , \blacksquare , \blacktriangleleft , \blacktriangleright) on the remote control to control playback.



- To control iTunes playback with the remote control of the unit, you need to configure the iTunes preferences to enable iTunes control from remote speakers in advance.

iTunes (example of English version)

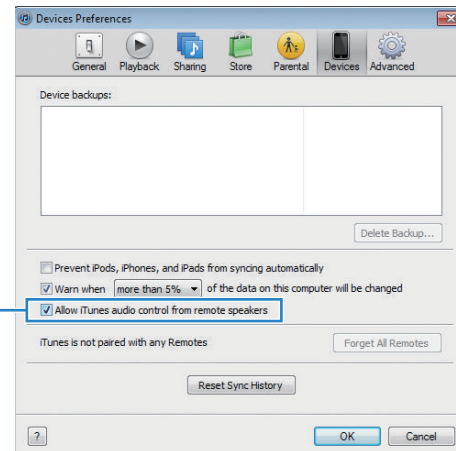

Check this box

Playing back music in multiple rooms (multi-zone)

The multi-zone function allows you to play back different input sources in the room where the unit is installed (Main zone) and in another room (Zone2).

For example, while you are watching TV in the living room (Main zone), another person can listen to radio in the study room (Zone2).

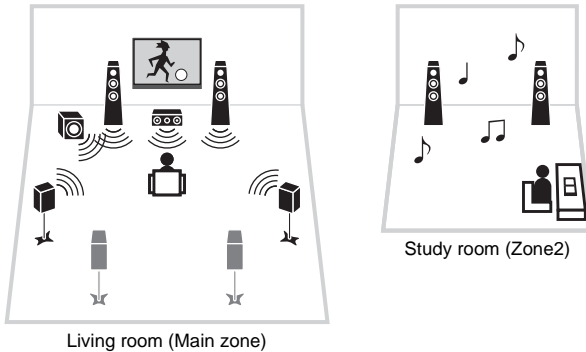

- Analog audio sources (including FM/AM radio), and *Bluetooth*, USB, and network sources can be output to Zone2. To listen to the playback of an external device in Zone2, you need to connect the device to the AUDIO jacks (AV 5–6 or AUDIO 1–2 jacks) of the unit. The party mode (p.85) allows you to play back the same audio output in Main zone as Zone2, whatever the input audio signal type.

Preparing Zone2

Connect the device that will be used in Zone2 to the unit. The connection method varies depending on the amplifier being used (the unit or an external amplifier).

Caution

- Remove the unit's power cable from the AC wall outlet before connecting speakers or an external amplifier.
- Ensure that the core wires of the speaker cable do not touch one another or come into contact with the unit's metal parts. Doing so may damage the unit or the speakers. If the speaker cables short circuit, "Check SP Wires" will appear on the front display when the unit is turned on.

■ Using the unit's internal amplifier

Connect the speakers placed in Zone2 to the unit with speaker cables.

To utilize the EXTRA SP terminals for Zone2 speakers, set "Power Amp Assign" (p.103) in the "Setup" menu to "7ch +1ZONE" after connecting the power cable to an AC wall outlet.

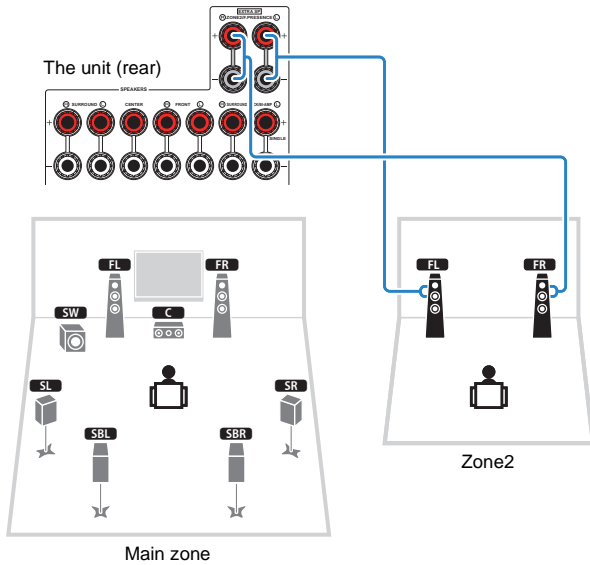

- When Zone2 output is enabled (p.84), the surround back speakers in the main zone do not output sound.

■ Using an external amplifier

Connect the external amplifier (with volume control) placed in Zone2 to the unit with a stereo pin cable.

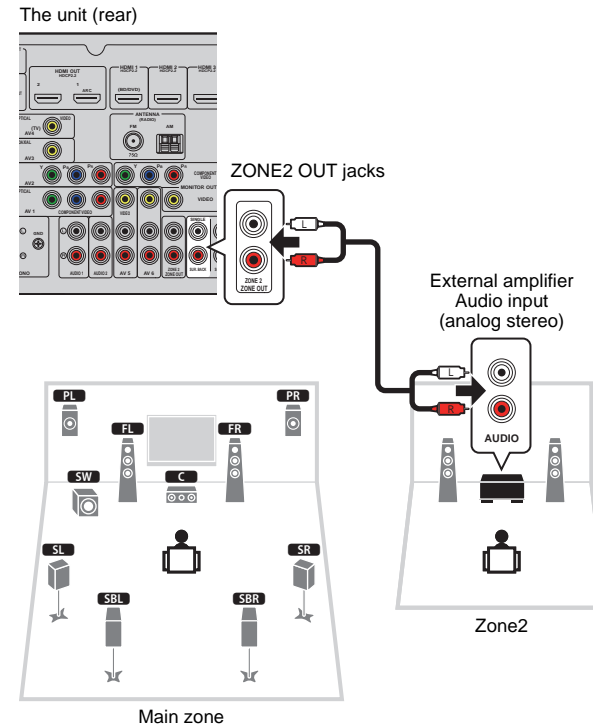

■ Operating the unit from Zone2 (remote connection)

You can operate the unit or external devices from Zone2 using the remote control supplied with each device if you connect an infrared signal receiver/emitter to the unit's REMOTE IN/OUT jacks.



- (China, Korea, U.K. and Europe models only)
You can operate external devices with the supplied remote control if you register a remote control code for each device. For details, refer to "Supplement for Remote Control" on the supplied CD-ROM.

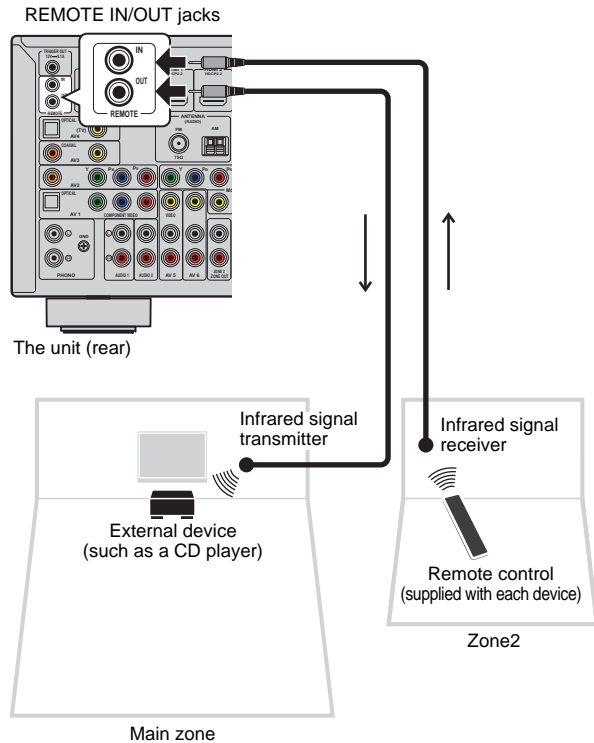

Remote connections between Yamaha products

An infrared signal transmitter is not required if you are using Yamaha products that support remote connections, as the unit does. You can transmit remote control signals by connecting the REMOTE IN/OUT jacks with monaural mini-jack cables and an infrared signal receiver.

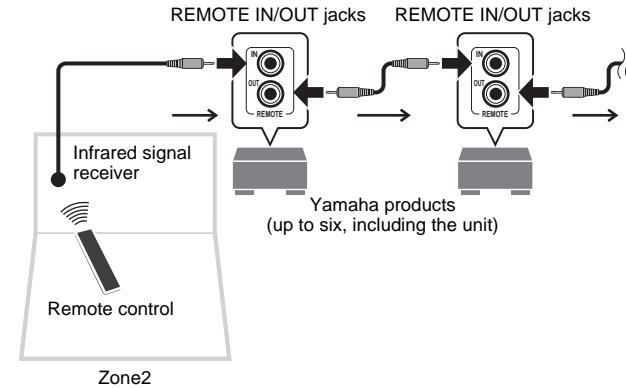

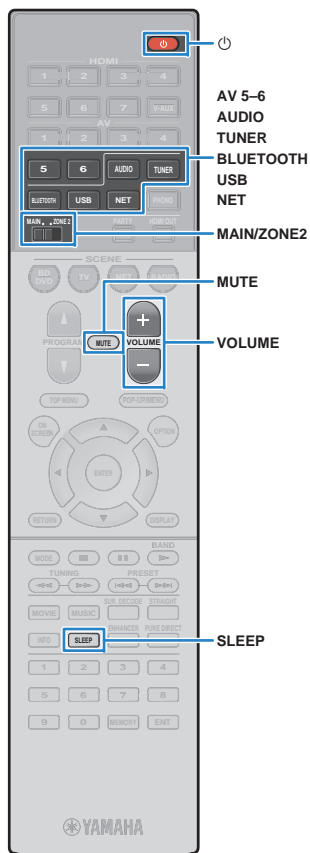

Controlling Zone2

1 Set MAIN/ZONE2 to “ZONE2”.

2 Press (receiver power).

Each time you press the key, Zone2 output is enabled or disabled.

When Zone2 output is enabled, “ZONE2” lights up in the front display.

3 Use the following keys to select an input source.

AV 5–6: AV 5–6 (AUDIO) jacks

AUDIO: AUDIO 1–2 jacks (press repeatedly to select “AUDIO1” or “AUDIO2”)

TUNER: FM/AM radio

BLUETOOTH: *Bluetooth* connection (the unit as a *Bluetooth* receiver)

USB: USB jack (on the front panel)

NET: NETWORK sources (press repeatedly to select a desired network source)

V-AUX: VIDEO AUX (AUDIO) jacks (on the front panel) (RX-A850 only)

PHONO: PHONO jacks (RX-A850 only)



- You cannot select *Bluetooth*, USB and network sources exclusively for each zone. For example, if you select “SERVER” for Zone2 when “USB” is selected for the main zone, the input source for the main zone also switches to “SERVER”.

4 Start playback on the external device or select a radio station.

Refer to the instruction manual for the external device.

For details on the following operations, see the corresponding pages.

- Listening to FM/AM radio (p.60)
- Playing back music via *Bluetooth* (p.65)
- Playing back iPod music (p.66)
- Playing back music stored on a USB storage device (p.69)
- Playing back music stored on media servers (PCs/NAS) (p.72)
- Listening to Internet radio (p.76)
- Playing back music with AirPlay (p.79)



- The on-screen operations are not available for Zone2. Use the front display or web control (p.86) to control Zone2.
- AirPlay is available in Zone2 only when AirPlay playback is ongoing in the main zone.



- To set the sleep timer (120 min, 90 min, 60 min, 30 min, off), press SLEEP repeatedly. The Zone2 output will be disabled after a specified period of time.
- To adjust the Zone2 volume, press VOLUME or MUTE (when using the unit’s internal amplifier). When using an external amplifier, use the volume control on it.
- The Zone 2 input automatically switches in conjunction with the input source selected in the main zone when “Main Zone Sync” is selected as the Zone 2 input with the web control (p.86) or AV CONTROLLER (p.8).
- To play back DSD audio in Zone2, select “Main Zone Sync” as the Zone2 input or use the party mode (p.85).

Caution

- To avoid unexpected noise, never play back DTS-CDs in Zone2.



■ Enjoying the same source in multiple rooms (party mode)

The party mode allows you to play back in Zone2 the same music that is being played back in the main zone. During the party mode, stereo playback is automatically selected for all zones. Utilize this function when you want to use main zone music as background music for a house party.

1 Press PARTY.

Each time you press the key, the party mode is turned on or off.

When the party mode is turned on, "PARTY" lights up in the front display.



- If the party mode does not work on Zone2, set "Party Mode Set" (p.114) in the "Setup" menu to "Enable" (default).

Controlling the unit from a web browser (web control)

You can control the unit with the web control screen displayed in a web browser.

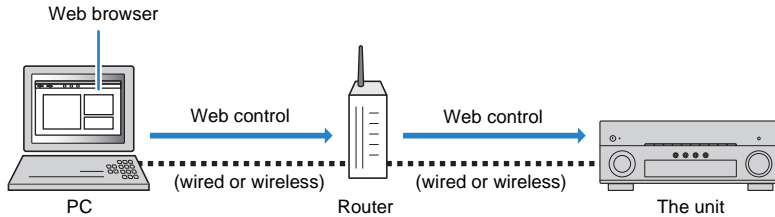

- To use this function, the unit and your PC must be connected to the same router.
- Some security software installed on your PC may block the access of the unit to your PC. In these cases, configure the security software appropriately.
- To display the web control screen or turn on the unit from the web control when the unit is in standby mode, set "Network Standby" (p.88) to "On".
- We recommend using one of the following web browsers.
 - Internet Explorer 9.x, 10.x or 11.x
 - Safari 7.x

1 Start the web browser.

2 Enter the IP address of the unit in the address bar of the web browser.

(Example)



- You can check the IP address of the unit in "Network" (p.118) in the "Information" menu.
- You can bookmark the unit's IP address in the browser or create a shortcut link (p.88) to access the web control screen quickly in the future. However, if you are using a DHCP server, the IP address of the unit may change each time the unit is turned on.
- If you have enabled the MAC address filter (p.112), you need to specify the MAC address of your PC to allow the PC to access the unit. For information on how to check the MAC address of your PC, refer to its instruction manual.
- If you are using Windows 8, we recommend you start Internet Explorer in the following way.
 - Select "Desktop" in the Start screen and click the Internet Explorer icon at the bottom left of the screen.
- By using the application for smartphone/tablet "AV CONTROLLER", you can control the unit from an iPhone, iPad, iPod touch or Android devices (p.8).

■ Top menu screen

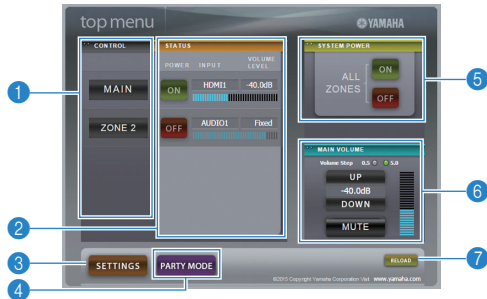

- 1 **CONTROL**
Moves to the control screen for the selected zone.
- 2 **STATUS**
Turns on/off the power for each zone or displays the input source and volume set for each zone.
- 3 **SETTINGS**
Moves to the settings screen.
- 4 **PARTY MODE**
Turns on/off the party mode (p.85).
- 5 **SYSTEM POWER**
Turns on/off the power for all zones.
- 6 **MAIN VOLUME**
Adjusts the volume or mutes the audio output for the main zone. You can also select the increments used for volume adjustment.
- 7 **RELOAD**
Reloads the current status of the unit.

■ Control screen



- 1 **PLAY INFO**
Selects an input source or controls playback for the selected zone.
 - 2 **TOP MENU**
Moves to the top menu screen.
 - 3 **SCENE**
Selects a scene for the selected zone.
 - 4 **POWER**
Turns on/off the power for the selected zone.
 - 5 **VOLUME**
Adjusts the volume or mutes the audio output for the selected zone. You can also select the increments used for volume adjustment.
 - 6 **RELOAD**
Reloads the current status of the unit.
- !**
- Multi-zone volume adjustment is not available when an external amplifier is used.

Settings screen

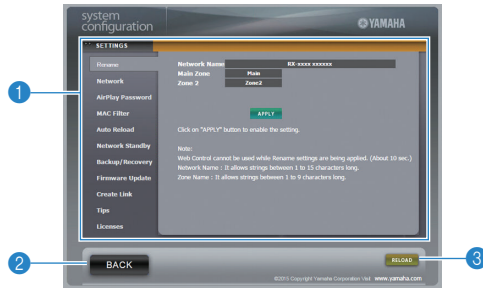

1 Rename

Edits the network name (the unit's name on the network) (p.113) or the name of each zone (p.114). Click "APPLY" to apply the changes to the unit.

Network

Selects the network connection method (p.111) or configures the network parameters (such as IP address) (p.112). Click "APPLY" to apply the changes to the unit.

AirPlay Password

Sets the password to restrict access to the unit via AirPlay (p.79). Click "APPLY" to apply the changes to the unit.

MAC Filter

Sets the MAC address filter (p.112) to limit access to the unit from the network devices. Click "APPLY" to apply the changes to the unit.

Auto Reload

Enables/disables automatic reloading. When "Auto Reload" is "On" (enabled), the web control screen reloads the status of the unit every 5 seconds.

Network Standby

Enables/disables the network standby function (p.112).

Backup/Recovery

Creates a backup of the unit's settings on the PC or restores the settings from the backup.

Firmware Update

Updates the firmware of the unit by using the firmware you have downloaded on the PC. Follow the on-screen instructions to start the firmware update.

Create Link

Creates a shortcut link to the desired control screen.

Tips

Displays tips for use of the web control.

Licenses

Displays the licenses of the software used in the unit.

2 BACK

Moves to the top menu screen.

3 RELOAD

Reloads the current status of the unit.

Note

- If the network settings are changed, you may need to restart the browser or regain access to the unit.
- When using the MAC address filter, make sure you specify the MAC addresses of your network devices correctly. Otherwise, the unit will be inaccessible from your network devices such as PCs and other external devices.
- Do not operate the unit during the recovery process, as this may result in the incorrect recovery of the settings. When the recovery finishes, click "OK" to set the unit to standby mode.
- The backup does not contain user information (such as user account and password) or unit-specific information (such as MAC address and IP address).
- Some characters entered with a PC may not appear correctly on the unit.

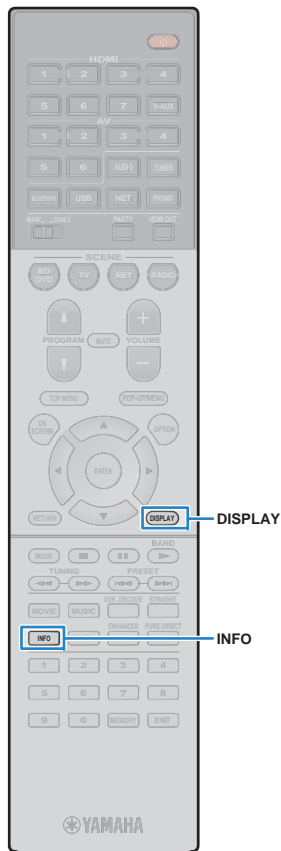

Viewing the current status

Switching information on the front display

1 Press INFO.

Each time you press the key, the displayed item changes.



Item name

About 3 seconds later, the corresponding information for the displayed item appears.



Information



- Available items vary depending on the selected input source. The displayed item can also be applied separately to each input source group.

Input source group	Item
HDMI*1 V-AUX AV 1-6 AUDIO 1-2	Input (input source name), DSP Program (sound mode name), Audio Decoder (decoder name*2)
TUNER	Frequency (frequency), DSP Program (sound mode name), Audio Decoder (decoder name*2) * (U.K. and Europe models only) Radio Data System data is also available when the unit is tuned into a Radio Data System broadcasting station (p.62).
Bluetooth USB SERVER AirPlay	Song (song title), Artist (artist name), Album (album name), DSP Program (sound mode name), Audio Decoder (decoder name*2) * During simple playback of iPod: Input (input source name), DSP Program (sound mode name), Audio Decoder (decoder name*)

Input source group	Item
NET RADIO	Song (song title), Album (album name), Station (station name), DSP Program (sound mode name), Audio Decoder (decoder name*2)
PHONO	(RX-A850 only) Input (input source name), DSP Program (sound mode name), Audio Decoder (decoder name*2)

*1 HDMI 1-7 for RX-A850, HDMI 1-5 for RX-A750

*2 The name of the audio decoder currently activated is displayed. If no audio decoder is activated, "Decoder Off" appears.

Viewing the status information on the TV

1 Press DISPLAY.

The following information is displayed on the TV.

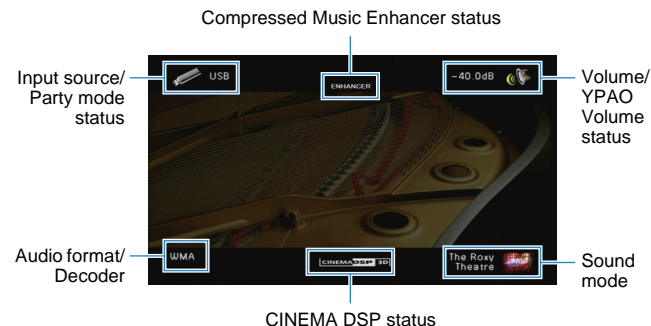

2 To close the information display, press DISPLAY.

Configuring playback settings for different playback sources (Option menu)

You can configure separate playback settings for different playback sources. This menu is available on the front panel (or on the TV screen), allowing you to easily configure settings during playback.

1 Press **OPTION**.



Front display

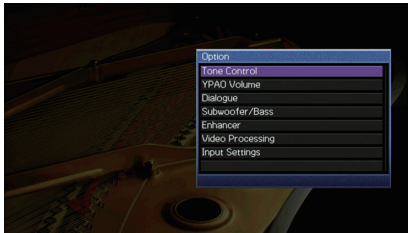

TV screen

2 Use the cursor keys to select an item and press **ENTER**.



• To return to the previous screen during menu operations, press **RETURN**.

3 Use the cursor keys (**</>**) to select a setting.

4 To exit from the menu, press **OPTION**.

Option menu items



- Available items vary depending on the selected input source.
- Text in parentheses denotes indicators on the front display.
- Default settings are underlined.

Item	Function	Page
Tone Control (Tone Control)	Adjusts the high-frequency range and low-frequency range of sounds.	91
YPAO Volume (YPAO Volume)	<u>YPAO Volume (YPAO Vol.)</u>	Enables/disables YPAO Volume. 91
	Adaptive DRC (A.DRC)	Sets whether the dynamic range (from maximum to minimum) is automatically adjusted when the volume is adjusted. 91
Dialogue (Dialog)	Dialogue Level (Dialog Lvl)	Adjusts the volume of dialogue sounds. 91
	Dialogue Lift (Dialog Lift)	Adjusts the perceived height of dialogue sounds. 91
Subwoofer/Bass (Subwoofer/Bass)	Subwoofer Trim (SW.Trim)	Fine-adjusts the subwoofer volume. 92
	Extra Bass (Extra Bass)	Enables/disables Extra Bass. 92
Enhancer (Enhancer)	Enables/disables Compressed Music Enhancer. 92	
Video Processing (Video Process.)	Enables/disables the video signal processing settings configured in the "Setup" menu. 92	
Input Settings (Input Settings)	Input Trim (In.Trim)	Corrects volume differences between input sources. 92
	Video Out (V.Out)	Selects a video to be output with the audio input source. 92
FM Mode (FM Mode)	Switches between stereo and monaural for FM radio reception. 92	
Traffic Program (Traffic Program)	(U.K. and Europe models only) Automatically searches for a traffic information station. 63	
Shuffle (Shuffle)	Configures the shuffle setting for the iPod (p.68), USB storage device (p.71), or media server (p.75). —	
Repeat (Repeat)	Configures the repeat setting for the iPod (p.68), USB storage device (p.71), or media server (p.75). —	

Tone Control (Tone Control)

Adjusts the high-frequency range (Treble) and low-frequency range (Bass) of sounds.

Choices

Treble (Treble), Bass (Bass)

Setting range

-6.0 dB to Bypass (Bypass) to +6.0 dB, *0.5 dB increments



- If you set an extreme value, sounds may not match those from other channels.

Adjusting with the front panel controls

- ① Press TONE CONTROL to select “Treble” or “Bass”.
- ② Press PROGRAM to make an adjustment.

YPAO Volume (YPAO Volume)

Enables/disables YPAO Volume or Adaptive DRC.

YPAO Volume (YPAO Vol.)

Enables/disables YPAO Volume. When YPAO Volume is enabled, the high- and low-frequency levels are automatically adjusted according to the volume so that you can enjoy natural sounds even at low volume.

Settings

<u>Off (Off)</u>	Disables YPAO Volume.
On (On)	Enables YPAO Volume.



- YPAO Volume works effectively after the measurement results of “Auto Setup” have been already saved (p.35).
- We recommend enabling both YPAO Volume and Adaptive DRC when you are listening at lower volumes or at night.

Adaptive DRC (A.DRC)

Sets whether the dynamic range (from maximum to minimum) is automatically adjusted when the volume level is adjusted. When it is set to “On”, it is useful for listening to playback at a low volume at night.

Settings

<u>Off (Off)</u>	The dynamic range is not automatically adjusted.
On (On)	Automatically adjusts the dynamic range when YPAO Volume is enabled.

If “On” is selected, the dynamic range becomes narrow at a low volume and wide at a high volume.

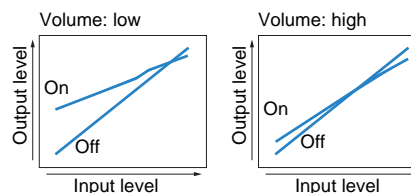

Dialogue (Dialog)

Adjusts the volume or perceive height of dialogue sounds.

Dialogue Level (Dialog Lvl)

Adjusts the volume of dialogue sounds. If dialogue sounds cannot be heard clearly, you can turn up its volume by increasing this setting.

Setting range

0 to 3

Dialogue Lift (Dialog Lift)

Adjusts the perceived height of dialogue sounds. If the dialogue sounds as if it is coming from below the TV screen, you can raise its perceived height by increasing this setting.



- This setting is available only when one of the following conditions is met.
 - One of the sound programs (except for 2ch Stereo and 7ch Stereo) is selected when presence speakers are used.
 - Virtual Presence Speaker (VPS) (p.55) is working.
(You may hear dialogue sounds from the surround speakers depending on the listening position.)

Setting range

0 to 5 (The bigger the value the higher the position)

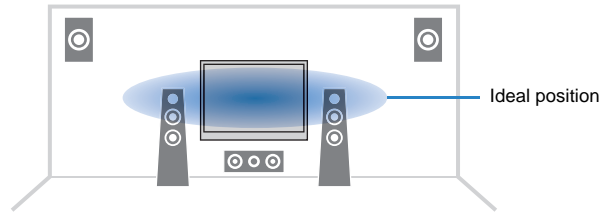

Subwoofer/Bass (Subwoofer/Bass)

Adjust the subwoofer volume or bass sound.

Subwoofer Trim (SW.Trim)

Fine-adjusts the subwoofer volume.

Setting range

-6.0 dB to 0.0 dB to +6.0 dB (0.5 dB increments)

Extra Bass (Extra Bass)

Enables/disables Extra Bass. When Extra Bass is enabled, you can enjoy enhanced bass sounds, regardless of the size of the front speakers and the presence or absence of the subwoofer.

Settings

<u>Off (Off)</u>	Disables Extra Bass.
On (On)	Enables Extra Bass.

Enhancer (Enhancer)

Enables/disables Compressed Music Enhancer (p.59).



- This setting is applied separately to each input source.
- You can also use ENHANCER on the remote control to enable/disable Compressed Music Enhancer (p.59).

Settings

<u>Off (Off)</u>	Disables Compressed Music Enhancer.
On (On)	Enables Compressed Music Enhancer.

Default

TUNER, Bluetooth, USB, (network sources): On (On)

Others: Off (Off)

Video Processing (Video Process.)

Enables/disables the video signal processing (resolution and aspect ratio) settings configured in "Processing" (p.109) in the "Setup" menu.

Settings

<u>Direct (Direct)</u>	Disables the video signal processing.
Processing (Processing)	Enables the video signal processing.

Input Settings (Input Settings)

Configures the input settings.



- This setting is applied separately to each input source.

Input Trim (In.Trim)

Corrects volume differences between input sources. If you are bothered by volume differences when switching between input sources, use this function to correct it.

Setting range

-6.0 dB to 0.0 dB to +6.0 dB (0.5 dB increments)

Video Out (V.Out)

Selects a video to be output with the audio input source.

Settings

<u>Off (Off)</u>	Does not output video.
HDMI (HDMI), AV 1-6 (AV1-6), V-AUX (V-AUX)	Outputs video input through the corresponding video input jacks.

* HDMI 1-7 for RX-A850, HDMI 1-5 for RX-A750

FM Mode (FM Mode)

Switches between stereo and monaural for FM radio reception.

Settings

<u>Stereo (Stereo)</u>	Receives FM radio in stereo sounds.
Mono (Mono)	Receives FM radio in monaural sounds.

CONFIGURATIONS

Configuring input sources (Input menu)

You can change the input source settings using the TV screen.

- 1 Press ON SCREEN.
- 2 Use the cursor keys to select “Input” and press ENTER.

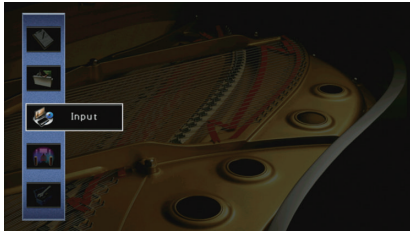

- 3 Use the cursor keys (</>) to select an input source to be configured and press the cursor key (△).

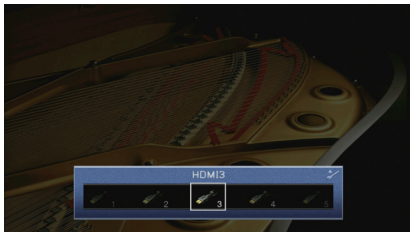

The input source of the unit also changes.



- You can still switch the input source by using cursor keys (</>) after Step 3.

- 4 Use the cursor keys (△/▽) to select an item and press ENTER.



- To return to the previous screen during menu operations, press RETURN.

- 5 Use the cursor keys to select a setting and press ENTER.

- 6 To exit from the menu, press ON SCREEN.

Input menu items



- Available items vary depending on the selected input source.
- Default settings are underlined.

Item	Function	Page
<u>Rename/Icon Select</u>	Changes the input source name and icon.	94
<u>Audio In</u>	Combines the video jack of the selected input source with an audio jack of others.	94
<u>Decoder Mode</u>	Sets the format of digital audio playback to DTS.	94
<u>Volume Interlock</u>	Enables/disables volume controls from iTunes/iPod via AirPlay.	95
<u>DMC Control</u>	Selects whether to allow a DLNA-compatible Digital Media Controller (DMC) to control playback.	95

Rename/Icon Select

Changes the input source name and icon displayed on the front display or TV screen.

Input sources

HDMI*¹, V-AUX, AV 1–6, AUDIO 1–2, USB, PHONO*²

*¹ HDMI 1–7 for RX-A850, HDMI 1–5 for RX-A750

*² RX-A850 only

Setup procedure

- 1 Use the cursor keys (</>) to select a template and press the cursor key (▽).



- You cannot change the template or icon for “USB” when an iPod is connected.

- 2 Use the cursor keys (</>) to select an icon and press the cursor key (▽).
- 3 Press ENTER to enter the name edit screen.
- 4 Use the cursor keys and ENTER to rename and select “ENTER” to confirm the entry.



- To clear the entry, select “CLEAR”.

- 5 Use the cursor keys to select “OK” and press ENTER.



- To restore the default setting, select “RESET”.

- 6 To exit from the menu, press ON SCREEN.

Audio In

Combines the video jack of the selected input source with an audio jack of others. For example, use this function in the following cases.

- Connecting a playback device that supports HDMI video output, but not HDMI audio output
- Connecting a playback device that has component video jacks and analog stereo jacks (such as game consoles)

Input sources

HDMI*, AV 1–2

* HDMI 1–7 for RX-A850, HDMI 1–5 for RX-A750

Setup procedure

(To input audio through a digital optical jack)

Select “AV1” or “AV4” and connect the device to the unit’s corresponding audio jacks with a digital optical cable.

(To input audio through a digital coaxial jack)

Select “AV2” or “AV3” and connect the device to the unit’s corresponding audio jacks with a digital coaxial cable.

(To input audio through analog audio jacks)

Select “AV5”, “AV6”, “AUDIO1”, or “AUDIO2”, and connect the device to the unit’s corresponding audio jacks with a stereo pin cable.

Decoder Mode

Sets the format of digital audio playback to “DTS”.

For example, if the unit does not detect DTS audio and outputs noise, set “Decoder Mode” to “DTS”.

Input sources

HDMI*, V-AUX, AV 1–4

* HDMI 1–7 for RX-A850, HDMI 1–5 for RX-A750

Settings

Auto	Automatically selects an audio format to match the input audio signal.
DTS	Selects DTS only. (Other audio signals are not reproduced.)

■ Volume Interlock

Enables/disables volume controls from iTunes/iPod via AirPlay.

Input sources

AirPlay

Settings

Off	Disables volume controls from iTunes/iPod.
Limited	Enables volume controls from iTunes/iPod within the limited range (-80 dB to 0 dB and mute).
Full	Enables volume controls from iTunes/iPod in the full range (-80 dB to +16.5 dB and mute).

■ DMC Control

Selects whether to allow DLNA-compatible Digital Media Controller (DMC) to control playback.

Input source

SERVER

Settings

Disable	Does not allow DMCs to control playback.
Enable	Allows DMCs to control playback.



- A Digital Media Controller (DMC) is a device that can control other network devices through the network. When this function is enabled, you can control playback of the unit from DMCs (such as Windows Media Player 12) on the same network.

Configuring the SCENE function (Scene menu)

You can change the settings of the SCENE function (p.53) using the TV screen.

- 1 Press ON SCREEN.
- 2 Use the cursor keys to select “Scene” and press ENTER.

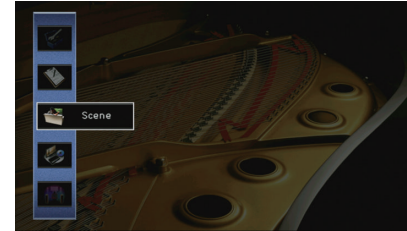

- 3 Use the cursor keys (</>) to select a scene to be configured and press the cursor key (Δ).

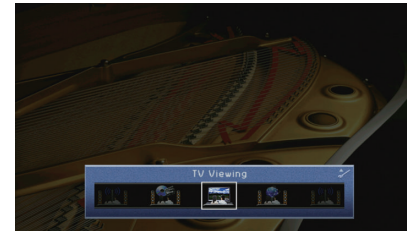

- You can still switch the scene by using cursor keys (</>) after Step 3.

4 Use the cursor keys (Δ/∇) to select an item and press ENTER.



5 Use the cursor keys and ENTER to change the setting.

6 To exit from the menu, press ON SCREEN.

Scene menu items

Item	Function	Page
Save	Registers the current settings in the selected scene.	96
Load	Loads the settings registered for the selected scene. You can also configure the SCENE link playback setting or view the scene assignments.	96
Rename/Icon Select	Changes the scene name and icon.	97
Reset	Restores the default settings for the selected scene.	97

Save

Registers the unit's current settings (input source, sound program/surround decoder, Compressed Music Enhancer on/off, and HDMI output jack [RX-A850 only]) in the selected scene.



- If you have changed the input assignment for a scene, you also need to change the external device assigned to the corresponding SCENE key (p.53).

Load

Loads the settings registered for the selected scene.

Select "DETAIL" to configure the SCENE link playback setting or view the scene assignments.

Device Control

Recalls a selected scene and starts its playback on an external device connected to the unit via HDMI. (SCENE link playback)

Settings

Off	Disables the SCENE link playback function.
HDMI Control	Enables SCENE link playback using HDMI Control signals. Select this if an HDMI Control-compatible device (such as a BD/DVD player) is connected to the unit via HDMI. It also turns on the TV if it supports HDMI Control.

Default

SCENE1 (BD/DVD), SCENE2 (TV): HDMI Control

SCENE3 (NET), SCENE4 (RADIO): Off



- To control playback of an HDMI Control-compatible device by SCENE link playback, you need to set "HDMI Control" in the "Setup" menu to "On" and perform the HDMI Control link setup (p.139).

Detail

Displays the assignments of the selected scene.

Input	Input source to be used
HDMI Output	(RX-A850 only) HDMI OUT jack to be used
Mode	Sound program/surround decoder to be used
Enhancer	Compressed Music Enhancer on/off

Rename/Icon Select

Changes the scene name and icon displayed on the front display or TV screen.

Setup procedure

- 1 Use the cursor keys (</>) to select an icon and press the cursor key (▽).

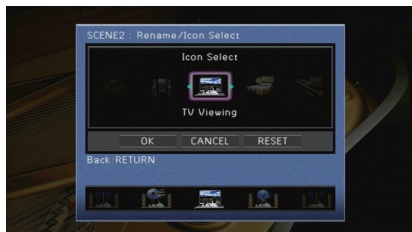

- 2 Press ENTER to enter the name edit screen.
- 3 Use the cursor keys and ENTER to rename and select "ENTER" to confirm the entry.

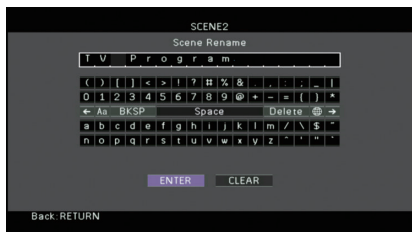

- To clear the entry, select "CLEAR".

- 4 Use the cursor keys to select "OK" and press ENTER.



- To restore the default setting, select "RESET".

- 5 To exit from the menu, press ON SCREEN.

Reset

Restores the default settings (p.53) for the selected scene.

Configuring sound programs/surround decoders (DSP Program menu)

You can change the settings of the sound programs and surround decoders using the TV screen.

- 1 Press ON SCREEN.
- 2 Use the cursor keys to select "DSP Program" and press ENTER.

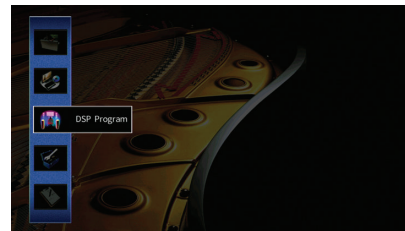

- 3 Use the cursor keys (</>) to select a sound program to be configured and press the cursor key (△).

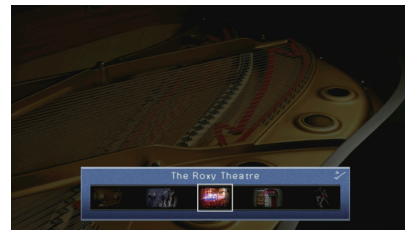

- You can still switch the sound program by using cursor keys (</>) after Step 3.

4 Use the cursor keys (Δ/∇) to select an item and press ENTER.



- To return to the previous screen during menu operations, press RETURN.
- To restore the default settings for the selected sound program, select "Reset".

5 Use the cursor keys to select a setting and press ENTER.

6 To exit from the menu, press ON SCREEN.

DSP Program menu items



- Available items vary depending on the selected sound program or surround decoder.
- Default settings are underlined.

Settings for sound programs

Item	Function	Settings
Decode Type	Selects a surround decoder to be used in combination with the selected sound program.	<input type="checkbox"/> Surround (RX-A850 only)*, <input type="checkbox"/> PLIIx Movie (<input type="checkbox"/> PLII Movie), <input type="checkbox"/> PLIIx Music* (<input type="checkbox"/> PLII Music*), <input type="checkbox"/> PLIIx Game* (<input type="checkbox"/> PLII Game*), Neo:6 Cinema, Neo:6 Music* (* Available only when "SURROUND DECODER" is selected)
DSP Level	Adjusts the sound field effect level.	-6 dB to <u>0 dB</u> to +3 dB Higher to enhance the sound field effect, and lower to reduce it.
Initial Delay	Adjusts the delay between the direct sound and presence sound field generation.	1 ms to 99 ms Higher to enhance the delay effect, and lower to reduce it.
Surround Initial Delay	Adjusts the delay between the direct sound and surround sound field generation.	1 ms to 49 ms Higher to enhance the delay effect, and lower to reduce it.
Surround Back Initial Delay	Adjusts the delay between the direct sound and surround back sound field generation.	1 ms to 49 ms Higher to enhance the delay effect, and lower to reduce it.
Room Size	Adjusts the broadening effect of the presence sound field.	0.1 to 2.0
Surround Room Size	Adjusts the broadening effect of the surround sound field.	Higher to enhance the broadening effect, and lower to reduce it.
Surround Back Room Size	Adjusts the broadening effect of the surround back sound field.	Higher to enhance the broadening effect, and lower to reduce it.
Liveness	Adjusts the loss of the presence sound field.	0 to 10
Surround Liveness	Adjusts the loss of the surround sound field.	Higher to enhance the reflectivity, and lower to reduce it.
Surround Back Liveness	Adjusts the loss of the surround back sound field.	Higher to enhance the reflectivity, and lower to reduce it.

Item	Function	Settings
Reverb Time	Adjust the decay time of the rear reverberant sound.	1.0 s to 5.0 s Higher to enrich the reverberant sound and lower to have clear sound.
Reverb Delay	Adjusts the delay between the direct sound and reverberant sound generation.	0 ms to 250 ms Higher to enhance the delay effect, and lower to reduce it.
Reverb Level	Adjusts the volume of the reverberant sound.	0% to 100% Higher to strengthen the reverberant sound, and lower to weaken it.

The following items are available when you select “2ch Stereo” or “7ch Stereo”.

Sound program	Item	Function	Settings
2ch Stereo	Direct	Selects whether to automatically bypass the DSP circuit when an analog audio source is played back.	<u>Auto</u> , Off
	Level	Adjusts the entire volume.	-5 to 0 to +5
	Front / Rear Balance	Adjusts the front and rear volume balance.	-5 to 0 to +5 Higher to enhance the front side, and lower to enhance the rear side.
7ch Stereo	Left / Right Balance	Adjusts the left and right volume balance.	-5 to 0 to +5 Higher to enhance the right side, and lower to enhance the left side.
	Height Balance	Adjust the height volume balance using the presence speakers.	0 to 5 to 10 Higher to enhance the upside, and lower to enhance the downside. (The presence speakers do not produce sounds when “Height Balance” is set to “0”.)
	Monaural Mix	Enables/disables monaural sound output.	<u>Off</u> , On



- Available items in “7ch Stereo” vary depending on the speaker system being used.

Settings for decoders

The following items are available when you set “Decode Type” of “SURROUND DECODER” to “ PLIIx Music” or “Neo:6 Music”.

Decode Type	Item	Function	Settings
PLIIx Music	Panorama	Adjusts the broadening effect of the front sound field.	<u>Off</u> , On Select “On” to wrap front left/right channel sounds around the field and generate a spacious sound field in combination with the surround sound field.
	Center Width	Adjusts the broadening effect of the center sound field.	0 to 3 to 7 Higher to enhance the broadening effect, and lower to reduce it (closer to center).
	Dimension	Adjusts the difference in level between the front and surround sound fields.	-3 to 0 to +3 Higher to strengthen the front sound field and lower to strengthen the surround sound field.
Neo:6 Music	Center Image	Adjusts the center orientation level (broadening effect) of the front sound field.	0.0 to 0.3 to 1.0 Higher to strengthen the center orientation level (less broadening effect) and lower to weaken (more broadening effect).

(RX-A850 only)

The following item is available when you set “Decode Type” of “SURROUND DECODER” to “ Surround”.

Decode Type	Item	Function	Settings
Surround	Center Spread	Selects whether to spread the center channel signals to left and right when 2-channel source is played.	<u>Off</u> , On Select “On” to spread center channel signals to left and right if you feel the center sound is too strong when 2-channel source is played.

Configuring various functions (Setup menu)

You can configure the unit's various function with the menu displayed on the TV screen.

- 1 Press ON SCREEN.
- 2 Use the cursor keys to select "Setup" and press ENTER.

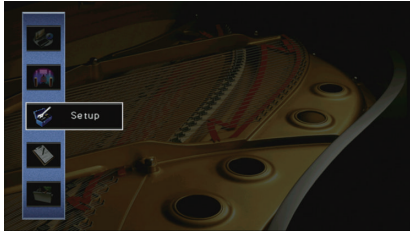

- 3 Use the cursor keys (</>) to select a menu.

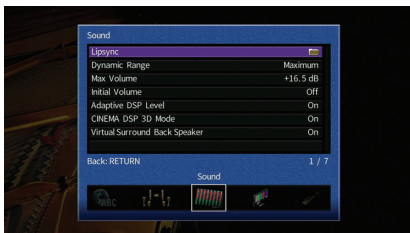

- 4 Use the cursor keys (Δ/∇) to select an item and press ENTER.



- To return to the previous screen during menu operations, press RETURN.

- 5 Use the cursor keys to select a setting and press ENTER.
- 6 To exit from the menu, press ON SCREEN.

Setup menu items

Menu	Item	Function	Page		
Speaker	Auto Setup	Automatically optimizes the speaker settings (YPAO).	35		
	Manual Setup	Power Amp Assign	Selects a speaker system.	103	
		Front	Selects the size of the front speakers.	103	
		Center	Selects whether or not a center speaker is connected and its size.	103	
		Surround	Selects whether or not surround speakers are connected and their size.	103	
		Surround Back	Selects whether or not surround back speakers are connected and their size.	104	
		Configuration	Front Presence	Selects whether or not front presence speakers are connected and their size (RX-A850 only).	104
		Subwoofer	Selects whether or not a subwoofer is connected and its phase.	104	
		Layout	Selects the layouts of the surround speakers and front presence speakers (RX-A850 only).	104	
		Bass Cross Over	(RX-A750 only) Sets the lower limit of the low-frequency component that can be output from speakers whose size is set to "Small".	105	
		Distance	Sets the distance between each speaker and listening position.	105	
		Level	Adjusts the volume of each speaker.	105	
		Parametric EQ	Adjusts the tone with an equalizer.	105	
		Test Tone	Enables/disables the test tone output.	106	
		Delay Enable	Enables/disables the Lipsync adjustment for each input source.	107	
		Sound	Lipsync	Auto/Manual Select	Selects the method to adjust the delay between video and audio output.
Adjustment	Adjusts the delay between video and audio output manually.		107		
Dynamic Range	Selects the dynamic range adjustment method for bitstream audio (Dolby Digital and DTS signals) playback.		107		
Max Volume	Sets the maximum volume to prevent excessive loudness.		107		
Initial Volume	Sets the initial volume for when this receiver is turned on.		108		
Adaptive DSP Level	Selects whether to automatically adjust the CINEMA DSP effect level when the volume is adjusted.		108		
CINEMA DSP 3D Mode	Enables/disables CINEMA DSP 3D.		108		
Virtual Surround Back Speaker	Selects whether to create Virtual Surround Back Speaker (VSBS) using the surround speakers.		108		
Object Decode Mode	(RX-A850 only) Enables/disables playback of object-based audio signals such as Dolby Atmos contents.		108		
Video	Video Mode		Enables/disables the video signal processing (resolution and aspect ratio).	109	

Menu	Item	Function	Page	
HDMI	HDMI Control	Enables/disables HDMI Control. You can also configure the relevant settings (such as ARC and TV audio input).	110	
	Audio Output	Selects a device to output audio.	111	
	Standby Through	Select whether to output videos/audio (input through HDMI jacks) to the TV when the unit is in standby mode.	111	
Network	Network Connection	Selects the network connection method.	111	
	IP Address	Configures the network parameters (such as IP address).	112	
	Network Standby	Selects whether to enable/disable the function that turns on the unit from other network devices.	112	
	MAC Address Filter	Sets the MAC address filter to limit access to the unit from other network devices.	112	
	Network Name	Edits the network name (the unit's name on the network) displayed on other network devices.	113	
Bluetooth	Bluetooth	Enables/disables the <i>Bluetooth</i> functions.	113	
	Audio Receive Disconnect	Terminates the <i>Bluetooth</i> connection between the <i>Bluetooth</i> device (such as smartphones) and the unit.	65	
	Bluetooth Standby	Selects whether to enable/disable the function that turns on the unit from <i>Bluetooth</i> devices (<i>Bluetooth</i> standby).	113	
Multi Zone	Main Zone Set Zone Rename	Changes the zone name (for main zone) displayed on the TV screen.	114	
		Max Volume	Sets the Zone2 maximum volume to prevent excessive loudness in the second zone.	114
	Zone2 Set Initial Volume	Sets the Zone2 initial volume for when the unit is turned on.	114	
		Zone Rename	Changes the zone name (for Zone2) displayed on the TV screen.	114
		Party Mode Set	Enables/disables switching to the party mode.	114
Function		Dimmer (Front Display)	Adjusts the brightness of the front display.	115
	Display Set Short Message	Selects whether to display short messages on the TV screen when the unit is operated.	115	
		Wallpaper	Selects the image to be used as wallpaper on the TV.	115
	Trigger Output Trigger Mode	Specifies the condition for the TRIGGER OUT jack to function.	115	
		Target Zone	Specifies the zone with which the TRIGGER OUT jack functions are synchronized.	116
		Memory Guard	Prevents accidental changes to the settings.	116
ECO	Auto Power Standby	Sets the amount of time for the auto-standby function.	116	
	ECO Mode	Enables/disables the eco mode (power saving mode).	116	
Language		Select an on-screen menu language.	117	

Speaker (Manual Setup)

Configures the speaker settings manually.



- Default settings are underlined.

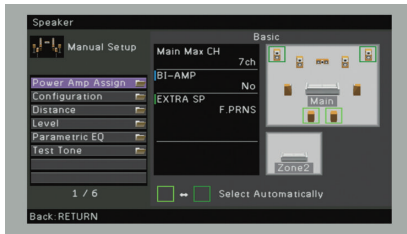

Power Amp Assign

Selects a speaker system.

In addition to the 5.1- or 7.1-channel speaker system, various speaker configurations are possible using the front presence speakers, Zone2 speakers, or bi-amp connection.

Settings

<u>Basic</u>	Select this option when you use a normal speaker system (not using Zone2 speakers or a bi-amp connection).
7ch +1ZONE	Select this option when you use Zone2 speakers (p.82) in addition to the speaker system in the main zone.
5ch BI-AMP	Select this option when you connect front speakers that support bi-amp connections (p.22).

Configuration

Configures the output characteristics of the speakers.



- When you configure the speaker size, select "Large" if the woofer diameter of your speaker is 16 cm (6-1/4") or larger or "Small" if it is smaller than 16 cm (6-1/4").
- (RX-A850 only)
You can configure the crossover frequency of each speaker after the speaker size is set to "Small". The subwoofer or front speakers will produce corresponding channel low-frequency components lower than the specified crossover frequency (default: 80 Hz).
- (RX-A750 only)
You can configure the crossover frequency of the speakers whose sizes are set to "Small". For details, refer to "Bass Cross Over" (p.105).

Front

Selects the size of the front speakers.

Settings

<u>Large</u>	Select this option for large speakers. The front speakers will produce all of the front channel frequency components.
<u>Small</u>	Select this option for small speakers. The subwoofer will produce front channel low-frequency components.



- "Front" is automatically set to "Large" when "Subwoofer" is set to "None".

Center

Selects whether or not a center speaker is connected and its size.

Settings

<u>Large</u>	Select this option for large speakers. The center speaker will produce all of the center channel frequency components.
<u>Small</u>	Select this option for small speakers. The subwoofer or front speakers will produce center channel low-frequency components.
<u>None</u>	Select this option when no center speaker is connected. The front speakers will produce center channel audio.

Surround

Selects whether or not surround speakers are connected and their sizes.

Settings

<u>Large</u>	Select this option for large speakers. The surround speakers will produce all of the surround channel frequency components.
<u>Small</u>	Select this option for small speakers. The subwoofer or front speakers will produce surround channel low-frequency components.
<u>None</u>	Select this option when no surround speakers are connected. The front speakers will produce surround channel audio. Virtual CINEMA DSP works when you select a sound program.

Surround Back

Selects whether or not surround back speakers are connected and their sizes.

Settings

Large x1	Select this option when one large speaker is connected. The surround back speaker will produce all of the surround back channel frequency components.
Large x2	Select this option when two large speakers are connected. The surround back speakers will produce all of the surround back channel frequency components.
Small x1	Select this option when one small speaker is connected. The subwoofer or front speakers will produce surround back channel low-frequency components.
<u>Small x2</u>	Select this option when two small speakers are connected. The subwoofer or front speakers will produce surround back channel low-frequency components.
None	Select this option when no surround back speakers are connected. The surround speakers will produce surround back channel audio.



- This setting is not available in the following cases:
 - “Power Amp Assign” is set to “5ch BI-AMP”
 - “Surround” is set to “None”
 - “Layout (Surround)” is set to “Front”

Front Presence

Selects whether or not front presence speakers are connected and their size (RX-A850 only).

Settings (RX-A850)

Large	Select this option for large speakers.
<u>Small</u>	Select this option for small speakers.
None	Select this option when no front presence speakers are connected.

Settings (RX-A750)

<u>Use</u>	Select this option when front presence speakers are connected.
None	Select this option when no front presence speakers are connected.



- This setting is not available when “Power Amp Assign” is set to “5ch BI-AMP” or “7ch +1ZONE”.

Subwoofer

Selects whether or not a subwoofer is connected and its phase.

Settings

Use	<u>Normal</u>	Select this option when a subwoofer is connected (phase not reversed). The subwoofer will produce LFE (low-frequency effect) channel audio and low-frequency components from other channels.
	Reverse	Select this option when a subwoofer is connected (phase reversed). The subwoofer will produce LFE (low-frequency effect) channel audio and low-frequency components from other channels.
None		Select this option when no subwoofer is connected. The front speakers will produce LFE (low-frequency effect) channel audio and low-frequency components from other channels.



- When the bass sound is lacking or unclear, switch the subwoofer phase.

Layout

Selects the layouts of the surround speakers and front presence speakers (RX-A850 only).

Surround

Selects a surround speaker layout when surround speakers are used.

Settings

<u>Rear</u>	Select this option when surround speakers are placed on the rear side of the room.
Front	Select this option when surround speakers are placed on the front side of the room. Virtual CINEMA FRONT (p.57) works in this case.



- This setting is not available when “Configuration (Surround)” is set to “None”.

Front Presence

(RX-A850 only)

Selects a front presence layout when front presence speakers are used. This setting facilitates the optimization of the sound field effect.

Settings

Front Height	Select this option when front presence speakers are installed on the front side wall.
Overhead	Select this option when front presence speakers are installed to the ceiling.
Dolby Enabled SP	Select this option when using the Dolby Enabled speakers as the front presence speakers.



- This setting is not available when "Configuration (Front Presence)" is set to "None".
- To play Dolby Atmos contents using the front presence speakers, refer to "Dolby Atmos (RX-A850 only)" (p.142).

About Dolby Atmos® (RX-A850 only)

- The unit supports the surround technology "Dolby Atmos". To get the most from Dolby Atmos contents on the unit, refer to "Dolby Atmos (RX-A850 only)" (p.142) to lay out the speakers and configure the settings.

Bass Cross Over

(RX-A750 only)

Sets the lower limit of the low-frequency components that can be output from a speaker whose size is set to "Small". A frequency sound lower than the specified value will be produced from the subwoofer or front speakers

Settings

40 Hz, 60 Hz, 80 Hz, 90 Hz, 100 Hz, 110 Hz, 120 Hz, 160 Hz, 200 Hz



- If the volume and crossover frequency are adjustable on your subwoofer, set the volume to half and crossover frequency to maximum.

Distance

Sets the distance between each speaker and listening position so that sounds from the speakers reach the listening position at the same time. First, select the unit of distance from "Meter" or "Feet".

Choices

Front L, Front R, Center, Surround L, Surround R, Surround Back L, Surround Back R, Front Presence L, Front Presence R, Subwoofer

Setting range

0.30 m to 3.00 m to 24.00 m (1.0 ft to 10.0 ft to 80.0 ft), *0.05 m (0.2 ft) increments

Level

Adjusts the volume of each speaker.

Choices

Front L, Front R, Center, Surround L, Surround R, Surround Back L, Surround Back R, Front Presence L, Front Presence R, Subwoofer

Setting range

-10.0 dB to 0.0 dB to +10.0 dB (0.5 dB increments)

Parametric EQ

Adjusts the tone with an equalizer.

Settings

Manual	Select this option when you want to adjust the equalizer manually. For details, see "Manual equalizer adjustment".
YPAO:Flat	Adjusts individual speakers to achieve the same characteristics.
YPAO:Front	Adjusts individual speakers to achieve the same characteristics as the front speakers.
YPAO:Natural	Adjusts all speakers to achieve a natural sound.
Through	Does not use the equalizer.



- "YPAO:Flat", "YPAO:Front", and "YPAO:Natural" are available only when the measurement results of "Auto Setup" have already been saved (p.35). Press ENTER again to view the measurement results.

Manual equalizer adjustment

- 1 Set “Parametric EQ” to “Manual” and press ENTER.
- 2 Press ENTER again to enter the edit screen.
- 3 Use the cursor keys to select a speaker and press ENTER.



- To restore the default settings for all speakers, select “PEQ Data Clear” and then “OK”.
- To copy the parametric equalizer values acquired with “Auto Setup” (p.35) to the “Manual” fields for fine adjustment, select “PEQ Data Copy” and then an equalizer type.

- 4 Use the cursor keys (</>) to select a center frequency from the 7 preset bands (4 for subwoofer [RX-A850 only]) and the cursor keys (Δ/▽) to adjust the gain.

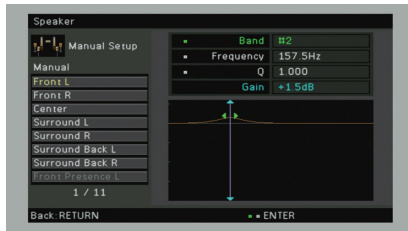

Setting range

Gain: -20.0 dB to +6.0 dB

- 5 To fine-adjust the center frequency or Q factor (bandwidth), press ENTER repeatedly to select an item.

Frequency: Use the cursor keys (</>) to adjust the center frequency of the selected band and the cursor keys (Δ/▽) to adjust the gain.

Q: Use the cursor keys (</>) to adjust the Q factor (bandwidth) of the selected band and the cursor keys (Δ/▽) to adjust the gain.

Setting range

Center frequency: 31.3 HZ to 16.0 kHz (31.3 Hz to 250.0 Hz for subwoofer [RX-A850 only])

Q factor: 0.500 to 10.080

- 6 To exit from the menu, press ON SCREEN.

Test Tone

Enables/disables the test tone output. Test tone output helps you to adjust the speaker balance or equalizer while confirming its effect.

Settings

Off	Does not output test tones.
On	Outputs test tones automatically when you adjust the speaker balance or equalizer.

Sound

Configures the audio output settings.

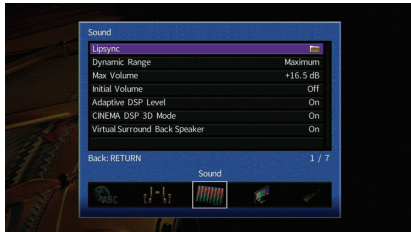

Lipsync

Adjusts the delay between video and audio output.

Delay Enable

Enables/disables the Lipsync adjustment for each input source.

Choices

HDMI*, AV 1-6, V-AUX, AUDIO 1-2

* HDMI 1-7 for RX-A850, HDMI 1-5 for RX-A750

Settings

Disable	Disable the Lipsync adjustment for the selected input source.
Enable	Enables the Lipsync adjustment for the selected input source.

Auto/Manual Select

Selects the method to adjust the delay between video and audio output.

Setting range

Auto	Adjusts the delay between video and audio output automatically when a TV that supports an automatic lipsync function is connected to the unit via HDMI. If necessary, you can fine-adjust the audio output timing in "Adjustment".
Manual	Select this option when you want to adjust the delay between video and audio output manually. Adjust the audio output timing in "Adjustment".



- Even if "Auto/Manual Select" is set to "Auto", the automatic adjustment does not work depending on the TV connected to the unit. In this case, adjust the delay manually in "Adjustment".

Adjustment

Adjusts the delay between video and audio output manually when "Auto/Manual Select" is set to "Manual". You can fine-adjust the audio output timing when "Auto/Manual Select" is set to "Auto".

Setting range

0 ms to 500 ms (1 ms increments)



- "Offset" shows the difference between automatic adjustment and fine adjustment.

Dynamic Range

Selects the dynamic range adjustment method for bitstream audio (Dolby Digital and DTS signals) playback.

Settings

Maximum	Produces audio without adjusting the dynamic range.
Standard	Optimizes the dynamic range for regular home use.
Minimum/Auto	Sets the dynamic range for clear sound even at night or at low volumes. When playing back Dolby TrueHD signals, the dynamic range is automatically adjusted based on the input signal information.

Max Volume

Sets the maximum volume to prevent excessive loudness.

Setting range

-30.0 dB to +15.0 dB (5.0 dB increments), ±16.5 dB

■ Initial Volume

Sets the initial volume when the receiver is turned on.

Settings

<u>Off</u>	Sets the level to the volume level of the unit when it last entered standby mode.
<u>On</u>	Sets at Mute or the specified volume level (-80 dB to +16.5 dB, 0.5 dB increments). (This setting works only when the initial volume is set lower than "Max Volume".)

■ Adaptive DSP Level

Selects whether to automatically adjust the CINEMA DSP effect level when the volume is adjusted.

Settings

<u>Off</u>	Does not adjust the effect level automatically.
<u>On</u>	Adjusts the effect level automatically.

■ CINEMA DSP 3D Mode

Enables/disables CINEMA DSP 3D (p.55). If this function is set to "On", CINEMA DSP 3D functions with the selected sound programs (except 2ch Stereo and 7ch Stereo).

Settings

<u>Off</u>	Disables CINEMA DSP 3D.
<u>On</u>	Enables CINEMA DSP 3D.

■ Virtual Surround Back Speaker

Selects whether to create Virtual Surround Back Speaker (VSBS) using the surround speakers. When VSBS is enabled, the unit creates VSBS when no surround back speakers are connected.

Settings

<u>Off</u>	Disables Virtual Surround Back Speaker (VSBS).
<u>On</u>	Enables Virtual Surround Back Speaker (VSBS).



- VSBS is effective only when 6.1- or 7.1-channel content is played back.

■ Object Decode Mode

(RX-A850 only)

Enables/disables playback of object-based audio signals such as Dolby Atmos contents.

Settings

<u>Disable</u>	Disables playback of object-based audio signals. Those signals will be played in normal 5.1-/7.1-channel audio.
<u>Enable</u>	Enables playback of object-based audio signals.



- Regardless of this setting, object-based audio signals are played in normal 5.1-/7.1-channel audio if any of CINEMA DSP programs is selected.

Video

Configures the video output settings.

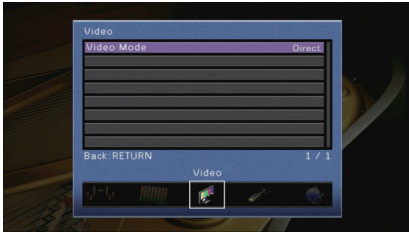

Video Mode

Enables/disables the video signal processing (resolution and aspect ratio).

Settings

<u>D</u> irect	Disables the video signal processing.
P <small>rocessing</small>	Enables the video signal processing. Select a resolution and an aspect ratio in "Resolution" and "Aspect".



- When "Video Mode" is set to "Direct", the unit transmits video signals with the least circuitry in order to reduce video output delay.
- When "Video Mode" is set to "Processing" and the resolution is being converted, short messages are not displayed on the TV screen.

Resolution

Selects a resolution to output HDMI video signals when "Video Mode" is set to "Processing".

Settings

Through	Does not convert the resolution.
<u>A</u> uto	Selects a resolution automatically in accordance with TV resolution.
480p/576p, 720p, 1080i, 1080p, 4K	Output video signals with a selected resolution. (Only the resolutions supported by your TV are selectable.)



- If you need to select a resolution that is not supported by your TV, set "MON.CHK" (p.121) in the "ADVANCED SETUP" menu to "SKIP" and try again. (Note that the output video may not be displayed on your TV normally.)

Aspect

Selects an aspect ratio to output HDMI video signals when "Video Mode" is set to "Processing".

Settings

<u>T</u> hrough	Does not convert the aspect ratio.
16:9 Normal	Outputs 4:3 video signals to a 16:9 TV with black bands on either side of the screen.



- This setting functions only when 480i/576i or 480p/576p signals are converted into 720p, 1080i, 1080p, or 2160p (4K) signals.

HDMI

Configures the HDMI settings.



HDMI Control

Enables/disables HDMI Control (p. 139).

Settings

Off	Disables HDMI Control.
On	Enables HDMI Control. Configure the settings in "TV Audio Input", "ARC" and "Standby Sync".



- To use HDMI control, you need to perform the HDMI Control link setup (p.139) after connecting HDMI Control-compatible devices.

TV Audio Input

Selects an audio input jack of the unit to be used for TV audio input when "HDMI Control" is set to "On". The unit's input source automatically switches to TV audio when the TV input is switched to its built-in tuner.

Settings

AV 1-6, AUDIO 1-2

Default

AV 4



- When using ARC to input TV audio to the unit, you cannot use the input jacks selected here for connecting an external device because the input will be used for TV audio input.

ARC

Enables/disables ARC (p.140) when "HDMI Control" is set to "On".

Settings

Off	Disables ARC.
On	Enables ARC.



- You do not need to change this setting normally. In case noises are produced from the speakers connected to the unit because TV audio signals input to the unit via ARC are not supported by the unit, set "ARC" to "Off" and use the TV's speakers.

Standby Sync

Select whether to use HDMI control to link the standby behavior of the TV and the unit when "HDMI Control" is set to "On".

Settings

Off	Does not set the unit to standby mode when the TV is turned off.
On	Sets the unit to standby mode when the TV is turned off.
Auto	Sets the unit to standby mode when the TV is turned off only when the unit is receiving TV audio or HDMI signals.

■ Audio Output

Selects a device to output audio.



- This setting (except for “HDMI OUT2” [RX-A850 only]) is available only when “HDMI Control” is set to “Off”.

Amp

Enables/disables the audio output from the speakers connected to the unit.

Settings

Off	Disables the audio output from the speakers.
On	Enables the audio output from the speakers.

HDMI OUT1, HDMI OUT2 (RX-A850 only) HDMI OUT (TV) (RX-A750 only)

Enables/disables the audio output from a TV connected to the HDMI OUT jack.

Settings

Off	Disables the audio output from the TV.
On	Enables the audio output from the TV.

■ Standby Through

Select whether to output videos/audio (input through HDMI jacks) to the TV when the unit is in standby mode. If this function is set to “On” or “Auto”, you can use the input selection keys (HDMI, V-AUX) to select an HDMI input even when the unit is in standby mode (the standby indicator on the unit blinks).

Settings

Off	(This setting is available only when “HDMI Control” is set to “Off”.) Does not output videos/audio to the TV.
On	Outputs videos/audio to the TV. (The unit consumes more power than when “Off” is selected.)
Auto	Outputs videos/audio to the TV. If no signals are detected, the unit is set to the power saving mode.

Network

Configures the network settings.



■ Network Connection

Selects the network connection method.

Settings

Wired	Select this option when you want to connect the unit to a network with a commercially-available network cable (p.31)
Wireless (Wi-Fi)	Select this option when you want to connect the unit to a network via the wireless router (access point). For details on settings, see “Connecting the unit to a wireless network” (p.44).
Wireless Direct	Select this option when you want to connect a mobile device to the unit directly. For details on settings, see “Connecting a mobile device to the unit directly (Wireless Direct)” (p.50).

■ IP Address

Configures the network parameters (such as IP address).

DHCP

Select whether to use a DHCP server.

Settings

Off	Does not use a DHCP server. Configure the network parameters manually. For details, see “Manual network settings”.
On	Uses a DHCP server to automatically obtain the unit's network parameters (such as IP address).

■ Manual network settings

- 1 Set “DHCP” to “Off”.
- 2 Use the cursor keys (Δ/∇) to select a parameter type and press ENTER.

IP Address	Specifies an IP address.
Subnet Mask	Specifies a subnet mask.
Default Gateway	Specifies the IP address of the default gateway.
DNS Server (P)	Specifies the IP address of the primary DNS server.
DNS Server (S)	Specifies the IP address of the secondary DNS server.

- 3 Use the cursor keys (\leftarrow/\rightarrow) to move the edit position and the cursor keys (Δ/∇) to select a value.
- 4 To confirm the setting, press ENTER.
- 5 To configure another network parameter, repeat steps 2 to 4.
- 6 To save the changes, use the cursor keys to select “OK” and press ENTER.
- 7 To exit from the menu, press ON SCREEN.

■ Network Standby

Selects whether the unit can be turned on from other network devices (network standby).

Settings

Off	Disables the network standby function.
On	Enables the network standby function. (The unit consumes more power than when “Off” is selected.)
Auto	Enables the network standby function. (If “Network Connection” is set to “Wired”, the unit is set to the power saving mode when the network cable is disconnected.)

■ MAC Address Filter

Sets the MAC address filter to limit access to the unit from other network devices.

Filter

Enables/disables the MAC address filter.

Settings

Off	Disables the MAC address filter.
On	Enables the MAC address filter. In “MAC Address 1–10”, specify the MAC addresses of the network devices that will be permitted access to the unit.



- AirPlay (p.79) and DMC (p.95) operations are not subject to the MAC address filter.

MAC Address 1–10

Specifies the MAC addresses (up to 10) of the network devices that will be permitted access to the unit when “Filter” is set to “On”.

■ Procedure

- 1 Use the cursor keys (Δ/∇) to select “MAC Address 1–5” or “MAC Address 6–10” and press ENTER.
- 2 Use the cursor keys (Δ/∇) to select an MAC address number and press ENTER.
- 3 Use the cursor keys (\leftarrow/\rightarrow) to move the edit position and the cursor keys (Δ/∇) to select a value.
- 4 To confirm the setting, press ENTER.
- 5 To save the changes, use the cursor keys to select “OK” and press ENTER.
- 6 To exit from the menu, press ON SCREEN.

Network Name

Edits the network name (the unit's name on the network) displayed on other network devices.

Procedure

- 1 Press **ENTER** to enter the name edit screen.
- 2 Use the cursor keys and **ENTER** to rename and select "**ENTER**" to confirm the entry.

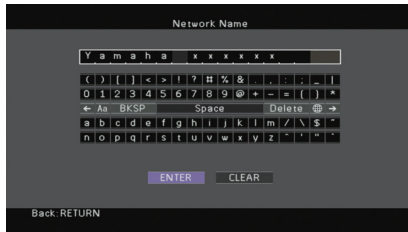

- To clear the entry, select "CLEAR".

- 3 Use the cursor keys to select "OK" and press **ENTER**.



- To restore the default setting, select "RESET".

- 4 To exit from the menu, press **ON SCREEN**.

Bluetooth

Configures the *Bluetooth* settings.

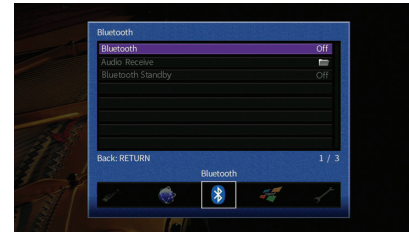

Bluetooth

Enables/disables the *Bluetooth* function (p.65).

Settings

Off	Disables the <i>Bluetooth</i> function.
On	Enables the <i>Bluetooth</i> function.

Bluetooth Standby

Selects whether to enable/disable the function that turns on the unit from *Bluetooth* devices (*Bluetooth* standby). If this function is set to "On", the unit automatically turns on when a connect operation is performed on the *Bluetooth* device.

Settings

Off	Disables the <i>Bluetooth</i> standby function.
On	Enables the <i>Bluetooth</i> standby function. (The unit consumes more power than when "Off" is selected.)



- This setting is not available when "Network Standby" (p.112) is set to "Off".

Multi Zone

Configures the multi zone settings.



Main Zone Set

Configures the main zone setting.

Zone Rename

Changes the zone name (for main zone) displayed on the TV screen.

Procedure

- 1 Press **ENTER** to enter the name edit screen.
- 2 Use the cursor keys and **ENTER** to rename and select **"ENTER"** to confirm the entry.

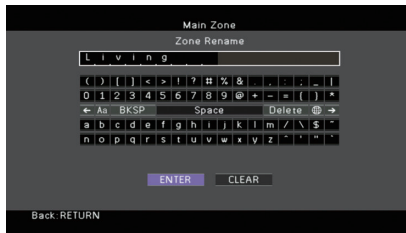

- To clear the entry, select **"CLEAR"**.

- 3 Use the cursor keys to select **"OK"** and press **ENTER**.



- To restore the default setting, select **"RESET"**.

- 4 To exit from the menu, press **ON SCREEN**.

Zone2 Set

Configures the Zone2 settings.

Max Volume

Sets the Zone2 maximum volume to prevent excessive loudness.

Setting range

-30.0 dB to +15.0 dB (5.0 dB increments), +16.5 dB



- This setting is available only when **"Power Amp Assign"** (p.103) is set to **"7ch +1ZONE"**.

Initial Volume

Sets the Zone2 initial volume for when the unit is turned on.

Settings

Off	Sets the level at the volume level of the unit when it last entered standby mode.
On	Sets at Mute or the specified volume level (-80 dB to +16.5 dB, 0.5 dB increments). (This setting works only when the initial volume is set lower than "Max Volume".)



- This setting is available only when **"Power Amp Assign"** (p.103) is set to **"7ch +1ZONE"**.

Zone Rename

Changes the zone name (for Zone2) displayed on the TV screen.

You can change the zone name in the same manner as **"Zone Rename"** in **"Main Zone Set"** (p.114).

Party Mode Set

Enables/disables switching to the party mode (p.85).

Choice

Target: Zone 2

Settings

Disable	Disables switching to the party mode.
Enable	Enables switching to the party mode. You can turn on/off the party mode by pressing PARTY on the remote control.

Function

Configures the functions that make the unit easier to use.



Display Set

Configures the settings related to the front display and TV screen display.

Dimmer (Front Display)

Adjusts the brightness of the front display.

Setting range

-4 to 0 (higher to brighten)



- The front display may become dark when "ECO Mode" (p.116) is set to "On".

Short Message

Selects whether to display short messages on the TV screen when the unit is operated (such as input selection and volume adjustment).

Settings

<u>On</u>	Displays short messages on the TV screen.
Off	Does not display short messages on the TV screen.

Wallpaper

Selects the image to be used as wallpaper on the TV.

Settings

<u>Piano</u>	Displays the piano image on the TV screen when there is no video signal.
Gray	Displays a gray background on the TV screen when there is no video signal.

Trigger Output

Sets the TRIGGER OUT jack to function in sync with the power status of each zone or input switching.

Trigger Mode

Specifies the condition for the TRIGGER OUT jack to function.

Settings

<u>Power</u>	The TRIGGER OUT jack functions in sync with the power status of the zone specified with "Target Zone."
Source	The TRIGGER OUT jack functions in sync with the input switching in the zone specified with "Target Zone." An electronic signal is transmitted according to the setting made in "Source."
Manual	Select this to manually switch the output level for electronic signal transmission with "Manual."

Source

Specifies the output level of the electronic signal transmitted with each input, switching when "Trigger Mode" is set to "Source".

Choices

HDMI*1, AV 1-6, V-AUX, AUDIO 1-2, TUNER, PHONO*2, (network sources), Bluetooth, USB

*1 HDMI 1-7 for RX-A850, HDMI 1-5 for RX-A750

*2 RX-A850 only

Settings

<u>Low</u>	Stops the electronic signal transmission when you switch to the input source specified in this option.
High	Transmits the electronic signal when you switch to the input source specified in this option.

Manual

Switches the output level for electronic signal transmission manually when "Trigger Mode" is set to "Manual". This setting can also be used to confirm proper function of the external device connected via the TRIGGER OUT jack.

Choices

<u>Low</u>	Stops the electronic signal transmission.
High	Transmits the electronic signal.

Target Zone

Specifies the zone with which the TRIGGER OUT jack functions are synchronized.

Settings

Main	When "Trigger Mode" is set to "Power," electronic signal transmission is synchronized with the power status of the main zone. When "Trigger Mode" is set to "Source," electronic signal transmission is synchronized with the input switching in the main zone.
Zone2	When "Trigger Mode" is set to "Power," electronic signal transmission is synchronized with the power status of Zone2. When "Trigger Mode" is set to "Source," electronic signal transmission is synchronized with the input switching in Zone2.
All	When "Trigger Mode" is set to "Power," electronic signal transmission is synchronized with the power status of the main zone or Zone2. When "Trigger Mode" is set to "Source," electronic signal transmission is synchronized with the input switching in the main zone or Zone2.

Memory Guard

Prevents accidental changes to the settings.

Settings

Off	Does not protect the settings.
On	Protects the settings until "Off" is selected.



- When "Memory Guard" is set to "On", the lock icon (🔒) is displayed on the menu screen.

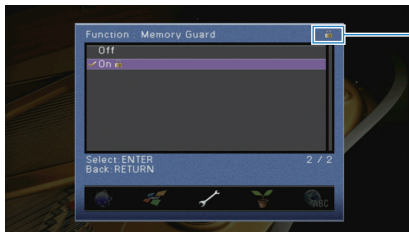

Icon

ECO

Configures the power supply settings.

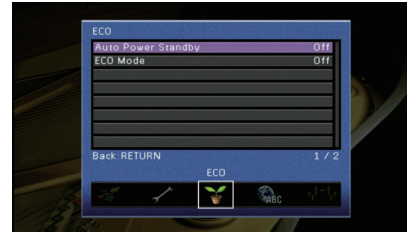

Auto Power Standby

Sets the amount of time for the auto-standby function. If you do not operate the unit or if no input signals are detected for the specified time, the unit will automatically go into standby mode.

Settings

Off	Does not set the unit to standby mode automatically.
20 Minutes	Sets the unit to standby mode when you have not operated the unit and no input signals are detected for 20 minutes.
2 Hours, 4 Hours, 8 Hours, 12 Hours	Sets the unit to standby mode when you have not operated the unit for the specified time. For example, when "2 Hours" is selected, the unit will switch to standby mode if you do not operate it for 2 hours.

Default

U.K. and Europe models: 20 Minutes
Other models: Off



- Just before the unit enters standby mode, "AutoPowerStdby" appears and then countdown starts in the front display.

ECO Mode

Enables/disables the eco (power saving) mode.

When the eco mode is enabled, you can reduce the unit's power consumption.

Settings

Off	Disables the eco mode.
On	Enables the eco mode.



- The new setting will take effect after the unit is restarted.
- When "ECO Mode" is set to "On", the front panel display may become dark.
- If you want to play audio at high volume, set "ECO Mode" to "Off".

Language

Select an on-screen menu language.

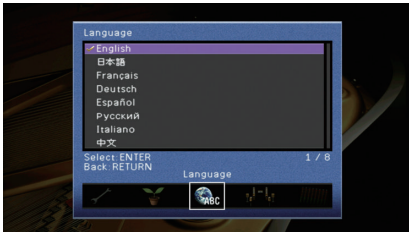

Settings

English	English
日本語	Japanese
Français	French
Deutsch	German
Español	Spanish
Русский	Russian
Italiano	Italian
中文	Chinese



- The information on the front display is provided in English only.

Viewing information about the unit (Information menu)

You can view information about the unit using the TV screen.

- 1 Press ON SCREEN.
- 2 Use the cursor keys to select “Information” and press ENTER.

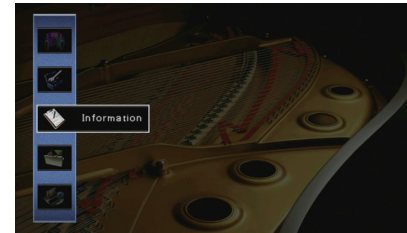

- 3 Use the cursor keys (</>) to select an information type.

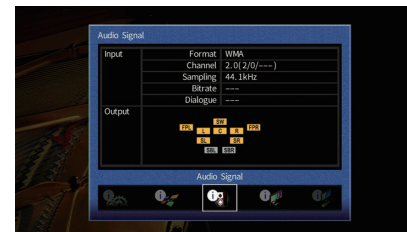

- 4 To exit from the menu, press ON SCREEN.

Types of information

■ Audio Signal

Displays information about the current audio signal.

Input	Format	Audio format of the input signal
	Channel	The number of source channels in the input signal (front/surround/LFE) For example, "5.1 (3/2/0.1)" means 5.1ch in total (3 front channels, 2 surround channels, and LFE).
	Sampling	The number of samples per second of the input digital signal
	Bitrate	The amount of data per second of the input bitstream signal
	Dialogue	The dialogue normalization level of the input bitstream signal
Output	The speaker terminals from which signals are output	



- Even when the unit is set to output bitstream signals directly, the signal may be converted depending on the specifications and settings of the playback device.

■ Video Signal

Displays information about the current video signal.

HDMI Signal	Presence or absence of HDMI signal input/output
HDMI Resolution	Resolutions of input signal (analog or HDMI) and output signal (HDMI)
Analog Resolution	Resolutions of input signal (analog) and signal output at the MONITOR OUT jacks (analog)

■ HDMI Monitor

Displays information about the TVs connected to the HDMI OUT jacks.

Interface	TV interface
Video Resolution	Resolutions supported by the TV



- (RX-A850 only)
Use the cursor keys (△/▽) to switch between "OUT1" and "OUT2".

■ Network

Displays the network information on the unit.

(When using wired or wireless [Wi-Fi] network connection)

IP Address	IP address
Subnet Mask	Subnet mask
Default Gateway	The IP address of the default gateway
DNS Server (P)	The IP address of the primary DNS server
DNS Server (S)	The IP address of the secondary DNS server
MAC Address (Ethernet)	MAC address
MAC Address (Wi-Fi)	
vTuner ID	vTuner ID
Network Name	Network name (the unit's name on the network)
Wired/Wireless	The status of the wired or wireless connection
SSID	(When using wireless [Wi-Fi] network connection) The SSID of the wireless network

(When using Wireless Direct)

SSID	The SSID of the wireless network
Security	Security method
Security Key	Security key
IP Address	IP address
Subnet Mask	Subnet mask
MAC Address (Wi-Fi)	MAC address
Network Connection	"Wireless Direct" indication

System

Displays the system information on the unit.

Remote ID	The unit's remote control ID setting (p.120)
TV Format	The unit's video signal type (p.120)
Speaker Impedance	The speaker impedance setting of the unit (p.120)
Tuner Freq. Step	(Asia and General models only) The FM/AM tuning frequency setting of the unit (p.120)
System ID	System ID number
Firmware Version	The version of firmware installed on the unit



- If the unit detects a newer firmware over the network, "!" (exclamation mark) appears at the upper right of the "Information" and "System" icons, and the corresponding message will be displayed in this screen. You can update the unit's firmware by pressing ENTER in this screen and following the procedure in "Updating the unit's firmware via the network" (p.123).

Multi Zone

Displays information about Zone2.

Input	The input source selected for Zone2
Volume	The volume setting for Zone2

Configuring the system settings (ADVANCED SETUP menu)

Configure the system settings of the unit while viewing the front display.

- 1 Set the unit to standby mode.
- 2 While holding down **STRAIGHT** on the front panel, press **MAIN ZONE** .

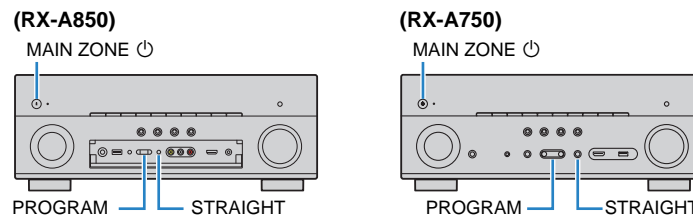

- 3 Press **PROGRAM** to select an item.
- 4 Press **STRAIGHT** to select a setting.
- 5 Press **MAIN ZONE**  to set the unit to standby mode and turn it on again.
The new settings take effect.

ADVANCED SETUP menu items



- Default settings are underlined.

Item	Function	Page
SP IMP.	Changes the speaker impedance setting.	120
REMOTE ID	Selects the unit's remote control ID.	120
TU	(Asia and General models only) Changes the FM/AM tuning frequency setting.	120
TV FORMAT	Switches the video signal type.	120
MON.CHK	Removes the limitation on HDMI video output.	121
4K MODE	Selects the HDMI 4K signal format.	121
INIT	Restores the default settings.	121

Item	Function	Page
UPDATE	Updates the firmware.	122
VERSION	Checks the version of firmware currently installed on the unit.	122

Changing the speaker impedance setting (SP IMP.)



Change the unit's speaker impedance settings depending on the impedance of the speakers connected.

Settings

6 Ω MIN	Select this option when you connect 6-ohm speakers to the unit. You can also use 4-ohm speakers as the front speakers.
8 Ω MIN	Select this option when you connect 8-ohm or higher speakers to the unit.

Selecting the remote control ID (REMOTE ID)



Change the unit's remote control ID so that it matches the remote control's ID (default: ID1). When using multiple Yamaha AV receivers, you can set each remote control with a unique remote control ID for its corresponding receiver.

Settings

ID1, ID2

■ Changing the remote control ID of the remote control

- 1 To select ID1, hold down the cursor key (<) and SCENE (BD/DVD) together for 3 seconds.
To select ID2, hold down the cursor key (<) and SCENE (TV) together for 3 seconds.

Changing the FM/AM tuning frequency setting (TU)

(Asia and General models only)



Change the FM/AM tuning frequency setting of the unit depending on your country or region.

Settings

FM100/AM10	Select this when you want to adjust the FM frequency by 100-kHz steps and AM by 10-kHz steps.
FM50/AM9	Select this when you want to adjust the FM frequency by 50-kHz steps and AM by 9-kHz steps.

Switching the video signal type (TV FORMAT)



Switch the video signal type of the unit so that it matches to the format of your TV.

Settings

NTSC, PAL

Default

U.S.A., Canada, Korea and General models: NTSC
Other models: PAL

Removing the limitation on HDMI video output (MON.CHK)



MON.CHK YES

The unit automatically detects resolutions supported by a TV connected to the HDMI OUT jack.

Disable the monitor check function if you want to specify a resolution in "Resolution" (p.109) when the unit cannot detect the TV's resolution or when you want to specify a different resolution than the detected resolution.

Settings

<u>YES</u>	Enables the monitor check function. (Outputs video signals with a resolution supported by the TV only.)
SKIP	Disables the monitor check function. (Outputs video signals with a specified resolution regardless of compatibility with the TV.)



- Reset to "YES" if the unit becomes inoperable because video from the unit cannot be displayed on the TV after "MON.CHK" has been set to "SKIP".

Selecting the HDMI 4K signal format (4K MODE)



4K MODE MODE 2

Selects the format of signals input/output at the unit when HDMI 4K (60 Hz/50 Hz) compatible TV and playback device are connected to the unit.

Settings

<u>MODE 1</u>	Inputs/outputs 4K (60 Hz/50 Hz) signals in 4:4:4, 4:2:2 or 4:2:0 format. (4:2:0 format only for VIDEO AUX [HDMI IN] jack) Depending on the connected device or HDMI cables, video may not be displayed correctly. In this case, select "MODE 2".
<u>MODE 2</u>	Inputs/outputs 4K (60 Hz/50 Hz) signals in 4:2:0 format.



- When "MODE 1" is selected, use a high-speed HDMI cable that supports 18 Gbps.

Restoring the default settings (INIT)



INIT CANCEL

Restores the default settings for the unit.

Choices

<u>VIDEO</u>	Restores the default settings for video configurations.
ALL	Restores the default settings for the unit.
CANCEL	Does not perform an initialization.

Updating the firmware (UPDATE)

A screenshot of a monochrome LCD display showing the text 'UPDATE' followed by a series of dots and the text 'USB'.

New firmware that provides additional features or product improvements will be released as needed. Updates can be downloaded from the Yamaha website. If the unit is connected to the Internet, you can download the firmware via the network. For details, refer to the information supplied with updates.

■ Firmware update procedure

Do not perform this procedure unless firmware update is necessary. Also, make sure you read the information supplied with updates before updating the firmware.

- 1 Press **STRAIGHT** repeatedly to select “USB” or “NETWORK” and press **INFO** to start firmware update.

Choices

USB	Update the firmware using a USB memory device.
NETWORK	Update the firmware via the network.



- If the unit detects newer firmware over the network, the corresponding message will be displayed after **ON SCREEN** is pressed. In this case, you can also update the unit's firmware by following the procedure in “Updating the unit's firmware via the network” (p.123).

Checking the firmware version (VERSION)

A screenshot of a monochrome LCD display showing the text 'VERSION' followed by a series of dots and the text 'XX.XX'.

Check the version of firmware currently installed on the unit.



- You can also check the firmware version in “System” (p.119) in the “Information” menu.
- It may take a while until the firmware version is displayed.



Cursor keys
ENTER

Updating the unit's firmware via the network

New firmware that provides additional features or product improvements will be released as needed. If the unit is connected to the Internet, you can download the firmware via the network and update it.

Note

- Do not operate the unit or disconnect the power cable or network cable during firmware update. Firmware update takes about 20 minutes or more (depending on your Internet connection speed).
- If the unit is connected to the wireless network, network update may not be possible depending on the condition of the wireless connection. In this case, update the firmware using the USB memory device (p.122).
- For details on update, visit the Yamaha website.



- You can also update the firmware using the USB memory device from the "ADVANCED SETUP" menu (p.122).

A firmware update is available if the following message is displayed after ON SCREEN is pressed.



1 Read the on-screen description.

2 To start the firmware update, use the cursor keys to select "START" and press ENTER.

The on-screen display turns off.

3 If "Update Success Please Power Off!" appears on the front display, press MAIN ZONE  on the front panel.

The firmware update is complete.



- If you want to update the firmware later, select "CLOSE" in Step 2. "!" (exclamation mark) appears at the upper right of the "Information" and "System" icons, and a message will be displayed in the "System" screen (p.119). You can update the unit's firmware by pressing ENTER in the "System" screen.

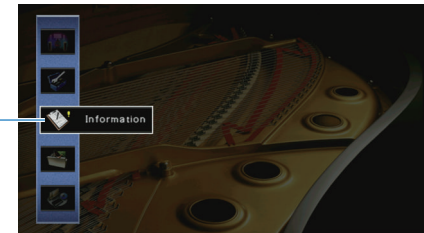

Information icon

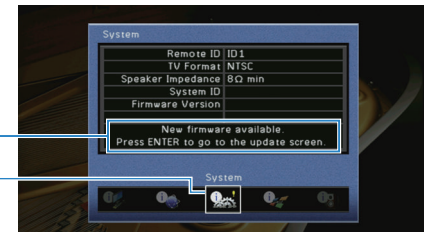

Message

System Icon

APPENDIX

Frequently asked questions

The new speaker system does not provide an ideal sound balance...

If you have changed speakers or have a new speaker system, use “Auto Setup” to optimize the speaker settings again (p.35). If you want to adjust the speaker settings manually, use “Manual Setup” in the “Setup” menu (p.103).

Since we have small children, we want to set limitations on the volume control...

If a small child accidentally operates the controls on the main unit or remote control, the volume may suddenly increase. This may also cause injury or damage the unit or speakers. We recommend using “Max Volume” in the “Setup” menu to set the maximum volume level for the unit in advance (p.107). You can also set the maximum volume for Zone2 (p.114).

I am occasionally startled by a sudden loud sound when turning on the unit...

By default, the volume level when the unit last entered standby mode is automatically applied. If you want to fix the volume, use “Initial Volume” in the “Setup” menu to set the volume to be applied when the receiver is turned on (p.108). You can also set the initial volume for Zone2 (p.114).

We are bothered by volume differences when switching between input sources...

You can correct volume differences between input sources by utilizing “Input Trim” in the “Option” menu (p.92).

I made HDMI connections but HDMI Control does not work at all...

To use HDMI Control, you need to perform the HDMI Control link setup (p.139). After connecting HDMI Control-compatible devices (such as BD/DVD players) to the unit,

enable HDMI Control on each device and perform the HDMI Control link setup. This setup is required every time you add a new HDMI Control-compatible device to your system. For information on how HDMI Control works between your TV and playback devices, refer to the instruction manuals for each device.

I want to turn off the on-screen messages displayed during operations...

By default, short messages are displayed on the TV screen when the unit is operated (such as input selection and volume adjustment). If the short messages bother you when you are watching movies or sports, configure “Short Message” (p.115) in the “Setup” menu to turn off the short messages.

I want to prevent accidental changes to the settings...

You can protect the settings configured on the unit (such as speaker settings) by utilizing “Memory Guard” in the “Setup” menu (p.116).

The unit’s remote control is simultaneously controlling another Yamaha product as well as the unit...

When using multiple Yamaha products, the remote control may work on another Yamaha product or another remote control may work on the unit. If this happens, register different remote control IDs for the devices that you want to control with each remote control (p.120).

I want to enjoy videos/audio played back on the video device even when the unit is in standby mode...

If you have connected a video device to the unit with HDMI, you can output videos/audio played back on the video device to the TV even when the unit is in standby mode. To use this function, set “Standby Through” (p.111) in the “Setup” menu to “On” or “Auto”. You can also switch the input source using the remote control of the unit when this function is enabled.

Troubleshooting



Refer to the table below when the unit does not function properly.

If the problem you are experiencing is not listed below or if the instructions below do not help, turn off the unit, disconnect the power cable, and contact the nearest authorized Yamaha dealer or service center.

First, check the following:

- ① **The power cables of the unit, TV and playback devices (such as BD/DVD players) are connected to AC wall outlets securely.**
- ② **The unit, subwoofer, TV and playback devices (such as BD/DVD players) are turned on.**
- ③ **The connectors of each cable are securely inserted in to jacks on each device.**

Power, system and remote control

Problem	Cause	Remedy
The power does not turn on.	The protection circuitry has been activated three times consecutively. When the unit is in this condition, the standby indicator on the unit blinks if you try to turn on the power.	As a safety precaution, capability to turn on the power is disabled. Contact your nearest Yamaha dealer or service center to request repair.
The power does not turn off.	The internal microcomputer has frozen, due to an external electric shock (such as lightning or excessive static electricity) or to a drop in the power supply voltage.	Hold down MAIN ZONE  on the front panel for more than 10 seconds to initialize and reboot the unit. (If the problem persists, disconnect the power cable from the AC wall outlet and plug it again.)
The power turns off (standby mode) immediately.	The unit was turned on while a speaker cable was shorted.	Twist the bare wires of each speaker cable firmly and reconnect to the unit and speakers (p.21).
The unit enters standby mode automatically.	The sleep timer worked.	Turn on the unit and start playback again.
	The auto-standby function kicked in because the unit was not used for the specified time.	To disable the auto-standby function, set "Auto Power Standby" in the "Setup" menu to "Off" (p.116).
	The speaker impedance setting is incorrect.	Set the speaker impedance to match your speakers (p.120).
	The protection circuitry has been activated because of a short circuit.	Twist the bare wires of each speaker cable firmly and reconnect to the unit and speakers (p.21).
The unit is not reacting.	The internal microcomputer is frozen, due to an external electric shock (such as lightning or excessive static electricity) or to a drop in the power supply voltage.	Hold down MAIN ZONE  on the front panel for more than 10 seconds to initialize and reboot the unit. (If the problem persists, disconnect the power cable from the AC wall outlet and plug it again.)

Problem	Cause	Remedy
The unit cannot be controlled using the remote control.	The unit is out of the operating range.	Use the remote control within the operating range (p.5).
	The batteries are weak.	Replace with new batteries.
	The unit's remote control sensor is exposed to direct sunlight or strong lighting.	Adjust the lighting angle, or reposition the unit.
	(RX-A850 [China, Korea, U.K. and Europe models] only) The remote control is set to control external devices.	Press RECEIVER to set the remote control to control the unit (the key lights up in orange).
	The remote control IDs of the unit and the remote control are not identical.	Change the remote control ID of the unit or the remote control (p.120).

Audio

Problem	Cause	Remedy
No sound.	Another input source is selected.	Select an appropriate input source with the input selection keys.
	Signals that the unit cannot reproduce are being input.	Some digital audio formats cannot be played back on the unit. To check the audio format of the input signal, use "Audio Signal" in the "Information" menu (p.118).
	The cable connecting the unit and playback device is defective.	If there is no problem with the connection, replace with another cable.
The volume cannot be increased.	The maximum volume is set.	Use "Max Volume" in the "Setup" menu to adjust the maximum volume (p.107).
	A device connected to the output jacks of the unit is not turned on.	Turn on all devices connected to the output jacks of the unit.
No sound is coming from a specific speaker.	The playback source does not contain a signal for the channel.	To check it, use "Audio Signal" in the "Information" menu (p.118).
	The currently selected sound program/decoder does not use the speaker.	To check it, use "Test Tone" in the "Setup" menu (p.106).
	Audio output of the speaker is disabled.	Perform "Auto Setup" (p.35) or use "Configuration" in the "Setup" menu to change the speaker settings (p.103).
	The volume of the speaker is set too low.	Perform "Auto Setup" (p.35) or use "Level" in the "Setup" menu to adjust the speaker volume (p.105).
	The speaker cable connecting the unit and the speaker is defective.	If there is no problem with the connection, replace with another speaker cable.
	The speaker is malfunctioning.	To check it, replace with another speaker. If the problem persists, the unit may be malfunctioning.
No sound is coming from the subwoofer.	The playback source does not contain LFE or low-frequency signals.	To check if the subwoofer is working properly, use "Test Tone" in the "Setup" menu (p.106).
	Subwoofer output is disabled.	Perform "Auto Setup" (p.35) or set "Subwoofer" in the "Setup" menu to "Use" (p.104).
	The volume of the subwoofer is too low.	Adjust the volume on the subwoofer.
	The subwoofer has been turned off by its auto-standby function.	Disable the auto-standby function of the subwoofer or adjust its sensitivity level.

Problem	Cause	Remedy
No sound from the playback device (connected to the unit with HDMI).	The TV does not support HDCP (High-bandwidth Digital Content Protection).	Refer to the instruction manuals for the TV and check the TV's specifications.
	The unit is set not to output audio input through HDMI jacks from the SPEAKERS terminals.	In "Audio Output" in the "Setup" menu, set "Amp" to "On" (p.111).
	The number of devices connected to the HDMI OUT jack exceeds the limit.	Disconnect some of the HDMI devices.
No sound from the TV (when HDMI Control is used).	The TV is set to output audio from the TV speakers.	Change the audio output setting on your TV so that the TV audio is output from the speakers connected to the unit.
	A TV that does not support ARC is connected to the unit only with an HDMI cable.	Use a digital optical cable to make an audio connection (p.24).
	(If the TV is connected to the unit with an audio cable) The TV audio input setting does not match the actual connection.	Use "TV Audio Input" in the "Setup" menu to select the correct audio input jack (p.110).
	(If you are trying to use ARC) ARC is disabled on the unit or TV.	Set "ARC" in the "Setup" menu to "On" (p.110). Also, enable ARC on the TV.
Only the front speakers work on multichannel audio.	The playback device is set to output 2-channel audio (such as PCM) only.	To check it, use "Audio Signal" in the "Information" menu (p.118). If necessary, change the digital audio output setting on the playback device.
Noise/hum is heard.	The unit is too close to another digital or radio frequency device.	Move the unit further away from the device.
	The cable connecting the unit and playback device is defective.	If there is no problem with the connection, replace with another cable.
The sound is distorted.	The volume of the unit is too high.	Turn down the volume. If "ECO Mode" is set to "On", set it to "Off" (p.116).
	A device connected to the unit's output jacks is not turned on.	Turn on all devices connected to the unit's output jacks.

Video

Problem	Cause	Remedy
No video.	Another input source is selected on the unit.	Select an appropriate input source with the input selection keys.
	Another input source is selected on the TV.	Switch the TV input to display the video from the unit.
	The video signal output from the unit is not supported by the TV.	Set "MON.CHK" in the "ADVANCED SETUP" menu to "YES" (p.121).
	The cable connecting the unit and TV (or playback device) is defective.	If there is no problem with the connection, replace with another cable.
No video from the playback device (connected to the unit with HDMI).	The input video signal (resolution) is not supported by the unit.	To check the information about the current video signal (resolution), use "Video Signal" in the "Information" menu (p.118). For information about video signals supported by the unit, see "HDMI signal compatibility" (p.141).
	The TV does not support HDCP (High-bandwidth Digital Content Protection).	Refer to the instruction manuals for the TV and check the TV's specifications. If you want to play back contents that require HDCP 2.2-compatible devices, both the TV and playback device must support HDCP 2.2.
	The playback device that supports HDCP 2.2 is connected to other than the HDMI 1-3 jack.	To play back contents that require HDCP 2.2-compatible devices, connect the playback device to the HDMI 1-3 jack (p.26).
	The number of devices connected to the HDMI OUT jack is over the limit.	Disconnect some of the HDMI devices.
The menu of the unit is not displayed on the TV.	The TV is not connected to the unit via HDMI.	You can display the menu of the unit on the TV only when they are connected with an HDMI cable. If necessary, use an HDMI cable to connect them (p.24).
	Another input source is selected on the TV.	Switch the TV input to display the video from the unit (HDMI OUT jack).

FM/AM radio

Problem	Cause	Remedy
FM radio reception is weak or noisy.	There is multi-path interference.	Adjust the FM antenna height or orientation, or place it in a different location.
	Your area is too far from the FM station transmitter.	Set "FM Mode" in the "Option" menu to "Mono" to select monaural FM radio reception (p.92). Use an outdoor FM antenna. We recommend using a sensitive multi-element antenna.
AM radio reception is weak or noisy.	The noises may be caused by fluorescent lamps, motors, thermostats, or other electrical equipment.	It is difficult to completely eliminate noise. It may be reduced by using an outdoor AM antenna.

Problem	Cause	Remedy
Radio stations cannot be selected automatically.	Your area is too far from the FM station transmitter.	Select the station manually (p.61). Use an outdoor antenna. We recommend using a sensitive multi-element antenna.
	The AM radio signal is weak.	Adjust the AM antenna orientation.
		Select the station manually (p.61).
		Use an outdoor AM antenna. Connect it to the ANTENNA (AM) jack together with the supplied AM antenna.
AM radio stations cannot be registered as presets.	Auto Preset has been used.	Auto Preset is for registering FM radio stations only. Register AM radio stations manually (p.61).

Bluetooth

Problem	Cause	Remedy
A Bluetooth connection cannot be established.	The <i>Bluetooth</i> function of the unit is disabled.	Enable the <i>Bluetooth</i> function (p.113).
	Another <i>Bluetooth</i> device is already connected to the unit.	Terminate the current <i>Bluetooth</i> connection and then establish a new connection (p.65).
	The unit and the <i>Bluetooth</i> device are too far apart.	Move the <i>Bluetooth</i> device closer to the unit.
	There is a device (such as microwave oven and wireless LAN) that outputs signals in the 2.4 GHz frequency band nearby.	Move the unit away from those devices.
	The <i>Bluetooth</i> device does not support A2DP.	Use a <i>Bluetooth</i> device that supports A2DP.
	The connection information registered on the <i>Bluetooth</i> device is not working for some reason.	Delete the connection information on the <i>Bluetooth</i> device, and then establish a connection between the <i>Bluetooth</i> device and the unit again (p.65).
No sound is produced, or the sound is interrupted during playback.	The volume of the <i>Bluetooth</i> device is set too low.	Turn up the volume of the <i>Bluetooth</i> device.
	The <i>Bluetooth</i> device is not set to send audio signals to the unit.	Switch the audio output of the <i>Bluetooth</i> device to the unit.
	The <i>Bluetooth</i> connection has been terminated.	Establish a <i>Bluetooth</i> connection between the <i>Bluetooth</i> device and the unit again (p.65).
	The unit and the <i>Bluetooth</i> device are too far apart.	Move the <i>Bluetooth</i> device closer to the unit.
	There is a device (such as microwave oven and wireless LAN) that outputs signals in the 2.4 GHz frequency band nearby.	Move the unit away from those devices.

USB and network

Problem	Cause	Remedy
The unit does not detect the USB device.	The USB device is not connected to the USB jack securely.	Turn off the unit, reconnect your USB device, and turn the unit on again.
	The file system of the USB device is not FAT16 or FAT32.	Use a USB device with FAT16 or FAT32 format.
Folders and files in the USB device cannot be viewed.	The data in the USB device is protected by the encryption.	Use a USB device without an encryption function.
The network feature does not function.	The network parameters (IP address) have not been obtained properly.	Enable the DHCP server function on your router and set "DHCP" in the "Setup" menu to "On" on the unit (p.112). If you want to configure the network parameters manually, check that you are using an IP address which is not used by other network devices in your network (p.112).
The unit cannot connect to the Internet via a wireless router (access point).	The wireless router (access point) is turned off.	Turn on the wireless router.
	The unit and the wireless router (access point) are too far apart.	Place the unit and the wireless router (access point) closer to each other.
	There is an obstacle between the unit and the wireless router (access point).	Move the unit and the wireless router (access point) in a location where there are no obstacles between them.
Wireless network is not found.	Microwave ovens or other wireless devices in your neighborhood might disturb the wireless communication.	Turn off these devices.
	Access to the network is restricted by the firewall settings of the wireless router (access point).	Check the firewall setting of the wireless router (access point).
The unit does not detect the PC.	The media sharing setting is not correct.	Configure the sharing setting and select the unit as a device to which music contents are shared (p.72).
	Some security software installed on your PC is blocking the access of the unit to your PC.	Check the settings of security software installed on your PC.
	The unit and PC are not in the same network.	Check the network connections and your router settings, and then connect the unit and the PC to the same network.
	The MAC address filter is enabled on the unit.	In "MAC Address Filter" in the "Setup" menu, disable the MAC address filter or specify the MAC address of your PC to allow it to access to the unit (p.112).
The files in the PC cannot be viewed or played back.	The files are not supported by the unit or the media server.	Use the file format supported by both the unit and the media server. For information about the file formats supported by the unit, see "Playing back music stored on media servers (PCs/NAS)" (p.72).
The Internet radio cannot be played.	The selected Internet radio station is currently not available.	There may be a network problem at the radio station, or the service may have been stopped. Try the station later or select another station.
	The selected Internet radio station is currently broadcasting silence.	Some Internet radio stations broadcast silence at certain of times of the day. Try the station later or select another station.
	Access to the network is restricted by the firewall settings of your network devices (such as the router).	Check the firewall settings of your network devices. The Internet radio can be played only when it passes through the port designated by each radio station. The port number varies depending on the radio station.
The iPod does not recognize the unit when using AirPlay.	The unit is connected to a multiple SSID router.	Access to the unit might be restricted by the network separation function on the router. Connect the iPod to the SSID which can access the unit.

Problem	Cause	Remedy
The application for smartphone/tablet “AV CONTROLLER” does not detect the unit.	The unit and smartphone/tablet are not in the same network.	Check the network connections and your router settings, and then connect the unit and smartphone/tablet to the same network.
	The MAC address filter is enabled on the unit.	In “MAC Address Filter” in the “Setup” menu, disable the MAC address filter or specify the MAC address of your smartphone/tablet to allow it to access to the unit (p.112).
Firmware update via the network is failed.	It may not be possible depending on the condition of the network.	Update the firmware via the network again or use a USB memory device (p.122).

Error indications on the front display

Message	Cause	Remedy
Access denied	Access to the PC is denied.	Configure the sharing settings and select the unit as a device to which music contents are shared (p.72).
Access error	The unit cannot access the USB device.	Turn off the unit and reconnect your USB device. If the problem persists, try another USB device.
	The unit cannot access the iPod.	Turn off the iPod and turn it on again.
	The connected iPod is not supported by the unit.	Use an iPod supported by the unit (p.66).
	There is a problem with the signal path from the network to the unit.	Make sure your router and modem are turned on. Check the connection between the unit and your router (or hub) (p.31).
Check SP Wires	The speaker cables short circuit.	Twist the bare wires of the cables firmly and connect to the unit and speakers properly.
Internal Error	An internal error has occurred.	Contact the nearest authorized Yamaha dealer or service center.
No content	There are no playable files in the selected folder.	Select a folder that contains files supported by the unit.
No device	The unit cannot detect the USB device.	Turn off the unit and reconnect your USB device. If the problem persists, try another USB device.
	The unit cannot detect the iPod.	Turn off the iPod and then turn it on again.
Please wait	The unit is preparing for connecting to the network.	Wait until the message disappears. If the message stays more than 3 minutes, turn off the unit and turn it on again.
RemID Mismatch	The remote control IDs of the unit and the remote control are not identical.	Change the remote control ID of the unit or the remote control (p.120).
Unable to play	The unit cannot play back the songs stored on the iPod for some reason.	Check the song data. If it cannot be played on the iPod itself, the song data or storage area may be defective.
	The unit cannot play back the songs stored on the PC for some reason.	Check if the format of files you are trying to play is supported by the unit. For information about the formats supported by the unit, see "Playing back music stored on media servers (PCs/NAS)" (p.72). If the unit supports the file format, but still cannot play back any files, the network may be overloaded with heavy traffic.
USB Overloaded	An overcurrent is flowing through the USB device.	Turn off the unit and reconnect your USB device. If the problem persists, try another USB device.
Version error	Firmware update is failed.	Update the firmware again.

Ideal speaker layout

Use this diagram as a guide. You do not need to adjust the speaker layout to the following diagram exactly.

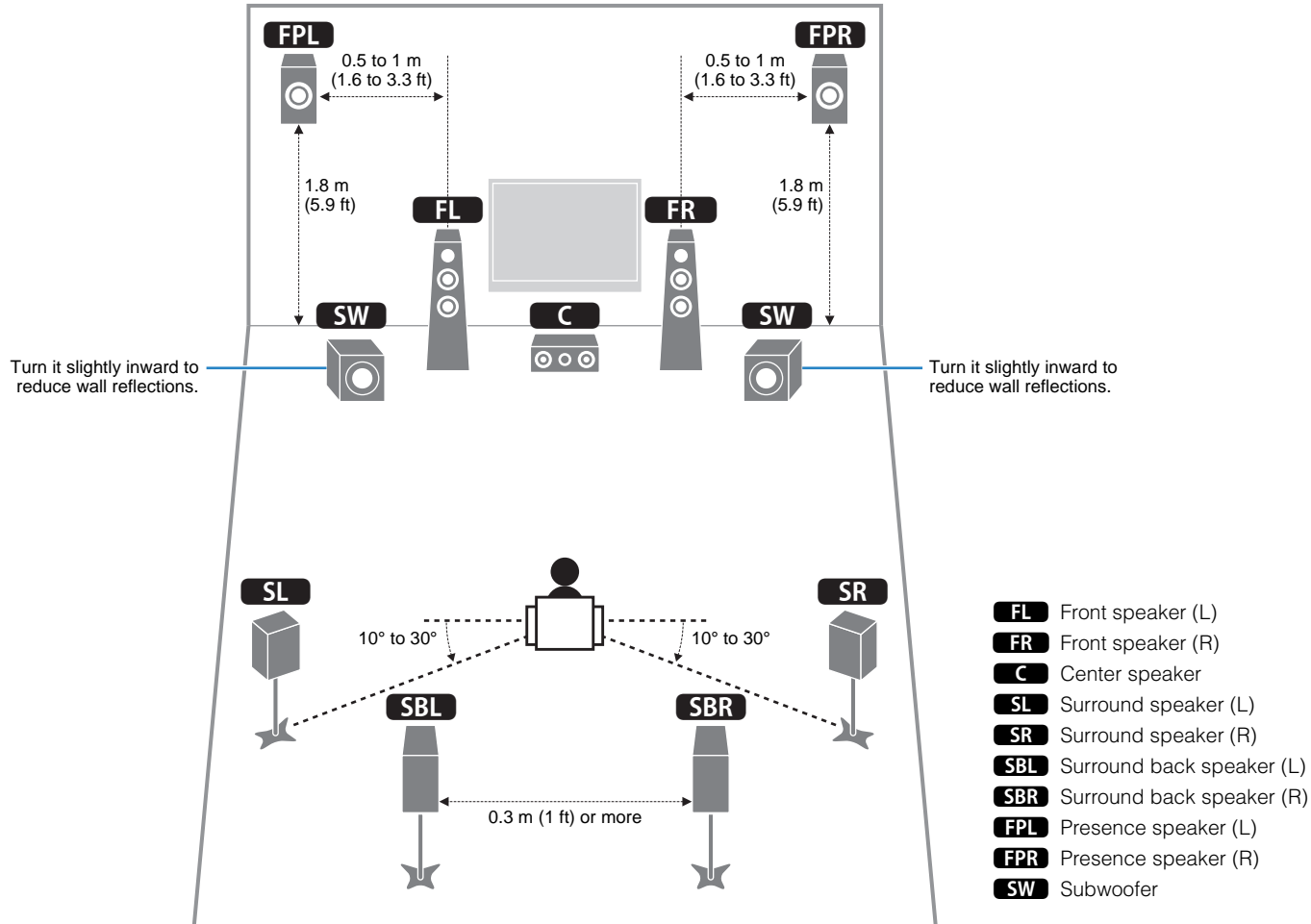

Audio information

■ Audio decoding format

Dolby Atmos (RX-A850 only)

Introduced first in the cinema, Dolby Atmos brings a revolutionary sense of dimension and immersion to the Home Theater experience. Dolby Atmos is an adaptable and scalable object based format that reproduces audio as independent sounds (or objects) that can be accurately positioned and move dynamically throughout the 3 dimensional listening space during playback. A key ingredient of Dolby Atmos is the introduction of a height plane of sound above the listener.

Dolby Atmos Stream (RX-A850 only)

Dolby Atmos content will be delivered to your Dolby Atmos enabled AV receiver via Dolby Digital Plus or Dolby TrueHD on Blu-ray Disc, downloadable files and streaming media. A Dolby Atmos stream contains special metadata that describes the positioning of sounds within the room. This object audio data is decoded by a Dolby Atmos AV receiver and scaled for optimum playback through Home Theater speaker systems of every size and configuration.

Dolby Digital

Dolby Digital is a compressed digital audio format developed by Dolby Laboratories, Inc. that supports 5.1-channel audio. This technology is used for audio on most DVD discs.

Dolby Digital EX

Dolby Digital EX creates total 6.1-channel audio from 5.1-channel sources that are recorded with Dolby Digital Surround EX. This decoder adds a surround back sound to the original 5.1-channel sound.

Dolby Digital Plus

Dolby Digital Plus is a compressed digital audio format developed by Dolby Laboratories, Inc. that supports 7.1-channel audio. Dolby Digital Plus remains fully compatible with the existing multichannel audio systems that support Dolby Digital. This technology is used for audio on BD (Blu-ray discs).

Dolby Enabled Speaker (RX-A850 only)

A convenient alternative to speakers built into the ceiling, products utilizing Dolby speaker technology employ the ceiling above you as a reflective surface for reproducing audio in the height plane above the listener. Dolby enabled speakers feature a unique upward firing driver and special signal processing that can be built into a conventional speaker, or a standalone speaker module, minimally impacting the overall speaker system footprint while providing an immersive listening experience during Dolby Atmos and Dolby surround playback.

Dolby Pro Logic II

Dolby Pro Logic II enables 5-channel playback from 2-channel sources. There are three modes available: "Music mode" for music sources, "Movie mode" for movie sources, and "Game mode" for game sources.

Dolby Pro Logic IIx

Dolby Pro Logic IIx enables 7-channel playback from 2-channel or multichannel sources. There are three modes available: "Music mode" for music sources, "Movie mode" for movie sources and "Game mode" for game sources (for 2-channel sources only).

Dolby Surround (RX-A850 only)

Dolby surround is a next generation surround technology that intelligently up mixes stereo; 5.1 and 7.1 content for playback through your surround speaker system. Dolby surround is compatible with traditional speaker layouts, as well as Dolby Atmos enabled playback systems that employ in-ceiling speakers or products with Dolby speaker technology.

Dolby TrueHD

Dolby TrueHD is an advanced lossless audio format developed by Dolby Laboratories, Inc. to offer a high-definition home theater experience with the quality of the studio master. Dolby TrueHD can carry up to eight channels of 96 kHz/24-bit audio (up to six channels of 192 kHz/24-bit audio) simultaneously. This technology is used for audio on BD (Blu-ray discs).

DSD (Direct Stream Digital)

DSD (Direct Stream Digital) technology stores audio signals on digital storage media, such as SACD (Super Audio CDs). The signals are stored at a high-frequency sampling rate (such as 2.8224 MHz and 5.6448 MHz). The highest frequency response is equal to or higher than 100 kHz, with a dynamic range of 120 dB. This technology offers better audio quality than that used for CDs.

DTS 96/24

DTS 96/24 is a compressed digital audio format that supports 5.1-channel and 96 kHz/24-bit audio. This format remains fully compatible with the existing multichannel audio systems that support DTS Digital Surround. This technology is used for music DVDs, etc.

DTS Digital Surround

DTS Digital Surround is a compressed digital audio format developed by DTS, Inc. that supports 5.1-channel audio. This technology is used for audio on most DVD discs.

DTS-ES

DTS-ES creates total 6.1-channel audio from 5.1-channel sources that are recorded with DTS-ES. This decoder adds a surround back sound to the original 5.1-channel sound. In the DTS-ES Matrix 6.1 format, a surround back sound is recorded in the surround channels, and in the DTS-ES Discrete 6.1 format, a discrete surround back channel is recorded.

DTS Express

DTS Express is a compressed digital audio format that supports 5.1-channel audio and allows a higher compression rate than the DTS Digital Surround format developed by DTS, Inc. This technology is developed for audio streaming services on the Internet and secondary audio on BD (Blu-ray discs).

DTS-HD High Resolution Audio

DTS-HD High Resolution Audio is a compressed digital audio format developed by DTS, Inc. that supports 7.1-channel and 96 kHz/24-bit audio. DTS-HD High Resolution Audio remains fully compatible with the existing multichannel audio systems that support DTS Digital Surround. This technology is used for audio on BD (Blu-ray discs).

DTS-HD Master Audio

DTS-HD Master Audio is an advanced lossless audio format developed to offer a high-definition home theater experience with the quality of the studio master by DTS, Inc. DTS-HD Master Audio can carry up to eight channels of 96 kHz/24-bit audio (up to six channels of 192 kHz/24-bit audio) simultaneously. This technology is used for audio on BD (Blu-ray discs).

DTS Neo:6

DTS Neo:6 enables 6-channel playback from 2-channel sources. There are two modes available: "Music mode" for music sources and "Cinema mode" for movie sources. This technology provides discrete full-bandwidth matrix channels of surround sound.

FLAC

FLAC is a file format for lossless audio data compression. FLAC is inferior to lossy compressed audio formats in compression rate but provides higher audio quality.

MP3

One of the compressed digital audio format used by MPEG. With psychoacoustic technologies, this compression method achieves a high compression rate. Reportedly, it is capable of compressing data quantity by about 1/10 maintaining a certain level of audio quality.

MPEG-4 AAC

An MPEG-4 audio standard. It is used for mobile telephones, portable audio players, and audio streaming services on Internet because it allows a high compression rate of data while maintaining better audio quality than MP3.

PCM (Pulse Code Modulation)

PCM is a signal format under which an analog audio signal is digitized, recorded, and transmitted. This technology is the basis of all other audio format. This technology is used as a lossless audio format called Linear PCM for audio on a variety of media, including CDs and BD (Blu-ray discs).

Sampling frequency/Quantization bit

Sampling frequency and quantization bits indicate the quantity of information when an analog audio signal is digitized. These values are noted as in the following example: "48 kHz/24-bit".

- Sampling frequency
Sampling frequency (the number of times the signal is sampled per second) is called the sampling rate. When the sampling frequency is higher, the range of frequencies that can be played back are wider.
- Quantization bit
The number of quantization bits indicate the degree of accuracy when converting the sound level into a numeric value. When the number of quantized bits is higher, the expression of the sound level is more accurate.

WAV

Windows standard audio file format, which defines the method of recording the digital data obtained by converting audio signals. By default, the PCM method (no compression) is used, but you can also use other compression methods.

WMA (Windows Media Audio)

One of the compressed digital audio formats developed by Microsoft Corporation. With psychoacoustic technologies, this compression method achieves a high compression rate. Reportedly, it is capable of compressing data quantity by about 1/20 maintaining a certain level of audio quality.

Others

Bi-amplification connection (Bi-amp)

A bi-amplification connection uses two amplifiers for a speaker. When you use the bi-amplification connection, the unit drives the tweeter and woofer in a speaker with the discrete amplifiers. As a consequence, the tweeter and woofer provide clear audio signal without the interference.

LFE (Low Frequency Effects) 0.1 channel

This channel reproduces low-frequency bass signals and has a frequency range from 20 Hz to 120 Hz. This channel is added to the channels for all bands with Dolby Digital or DTS to enhance low frequency audio effects. This channel is labeled 0.1 because it is limited to only low frequency audio.

Lip sync

Video output sometimes lags behind audio output due to the complexity of signal processing caused by an increase in video signal capacity. Lip sync is a technique for automatically correcting the timing lag between audio and video output.

HDMI and video information

Component video signal

With the component video signal system, the video signal is separated into the Y signal for luminance and the Pb and Pr signals for chrominance. Color can be reproduced more faithfully with this system because each of these signals is independent.

Composite video signal

With the composite video signal system, color, brightness, and synchronization data signals are combined and transmitted with a single cable.

Deep Color

Deep Color is a technology that HDMI specification supports. Deep Color increases the number of available colors within the boundaries defined by the RGB or YCbCr color space. Conventional color systems process the color using 8 bits. Deep Color processes the color with 10, 12, or 16 bits. This technology allows HDTVs and other displays to increase from millions of colors to billions of colors and eliminate on-screen color banding for smooth tonal transitions and subtle gradations between colors.

HDCP

HDCP (High-bandwidth Digital Content Protection) is a digital copy protection form that prevents copying of digital contents as it travels across connections (such as HDMI).

HDMI

HDMI (High-Definition Multimedia Interface) is the world-wide standard interface for digital audio/video signal transmission. This interface transmits both digital audio and digital video signals using a single cable without any loss. HDMI complies with HDCP (High-bandwidth Digital Content Protection) and provides a secure audio/video interface. For further information on HDMI, visit the HDMI website at "<http://www.hdmi.org/>".

x.v.Color

"x.v.Color" is a technology that the HDMI specification supports. It is a more extensive color space than sRGB and allows the expression of colors that were not hitherto possible. While remaining compatible with the color gamut of sRGB standards, "x.v.Color" expands the color space, and thus can produce more vivid, natural images.

Network information

SSID

SSID (Service Set Identifier) is a name that identifies a particular wireless LAN access point.

Wi-Fi

Wi-Fi (Wireless Fidelity) is a technology that allows an electronic device to exchange data or connect to the Internet wirelessly using radio waves. Wi-Fi offers the advantage of eliminating the complexity of making connections with network cables by using wireless connection. Only products that complete Wi-Fi Alliance interoperability tests can carry the "Wi-Fi Certified" trademark.

WPS

WPS (Wi-Fi Protected Setup) is a standard established by the Wi-Fi Alliance, which allows easy establishment of a wireless home network.

Yamaha technologies

CINEMA DSP (Digital Sound Field Processor)

Since the Dolby Surround and DTS systems were originally designed for use in movie theaters, their effect is best experienced in a theater that has many speakers designed for acoustic effects. Since home conditions (such as room size, wall material, and number of speakers) can differ so widely, it is inevitable that there are differences in the sound that you hear. Based on a wealth of actually measured data, CINEMA DSP, Yamaha's original DSP technology provides the audiovisual experience of a movie theater in your own home.

CINEMA DSP 3D

The actually measured sound field data contain the information of the height of the sound images. CINEMA DSP 3D mode achieves the reproduction of the accurate height of the sound images so that it creates the accurate and intensive 3D sound fields in a listening room.

Compressed Music Enhancer

The Compressed Music Enhancer feature compensates for missing harmonics in compression music formats (such as MP3). As a result, this technology provides improved performance for the overall sound system.

SILENT CINEMA

Yamaha has developed a natural, realistic sound effect DSP algorithm for headphones. Parameters for headphones have been set for each sound program, so that accurate representations of all the sound programs can be enjoyed on headphones.

Virtual CINEMA DSP

Virtual CINEMA DSP allows the system to virtually reproduce the sound field of the surround speakers with front left and right speakers. Even if the surround speakers are not connected, the unit creates the realistic sound field in a listening room.

Virtual CINEMA FRONT

Virtual CINEMA FRONT allows the system to virtually reproduce the sound field of the surround speakers with front surround speakers. Even if the surround speakers placed in the front, the unit creates the realistic sound field in a listening room.

Virtual Presence Speaker (VPS)

Virtual Presence Speaker allows the system to virtually reproduce the height of the 3D sound field without front presence speakers. Even if the front presence speakers are not connected, the unit creates the 3D sound field in your room.

Virtual Surround Back Speaker (VSBS)

Virtual Surround Back Speaker allows the system to virtually reproduce the sound field of the surround back speakers. Even if the surround back speakers are not connected, the unit adds a sense of depth to the rear sound field of CINEMA DSP.

Supported devices and file formats

Supported devices

Bluetooth device

- The unit supports *Bluetooth* devices that support A2DP or AVRCP.
- A *Bluetooth* device may not be detected by the unit or some feature may not be compatible, depending on the model.

USB devices

- The unit supports USB mass storage class devices (e.g., flash memories or portable audio players) using FAT16 or FAT32 format.
- Do not connect devices other than USB mass storage class devices (such as USB chargers or USB hubs), PCs, card readers, an external HDD, etc.
- USB devices with encryption cannot be used.
- Some features may not be compatible, depending on the model or manufacturer of the USB storage device.

iPod

Made for.

iPhone 6 Plus, iPhone 6, iPhone 5s, iPhone 5c, iPhone 5, iPhone 4s, iPhone 4, iPhone 3GS, iPhone 3G
iPod touch (2nd, 3rd, 4th and 5th generation)
iPod nano (2nd, 3rd, 4th, 5th, 6th and 7th generation)
(as of April 2015)

- An iPod may not be detected by the unit or some features may not be compatible, depending on the model or software version of the iPod.

AirPlay

AirPlay works with iPhone, iPad, and iPod touch with iOS 4.3.3 or later, Mac with OS X Mountain Lion or later, and Mac and PC with iTunes 10.2.2 or later.
(as of April 2015)

File formats

USB/PC (NAS)

File	Sampling frequency (kHz)	Quantization bitrate (bit)	Bitrate	The number of channels	Gapless playback
WAV *	32/44.1/48/88.2/96/176.4/192	16/24	—	2	✓
MP3	32/44.1/48	—	8 to 320	2	—
WMA	32/44.1/48	—	8 to 320	2	—
MPEG-4 AAC	32/44.1/48	—	8 to 320	2	—
FLAC	32/44.1/48/88.2/96/176.4/192	16/24	—	2	✓
ALAC	32/44.1/48/88.2/96	16/24	—	2	✓
AIFF	32/44.1/48/88.2/96/176.4/192	16/24	—	2	✓
DSD	2.8 MHz/5.6 MHz	1	—	2	—

* Linear PCM format only



- To play back FLAC files stored on a PC or NAS, you need to install server software that supports sharing of FLAC files via DLNA on your PC or use a NAS that supports FLAC files.
- Digital Rights Management (DRM) contents cannot be played back.

Video signal flow

Video signals input from a video device to the unit are output to a TV as shown below.

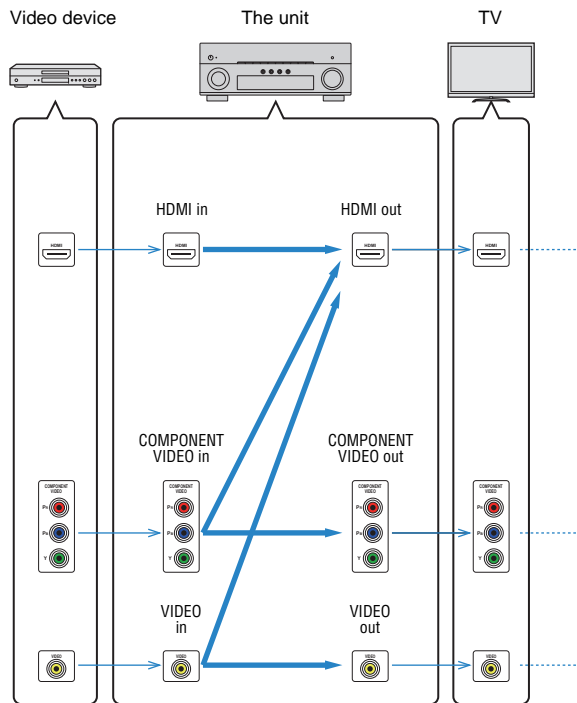

Video conversion table



- You can select the resolution and the aspect ratio applied to HDMI-output video processing in "Video Mode" (p.109) in the "Setup" menu.
- The unit does not convert 480-line and 576-line video signals interchangeably.

	Resolution	HDMI out						COMPONENT VIDEO out				VIDEO out	
		480i/576i	480p/576p	720p	1080i	1080p	4K	480i/576i	480p/576p	720p	1080i	480i/576i	
HDMI in	480i/576i	→	→	→	→	→	→						
	480p/576p		→	→	→	→	→						
	720p			→	→	→	→						
	1080i			→	→	→	→						
	1080p/50, 60 Hz			→	→	→	→						
	1080p/24 Hz					→	→						
	4K						→						
COMPONENT VIDEO in	480i/576i	→	→	→	→	→	→	→					
	480p/576p								→				
	720p									→			
	1080i										→		
VIDEO in	480i/576i	→	→	→	→	→	→						→

→ : Available

Information on HDMI

HDMI Control

HDMI Control allows you to operate external devices via HDMI. If you connect a TV that supports HDMI Control to the unit with an HDMI cable, you can control the unit (such as power and volume) with TV remote control operations. You can also control playback devices (such as HDMI Control-compatible BD/DVD players) connected to the unit with an HDMI cable.

For details on connections, see “Connecting a TV” (p.24) and “Connecting video devices (such as BD/DVD players)” (p.26).

Operations available from the TV's remote control

- Standby synchronization
- Volume control including mute
- Switching to input audio from the TV when the TV input is switched to its built-in tuner
- Switching to input video/audio from the selected playback device
- Switching between audio output devices (the unit or TV speaker)

(Example)

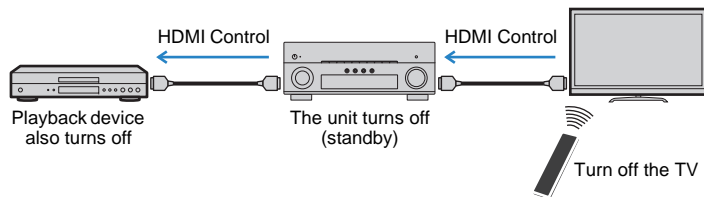

Operations available from the unit's remote control

- Starting playback on the playback device and turning on the TV with a scene selection (p.53)
- Switching the TV input to display the on-screen menu (when ON SCREEN is pressed)
- Controlling the playback device (playback and menu operations) using the external device operation keys

(Example)

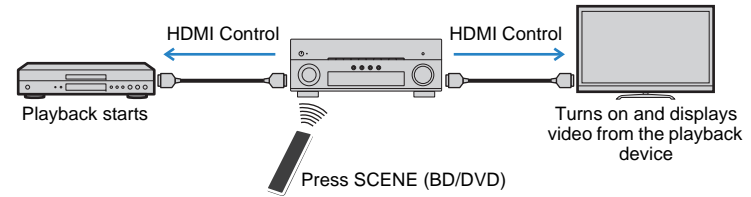

To use HDMI Control, you need to perform the following HDMI Control link setup after connecting the TV and playback devices.

For details on settings and operating your TV, refer to the instruction manual for the TV.



- This setup is required every time you add a new HDMI Control-compatible device to your system.

1 Turn on the unit, TV, and playback devices.

2 Configure the settings of the unit.

- ① Switch the TV input to display video from the unit.
- ② Press ON SCREEN.

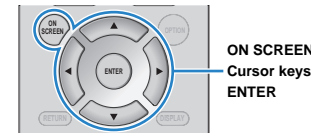

- ③ Use the cursor keys to select "Setup" and press ENTER.

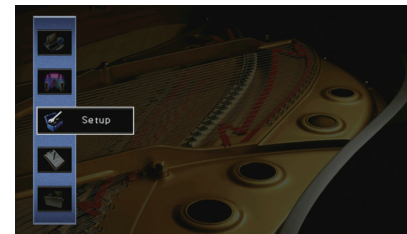

- ④ Use the cursor keys (</>) to select “HDMI”.



- ⑤ Use the cursor keys (△/▽) to select “HDMI Control” and press ENTER.
⑥ Use the cursor keys to select “On”.
⑦ Press ON SCREEN.

3 Enable HDMI Control on the TV and playback devices (such as HDMI Control-compatible BD/DVD players).

4 Turn off the main power of the TV and then turn off the unit and playback devices.

5 Turn on the unit and playback devices and then turn on the TV.

6 Switch the TV input to display the video from the unit.

7 Check the followings.

On the unit: The input to which the playback device is connected is selected.
If not, select the input source manually.

On the TV: The video from the playback device is displayed.

8 Check that the unit is properly synchronized with the TV by turning off the TV or adjusting the TV volume with the TV remote control.



- If HDMI Control does not work properly, try unplugging the TV in Step 2 and plugging in the TV again in Step 3. It may solve the problem. Also, HDMI Control may not work if the number of connected devices exceeds the limit. In this case, disable HDMI Control on the devices not in use.
- If the unit is not synchronized to the TV's power operations, check the priority of the audio output setting on the TV.
- We recommend using TV and playback devices from the same manufacturer so that HDMI Control works more effectively.
- We do not assure the operation of all HDMI Control-compatible devices.

Audio Return Channel (ARC)

ARC allows you to input TV audio to the unit with the HDMI cable which transmits video signal to the TV.

Check the following after the HDMI Control settings.

1 Select a TV program with the TV remote control.

2 Check that the input source of the unit will be automatically switched to “AV 4” and the TV audio will be played back on the unit.

If you cannot hear the TV audio, check the following:

- “ARC” (p.110) in the “Setup” menu is set to “On”.
- The HDMI cable is connected to the ARC-compatible HDMI jack (HDMI jack marked “ARC”) on the TV.

Some HDMI jack on the TV is not compatible with ARC. For details, refer to the instruction manual for the TV.



- If the audio is interrupted while using ARC, set “ARC” (p.110) in the “Setup” menu to “Off” and use a digital optical cable to input TV audio to the unit (p.26).
- When using ARC, connect a TV with an HDMI cable that supports ARC.



- “AV 4” is set as TV audio input at the factory. If you have connected any external device to the AV 4 jacks, use “TV Audio Input” (p.110) in the “Setup” menu to change the TV audio input assignment. To use the SCENE function (p.53), you also need to change the input assignment for SCENE (TV).

HDMI signal compatibility

Audio signals

Audio signal type	Audio signal format	Compatible media (example)
2ch Linear PCM	2ch, 32 to 192 kHz, 16/20/24 bit	CD, DVD-Video, DVD-Audio
Multichannel Linear PCM	8ch, 32 to 192 kHz, 16/20/24 bit	DVD-Audio, BD (Blu-ray disc), HD DVD
DSD	2 to 5.1ch, 2.8224 MHz, 1 bit	SACD
Bitstream	Dolby Digital, DTS	DVD-Video
Bitstream (High definition audio)	Dolby TrueHD, Dolby Digital Plus, DTS-HD Master Audio, DTS-HD High Resolution Audio, DTS Express	BD (Blu-ray disc), HD DVD

Video signals

The unit is compatible with the video signals of the following resolutions:

- VGA
- 480i/60 Hz
- 576i/50 Hz
- 480p/60 Hz
- 576p/50 Hz
- 720p/60 Hz, 50 Hz
- 1080i/60 Hz, 50 Hz
- 1080p/60 Hz, 50 Hz, 30 Hz, 25 Hz, 24 Hz
- 4K/60 Hz, 50Hz, 30 Hz, 25 Hz, 24 Hz



- When CPPM copy-protected DVD-Audio is played back, video/audio signals may not be output, depending on the type of the DVD player.
- The unit is not compatible with HDCP-incompatible HDMI or DVI devices. For details, refer to the instruction manual for each device.
- To decode audio bitstream signals on the unit, set the input source device appropriately so that the device outputs the bitstream audio signals directly (does not decode the bitstream signals on the playback device). For details, refer to the instruction manual for the playback device.

Dolby Atmos (RX-A850 only)

The unit supports the surround technology “Dolby Atmos”. By playing back Dolby Atmos contents on the unit, you can enjoy realistic sound from any direction including from overhead, bringing astounding clarity and power to home theaters, and providing a detailed and deep experience that’s just like real life.

The unit also supports Dolby Surround, which can create a real acoustic space (including overhead) even when a conventional content is played.

To get the most from Dolby Atmos contents, follow the procedure below to lay out the speakers and configure the settings.

■ Placing speakers

To play Dolby Atmos contents on the unit, use one of the following speaker systems. We recommend using two (front set) presence speakers in addition to the standard 5.1- or 7.1-channel speaker system.

Speaker type	Abbr.	Speaker system (the number of channels) (*1)		
		7.1	5.1.2	7.1.2
Front (L/R)	FL FR	●	●	●
Center	C	●	●	●
Surround (L/R)	SL SR	●	●	●
Surround back (L/R)	SBL SBR	●		●
Presence (L/R)	FPL FPR		●	●
Subwoofer (*2)	SW	●	●	●

*1 (About the number of channels) For example, “5.1.2” denotes “standard 5.1-channel plus 2 for overhead speaker channels”.

*2 You can use up to 2 subwoofers (subwoofer use is optional).

□ Presence speaker layout

The unit provides three layout patterns for presence speakers (Front Height, Overhead and Dolby Enabled SP). Choose a layout pattern that suits your listening environment.



- You can enjoy Dolby Atmos or Cinema DSP 3D with any layout pattern.

Front Height

Select this option when presence speakers are installed on the front side wall. It delivers a natural sound field with excellent linkage of left, right, top and bottom sound spaces, and sound extensity effectively.



Overhead

Select this option when presence speakers are installed to the ceiling above the listening position. It delivers realistic overhead sound effects and sound field with excellent linkage of front and rear sound spaces effectively.



- For details on the installation position of ceiling speakers, see “Notes on installation of ceiling speakers” (p.144).

Dolby Enabled SP

Select this option when using the Dolby Enabled speakers as the presence speakers. It utilizes sounds reflected from ceiling and lets you enjoy overhead sounds only from speakers that are placed at the same level as traditional speakers.



- Place the Dolby Enabled speakers on top of or near the traditional front speakers. A Dolby Enabled speaker unit may be integrated into a traditional speaker. For details, refer to the instruction manual of the Dolby Enabled speakers.

Configuring the settings for Dolby Atmos playback

After making necessary connections (such as speakers and a TV) (p.20 to 33), follow the procedure below to configure the settings required for playing back Dolby Atmos contents.

1 Turn on the unit and TV.

2 Configure the settings of the unit.

- ① Switch the TV input to display video from the unit.
- ② Press ON SCREEN.

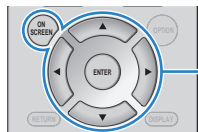

ON SCREEN
Cursor keys
ENTER

- ③ Use the cursor keys to select "Setup" and press ENTER.
- ④ Select "Speaker" → "Manual Setup" → "Configuration" and set "Front Presence" to "Large" or "Small".



- It makes no difference if you select "Large" or "Small". This setting will be automatically adjusted by YPAO.

- ⑤ Select "Layout" and set "Surround" to "Rear" (default).



- Virtual CINEMA FRONT (p.57) does not support playback of Dolby Atmos contents.

- ⑥ Select the presence speaker layout in "Front Presence".



- When using Dolby Enabled speakers, be sure to select "Dolby Enabled SP" before performing YPAO.

3 Perform YPAO to optimize the speaker settings automatically (p.35)

4 Press SUR.DECODE repeatedly to select "Surround" as the surround decoder (p.58).

This completes all the preparations. Enjoy Dolby Atmos contents with the unit.



- When "Object Decode Mode" (p.108) in the "Setup" menu is set to "Enable" (default), you can also enjoy Dolby Atmos contents with Dolby Atmos playback in the straight decode mode (p.58).



- To enjoy Dolby Atmos contents on the unit, set "Object Decode Mode" (p.108) in the "Setup" menu to "Enable" (default).
- Dolby Atmos contents will be reproduced in Dolby TrueHD, Dolby Digital Plus or multi-channel PCM format in the following situations.
 - Any sound program or a surround decoder other than the Dolby Surround decoder is selected.
 - Neither surround back nor presence speakers are used.
 - Headphones are used (2-channel playback).

■ Notes on installation of ceiling speakers

When installing presence speakers to a ceiling, install them just above the listening position, or the ceiling between the extensions of the front speakers and listening position.

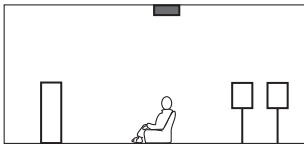
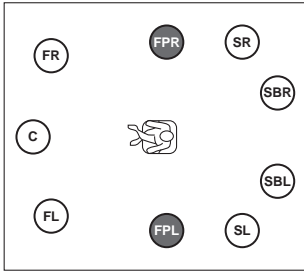

Caution

- Be sure to use speakers that are made for ceiling use and take anti-drop measures. Ask a qualified contractor or dealer personnel for installation works.

Reference diagram (rear panel)

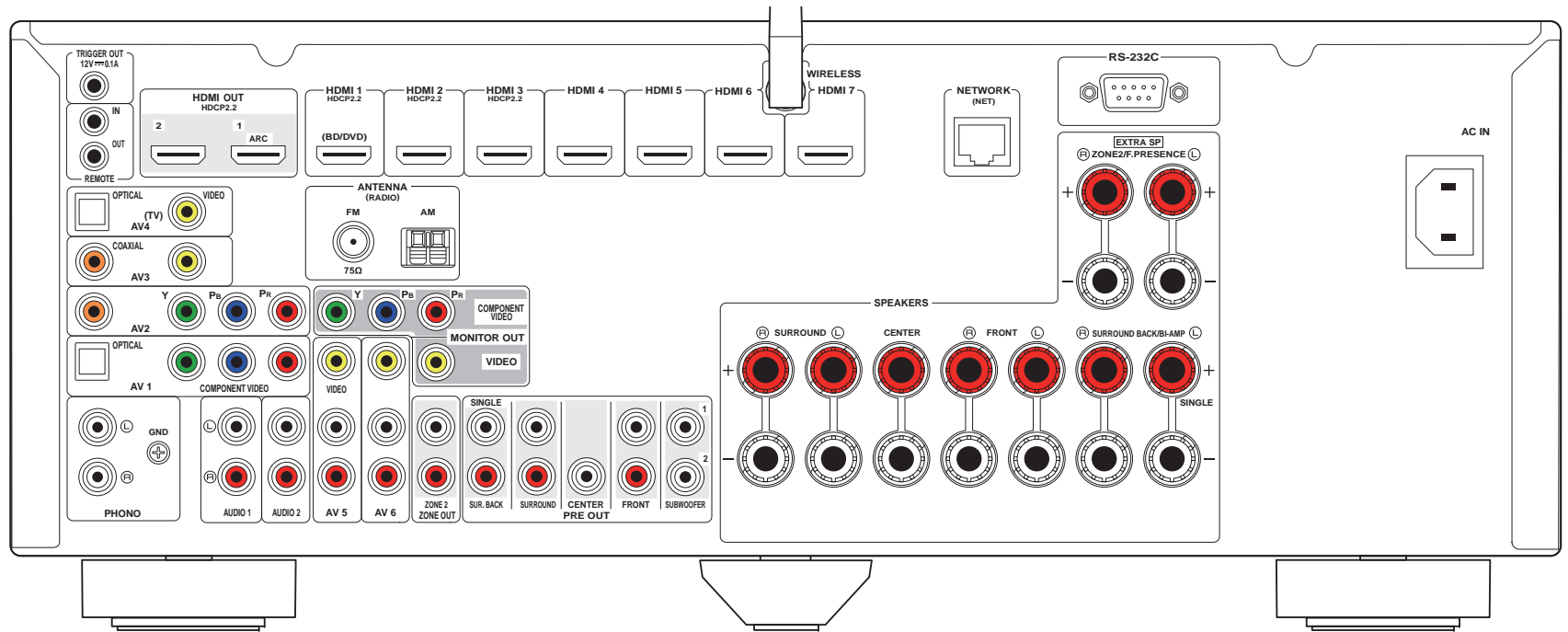

(RX-A850 U.S.A. model)



- The area around the video/audio output jacks is marked in white on the actual product to prevent improper connections.

Trademarks

[RX-A750]



[RX-A850]



Manufactured under license from Dolby Laboratories. Dolby, Dolby Atmos, Dolby Surround, Pro Logic, Surround EX and the double-D symbol are trademarks of Dolby Laboratories.



For DTS patents, see <http://patents.dts.com>. Manufactured under license from DTS Licensing Limited. DTS, DTS-HD, the Symbol, & DTS and the Symbol together are registered trademarks, and DTS-HD Master Audio is a trademark of DTS, Inc. © DTS, Inc. All Rights Reserved.



"Made for iPod" and "Made for iPhone" mean that an electronic accessory has been designed to connect specifically to iPod or iPhone, respectively, and has been certified by the developer to meet Apple performance standards.

Apple is not responsible for the operation of this device or its compliance with safety and regulatory standards.

Please note that the use of this accessory with iPod or iPhone may affect wireless performance.

iTunes, AirPlay, iPhone, iPod, iPod nano, iPod touch, and Safari are trademarks of Apple Inc., registered in the U.S. and other countries.

App Store is a service mark of Apple Inc.



The Bluetooth® word mark and logos are registered trademarks owned by Bluetooth SIG, Inc. and any use of such marks by Yamaha Corporation is under license.

Bluetooth protocol stack (Blue SDK)

Copyright 1999-2014 OpenSynergy GmbH

All rights reserved. All unpublished rights reserved.



This receiver supports network connections.



HDMI, the HDMI Logo, and High-Definition Multimedia Interface are trademarks or registered trademarks of HDMI Licensing LLC in the United States and other countries.

x.v.Color™

"x.v.Color" is a trademark of Sony Corporation.



DLNA™ and DLNA CERTIFIED™ are trademarks or registered trademarks of Digital Living Network Alliance. All rights reserved. Unauthorized use is strictly prohibited.

Windows™

Windows is a registered trademark of Microsoft Corporation in the United States and other countries.

Internet Explorer, Windows Media Audio and Windows Media Player are either registered trademarks or trademarks of Microsoft Corporation in the United States and/or other countries.

Android™ Google Play™

Android and Google Play are trademarks of Google Inc.

Blu-ray is a trademark of the Blu-ray Disc Association.



The Wi-Fi CERTIFIED Logo is a certification mark of the Wi-Fi Alliance.

The Wi-Fi Protected Setup Identifier Mark is a mark of the Wi-Fi Alliance.

SILENT™ CINEMA

"SILENT CINEMA" is a trademark of Yamaha Corporation.

Google Noto Fonts

Copyright © 2012 Google Inc. All rights reserved.

Licensed under the Apache License, Version 2.0 (the "License"); you may not use this file except in compliance with the License.

You may obtain a copy of the License at

<http://www.apache.org/licenses/LICENSE-2.0>

Unless required by applicable law or agreed to in writing, software distributed under the License is distributed on an "AS IS" BASIS, WITHOUT WARRANTIES OR CONDITIONS OF ANY KIND, either express or implied.

See the License for the specific language governing permissions and limitations under the License.

Explanations regarding GPL

This product utilizes GPL/LGPL open-source software in some sections. You have the right to obtain, duplicate, modify, and redistribute this open-source code only. For information on GPL/LGPL open source software, how to obtain it, and the GPL/LGPL license, refer to the Yamaha Corporation website (<http://download.yamaha.com/sourcecodes/musiccast/>).

Specifications

Input jacks

- Analog Audio
[RX-A850]
Audio x 6 (AV 5–6, AUDIO 1–2, PHONO, V-AUX)
[RX-A750]
Audio x 4 (AV 5–6, AUDIO 1–2)
- Digital Audio (Supported frequencies: 32 kHz to 96 kHz)
Optical x 2 (AV 1, AV 4)
Coaxial x 2 (AV 2–3)
- Video
[RX-A850]
Composite x 5 (AV 3–6, V-AUX)
Component x 2 (AV 1–2)
[RX-A750]
Composite x 4 (AV 3–6)
Component x 2 (AV 1–2)
- HDMI Input
[RX-A850]
HDMI x 8 (HDMI 1–7, V-AUX)
[RX-A750]
HDMI x 6 (HDMI 1–5, V-AUX)
- Other
USB x 1 (USB2.0)
NETWORK x 1 (100Base-TX/10Base-T)

Output jacks

- Analog Audio
[RX-A850]
 - Speaker Out x 9 (7 ch) (FRONT L/R, CENTER, SURROUND L/R, SURROUND BACK L/R^{*1}, EXTRA SP L/R^{*2})
^{*1} Note: Assignment is possible [SURROUND BACK, BI-AMP (FRONT L/R)]
 - ^{*2} Note: Assignment is possible [ZONE2, PRESENCE]
 - Pre Out x 7 (FRONT L/R, CENTER, SURROUND L/R, SURROUND BACK L/R)
 - Subwoofer Out x 2 (SUBWOOFER 1–2, mono)
 - ZONE2 OUT x 1
 - Headphone x 1
[RX-A750]
 - Speaker Out x 9 (7 ch) (FRONT L/R, CENTER, SURROUND L/R, SURROUND BACK L/R^{*1}, EXTRA SP L/R^{*2})
^{*1} Note: Assignment is possible [SURROUND BACK, BI-AMP (FRONT L/R)]
 - ^{*2} Note: Assignment is possible [ZONE2, PRESENCE]
 - Subwoofer Out x 2 (SUBWOOFER 1–2, mono)
 - ZONE2 OUT x 1
 - Headphone x 1
- Video
MONITOR OUT
 - Component x 1
 - Composite x 1
 - HDMI Output
[RX-A850]
HDMI OUT x 2 (HDMI OUT 1–2)
[RX-A750]
HDMI OUT x 1

Other jacks

- YPAO MIC x 1
- REMOTE IN x 1
- REMOTE OUT x 1
- TRIGGER OUT x 1
- RS-232C x 1 [RX-A850 only]

HDMI

- HDMI features: Deep Color, "x.v.Color," Auto Lip Sync, ARC (Audio Return Channel), 3D, 4K Ultra HD
- Video Format (Repeater Mode)
 - VGA
 - 480i/60 Hz
 - 576i/50 Hz
 - 480p/60 Hz
 - 576p/50 Hz
 - 720p/60 Hz, 50 Hz
 - 1080i/60 Hz, 50 Hz
 - 1080p/60 Hz, 50 Hz, 30 Hz, 25 Hz, 24 Hz
 - 4K/60 Hz, 50Hz, 30 Hz, 25 Hz, 24 Hz
- Audio Format
 - Dolby Atmos
 - Dolby TrueHD
 - Dolby Digital Plus
 - Dolby Digital
 - DTS-HD Master Audio
 - DTS-HD High Resolution Audio
 - DTS Express
 - DTS
 - DSD 2-ch to 6-ch
 - PCM 2-ch to 8-ch (Max. 192 kHz/24-bit)
- Content Protection: HDCP compatible (HDMI 1–3: HDCP 2.2 compatible)
- Link Function: CEC supported

TUNER

- Analog Tuner
[U.K. and Europe models]
FM/AM with Radio Data System x 1 (TUNER)
[Other models]
FM/AM x 1 (TUNER)

USB

- Capable of iPod, Mass Storage Class USB Memory
- Current Supply Capacity: 1 A

Bluetooth

- Sink Function
Source Device to AVR (ex. Smartphone/Tablet)
- Capable of Play/Stop Operation from Sink Device
- Bluetooth Version..... Ver. 2.1+EDR
- Supported Profile..... A2DP, AVRCP
- Supported Codec..... SBC, AAC
- Wireless Output Bluetooth Class 2
- Maximum Communication Distance..... 10 m (33 ft)

Network

- PC Client Function
- Compatible with DLNA ver. 1.5
- AirPlay supported
- Internet Radio
- WiFi function
 - Capable of WPS by PIN Method and Push-Button-Method
 - Capable of sharing with iOS devices by wireless connection and USB connection
 - Capable of Direct Connection with Mobile Device
 - Available Security Method: WEP, WPA2-PSK (AES), Mixed Mode
 - Radio Frequency Band: 2.4GHz
 - Wireless Network Standard: IEEE 802.11 b/g/n

Compatible Decoding Formats

- Decoding Format
[RX-A850]
 - Dolby Atmos
 - Dolby TrueHD, Dolby Digital Plus
 - Dolby Digital, Dolby Digital EX
 - DTS-HD Master Audio, DTS-HD High Resolution Audio, DTS Express
 - DTS 96/24, DTS-ES Matrix 6.1, DTS-ES Discrete 6.1
 - DTS Digital Surround
[RX-A750]
 - Dolby TrueHD, Dolby Digital Plus
 - Dolby Digital, Dolby Digital EX
 - DTS-HD Master Audio, DTS-HD High Resolution Audio, DTS Express
 - DTS 96/24, DTS-ES Matrix 6.1, DTS-ES Discrete 6.1
 - DTS Digital Surround
- Post Decoding Format
[RX-A850]
 - Dolby Pro Logic
 - Dolby Pro Logic II Music, Dolby Pro Logic II Movie, Dolby Pro Logic II Game
 - Dolby Pro Logic IIx Music, Dolby Pro Logic IIx Movie, Dolby Pro Logic IIx Game
 - Dolby Surround
 - DTS Neo:6 Music, DTS Neo:6 Cinema
[RX-A750]
 - Dolby Pro Logic
 - Dolby Pro Logic II Music, Dolby Pro Logic II Movie, Dolby Pro Logic II Game
 - Dolby Pro Logic IIx Music, Dolby Pro Logic IIx Movie, Dolby Pro Logic IIx Game
 - DTS Neo:6 Music, DTS Neo:6 Cinema

Audio Section

- Rated Output Power (2-channel driven)
[RX-A850]
(20 Hz to 20 kHz, 0.06% THD, 8 Ω)
Front L/R..... 100 W+100 W
(1 kHz, 0.9% THD, 8 Ω)
[U.S.A. and Canada models]
Front L/R..... 110 W+110 W
Center 110 W
Surround L/R 110 W+110 W
Surround Back L/R..... 110 W+110 W
[RX-A750]
(20 Hz to 20 kHz, 0.06% THD, 8 Ω)
Front L/R..... 90 W+90 W
(1 kHz, 0.9% THD, 8 Ω)
[U.S.A. and Canada models]
Front L/R..... 105 W+105 W
Center 105 W
Surround L/R 105 W+105 W
Surround Back L/R..... 105 W+105 W
- Rated Output Power (1-channel driven)
[RX-A850]
(1 kHz, 0.9% THD, 8 Ω)
Front L/R..... 130 W/ch
Center 130 W/ch
Surround L/R 130 W/ch
Surround Back L/R..... 130 W/ch
(1 kHz, 0.9% THD, 4 Ω)
Front L/R [U.K. and Europe models]..... 160 W/ch
[RX-A750]
(1 kHz, 0.9% THD, 8 Ω)
Front L/R..... 125 W/ch
Center 125 W/ch
Surround L/R 125 W/ch
Surround Back L/R..... 125 W/ch
(1 kHz, 0.9% THD, 4 Ω)
Front L/R [U.K. and Europe models]..... 150 W/ch

- Maximum Effective Output Power (JEITA, 1 kHz, 10% THD, 8 Ω)
[RX-A850]
[China, Korea, Asia and General models]
Front L/R 160 W/ch
Center 160 W/ch
Surround L/R 160 W/ch
Surround Back L/R 160 W/ch
[RX-A750]
[Asia model]
Front L/R 150 W/ch
Center 150 W/ch
Surround L/R 150 W/ch
Surround Back L/R 150 W/ch
- Dynamic Power (IHF)
[RX-A850]
Front L/R (8/6/4/2 Ω) 130/170/195/240 W
[RX-A750]
Front L/R (8/6/4/2 Ω) 125/165/190/235 W
- Damping Factor
Front L/R, 20 Hz to 20 kHz, 8 Ω 100 or more
- Input Sensitivity / Input Impedance
[RX-A850]
PHONO (1 kHz, 100 W/8 Ω) 3.5 mV/47 kΩ
AV 5 etc. (1 kHz, 100 W/8 Ω) 200 mV/47 kΩ
[RX-A750]
AV 5 etc. (1 kHz, 100 W/8 Ω) 200 mV/47 kΩ
- Maximum Input Signal
[RX-A850]
PHONO (1 kHz, 0.1% THD) 60 mV
AV 5 etc. (1 kHz, 0.5% THD, Effect On) 2.3 V
[RX-A750]
AV 5 etc. (1 kHz, 0.5% THD, Effect On) 2.3 V

- Output Level / Output Impedance
[RX-A850]
PRE OUT 1 V/1.2 kΩ
SUBWOOFER 1 V/1.2 kΩ
ZONE2 OUT 200 mV/1.2 kΩ
[RX-A750]
SUBWOOFER 1 V/1.2 kΩ
ZONE2 OUT 200 mV/1.2 kΩ
- Headphone Impedance 16 Ω or more
- Frequency Response
AV 5 etc. to Front (10 Hz to 100 kHz) +0/-3 dB
- RIAA Equalization Deviation
[RX-A850]
PHONO 0±0.5 dB
- Total Harmonic Distortion
[RX-A850]
PHONO to Speaker Out (FRONT) (20 Hz to 20 kHz, 1 V)
..... 0.02% or less
AV 5 etc. to Front (Pure Direct)
(20 Hz to 20 kHz, 50 W, 8 Ω) 0.06% or less
[RX-A750]
AV 5 etc. to Front (Pure Direct)
(20 Hz to 20 kHz, 50 W, 8 Ω) 0.06% or less
- Signal to Noise Ratio (IHF-A Network)
[RX-A850]
PHONO (Input Shorted 35 mV, Speaker Out [FRONT])
..... 96 dB or more
AV 5 etc. (Pure Direct) (Input 1 kΩ Shorted, Speaker Out)
..... 110 dB or more
[RX-A750]
AV 5 etc. (Pure Direct) (Input 1 kΩ Shorted, Speaker Out)
..... 110 dB or more
- Residual Noise (IHF-A Network)
Front L/R (Speaker Out) 150 μV or less

- Channel Separation
[RX-A850]
PHONO (Input Shorted, 1 kHz/10 kHz) ...60 dB/55 dB or more
AV 5 etc. (Input 1 kΩ Shorted, 1 kHz/10 kHz)
..... 70 dB/50 dB or more
[RX-A750]
AV 5 etc. (Input 1 kΩ Shorted, 1 kHz/10 kHz)
..... 70 dB/50 dB or more
- Volume Control
Range MUTE, -80 dB to +16.5 dB
Step 0.5 dB
- Tone Control Characteristics
Bass Boost/Cut ±6 dB/0.5 dB Step at 50 Hz
Bass Turnover 350 Hz
Treble Boost/Cut ±6 dB/0.5 dB Step at 20 kHz
Treble Turnover 3.5 kHz
- Filter Characteristics
(fc=40/60/80/90/100/110/120/160/200 Hz)
H.P.F. (Front, Center, Surround, Surround Back) 12 dB/oct.
L.P.F. (Subwoofer) 24 dB/oct.

Video Section

- Video Signal Type NTSC/PAL/SECAM
- Video Signal Level
Composite 1 Vp-p/75 Ω
Component
Y 1 Vp-p/75 Ω
Pb/Pr 0.7 Vp-p/75 Ω
- Video Maximum Input Level 1.5 Vp-p or more
- Video Signal to Noise Ratio 50 dB or more
- Monitor Out Frequency Response
Component 5 Hz to 60 MHz, -3 dB

FM Section

- Tuning Range
[U.S.A. and Canada models] 87.5 MHz to 107.9 MHz
[Asia and General models]
..... 87.5/87.50 MHz to 108.0/108.00 MHz
[Other models]..... 87.50 MHz to 108.00 MHz
- 50 dB Quiet Sensitivity (IHF, 1 kHz, 100% MOD.)
Mono..... 3 μ V (20.8 dBf)
- Signal to Noise Ratio (IHF)
Mono..... 65 dB
Stereo 64 dB
- Harmonic Distortion (IHF, 1 kHz)
Mono..... 0.5%
Stereo 0.6%
- Antenna Input 75 Ω unbalanced

AM section

- Tuning Range
[U.S.A. and Canada models] 530 kHz to 1710 kHz
[Asia and General models]..... 530/531 kHz to 1710/1611 kHz
[Other models]..... 531 kHz to 1611 kHz

General

- Power Supply
[U.S.A. and Canada models] AC 120 V, 60 Hz
[General model]..... AC 110 to 120/220 to 240 V, 50/60 Hz
[China model] AC 220 V, 50 Hz
[Korea model] AC 220 V, 60 Hz
[Australia model] AC 240 V, 50 Hz
[U.K. and Europe models] AC 230 V, 50 Hz
[Asia model] AC 220 to 240 V, 50/60 Hz
- Power Consumption
[U.S.A. and Canada models] 400 W
[China, Asia and General models] 270 W
[Other models]..... 300 W

- Standby Power Consumption
HDMI Control Off, Standby Through Off 0.1 W
HDMI Control On, Standby Through On (No Signals)..... 1.3 W
Network Standby On
Wired 2.4 W
Wi-Fi 2.4 W
Wireless Direct 2.5 W
Bluetooth Standby On 2.3 W
HDMI Control On, Standby Through On (No Signals),
Network Standby On (Wireless Direct)..... 3.1 W
- Maximum Power Consumption
[Asia and General models] 590 W
- Dimensions (W x H x D)
[RX-A850]
[China, U.K. and Europe models]
..... 435 x 171 x 382 mm (17-1/8" x 6-3/4" x 15")
[Other models]
..... 435 x 171 x 380 mm (17-1/8" x 6-3/4" x 15")
[RX-A750] 435 x 171 x 380 mm (17-1/8" x 6-3/4" x 15")
* Including legs and protrusions
- Reference Dimensions (W x H x D) (with wireless antenna upright)
[RX-A850]
[China, U.K. and Europe models]
..... 435 x 234 x 382 mm (17-1/8" x 9-1/4" x 15")
[Other models]
..... 435 x 234 x 380 mm (17-1/8" x 9-1/4" x 15")
[RX-A750] 435 x 234 x 380 mm (17-1/8" x 9-1/4" x 15")
* Including legs and protrusions
- Weight
[RX-A850] 10.6 kg (23.4 lbs)
[RX-A750] 10.5 kg (23.2 lbs)

* Specifications are subject to change without notice.

Index

Symbols

- Exclamation mark (!) 119, 123
- Lock icon (🔒) 116

Numerics

- 2.1-channel system 19
- 2ch Stereo 56
- 4K Ultra HD 141
- 5.1-channel system 18
- 7.1-channel system 17, 20, 21

A

- Adaptive DRC 91
- ADVANCED SETUP 119
- AirPlay 79
- AM radio 60
- ARC (Audio Return Channel) 140
- Audio Decoder (front display information) 89
- Auto Power Standby 116
- Auto Preset (FM radio) 64

B

- Banana plug 21
- Bluetooth 65
- bookmark 78

C

- CINEMA DSP 55
- Compressed Music Enhancer 59
- Crossover frequency setting (subwoofer) 35

D

- Decoder Off (front display information) 89
- Dialogue 91, 118
- Dimmer 115
- DLNA 72
- DMC (Digital Media Controller) 95
- Dolby Atmos 58, 108, 142
- DSP Program (front display information) 89

E

- ECO 116
- Error indication (front display) 132
- External power amplifier 32
- Extra Bass 92

F

- Firmware update 122, 123
- FM radio 60
- Frequency step setting 60, 120
- Front display information 89

H

- HDCP 26, 128, 136
- HDMI output selection 52
- HDMI signal compatibility 141

I

- Initial Volume 108, 114
- Input (front display information) 89
- Input Trim 92
- Internet radio 76
- iPod content playback 66

M

- MAC Address Filter 112
- Max Volume 107, 114
- Memory Guard 116
- Multiple room playback 81
- MUTE 52, 84

N

- NAS content playback 72
- Network Connection 111
- Network information 118
- Network Name 113
- Network Standby 112

O

- Option menu 90

P

- Parametric EQ 105
- Party mode 85
- Power Amp Assign 103
- Preset station selection (FM/AM radio) 62
- Pure Direct 59

R

- Radio Data System tuning 62
- Remote control 14
- Remote ID 120
- Rename 94, 97, 113
- Repeat 68, 71, 75

S

- SCENE function 53
- Selecting an on-screen menu language 34
- Setup menu 100
- Short Message 115
- Shuffle 68, 71, 75
- Signal information 118
- Sleep timer 14
- Sound program 55, 56
- Speaker impedance 16
- Standby Through 111
- Straight decode 58
- Subwoofer Trim 92
- Surround decoder 58

T

- Test Tone 106
- Tone Control 91
- Trigger function 32

U

- USB storage device content playback 69

V

- Video/audio input jack combination 27

Virtual CINEMA FRONT 57
Virtual Surround Back Speaker (VSBS) 108

W

Wallpaper 115
Web control 86
Wireless (Wi-Fi) 44, 111
Wireless Direct 50, 111
WPS 46

Y

YPAO
(Yamaha Parametric room Acoustic Optimizer) 35
YPAO Volume 91

Z

Zone2 81, 114



YAMAHA CORPORATION

© 2015 Yamaha Corporation YH006A0/EN