



# *RX-V365*

---

*AV Receiver*

OWNER'S MANUAL

# IMPORTANT SAFETY INSTRUCTIONS

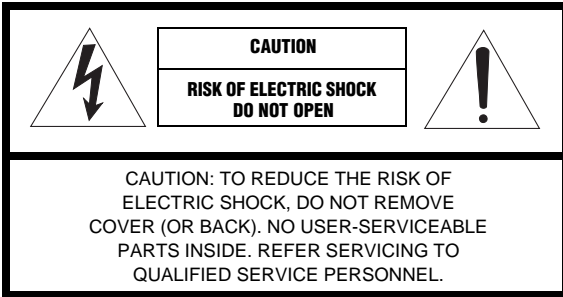

## • Explanation of Graphical Symbols



The lightning flash with arrowhead symbol, within an equilateral triangle, is intended to alert you to the presence of uninsulated "dangerous voltage" within the product's enclosure that may be of sufficient magnitude to constitute a risk of electric shock to persons.



The exclamation point within an equilateral triangle is intended to alert you to the presence of important operating and maintenance (servicing) instructions in the literature accompanying the appliance.

- 1 Read Instructions – All the safety and operating instructions should be read before the product is operated.
- 2 Retain Instructions – The safety and operating instructions should be retained for future reference.
- 3 Heed Warnings – All warnings on the product and in the operating instructions should be adhered to.
- 4 Follow Instructions – All operating and use instructions should be followed.
- 5 Cleaning – Unplug this product from the wall outlet before cleaning. Do not use liquid cleaners or aerosol cleaners.
- 6 Attachments – Do not use attachments not recommended by the product manufacturer as they may cause hazards.
- 7 Water and Moisture – Do not use this product near water – for example, near a bath tub, wash bowl, kitchen sink, or laundry tub; in a wet basement; or near a swimming pool; and the like.
- 8 Accessories – Do not place this product on an unstable cart, stand, tripod, bracket, or table. The product may fall, causing serious injury to a child or adult, and serious damage to the product. Use only with a cart, stand, tripod, bracket, or table recommended by the manufacturer, or sold with the product. Any mounting of the product should follow the manufacturer's instructions, and should use a mounting accessory recommended by the manufacturer.
- 9 A product and cart combination should be moved with care. Quick stops, excessive force, and uneven surfaces may cause the product and cart combination to overturn.
- 10 Ventilation – Slots and openings in the cabinet are provided for ventilation and to ensure reliable operation of the product and to protect it from overheating, and these openings must not be blocked or covered. The openings should never be blocked by placing the product on a bed, sofa, rug, or other similar surface. This product should not be placed in a built-in installation such as a bookcase or rack unless proper ventilation is provided or the manufacturer's instructions have been adhered to.
- 11 Power Sources – This product should be operated only from the type of power source indicated on the marking label. If you are not sure of the type of power supply to your home, consult your product dealer or local power company. For products intended to operate from battery power, or other sources, refer to the operating instructions.
- 12 Grounding or Polarization – This product may be equipped with a polarized alternating current line plug (a plug having one blade wider than the other). This plug will fit into the power outlet only one way. This is a safety feature. If you are unable to insert the plug fully into the outlet, try reversing the plug. If the plug should still fail to fit, contact your electrician to replace your obsolete outlet. Do not defeat the safety purpose of the polarized plug.
- 13 Power-Cord Protection – Power-supply cords should be routed so that they are not likely to be walked on or pinched by items placed upon or against them, paying particular attention to cords at plugs, convenience receptacles, and the point where they exit from the product.
- 14 Lightning – For added protection for this product during a lightning storm, or when it is left unattended and unused for long periods of time, unplug it from the wall outlet and disconnect the antenna or cable system. This will prevent damage to the product due to lightning and power-line surges.
- 15 Power Lines – An outside antenna system should not be located in the vicinity of overhead power lines or other electric light or power circuits, or where it can fall into such power lines or circuits. When installing an outside antenna system, extreme care should be taken to keep from touching such power lines or circuits as contact with them might be fatal.
- 16 Overloading – Do not overload wall outlets, extension cords, or integral convenience receptacles as this can result in a risk of fire or electric shock.
- 17 Object and Liquid Entry – Never push objects of any kind into this product through openings as they may touch dangerous voltage points or short-out parts that could result in a fire or electric shock. Never spill liquid of any kind on the product.
- 18 Servicing – Do not attempt to service this product yourself as opening or removing covers may expose you to dangerous voltage or other hazards. Refer all servicing to qualified service personnel.
- 19 Damage Requiring Service – Unplug this product from the wall outlet and refer servicing to qualified service personnel under the following conditions:
  - a) When the power-supply cord or plug is damaged,
  - b) If liquid has been spilled, or objects have fallen into the product,
  - c) If the product has been exposed to rain or water,



- d) If the product does not operate normally by following the operating instructions. Adjust only those controls that are covered by the operating instructions as an improper adjustment of other controls may result in damage and will often require extensive work by a qualified technician to restore the product to its normal operation,
  - e) If the product has been dropped or damaged in any way, and
  - f) When the product exhibits a distinct change in performance - this indicates a need for service.
- 20 Replacement Parts** – When replacement parts are required, be sure the service technician has used replacement parts specified by the manufacturer or have the same characteristics as the original part. Unauthorized substitutions may result in fire, electric shock, or other hazards.
- 21 Safety Check** – Upon completion of any service or repairs to this product, ask the service technician to perform safety checks to determine that the product is in proper operating condition.
- 22 Wall or Ceiling Mounting** – The unit should be mounted to a wall or ceiling only as recommended by the manufacturer.
- 23 Heat** – The product should be situated away from heat sources such as radiators, heat registers, stoves, or other products (including amplifiers) that produce heat.

**24 Outdoor Antenna Grounding** – If an outside antenna or cable system is connected to the product, be sure the antenna or cable system is grounded so as to provide some protection against voltage surges and built-up static charges. Article 810 of the National Electrical Code, ANSI/NFPA 70, provides information with regard to proper grounding of the mast and supporting structure, grounding of the lead-in wire to an antenna discharge unit, size of grounding conductors, location of antenna discharge unit, connection to grounding electrodes, and requirements for the grounding electrode.

EXAMPLE OF ANTENNA GROUNDING

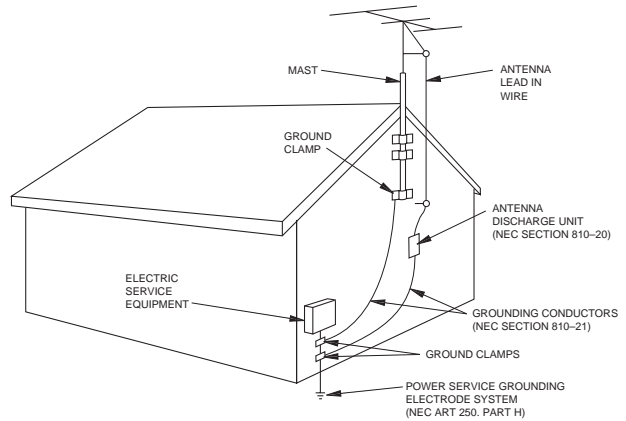

NEC – NATIONAL ELECTRICAL CODE

**Note to CATV system installer:**

This reminder is provided to call the CATV system installer’s attention to Article 820-40 of the NEC that provides guidelines for proper grounding and, in particular, specifies that the cable ground shall be connected to the grounding system of the building, as close to the point of cable entry as practical.

**FCC INFORMATION (for US customers)**

**1 IMPORTANT NOTICE: DO NOT MODIFY THIS UNIT!**

This product, when installed as indicated in the instructions contained in this manual, meets FCC requirements. Modifications not expressly approved by Yamaha may void your authority, granted by the FCC, to use the product.

**2 IMPORTANT:** When connecting this product to accessories and/or another product use only high quality shielded cables. Cable/s supplied with this product **MUST** be used. Follow all installation instructions. Failure to follow instructions could void your FCC authorization to use this product in the USA.

**3 NOTE:** This product has been tested and found to comply with the requirements listed in FCC Regulations, Part 15 for Class “B” digital devices. Compliance with these requirements provides a reasonable level of assurance that your use of this product in a residential environment will not result in harmful interference with other electronic devices.

This equipment generates/uses radio frequencies and, if not installed and used according to the instructions found in the users manual, may cause interference harmful to the operation of other electronic devices.

Compliance with FCC regulations does not guarantee that interference will not occur in all installations. If this product is found to be the source of interference, which can be determined by turning the unit “OFF” and “ON”, please try to eliminate the problem by using one of the following measures:

Relocate either this product or the device that is being affected by the interference.

Utilize power outlets that are on different branch (circuit breaker or fuse) circuits or install AC line filter/s.

In the case of radio or TV interference, relocate/reorient the antenna. If the antenna lead-in is 300 ohm ribbon lead, change the lead-in to coaxial type cable.

If these corrective measures do not produce satisfactory results, please contact the local retailer authorized to distribute this type of product. If you can not locate the appropriate retailer, please contact Yamaha Electronics Corp., U.S.A. 6660 Orangethorpe Ave, Buena Park, CA 90620.

The above statements apply **ONLY** to those products distributed by Yamaha Corporation of America or its subsidiaries.

## Caution: Read this before operating your unit.

- 1 To assure the finest performance, please read this manual carefully. Keep it in a safe place for future reference.
- 2 Install this sound system in a well ventilated, cool, dry, clean place – away from direct sunlight, heat sources, vibration, dust, moisture, and/or cold. Allow ventilation space of at least 30 cm on the top, 20 cm on the left and right, and 20 cm on the back of this unit.
- 3 Locate this unit away from other electrical appliances, motors, or transformers to avoid humming sounds.
- 4 Do not expose this unit to sudden temperature changes from cold to hot, and do not locate this unit in an environment with high humidity (i.e. a room with a humidifier) to prevent condensation inside this unit, which may cause an electrical shock, fire, damage to this unit, and/or personal injury.
- 5 Avoid installing this unit where foreign objects may fall onto this unit and/or this unit may be exposed to liquid dripping or splashing. On the top of this unit, do not place:
  - Other components, as they may cause damage and/or discoloration on the surface of this unit.
  - Burning objects (i.e. candles), as they may cause fire, damage to this unit, and/or personal injury.
  - Containers with liquid in them, as they may fall and liquid may cause electrical shock to the user and/or damage to this unit.
- 6 Do not cover this unit with a newspaper, tablecloth, curtain, etc. in order not to obstruct heat radiation. If the temperature inside this unit rises, it may cause fire, damage to this unit, and/or personal injury.
- 7 Do not plug in this unit to a wall outlet until all connections are complete.
- 8 Do not operate this unit upside-down. It may overheat, possibly causing damage.
- 9 Do not use force on switches, knobs and/or cords.
- 10 When disconnecting the power cable from the wall outlet, grasp the plug; do not pull the cable.
- 11 Do not clean this unit with chemical solvents; this might damage the finish. Use a clean, dry cloth.
- 12 Only voltage specified on this unit must be used. Using this unit with a higher voltage than specified is dangerous and may cause fire, damage to this unit, and/or personal injury. Yamaha will not be held responsible for any damage resulting from use of this unit with a voltage other than specified.
- 13 To prevent damage by lightning, keep the power cord and outdoor antennas disconnected from a wall outlet or the unit during a lightning storm.
- 14 Do not attempt to modify or fix this unit. Contact qualified Yamaha service personnel when any service is needed. The cabinet should never be opened for any reasons.
- 15 When not planning to use this unit for long periods of time (i.e. vacation), disconnect the AC power plug from the wall outlet.
- 16 Install this unit near the AC outlet and where the AC power plug can be reached easily.
- 17 Be sure to read the “Troubleshooting” section on common operating errors before concluding that this unit is faulty.
- 18 Before moving this unit, press **(A) STANDBY/ON** to set this unit in the standby mode, and disconnect the AC power plug from the wall outlet.
- 19 **VOLTAGE SELECTOR** (Asia and General models only)  
The **VOLTAGE SELECTOR** on the rear panel of this unit must be set for your local main voltage **BEFORE** plugging into the AC wall outlet. Voltages are:  
..... AC 110–120/220–240 V, 50/60 Hz
- 20 The batteries shall not be exposed to excessive heat such as sunshine, fire or like.
- 21 Excessive sound pressure from earphones and headphones can cause hearing loss.
- 22 When replacing the batteries, be sure to use batteries of the same type. Danger of explosion may happen if batteries are incorrectly replaced.

### WARNING

TO REDUCE THE RISK OF FIRE OR ELECTRIC SHOCK, DO NOT EXPOSE THIS UNIT TO RAIN OR MOISTURE.

As long as this unit is connected to the AC wall outlet, it is not disconnected from the AC power source even if you turn off this unit by **(A) STANDBY/ON**. In this state, this unit is designed to consume a very small quantity of power.

### FOR CANADIAN CUSTOMERS

To prevent electric shock, match wide blade of plug to wide slot and fully insert.  
This Class B digital apparatus complies with Canadian ICES-003.

### POUR LES CONSOMMATEURS CANADIENS

Pour éviter les chocs électriques, introduire la lame la plus large de la fiche dans la borne correspondante de la prise et pousser jusqu'au fond.  
Cet appareil numérique de la classe B est conforme à la norme NMB-003 du Canada.

### IMPORTANT

Please record the serial number of this unit in the space below.  
**MODEL:**  
**Serial No.:**  
The serial number is located on the rear of the unit. Retain this Owner's Manual in a safe place for future reference.

# Contents

## INTRODUCTION

<b>Features</b> .....	2
Supplied accessories .....	2
<b>Functional overview</b> .....	3
Front panel .....	3
Front panel display.....	4
Remote control.....	5
Rear panel .....	6
<b>Quick start guide</b> .....	7

## PREPARATION

<b>Preparation of remote control</b> .....	8
<b>Connections</b> .....	9
Placing speakers.....	9
Connecting speakers .....	9
Connecting video components.....	11
Connecting other components .....	13
Using the VIDEO AUX jacks on the front panel ....	15
Connecting the FM and AM antennas .....	15
Connecting the power cable.....	15
Turning on and off the power .....	15
<b>Basic setup</b> .....	16

## BASIC OPERATION

<b>Playback</b> .....	17
Basic procedure.....	17
Additional operations.....	18
<b>Selecting the SCENE templates</b> .....	21
Selecting the desired SCENE template.....	21
Creating your original SCENE templates .....	23
Using remote control on the SCENE feature .....	24
<b>Sound field programs</b> .....	25
Selecting sound field programs.....	25
<b>FM/AM tuning</b> .....	27
Overview.....	27
FM/AM tuning operations .....	27
Preset FM/AM stations .....	27
<b>Using iPod™</b> .....	29
Control and functions for iPod™.....	29
<b>Using Bluetooth™ components</b> .....	30
Pairing the Bluetooth™ receiver and your Bluetooth™ component .....	30
Playback of the Bluetooth™ component .....	30

## ADVANCED OPERATION

<b>Set menu</b> .....	31
Using set menu.....	32
1 SOUND MENU .....	32
2 INPUT MENU .....	34
3 OPTION MENU .....	35
<b>Remote control features</b> .....	37
Controlling this unit, a TV, or other components ....	37
Setting remote control codes.....	39
<b>Advanced setup</b> .....	40

## ADDITIONAL INFORMATION

<b>Troubleshooting</b> .....	41
<b>Glossary</b> .....	46
<b>Specifications</b> .....	47
<b>Index</b> .....	48

## APPENDIX

### (at the end of this manual)

<b>List of remote control codes</b> .....	i
---	---

### About this manual

- \* indicates a tip for your operation.
- Some operations can be performed by using either the buttons on the front panel or the ones on the remote control. In case the button names differ between the front panel and the remote control, the button name on the remote control is given in parentheses.
- This manual is printed prior to production. Design and specifications are subject to change in part as a result of improvements, etc. In case of differences between the manual and product, the product has priority.
- “**ⓐSTANDBY/ON**” or “**ⓑDVD**” (example) indicates the name of the parts on the front panel or the remote control. Refer to the “Functional overview” on page 3.

INTRODUCTION

PREPARATION

BASIC OPERATION

ADVANCED OPERATION

ADDITIONAL INFORMATION

APPENDIX

English

# INTRODUCTION

## Features

### Built-in 5-channel power amplifier

- ◆ Minimum RMS output power [U.S.A. and Canada models] (1 kHz, 0.9% THD, 8 Ω)  
Front: 100 W/ch  
Center: 100 W  
Surround: 100 W/ch  
[Other models] (1 kHz, 0.9% THD, 6 Ω)  
Front: 100 W/ch  
Center: 100 W  
Surround: 100 W/ch

### Various input/output connectors

- ◆ HDMI (IN x 2, OUT x 1), Component video (IN x 3, OUT x 1), Composite video (IN x 3, OUT x 2), Coaxial digital audio (IN x 1), Optical digital audio (IN x 2), Analog audio (IN x 9, OUT x 2)
- ◆ Speaker out (5-channel), Subwoofer out
- ◆ Discrete multi-channel input (6-channel)

### SCENE select function

- ◆ Preset SCENE templates for various situations
- ◆ SCENE template customizing capability

### Sound field programs

- ◆ Proprietary Yamaha technology for the creation of surround field
- ◆ Compressed Music Enhancer mode
- ◆ SILENT CINEMA™

### Decoders and DSP circuits

- ◆ Dolby Digital decoder
- ◆ Dolby Pro Logic/Dolby Pro Logic II decoder
- ◆ DTS decoder
- ◆ Virtual CINEMA DSP
- ◆ SILENT CINEMA™

### Sophisticated FM/AM tuner

- ◆ 40-station random and direct preset tuning
- ◆ Automatic preset tuning

### HDMI™ (High-Definition Multimedia Interface)

- ◆ HDMI interface for standard, enhanced or high-definition video (includes 1080p video signal transmission)

### DOCK terminal

- ◆ DOCK terminal to connect a Yamaha iPod universal dock (such as YDS-11, sold separately) or Bluetooth wireless audio receiver (such as YBA-10, sold separately)

### Other features

- ◆ 192-kHz/24-bit D/A converter
- ◆ iPod controlling capability
- ◆ Sleep timer
- ◆ Cinema and music night listening modes
- ◆ Remote control with preset remote control codes



Manufactured under license from Dolby Laboratories. "Dolby," "Pro Logic," and the double-D symbol are trademarks of Dolby Laboratories.



Manufactured under license under U.S. Patent No's: 5,451,942;5,956,674;5,974,380;5,978,762;6,487,535 and other U.S. and worldwide patents issued and pending. DTS is a registered trademark and the DTS logos and symbol are trademarks of DTS, Inc. © 1996-2007 DTS, Inc. All Rights Reserved.

### iPod™

"iPod" is a trademark of Apple Inc., registered in the U.S. and other countries.

### Bluetooth™

Bluetooth is a registered trademark of the Bluetooth SIG and is used by Yamaha in accordance with a license agreement.

## HDMI

"HDMI," the "HDMI" logo and "High-Definition Multimedia Interface" are trademarks, or registered trademarks of HDMI Licensing LLC.

### SILENT™ CINEMA

"SILENT CINEMA" is a trademark of Yamaha Corporation.

## We Want You Listening For A Lifetime



Yamaha and the Electronic Industries Association's Consumer Electronics Group want you to get the most out of your equipment by playing it at a safe level. One that lets the sound come through loud and clear without annoying blaring or distortion - and, most importantly, without affecting your sensitive hearing. Since hearing damage from loud sounds is often undetectable until it is too late, Yamaha and the Electronic Industries Association's Consumer Electronics Group recommend you to avoid prolonged exposure from excessive volume levels.

## Supplied accessories

Check that you received all of the following parts.

- Remote control
- Batteries (2) (AAA, R03, UM-4)
- AM loop antenna
- Indoor FM antenna

# Functional overview

## Front panel

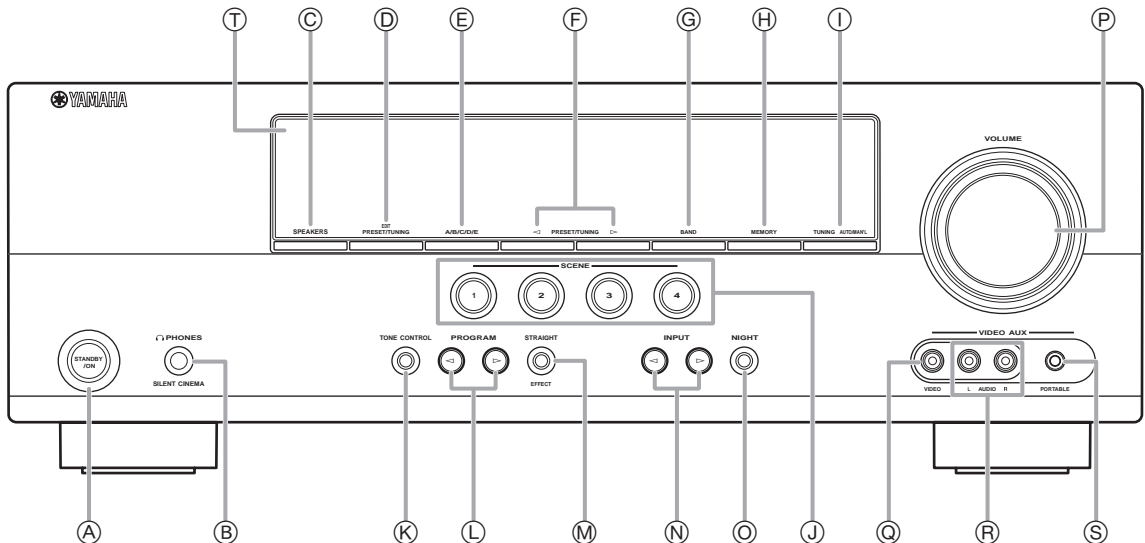

- (A) STANDBY/ON**  
Turns on this unit, or sets it to standby mode (see page 15).
- (B) PHONES jack**  
Connect to a pair of headphones (see page 19).
- (C) SPEAKERS**  
Turns on or off the set of front speakers connected to the FRONT A or FRONT B speaker terminals (see page 18).
- (D) EDIT PRESET/TUNING**  
Switches the tuning mode (see page 27).
- (E) A/B/C/D/E**  
Selects the preset station group (A to E) (see page 28).
- (F) PRESET/TUNING </>**  
Tunes into radio stations manually or automatically and selects a preset station group (see page 27).
- (G) BAND**  
Selects the reception band from FM and AM (see page 27).
- (H) MEMORY**  
Stores a station that you tuned into as a preset station (see page 27).
- (I) TUNING AUTO/MAN'L**  
Selects a tuning method from automatic or manual tuning (see page 27).
- (J) SCENE 1/2/3/4**  
Recalls an input source and a sound field program assigned to each SCENE button (see page 21).
- (K) TONE CONTROL**  
Selects "BASS" and "TREBLE" to adjust frequency response (see page 19).
- (L) PROGRAM </>**  
Selects a sound field program (see page 25).
- (M) STRAIGHT**  
Activates the "STRAIGHT" mode (see page 26).
- (N) INPUT </>**  
Selects an input source (see page 17).
- (O) NIGHT**  
Selects a night listening mode (see page 19).
- (P) VOLUME control**  
Adjusts the volume level of this unit (see page 17).
- (Q) VIDEO (VIDEO AUX) jack**  
Connects to a game console or a video camera using a composite video cable (see page 15).
- (R) AUDIO L/R (VIDEO AUX) jacks**  
Connects to a game console or a video camera using analog audio cables (see page 15).
- (S) PORTABLE (VIDEO AUX) jack**  
Connects to an audio component (such as iPod) (see page 15).
- (T) Front panel display**  
Shows information about the operational status of this unit (see page 17).

## Front panel display

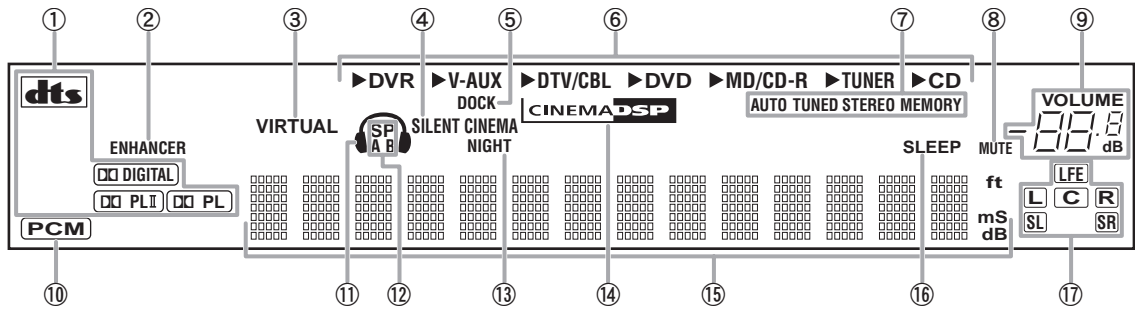

- ① **Decoder indicator**  
Lights up when any of the decoders of this unit functions.
- ② **ENHANCER indicator**  
Lights up when the Compressed Music Enhancer mode is selected (see page 25).
- ③ **VIRTUAL indicator**  
Lights up when Virtual CINEMA DSP is active (see page 26).
- ④ **SILENT CINEMA indicator**  
Lights up when headphones are connected and a sound field program is selected (see page 26).
- ⑤ **DOCK indicator**  
Lights up or flashes according to the state of Yamaha iPod universal dock or Bluetooth Wireless Audio Receiver connected to this unit (see pages 14 and 30).
- ⑥ **Input source indicators**  
The corresponding cursor lights up to show the currently selected input source.
- ⑦ **Tuner indicators**  
Lights up when this unit is in the FM or AM tuning mode (see page 27).
- ⑧ **MUTE indicator**  
Flashes while the MUTE function is on (see page 19).
- ⑨ **VOLUME level indicator**  
Indicates the current volume level.
- ⑩ **PCM indicator**  
Lights up when this unit is reproducing PCM (Pulse Code Modulation) digital audio signals.
- ⑪ **Headphones indicator**  
Lights up when headphones are connected (see page 19).
- ⑫ **SP A B indicators**  
Lights up according to the set of front speakers selected (see page 17).
- ⑬ **NIGHT indicator**  
Lights up when you select a night listening mode (see page 19).
- ⑭ **CINEMA DSP indicator**  
Lights up when you select a sound filed program (see page 26).
- ⑮ **Multi-information display**  
Shows the name of the current sound field program and other information when adjusting or changing settings.
- ⑯ **SLEEP indicator**  
Lights up while the sleep timer is on (see page 20).

⑰ **Input channel and speaker indicators**

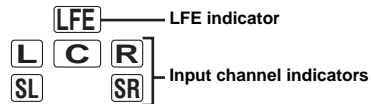

- **LFE indicator**  
Lights up when the input signal contains the LFE signal.
- **Input channel indicators**  
Indicates the channel components of the current digital input signal.

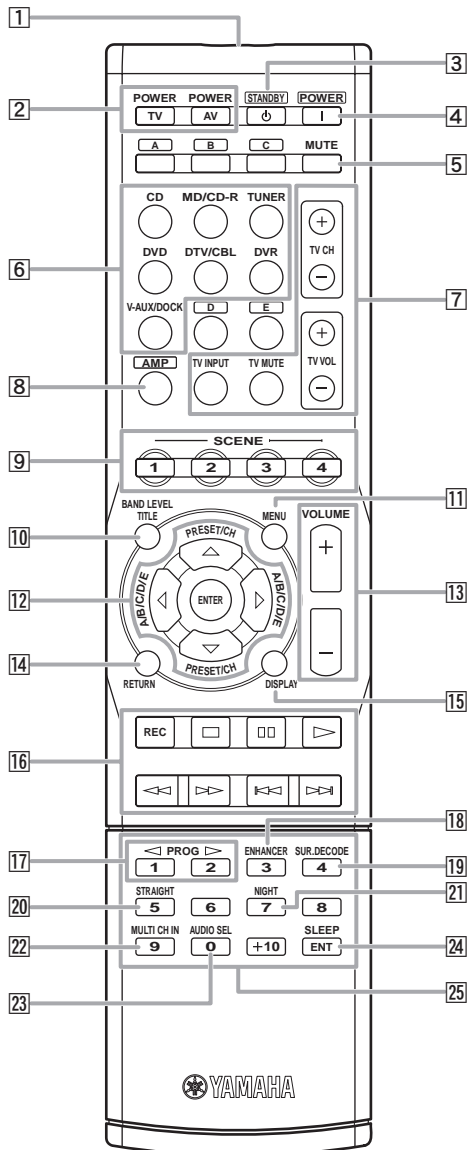

## Remote control

**1 Infrared window**

Outputs infrared control signals (see page 8).

**2 TV/AV POWER**

Turns your TV or other components on or off (see page 38).

**3 STANDBY (⏻)**

Sets this unit to the standby mode (see page 15).

**4 POWER (⏻)**

Turns this unit on (see page 15).

**5 MUTE**

Mutes audio output (see page 19).

**6 Input selector buttons**

Switches the input source to each source (see page 17).

**7 TV control buttons**

Controls your TV (see page 37).

**8 AMP**

Press this button before you control this unit (see page 17).

**9 SCENE 1/2/3/4**

Recalls an input source and a sound field program assigned to each SCENE button (see page 21).

**10 BAND LEVEL TITLE**

Selects the speaker that you want to adjust (see page 19).

**11 MENU**

Displays the set menu on the front panel display (see page 32).

**12 Cursors (</> / ▽ / △) / ENTER**

- Press cursors to navigate the set menu (see page 32).
- Press ENTER to confirm a selection in the set menu (see page 32).

**13 VOLUME +/-**

Adjusts the volume level of this unit (see page 17).

**14 RETURN**

Returns the previous menu level when the set menu is displayed (see page 32).

**15 DISPLAY**

Displays the information of external components (such as a DVD player) (see page 38).

**16 Control buttons**

Control external components (such as a DVD player) connected to this unit (see page 38).

**17 PROG </>**

Selects the sound field program (see page 25).

**18 ENHANCER**

Sets the sound field program to the “Music Enh. 2ch” or “Music Enh. 5ch” (see page 25).

**19 SUR.DECODE**

Selects a decoder from four decoders (see page 26).

**20 STRAIGHT**

Activates the “STRAIGHT” mode (see page 26).

**21 NIGHT**

Selects a night listening mode (see page 19).

**22 MULTI CH IN**

Sets the input source to MULTI CH IN (see page 18).

**23 AUDIO SEL**

Selects an audio input select setting for each input source (see page 18).

**24 SLEEP**

Sets the sleep timer (see page 20).

**25 Numeric buttons**

Enter remote control codes or preset station number (see page 39).

## Rear panel

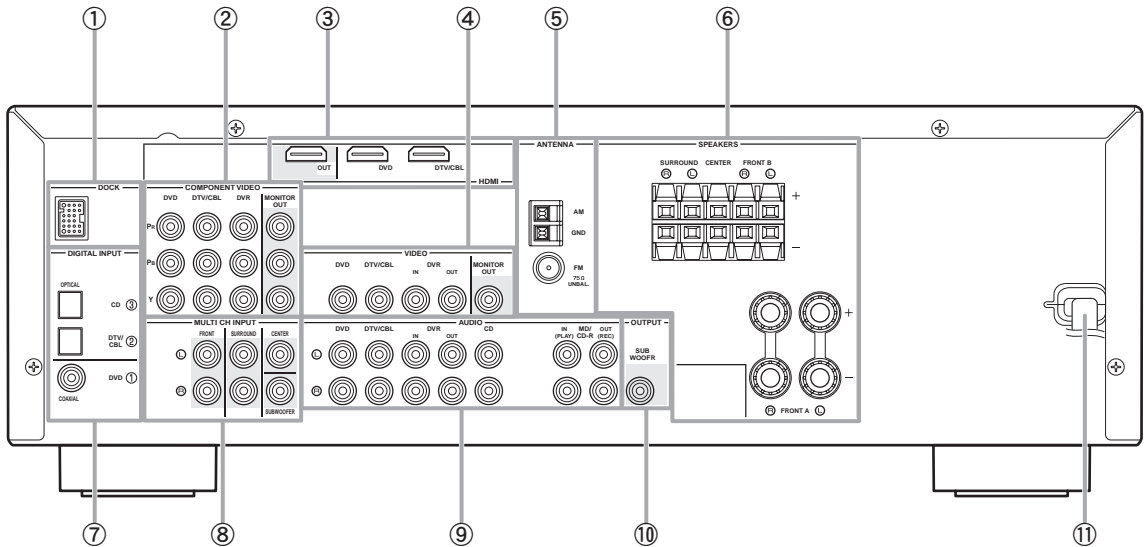

**① DOCK terminal**

Connect to the Yamaha iPod Universal Dock (such as YDS-11, sold separately) or Bluetooth Wireless Audio Receiver (such as YBA-10, sold separately) using its dedicated cable (see page 14).

**② COMPONENT VIDEO jacks**

Connect to Y, Pb/CB and Pr/CR jacks on your video components with component video cables (see page 11).

- DVD input jacks
- DTV/CBL input jacks
- DVR input jacks
- MONITOR OUT output jacks

**③ HDMI terminals**

Connect to HDMI output/input terminals on your external components with HDMI cables (see page 11).

- HDMI DVD terminal
- HDMI DTV/CBL terminal
- HDMI OUT output terminal

**④ VIDEO jacks**

Connect to video jacks on your video components with composite video cables (see page 11).

- DVD input jack
- DTV/CBL input jack
- DVR IN jack
- DVR OUT jack
- MONITOR OUT jack

**⑤ ANTENNA terminals**

Connect to the supplied FM and AM antennas (see page 15).

**⑥ SPEAKERS terminals**

Connect to each speakers (see page 9).

- FRONT A L/R
- FRONT B L/R
- SURROUND L/R
- CENTER

**⑦ DIGITAL INPUT jacks**

Connect to the DIGITAL output jacks on your digital audio components with Coaxial/Optical digital audio cables.

This input jacks support PCM, Dolby Digital and DTS bitstream (see page 11).

- COAXIAL (DVD)
- OPTICAL (DTV/CBL)
- OPTICAL (CD)

**⑧ MULTI CH INPUT jacks**

Connect to the output jacks on your multi-format player or external decoder with analog audio cables (see page 14).

- FRONT L/R jack
- SURROUND L/R jack
- CENTER jack
- SUBWOOFER jack

**⑨ AUDIO jacks**

Connect to the audio output/input jacks on your components with analog audio cables (see page 11).

- DVD L/R jack
- DTV/CBL L/R jack
- DVR IN L/R jack
- DVR OUT L/R jack
- CD L/R jack
- IN (PLAY) L/R jack
- OUT (REC) L/R jack

**⑩ SUBWOOFER OUTPUT jack**

Connect to a Subwoofer with an analog audio cable (see page 9).

**⑪ Power cable**

Connect to a standard AC outlet (see page 15).

# Quick start guide

The following steps describe the easiest way to operate this unit. See the related pages for details on the operation and settings.

## Step 1: Check the items

In these steps, you need the following items which are not included in the package of this unit.

### ❑ Speakers

We recommend magnetically shielded speakers.

- ❑ **Front speaker** ..... x 2  
At least two front speakers are required to start playback.
- ❑ **Center speaker** ..... x 1
- ❑ **Surround speaker** ..... x 2
- ❑ **Active subwoofer** ..... x 1  
Select an active subwoofer equipped with an RCA input jack.
- ❑ **Speaker cable** ..... x 5
- ❑ **Subwoofer cable** ..... x 1  
Select a monaural RCA cable.
- ❑ **DVD player** ..... x 1  
Select DVD player equipped with coaxial digital audio output jack and composite video output jack.
- ❑ **Video monitor** ..... x 1  
Select a TV monitor, video monitor or projector equipped with a composite video input jack.
- ❑ **Video cable** ..... x 2  
Select an RCA composite video cable.
- ❑ **Digital coaxial audio cable** ..... x 1

## Step 2: Set up your speakers

Place your speakers in the room and connect them to this unit.

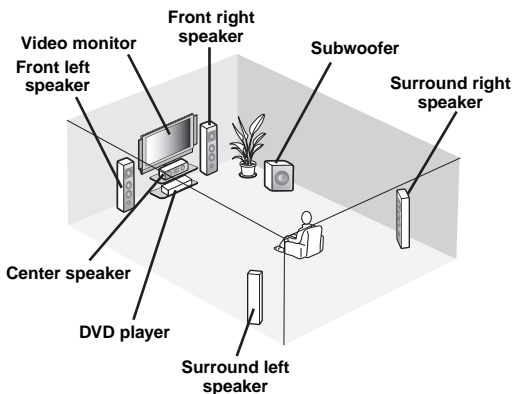

- Placing speakers ..... P. 9
- Connecting speakers ..... P. 9

## Step 3: Connect your components

Connect your TV, DVD player or other components.

- Connecting a TV monitor or projector ..... P. 12
- Connecting audio and video components ..... P. 13
- Connecting a multi-format player or an external decoder ..... P. 14
- Connecting a Yamaha iPod universal dock or Bluetooth Wireless Audio Receiver ..... P. 14
- Using the VIDEO AUX jacks on the front panel ..... P. 15
- Connecting the FM and AM antennas ..... P. 15

## Step 4: Turn on the power

Connect the power cable and turn on this unit.

- Connecting the power cable ..... P. 15
- Turning on and off the power ..... P. 15

## Step 5: Select the input source and start playback

Select the component connected in the step 3 as an input source and start playback.

- Basic procedure ..... P. 17
- Selecting the SCENE templates ..... P. 21
- Adjusting the sound field programs ..... P. 25

# PREPARATION

## Preparation of remote control

### Installing batteries in the remote control

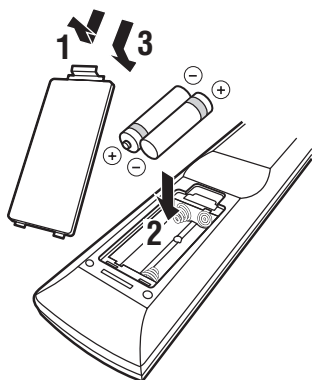

- 1 Take off the battery compartment cover.
- 2 Insert the four supplied batteries (AAA, R03, UM-4) according to the polarity markings (+ and -) on the inside of the battery compartment.
- 3 Snap the battery compartment cover back into place.

#### Notes

- Change all of the batteries if you notice the following conditions:
  - the operation range of the remote control decreases.
- Do not use old batteries together with new ones.
- Do not use different types of batteries (such as alkaline and manganese batteries) together. Read the packaging carefully as these different types of batteries may have the same shape and color.
- If the batteries have leaked, dispose of them immediately. Avoid touching the leaked material or letting it come into contact with clothing, etc. Clean the battery compartment thoroughly before installing new batteries.
- Do not throw away batteries with general house waste; dispose of them correctly in accordance with your local regulations.
- If the remote control is without batteries for more than 2 minutes, or if exhausted batteries remain in the remote control, the contents of the memory may be cleared. When the memory is cleared, insert new batteries and set up the remote control code.

### Using the remote control

The remote control transmits a directional infrared ray. Be sure to aim the remote control directly at the remote control sensor on this unit during operation.

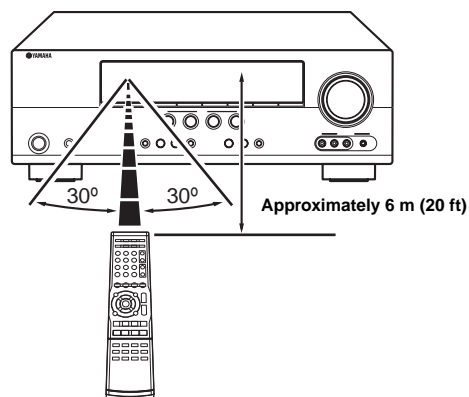

#### 1 Infrared window

Outputs infrared control signals. Aim this window at the component you want to operate.



- To set the remote control codes for other components, see page 39.

#### Notes

- Do not spill water or other liquids on the remote control.
- Do not drop the remote control.
- Do not leave or store the remote control in the following types of conditions:
  - places of high humidity, such as near a bath
  - places of high temperature, such as near a heater or stove
  - places of extremely low temperatures
  - dusty places
- To set the remote control codes for other components, see page 39.

# Connections

## Placing speakers

The speaker layout below shows the speaker setting we recommend. You can use it to enjoy CINEMA DSP and multi-channel audio sources.

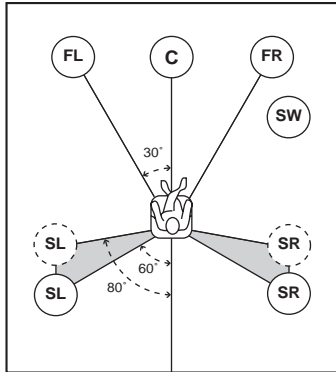

### Front left and right speakers (FL and FR)

The front speakers are used for the main source sound plus effect sounds. Place these speakers at an equal distance from the ideal listening position. The distance of each speaker from each side of the video monitor should be the same.

### Center speaker (C)

The center speaker is for the center channel sounds (dialog, vocals, etc.). If for some reason it is not practical to use a center speaker, you can do without it. Best results, however, are obtained with the full system.

### Surround left and right speakers (SL and SR)

The surround speakers are used for effect and surround sounds.

### Subwoofer (SW)

The use of a subwoofer with a built-in amplifier, such as the Yamaha Active Servo Processing Subwoofer System, is effective not only for reinforcing bass frequencies from any or all channels, but also for high fidelity sound reproduction of the LFE (low-frequency effect) channel included in Dolby Digital and DTS sources. The position of the subwoofer is not so critical, because low bass sounds are not highly directional. But it is better to place the subwoofer near the front speakers. Turn it slightly toward the center of the room to reduce wall reflections.

## Connecting speakers

Be sure to connect the left channel (L), right channel (R), “+” (red) and “-” (black) properly. If the connections are faulty, this unit cannot reproduce the input sources accurately.

### Caution

- Use speakers with the specified impedance shown on the rear panel of this unit.
- Before connecting the speakers, make sure that this the AC power plug is disconnected from the AC wall outlet.
- Do not let the bare speakers wires touch each other or do not let them touch any metal part of this unit. This could damage this unit and/or speakers.
- Use magnetically shielded speakers. If this type of speaker still creates interference with the monitor, place the speakers away from the monitor.
- If you are to use 6-ohm speakers, be sure to set “SP IMP.” to “6ΩMIN” before using this unit. See page 40 for details on setting “SP IMP.”

### ■ 5.1-channel speaker connection

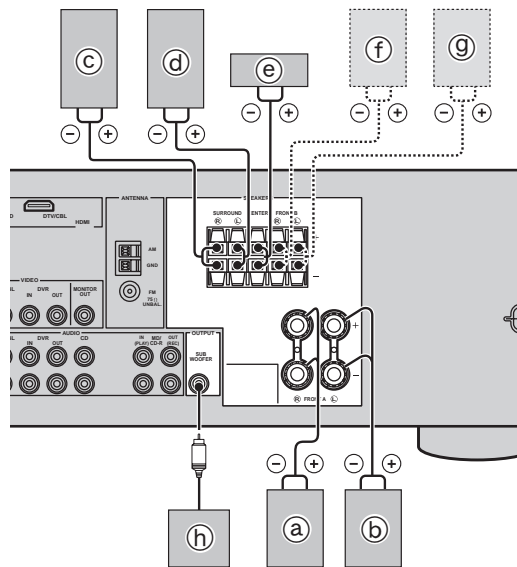

Speakers	Jacks on this unit
(a) Front speaker (A) Right*	FRONT A (R)
(b) Front speaker (A) Left*	FRONT A (L)
(c) Surround speaker Right	SURROUND (R)
(d) Surround speaker Left	SURROUND (L)
(e) Center speaker	CENTER
(f) Front speaker (B) Right*	FRONT B (R)
(g) Front speaker (B) Left*	FRONT B (L)
(h) Subwoofer	SUBWOOFER

\* You can select the front speaker set from Front speakers (A) and Front speakers (B) by pressing **ⓈPEAKERS** repeatedly. See page 18 for details.

■ **Connect speaker cables to each speaker**

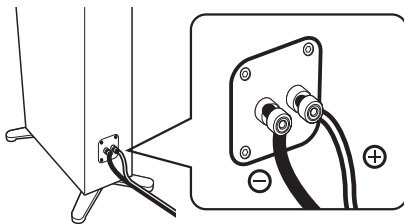

Cables are colored or shaped differently, perhaps with a stripe, groove or ridge. Connect the striped (grooved, etc.) cable to the “+” (red) terminals of your speaker. Connect the plain cable to the “-” (black) terminals.

■ **Before connecting to the SPEAKERS terminal**

A speaker cord is actually a pair of insulated cables running side by side. Cables are colored or shaped differently, perhaps with a stripe, groove or ridges. Connect the striped (grooved, etc.) cable to the “+” (red) terminals of this unit and your speaker. Connect the plain cable to the “-” (black) terminals.

Remove approximately 10 mm (3/8”) of insulation from the end of each speaker cable and then twist the bare wires of the cable together to prevent short circuits.

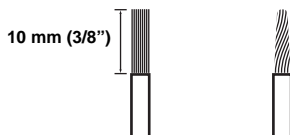

■ **Connecting to the FRONT A terminals**

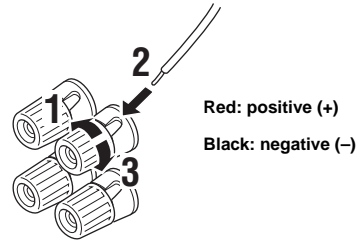

- 1 Loosen the knob.
- 2 Insert the bare end of the speaker wire into the slit on the terminal.
- 3 Tighten the knob to secure the wire.

**Connecting the banana plug (except Europe, Russia, Korea, and Asia models)**

The banana plug is a single-pole electrical connector widely used to terminate speaker cables. First, tighten the knob and then insert the banana plug connector into the end of the corresponding terminal.

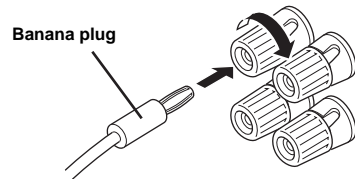

■ **Connecting to the FRONT B, CENTER, and SURROUND terminals**

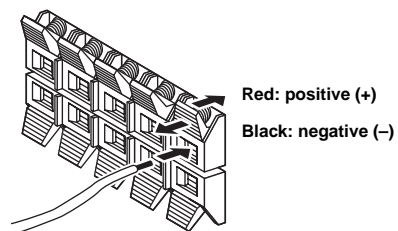

- 1 Press down the tab.
- 2 Insert the bare end of the speaker wire into the hole on the terminal.
- 3 Release the tab to secure the wire.

## Connecting video components

### Information on jacks and cable plugs

#### Audio jacks and cable plugs

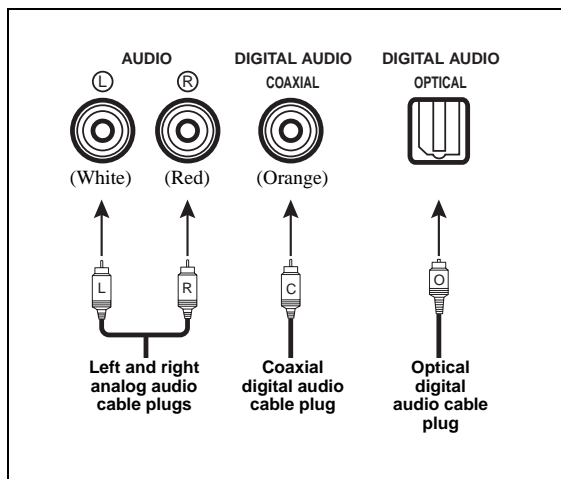

#### AUDIO jacks

For conventional analog audio signals transmitted via left and right analog audio cables. Connect red plugs to the right jacks and white plugs to the left jacks.

#### COAXIAL jack

For digital audio signals transmitted via coaxial digital audio cable.

#### OPTICAL jacks

For digital audio signals transmitted via optical digital audio cables.

#### Notes

- You can use the digital jacks to input PCM, Dolby Digital, and DTS bitstreams. All digital input jacks are compatible with digital signals with up to 96 kHz of sampling frequency.
- This unit handles digital and analog signals independently. Thus audio signals input at the digital jacks are not output at the analog AUDIO OUT (REC) jack.

#### Video jacks and cable plugs

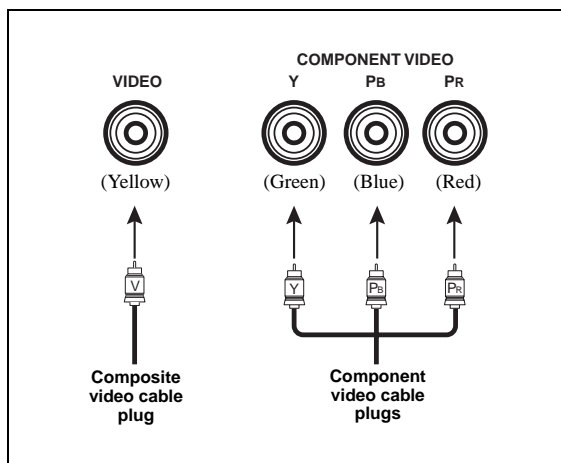

#### VIDEO jacks

For conventional composite video signals transmitted via composite video cables.

#### COMPONENT VIDEO jacks

For component signals, separated into the luminance (Y) and chrominance (PB, PR) video signals transmitted on separate wires of component video cables.

#### Video signal flow for MONITOR OUT

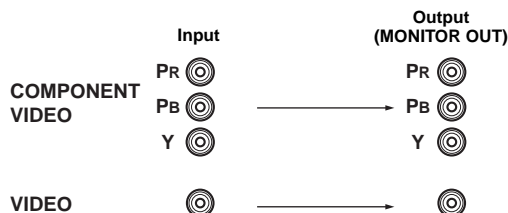

#### Information on HDMI™

Audio signals input at the HDMI jack are not output from any speaker terminals but output from the connected video monitor. To enjoy the sound from speakers connected to this unit,

- make an analog or digital connection besides the HDMI connection (see page 13).
- mute the volume of the connected video monitor.

You can play back pictures by connecting your video monitor and video source component to this unit using HDMI connections.

At that time, audio/video signals output from the connected component (such as DVD player etc.) are output to the connected video monitor only when this unit is turned on and set to the input source (DVD or DTV/CBL).

Furthermore, available audio/video signals depend on the specification of the connected video monitor. Refer to the instruction manual of each connected component.

#### HDMI jack and cable plug

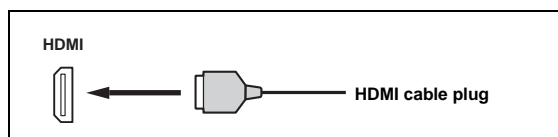

- We recommend using an HDMI cable shorter than 5 meters (16 feet) with the HDMI logo printed on it.
- Use a conversion cable (HDMI jack ↔ DVI-D jack) to connect this unit to other DVI components.

#### Using the AUDIO OUT REC jack

You can record the audio signal output at the AUDIO OUT (REC) jack by using the recording components.

#### Note

- Check the copyright laws in your country to record from CDs, radio, etc. Recording of copyrighted material may infringe copyright laws.

## Connecting a TV monitor or projector



Make sure that this unit and other components are unplugged from the AC wall outlets.

### Note

- If you turn off the video monitor connected to the HDMI OUT jack via a DVI connection, the connection may fail. In this case, the HDMI indicator flashes irregularly.

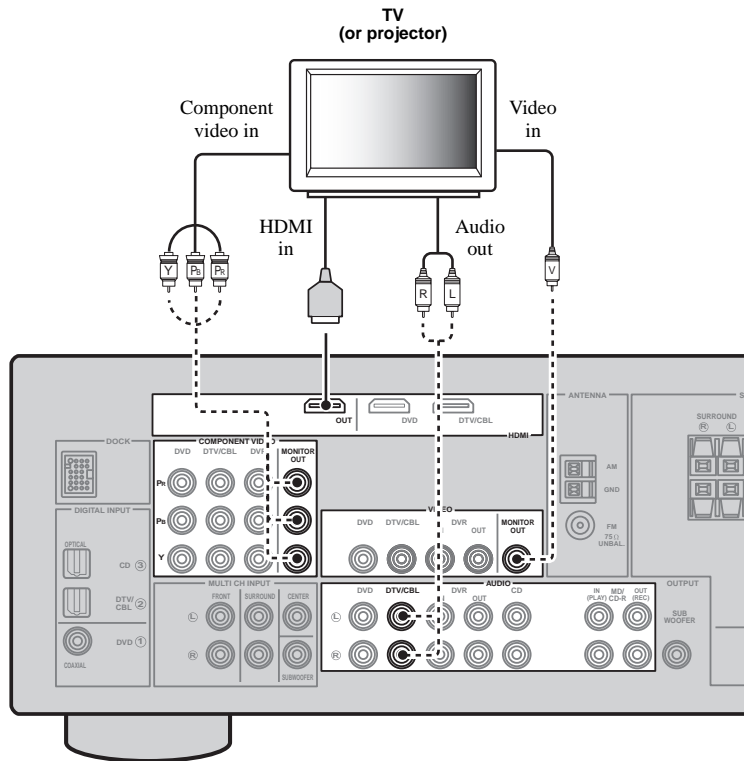

————— Recommended connections

- - - - - Alternative connections



## Connecting other components

### Connecting audio and video components

This unit has three types of audio jacks, two types of video jacks and HDMI jacks. You can choose the connection method depending on the component to be connected.

#### ■ Connecting example (connecting a DVD player)

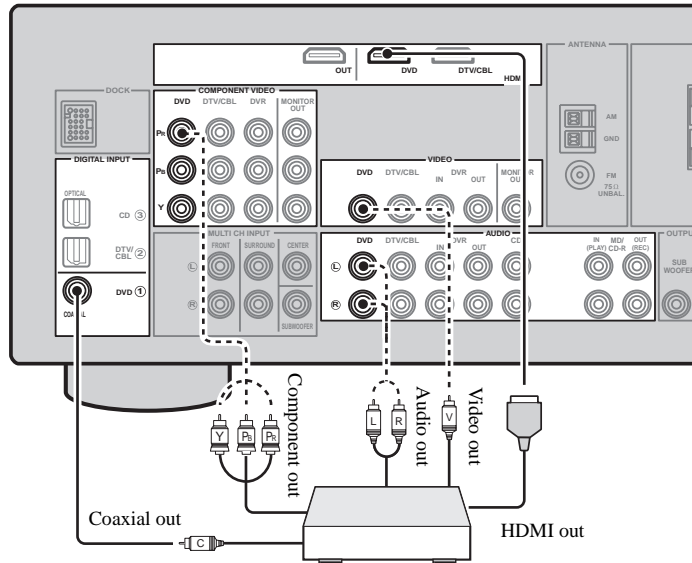

————— Recommended connections

----- Alternative connections

#### ■ Jacks used for audio and video connections

Recommended connections are indicated by (\*). When connecting a recording component, you need to make additional connections for recording (signal transmission from this unit to the recording component).



Make sure that this unit and other components are unplugged from the AC wall outlets.



- You can also use the VIDEO AUX jacks (see page 15) on the front panel to connect an additional component.
- To confirm the positions of "jacks on this unit" in the following table, refer to "Rear panel" in "Functional overview" on page 6.

Component	Signal type	Jacks on component	Jacks on this unit
DVD player or Blu-ray Disc	Video	HDMI out*	HDMI (DVD)*
		Component out	COMPONENT VIDEO (DVD)
		Video out (composite)	VIDEO (DVD)
	Audio	Optical out*	COAXIAL (DVD)*
Audio out (analog)		AUDIO (DVD)	
Set-top box	Video	HDMI out*	HDMI (DTV/CBL)*
		Component out	COMPONENT VIDEO (DTV/CBL)
		Video out (composite)	VIDEO (DTV/CBL)
	Audio	Optical out*	OPTICAL (DTV/CBL)*
		Analog out (analog)	AUDIO (DTV/CBL)

Component	Signal type	Jacks on component	Jacks on this unit
DVD recorder	Video	HDMI out*	HDMI (DVR)*
		Video out (composite)	VIDEO (DVR IN)
	Audio	Audio out (analog)*	AUDIO (IN (PLAY))*
	Audio recording	Audio in (analog)*	AUDIO (OUT (REC))*
	Video recording	Video in (composite)*	VIDEO (DVR OUT)*
	Audio	Coaxial out*	OPTICAL (CD)*
CD player	Audio	Audio out (analog)	AUDIO (CD)
	Audio recording	Audio in (analog)*	AUDIO (OUT (REC))*

**Notes**

- Be sure to make the same type of video connections as those made for your TV if the video conversion is disabled. For example, if you connected your TV to the VIDEO MONITOR OUT jack of this unit, connect other components to the VIDEO jacks.
- Check the copyright laws in your country to record from CDs, radio, etc. Recording of copyrighted material may infringe copyright laws.
- To make a digital connection to a component other than the default one assigned to each DIGITAL INPUT or DIGITAL OUTPUT jack, configure the "INPUT ASSIGN" setting (see page 34).
- Only analog audio signals output at AUDIO OUT (REC) jack can be recorded using the recording components. Therefore Digital signals input at the DIGITAL INPUT jacks or analog signals input at MULTI CH INPUT jacks can be output at the analog AUDIO OUT (REC) jack for recording.

**Connecting a multi-format player or an external decoder**

This unit is equipped with 6 additional input jacks (FRONT L/R, SURROUND L/R, CENTER and SUBWOOFER) for discrete multi-channel input from a multi-format player, external decoder or sound processor. Connect the output jacks on your multi-format player or external decoder to the MULTI CH INPUT jacks. Be sure to match the left and right output jacks to the left and right input jacks for the front and surround channels.

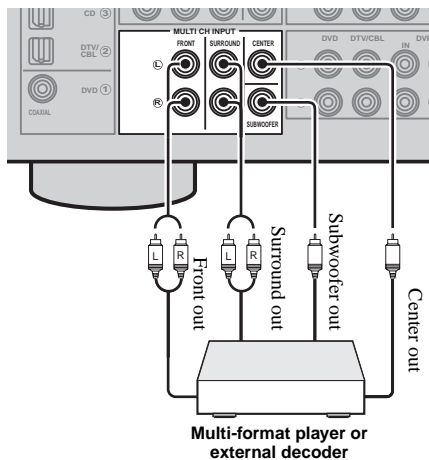

**Notes**

- When you select the component connected to the MULTI CH INPUT jacks as the input source (see page 34), this unit automatically turns off the digital sound field processor, and you cannot select sound field programs.
- This unit does not redirect signals input at the MULTI CH INPUT jacks to accommodate for missing speakers. We recommend that you connect a 5.1-channel speaker system before using this feature.
- The source connected to the MULTI CH INPUT jacks on this unit cannot be recorded.

**Connecting a Yamaha iPod universal dock or Bluetooth Wireless Audio Receiver**

This unit is equipped with the DOCK terminal on the rear panel that allows you to connect a Yamaha iPod universal dock (such as YDS-11, sold separately) or Bluetooth Wireless Audio Receiver (such as YBA-10, sold separately).

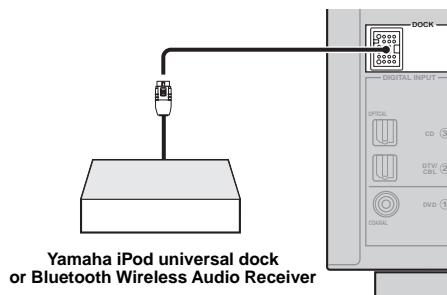

## Using the VIDEO AUX jacks on the front panel

Use the VIDEO AUX jacks on the front panel to connect a game console or a video camera to this unit. To reproduce the source signals input at these jacks, select “V-AUX” as the input source.

### Caution

Be sure to turn down the volume of this unit and other components before making connections.

### Notes

- The audio signals input at the DOCK terminal on the rear panel take priority over the ones input at the VIDEO AUX jacks.
- The audio signals input at the PORTABLE mini jack take priority over the ones input at the AUDIO L/R jacks.

## Connecting the FM and AM antennas

Both FM and AM indoor antennas are supplied with this unit. In general, these antennas should provide sufficient signal strength. Connect each antenna correctly to the designated terminals.

### Notes

- The AM loop antenna should be placed away from this unit.
- A properly installed outdoor antenna provides clearer reception than an indoor one. If you experience poor reception quality, install an outdoor antenna. Consult the nearest authorized Yamaha dealer or service center about outdoor antennas.
- The AM loop antenna should always be connected, even if an outdoor AM antenna is connected to this unit.

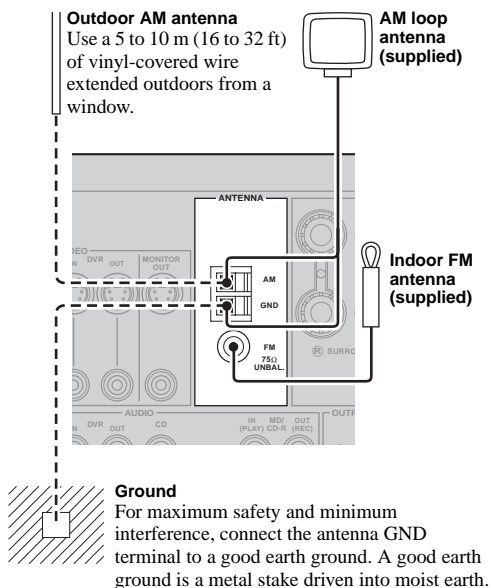

## Connecting the wire of the AM loop antenna

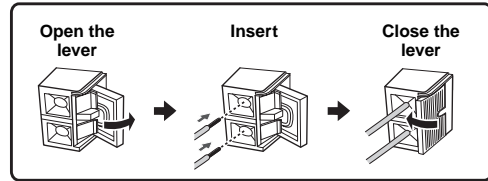

## Assembling the supplied AM loop antenna

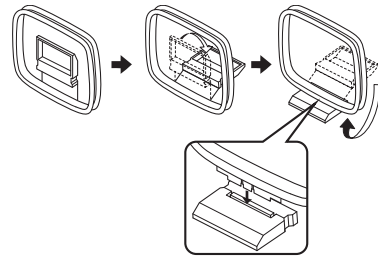

### Note

- The types of the supplied AM loop antenna is different depending on the models.

## Connecting the power cable

Once all connections are complete, plug the power cable into the AC wall outlet.

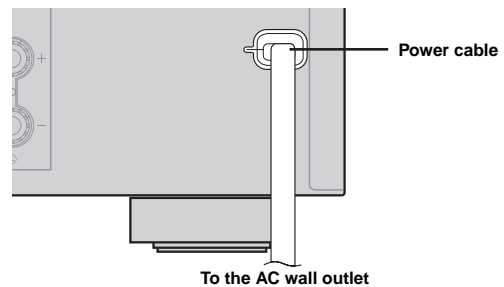

## Turning on and off the power

### Turning on this unit

Press **(A) STANDBY/ON** (or **(4) POWER**) to turn on this unit.



- When you turn on this unit, there will be a 4 to 5-second delay before this unit can reproduce sound.

### Set this unit to the standby mode

Press **(A) STANDBY/ON** (or **(3) STANDBY**) to turn off this unit.

### Note

- In the standby mode, this unit consumes a small amount of power in order to receive infrared signals from the remote control.

# Basic setup

The “BASIC SETUP” feature is a useful way to set up your system quickly and with minimal effort.

## Notes

- Make sure that you disconnect your headphones from this unit.
- If you wish to configure this unit manually using more precise adjustments, use the detailed parameters in “SOUND MENU” (see page 32).
- Altering any parameters in “BASIC SETUP” resets all parameters manually adjusted in “SOUND MENU” (see page 32).
- Initial settings are indicated by (\*) in the following each parameters.
- Press **[4]RETURN** on the remote control to return to the previous menu level.

**1 Press [8]AMP on the remote control.**

**2 Press [1]MENU.**  
“BASIC SETUP” appears on the front panel display.

**3 Press [12]ENTER to enter “BASIC SETUP.”**  
“ROOM: S M L” appears on the front panel display.

**4 Press [12]< / > to select the desired setting.**  
Select the size of the room where you have installed your speakers. The room sizes are defined as follows:

Choice	Approximate Size of the room
S	16 x 13 ft, 200 ft <sup>2</sup> (4.8 x 4.0 m, 20 m <sup>2</sup> )
M*	20 x 16 ft, 300 ft <sup>2</sup> (6.3 x 5.0 m, 30 m <sup>2</sup> )
L	26 x 19 ft, 450 ft <sup>2</sup> (7.9 x 5.8 m, 45 m <sup>2</sup> )

**5 Press [12]∇ to select “SUBWOOFER” and then [12]< / > to select the desired setting.**  
“SUBWOOFER” and the current setting appear on the front panel display.

Choice	Condition
YES*	When you have a subwoofer in your system.
NONE	When you do not have a subwoofer in your system.

**6 Press [12]∇ to select “SPEAKERS” and then [12]< / > to select the number of speakers connected to this unit.**  
“SPEAKERS” and the current setting appear on the front panel display.

Choice	Display	Speakers
2SPk	[L] [R]	Front L/R
3SPk	[L] [C] [R]	Front L/R Center
4SPk	[L] [R] [SL] [SR]	Front L/R, Surround L/R
5SPk*	[L] [C] [R] [SL] [SR]	Front L/R, Center, Surround L/R

**7 Press [12]∇ to select “SET” and then [12]< / > to select the desired settings.**  
“SET” and “CANCEL” appear on the front panel display.

Choice	Function
SET	Applies the settings you made.
CANCEL*	Cancels the setup procedure without making any changes.



- You can also press **[1]MENU** to cancel the setup procedure.

**8 Press [12]ENTER to confirm your selection.**  
If you selected “SET” in step 7, each speaker outputs a test tone twice in turn. “CHECK:TestTone” appears on the front panel display for a few seconds and then “CHECK OK?” appears on the front panel display.



- Check the speaker connections (see page 9) and adjust the “SPEAKERS” settings back in step 6, if necessary.
- The indicator of the speaker currently outputting the test tone flashes on the front panel display.

**9 Press [12]< / > to select the desired settings.**

Choice	Function
YES*	Completes the setup procedure if the test tone levels from each speaker were satisfactory.
NO	Proceeds to the speaker level adjustment menu to balance the output level of each speaker.

**10 Press [12]ENTER to confirm your selection.**

- If you selected “YES” in step 9, the setup procedure is completed and then display returns to the top set menu display. Press **[1]MENU** to exit from “BASIC SETUP.”
- If you selected “NO” in step 9, the front speaker level adjustment display appears on the front panel display.

**11 Press [12]△ / ∇ to select a speaker and then [12]< / > to adjust the balance.**  
The selected speaker and the front left speaker (or the surround left speaker) output a test tone in turn.

- Press **[12]>** to increase the value.
- Press **[12]<** to decrease the value.

■ **The balance between speakers you can adjust in each item is defined as follows.**

Choice	Adjusted balance between speakers
FR	the front left and right speakers
C	the front left and center speakers
SL	the front left and surround left speakers
SR	the surround left and surround right speakers
SWFR	the front left speaker and the subwoofer

## Note

- The available speaker channels differ depending on the setting of the speakers.

**12 Press [1]MENU to exit from “BASIC SETUP.”**

# BASIC OPERATION

## Playback

### Caution

Extreme caution should be exercised when you play back CDs encoded in DTS. If you play back a CD encoded in DTS on a DTS-incompatible CD player, you will only hear some unwanted noise that may damage your speakers. Check whether your CD player supports CDs encoded in DTS. Also, check the sound output level of your CD player before you play back a CD encoded in DTS.

### Basic procedure

- 1 Turn on external components (TV, DVD player, etc.) connected to this unit.
- 2 Press **SPEAKERS** repeatedly to select the front speakers you want to use.  
The respective speaker indicators lights up on the front panel display.
- 3 Press **INPUT**  $\triangleleft/\triangleright$  repeatedly (or press one of the input selector buttons (**6**)) to select the desired input source.  
The name of the currently selected input source appears on the front panel display for a few seconds.

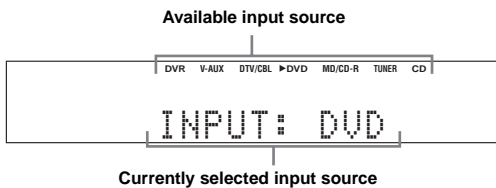

- 4 Start playback on the selected component or select a broadcast station.

### Notes

- Refer to the operating instructions for the source component.
- See page 27 for details about FM or AM tuning instructions.



- To adjust the level of each speaker, see page 19.

- 5 Rotate **VOLUME** (or press **VOLUME +/-**) to adjust the volume to the desired output level.

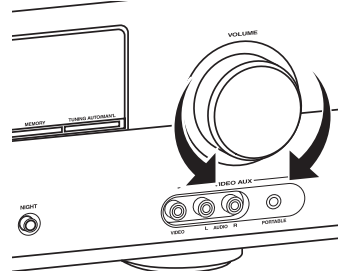

- See page 19 to adjust the level of each speaker.
- This does not affect the AUDIO OUT (REC) level.
- You can set the initial volume level and maximum volume level (see page 34).

- 6 Press **PROGRAM**  $\triangleleft/\triangleright$  (or press **AMP** and then **PROG**  $\triangleleft/\triangleright$ ) repeatedly to select the desired sound field program.

The name of the selected sound field program appears on the front panel display.

See page 21 for details about sound field programs.

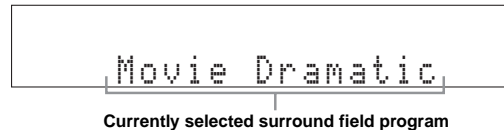

### Notes

- Choose a sound field program based on your listening preference, not merely on the name of the program.
- When you select an input source, this unit automatically selects the last sound field program used with the corresponding input source.
- Sound field programs cannot be selected when the component connected to the MULTI CH INPUT jacks is selected as the input source (see page 18).
- When PCM signals with a sampling frequency higher than 48 kHz are input, this unit is automatically set to the "STRAIGHT" mode (see page 26).
- To display information about the currently selected input source on the front panel display, see page 20 for details.

## Guide to contents

When you want...	See page
Adjust the tonal quality of the front speakers	19
Edit parameters of sound field programs	26
Enjoy the sources which have wide dynamic range at night	19
Use headphones	19
Select a decoder to play back sources with	26
Set this unit to the standby mode automatically	20

## Additional operations

### Using input setting features

Use the following features to select input jack or input source.

#### ■ Selecting the front speaker set

Press **Ⓢ****SPEAKERS** repeatedly change the active front speaker set that is connected to the **FRONT A** or **FRONT B** speaker terminals or turn off the front speakers.

The active front speaker set changes as follows:

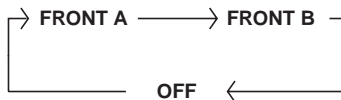

#### Note

- Turn off the volume level of this unit before you switch the front speaker setting.

#### ■ Using the Zone B feature

When you set “FRONT B” to “ZONE B” (see page 32), you can use the speakers connected to FRONT B speaker terminals in another room (Zone B).

Press **Ⓢ****SPEAKERS** on the front panel repeatedly to turn on or off the Zone B speakers.

When you activate the Zone B speakers, all the speakers in the main room are muted.

#### Notes

- You cannot activate both the main room and Zone B speakers simultaneously.
- If you select CINEMA DSP sound field program and activate the Zone B speakers, Virtual CINEMA DSP is activated automatically (see page 26).

#### ■ Selecting the component connected to the MULTI CH INPUT jacks as the input source

Use this feature to select the component connected to the MULTI CH INPUT jacks (see page 14) as the input source.

Press **Ⓢ****INPUT** **</>** repeatedly (or press **Ⓢ****AMP** and then press **Ⓢ****MULTI CH IN**) to select “MULTI CH.”

“MULTI CH” appears on the front panel display.



- You can configure the multi channel input settings in “MULTI CH” (see page 14).

#### Notes

- Sound field programs, or the night listening mode, etc. cannot be selected when “MULTI CH” is selected as the input source.
- When headphones are used, signals are output only from the front left and right channels.

#### ■ Selecting audio input jacks (AUDIO SELECT)

Use this feature (audio input jack select) to switch the input jack assigned to an input source when two or more jacks are assigned to an input source.



- We recommend that you set the audio input jack select to “AUTO” in most cases.
- You can adjust the default audio input jack select of this unit by using “AUDIO SELECT” in “OPTION MENU” (see page 36).

**1** Press **Ⓢ****INPUT** **</>** repeatedly (or press one of the input selector buttons (**Ⓢ**)) to select the desired input source.

**2** Press **Ⓢ****AMP** and then **Ⓢ****AUDIO SEL** repeatedly to select the desired Audio input jack select setting.

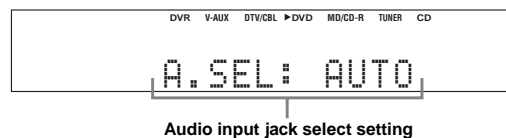

Choice	Function
AUTO	Automatically selects input signals in the following order: (1) Digital signals (2) Analog signals
ANALOG	Selects only analog signals. If no analog signals are input, no sound is output.



- You can configure the audio input jack select setting in “AUDIO SELECT.”

#### Note

- This feature is not available if no digital input jack is assigned to the selected input source in “INPUT ASSIGN” (see page 34).

## Using audio features

Use the following features to adjust the audio output or speaker level.

### ■ Muting the audio output

Press **[5] MUTE** on the remote control to mute the audio output. Press **[5] MUTE** again to resume the audio output.



- You can also rotate **[P] VOLUME** (or press **[13] VOLUME +/-**) to resume the audio output.
- You can configure the muting level by using “MUTE TYP.” in “SOUND MENU” (see page 34).
- The MUTE indicator flashes on the front panel display when the audio output is muted and disappears from the front panel display when the audio output is resumed.

### ■ Adjusting the tonal quality

Use this feature to adjust the balance of bass and treble for the front left and right speaker channels.

Press **[K] TONE CONTROL** repeatedly to select “BASS” or “TREBLE” and then press **[L] PROGRAM </>** to adjust the corresponding frequency response level.

Control range: -10 to +10 dB

Each choice is defined as follows.

Choice	Function
BASS	Adjusts the low-frequency response.
TREBLE	Adjusts the high-frequency response.

#### Notes

- Speaker and headphone adjustments are stored independently.
- If you increase or decrease the high-frequency or low-frequency sound to an extreme level, the tonal quality of the surround speakers may not match that of the front left and right speakers.
- This does not affect recorded material.

### ■ Adjusting the speaker level

You can adjust the output level of each speaker while listening to a music source. This is also possible when playing sources input at the MULTI CH INPUT jacks.

#### Note

- This operation will override the level adjustment made in “SP LEVEL” (see page 33).

1 Press **[8] AMP** and then press **[10] BAND LEVEL TITLE** repeatedly to select the speaker you want to adjust.

Choice	Description
FRONT L	Front left speaker
FRONT R	Front right speaker
CENTER	Center speaker
SWFR	Subwoofer
SUR.L	Surround left speaker
SUR.R	Surround right speaker



- Once you press **[10] BAND LEVEL TITLE** on the remote control, you can also select the speaker by pressing **[12] Δ / ∇**.
- The available speaker channels differ depending on the speaker settings.

2 Press **[12] </>** on the remote control (or press **[F] PRESET/TUNING </>**) to adjust the speaker output level.

Control range: -10.0 dB to +10.0 dB

## Using optional features

Use the following features to utilize various useful functions equipped on this unit.

### ■ Using your headphones

Connect a pair of headphones with a stereo analog audio cable plug to the PHONES jack on the front panel.



- When you select a sound field program, SILENT CINEMA mode is automatically activated (see page 26).

#### Notes

- When you connect headphones, no signals are output at the speaker terminals.
- All Dolby Digital and DTS audio signals are mixed down to the left and right headphone channels.

### ■ Selecting the night listening mode

The night listening modes are designed to improve listenability at lower volumes or at night.

1 Press **[O] NIGHT** (or press **[8] AMP** and then **[21] NIGHT**) repeatedly to select “NIGHT:CINEMA” or “NIGHT:MUSIC.”

Each choice is defined as follows.

Choice	Function
NIGHT:CINEMA	Narrows the dynamic range of film soundtracks and makes dialog easier to hear at lower volumes.
NIGHT:MUSIC	Preserves ease-of-listening for all sounds.
NIGHT OFF	Disables this feature.



- When a night listening mode is selected, the NIGHT indicator lights up on the front panel display.

2 Press **[12] </>** to adjust the effect level while “NIGHT:CINEMA” or “NIGHT:MUSIC” is displayed on the front panel display.

Each choice is defined as follows.

Choice	Function
MIN	Slightly lowers the effect level.
MID*	Moderately lowers the effect level.
MAX	Considerably lowers the effect level.



- “NIGHT:CINEMA” and “NIGHT:MUSIC” adjustments are stored independently.

**Notes**

- You cannot use the night listening modes in the following cases:
  - when the component connected to the MULTI CH INPUT jacks is selected as the input source.
  - when headphones are connected to the PHONES jack.
  - when the sampling frequency of the input sources are higher than 48 kHz.
- The effect of night listening modes may vary depending on the input source and surround sound settings you use.

**■ Displaying the input source information (SIGNAL INFO)**

You can display the format, sampling frequency, channel, bit rate and flag data of the current input signal.

**1 Press [8]AMP and then press [11]MENU on the remote control.**

“BASIC SETUP” appears on the front panel display.

• BASIC SETUP

**2 Press [12]▲ / ▼ repeatedly to select “SIGNAL INFO” and then press [12]ENTER.**

**3 Press [12]▲ / ▼ to switch the displayed information.**

The following information about the input source appears on the front panel display.

Choice	Description
FORMAT	Signal format.
SAMPLING	The number of samples per second taken from a continuous signal to make discrete signals.
CHANNEL	The number of source channels in the input signal (front/surround/LFE).
BITRATE	The number of bits passing a given point per second.
FLAG	Flag data encoded in DTS, Dolby Digital, or PCM signals that cue this unit to automatically switch decoders.

**4 Press [11]MENU on the remote control again to exit from “SET MENU.”**

**■ Using the sleep timer**

Use this feature to automatically set this unit to the standby mode after a certain amount of time. The sleep timer is useful when you are going to sleep while this unit is playing or recording from a source.

**Press [8]AMP and then press [24]SLEEP repeatedly to set the amount of time.**

The sleep timer setting changes as follows.



Once the sleep timer is set, the SLEEP indicator lights up on the front panel display, and the display returns to the selected sound field program.

**To cancel the sleep timer**

Press [24]SLEEP on the remote control repeatedly to select “SLEEP OFF.”



- If you set the main zone to the standby mode, the sleep timer is automatically canceled.

**■ Playing video sources in the background**

You can combine a video image from a video source with sound from an audio source. For example, you can enjoy listening to classical music while viewing beautiful scenery from the video source on the video monitor.

**Press the input selector buttons ([6]) on the remote control to select a video source and then an audio source.**

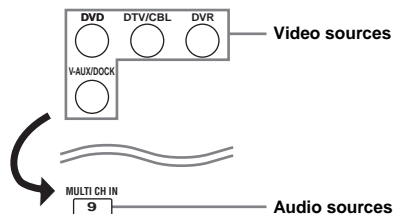
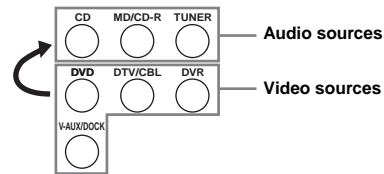



# Selecting the SCENE templates

Just by pressing one SCENE button, you can recall your favorite input source and sound field program according to the SCENE template that has been assigned to the SCENE button. The SCENE templates are built combinations of input sources and sound field programs.

This unit is equipped with 13 preset SCENE templates for various situations. The following SCENE templates are assigned to respective SCENE buttons in the default settings.

Default SCENE button	The name of the SCENE template and its description
SCENE 1	<b>DVD Viewing</b> – input source: DVD – sound field program: STRAIGHT For when you want to enjoy a DVD playback.
SCENE 2	<b>Disc Listening</b> – input source: DVD – sound field program: 5ch Stereo For when you want to listen to a music disc from the connected DVD player as the background music for this room.
SCENE 3	<b>TV Viewing *1</b> – input source: DTV/CBL – sound field program: STRAIGHT For when you want to watch a TV program.
SCENE 4	<b>Radio Listening *2, *3, *4</b> – input source: TUNER – sound field program: Music Enh. 5ch For when you want to listen to a music program from the FM radio station.

## Notes

- \*1 You must connect a cable TV or a satellite tuner to this unit in advance. See page 13 for details.
- \*2 You need to connect the supplied FM and AM antennas to this unit in advance. See page 15 for details.
- \*3 You have to tune into the desired radio station. See pages 27 to 28 for the tuning information.
- \*4 To achieve the best possible reception, orient the connected AM loop antenna, or adjust the position of the end of the indoor FM antenna.

## Selecting the desired SCENE template

If you want to use other SCENE templates, you can select the desired SCENE templates from the SCENE template library and assign the templates to the selected SCENE buttons on the front panel and the remote control.

Select the desired SCENE template

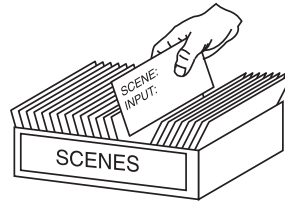

SCENE template library (Image)



Assign the SCENE template to the SCENE button

### 1 Press and hold the desired **SCENE** (or **SCENE**) button for 3 seconds.

The MEMORY indicator on the front panel starts to flash, and the name of currently assigned SCENE template appears on the front panel display.



### 2 Press **INPUT** </> (or press **AMP** and then **</>**) to select the desired template.



### 3 Press the **SCENE** (or **SCENE**) button again to confirm the selection.

The MEMORY indicator stops flashing and the select SCENE template is assigned to the button.



- To cancel the procedure, press **AMP** and then **RETURN**.

## Note

- Once the desired SCENE templates are assigned to the corresponding SCENE buttons, you may need to set the input source of the SCENE template on the remote control. See page 24 for details.

## Which SCENE template would you like to select?

The following tables indicate preset SCENE template descriptions. Select the corresponding SCENE templates for the desired source. The illustrations of the SCENE button in the following table indicate that the SCENE templates in those cells are assigned to the SCENE buttons, respectively.

You can also create your original SCENE templates by editing the preset SCENE templates. See page 23 for details.

### ■ Video sources (DVD video, Recorded video)

SCENE template	Input source	Playback mode	Features
 DVD Viewing	DVD	STRAIGHT	Select this SCENE template when you play back general contents on your DVD player.
DVD Movie Viewing	DVD	Movie Dramatic	Select this SCENE template when you play back movies on your DVD player.
DVD Live Viewing	DVD	Pop/Rock	Select this SCENE template when you enjoy music live video on your DVD player.
DVR Viewing	DVR	Movie Dramatic	Select this SCENE template when you play back movies on your digital video recorder.

### ■ Music discs (CD, SA-CD or DVD-Audio)

SCENE template	Input source	Playback mode	Features
Music Disc Listening	DVD	2ch Stereo	Select this SCENE template when you play back music discs on your DVD player.
 Disc Listening	DVD	5ch Stereo	Select this SCENE template when you play back music sources as the back ground music on your DVD player.
CD Listening	CD	5ch Stereo	Select this SCENE template when you play back music source as the back ground music on your CD player.
CD Music Listening	CD	2ch Stereo	Select this SCENE template when you play back music discs on your CD player.

### ■ Radio programs

SCENE template	Input source	Playback mode	Features
 Radio Listening	TUNER	Music Enh. 5ch	Select this SCENE template when you enjoy FM or AM radio programs.

### ■ iPod or Bluetooth component

SCENE template	Input source	Playback mode	Features
Dock Listening	DOCK	Music Enh. 5ch	Select this SCENE template when you play back music on your iPod stationed in a Yamaha iPod universal dock or Bluetooth component that is connected to the Bluetooth receiver.

### ■ TV programs

SCENE template	Input source	Playback mode	Features
 TV Viewing	DTV/CBL	STRAIGHT	Select this SCENE template when you enjoy TV programs.
TV Sports Viewing	DTV/CBL	TV Sports	Select this SCENE template when you enjoy sports programs on TV.

■ Video games

SCENE template	Input source	Playback mode	Features
Game Playing	V-AUX	Game	Select this SCENE template when you play video games.

**Note**

- When an iPod is connected to the Yamaha iPod universal dock or a Bluetooth component is connected to the Bluetooth receiver, this unit plays back the audio sources input at the DOCK terminal.

### Creating your original SCENE templates

You can create your original SCENE templates for each SCENE button. Refer to the preset 13 SCENE templates to create the original SCENE templates.

### Customizing the preset SCENE templates

Use this feature to customize the preset SCENE templates.

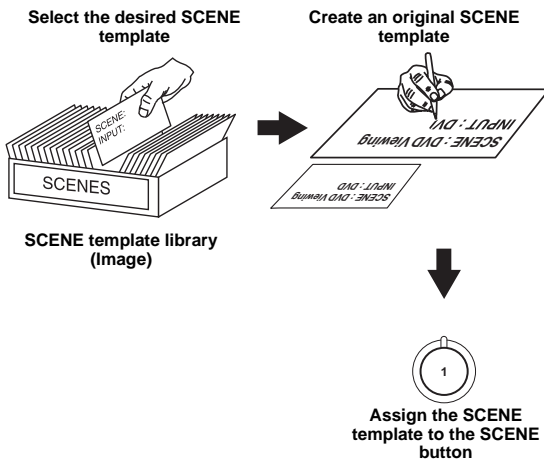

**1** Press and hold the desired **[9]SCENE** button for 3 seconds and then press **[8]AMP**.

The MEMORY indicator on the front panel starts to flash.



**Note**

- When the SCENE template you want to customize is not assigned to any of the **[9]SCENE** button, press **[12]</>** repeatedly to recall the desired SCENE template (see page 21).

**2** Press **[12]▲/▼** to select the desired parameter of the SCENE template and then **[12]</>** to select the desired value of the selected parameter.

You can adjust the following parameters for a SCENE template:

- The input source component
- The active sound field programs or STRAIGHT mode
- The night listening mode setting (see page 19)
  - SYSTEM: Keeps the current night listening mode.
  - CINEMA: Sets the night listening mode to the CINEMA mode.
  - MUSIC: Sets the night listening mode to the MUSIC mode.

**3** Press the **[9]SCENE** button again to confirm the edit.



- An asterisk mark (\*) appears by the name of the original SCENE template.
- To cancel the procedure, press **[8]AMP** and then **[14]RETURN**.

**Notes**

- After changing the assignment of the SCENE template to the **[9]SCENE** buttons, you may need to set the input source of the SCENE template on the remote control. See page 24 for details.
- You can create a customized SCENE template for each **[9]SCENE** button, and if you create another customized SCENE template, this unit overwrites the old customized SCENE template with the new one.
- The customized SCENE template is only available for the assigned **[9]SCENE** button.

## Using remote control on the SCENE feature

### Controlling the input source components in the SCENE mode

You can operate both this unit and the input source component by using the remote control. You must set the appropriate remote control code for each input source in advance (see page 39).

- 1 Press the desired **[9]SCENE** button on the remote control.
- 2 Press the desired buttons in the \* area below to control the input source component of the selected SCENE template.

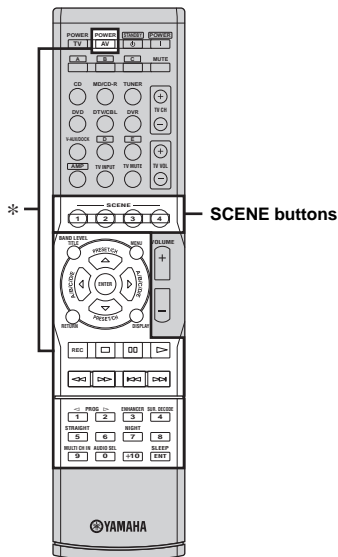

#### Note

- These buttons control the input source component. See page 37 for details of the function of each button.

### Setting input source of the customized SCENE template on the remote control

If you customize the input source of the selected SCENE template, you must set the input source of the SCENE template on the remote control to operate the input source component correctly.

Press and hold the **[9]SCENE** button and the desired input selector button (**[6]**) for 3 seconds.



- Press the **[9]SCENE** button again to operate the input source component.

# Sound field programs

This unit is equipped with a variety of precise digital decoders that allow you to enjoy multi-channel playback from almost any stereo or multi-channel sound source. This unit is also equipped with a Yamaha digital sound field processing (DSP) chip containing several sound field programs which you can use to enhance your playback experience.

## Selecting sound field programs

Press **PROGRAM**  $\triangleleft/\triangleright$  (or press **AMP** and then press **PROG**  $\triangleleft/\triangleright$  repeatedly).

The name of the selected sound field program appears on the front panel display.

## Sound field program descriptions



- Select a sound field program based on your listening preference, not merely on the name of the program, etc.
- The available sound field parameters differ depending on the settings of the speakers.

### Notes

- When you select an input source, this unit automatically selects the last sound field program used with corresponding input source.
- Sound field programs cannot be selected when the component connected to the MULTI CH INPUT jacks is selected as the input source (see page 18).
- When PCM signals with a sampling frequency higher than 48 kHz are input, this unit is automatically set to the “STRAIGHT” mode (see page 26).



- Choose a sound field program based on your listening preference, not merely on the name of the program itself.
- You can select “Music Enh. 2ch” and “Music Enh. 5ch” by pressing **ENHANCER** repeatedly.

Category	Program	Features
MUSIC	Pop/Rock	CINEMA DSP processing. This program presents an image of pop, rock, or jazz live concert. The sound field reproduces the spaciousness of a massive pavilion with an emphasis on the vividness of vocals on the stage and solo instruments and the beats of rhythm instruments.
	Hall	CINEMA DSP processing. This sound field is suitable for classic and orchestral music. The program uses data collected in a large concert hall in Munich. You can enjoy delicate and beautiful reverberation and a majestic atmosphere.
	Jazz	CINEMA DSP processing. The sound field is suitable for jazz and fusion music. It uses data collected in a famous jazz club in New York. You can enjoy clear reverberation.
ENTERTAIN	Game	CINEMA DSP processing. You can enjoy dynamic and thrilling sound effects as you play games. The program lets you feel the depth and three-dimensional surrounding sounds of the field where you are playing, and offers cinema-like surrounding sound effects for the scenes of movies.
	TV Sports	CINEMA DSP processing. You can enjoy sports relays broadcast in stereo and variety shows with a live sound environment. For sports relays, the voices of commentators and announcers come clearly from the center; the cheers and atmosphere in the stadium spread around within a comfortable range, and you can feel like as if you are in the stadium.
MOVIE	Movie Spacious	CINEMA DSP processing. The sound field is suitable for movies with an emphasis on spectacular sound effects, and is a perfect fit with a wide screen. The program reproduces a wide dynamic range from minimum sound effects to powerful sounds.
	Movie Dramatic	CINEMA DSP processing. This sound field is also suitable for movies with an emphasis on three-dimensional sound effects. It restrains reverberation to an moderate extent, but reproduces sound effects and background music in a soft, three-dimensional manner with clarity and center orientation of voices as pivots.
STEREO	2ch Stereo	Downmixes multi-channel sources to 2 channel or plays back 2-channel sources as they are.
	5ch Stereo	CINEMA DSP processing. Using this program increases the listening position range. This is a sound field suitable for background music at parties.
ENHANCER	Music Enh. 2ch Music Enh. 5ch	Select these programs to play back compression artifacts (such as the MP3 format) in 2-channel or 5-channel stereo. This program enhances your listening experience by regenerating the missing harmonics in a compression artifact.

**■ Selecting decoders for 2-channel sources (surround decode mode)**

Signals input from 2-channel sources can also be played back on multi-channels.

Press **[8]AMP** and then press **[19]SUR. DECODE** repeatedly to select a decoder.

You can select from the following decoders depending on the type of source you are playing and your personal preference.

STANDARD	Function
PRO LOGIC	Dolby Pro Logic processing for any sources
PLII Movie	Dolby Pro Logic II processing for movie sources
PLII Music	Dolby Pro Logic II processing for music sources
PLII Game	Dolby Pro Logic II processing for game sources

**■ Editing sound field parameters**

Although you can enjoy good quality sound with the factory default parameters, you can change some of the parameters to better suit the input source or your listening room.

**1** While listening to a source, press **[8]AMP** and then press **[12]△ / ▽** to select desired parameter.

**2** Press **[12]◀ / ▶** to change the parameter value.

**Note**

- You cannot change parameter values when “MEM.GUARD” in “OPTION MENU” is set to “ON” (see page 35).



- Initial settings are indicated by (\*) in the following each parameter.

**For Pop/Rock, Hall, Jazz, Game, TV Sports, Movie Spacious and Movie Dramatic:**

**DSP level** DSP LEVEL

Function:	Adjusts the effect level.
Choices:	MIN, MID*, MAX

**For PRO LOGIC II Music:**

**Panorama** PANORAMA

Function:	Sends stereo signals to the surround speakers as well as the front speakers for a wraparound effect.
Choices:	OFF*, ON

**Dimension** DIMENSION

Function:	Gradually adjusts the sound field either towards the front or towards the rear.
Control range:	-3 (towards the rear) to +3 (towards the front), initial setting is STD (standard).

**Center width** CT WIDTH

Function:	Adjusts the center image from all three front speakers to varying degrees. A larger value adjusts the center image towards the front left and right speakers.
Control range:	0 (center channel sound is output only from center speaker) to 7 (center channel sound is output only from front left and right speakers), initial setting is 3.

**For Music Enh. 2ch and Music Enh. 5ch**

**Effect level**

Function:	Adjusts the effect level.
Choices:	LOW, HIGH*

**■ Using sound field programs without surround speakers (Virtual CINEMA DSP)**

Virtual CINEMA DSP allows you to enjoy the CINEMA DSP sound field programs without surround speakers. When you set “SUR. L/R” to “NONE” (see page 33), Virtual CINEMA DSP is activated automatically whenever you select a CINEMA DSP sound field program (see page 25).

**■ Enjoying multi-channel sources and sound field programs with headphones (SILENT CINEMA)**

SILENT CINEMA allows you to enjoy multi-channel music or movie sound through ordinary headphones. SILENT CINEMA is activated automatically whenever you connect headphones to the PHONES jack while listening to CINEMA DSP sound field programs (see page 25).



- When it is activated, the SILENT CINEMA indicator lights up on the front panel display.

**■ Enjoying unprocessed input sources (Straight decoding mode)**

When this unit is in the “STRAIGHT” mode, 2-channel stereo sources are output from only the front left and right speakers. Multi-channel sources are decoded straight into the appropriate channels without any additional effect processing.

Press **[M]STRAIGHT** (or press **[8]AMP** and then **[20]STRAIGHT**) to select “STRAIGHT.”

“STRAIGHT” appears on the front panel display.

**To deactivate the “STRAIGHT” mode**

Press **[M]STRAIGHT** (or **[20]STRAIGHT**) again so that “STRAIGHT” disappears from the front panel display.

# FM/AM tuning

## Overview

You can use two tuning modes to tune into a desired FM/AM station:

### ■ Frequency tuning mode

You can search or specify the frequency of the desired FM/AM station automatically or manually (see “FM/AM tuning operations” on this page).

### ■ Preset tuning mode

You can preset the desired FM/AM station in advance, and then recall the station by specifying the preset group and number (see “Selecting preset stations” on page 28).

#### Note

- Orient the connected AM loop antenna, or adjust the position of the end of the indoor FM antenna for the best reception.

## FM/AM tuning operations

- 1 Press **INPUT**  $\triangleleft/\triangleright$  repeatedly so that “TUNER” is displayed on the front panel display.
- 2 Press **BAND** to select the reception band (FM or AM).
- 3 To search the station automatically, press **TUNING AUTO/MAN'L** so that the AUTO indicator lights up on the front panel display. To search the station manually, press **TUNING AUTO/MAN'L** again so that the AUTO indicator disappears from the front panel display.

Lights up during automatic tuning

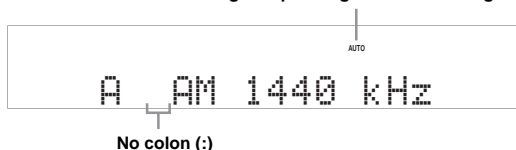

If a colon (:) appears on the front panel display, automatic/manual tuning is not possible. Press **EDIT PRESET/TUNING** to turn the colon (:) off.

- 4 To begin automatic tuning, press **PRESET/TUNING**  $\triangleleft/\triangleright$  once. To tune into the desired station manually, press **PRESET/TUNING**  $\triangleleft/\triangleright$  repeatedly.

When this unit is tuned into a station, the TUNED indicator lights up and the frequency of the received station is shown on the front panel display.



- To tune into a higher frequency, press **PRESET/TUNING**  $\triangleright$ .
- To tune into a lower frequency, press **PRESET/TUNING**  $\triangleleft$ .

#### Note

- If the signal from the station you want to select is weak, tune into it manually.

## Preset FM/AM stations

Use this feature to store up to 40 stations (A1 to E8: 8 preset station numbers in each of 5 preset station groups). Preset the desired stations to this unit by using the automatic or manual station preset.

### Automatic station preset

You can use the automatic preset tuning feature to store up to 40 FM stations with strong signals in order.

- 1 Press **INPUT**  $\triangleleft/\triangleright$  repeatedly so that “TUNER” is displayed on the front panel display.
- 2 Press **BAND** to select “FM” as the reception band.
- 3 Press and hold **MEMORY** for more than 3 seconds.

The preset station number as well as the MEMORY and AUTO indicators flashes. After approximately 5 seconds, automatic presetting status from the current frequency and proceeds toward the higher frequencies.

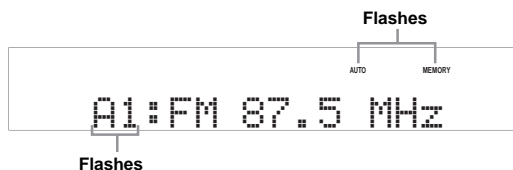

When automatic preset tuning is completed, the front panel display shows the frequency of the last preset station.



- You can select the preset station group and the preset station number where the first received station will be stored by pressing **ⓐA/B/C/D/E** and then **ⓕPRESET/TUNING** **◀/▶**.

**Notes**

- Any stored station data existing under a preset station number is cleared when you store a new station under the same preset station number.
- Only FM stations with sufficient signal strength are stored automatically by automatic preset tuning. If the station you want to store is weak in signal strength, tune it manually and store it as described in “Manual station preset” on this page.

**Manual station preset**

Use this feature to store the FM or AM stations manually.

- Tune into a station.**  
See page 27 for using instructions.
- Press **ⓐMEMORY**.**  
The MEMORY indicator flashes on the front panel display for approximately 30 seconds.
- Press **ⓐA/B/C/D/E** and **ⓕPRESET/TUNING** **◀/▶** repeatedly to select a preset station group and number (A1 to E8) while the MEMORY indicator is flashing.**  
Check that the colon (:) appears on the front panel display.
  - To select a higher preset station group and number, press **ⓕPRESET/TUNING** **▶**.
  - To select a lower preset station group and number, press **ⓕPRESET/TUNING** **◀**.

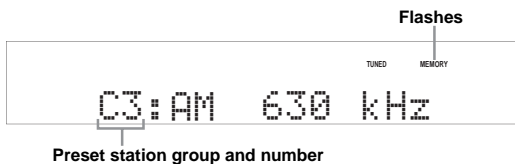

- Press **ⓐMEMORY** while the MEMORY indicator is flashing.**  
The station band and frequency appear on the front panel display with the preset station group and number you have selected.



**Selecting preset stations**

You can tune into any desired station simply by selecting the preset station group and number under which it is stored.

When performing this operation with the remote control, press **ⓖTUNER** to select “TUNER” as the input source.

- Press **ⓐA/B/C/D/E** (or **ⓗ◀/▶**) repeatedly to select the desired preset station group (A to E).**

The preset station group letter appears on the front panel display and changes each time you press the button.

- Press **ⓕPRESET/TUNING** **◀/▶** (or **ⓗ△/▽**) to select the desired preset station number (1 to 8).**

The preset station group and number, along with station band and frequency, appear on the front panel display.



- You can select the desired preset station number (1 to 8) directly by pressing the numeric buttons (**ⓗ**).

**Exchanging preset stations**

You can exchange the assignments of two preset stations between the two. The example below describes the procedure to exchange preset station “E1” and “A5.”

- Select preset station “E1” using **ⓐA/B/C/D/E** and **ⓕPRESET/TUNING** **◀/▶**.**  
See “Selecting preset stations” on this page.

- Press and hold **ⓓEDIT PRESET/TUNING** for more than 3 seconds.**

“E1” and the MEMORY indicator flash on the front panel display.

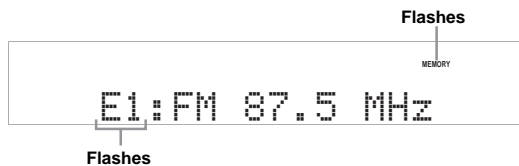

- Select preset station “A5” using **ⓐA/B/C/D/E** and **ⓕPRESET/TUNING** **◀/▶**.**

“A5” and the MEMORY indicator flash on the front panel display.  
See “Selecting preset stations” on this page.

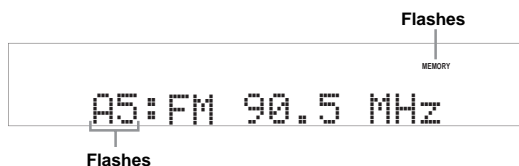

- Press **ⓓEDIT PRESET/TUNING** again.**  
“EXCHANGE E1-A5” appears on the front panel display and the assignments of the two preset stations are exchanged.



# Using iPod™

Once you have stationed your iPod in a Yamaha iPod universal dock (such as the YDS-11, sold separately) connected to the DOCK terminal of this unit (see page 14), you can enjoy playback of your iPod using the supplied remote control.

## ■ Supported iPod

iPod (Click Wheel, including iPod classic)  
iPod nano  
iPod mini  
iPod touch

## ■ Battery charge feature

Your iPod battery is automatically charged when your iPod is stationed in a Yamaha iPod universal dock connected to the DOCK terminal of this unit as long as this unit is turned on.

## ■ Stationing your iPod to the Yamaha iPod universal dock

Once you station your iPod to the Yamaha iPod universal dock, “iPod connected” and the DOCK indicator appears on the front panel display when “V-AUX” is selected as the input source.

## Control and functions for iPod™

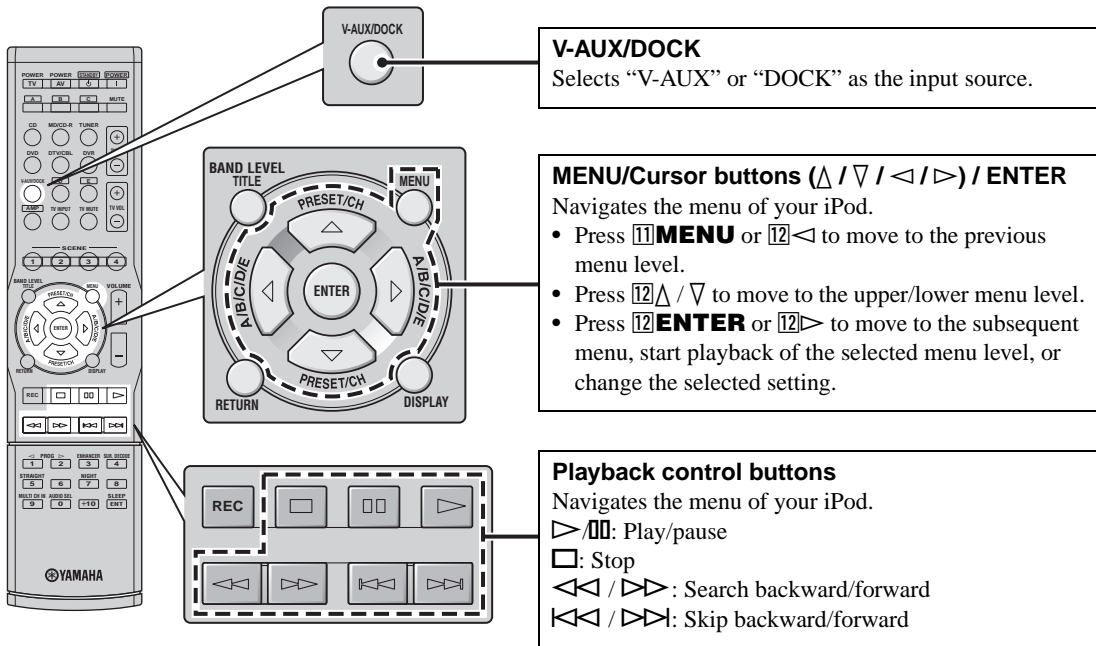

## Notes

- Operations can be also done with the controls on your iPod. Refer to the instruction manuals of your iPod for the operations on your iPod.
- Some features may not be compatible depending on the model or the software version of your iPod.
- For a complete list of status messages that appear on the front panel display, see the “iPod” section in “Troubleshooting” on page 44.

# Using Bluetooth™ components

You can connect a Bluetooth Wireless Audio Receiver (such as YBA-10, sold separately) to the DOCK terminal of this unit and enjoy the music contents stored in your Bluetooth component (such as a portable music player) without wiring between this unit and the Bluetooth component. You need to perform “pairing” for the connected Bluetooth receiver and your Bluetooth component in advance.

## Pairing the Bluetooth™ receiver and your Bluetooth™ component

Pairing must be performed when you use a Bluetooth component with the Bluetooth receiver connected to this unit for the first time or if the pairing data has been deleted. “Pairing” refers to the operation of registering a Bluetooth component for Bluetooth communications.



- You need to perform the pairing operation only when you use the Bluetooth component with the Bluetooth receiver for the first time.
- You need to perform the pairing operations both on this unit and on the Bluetooth component. If necessary, refer to operating instructions of the Bluetooth component.

There are two pairing methods: pairing by using “START PAIRING” in “SET MENU” and quick pairing.

### ■ Pairing by using “SET MENU”

Use this feature to perform pairing of this unit and the video monitor. Select “START PAIRING” in “INPUT MENU.” See page 36 for details.

### ■ Quick pairing

To ensure security, a time limit of 8 minutes is set for the pairing operation. You are recommended to read and fully understand all the instructions before starting.

**1 Press [8]AMP and then press [N]INPUT </> repeatedly (or press [6]V-AUX/DOCK) to select “V-AUX” as the input source.**

**2 Turn on the Bluetooth component you want to pair with.**

**3 Press and hold [C]BAND (or [10]BAND LEVEL TITLE) for 3 seconds.**

Once the Bluetooth receiver starts pairing, “Searching...” appears for a moment. While the Bluetooth receiver is in the pairing mode, DOCK indicator flashes on the front panel display.



- To cancel the pairing, press [C]BAND (or [10]BAND LEVEL TITLE) again.

### Note

- If the Bluetooth receiver is not connected to the DOCK terminal of this unit, “No BT adapter” appears on the front panel display.

**4 Check that the Bluetooth component detects the Bluetooth receiver.**

If the Bluetooth component detects the Bluetooth receiver, “YBA-10 YAMAHA” (example) appears in the Bluetooth device list.

**5 Select the Bluetooth receiver in the Bluetooth device list and then enter the pass key “0000” to the Bluetooth component.**

When the pairing is completed successfully, “Completed” appears on the front panel display.

### Note

- The Bluetooth Wireless Audio Receiver can be paired with up to eight other components. When pairing is conducted successfully with a ninth component and the pairing data is registered, the pairing data for the least recently used other component is cleared.

## Playback of the Bluetooth™ component

**1 Press [8]AMP and then press [N]INPUT </> repeatedly (or press [6]V-AUX/DOCK) to select “V-AUX” as the input source.**

**2 Start playback of your Bluetooth component.**

When the connected Bluetooth receiver detects the Bluetooth component, “BT connected” and the DOCK indicator appears on the front panel display.



- When you press [12]ENTER on the remote control, the connected Bluetooth receiver searches and connect to the last connected Bluetooth component. If the Bluetooth receiver cannot find the Bluetooth component, “Not found” appears on the front panel display.
- To disconnect the Bluetooth receiver from the Bluetooth component, press [14]RETURN.

# ADVANCED OPERATION

## Set menu

You can use the following parameters in the set menu to adjust a variety of system settings and customize the way this unit operates. Change the initial settings to reflect the needs of your listening environment.

### Basic setup BASIC SETUP

Use this feature to automatically adjust speaker and system parameters (see page 16).

### Manual setup MANUAL SETUP

Use this feature to manually adjust speaker and system parameters.

#### ■ Sound menu 1 SOUND MENU

Use this menu to manually adjust any speaker settings, alter the quality and tone of the sound output by the system or compensate for video signal processing delays when using LCD monitors or projectors.

Parameter	Features	Page
A)SPEAKER SET	Selects the size of each speaker, the speakers for low-frequency signal output, the crossover frequency, and the location of the front speakers connected to the FRONT B terminals.	32
B)SP LEVEL	Adjusts the output level of each speaker.	33
C)SP DISTANCE	Adjusts the distance of each speaker.	33
D)CENTER GEQ	Adjusts the tonal quality of the center speaker.	33
E)LFE LEVEL	Adjusts the output level of the LFE channel for Dolby Digital or DTS signals.	34
F)D. RANGE	Adjusts the dynamic range of Dolby Digital or DTS signals.	34
G)AUDIO SET	Adjusts the muting level, audio delay settings, maximum volume level and initial volume level.	34

#### ■ Input menu 2 INPUT MENU

Use this menu to manually reassign the input jacks, select the input mode or rename the input source.

Parameter	Features	Page
A)INPUT ASSIGN	Assigns the input jacks on this unit according to the component to be used.	34
B)INPUT RENAME	Changes the name of the input source.	34
C)VOLUME TRIM	Adjusts the output volume of each jack.	35
D)DECODER MODE	Selects the decoder mode for the sources connected to the DIGITAL INPUT jacks on the rear panel of this unit.	35
E)MULTI CH SET	Select the video source played in the background of the sources input from the MULTI CH INPUT jacks.	35

#### ■ Option menu 3 OPTION MENU

Use this menu to manually adjust the optional system parameters.

Parameter	Features	Page
A)DISPLAY SET	Adjusts the brightness of the front panel display.	35
B)MEMORY GUARD	Locks sound field program parameters and other set menu settings.	35
C)AUDIO SELECT	Designates the default audio input jack select setting mode for the input sources connected to the DIGITAL INPUT jacks when you turn on the power of this unit.	36
D)PARAM. INI	Sets all the parameters of the sound field programs to the initial factory settings.	36
E)BLUETOOTH	Pairs the connected Bluetooth Wireless Audio Receiver (such as YBA-10, sold separately) with a Bluetooth component (see page 30).	36

### Signal information SIGNAL INFO

Use this feature to check audio signal information (see page 20).

## Using set menu

Use the remote control to access and adjust each parameter.



- You can change the set menu parameters while this unit is reproducing sound.

**1** Press **[8]AMP** and then press **[11]MENU** on the remote control.  
“BASIC SETUP” appears on the front panel display.

**2** Press **[12]▲ / ▼** to select “MANUAL SETUP.”

• MANUAL SETUP

**3** Press **[12]ENTER** to enter “MANUAL SETUP.”  
“1 SOUND MENU” appears on the front panel display.

1 SOUND MENU

**4** Press **[12]▲ / ▼** repeatedly and then press **[12]ENTER** to select and enter the desired menu.

The following menus appear on the front panel display as you press **[12]▲ / ▼** repeatedly.

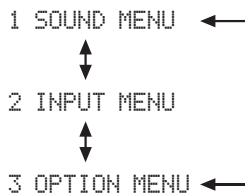

**5** Press **[12]▲ / ▼** repeatedly and then press **[12]ENTER** to select and enter the desired submenu.

- Repeat this step to navigate to and enter the items you want to adjust.
- To return to the previous menu level, press **[14]RETURN**.

**6** Press **[12]▲ / ▼** to select the desired parameter and then **[12]◀ / ▶** to change the parameter value.

- Press **[12]▶** to increase the value.
- Press **[12]◀** to decrease the value.

**7** Press **[11]MENU** to exit from set menu.

## 1 SOUND MENU

Use this menu to manually adjust any speaker settings or compensate for video signal processing delays when using LCD monitors or projectors.



- Initial settings are indicated by (\*) in this following each parameter.

**Speaker settings** A)SPEAKER SET

Use this feature to manually adjust any speaker settings.

■ **FRONT B speaker setting** FRONT B

Use this feature to select the location of the front speakers connected to the FRONT B terminals.

Choice	Condition
FRONT*	When FRONT B speakers are set in the main zone.
ZONE B	When FRONT B speakers are set in another zone. This setting mutes all the speakers in the main room when FRONT B is selected by <b>ⓈPEAKERS</b> .

### Notes

- If you connect headphones to the PHONES jack on this unit, the sound is output from both headphones and the FRONT B terminals while “FRONT B” is set to “ZONE B.”
- If a DSP program is selected when “FRONT B” is set to “ZONE B,” this unit automatically enters the Virtual CINEMA DSP mode (see page 26).

Woofers diameter of a speaker is 16 cm (6.5 in) or larger: large  
Woofers diameter of a speaker is smaller than 16 cm (6.5 in): small

■ **Front speakers, Center speaker, Surround left/right speakers**

FRONT, CENTER, SUR. LR

Select “LARGE (LRG)” or “SMALL (SML)” depending on the size of your each speaker. When Center speaker or Surround speakers is not connected, select “NONE.”

Initial setting:

FRONT: “LARGE”  
CENTER: “SML”  
SUR. LR: “SML”

### Notes

- When “BASS OUT” is set to “FRNT” (see page 32), you can select only “LARGE” in “FRONT.” If “FRONT” is set to a setting other than “LARGE” in advance, this unit automatically changes the value to “LARGE.”
- When you select “NONE” in “CENTER,” the center channel signals are directed to the front left and right speakers.
- When you select “NONE” in “SUR. LR,” this unit is automatically enters the Virtual CINEMA DSP mode (see page 26).

■ **LFE/Bass out** BASS OUT

Use this feature to select the speakers that output the LFE (low-frequency effect) and the low-frequency signals.



- If you are not satisfied with the bass sounds from your speakers, you can change these settings according to your preference.

## LFE signals output

Choice	Subwoofer	Front speakers	Other speakers
BOTH*	Output	No output	No output
SWFR	Output	No output	No output
FRONT	No output	Output	No output

## Low-frequency signals output

Choice	Subwoofer	Front speakers	Other speakers
BOTH*	*1	*2	*3
SWFR	*4	*3	*3
FRONT	No output	*1	*3

## Notes

- \*1 Outputs the low-frequency signals of the front channels and other speakers to "SML" or "NONE."
- \*2 Always output the low-frequency signals of the front channels.
- \*3 Output the low-frequency signals if the sizes of speakers are set to "LARGE" (or "LRG").
- \*4 Output the low-frequency signals of the speakers set to "SML."

## ■ Crossover CROSSOVER

Use this feature to select a crossover frequency of all the speakers set to "SML" (or "SMALL") or to "NONE" in "SPEAKER SET" (see pages 31 and 32).

Choices: 40Hz, 60Hz, 80Hz\*, 90Hz, 100Hz, 110Hz, 120Hz, 160Hz, 200Hz

## Note

- All frequencies below the selected frequency will be sent to the subwoofer or to the speakers set to "LRG" (or "LARGE") in "SPEAKER SET" (see pages 31 and 32).

## ■ Subwoofer phase SWFR PHASE

Use this feature to switch the phase of your subwoofer if bass sounds are lacking or unclear.

Choice	Function
NRM*	Does not reverse the phase of your subwoofer.
REV	Sets the phase of your subwoofer to reverse.

## Speaker level B)SP LEVEL

Use this feature to manually adjust the output level of each speaker.

Control range: -10 to 0\* to +10 dB

Control step: 1 dB

SP LEVEL	Adjusted speaker
FL	Front left speaker
FR	Front right speaker
C	Center speaker
SL	Surround left speaker
SR	Surround right speaker
SWFR	Subwoofer

## Notes

- The available speaker channels differ depending on the setting of the speakers.
- This does not affect recorded material.

## Speaker distance C)SP DISTANCE

Use this feature to manually adjust the distance of each speaker and the delay applied to the respective channel. All sounds would be adjusted to arrive at the listening position at the same time regardless of distance from each speaker.

## ■ Unit UNIT

Choice	Condition
meters	When you adjust speaker distances in meters.
feet*	When you adjust speaker distances in feet.

## ■ Speaker distances

Control range: 0.30 to 24.00 m (1.0 to 80.0 ft)

Control step: 0.10 m (0.5 ft)

Initial setting:

FRONT L/FRONT R/SWFR: 3.00 m (10.0 ft)

CENTER: 2.60 m (8.5 ft)

SUR. L/SUR. R: 2.40 m (8.0 ft)

SP DISTANCE	Adjusted speaker
FRONT L	Front left speaker
FRONT R	Front right speaker
CENTER	Center speaker
SUR. L	Surround left speaker
SUR. R	Surround right speaker
SWFR	Subwoofer

## Note

- The available speaker channels differ depending on the setting of the speakers.

## Center graphic equalizer D)CENTER GEO

Use this feature to adjust the built-in 5-frequency band (100Hz, 300Hz, 1kHz, 3kHz and 10kHz) graphic equalizer for the center channel so that the tonal quality of the center speaker matches that of the front speakers.

Control range: -6.0 to 0\* to +6.0 dB

Control step: 0.5 dB



- Press  $\boxed{\Delta}$  /  $\boxed{\nabla}$  to select a frequency band and  $\boxed{\leftarrow}$  /  $\boxed{\rightarrow}$  to adjust the selected frequency band.
- You can make adjustment while listening to the currently source or a test tone.

Following is an example where "100Hz" is selected as the frequency band.



### ■ Test tone TEST

Use this feature to make adjustments for “CENTER GEQ” while listening to a test tone.

Choice	Function
OFF*	Stops test tones and output the currently.
ON	Outputs test tones from the center and from left speakers.

### Low-frequency effect level E\LFE LEVEL

Use this feature to adjust the output level of the LFE (low-frequency effect) channel according to the capacity of your subwoofer or headphones.

Control range: -20 to 0\* dB

Control step: 1 dB

### ■ Speaker LFE SP LFE

Adjusts the speaker LFE level.

### ■ Headphone LFE HP LFE

Adjusts the headphone LFE level.

#### Notes

- Depending on the settings of “BASS OUT” (see page 32), some signals may not be output at the SUBWOOFER OUTPUT jack.
- The LFE channel carries low-frequency special effects which are only added to certain scenes.
- This setting is effective when the input signal contains the LFE channel.

### Dynamic range F\O.D. RANGE

Use this feature to select the amount of dynamic range compression to be applied to your speakers or headphones. This setting is effective only when this unit is decoding Dolby Digital and DTS signals.

Choice	Function
MIN	Adjusts the dynamic range to narrow.
STD	Adjusts the dynamic range to medium.
MAX*	Preserves the greatest amount of dynamic range.

### ■ Speaker dynamic range SP D.R

Adjusts the speaker compression.

### ■ Headphone dynamic range HP D.R

Adjusts the headphone compression.

### Audio settings G\AUDIO SET

Use this feature to adjust the overall audio settings of this unit.

### ■ Mute type MUTE TYP.

Use this feature to adjust how much the mute function reduces the output volume (see page 19).

Choice	Function
FULL*	Completely mutes all the audio output.
-20dB	Reduces the current volume by 20 dB.

### ■ Audio delay A.DELAY

Use this feature to delay the sound output and synchronize it with the video image. This may be necessary for certain LCD monitors or projectors.

Control range: 0\* to 160 ms

Control step: 1 ms

### ■ Maximum volume MAX VOL.

Use this feature to set the maximum volume level regardless of the original volume range. This feature is useful to avoid the unexpected loud sound.

Control range: +16 dB\*, +10 dB to -30 dB

Control step: 5 dB

#### Note

- The “MAX VOL.” setting takes priority over the “Initial Volume” setting. For example, if “INI.VOL.” is set to -20 dB and “MAX VOL.” is set to -30 dB, the volume level is automatically set to -30 dB when you turn on the power of this unit next time.

### ■ Initial volume INI.VOL.

Use this feature to set the volume level when the power of this unit is turned on.

Choices: Off\*, -80 dB to +16 dB

Control step: 1 dB

#### Note

- The “MAX VOL.” setting takes priority over the “INI.VOL.” setting.

## 2 INPUT MENU

Use this menu to reassign the input jacks, select the input mode or rename the input source.



- Initial settings are indicated by (\*) in this following each parameter.

### Input assignment A\INPUT ASSIGN

Use this feature to assign the input jacks according to the component to be used if the initial settings of this unit do not correspond to your needs.

Choices: CD, MD/CD-R, DVD, DTV/CBL, V-AUX, DVR

Initial setting:

IN (1) (COAXIAL jack): DVD

IN (2) (OPTICAL (DTV/CBL) jack): DTV/CBL

IN (3) (OPTICAL (CD) jack): CD

#### Notes

- You cannot select a specific item more than once.
- You cannot assign the same input source to both “IN (2)” and “IN (3).” For example, you assign “CD” to “IN (2),” “——” appears in “IN (3).”
- Once the input jacks are reassigned, you can select the corresponding component by using **INPUT** </> (or the input selector buttons (6) on the remote control).

### Input rename B\INPUT RENAME

Use this feature to change the name of the input source that appears on the front panel display.

The following is an example where “DVD” is renamed “My DVD.”



**1** Press one of the input selector buttons (**[6]**) or **[22] MULTI CH IN** to select the input source you want to change the name of.

**2** Press **[8] AMP** and then press **[12] </>** on the remote control to place the “\_” (underscore) under the space or the character you want to edit.

**3** Press **[12] ^ / v** to select the character you want to use and then press **[12] </>** to move to the next space.

#### Notes

- You can use up to 8 characters for each input.
- Press **[12] v** to change the character in the following order, or press **[12] ^** to go in the reverse order:  
A to Z, a space, 0 to 9, a space, a to z, a space, symbols (#, \*, -, +, etc.)

**4** Repeat steps 1 through 3 to rename each input source.

**5** Press **[11] MENU** to exit from “INPUT RENAME.”

#### Volume trim C>VOLUME TRIM

Use this feature to adjust the level of the signal input at each jack. This is useful if you want to balance the level of each input source to avoid sudden changes in volume when switching between input sources.

Press one of the input selector buttons (**[6]**) or **[22] MULTI CH IN** to select the input source you want to adjust the level.

Choices: CD, TUNER, MD/CD-R, DVD, DTV/CBL, V-AUX (DOCK), DVR, MULTI CH IN

Control range: -6.0 to 0.0\* to +6.0 dB

Control step: 1.0 dB

#### Decoder mode D>DECODER MODE

##### Decoder select mode

Use this feature to designate the default decoder mode for the input sources connected to the DIGITAL INPUT jacks.

Choice	Function
AUTO*	Automatically detect the type of input signals and selects the appropriate decoder mode.
LAST	Automatically select the last decoder mode used the connected input source.

##### DTS decoder prioritize setting

Choice	Function
AUTO*	Automatically detect the type of input signals and selects the appropriate input mode.
DTS	Enables to playback a DTS-CD.

#### Multi channel input setup

##### E>MULTI CH SET

##### BGV BGV

Use this feature to select the video source played in the background of the sources input from the MULTI CH INPUT jacks.

Choices: LAST\*, DVR, V-AUX, DTV/CBL, DVD



- Select “LAST” to set this unit to automatically select the last selected video source as the background video source.

### 3 OPTION MENU

Use this menu to adjust the optional system parameters.



- Initial settings are indicated by (\*) in this following each parameter.

#### Display settings A>DISPLAY SET

##### Dimmer DIMMER

Use this feature to adjust the brightness of the front panel display.

Control range: -4 to 0\*

Control step: 1

- Press **[12] <** to make the front panel display dimmer.
- Press **[12] >** to make the front panel display brighter.

#### Memory guard B>MEMORY GUARD

##### Memory guard MEM.GUARD

Use this feature to prevent accidental changes to DSP program parameter values and other system settings.

Choice	Function
OFF*	Turns off the “MEM.GUARD” feature.
ON	Protects: <ul style="list-style-type: none"> <li>– sound field program parameters</li> <li>– all set menu items</li> <li>– SCENE template parameters</li> </ul>

#### Note

- When “MEM.GUARD” is set to “ON,” you cannot select and adjust any other set menu items.

**Audio select** C)AUDIO SELECT

Use this feature to designate the default audio input jack select setting for the input sources.

Choice	Function
AUTO*	Automatically detect the type of input signals and select the appropriate input mode.
LAST	Automatically select the last input mode used for the connected input source (see page 18).

**Parameter initialization** D)PARAM. INI

Use this feature to set all the parameters of the sound field programs to the initial factory settings.

Choice	Function
NO*	Cancels the parameter initialization and returns to the previous menu level.
YES	Sets all the sound field parameters to the initial factory settings.

**Notes**

- You cannot automatically revert to the previous parameter settings once you initialize the sound field program parameters.
- You cannot separately initialize individual sound field programs.

**Bluetooth setting** E)BLUETOOTH**Start pairing** START PAIRING

Use this feature to start pairing the connected Bluetooth Wireless Audio Receiver (such as YBA-10, sold separately) with your Bluetooth component. For details about the pairing, refer to “Pairing the Bluetooth™ receiver and your Bluetooth™ component” on page 30.

To ensure security, a time limit of 8 minutes is set for the pairing operation. You are recommended to read and fully understand all the instructions before starting.

**1 Select “START PAIRING” in “BLUETOOTH” and then press [ENTER] to start pairing.**

The connected Bluetooth receiver starts searching Bluetooth components. “Searching...” appears on the front panel display.

**2 Check that the Bluetooth component detects the Bluetooth receiver.**

For details, refer to the instruction manual of the Bluetooth component.

**3 Select the Bluetooth receiver in the Bluetooth device list and then enter the pass key “0000” on the Bluetooth component.**

Once this unit completes the pairing successfully, “Completed” appears.



- To cancel the pairing, press [RETURN] to exit from “START PAIRING.”

**4 Press [RETURN] to exit from “START PAIRING.”****Notes**

- If the connected Bluetooth receiver cannot find any Bluetooth components, “Not found” appears.
- If a Bluetooth receiver is not connected to this unit, “No BT adapter” appears.



# Remote control features

In addition to controlling this unit, the remote control can also operate other audiovisual components made by Yamaha and other manufacturers. To control your TV or other components, you must set up the appropriate remote control code for each input source (see page 39).

## Controlling this unit, a TV, or other components

### ■ Controlling this unit

Press **[8]AMP** to control this unit.

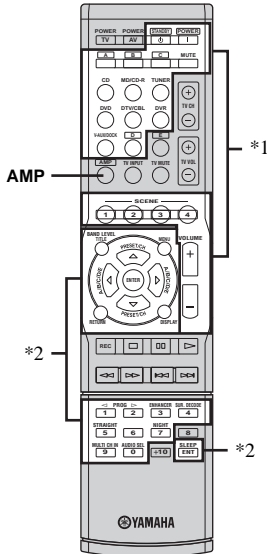

### ■ Controlling a TV

Press **[6]DTV/CBL** to control your TV. To control your TV, set the appropriate remote control code for **[6]DTV/CBL** (see page 39).

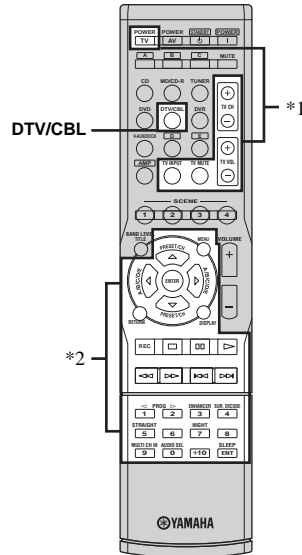

### Notes

- \*1 These buttons always control this unit.
- \*2 These buttons control this unit only when **[8]AMP** is pressed.

### Notes

- \*1 These buttons always control your TV regardless of whether you press **[6]DTV/CBL** or not.

Remote control	Digital TV/Cable TV
TV POWER	Turns on or off the power.
TV CH +/-	Changes the channel number.
TV VOL +/-	Increases or decreases the volume level.
TV INPUT	Changes the input source.
TV MUTE	Mutes the audio output.

- \*2 These buttons control your TV only when **[6]DTV/CBL** is pressed. For details, see the "Digital TV/Cable TV" column on page 38.



- You can control more than one TV by setting the appropriate remote control code for any input source selector buttons other than **[6]DTV/CBL**. In such a case, you can control the buttons highlighted above (\*1 and \*2) when you press the input source selector button.

### Controlling other components

Press one of the input selector buttons ([6]) or A to E buttons to control other components. You must set the appropriate remote control code for each input source in advance (see page 39). The following table shows the function of each control button used to control other components assigned to each input selector button. Be advised that some buttons may not correctly operate the selected component.



- The remote control has 13 modes (input areas) to control components so that the remote control can operate up to 13 different components.
- When you press one of the optional component control area buttons (A to E), you can control the desired component without changing the input source of this unit.

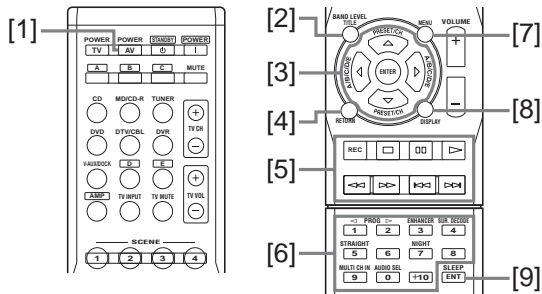

Remote control	DVD player/ recorder	VCR	Digital TV/ Cable TV	LD player	CD player	MD/CD recorder	Tuner
[1] AV POWER	Power *1	Power *1	Power *2	Power *1	Power *1	Power *1	
[2] TITLE	Title						Band
[3] PRESET/CH Δ	Up	VCR channel up	Up				Preset up (1-8)
PRESET/CH ∇	Down	VCR channel down	Down				Preset down (1-8)
A/B/C/D/E ◀	Left		Left				Preset down (A-E)
A/B/C/D/E ▶	Right		Right				Preset up (A-E)
ENTER	Enter		Enter				
[4] RETURN	Return		Return				
[5] REC	Disc skip (player) Rec (recorder)	Rec	Rec *2		Disc skip	Rec	
▷	Play	Play	Play *2	Play	Play	Play	
◀◀	Search backward	Search backward	Search backward *2	Search backward	Search backward	Search backward	
▷▷	Search forward	Search forward	Search forward *2	Search forward	Search forward	Search forward	
⏸	Pause	Pause	Pause *2	Pause	Pause	Pause	
◀◀	Skip backward	Skip backward	Skip backward *2	Skip backward	Skip backward	Skip backward	
▷▷	Skip forward	Skip forward	Skip forward *2	Skip forward	Skip forward	Skip forward	
□	Stop	Stop	Stop *2	Stop	Stop	Stop	
[6] 1-9, 0, +10	Numeric buttons	Numeric buttons	Numeric buttons	Numeric buttons	Numeric buttons	Numeric buttons	Preset stations (1-8)
[7] MENU	Menu		Menu				
[8] DISPLAY	Display	Display	Display	Display	Display	Display	
[9] ENT	Title/Index	Enter	Enter	Chapter/Time	Index	Index	

### Notes

- \*1 This button is operational only when the original remote control supplied with the component has a POWER button.
- \*2 These buttons operate your DVD recorder only when you set the appropriate remote control code for DVR (see page 39).

## Setting remote control codes

You can control other components by setting the appropriate remote control codes. For a complete list of available remote control codes, refer to “List of remote control codes” at the end of this manual.

### Remote control code default settings

Input source	Component category	Manufacturer	Default code
CD	CD	Yamaha	5013
MD/CD-R	CD-R	Yamaha	5001
TUNER	TUNER	Yamaha	5007
DVD	DVD	Yamaha	2000
DTV/CBL	—	—	—
V-AUX/ DOCK	TUNER	Yamaha	5011
DVR	DVR	Yamaha	2011
A	TUNER	Yamaha	5012
B	TUNER	Yamaha	5009
C	TUNER	Yamaha	5017
D	—	—	—
E	—	—	—

#### Note

- You may not be able to operate your Yamaha component even if a Yamaha remote control code is preset as listed above. In this case, try setting another Yamaha remote control code.

- While pressing and holding one of the input selector buttons (6) on the remote control to select the input area you want to set up, press 2 AV POWER for more than 3 seconds.

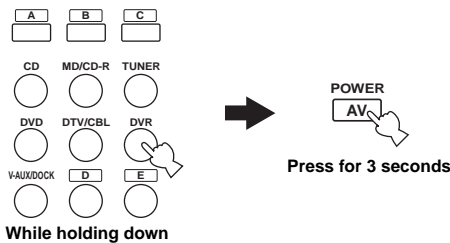

- Press the numeric buttons (0 to 9) (25) to enter the four-digit remote control code for the component to be used.

When the setting succeeds, “RemoteSetup OK” appears; however, when it does not, “RemoteSetup NG” appears on the front panel display.

#### Notes

- If the manufacturer of your component has more than one code, try each of them until you find the correct one.
- If you do not press any buttons within 30 seconds in step 2, the setup process is canceled. If this happens, repeat the setup procedure.

#### Resetting all remote control codes

Use this feature to clear all the remote control codes previously set and reset all of them to the initial factory settings.

- While pressing and holding 8 AMP, press 2 AV POWER for more than 3 seconds.



- Press the numeric buttons (25) to enter the code number “9981.”

“RemoteSetup OK” appears on the front panel display, and the remote control codes previously set are cleared and reset to the initial factory settings.



- If you do not press any buttons within 30 seconds after step 1, the clearing process is canceled. In this case, repeat the clearing procedure.

# Advanced setup

This unit has additional menus that are displayed on the front panel display. The advanced setup menu offers additional operations to adjust and customize the way this unit operates. Change the initial settings (indicated by (\*) in this following parameter) to reflect the needs of your listening environment.

## Notes

- Only **ⒶSTANDBY/ON**, **ⓁPROGRAM** </> and **ⓂSTRAIGHT** are effective while you are using the advanced setup menu.
- No other operations can be made while you are using the advanced setup menu.
- The advanced setup menu is only available on the front panel display.

**1 Press ⒶSTANDBY/ON on the front panel to set this unit to the standby mode.**

**2 Press and hold ⓀTONE CONTROL and then press ⒶSTANDBY/ON to turn on this unit.**

This unit turns on, and the advanced setup menu appears on the front panel display.

**3 Press ⓁPROGRAM </> to select the parameter you want to adjust.**

The name of the selected parameter appears on the front panel display.

**4 Press ⓂSTRAIGHT repeatedly to change the selected parameter setting.**

**5 Press ⒶSTANDBY/ON to confirm your selection and set this unit to the standby mode.**



- The settings you made are reflected next time you turn on this unit.

## ■ Speaker impedance SP IMP. (U.S.A. and Canada models only)

### Caution

If you are to use 6 ohm speakers, set “SP IMP.” to “6ΩMIN” as follows BEFORE using this unit.

Use this feature to set the speaker impedance of this unit so that it matches that of your speakers.

Choices: 8ΩMIN\*, 6ΩMIN

- Select “8ΩMIN” to set the speaker impedance to 8 Ω.
- Select “6ΩMIN” to set the speaker impedance to 6 Ω.

SP IMP.	Speaker	Impedance level
8ΩMIN	Front (A or B)	The impedance of each speaker must be 8 Ω or higher.
	Center	
	Surround	
6ΩMIN	Front (A or B)	The impedance of each speaker must be 6 Ω or higher.
	Center	
	Surround	

## ■ Initializing PRESET

Use this feature to reset all the parameters of this unit to the initial factory settings.

Choices: CANCEL\*, RESET

- Select “CANCEL” not to reset any parameters of this unit.
- Select “RESET” to reset the parameters of this unit.

## Notes

- This setting completely resets all the parameters of this unit including the set menu parameters. However, the advanced setup menu parameters will not be initialized.
- The initial factory settings are activated next time you turn on this unit.

# ADDITIONAL INFORMATION

## Troubleshooting

Refer to the table below when this unit does not function properly. If the problem you are experiencing is not listed below or if the instruction below does not help, turn off this unit, disconnect the power cable, and contact the nearest authorized Yamaha dealer or service center.

### ■ General

Problem	Cause	Remedy	See page
<b>This unit fails to turn on or enters the standby mode soon after the power is turned on.</b>	The power cable is not connected or the plug is not completely inserted.	Connect the power cable firmly.	—
	The speaker impedance setting is incorrect.	Set the speaker impedance to match your speakers.	40
	The protection circuitry has been activated.	Make sure that all speaker wire connections on this unit and on all speakers are secure and that the wire for each connection does not touch anything other than its respective connection.	9
	This unit has been exposed to a strong external electric shock (such as lightning or strong static electricity).	Set this unit to the standby mode, disconnect the power cable, plug it back in after 30 seconds and then use it normally.	—
<b>No sound</b>	Incorrect input or output cable connections.	Connect the cables properly. If the problem persists, the cables may be defective.	11-13
	No appropriate Audio input jack select has been set.	Set an appropriate Audio input jack select.	36
	No appropriate input source has been selected.	Select an appropriate input source with <b>Ⓝ INPUT</b> ◀ / ▶ on the front panel (or the input selector buttons (Ⓜ) on the remote control).	17, 18
	Speaker connections are not secure.	Secure the connections.	9
	The front speakers to be used have not been selected properly.	Select the front speakers with <b>Ⓢ SPEAKERS</b> .	18
	The volume is turned down.	Turn up the volume.	—
	The sound is muted.	Press <b>Ⓜ MUTE</b> or <b>Ⓜ VOLUME +/-</b> on the remote control to resume audio output and then adjust the volume.	19
	Signals this unit cannot reproduce are being input from a source component, such as a CD-ROM.	Play a source whose signals can be reproduced by this unit.	—
	Audio signals input at the HDMI jack are not output from any speaker terminals.	Make an analog or digital connection beside the HDMI connection.	—
	The setting of the connected component is improper.	Make an appropriate setting following the instruction manual of the connected component.	—
<b>The sound suddenly goes off.</b>	The protection circuitry has been activated because of a short circuit, etc.	Check that the impedance setting is correct. Check that the speaker wires are not touching each other and then turn this unit back on.	40 —
	The sleep timer has turned off this unit.	Turn on this unit, and play the source again.	—
	The sound is muted.	Press <b>Ⓜ MUTE</b> or <b>Ⓜ VOLUME +/-</b> on the remote control to resume audio output.	19

<b>Problem</b>	<b>Cause</b>	<b>Remedy</b>	<b>See page</b>
<b>Sound is heard from the speaker on one side only.</b>	Incorrect cable connections.	Connect the cables properly. If the problem persists, the cables may be defective.	11-14
	Incorrect settings in "SP LEVEL."	Adjust the "SP LEVEL" settings.	33
<b>Only the center speaker outputs substantial sound.</b>	When playing a monaural source with a CINEMA DSP program, the source signal is directed to the center channel, and the front and surround speakers output effect sounds.		
<b>No sound is heard from the center speaker.</b>	"CENTER" in "SPEAKER SET" is set to "NONE."	Set "CENTER" to "SML" or "LRG."	32
	Some sound field programs do not output sounds from the center speaker.	Try another sound field program.	25
<b>No sound is heard from the surround speakers.</b>	"SUR. LR" in "SPEAKER SET" is set to "NONE."	Set "SUR. LR" to "SML" or "LRG."	32
	This unit is in the "STRAIGHT" mode and a monaural source is being played back.	Press  <b>STRAIGHT</b> on the front panel so that "STRAIGHT" disappears from the front panel display.	26
<b>No sound is heard from the subwoofer.</b>	"BASS OUT" in "SPEAKER SET" is set to "FRNT" when a Dolby Digital or DTS signal is being played.	Set "BASS OUT" to "SWFR" or "BOTH."	32
	"BASS OUT" in "SPEAKER SET" is set to "SWFR" or "FRNT" when a 2-channel source is being played.	Set "BASS OUT" to "BOTH."	32
	The source does not contain low-frequency bass signals.		
<b>Dolby Digital or DTS sources cannot be played. (Dolby Digital or DTS indicator on the front panel display does not light up.)</b>	The connected component is not set to output Dolby Digital or DTS digital signals.	Make an appropriate setting following the operating instructions for your component.	—
	Audio input jack select is set to "ANALOG."	Set Audio input jack select to "AUTO."	18
<b>A humming sound is heard.</b>	Incorrect cable connections.	Connect the audio cables firmly. If the problem persists, the cables may be defective.	—
<b>The volume level cannot be increased, or the sound is distorted.</b>	You are attempting to set the volume level higher than the maximum volume level.	Adjust "MAX VOL." setting.	34
	The component connected to the AUDIO OUT (REC) jack on this unit is turned off.	Turn on the power of the component.	—
<b>The sound effect cannot be recorded.</b>	It is not possible to record the sound effect with a recording component.		
<b>A source cannot be recorded by an analog component connected to the AUDIO OUT (REC) jack.</b>	The source component is not connected to the analog AUDIO IN jacks on this unit.	Connect the source component to the analog AUDIO IN jacks.	13

Problem	Cause	Remedy	See page
<b>The sound field parameters and some other settings of this unit cannot be changed.</b>	"MEM.GUARD" in "OPTION MENU" is set to "ON."	Set "MEM.GUARD" to "OFF."	35
<b>This unit does not operate properly.</b>	The internal microcomputer has been frozen by an external electric shock (such as lightning or excessive static electricity) or by a power supply with low voltage.	Disconnect the power cable from the AC wall outlet and then plug it in again after about 30 seconds.	—
<b>"CHECK SP WIRES" appears on the front panel display.</b>	Speaker cables are short-circuited.	Make sure all speaker cables are connected correctly.	9
<b>There is noise interference from digital or radio frequency equipment.</b>	This unit is too close to the digital or high-frequency equipment.	Move this unit further away from such equipment.	—
<b>The picture is disturbed.</b>	The video source uses scrambled or encoded signals to prevent dubbing.		
<b>This unit suddenly enters the standby mode.</b>	The internal temperature is too high and the overheat protection circuitry has been activated.	Wait about 1 hour for this unit to cool down and then turn it back on.	—
<b>Virtual CINEMA DSP is not activated.</b>	"MULTI CH" is selected as the input source.	Select an input source other than "MULTI CH."	17
	Headphones are connected to the PHONES jack.	Disconnect the headphone plug from the PHONES jack.	—
	This unit is in the "5ch Stereo" mode.	Exit from the "5ch Stereo" mode.	21
<b>SILENT CINEMA is not activated.</b>	"MULTI CH" is selected as the input source.	Select an input source other than "MULTI CH."	17
	The unit is in the "2ch Stereo," "STRAIGHT" or "Music Enh.2ch" mode.	Exit from the "2ch Stereo," "STRAIGHT" or "Music Enh2ch" mode.	21

■ Tuner

Problem	Cause	Remedy	See page
<b>FM stereo reception is noisy.</b>	The characteristics of FM stereo broadcasts may cause this problem when the transmitter is too far away or the antenna input is poor.	Check the antenna connections.	15
		Try using a high-quality directional FM antenna.	—
		Use the manual tuning method.	27
<b>There is distortion, and clear reception cannot be obtained even with a good FM antenna.</b>	There is multi-path interference.	Adjust the antenna position to eliminate multi-path interference.	—
<b>The desired station cannot be tuned into with the automatic tuning method.</b>	The signal is too weak.	Use a high-quality directional FM antenna.	—
		Use the manual tuning method.	27
<b>Previously preset stations can no longer be tuned into.</b>	This unit has been disconnected for a long period.	Set preset stations.	27

Problem	Cause	Remedy	See page
<b>The desired station cannot be tuned into with the automatic tuning method.</b>	The signal is weak or the antenna connections are loose.	Tighten the AM loop antenna connections and orient it for the best reception.	—
		Use the manual tuning method.	27
<b>AM There are continuous crackling and hissing noises.</b>	Noises result from lightning, fluorescent lamps, motors, thermostats and other electrical equipment.	Use an outdoor antenna and a ground wire. This will help somewhat, but it is difficult to eliminate all noise.	—
<b>There are buzzing and whining noises.</b>	A TV set is being used nearby.	Move this unit away from the TV set.	—

■ **iPod**

**Note**

- In case of a transmission error without a status message appearing on the front panel display, check the connection to your iPod (see page 14).

Status message	Cause	Remedy	See page
Connect error	There is a problem with the signal path from your iPod to this unit.	Turn off this unit and reconnect the Yamaha iPod universal dock to the DOCK terminal of this unit. Try resetting your iPod.	14 —
Unknown iPod	The iPod being used is not supported by this unit.	Only iPod (Click and Wheel), iPod nano, and iPod mini are supported.	—
iPod connected	Your iPod is properly stationed in a Yamaha iPod universal dock (such as YDS-11, sold separately) connected to the DOCK terminal of this unit, and the connection between your iPod and this unit is complete.		
Disconnected	Your iPod was removed from a Yamaha iPod universal dock (such as YDS-11, sold separately) connected to the DOCK terminal of this unit.	Station your iPod back in a Yamaha iPod universal dock (such as YDS-11, sold separately) connected to the DOCK terminal of this unit.	14

■ **Bluetooth**

Status message	Cause	Remedy	See page
Searching...	The Bluetooth receiver and the Bluetooth component is in the middle of the pairing.		
	The Bluetooth receiver and the Bluetooth component is in the middle of establishing the connection.		
Completed	The pairing is completed.		
Canceled	The pairing is canceled.		
BT connected	The connection between the Bluetooth Wireless Audio Receiver (such as YBA-10, sold separately) and the Bluetooth component is established.		
Disconnected	The Bluetooth component is disconnected from the Bluetooth receiver (such as YBA-10, sold separately).		
No BT adapter	The Bluetooth receiver is not connected to the DOCK terminal.	Connect the Bluetooth Wireless Audio Receiver (such as YBA-10, sold separately) to the DOCK terminal.	14



■ Remote control

Problem	Cause	Remedy	See page
<b>The remote control does not work nor function properly.</b>	Wrong distance or angle.	The remote control functions within a maximum range of 6 m (20 ft) and no more than 30 degrees off-axis from the front panel.	8
	Direct sunlight or lighting (from an inverter type of fluorescent lamp, etc.) is striking the remote control sensor of this unit.	Reposition this unit.	—
	The batteries are weak.	Replace all batteries.	8
	The remote control code is not correctly set.	Set the remote control code correctly using “List of remote control codes” at the end of this manual.	39
		Try setting another code for the same manufacturer using “List of remote control codes” at the end of this manual.	39
Even if the remote control code is correctly set, there are some models that do not respond to the remote control.			

■ Resetting the system

Use this feature to reset all the parameters of this unit to the initial factory settings. For details about the procedure of resetting the system, see “Initializing” in “Advanced setup” on page 40.

## ■ Audio information

### Dolby Digital

Dolby Digital is a digital surround sound system that gives you completely independent multi-channel audio. With 3 front channels (front L/R and center), and 2 surround stereo channels, Dolby Digital provides 5 full-range audio channels. With an additional channel especially for bass effects, called LFE (Low Frequency Effect), the system has a total of 5.1-channels (LFE is counted as 0.1 channel). By using 2-channel stereo for the surround speakers, more accurate moving sound effects and surround sound environment are possible than with Dolby Surround. The wide dynamic range from maximum to minimum volume reproduced by the 5 full-range channels and the precise sound orientation generated using digital sound processing provide listeners with unprecedented excitement and realism. With this unit, any sound environment from monaural up to a 5.1-channel configuration can be freely selected for your enjoyment.

### Dolby Pro Logic II

Dolby Pro Logic II is an improved technique used to decode vast numbers of existing Dolby Surround sources. This new technology enables a discrete 5-channel playback with 2 front left and right channels, 1 center channel, and 2 surround left and right channels instead of only 1 surround channel for conventional Pro Logic technology. There are three modes available: "Music mode" for music sources, "Movie mode" for movie sources and "Game mode" for game sources.

### Dolby Surround

Dolby Surround uses a 4-channel analog recording system to reproduce realistic and dynamic sound effects: 2 front left and right channels (stereo), a center channel for dialog (monaural), and a surround channel for special sound effects (monaural). The surround channel reproduces sound within a narrow frequency range. Dolby Surround is widely used with nearly all video tapes and laser discs, and in many TV and cable broadcasts as well. The Dolby Pro Logic decoder built into this unit employs a digital signal processing system that automatically stabilizes the volume on each channel to enhance moving sound effects and directionality.

### DTS Digital Surround

DTS digital surround was developed to replace the analog soundtracks of movies with a 5.1-channel digital sound track, and is now rapidly gaining popularity in movie theaters around the world. DTS, Inc. has developed a home theater system so that you can enjoy the depth of sound and natural spatial representation of DTS digital surround in your home. This system produces practically distortion-free 5.1-channel sound (technically, left, right and center channels, 2 surround channels, plus an LFE 0.1 channel as a subwoofer, for a total of 5.1-channels).

### LFE 0.1 channel

This channel reproduces low-frequency bass signals. The frequency range of this channel is from 20 Hz to 120 Hz. This channel is counted as 0.1 because it only enforces a low-frequency range compared to the full-range reproduced by the other 5 channels in Dolby Digital or DTS 5.1-channel systems.

### PCM (Linear PCM)

Linear PCM is a signal format under which an analog audio signal is digitized, recorded and transmitted without using any compression. This is used as a method of recording CDs and DVD audio. The PCM system uses a technique for sampling the size of the analog signal per very small unit of time. Standing for "Pulse Code Modulation," the analog signal is encoded as pulses and then modulated for recording.

## Sampling frequency and number of quantized bits

When digitizing an analog audio signal, the number of times the signal is sampled per second is called the sampling frequency, while the degree of fineness when converting the sound level into a numeric value is called the number of quantized bits. The range of rates that can be played back is determined based on the sampling rate, while the dynamic range representing the sound level difference is determined by the number of quantized bits. In principle, the higher the sampling frequency, the wider the range of frequencies that can be played back, and the higher the number of quantized bits, the more finely the sound level can be reproduced.

## ■ Sound field program information

### CINEMA DSP

Since the Dolby Surround and DTS systems were originally designed for use in movie theaters, their effect is best felt in a theater having many speakers designed for acoustic effects. Since home conditions, such as room size, wall material, number of speakers, and so on, can differ so widely, it is inevitable that there are differences in the sound heard. Based on a wealth of actually measured data, Yamaha CINEMA DSP uses Yamaha original DSP technology to combine Dolby Pro Logic, Dolby Digital and DTS systems to provide the audiovisual experience of movie theater in the listening room of your own home.

### SILENT CINEMA

Yamaha has developed a natural, realistic sound effect DSP algorithm for headphones. Parameters for headphones have been set for each sound field program so that accurate representations of all the sound field programs can be enjoyed on headphones.

### Virtual CINEMA DSP

Yamaha has developed a Virtual CINEMA DSP algorithm that allows you to enjoy DSP surround effects even without any surround speakers by using virtual surround speakers. It is even possible to enjoy Virtual CINEMA DSP using a minimal two-speaker system that does not include a center speaker.

## ■ Video information

### Component video signal

With the component video signal system, the video signal is separated into the Y signal for the luminance and the PB and PR signals for the chrominance. Color can be reproduced more faithfully with this system because each of these signals is independent. The component signal is also called the "color difference signal" because the luminance signal is subtracted from the color signal. A monitor with component input jacks is required in order to output component signals.

### Composite video signal

With the composite video signal system, the video signal is composed of three basic elements of a video picture: color, brightness and synchronization data. A composite video jack on a video component transmits these three elements combined.

# Specifications

## AUDIO SECTION

- Minimum RMS Output Power for Front, Center, Surround  
[U.S.A. and Canada models]  
1 kHz, 0.9% THD, 8 Ω ..... 100 W/ch  
[Other models]  
1 kHz, 0.9% THD, 6 Ω ..... 100 W/ch
- Maximum Power (JEITA)  
[U.S.A. and Canada models]  
1 kHz, 10% THD, 8 Ω ..... 135 W/ch  
[Asia, China, Korea and General models]  
1 kHz, 10% THD, 6 Ω ..... 135 W/ch
- MAX Power Per Channel  
[U.K., Russia, and Europe models]  
1 kHz, 0.7% THD, 4 Ω ..... 105 W or more
- IEC Power  
[U.K., Russia, and Europe models]  
1 kHz, 0.1% THD, 6 Ω ..... 90 W or more
- Dynamic Power  
[U.S.A. and Canada models] (Impedance Selector: 8 Ω)  
(IHF, 8/6/4/2 Ω) ..... 110/130/160/180 W  
[Other models]  
(IHF, 6/4/2 Ω) ..... 105/130/150 W
- Dynamic Headroom [U.S.A. and Canada models]  
8 Ω ..... 0.41 dB
- Frequency Response  
CD, etc. to Front ..... 10 Hz to 100 kHz, 0/-3 dB  
V-AUX to Front ..... 10 Hz to 20 kHz, 0/-3 dB
- Total Harmonic Distortion  
CD, etc. (2ch stereo) to Front SP OUT,  
[U.S.A. and Canada models]  
1 kHz, 50 W/8 Ω ..... 0.06% or less  
[Other models]  
1 kHz, 50 W/6 Ω ..... 0.06% or less
- Signal to Noise Ratio (IHF-A Network)  
CD, etc. (STEREO) Input shorted  
250 mV ..... 100 dB or more  
200 mV ..... 98 dB or more
- Residual Noise (IHF-A Network)  
Front L/R ..... 170 μV or less
- Channel Separation  
CD, etc. Input 5.1 kΩ shorted (1 kHz/10 kHz)  
..... 60 dB/45 dB or more
- Tone Control  
BASS Boost/Cut ..... ±10 dB/100 Hz  
TREBLE Boost/Cut ..... ±10 dB/20 kHz
- Headphone Jack Rated Output/Impedance  
CD, etc. (1 kHz, 200 mV, 8 Ω) ..... 0.4 V/470 Ω
- Input Sensitivity/Input Impedance  
CD, etc. .... 200 mV/47 kΩ  
MULTI CH INPUT ..... 200 mV/47 kΩ
- Maximum Input Signal  
CD, etc. 1 kHz, 0.5% THD (EFFECT ON) ..... 2.0 V or more
- Output Level/Output Impedance  
AUDIO OUT (REC) ..... 200 mV/1.2 kΩ  
SUBWOOFER OUTPUT  
(2ch Stereo and FRONT SP: SMALL) ..... 4 V/1.2 kΩ

- Filter Characteristics (fc=40/60/80/90/100/110/120/160/200 Hz)  
H.P.F. (Front, Center, Surround) ..... 12 dB/oct.  
L.P.F. (Subwoofer) ..... 24 dB/oct.

## VIDEO SECTION

- Signal Level  
Composite ..... 1 Vp-p/75 Ω  
Component ..... 1 Vp-p/75 Ω (Y), 0.7 Vp-p/75 Ω (PB/PR)
- Video Maximum Input Level ..... 1.5 Vp-p or more
- Signal to Noise Ratio ..... 50 dB or more
- Frequency Response (MONITOR OUT)  
Component Signal ..... 5 Hz to 60 MHz, -3 dB

## FM SECTION

- Tuning Range  
[U.S.A. and Canada models] ..... 87.5 to 107.9 MHz  
[Asia and General models] ..... 87.5/87.50 to 108.0/108.00 MHz  
[Other models] ..... 87.50 to 108.00 MHz
- 50 dB Quieting Sensitivity (IHF, 100% mod.)  
Mono ..... 2.8 μV (20.2 dBf)
- Signal to Noise Ratio (IHF)  
Mono/Stereo ..... 73 dB/70 dB
- Harmonic Distortion (1 kHz)  
Mono/Stereo ..... 0.5%/0.5%

## AM SECTION

- Tuning Range  
[U.S.A. and Canada models] ..... 530 to 1710 kHz  
[Asia and General models] ..... 530/531 to 1710/1611 kHz  
[Other models] ..... 531 to 1611 kHz

## GENERAL

- Power Supply  
[U.S.A. and Canada models] ..... 120 V AC, 60 Hz  
[Australia model] ..... 240 V AC, 50 Hz  
[Korea model] ..... 220 V AC, 60 Hz  
[China model] ..... 220 V AC, 50 Hz  
[U.K., Russia, and Europe models] ..... 230 V AC, 50 Hz  
[Asia and General models]  
..... 110-120/220-240 V AC, 50/60 Hz
- Power Consumption  
[U.S.A. and Canada models] ..... 240 W/320 VA  
[Other models] ..... 240 W
- Standby Power Consumption  
[Except Asia and General models] ..... 0.8 W
- Maximum Power Consumption  
[Asia and General models]  
5ch, 10%/THD ..... 530 W
- Dimensions (W x H x D) ..... 435 x 151 x 318 mm  
(17-1/8" x 5-15/16" x 12-1/2")
- Weight ..... 8.0 kg (17 lbs 10 oz)

\* Specifications are subject to change without notice.

# Index

## ■ Numerics

1 SOUND MENU .....	31, 32
2 INPUT MENU .....	31, 34
2ch Stereo .....	25
3 OPTION MENU .....	31, 35
5ch Stereo .....	25

## ■ A

A)DISPLAY SET .....	35
A)INPUT ASSIGN .....	34
A)SPEAKER SET .....	32
A.DELAY .....	34
A/B/C/D/E, front panel .....	3
Adjusting the speaker level .....	19
Adjusting the tonal quality .....	19
AM tuning .....	27
AMP, remote control .....	5
ANTENNA terminals .....	6
Audio cable plugs .....	11
Audio delay .....	34
AUDIO jacks .....	6, 11
Audio jacks .....	11
AUDIO L/R (VIDEO AUX) jacks, front panel .....	3
AUDIO SEL, remote control .....	5
AUDIO SELECT .....	18
Audio select .....	36
Audio settings .....	34
Automatic preset tuning .....	27
Automatic tuning .....	27

## ■ B

B)INPUT RENAME .....	34
B)MEMORY GUARD .....	35
B)SP LEVEL .....	33
BAND LEVEL TITLE, remote control .....	5
BAND, front panel .....	3
BASIC SETUP .....	16, 31
Basic setup .....	31
BASS OUT .....	32
BGV .....	35
Bluetooth setting .....	36
Bluetooth status message .....	44
BT connected, Bluetooth status message .....	44

## ■ C

C)AUDIO SELECT .....	36
C)SP DISTANCE .....	33
C)VOLUME TRIM .....	35
Canceled, Bluetooth status message .....	44
CD Listening .....	22
CD Music Listening .....	22
CENTER .....	32
Center graphic equalizer .....	33
Center speaker .....	32
Center width .....	26
CINEMA DSP indicator .....	4
Completed, Bluetooth status message .....	44
COMPONENT VIDEO jacks .....	6, 11
Connect error, iPod controlling status message .....	44
Connecting a DVD player .....	13
Connecting a TV .....	12
Connecting audio components .....	13
Connecting speakers .....	9
Connecting the AM antennas .....	15
Connecting the Bluetooth Wireless Audio Receiver .....	14
Connecting the FM antennas .....	15
Connecting the power cable .....	15
Connecting the Yamaha iPod universal dock .....	14
Connecting to CD player .....	13
Connecting to DVD recorder .....	13
Connecting to MD recorder/CD recorder .....	13
Connecting to the CENTER terminals .....	10

## Connecting to the COMPONENT

VIDEO jacks .....	11
Connecting to the FRONT A terminals .....	10
Connecting to the FRONT B terminals .....	10
Connecting to the HDMI jacks .....	11
Connecting to the MULTI CH INPUT jacks .....	14
Connecting to the SURROUND terminals .....	10
Connecting video components .....	13
Control buttons, remote control .....	5
Creating original SCENE templates .....	23
CROSSOVER .....	33
Crossover .....	33
CT WIDTH .....	26
Cursors/ENTER, remote control .....	5

## ■ D

D)CENTER GEO .....	33
D)DECODER MODE .....	35
D)PARAM. INI .....	36
Decoder indicator .....	4
Decoder mode .....	35
Decoder select mode .....	35
DIGITAL AUDIO COAXIAL jack .....	11
DIGITAL AUDIO OPTICAL jacks .....	11
DIGITAL INPUT COAXIAL assignment .....	34
DIGITAL INPUT jacks .....	6
DIMENSION .....	26
Dimension .....	26
DIMMER .....	35
Dimmer .....	35
Disc Listening .....	22
Disconnected, Bluetooth status message .....	44
Disconnected, iPod controlling status message .....	44
Display settings .....	35
DISPLAY, remote control .....	5
DOCK indicator, Front panel display .....	4
Dock Listening .....	22
DOCK terminal .....	6
DSP LEVEL .....	26
DSP level .....	26
DTS decoder prioritize setting .....	35
DVD Live Viewing .....	22
DVD Movie Viewing .....	22
DVD Viewing .....	22
DVR Viewing .....	22
Dynamic range .....	34

## ■ E

E)BLUETOOTH .....	36
E)LFE LEVEL .....	34
E)MULTI CH SET .....	35
EDIT PRESET/TUNING, front panel .....	3
Editing sound field parameters .....	26
ENHANCER indicator .....	4
ENHANCER, remote control .....	5
Enjoying 2-channel sources using the standard decoders .....	26
Exchanging preset stations .....	28

## ■ F

F)D.RANGE .....	34
FM tuning .....	27
FRONT .....	32
FRONT B .....	32
FRONT B speaker setting .....	32
Front panel .....	3
Front panel display .....	3, 4
Front speakers .....	32

## ■ G

G)AUDIO SET .....	34
Game Playing .....	23

## ■ H

Hall .....	25
HDMI .....	11
HDMI jack, HDMI cable plug .....	11
HDMI terminals .....	6
Headphone dynamic range .....	34
Headphone LFE .....	34
Headphones indicator .....	4
HP D.R .....	34
HP LFE .....	34

## ■ I

Infrared window .....	8
Infrared window, remote control .....	5
INI.VOL .....	34
Initial volume .....	34
Initializing .....	40
Input assignment .....	34
Input channel and speaker indicators .....	4
Input channel indicators .....	4
Input menu .....	31
Input rename .....	34
Input selector buttons, remote control .....	5
Input source indicators .....	4
Input source information .....	20
INPUT, front panel .....	3
Installing batteries in the remote control .....	8
iPod connected, iPod controlling status message .....	44
iPod control, Status message .....	44

## ■ J

Jazz .....	25
------------	----

## ■ L

LFE indicator .....	4
LFE/Bass out .....	32
Listening to unprocessed input signals .....	26
Low-frequency effect level .....	34

## ■ M

Manual preset tuning .....	28
MANUAL SETUP .....	31
Manual setup .....	31
Manual tuning .....	27
MAX VOL .....	34
Maximum volume .....	34
MEM.GUARD .....	35
Memory guard .....	35
MEMORY, front panel .....	3
MENU, remote control .....	5
Movie Dramatic .....	25
Movie Spacious .....	25
MULTI CH IN, remote control .....	5
MULTI CH INPUT jacks .....	6
Multi-channel input setup .....	35
Multi-channel sources and sound field programs with headphones .....	26
Multi-information display .....	4
Music Disc Listening .....	22
Music Enh. 2ch .....	25
Music Enh. 5ch .....	25
MUTE indicator .....	4
MUTE TYP. ....	34
Mute type .....	34
MUTE, remote control .....	5
Muting the audio output .....	19

## ■ N

NIGHT indicator .....	4
Night listening mode .....	19
NIGHT, front panel .....	3
NIGHT, remote control .....	5
No BT adapter, Bluetooth status message .....	44
Numeric buttons, remote control .....	5

## ■ O

Option menu .....31

## ■ P

Pairing, Bluetooth control .....30  
 PANORAMA .....26  
 Panorama .....26  
 Parameter initialization .....36  
 PCM indicator .....4  
 PHONES jack, front panel .....3  
 Placing speakers .....9  
 Playing video sources in the background .....20  
 Pop/Rock .....25  
 PORTABLE (VIDEO AUX) jack,  
 front panel .....3  
 Power cable .....6  
 POWER, remote control .....5  
 PRESET .....40  
 Preset SCENE templates .....22  
 PRESET/TUNING, front panel .....3  
 PROG, remote control .....5  
 PROGRAM, front panel .....3

## ■ R

Radio Listening .....22  
 Rear panel .....6  
 Remote control .....5  
 Resetting the system .....40  
 RETURN, remote control .....5

## ■ S

SCENE .....21  
 SCENE 1/2/3/4, front panel .....3  
 SCENE 1/2/3/4, remote control .....5  
 Searching..., Bluetooth status message .....44  
 Selecting audio input jacks .....18  
 Selecting preset stations .....28  
 Selecting the MULTI CH INPUT  
 component as the input source .....18  
 Selecting the night listening mode .....19  
 Selecting the SCENE templates .....21  
 Set menu .....31  
 Set this unit to the standby mode .....15  
 Setting input source of the customized SCENE  
 template on the remote control .....24  
 Setting remote control codes .....39  
 Setting the speaker impedance .....40  
 SIGNAL INFO .....20  
 Signal information .....31  
 SILENT CINEMA .....26  
 SILENT CINEMA indicator .....4  
 SLEEP indicator .....4  
 Sleep timer .....20  
 SLEEP, remote control .....5  
 Sound field programs .....25  
 Sound menu .....31  
 SP A B indicators .....4  
 SP D.R .....34  
 SP IMP. ....40  
 SP LFE .....34  
 Speaker distance .....33  
 Speaker distances .....33  
 Speaker dynamic range .....34  
 Speaker impedance .....40  
 Speaker level .....33  
 Speaker LFE .....34  
 Speaker settings .....32  
 SPEAKERS terminals .....6  
 SPEAKERS, front panel .....3  
 Specifications .....47  
 STANDBY, remote control .....5  
 STANDBY/ON, front panel .....3  
 START PAIRING .....36  
 Start pairing .....36  
 Straight decoding mode .....26  
 STRAIGHT, front panel .....3  
 STRAIGHT, remote control .....5  
 SUBWOOFER OUTPUT jack .....6

Subwoofer phase .....33  
 Supplied accessories .....2  
 SUR. LR .....32  
 SUR.DECODE, remote control .....5  
 Surround left/right speakers .....32  
 SWFR PHASE .....33

## ■ T

TEST .....34  
 Test tone .....34  
 TONE CONTROL, front panel .....3  
 Troubleshooting .....41  
 Tuner indicators .....4  
 TUNING AUTO/MAN'L, front panel .....3  
 Turning off the power .....15  
 Turning on the power .....15  
 TV control buttons, remote control .....5  
 TV Sports .....25  
 TV Sports Viewing .....22  
 TV Viewing .....22  
 TV/AV POWER, remote control .....5

## ■ U

UNIT .....33  
 Unit .....33  
 Unknown iPod, iPod controlling status  
 message .....44  
 Using the remote control .....8  
 Using the VIDEO AUX jacks .....15  
 Using your headphones .....19

## ■ V

VIDEO (VIDEO AUX) jack, front panel .....3  
 Video cable plugs .....11  
 VIDEO jacks .....6, 11  
 Video jacks .....11  
 Virtual CINEMA DSP .....26  
 VIRTUAL indicator .....4  
 VOLUME +/-, remote control .....5  
 VOLUME control, front panel .....3  
 VOLUME level indicator .....4  
 Volume Trim .....35

## ■ Z

Zone B .....18

“(A)STANDBY/ON” or  
 “(6)DVD” (example) indicates the  
 name of the parts on the front panel  
 or the remote control. Refer to  
 “Functional overview” on page 3.

# List of remote control codes

---

## Blu-ray Player

Samsung 2137

---

## CD Player

Yamaha 5000, 5013

---

## CD Recorder

Yamaha 5001

---

## DVD

### Acoustic Solutions

2078

Aiwa 2055, 2100

Akai 2096

Akura 2076

Alba 2078, 2086

Apex 2027, 2049

Awa 2078

Axion 2078

Brainwave 2096

Brandt 2073, 2085

Broksonic 2060

Bush 2075, 2078, 2112

Centrex 2077

Classic 2078

Clatronic 2075

Coby 2078

C-Tech 2074

CyberHome 2025, 2079, 2091

Daewoo 2092, 2098

Dansai 2096

Daytek 2080, 2089

DEC 2075

Denon 2030, 2102, 2103

Denver 2075, 2076

Diamond 2074

DK Digital 2094

Dual 2078

D-Vision 2096

DVX 2074

Elta 2096

Euroline 2096

Funai 2052, 2058

Global Solutions 2074

Global Sphere 2074

Goodmans 2075, 2077, 2078

Grundig 2077, 2098

H&B 2075

Haaz 2074

HE 2078

Hitachi 2032, 2072

Home Electronics

2078

Innovation 2072

Irradio 2134

JDB 2078

JVC 2033, 2045, 2053,

2073, 2099

Kenwood 2030, 2097

Kingavon 2075

Koda 2075

Lawson 2074

Lenco 2075

LG 2084, 2087

Lifetec 2072

Limit 2074

LogicLab 2074

Luxor 2077

Magnavox 2037, 2073, 2075

Magnum 2072

MBO 2078

Medion 2072

Micommaxx 2072

Micromedia 2073

Microstar 2072

Mitsubishi 2035

Mizuda 2075

Mustek 2078

Naiko 2077

Onkyo 2073, 2135

Orava 2075

P&B 2075

Pacific 2074

Panasonic 2030, 2040, 2054,

2057, 2105, 2110

Philips 2019, 2026, 2046,

2073, 2081, 2090

Pioneer 2036, 2082

Proline 2077

Provision 2075

RCA 2031, 2042, 2050,

2051

Red Star 2076

Reoc 2074

Roadstar 2075, 2078, 2086

Rowa 2077

Saba 2085

Sabaki 2074

Samsung 2032, 2041, 2104,

2113

Sansui 2074

Sanyo 2095

ScanMagic 2078

Scientific Labs 2074

Scott 2088

SEG 2074, 2086

Sharp 2034, 2043, 2059,

2093, 2106

Silva 2076

Singer 2074

Skymaster 2074, 2078

Skyworth 2076

SM Electronic 2074, 2078

Sony 2028, 2029, 2039,

2083, 2107

Soundmaster 2074

Soundmax 2074

Standard 2074

Star Cluster 2074

Starmedia 2075

Supervision 2074, 2078

Sylvania 2052, 2058

Synn 2074

TCM 2072

Teac 2074

Tec 2076

Technics 2030

Technika 2096

Technosonic 2096

Tevion 2072, 2074

Thomson 2085, 2109

Tokai 2076

Toshiba 2026, 2044, 2048,

2056, 2073, 2108,

2111

United 2078

Voxson 2078

Wharfedale 2074

Xlogic 2074

Yakumo 2077

Yamada 2077

Yamaha 2000, 2001, 2003,

2030, 2101

Yukai 2078

Zenith 2038, 2047, 2073

2073

2072

2073

2072

2035

2075

2078

2077

2073, 2135

2075

2075

2074

2030, 2040, 2054,

2057, 2105, 2110

2019, 2026, 2046,

2073, 2081, 2090

2036, 2082

2077

2075

2031, 2042, 2050,

2051

2076

2074

2075, 2078, 2086

2077

2085

2074

2032, 2041, 2104,

2113

2074

2095

2078

2074

2088

2074, 2086

2034, 2043, 2059,

2093, 2106

2076

2074

2074, 2078

2076

2074, 2078

2028, 2029, 2039,

2083, 2107

2074

2074

2074

2074

2075

2074, 2078

2052, 2058

2074

2072

2074

2076

2085, 2109

2076

2026, 2044, 2048,

2056, 2073, 2108,

2111

2078

2078

2074

2074

2077

2077

2077

2077

2077

2077

2077

2077

2077

2077

2077

2077

2077

Microsoft 2132

Mind 2132

Niveus Media 2132

Northgate 2132

Panasonic 2015, 2016, 2017,

2120

Philips 2117, 2121, 2123,

2128

Pioneer 2012, 2013, 2014

Proscan 2129

RCA 2116, 2124, 2129,

2133

ReplayTV 2118, 2119, 2120

Sharp 2009, 2010

Sonic Blue 2119, 2120

Sony 2005, 2006, 2007,

2122, 2130, 2131,

2132

Stack 10 2132

Stack 9 2132

Systemax 2132

Tagar Systems 2132

Tivo 2116, 2121, 2122,

2123, 2130, 2131

Toshiba 2004, 2125, 2132

Touch 2132

UltimateTV 2133

Viewsonic 2132

Voodoo 2132

Yamaha 2011

ZT Group 2132

2132

2132

2132

2132

2132

2132

2132

2132

2132

2132

2132

2132

2132

2132

2132

2132

2132

2132

2132

2132

2132

2132

2132

2132

Akai	0059, 0065, 0127, 0129, 0130, 0200, 0204, 0208, 0209, 0213, 0217, 0218, 0255	Cascade	0208	Envision	0060, 0061	Hisawa	0209, 0218
		Cathay	0213, 0217	Erres	0213, 0217	Hitachi	0006, 0014, 0015, 0016, 0042, 0060, 0061, 0095, 0105, 0127, 0156, 0179, 0180, 0204, 0207, 0210, 0211, 0215, 0216, 0251
		CCE	0127	ESA	0080		
		Celebrity	0059	Etron	0208		
		Centurion	0213, 0217	Euro-Feel	0206		
Akiba	0209, 0218	Century	0205	Euroline	0217		
Akura	0206, 0209, 0218	CGE	0214, 0215	Euroman	0200		
Alaron	0200	Cimline	0208, 0218	Euromann	0206, 0207, 0213		
Alba	0200, 0207, 0208, 0209, 0217, 0218	Citizen	0060, 0061, 0062, 0064	Europhon	0200, 0204, 0207, 0213, 0215	Hornymphon	0213
ALBIRAL	0212	City	0208	Fenner	0208	Hoshai	0209, 0218
Allstar	0213	Clarivox	0212, 0217	Ferguson	0212, 0217, 0226	Huanyu	0200, 0207
Amplivision	0207	Clatronic	0206, 0207, 0208, 0209, 0213, 0214, 0218	Fidelity	0200, 0207, 0210	Hygashi	0200, 0207
Amstrad	0204, 0206, 0208, 0209, 0218			Finlandia	0210	Hyper	0200, 0207, 0208, 0214, 0215
Amtron	0062	CMS	0200	Finlux	0204, 0205, 0207, 0213, 0215, 0217	Hypson	0206, 0207, 0213, 0217
Anam	0208	Colortyme	0060, 0061	Firstline	0200, 0207, 0208, 0213, 0214	ICE	0127, 0200, 0206, 0207, 0208, 0209, 0213, 0218
Anam National	0062	Concerto	0060, 0061	Fisher	0064, 0127, 0128, 0205, 0207, 0215	ICeS	0200, 0218
Anglo	0208	Concorde	0208	Flint	0213, 0218	IMA	0062
Anitech	0206, 0208	Condor	0200, 0207, 0213	Formenti	0200, 0205, 0207, 0215, 0217	Imperial	0211, 0213, 0214, 0215
Ansonic	0203, 0208	Contec	0200, 0207, 0208	Formenti-Phoenix		Indiana	0213, 0217
AOC	0060, 0061	Contec/Cony	0062			Infinity	0063
Apex	0118, 0122, 0132	Continental Edison				Ingelen	0211
Arc en Ciel	0216		0216			Ingersol	0208
Arcam	0200	Cosmel	0208		0200	Inno Hit	0201, 0204, 0207, 0208, 0209, 0213, 0217, 0218
Arcam Delta	0207	Craig	0062	Fortress	0205	Innovation	0206, 0208
Aristona	0213, 0217	Crosley	0205, 0214, 0215	Frontech	0206, 0208, 0210, 0211, 0214	Interbuy	0208, 0214
ASA	0205, 0211	Crown	0062, 0063, 0128, 0208, 0213, 0217	Fujitsu	0023, 0024, 0025, 0088, 0127	Interfunk	0205, 0211, 0213, 0214, 0216, 0217
Asberg	0213					International	0200
Astra	0208	CS Electronics	0200, 0207, 0209, 0214, 0218	Funai	0033, 0034, 0035, 0036, 0037, 0062, 0206	Intervision	0206, 0207, 0218
Asuka	0200, 0206, 0207, 0209, 0218	CTC	0214			Irradio	0201, 0208, 0209, 0213, 0217, 0218
Atlantic	0200, 0207, 0213, 0217	Curtis Mathes	0057, 0060, 0061, 0064, 0065	Futuretech	0062	Isukai	0209, 0218
Atori	0208	CXC	0062	Gateway	0094	ITC	0207, 0215
AudioSonic	0207, 0208, 0209, 0213, 0216, 0217, 0218	Cybertron	0209, 0218	GBC	0208, 0215, 0218	ITS	0200, 0209, 0213, 0218
		Daewoo	0060, 0061, 0120, 0127, 0155, 0193, 0200, 0207, 0208, 0213, 0218, 0238	GE	0057, 0060, 0061, 0122, 0147	ITT	0129, 0208, 0211
AudioTon	0207			GEC	0204, 0207, 0211, 0213, 0217	ITV	0208, 0217
Audiovox	0062			Geloso	0208, 0210, 0215	JBL	0063
Autovox	0205, 0206, 0207	Dainichi	0200, 0209, 0218	General Technic	0208	JC Penney	0057, 0060, 0061
Awa	0200	Dansai	0200, 0206, 0213, 0217	Genexxa	0209, 0211, 0213, 0218	JCB	0059
Baird	0216			Gibraltar	0060	Jensen	0060, 0061
Bang & Olufsen	0205	Dantax	0217	GoldHand	0200	JVC	0017, 0018, 0019, 0108, 0136, 0153, 0178, 0190, 0213, 0218
Basic Line	0208, 0209, 0213, 0218	Daytron	0060, 0061, 0208	GoldStar	0060, 0061, 0127, 0128, 0200, 0201, 0207, 0208, 0210, 0213, 0214, 0215, 0217	Kaisui	0200, 0207, 0208, 0209, 0218
		De Graaf	0210			Kamosonic	0207
Bastide	0207	Decca	0204, 0207, 0213, 0217			Kamp	0200, 0207
Baur	0217					Kapsch	0211
Beko	0228	Desmet	0213, 0217			Karcher	0207, 0208, 0212, 0217
Belcor	0060	Diamond	0200			Kawasho	0059, 0060, 0061, 0200
Bell & Howell	0058, 0064	Dimensia	0057			Kendo	0128, 0210
Benq	0081	Dixi	0208, 0213, 0217	Goodmans	0171, 0201, 0204, 0206, 0208, 0213, 0217, 0240	Kennedy	0215
Beon	0213, 0217	DTS	0208			Kenwood	0060, 0061
Bestar	0213	Dual	0207, 0215, 0216	GPM	0209, 0218	Kingsley	0200, 0207
Binatone	0207	Dual-Tec	0207, 0208, 0215	Graetz	0211	Kloss Novabeam	0062
Black Star	0214	Dumont	0060, 0127, 0205, 0207	Granada	0204, 0207, 0210, 0213, 0217	Kneissel	0203
Blue Sky	0209, 0218	Durabrand	0126			Kolster	0213
Bondstec	0214	Dux	0217	Grandin	0208, 0209, 0217	Konka	0209, 0218
Boots	0207	Dynatron	0213, 0217	Grundig	0128, 0130, 0222, 0236, 0255	Korpel	0213, 0217
Bradford	0062	Elbe	0203, 0204, 0212, 0218			Korting	0205
Brandt	0216, 0226	Elbe-Sharp	0204	Grunpy	0062	Koyoda	0208
Brionvega	0205, 0213, 0217	Elcit	0204, 0205	Halifax	0200, 0206, 0207	KTV	0062, 0127, 0207
Britannia	0200, 0207	ELECTRO TECH		Hallmark	0060, 0061	Kyoto	0200, 0212
Brockwood	0060			Hampton	0200, 0207		
Broksonic	0138		0208	Hanseatic	0203, 0207, 0208, 0213, 0215, 0217		
Bruns	0205	Electroband	0059				
BSR	0215	Electrohome	0059, 0060, 0061	Hantarex	0204, 0208		
BTC	0209, 0218	Elin	0200, 0207, 0213, 0217	Harvard	0062		
Bush	0177, 0208, 0209, 0210, 0213, 0215, 0216, 0217, 0218, 0230, 0237	Elite	0209, 0213, 0218	HCM	0206, 0207, 0208, 0218		
		Elman	0215	Hifivox	0216		
		Elta	0200, 0208	Higashi	0200		
Candle	0060, 0061	Emerson	0060, 0061, 0062, 0064, 0128, 0205	Hinari	0208, 0209, 0213, 0217, 0218		
Capsonic	0206						

Lenco	0208	NEC	0026, 0053, 0060,	0182, 0194, 0195,	Sanyo	0020, 0021, 0022,	
Lenoir	0207, 0208		0061, 0096, 0127	0211, 0213, 0216,		0049, 0060, 0064,	
Lesla	0214	Neckermann	0205, 0207, 0210,	0217, 0250		0127, 0128, 0200,	
Leyco	0206, 0213, 0217		0213, 0217, 0255	0206, 0213		0203, 0207, 0215	
LG	0016, 0038, 0039,	NEI	0213, 0217	Plantron			
	0127, 0128, 0157,	Nesco	0214	Polaroid	0075	SBR	0217
	0158, 0163, 0164,	NET-TV	0082, 0101	Poppy	0208	SCHAUB LORENTZ	0211
	0166, 0188, 0189,	New Tech	0208, 0213	Portland	0060, 0061		
	0200, 0201, 0207,	New World	0209, 0218	Prandoni-Prince	0204, 0210	Schneider	0207, 0209, 0213,
	0208, 0210, 0213,	Nicamagic	0200, 0207	Precision	0207		0215, 0216, 0217,
	0214, 0215, 0217	Nikkai	0200, 0206, 0207,	Prima	0208, 0211		0218
Liesenk	0217		0209, 0213, 0217,	Profex	0208	Scotch	0061
Life	0206, 0208		0218	Profi-Tronic	0213	Scott	0060, 0061, 0062
Lifetec	0206, 0208, 0218	Nikko	0061	Proline	0213	Sears	0057, 0060, 0061,
Loewe	0063, 0128, 0203,	Noblisko	0200, 0207	Proscan	0057		0064
	0204, 0223, 0227	Nogamatic	0216	Prosonic	0200, 0207, 0217	SEG	0200, 0206, 0207,
Loewe Opta	0205, 0213, 0217	Nokia	0129, 0211	Protech	0206, 0207, 0208,		0214, 0215, 0217
Logik	0058	Nordmende	0205, 0211, 0213,		0213, 0214, 0215,	SEI	0204
Luma	0210, 0217		0216	Proton	0060, 0061	SEI-Sinudyne	0204, 0205, 0211
Lumatron	0210, 0213, 0217	Nordvision	0217	Provision	0217	Seleco	0210, 0211, 0215
Lux May	0213	Oceanic	0211	Pulsar	0060	Sencora	0208
Luxman	0060, 0061	Olevia	0084	Pye	0213, 0217	Sentra	0218
Luxor	0201, 0207, 0210	ONCEAS	0207	Pymi	0208	Serino	0200
LXI	0057, 0061, 0063,	Onwa	0062, 0218	Quasar	0152, 0214	Sharp	0009, 0010, 0011,
	0064	Orbit	0213	Quelle	0201, 0206, 0207,		0060, 0061, 0066,
Magnadyne	0204, 0205, 0214,	Orion	0126, 0204, 0208,		0213, 0214, 0215,		0070, 0087, 0111,
	0215, 0217		0213, 0217, 0235		0217		0143, 0145, 0167,
Magnafon	0200, 0204, 0207	Orline	0218	Radialva	0218		0168, 0169, 0198,
Magnavox	0060, 0061, 0063,	Orsowe	0204	Radio Shack	0064		0204, 0224, 0247,
	0102, 0103, 0150	Osaki	0127, 0206, 0207,	Radio Shack/Realistic		Shogun	0248, 0249
Magnum	0206, 0208		0209, 0218		0057, 0060, 0061,		0060
Majestic	0058	Osio	0201		0062, 0064	Siarem	0204, 0205, 0215
Mandor	0206	Oso	0209, 0218	Radiola	0213, 0217	Sicatel	0212
Manesth	0206, 0207, 0213,	Osume	0218	Radiomarelli	0204, 0205, 0214	Siemens	0255
	0217	Otto Versand	0204, 0207, 0213,	Radiotone	0213	Sierra	0213
Marantz	0060, 0061, 0063,		0215, 0216, 0217,	RCA	0057, 0060, 0061,	Signature	0058
	0090, 0213, 0217		0255		0091, 0133, 0135,	Silva	0200
Marelli	0205	Pael	0200, 0207		0147, 0149	Singer	0205, 0214, 0215
Mark	0200, 0213, 0217	Palladium	0207	Realistic	0064	Sinudyne	0204, 0205, 0215,
Matsui	0204, 0207, 0208,	Panama	0200, 0206, 0207,		0064		0217
	0210, 0213, 0217		0208	Revox	0213, 0217	Skantic	0211
Mediator	0213, 0217	Panasonic	0006, 0007, 0063,	Rex	0206, 0210, 0211	Solavox	0211
Medion	0206, 0208		0073, 0074, 0097,	RFT	0203, 0205	Sonoko	0206, 0207, 0208,
Megatron	0061		0110, 0114, 0137,	Rhapsody	0200		0213, 0217
Melectronic	0200, 0207, 0208,		0141, 0151, 0162,	R-Line	0213, 0217	Sonolor	0211
	0211, 0213, 0216,		0165, 0186, 0204,	Roadstar	0206, 0208, 0209,	Sontec	0213, 0217
	0217		0211, 0244, 0245,		0218, 0237	Sony	0041, 0059, 0067,
Memorex	0058, 0061, 0064,		0246, 0254	Robotron	0205		0085, 0086, 0174,
	0208	Pathe Cinema	0200, 0203, 0207,	Rowa	0200		0196, 0199, 0208,
Memphis	0208		0212, 0215	RTF	0205		0219, 0234
Metz	0205	Pathe Marconi	0212, 0216	Saba	0204, 0205, 0211,	Sound & Vision	0209, 0218
MGA	0060, 0061	Pausa	0208		0216	Soundesign	0060, 0061, 0062
Micromaxx	0206, 0208	Perdio	0200	saccs	0212	Soundwave	0213, 0217
Microstar	0206, 0208	Philco	0060, 0061, 0063,	Saisho	0204, 0206, 0207,	SSS	0060, 0062
Minerva	0204		0128, 0205, 0214,	Salora	0208	Standard	0207, 0208, 0209,
Minoka	0213		0215		0201, 0204, 0210,		0213, 0218
Mitsubishi	0006, 0015, 0016,	Philharmonic	0207		0211, 0215	Starlight	0217
	0048, 0060, 0061,	Philips	0040, 0060, 0063,	Sambers	0204	Starlite	0062
	0104, 0112, 0113,		0072, 0115, 0116,	Sampo	0060, 0061, 0083,	Stenway	0218
	0125, 0205, 0213		0124, 0130, 0150,		0101	Stern	0210, 0211
Mivar	0200, 0201, 0202,		0175, 0184, 0187,	Samsung	0029, 0030, 0031,	Sunkai	0208, 0218
	0203, 0204, 0207		0205, 0207, 0213,		0032, 0044, 0045,	Sunwood	0208, 0213
Montgomery Ward			0215, 0217, 0220,		0046, 0047, 0060,	Superla	0200, 0204, 0207
	0058		0221, 0232, 0233,		0061, 0065, 0068,	SuperTech	0200
MTC	0060, 0061, 0128,		0252, 0253		0069, 0071, 0079,	Supra	0208
	0200	Philips Magnavox			0087, 0127, 0128,	Supreme	0059
Multi System	0217		0124		0130, 0144, 0160,	Susumu	0209
Multitech	0062, 0127, 0128,	Phoenix	0200, 0205, 0213,		0161, 0170, 0176,	Sutron	0208
	0200, 0207, 0208,		0217		0183, 0185, 0200,	Sydney	0200, 0207
	0210, 0214, 0215,	Phonola	0200, 0205, 0213,		0201, 0206, 0207,	Sylvania	0060, 0061, 0063,
	0217		0217		0208, 0213, 0217,		0080, 0134, 0142,
Murphy	0200, 0207	Pilot	0060		0239, 0241, 0242,		0148
NAD	0061	Pioneer	0012, 0013, 0060,	Sandra	0243	Symphonic	0062, 0080
Naonis	0210		0061, 0098, 0109,	Sansui	0200, 0207	Sysline	0217
			0117, 0128, 0181,		0123, 0126, 0213	Sytong	0200



Tandy	0127, 0207, 0209, 0211, 0218	Weltblick	0213, 0217	Alba	1044, 1050	GoldHand	1050
Tashiko	0200, 0207, 0210	Weston	0215	American High	1004	Goldstar	1000, 1003, 1042, 1045
Tatung	0127, 0204, 0207, 0213, 0217, 0237	White Westinghouse	0200, 0207, 0217	Amstrad	1042	Goodmans	1042, 1045, 1050, 1069
TCM	0206, 0208	Yamaha	0000, 0001, 0002, 0003, 0004, 0005, 0060, 0061	Anitech	1050	Gradiente	1005
Teac	0127	Yamishi	0218	ASA	1045, 1046	Graetz	1043, 1047
Tec	0207, 0208, 0214, 0215	Yoko	0200, 0206, 0207, 0208, 0209, 0213, 0217, 0218	Asha	1002, 1014	Granada	1046, 1047, 1049
Techwood	0060, 0061	Yorx	0209, 0218	Asuka	1042, 1045, 1046, 1050	Grandin	1042, 1045, 1050
Teknika	0058, 0060, 0061, 0062	Zanussi	0210	Audio Dynamics	1000	Grundig	1046, 1050, 1062
Teleavia	0216	Zenith	0058, 0060, 0100, 0105, 0119, 0121, 0154	Audiovox	1003	Hanseatic	1045, 1046
Telecor	0218			Baird	1042, 1043, 1047	Harley Davidson	1005
Telefunken	0065, 0213, 0216			Basic Line	1044, 1050	Harman/Kardon	1000
Telegazi	0218			Baur	1046	Harwood	1006
Teletech	0208, 0214, 0217			Beaumarck	1002, 1014	HCM	1050
Teleton	0207			Bell & Howell	1001	Headquarter	1001
Televideon	0200			Blaupunkt	1046, 1048	Hinari	1044, 1050
Tensai	0208, 0209, 0213, 0218			Broksonic	1012, 1013	Hisawa	1044
Tesmet	0213			Bush	1044, 1050, 1066	Hitachi	1007, 1010, 1039, 1042, 1043, 1046, 1049
Tevion	0206, 0208			Calix	1003	Hughes Network Systems	1010
Texet	0200, 0207			Candle	1002, 1003	Hypson	1044, 1050
Thomson	0191, 0192, 0207, 0213, 0216, 0226			Canon	1004	Imperial	1042
Thorn	0212, 0217			CCE	1006	Inno Hit	1046, 1050
TMK	0060, 0061			CGE	1042, 1043	Innovation	1044, 1048
Tokai	0213			Cimline	1044, 1050	Instant Replay	1004
Tokyo	0200, 0207			Citizen	1002, 1003	Interbuy	1045
Toshiba	0027, 0043, 0053, 0054, 0064, 0078, 0089, 0090, 0106, 0107, 0127, 0131, 0140, 0146, 0159, 0197, 0225, 0231, 0237			Colortyme	1000	Interfunk	1046, 1047
Towada	0211, 0215			Colt	1006	Intervision	1042
Transtec	0200			Craig	1002, 1003, 1006, 1014	Irradio	1045, 1050
Trident	0204			Crown	1050	ITT	1043, 1047
Tristar	0218			Curtis Mathes	1000, 1002, 1004, 1009	ITV	1045
Triumph	0204			Cybernex	1002, 1014	JC Penney	1000, 1001, 1002, 1003, 1004, 1006
Uher	0211, 0213			Daewoo	1005, 1038, 1061, 1067	JCL	1004
Ultravox	0200, 0205, 0207, 0214, 0215			Dansai	1050	Jensen	1007
United	0217			Dantax	1044	JVC	1000, 1001, 1007, 1011, 1017, 1036, 1043
Universum	0127, 0128, 0129, 0201, 0206, 0213, 0214, 0215, 0217			DBX	1000	Kaisui	1050
Univox	0212			De Graaf	1046, 1049	Karcher	1046
Vestel	0210, 0211, 0213, 0214, 0215, 0217			Decca	1042, 1043, 1046	Kendo	1044
Vexa	0208, 0217			Denon	1010	Kenwood	1000, 1001, 1007, 1011, 1043
VICTOR	0200			Dimensia	1009	KLH	1006
Videologique	0200, 0207, 0209, 0218			Dual	1043, 1046	Kodak	1003, 1004
Videosat	0214			Dumont	1042, 1046, 1047, 1049	Korpel	1050
VideoSystem	0213			Dynatech	1005	Leyco	1050
Videotechnic	0200			Electrohome	1003	LG	1003, 1042, 1045, 1071
Vidtech	0060, 0061			Electroponic	1003	Lifetec	1044, 1048
Viewsonic	0076, 0077, 0092, 0099, 0172, 0173			Elta	1050	Lloyd's	1005
Visiola	0200, 0207			Emerson	1003, 1004, 1005, 1012, 1013	Loewe	1048
Vision	0213			Etzuko	1050	Loewe Opta	1045, 1046
Vortec	0213, 0217			Ferguson	1043	Logik	1006, 1050
Voxson	0205, 0210, 0211, 0213			Fidelity	1042	Luxor	1047
Waltham	0207, 0212			Finlandia	1046, 1047, 1049	LXI	1003
Wards	0057, 0058, 0060, 0061, 0063			Finlux	1042, 1043, 1046, 1047, 1049	M Electronic	1042
Watson	0213, 0217, 0218			FIRST LINE	1044, 1045, 1049, 1050	Magnasonic	1047
Watt Radio	0200, 0207, 0212, 0215			Fisher	1001, 1047	Magnavox	1004, 1018, 1033
Wega	0205			Flint	1044	Magnin	1003, 1014
				Formenti/Phoenix	1046	Manesth	1050
				Fuji	1004	Marantz	1000, 1001, 1004, 1046, 1051
				Fujitsu	1042	Marta	1003
				Funai	1005, 1042	Matsui	1044, 1045
				Galaxy	1042	Matsushita	1004
				Garrard	1005	Mediator	1046
				GBC	1050	Medion	1044, 1048
				GE	1002, 1004, 1009, 1014, 1030	MEI	1004
				GEC	1046		
				Geloso	1050		
				General Technic	1044, 1048		
				Go Video	1014		

### TV/DVD

Aiwa	0139, 2055
Apex	0132, 2049
Broksonic	0138, 2060
Bush	0230, 2112
JVC	0136, 2053
Panasonic	0137, 0254, 2054, 2110
RCA	0133, 0135, 2050, 2051
Sylvania	0134, 2052
Thomson	0226, 2109
Toshiba	0131, 0231, 2048, 2111

### TV/DVD/VCR

Panasonic	0141, 1040, 2057
Samsung	0241, 1070, 2113
Sharp	0143, 1028, 2059
Sylvania	0142, 1041, 2058
Toshiba	0140, 1029, 2056

### TV/VCR

Aiwa	0237, 1066
Bush	0237, 1066
Daewoo	0155, 0238, 1038, 1067
GE	0147, 1030
Goodmans	0240, 1069
Grundig	0236, 1062
Hitachi	0156, 1039
JVC	0153, 1036
Magnavox	0150, 1033
Orion	0235, 1065
Panasonic	0151, 1034
Philips	0150, 0232, 0233, 1033, 1062, 1063
Quasar	0152, 1035
RCA	0149, 1032
Roadstar	0237, 1066
Samsung	0144, 0239, 1027, 1068
Sharp	0145, 1028
Sony	0234, 1064
Sylvania	0148, 1031
Tatung	0237, 1066
Toshiba	0146, 0237, 1029, 1066
Zenith	0154, 1037

### VCR

Admiral	1008, 1013
Adventura	1005
Aiwa	1005, 1042, 1043, 1044, 1066
Akai	1007, 1043
Akiba	1050
Akura	1043, 1050

## List of remote control codes

The following remote control codes are available in addition to “List of remote control codes” at the end of the owner’s manual.

### VCR

Memorex	1001, 1002, 1003, 1004, 1005, 1008, 1013, 1014, 1042, 1045, 1047	Panasonic	1004, 1020, 1034, 1040, 1048, 1054, 1072	Saisho	1044, 1050	Tashiko	1003, 1042
Memphis	1050	Pathe Marconi	1043	Salora	1047	Tatung	1007, 1042, 1043, 1046, 1066
Metz	1048	Penney	1010, 1014	Samsung	1002, 1014, 1021, 1027, 1052, 1068, 1070	TCM	1044, 1048
MGA	1014	Pentax	1010, 1049	Sanky	1008	Teac	1005, 1007
MGN Technology		Perdio	1042	Sansui	1007, 1011, 1013, 1043	Technics	1004, 1048
	1002, 1014	Philco	1004, 1051	Sanyo	1001, 1002, 1014, 1047	Teknika	1003, 1004, 1005
Micromaxx	1044, 1048	Philips	1004, 1025, 1033, 1046, 1056, 1057, 1059, 1062, 1063	SBR	1046	Teleavia	1043
Microstar	1044, 1048	Philips Magnavox		Schaub Lorenz	1042, 1043, 1047	Telefunken	1043
Migros	1042		1018	Schneider	1042, 1044, 1045, 1046, 1050	Tenosal	1050
Minolta	1010	Phonola	1046	Scott	1012	Tensai	1042, 1045, 1050
Mitsubishi	1011, 1042, 1046	Pilot	1003	Sears	1001, 1003, 1004, 1010	Tevion	1044, 1048
Montgomery Ward		Pioneer	1011, 1046	SEI-Sinudyne	1046	Thomson	1043, 1058
	1008	Prinz	1042	Seleco	1043	Thorn	1043, 1047
Motorola	1004, 1008	Profex	1050	Sentron	1050	TMK	1002, 1014
MTC	1002, 1014	Profitronic	1014	Sharp	1008, 1023, 1028, 1053, 1073	Tokai	1045, 1050
Multitech	1002, 1005, 1006, 1042, 1046, 1050	Proline	1042	Shintom	1006, 1047, 1050	Tonsai	1050
Murphy	1042	Proscan	1009	Shivaki	1045	Toshiba	1013, 1024, 1029, 1043, 1046, 1066, 1075
National	1048	Prosonic	1044	Shogun	1002, 1014	Totevision	1002, 1003, 1014
NEC	1000, 1001, 1007, 1011, 1043, 1051	Protex	1006	Siemens	1045, 1047	Towada	1050
Neckermann	1043, 1046	Pye	1046, 1056	Signature 2000	1008	Towika	1050
NEI	1046	Quarter	1001	Silva	1045	Uher	1045
Nesco	1050	Quartz	1001, 1047	Singer	1004, 1006	Unitech	1002, 1014
Nikko	1003	Quasar	1004, 1035	Sinudyne	1046	Universum	1042, 1045, 1046
Noblex	1002, 1014	Quelle	1042, 1046, 1047	Sontec	1045	Vector Research	1000
Nokia	1043, 1047	Radio Shack	1003	Sony	1016, 1019, 1055, 1060, 1064, 1074	Video Concepts	1000
Nordmende	1043	Radio Shack/Realistic	1001, 1002, 1003, 1004, 1005, 1008	STS	1004, 1010	Videon	1044, 1048
Oceanic	1042, 1043	Radiola	1046	Sunkai	1044	Videosonic	1002, 1014
Okano	1044	Radix	1003	Sunstar	1042	Wards	1002, 1003, 1004, 1005, 1006, 1008, 1010, 1014
Olympus	1004	Randex	1003	Suntronic	1042	Weltblick	1045
Optimus	1003, 1008	RCA	1002, 1004, 1009, 1010, 1014, 1015, 1022, 1032	Sunwood	1050	White Westinghouse	1013
Orion	1012, 1013, 1044, 1065	Realistic	1001, 1002, 1003, 1004, 1005, 1008	Sylvania	1004, 1005, 1031, 1041	XR-1000	1004, 1005, 1006
Orson	1042	Rex	1043	Symphonic	1005	Yamaha	1000, 1001, 1007
Osaki	1042, 1045, 1050	RFT	1046	Taisho	1044	Yamishi	1050
Otto Versand	1046	Roadstar	1045, 1050, 1066	Tandy	1001	Yokan	1050
Palladium	1043, 1045, 1050	Saba	1043			Yoko	1045, 1050
						Zenith	1013, 1026, 1037





© 2009 Yamaha Corporation All rights reserved.

YAMAHA CORPORATION  
Printed in China © WQ95850

The letters in circles and the numbers in squares correspond to those in the Owner's Manual.  
 Les lettres dans les cercles et les numéros dans les carrés correspondent à ceux du mode d'emploi.

## ■ Front panel/Face avant

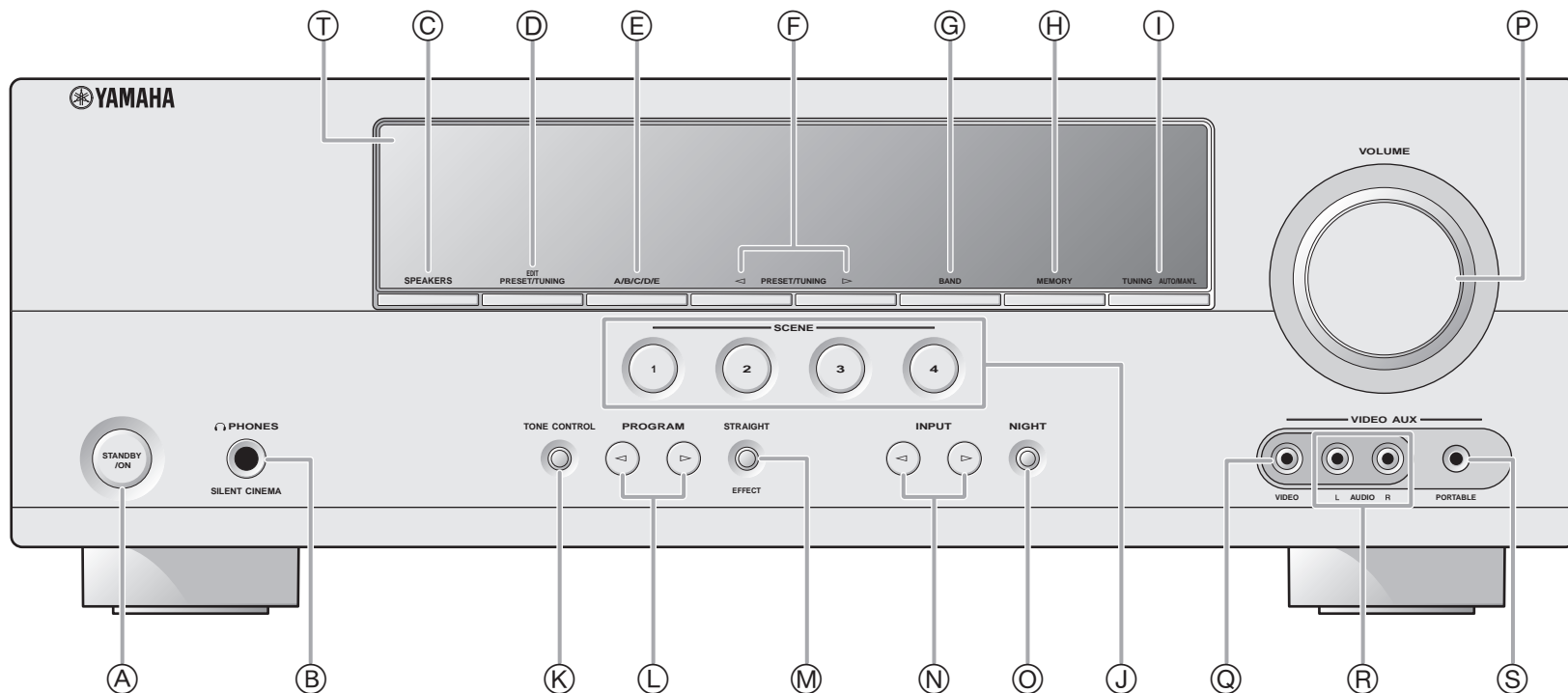

# ■ Remote control/Boîtier de télécommande

