

RX-V463

AV Receiver

Ampli-tuner audio-vidéo

OWNER'S MANUAL
MODE D'EMPLOI
BEDIENUNGSANLEITUNG
BRUKSANVISNING
GEBRUIKSAANWIJZING
ИНСТРУКЦИЯ ПО ЭКСПЛУАТАЦИИ

Caution: Read this before operating your unit.

- 1 To assure the finest performance, please read this manual carefully. Keep it in a safe place for future reference.
- 2 Install this sound system in a well ventilated, cool, dry, clean place – away from direct sunlight, heat sources, vibration, dust, moisture, and/or cold. Allow ventilation space of at least 30 cm on the top, 20 cm on the left and right, and 20 cm on the back of this unit.
- 3 Locate this unit away from other electrical appliances, motors, or transformers to avoid humming sounds.
- 4 Do not expose this unit to sudden temperature changes from cold to hot, and do not locate this unit in a environment with high humidity (i.e. a room with a humidifier) to prevent condensation inside this unit, which may cause an electrical shock, fire, damage to this unit, and/or personal injury.
- 5 Avoid installing this unit where foreign object may fall onto this unit and/or this unit may be exposed to liquid dripping or splashing. On the top of this unit, do not place:
 - other components, as they may cause damage and/or discoloration on the surface of this unit.
 - burning objects (i.e. candles), as they may cause fire, damage to this unit, and/or personal injury.
 - containers with liquid in them, as they may fall and liquid may cause electrical shock to the user and/or damage to this unit.
- 6 Do not cover this unit with a newspaper, tablecloth, curtain, etc. in order not to obstruct heat radiation. If the temperature inside this unit rises, it may cause fire, damage to this unit, and/or personal injury.
- 7 Do not plug in this unit to a wall outlet until all connections are complete.
- 8 Do not operate this unit upside-down. It may overheat, possibly causing damage.
- 9 Do not use force on switches, knobs and/or cords.
- 10 When disconnecting the power cable from the wall outlet, grasp the plug; do not pull the cord.
- 11 Do not clean this unit with chemical solvents; this might damage the finish. Use a clean, dry cloth.
- 12 Only voltage specified on this unit must be used. Using this unit with a higher voltage than specified is dangerous and may cause fire, damage to this unit, and/or personal injury. Yamaha will not be held responsible for any damage resulting from use of this unit with a voltage other than specified.
- 13 To prevent damage by lightning, keep the power cord and outdoor antennas disconnected from a wall outlet or the unit during a lightning storm.
- 14 Do not attempt to modify or fix this unit. Contact qualified Yamaha service personnel when any service is needed. The cabinet should never be opened for any reasons.
- 15 When not planning to use this unit for long periods of time (i.e. vacation), disconnect the AC power plug from the wall outlet.
- 16 Install this unit near the AC outlet and where the AC power plug can be reached easily.
- 17 Be sure to read the “Troubleshooting” section on common operating errors before concluding that this unit is faulty.
- 18 Before moving this unit, press **ⓐSTANDBY/ON** to set this unit in the standby mode, and disconnect the AC power plug from the wall outlet.
- 19 **VOLTAGE SELECTOR** (Asia and General models only)
The **VOLTAGE SELECTOR** on the rear panel of this unit must be set for your local main voltage **BEFORE** plugging into the AC wall outlet. Voltages are:
Asia model 220/230–240 V AC, 50/60 Hz
General model 110/120/220/230–240 V AC, 50/60 Hz

- 20 Excessive sound pressure from earphones and headphones can cause hearing loss.
- 21 The batteries shall not be exposed to excessive heat such as sunshine, fire or the like.

WARNING

TO REDUCE THE RISK OF FIRE OR ELECTRIC SHOCK, DO NOT EXPOSE THIS UNIT TO RAIN OR MOISTURE.

This unit is not disconnected from the AC power source as long as it is connected to the wall outlet, even if this unit itself is turned off by **ⓐSTANDBY/ON**. This state is called the standby mode. In this state, this unit is designed to consume a very small quantity of power.

■ For U.K. customers

If the socket outlets in the home are not suitable for the plug supplied with this appliance, it should be cut off and an appropriate 3 pin plug fitted. For details, refer to the instructions described below.

Note

The plug severed from the mains lead must be destroyed, as a plug with bared flexible cord is hazardous if engaged in a live socket outlet.

■ Special Instructions for U.K. Model

IMPORTANT

THE WIRES IN MAINS LEAD ARE COLOURED IN ACCORDANCE WITH THE FOLLOWING CODE:

Blue: NEUTRAL

Brown: LIVE

As the colours of the wires in the mains lead of this apparatus may not correspond with the coloured markings identifying the terminals in your plug, proceed as follows:

The wire which is coloured BLUE must be connected to the terminal which is marked with the letter N or coloured BLACK. The wire which is coloured BROWN must be connected to the terminal which is marked with the letter L or coloured RED.

Making sure that neither core is connected to the earth terminal of the three pin plug.



This symbol mark is according to the EU directive 2002/96/EC.

This symbol mark means that electrical and electronic equipment, at their end-of-life, should be disposed of separately from your household waste. Please act according to your local rules and do not dispose of your old products with your normal household waste.

Contents

INTRODUCTION

Features	2
Getting started	3
Quick start guide	4
Preparation: Check the items	4
Step 1: Set up your speakers	5
Step 2: Connect your DVD player and other components	6
Step 3: Press SCENE 1 button	7
What do you want to do with this unit?	8

PREPARATION

Connections	9
Rear panel	9
Placing speakers	10
Connecting speakers	11
Information on jacks and cable plugs	13
Information on HDMI™	14
Audio and video signal flow	14
Connecting video components	15
Connecting other components	16
Connecting audio components	18
Connecting a Yamaha iPod™ universal dock or Bluetooth™ adapter	19
Using the VIDEO AUX jacks on the front panel	19
Connecting the FM and AM antennas	20
Connecting the power cable	20
Turning on and off the power	21
Front panel display	22
Optimizing the speaker setting for your listening room	24
Using AUTO SETUP	24

BASIC OPERATION

Selecting the SCENE templates	28
Selecting the desired SCENE template	28
Creating your original SCENE templates	31
Using remote control on the SCENE feature	32
Playback	33
Basic operations	33
Selecting audio input jacks (AUDIO SELECT)	34
Selecting the MULTI CH INPUT component	34
Displaying the current status of this unit on a video monitor	35
Using your headphones	35
Muting the audio output	35
Playing video sources in the background of an audio source	36
Displaying the input source information	36
Using the sleep timer	37
Sound field programs	38
Sound field program descriptions	38
Using audio features	41
Enjoying high quality sound	41
Adjusting the tonal quality	41
Adjusting the speaker level	41
Selecting the night listening mode	42
FM/AM tuning	43
Automatic tuning	43
Manual tuning	43
Automatic preset tuning	44
Manual preset tuning	44
Selecting preset stations	45
Exchanging preset station	45

Radio Data System tuning (Europe and Russia models only)	46
Displaying the Radio Data System information	46
Selecting the Radio Data System program type (PTY SEEK mode)	47
Using the enhanced other networks (EON) data service	48
Using a USB memory device or a USB portable audio player	49
Playback operation	49
Using iPod™	51
Controlling iPod™	51
Using Bluetooth™ components	53
Pairing the Bluetooth™ adapter and your Bluetooth™ component	53
Playback of the Bluetooth™ component	53
Recording	54

ADVANCED OPERATION

SET MENU	55
Using SET MENU	56
1 SOUND MENU	57
2 INPUT MENU	62
3 OPTION MENU	64
Remote control features	67
Controlling this unit, a TV, or other components	67
Setting remote control codes	69
Advanced setup	70

ADDITIONAL INFORMATION

Troubleshooting	71
Glossary	81
Specifications	83
Index	84

APPENDIX

(at the end of this manual)

Front panel	i
Remote control	ii
List of remote control codes	iii

About this manual

- * indicates a tip for your operation.
- Some operations can be performed by using either the buttons on the front panel or the ones on the remote control. In case the button names differ between the front panel and the remote control, the button name on the remote control is given in parentheses.
- This manual is printed prior to production. Design and specifications are subject to change in part as a result of improvements, etc. In case of differences between the manual and product, the product has priority.
- “**ⓈPEAKERS**” or “**ⓈDVD**” (example) indicates the name of the parts on the front panel or the remote control. Refer to the attached sheet or the pages at the end of this manual for the information about each position of the parts.
- The symbol “**☞**” with page number(s) indicates the corresponding reference page(s).

INTRODUCTION

PREPARATION

BASIC OPERATION

ADVANCED OPERATION

ADDITIONAL INFORMATION

APPENDIX

English

Features

Built-in 5-channel power amplifier

- ◆ Minimum RMS output power
[U.S.A. and Canada models]
(1 kHz, 0.9% THD, 8 Ω)
105 W/ch
[Other models]
(1 kHz, 0.9% THD, 6 Ω)
105 W/ch

SCENE select function

- ◆ Preset SCENE templates for various situations
- ◆ SCENE template customizing capability

Decoders and DSP circuits

- ◆ Proprietary Yamaha technology for the creation of multi-channel surround sound
- ◆ Compressed Music Enhancer mode
- ◆ Dolby Digital decoder
- ◆ Dolby Pro Logic/Dolby Pro Logic II decoder
- ◆ DTS decoder
- ◆ Virtual CINEMA DSP
- ◆ SILENT CINEMA™

Radio tuners

- ◆ FM/AM tuning capability
- ◆ Radio Data System capability (Europe model only)



Manufactured under license from Dolby Laboratories.

"Dolby", "Pro Logic", and the double-D symbol are trademarks of Dolby Laboratories.

SILENT™
CINEMA

"SILENT CINEMA" is a trademark of Yamaha Corporation.

iPod™

"iPod" is a trademark of Apple, Inc., registered in the U.S. and other countries.

HDMI (High-Definition Multimedia Interface)

- ◆ HDMI interface for standard, enhanced or high-definition video (includes 1080p video signal transmission) as well as multi-channel digital audio

DOCK terminal

- ◆ DOCK terminal to connect a Yamaha iPod universal dock (such as YDS-10, sold separately) or Bluetooth adapter (such as YBA-10, sold separately)

USB features

- ◆ USB port to connect a USB memory device or a USB portable audio player
- ◆ MP3, WMA and WAV capability

Other features

- ◆ YPAO (Yamaha Parametric Room Acoustic Optimizer) for automatic speaker setup
- ◆ 192-kHz/24-bit D/A converter
- ◆ DIRECT mode for high quality sound for all sources
- ◆ 6 additional input jacks for discrete multi-channel input
- ◆ OSD (on-screen display) menus that allow you to optimize this unit to suit your individual audiovisual system
- ◆ Component video input/output capability (3 COMPONENT VIDEO INs and 1 MONITOR OUT)
- ◆ Optical and coaxial digital audio signal jacks
- ◆ Sleep timer
- ◆ Cinema and music night listening modes
- ◆ iPod controlling capability
- ◆ Remote control with preset remote control codes



"DTS" and "DTS Digital Surround" are registered trademarks of DTS, Inc.

Bluetooth™

Bluetooth is a registered trademark of the Bluetooth SIG and is used by Yamaha in accordance with a license agreement.

HDMI

"HDMI", the "HDMI" logo and "High-Definition Multimedia Interface" are trademarks or registered trademarks of HDMI Licensing LLC.

Getting started

■ Supplied accessories

Check that you received all of the following parts.

- Remote control
- Batteries (2) (AAA, R03, UM-4)
- Optimizer microphone
- AM loop antenna
- Indoor FM antenna

■ VOLTAGE SELECTOR (Asia and General models only)

Caution

The VOLTAGE SELECTOR on the rear panel of this unit must be set for your local voltage BEFORE plugging the power cable into the AC wall outlet. Improper setting of the VOLTAGE SELECTOR may cause damage to this unit and create a potential fire hazard.

Rotate the VOLTAGE SELECTOR clockwise or counterclockwise to the correct position using a straight slot screwdriver.

Voltages are as follows:

Asia model 220/230–240 V AC, 50/60 Hz

General model

..... 110/120/220/230–240 V AC, 50/60 Hz

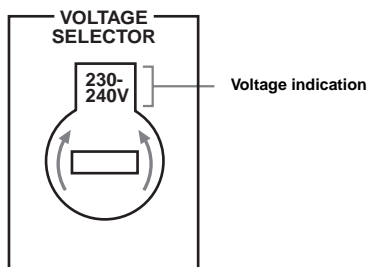

■ Installing batteries in the remote control

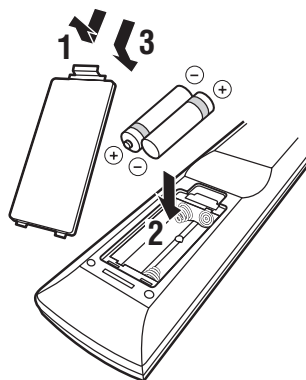

1 Take off the battery compartment cover.

2 Insert the two supplied batteries (AAA, R03, UM-4) according to the polarity markings (+ and –) on the inside of the battery compartment.

3 Snap the battery compartment cover back into place.

Notes

- Change all of the batteries if you notice that the operation range of the remote control decreases.
- Do not use an old battery and a new one together.
- Do not use different types of batteries (such as alkaline and manganese batteries) together. Read the packaging carefully as these different types of batteries may have the same shape and color.
- If the batteries have leaked, dispose of them immediately. Avoid touching the leaked material or letting it come into contact with clothing, etc. Clean the battery compartment thoroughly before installing new batteries.
- Do not throw away batteries with general house waste; dispose of them correctly in accordance with your local regulations.
- If the remote control is without batteries for more than 2 minutes, or if exhausted batteries remain in the remote control, the contents of the memory may be cleared. When the memory is cleared, insert new batteries and set up the remote control code.

Quick start guide

The following steps describe the easiest way to enjoy DVD movie playback in your home theater.

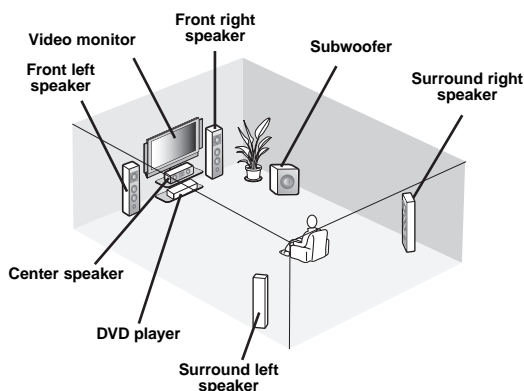

Step 1: Set up your speakers

P. 5

Step 2: Connect your DVD player and other components

P. 6

Step 3: Press SCENE 1 button

P. 7

Enjoy DVD playback!

Preparation: Check the items

Prepare the following items.

- Speakers**
 - Front speaker** x 2
 - Center speaker** x 1
 - Surround speaker** x 2Select magnetically shielded speakers. The minimum required speakers are two front speakers. The priority of the requirement of other speakers is as follows:
 1. Two surround speakers
 2. Center speaker
- Active subwoofer** x 1
Select an active subwoofer equipped with an RCA input jack.
- Speaker cable** x 5
- Subwoofer cable** x 1
Select a monaural RCA cable.
- DVD player** x 1
Select DVD player equipped with coaxial digital audio output jack and composite video output jack.
- Video monitor** x 1
Select a TV monitor, video monitor or projector equipped with a composite video input jack.
- Video cable** x 2
Select an RCA composite video cable.
- Digital coaxial audio cable** x 1

Step 1: Set up your speakers

Place your speakers in the room and connect them to this unit.

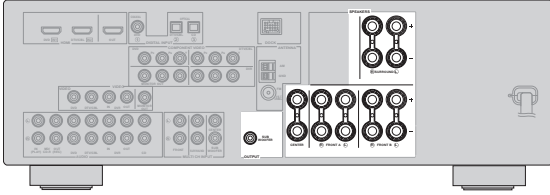

1 Place your speakers and subwoofer in the room.

2 Connect speaker cables to each speaker.

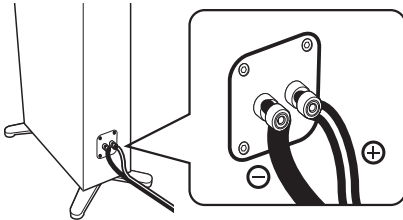

Cables are colored or shaped differently, perhaps with a stripe, groove or ridge. Connect the striped (grooved, etc.) cable to the “+” (red) terminals of your speaker. Connect the plain cable to the “-” (black) terminals.

3 Connect each speaker cable to the corresponding speaker terminal of this unit.

- ① Make sure that this unit and the subwoofer are unplugged from the AC wall outlets.
- ② Twist the exposed wires of the speaker cables together to prevent short circuits.
- ③ Do not let the bare speaker wires touch each other.
- ④ Do not let the bare speaker wires touch any metal part of this unit.

Be sure to connect the left channel (L), right channel (R), “+” (red) and “-” (black) properly.

Front and center speakers

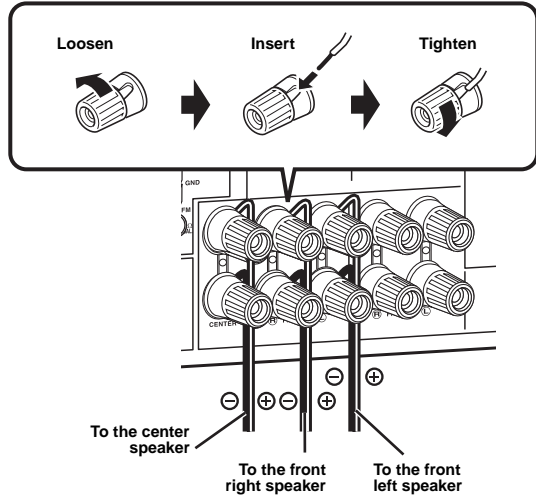

Surround speakers

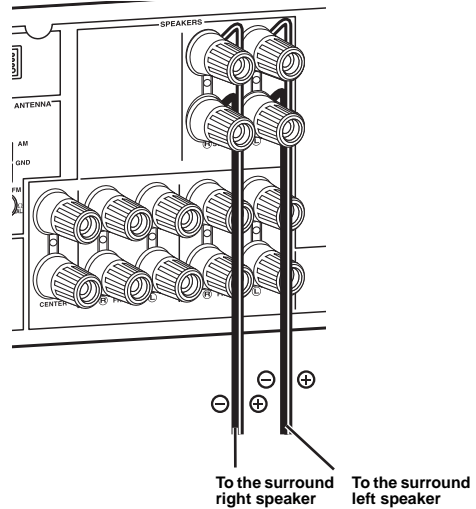

4 Connect the subwoofer cable to the input jack of the subwoofer and the SUBWOOFER OUTPUT jack of this unit.

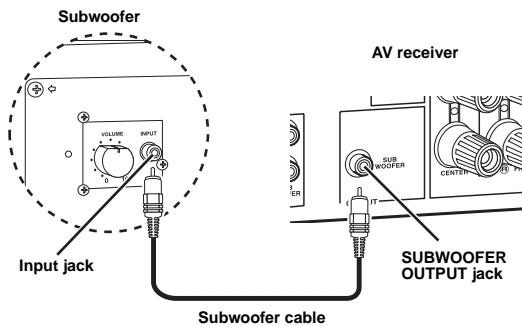

Step 2: Connect your DVD player and other components

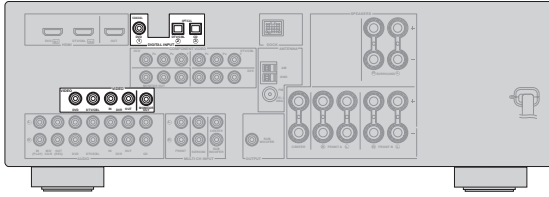

Make sure that this unit and the DVD player are unplugged from the AC wall outlets.

- 1 Connect the digital coaxial audio cable to the digital coaxial audio output jack of your DVD player and the DVD DIGITAL INPUT COAXIAL jack of this unit.

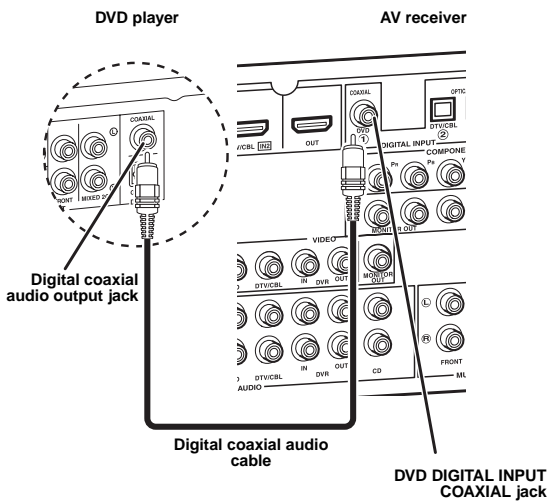

- 3 Connect the video cable to the video input jack of your video monitor and the VIDEO MONITOR OUT jack of this unit.

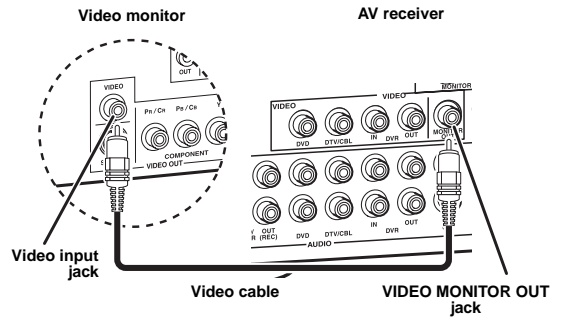

- 4 Connect the power plug of this unit and other components into the AC wall outlet.

■ For further connections

- Using the other kind of speaker combinations [P. 11](#)
- Connecting video components [P. 15](#)
- Connecting a DVD player [P. 16](#)
- Connecting a DVD recorder [P. 17](#)
- Connecting a set-top box [P. 17](#)
- Connecting a CD player and a CD recorder/MD recorder [P. 18](#)
- Connecting a multi-format player or an external decoder [P. 18](#)
- Connecting a Yamaha iPod/Bluetooth dock [P. 19](#)
- Using the VIDEO AUX jacks on the front panel [P. 19](#)
- Connecting an FM/AM antenna [P. 20](#)
- Using the USB jack on the front panel [P. 49](#)

- 2 Connect the video cable to the composite video output jack of your DVD player and the DVD VIDEO jack of this unit.

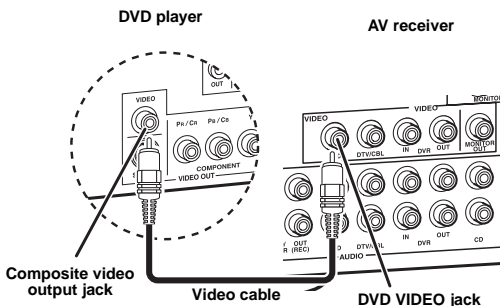

Step 3: Press SCENE 1 button

1 Turn on the video monitor and then set the input source selector of the video monitor to this unit.

2 Press @SCENE 1.

This unit is turned on. “DVD Viewing” appears in the front panel display, and this unit automatically optimize own status for the DVD playback.

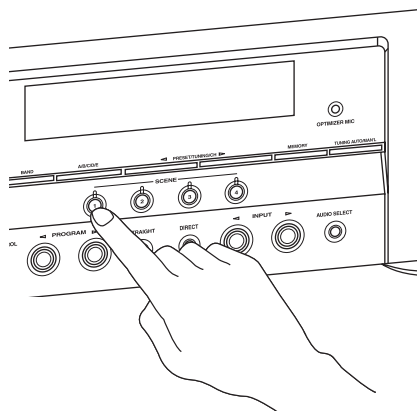

The indicator on the selected SCENE button lights up while this unit is in the SCENE mode.

3 Start playback of the desired DVD on your player.

4 Rotate ①VOLUME to adjust the volume.

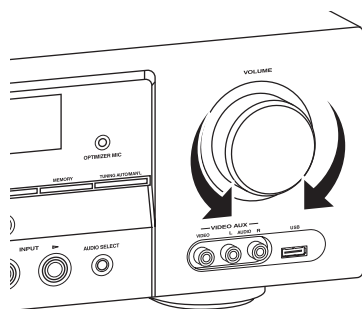

Note

When you change the input source or sound field program, the SCENE mode is deactivated.

About SCENE function

Just by pressing one SCENE button, you can turn on this unit and recall your favorite input source and sound field program according to the SCENE template that has been assigned to the SCENE button. The SCENE templates are built combinations of input sources and sound field programs.



If you connect a Yamaha product that has capability of the SCENE control signals, this unit can automatically activate the component and start playback. Refer to the instruction manual of the DVD player for further information.

The default assigned SCENE templates

Default SCENE button	The name of the SCENE template and its description
SCENE 1	DVD Movie Viewing – input source: DVD – sound field program: Movie Dramatic For when you want to enjoy a movie from the connected DVD player.
SCENE 2	Music Disc Listening – input source: DVD – sound field program: 2ch Stereo For when you want to listen to a music disc from the connected DVD player.
SCENE 3	TV Viewing *1 – input source: DTV/CBL – sound field program: STRAIGHT For when you want to watch a TV program.
SCENE 4	Radio Listening *2, *3, *4 – input source: TUNER – sound field program: 5ch Enhancer For when you want to listen to a music program from the FM radio station.

Notes

*1 You must connect a cable TV or a satellite tuner to this unit in advance. See page 17 for details.

*2 You need to connect the supplied FM and AM antennas to this unit in advance. See page 20 for details.

*3 You must tune into the desired radio station in advance. See pages 43 to 45 for tuning information.

*4 To achieve the best possible reception, orient the connected AM loop antenna, or adjust the position of the end of the indoor FM antenna.



You can change the assigned SCENE template for the SCENE buttons. See page 28 for details.

■ After using this unit...

Press **(A) STANDBY/ON** on the front panel to set this unit to the standby mode.

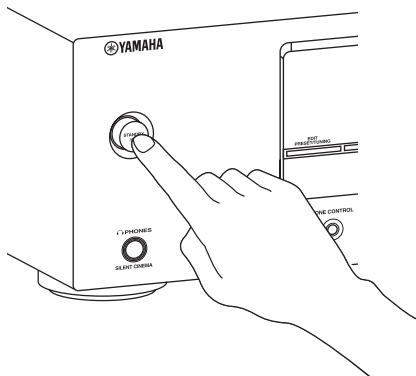

This unit is set to the standby mode. In the standby mode, this unit consumes a small amount of power in order to receive infrared signals from the remote control. To turn on this unit from the standby mode, press **(A) STANDBY/ON** (or **(17) POWER**). See page 21 for details.

What do you want to do with this unit?

■ Customizing the SCENE templates

- Using various SCENE templates P. 28
- Creating your original SCENE templates P. 31

■ Using various input sources

- Basic controls of this unit P. 33
- Enjoying FM/AM radio programs P. 43
- Using your USB portable device with this unit P. 49
- Using your iPod with this unit P. 51
- Using your Bluetooth components with this unit P. 53

■ Using various sound features

- Using various sound field programs P. 38
- Using the direct mode for the high quality sound P. 41
- Customizing the sound field programs P. 40

■ Adjusting the parameters of this unit

- Automatically optimizing the speaker parameters for your listening room (AUTO SETUP) P. 24
- Manually adjusting various parameters of this unit P. 55
- Setting the remote control P. 67
- Adjusting the advanced parameters P. 70

■ Additional features

- Automatically turning off this unit P. 37

Connections

Rear panel

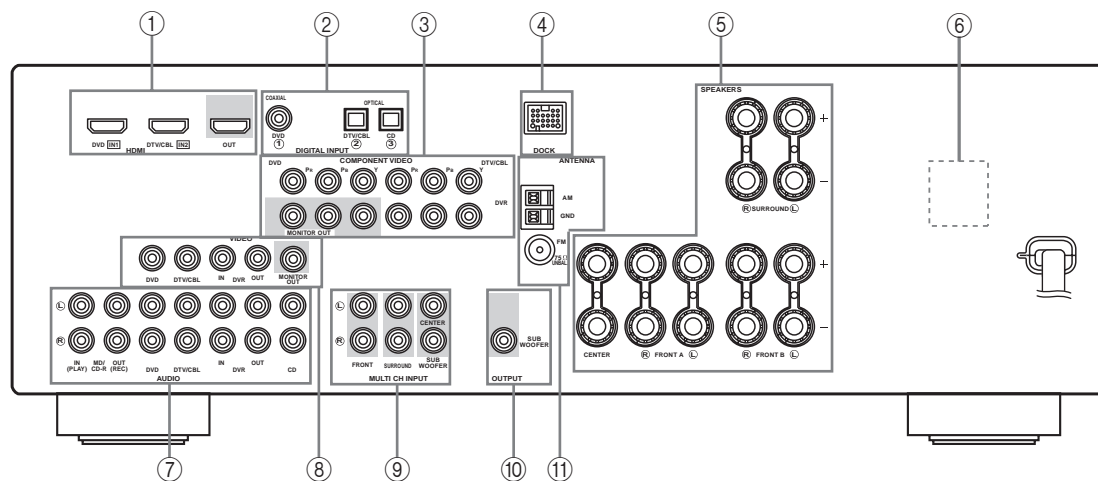

Name	Page
① HDMI jacks	14
② DIGITAL INPUT jacks	13
③ COMPONENT VIDEO jacks	13
④ DOCK terminal	19
⑤ Speaker terminals	11
⑥ VOLTAGE SELECTOR (Asia and General models only)	3
⑦ AUDIO jacks	13
⑧ VIDEO jacks	13
⑨ MULTI CH INPUT jacks	18
⑩ SUBWOOFER OUTPUT jack	11
⑪ ANTENNA terminals	20

Placing speakers

The speaker layout below shows the speaker setting we recommend. You can use it to enjoy CINEMA DSP and multi-channel audio sources.

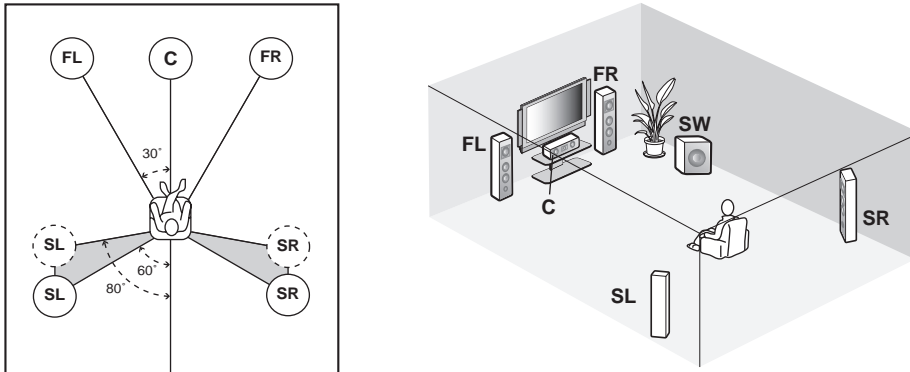

Front left and right speakers (FL and FR)

The front speakers are used for the main source sound plus effect sounds. Place these speakers at an equal distance from the ideal listening position. The distance of each speaker from each side of the video monitor should be the same.

Center speaker (C)

The center speaker is for the center channel sounds (dialog, vocals, etc.). If for some reason it is not practical to use a center speaker, you can do without it. Best results, however, are obtained with the full system.

Surround left and right speakers (SL and SR)

The surround speakers are used for effect and surround sounds.

Subwoofer (SW)

The use of a subwoofer with a built-in amplifier, such as the Yamaha Active Servo Processing Subwoofer System, is effective not only for reinforcing bass frequencies from any or all channels, but also for high fidelity sound reproduction of the LFE (low-frequency effect) channel included in Dolby Digital and DTS sources. The position of the subwoofer is not so critical, because low bass sounds are not highly directional. But it is better to place the subwoofer near the front speakers. Turn it slightly toward the center of the room to reduce wall reflections.

Connecting speakers

Be sure to connect the left channel (L), right channel (R), “+” (red) and “-” (black) properly. If the connections are faulty, this unit cannot reproduce the input sources accurately.

Caution

- Before connecting the speakers, make sure that the AC power plug is disconnected from the AC wall outlet.
- Do not let the bare speaker wires touch each other or let them touch any metal part of this unit. This could damage this unit and/or the speakers. If the speaker wires are short-circuited, “CHECK SP WIRES” appears in the front panel display when you turn on this unit.
- Use the magnetically shielded speakers. If this type of speaker still creates interference with the monitor, place the speakers away from the monitor.

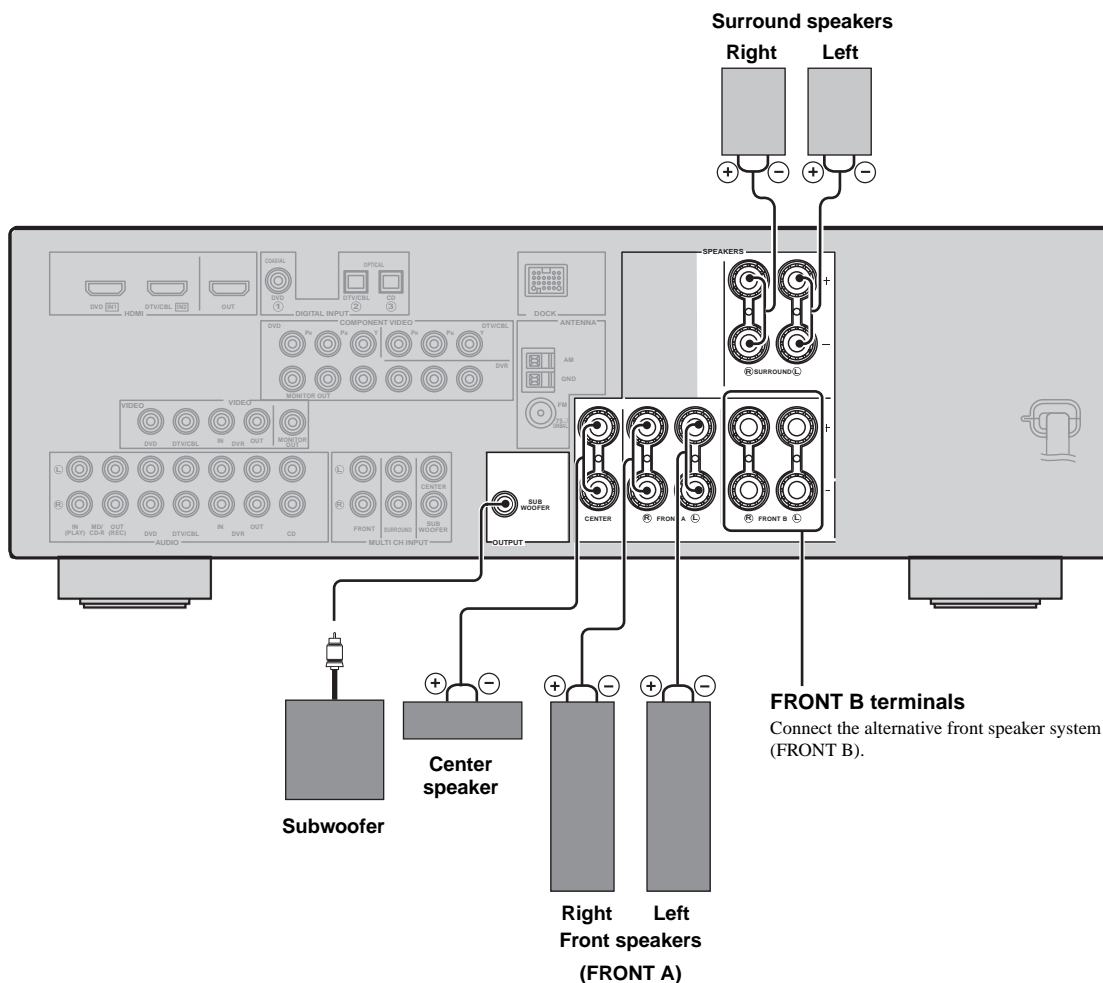

■ Before connecting to the SPEAKERS terminal

A speaker cord is actually a pair of insulated cables running side by side. Cables are colored or shaped differently, perhaps with a stripe, groove or ridges. Connect the striped (grooved, etc.) cable to the “+” (red) terminals of this unit and your speaker. Connect the plain cable to the “-” (black) terminals.

Remove approximately 10 mm (3/8”) of insulation from the end of each speaker cable and then twist the bare wires of the cable together to prevent short circuits.

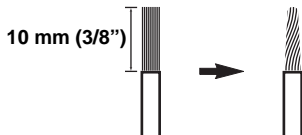

■ Connecting to the SPEAKER terminals

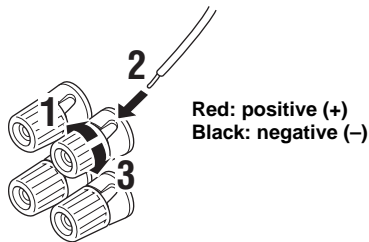

1 Loosen the knob.

2 Insert the bare end of the speaker wire into the hole on the terminal.

3 Tighten the knob to secure the wire.

Connecting the banana plug (except Europe, Russia, Korea, and Asia models)

The banana plug is a single-pole electrical connector widely used to terminate speaker cables. First, tighten the knob and then insert the banana plug connector into the end of the corresponding terminal.

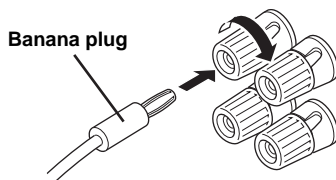

Information on jacks and cable plugs

Connect one of the type of the audio jack(s) and/or video jack(s) that your input components are equipped with.

Audio jacks and cable plugs

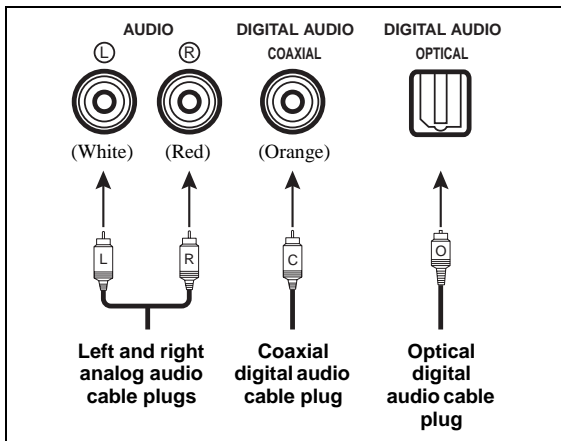

Video jacks and cable plugs

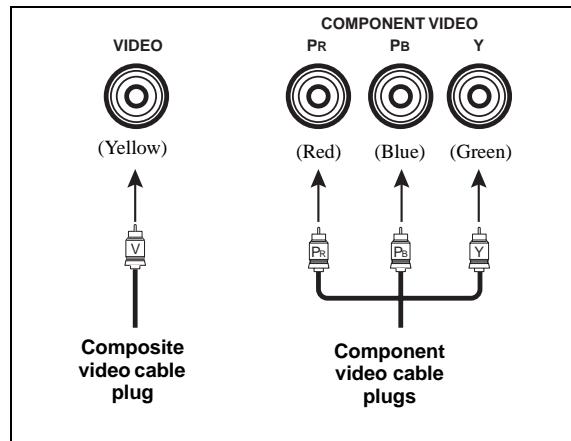

■ Audio jacks

This unit has three types of audio jacks. Connection depends on the availability of audio jacks on your other components.

AUDIO jacks

For conventional analog audio signals transmitted via left and right analog audio cables. Connect red plugs to the right jacks and white plugs to the left jacks.

DIGITAL AUDIO COAXIAL jack

For digital audio signals transmitted via a coaxial digital audio cable.

DIGITAL AUDIO OPTICAL jacks

For digital audio signals transmitted via optical digital audio cables.

Notes

- You can use the digital jacks to input PCM, Dolby Digital and DTS bitstreams. Optical input jacks are compatible with digital signals with up to 96 kHz of sampling frequency.
- This unit handles digital and analog signals independently. Thus audio signals input at the digital jacks are not output at the analog AUDIO OUT (REC) jacks.

■ Video jacks

This unit has two types of video jacks. Connection depends on the availability of input jacks on your video monitor.

VIDEO jacks

For conventional composite video signals transmitted via composite video cables.

COMPONENT VIDEO jacks

For component signals, separated into the luminance (Y) and chrominance (Pb, Pr) video signals transmitted on separate wires of component video cables.

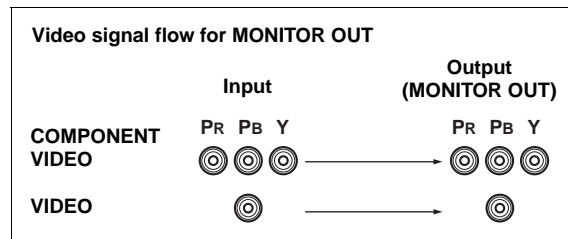

Note

The OSD signal is not output at the DVR OUT (REC) jacks.

Information on HDMI™

■ HDMI compatibility with this unit

Audio signal types	Audio signal formats	Compatible HDMI components
2ch Linear PCM	2ch, 32-192 kHz, 16/20/24 bit	CD, DVD-Video, DVD-Audio, etc.
Multi-ch Linear PCM	8ch, 32-192 kHz, 16/20/24 bit	DVD-Audio, etc.
Bitstream	Dolby Digital, DTS	DVD-Video, etc.

This unit's HDMI interface is based on the following standards:

- HDMI Version 1.2a (High-Definition Multimedia Interface Specification Version 1.2a) licensed by HDMI Licensing, LLC.
- HDCP (High-bandwidth Digital Content Protection System) licensed by Digital Content Protection, LLC.

Notes

- When CPPM copy-protected DVD audio is played back, video and audio signals may not be output depending on the type of the DVD player.
- This unit is not compatible with HDCP-incompatible HDMI or DVI components.
- You can check the potential problem about the HDMI connection (see page 36).

■ HDMI jack and cable plug

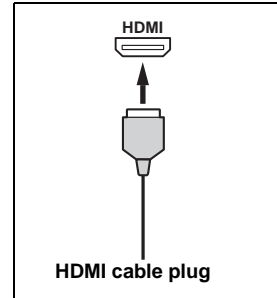

- We recommend using an HDMI cable shorter than 5 meters (16 feet) with the HDMI logo printed on it.
- Use a conversion cable (HDMI jack ↔ DVI-D jack) to connect this unit to other DVI components.

Notes

- Do not disconnect or connect the cable or turn off the power of the HDMI components connected to the HDMI OUT jack of this unit while data is being transferred. Doing so may disrupt playback or cause noise.
- Audio signals input at input jacks other than the HDMI IN DVD or HDMI IN DTV/CBL jack of this unit cannot be digitally output at the HDMI OUT jack.
- If you turn off the power of the video monitor connected to the HDMI OUT jack via a DVI connection, this unit may fail to establish the connection to the component.

Audio and video signal flow

■ Audio signal flow

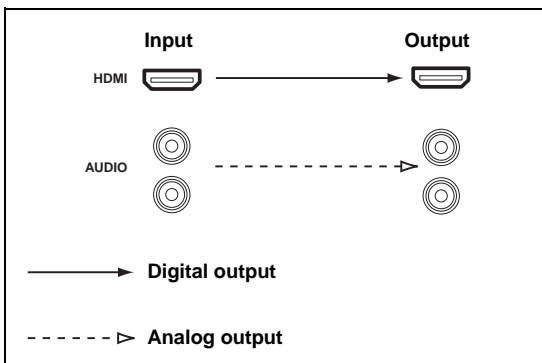

Notes

- 2-channel as well as multi-channel PCM, Dolby Digital and DTS signals input at the HDMI IN DVD or HDMI IN DTV/CBL jack can be output at the HDMI OUT jack only when "SUPPORT AUDIO" is set to "Other" (see page 61).
- Audio signals input at the HDMI IN jacks are not output at the AUDIO output jacks.

■ Video signal flow

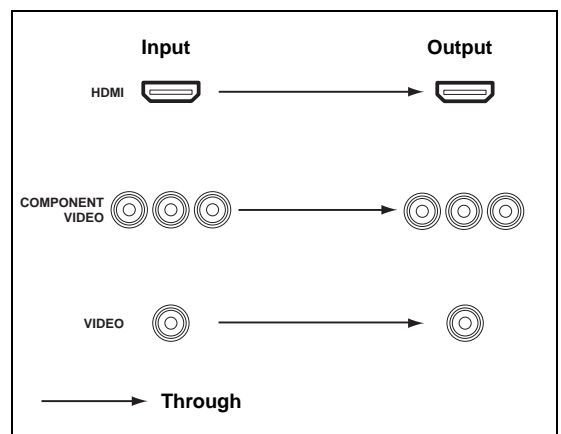

Connecting video components

Connect your TV (or projector) to the HDMI OUT jack, the COMPONENT VIDEO MONITOR OUT jacks, or the VIDEO MONITOR OUT jack of this unit.



Make sure that this unit and other components are unplugged from the AC wall outlets.



You can choose to play back HDMI audio signals on this unit or on another HDMI component connected to the HDMI OUT jack of this unit. Use the “SUPPORT AUDIO” parameter in “SOUND MENU” to select the component to play back HDMI audio signals (see page 61).

Notes

- Some video monitors connected to this unit via a DVI connection fail to recognize the HDMI audio/video signals being input if they are in the standby mode. In this case, the HDMI indicator flashes irregularly.
- When you connect your TV monitor or projector via HDMI connection, the OSD does not appear. In such cases, connect the TV monitor or projector via component, or video connection.
- Connect the input source components to the HDMI IN DVD or HDMI IN DTV/CBL jack to display the video images on the video monitor connected to the HDMI OUT jack.

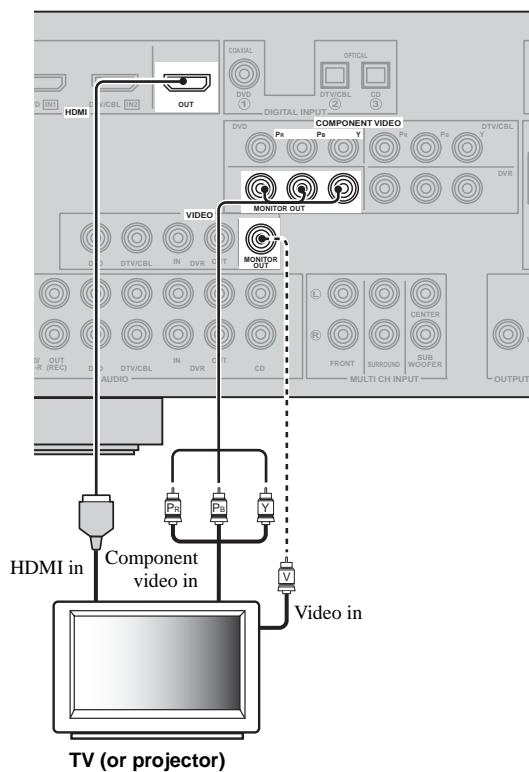

———— indicates recommended connections

----- indicates alternative connections

Connecting other components



Make sure that this unit and other components are unplugged from the AC wall outlets.

Notes

- Be sure to make the same type of video connections as those made for your TV (see page 15).
- To make a digital connection to a component other than the default component assigned to DIGITAL INPUT jack, select the corresponding setting for “OPTICAL IN” or “COAXIAL IN” in “INPUT ASSIGNMENT” (see page 62).

■ Connecting a DVD player

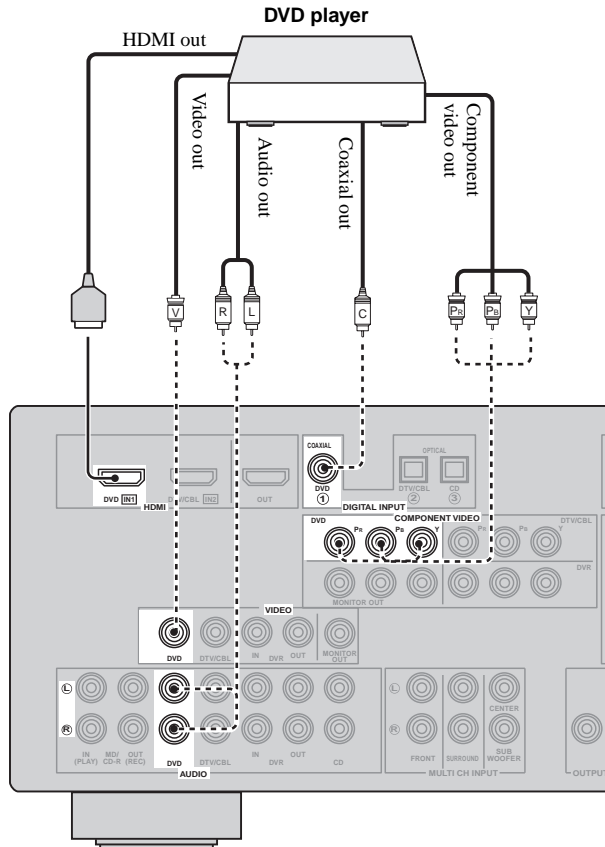

———— indicates recommended connections

- - - - - indicates alternative connections
(One for the video connection,
and one for the audio connection)

■ Connecting a DVD recorder, PVR or VCR

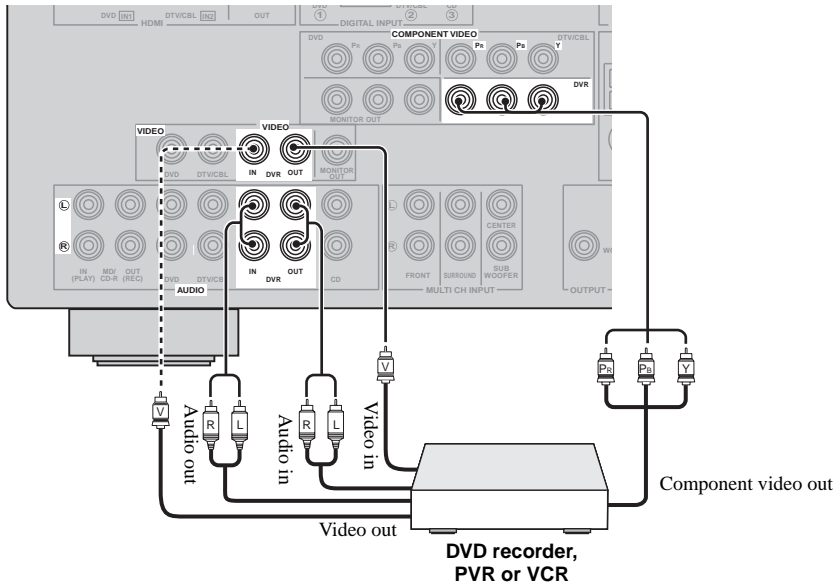

■ Connecting a set-top box

Satellite receiver, cable TV receiver or HDTV decoder

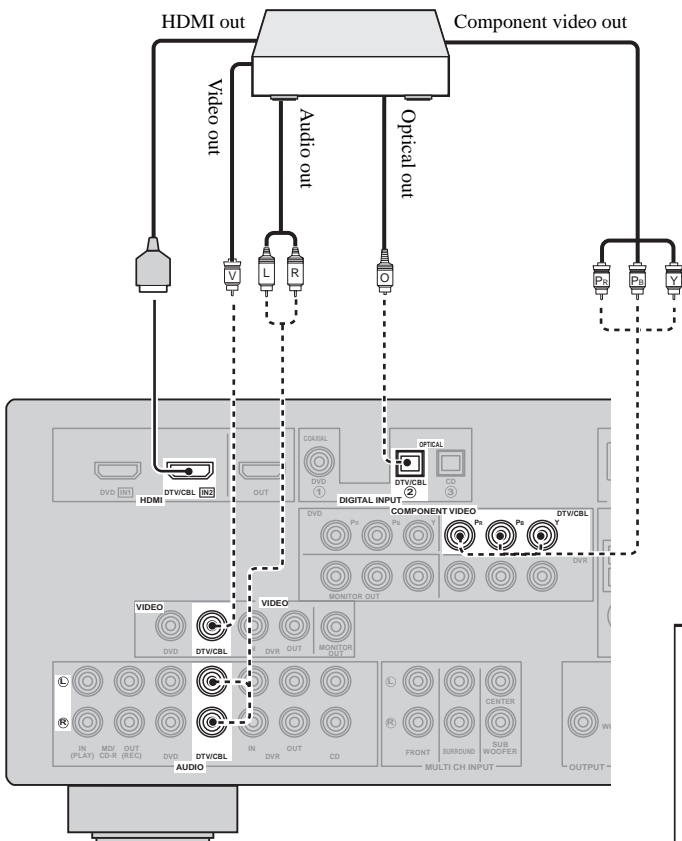

— indicates recommended connections
 indicates alternative connections (One for the video connection, and one for the audio connection)

Connecting audio components

Connect the audio components as follows.

■ Connecting a CD player and a CD recorder/MD recorder

Notes

- When you connect your CD player via analog and digital connection, priority is given to the signal input at the DIGITAL INPUT jack.
- To make a digital connection to a component other than the default component assigned to each DIGITAL INPUT jack, select the corresponding setting in “INPUT ASSIGNMENT” (see page 62).



Make sure that this unit and other components are unplugged from the AC wall outlets.

— indicates recommended connections
 - - - - - indicates alternative connections

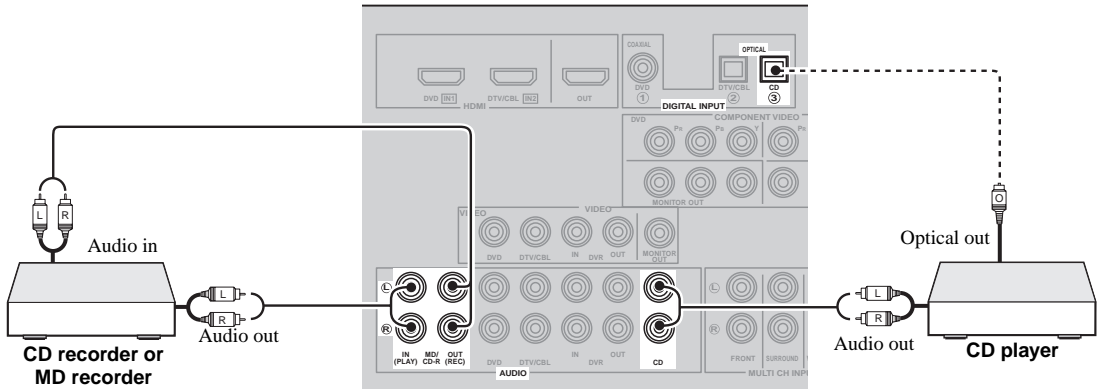

■ Connecting a multi-format player or an external decoder

This unit is equipped with 6 additional input jacks (FRONT L/R, SURROUND L/R, CENTER and SUBWOOFER) for discrete multi-channel input from a multi-format player, external decoder or sound processor. Connect the output jacks on your multi-format player or external decoder to the MULTI CH INPUT jacks. Be sure to match the left and right output jacks to the left and right input jacks for the front and surround channels.

Notes

- When you select the component connected to the MULTI CH INPUT jacks as the input source (see page 34), this unit automatically turns off the digital sound field processor, and you cannot select sound field programs.
- This unit does not redirect signals input at the MULTI CH INPUT jacks to accommodate for missing speakers. We recommend that you connect a 5.1-channel speaker system before using this feature.

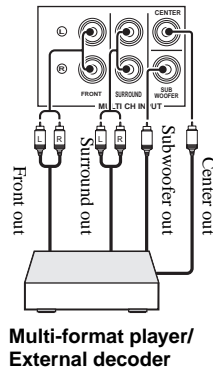

Connecting a Yamaha iPod™ universal dock or Bluetooth™ adapter



Make sure that this unit and other components are unplugged from the AC wall outlets.

This unit is equipped with the DOCK terminal on the rear panel that allows you to connect a Yamaha iPod universal dock (such as YDS-10, sold separately) or Bluetooth adapter (such as YBA-10, sold separately). Connect a Yamaha iPod universal dock or Bluetooth adapter to the DOCK terminal on the rear panel of this unit using its dedicated cable.

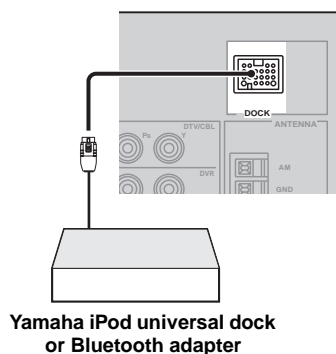

Using the VIDEO AUX jacks on the front panel

Use the VIDEO AUX jacks on the front panel to connect a game console or a video camera to this unit.

Caution

Be sure to turn down the volume of this unit and other components before making connections.

Notes

- To reproduce the source signals input at these jacks, select “V-AUX” as the input source.
- When audio signals are input at the AUDIO jacks and the DOCK terminal on the rear panel, the priority order of the input signal is as follows:
 - DOCK
 - AUDIO

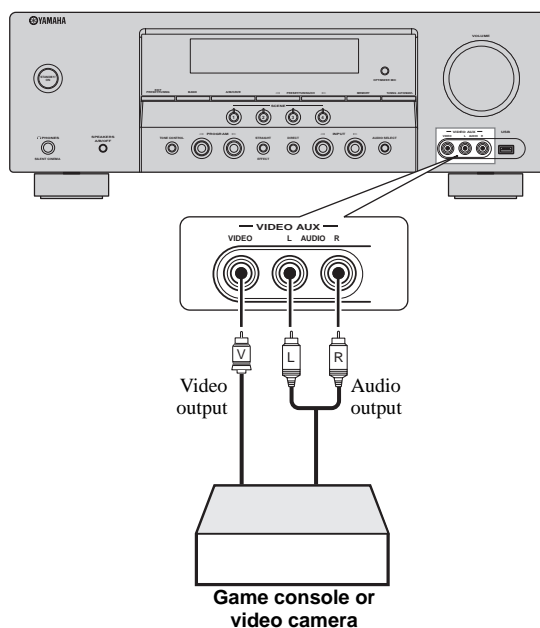

Connecting the FM and AM antennas

Both FM and AM indoor antennas are supplied with this unit. Connect each antenna correctly to the designated terminals. In general, these antennas should provide sufficient signal strength.



See right for connection information of the supplied AM loop antenna.

Notes

- The AM loop antenna should be placed away from this unit.
- The AM loop antenna should always be connected, even if an outdoor AM antenna is connected to this unit.
- A properly installed outdoor antenna provides clearer reception than an indoor one. If you experience poor reception quality, install an outdoor antenna. Consult the nearest authorized Yamaha dealer or service center about outdoor antennas.

Outdoor AM antenna

Use a 5 to 10 m (16 to 33 ft) vinyl-covered wire extended outdoors from a window.

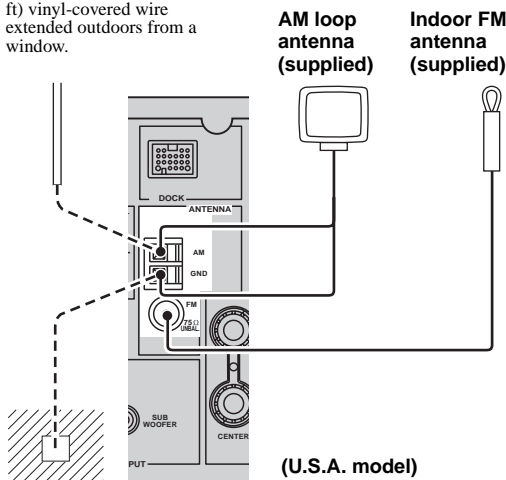

Ground (GND terminal)

For maximum safety and minimum interference, connect the antenna GND terminal to a good earth ground. A good earth ground is a metal stake driven into moist earth.

Connecting the wire of the AM loop antenna

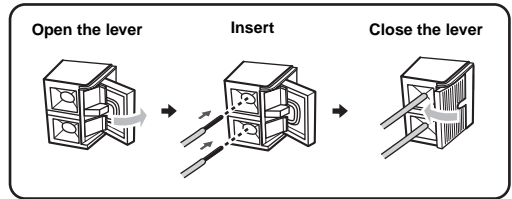

The wire of the AM loop antenna does not have any polarity and you can connect either end of the wire to AM or GND terminal.

Assembling the supplied AM loop antenna

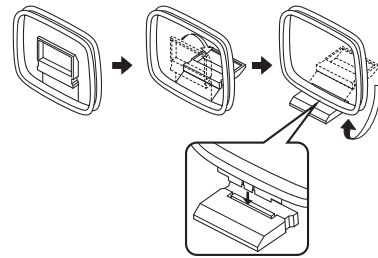

Note

The types of the supplied AM loop antenna is different depending on the models.

Connecting the power cable

Once all connections are complete, plug the power cable into the AC wall outlet.

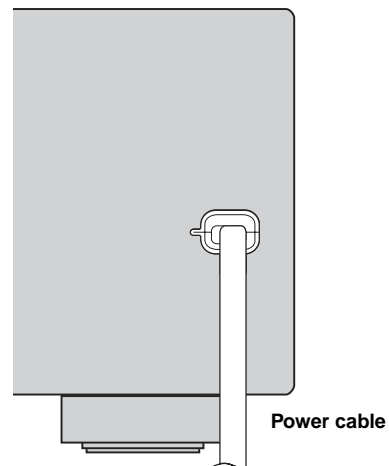

Turning on and off the power

■ Turning on this unit

Press **(A) STANDBY/ON** (or **(V) POWER**) to turn on this unit.



When you turn on this unit, there will be a 4 to 5-second delay before this unit can reproduce sound.

■ Set this unit to the standby mode

Press **(A) STANDBY/ON** (or **(B) STANDBY**) to set this unit to the standby mode.

In the standby mode, this unit consumes a small amount of power in order to receive infrared signals from the remote control.

Front panel display

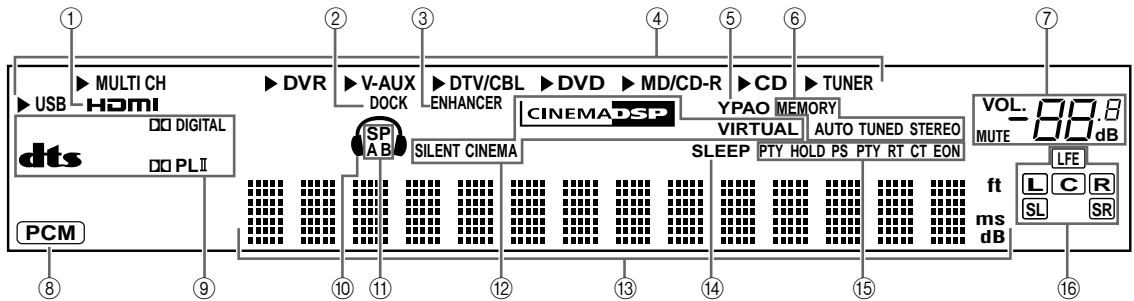

① HDMI indicator

Lights up when the signal of the selected input source is input at the HDMI IN jacks (see page 14).

② DOCK indicator

- Lights up when you station your iPod in a Yamaha iPod universal dock (such as YDS-10, sold separately) connected to the DOCK terminal of this unit (see page 19) and V-AUX is selected as the input source.
- Flashes while the connected Yamaha Bluetooth adapter (such as YBA-10, sold separately) and the Bluetooth component is in the pairing (see page 53) or the Bluetooth adapter is searching the Bluetooth component (see page 53).
- Lights up while the connected Yamaha Bluetooth adapter is connected to the Bluetooth component (see page 19).

③ ENHANCER indicator

Lights up when the Compressed Music Enhancer mode is selected (see page 38).

④ Input source indicators

The corresponding cursor lights up to show the currently selected input source.

⑤ YPAO indicator

Lights up when you run "AUTO SETUP" and when the speaker settings set in "AUTO SETUP" are used without any modifications (see page 24).

⑥ Tuner indicators

Lights up when this unit is in the FM or AM tuning mode (see pages 43 to 45).

⑦ MUTE indicator and VOLUME level indicator

- The MUTE indicator flashes while the MUTE function is on (see page 35).
- Indicates the current volume level.

⑧ PCM indicator

Lights up when this unit is reproducing PCM (Pulse Code Modulation) digital audio signals.

⑨ Decoder indicators

The respective indicator lights up when any of the decoders of this unit function.

⑩ Headphone indicator

Lights up when headphones are connected (see page 35).

⑪ SP A B indicators

Light up according to the set of front speakers activated (see page 33).

SP A: The FRONT A speakers are activated.

SP B: The FRONT B speakers are activated.

⑫ CINEMA DSP indicator

Lights up when you select a CINEMA DSP sound field program (see page 39).

VIRTUAL indicator

Lights up when Virtual CINEMA DSP is active (see page 39).

SILENT CINEMA indicator

Lights up when headphones are connected and a sound field program is selected (see page 39).

⑬ Multi-information display

Shows the name of the current sound field program and other information when adjusting or changing settings.

⑭ SLEEP indicator

Lights up while the sleep timer is on (see page 37).

⑮ Radio Data System indicators (Europe and Russia models only)

PTY HOLD

Lights up while searching for the Radio Data System stations in the PTY SEEK mode.

PS, PTY, RT and CT

Light up according to the selected Radio Data System display mode.

EON

Lights up when the EON data service is being received.

⑯ Input channel and speaker indicators

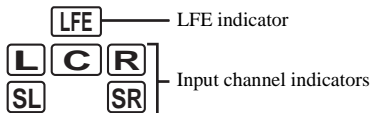

Input channel indicators

- Indicate the channel components of the current digital input signal.
- Light up or flash according to the settings of the speakers when this unit is in the automatic setup procedure (see page 24) or the speaker level setting procedure in the “SP LEVEL” (see page 59).

■ Using the remote control

The remote control transmits a directional infrared ray. Be sure to aim the remote control directly at the remote control sensor on this unit during operation.

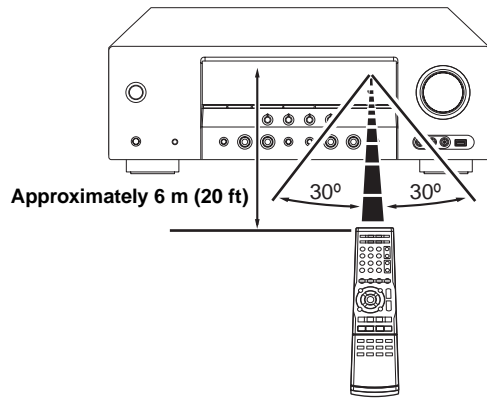

① Infrared window

Outputs infrared control signals. Aim this window at the component you want to operate.



To set the remote control codes for other components, see page 69.

Notes

- Do not spill water or other liquids on the remote control.
- Do not drop the remote control.
- Do not leave or store the remote control in the following types of conditions:
 - places of high humidity, such as near a bath
 - places of high temperature, such as near a heater or stove
 - places of extremely low temperatures
 - dusty places

Optimizing the speaker setting for your listening room

This unit employs the YPAO (Yamaha Parametric Room Acoustic Optimizer) technology which lets you avoid troublesome listening-based speaker setup and achieves highly accurate sound adjustments automatically. The supplied optimizer microphone collects and this unit analyzes the sound your speakers produce in your actual listening environment.

Using AUTO SETUP

Notes

- Be advised that it is normal for loud test tones to be output during the “AUTO SETUP” procedure.
- To achieve the best results, make sure the room is as quiet as possible while the “AUTO SETUP” procedure is in progress. If there is too much ambient noise, the results may not be satisfactory.



You can run “AUTO SETUP” using the system menu that appears in the OSD or in the front panel display. This manual uses the OSD illustrations to explain the “AUTO SETUP” procedure.

1 Make sure of the following check points.

Note

Before starting the automatic setup, check the following check points.

- Speakers are connected appropriately.
- Headphones are disconnected from this unit.
- This unit and the video monitor are turned on.
- This unit is selected as the video input source of the video monitor.
- The connected subwoofer is turned on and the volume level is set to about half way (or slightly less).
- The crossover frequency controls of the connected subwoofer is set to the maximum.

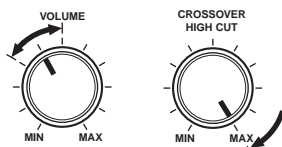

Controls of a subwoofer (example)

- FRONT A speakers are selected as the front speaker system (see page 33).
- The room is sufficiently quiet.

2 Connect the supplied optimizer microphone to the OPTIMIZER MIC jack on the front panel.

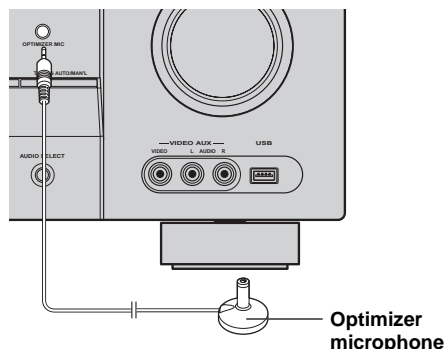

The following display appears in the OSD.



3 Place the optimizer microphone at your normal listening position on a flat level surface with the microphone heading upward.

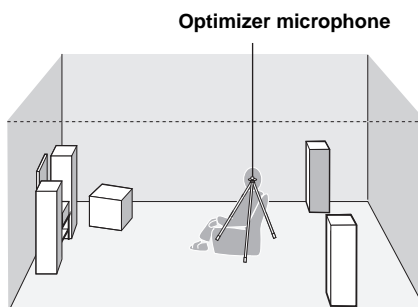

It is recommended that you use a tripod (etc.) to affix the optimizer microphone at the same height as your ears would be when you are seated in your listening position. You can use the attached screw of a tripod (etc.) to fix the optimizer microphone to the tripod (etc.).

4 Make sure that “SETUP” is set to “AUTO” and the pointer is pointing at “START”.



You can also select the following setup methods. In this case, press **7**▲ to select “SETUP”, press **7**◀/▶ to select the one of the following choices and then select “START”.

Choices: **AUTO**, RELOAD, UNDO, DEFAULT

- Select “AUTO” to automatically run the entire “AUTO SETUP” procedure.
- Select “RELOAD” to reload the last “AUTO SETUP” settings and override the previous settings.
- Select “UNDO” to undo the last “AUTO SETUP” settings and restore the previous settings.
- Select “DEFAULT” to reset the “AUTO SETUP” parameters to the initial factory settings.

Note

“RELOAD” or “UNDO” is available only when you have previously run “AUTO SETUP” and confirmed the results.

5 Press **7**▼ to select “START” and then press **7**ENTER to start the setup procedure.

The following message appears in the OSD.

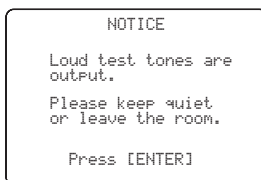

Before proceeding next operation

Once you perform the next operation, this unit starts the automatic setup procedure. For more accurate measurements, keep quiet and move to the wall where speakers are not around. We recommend that you leave the listening room during the automatic setup procedure.

6 Press **7**ENTER to start the setup procedure.

This unit starts the auto setup procedure. Loud test tones are output from each speaker during the auto setup procedure. Once all items are set, the result display appears in the OSD.

Notes

- During the auto setup procedure, do not perform any operation on this unit.
- We recommend getting out of the room while this unit is in the auto setup procedure. It takes approximately 3 minutes for this unit to complete the auto setup procedure.

This unit performs the following checks:

Speaker wiring/volume level WIRING/LEVEL

Checks which speakers are connected and the polarity of each speaker. Also checks and adjusts the volume level of each speaker.

Speaker distance DISTANCE

Checks the distance of each speaker from the listening position and adjusts the timing of each channel.

Speaker size SIZE

Checks the frequency response of each speaker and sets the appropriate low-frequency crossover for each channel.

The display changes as follows.

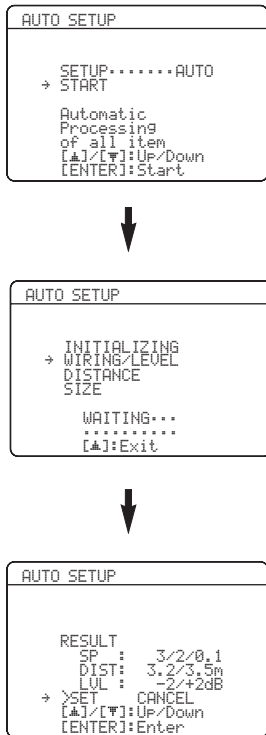

The results displayed under “RESULT” are as follows.

Number of speakers SP

Displays the number of speakers connected to this unit in the following order:
Front/Back/Subwoofer

Speaker distance DIST

Displays the speaker distance from the listening position in the following order:
Closest speaker distance/Farthest speaker distance

Speaker level LVL

Displays the speaker output level in the following order:
Lowest speaker output level/Highest speaker output level

Notes

- If “E-9:INTERNAL ERROR” appears during the testing procedure, restart from step 4.
- If you selected “RELOAD” in step 4, no test tones are output.
- If an error occurs during the “AUTO SETUP” procedure, the setup procedure is canceled and an error screen appears. For details, see “If an error screen appears” on page 27.
- When this unit detects potential problems during the “AUTO SETUP” procedure, “WARNING” and the number of warning messages appears (see page 27).

7 Press **⏪** and **⏩** to display the setup results in detail.

8 Press **⏪**/**⏩** repeatedly to toggle between the setup result displays.

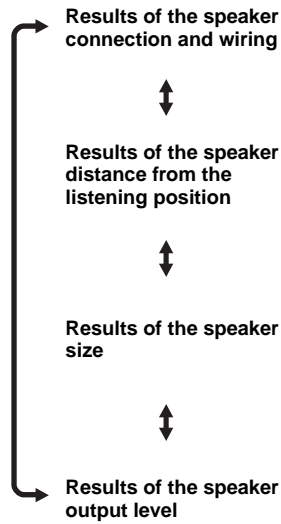

If you are not satisfied with the results or want to manually adjust each parameter, run “MANUAL SETUP” (see page 55).

Note

The distances displayed in the “DISTANCE” results may be longer than the actual distance depending on the characteristics of your speakers.

9 Press **⏩** to return to the result display.

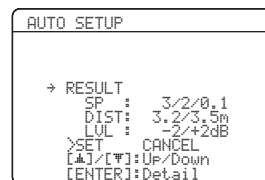

10 Press **⏮** and then press **⏪** to select “SET” or “CANCEL”.

Choices: **SET**, **CANCEL**

- Select “SET” to confirm the “AUTO SETUP” results.
- Select “CANCEL” to cancel the “AUTO SETUP” results.

11 Press **ENTER** to confirm your selection.

The top “SET MENU” display appears in the OSD.

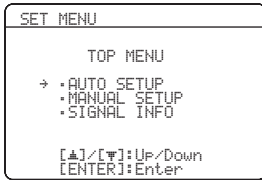

12 Press **MENU** to exit from “SET MENU”.

13 Disconnect the optimizer microphone from this unit.

The optimizer microphone is sensitive to heat. Keep it away from direct sunlight and do not place it on top of this unit.



If you change speakers, speaker positions, or the layout of your listening environment, run “AUTO SETUP” again to recalibrate your system.

■ **If an error screen appears**

Press **⏮** / **⏪** / **⏩** to select “RETRY” or “EXIT” and then press **ENTER**.

The following display is an example where “E-8:USER CANCEL” appears in the OSD.

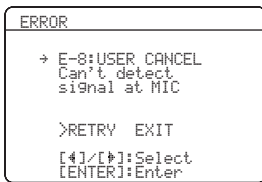

Choices: **RETRY**, **EXIT**

- Select “RETRY” to retry the “AUTO SETUP” procedure.
- Select “EXIT” to exit from the “AUTO SETUP” procedure.

■ **If “WARNING” appears**

When this unit detects potential problems during the “AUTO SETUP” procedure, “WARNING” appears in the result display. Check the warning messages to correct your speaker settings.

Note

Warnings differ from errors in that warnings do not cancel the “AUTO SETUP” procedure.

1 Make sure the pointer is pointing at “WARNING” and then press **ENTER** to display the detailed information about the warning.

The number on the right of “WARNING” indicates the number of warning messages.

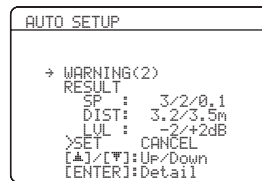

2 Press **⏮** repeatedly to toggle between the warning displays.

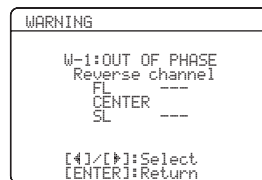

- For details about each warning message, see the “AUTO SETUP” section in “Troubleshooting” on page 75.
- When the corresponding warning message is not applicable to a speaker, “---” is displayed instead.

3 Press **ENTER** to return to the result display.

Selecting the SCENE templates

This unit is equipped with 16 preset SCENE templates for various situations of using this unit. As the initial factory setting, the following SCENE templates are assigned to each SCENE button:

SCENE 1: DVD Movie Viewing

SCENE 2: Music Disc Listening

SCENE 3: TV Viewing

SCENE 4: Radio Listening

If you want to use other SCENE templates, you can select the desired SCENE templates from the SCENE template library and assign the templates to the selected SCENE buttons on the front panel and the remote control.

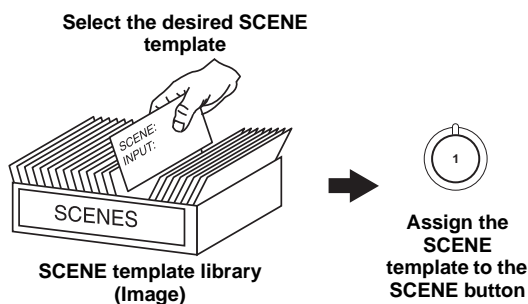

- 2 Press **Ⓢ INPUT** </> (or press **④ AMP** and then press **⑦ </>**) to select the desired template.

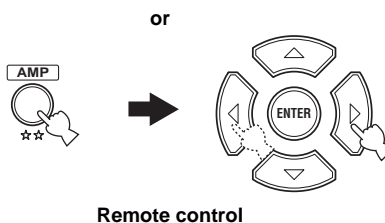
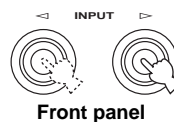

- 3 Press the **Ⓢ SCENE** (or **⑤ SCENE**) button again to confirm the selection.

The selected SCENE template is assigned to the button.



or



Selecting the desired SCENE template

- 1 Press and hold the desired **Ⓢ SCENE** (or **⑤ SCENE**) button for 3 seconds.

The indicator on the selected SCENE button on the front panel starts to flash, and the name of the currently assigned SCENE template appears in the front panel display.

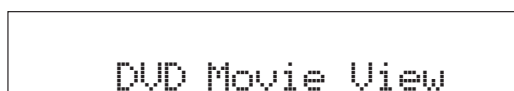
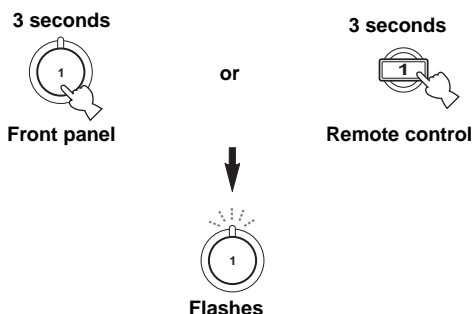

Note

Once the desired SCENE templates are assigned to the corresponding SCENE buttons, you may need to set the input source of the SCENE template on the remote control. See page 32 for details.

■ Which SCENE template would you like to select?

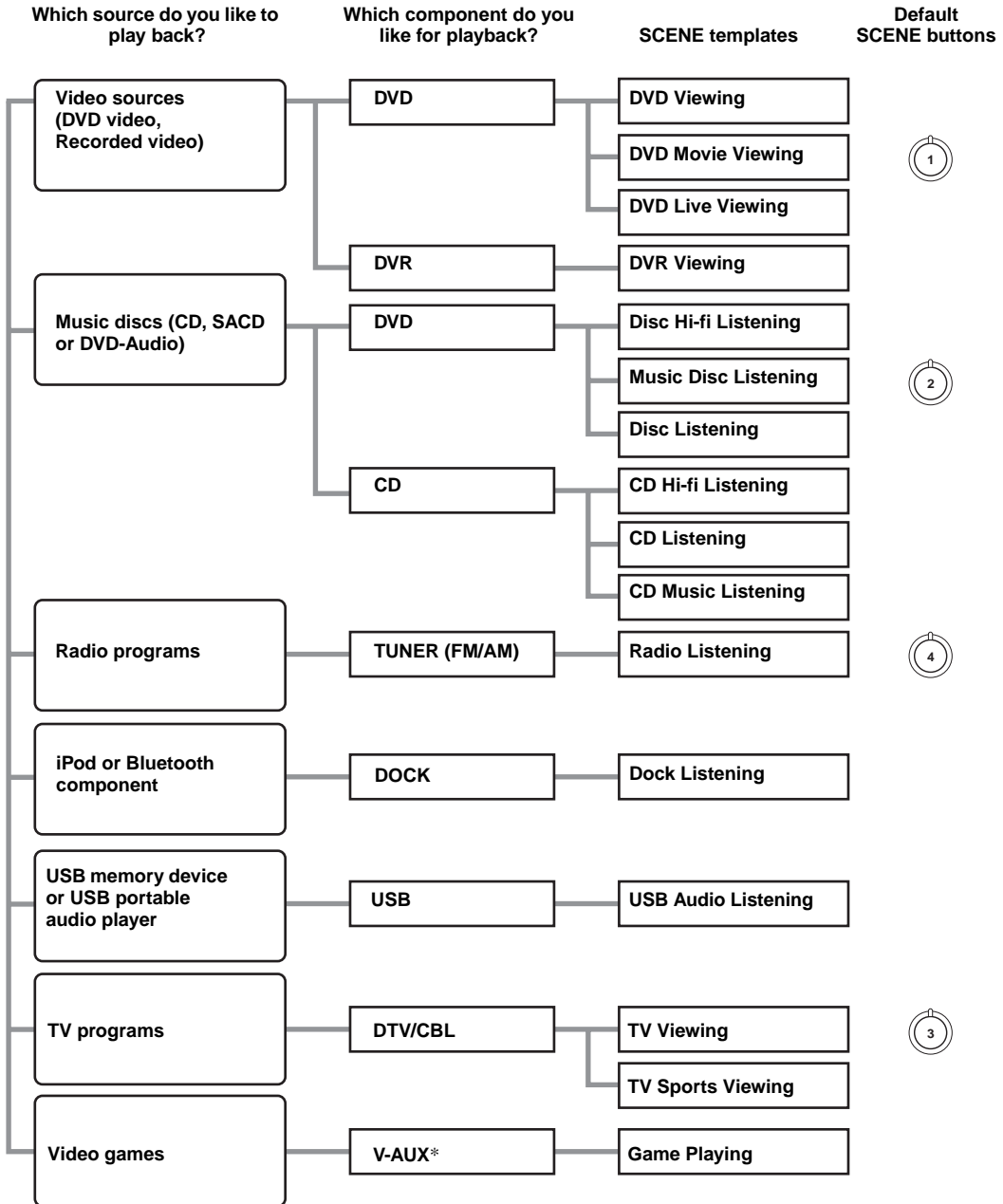

Note





* When iPod is connected to the Yamaha iPod universal dock or a Bluetooth component is connected to the Bluetooth adapter, this unit plays back the audio sources input at the DOCK terminal.



You can create your original SCENE templates by editing the preset SCENE templates. See page 31 for details.

■ Preset SCENE templates descriptions

The illustrations of the SCENE button in the following table indicate the assigned SCENE buttons in the default setting.

SCENE template	Input source	Playback mode	Features
DVD Viewing	DVD	STRAIGHT	Select this SCENE template when you play back general contents on the DVD player.
DVD Movie Viewing 	DVD	MOVIE Movie Dramatic	Select this SCENE template when you play back movies on your DVD player.
DVD Live Viewing	DVD	MUSIC Pop/Rock	Select this SCENE template when you enjoy the music live video on your DVD player.
DVR Viewing	DVR	MOVIE Movie Dramatic	Select this SCENE template when you play back movies on your digital video recorder.
Disc Hi-fi Listening	DVD	DIRECT	Select this SCENE template when you enjoy the high fidelity sound of the music discs on your DVD player.
Music Disc Listening 	DVD	STEREO 2ch Stereo	Select this SCENE template when you play back music discs on your DVD player.
Disc Listening	DVD	STEREO 5ch Stereo	Select this SCENE template when you play back music sources on your DVD player as the background music.
CD Hi-fi Listening	CD	DIRECT	Select this SCENE template when you enjoy the high fidelity sound of the music discs on your CD player.
CD Listening	CD	STEREO 5ch Stereo	Select this SCENE template when you play back music discs on your CD player as the background music.
CD Music Listening	CD	STEREO 2ch Stereo	Select this SCENE template when you play back music source on your CD player.
Radio Listening 	TUNER	MUSIC ENHANCER 5ch Enhancer	Select this SCENE template when you enjoy FM or AM radio programs.
Dock Listening	DOCK	MUSIC ENHANCER 5ch Enhancer	Select this SCENE template when you play back music on your iPod stationed in a Yamaha iPod universal dock or Bluetooth component that is connected to the Bluetooth adapter.
USB Audio Listening	USB	MUSIC ENHANCER 5ch Enhancer	Select this SCENE template when you play back music on your USB memory device or a USB portable audio player.
TV Viewing 	DTV/CBL	STRAIGHT	Select this SCENE template when you enjoy general programs on your TV.
TV Sports Viewing	DTV/CBL	ENTERTAINMENT TV Sports	Select this SCENE template when you enjoy sports programs on your TV.
Game Playing	V-AUX	ENTERTAINMENT Game	Select this SCENE template when you play video games.

Creating your original SCENE templates

You can create your original SCENE templates for each SCENE button. You can refer to the preset 16 SCENE templates to create the original SCENE templates.

■ Customizing the preset SCENE templates

Use this feature to customize the preset SCENE templates.

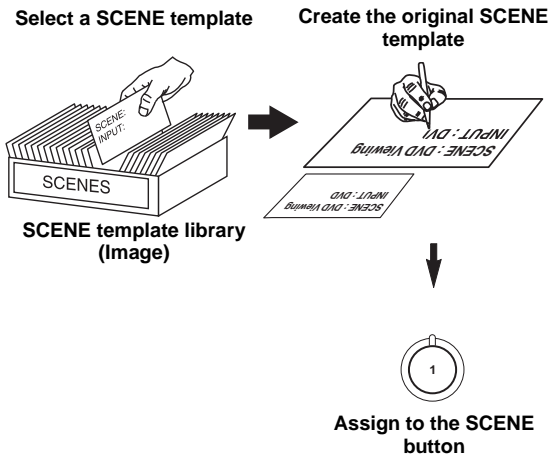

1 Turn on the video monitor connected to this unit.

2 Press and hold the desired **⑤ SCENE** button for 3 seconds.

The SCENE template customizing screen appears on the video monitor.



Note

When the SCENE template you want to customize is not assigned to any of the **⑤ SCENE** buttons, press **④ AMP** and then press **⑦ </>** repeatedly to recall the desired SCENE template on the menu screen.

3 Press **④ AMP** and then **⑦ Δ / ▽** to select the desired parameter of the SCENE template and then **⑦ </>** to select the desired value of the selected parameter.

You can adjust the following parameters for a SCENE template:

- **INPUT:** The input source component
- **MODE:** The active sound field programs, STRAIGHT or DIRECT mode (see pages 39 and 41)
- **NIGHT:** The night listening mode setting (see page 42)
 - **SYSTEM:** Keeps the current night listening mode.
 - **CINEMA:** Sets the night listening mode to the CINEMA mode.
 - **MUSIC:** Sets the night listening mode to the MUSIC mode.

4 Press the **⑤ SCENE** button again to confirm the edit.



An asterisk mark (*) appears by the name of the original SCENE template.

Notes

- Once the desired SCENE templates are assigned to the corresponding **⑤ SCENE** buttons, you may need to set the input source of the SCENE template on the remote control. See page 32 for details.
- You can create a customized SCENE template for each **⑤ SCENE** button, and if you create another customized SCENE template, this unit overwrites the old customized SCENE template with the new one.
- The newly created template is only available for the assigned **⑤ SCENE** button.

■ Renaming the SCENE templates

Select the name of the SCENE template at step 3 of “Customizing the preset SCENE templates” and then press **⑦ ENTER**.

- Press **⑦ Δ / ▽** to select the desired character.
- Press **⑦ </>** to place “_” (underscore) under the space or the desired character.
- Press **⑧ RETURN** to cancel the new name.
- Press **⑦ ENTER** to confirm the new name.

Using remote control on the SCENE feature

■ Controlling the input source components in the SCENE mode

You can operate both this unit and the input source component by using the remote control. You must set the appropriate remote control code for each input source in advance (see page 69).

- 1 Press the desired ⑤ SCENE button on the remote control.
- 2 Press the desired buttons in the * area below to control the input source component of the selected SCENE template.

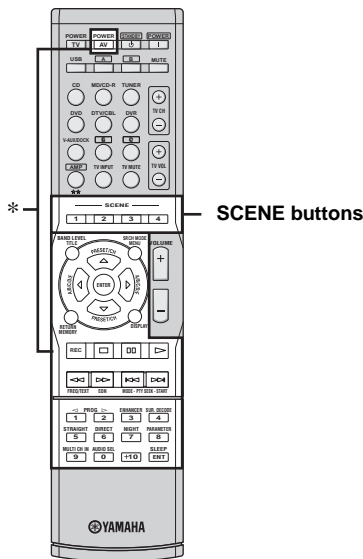

Note

* These buttons control the input source component. See page 68 for details of the function of each button.

■ Setting input source of the customized SCENE template on the remote control

If you customize the input source of the selected SCENE template, you must set the input source of the SCENE template on the remote control to operate the input source component correctly.

- Press and hold the ⑤ SCENE button and the desired input selector button (③) for 3 seconds.



Press the ⑤ SCENE button again to operate the input source component.

Playback

Caution

Extreme caution should be exercised when you play back CDs encoded in DTS. If you play back a CD encoded in DTS on a DTS-incompatible CD player, you will only hear some unwanted noise that may damage your speakers. Check whether your CD player supports CDs encoded in DTS. Also, check the sound output level of your CD player before you play back a CD encoded in DTS.

Basic operations

1 Turn on the video monitor connected to this unit.

2 Press SPEAKERS repeatedly to select the front speakers you want to use.

The respective speaker indicators lights up in the front panel display.

3 Press INPUT \leftarrow/\rightarrow repeatedly (or press one of the input selector buttons (3)) to select the desired input source.

The name of the currently selected input source appears in the front panel display for a few seconds.

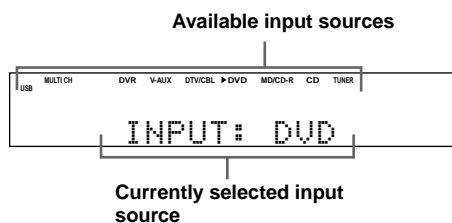

4 Start playback on the selected component or select a broadcast station.

- Refer to the operating instructions for the source component.
- See page 43 for details about FM/AM tuning instructions.

5 Rotate VOLUME (or press VOLUME +/-) to adjust the volume to the desired output level.

6 Press PROGRAM \leftarrow/\rightarrow repeatedly (or press AMP and then PROG \leftarrow/\rightarrow repeatedly) to select the desired sound field program.

The name of the selected sound field program appears in the front panel display.

See page 38 for details about sound field programs.



Notes

- Choose a sound field program based on your listening preference, not merely on the name of the program.
- When you select an input source, this unit automatically selects the last sound field program used with the corresponding input source.
- Sound field programs cannot be selected when the component connected to the MULTI CH INPUT jacks is selected as the input source (see page 34).
- When PCM signals with a sampling frequency higher than 48 kHz are input, this unit is automatically set to the "STRAIGHT" mode (see page 39).
- To display information about the currently selected input source in the OSD, see page 36 for details.

■ A quick guide to contents

When you want to...	See page
Enjoy high quality sound	41
Adjust the tonal quality of the front speakers	41
Adjust the parameters of sound field programs	40
Enjoy the sources with a wide dynamic range at night	42
Use headphones	35
Select a decoder to play back sources with	39
Automatically set this unit to the standby mode	37

Selecting audio input jacks (AUDIO SELECT)

This unit comes with a variety of input jacks. Use this feature (audio input jack select) to switch between input jacks when more than one input jack is assigned to as the same input source.



- We recommend setting the audio input jack select to “AUTO” in most cases.
- You can adjust the default audio input jack select of this unit by using “AUDIO SELECT” in “OPTION MENU” (see page 65).

Press **ⓅAUDIO SELECT** (or press **④AMP** and then **ⓅAUDIO SEL**) repeatedly to select the desired audio input jack select setting.

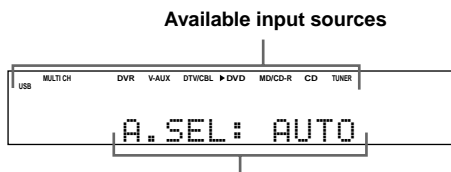

AUDIO SELECT	Function
AUTO	Automatically selects input signals in the following order: (1) HDMI (2) Digital signals (3) Analog signals
HDMI	Selects only HDMI signals. When HDMI signals are not input, no sound is output.
COAX/OPT	Selects only digital signals. When no signals are input, no sound is output.
ANALOG	Selects only analog signals. If no analog signals are input, no sound is output.

Note

This feature is not available when no digital input jacks (OPTICAL, COAXIAL and HDMI) are assigned. In addition, HDMI is not available as an audio input jack select setting when the HDMI IN DVD and HDMI IN DTV/CBL jacks are not used. Use “INPUT ASSIGNMENT” in “INPUT MENU” to reassign the respective input jack (see page 62).

Selecting the MULTI CH INPUT component

Use this feature to select the component connected to the MULTI CH INPUT jacks (see page 18) as the input source.

Press **ⓄINPUT** **◀/▶** repeatedly (or press **④AMP** and then **ⓄMULTI CH IN**) to select **MULTI CH**.

“MULTI CH” appears in the front panel display.



Use “MULTI CH SET” menu in “INPUT MENU” to set the parameters for MULTI CH INPUT (see page 63).

Note

The input signals are amplified and output directly without sound processing. Therefore, you cannot activate sound field programs, the night listening mode, etc. while MULTI CH is selected as the input source.

Displaying the current status of this unit on a video monitor

You can display the operating information of this unit on a video monitor.

1 Turn on the video monitor connected to this unit.

2 Press **DISPLAY**.

The current status screen appears in the OSD.

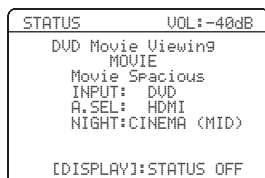

You can select the amount of time that the current status is displayed in the OSD by using the “OSD-AMP” parameter in “OPTION MENU” (see page 64).

Note

The OSD signal is not output at the DVR VIDEO OUT jacks and will not be recorded.

Using your headphones

Connect a pair of headphones with a stereo analog audio cable plug to the PHONES jack on the front panel.

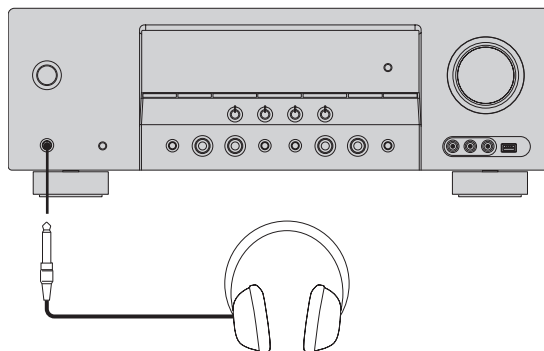

When you select a sound field program, SILENT CINEMA mode is automatically activated (see page 39).

Notes

- When you connect headphones, no signals are output at the speaker terminals.
- All Dolby Digital and DTS audio signals are mixed down to the left and right headphone channels.

Muting the audio output

Press **MUTE** to mute the audio output. Press **MUTE** again to resume the audio output.



- You can also rotate **VOLUME** or press **VOLUME +/-** to resume the audio output.
- You can adjust the muting level by using the “MUTE TYPE” parameter in “SOUND MENU” (see page 60).
- The MUTE indicator flashes in the front panel display when the audio output is muted and disappears from the front panel display when the audio output is resumed.

Playing video sources in the background of an audio source

You can combine a video image from a video source with sound from an audio source. For example, you can enjoy listening to classical music while viewing beautiful scenery from the video source on the video monitor.

Press the input selector buttons (3) to select a video source and then an audio source.

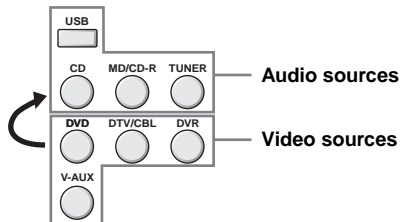

- You can also select “MULTI CH” as the audio source (see page 34). Press 4 AMP and then press 10 MULTI CH IN.
- Set the “BGV” parameter in the “MULTI CH SET” menu to the desired setting to select the default background video input source of the MULTI CH INPUT sources (see page 63).

Displaying the input source information

You can display the format, sampling frequency, channel, bit rate and flag data of the current input signal.

1 Press 4 AMP and then 2 MENU.

The top “SET MENU” display appears in the OSD.

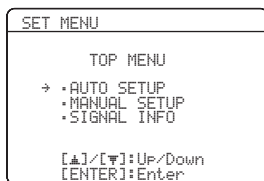

2 Press 7 ▽ repeatedly to select “SIGNAL INFO” and then press 7 ENTER.

The audio information about the input source appears in the OSD.

3 Press 7 ◀/▶ to toggle between the audio and video information displays.

4 Press 2 MENU again to exit from “SET MENU”.

Audio information

Information	Descriptions
FORMAT	Signal format. When this unit cannot detect a digital signal, it automatically switches to analog input.
SAMPLING	The number of samples per second taken from a continuous signal to make a discrete signal.
CHANNEL	The number of source channels in the input signal (front/surround/LFE). For example, a multi-channel soundtrack with 3 front channels, 2 surround channels and LFE, is displayed as “3/2/0.1”.
BITRATE	The number of bits passing a given point per second.
FLAG	Flag data encoded in DTS, Dolby Digital, or PCM signals that cue this unit to automatically switch decoders.

Note

“—” appears when this unit cannot display the corresponding information.

Video information

Information	Descriptions
HDMI SIGNAL	Type of the source video signals and the video signals output at the HDMI OUT jack of this unit.
HDMI RES.	Resolution of the HDMI signals input or output at the HDMI IN/OUT jacks of this unit.
HDMI ERROR (Only when error is detected)	Error message for HDMI sources or connected HDMI devices. See “HDMI error and message” for details.

Note

“—” appears when this unit cannot display the corresponding information.

HDMI error and message

Message	Cause
DEVICE OVER	The number of the connected HDMI components is over the limit.
HDCP ERROR	HDCP authentication failed.
OUT OF RES.	The connected monitor is not compatible with the resolution of the input video signal.

Using the sleep timer

Use this feature to automatically set this unit to the standby mode after a certain amount of time.

Press **④AMP** and then press **ⓈSLEEP** repeatedly to set the amount of time.

Each time you press **ⓈSLEEP**, the front panel display changes as shown below.

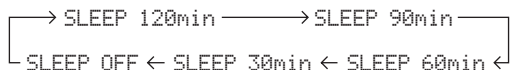

The SLEEP indicator flashes while you are switching the amount of time for the sleep timer. Once the sleep timer is set, the SLEEP indicator lights up in the front panel display, and the display returns to the selected sound field program.



- To cancel the sleep timer, press **④AMP** and then press **ⓈSLEEP** repeatedly until “SLEEP OFF” appears in the front panel display.
- The sleep timer setting can also be canceled by pressing **ⒶSTANDBY/ON** (or **ⓈSTANDBY**) to set this unit to the standby mode.

Sound field programs

This unit is equipped with a variety of precise digital decoders that allow you to enjoy multi-channel playback from almost any stereo or multi-channel sound source.

Press **PROGRAM** $\triangleleft/\triangleright$ (or press **AMP** and then press **PROG** $\triangleleft/\triangleright$ repeatedly).

The name of the selected sound field program appears in the front panel display.

Notes

- When you select an input source, this unit automatically selects the last sound field program used with the corresponding input source.
- Sound field programs cannot be selected when the component connected to the MULTI CH INPUT jacks is selected as the input source (see page 34).
- When PCM signals with a sampling frequency higher than 48 kHz are input, this unit is automatically set to the “STRAIGHT” mode (see page 39).



Choose a sound field program based on your listening preference, not merely on the name of the program itself.

Sound field program descriptions

Category	Program	Features
MUSIC	Pop/Rock	CINEMA DSP processing. This program presents an image of pop, rock, or jazz live concert. The sound field reproduces the spaciousness of a massive pavilion with an emphasis on the vividness of vocals on the stage and solo instruments and the beats of rhythm instruments.
	Hall	CINEMA DSP processing. This sound field is suitable for classic and orchestral music. The program uses data collected in a large concert hall in Munich. You can enjoy delicate and beautiful reverberation and a majestic atmosphere.
	Jazz	CINEMA DSP processing. The sound field is suitable for jazz and fusion music. It uses data collected in a famous jazz club in New York. You can enjoy clear reverberation.
ENTERTAINMENT	Game	CINEMA DSP processing. You can enjoy dynamic and thrilling sound effects as you play games. The program lets you feel the depth and three-dimensional surrounding sounds of the field where you are playing, and offers cinema-like surrounding sound effects for the scenes of movies.
	TV Sports	CINEMA DSP processing. You can enjoy sports relays broadcast in stereo and variety shows with a live sound environment. For sports relays, the voices of commentators and announcers come clearly from the center; the cheers and atmosphere in the stadium spread around within a comfortable range, and you can feel like as if you are in the stadium.
MOVIE	Movie Spacious	CINEMA DSP processing. The sound field is suitable for movies with an emphasis on spectacular sound effects, and is a perfect fit with a wide screen. The program reproduces a wide dynamic range from minimum sound effects to powerful sounds.
	Movie Dramatic	CINEMA DSP processing. This sound field is also suitable for movies with an emphasis on three-dimensional sound effects. It restrains reverberation to an moderate extent, but reproduces sound effects and background music in a soft, three-dimensional manner with clarity and center orientation of voices as pivots.
STEREO	2ch Stereo	Downmixes multi-channel sources to 2 channel or plays back 2-channel sources as they are.
	5ch Stereo	CINEMA DSP processing. Using this program increases the listening position range. This is a sound field suitable for background music at parties.
MUSIC ENHANCER	2ch Enhancer 5ch Enhancer	Select these programs to play back compression artifacts (such as the MP3 format) in 2-channel or 5-channel stereo. This program enhances your listening experience by regenerating the missing harmonics in a compression artifact.

Note

The sound field programs of this unit are recreations of real-world acoustic environments made from precise measurements taken in the actual concert hall, music venue, movie theater, etc. Thus, you may notice variations in the strength of the reflections coming from each direction.

■ Enjoying 2-channel sources using the standard decoders

Signals input from 2-channel sources can also be played back on multi-channels.

Press **④AMP** and then press **ⓈSUR. DECODE** repeatedly to select a decoder.

You can select from the following decoders depending on the type of source you are playing and your personal preference.

Decoder	Functions
Pro Logic	Dolby Pro Logic processing for any sources
PLII Movie	Dolby Pro Logic II processing for movie sources
PLII Music	Dolby Pro Logic II processing for music sources
PLII Game	Dolby Pro Logic II processing for game sources

■ Using sound field programs without surround speakers (Virtual CINEMA DSP)

Virtual CINEMA DSP allows you to enjoy the CINEMA DSP programs without surround speakers by creating virtual speakers.

If you set “SUR. L/R SP” to “NONE” (see page 58), Virtual CINEMA DSP is automatically activated whenever you select a CINEMA DSP program (see page 38).

Note

Virtual CINEMA DSP will not be activated even when “SUR. L/R SP” is set to “NONE” (see page 58) in the following cases:

- when “5ch Stereo” (see page 38) is selected.
- when headphones are connected to the PHONES jack.

■ Enjoying multi-channel sources and sound field programs with headphones (SILENT CINEMA)

SILENT CINEMA allows you to enjoy multi-channel music or movie sound, including Dolby Digital and DTS sources, through ordinary headphones. SILENT CINEMA is automatically activated whenever you connect headphones to the PHONES jack while listening to CINEMA DSP sound field programs (except for 5ch Stereo) (see page 38). When activated, the SILENT CINEMA indicator lights up in the front panel display.

■ Enjoying unprocessed input sources (Straight decoding mode)

When this unit is in the “STRAIGHT” mode, multi-channel sources are decoded straight into the appropriate channels without any additional effect processing. 2-channel stereo sources are output from only the front left and right speakers.

Press **ⓂSTRAIGHT** (or press **④AMP** and then press **ⓈSTRAIGHT**) to select “STRAIGHT”.

To deactivate the “STRAIGHT” mode, press **ⓂSTRAIGHT** (or press **④AMP** and then **ⓈSTRAIGHT**) again so that “STRAIGHT” disappears from the front panel display.

■ Editing sound fields parameters

You can enjoy good quality sound with the factory default parameters. Although you do not have to change the initial settings, you can change some of the parameters to better suit the input source or your listening room.

- 1 While listening to a source, press **④AMP** and then press **⑦PARAMETER**.
- 2 Press **⑦△/▽** to select the desired parameter you want to change.
- 3 Press **⑦</>** to change the parameter value.

Note

You cannot change parameter values when "MEMORY GUARD" in "OPTION MENU" is set to "ON" (see page 64).



Initial settings are indicated in bold under each parameter.

For Pop/Rock, Hall, Jazz, Game, TV Sports, Movie Spacious and Movie Dramatic:

DSP level **DSP LEVEL**

Function: Adjusts the effect level.

Choices: **MIN, MID, MAX**

For 2ch Enhancer and 5ch Enhancer:

Effect level **EFFECT LEVEL**

Function: Adjusts the effect level.

Choices: **LOW, HIGH**

For Pro Logic II Music:

Panorama **PANORAMA**

Function: Sends stereo signals to the surround speakers as well as the front speakers for a wraparound effect.

Choices: **OFF, ON**

Dimension **DIMENSION**

Function: Gradually adjusts the sound field either towards the front or towards the rear.

Control range: -3 (towards the rear) to +3 (towards the front), initial setting is STD (standard).

Center width **CT WIDTH**

Function: Adjusts the center image from all three front speakers to varying degrees. A larger value adjusts the center image towards the front left and right speakers.

Control range: 0 (center channel sound is output only from center speaker) to 7 (center channel sound is output only from front left and right speakers), initial setting is 3.

Using audio features

Enjoying high quality sound

Use the DIRECT mode to enjoy the high quality sounds of the selected source. When the DIRECT mode is activated, this unit plays back the selected source with the least circuitry.

Press **DIRECT** (or press **AMP** and then **DIRECT**) to select “DIRECT”.

Notes

- “TONE CONTROL” and “SOUND MENU” (see page 57) settings (except for speaker level settings) are not effective.
- The front panel display automatically dims.



While DIRECT mode is activated, the front panel display turns on momentarily when an operation is performed.

Adjusting the tonal quality

Use this feature to adjust the balance of bass and treble for the front left and right speaker channels.



Speaker and headphone adjustments are stored independently.

1 Press **TONE CONTROL** repeatedly to select the high-frequency response (TREBLE) or the low-frequency response (BASS).

2 Press **PROGRAM** **</>** repeatedly to adjust the high-frequency response (TREBLE) or the low-frequency response (BASS).

Notes

- If you increase or decrease the high-frequency or the low-frequency sound to an extreme level, the tonal quality of the surround speakers may not match.
- TONE CONTROL is not effective when this unit is in the DIRECT mode, or when MULTI CH is selected as the input source.

Adjusting the speaker level

You can adjust the output level of each speaker while listening to a music source. This is also possible when playing sources input at the MULTI CH INPUT jacks.

Note

This operation will override the level adjustments made in “AUTO SETUP” (see page 24) and “SP LEVEL” (see page 59).

1 Press **AMP** and then press **LEVEL** on the remote control and then **Δ / ▽** to select the speaker you want to adjust.

Display	Adjusted speaker
FRONT L	Front left speaker
FRONT R	Front right speaker
CENTER	Center speaker
SWFR	Subwoofer
SUR. L	Surround left speaker
SUR. R	Surround right speaker



- The available speaker channels differ depending on the setting of the speakers.
- When the video monitor is turned on, the “SPEAKER LEVEL” adjustment menu appears in the video monitor.

2 Press **Δ / ▽** to adjust the speaker output level.

- Press **Δ** to increase the value.
- Press **▽** to decrease the value.
- Control range: -10 dB to +10 dB

3 Press **LEVEL** to turn off the speaker level adjustment display.

Selecting the night listening mode

The night listening modes are designed to improve listenability at lower volumes or at night.

- 1 Press **④AMP** and then **ⓈNIGHT** repeatedly to select “**NIGHT:CINEMA**” or “**NIGHT:MUSIC**”.

Choices: NIGHT:CINEMA, NIGHT:MUSIC, OFF

- Select “NIGHT:CINEMA” when watching films to reduce the dynamic range of film soundtracks and make dialog easier to hear at lower volumes.
- Select “NIGHT:MUSIC” when listening to music sources to preserve ease-of-listening for all sounds.
- Select “OFF” if you do not want to use this feature.



When a night listening mode is selected, the NIGHT indicator lights up in the front panel display.

- 2 Press **⑦◀/▶** to adjust the effect level while “**NIGHT:CINEMA**” or “**NIGHT:MUSIC**” is displayed in the front panel display.

Effect.Lvl: MID

Choices: MIN, **MID**, MAX

- Select “MIN” for minimum compression.
- Select “MID” for standard compression.
- Select “MAX” for maximum compression.



“NIGHT:CINEMA” and “NIGHT:MUSIC” adjustments are stored independently.

Notes

- You cannot use the night listening modes in the following cases:
 - when the DIRECT mode (see page 41) is selected.
 - when the component connected to the MULTI CH INPUT jacks is selected as the input source (see page 34).
 - when headphones are connected to the PHONES jack.
- The night listening modes may vary in effectiveness depending on the input source and surround sound settings you use.

FM/AM tuning

There are 2 tuning methods: automatic and manual. Automatic tuning is effective when station signals are strong and there is no interference. If the signal from the station you want to select is weak, tune into it manually. You can also use the automatic and manual preset tuning features to store up to 40 stations.

Automatic tuning

Automatic tuning is effective when station signals are strong and there is no interference.

- 1 Press **ⓈINPUT** $\triangleleft/\triangleright$ repeatedly so that **"TUNER"** is displayed in the front panel display.
- 2 Press **ⓈBAND** to select the reception band (FM or AM).
- 3 Press **ⓈTUNING AUTO/MAN'L** so that the **AUTO** indicator lights up in the front panel display.

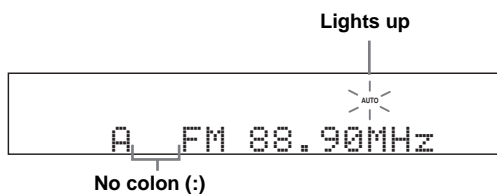

If a colon (:) appears in the front panel display, automatic tuning is not possible. Press **ⓈPRESET/TUNING** to turn the colon (:) off.

- 4 Press **ⓈPRESET/TUNING/CH** $\triangleleft/\triangleright$ once to begin automatic tuning.
- When this unit is tuned into a station, the **TUNED** indicator lights up and the frequency of the received station is shown in the front panel display.

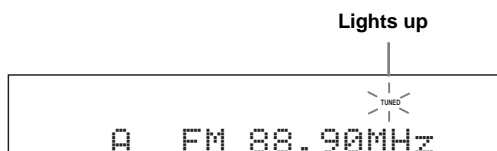

Manual tuning

If the signal received from the station you want to select is weak, tune into it manually.

Note

Manually tuning into an FM station automatically switches the tuner to monaural reception to increase the signal quality.

- 1 Press **ⓈINPUT** $\triangleleft/\triangleright$ repeatedly so that **"TUNER"** is displayed in the front panel display.
 - 2 Press **ⓈBAND** to select the reception band (FM or AM).
 - 3 Press **ⓈTUNING AUTO/MAN'L** so that the **AUTO** indicator disappears from the front panel display.
-
- No colon (:)
- 4 Press **ⓈPRESET/TUNING/CH** $\triangleleft/\triangleright$ to tune into the desired station manually.



Hold down the button to continue searching.

Automatic preset tuning

You can use the automatic preset tuning feature to store FM stations with strong signals up to 40 (A1 to E8: 8 preset station numbers in each of the 5 preset station groups) of those stations in order. You can then recall any preset station easily by selecting the preset station number.

- 1 Press **Ⓢ** **INPUT** **</>** repeatedly so that “**TUNER**” is displayed in the front panel display.
- 2 Press **Ⓢ** **BAND** to select “**FM**” as the reception band.
- 3 Press and hold **Ⓢ** **MEMORY** for more than 3 seconds.
The preset station number as well as the **MEMORY** and **AUTO** indicators flashes. After approximately 5 seconds, automatic presetting starts from the current frequency and proceeds toward the higher frequencies.

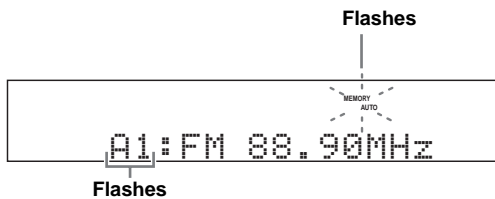

When automatic preset tuning is completed, the front panel display shows the frequency of the last preset station.



You can select the preset station group and the preset station number where the first received station will be stored by pressing **Ⓢ** **A/B/C/D/E** and then **Ⓢ** **PRESET/TUNING/CH** **</>**.

Notes

- Any stored station data existing under a preset station number is cleared when you store a new station under the same preset station number.
- Only FM stations with sufficient signal strength are stored automatically by automatic preset tuning. If the station you want to store is weak in signal strength, tune into it manually and store it as described in “Manual preset tuning” on this page.
- Only Radio Data System broadcasting stations are stored automatically by automatic preset tuning (Europe and Russia models only).

Manual preset tuning

You can also store up to 40 stations (A1 to E8: 8 preset station numbers in each of the 5 preset station groups) manually.

- 1 Tune into a station automatically or manually.
See page 43 for tuning instructions.
- 2 Press **Ⓢ** **MEMORY**.
The **MEMORY** indicator flashes in the front panel display for approximately 30 seconds.
- 3 Press **Ⓢ** **A/B/C/D/E** and **Ⓢ** **PRESET/TUNING/CH** **</>** repeatedly to select a preset station group (A1 to E8) while the **MEMORY** indicator is flashing.
Check that the colon (:) appears in the front panel display.

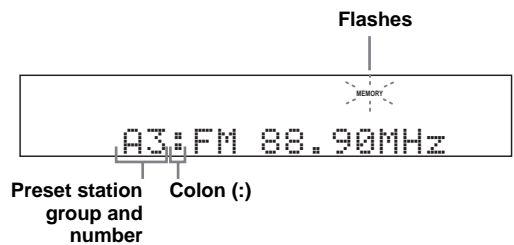

- 4 Press **Ⓢ** **MEMORY** while the **MEMORY** indicator is flashing.
The station band and frequency appear in the front panel display with the preset station group and number you have selected.

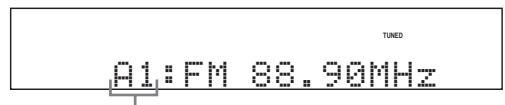

Notes

- Any stored station data existing under a preset station number is cleared when you store a new station under the same preset station number.
- The reception mode (stereo or monaural) is stored along with the station frequency.

Selecting preset stations

You can tune into any desired station simply by selecting the preset station group and number under which it was stored.



When performing this operation with the remote control, press **TUNER** to select "TUNER" as the input source.

- 1 Press **A/B/C/D/E** (or **A/B/C/D/E** $\triangleleft/\triangleright$) repeatedly to select the desired preset station group (A to E).

The preset station group letter appears in the front panel display and changes each time you press the button.

- 2 Press **PRESET/TUNING/CH** $\triangleleft/\triangleright$ (or **PRESET/CH** \triangle/∇) to select the desired preset station number (1 to 8).

The preset station group and number appear in the front panel display along with the station band and frequency.

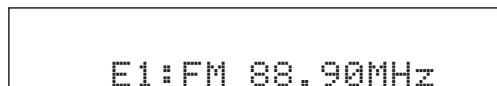

You can select the desired preset station number (1 to 8) directly by pressing the numeric buttons on the remote control.

Exchanging preset station

You can exchange the assignments of two preset stations with each other. The example below describes the procedure to exchange preset station "E1" with "A5".

- 1 Select preset station "E1" using **A/B/C/D/E** and **PRESET/TUNING/CH** $\triangleleft/\triangleright$. See "Selecting preset stations" on this page.

- 2 Press and hold **PRESET/TUNING** for more than 3 seconds. "E1" and the MEMORY indicator flash in the front panel display.

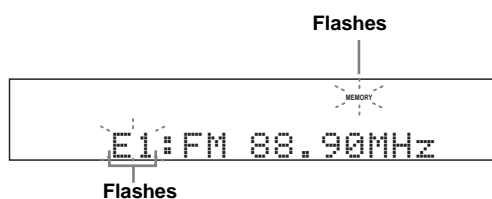

- 3 Select preset station "A5" using **A/B/C/D/E** and **PRESET/TUNING/CH** $\triangleleft/\triangleright$.

"A5" and the MEMORY indicator flash in the front panel display.

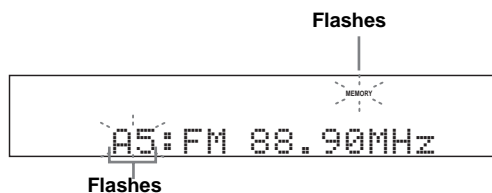

- 4 Press **PRESET/TUNING** again. "EXCHANGE E1-A5" appears in the front panel display and the assignments of the two preset stations are exchanged.

Radio Data System tuning (Europe and Russia models only)

Radio Data System is a data transmission system used by FM stations in many countries. This unit can receive various Radio Data System data such as PS (program service), PTY (program type), RT (radio text), CT (clock time), and EON (enhanced other networks) when receiving Radio Data System broadcasting stations.

Displaying the Radio Data System information

Use this feature to display the 4 types of the Radio Data System information: PS (program service), PTY (program type), RT (radio text) and CT (clock time). The corresponding indicators light up in the front panel display.

Notes

- You can select one of the Radio Data System display modes only when the corresponding Radio Data System indicator lights up in the front panel display. It may take a while for this unit to receive all of the Radio Data System data from the station.
- You can select only the available Radio Data System display modes being offered by the station.
- If the signals being received are not strong enough, this unit may not be able to utilize the Radio Data System data. In particular, the “RT” mode requires a large amount of data and may not be available even when the other Radio Data System display modes are available.
- In case of poor reception conditions, press **Ⓜ TUNING AUTO/ MAN'L** on the front panel so that the AUTO indicator disappears from the front panel display.
- If the signal strength is weakened by external interference while this unit is receiving the Radio Data System data, the reception may be cut off unexpectedly and “...WAIT” appears in the front panel display.
- When the “RT” mode is selected, this unit can display the program information by a maximum of 64 alphanumeric characters, including the umlaut symbol. Unavailable characters are displayed with the “_” (underscore).
- If the reception is cut off when the “CT” mode is selected, “CT WAIT” appears in the front panel display.

1 Tune into the desired Radio Data System broadcasting station.

- We recommend using the automatic preset tuning to tune into the Radio Data System broadcasting stations (see page 44).
- You can also use PTY SEEK mode to tune into the desired Radio Data System broadcasting station from the preset ones.

2 Press **Ⓜ FREQ/TEXT** on the remote control repeatedly to select the desired Radio Data System display mode.

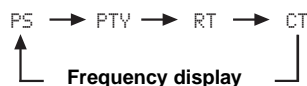

- Select “PS” to display the name of the Radio Data System program currently being received.
- Select “PTY” to display the type of the Radio Data System program currently being received.
- Select “RT” to display the information on the Radio Data System program currently being received.
- Select “CT” to display the current time.

Selecting the Radio Data System program type (PTY SEEK mode)

Use this feature to select the desired radio program by program type from the all preset Radio Data System broadcasting stations.



Use the automatic preset tuning feature to preset Radio Data System broadcasting stations (see page 44).

1 Press **③ TUNER** on the remote control to select “TUNER” as the input source.

2 Press **Ⓜ PTY SEEK MODE** on the remote control to set this unit to the PTY SEEK mode.

The name of the program type or “NEWS” flashes in the front panel display.



To cancel the PTY SEEK mode, press **Ⓜ PTY SEEK MODE** on the remote control again.

3 Press **⑦ PRESET/CH Δ/∇** on the remote control to select the desired program type.

The name of the selected program type appears in the front panel display.

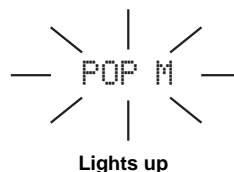

Program type	Descriptions
NEWS	News
AFFAIRS	Current affairs
INFO	General information
SPORT	Sports
EDUCATE	Education
DRAMA	Drama
CULTURE	Culture
SCIENCE	Science
VARIED	Light entertainment
POP M	Popular music
ROCK M	Rock music
M.O.R. M	Middle-of-the-road music (easy-listening)
LIGHT M	Light classics
CLASSICS	Serious classics
OTHER M	Other music

- 4 Press **Ⓜ** **PTY SEEK START** on the remote control to start searching for all the available Radio Data System preset stations.

The name of the selected program type flashes and the PTY HOLD indicator lights up in the front panel display while this unit is searching for stations.



Flashes



Lights up



To stop searching for stations, press **Ⓜ** **PTY SEEK START** on the remote control again.

Notes

- This unit stops searching for stations when a station broadcasting the selected program type is found.
- If the station found is not the one you desire, press **Ⓜ** **PTY SEEK START** again to resume searching for another station broadcasting the same program type.

Using the enhanced other networks (EON) data service

Use this feature to receive the EON (enhanced other networks) data service of the Radio Data System station network. Once you select one of the 4 Radio Data System program types (NEWS, AFFAIRS, INFO, or SPORT), this unit automatically searches for all the available preset stations that are scheduled to broadcast the EON data service of the selected program type for a certain duration of time. When the scheduled EON data service starts, this unit automatically switches to the local station broadcasting the EON data service and then switches back to the national station once the EON data service ends.

Notes

- You can use this feature only when the EON data service is available.
- The EON indicator lights up in the front panel display only when the EON data service is being received from a Radio Data System station.

- 1 Tune into the desired Radio Data System broadcasting station.

- 2 Make sure the EON indicator is lit in the front panel display.

If the EON indicator is not lit in the front panel display, select another Radio Data System program so that the EON indicator lights up.



- 3 Press **Ⓜ** **EON** on the remote control repeatedly to select one of the 4 Radio Data System program types (NEWS, AFFAIRS, INFO or SPORT).

The name of the selected program type appears in the front panel display.



Lights up



To cancel the EON feature, press **Ⓜ** **EON** on the remote control repeatedly until the name of the program type disappears and "EON OFF" appears in the front panel display.

Using a USB memory device or a USB portable audio player

Use this feature to enjoy WAV (PCM format only), MP3 and WMA files saved on your USB memory device or USB portable audio player connected to the USB port on the front panel of this unit.

Supported USB devices

This unit supports USB mass storage class devices (except USB hard disk drives) using FAT16 or FAT32 format.

Notes

- Only the first partition (32 GB or less) is displayed in the OSD. You cannot select files in other partitions.
- Up to 8 levels of directory hierarchy and 500 music files per directory are recognized.
- Some devices may not work properly even if they meet the requirements.
- Some WAV, MP3 and WMA files may not be playable or may be noisy when played.

Connecting a USB memory device or a USB portable audio player

Connect a USB jack of a USB memory device or USB portable audio player to the USB port on the front panel of this unit.

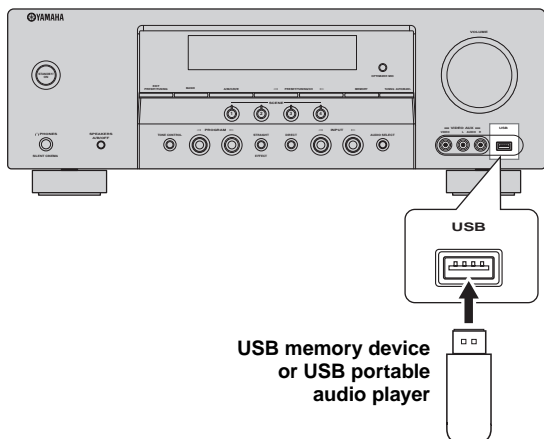

Playback operation

Follow the procedures below to enjoy the music stored in your USB device or a USB portable audio player.

- 1 Press **INPUT** $\triangleleft/\triangleright$ repeatedly (or press **USB**) to select **USB**.

The cursor on the left of the USB indicator lights up in the front panel display, and the contents previously played is automatically played.

Lights up

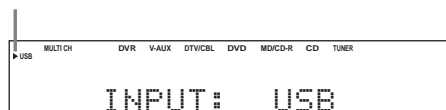

- 2 Press **DISPLAY** to display the top USB file list.

The USB file list appears in the OSD.

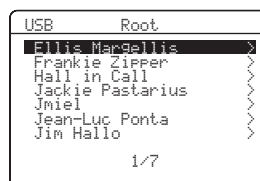

- “>” in the right corner of each menu line indicates that there is a submenu available in the next menu level.
- When this unit is in the top directory, “Root” appears beside “USB”.

3 Press Δ / ∇ / \leftarrow / \rightarrow on the remote control to select the desired file.

- Press Δ / ∇ to select the desired file/folder.
- Press ENTER or \rightarrow to enter the selected folder.
- Press \leftarrow to return to the previous folder level.

4 Press ENTER to play the selected file.



- You can use \leftarrow / \rightarrow to skip backward/forward and STOP / \square to start/stop playback independently from the menu in the OSD.
- You can set the settings for repeat and shuffle mode by using the "USB PLAY STYLE" parameters in "OPTION MENU" (see page 66).
- You can select the display mode in the front panel display by using "FL SCROLL" in "OPTION MENU" (see page 64).

The function of the play information display

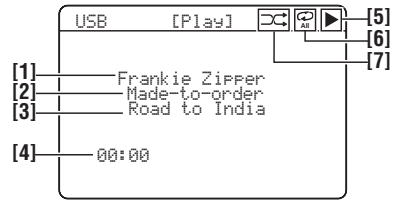

[1] Name of the artist

[2] Name of the album



[3] Name of the song

[4] Elapsed time

Note

When the elapsed time exceed "99:59", "--:--" appeared instead of the time.

[5] ► (playback) icon

[6]  (all repeat),  (single repeat) icons

When "REPEAT" of the "USB PLAY STYLE" in "OPTION MENU" (see page 66) is set to "OFF", no icon appears in the top right corner while files or folders are being played.

[7]  (shuffle) icon

When "SHUFFLE" of the "USB PLAY STYLE" in "OPTION MENU" (see page 66) is set to "OFF", no icon appears in the top right corner while files or folders are being played.

Using iPod™

Once you have stationed your iPod in a Yamaha iPod universal dock (such as YDS-10, sold separately) connected to the DOCK terminal of this unit (see page 19), you can enjoy playback of your iPod using the supplied remote control. You can also use the Compressed Music Enhancer mode of this unit to improve the sound quality of the compression artifacts (such as the MP3 format) stored on your iPod (see page 19).

Notes

- Only iPod (Click and Wheel), iPod nano, and iPod mini are supported.
- Some features may not be compatible depending on the model or the software version of your iPod.



- For a complete list of status messages that appear in the front panel display and in the OSD, see the “iPod” section in “Troubleshooting” on page 78.
- Once your iPod is stationed in a Yamaha iPod universal dock, this unit begins signal transmission with your iPod.
- Once the connection between your iPod and this unit is complete, “iPod connected” appears in the front panel display and the DOCK indicator lights up in the front panel display.
- Only the analog audio and video signals of your iPod are input at the DOCK terminal, and the analog audio signals can be output at the analog AUDIO OUT (REC) jacks for recording.

Controlling iPod™

You can control your iPod when “V-AUX” is selected as the input source. The operations of your iPod can be done with the aid of the OSD of this unit (menu browse mode) or without it (simple remote mode).

Remote control operation

Before performing the following operations, press **③ V-AUX/DOCK**.

Button	Function
⑦ ENTER	Subsequent menu
△	Menu up
▽	Menu down
◀	Previous menu
▶	Subsequent menu
⑨ ◀◀	Search backward (Press and hold)
▶▶	Search forward (Press and hold)
◀◀	Skip backward
▶▶	Skip forward
⏸	Pause (Menu browse mode) Play/Pause (Simple remote mode)
▶	Play (Menu browse mode) Play/Pause (Simple remote mode)
② MENU	Previous menu
③ DISPLAY	Display

Controlling iPod in the simple remote mode

You can perform the basic operations of your iPod (play, stop, skip, etc.) using the supplied remote control without the aid of the OSD of this unit.



- You can view the photos or video clips stored on your iPod (some models only).
- Operations can be also done with the controls on your iPod.

■ Controlling iPod in the menu browse mode

You can perform the advanced operations of your iPod using the supplied remote control when you connect this unit and a monitor using the VIDEO connection. You can browse the songs stored on your iPod in the OSD. Further, you can change or adjust settings for your iPod to suit your personal preferences.



- The name of the song being played also appears in the front panel display according to the “FL SCROLL” parameter in “OPTION MENU” (see page 64).
- You can select the amount of time the iPod menu and play information is displayed in the OSD by using the “OSD-SOURCE” in “OPTION MENU” (see page 64)

Notes

- Operations cannot be done with the controls on your iPod.
- The Yamaha logo appears in the display window of your iPod.
- There are some characters that cannot be displayed in the front panel display or in the OSD of this unit. Those characters are replaced with underscores “_”.
- The “Settings” parameters can be changed or adjusted only in the OSD. Press **ENTER** repeatedly to toggle between the “Settings” parameter settings.
- You cannot browse the photos or video clips stored on your iPod in the OSD. Use the simple remote mode to enjoy watching the photos or video clips stored on your iPod.

1 Press **V-AUX/DOCK** and then **DISPLAY**.

The following display appears in the OSD.



2 Press **UP/DOWN/LEFT/RIGHT** to navigate the iPod menu and then press **ENTER** to begin playback of the selected song.

Choices: Playlists (playlists), Artists (artists), Albums (albums), Songs (songs), Genres (genres), Composers (composers), Settings (settings)

- Playlists > Songs
- Artists > Albums > Songs
- Albums > Songs
- Songs
- Genres > Artists > Albums > Songs
- Composers > Albums > Songs
- Settings > Shuffle, Repeat

Shuffle Shuffle

Use this feature to set this unit to play songs or albums in random order.

Choices: Off, Songs, Albums

- Select “Off” to deactivate this feature.
- Select “Songs” to set this unit to play songs in random order.
- Select “Albums” to set this unit to play albums in random order.



When “Shuffle” is set to a setting other than “Off”, “” appears in the top right corner while songs or albums are being shuffled.



Repeat Repeat

Use this feature to set this unit to repeat one song or a sequence of songs.

Choices: Off, One, All

- Select “Off” to deactivate this feature.
- Select “One” to set this unit to repeat one song.
- Select “All” to set this unit to repeat a sequence of songs.



When “Repeat” is set to a setting other than “Off”, “” or “” appears in the top right corner while one song or a sequence of songs are being repeated.

■ The function of the play information display

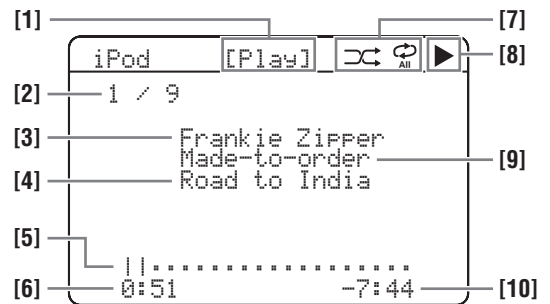

[1] Playback status

[2] Track number/total tracks

[3] Artist name

[4] Song title

[5] Progress bar

[6] Elapsed time

[7] Shuffle and repeat icons

[8] **▶** (playback), **||** (pausing), **⏭** (search forward) and **⏮** (search backward)

[9] Name of the album

[10] Remaining time

Using Bluetooth™ components

You can connect a Yamaha Bluetooth adapter (such as YBA-10, sold separately) to the DOCK terminal of this unit and enjoy the music contents stored in your Bluetooth component (such as a portable music player) without wiring between this unit and the Bluetooth component. You need to perform “pairing” the connected Bluetooth adapter and your Bluetooth component in advance.

Pairing the Bluetooth™ adapter and your Bluetooth™ component

Pairing must be performed when using a Bluetooth component with the Bluetooth adapter connected to this unit for the first time or if the pairing data has been deleted. “Pairing” refers to the operation of registering a Bluetooth component for Bluetooth communications.



- You only need the pairing operation for the first time that you use the Bluetooth component with the Bluetooth adapter.
- Pairing requires operations on this unit and on the other component with which Bluetooth communications are to be established. If necessary, refer to the other component’s operating instructions.

There are two pairing methods: pairing by using “START PAIRING” in “SET MENU” and quick pairing.

■ Pairing by using “SET MENU”

Use this feature to perform pairing with the video monitor. Select “START PAIRING” in “INPUT MENU”. See page 62 for details.

■ Quick pairing

To ensure security, a time limit of 8 minutes is set for the pairing operation. You are recommended to read and fully understand all the instructions before starting.

1 Press **ⓈINPUT** **</>** repeatedly (or press **ⓈV-AUX/DOCK**) to select “V-AUX” as the input source.

2 Turn on the Bluetooth component you want to pair with.

3 Press and hold **ⓈBAND** (or **ⓈBAND**) for 3 seconds.

Once the Bluetooth adapter starts pairing, “Searching...” appears for a moment. While the Bluetooth adapter is in the pairing mode, DOCK indicator flashes in the front panel display.



To cancel the pairing, press **ⓈBAND** (or **ⓈBAND**) again.

Note

If the Bluetooth adapter is not connected to the DOCK terminal of this unit, “No BT adapter” appears in the front panel display.

4 Check that the Bluetooth component detects the Bluetooth adapter.

If the Bluetooth component detects the Bluetooth adapter, “YBA-10 YAMAHA” (example) appears in the Bluetooth device list.

5 Select the Bluetooth adapter in the Bluetooth device list and then enter the pass key “0000” on the Bluetooth component.

When the pairing procedure is successful, “Completed” appears in the front panel display.

Note

The Yamaha Bluetooth adapter can be paired with up to eight Bluetooth components. When pairing is conducted successfully with a ninth component and the pairing data is registered, the pairing data for the least recently used other component is cleared.

Playback of the Bluetooth™ component

1 Press **ⓈINPUT** **</>** repeatedly (or press **ⓈV-AUX/DOCK**) to select “V-AUX” as the input source.

2 Start playback of your Bluetooth component. When the connected Bluetooth adapter detects the Bluetooth component, “BT connected” and the DOCK indicator appears in the front panel display.



- When you press **ⓈENTER**, the connected Bluetooth adapter searches and connect to the last connected Bluetooth component. If the Bluetooth adapter cannot find the Bluetooth component, “Not found” appears in the front panel display.
- To disconnect the Bluetooth adapter from the Bluetooth component, press **ⓈRETURN**.

Recording

Recording adjustments and other operations are performed from the recording components. Refer to the operating instructions for those components.

Notes



- When this unit is set to the standby mode, you cannot record between other components connected to this unit.
- TONE CONTROL (see page 41) and VOLUME settings, speaker levels (see page 41) and the sound field programs (see page 38) do not affect recorded material.
- The source connected to the MULTI CH INPUT jacks of this unit cannot be recorded.
- Digital signals input at the DIGITAL INPUT jacks are not output at the analog AUDIO OUT (REC) jacks for recording. Therefore, if your source component is connected to provide only digital signals, you cannot record the source.
- A given input source is not output on the same AUDIO OUT (REC) channel.
- The analog audio signals input at the DOCK terminal can be output at the analog AUDIO OUT (REC) jacks for recording.
- Once you have connected a recording component to this unit, keep the component turned on while using this unit. If the component is turned off, this unit may distort the sound from other components.
- Check the copyright laws in your country to record from CDs, radio, etc. Recording of copyrighted material may infringe copyright laws.



Do a test recording before you start an actual recording.

If you play back a video source that uses scrambled or encoded signals to prevent it from being dubbed, the picture itself may be disturbed due to those signals.

1 Turn on all the connected components.

2 Press  INPUT </> repeatedly (or press one of the input selector buttons ()) to select the source component you want to record from.

3 Start playback on the selected source component or select a broadcast station.

4 Start recording on the recording component.

SET MENU

You can use the following parameters in “SET MENU” to adjust a variety of system settings and customize the way this unit operates. Change the initial settings (indicated in bold under each parameter) to reflect the needs of your listening environment.

■ Auto setup **AUTO SETUP**

Use this feature to automatically adjust speaker and system parameters (see page 24).

■ Manual setup **MANUAL SETUP**

Use this feature to manually adjust speaker and system parameters.

Sound menu 1 **SOUND MENU**

Parameter	Features	Page
A)SPEAKER SET	Selects the size of each speaker, the speakers for low-frequency signal output, and the crossover frequency, and the location of the front speakers connected to the FRONT B terminals.	57
B)SP LEVEL	Adjusts the output level of each speaker.	59
C)SP DISTANCE	Adjusts the delay time of each speaker.	59
D)CENTER GEQ	Adjusts the tonal quality of the center speaker.	60
E)LFE LEVEL	Adjusts the output level of the LFE channel for Dolby Digital or DTS signals.	60
F)DYNAMIC RANGE	Adjusts the dynamic range of Dolby Digital or DTS signals.	60
G)AUDIO SET	Adjusts the muting level, audio delay, maximum volume level and initial volume level.	60
H)HDMI SET	Selects whether to play back HDMI audio signals on this unit or on another HDMI component connected to the HDMI OUT jack.	61

Input menu 2 **INPUT MENU**

Parameter	Features	Page
A)INPUT ASSIGNMENT	Assigns the input jacks of this unit according to the component to be used.	62
B)INPUT RENAME	Changes the name of the input source.	62
C)VOLUME TRIM	Adjusts the output volume of each input source.	63
D)DECODER MODE	Selects the decoder mode for the sources connected to the DIGITAL INPUT jacks on the rear panel of this unit.	63
E)MULTI CH SET	Selects the video source played in the background of the sources input from the MULTI CH INPUT jacks.	63

Option menu 3 OPTION MENU

Parameter	Features	Page
A)DISPLAY SET	Adjusts the brightness of the front panel display and the way in which the iPod information is displayed.	64
B)MEMORY GUARD	Locks sound field program parameters and other “SET MENU” settings.	64
C)AUDIO SELECT	Designates the default audio input jack select setting for the input sources connected to the DIGITAL INPUT jacks when you turn on the power of this unit.	65
D)PARAM. INI	Initializes the parameters of a group of sound field programs.	65
E)BLUETOOTH SET	Pair the connected Yamaha Bluetooth adapter (such as YBA-10, sold separately) with a Bluetooth component (see page 53).	65
F)USB PLAY STYLE	Adjusts the playback style of a USB source.	66

■ Signal information SIGNAL INFO

Use this feature to check audio signal information (see page 36).

Using SET MENU

Use the remote control to access and adjust each parameter.



You can change the “SET MENU” parameters while this unit is reproducing sound.

1 Press **4** AMP and then press **2** MENU to enter “SET MENU”.

The top “SET MENU” display appears in the OSD.

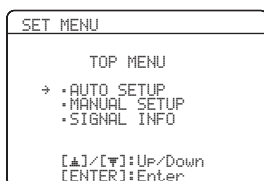

2 Press **7** Δ / ▽ to select “MANUAL SETUP”.

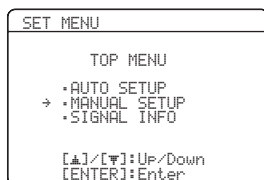

3 Press **7** ENTER to enter “MANUAL SETUP”.

The “MANUAL SETUP” display appears in the OSD.

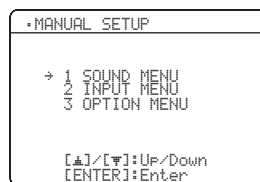

4 Press **7** Δ / ▽ / ◀ / ▶ and **7** ENTER to select and change the parameter.

- Press **7** Δ / ▽ to select the desired menu or parameter.
- Press **7** ◀ / ▶ to change the parameter value.
- Press **7** ENTER to enter the selected menu or to confirm the parameter.
- Press **8** RETURN to return to the previous menu level.

5 Press **2** MENU to exit from “SET MENU”.

1 SOUND MENU

Use this menu to manually adjust any speaker settings or compensate for video signal processing delays when using LCD monitors or projectors.

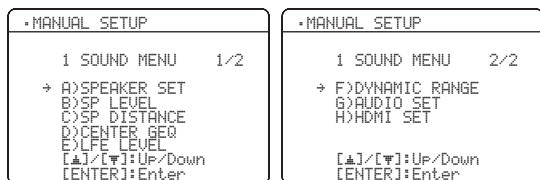

■ Speaker settings A>SPEAKER SET

Use this feature to manually adjust any speaker settings.

FRONT B speaker setting FRONT B

Use this feature to select the location of the front speakers connected to the FRONT B terminals.

Choices: **FRONT**, ZONE B



- Select "FRONT" to turn on or off SPEAKERS A and B when the speakers connected to the FRONT B terminals are set in the main zone.
- Select "ZONE B" if the speakers connected to the FRONT B terminals are set in another zone. If SPEAKERS A is turned off and SPEAKERS B is turned on, all the speakers including the subwoofer in the main zone are muted and this unit outputs sound at the FRONT B terminals only.

Notes

- If you connect headphones to the PHONES jack of this unit, the sound is output from both headphones and the FRONT B terminals when "FRONT B" is set to "ZONE B".
- If a DSP program is selected when "FRONT B" is set to "ZONE B", this unit automatically enters the Virtual CINEMA DSP mode (see page 39).

Woofer section of a speaker is 16 cm (6.5 in) or larger:
large
Woofer section of a speaker is smaller than 16 cm (6.5 in): small

Front speakers FRONT SP

Choices: **SMALL**, **LARGE**

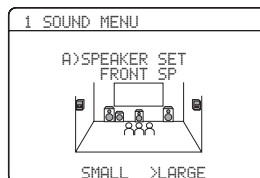

When the front speakers are large

Select "LARGE" (large).

When the front speakers are small

Select "SMALL" (small).

Note

When "LFE/BASS OUT" is set to "FRONT" (see page 58), you can select only "LARGE" in "FRONT SP". If the value of "FRONT SP" is set to a setting other than "LARGE" in advance, this unit automatically changes the value to "LARGE".

Center speaker CENTER SP

Choices: **NONE**, **SML**, **LRG**



When the center speaker is large

Select "LRG" (large).

When the center speaker is small

Select "SML" (small).

When you do not use the center speaker

Select "NONE" (none). The center channel signals are directed to the front left and right speakers.

Surround left/right speakers SUR. L/R SP

Choices: NONE, **SML**, LRG

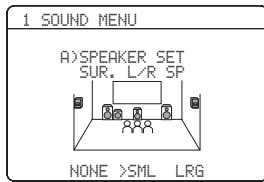

When the surround speakers are large

Select "LRG" (large).

When the surround speakers are small

Select "SML" (small).

When you do not use the surround speakers

Select "NONE" (none). This unit is set to the Virtual CINEMA DSP mode (see page 39).

LFE Bass out LFE/BASS OUT

Use this feature to select the speakers that output the LFE (low-frequency effect) and the low-frequency signals.

Choices: SWFR, FRNT, **BOTH**

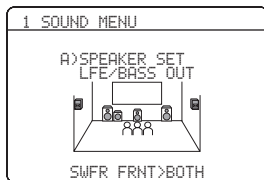

When a subwoofer is connected to this unit and you want to get natural bass sound

Select "SWFR" (subwoofer). The LFE signals as well as the low-frequency signals of other speakers set to "SML" (or "SMALL") are directed to the subwoofer.

When a subwoofer is connected to this unit and you want to get rich bass sound

Select "BOTH" (both). The low-frequency signals of any source are output from the subwoofer. The LFE signals as well as the low-frequency signals of other speakers set to "SML" (or "SMALL") are directed to the subwoofer. The low-frequency signals of the front left and right channels are directed to the front left and right speakers and the subwoofer regardless of the "FRONT SP" setting (see page 57).

When you do not use a subwoofer

Select "FRNT" (front). The LFE signals, the low-frequency signals of the front left and right channels, and the low-frequency signals of other speakers set to "SML" (or "SMALL") are all directed to the front left and right speakers regardless of the "FRONT SP" setting (see page 57).

Crossover CROSS OVER

Use this feature to select a crossover frequency of all the speakers set to "SML" (or "SMALL") in "SPEAKER SET" (see pages 57). All frequencies below the selected frequency will be sent to the subwoofer or front speakers depending on the setting of "LFE/BASS OUT" in "SPEAKER SET" (see pages 57).

Choices: 40Hz, 60Hz, **80Hz**, 90Hz, 100Hz, 110Hz, 120Hz, 160Hz, 200Hz



Subwoofer phase SUBWOOFER PHASE

Use this feature to switch the phase of your subwoofer if bass sounds are lacking or unclear.

Choices: **NORMAL**, REVERSE



- Select "NORMAL" if you do not want to reverse the phase of your subwoofer.
- Select "REVERSE" to reverse the phase of your subwoofer.

Speaker level B>SP LEVEL

Use this feature to manually adjust the output level of each speaker.

Control range: -10 to +10 dB

Control step: 1 dB

Initial setting: 0 dB

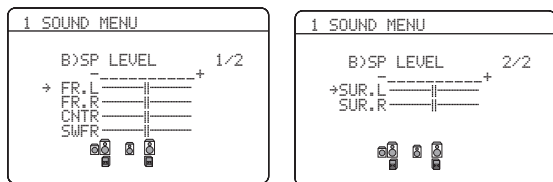

SP LEVEL	Adjusted speaker
FR.L	Front left speaker
FR.R	Front right speaker
CNTR	Center speaker
SWFR	Subwoofer
SUR.L	Surround left speaker
SUR.R	Surround right speaker

Note

The available speaker channels differ depending on the setting of the speakers.

Speaker distance C>SP DISTANCE

Use this feature to manually adjust the distance of each speaker and the delay applied to the respective channel.

Ideally, each speaker should be the same distance from the main listening position. However, this is not possible in most home situations. Thus, a certain amount of delay must be applied to the sound from each speaker so that all sounds will arrive at the listening position at the same time.

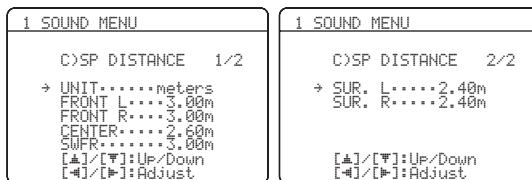

Unit UNIT

Choices: meters (m), feet (ft)

Initial setting:

[U.S.A. and Canada models]: feet (ft)

[Other models]: meters (m)

- Select “meters” to adjust speaker distances in meters.
- Select “feet” to adjust speaker distances in feet.

Speaker distances

Control range: 0.30 to 24.00 m (1.0 to 80.0 ft)

Control step: 0.10 m (0.5 ft)

Initial setting:

FRONT L/FRONT R/SWFR: 3.00 m (10.0 ft)

CENTER: 2.60 m (8.5 ft)

SUR. L/SUR. R: 2.40 m (8.0 ft)

SP DISTANCE	Adjusted speaker
FRONT L	Front left speaker
FRONT R	Front right speaker
CENTER	Center speaker
SWFR	Subwoofer
SUR. L	Surround left speaker
SUR. R	Surround right speaker

Note

The available speaker channels differ depending on the setting of the speakers.

■ **Center speaker equalizer** D>CENTER GEQ

Use this feature to adjust the built-in 5-frequency band (100 Hz, 300 Hz, 1 kHz, 3 kHz and 10 kHz) graphic equalizer for the center channel so that the tonal quality of the center speaker matches that of the front speakers. You can make adjustments while listening to the currently selected source component or a test tone.

Control range: -6.0 to +6.0 dB

Control step: 0.5 dB

Initial setting: 0 dB

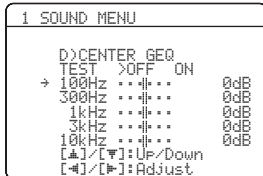

Test tone TEST

Use this feature to make adjustments for “CENTER GEQ” while listening to a test tone.

Choices: **OFF**, **ON**

- Select “OFF” to stop test tones and output the currently selected source component.
- Select “ON” to output test tones from the center and front left speakers.

■ **Low-frequency effect level** E>LFE LEVEL

Use this feature to adjust the output level of the LFE (low-frequency effect) channel according to the capacity of your subwoofer or headphones. The LFE channel carries low-frequency special effects which are only added to certain scenes. This setting is effective when the input signal contains the LFE channel.

Control range: -20 to **0** dB

Control step: 1 dB



Speaker SPEAKER

Adjusts the speaker LFE level.

Headphone HEADPHONE

Adjusts the headphone LFE level.

Note

Depending on the settings of “LFE/BASS OUT” (see page 58), some signals may not be output at the SUBWOOFER OUTPUT jack.

■ **Dynamic range** F>DYNAMIC RANGE

Use this feature to select the amount of dynamic range compression to be applied to your speakers or headphones. This setting is effective only when this unit is decoding Dolby Digital and DTS signals.



Speaker SPEAKER

Adjusts the speaker compression.

Headphone HEADPHONE

Adjusts the headphone compression.

Choices: **MIN**, **STD**, **MAX**

- Select “MIN” (minimum) if you regularly listen at low volume levels.
- Select “STD” (standard) for general use.
- Select “MAX” (maximum) to preserve the greatest amount of dynamic range.

■ **Audio settings** G>AUDIO SET

Use this feature to adjust the overall audio settings of this unit.

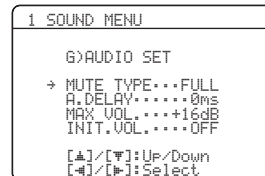

Mute type MUTE TYPE

Use this feature to adjust how much the mute function reduces the output volume (see page 35).

Choices: **FULL**, -20dB

- Select “FULL” to completely mute all the audio output.
- Select “-20dB” to reduce the current volume by 20 dB.

Audio delay A.DELAY

Use this feature to delay the sound output and synchronize it with the video image. This may be necessary when using certain LCD monitors or projectors.

Control range: **0** to 160 ms

Control step: 1 ms

Maximum volume MAX VOL.

Use this feature to set the maximum volume level. This feature is useful to avoid the unexpected loud sound by mistake. For example, the original volume range is -80 dB to +16 dB. However, when "MAX VOL." is set to -5 dB, the volume range becomes -80 dB to -5 dB.

Control range: -30 dB to +10 dB, **+16 dB**

Control step: 5 dB

Note

The "MAX VOL." setting takes priority over the "INIT.VOL." setting. For example, if "INIT.VOL." is set to -20 dB and "MAX VOL." is set to -30 dB, the volume level is automatically set to -30 dB when you turn on the power of this unit next time.

Initial volume INIT. VOL.

Use this feature to set the volume level when the power of this unit is turned on.

Choices: **OFF**, MUTE, -80 dB to +16 dB

Control step: 1 dB

Note

The "MAX VOL." setting takes priority over the "INIT.VOL." setting.

HDMI set H>HDMI SET

Use this feature to select the component to play back HDMI audio signals.

**Support audio** SUPPORT AUDIO

Use this feature to select whether to play back HDMI audio signals on this unit or on another HDMI component connected to the HDMI OUT jack on the rear panel of this unit.

Choice	Functions
RX-U463	Plays back HDMI audio signals on this unit. The HDMI audio signals input at the HDMI input jacks of this unit are not output to the HDMI component connected to the HDMI OUT jack on the rear panel of this unit.
Other	Plays back HDMI audio signals on another HDMI component connected to the HDMI OUT jack.

Notes

- This unit transmits audio and video signals input at the HDMI input jacks to the HDMI out jack only when this unit is turned on even if "SUPPORT AUDIO" is set to "Other".
- Available audio/video signals depend on the specification of the connected video monitor. Refer to the instruction manual of each connected component.

2 INPUT MENU

Use this menu to reassign the input jacks, select the decoder mode or rename the input source.

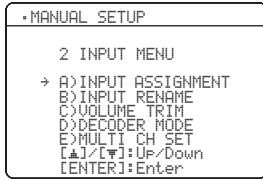

■ Input assignment

A) INPUT ASSIGNMENT

Use this feature to assign the input jacks according to the component to be used if the initial settings of this unit do not correspond to your needs. Change the following parameters to reassign the respective jacks and effectively connect more components.

Once the input jacks are reassigned, you can select the corresponding component by using **⊙** INPUT ◀/▶ (or the input selector buttons (③)).

For COAXIAL INPUT jack 1

COAXIAL IN (1)

Choices: (1) CD, MD/CD-R, **DVD**, DTV/CBL, V-AUX, DVR

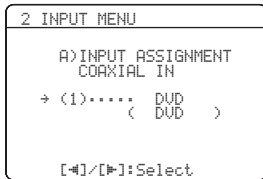

For OPTICAL INPUT jacks 2 and 3

OPTICAL IN (2)

OPTICAL IN (3)

Choices: (2) CD, MD/CD-R, DVD, **DTV/CBL**, V-AUX, DVR

(3) **CD**, MD/CD-R, DVD, DTV/CBL, V-AUX, DVR

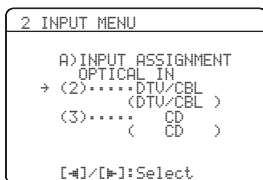

Note

You cannot select a specific item more than once.

For HDMI jacks 1 and 2

HDMI IN [1]

HDMI IN [2]

Choices: [1] **DVD**, DTV/CBL, V-AUX, DVR
[2] DVD, **DTV/CBL**, V-AUX, DVR

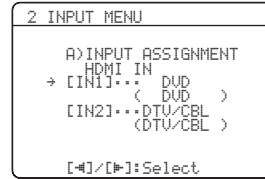

■ Input rename B) INPUT RENAME

Use this feature to change the name of the input source that appears in the OSD and in the front panel display.

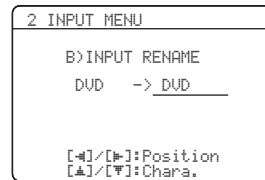

- 1 Press one of the input selector buttons (③) or **Ⓜ** MULTI CH IN to select the input source you want to change the name of.

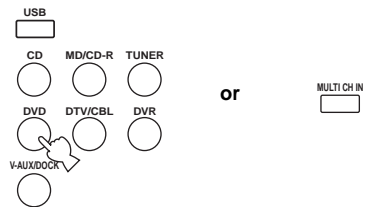

- 2 Press **Ⓜ** AMP and then press **Ⓡ** ◀/▶ on the remote control to place the “_” (underscore) under the space or the character you want to edit.

- 3 Press **Ⓡ** ▲/▼ to select the character you want to use and then press **Ⓡ** ◀/▶ to move to the next space.

Notes

- You can use up to 8 characters for each input.
- Press **Ⓡ** ▼ to change the character in the following order, or press **Ⓡ** ▲ to go in the reverse order: A to Z, a space, 0 to 9, a space, a to z, a space, symbols (#, *, -, +, etc.)

4 Repeat steps 1 through 3 to rename each input source.

5 Press **ENTER** to exit from “INPUT RENAME”.

■ Volume trim C>VOLUME TRIM

Use this feature to adjust the output volume of each source. This is useful if you want to balance the level of each input source to avoid sudden changes in volume when switching between input sources.

Choices: CD, MD/CD-R, TUNER, DVD, DTV/CBL, V-AUX, DVR, DOCK, USB, MULTI CH

Control range: -6.0 to +6.0 dB

Control step: 1.0 dB

Initial setting: 0.0 dB

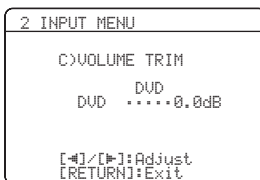

Note

You can only adjust the value for DOCK when your iPod is stationed in the Yamaha Universal Dock connected to this unit.

■ Decoder mode D>DECODER MODE

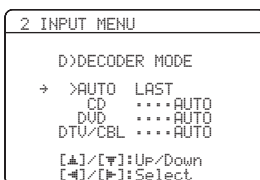

Decoder select mode

Use this feature to designate the default decoder mode for the input sources connected to the DIGITAL INPUT jacks when you turn on the power of this unit.

Choices: **AUTO**, **LAST**

- Select “AUTO” if you want this unit to automatically detect the type of input signals and select the appropriate decoder mode.
- Select “LAST” if you want this unit to automatically select the last decoder mode used the connected input source.

DTS decoder prioritize setting

Choices: **AUTO**, **DTS**

- Select “AUTO” if you want this unit to automatically detect input signal types and select the appropriate input mode.
- Select “DTS” when you play back a DTS-CD.

■ Multi channel input setup

E>MULTI CH SET

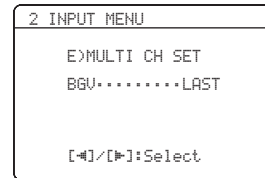

Background Video BGV

Use this feature to select the video source played in the background of the sources input at the MULTI CH INPUT jacks.

Choices: DVD, DTV/CBL, V-AUX, DVR, **LAST**



Select “LAST” to set this unit to automatically select the last selected video source as the background video source.

3 OPTION MENU

Use this menu to adjust the optional system parameters.

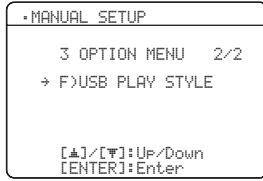
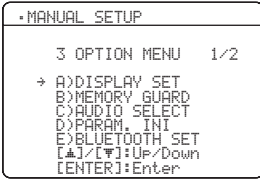

■ Display settings A)DISPLAY SET

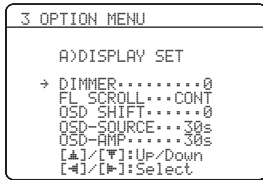

Dimmer DIMMER

Use this feature to adjust the brightness of the front panel display.

Control range: -4 to 0

Control step: 1

- Press **7**◀ to make the front panel display dimmer.
- Press **7**▶ to make the front panel display brighter.

Front panel display scroll FL SCROLL

Use this feature to set whether to display the information (such as a song title or a channel name) in the front panel display in a continuous manner or by the first 14 alphanumeric characters after scrolling all characters once when “DOCK” is selected as the input source.

Choices: **CONT**, **ONCE**

- Select “CONT” to display the operation status in the front panel display in a continuous manner.
- Select “ONCE” to display the operation status in the front panel display by the first 14 alphanumeric characters after scrolling all characters once.

OSD shift OSD SHIFT

Use this feature to adjust the vertical position of the OSD.

Control range: -5 (downward) to +5 (upward)

Control step: 1

Initial setting: 0

- Press **7**◀ to lower the position of the OSD.
- Press **7**▶ to raise the position of the OSD.

Source feature OSD display time

OSD-SOURCE

Use this feature to set the amount of time to display the iPod menu in the OSD after you perform a certain operation.

Choices: ON, 10s, **30s**

- Select “ON” to display the OSD unceasingly during an operation.
- Select “10s” to turn off the OSD 10 seconds after you perform a certain operation.
- Select “30s” to turn off the OSD 30 seconds after you perform a certain operation.

Amplifier function OSD display time

OSD-AMP

Use this feature to set the amount of time to display the status after you perform a certain operation.

Choices: ON, 10s, **30s**

- Select “ON” to display the OSD constantly during an operation.
- Select “10s” to turn off the OSD 10 seconds after you perform a certain operation.
- Select “30s” to turn off the OSD 30 seconds after you perform a certain operation.

■ Memory guard B)MEMORY GUARD

Use this feature to prevent accidental changes to DSP program parameter values and other system settings.

Choices: **OFF**, ON

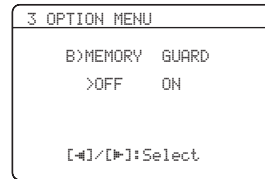

- Select “OFF” to turn off the “MEMORY GUARD” feature.
- Select “ON” to protect:
 - sound field program parameters
 - all “SET MENU” items
 - all speaker levels
 - SCENE template parameters

Note

When “MEMORY GUARD” is set to “ON”, you cannot select and adjust any other “SET MENU” items.

■ Audio select C>AUDIO SELECT

Use this feature to designate the default audio input jack select setting for the input sources when you turn on the power of this unit.

Choices: **AUTO**, **LAST**



- Select “AUTO” if you want this unit to automatically detect the type of input signals and select the appropriate input mode.
- Select “LAST” if you want this unit to automatically select the last input mode used for the connected input source (see page 34).

■ Parameter initialization D>PARAM. INI

Use this feature to set all the parameters of the sound field programs to the initial factory settings.

Choices: **NO**, **YES**

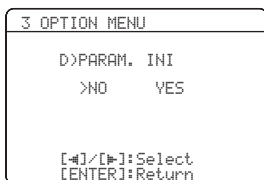

- Select “NO” to cancel the parameter initialization and return to the previous menu screen.
- Select “YES” and press **Ⓜ**ENTER to set all the sound field parameters to the initial factory settings.

Notes

- You cannot automatically revert to the previous parameter settings once you initialize the sound field program parameters.
- You cannot separately initialize individual sound field programs.
- You cannot initialize any sound field program groups when “MEMORY GUARD” is set to “ON”.

■ Bluetooth setting E>BLUETOOTH SET



Use this feature to start pairing the connected Yamaha Bluetooth adapter (such as YBA-10, sold separately) with your Bluetooth component. For details about the pairing, refer to “Pairing the Bluetooth™ adapter and your Bluetooth™ component” on page 53.

To ensure security, a time limit of 8 minutes is set for the pairing operation. You are recommended to read and fully understand all the instructions before starting.

1 Press **Ⓜ**ENTER to start pairing.

The connected Bluetooth adapter starts searching Bluetooth components. “Searching...” appears in the video monitor.

2 Check that the Bluetooth component detects the Bluetooth adapter.

If the Bluetooth component the Bluetooth adapter, “YBA-10 YAMAHA” (example) appears in the Bluetooth device list.

3 Select the Bluetooth adapter in the Bluetooth device list and then enter the pass key “0000” on the Bluetooth component.

Once this unit completes the pairing successfully, “Pairing completed” appears.



To cancel the pairing, press **Ⓜ**RETURN to exit from “START PAIRING”.

4 Press **Ⓜ**RETURN to exit from “START PAIRING”.

Notes

- If the connected Bluetooth adapter cannot find any Bluetooth components, “Not found” appears.
- If a Bluetooth adapter is not connected to this unit, “No BT adapter” appears.

■ USB playback styles F>USB PLAY STYLE

Use this feature to adjust the playback style according to your preference. You can shuffle files in a random order or repeat one specific file or a sequence of files.

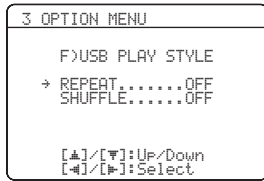

Repeat REPEAT

Use this feature to set this unit to repeat one file or a sequence of files.

Choices: **OFF**, SINGLE, ALL

- Select “OFF” to deactivate this feature.
- Select “SINGLE” to set this unit to repeat one file.
- Select “ALL” to set this unit to repeat a sequence of files.

Shuffle SHUFFLE

Use this feature to set this unit to play files or folders in a random order.

Choices: **OFF**, ON

- Select “OFF” to deactivate this feature.
- Select “ON” to set this unit to play files or folders in a random order.

Remote control features

In addition to controlling this unit, the remote control can also operate other audiovisual components made by Yamaha and other manufacturers. To control your TV or other components, you must set up the appropriate remote control code for each input source (see page 69).

Controlling this unit, a TV, or other components

■ Controlling this unit

Press **④AMP** to control this unit.

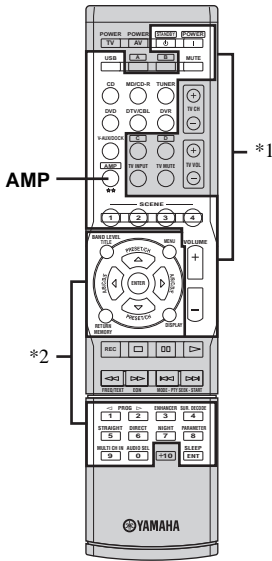

■ Controlling a TV

Press **③DTV/CBL** to control your TV. To control your TV, you must set the appropriate remote control code for DTV/CBL (see page 69).

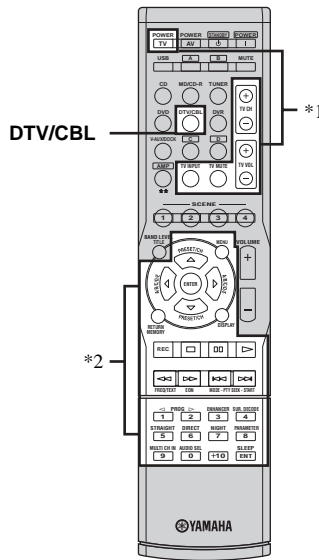

Notes

- *1 These buttons always control this unit.
- *2 These buttons control this unit only when **④AMP** is pressed.

Notes

- *1 These buttons always control your TV regardless of whether you press **③DTV/CBL** or not.

Remote control	Digital TV/Cable TV
TV POWER	Turns on or off the power.
TV CH +/-	Changes the channel number.
TV VOL +/-	Increases or decreases the volume level.
TV INPUT	Changes the input source.
TV MUTE	Mutes the audio output.

- *2 These buttons control your TV only when **③DTV/CBL** is pressed. For details, see the “Digital TV/Cable TV” column on page 68.



You can control more than one TV by setting the appropriate remote control code for any input source selector buttons other than **③DTV/CBL**. In such a case, you can control the buttons highlighted above (*1 and *2) when you press the input source selector button.

■ Controlling other components

Press one of the input selector buttons (③) or A to D buttons to control other components. You must set the appropriate remote control code for each input source in advance (see page 69). The following table shows the function of each control button used to control other components assigned to each input selector button. Be advised that some buttons may not correctly operate the selected component.



- The remote control has 13 modes (input areas) to control components so that the remote control can operate up to 13 different components.
- When you press one of the optional component control area buttons (A to D), you can control the desired component without changing the input source of this unit.

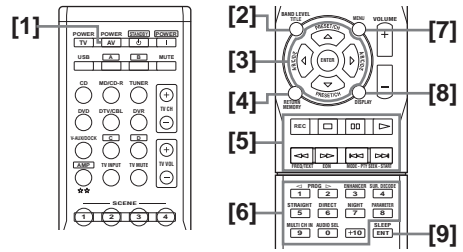

Remote control	DVD player/ recorder	VCR	Digital TV/ Cable TV	LD player	CD player	MD/CD recorder	Tuner
[1] AV POWER	Power *1	Power *1	Power *2	Power *1	Power *1	Power *1	
[2] TITLE	Title						Band
[3] PRESET/CH Δ	Up	VCR channel up	Up				Preset up (1-8)/ Tuning up
PRESET/CH ∇	Down	VCR channel down	Down				Preset down (1-8)/ Tuning down
A/B/C/D/E ◀	Left		Left				Preset down (A-E)
A/B/C/D/E ▶	Right		Right				Preset up (A-E)
ENTER	Enter		Enter				Hold
[4] RETURN	Return		Return				Memory
[5] REC	Disc skip (player) Rec (recorder)	Rec	Rec *2		Disc skip	Rec	
▷	Play	Play	Play *2	Play	Play	Play	
◀◀	Search backward	Search backward	Search backward *2	Search backward	Search backward	Search backward	Information
▶▶	Search forward	Search forward	Search forward *2	Search forward	Search forward	Search forward	
⏸	Pause	Pause	Pause *2	Pause	Pause	Pause	
◀◀◀	Skip backward	Skip backward	Skip backward *2	Skip backward	Skip backward	Skip backward	Audio program down
▶▶▶	Skip forward	Skip forward	Skip forward *2	Skip forward	Skip forward	Skip forward	Audio program up
□	Stop	Stop	Stop *2	Stop	Stop	Stop	
[6] 1-9, 0, +10	Numeric buttons	Numeric buttons	Numeric buttons	Numeric buttons	Numeric buttons	Numeric buttons	Preset stations (1-8)
[7] MENU	Menu		Menu				Search mode
[8] DISPLAY	Display	Display	Display	Display	Display	Display	Display
[9] ENT	Title/Index	Enter	Enter	Chapter/Time	Index	Index	Enter

Notes

*1 This button is operational only when the original remote control supplied with the component has a POWER button.

*2 These buttons operate your DVD recorder only when you set the appropriate remote control code for DVR (see page 69).

Setting remote control codes

You can control other components by setting the appropriate remote control codes. For a complete list of available remote control codes, refer to “List of remote control codes” at the end of this manual.

Remote control code default settings

Input source	Component category	Manufacturer	Default code
CD	CD	Yamaha	5013
MD/CD-R	CD-R	Yamaha	5001
TUNER	TUNER	Yamaha	5007
DVD	DVD	Yamaha	2000
DTV/CBL	—	—	—
V-AUX	TUNER	Yamaha	5011
DVR	DVR	Yamaha	2011
USB	TUNER	Yamaha	5012
A	TUNER	Yamaha	5009
B	TUNER	Yamaha	5017
C	TUNER	Yamaha	5009
D	TUNER	Yamaha	5017

Note

You may not be able to operate your Yamaha component even if a Yamaha remote control code is preset as listed above. In this case, try setting another Yamaha remote control code.

- 1 While pressing and holding one of the input selector buttons (③) on the remote control to select the input area you want to set up, press ② **AV POWER** for more than 3 seconds.

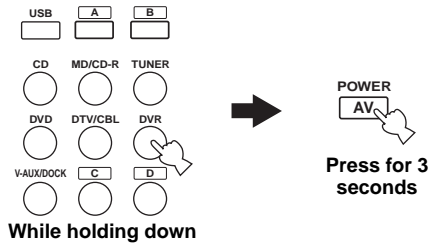

- 2 Press the numeric buttons (0 to 9) (⑩) to enter the four-digit remote control code for the component to be used.

When the setting succeeds, “RemoteSetup OK” appears; however, when it does not, “RemoteSetup NG” appears in the front panel display.

Notes

- If the manufacturer of your component has more than one code, try each of them until you find the correct one.
- If you do not press any buttons within 30 seconds in step 2, the setup process is canceled. If this happens, repeat the setup procedure.

Advanced setup

This unit has additional menus that are displayed in the front panel display. The advanced setup menu offers additional operations to adjust and customize the way this unit operates. Change the initial settings (indicated in bold under each parameter) to reflect the needs of your listening environment.

Notes

- Only **Ⓐ**STANDBY/ON, **Ⓛ**PROGRAM $\triangleleft/\triangleright$ and **Ⓜ**STRAIGHT are effective while you are using the advanced setup menu.
- No other operations can be made while you are using the advanced setup menu.
- The advanced setup menu is only available in the front panel display.

1 Press **Ⓐ**STANDBY/ON to set this unit to the standby mode.

2 Press and hold **Ⓚ**TONE CONTROL and then press **Ⓐ**STANDBY/ON to turn on this unit.

This unit turns on, and the advanced setup menu appears in the front panel display.

3 Press **Ⓛ**PROGRAM $\triangleleft/\triangleright$ to select the parameter you want to adjust.

The name of the selected parameter appears in the front panel display.

4 Press **Ⓜ**STRAIGHT repeatedly to change the selected parameter setting.

5 Press **Ⓐ**STANDBY/ON to confirm your selection and set this unit to the standby mode.



The settings you made are reflected next time you turn on this unit.

■ Tuner frequency step TU (Asia and General models only)

Use this feature to set the tuner frequency step according to the frequency spacing in your area.

Choices: AM10/FM100, **AM9/FM50**

- Select “AM10/FM100” for North, Central and South America.
- Select “AM9/FM50” for all other areas.

■ Initializing INIT.

Use this feature to reset all the parameters of this unit to the initial factory settings (see page 80).

Choices: **CANCEL**, RESET

- Select “CANCEL” not to reset any parameters of this unit.
- Select “RESET” to reset the parameters of this unit.

Notes

- This setting completely resets all the parameters of this unit including the “SET MENU” parameters. However, the advanced setup menu parameters will not be initialized.
- The initial factory settings are activated next time you turn on this unit.

Troubleshooting

Refer to the table below when this unit does not function properly. If the problem you are experiencing is not listed below or if the instruction below does not help, turn off this unit, disconnect the power cable, and contact the nearest authorized Yamaha dealer or service center.

■ General

Problem	Cause	Remedy	See page
This unit fails to turn on or enters the standby mode soon after the power is turned on.	The power cable is not connected or the plug is not completely inserted.	Connect the power cable firmly.	—
	The protection circuitry has been activated.	Make sure that all speaker wire connections on this unit and on all speakers are secure and that the wire for each connection does not touch anything other than its respective connection.	11
	This unit has been exposed to a strong external electric shock (such as lightning or strong static electricity).	Set this unit to the standby mode, disconnect the power cable, plug it back in after 30 seconds and then use it normally.	—
No sound.	Incorrect input or output cable connections.	Connect the cables properly. If the problem persists, the cables may be defective.	13-18
	No appropriate Audio input jack select has been set.	Set an appropriate Audio input jack select.	34
	Audio input jack select is set to “HDMI”, “COAX/OPT” or “ANALOG”.	Set Audio input jack select to “AUTO”.	34
	Audio input jack select is set to “ANALOG” while playing a source encoded in Dolby Digital or DTS.	Set Audio input jack select to “AUTO” or “COAX/OPT”.	34
	No appropriate input source has been selected.	Select an appropriate input source with Ⓢ INPUT </> (or the input selector buttons Ⓢ).	33
	Speaker connections are not secure.	Secure the connections.	11
	The front speakers to be used have not been selected properly.	Select the front speakers with Ⓢ SPEAKERS.	33
	The volume is turned down.	Turn up the volume.	—
	The sound is muted.	Press Ⓢ MUTE or Ⓢ VOLUME +/- to resume audio output and then adjust the volume.	35
	Signals this unit cannot reproduce are being input from a source component, such as a CD-ROM.	Play a source whose signals can be reproduced by this unit.	—
	The HDMI components connected to this unit do not support the HDCP copy protection standards.	Connect HDMI components that support the HDCP copy protection standards.	14
“SUPPORT AUDIO” is set to “Other” and “HDMI” audio signals are not being played back on this unit.	Set “SUPPORT AUDIO” to “RX-V463” in “MANUAL SETUP”.	61	

Problem	Cause	Remedy	See page
The sound suddenly goes off.	The protection circuitry has been activated because of a short circuit, etc.	Check that the speaker wires are not touching each other and then turn this unit back on.	—
	The sleep timer has turned off this unit.	Turn on this unit, and play the source again.	—
	The sound is muted.	Press MUTE or VOLUME +/- to resume audio output.	35
Sound is heard from the speaker on one side only.	Incorrect cable connections.	Connect the cables properly. If the problem persists, the cables may be defective.	11-18
	Incorrect settings in “SP LEVEL”.	Adjust the “SP LEVEL” settings.	41
Only the center speaker outputs substantial sound.	When playing a monaural source with a CINEMA DSP program, the source signal is directed to the center channel, and the front and surround speakers output effect sounds.	This is not malfunction.	—
No sound is heard from the center speaker.	“CENTER SP” in “SPEAKER SET” is set to “NONE”.	Set “CENTER SP” to “SML” or “LRG”.	57
	Some sound field programs do not output sounds from the center speaker.	Try another sound field program.	38
No sound is heard from the surround speakers.	“SUR. L/R SP” in “SPEAKER SET” is set to “NONE”.	Set “SUR. L/R SP” to “SML” or “LRG”.	58
	This unit is in the “STRAIGHT” mode and a monaural source is being played back.	Press STRAIGHT so that “STRAIGHT” disappears from the front panel display.	39
No sound from the center, surround speakers when the FRONT B speakers are activated.	“FRONT B” in “SPEAKER SET” is set to “ZONE B”.	Set “FRONT B” to “FRONT”.	57
No sound is heard from the subwoofer.	“LFE/BASS OUT” in “SPEAKER SET” is set to “FRNT” when a Dolby Digital or DTS signal is being played.	Set “LFE/BASS OUT” to “SWFR” or “BOTH”.	58
	“LFE/BASS OUT” in “SPEAKER SET” is set to “SWFR” or “FRNT” when a 2-channel source is being played.	Set “LFE/BASS OUT” to “SWFR” or “BOTH”.	58
	The source does not contain low-frequency bass signals.	This is not malfunction.	—

Problem	Cause	Remedy	See page
Dolby Digital or DTS sources cannot be played. (Dolby Digital or DTS indicator in the front panel display does not light up.)	The connected component is not set to output Dolby Digital or DTS digital signals.	Make an appropriate setting following the operating instructions for your component.	—
	Audio input jack select is set to “ANALOG”.	Set Audio input jack select to “AUTO”.	34
A humming sound is heard.	Incorrect cable connections.	Connect the audio cables firmly. If the problem persists, the cables may be defective.	—
The volume level cannot be increased, or the sound is distorted.	You are attempting to set the volume level higher than the maximum volume level.	Adjust “MAX VOL.” setting.	61
	The component connected to the AUDIO OUT (REC) jacks of this unit is turned off.	Turn on the power of the component.	—
The sound effect cannot be recorded.	It is not possible to record the sound effect with a recording component.	This is not malfunction.	—
A source cannot be recorded by an analog component connected to the AUDIO OUT (REC) jacks.	The source component is not connected to the analog AUDIO IN jacks of this unit.	Connect the source component to the analog AUDIO IN jacks.	14, 18
The sound field parameters and some other settings of this unit cannot be changed.	“MEMORY GUARD” in “OPTION MENU” is set to “ON”.	Set “MEMORY GUARD” to “OFF”.	64
This unit does not operate properly.	The internal microcomputer has been frozen by an external electric shock (such as lightning or excessive static electricity) or by a power supply with low voltage.	Disconnect the power cable from the AC wall outlet and then plug it in again after about 30 seconds.	—
No sound is heard from the connected HDMI component.	The HDMI component does not accept the multi-channel audio signals.	Convert the multi-channel audio signals to the 2-channel audio signals at the source component such as a DVD player.	—
“CHECK SP WIRES” appears in the front panel display.	Speaker cables are short-circuited.	Make sure all speaker cables are connected correctly.	11
There is noise interference from digital or radio frequency equipment.	This unit is too close to the digital or high-frequency equipment.	Move this unit further away from such equipment.	—
The picture is disturbed.	The video source uses scrambled or encoded signals to prevent dubbing.	This is not malfunction.	—
This unit suddenly enters the standby mode.	The internal temperature is too high and the overheat protection circuitry has been activated.	Wait about 1 hour for this unit to cool down and then turn it back on.	—

■ Tuner

	Problem	Cause	Remedy	See page
FM	FM stereo reception is noisy.	The characteristics of FM stereo broadcasts may cause this problem when the transmitter is too far away or the antenna input is poor.	Check the antenna connections.	20
			Try using a high-quality directional FM antenna.	—
			Use the manual tuning method.	43
	There is distortion, and clear reception cannot be obtained even with a good FM antenna.	There is multi-path interference.	Adjust the antenna position to eliminate multi-path interference.	—
	The desired station cannot be tuned into with the automatic tuning method.	The signal is too weak.	Use a high-quality directional FM antenna.	—
			Use the manual tuning method.	43
	Previously preset stations can no longer be tuned into.	This unit has been disconnected for a long period.	Set preset stations.	44
AM	The desired station cannot be tuned into with the automatic tuning method.	The signal is weak or the antenna connections are loose.	Tighten the AM loop antenna connections and orient it for the best reception.	—
			Use the manual tuning method.	43
	There are continuous crackling and hissing noises.	Noise can result from lightning, fluorescent lamps, motors, thermostats and other electrical equipment.	Use an outdoor antenna and a ground wire. This will help somewhat, but it is difficult to eliminate all noise.	—
	There are buzzing and whining noises.	A TV set is being used nearby.	Move this unit away from the TV set.	—

■ AUTO SETUP

Before AUTO SETUP

Error message	Cause	Remedy	See page
Connect MIC!	Optimizer microphone is not connected.	Connect the supplied optimizer microphone to the OPTIMIZER MIC jack on the front panel.	24
Unplug HP!	Headphones are connected.	Unplug the headphones.	—

During AUTO SETUP

Error message	Cause	Remedy	See page
E-1:NO FRONT SP	Front L/R channel signals are not detected.	Check the front L/R speaker connections.	11
E-2:NO SUR.SP	A surround channel signal is not detected.	Check the surround speaker connections.	11
E-4:NOISY	Background noise is too loud.	Try running "AUTO SETUP" in a quiet environment.	—
		Turn off noisy electric equipment like air conditioners or move them away from the optimizer microphone.	—
E-6:NO MIC	The optimizer microphone was unplugged during the "AUTO SETUP" procedure.	Connect the supplied optimizer microphone to OPTIMIZER MIC jack on the front panel.	24
E-7:NO SIGNAL	The optimizer microphone does not detect test tones.	Check the microphone setting.	24
		Check the speaker connections and placement.	10, 11, 24
E-8:USER CANCEL	The "AUTO SETUP" procedure was cancelled due to user activity.	Run "AUTO SETUP" again.	24
E-9:INTERNAL ERROR	An internal error occurred.	Run "AUTO SETUP" again.	24

After AUTO SETUP

Warning message	Cause	Remedy	See page
W-1: OUT OF PHASE	Speaker polarity is not correct. This message may appear depending on the speakers even when the speakers are connected correctly.	Check the speaker connections for proper polarity (+ or -).	12
W-2: OVER 24m (80ft)	The distance between the nearest speaker and the furthest speaker is out of adjustable range.	Bring the speaker closer to the listening position.	—
W-3: LEVEL ERROR	The difference of volume level among speakers is excessive. (No level correction is made.)	If “SWFR:TOO LOUD” or “SWFR:TOO LOW” appears, adjust the output volume of the subwoofer.	24, 59
		Readjust the speaker installation so that all speakers are set in locations with similar conditions.	—
		Check the speaker connections.	11
		Use speakers of similar quality.	—

Notes

- If the “ERROR” or “WARNING” screens appears, check the cause of the problem, then run “AUTO SETUP” again.
- If a warning message “W-1”, “W-2”, or “W-3” appears, corrections are made, but they may not be optimal.
- If an error message “E-9” occurs repeatedly, please contact a qualified Yamaha service center.

■ USB

Problem	Cause	Remedy	See page
The music files and directories in the USB device cannot be viewed.	The music files and directories are placed in locations other than the FAT area.	Place music files and directories in the FAT area.	—
	You are attempting to browse directory hierarchies of over 8 levels or a directory with more than 500 files.	Modify the data structure on your USB device.	—
The USB device cannot be recognized.	The connected USB device is other than a USB mass storage class USB memory device or USB portable audio player.	This unit can recognize only a USB mass storage class USB memory device (except USB hard disk drives) or USB portable audio player. Also note that it cannot recognize certain USB devices even when they are devices as described above.	49
		Some devices may become easier to recognize when they are inserted before turning this unit on.	21
“Disconnected” is displayed even when a USB device is present.	This unit recognized the USB device as an illegal device.	Turn this unit off then on again.	21

Status message	Cause	Remedy	See page
Disconnected	Your USB memory device or USB portable audio player has been disconnected from the USB port of this unit.	Check the connection between this unit and your USB memory device or USB portable audio player.	—
	There is a problem with the signal path from your USB memory device or USB portable audio player to this unit.	Turn off this unit and reconnect your USB memory device or USB portable audio player to the USB port of this unit.	49
		Try resetting your USB memory device or USB portable audio player.	—
Access error	This unit cannot access your USB memory device or USB portable audio player.	Try another USB memory device or USB portable audio player.	—
	There is a problem with the signal path from your USB memory device or USB portable audio player to this unit.	Turn off this unit and reconnect your USB memory device or USB portable audio player to the USB port of this unit.	49
		Try resetting your USB memory device or USB portable audio player.	—
Unable to play	No varied data is detected.	Try another USB memory device or USB portable audio player.	—

■ iPod

Note

In case of a transmission error without a status message appearing in the front panel and in the OSD, check the connection to your iPod (see page 19).

Status message	Cause	Remedy	See page
Loading...	This unit is in the middle of recognizing the connection with your iPod.		
	This unit is in the middle of acquiring song lists from your iPod.		
Connect error	There is a problem with the signal path from your iPod to this unit.	Turn off this unit and reconnect the Yamaha iPod universal dock to the DOCK terminal of this unit.	19
		Try resetting your iPod.	—
Unknown iPod	The iPod being used is not supported by this unit.	Only iPod (Click and Wheel), iPod nano, and iPod mini are supported.	—
iPod connected	Your iPod is properly stationed in a Yamaha iPod universal dock (YDS-10, sold separately) connected to the DOCK terminal of this unit, and the connection between your iPod and this unit is complete.		
Disconnected	Your iPod was removed from a Yamaha iPod universal dock (YDS-10, sold separately) connected to the DOCK terminal of this unit.	Station your iPod back in a Yamaha iPod universal dock (YDS-10, sold separately) connected to the DOCK terminal of this unit.	19
Unable to play	This unit cannot play back the songs currently stored on your iPod.	Check that the songs currently stored on your iPod are playable.	—
		Store some other playable music files on your iPod.	—

■ Bluetooth

Status message	Cause	Remedy	See page
Searching...	The Bluetooth adapter and the Bluetooth component is in the middle of the pairing.		
	The Bluetooth adapter and the Bluetooth component is in the middle of establishing the connection.		
Completed	The pairing is completed.		
Canceled	The pairing is canceled.		
BT connected	The connection between the Yamaha Bluetooth adapter (such as YBA-10, sold separately) and the Bluetooth component is established.		
Disconnected	The Bluetooth component is disconnected from the Yamaha Bluetooth adapter (such as YBA-10, sold separately).		
No BT adapter	The Bluetooth adapter is not connected to the DOCK terminal.	Connect the Yamaha Bluetooth adapter (such as YBA-10, sold separately) to the DOCK terminal.	19

■ Remote control

Problem	Cause	Remedy	See page
The remote control does not work nor function properly.	Wrong distance or angle.	The remote control functions within a maximum range of 6 m (20 ft) and no more than 30 degrees off-axis from the front panel.	23
	Direct sunlight or lighting (from an inverter type of fluorescent lamp, etc.) is striking the remote control sensor of this unit.	Reposition this unit.	—
	The batteries are weak.	Replace all batteries.	3
	The remote control code is not correctly set.	Set the remote control code correctly using “List of remote control codes” at the end of this manual.	69
		Try setting another code for the same manufacturer using “List of remote control codes” at the end of this manual.	69
Even if the remote control code is correctly set, there are some models that do not respond to the remote control.			

■ Resetting the system

Use this feature to reset all the parameters of this unit to the initial factory settings.

- 1 Press **(A) STANDBY/ON** on the front panel to set this unit to the standby mode.

- 2 Press and hold **(K) TONE CONTROL** and then press **(A) STANDBY/ON** to turn on this unit.
The advanced setup menu appears in the front panel display.

- 3 Press **(L) PROGRAM** **</>** to select “INIT.”.

- 4 Press **(M) STRAIGHT** repeatedly to select “RESET”.
Select “CANCEL” to cancel the initialization procedure without making any changes.

- 5 Press **(A) STANDBY/ON** to confirm your selection and set this unit to the standby mode.

Notes

- This procedure completely resets all the parameters of this unit including the “SET MENU” parameters. However, the advanced setup menu parameters will not be initialized.
- The initial factory settings are activated next time you turn on this unit.



To cancel the initialization procedure at any time without making any changes, press **(M) STRAIGHT** repeatedly to select “CANCEL” and then press **(A) STANDBY/ON**.

Glossary

■ CINEMA DSP

Since the Dolby Surround and DTS systems were originally designed for use in movie theaters, their effect is best felt in a theater having many speakers designed for acoustic effects. Since home conditions, such as room size, wall material, number of speakers, and so on, can differ so widely, it is inevitable that there are differences in the sound heard. Based on a wealth of actually measured data, Yamaha CINEMA DSP uses Yamaha original sound field technology to combine Dolby Pro Logic, Dolby Digital and DTS systems to provide the audiovisual experience of a movie theater in the listening room of your own home.

■ Component video signal

With the component video signal system, the video signal is separated into the Y signal for the luminance and the Pb and Pr signals for the chrominance. Color can be reproduced more faithfully with this system because each of these signals is independent. The component signal is also called the “color difference signal” because the luminance signal is subtracted from the color signal. A monitor with component input jacks is required in order to output component signals.

■ Composite video signal

With the composite video signal system, the video signal is composed of three basic elements of a video picture: color, brightness and synchronization data. A composite video jack on a video component transmits these three elements combined.

■ Dolby Digital

Dolby Digital is a digital surround sound system that gives you completely independent multi-channel audio. With 3 front channels (front L/R and center), and 2 surround stereo channels, Dolby Digital provides 5 full-range audio channels. With an additional channel especially for bass effects, called LFE (Low Frequency Effect), the system has a total of 5.1-channels (LFE is counted as 0.1 channel). By using 2-channel stereo for the surround speakers, more accurate moving sound effects and surround sound environment are possible than with Dolby Surround. The wide dynamic range from maximum to minimum volume reproduced by the 5 full-range channels and the precise sound orientation generated using digital sound processing provide listeners with unprecedented excitement and realism. With this unit, any sound environment from monaural up to a 5.1-channel configuration can be freely selected for your enjoyment.

■ Dolby Pro Logic II

Dolby Pro Logic II is an improved technique used to decode vast numbers of existing Dolby Surround sources. This new technology enables a discrete 5-channel playback with 2 front left and right channels, 1 center channel, and 2 surround left and right channels instead of only 1 surround channel for conventional Pro Logic technology. There are three modes available: “Music mode” for music sources, “Movie mode” for movie sources and “Game mode” for game sources.

■ Dolby Surround

Dolby Surround uses a 4-channel analog recording system to reproduce realistic and dynamic sound effects: 2 front left and right channels (stereo), a center channel for dialog (monaural), and a surround channel for special sound effects (monaural). The surround channel reproduces sound within a narrow frequency range. Dolby Surround is widely used with nearly all video tapes and laser discs, and in many TV and cable broadcasts as well. The Dolby Pro Logic decoder built into this unit employs a digital signal processing system that automatically stabilizes the volume on each channel to enhance moving sound effects and directionality.

■ DTS Digital Surround

DTS digital surround was developed to replace the analog soundtracks of movies with a 5.1-channel digital sound track, and is now rapidly gaining popularity in movie theaters around the world. DTS, Inc. has developed a home theater system so that you can enjoy the depth of sound and natural spatial representation of DTS digital surround in your home. This system produces practically distortion-free 5.1-channel sound (technically, left, right and center channels, 2 surround channels, plus an LFE 0.1 channel as a subwoofer, for a total of 5.1-channels).

■ HDMI

HDMI (High-Definition Multimedia Interface) is the first industry-supported, uncompressed, all-digital audio/video interface. Providing an interface between any source (such as a set-top box or AV receiver) and an audio/video monitor (such as a digital television), HDMI supports standard, enhanced or high-definition video as well as multi-channel digital audio using a single cable. HDMI transmits all ATSC HDTV standards and supports 8-channel digital audio, with bandwidth to spare to accommodate future enhancements and requirements. When used in combination with HDCP (High-bandwidth Digital Content Protection), HDMI provides a secure audio/video interface that meets the security requirements of content providers and system operators. For further information on HDMI, visit the HDMI website at "<http://www.hdmi.org/>".

■ LFE 0.1 channel

This channel reproduces low-frequency signals. The frequency range of this channel is from 20 Hz to 120 Hz. This channel is counted as 0.1 because it only enforces a low-frequency range compared to the full-range reproduced by the other 5 channels in Dolby Digital or DTS 5.1-channel systems.

■ MP3

One of the audio compression methods used by MPEG. It employs the irreversible compression method, which achieves a high compression rate by thinning out the data of hardly audible part to the human ears. It is said to be capable of compressing the data quantity by about 1/11 (128 kbps) while maintaining a similar audio quality to music CD.

■ PCM (Linear PCM)

Linear PCM is a signal format under which an analog audio signal is digitized, recorded and transmitted without using any compression. This is used as a method of recording CDs and DVD audio. The PCM system uses a technique for sampling the size of the analog signal per very small unit of time. Standing for "Pulse Code Modulation", the analog signal is encoded as pulses and then modulated for recording.

■ Sampling frequency and number of quantized bits

When digitizing an analog audio signal, the number of times the signal is sampled per second is called the sampling frequency, while the degree of fineness when converting the sound level into a numeric value is called the number of quantized bits. The range of rates that can be played back is determined based on the sampling rate, while the dynamic range representing the sound level difference is determined by the number of quantized bits. In principle, the higher the sampling frequency, the wider the range of frequencies that can be played back, and the higher the number of quantized bits, the more finely the sound level can be reproduced.

■ SILENT CINEMA

Yamaha has developed a natural, realistic sound effect DSP algorithm for headphones. Parameters for headphones have been set for each sound field so that accurate representations of all the sound field programs can be enjoyed on headphones.

■ Virtual CINEMA DSP

Yamaha has developed a Virtual CINEMA DSP algorithm that allows you to enjoy DSP sound field surround effects even without any surround speakers by using virtual surround speakers. It is even possible to enjoy Virtual CINEMA DSP using a minimal two-speaker system that does not include a center speaker.

■ WAV

Windows standard audio file format, which defines the method of recording the digital data obtained by converting audio signals. It does not specify the compression (coding) method so a desired compression method can be used with it. By default, it is compatible with the PCM method (no compression) and some compression methods including the ADPCM method.

■ WMA

An audio compression method developed by Microsoft Corporation. It employs the irreversible compression method, which achieves a high compression rate by thinning out the data of hardly audible part to the human ears. It is said to be capable of compressing the data quantity by about 1/22 (64 kbps) while maintaining a similar audio quality to music CD.

Specifications

AUDIO SECTION

- Minimum RMS Output Power for Front, Center, Surround
[U.S.A. and Canada models]
1 kHz, 0.9% THD, 8 Ω 105 W
[Other models]
1 kHz, 0.9% THD, 6 Ω 105 W
- Maximum Power for Front, Center, Surround (JEITA)
[Asia, General, China, and Korea models]
1 kHz, 10% THD, 6 Ω 130 W
- Dynamic Power
[U.S.A. and Canada models]
(IHF, 8/6/4/2 Ω) 90/110/130/150 W
[Other models]
(IHF, 6/4/2 Ω) 100/110/125 W
- Dynamic Headroom [U.S.A. and Canada models]
8 Ω 0.27 dB
- Maximum Input Signal
CD, etc. Effect On, 1 kHz, 0.5% THD 2.0 V or more
- Frequency Response
CD, etc. to Front L/R 10 Hz to 100 kHz, -3 dB
- Total Harmonic Distortion
[U.S.A. and Canada models]
(1 kHz, 45 W, Front L/R, 8 Ω) 0.06% or less
[Other models]
(1 kHz, 50 W, Front L/R, 6 Ω) 0.06% or less
- Signal to Noise Ratio (IHF-A Network)
CD (200 mV) to Front L/R, Effect Off 98 dB or more
CD (250 mV) to Front L/R, Effect Off 100 dB or more
- Residual Noise (IHF-A Network)
Front L/R 150 μV or less
- Channel Separation (1 kHz/10 kHz)
CD, etc. (5.1 kΩ shorted) to Front L/R
..... 60 dB/45 dB or more
- Tone Control (Front L/R)
BASS Boost/Cut ±10 dB/100 Hz
TREBLE Boost/Cut ±10 dB/20 kHz
- Headphone Jack Rated Output/Impedance 400 mV/470 Ω
- Input Sensitivity/Input Impedance
CD, etc. 200 mV/47 kΩ
MULTI CH INPUT 200 mV/47 kΩ
- Output Level/Output Impedance
AUDIO OUT (REC) 200 mV/1.2 kΩ
SUBWOOFER OUTPUT 4 V/1.2 kΩ
- Filter Characteristics (fc=40/60/80/90/100/110/120/160/200 Hz)
H.P.F.
(FRONT SP, CENTER SP, SUR. L/R SP:
SMALL/SML) 12 dB/oct.
L.P.F. (Subwoofer) 24 dB/oct.

VIDEO SECTION

- Video Signal Type (Gray back)
[U.S.A., Canada, Korea and General models] NTSC
[Other models] PAL

- Signal Level
Composite 1 V_{p-p}/75 Ω
Component 1 V_{p-p}/75 Ω (Y), 0.7 V_{p-p}/75 Ω (Pb/Pr)
- Signal to Noise Ratio 50 dB or more
- Maximum Input Level 1.5 V_{p-p} or more
- Frequency Response (MONITOR OUT)
Component Signal 5 Hz to 60 MHz, -3 dB

FM SECTION

- Tuning Range
[U.S.A. and Canada models] 87.5 to 107.9 MHz
[Asia and General models] 87.5/87.50 to 108.0/108.00 MHz
[Other models] 87.50 to 108.00 MHz
- 50 dB Quieting Sensitivity (IHF, 100% mod.)
Mono 2.8 μV (20.2 dBf)
- Signal to Noise Ratio (IHF)
Mono/Stereo 73 dB/70 dB
- Harmonic Distortion (1 kHz)
Mono/Stereo 0.5%/0.5%
- Antenna Input (unbalanced) 75 Ω

AM SECTION

- Tuning Range
[U.S.A. and Canada models] 530 to 1710 kHz
[Asia and General models] 530/531 to 1710/1611 kHz
[Other models] 531 to 1611 kHz

GENERAL

- Power Supply
[Europe, and Russia models] 230 V AC, 50 Hz
[U.S.A. and Canada models] 120 V AC, 60 Hz
[Australia model] 240 V AC, 50 Hz
[Korea model] 220 V AC, 60 Hz
[China model] 220 V AC, 50 Hz
[Asia model] 220/230-240 V AC, 50/60 Hz
[General model] 110/120/220/230-240 V AC, 50/60 Hz
- Power Consumption
[U.S.A. and Canada models] 240 W/320 VA
[Other models] 240 W
- Standby Power Consumption 0.8 W
- Maximum Power Consumption [Asia and General models only]
5ch, 10% THD 440 W
- Dimensions (W x H x D) 435 x 151 x 352 mm
(17-1/8" x 5-15/16" x 13-7/8")
- Weight 8.5 kg (18 lbs 12 oz)

* Specifications are subject to change without notice.

Index

■ Numerics

1 SOUND MENU, Manual setup	55
2 INPUT MENU, Manual setup	55
2ch Enhancer, Sound field program	38
2ch Stereo, Sound field program	38
3 OPTION MENU	64
3 OPTION MENU, Manual setup	56
5ch Enhancer, Sound field program	38
5ch Stereo, Sound field program	38

■ A

A)DISPLAY SET, Option menu	64
A)INPUT ASSIGNMENT, Input menu	62
A)SPEAKER SET, Sound menu	57
A.DELAY, Audio settings	60
AFFAIRS, Radio Data System program type	47
AM antenna connection	20
AM tuning	43
Amplifier function OSD display time, Display settings	64
Audio components, Connection	18
Audio delay, Audio settings	60
Audio information	36
Audio input jacks selection	34
AUDIO jacks	13
Audio jacks	13
AUDIO SELECT	34
Audio select, Option menu	65
Audio settings, Sound menu	60
Audio signal flow	14
AUTO SETUP	24
AUTO SETUP, Error message	75
Automatic preset tuning, FM/AM tuning	44
Automatic tuning, FM/AM tuning	43

■ B

B)INPUT RENAME, Input menu	62
B)MEMORY GUARD, Option menu	64
B)SPEAKER LEVEL, Sound menu	59
Background Video, Multi channel input setup	63
BGV, Multi channel input setup	63
Bluetooth setting, Option menu	65
BT connected, Bluetooth status message	79

■ C

C)AUDIO SELECT, Option menu	65
C)SP DISTANCE, Sound menu	59
C)VOLUME TRIM, Input menu	63
Canceled, Troubleshooting	79
CD player, Connection	18
CD recorder, Connection	18

CENTER SP, Speaker settings	57
Center speaker equalizer, Sound menu	60
Center speaker, Speaker settings	57
Center width, Sound field parameter	40
CINEMA DSP indicator	23
CLASSICS, Radio Data System program type	47
Clock time, Radio Data System information	46
COAXIAL IN (1), Input assignment	62
COAXIAL INPUT assignment, Input assignment	62
COAXIAL INPUT jacks	62
Completed, Bluetooth status message	79
COMPONENT VIDEO jacks	13
Connect error, iPod controlling status message	78
Connect MIC!, Auto setup error message	75
Connecting to the FRONT A terminals	12
Connection, AM antenna connection	20
Connection, Audio components	18
Connection, CD player	18
Connection, CD recorder	18
Connection, DVD player	16
Connection, DVD recorder	17
Connection, external decoder	18
Connection, FM antenna	20
Connection, HDMI	14
Connection, MD recorder	18
Connection, Multi-format player	18
Connection, Power cable	20
Connection, PVR	17
Connection, set-top boxes	17
Connection, VCR	17
Connection, Video components	15
Connection, Yamaha iPod universal dock	19
Controlling a TV	67
Controlling other components, Remote control	68
Controlling this unit, Remote control	67
Creating original SCENE templates	31
CROSSOVER, Speaker settings	58
Crossover, Speaker settings	58
CT indicator	23
CT WIDTH, Sound field parameter	40
CT, Radio Data System information	46
CULTURE, Radio Data System program type	47
Current status display	35

■ D

D)CENTER GEQ, Sound menu	60
D)DECODER MODE, Input menu	63
D)PARAM. INI, Option menu	65

Decoder indicators	22
Decoder mode, Input menu	63
Decoder select mode, Decoder mode ..	63
DIGITAL AUDIO COAXIAL jacks ...	13
DIGITAL AUDIO OPTICAL jacks ...	13
DIMENSION, Sound field parameter	40
Dimension, Sound field parameter	40
DIMMER, Display settings	64
Dimmer, Display settings	64
DIRECT	41
Disconnected, Bluetooth status message	79
Disconnected, iPod controlling status message	78
Display settings, Option menu	64
DIST	26
DIST, Auto setup result	26
DISTANCE	25
DISTANCE, Auto setup	25
DOCK indicator	22
DRAMA, Radio Data System program type	47
DSP LEVEL, Sound field parameter ..	40
DSP level, Sound field parameter	40
DTS decoder prioritize setting, Decoder mode	63
DVD player connection	16
DVD recorder connection	17
Dynamic range, Sound menu	60

■ E

E)LFE LEVEL, Sound menu	60
E)MULTI CH SET, Input menu	63
E-1:NO FRONT SP, Auto setup error message	75
E-2:NO SURR.SP, Auto setup error message	75
E-4:NOISY, Auto setup error message	75
E-6:NO MIC, Auto setup error message	75
E-7:NO SIGNAL, Auto setup error message	75
E-8:USER CANCEL, Auto setup error message	75
E-9:INTERNAL ERROR, Auto setup error message	75
EDUCATE, Radio Data System program type	47
Effect level, Sound field parameter	40
Enhanced other networks data service, Radio Data System tuning	48
ENHANCER indicator	22
EON data service, Radio Data System tuning	48
EON indicator	23
Exchange, Preset station, FM/AM tuning	45
External decoder connection	18

F

F) DYNAMIC RANGE, Sound menu	60
Factory presets, Advanced setup	70
FL SCROLL, Display settings	64
FM antenna	20
FM antenna connection	20
FM tuning	43
FRONT B speaker setting, Speaker settings	57
FRONT B, Speaker settings	57
Front panel display	22
Front panel display scroll, Display settings	64
FRONT SP, Speaker settings	57
Front speakers, Speaker settings	57

G

G) AUDIO SET, Sound menu	60
Games, Sound field program	38

H

H) HDMI SET, Sound menu	61
Hall, Sound field program	38
HDMI indicator	22
HDMI set, Sound menu	61
HDMI, Connection	14
HEADPHONE, Dynamic range	60
Headphone, Dynamic range	60
HEADPHONE, Low-frequency effect level	60
Headphone, Low-frequency effect level	60
Headphones	35
Headphones indicator	22

I

INFO, Radio Data System program type	47
Infrared window, Remote control	23
INI.VOL., Audio settings	61
Initial volume, Audio settings	61
Input assignment, Input menu	62
Input channel and speaker indicators	23
Input channel indicators	23
Input menu, Manual setup	55
Input rename, Input menu	62
Input source indicators	22
Input source information display	36
iPod connected, iPod controlling status message	78
iPod control, Status message	78
iPod using	51

J

Jazz, Sound field program	38
---------------------------------	----

L

LFE/BASS OUT, Speaker settings	58
LFE/Bass out, Speaker settings	58
LIGHT M, Radio Data System program type	47
Loading..., iPod controlling status message	78

Low-frequency effect level, Sound menu	60
LVL	26
LVL, Auto setup result	26

M

M.O.R. M, Radio Data System program type	47
Manual preset tuning, FM/AM tuning	44
MANUAL SETUP, SET MENU	55
Manual setup, SET MENU	55
Manual tuning, FM/AM tuning	43
MAX VOL., Audio settings	61
Maximum volume, Audio settings	61
MD recorder, Connection	18
Memory guard, Option menu	64
Menu browse mode, iPod controlling	52
Movie Dramatic, Sound field program	38
Movie Spacious, Sound field program	38
MULTI CH INPUT component selection	34
Multi channel input setup, Input menu	63
Multi-channel source with headphones	39
Multi-format player connection	18
Multi-information display	23
MUTE	35
MUTE indicator	22
MUTE TYPE, Audio settings	60
Muting	35

N

NEWS, Radio Data System program type	47
Night listening mode	42
No BT Adapter, Bluetooth status message	79
Number of speakers	26
Number of speakers, Auto setup result	26

O

OPTICAL IN (2), Input assignment	62
OPTICAL IN (3), Input assignment	62
OPTICAL INPUT assignment, Input assignment	62
OPTIMIZER MIC jack, Auto setup	24
Optimizer microphone	24
Optimizer microphone, Auto setup	24
Optimizing speaker setting	24
Option menu, Manual setup	56
OSD SHIFT, Display settings	64
OSD shift, Display settings	64
OSD-AMP, Display settings	64
OSD-SOURCE, Display settings	64

Other components controlling by remote control	68
Other components controlling, Remote control	68
OTHER M, Radio Data System program type	47

P

PANORAMA, Sound field parameter	40
Panorama, Sound field parameter	40
Parameter initialization, Option menu	65
PCM indicator	22
PHONES jack	35
Play information display, iPod controlling	52
Play information display, USB controlling	50
Playing video sources in the background	36
PLII Game	39
PLII Movie	39
PLII Music	39
POP M, Radio Data System program type	47
Pop/Rock, Sound field program	38
Power cable, Connection	20
Preset SCENE templates	30
Preset station exchange, FM/AM tuning	45
Preset station selection, FM/AM tuning	45
PRESET, Advanced setup	70
Pro Logic	39
Program service, Radio Data System information	46
Program type, Radio Data System information	46
PS indicator	23
PS, Radio Data System information	46
PTY HOLD indicator	23
PTY indicator	23
PTY SEEK mode, Radio Data System tuning	47
PTY, Radio Data System information	46
Pure hi-fi sound	41
PVR connection	17

R

Radio Data System indicator	23
Radio Data System tuning	46
Radio text, Radio Data System information	46
Remote control codes	iii
Remote control, Troubleshooting	80
Rename, SCENE template	31
Repeat	52
Repeat, iPod controlling	52
Resetting the system	80
ROCK M, Radio Data System program type	47
RT indicator	23

- RT, Radio Data System information 46
- **S**
- SCENE 1 7
- SCENE template selection 28
- SCIENCE, Radio Data System program
type 47
- Searching...,
Bluetooth status message 79
- Selection, Audio input jacks 34
- Selection, MULTI CH INPUT
component 34
- Selection, Preset station,
FM/AM tuning 45
- Selection, Radio Data System program
type 47
- Selection, SCENE template 28
- SET MENU 55
- Setting remote control codes 69
- Setting SCENE template input source,
Remote control 32
- Set-top box connection 17
- Shuffle, iPod controlling 52
- SILENT CINEMA 39
- SILENT CINEMA indicator 23
- Simple remote mode,
iPod controlling 51
- SIZE 25
- SIZE, Auto setup 25
- SLEEP indicator 23
- Sleep timer 37
- Sound field programs
with headphones 39
- Sound menu, Manual setup 55
- Source feature OSD display time,
Display settings 64
- SP 26
- SP A B indicators 22
- SP, Auto setup result 26
- Speaker distance 25, 26
- Speaker distance, Auto setup 25
- Speaker distance, Auto setup result 26
- Speaker distance, Sound menu 59
- Speaker distances, Speaker distance 59
- Speaker level 26
- Speaker level adjustment 41
- Speaker level, Auto setup result 26
- Speaker level, Sound menu 59
- Speaker settings, Sound menu 57
- Speaker size 25
- Speaker size, Auto setup 25
- Speaker wiring 25
- Speaker wiring, Auto setup 25
- Speaker wiring/volume level,
Auto setup 25
- SPEAKER, Dynamic range 60
- Speaker, Dynamic range 60
- SPEAKER,
Low-frequency effect level 60
- Speaker, Low-frequency effect level ... 60
- Specifications 83
- SPORT, Radio Data System
program type 47
- STRAIGHT 39
- Straight 39
- SUBWOOFER PHASE,
Speaker settings 58
- Subwoofer phase, Speaker settings 58
- SUPPORT AUDIO, HDMI set 61
- Support audio, HDMI set 61
- SUR. L/R SP, Speaker settings 58
- Surround left/right speakers,
Speaker settings 58
- **T**
- Test tone, Center speaker equalizer 60
- TEST, Center speaker equalizer 60
- Tonal quality adjustment 41
- Troubleshooting 71
- TU, Advanced setup 70
- Tuner (FM/AM),
Troubleshooting 74
- Tuner frequency step,
Advanced setup 70
- Tuner indicators 22
- Turning off the power 21
- Turning on the power 21
- TV Sports, Sound field program 38
- **U**
- Unable to play, iPod controlling status
message 78
- UNIT, Speaker distance 59
- Unit, Speaker distance 59
- Unknown iPod, iPod controlling status
message 78
- Unplug HP!,
Auto setup error message 75
- USB memory device using, USB portable
audio player using 49
- USB playback operation 49
- USB playback styles 66
- USB, Troubleshooting 77
- **V**
- VARIED, Radio Data System program
type 47
- VCR connection 17
- VIDEO AUX jacks, Front panel 19
- Video components, Connection 15
- Video information 36
- VIDEO jacks 13
- Video jacks 13
- Video signal flow 14
- Video sources in the background 36
- Virtual CINEMA DSP 39
- VIRTUAL indicator 23
- VOLTAGE SELECTOR 3
- VOLUME level indicator 22
- Volume Trim, Input menu 63
- **W**
- W-1:OUT OF PHASE,
Auto setup error message 76
- W-2:DISTANCE ERROR,
Auto setup error message 76
- W-3:LEVEL ERROR,
Auto setup error message 76
- WIRING/LEVEL 25
- WIRING/LEVEL, Auto setup 25
- **Y**
- Yamaha iPod universal dock,
Connection 19
- Yamaha Parametric Room Acoustic
Optimizer 24
- YPAO 24
- YPAO (Yamaha Parametric Room
Acoustic Optimizer) 24
- YPAO indicator 22

“**ⓄSPEAKERS**” or “**ⓄDVD**” (example) indicates the name of the parts on the front panel or the remote control. Refer to the attached sheet or the pages at the end of this manual for the information about each position of the parts.

Limited Guarantee for European Economic Area (EEA) and Switzerland

Thank you for having chosen a Yamaha product. In the unlikely event that your Yamaha product needs guarantee service, please contact the dealer from whom it was purchased. If you experience any difficulty, please contact Yamaha representative office in your country. You can find full details on our website (<http://www.yamaha-hifi.com/> or <http://www.yamaha-uk.com/> for U.K. resident).

The product is guaranteed to be free from defects in workmanship or materials for a period of two years from the date of the original purchase. Yamaha undertakes, subject to the conditions listed below, to have the faulty product or any part(s) repaired, or replaced at Yamaha's discretion, without any charge for parts or labour. Yamaha reserves the right to replace a product with that of a similar kind and/or value and condition, where a model has been discontinued or is considered uneconomic to repair.

Conditions

1. The original invoice or sales receipt (showing date of purchase, product code and dealer's name) MUST accompany the defective product, along with a statement detailing the fault. In the absence of this clear proof of purchase, Yamaha reserves the right to refuse to provide free of charge service and the product may be returned at the customer's expense.
2. The product MUST have been purchased from an AUTHORISED Yamaha dealer within the European Economic Area (EEA) or Switzerland.
3. The product must not have been the subject of any modifications or alterations, unless authorised in writing by Yamaha.
4. The following are excluded from this guarantee:
 - a. Periodic maintenance and repair or replacement of parts due to normal wear and tear.
 - b. Damage resulting from:
 - (1) Repairs performed by the customer himself or by an unauthorised third party.
 - (2) Inadequate packaging or mishandling, when the product is in transit from the customer. Please note that it is the customer's responsibility to ensure the product is adequately packaged when returning the product for repair.
 - (3) Misuse, including but not limited to (a) failure to use the product for its normal purpose or in accordance with Yamaha's instructions on the proper use, maintenance and storage, and (b) installation or use of the product in a manner inconsistent with the technical or safety standards in force in the country where it is used.
 - (4) Accidents, lightning, water, fire, improper ventilation, battery leakage or any cause beyond Yamaha's control.
 - (5) Defects of the system into which this product is incorporated and/or incompatibility with third party products.
 - (6) Use of a product imported into the EEA and/or Switzerland, not by Yamaha, where that product does not conform to the technical or safety standards of the country of use and/or to the standard specification of a product sold by Yamaha in the EEA and/or Switzerland.
 - (7) Non AV (Audio Visual) related products.
(Products subject to "Yamaha AV Guarantee Statement" are defined in our website at <http://www.yamaha-hifi.com/> or <http://www.yamaha-uk.com/> for U.K. resident.)
5. Where the guarantee differs between the country of purchase and the country of use of the product, the guarantee of the country of use shall apply.
6. Yamaha may not be held responsible for any losses or damages, whether direct, consequential or otherwise, save for the repair or replacement of the product.
7. Please backup any custom settings or data, as Yamaha may not be held responsible for any alteration or loss to such settings or data.
8. This guarantee does not affect the consumer's statutory rights under applicable national laws in force or the consumer's rights against the dealer arising from their sales/purchase contract.

■ Front panel/Face avant/Frontblende/Frontpanelen/Voorpaneel/
Фронтальная панель

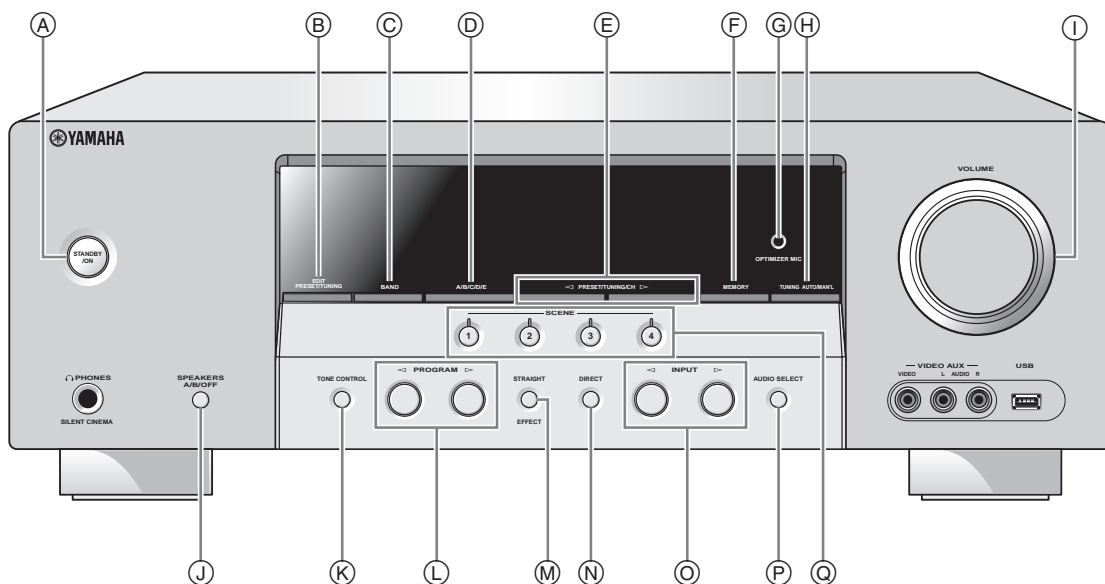

■ Remote control/Boîtier de télécommande/Fernbedienung/Fjärrkontrollen/
Afstandsbediening/Пульт ДУ

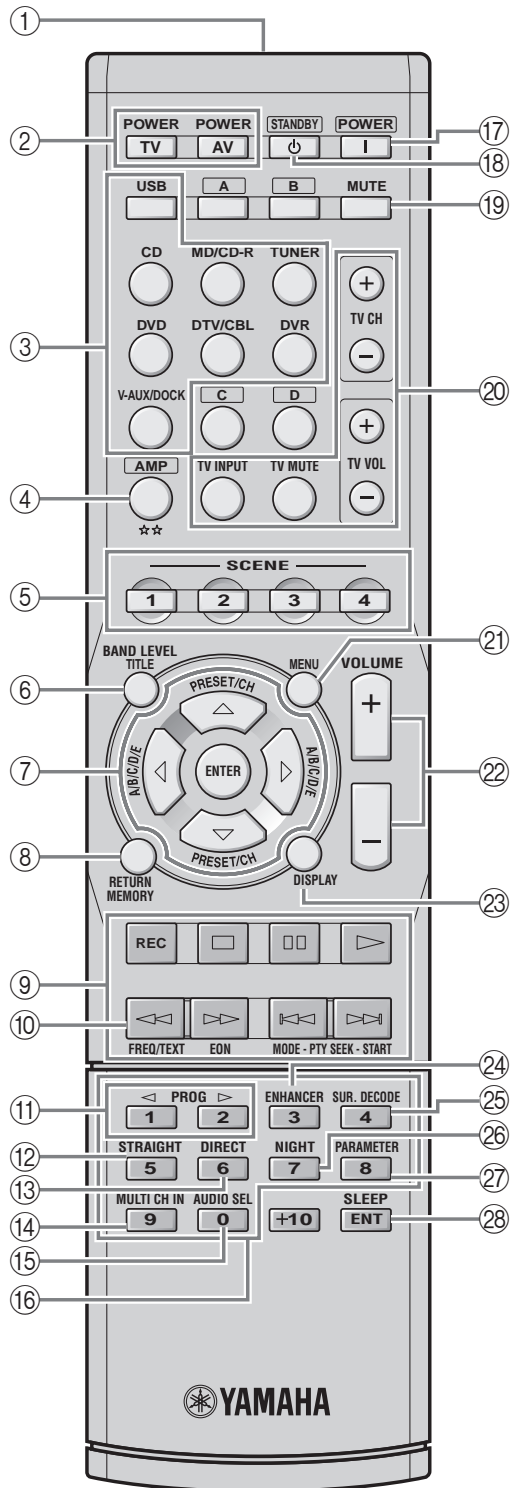

List of remote control codes

Liste des codes de commande

Liste der Fernbedienungscodes

Lista över fjärrstyrningskoder

Lijst met afstandsbedieningscodes

Список кодов дистанционного управления

Blu-ray player

Samsung 2137

CD player

Yamaha 5000, 5013

CD Recorder

Yamaha 5001

DVD

Acoustic Solutions

2078
 Aiwa 2055, 2100
 Akai 2096
 Akura 2076
 Alba 2078, 2086
 Apex 2027, 2049
 Awa 2078
 Axion 2078
 Brainwave 2096
 Brandt 2073, 2085
 Broksonic 2060
 Bush 2075, 2078, 2112
 Centrex 2077
 Classic 2078
 Clatronic 2075
 Coby 2078
 C-Tech 2074
 CyberHome 2025, 2079, 2091
 Daewoo 2092, 2098
 Dansai 2096
 Daytek 2080, 2089
 DEC 2075
 Denon 2030, 2102, 2103
 Denver 2075, 2076
 Diamond 2074
 DK Digital 2094
 Dual 2078
 D-Vision 2096
 DVX 2074
 Elta 2096
 Euroline 2096
 Funai 2052, 2058
 Global Solutions 2074
 Global Sphere 2074
 Goodmans 2075, 2077, 2078
 Grundig 2077, 2098
 H&B 2075
 Haaz 2074
 HE 2078
 Hitachi 2032, 2072
 Home Electronics 2078
 Innovation 2072
 Irradio 2134
 JDB 2078
 JVC 2033, 2045, 2053,
 2073, 2099
 Kenwood 2030, 2097
 Kingavon 2075
 Koda 2075
 Lawson 2074

Lenco 2075
 LG 2084, 2087
 Lifetec 2072
 Limit 2074
 LogicLab 2074
 Luxor 2077
 Magnavox 2037, 2073, 2075
 Magnum 2072
 MBO 2078
 Medion 2072
 Micromaxx 2072
 Micromedia 2073
 Microstar 2072
 Mitsubishi 2035
 Mizuda 2075
 Mustek 2078
 Naiko 2077
 Onkyo 2073, 2135
 Orava 2075
 P&B 2075
 Pacific 2074
 Panasonic 2030, 2040, 2054,
 2057, 2105, 2110
 Philips 2019, 2026, 2046,
 2073, 2081, 2090
 Pioneer 2036, 2082
 Proline 2077
 Provision 2075
 RCA 2031, 2042, 2050,
 2051
 Red Star 2076
 Reoc 2074
 Roadstar 2075, 2078, 2086
 Rowa 2077
 Saba 2085
 Sabaki 2074
 Samsung 2032, 2041, 2104,
 2113
 Sansui 2074
 Sanyo 2095
 ScanMagic 2078
 Scientific Labs 2074
 Scott 2088
 SEG 2074, 2086
 Sharp 2034, 2043, 2059,
 2093, 2106
 Silva 2076
 Singer 2074
 Skymaster 2074, 2078
 Skyworth 2076
 SM Electronic 2074, 2078
 Sony 2028, 2029, 2039,
 2083, 2107
 Soundmaster 2074
 Soundmax 2074
 Standard 2074
 Star Cluster 2074
 Starmedia 2075
 Supervision 2074, 2078
 Sylvania 2052, 2058
 Synn 2074
 TCM 2072
 Teac 2074

Tec 2076
 Technics 2030
 Technika 2096
 Technosonic 2096
 Tevion 2072, 2074
 Thomson 2085, 2109
 Tokai 2076
 Toshiba 2026, 2044, 2048,
 2056, 2073, 2108,
 2111
 United 2078
 Voxson 2078
 Wharfedale 2074
 Xlogic 2074
 Yakumo 2077
 Yamada 2077
 Yamaha 2000, 2001, 2003,
 2030, 2101
 Yukai 2078
 Zenith 2038, 2047, 2073

DVD Recorder

Apex 2024
 JVC 2070
 LG 2071
 Panasonic 2020, 2065, 2066,
 2067
 Philips 2019, 2061, 2062,
 2063
 Pioneer 2021
 RCA 2018
 Sony 2022, 2064
 Toshiba 2068
 Yamaha 2023
 Yukai 2069

DVD/LD

Pioneer 2036

DVD/VCR

JVC 1017, 2045
 LG 1071, 2087
 Panasonic 1020, 1072, 2040,
 2105
 Philips 1025
 RCA 1022, 2042
 Samsung 1021, 2041, 2104
 Sharp 1023, 1073, 2043,
 2106
 Sony 1019, 1074, 2039,
 2107
 Toshiba 1024, 1075, 2044,
 2108
 Zenith 1026, 2047

DVD-DVR

Panasonic 2067
 Pioneer 2114
 Samsung 2115
 Toshiba 2068

DVR

ABS 2132

Alienware 2132
 CyberPower 2132
 Dell 2132
 DIRECTV 2123, 2128, 2129,
 2133
 DISH Network 2126, 2127
 Dishpro 2126
 EchoStar 2126, 2127
 ExpressVu 2126
 Gateway 2132
 GOI 2126
 Hewlett Packard 2132
 Hitachi 2008
 Howard Computers 2132
 HTS 2126
 Hughes 2123, 2128
 Humax 2123
 Hush 2132
 iBUYPOWER 2132
 JVC 2126, 2127
 Linksys 2132
 Media Center PC 2132
 Microsoft 2132
 Mind 2132
 Niveus Media 2132
 Northgate 2132
 Panasonic 2015, 2016, 2017,
 2120
 Philips 2117, 2121, 2123,
 2128
 Pioneer 2012, 2013, 2014
 Proscan 2129
 RCA 2116, 2124, 2129,
 2133
 ReplayTV 2118, 2119, 2120
 Sharp 2009, 2010
 Sonic Blue 2119, 2120
 Sony 2005, 2006, 2007,
 2122, 2130, 2131,
 2132
 Stack 10 2132
 Stack 9 2132
 Systemax 2132
 Tagar Systems 2132
 Tivo 2116, 2121, 2122,
 2123, 2130, 2131
 Toshiba 2004, 2125, 2132
 Touch 2132
 UltimateTV 2133
 Viewsonic 2132
 Voodoo 2132
 Yamaha 2011
 ZT Group 2132

HD DVD

Toshiba 2136

iPod

Yamaha 5011

LD player		Bang & Olufsen 0205	Dantax 0217	Genexxa 0209, 0211, 0213, 0218
Yamaha 2002		Basic Line 0208, 0209, 0213, 0218	Daytron 0060, 0061, 0208	Gibraltar 0060
MD		Bastide 0207	De Graaf 0210	GoldHand 0200
Yamaha 5002, 5003, 5004		Baur 0217	Decca 0204, 0207, 0213, 0217	GoldStar 0060, 0061, 0127, 0128, 0200, 0201, 0207, 0208, 0210, 0213, 0214, 0215, 0217
TAPE DECK		Beko 0228	Desmet 0213, 0217	Goodmans 0171, 0201, 0204, 0206, 0208, 0213, 0217, 0240
Yamaha 5005, 5006		Belcor 0060	Diamond 0200	GPM 0209, 0218
TUNER		Bell & Howell 0058, 0064	Dimensia 0057	Graetz 0211
Yamaha 5007, 5008, 5009, 5010, 5012, 5014, 5015, 5016, 5017, 5018		Benq 0081	Dixi 0208, 0213, 0217	Granada 0204, 0207, 0210, 0213, 0217
TV		Beon 0213, 0217	DTS 0208	Grandin 0208, 0209, 0217
Acer 0093		Bestar 0213	Dual 0207, 0215, 0216	Grundig 0128, 0130, 0222, 0236, 0255
Acme 0207		Binatone 0207	Dual-Tec 0207, 0208, 0215	Grunpy 0062
Acura 0208		Black Star 0214	Dumont 0060, 0127, 0205, 0207	Halifax 0200, 0206, 0207
ADA 0255		Blaupunkt 0255	Durabrand 0126	Hallmark 0060, 0061
ADC 0206		Blue Sky 0209, 0218	Dux 0217	Hampton 0200, 0207
Admiral 0058, 0205, 0206, 0210, 0211		Bondstec 0214	Dynatron 0213, 0217	Hanseatic 0203, 0207, 0208, 0213, 0215, 0217
Adyson 0200, 0207		Boots 0207	Elbe 0203, 0204, 0212, 0218	Hantarex 0204, 0208
Agashi 0200		Bradford 0062	Elbe-Sharp 0204	Harvard 0062
Agazi 0206		Brandt 0216, 0226	Elcit 0204, 0205	HCM 0206, 0207, 0208, 0218
AGB 0204		Brionvega 0205, 0213, 0217	ELECTRO TECH 0208	Hifivox 0216
Aiko 0127, 0200, 0207, 0208		Britannia 0200, 0207	Electroband 0059	Higashi 0200
Aiwa 0028, 0139, 0229, 0237		Brockwood 0060	Electrohome 0059, 0060, 0061	Hinari 0208, 0209, 0213, 0217, 0218
Akai 0059, 0065, 0127, 0129, 0130, 0200, 0204, 0208, 0209, 0213, 0217, 0218, 0255		Broksonic 0138	Elin 0200, 0207, 0213, 0217	Hisawa 0209, 0218
Akiba 0209, 0218		Bruns 0205	Elite 0209, 0213, 0218	Hitachi 0006, 0014, 0015, 0016, 0042, 0060, 0061, 0095, 0105, 0127, 0156, 0179, 0180, 0204, 0207, 0210, 0211, 0215, 0216, 0251
Akura 0206, 0209, 0218		BSR 0215	Elman 0215	Hornophon 0213
Alaron 0200		BTC 0209, 0218	Elta 0200, 0208	Hoshai 0209, 0218
Alba 0200, 0207, 0208, 0209, 0217, 0218		Bush 0177, 0208, 0209, 0210, 0213, 0215, 0216, 0217, 0218, 0230, 0237	Emerson 0060, 0061, 0062, 0064, 0128, 0205	Huan-yu 0200, 0207
ALBIRAL 0212		Candle 0060, 0061	Envision 0060, 0061	Hygashi 0200, 0207
Allstar 0213		Capsonic 0206	Erres 0213, 0217	Hyper 0200, 0207, 0208, 0214, 0215
Amplivision 0207		Cascade 0208	ESA 0080	Hypson 0206, 0207, 0213, 0217
Amstrad 0204, 0206, 0208, 0209, 0218		Cathay 0213, 0217	Etron 0208	ICE 0127, 0200, 0206, 0207, 0208, 0209, 0213, 0218
Amtron 0062		CCE 0127	Euro-Feel 0206	ICeS 0200, 0218
Anam 0208		Celebrity 0059	Euroline 0217	IMA 0062
Anam National 0062		Centurion 0213, 0217	Euroman 0200	Imperial 0211, 0213, 0214, 0215
Anglo 0208		Century 0205	Euroman 0200	Indiana 0213, 0217
Anitech 0206, 0208		CGE 0214, 0215	Euromann 0206, 0207, 0213	Infinity 0063
Ansonic 0203, 0208		Cimline 0208, 0218	Europhon 0200, 0204, 0207, 0213, 0215	Ingelen 0211
AOC 0060, 0061		Citizen 0060, 0061, 0062, 0064	Fenner 0208	Ingersol 0208
Apex 0118, 0122, 0132		City 0208	Ferguson 0212, 0217, 0226	Inno Hit 0201, 0204, 0207, 0208, 0209, 0213, 0217, 0218
Arc en Ciel 0216		Clarivox 0212, 0217	Fidelity 0200, 0207, 0210	Innovation 0206, 0208
Arcam 0200		Clatronic 0206, 0207, 0208, 0209, 0213, 0214, 0218	Finlandia 0210	Interbuy 0208, 0214
Arcam Delta 0207		CMS 0200	Finlux 0204, 0205, 0207, 0213, 0215, 0217	Interfunk 0205, 0211, 0213, 0214, 0216, 0217
Aristona 0213, 0217		Colortyme 0060, 0061	Firstline 0200, 0207, 0208, 0213, 0214	International 0200
ASA 0205, 0211		Concerto 0060, 0061	Fisher 0064, 0127, 0128, 0205, 0207, 0215	Intervision 0206, 0207, 0218
Asberg 0213		Concorde 0208	Flint 0213, 0218	Irradio 0201, 0208, 0209, 0213, 0217, 0218
Astra 0208		Condor 0200, 0207, 0213	Formenti 0200, 0205, 0207, 0215, 0217	Isukai 0209, 0218
Asuka 0200, 0206, 0207, 0209, 0218		Contec 0200, 0207, 0208	Formenti-Phoenix 0200	ITC 0207, 0215
Atlantic 0200, 0207, 0213, 0217		Contec/Cony 0062	Fortress 0205	ITS 0200, 0209, 0213, 0218
Atori 0208		Continental Edison 0216	Frontech 0206, 0208, 0210, 0211, 0214	
Audiosonic 0207, 0208, 0209, 0213, 0216, 0217, 0218		Cosmel 0208	Fujitsu 0023, 0024, 0025, 0088, 0127	
AudioTon 0207		Craig 0062	Funai 0033, 0034, 0035, 0036, 0037, 0062, 0206	
Audiovox 0062		Crosley 0205, 0214, 0215	Futuretech 0062	
Autovox 0205, 0206, 0207		Crown 0062, 0063, 0128, 0208, 0213, 0217	Gateway 0094	
Awa 0200		CS Electronics 0200, 0207, 0209, 0214, 0218	GBC 0208, 0215, 0218	
Baird 0216		CTC 0214	GE 0057, 0060, 0061, 0122, 0147	
		Curtis Mathes 0057, 0060, 0061, 0064, 0065	GEC 0204, 0207, 0211, 0213, 0217	
		CXC 0062	Geloso 0208, 0210, 0215	
		Cybertron 0209, 0218	General Technic 0208	
		Daewoo 0060, 0061, 0120, 0127, 0155, 0193, 0200, 0207, 0208, 0213, 0218, 0238		
		Dainichi 0200, 0209, 0218		
		Dansai 0200, 0206, 0213, 0217		

ITT	0129, 0208, 0211	Medion	0206, 0208	Panasonic	0006, 0007, 0063,	RFT	0203, 0205
ITV	0208, 0217	Megatron	0061		0073, 0074, 0097,	Rhapsody	0200
JBL	0063	Meletronic	0200, 0207, 0208,		0110, 0114, 0137,	R-Line	0213, 0217
JC Penney	0057, 0060, 0061		0211, 0213, 0216,		0141, 0151, 0162,	Roadstar	0206, 0208, 0209,
JCB	0059		0217		0165, 0186, 0204,		0218, 0237
Jensen	0060, 0061	Memorex	0058, 0061, 0064,		0211, 0244, 0245,	Robotron	0205
JVC	0017, 0018, 0019,		0208		0246, 0254	Rowa	0200
	0108, 0136, 0153,	Memphis	0208	Pathe Cinema	0200, 0203, 0207,	RTF	0205
	0178, 0190, 0213,	Metz	0205		0212, 0215	Saba	0204, 0205, 0211,
	0218	MGA	0060, 0061	Pathe Marconi	0212, 0216		0216
Kaisui	0200, 0207, 0208,	Micromaxx	0206, 0208	Pausa	0208	saccs	0212
	0209, 0218	Microstar	0206, 0208	Perdio	0200	Saisho	0204, 0206, 0207,
Kamosonic	0207	Minerva	0204	Philco	0060, 0061, 0063,		0208
Kamp	0200, 0207	Minoka	0213		0128, 0205, 0214,	Salora	0201, 0204, 0210,
Kapsch	0211	Mitsubishi	0006, 0015, 0016,		0215		0211, 0215
Karcher	0207, 0208, 0212,		0048, 0060, 0061,	Philharmonic	0207	Sambers	0204
	0217		0104, 0112, 0113,	Philips	0040, 0060, 0063,	Sampo	0060, 0061, 0083,
			0125, 0205, 0213		0072, 0115, 0116,		0101
Kawasho	0059, 0060, 0061,	Mivar	0200, 0201, 0202,		0124, 0130, 0150,	Samsung	0029, 0030, 0031,
	0200		0203, 0204, 0207		0175, 0184, 0187,		0032, 0044, 0045,
Kendo	0128, 0210	Montgomery Ward	0058		0205, 0207, 0213,		0046, 0047, 0060,
Kennedy	0215				0215, 0217, 0220,		0061, 0065, 0068,
Kenwood	0060, 0061	MTC	0060, 0061, 0128,		0221, 0232, 0233,		0069, 0071, 0079,
Kingsley	0200, 0207		0200		0252, 0253		0087, 0127, 0128,
Kloss Novabeam		Multi System	0217	Philips Magnavox			0130, 0144, 0160,
	0062				0124		0161, 0170, 0176,
Kneissel	0203	Multitech	0062, 0127, 0128,				0183, 0185, 0200,
Kolster	0213		0200, 0207, 0208,	Phoenix	0200, 0205, 0213,		0201, 0206, 0207,
Konka	0209, 0218		0210, 0214, 0215,		0217		0208, 0213, 0217,
Korpel	0213, 0217		0217	Phonola	0200, 0205, 0213,		0239, 0241, 0242,
Korting	0205	Murphy	0200, 0207		0217		0243
Koyoda	0208	NAD	0061	Pilot	0060		
KTV	0062, 0127, 0207	Naonis	0210	Pioneer	0012, 0013, 0060,	Sandra	0200, 0207
Kyoto	0200, 0212	NEC	0026, 0053, 0060,		0061, 0098, 0109,	Sansui	0123, 0126, 0213
Lenco	0208		0061, 0096, 0127		0117, 0128, 0181,	Sanyo	0020, 0021, 0022,
Lenoir	0207, 0208	Neckermann	0205, 0207, 0210,		0182, 0194, 0195,		0049, 0060, 0064,
Lesla	0214		0213, 0217, 0255		0211, 0213, 0216,		0127, 0128, 0200,
Leyco	0206, 0213, 0217	NEI	0213, 0217		0217, 0250		0203, 0207, 0215
LG	0016, 0038, 0039,	Nesco	0214	Plantron	0206, 0213	SBR	0217
	0127, 0128, 0157,	NET-TV	0082, 0101	Polaroid	0075	SCHAUB LORENTZ	
	0158, 0163, 0164,	New Tech	0208, 0213	Poppy	0208		0211
	0166, 0188, 0189,	New World	0209, 0218	Portland	0060, 0061	Schneider	0207, 0209, 0213,
	0200, 0201, 0207,	Nicamagic	0200, 0207	Prandoni-Prince	0204, 0210		0215, 0216, 0217,
	0208, 0210, 0213,	Nikkai	0200, 0206, 0207,	Precision	0207		0218
	0214, 0215, 0217		0209, 0213, 0217,	Prima	0208, 0211	Scotch	0061
Liesenk	0217		0218	Profex	0208	Scott	0060, 0061, 0062
Life	0206, 0208	Nikko	0061	Profi-Tronic	0213	Sears	0057, 0060, 0061,
Lifetec	0206, 0208, 0218	Nobliko	0200, 0207	Proline	0213		0064
Loewe	0063, 0128, 0203,	Nogamatic	0216	Proscan	0057	SEG	0200, 0206, 0207,
	0204, 0223, 0227	Nokia	0129, 0211	Prosonic	0200, 0207, 0217		0214, 0215, 0217
Loewe Opta	0205, 0213, 0217	Nordmende	0205, 0211, 0213,	Protech	0206, 0207, 0208,	SEI	0204
Logik	0058		0216		0213, 0214, 0215,	SEI-Sinudyne	0204, 0205, 0211
Luma	0210, 0217	Nordvision	0217		0217	Seleco	0210, 0211, 0215
Lumatron	0210, 0213, 0217	Oceanic	0211	Proton	0060, 0061	Sencora	0208
Lux May	0213	Olevia	0084	Provision	0217	Sentra	0218
Luxman	0060, 0061	ONCEAS	0207	Pulsar	0060	Serino	0200
Luxor	0201, 0207, 0210	Onwa	0062, 0218	Pye	0213, 0217	Sharp	0009, 0010, 0011,
LXI	0057, 0061, 0063,	Orbit	0213	Pymi	0208		0060, 0061, 0066,
	0064	Orion	0126, 0204, 0208,	Quasar	0152, 0214		0070, 0087, 0111,
Magnadyne	0204, 0205, 0214,		0213, 0217, 0235	Quelle	0201, 0206, 0207,		0143, 0145, 0167,
	0215, 0217	Orline	0218		0213, 0214, 0215,		0168, 0169, 0198,
Magnafon	0200, 0204, 0207	Orsowe	0204		0217		0204, 0224, 0247,
Magnavox	0060, 0061, 0063,	Osaki	0127, 0206, 0207,	Radialva	0218		0248, 0249
	0102, 0103, 0150		0209, 0218	Radio Shack	0064	Shogun	0060
Magnum	0206, 0208	Osio	0201	Radio Shack/Realistic		Siarem	0204, 0205, 0215
Majestic	0058	Oso	0209, 0218		0057, 0060, 0061,	Sicatel	0212
Mandor	0206	Osume	0218		0062, 0064	Siemens	0255
Manesth	0206, 0207, 0213,	Otto Versand	0204, 0207, 0213,	Radiola	0213, 0217	Sierra	0213
	0217		0215, 0216, 0217,	Radiomarelli	0204, 0205, 0214	Signature	0058
Marantz	0060, 0061, 0063,		0255	Radiotone	0213	Silva	0200
	0090, 0213, 0217	Pael	0200, 0207	RCA	0057, 0060, 0061,	Singer	0205, 0214, 0215
Marelli	0205	Palladium	0207		0091, 0133, 0135,	Sinudyne	0204, 0205, 0215,
Mark	0200, 0213, 0217	Panama	0200, 0206, 0207,		0147, 0149		0217
Matsui	0204, 0207, 0208,		0208	Realistic	0064	Skantic	0211
	0210, 0213, 0217			Revov	0213, 0217	Solavox	0211
Mediator	0213, 0217			Rex	0206, 0210, 0211		

Sonoko	0206, 0207, 0208, 0213, 0217	Uher	0211, 0213	Daewoo	0155, 0238, 1038, 1067	Dual	1043, 1046
Sonorol	0211	Ultravox	0200, 0205, 0207, 0214, 0215	GE	0147, 1030	Dumont	1042, 1046, 1047, 1049
Sontec	0213, 0217	United	0217	Goodmans	0240, 1069	Dynatech	1005
Sony	0041, 0059, 0067, 0085, 0086, 0174, 0196, 0199, 0208, 0219, 0234	Universum	0127, 0128, 0129, 0201, 0206, 0213, 0214, 0215, 0217	Grundig	0236, 1062	Electrohome	1003
Sound & Vision	0209, 0218	Univox	0212	Hitachi	0156, 1039	Electrophonic	1003
Soundesign	0060, 0061, 0062	Vestel	0210, 0211, 0213, 0214, 0215, 0217	JVC	0153, 1036	Elta	1050
Soundwave	0213, 0217	Vexa	0208, 0217	Magnavox	0150, 1033	Emerson	1003, 1004, 1005, 1012, 1013
SSS	0060, 0062	Victor	0213	Orion	0235, 1065	Etzuko	1050
Standard	0207, 0208, 0209, 0213, 0218	VIDEOLOGIC	0200	Panasonic	0151, 1034	Ferguson	1043
Starlight	0217	Videologique	0200, 0207, 0209, 0218	Philips	0150, 0232, 0233, 1033, 1062, 1063	Fidelity	1042
Starlite	0062	Videosat	0214	Quasar	0152, 1035	Finlandia	1046, 1047, 1049
Stenway	0218	VideoSystem	0213	RCA	0149, 1032	Finlux	1042, 1043, 1046, 1047, 1049
Stern	0210, 0211	Videotechnic	0200	Roadstar	0237, 1066	FIRST LINE	1044, 1045, 1049, 1050
Sunkai	0208, 0218	Vidtech	0060, 0061	Samsung	0144, 0239, 1027, 1068	Fisher	1001, 1047
Sunwood	0208, 0213	Viewsonic	0076, 0077, 0092, 0099, 0172, 0173	Sharp	0145, 1028	Flint	1044
Superla	0200, 0204, 0207	Visiola	0200, 0207	Sony	0234, 1064	Formenti/Phoenix	1046
SuperTech	0200	Vision	0213	Sylvania	0148, 1031	Fuji	1004
Supra	0208	Vortec	0213, 0217	Tatung	0237, 1066	Fujitsu	1042
Supreme	0059	Voxson	0205, 0210, 0211, 0213	Toshiba	0146, 0237, 1029, 1066	Funai	1005, 1042
Susumu	0209	Waltham	0207, 0212	Zenith	0154, 1037	Galaxy	1042
Sutron	0208	Wards	0057, 0058, 0060, 0061, 0063	VCR		Garrard	1005
Sydney	0200, 0207	Watson	0213, 0217, 0218	Admiral	1008, 1013	GBC	1050
Sylvania	0060, 0061, 0063, 0080, 0134, 0142, 0148	Watt Radio	0200, 0207, 0212, 0215	Adventura	1005	GE	1002, 1004, 1009, 1014, 1030
Symphonic	0062, 0080	Wega	0205	Aiwa	1005, 1042, 1043, 1044, 1066	GEC	1046
Sysline	0217	Weltblick	0213, 0217	Akai	1007, 1043	Geloso	1050
Sytong	0200	Weston	0215	Akura	1043, 1050	General Technic	1044, 1048
Tandy	0127, 0207, 0209, 0211, 0218	White Westinghouse	0200, 0207, 0217	Alba	1044, 1050	Go Video	1014
Tashiko	0200, 0207, 0210	Yamaha	0000, 0001, 0002, 0003, 0004, 0005, 0060, 0061	American High	1004	GoldHand	1050
Tatung	0127, 0204, 0207, 0213, 0217, 0237	Yamishi	0218	Amstrad	1042	Goldstar	1000, 1003, 1042, 1045
TCM	0206, 0208	Yoko	0200, 0206, 0207, 0208, 0209, 0213, 0217, 0218	Anitech	1050	Goodmans	1042, 1045, 1050, 1069
Teac	0127			ASA	1045, 1046	Gradiente	1005
Tec	0207, 0208, 0214, 0215			Asha	1002, 1014	Graetz	1043, 1047
Techwood	0060, 0061			Asuka	1042, 1045, 1046, 1050	Granada	1046, 1047, 1049
Teknika	0058, 0060, 0061, 0062			Audio Dynamics	1000	Grandin	1042, 1045, 1050
Teleavia	0216			Audiovox	1003	Grundig	1046, 1050, 1062
Telecor	0218			Baird	1042, 1043, 1047	Hanseatic	1045, 1046
Telefunken	0065, 0213, 0216			Basic Line	1044, 1050	Harley Davidson	1005
Telegazi	0218			Baur	1046	Harman/Kardon	1000
Teletech	0208, 0214, 0217			Beaumarck	1002, 1014	Harwood	1006
Teleton	0207			Bell & Howell	1001	HCM	1050
Televideon	0200			Blaupunkt	1046, 1048	Headquarter	1001
Tensai	0208, 0209, 0213, 0218			Broksonic	1012, 1013	Hinari	1044, 1050
Tesmet	0213			Bush	1044, 1050, 1066	Hisawa	1044
Tevion	0206, 0208			Calix	1003	Hitachi	1007, 1010, 1039, 1042, 1043, 1046, 1049
Textet	0200, 0207			Candle	1002, 1003	Hughes Network Systems	1010
Thomson	0191, 0192, 0207, 0213, 0216, 0226			Canon	1004	Hypson	1044, 1050
Thorn	0212, 0217			CCE	1006	Imperial	1042
TMK	0060, 0061			CGE	1042, 1043	Inno Hit	1046, 1050
Tokai	0213			Cimline	1044, 1050	Innovation	1044, 1048
Tokyo	0200, 0207			Citizen	1002, 1003	Instant Replay	1004
Toshiba	0027, 0043, 0053, 0054, 0064, 0078, 0089, 0090, 0106, 0107, 0127, 0131, 0140, 0146, 0159, 0197, 0225, 0231, 0237			Colorzyme	1000	Interbuy	1045
Towada	0211, 0215			Colt	1006	Interfunk	1046, 1047
Transtec	0200			Craig	1002, 1003, 1006, 1014	Intervision	1042
Trident	0204			Crown	1050	Irradio	1045, 1050
Tristar	0218			Curtis Mathes	1000, 1002, 1004, 1009	ITT	1043, 1047
Triumph	0204			Cybernex	1002, 1014	ITV	1045
				Daewoo	1005, 1038, 1061, 1067	JC Penney	1000, 1001, 1002, 1003, 1004, 1006
				Dansai	1050	JCL	1004
				Dantax	1044	Jensen	1007
				DBX	1000	JVC	1000, 1001, 1007, 1011, 1017, 1036, 1043
				De Graaf	1046, 1049	Kaisui	1050
				Decca	1042, 1043, 1046		
				Denon	1010		
				Dimensia	1009		

Karcher	1046	National	1048	Radio Shack/Realistic		Sunstar	1042
Kendo	1044	NEC	1000, 1001, 1007, 1011, 1043, 1051		1001, 1002, 1003, 1004, 1005, 1008	Suntronic	1042
Kenwood	1000, 1001, 1007, 1011, 1043	Neckermann	1043, 1046	Radiola	1046	Sunwood	1050
KLH	1006	NEI	1046	Radix	1003	Sylvania	1004, 1005, 1031, 1041
Kodak	1003, 1004	Nesco	1050	Randex	1003	Symphonic	1005
Korpel	1050	Nikko	1003	RCA	1002, 1004, 1009, 1010, 1014, 1015, 1022, 1032	Taisho	1044
Leyco	1050	Noblex	1002, 1014			Tandy	1001
LG	1003, 1042, 1045, 1071	Nokia	1043, 1047	Realistic	1001, 1002, 1003, 1004, 1005, 1008	Tashiko	1003, 1042
Lifetec	1044, 1048	Nordmende	1043			Tatung	1007, 1042, 1043, 1046, 1066
Lloyd's	1005	Oceanic	1042, 1043	Rex	1043	TCM	1044, 1048
Loewe	1048	Okano	1044	RFT	1046	Teac	1005, 1007
Loewe Opta	1045, 1046	Olympus	1004	Roadstar	1045, 1050, 1066	Technics	1004, 1048
Logik	1006, 1050	Optimus	1003, 1008	Saba	1043	Teknika	1003, 1004, 1005
Luxor	1047	Orion	1012, 1013, 1044, 1065	Saisho	1044, 1050	Teleavia	1043
LXI	1003	Orson	1042	Salora	1047	Telefunken	1043
M Electronic	1042	Osaki	1042, 1045, 1050	Samsung	1002, 1014, 1021, 1027, 1052, 1068, 1070	Tenosal	1050
Magnasonic	1047	Otto Versand	1046			Tensai	1042, 1045, 1050
Magnavox	1004, 1018, 1033	Palladium	1043, 1045, 1050	Sanky	1008	Tevion	1044, 1048
Magnin	1003, 1014	Panasonic	1004, 1020, 1034, 1040, 1048, 1054, 1072	Sansui	1007, 1011, 1013, 1043	Thomson	1043, 1058
Manesth	1050					Thorn	1043, 1047
Marantz	1000, 1001, 1004, 1046, 1051	Pathe Marconi	1043	Sanyo	1001, 1002, 1014, 1047	TMK	1002, 1014
Marta	1003	Penney	1010, 1014			Tokai	1045, 1050
Matsui	1044, 1045	Pentax	1010, 1049	SBR	1046	Tonsai	1050
Matsushita	1004	Perdio	1042	Schaub Lorenz	1042, 1043, 1047	Toshiba	1013, 1024, 1029, 1043, 1046, 1066, 1075
Mediator	1046	Philco	1004, 1051	Schneider	1042, 1044, 1045, 1046, 1050	Totevision	1002, 1003, 1014
Medion	1044, 1048	Philips	1004, 1025, 1033, 1046, 1056, 1057, 1059, 1062, 1063	Scott	1012	Towada	1050
MEI	1004			Sears	1001, 1003, 1004, 1010	Towika	1050
Memorex	1001, 1002, 1003, 1004, 1005, 1008, 1013, 1014, 1042, 1045, 1047	Philips Magnavox	1018	SEG	1050	Uher	1045
Memphis	1050	Phonola	1046	SEI-Sinudyne	1046	Unitech	1002, 1014
Metz	1048	Pilot	1003	Seleco	1043	Universum	1042, 1045, 1046
MGA	1014	Pioneer	1011, 1046	Sentron	1050	Vector Research	1000
MGN Technology		Prinz	1042	Sharp	1008, 1023, 1028, 1053, 1073	Video Concepts	1000
	1002, 1014	Profex	1050			Videon	1044, 1048
Micromaxx	1044, 1048	Profronic	1014	Shintom	1006, 1047, 1050	Videosonic	1002, 1014
Microstar	1044, 1048	Proline	1042	Shivaki	1045	Wards	1002, 1003, 1004, 1005, 1006, 1008, 1010, 1014
Migros	1042	Proscan	1009	Shogun	1002, 1014		
Minolta	1010	Prosonic	1044	Siemens	1045, 1047	Weltblick	1045
Mitsubishi	1011, 1042, 1046	Protec	1006	Signature 2000	1008	White Westinghouse	
Montgomery Ward		Pye	1046, 1056	Silva	1045		1013
	1008	Quarter	1001	Singer	1004, 1006	XR-1000	1004, 1005, 1006
Motorola	1004, 1008	Quartz	1001, 1047	Sinudyne	1046	Yamaha	1000, 1001, 1007
MTC	1002, 1014	Quasar	1004, 1035	Sontec	1045	Yamishi	1050
Multitech	1002, 1005, 1006, 1042, 1046, 1050	Quelle	1042, 1046, 1047	Sony	1016, 1019, 1055, 1060, 1064, 1074	Yokan	1050
Murphy	1042	Radio Shack	1003			Yoko	1045, 1050
				STS	1004, 1010	Zenith	1013, 1026, 1037
				Sunkai	1044		



© 2008 YAMAHA CORPORATION All rights reserved.

YAMAHA ELECTRONICS CORPORATION, USA 6660 ORANGETHORPE AVE., BUENA PARK, CALIF. 90620, U.S.A.
 YAMAHA CANADA MUSIC LTD. 135 MILNER AVE., SCARBOROUGH, ONTARIO M1S 3R1, CANADA
 YAMAHA ELEKTRONIK EUROPA G.m.b.H. SIEMENSSTR. 22-34, 25462 RELINGEN BEI HAMBURG, GERMANY
 YAMAHA ELECTRONIQUE FRANCE S.A. RUE AMBROISE CROIZAT BP70 CROISSY-BEAUBOURG 77312 MARNE-LA-VALLEE CEDEX02. FRANCE
 YAMAHA ELECTRONICS (UK) LTD. YAMAHA HOUSE, 200 RICKMANSWORTH ROAD WATFORD, HERTS WD18 7GQ, ENGLAND
 YAMAHA SCANDINAVIA A.B. J A WETTERGRENS GATA 1, BOX 30053, 400 43 VÄSTRA FRÖLUNDA, SWEDEN
 YAMAHA MUSIC AUSTRALIA PTY. LTD. LEVEL 1, 99 QUEENSBIDGE STREET, SOUTHBANK, VIC 3006, AUSTRALIA

YAMAHA CORPORATION
 Printed in China ☞ WN25730

The circled numbers and alphabets correspond to those in the Owner's Manual.
 Les nombres et lettres dans un cercle correspondent à ceux du mode d'emploi.
 Die umkreisten Zahlen und Buchstaben entsprechen denen in der Bedienungsanleitung.
 Inringade nummer och bokstäver motsvarar de som anges i bruksanvisningen.
 I manuali e le lettere dell'alfabeto corrispondono a quelli nel Manuale di istruzioni.
 Los números y las letras en el interior de círculos se corresponden con aquellos del manual de instrucciones.
 De omcirkelde cijfers en letters corresponderen met die in de Gebruiksaanwijzing.
 Цифры и буквы в кружках относятся к цифрам и буквам в Инструкции по эксплуатации.
 带圆圈的数字和文字与说明书中的同类数字和文字相对应。
 원 번호 및 원 알파벳은 사용 설명서 안의 표기와 일치합니다.

■ **Front panel/Face avant/Frontblende/Frontpanelen/Pannello anteriore/Panel delantero/Voorpaneel/
 Фронтальная панель/ 前部面板 / 전면 패널**

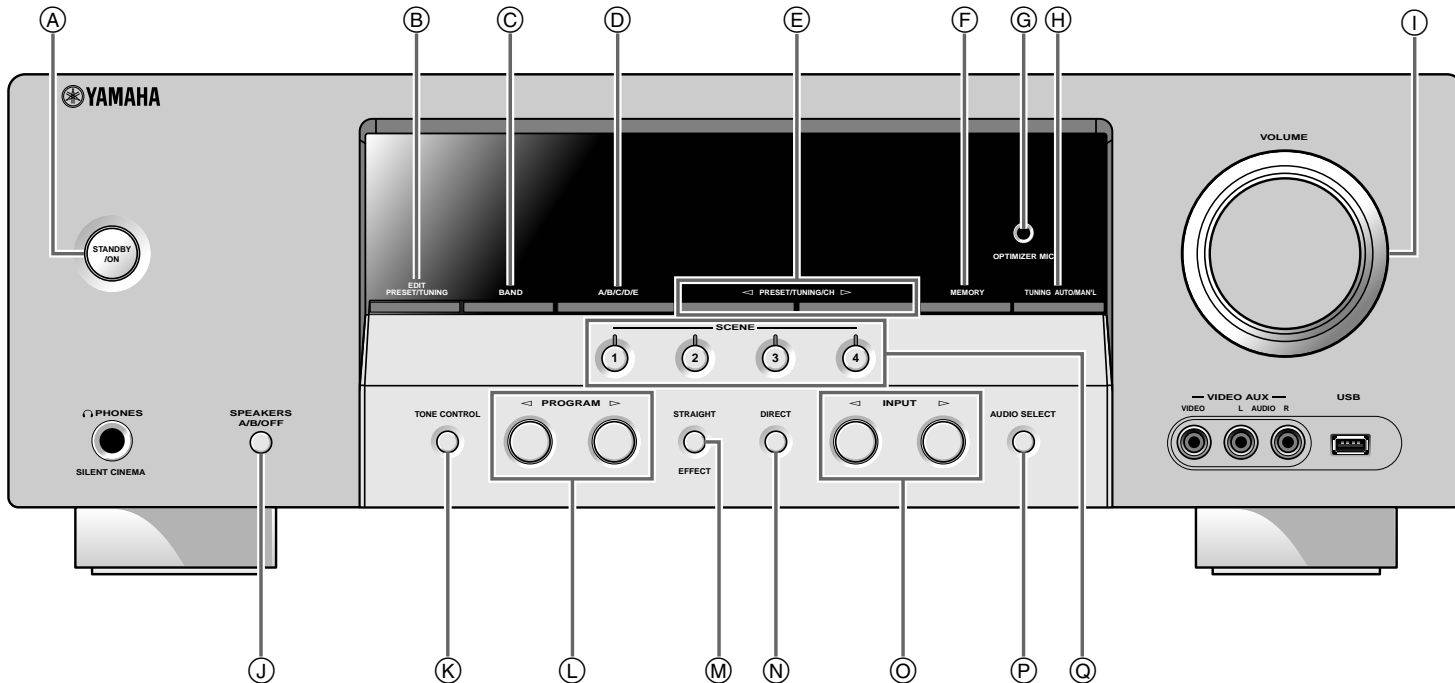

■ Remote control/Boîtier de télécommande/Fernbedienung/Fjärrkontrollen/
Telecomando/Mando a distancia/Afstandsbediening/Пульт ДУ/ 遥控器 /
리모콘

