

YAMAHA RX-V1070/870

Natural Sound Stereo Receiver

Thank you for selecting this YAMAHA stereo receiver.



OWNER'S MANUAL

CONTENTS

Safety Instructions	2
Features	4
Supplied Accessories	4
Profile of This Unit	5
Speaker Setup for This Unit	6
Connections	7
Adjustment Before Operation ...	12
Operations	15
Tuning Operations	17
Using Digital Sound Field Processor (DSP)	19
Setting the SLEEP Timer	24
Remote Control Transmitter ...	25
Notes about the Remote Control Transmitter	28
Troubleshooting	29
Specifications	30

IMPORTANT!

Please record the serial number of this unit in the space below.

Model:
Serial No.:

The serial number is located on the rear of the unit.
Retain this Owner's Manual in a safe place for future reference.

WARNING

TO REDUCE THE RISK OF FIRE OR ELECTRIC SHOCK, DO NOT EXPOSE THIS UNIT TO RAIN OR MOISTURE.

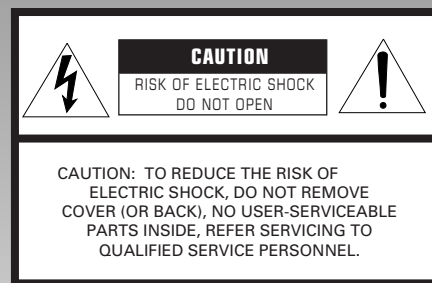

• Explanation of Graphical Symbols



The lightning flash with arrowhead symbol, within an equilateral triangle, is intended to alert you to the presence of uninsulated "dangerous voltage" within the product's enclosure that may be of sufficient magnitude to constitute a risk of electric shock to persons.



The exclamation point within an equilateral triangle is intended to alert you to the presence of important operating and maintenance (servicing) instructions in the literature accompanying the appliance.

SAFETY INSTRUCTIONS

- 1 Read Instructions – All the safety and operating instructions should be read before the unit is operated.
- 2 Retain Instructions – The safety and operating instructions should be retained for future reference.
- 3 Heed Warnings – All warnings on the unit and in the operating instructions should be adhered to.
- 4 Follow Instructions – All operating and other instructions should be followed.
- 5 Water and Moisture – The unit should not be used near water – for example, near a bathtub, washbowl, kitchen sink, laundry tub, in a wet basement, or near a swimming pool, etc.
- 6 Carts and Stands – The unit should be used only with a cart or stand that is recommended by the manufacturer.

- 6A A unit and cart combination should be moved with care. Quick stops, excessive force, and uneven surfaces may cause the unit and cart combination to overturn.



- 7 Wall or Ceiling Mounting – The unit should be mounted to a wall or ceiling only as recommended by the manufacturer.
- 8 Ventilation – The unit should be situated so that its location or position does not interfere with its proper ventilation. For example, the unit should not be situated on a bed, sofa, rug, or similar surface, that may block the ventilation openings; or placed in a built-in installation, such as a bookcase or cabinet that may impede the flow of air through the ventilation openings.
- 9 Heat – The unit should be situated away from heat sources such as radiators, stoves, or other appliances that produce heat.
- 10 Power Sources – The unit should be connected to a power supply only of the type described in the operating instructions or as marked on the unit.
- 11 Power-Cord Protection – Power-supply cords should be routed so that they are not likely to be walked on or pinched by items placed upon or against them, paying particular attention to cords at plugs, convenience receptacles, and the point where they exit from the unit.
- 12 Cleaning – The unit should be cleaned only as recommended by the manufacturer.
- 13 Nonuse Periods – The power cord of the unit should be unplugged from the outlet when left unused for a long period of time.
- 14 Object and Liquid Entry – Care should be taken so that objects do not fall into and liquids are not spilled into the inside of the unit.
- 15 Damage Requiring Service – The unit should be serviced by qualified service personnel when:

- A. The power-supply cord or the plug has been damaged; or
 - B. Objects have fallen, or liquid has been spilled into the unit; or
 - C. The unit has been exposed to rain; or
 - D. The unit does not appear to operate normally or exhibits a marked change in performance; or
 - E. The unit has been dropped, or the cabinet damaged.
- 16 Servicing – The user should not attempt to service the unit beyond those means described in the operating instructions. All other servicing should be referred to qualified service personnel.
 - 17 Power Lines – An outdoor antenna should be located away from power lines.
 - 18 Grounding or Polarization – Precautions should be taken so that the grounding or polarization is not defeated.
 - 19 Outdoor Antenna Grounding – If an outside antenna is connected to this unit, be sure the antenna system is grounded so as to provide some protection against voltage surges and built-up static charges. Article 810 of the National Electrical Code, ANSI/NFPA 70, provides information with regard to proper grounding of the mast and supporting structure, grounding of the lead-in wire to an antenna discharge unit, size of grounding conductors, location of antenna discharge unit, connection to grounding electrodes, and requirements for the grounding electrode.

EXAMPLE OF ANTENNA GROUNDING

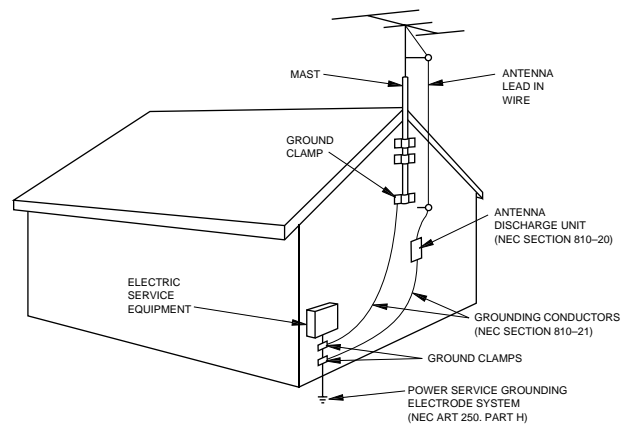

NEC – NATIONAL ELECTRICAL CODE

Note to CATV system installer:

This reminder is provided to call the CATV system installer's attention to Article 820-40 of the NEC that provides guidelines for proper grounding and, in particular, specifies that the cable ground shall be connected to the grounding system of the building, as close to the point of cable entry as practical.

Caution: Read this before operating your unit

- 1 To ensure the finest performance, please read this manual carefully. Keep it in a safe place for future reference.
- 2 Install your unit in a cool, dry, clean place – away from windows, heat sources, and too much vibration, dust, moisture or cold. Avoid sources of hum (transformers, motors). To prevent fire or electrical shock, do not expose to rain and water.
- 3 Do not operate the unit upside-down. It may overheat, possibly causing damage.
- 4 Never open the cabinet. If a foreign object drops into the set, contact your dealer.
- 5 Do not use force on switches, knobs or cords. When moving the set, first turn the unit off. Then gently disconnect the power plug and the cords connecting to other equipment. Never pull the cord itself.
- 6 Do not attempt to clean the unit with chemical solvents; this might damage the finish. Use a clean, dry cloth.
- 7 Always set the volume control to “– ∞” before starting the audio source play: increase the volume gradually to an appropriate level after the play is started.
- 8 To prevent lightning damage, pull out the power cord and remove the antenna cable during an electrical storm.
- 9 Be sure to read the “Troubleshooting” section on common operating errors before concluding that your unit is faulty.
- 10 Do not connect audio equipment to the AC outlets on the rear panel if that equipment requires more power than the outlets are rated to provide.

FCC INFORMATION

1. IMPORTANT NOTICE : DO NOT MODIFY THIS UNIT!

This product, when installed as indicated in the instructions contained in this manual, meets FCC requirements. Modifications not expressly approved by Yamaha may void your authority, granted by the FCC, to use the product.

2. **IMPORTANT** : When connecting this product to accessories and/or another product use only high quality shielded cables. Cable/s supplied with this product **MUST** be used. Follow all installation instructions. Failure to follow instructions could void your FCC authorization to use this product in the USA.

3. **NOTE** : This product has been tested and found to comply with the requirements listed in FCC Regulations, Part 15 for Class “B” digital devices. Compliance with these requirements provides a reasonable level of assurance that your use of this product in a residential environment will not result in harmful interference with other electronic devices.

This equipment generates/uses radio frequencies and, if not installed and used according to the instructions found in the users manual, may cause interference harmful to the operation of other electronic devices.

Compliance with FCC regulations does not guarantee that interference will not occur in all installations. If this product is found to be the source of interference, which can be determined by turning the unit “OFF” and “ON”, please try to eliminate the problem by using one of the following measures:

Relocate either this product or the device that is being affected by the interference.

Utilize power outlets that are on different branch (circuit breaker or fuse) circuits or install AC line filter/s.

In the case of radio or TV interference, relocate/reorient the antenna. If the antenna lead-in is 300 ohm ribbon lead, change the lead-in to coaxial type cable.

If these corrective measures do not produce satisfactory results, please contact the local retailer authorized to distribute this type of product. If you can not locate the appropriate retailer, please contact Yamaha Electronics Corp., U.S.A. 6660 Orangethorpe Ave, Buena Park, CA 90620.

The above statements apply **ONLY** to those products distributed by Yamaha Corporation of America or its subsidiaries.

We Want You Listening For A Lifetime

YAMAHA and the Electronic Industries Association's Consumer Electronics Group want you to get the most out of your equipment by playing it at a safe level. One that lets the sound come through loud and clear without annoying blaring or distortion – and, most importantly, without affecting your sensitive hearing. Since hearing damage from loud sounds is often undetectable until it is too late, YAMAHA and the Electronic Industries Association's Consumer Electronics Group recommend you to avoid prolonged exposure from excessive volume levels.



FEATURES

- 5 Speaker Configuration

<RX-V1070>

Front: 110W + 110W (8Ω)/135W + 135W (6Ω)
RMS Output Power, 0.015% THD,
20–20,000 Hz

Center: 110W (8Ω)/135W (6Ω) RMS Output
Power, 0.015% THD, 20–20,000 Hz

Rear: 30W + 30W (8Ω)/40W + 40W (6Ω) RMS
Output Power, 0.08% THD, 1,000 Hz

<RX-V870>

Front: 80W + 80W (8Ω)/95W + 95W (6Ω) RMS
Output Power, 0.015% THD,
20–20,000 Hz

Center: 80W (8Ω)/95W (6Ω) RMS Output Power,
0.015% THD, 20–20,000 Hz

Rear: 25W + 25W (8Ω)/28W + 28W (6Ω) RMS
Output Power, 0.08% THD, 1,000 Hz

- Digital Sound Field Processor (Including Dolby Pro Logic Surround Decoder)
4 Programs for Audio Sources
4 Programs for Audio/Video Sources
- Automatic Input Balance Control for Dolby Surround
- Test Tone Generator for Easier Speaker Output Balance Adjustment
- 3 Center Channel Modes (NORMAL/WIDE/PHANTOM)
- 40-Station Random Preset Tuning
- Video Signal Input/Output Capability (Including S Video Connections)
- SLEEP Timer
- On Screen Displays Which Is Helpful in Controlling This Unit
- Programmable Remote Control Transmitter

SUPPLIED ACCESSORIES

After unpacking, check that the following parts are contained.

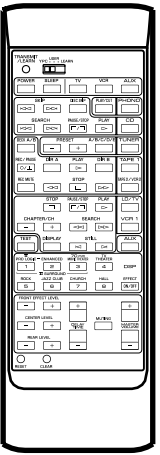
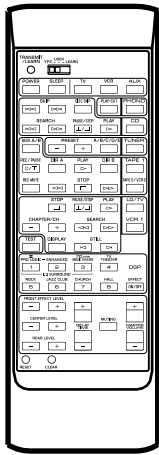
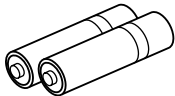
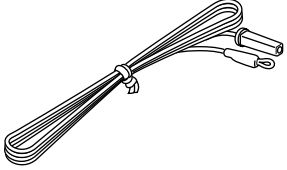
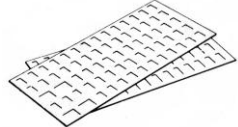
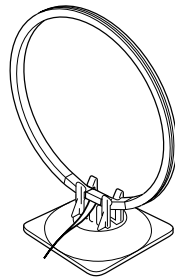
<ul style="list-style-type: none"> ● Remote Control Transmitter <div style="display: flex; justify-content: space-around;"> <div style="text-align: center;"> <p><RX-V1070></p>  </div> <div style="text-align: center;"> <p><RX-V870></p>  </div> </div>	<ul style="list-style-type: none"> ● Batteries (size AA, R6, UM-3) 	<ul style="list-style-type: none"> ● Indoor FM Antenna 
	<ul style="list-style-type: none"> ● User Program Sheets 	<ul style="list-style-type: none"> ● AM Loop Antenna 

OPEN/CLOSE THE CONTROL DOOR <for RX-V1070 only>

When it is not necessary to operate controls inside the control door, close the door.

To close the door

To open the door

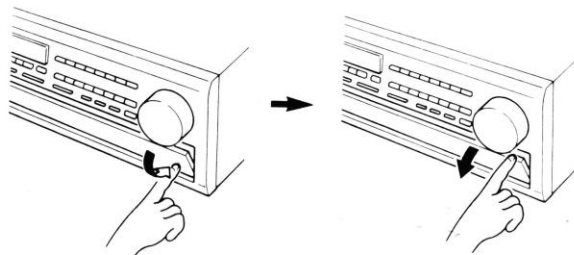
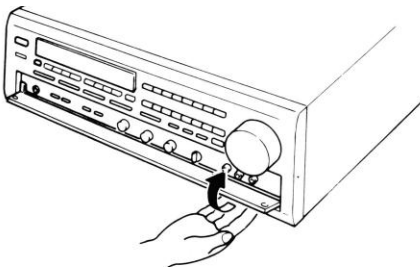

PROFILE OF THIS UNIT

You are the proud owner of this Yamaha stereo receiver –an extremely sophisticated audio component. The Digital Sound Field Processor (DSP) built into this unit takes full advantage of Yamaha’s undisputed leadership in the field of digital audio processing to bring you a whole new world of listening experiences. Follow the instructions in this manual carefully when setting up your system, and this unit will sonically transform your room into a wide range of listening environments –movie theater, concert hall, and so on. In addition, you get incredible realism from Dolby-encoded video sources using the built-in Dolby Pro Logic Surround Decoder. Rather than tell you about the wonders of digital sound field processing, however, let’s get right down to the business of setting up the system and trying out its many capabilities. Please read this operation manual carefully and store it in a safe place for later reference.

Digital Sound Field Processing

What is it that makes live music so good? Today’s advanced sound reproduction technology lets you get extremely close to the sound of a live performance, but chances are you’ll still notice something missing: the acoustic environment of the live concert hall. Extensive research into the exact nature of the sonic reflections that create the ambience of a large hall has made it possible for Yamaha engineers to bring you this same sound in your own listening room, so you’ll feel all the sound of a live concert.

What’s more, our technicians, armed with sophisticated measuring equipment, have even made it possible to capture the acoustics of a variety of venues such as an actual concert hall, theater, etc. to allow you to accurately recreate one of several actual live performance environments, all in your own home.

Dolby Pro Logic Surround

The Dolby Pro Logic Surround Decoder program lets you experience the dramatic realism and impact of Dolby Surround movie theater sound in your own home. Dolby Pro Logic gets its name from its professional-grade steering logic circuitry, which provides greater effective channel separation for a much higher degree of realism than the “passive” Dolby Surround circuits found in today’s typical home audio/video equipment. Dolby Pro Logic Surround provides a true center channel, so that there are four independent channels, unlike passive Dolby Surround which has in effect only three channels: left, right, and rear. This center channel allows listeners seated in even less-than-ideal positions to hear the dialog originating from action on the screen while getting a stereo effect as well.

This Dolby Pro Logic Surround Decoder employs a digital signal processing system. This system increases sound stability at each channel and minimizes crosstalk between channels compared to conventional analog Dolby signal processing. In addition, this unit features a built-in automatic input balance control. This circuit always presents you the best surround conditions without performing manual adjustments.

Dolby Pro Logic Surround + DSP

You can also enjoy Dolby Pro Logic with two modes of Digital Surround field processing. These combinations expand the surround effect. One is the “ENHANCED” Dolby Pro Logic Surround, which recreates the surround effect of the 35 mm film movie theater.

The other is the combination of Dolby Pro Logic and the sound field program “70 mm MOVIE THEATER”, which recreates the listening experience of a 70 mm film theater.

Directional Enhancement Circuit + DSP

The newly featured directional enhancement circuit expands and focuses the digital sound field by emphasizing position of sound.

This effect puts you in the midst of the action, while centering and focusing your attention to the screen. This circuit is available on the sound field program “TV THEATER”.

SPEAKER SETUP FOR THIS UNIT

SPEAKERS TO BE USED

This unit is designed to provide the best sound-field quality with a 5 speaker configuration. The speakers to be used with this unit will be mainly front speakers, rear speakers, and a center speaker. (You can omit the center speaker. Refer to the “**4-Speaker Configuration**” shown below.)

The front speakers are used for the output of the main source sound and the effect sound. They will probably be the speakers of your present stereo speaker system. The rear speakers are used for the output of the effect sound. And the center speaker is used for the output of the center sound (most important effects as well as dialogue) encoded with the Dolby Surround. The rear and center speakers do not need to be equal in power to the front speakers. However, all the speakers should have high enough power handling to accept the maximum output of this unit.

SPEAKER CONFIGURATION

5-Speaker Configuration

This configuration is the most effective and is the one that is recommended. In this configuration, the center speaker is necessary as well as the rear speakers. If the digital sound field program is in **DOLBY PRO LOGIC, ENHANCED** or **TV THEATER** mode conversations will be output from the center speaker and the ambience will be excellent.

- Set the center mode to the “**NORMAL**” or “**WIDE**” position. (For details, refer to page 13.)

4-Speaker Configuration

The center speaker is not used in this configuration. If the digital sound field program is in the **DOLBY PRO LOGIC, ENHANCED** or **TV THEATER** mode, the center sound is output from the left and the right front speakers. However, the sound effect of other programs can be the same as that of the 5-speaker configuration.

- Be sure to set the center mode to the “**PHANTOM**” position. (For details, refer to page 13.)

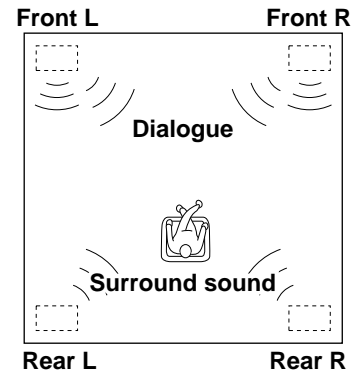
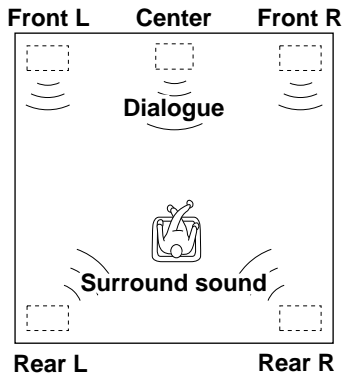

SPEAKER PLACEMENT

The recommended speaker configuration, the 5-speaker configuration, will require two speaker pairs: **front speakers** (your normal stereo speakers), and **rear speakers**, plus a **center speaker**. When you place these speakers, refer to the following.

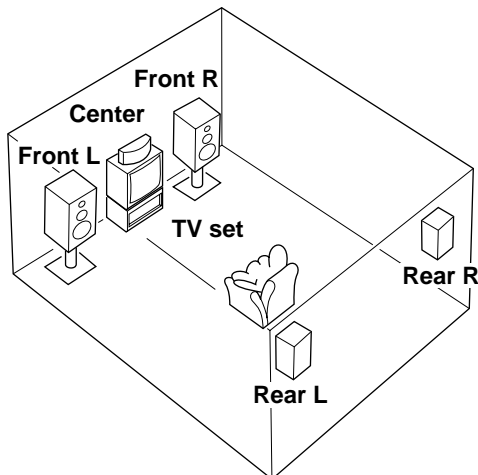

- Front:** In normal position. (The position of your present stereo speaker system.)
- Rear:** Behind your listening position, facing slightly inward. Nearly six feet (approx. 1.8 m) up from the floor.
- Center:** Precisely between the front speakers. (To avoid interference with TV sets, use a magnetically shielded speaker. If, however, it is not effective, keep the speaker away from TV sets.)

CONNECTIONS

Before attempting to make any connections to or from this unit, be sure to first switch OFF the power to this unit and to any other components to which connections are being made.

CONNECTIONS WITH OTHER COMPONENTS

When making connections between this unit and other components, be sure all connections are made correctly, that is to say L (left) to L, R (right) to R, “+” to “+” and “-” to “-”. Also, refer to the owner’s manual for each component to be connected to this unit.

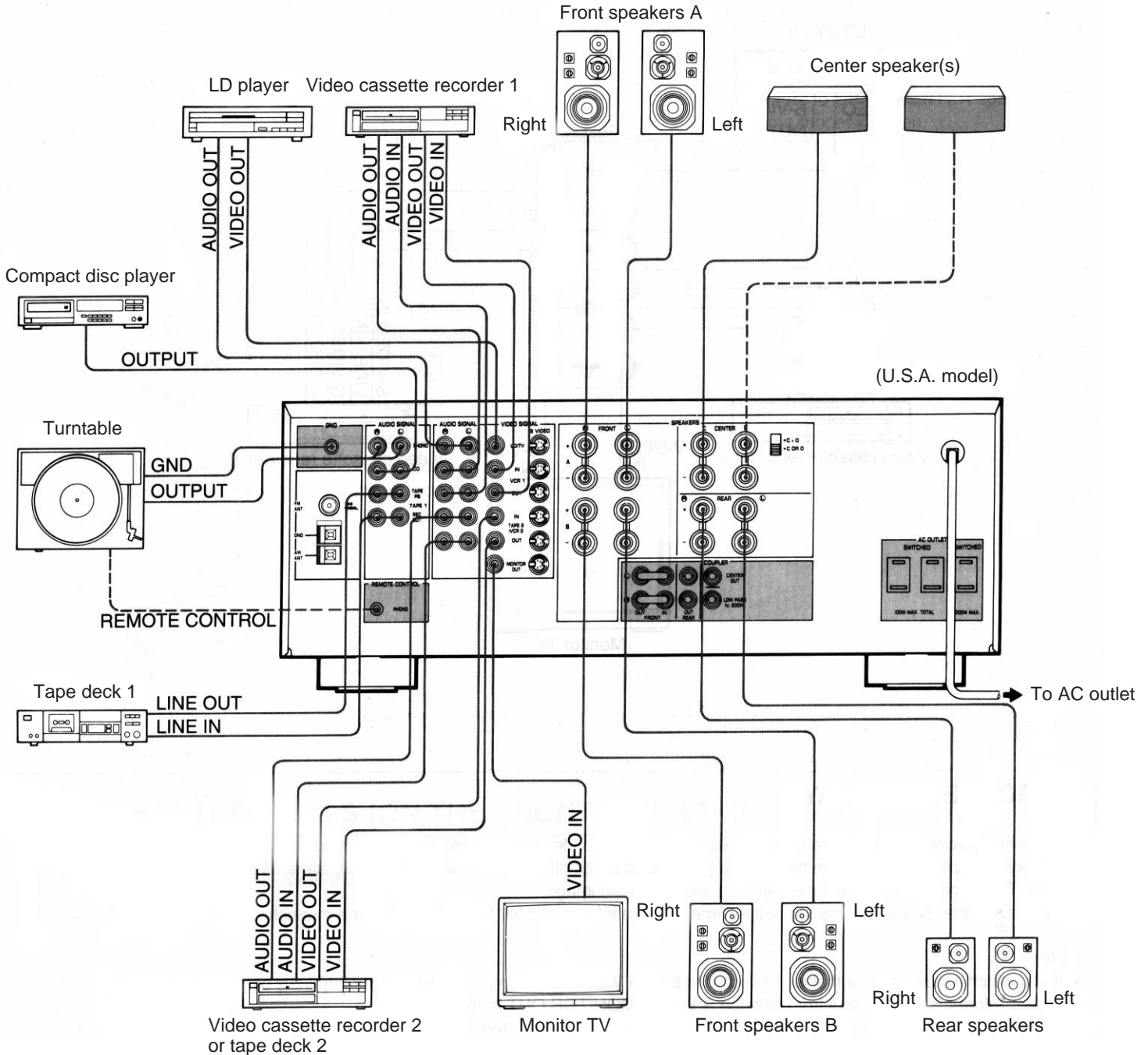

 : Refer to “ABOUT THE ACCESSORY TERMINALS” on page 10.

CONNECTING S VIDEO TERMINALS

If your video cassette recorder, video disc player, etc. and your monitor are equipped with "S" (high-resolution) video terminals, connect them to this unit's S VIDEO terminals, and connect this unit's S VIDEO MONITOR OUT terminal to the "S" video input of your monitor. Otherwise, connect the composite video terminals from your video cassette recorder, video disc player, etc. to the composite video terminals of this unit, and connect this unit's composite MONITOR OUT terminal to the composite video input of your monitor.

Note
If video signals are sent to both S VIDEO input and composite input terminals, the signals will be sent to their respective output terminals independently.

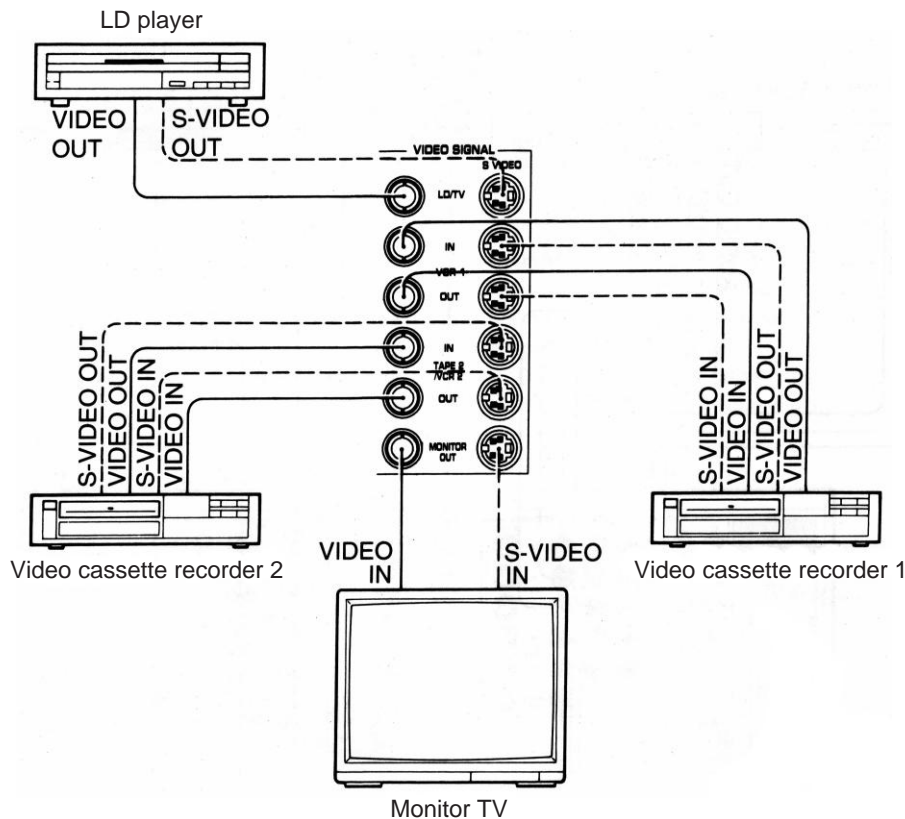

ON SCREEN DISPLAYS

If you connect your video cassette recorder, video disc player, video monitor, etc. to this unit, you can take advantage of this unit's capability to display DSP program names and information about other various settings and adjustments on your video monitor's screen. This information will be superimposed over the video image.

If there is no video source connected or it is turned off, the information will be displayed over a monochromatic background.

Notes

- If you watch a video source that is connected to both S VIDEO and composite video input terminals of this unit, signals of screen display information are output from only the S VIDEO MONITOR OUT terminal.
- When no video signal is input to either S VIDEO input or composite video input terminals of this unit, signals of screen display information are output from both S VIDEO MONITOR OUT and composite MONITOR OUT terminals with a monochromatic background.

* For the General Model, if the PAL/NTSC switch on the rear panel is set to "PAL", nothing will be output from either S VIDEO MONITOR OUT or composite MONITOR OUT terminal in this case.

CONNECTING SPEAKERS

Connect the **SPEAKERS** terminals to your speakers with wire of the proper gauge, cut to be as short as possible. If the connections are faulty, no sound will be heard from the speakers. Make sure that the polarity of the speaker wires is correct, that is, + and – markings are observed. If these wires are reversed, the sound will be unnatural and will lack bass. **Do not let the bare speaker wires touch each other and do not let them touch the metal parts of this unit as this could damage this unit and/or speakers.**

- Use speakers with the specified impedance shown on the rear of this unit.

How to Connect:

Red: positive (+)
Black: negative (-)

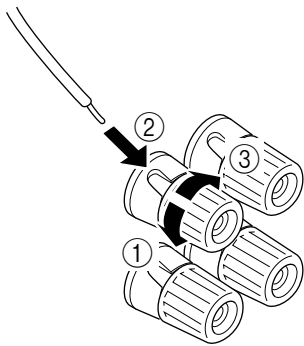

- ① Unscrew the knob.
- ② Insert the bare wire.
[Remove approx. 5mm (1/4") insulation from the speaker wires.]
- ③ Tighten the knob and secure the wire.

* Banana Plug connections are also possible. Simply insert the Banana Plug connector into the corresponding terminal.

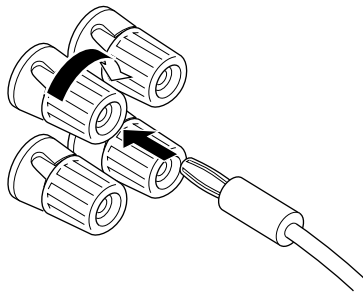

Front speaker connection:

One or two speaker systems can be connected to this unit. If you connect only one speaker system, connect it to either the **FRONT A** or **B** terminals.

Rear speaker connection:

One rear speaker system can be connected to the **REAR** terminals.

Center speaker connection:

One or two center speakers can be connected to this unit. If you connect only one center speaker, connect it to either the **CENTER C** or **D** terminals.

While connecting, be sure to set the **CENTER** speaker impedance switch to the proper position.

Set to **"C + D"** when using two center speakers, or to **"C OR D"** when using only one center speaker. If the switch is set to the improper position, no sound may be heard from the center speaker.

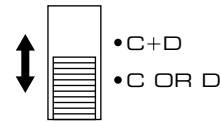

USING AUX TERMINALS (ON THE FRONT PANEL) <for RX-V1070 only>

These terminals are used to connect an auxiliary video input source such as a camcorder to this unit.

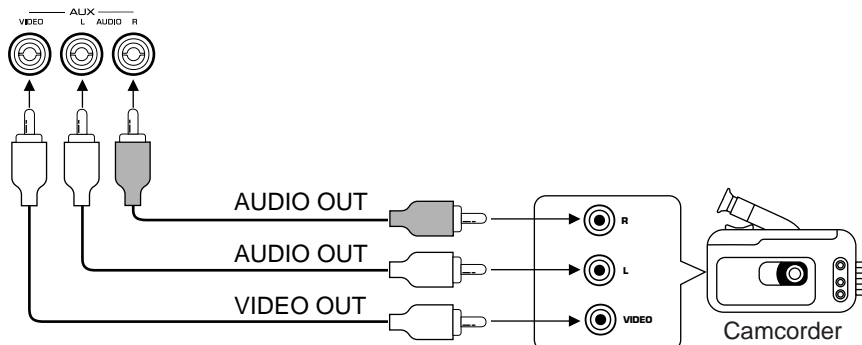

ABOUT THE ACCESSORY TERMINALS

AC OUTLETS

(U.S.A., Canada and General models)

..... 2 SWITCHED OUTLETS and 1 UNSWITCHED OUTLET
(Australia model) 1 SWITCHED OUTLET

Use these to connect the power cords from your components to this unit.

The power to the **SWITCHED** outlets is controlled by this unit's **POWER** switch or the provided remote control transmitter's **POWER** key. These outlets will supply power to any component whenever this unit is turned on.

The power to the **UNSWITCHED** outlet can not be controlled by this unit's **POWER** switch or the provided remote control transmitter's **POWER** key.

<U.S.A. and General models>

The maximum power (total power consumption of components) that can be connected to the **SWITCHED AC OUTLETS** is 100 watts.

The maximum power (total power consumption of components) that can be connected to the **UNSWITCHED AC OUTLET** is 200 watts.

<Canada model>

The maximum power (total power consumption of components) that can be connected to the **SWITCHED AC OUTLETS** is 120 watts.

The maximum power (total power consumption of components) that can be connected to the **UNSWITCHED AC OUTLET** is 180 watts.

<Australia model>

The maximum power (total power consumption of components) that can be connected to the **SWITCHED AC OUTLET** is 100 watts.

REMOTE CONTROL (PHONO) connector

If you have a YAMAHA turntable with the terminal for remote control, connect it to this connector by using the cable provided with the turntable. This connection allows you to control the turntable from the provided remote control transmitter.

GND terminal (For turntable use)

Connecting the ground wire of the turntable to this terminal will minimize hum, but in some cases better results may be obtained with the ground wire disconnected.

FRONT OUT terminals

These terminals are for front-channel line output. Leave the jumper bars connected to **FRONT IN** terminals when you use the built-in amplifier.

However, if you drive front speakers with an external stereo power amplifier, remove the jumper bars and connect the input terminals of the external amplifier (MAIN IN or AUX terminals of a power amplifier or an integrated amplifier) to these terminals.

FRONT IN terminals

These terminals are for line input to the built-in front-channel amplifier. Leave the jumper bars connected to **FRONT OUT** terminals when you use the built-in amplifier.

However, if you drive front speakers with an external stereo power amplifier, remove the jumper bars.

REAR OUT terminals

These terminals are for rear-channel line output. If you use the built-in amplifier, there is no connection to these terminals. However, if you drive rear speakers with an external stereo power amplifier, connect the input terminals of the external amplifier to these terminals.

If you use the built-in amplifier and the external power amplifier at the same time, the sound will be output only through the external one.

CENTER OUT terminal

This terminal is for center-channel line output. There is no connection to this terminal when you use the built-in amplifier. However, if you drive a center speaker with an external power amplifier, connect the input terminal of the external amplifier to this terminal.

If you use the built-in amplifier and the external power amplifier at the same time, the sound will be output only through the external one.

LOW PASS terminal

This terminal is for output to a mono amplifier driving a subwoofer. Frequencies above 200 Hz are filtered out so that only the bass range remains.

ANTENNA CONNECTIONS

- Each antenna should be connected to the designated terminals correctly, referring to the following figure.
- Both AM and FM indoor antennas are included with this unit. In general, these antennas will probably provide sufficient signal strength. Nevertheless, a properly installed outdoor antenna will give clearer reception than an indoor one. If you experience poor reception quality, an outdoor antenna may result in improvement.

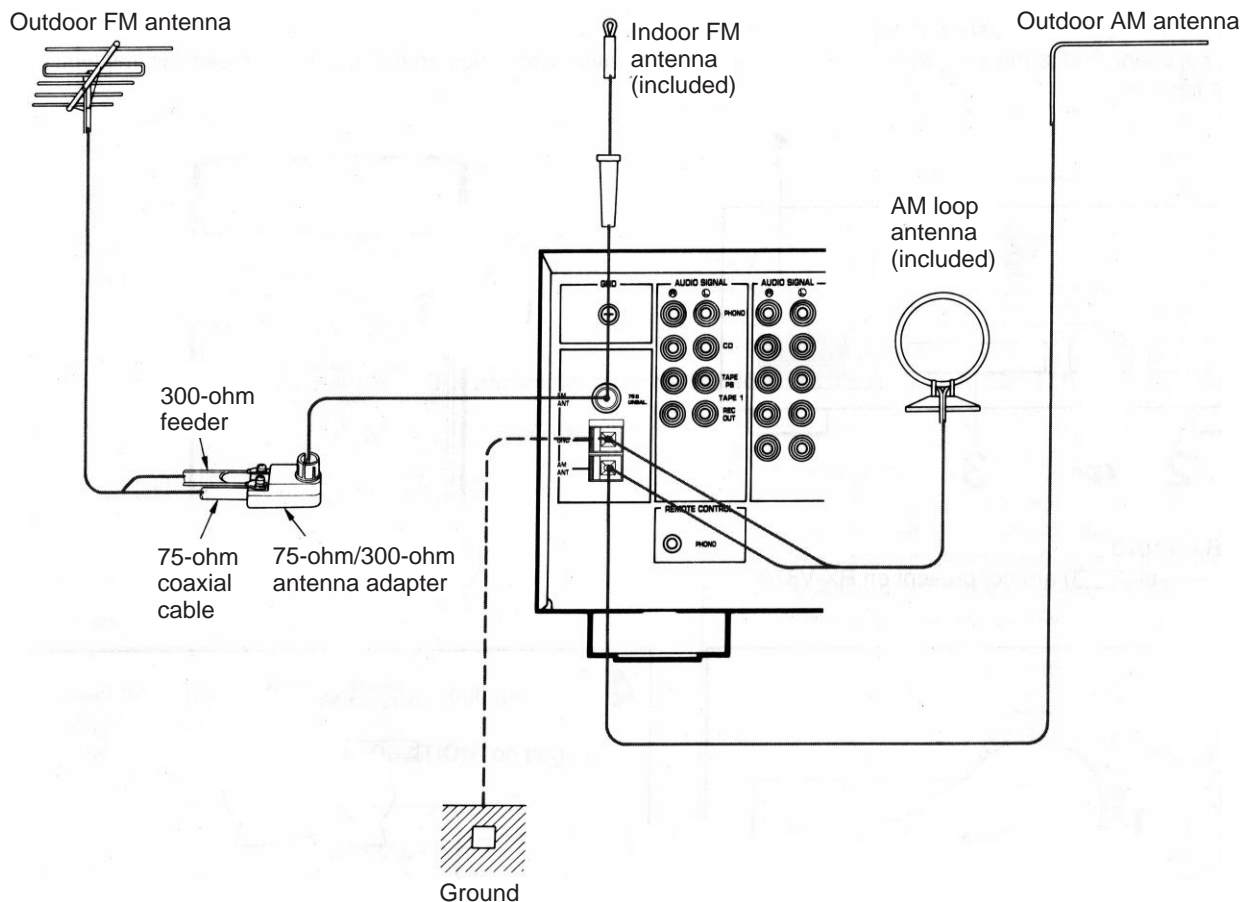

Connecting the AM loop antenna

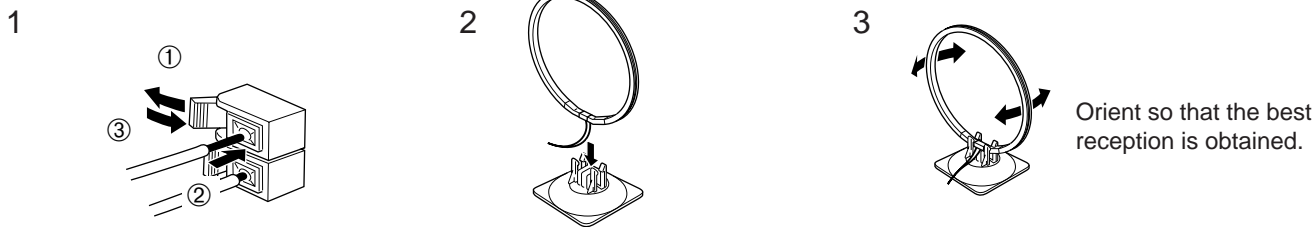

- * The AM loop antenna should be placed apart from the main unit. The antenna may be hung on a wall.
- * The AM loop antenna should be kept connected, even if an outdoor AM antenna is connected to this unit.

GND terminal

For maximum safety and minimum interference, connect the **GND** terminal to a good grounding. A good grounding is a metal stake driven into moist earth.

Notes

- When connecting the indoor FM antenna, make sure that the grooved part of the connector hole is facing downward.
- If you need an outdoor FM antenna to improve FM reception quality, either a 300-ohm feeder or a coaxial cable may be used. In locations troubled by electrical interference, a coaxial cable is preferable.

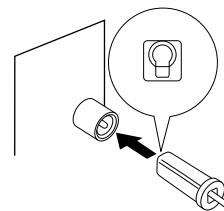

ADJUSTMENT BEFORE OPERATION

Speaker balance adjustment

This procedure lets you adjust the sound output level balance between the front, center, and rear speakers using the built-in test tone generator. With this adjustment, the sound output level heard at the listening position will be the same from each speaker. This is important for the best performance of the digital sound field processor.

The adjustment of each speaker output level should be done at your listening position with the remote control transmitter.

Otherwise, the result may not be satisfactory.

* If your monitor is connected to this unit, by turning it on, display information and image on the monitor's screen will help you to perform this adjustment.

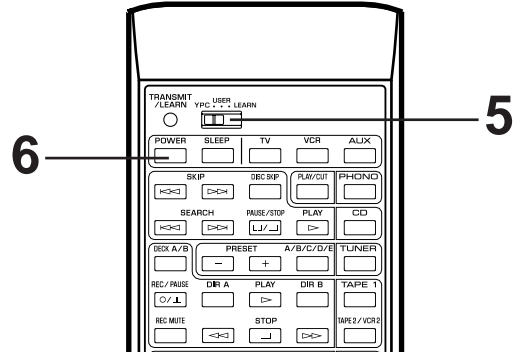
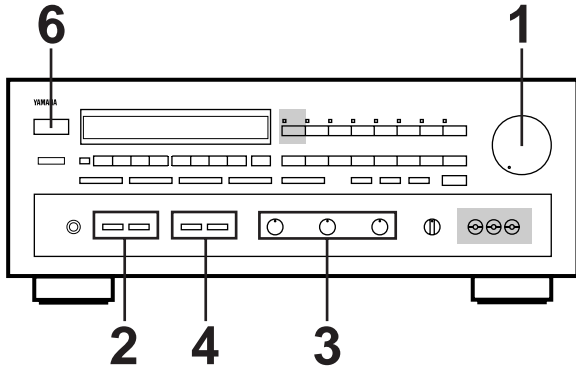

Illustrations: RX-V1070

Parts in shaded areas (■) are not present on RX-V870.

1

Set to "∞".

2

Select the front speakers to be used.

SPEAKERS

A	B
ON	ON
OFF	OFF

* If you use two front speaker systems, press both the A and B switches.

3

BASS

Set to "DEFEAT".

TREBLE

Set to "DEFEAT".

BALANCE

Set to "0".

4

BASS EXTENSION

ON

OFF

TONE BYPASS

ON

OFF

↓

OFF

Set to "OFF".

5

USER

YPC . . . LEARN

Set to "YPC".

6

POWER

12

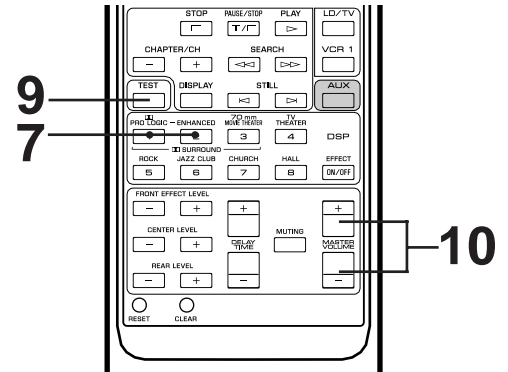
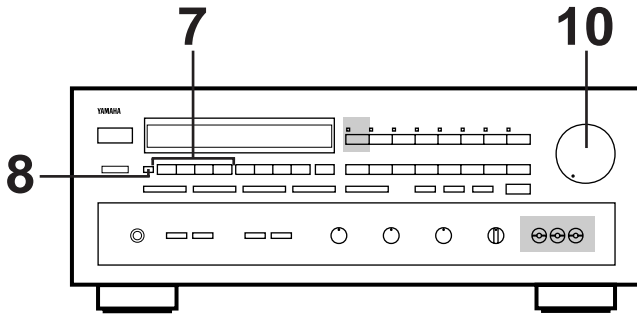

Illustrations: RX-V1070

Parts in shaded areas (■) are not present on RX-V870.

For detailed information on the remote control transmitter, refer to “REMOTE CONTROL TRANSMITTER” on page 25.

7

PRO LOGIC

or

ENHANCED

8 Select the center mode according to your speaker configuration.
(Refer to “SPEAKER CONFIGURATION” on page 6.)

CENTER MODE

NORMAL

↓

WIDE

↓

PHANTOM

On the feature of each mode, refer to the “Note” shown below.

9

TEST

→

NORMAL

Flashes continuously.

10 Turn up the volume by using the remote control transmitter. You will hear a test tone (like pink noise) from the left front speaker, then the right front speaker, and then the center rear speakers, for about two seconds each. The display changes as shown below.

- * If your monitor is on, the state of test tone output is also shown by an image of audio listening room on the monitor's screen.
- * The test tone from the left rear speaker and the right rear speaker will be heard at the same time.

Note
In step 8, when you select the center mode, note the following.

For 5 speaker configuration)
NORMAL: Select this mode when you use a center speaker that is smaller than the front speakers. In this mode, the bass tone will be output from the front speakers.
WIDE: Select this mode when you use the center speaker approximately same sized as the front speakers.

For 4 speaker configuration)
PHANTOM: Select this mode when you do not use the center speaker. The center sound will be output from the left and right front speakers.

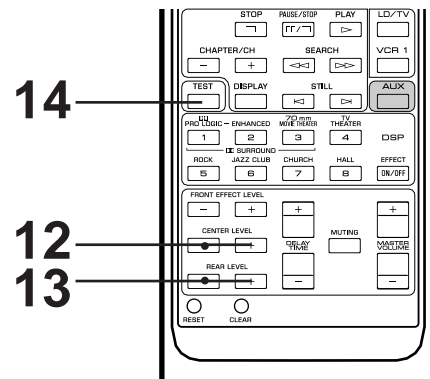
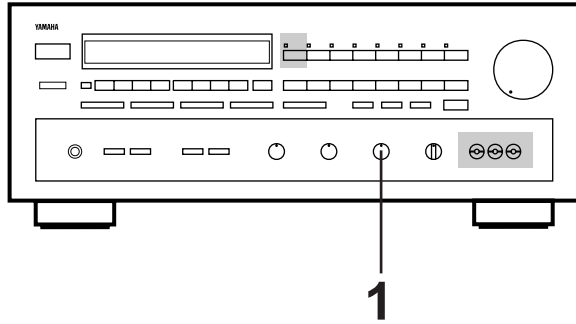

Illustrations: RX-V1070

Parts in shaded areas (■) are not present on RX-V870.

11 Adjust the **BALANCE** control so that the effect sound output level of the left front speaker and the right front speaker are the same.



12 Make the sound output level of the center speaker the same as that of the front speakers with the **CENTER LEVEL** key.

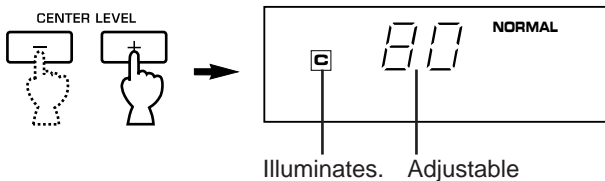

13 Make the sound output level of the rear speakers the same as that of the front speakers with the **REAR LEVEL** key.

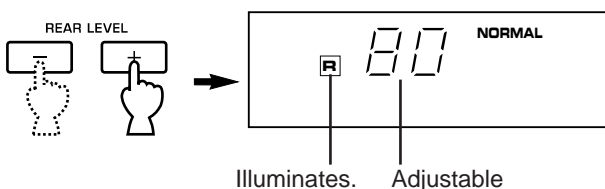

14 Cancel the test tone.



Notes

- The **FRONT EFFECT LEVEL** key does not function if the unit is in the “test” mode. Because the effect sound output level of the front speakers is used as the basis in speaker balance adjustment.
- Once you have completed these adjustments, you can adjust whole sound level on your audio system by using the **VOLUME** control (or the **MASTER VOLUME** keys on the remote control transmitter).
- If you use external power amplifiers, their volume controls may also be adjusted to achieve proper balance.
- In step 12, if the center mode is in the “**PHANTOM**” position, the sound output level of the center speaker can not be adjusted. This is because in this mode, the center sound is automatically output from the left and right front speakers.

OPERATIONS

Illustrations: RX-V1070

Parts in shaded areas () are not present on RX-V870.

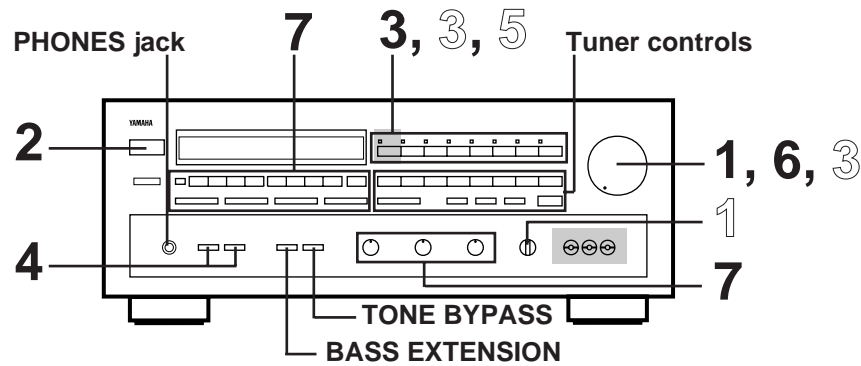

To play a source

- 1**

Set to the "∞" position.
- 2**

POWER
- 3** Select the desired input source with the input selector switches. (For video sources, turn the TV/monitor ON.)

* The indicator corresponding to the selected input source will illuminate.
- 4** Select the front speakers to be used.

SPEAKERS

A B

ON ON

OFF OFF

* If you use two front speaker systems, press both the A and B switches.
- 5** Play the source. (For detailed information on the tuning operation, refer to the page 17.)
- 6**

Adjust to the desired output level.

- 7** If desired, adjust the **BASS**, **TREBLE**, **BALANCE** controls, etc. (refer to page 16) and use the digital sound field processor. (Refer to page 19.)

To record a source to tape (or dub from a tape to another)

- 1** Select the source to be recorded.

* "AUX" is not present on RX-V870.
- 2** Play the source.
- 3** Confirm the source by selecting it with the input selector switch and turning up the **VOLUME** control.
- 4** Set the tape deck or VCR to the recording mode.
- 5** If your tape deck has three head monitoring capability, you can monitor the signal just recorded by selecting the tape deck in the recording mode with the input selector switch.

* Also, refer to the manual of the tape deck being used.

Notes

- If you want to enjoy another source while recording, select it with the input selector switch.
- Adjusting the **VOLUME**, **BASS**, **TREBLE**, **BALANCE** controls, **BASS EXTENSION** and **TONE BYPASS** switch and operating the digital sound field processor during recording have no effect on the material being recorded.

Adjusting the BALANCE control

Adjust the balance of the output volume to the left and right speakers to compensate for sound imbalance caused by speaker location or listening room conditions.



Note

This control is effective only for the sound from the front speakers.

Selecting the SPEAKER system

Because one or two speaker systems (as front speakers) can be connected to this unit, the **SPEAKERS** switches allow you to select speaker system A or B, or both at once.

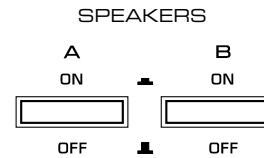

Adjusting the BASS and TREBLE controls



BASS : Turn this clockwise to increase (or counter-clockwise to decrease) the low frequency response.

TREBLE : Turn this clockwise to increase (or counter-clockwise to decrease) the high frequency response.

Note

These controls are effective only for the sound from the front speakers.

Using the TONE BYPASS switch

Press this switch to revert instantly to the flat states of the **BASS** and **TREBLE** controls without changing the setting of these controls.

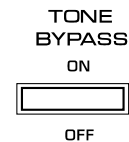

Using the BASS EXTENSION switch

You can boost bass frequency response by setting this switch to the "ON" position. This switch is effective only on the sound from the front speakers.



When you listen with headphones

Connect the headphones to the **PHONES** jack. You can listen to the main sound through headphones. When listening with headphones privately, set both the **SPEAKERS A** and **B** switches to the **OFF** position.

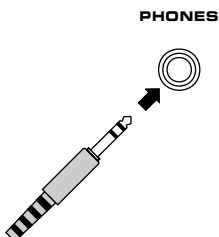

TUNING OPERATIONS

Normally, if station signals are strong and there is no interference, quick automatic-search tuning (AUTOMATIC TUNING) is possible. However, if signals of the station you want to select are weak, you must tune to it manually (MANUAL TUNING).

Illustrations: RX-V1070
Parts in shaded areas (■) are not present on RX-V870.

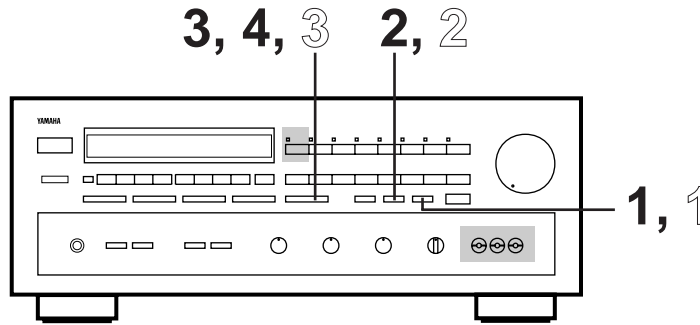

AUTOMATIC TUNING

- 1** Select the reception band (FM or AM) while watching the display.
- 2** Press the TUNING MODE selector to enter automatic tuning mode.
- 3** Use the TUNING UP/DOWN buttons to manually tune to the desired station.

To tune to a higher frequency, press the right side once.
To tune to a lower frequency, press the left side once.
- 4** If the station where tuning search stopped is not the desired one, follow step 3 again.

* If the tuning search does not stop at the desired station (because the signals of the station are weak), change to the MANUAL TUNING method.

MANUAL TUNING

- 1** Select the reception band (FM or AM) while watching the display.
- 2** Press the TUNING MODE selector. "AUTO TUNING" goes off.
- 3** Tune to the desired station manually.

* To continue tuning search, press and hold the button.

Note

If you tune to a FM station manually, it is received in monaural mode automatically to increase the signal quality.

Display information

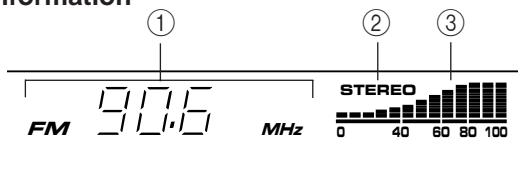

- ① Displays the band and frequency of the received station.
- ② Illuminates when an FM stereo broadcast with sufficient signal strength is received.
- ③ Indicates the signal level of the received station.

PRESET TUNING

This unit can store station frequencies (selected by tuning operation) by using preset station buttons. With this function, you can select any desired station simply by pressing the corresponding preset station button. Up to 40 stations (8 stations per page) can be programmed.

Illustrations: RX-V1070

Parts in shaded areas () are not present on RX-V870.

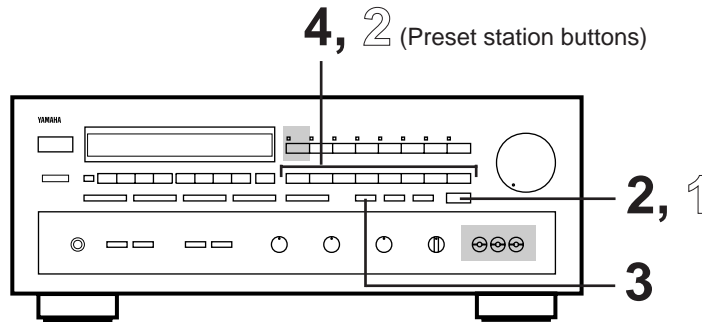

To program stations

- 1** Tune to the desired station.
(Refer to the previous page for tuning procedures.)
- 2** Select the desired page (A – E) of preset station buttons while watching the display.
- 3**

Flashes for about 5 seconds.
- 4** Press a preset station button before “MEMORY” goes off from the display.

Shows the displayed station has been programmed to A1.

* In the same way, program other stations to A2, A3 ... A8.
* You can program more stations to the preset station buttons on other pages in the same way by selecting other pages in step 2.

To recall a preset station

- 1** Select the page of preset station buttons.
- 2**

Select the desired preset station button.

Notes

- A new setting can be programmed in place of the former one.
- For presets, the setting of the reception mode (stereo or monaural) is stored along with the station frequency.

Memory back-up

The memory back-up circuit prevents the programmed data from being lost even if the **POWER** switch is turned off or the power plug is disconnected from the AC outlet or the power is cut due to temporary power failure. If, however, the power is cut for more than two weeks, the memory may be erased. If so, it can be re-programmed simply by following the PRESET TUNING steps.

USING DIGITAL SOUND FIELD PROCESSOR (DSP)

This unit incorporates a sophisticated, multi-program digital sound field processor, which allows you to expand and shape the audio sound field from both the audio and video sources, for a theater-like experience in the listening/viewing room.

This digital sound field processor has 8 programs; 4 programs for audio sources and 4 programs for Audio/Video sources. You can create an excellent audio sound field by selecting the suitable program and adding desired adjustments. In addition, when the digital sound field program is in the **DOLBY PRO LOGIC, ENHANCED** or **70 mm MOVIE THEATER** mode, the built-in automatic input balance control functions. This presents you the best surround condition without manual adjustment.

Selects center mode.
(For details, refer to page 13.)

Displays your selection on the DSP or other informations.

Digital sound field program selector

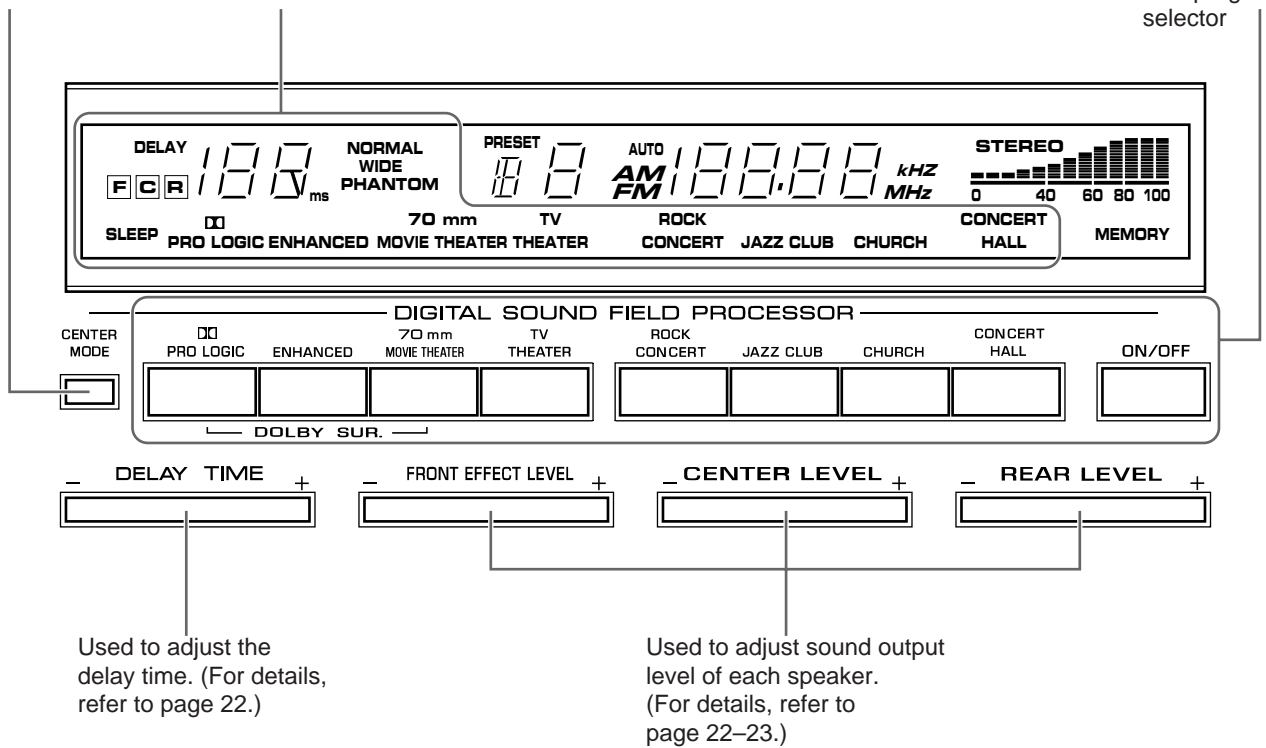

Used to adjust the delay time. (For details, refer to page 22.)

Used to adjust sound output level of each speaker. (For details, refer to page 22-23.)

Description of Each Sound Field Program

PROGRAM	FEATURE
 PRO LOGIC	This program reproduces sources encoded with the Dolby Surround. The employment of the digital signal processing system improves crosstalk and transfers the sound source more smoothly and precisely, compared to the conventional type. A stable movie sound field is recreated.
ENHANCED	This program reproduces sources encoded with the Dolby Surround. Enhancing the "Normal" Dolby Pro Logic, the DSP technology simulates the multi-surround speaker systems of a 35 mm film theater, thus widening the surrounded-sound field with greater presence.
70 mm MOVIE THEATER	The Yamaha DSP technology is ideally combined with the Dolby Pro Logic to present you incredible listening experience of the 70 mm film movie theater. This program is ideal for precisely reproducing the sound design of the newest movies. The sound field is made according to the design of the newest movie theaters, so the reverberations of the sound field itself are restrained as much as possible. The three dimensional feeling of the sound field is emphasized, and dialog is precisely oriented on the screen. You can enjoy watching S.F.X., adventure movies, etc. with this program.
TV THEATER	This program simulates the sound field of a jazz or rock concert. By featuring the directional enhancement circuit, vocals are oriented on the screen and the sound field is widely expanded. Your attention will be focused on the screen in enthusiastic atmosphere, as if attending an actual jazz or rock concert.
ROCK CONCERT	This program is suitable for rock music. A big, powerful sound is reproduced lively and dynamically.
JAZZ CLUB	This is a small, cozy jazz club with a low ceiling. The sound is very close and intimate.
CHURCH	This program recreates the acoustic environment of a modern church with a high pointed dome and columns along the sides. This interior produces a very few primary reflections.
CONCERT HALL	In this program, the center seems even more deeply behind the front speaker pair, creating an expansive, large hall ambience.
ON/OFF	Whenever pressed, this switches on/off the built-in digital sound field processor (DSP). When the DSP is on, a program name illuminates in the display and sound output is from the front, rear and (or) center speakers. Conversely, no illumination of program name and no output from the rear and center speakers show that the DSP is off.

Description of Dolby Pro Logic Surround

 **DOLBY PRO LOGIC SURROUND:** This unit employs the Dolby Pro Logic Surround system. This system is similar to professional Dolby Stereo decoders used in movie theaters. By employing a four-channel system, the Dolby Pro Logic Surround system divides the input signals into four levels: the left and right main channels, the center channel (to characterize dialog), and the rear surround-sound channels (to characterize sound effects, background noise and other ambient noise).

Dolby Surround is encoded on the sound track of commercially available video cassettes and video discs as well. When you play a source encoded with Dolby Surround on your home video system, the Dolby Pro Logic Surround mode on this unit decodes the signal and feeds the surround-sound effects. The Dolby Pro Logic Surround mode may not be always effective on video sources not encoded with Dolby Surround.

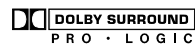

Manufactured under license from Dolby Laboratories Licensing Corporation. Additionally licensed under one or more of the following patents: U.S. number 3,950,590; Canadian numbers 1,004,603 and 1,037,877. "Dolby", "Pro Logic", and the double-D symbol are trademarks of Dolby Laboratories Licensing Corporation.

To play a source with the digital sound field processor

Illustrations: RX-V1070

Parts in shaded areas () are not present on RX-V870.

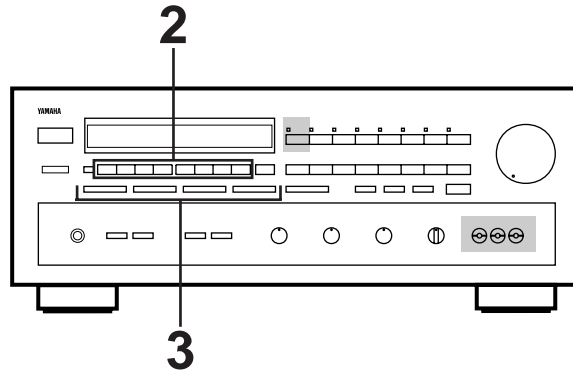

1 Follow step 1–6 shown in “**OPERATIONS**” on page 15.

2 Select the desired program that is suitable for the source.

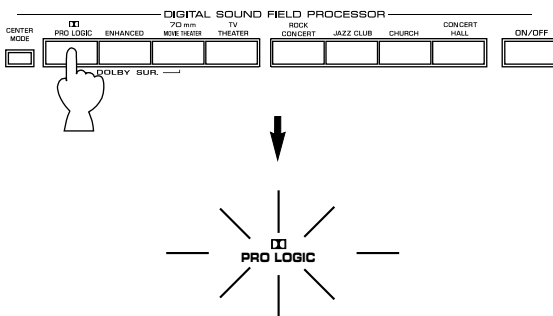

The corresponding indicator will illuminate.

3 If desired, adjust the delay time and the output level of each speaker. (For details, refer to the corresponding descriptions on page 22–23.)

Notes

- If you prefer to cancel the selected program, press the **ON/OFF** switch. The sound will be the normal 2-channel stereo without surround sound effect.
- In the **ROCK CONCERT**, **JAZZ CLUB**, **CHURCH** and **CONCERT HALL** modes, no sound is heard from the center speaker.
- When a monaural sound source is played in the **DOLBY PRO LOGIC** or **ENHANCED** mode, no sound is heard from the front speakers and the rear speakers. Sound is heard only from the center speaker. However, if the center mode is in the **PHANTOM**, the front speakers output the sound of the center speaker.
- If you connect an external amplifier to this unit, see if it has built-in surround sound or ambience circuitry. If it does, then be sure that the surround or ambience circuitry on that amplifier is off while you are using the digital sound field processor's Dolby Pro Logic Surround decoding function.
- When this unit is in the Dolby Pro Logic Surround mode, if the main-source sound is considerably altered by overadjustment of the **BASS**, **TREBLE** controls or **BASS EXTENSION** switch, the relationship between the center and rear channels may produce an unnatural effect.

Adjustment of DELAY TIME

You can adjust the time difference between the beginning of the source sound and the beginning of the effect sound with the **DELAY TIME** control.

The **DELAY TIME** control is effective with all programs.

By applying more or less delay, sound effects, background noise, and ambient noise coming at you from the rear speakers can be enhanced or subdued for extra effect.

1. **PRO LOGIC:** from 15 to 30 milliseconds
(Preset value: 20 milliseconds)
2. **ENHANCED:** from 15 to 30 milliseconds
(Preset value: 20 milliseconds)
3. **70 mm MOVIE THEATER:** from 15 to 30 milliseconds
(Preset value: 10 milliseconds)
4. **TV THEATER:** from 1 to 50 milliseconds
(Preset value: 10 milliseconds)
5. **ROCK CONCERT:** from 1 to 50 milliseconds
(Preset value: 15 milliseconds)
6. **JAZZ CLUB:** from 1 to 50 milliseconds
(Preset value: 11 milliseconds)
7. **CHURCH:** from 1 to 50 milliseconds
(Preset value: 40 milliseconds)
8. **CONCERT HALL:** from 1 to 50 milliseconds
(Preset value: 30 milliseconds)

- By continuously pressing “+” or “-” on the **DELAY TIME** control, the value changes continuously. However, the value stops changing momentarily at the preset point.

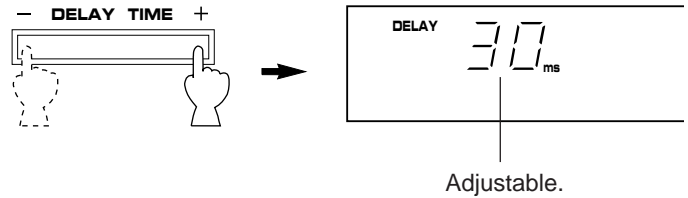

Note

Adding too much delay will cause an unnatural effect with some sources. Experiment with the **DELAY TIME** control to create the effect that you find most suitable.

Adjustment of the FRONT EFFECT LEVEL

If desired, you can adjust the effect sound output level of the front speakers with this control. The output level is preset to be 80. However, you can adjust the level between 1 and 100.

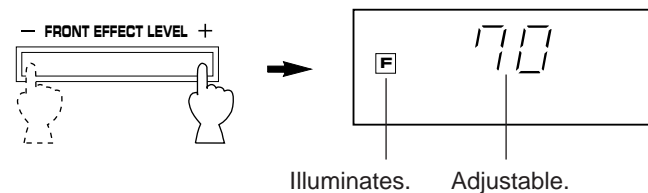

- If the digital sound field program is in the **DOLBY PRO LOGIC** mode, the **FRONT EFFECT LEVEL** control does not function.
- Once the output level is adjusted, the level value will be the same in all the digital sound field programs except for the **DOLBY PRO LOGIC**.
- If a digital sound field program is not used, the **FRONT EFFECT LEVEL** control does not function.

Adjustment of the CENTER LEVEL

If desired, you can adjust the sound output level of the center speaker with this control even if the output level is already set in “**Speaker balance adjustment**” on page 12.

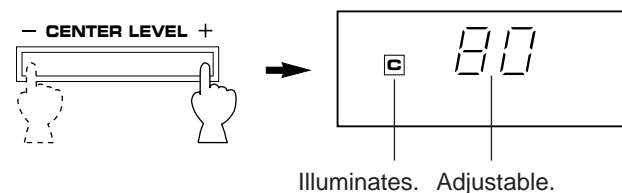

- By continuously pressing “+” or “-” on the **CENTER LEVEL** control, the level value changes continuously. However, the value stops changing momentarily at the point which was once set in the “test” mode.
- If the digital sound field program is in the **ROCK CONCERT**, **JAZZ CLUB**, **CHURCH** or **CONCERT HALL** mode, the **CENTER LEVEL** control can not function.
- Once the output level is adjusted, the level value will be the same in all the digital sound field programs except the above-mentioned ones.
- If a digital sound field program is not used, the **CENTER LEVEL** control does not function.

Adjustment of the REAR LEVEL

If desired, you can adjust the sound output level of the rear speakers with this control even if the output level is already set in "Speaker balance adjustment" on page 12.

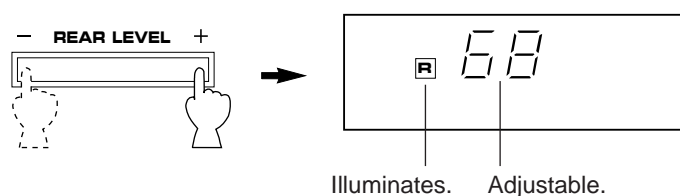

- By continuously pressing "+" or "-" on the **REAR LEVEL** control, the level value changes continuously. However, the value stops changing momentarily at the point which was once set in the "test" mode.
- Once the output level is adjusted, the level value will be the same in all the digital sound field programs.
- If a digital sound field program is not used, the **REAR LEVEL** control does not function.

Note

The values of the **DELAY TIME**, the **FRONT EFFECT LEVEL**, **CENTER LEVEL**, and **REAR LEVEL** you set the last time will remain memorized even when the power of this unit is off. However, if the power plug cord is kept disconnected for more than one week, these values will be invalid.

SETTING THE SLEEP TIMER

If you use the SLEEP timer of this unit, you can set this unit to be turned off automatically. When you are going to sleep while enjoying a broadcast or other desired input source, this timer function is helpful.

Notes

- The SLEEP timer can be controlled only with the remote control transmitter.
- The components on which the SLEEP timer is effective are the sources connected to a **SWITCHED OUTLET** on the rear panel of this unit.

To set the SLEEP time

1

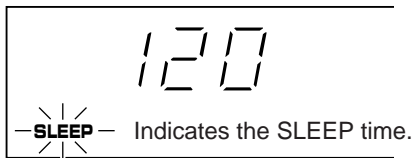
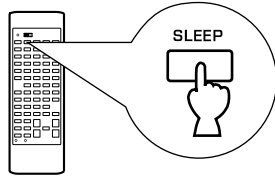

Flashes on and off continuously.

Select the desired SLEEP time. Whenever the **SLEEP** key is pressed, the SLEEP time will change as follows.

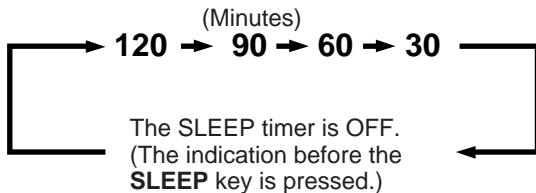

After a while, the display returns to the indication before the SLEEP timer is set, and the "SLEEP" indicator stops flashing and illuminates.

- 2 The unit will be turned off automatically after the passing of the SLEEP time you selected.

To cancel the selected SLEEP time

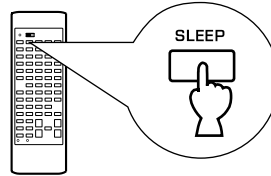

Press once when the SLEEP time displays 30.

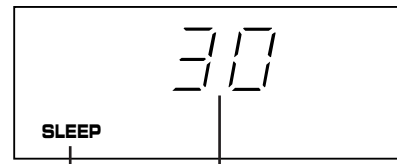

Goes off.

Returns to the indication before the SLEEP timer is set.

REMOTE CONTROL TRANSMITTER

The provided remote control transmitter is designed to control this unit and other YAMAHA components. If the CD player, turntable, LD player and tape deck connected to this unit are YAMAHA components, then this remote control transmitter will also control various functions of each component.

Moreover, this remote control transmitter can learn various functions from other remote control transmitters without losing the preset key functions. If you use this "learning" function, you will no more need so many remote control transmitters to control various components to be used. For details, refer to page 27.

KEY FUNCTIONS

When you operate this unit and/or other YAMAHA components with this remote control transmitter, set the **YPC-USER-LEARN** switch to the **YPC** (Yamaha Preset Code) position.

For Control of This Unit

Refer to "YPC-USER-LEARN switch" on page 27.

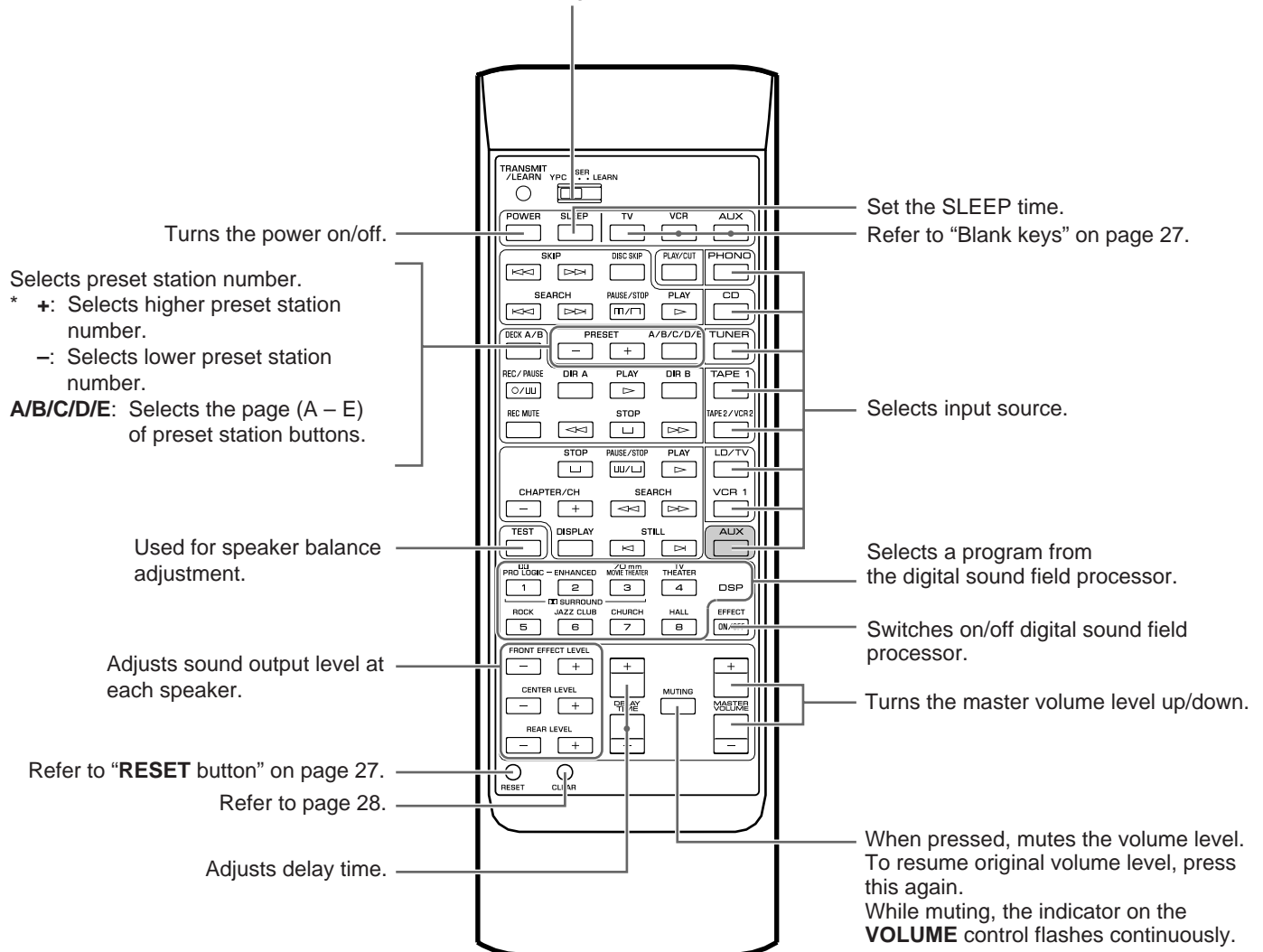

Illustrations: RX-V1070

Parts in shaded areas (■) are not present on RX-V870.

For Other Component Control

Identify the remote control transmitter keys with your component's keys. If these keys are identical, their function will be the same. On each key function, refer to the corresponding instruction on your component's manual.

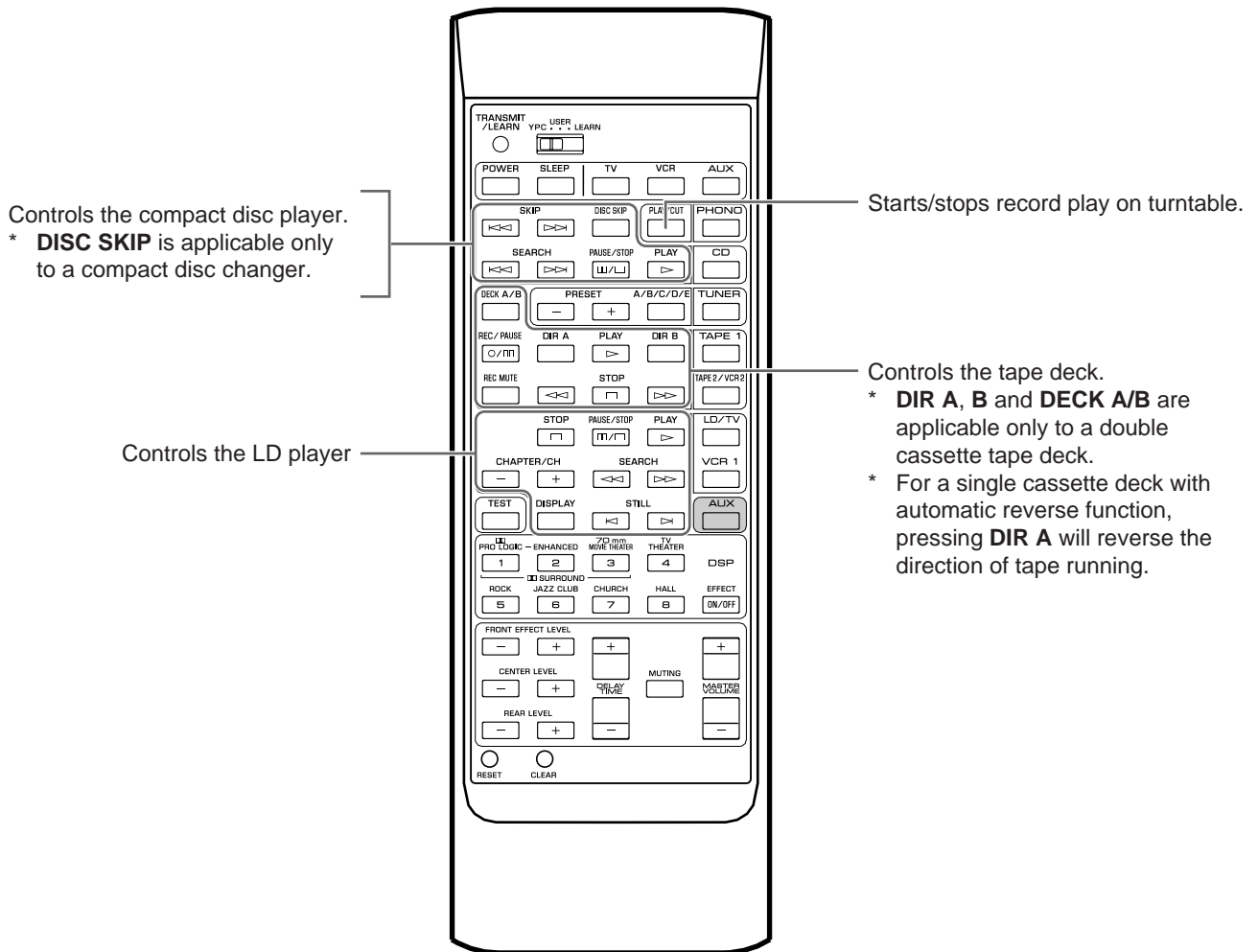

Illustrations: RX-V1070

Parts in shaded areas (■) are not present on RX-V870.

REMOTE CONTROL “LEARNING” FUNCTION

The keys on this remote control transmitter can be programmed to “learn” key-functions from other remote control transmitters. By using this feature, this unit can then be used in place of one or more other remote control transmitters, thus making operation of your various audio and video components more convenient. Use the included user program sheets to indicate a new function learned for each key.

Note
There may occasionally be instances in which, due to the signal-coding and modulation employed by the other remote control transmitter, this unit will not be able to “learn” its signals.

To Learn a New Function

1

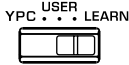

Set to the “LEARN” position.

2 Press a key on this unit where a new function will be learned.

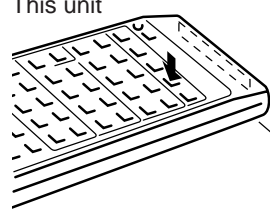

This unit

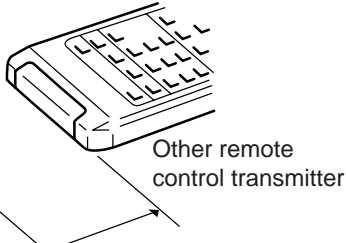

Other remote control transmitter

About 5–10 cm (2–4 in.)

3 Press and hold the key (on the other remote control transmitter) where the desired new function is.

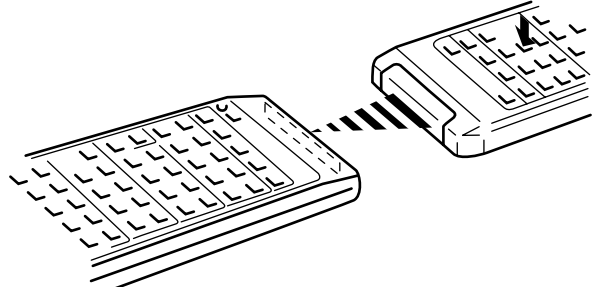

When the **TRANSMIT/LEARN** indicator stops illuminating, the learning is finished.

4 Repeat step 2–3 until all desired functions are successfully learned.

5 Set to the “USER” position.

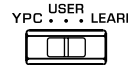

Try operating your components.

Notes

- When you operate the desired component with this remote control transmitter, **TRANSMIT/LEARN** indicator will flash steadily.
- The originally preset function of a key is still available in the **USER** position if a new function has not been learned to the key.
- Successful learning to a key results in the erasure of previously learned functions and their replacement by the newly learned ones.
- If there is no more room in the memory area for a function to be learned, the **TRANSMIT/LEARN** indicator will flash two times. In this case, even if some keys are not occupied with functions from other remote control transmitters, no further learning is possible.

Memory back-up

All of the learned functions will be retained while you replace the batteries. However, if no batteries are installed for a few hours, the learned functions will be erased and will have to be learned again.

Blank keys (Refer to page 25.)

These keys have no preset functions and are used only for learning other remote control transmitter’s functions.

YPC-USER-LEARN switch (Refer to page 25.)

- YPC:** Set to this position when using preset key functions (for controlling this unit and/or YAMAHA components).
* “YPC” is the abbreviation of YAMAHA Preset Code.
- USER:** Set to this position when using “learned” key functions.
- LEARN:** Set to this position when learning new key functions from other remote control transmitters.

RESET button (Refer to page 25.)



Press this button to “reset” the internal microcomputer which controls remote control operations. Microcomputer “reset” is necessary when the remote control freezes.

* Pressing the **RESET** button will not erase learned functions.

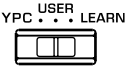
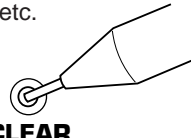
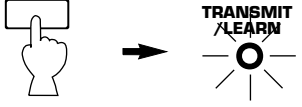
To Clear a Learned Function

1	 <p>Set to the "USER" position.</p>
2	<p>Press and hold the CLEAR button using the point of a mechanical pencil, etc.</p>  <p style="text-align: center;">CLEAR</p>
3	<p>Press and hold the key where the learned function to be deleted is until the indicator flashes 3 times.</p>  <p>To clear two or more functions, repeat step 2 and 3.</p>

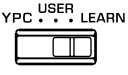
To Clear All Learned Functions

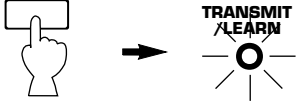
1	 <p>Set to the "LEARN" position.</p>
2	<p>Press and hold the CLEAR button using the point of a mechanical pencil, etc.</p>  <p style="text-align: center;">CLEAR</p>
3	<p>Press and hold any key until the indicator flashes 7 times.</p> 

Note

If a key is not pressed soon after the **CLEAR** button is pressed, this unit will automatically return to the status that was in effect before the **CLEAR** button was pressed.

NOTES ABOUT THE REMOTE CONTROL TRANSMITTER

Battery installation

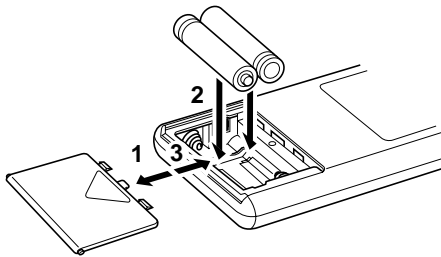

Battery replacement

If you find that the remote control transmitter must be used closer to the main unit, the batteries are weak. Replace both batteries with new ones.

Notes

- Use only AA, R6, UM-3 batteries for replacement.
- Be sure the polarities are correct. (See the illustration inside the battery compartment.)
- Remove the batteries if the remote control transmitter will not be used for an extended period of time.
- If batteries leak, dispose of them immediately. Avoid touching the leaked material or letting it come in contact with clothing, etc. Clean the battery compartment thoroughly before installing new batteries.

Remote control transmitter operation range

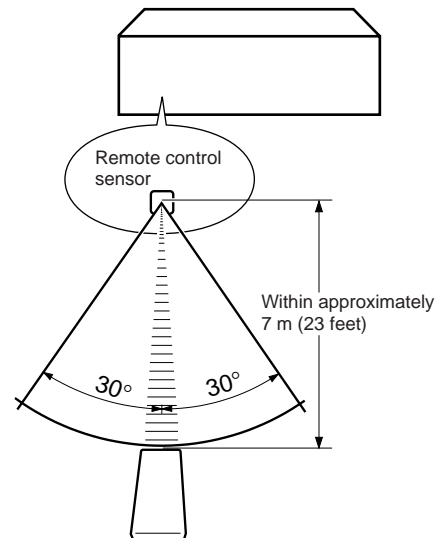

Notes

- There should be no large obstacles between the remote control transmitter and the main unit.
- If the remote control sensor is directly illuminated by strong lighting (especially an inverter type of fluorescent lamp etc.), it might cause the remote control transmitter not to work correctly. In this case, reposition the main unit to avoid direct lighting.

TROUBLESHOOTING

If the unit fails to operate normally, check the following points to determine whether the fault can be corrected by the simple measures suggested. If it cannot be corrected, or if the fault is not listed in the SYMPTOM column, disconnect the power cord and contact your authorized YAMAHA dealer or service center for help.

	SYMPTOM	CAUSE	REMEDY
Amplifier	The unit fails to turn on when the POWER switch is pressed.	Power cord is not plugged in or is not completely inserted.	Firmly plug in the power cord.
	No sound or no picture.	Incorrect output cord connections.	Connect the cords properly. If the problem persists, the cords may be defective.
		The MUTING switch is ON.	First, turn the volume control to full left. Then, turn the MUTING switch OFF with the remote control transmitter and adjust the volume.
		Appropriate input selector is not pressed.	Press the appropriate input selector corresponding to the input source.
	The sound suddenly goes off.	The protection circuit has activated because of short circuit etc.	Turning the unit off and then on will reset the protection circuit.
	Only one side speaker outputs the sound.	Incorrect setting of the BALANCE control.	Adjust it to the appropriate position.
		Incorrect cord connection.	Connect cord properly. If the problem persists, the cables may be defective.
	Sound "hums".	Incorrect cord connections.	Firmly connect the audio plugs. If the problem persists, the cord may be defective.
		No connection from the turntable to the GND terminal.	Make the GND connection between the turntable and this unit.
	The volume level is low while playing a record.	The record is being played on a turntable with an MC cartridge.	The player should be connected to the unit through the MC head amplifier.
No sound from the rear speakers.	The sound output level of the rear speakers is 0.	Turn up the sound output level with the REAR LEVEL key.	
	The monaural sound source is played in DOLBY PRO LOGIC or ENHANCED mode.	Select another program suitable for the monaural sound source.	
No sound from the center speaker.	The sound output level of the center speaker is 0.	Turn up the sound output level with the CENTER LEVEL key.	
	The center mode is in PHANTOM mode.	Select NORMAL or WIDE.	
	Incorrect sound field program selection.	Select the appropriate program.	
	No sound field program is selected.		
FM	FM stereo reception is noisy.	Because of the characteristics of FM stereo broadcasts, this is limited to cases where the transmitter is too far away or the antenna input is poor.	Check the antenna connections. Try using a multiple element FM antenna.
	There is distortion and clear reception cannot be obtained even with a good FM antenna.	There is multipath interference.	Adjust antenna placement to eliminate multipath interference.
	A desired station cannot be tuned in with Auto tuning.	The station is too weak.	Use Manual tuning mode. Use a high quality directional FM antenna.
AM	A desired station cannot be tuned in with Auto tuning.	Weak signal or loose antenna connections.	Tighten the AM loop antenna connections and rotate it for best reception. Use Manual tuning mode.
	There are continuous crackling and hissing noises.	Noises will result from lightning, fluorescent lamps, motors, thermostats and other electrical equipment.	Use an outdoor antenna and a ground wire. This will help somewhat but it is difficult to eliminate all noise.
	There are buzzing and whining noises (especially in the evening).	A television set is being used nearby.	Relocate this unit away from the TV.
Remote control transmitter	The remote control transmitter does not work.	Direct sunlight or lighting (of an inverter type of fluorescent lamp etc.) is striking the remote control sensor of the main unit.	Change the position of the main unit.
		The batteries of this remote control transmitter are weak.	Replace the batteries with new ones and press the RESET button on the remote control transmitter.
	Learning cannot be made successfully. (The TRANSMIT/LEARN indicator does not illuminate or flash.)	The batteries of this remote control transmitter and/or the other remote control transmitter are weak.	Replace the batteries (and press the RESET button for this remote control transmitter).
		The distance between the two remote control transmitters is too long or too short.	Place the remote control transmitters with the proper distance.
		The signal coding or modulation of the other remote control transmitter is not compatible with this remote control transmitter.	Learning is not possible.
		Memory capacity is full.	Further learning is not possible without deleting unnecessary commands.
The internal microcomputer "freezes".	Press the RESET button on the remote control transmitter.		
Others	The sound is degraded when monitoring is performed by using the headphones connected to the compact disc player or cassette deck which are connected with this unit.	Power cord of this unit is not plugged in.	Plug in the power cord.

SPECIFICATIONS

AUDIO SECTION

Minimum RMS Output Power per Channel

Front L, R

8 ohms, 20 Hz to 20 kHz, 0.015% THD

<RX-V1070>110W+110W

<RX-V870>80W+80W

6 ohms, 20 Hz to 20 kHz, 0.015% THD

<RX-V1070>135W+135W

<RX-V870>95W+95W

Center

8 ohms, 20 Hz to 20 kHz, 0.015% THD

<RX-V1070>110W

<RX-V870>80W

6 ohms, 20 Hz to 20 kHz, 0.015% THD

<RX-V1070>135W

<RX-V870>95W

Rear L, R

8 ohms, 1 kHz, 0.08% THD

<RX-V1070>30W+30W

<RX-V870>25W+25W

6 ohms, 1 kHz, 0.08% THD

<RX-V1070>40W+40W

<RX-V870>28W+28W

Dynamic Power per Channel
(by IHF Dynamic Headroom measuring method)

8/6 ohms

<RX-V1070>160W/190W

<RX-V870>110W/140W

Dynamic Headroom

8/6 ohms

<RX-V1070>1.6 dB/2.0 dB

<RX-V870>1.4 dB/1.7 dB

Input Sensitivity/Impedance

PHONO MM2.5 mV/47 k-ohms

CD/TUNER/TAPE/LD-TV/VCR150 mV/47 k-ohms

AUX <RX-V1070 only>150 mV/47 k-ohms

FRONT IN1V/47 k-ohms

Maximum Input Signal (1 kHz, 0.01% THD)

PHONO MM90 mV

Output Level/Impedance

REC OUT150 mV/470 ohms

FRONT OUT1V/3.3 k-ohms

LOW PASS0.8V/3.9 k-ohms

Maximum Voltage Output (1 kHz, 0.01% THD)

FRONT OUT4.8V

Headphone Jack Rated Output/Impedance

8 ohms, 1 kHz, 0.01% THD

Output Level0.6V

Impedance390 ohms

Frequency Response (20 Hz to 20 kHz)

CD/TUNER/TAPE/LD-TV/VCR0±1.5 dB

AUX <RX-V1070 only>0±1.5 dB

FRONT IN0±0.3 dB

RIAA Equalization Deviation

PHONO MM0±0.5 dB

Total Harmonic Distortion (20 Hz to 20 kHz)

PHONO MM to REC OUT (1V)0.01%

CD/TUNER/TAPE/LD-TV/VCR to FRONT OUT (1V)0.008%

AUX to FRONT OUT (1V) <RX-V1070 only>0.008%

FRONT IN to SP OUT

<RX-V1070>

(50W/8 ohms)0.008%

(60W/6 ohms)0.008%

<RX-V870>

(40W/8 ohms)0.008%

(50W/6 ohms)0.008%

Signal-to-Noise Ratio (IHF-A Network)

PHONO MM (5 mV Input Shorted)More than 86 dB

CD/TUNER/TAPE/LD-TV/VCR (Input Shorted)More than 93 dB

AUX (Input Shorted) <RX-V1070 only>More than 93 dB

Residual Noise (IHF-A Network)150 µV

Channel Separation (Vol. -30 dB)

PHONO MM (Input Shorted 1 kHz/10 kHz)60 dB/45 dB

CD/TUNER/TAPE/LD-TV/VCR (Input 5.1 k-ohms Terminated 1 kHz/10 kHz)60 dB/45 dB

AUX (Input 5.1 k-ohms Terminated 1 kHz/10 kHz) <RX-V1070 only>60 dB/45 dB

Tone Control Characteristics

BASS: Boost/cut±10 dB (50 Hz)

Turnover Frequency350 Hz

TREBLE: Boost/cut±10 dB (20 kHz)

Turnover Frequency3.5 kHz

BASS EXTENSION+7 dB (50 Hz)

Audio Muting∞

VIDEO

Video Signal Type

[U.S.A. and Canada model]NTSC

[Australia model]PAL

[General model]NTSC/PAL

Video Signal Level1 Vp-p/75 ohms

S-Video Signal Level

Y1 Vp-p/75 ohms

C0.286 Vp-p/75 ohms

Maximum Input LevelMore than 1.5 Vp-p

Signal-to-Noise Ratio50 dB

Frequency Response5 Hz-10 MHz, -3 dB

FM SECTION

Tuning Range

[U.S.A. and Canada models]87.5 to 107.9 MHz

[Australia and General models]87.50 to 108.00 MHz

50 dB Quieting Sensitivity (IHF, 75 ohms)

Mono1.55 µV (15.1 dBf)

Stereo21 µV (37.7 dBf)

Usable Sensitivity (75 ohms)

(30 dB S/N Quieting, 1 kHz, 100% mod.)

.....0.8 µV (9.3 dBf)

Image Response Ratio45 dB

IF Response Ratio80 dB

Spurious Response Ratio70 dB

AM Suppression Ratio55 dB

Capture Ratio1.5 dB

Alternate Channel Selectivity85 dB

Signal-to-Noise Ratio (IHF) Mono/Stereo81 dB/76 dB

Harmonic Distortion

Mono/Stereo (1 kHz)0.1/0.2%

Stereo Separation (1 kHz)50 dB

Frequency Response

20 Hz to 15 kHz0 ±1.5 dB

AM SECTION

Tuning Range

[U.S.A., Canada and General models]530 to 1,710 kHz

[Australia and General models]531 to 1,611 kHz

Usable Sensitivity100 µV/m

Selectivity32 dB

Signal-to-Noise Ratio50 dB

Image Response Ratio40 dB

Spurious Response Ratio50 dB

Harmonic Distortion0.3%

AUDIO SECTION

Output Level/Impedance

FM (100% mod., 1 kHz)700 mV/470 ohms

AM (30% mod., 400 Hz)200 mV/470 ohms

GENERAL

Power Supply

[U.S.A. and Canada models]AC 120V, 60 Hz

[Australia model]AC 240V, 50 Hz

[General model]AC 110/120/220/240V, 50/60 Hz

Power Consumption

<RX-V1070>

[U.S.A., Australia and General models]400W

[Canada model]750 VA, 600W

<RX-V870>

[U.S.A. model]300W

[Australia and General models]350W

[Canada model]600 VA, 500W

AC Outlets

[U.S.A. and General models]

2 SWITCHED OUTLETS100W max. total

1 UNSWITCHED OUTLET200W max. total

[Canada model]

2 SWITCHED OUTLETS120W max. total

1 UNSWITCHED OUTLET180W max. total

[Australia model]

1 SWITCHED OUTLET100W max. total

Dimensions (W x H x D)

.....435 x 171.5 x 468.5 mm

(17-1/8" x 6-3/4" x 18-7/16")

Weight

<RX-V1070>18.6 kg (40 lbs. 15 oz.)

<RX-V870>14.8 kg (32 lbs. 9 oz.)

AccessoriesAM loop antenna

Indoor FM antenna

Remote control transmitter

Batteries

User program sheets

Specifications are subject to change without notice.

YAMAHA

YAMAHA ELECTRONICS CORPORATION, USA 6660 ORANGETHORPE AVE., BUENA PARK, CALIF. 90620, U.S.A.
YAMAHA CANADA MUSIC LTD. 135 MILNER AVE., SCARBOROUGH, ONTARIO M1S 3R1, CANADA
YAMAHA ELECTRONIK EUROPA G.m.b.H. SIEMENSSTR. 22-34, D-25462 RELINGEN BEI HAMBURG, F.R. OF GERMANY
YAMAHA ELECTRONIQUE FRANCE S.A. RUE AMBROISE CROIZAT BP70 CROISSY-BEAUBOURG 77312 MARNE-LA-VALLEE CEDEX02, FRANCE
YAMAHA ELECTRONICS (UK) LTD. YAMAHA HOUSE, 200 RICKMANSWORTH ROAD WATFORD, HERTS WD1 7JS, ENGLAND
YAMAHA SCANDINAVIA A.B. J A WETTERGRENS GATA 1, BOX 30053, 400 43 VÄSTRA FRÖLUNDA, SWEDEN
YAMAHA MUSIC AUSTRALIA PTY, LTD. 17-33 MARKET ST., SOUTH MELBOURNE, 3205 VIC., AUSTRALIA

YAMAHA CORPORATION
VP63840-0 Printed in Japan BWWR, BB 8