

YAMAHA



DIGITAL RHYTHM PROGRAMMER

OWNER'S MANUAL

INTRODUCTION

Congratulations on your purchase of a Yamaha RX11 Digital Rhythm Programmer!

Your RX11 represents the crystallization of the most sophisticated electronic music technology, combining advanced microcomputer control with a top-quality digital PCM sound storage and reproduction system. With the RX11 you will be able to program virtually any type of rhythm pattern you required for your music, and since the instrument sounds are digitally recorded, they are indistinguishable from live percussion instruments.

To ensure that the RX11 will give you maximum performance and versatility, we urge you to read this operation manual carefully before attempting to operate the unit.

CONTENTS

CONNECTIONS

..... 4

PRECAUTIONS

..... 6

THE INSTRUMENTS

Getting to Know the RX11 Instruments 7

RX11 Instrument Chart 7

Selecting Instruments 7

Some Instrument Limitations 8

Instrument Level 8

Stereo Positioning (PAN) 8

Accents 8

Setting Accent Levels 8

Instrument Output 9

PATTERN OPERATIONS

Pattern Selection 9

The START and STOP/CONTINUE Buttons 10

Tempo 10

Real-Time Pattern Programming 10

Step-Write Pattern Programming 12

Quantize 13

Click Time 14

Pattern Memory Usage Graph 14

Pattern Clear 14

Instrument Clear 15

Pattern Copy 15

The Swing Function 16

SONG OPERATIONS

The Song Mode & Song Selection 17

Editing (Assembling a Song) 17

The Level Set Function 17

The Insert Function 18

The Delete Function 18

Repeats 18

Programming Tempo Changes 19

Song Clear 20

The Chain Function 20

CASSETTE OPERATIONS

Save/Verify 21

Load 21

CARTRIDGE OPERATIONS

Format 23

All Save 23

Single Save 24

All Load 25

Single Load 25

MIDI FUNCTIONS

Sync Modes 27

MIDI Reception Parameters 27

Instrument Key Numbers 28

The Initialize Function 29

MIDI Transmission Parameters 29

ERROR MESSAGES

..... 31

SPECIFICATIONS

..... 32

BLOCK DIAGRAM

..... 33

PATTERN CHART

..... 34

CONTROL PANEL

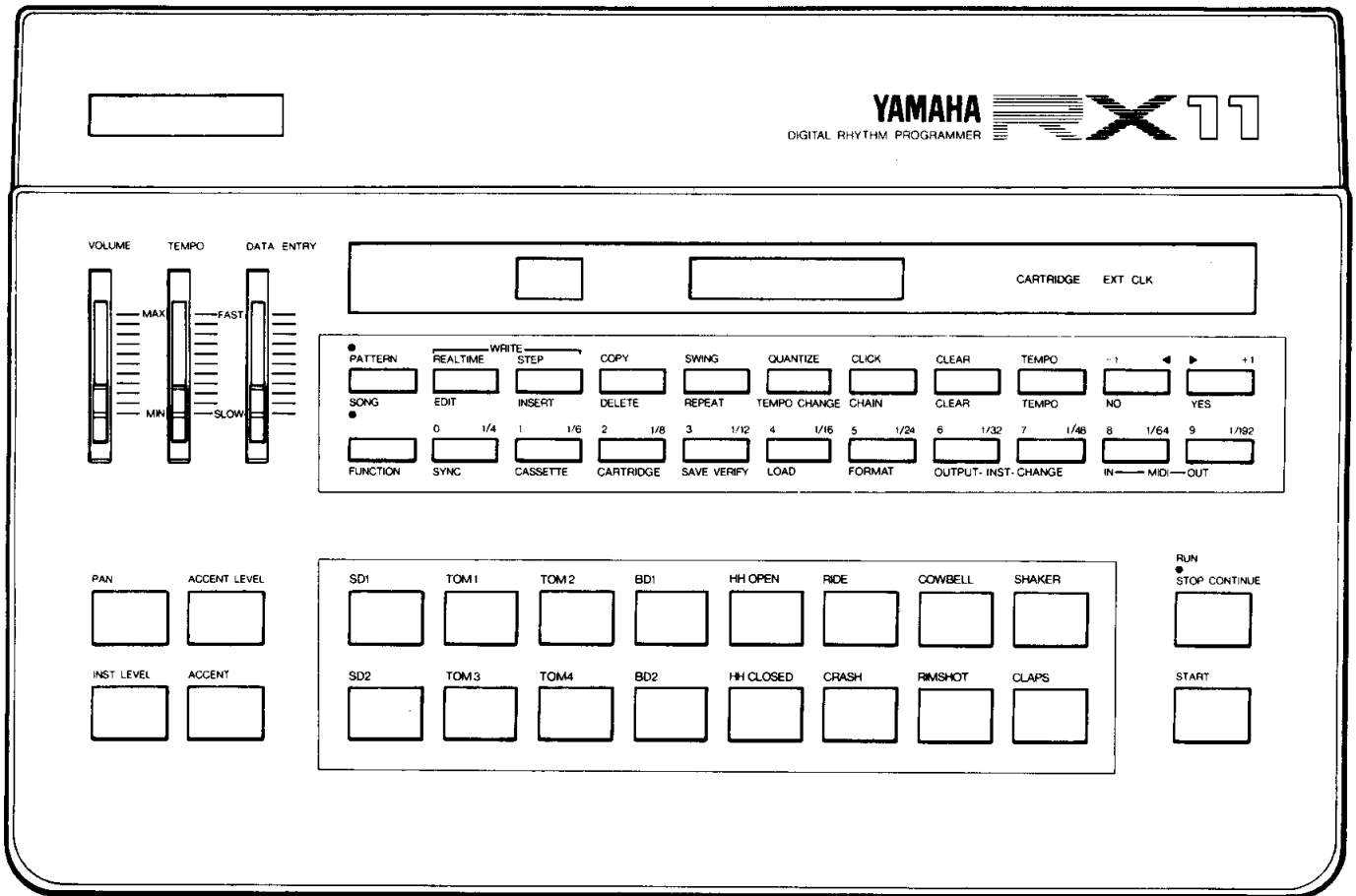

CONNECTIONS

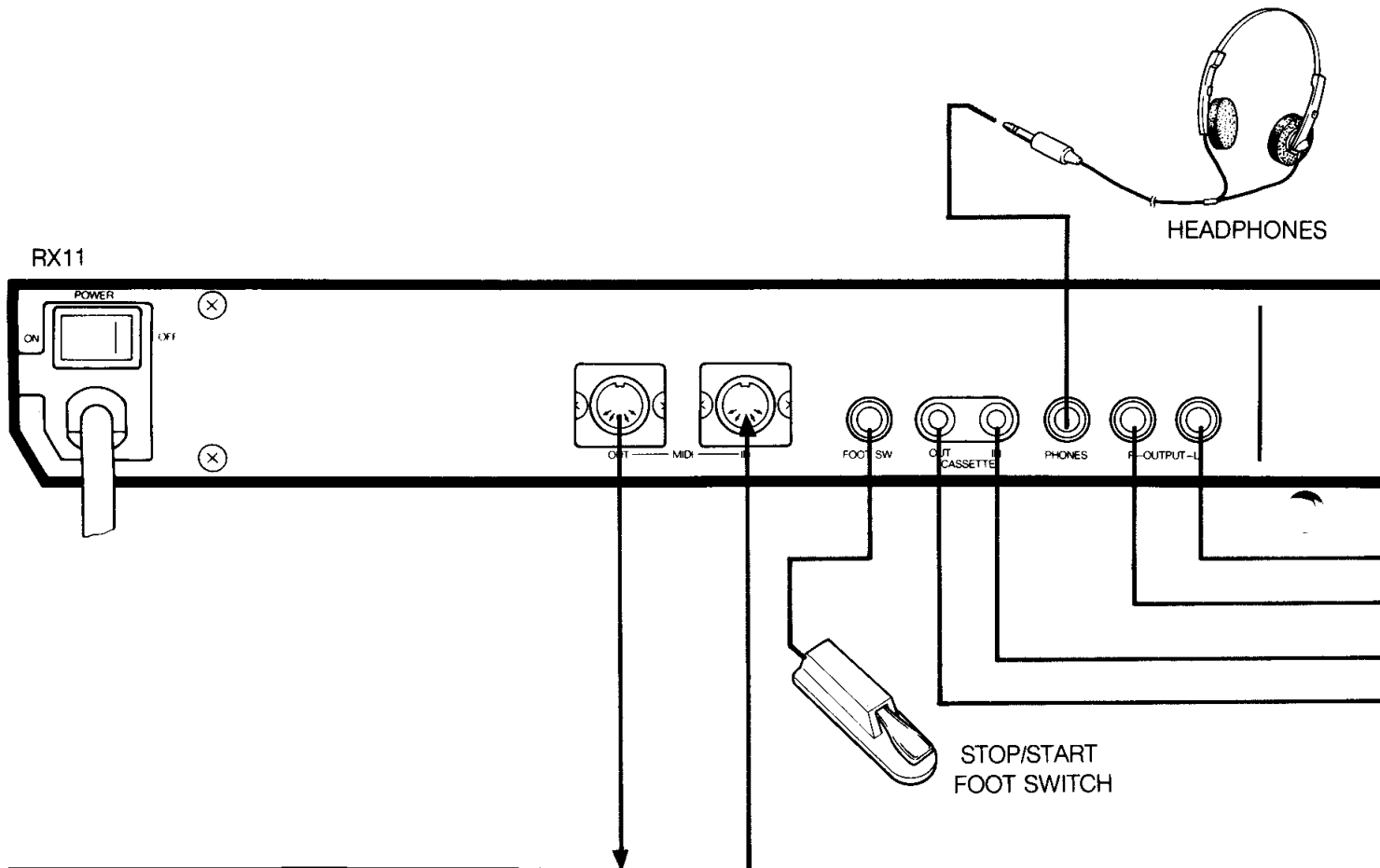

MIDI EQUIPMENT

A wide variety of MIDI compatible equipment may be used. These are just a few examples.

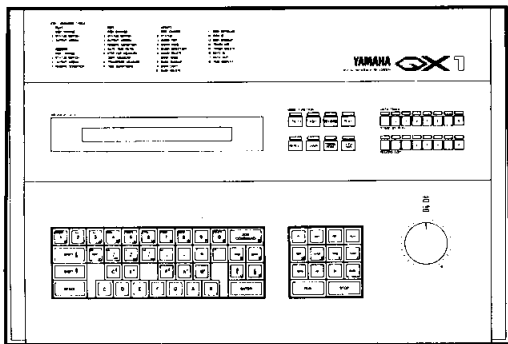

QX SEQUENCER

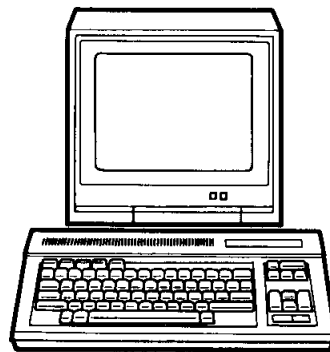

CX MUSIC COMPUTER

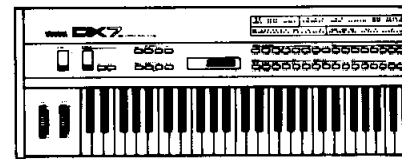

DX SYNTHESIZER

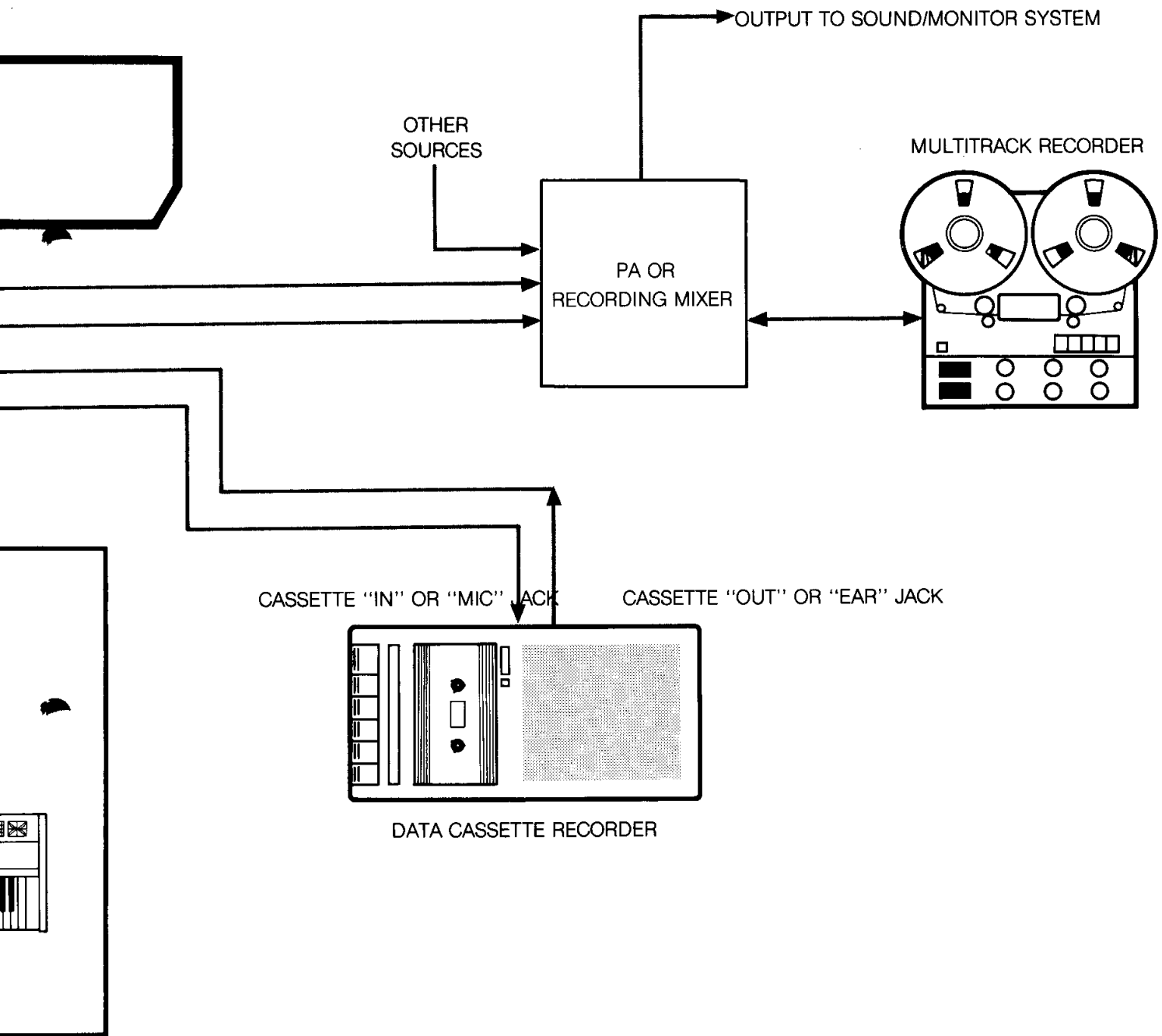

PRECAUTIONS

- Avoid placing the RX11 in locations exposed to direct sunlight or high temperatures, excessively high or low humidity, high dust concentration, or vibration.
- Be sure to connect the RX11 to an AC power supply that meets the power supply specifications listed on the rear of the unit.
- If there is any danger of lightning occurring nearby, remove the power plug from the wall socket in advance.
- Be sure to make all connections properly, as described in the "CONNECTIONS" section below.
- To avoid damaging your speakers and other playback equipment, turn off the power of all related equipment before making connections.
- Do not use excessive force in handling control switches and knobs.
- To avoid broken cords and short circuits, be sure to unplug all connectors by grasping the respective plugs—NOT the cords.
- Remove the power plug from the AC mains socket if the unit is not to be used for an extended period of time.
- Remove all plugs and connections if the unit is to be transported, to prevent damage to the cords and jacks.
- Do not use solvents such as benzene or paint thinner to clean the unit. Do not use insecticides or other pressurized spray products in proximity to the unit. Wipe off the exterior with soft cloth.

EFFECTS ON OTHER ELECTRONIC EQUIPMENT

- Since this unit incorporates digital circuitry, simultaneous use of other equipment such as TVs, radios, etc. in close proximity may cause noise and erroneous operation. If this occurs, separate the affected units sufficiently to eliminate the problem. It is also a good idea to use separate line filters on each piece of equipment.

CAUTION

- The RX11 pattern memory locations 00 through 36 contain factory-programmed rhythm patterns when the unit is shipped. Use the SAVE function (described on page **) to save these patterns on cassette tape or memory cartridge before programming your own patterns into these locations in order to prevent loss of the pre-programmed patterns.

THE INSTRUMENTS

Getting to Know the RX11 Instruments

The RX11 instruments can be played in real-time (without programming patterns or songs) by tapping on the black instrument buttons.

Using either a pair of headphones plugged into the RX11 PHONES jack, a stereo sound system fed from the RX11 L and R OUTPUT jacks, or a sound system incorporating a mixer fed from the RX11's individual instrument outputs, turn the RX11 ON and repeatedly tap any of the black instrument buttons (RIMSHOT, TOM1, TOM2, etc.) while gradually increasing the level of the linear VOLUME control until you can hear the instrument at a comfortable listening level.

- A brief output pulse appears at the RX11 outputs when the power is initially turned on. To prevent this from possibly damaging your speaker system, make sure the master volume control of your sound system, or the volume of the mixer channel to which the RX11 is connected, is set to minimum before the RX11 is turned ON. Better yet, turn the RX11 on first, then your sound system.

You can now "play" all the instrument buttons to become familiar with their sound. Some of the instrument buttons, however, have more than one function. The following chart lists all the instruments available with the instrument buttons:

(Instrument buttons with stars illustration)

Multi-Function Buttons are marked with a star

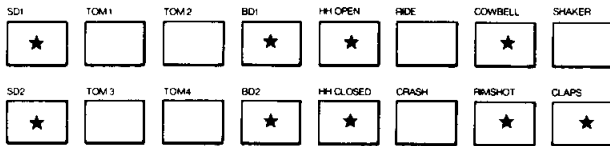

Dual-function buttons are marked with a star.

RX11 Instrument Chart

Instrument Button	Instruments
SD1	Heavy snare Medium snare Light snare Hi-tune snare 1 Hi-tune snare 2 Hi-tune snare 3 Hi-tune snare 4 Hi-tune snare 5
SD2	Heavy snare Medium snare Light snare Hi-tune snare 1 Hi-tune snare 2 Hi-tune snare 3 Hi-tune snare 4 Hi-tune snare 5
TOM1	10" deep-body tom-tom
TOM2	12" deep-body tom-tom
TOM3	14" floor tom-tom
TOM4	**" floor tom-tom

BD1	Heavy bass drum Medium bass drum 1 Medium bass drum 2
BD2	Heavy bass drum Medium bass drum 1 Medium bass drum 2
HH OPEN	Open Hi-Hat 1 Open Hi-Hat 2
HH CLOSED	Closed Hi-Hat 1 Closed Hi-Hat 2 Pedalled Hi-Hat
RIDE	Ride cymbal
CRASH	Crash cymbal
COWBELL	Cowbell 1 Cowbell 2
RIMSHOT	Rimshot 1 Rimshot 2
CLAPS	Hand claps 1 Hand claps 2

Selecting Instruments

First, enter the instrument select mode by holding down the green FUNCTION button while pressing the white INST-CHANGE button. The LCD panel will read "SELECT INST MODE" indicating that the instrument mode is active. Then press the black instrument button you wish to switch. Only the multi-instrument buttons will have any effect in this mode—SE, BD1, BD2, HH OPEN, HH CLOSED, COWBELL, RIMSHOT and CLAPS.

If, in response to the "SELECT INST MODE" display, the SD1 instrument button is pressed, the LCD panel will respond with the currently selected SD1 voice (refer to above instrument chart). This can be changed to any of the 8 available voices by using the +1/YES or -1/NO buttons to scroll forward or backward through the voice list. Once the desired snare has been selected, exit the instrument mode by pressing the INST-CHANGE button.

The same method of selection applies to all multi-instrument buttons: the +1/YES and -1/NO buttons select the instrument, and the INST-CHANGE button exits the instrument mode.

The instrument mode can be exited immediately (without making an instrument selection) by pressing the INST-CHANGE button.

Selecting Instruments (EX: SD1 Medium snare)

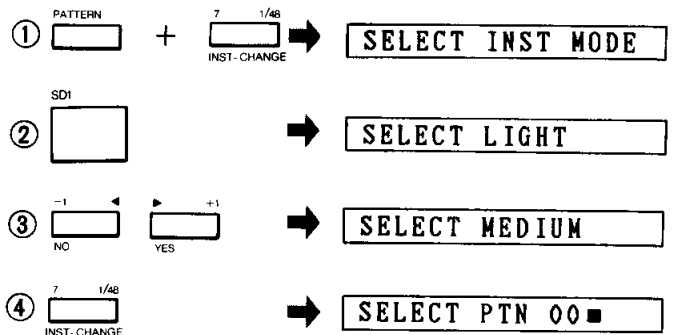

Some Instrument Limitations

Some of the RX11 instruments can not be used together on the same beat: i.e. they can not be played simultaneously. Instruments which can not be used on the same beat are:

- RIMSHOT, SD1 and SD2'
- TOM3 and TOM4.
- BD1 and BD2.
- HH OPEN AND HH CLOSED.

Of course, all these instruments can be used in the same pattern. It is advisable, therefore, to set similar instruments to different voices permitting greater scope and variety in pattern programming. SD1 and SD2 could be set to HEAVY and LIGHT, for example.

Instrument Level

The RX11 lets you individually adjust the level (volume) of each instrument so you can achieve the best overall balance or "drum mix".

The instrument level mode is entered simply by pressing the blue INST LEVEL button. The LCD panel will read "INST LEVEL" to indicate that the instrument level mode is active. Pressing any black instrument button then permits adjustment of that instrument's level via the linear DATA ENTRY control. The LCD panel will indicate the selected instrument followed by the currently set level—e.g. "TOM1 LEVEL 15". Maximum level for each instrument is 31, and minimum level is 00 (no sound). The nominal level for all instruments is 15. Once the instrument level mode is active, the instruments can be selected using the corresponding instrument buttons and adjusted in any sequence.

Press the INST LEVEL button a second time to exit the instrument level mode.

Instrument Level (EX: adjust TOM1 level)

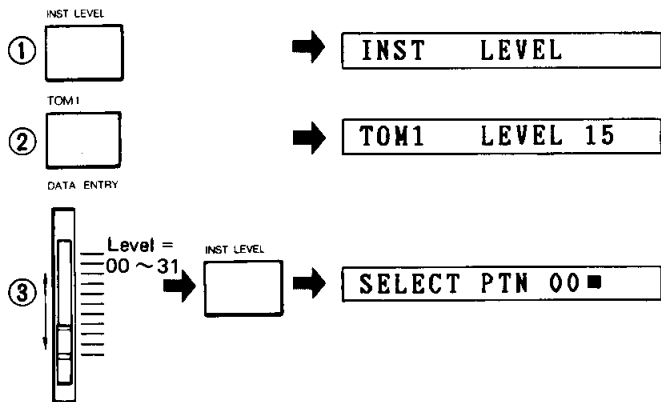

Stereo Positioning (PAN)

In addition to individually adjusting the level of each instruments, the RX11 makes it possible to individually locate instruments anywhere from left to right in the stereo sound field. Actually, each instrument can be located at any one of 15 discrete stereo locations using the PAN function.

The pan mode is entered simply by pressing the blue PAN button. The LCD panel will read "PAN LEVEL" to indicate that the pan mode is active. The instrument to be positioned

is then selected by pressing the corresponding black instrument button. The LCD panel will indicate the selected instrument followed by the currently set PAN position—e.g. "RIM L = 08 R = 08" would indicate that RIMSHOT is currently panned to stereo center since the left and right channel outputs are equal (08). "RIM L = 1 R = 15" would indicate that RIMSHOT is panned full-right (left channel output is minimum while right output is maximum). Once an instrument has been selected its PAN position is adjusted using the linear DATA ENTRY control. Once the PAN mode is active, instruments can be selected and adjusted in any sequence.

Press the PAN button a second time to exit the pan mode.

- The pan function only applies when the RX11 is in the STEREO OUT mode (See "Instrument Output", below).

Stereo Positioning (EX: Pan RIMSHOT)

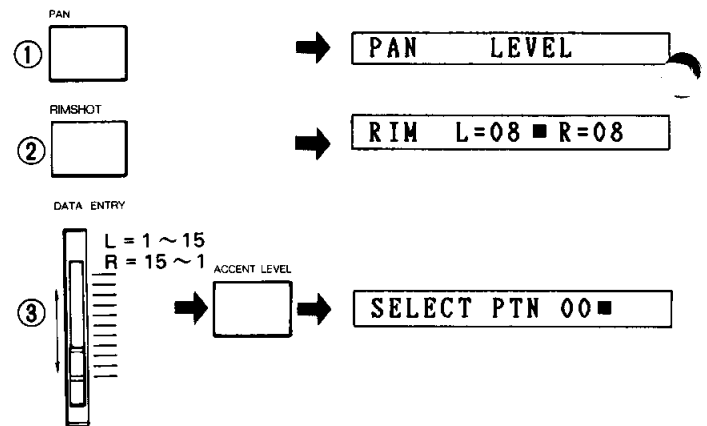

Accents

Pressing any instrument button while holding the green ACCENT button causes that instrument to be output at its accent level (set using the blue ACCENT LEVEL button) rather than at its normal instrument level (set using the INST LEVEL function). This applies whether the RX11 is being played in real time or whether it is being programmed by either of the possible methods—real-time write or step write (see PATTERN OPERATIONS section).

Setting Accent Levels

The accent level for each instrument can be set independently, making it possible to set the most natural level in relation to the instrument's normal level.

The accent level mode is entered simply by pressing the blue ACCENT LEVEL button. The LCD panel will read "ACCENT LEVEL" to indicate that the accent level mode is active. The instrument for which the accent level is to be set is then selected by pressing the corresponding black instrument button. The LCD panel will indicate the selected instrument followed by its currently set accent level—e.g. "TOM1 AC LEVEL 18". The accent level can then be adjusted using the linear DATA ENTRY control.

The accent level range is the same as the instrument level range: 00–31. The accent level setting, however, is added to the instrument level setting to produce the actual accent

PATTERN OPERATIONS

level. For example, if the instrument level is set at 15 and the accent level for that instrument is set at 05, then the actual accent level will be 20.

Once the accent level mode is active, instruments can be selected and adjusted in any sequence. Press the ACCENT LEVEL button a second time to exit the accent level mode.

Accent Level (EX: adjust TOM1 accent level)

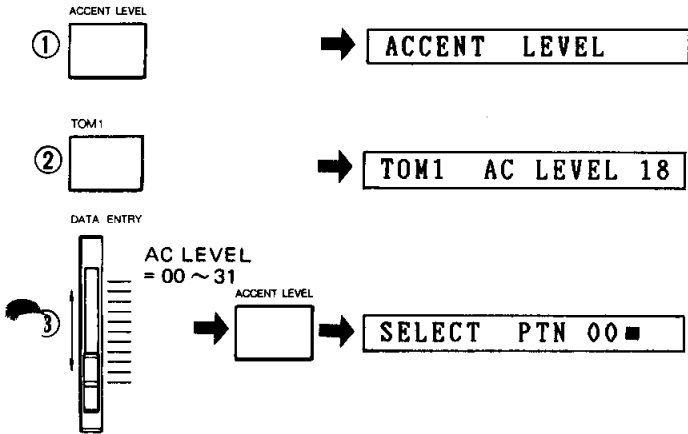

Instrument Output

The RX11 can be set to either the STEREO OUT or INDIVIDUAL OUT output modes, depending on the application and sound system configuration. While output from the individual outputs—COWBELL, CLAPS, SHAKER, TOM1, TOM2, BD, SD/RM, HH, CRASH and RIDE—remains the same in either mode, the output signal from the stereo R and L OUTPUT jacks is different in each mode. In the STEREO OUT mode, the R and L OUTPUT jacks deliver a stereo mix of all the RX11 instruments, their positions in the stereo field being determined by the PAN function, described above. In the INDIVIDUAL OUT mode, however, the R and L OUTPUT jacks become the individual outputs for the TOM4 and TOM3 instruments, respectively.

The instrument output mode is selected by first pressing the INST-OUTPUT button while holding the FUNCTION button. The currently selected instrument output mode will be displayed on the LCD panel: "STEREO OUT" or "INDIVIDUAL OUT". Pressing the -1/NO button alternates between the two modes, and pressing the +1/YES or INST-OUTPUT button selects the displayed mode and returns to the pattern or song mode.

An extra function is provided which determines whether individual instruments are sent to the R and L OUTPUT jacks in the STEREO OUT mode. The stereo on/off function is accessed by pressing the appropriate instrument button in response to the "STEREO OUT" display, described above. If you press the SD1 button, for example, the display will read "SD1 STEREO ON", indicating that the SD1 voice is being fed to the stereo outputs. The +1/YES button selects STEREO ON, and the -1/NO button selects STEREO OFF for the specified instrument. Pressing the INST-OUTPUT button returns to the pattern or song mode.

Pattern Selection

The RX11 is capable of storing up to 100 different patterns (00–99) in its internal pattern memory. Each pattern can be a maximum of 99 bars in length.

As shipped, the RX11 pattern memory contains 37 simple factory-programmed patterns—in pattern memories 00 through 36—that can be played immediately.

To select a pattern the RX11 must be in the pattern mode—this is the mode that is active when the RX11 is initially turned on. The red LED indicator above the PATTERN label on the green PATTERN/SONG selector is lighted, and the LCD panel reads either "SELECT PTN XX" (XX being the selected pattern number) or "PLAY PTN XX:BRYY" (XX being the selected pattern number and YY the currently playing bar of that pattern). The red digital LED display also indicates the number of the currently selected pattern.

Two methods of pattern selection are available:

1) Selecting Patterns Using the -1/NO and +1/YES Buttons

Pressing the -1/NO or +1/YES buttons decrements (decreases) or increments (increases) the selected pattern number by one, respectively. This method of selection is easy when going to an adjacent or nearby pattern number, but when selecting a pattern in a distant number range, the direct numeric selection method is quicker.

2) Direct Numeric Pattern Selection

The row of white buttons below the uppermost row of buttons on the panel can be used for direct numeric pattern number selection. Note that each button has a number—from 0 to 9—printed in white above its top left corner. Entering the desired pattern number using these buttons immediately selects that pattern. Input must be two digits—e.g. pattern 00 requires the 0 button to be pressed twice, to select pattern number 7 you would press the 0 button and then the 7 button (07).

Selecting patterns (EX: pattern 00 → 01 → 24)

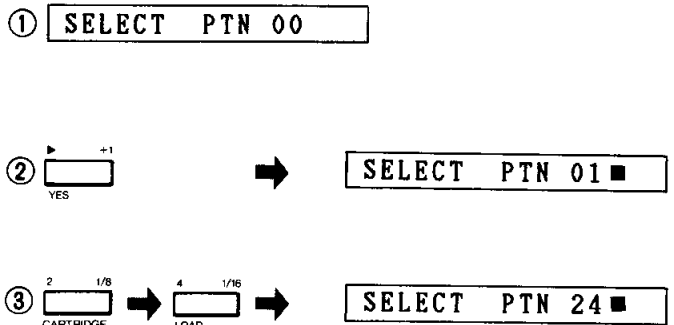

The START and STOP/CONTINUE Buttons

To play the selected pattern, simply press the red START button. The red RUN LED will light to indicate that the selected pattern is playing. If, for example, pattern number 15 is selected and played, the LCD panel will read "PLAY PTN15:BR01" indicating that bar number 1 (BR01) of pattern number 15 (PTN15) is playing.

To stop pattern playback press the blue STOP/CONTINUE button. The pattern can be restarted by pressing the STOP/CONTINUE button. In this case the pattern continues from the point at which it was last stopped, rather than starting from the beginning. Press START to start from the first beat of the pattern.

New patterns can be selected in the pattern mode even if another pattern is playing. When a pattern is playing, the newly selected pattern will begin immediately after the last beat of the first pattern.

Tempo

The linear TEMPO control can be used to adjust the pattern tempo. The TEMPO range is from 40 to 250 (40 to 250 quarter-note beats per minute).

For more precise tempo adjustment, however, use the TEMPO function, activated by pressing the TEMPO key. When the TEMPO key is pressed the LCD panel will indicate the currently set tempo: e.g. "TEMPO = 120". Although the TEMPO control can still be used for coarse tempo adjustment in this mode, finer control is available by using the -1/NO and +1/YES buttons. A single, quick press on -1/NO decrements the tempo by one beat, and +1/YES increments by one beat. Holding either the -1 or +1 buttons down causes continuous incrementing or decrementing in the corresponding direction. The TEMPO function also makes it possible to precisely set the desired tempo before beginning playback.

TEMPO Function

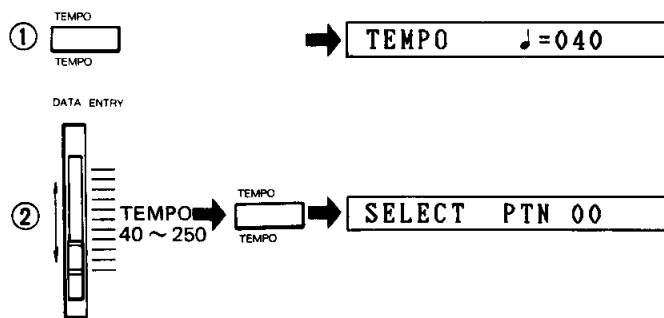

Real-Time Pattern Programming

NOTE

An understanding of the QUANTIZE function, described below, is essential for effective use of the real-time write function. We recommend that before actually trying out the real-time write function you should read through this section and then the "Quantize" section below. Then come back to this section and try out the function.

The RX11 permits programming your own rhythm patterns using two different methods—REAL TIME WRITE and STEP WRITE. The most direct of these is REAL TIME WRITE. This function lets you "play" your rhythm on the instrument keys, adding new instruments and rhythm lines until the pattern is complete.

First, select the pattern number you wish to program (if you're just starting, select a clear pattern—any pattern above 36). Enter the real time write mode (from the pattern mode) by pressing the REAL TIME WRITE button. The LCD panel will indicate that the real time write mode is active, and prompt you to input the time signature of your pattern (the flashing block cursor will be located immediately to the right of the first number of the time signature): "REALT.W.04/4". The default time signature is 4/4 ("04/4" on the LCD panel), and need not be entered if this is the time signature you need. If you wish to enter another time signature, however, use the white buttons labelled 0 to 9 (1/4 to 1/192) in their top left corner. Each input must be 2 digits. To input a 3/8 time signature, first input the 3 as "03" and confirm that it has been entered correctly on the LCD panel. Then press the REAL TIME WRITE button again to enter the second part of the time signature (notice that the flashing block cursor moves to the right of the second time signature figure when the REAL TIME WRITE button is pressed a second time). The second part of the time signature is entered using the fraction markings (1/4, 1/8, 1/6, etc.) over the number buttons. The RX11 will accept time signatures up to 99/32; 1/48 and 1/192 inputs will be ignored. Enter the 8 by pressing the button marked 1/8 and confirm on the display. This completes entry of the time signature. Now press the REAL TIME WRITE button again and you will be prompted to input the length of your pattern in bars: "REALT.W.01 BAR". The number of bars is entered via the white number keys, and must be input as two digits: 2 bars is input as "02", 4 bars would be input as "04". A pattern can have up to 99 bars.

To review, the real time write parameter input procedure is as follows:

1. Press REAL TIME WRITE button to enter real time write mode.
 2. Enter first part of time signature via white number buttons (integer markings, two digits).
 3. Press REAL TIME WRITE button to move cursor to second part of time signature.
 4. Enter second part of time signature via number buttons (fraction markings).
 5. Press REAL TIME WRITE button to prompt for number of bars in pattern.
 6. Enter number of bars via number buttons. (integer markings, two digits).
- The real time write mode can be exited at any time by pressing the STOP/CONTINUE button.
 - Steps 2–6 above can be skipped if the default parameters (4/4 time, 1 bar) are acceptable.

You are now ready to program your pattern.

Tap the red START button and you will hear the “click track” rhythm guide. The first click of each bar is accented (the actual time of the click function—whether the click is heard on every 1/4 note, every 1/8 note, etc.—can be adjusted using the CLICK function to be discussed later). The RX11 will continue cycling through the full length of the pattern while you record. Adjust the tempo using the TEMPO control, and start playing. For multi-bar patterns the first bar can be located by watching the LCD display panel: e.g. “REALT.W BAR 02” indicates that the current bar is bar 2. There’s no need to try and input all instruments at once. Just program one or two at a time, adding new instruments on successive cycles of the pattern. Input accented beats by using the ACCENT button (See “Accents” in the “THE INSTRUMENTS” section).

Make a mistake? Single notes can be cleared by holding down the CLEAR button (top row) and tapping the appropriate instrument button at the timing of the note that is to be cleared. When the pattern is complete, press the STOP/CONTINUE button.

You can add new instruments and rhythm lines to already-programmed patterns by simply selecting the pattern, entering the real time write mode, pressing the START button and writing as usual. The time signature or bar length of a programmed pattern CANNOT be changed. Time signature and number of bars can only be programmed in clear patterns (see the CLEAR function, below).

Real-Time Write (EX: 3/8 time, 2 bars)

① "XX" = any clear pattern number.

② →

③ → →

④ →

⑤ →

⑥ →

⑦ → →

⑧ → →

Enter pattern guided by click function.

→

Step-Write Pattern Programming

NOTE

An understanding of the QUANTIZE function, described below, is essential for effective use of the step write function. We recommend that before actually trying out the step write function you should read through this section and then the "Quantize" section below. Then come back to this section and try out the function.

While the REAL TIME WRITE function, described above, lets you input rhythm patterns in real time by playing on the instrument keys, the STEP WRITE function is used to input notes one at a time. This method is ideal for programming rhythm patterns from written scores, or from the pattern charts provided in the RX11 PATTERN BOOK. It also makes it possible to input extremely complex rhythm patterns that would be impossible to program using the real time method.

First select a clear pattern, then enter the step write mode by pressing the STEP WRITE button (from the pattern mode). The LCD panel will indicate that the step write mode is active, and prompt you to input the time signature: "STEP W. 04/4". The default time signature is 4/4 ("04/4" on the LCD panel), and need not be entered if this is the time signature you need. Time signature entry is the same as for real time write, as is entry of the pattern length in bars. The entire STEP WRITE parameter input process is as follows:

1. Press STEP WRITE button to enter step write mode.
 2. Enter first part of time signature via white number buttons (integer markings, two digits).
 3. Press STEP WRITE button to move cursor to second part of time signature.
 4. Enter second part of time signature via number buttons (fraction markings).
 5. Press STEP WRITE button to prompt for number of bars in pattern.
 6. Enter number of bars via number buttons. (integer markings, two digits).
- The step write mode can be exited at any time by pressing the STOP/CONTINUE button.
 - Steps 2–6 above can be skipped if the default parameters (4/4 time, 1 bar) are acceptable.

You are now ready to enter your pattern.

Tap the START button and the LCD panel will respond with "BAR 01 : BEAT 01", prompting you to input the first beat of bar one. You can now enter an instrument on beat 1 by pressing the appropriate instrument button, or a rest by pressing the +1/YES button. In either case, the beat will advance one count and you are then ready to enter the next instrument or rest. This process is continued until the last beat of the bar (the number of beats per bar is determined by the setting of the QUANTIZE function, described below).

If a one-bar pattern has been selected, the RX11 will then cycle back to the first beat of the bar, allowing you to continue to add new instruments. In the step write mode, only one instrument can be entered at a time. If more than one instrument is to be entered on a single beat, each instrument must be entered on successive cycles through the bar. If the pattern is more than one bar in length, the bar count will advance by one once the maximum beat count has been reached for each bar. The RX11 will cycle back to the first beat of bar 1 after the last beat of the last bar has been entered.

Exit the step write mode by pressing the STOP/CONTINUE button.

STEP WRITE mistakes can be corrected in the same way as REAL TIME WRITE mistakes: when you reach the beat at which the erroneous entry was made, simply hold down the CLEAR button and press the instrument button corresponding to the instrument to be cleared.

Patterns can be edited by adding new parts and deleting unwanted parts simply by re-entering the step write mode and stepping through the pattern using the +1/YES button until the edit point is located. The addition of new parts and deletion of unwanted parts are carried out as described above. The time signature or bar length of a programmed pattern CANNOT be changed. Time signature and number of bars can only be programmed in clear patterns (see the CLEAR function, below).

Step Write (EX: 4/4 time, 1 bar)

- ① STEP PTN XX "XX" = any clear pattern number.

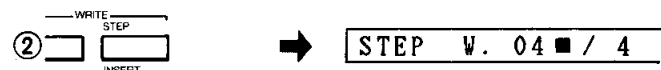

In this example 4/4 time will be accepted

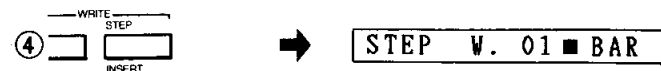

1-bar pattern is accepted



Enter BD on first beat

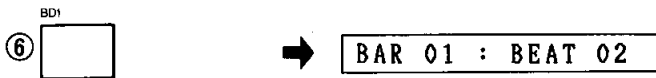

Enter rest on second beat



etc.

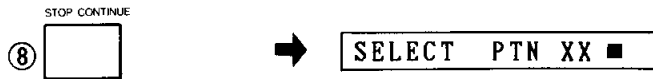

Quantize

Basically, **QUANTIZE** determines the smallest note-increments which can be programmed. The available quantize values are 1/4, 1/6, 1/8, 1/12, 1/16, 1/24, 1/32, 1/48 and 1/192 note increments—these are the fraction markings on the white number buttons. If, for example, **QUANTIZE** is set to 1/16, then the shortest notes that can be entered in either the real-time or step-write modes are 1/16th notes—i.e. the maximum number of beats that can be entered in one 4/4-time bar is 16.

— **QUANTIZE Applied to the Real-Time Write Mode** —

In the real-time write mode, this has an "error correcting" function. In other words if your timing while playing your pattern on the instrument keys is a little off, the off-time beats will be recorded at the nearest quantized beat. Thus, while simple patterns containing no more than 8 beats of any one instrument per measure will record with precise timing if quantize is set to 1/8. Subtle syncopations and rhythmic variations will only be recorded if quantize is set to 1/32 or even 1/48. Setting quantize to 1/192 records your pattern exactly as played. It is possible to quantize different instruments or groups of instruments at different values. Simply record the appropriate parts at value A, then exit the real-time write mode, reset the quantize value to B, then re-enter real-time write and add more parts.

— **QUANTIZE Applied to the Step-Write Mode** —

In the step write mode, the quantize function can save programming time by minimizing the number of steps required to enter each part. If, for example, **QUANTIZE** is set to 1/16, the beat count will proceed from 1 to 16 per bar. This is fine if 1/16th notes are to be entered, but an 8-beat bass drum line would require entry of several rests between each drum beat. It would be better to quantize to 1/8, enter the bass drum line, exit the step write mode and reset the quantize value to 1/16, then re-enter the step write mode and program a 16-beat hi-hat line.

Minimizing Rest Entry: 16 Beats

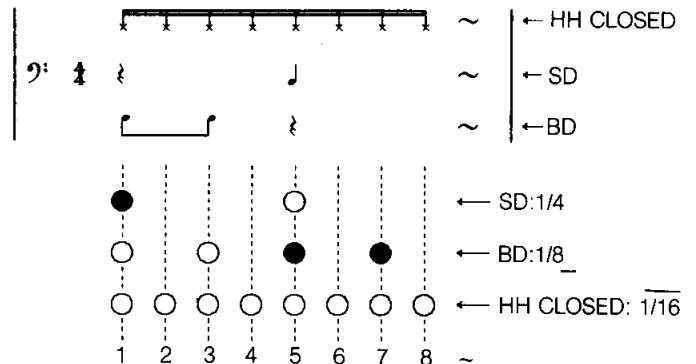

- Writing in notes with the instrument button step.
- Extending rest with the +1/YES key step.

Changing the quantize value also facilitates programming of complex rhythm lines. For example, 2-beat triplet snare fills could be added to an 8-beat pattern as follows:

Adding polyrhythms and Fill-ins: 2-beat triplets

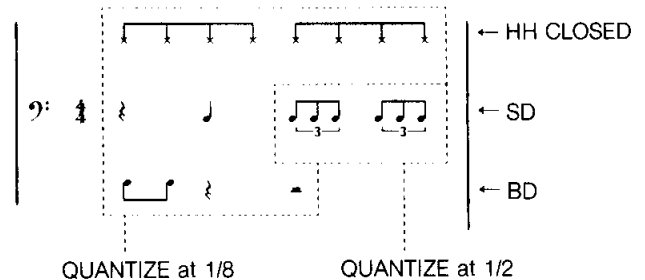

Subtle rhythm variations within a pattern can also be easily programmed by programming certain instruments at extremely fine quantize values.

Programming subtle rhythm variations

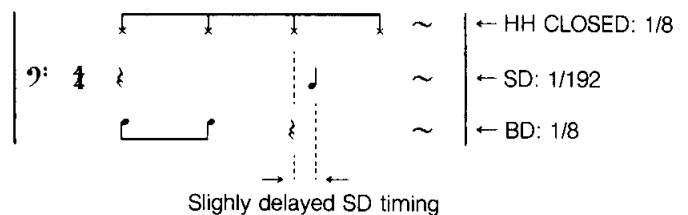

The quantize value is set by pressing the QUANTIZE button in the pattern mode (the QUANTIZE function cannot be called while a pattern is playing or during either of the write functions). The LCD panel will read "QUANTIZE = X/XX" where "X/XX" is the currently selected quantize value. The quantize value can then be changed by pressing the white number button with the fraction marking corresponding to the desired quantize value: 1/4, 1/6, 1/8, 1/12, 1/16, 1/24, 1/32, 1/48, or 1/192. If 1/192 is selected, the display will read "QUANTIZE = OFF" since this is the finest quantize value. Exit the quantize mode by pressing the QUANTIZE button.

Quantize (EX: QUANTIZE 1/16 → 1/8 → 1/32)

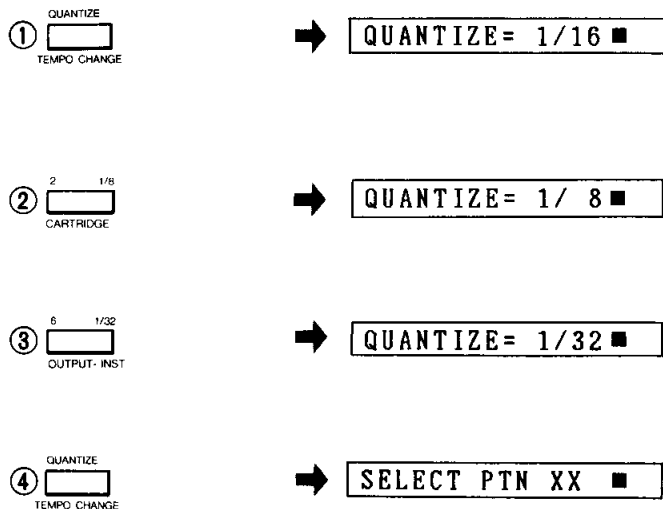

Click Time

This function sets the rhythm guide to "click" on every 1/4, 1/6, 1/8, 1/12, 1/16, 1/24 or 1/32 note during the real time write function. To change the click timing activate the click function by pressing the CLICK button in the pattern mode (the CLICK function cannot be called while a pattern is playing or during either of the write functions). The LCD panel will respond with "CLICK = 1/8" indicating that the rhythm guide is set to click on every eighth note (the default value). Change the click value simply by pressing the appropriate white number button, marked 1/4, 1/6, 1/8, 1/12, 1/16, 1/24 or 1/32. Inputs of 1/48 or 1/192 will be ignored. Exit the click function simply by pressing the CLICK button again.

Click Time (EX: CLICK 1/8 → 1/16)

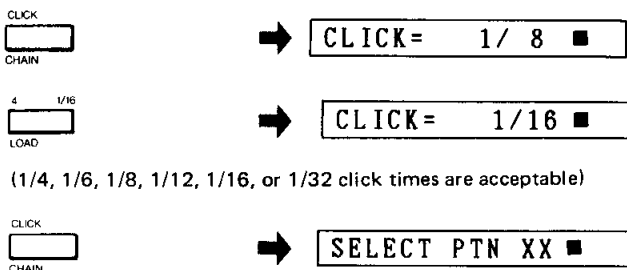

Pattern Memory Usage Graph

If the LOAD button is pressed while holding the FUNCTION button, the following display will appear.



The bar-graph portion of the display is formed of ten blocks, each of which is further divided into 5 sections. Each block represents 10% of the available memory space, and each block division represents 2% of total memory space. 10 blocks would represent 100% memory usage.

Pattern Clear

Single patterns can be cleared by selecting the pattern to be cleared and then pressing the CLEAR button. To confirm your intention to clear the pattern the RX11 LCD panel will respond with "CLEAR PTN XX?"—where "XX" is the number of the selected pattern. Press the +1/YES button to clear the pattern, or the -1/NO button to cancel the clear function.

Pattern Clear (Single)

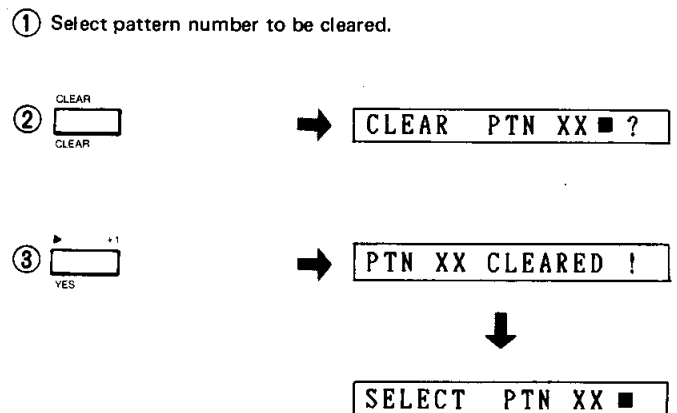

All patterns in memory—00 through 99—can be cleared simultaneously if necessary. This is a "hidden function" in the sense that it cannot be accessed directly—in order to prevent accidental erasure of the entire memory contents. First, press the CLEAR button from the pattern mode. When the "CLEAR PTN XX?" display appears, simultaneously press the ACCENT button and STOP/CONTINUE button. The LCD panel will respond with "CLEAR ALL PTNS?" to confirm your intention to clear all patterns. Press +1/YES clear the pattern memory, or press the -1/NO button to cancel the clear function. The "clear all patterns" function initializes the pattern memory, and can be used to restore normal operation should an operation error cause the RX11 software to malfunction.

Save the pattern memory contents onto a cassette tape (see "CASSETTE OPERATIONS" section) to prevent loss of patterns you wish to keep.

Pattern Clear (All Patterns)

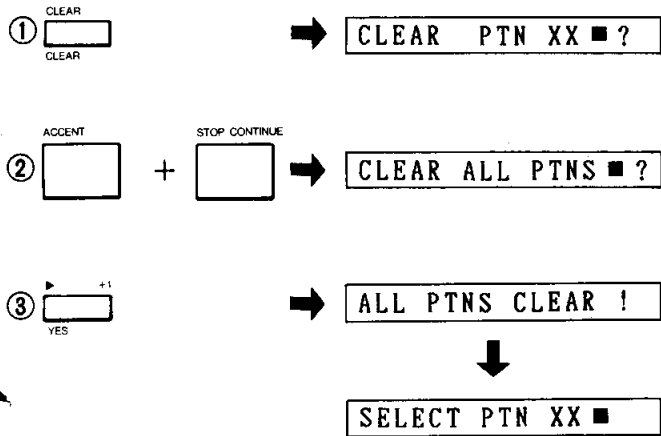

Instrument Clear

An entire instrument can be quickly cleared from any pattern by first calling the clear function by pressing the CLEAR button from the pattern mode. The LCD panel will read "CLEAR PTN XX?", as in the clear pattern function. Then if instead of pressing the +1/YES button you press the instrument button corresponding to the instrument to be cleared—we'll use RIDE in pattern number 01 as an example, the display will change to "CLEAR PT01 RIDE?". Press +1/YES to clear the instrument or -1/NO to cancel the clear function.

Instrument Clear (EX: Clear RIDE from pattern XX)

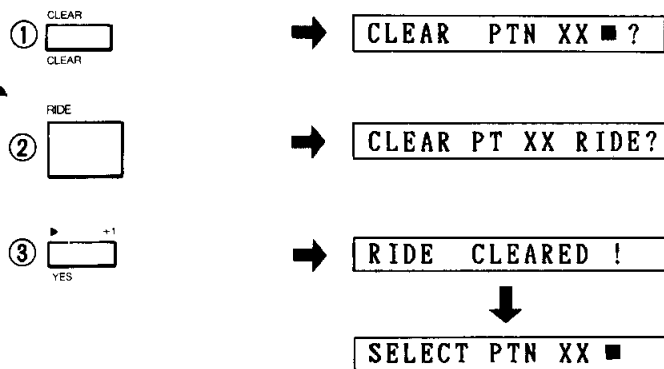

Pattern Copy

The RX11 permits two different pattern copy functions: COPY and CONNECT COPY.

- 1) COPY simply copies a pattern from one pattern number to any other pattern number. This is particularly handy when you want to add more instruments or rhythm lines, or otherwise alter an existing pattern, and still keep a copy of the original pattern.
- 2) CONNECT COPY makes it possible to combine two different patterns into one pattern. One pattern is appended (connected) to another pattern, and the combination is stored in a new pattern number. With this function it is possible to connect two patterns having different time signatures.

Both pattern copy functions are accessed by pressing the COPY button in the pattern mode. When the COPY button is pressed, the LCD panel will read "COPY ** + ** = ***".

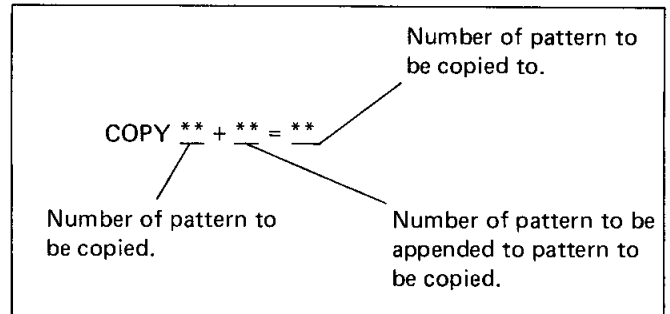

To simply copy from one pattern to another, first enter the number of the pattern you wish to copy via the white number buttons (the flashing block cursor should be located immediately to the right of the first asterisk pair), press the COPY key a second time causing the cursor to move to the right of the second (append pattern number) asterisk pair, without entering a number press the COPY again causing the cursor to move to the last asterisk pair. Enter the number of the pattern you wish to copy to, then press the COPY button again to execute the copy operation.

To connect one pattern to another and copy the combined pattern to a new location, enter the number of the pattern which is to be appended to the first pattern to be copied at the second asterisk pair. All other steps are the same as for normal copy, above.

If a pattern is already programmed in the pattern number to which a pattern or connected pair of patterns will be copied, the RX11 will confirm your intention to write a new pattern into that location with "REWRITE PTN XX?" on the LCD panel. If it's OK to write over the pattern, press the +1/YES button to execute the copy. Press -1/NO to cancel the copy function.

Pattern Copy

*COPY (EX: pattern 10 to pattern 20)

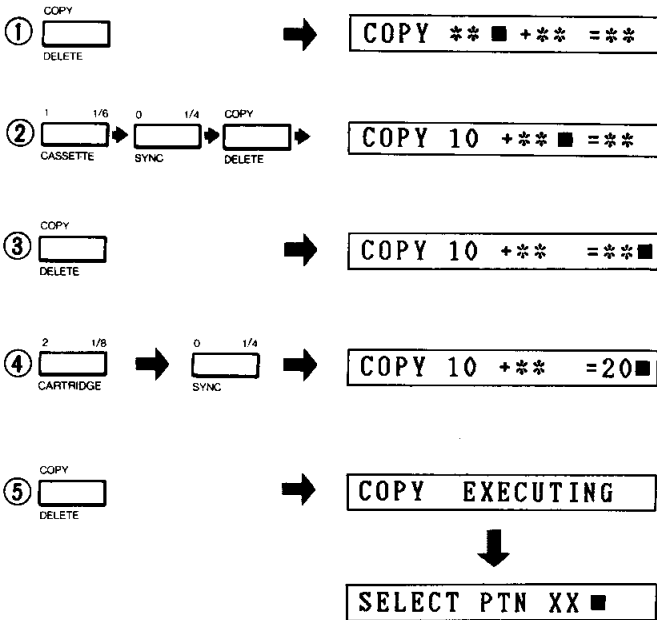

*CONNECT COPY (EX: patterns 10 + 15 to pattern 20)

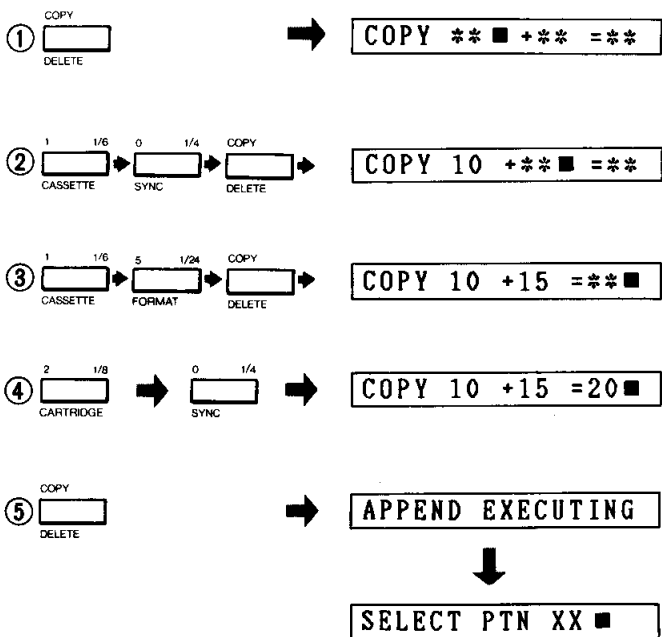

The Swing Function

This unique function can make your rhythm swing—automatically. It works by delaying the timing of the even-numbered beats in each bar (beat 2, 4, 6, 8, etc.) by a programmable amount, creating a jazz swing feel. The swing

function works **ONLY** in the real time write mode, and must be set to the required value before writing the pattern or rhythm lines within a pattern to which swing is to be applied. Further, the swing function works only with quantize values of 1/8 or 1/16.

Specifically, if the amount of time between the odd beats in a bar (1, 3, 5, etc.) is taken as 100%, then with no swing applied the even numbered beats will fall precisely midway between the odd beats—that is, 50%. The swing function makes it possible to set the time between odd and even beats to 50% (no swing), 54%, 58%, 63%, 67% or 71% of the time between the odd beats. A setting of 54% therefore produces the most subtle swing effect, while 71% produces the most pronounced swing effect.

Delaying the Timing of Even-numbered Notes with SWING

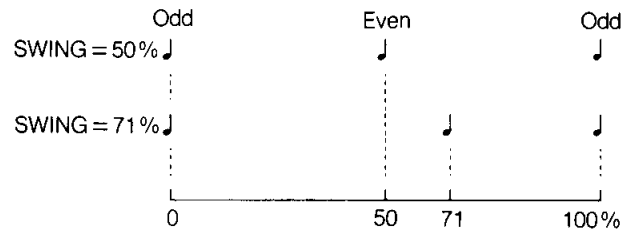

In the pattern mode, press the SWING button to call the swing function (the swing function cannot be called when a pattern is playing or when either of the write modes is active). The LCD will read "SWING LEVEL 50%", 50% being the default value (no swing). The +1/YES can then be used to increment through the available swing values—50%, 54%, 58%, 63%, 67%, 75%—while the -1/NO button decrements through the values. Once the desired swing value has been selected, press the SWING button again to return to the normal pattern mode and then begin the REAL TIME WRITE process. Use real time write to enter only those parts of the pattern to which you wish to apply the swing effect (this could be the entire pattern). Non-swing parts can then be added after exiting the real time write mode and returning the SWING LEVEL to 50%.

Swing (EX: SWING = 50% → 54% → 58%)

(Quantize must be set to 1/8 or 1/16)

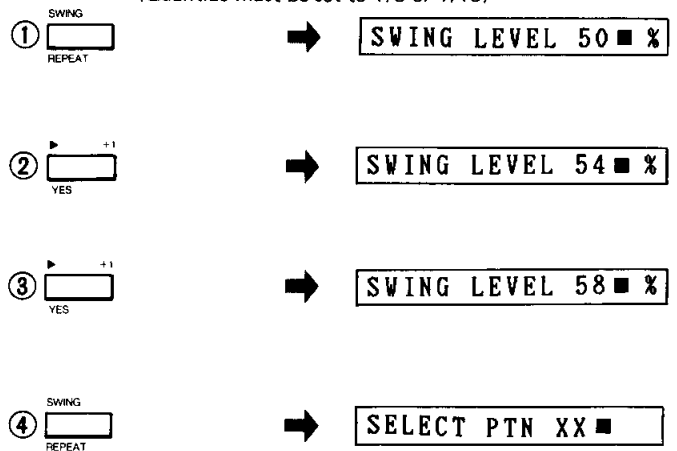

SONG OPERATIONS

The Song Mode & Song Selection

In the RX11 the term "song" refers to a number of patterns connected together to form the complete rhythm track for a musical piece—e.g. intro pattern, main pattern, bridge pattern, fill, etc. When used in a song, the individual patterns are referred to as the "parts" of the song. The RX11 has a song memory which is separate from the pattern memory, and is capable of storing up to 10 different songs (numbered 0 through 9). The maximum number of parts that can be used in a song is 255.

To perform any song-related operation—song programming, editing or playback—the RX11 must be in the SONG mode.

To enter the song mode, press the green PATTERN/SONG button while in the pattern mode (the song mode cannot be entered while a pattern is playing or either of the pattern write functions are active). The red LED below the SONG label on the PATTERN/SONG button should light, and the LCD will read "SELECT SONG 00". Pressing the PATTERN/SONG button alternates between the pattern and song modes.

Note that the SONG label below the PATTERN/SONG button is printed in blue. Except for the -1/NO and +1/YES buttons, all the buttons in the top row on the RX11 panel perform the functions indicated by their blue labels (printed below the buttons) when the song mode is active. The functions printed in white above the top-row buttons apply only in the pattern mode.

Once the song mode is active, songs 0 through 9 are selected simply by pressing the appropriate white number button. The START and STOP/CONTINUE buttons function in the same way as they do in the pattern mode, except that while a pattern cycles until it is stopped by pressing the STOP/CONTINUE button, a song will stop automatically when the end is reached.

Editing (Assembling a Song)

Select the song number you wish to program, then enter the edit mode by pressing the EDIT (blue label) button. The LCD panel will prompt you for the number of the pattern which will be programmed into part 1 of the song: "PART 001 = PTN ***". The number of the pattern to be loaded into the current part is entered via the white number buttons (2 digits) and appears on the display in place of the asterisks. When the first part has been entered, press the +1/YES button to go on to the next part, which is programmed in the same way. This process is repeated until the last part of the song has been entered. Once the last part has been entered, press the EDIT button again to exit the edit mode and return to the song mode. The programmed song can now be played.

While in the edit mode, the -1/NO and +1/YES buttons increment and decrement through the programmed parts, respectively. Holding either the +1 or -1 buttons down causes continuous incrementing or decrementing in the corresponding direction. This allows you to go back and check the song program, and alter incorrect pattern number entries.

Song Editing (EX: pattern 01 + 03 + 12 + . . .)

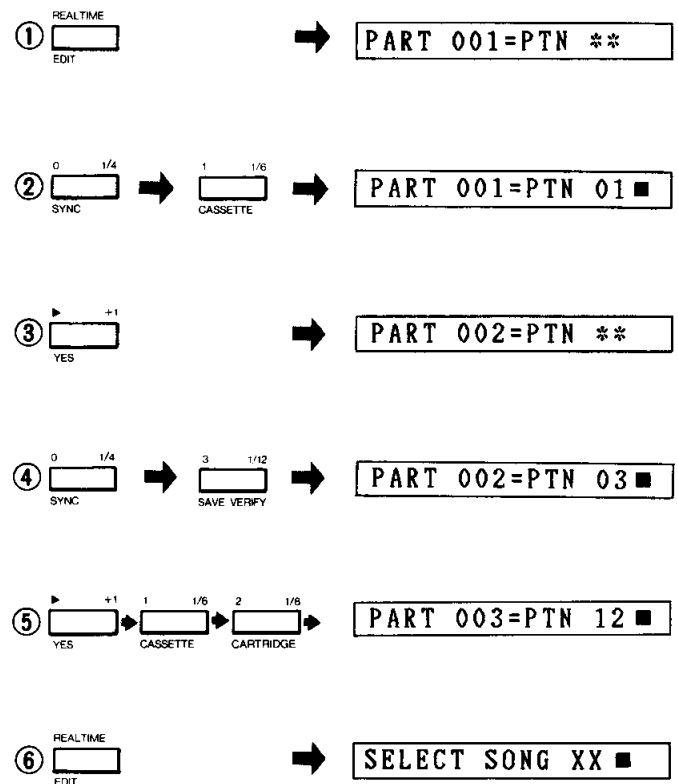

The Level Set Function

This function memorizes the PAN, INST LEVEL and ACCENT settings independently for each song. The level set procedure must be carried out immediately after calling the Edit mode (The LCD display should read "PART 001"). The level data is entered at this point simply by pressing the corresponding function button—PAN, INST LEVEL or ACCENT. When one of these buttons is pressed the LCD will respond with "XXXX SET", where "XXXX" is the name of the selected function (e.g. "ACCENT LEVEL SET"). Level set data is always memorized immediately prior to the PART 001 data

For songs on which the Level Set function has been used, the corresponding "XXXX SET" displays will appear immediately after the Edit mode is called. The +1/YES button is used to scroll through the Level Set displays to reach PART 001. The DELETE function, described below, can be used to delete Level Set data in the same way as it is used to delete song parts. To alter previously programmed Level Set data the corresponding PAN, INST LEVEL and ACCENT values must be altered as described in "THE INSTRUMENTS" section (page 8), and reset by calling the corresponding Level Set display in the Edit mode ("PANNING SET" to reset the PAN value, for example) function as described above, and then pressing the corresponding function button. The LCD will then read "REWRITE LEVEL?". Confirm your intention to rewrite the selected function by pressing the +1/YES button. Press -1/NO to cancel the level rewrite process.

The Insert Function

While in the edit mode, the insert function permits new patterns to be inserted anywhere between already-programmed parts. For example, suppose you have already programmed parts 1 through 4, but want to add a new part between parts 2 and 3, leaving you with a total of 5 parts instead of 4. Use the -1/NO and +1/YES buttons to locate part 3, which will contain the new part—the original parts 3 and 4 will be moved up to occupy parts 4 and 5. Press the INSERT button and the LCD panel will confirm your intention to insert part 3 with "INSERT PART 003?". If you then press the +1/YES button, the current parts 3 and 4 will be re-written into parts 4 and 5, leaving the original part 3 clear to receive the new part. The LCD panel will now read "PART 003 = PTN **", and the new part number is programmed into part 3 via the white number buttons. Editing can now continue as normal. Press the -1/NO in response to the "INSERT PART 003?" to cancel the insert function.

Insert (EX: insert new part-pattern 32- between parts 2 and 3)

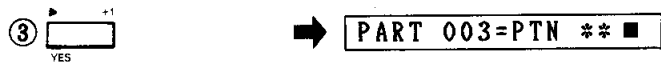
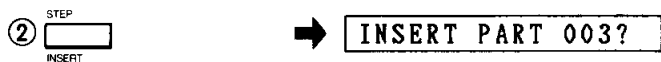
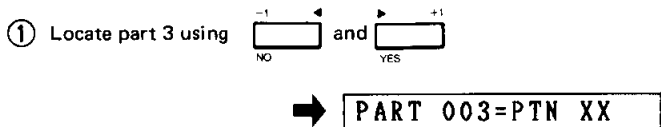

(Parts 3 and above all moved up one part)

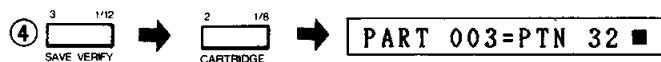

Continue editing as normal

The Delete Function

While in the edit mode, the delete function can be used to delete parts from a song program. For example, in the INSERT function description above, we inserted a new part between parts 2 and 3 in a 4-part program, leaving us with original parts 1 and 2, new part 3, and original parts 4 and 5. To delete the part we inserted (currently part 3), simply locate part 3 using the -1/NO and +1/YES keys and press

the DELETE button. The LCD panel will respond with "DELETE PART 003?". If the +1/YES button is then pressed, part 3 will be deleted and parts 4 and 5 will be re-written into parts 3 and 4, leaving us with our 4 original parts. Editing can now continue as normal. Press -1/NO in response to the "DELETE PART 003?" message to cancel the delete mode.

The DELETE function is used in the same way to delete level set data (PAN, INST LEVEL, ACCENT) inserted prior to PART 001. Repeats and tempo changes—discussed below—are also deleted with this function.

Delete (EX: delete part 3)

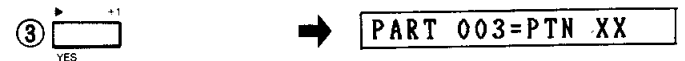
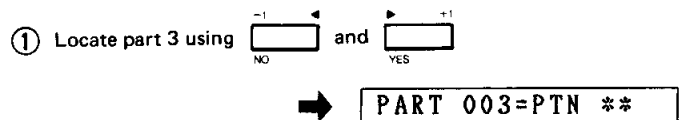

Parts 4 and above all moved back one part.

Repeats

The repeat function can save a considerable amount of programming time by making it possible to repeat any part or group of parts up to 100 times. The repeat function is used in the edit mode. Suppose, for example, we want to repeat part 3 of our 4-part song 3 times (this means part 3 would be played a total of 4 times—1 original and 3 repeats). Locate part 3 using the -1/NO and +1/YES buttons and press the REPEAT button. This does the equivalent of entering a repeat end sign () immediately after part 3—that is, part 3 will be the last part of the repeated segment. The LCD panel will respond with "GO TO PART ***?". The number of the part which is to be the first part of the repeated segment is then entered via the white number buttons—in this case, since we only intend to repeat part 3, enter a "3". We could repeat bars 1, 2, and 3, for example, by entering a "1" instead of a "3" ("GO TO PART 001"). Press the REPEAT button again and you will be prompted for the number of repeats: "REP COUNTS ***?". Enter the desired number of repeats via the white number buttons—in this case "3". Press the REPEAT button again to complete the repeat entry procedure. Now editing can continue as normal. Note that if you now increment through the parts, a "REPT for 03 to 003" message will appear between parts 3 and 4, indicating that part 3 will be repeated 3 times. Repeats can be deleted in the same way as parts by locating this message and using the delete function (See "The Delete Function", above).

Entering Repeats (EX: repeat part 3, 3 times)

- ① Locate part 3 using and → **PART 003=PTN XX**
- ② → **GO TO PART *** ?**
- ③ → **GO TO PART 003 ?**
- ④ → **REP COUNTS ** ?**
- ⑤ → **REP COUNTS 03**
- ⑥ → **PART 003=PTN XX**
(This complete actual repeat entry)
- ⑦ → **REPT for 03 to 003**
- ⑧ → **PART 004=PTN XX**

A number of repeats can be programmed in one song, and repeats can be "nested"—i.e. repeats can be programmed within repeats—to create complex progressions.

Tempo

The operation of the TEMPO function in the song mode is identical to the TEMPO function in the pattern mode—see "Tempo" in the "PATTERN OPERATIONS" section.

Programming Tempo Changes

This function makes it possible to program tempo changes to occur at any point during a song. Tempo changes are entered as an increase or decrease in tempo relative to the current tempo—determined by the TEMPO control, the TEMPO function, or a previous TEMPO CHANGE function. For example, if the current tempo is 100 and a tempo change of "20 UP" is encountered, the new tempo will be 120. If a tempo change of "40 DOWN" is then encountered, the tempo will drop to 80.

The TEMPO CHANGE function is used in the edit mode. Locate the part IMMEDIATELY BEFORE the desired tempo change using the -1/NO and +1/YES buttons, then press the TEMPO CHANGE button. The LCD panel will respond with "TEMPO IS 00 UP". The -1/NO and +1/YES buttons are then used to set the desired tempo change. Pressing either the -1/NO or +1/YES button once, quickly, decrements or increments the tempo change by one, respectively. Holding the -1/NO or +1/YES button down causes continuous incrementing or decrementing in the specified direction. Once the desired tempo change has been set, press the TEMPO CHANGE button again to return to the normal edit mode.

Programming Tempo Changes

(EX: Increase tempo by 20 after part 3)

- ① Locate part 3 using and → **PART 003=PTN XX**
- ② → **TEMPO IS 00 UP**
- ③ Hold until → **TEMPO IS 20 UP**
- ④ → **PART 003=PTN XX**

Note that if you now increment through the parts, a "TEMPO IS XX UP" or "TEMPO IS XX DOWN" message will appear immediately after the part at which the tempo change function was called ("XX" is the selected tempo change value). Tempo changes can be deleted in the same way as parts, by locating the tempo message and using the delete function (see "The Delete Function", above). A number of tempo changes can be programmed in one song.

Accelerando or ritardando effects can be produced by placing a number of small tempo changes between successive parts. To save programming time, tempo changes can be used in conjunction with repeats. For example, to produce a ritardando effect the tempo change and repeat functions could be combined as follows:

"PART 001 = PTN 01" → "TEMPO IS 02 DOWN" → "REPT for 09 to 001"

The tempo change must be entered before the repeat. Basically, the tempo change range is +50. Larger tempo changes can be programmed, however, by entering two consecutive tempo changes. The only restriction is that the total tempo range of the RX11 is from 40 to 250, and no tempo change can exceed these limits.

Song Clear

Single songs can be cleared by selecting the song to be cleared and then pressing the CLEAR button. To confirm your intention to clear the pattern the RX11 LCD panel will respond with "CLEAR SONG XX?"—where "XX" is the number of the selected song. Press the +1/YES button to clear the song, or the -1/NO button to cancel the clear function.

Song Clear (Single)

- 1 Select song number to be cleared

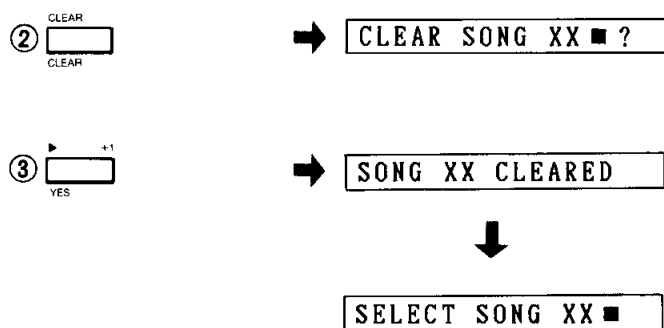

All songs in memory—0 through 9—can be cleared simultaneously if necessary. This is a "hidden function" in the sense that it cannot be accessed directly—in order to prevent accidental erasure of the entire song memory contents.

First, press the CLEAR button from the song mode. After the "CLEAR SONG XX?" display appears, simultaneously press the ACCENT button and STOP/CONTINUE button. The LCD panel will respond with "CLEAR ALL SONGS?" to confirm your intention to clear all songs. Press +1/YES to clear the song memory, or press the -1/NO button to cancel the clear function.

The "clear all songs" function initializes the song memory, and can be used to restore normal operation should an operation error cause the RX11 software to malfunction. Save the song memory contents onto a cassette tape (see "CASSETTE OPERATIONS" section) to prevent loss of songs you wish to keep.

Song Clear (All Songs)

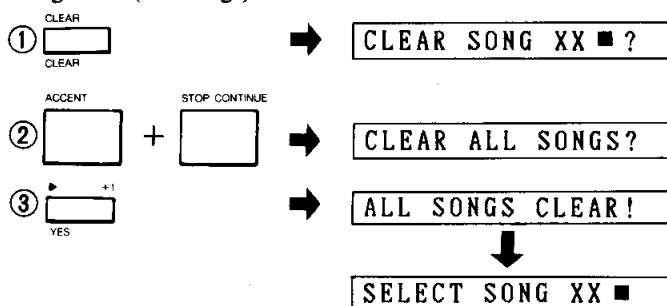

The Chain Function

The chain function makes it possible to connect up to 18 songs to be connected together for continuous playback, permitting creation of drum tracks for extremely long compositions. The chain mode is initially activated by pressing the CHAIN button in the song mode—the LCD panel will respond with "SONG CHAIN MODE", and the LED display will read "CH"—then any of the three available chain functions can be called. The three functions are:

1. CHAIN EDIT: this function lets you specify the sequence of songs to be played.
2. CHAIN CLEAR: this function clears the entire programmed chain.
3. CHAIN PLAY: this function plays the programmed chain.

Chain edit

The chain edit function is activated by pressing the EDIT button in response to the "SONG CHAIN MODE" display. The LCD panel will then read "STEP 01 = SONG **", prompting you to input the number of the first song in the chain. The song number is entered by pressing the appropriate number button. Once the first song number has been entered, go on to step 2 by pressing the +1/YES button, and enter the second song in the same way. Up to 18 steps (songs) can be entered. The +1/YES and -1/NO buttons can be used to scroll forward and backward through the chain, permitting alteration of already-entered song numbers when necessary. The chain edit mode can be re-entered at any time for editing purposes. Return to the "SONG CHAIN MODE" display by pressing the EDIT button.

Chain clear

The entire programmed chain can be cleared by pressing the CLEAR button in response to the "SONG CHAIN MODE" display. The LCD panel will respond with "CLEAR CHAIN ?". Press +1/YES to clear the chain or -1/NO to cancel the clear function.

CASSETTE OPERATIONS

Chain play

The programmed chain is played simply by pressing the START button in response to the "SONG CHAIN MODE" display. The STOP/CONTINUE button can be used to stop chain playback at any point, and resume playback again from the same point.

Exit the chain mode by pressing the CHAIN button.

From SONG mode

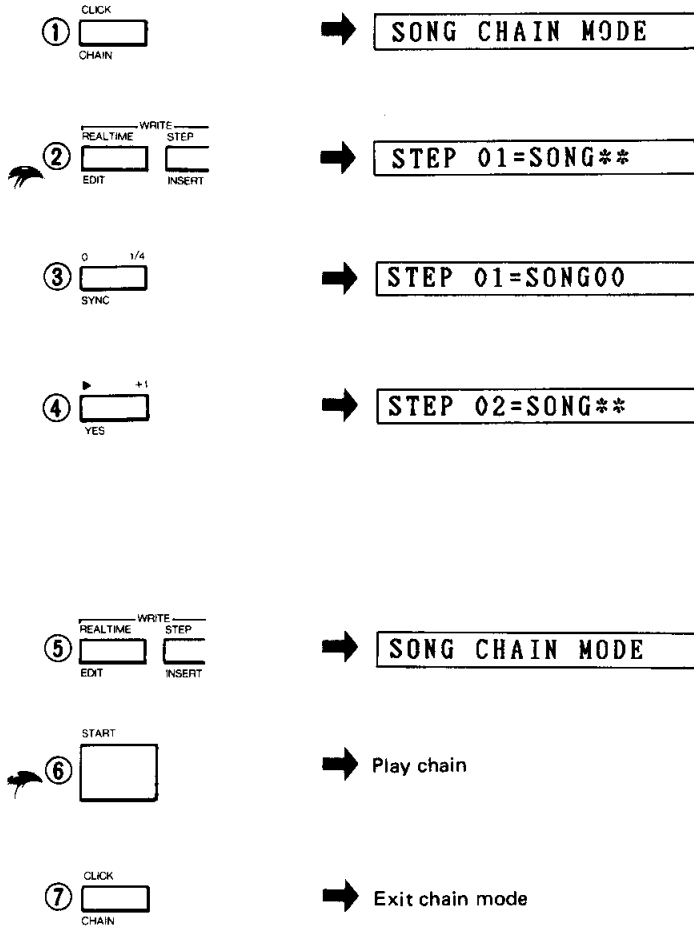

Although the RX11 has a considerable amount of internal storage capacity, a cassette interface has been provided to facilitate storage of an unlimited number of your original patterns and songs. The RX11 cassette save and load operations save and load the entire RX11 memory contents at once—all patterns and songs. Remember that when you perform a load operation the entire RX11 memory is rewritten, erasing any data it might contain.

We recommend that you use a cassette player designed specifically for personal computer data storage. If such a cassette deck is not available, however, use the highest quality unit at your disposal. If loading problems are encountered, try adjusting the output level control of the cassette player for optimum results. If the cassette player used has tone controls, these may need to be adjusted as well to facilitate loading of the data. In some cases it may also be necessary to clean and demagnetize the cassette deck's reproduction heads.

Before you begin a cassette operation, check that your cassette recorder is properly connected to the RX11 CASSETTE IN and OUT terminals (see "CONNECTIONS" section).

Save/Verify

The SAVE/VERIFY button permits access to two functions: 1) Save actually stores the data in the RX11 memory onto cassette tape, and 2) Verify automatically compares the data written onto the cassette with that in the RX11 memory in order to confirm that the data has been properly saved.

To begin any cassette operation, first enter the cassette control mode by pressing the CASSETTE button while holding the FUNCTION button. The LCD panel will read "CASSETTE CONTROL" indicating that the cassette control mode is active. To save the RX11 memory contents, then press the SAVE/VERIFY button. The LCD panel will confirm your intention to save to tape with "SAVE TO TAPE?". Press the +1/YES button to continue. The LCD panel will respond with "SAVE READY?". This is your cue to start the cassette recorder running in the record mode. Once you've started the recorder, press the +1/YES button and the actual save operation will begin. While the data is being saved the LCD panel will read "SAVE EXECUTING". After about 20 seconds, when the save operation has finished, the display will change to "VERIFY TAPE?", asking you if you would like to verify that the save operation was successful (we recommend that you do). At this point you should stop the cassette recorder. If you respond to the "VERIFY TAPE?" prompt with -1/NO, the RX11 will return to the CASSETTE CONTROL mode, from which you can then exit by pressing the CASSETTE button. If you do wish to verify the tape, rewind the cassette to the beginning of the file just saved and press the +1/YES button in response to the "VERIFY TAPE?" prompt. The LCD panel will respond with "VERIFY READY?". Press the +1/YES button and start the cassette recorder in the playback mode. While the RX11 compares the contents of its memory to the data saved on the tape, the LCD panel will read "VERIFY EXECUTING".

Verify takes about 20 seconds. If no data errors are encountered, the LCD panel will read "VERIFY OK". The cassette recorder can be stopped at this point. If an error is encountered, however, the display will read "VERIFY ERROR". If this happens, return to the cassette control mode by pressing the CASSETTE button and try saving the data again. The SAVE/VERIFY, LOAD, +1/YES or -1/NO buttons can also be used to return to the cassette control mode.

Save Data to Cassette and Verify

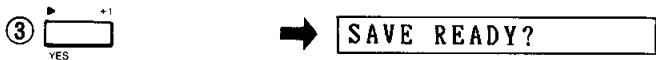
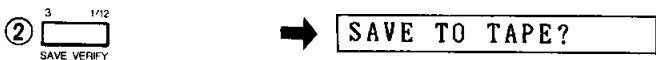
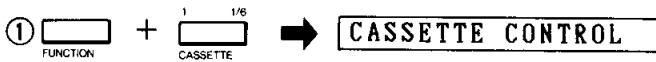

Start cassette recorder in RECORD mode.

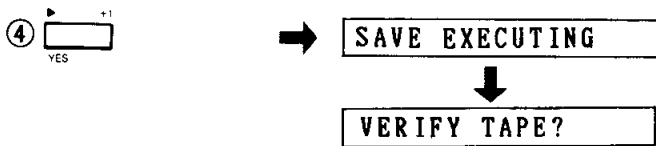

Stop cassette recorder, rewind to beginning of saved file to VERIFY.

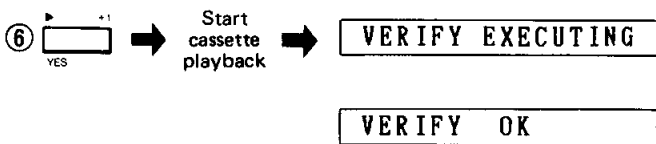

Stop cassette recorder

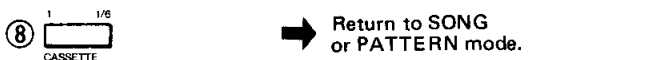

The verify function can be accessed directly, without going through the save operation, by responding -1/NO (or SAVE/VERIFY) to the "SAVE TO TAPE?" prompt. The save and verify operations can be interrupted at any time by pressing the CASSETTE button. The cassette control mode can be re-entered from any cassette operation prompt by pressing the CASSETTE button. The cassette control mode is also exited by pressing the CASSETTE button.

Load

To load data from a cassette tape into the RX11 memory, first enter the cassette control mode by pressing the CASSETTE button while holding down the FUNCTION button. When the LCD panel presents you with the "CASSETTE CONTROL" message, press the LOAD button. The LCD panel will respond with "LOAD FROM TAPE?". Press the +1/YES button to continue, or the -1/NO button to return to the cassette control mode. If the +1/YES button is pressed, the LCD panel will respond with "LOAD READY?". Make sure that the data cassette is rewound to the beginning of the file you wish to load, press the +1/YES button then start the cassette player in the playback mode to begin the load operation. While the RX11 is loading the data the display will read "LOAD EXECUTING". If the load operation is completed and no errors are detected, the RX11 will return directly to either the song or pattern mode. If a load error is detected the LCD display will read "LOAD ERROR!" In this case return to the cassette control mode by pressing the CASSETTE button (or the SAVE/VERIFY, LOAD, -1/NO or +1/YES buttons) and carry out the load process again.

Load Data from Cassette



Position cassette at beginning of file to LOAD.



Start cassette recorder in PLAY mode.

Return to SONG or PATTERN mode.

CARTRIDGE OPERATIONS

As a convenient alternative to cassette tape storage, the RX11 permits storage of pattern and song data on special Yamaha data cartridges—the same RAM-1 cartridges used to store Yamaha DX1 and DX7 Programmable Digital Algorithm Synthesizer voices. Cartridge operations include saving or loading all patterns and songs, and saving or loading single patterns. A format function is also provided to “set up” the RAM-1 cartridge to accept the RX11’s data format.

All cartridge functions are accessed from the cartridge control mode, which is activated by pressing the CARTRIDGE button while holding the FUNCTION button. The LCD panel will respond with “CARTRIDGE CTRL”, and the red “CARTRIDGE” indicator on the RX11 display panel will light. A cartridge MUST be properly inserted in the RX11 cartridge slot (located at the top left-hand corner of the RX11 panel) when the cartridge control mode is called, or the “CARTRG NOT READY” error message will be displayed and no cartridge operation will be accessible.

The cartridge control mode can be exited by pressing the CARTRIDGE button.

Format

The first step in using a RAM-1 data cartridge for storage of RX11 patterns and songs is to format the cartridge. This is done by first turning the cartridge’s memory protect switch OFF, inserting the cartridge firmly into the RX11 cartridge slot, activating the cartridge control mode as described above, and then activating the format function by pressing the FORMAT button. If the inserted cartridge has not yet been formatted for use with the RX11, or is formatted for use with another Yamaha product, the LCD panel will display the “FORMAT CONFLICT” message when the cartridge control mode is activated. Pressing the FORMAT button in response to either the “CARTRIDGE CTRL” or “FORMAT CONFLICT” displays will enter the format mode. The LCD panel will respond with “CARTRIDGE FORM?”. Press +1/YES to go ahead with the cartridge format process. The RX11 will re-confirm your intention to format the cartridge with the display—“ARE YOU SURE?”.

WARNING

The next press on the +1/YES button will begin the actual formatting operation, COMPLETELY ERASING ANY DATA ON THE CARTRIDGE!!!

Be sure to use a blank cartridge or one that does not contain data you wish to keep.

Press the +1/YES button to initiate the formatting process, or the -1/NO button to cancel and return to the cartridge control mode. If the +1/YES button is pressed, the display will read “UNDER WRITING!” for a few seconds, then “FORMATTING END” for a few seconds before returning to the cartridge control mode. The cartridge has now been formatted for use with the RX11.

Format

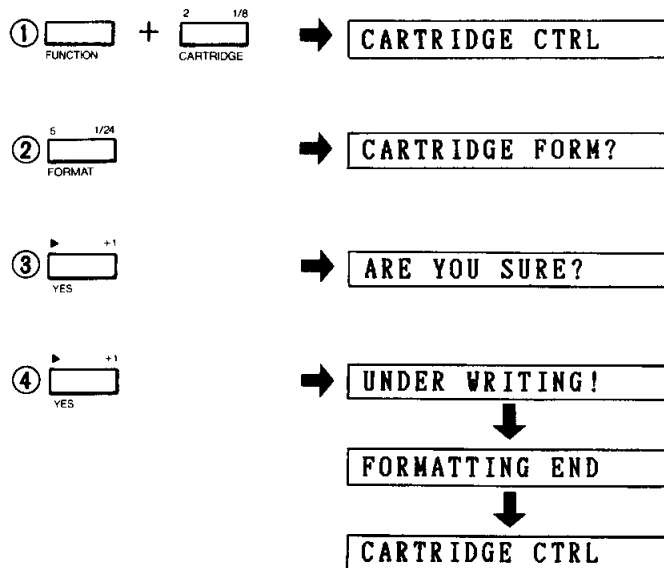

All Save

This operation saves the entire contents of the RX11 pattern and song memory onto the data cartridge. Press the SAVE/VERIFY button from the cartridge control mode. The LCD panel will respond with “SAVE ALL MEMORY?”. Confirm

All Save

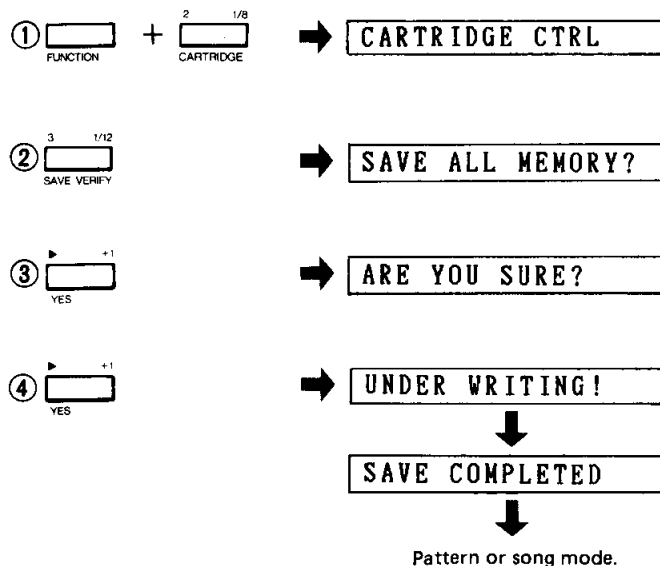

your intention to save the entire memory contents by pressing the +1/YES button again. The LCD panel will respond with "ARE YOU SURE?" for re-confirmation (any data residing in the cartridge is written over when a save operation is performed). To initiate the actual save operation press +1/YES again. The LCD panel will read "UNDER WRITING!" while the data is being saved, and then "SAVE COMPLETED" will be displayed for a few seconds before returning to the pattern or song mode.

Single Save

This function permits saving a single pattern from the RX11 pattern memory to any pattern memory location in the data cartridge. First press SAVE/VERIFY in the cartridge control mode, and then press -1/NO in response to the "SAVE ALL MEMORY?" display. The LCD panel will respond with "SAVE SINGLE PTN?", asking you if you wish to save a single pattern. Press +1/YES to continue, or -1/NO to cancel and return to the cartridge control mode. If +1/YES is pressed, the LCD panel will respond with "MEM ** → CRT ***", prompting you to input the pattern number to be saved, and the destination pattern memory number in the data cartridge. Input the pattern number to be saved using the white number keys, press the +1/YES button, then input the cartridge pattern memory location number into which the pattern is to be saved. Press +1/YES again and the RX11 will reconfirm your intention to save the pattern with the "ARE YOU SURE?" display. Press +1/YES to save, or -1/NO to return to the "MEM XX → CRT XX" display, allowing you to re-enter the pattern and cartridge numbers. In the latter case, pressing the -1/NO button returns the cursor to the "MEM" number, and pressing -1/NO again returns to the "SAVE SINGLE PTN?" display, from which you can return to the cartridge control mode by pressing the -1/NO button again.

To initiate the actual save operation press +1/YES again. The LCD panel will read "UNDER WRITING!" while the data is being saved, and then "SAVE COMPLETED" will be displayed for a few seconds before returning to the pattern or song mode.

The Single Save function does not permit writing a pattern to a cartridge memory location that already contains data. If this is attempted, the "ALREADY USED!" display will appear. Exit to the cartridge control mode by pressing the CARTRIDGE button.

Single Save

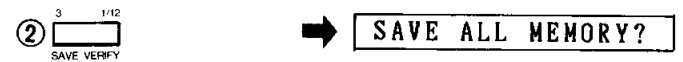

Enter MEM number

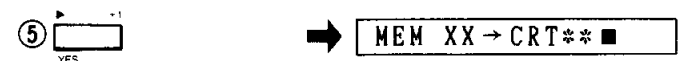

Enter CRT number

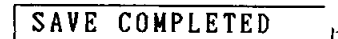
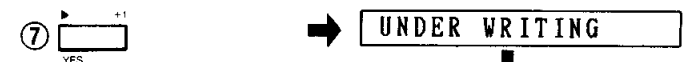

↓
Pattern or song mode.

All Load

This function loads the entire RX11 pattern and song memory from the data cartridge. Press the LOAD button in the cartridge control mode and the LCD panel will respond with "LOAD ALL MEMORY?". Press +1/YES to continue or -1/NO to cancel. If +1/YES is pressed the LCD panel will read "ARE YOU SURE?". Press +1/YES to initiate the actual load operation or -1/NO to cancel. If +1/YES is pressed, the LCD panel will display "LOAD COMPLETED!" for a few seconds before returning to the pattern or song display. The entire RX11 pattern and song memory now contains the cartridge data.

All Load

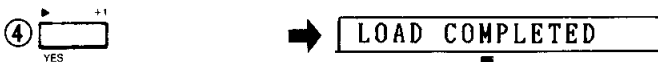
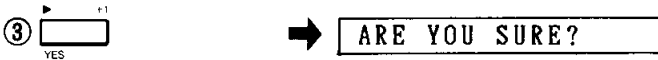
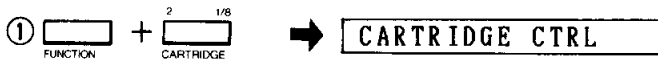

↓
Pattern or song mode.

Single Load

This function permits loading a single pattern from the data cartridge into any RX11 pattern memory location. First press LOAD in the cartridge control mode, and then press -1/NO in response to the "LOAD ALL MEMORY?" display. The LCD panel will respond with "LOAD SINGLE PTN?", asking you if you wish to load a single pattern. Press +1/YES to continue, or -1/NO to cancel and return to the cartridge control mode. If +1/YES is pressed, the LCD panel will respond with "CRT ** → MEM **", prompting you to input the pattern number to be loaded, and the destination pattern memory number in the RX11. Input the pattern number to be loaded using the white number keys, press the +1/YES button, then input the RX11 pattern memory location number into which the pattern is to be loaded. Press +1/YES again and the RX11 will reconfirm your intention to load the pattern with the "ARE YOU SURE?" display. Press +1/YES to load, or -1/NO to return to the "CRT XX → MEM XX" display, allowing you to re-enter the cartridge and RX11 pattern numbers. In the latter

case, pressing the -1/NO button returns the cursor to the "MEM" number, and pressing -1/NO again returns to the "LOAD SINGLE PTN?" display, from which you can return to the cartridge control mode by pressing the -1/NO button again.

To initiate the actual load operation press +1/YES again. The LCD panel will read "LOAD COMPLETED" for a few seconds before returning to the pattern or song mode.

The Single Load function does not permit writing a pattern to an RX11 pattern memory location that already contains data. If this is attempted, the "ALREADY USED!" display will appear. Exit to the cartridge control mode by pressing the CARTRIDGE button.

Single Load

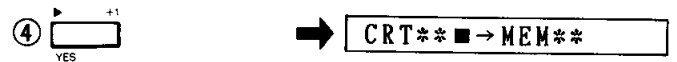
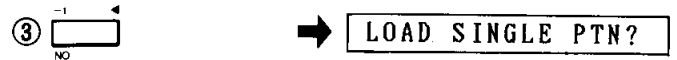
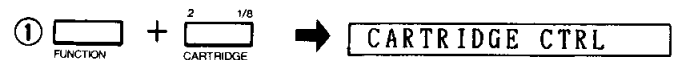

Enter CRT number

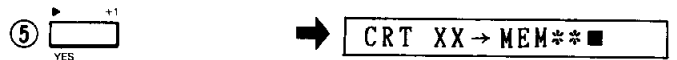

Enter MEM number

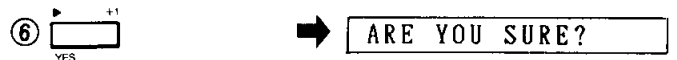

↓
Pattern or song mode.

MIDI FUNCTIONS

The RX11 features MIDI (Musical Instrument Digital Interface) IN and OUT terminals on the rear panel, allowing it to communicate with other MIDI compatible equipment. The following is a list of the possible MIDI control operations as well as the MIDI data type and transmit/receive conditions for each. Instructions for setting the various MIDI transmit and receive parameters follow.

1. MIDI CLOCK RECEPTION & TRANSMISSION

The RX11 can be synchronized to the clock of an external MIDI sequencer or music computer (such as the Yamaha QX-series sequencers or CX5M Music Computer).

External sequencers or music computers can be synchronized to the RX11's internal clock.

- MIDI Data Type: SYSTEM INFORMATION SYSTEM REALTIME DATA.
- Reception: Select MIDI CLOCK sync mode.
- Transmission: During pattern or song playback. Select INTERNAL CLOCK sync mode.

2. KEY NUMBER RECEPTION & TRANSMISSION

The RX11 instruments can be sequenced by an external sequencer or music computer.

The RX11 can be used to sequence an external MIDI synthesizer or another rhythm machine.

- MIDI Data Type: CHANNEL INFORMATION BASIC EVENT DATA.
- Reception: Set MIDI IN CHANNEL INFO to AVAIL, and either set the OMNI mode ON or specify reception channel.
- Transmission: During pattern or song playback. Set MIDI OUT CHANNEL INFO to AVAIL.

3. DATA ENTRY TRANSMISSION

The position of the Data Entry control can be transmitted to other MIDI equipment permitting remote control of some function of the receiving equipment (alm = 15). The data transmitted is MIDI channel information other event data.

- MIDI Data Type: CHANNEL INFORMATION OTHER EVENT DATA.
- Reception: NOT APPLICABLE.
- Transmission: When Data Entry control is operated during pattern or song mode. Set MIDI OUT CHANNEL INFO to AVAIL.

4. SONG SELECT TRANSMISSION & RECEPTION

An external MIDI device can be used to select RX11 song numbers while the RX11 is in the SONG mode.

- MIDI Data Type: SYSTEM INFORMATION SYSTEM COMMON DATA.

- Reception: During song mode "SELECT SONG" display.

- Transmission: When song number is selected in song mode.

5. START/STOP/CONTINUE TRANSMISSION & RECEPTION

Start, stop and continue commands controlling pattern, song or song chain operation can be transmitted to external MIDI equipment or received by the RX11 from external MIDI equipment.

- MIDI Data Type: SYSTEM INFORMATION SYSTEM REALTIME DATA.

- Reception: During pattern, song or chain modes.

- Transmission: When START or STOP/CONTINUE buttons are operated, or when footswitch is operated.

6. PARAMETER CHANGE TRANSMISSION & RECEPTION

A number of RX11 parameters can be changed under MIDI control. The parameters which can be changed are: MIDI IN KEY NUMBER, MIDI IN RECEIVE CHANNEL, INSTRUMENT LEVEL, ACCENT LEVEL, PAN, and INSTRUMENT CHANGE. Parameter change data communication is only possible with another RX11 or peripherals specifically designed to operate with the RX11.

- MIDI Data Type: SYSTEM INFORMATION SYSTEM EXCLUSIVE DATA.

- Reception: During pattern, song, pan, instrument level, or accent level modes. Set SYSTEM EXCLUSIVE to AVAIL, and set SYSTEM EXCLUSIVE channel to agree with transmitting equipment.

- Transmission: When corresponding RX11 controls are operated or functions are activated. Set SYSTEM EXCLUSIVE to AVAIL.

7. BULK DATA TRANSMISSION & RECEPTION

Pattern and song memory data can be transmitted or received via the MIDI interface. Communication is only possible with another RX11 or peripherals specifically designed to operate with the RX11.

- MIDI Data Type: SYSTEM INFORMATION SYSTEM EXCLUSIVE DATA.

- Reception: During pattern or song modes. Set SYSTEM EXCLUSIVE to AVAIL. Set SYSTEM EXCLUSIVE channel to agree with transmitting equipment.

- Transmission: Set SYSTEM EXCLUSIVE to AVAIL, and use MIDI TRANSMIT function.

8. BULK DUMP REQUEST

This MIDI signal, when received by the RX11, initiates bulk data transmission from the RX11 to an external MIDI device. Communication is only possible with another RX11 or peripherals specifically designed to operate with the RX11.

- MIDI Data Type: SYSTEM INFORMATION SYSTEM EXCLUSIVE DATA.

- Reception: BULK DUMP REQUEST from external MIDI equipment initiates BULK DATA transmission from RX11 during pattern or song modes. Set SYSTEM EXCLUSIVE to AVAIL, and set SYSTEM EXCLUSIVE CHANNEL to agree with transmitting equipment.

- Transmission: The BULK DUMP REQUEST signal is not transmitted by the RX11.

In addition to the above functions, an EXTERNAL SYNC mode permits synchronizing the RX11 to non-MIDI clock signals (gate clock signals) from some non-MIDI sequencers and rhythm machines.

Sync Modes

The RX11 offers three sync modes which function as follows:

1 – INTERNAL – This is the normal RX11 mode. The playback of patterns and songs is synchronized to the RX11's own internal clock, the speed of which is adjusted by the TEMPO control and TEMPO functions. The internal mode is also used when external sequencers or rhythm machines are to be synchronized to the RX11's internal clock, which is transmitted via the MIDI OUT connector.

2 – MIDI – In this mode the playback of patterns and songs is synchronized to a MIDI clock signal received from an external sequencer, music computer or another rhythm machine via the MIDI IN connector on the RX11 rear panel. In this case the tempo must be controlled at the device which is transmitting the MIDI clock signal.

3 – EXTERNAL – This is actually a non-MIDI function, permitting the RX11 to be synchronized to a gate-type clock from sequencers and rhythm machines that employ this type of clock system. When the EXTERNAL sync mode is activated, the synchronizing clock is received at the RX11 CASSETTE IN jack rather than at the MIDI IN connector.

The desired sync mode is selected by pressing the SYNC button while holding down the FUNCTION button. Normally, the LCD panel will read "INTERNAL CLOCK" indicating that the internal sync mode is selected. To select other modes, press the -1/NO button. Each press of the -1/NO button cycles the sync mode in the following order: INTERNAL → MIDI → EXTERNAL → INTERNAL → etc. Set the display to the desired mode then press +1/YES activate that mode. When either the MIDI or EXTERNAL clock modes are selected, the red "EXT. CLK" indicator on the RX11 display panel will light.

Sync Mode Selection

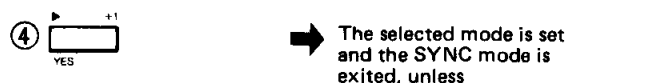
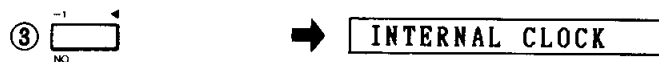
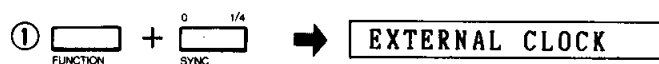

EXTERNAL CLOCK

is selected, in which case,

TIME BASE = 24 / ♩



MIDI Reception Parameters

Three main parameters must be set in order to receive MIDI data:

1 – CHANNEL INFO AVAILABLE/UNAVAILABLE – This parameter simply turns MIDI key number reception on or off. "CH INFO AVAIL" = MIDI key number reception is ON, "CH INFO UNAVAIL" = MIDI key number reception is OFF.

2 – OMNI MODE ON/OFF – When the OMNI mode is ON, the RX11 will receive MIDI data on all 16 available MIDI channels. This is the mode that will normally be used in setups where one MIDI transmitting device (a sequencer, etc) is controlling only the RX11. In some systems, however, the MIDI transmitting device may be required to control several different MIDI receiving devices in different ways. In this case, the OMNI mode must be turned OFF and the RX11 set to receive only on the MIDI channel containing pertinent data.

3 – RECEIVE CHANNEL (1 through 16) – When the OMNI mode is turned OFF, the RX11 must be set to receive MIDI data on a specific channel. The sequencer or music computer used to transmit the MIDI data might, for example, be transmitting melody data to a synthesizer on channel 1, and rhythm data to the RX11 on channel 2. The RX11 must therefore be set to receive on channel 2 only, to prevent the melody data from triggering the rhythm machine.

In some cases it may be necessary to continue and set the instrument key numbers as described in the "Instrument Key Numbers" section, below.

All these parameters are set by first entering the MIDI IN programming mode: press the MIDI IN button while holding down the FUNCTION button. The first display in response to this will normally be "CH INFO AVAIL" (default parameter). This means that the RX11 is ready to receive MIDI data. To turn MIDI reception OFF press the -1/NO button, causing the display to read "CH INFO UNAVAIL". The +1/YES and -1/NO buttons turn this function on or off, respectively. Select the required mode and press the MIDI IN button to activate it. The MIDI IN mode will be exited if "UNAVAIL" is selected. If "AVAIL" is selected, the LCD panel will then read "OMNI ON" (default parameter), indicating that the OMNI mode is on. If the OMNI ON mode is then activated by pressing the MIDI IN button, the MIDI reception parameter setting process is complete. If the OMNI mode is turned OFF by pressing the -1/NO key (the -1/NO button and +1/YES button turn the OMNI mode OFF and ON, respectively) and then activated by pressing the MIDI IN button, the RX11 will prompt you to set the MIDI receive channel with "RECEIVE CH = 01" (default parameter). The desired MIDI receive channel is then selected using the DATA ENTRY control. Once the channel has been selected, it is set by pressing the MIDI IN button.

Midi Reception Parameters

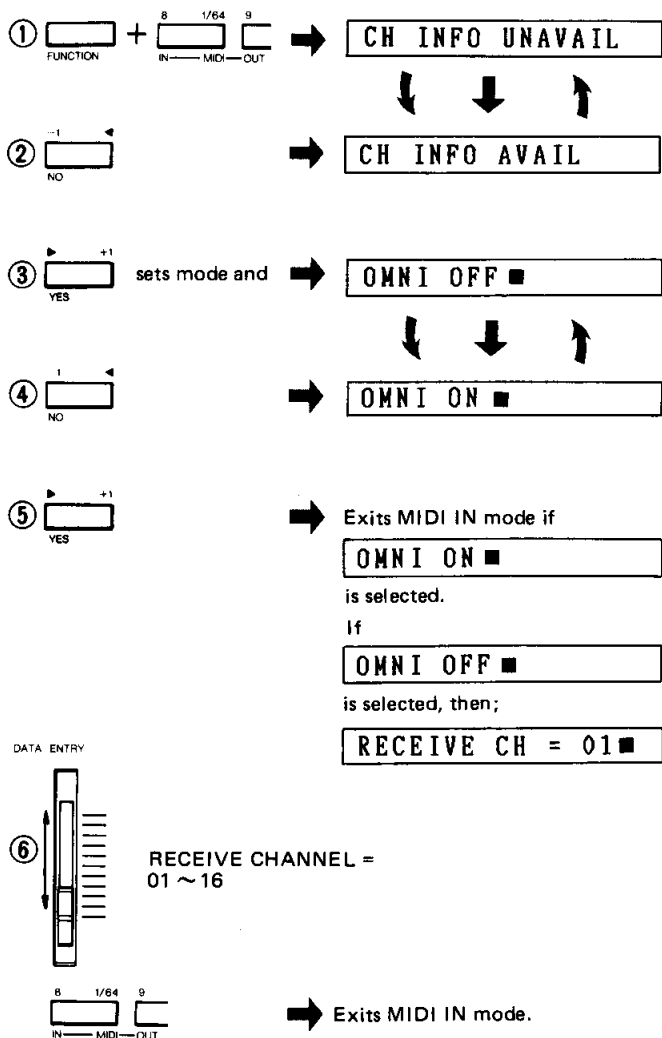

In order to set the instrument key numbers—described below—after setting the first two or three reception parameters described above, do not exit the MIDI IN mode by pressing the MIDI IN button in response to the "OMNI ON" or "RECEIVE CH = XX" display.

Instrument Key Numbers

The RX11 is capable of receiving and transmitting MIDI "key number" data via the MIDI IN and MIDI OUT connectors, respectively. A key number generally corresponds to the number (pitch) of a key played on a synthesizer keyboard. Middle C, for example, is MIDI key number 60. A MIDI sequencer, for example, outputs key numbers to a keyboard, causing the synthesizer to play the corresponding notes.

Each of the RX11's instruments can be assigned a key number between 36 and 99. This makes it possible for any key number transmitted by a MIDI synthesizer, sequencer or music computer to activate any RX11 instrument. Conversely, any instrument played on the RX11—in a pattern, song, or played manually—can activate any note on a synthesizer or any instrument on another rhythm machine.

The process for assigning key numbers to the RX11 instruments is actually an extension of the MIDI reception parameter designation process outlined above. The key number assignment mode can be entered from either the "OMNI ON/OFF" or "RECEIVE CH = XX" displays of the MIDI IN programming mode by pressing any of the instruments buttons. Suppose, for example, the RIMSHOT button is pressed in response to the "OMNI ON" display. The LCD panel will respond with "RIM NOTE = XX", where "XX" is a number (the key number currently set for the rimshot sound) between 36 and 99. Any new key number can be set using the DATA ENTRY control. Once set, other instruments can be selected in succession by pressing the appropriate instrument buttons, and their key numbers can be set in the same way. Press the MIDI IN button to exit the MIDI IN programming mode.

Setting Instrument Key Numbers (EX: Set SD Key number)

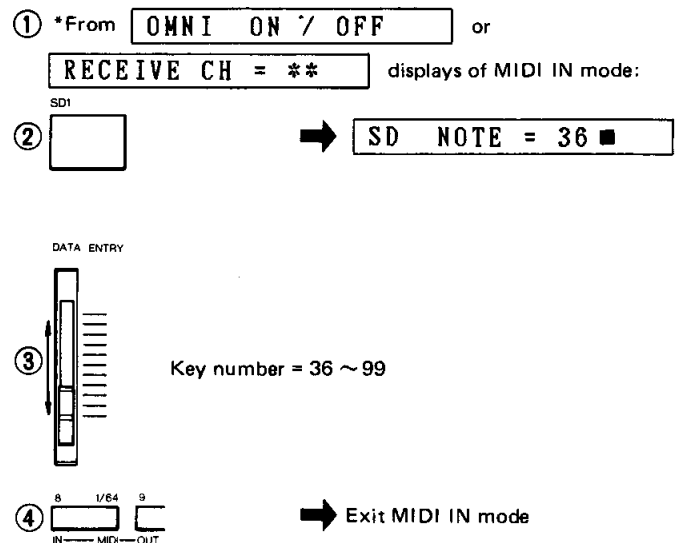

The Initialize Function

This function returns all instrument key numbers to their initial values. The initial key numbers for RX11 instruments are given in the following chart:

SD152 (E2)
SD249 (C # 2)
TOM153 (F2)
TOM250 (D2)
TOM348 (C2)
TOM447 (B1)
BD145 (A1)
BD244 (G # 1)
HH OPEN59 (B2)
HH CLOSED57 (A2)
RIDE62 (D3)
CRASH60 (C3)
COWBELL55 (G2)
RIM51 (D # 2)
SHAKER56 (G # 2)
CLAPS54 (F # 2)

The key numbers are initialized by pressing the **FORMAT** button while holding the **FUNCTION** button in the pattern or song modes. The LCD panel will respond with "INITIALIZE NOTE?". Press +1/YES to initialize or -1/NO to cancel. If +1/YES is pressed, the LCD panel will read "SET INITIAL NOTE" for a few seconds before returning to the pattern or song mode. All key numbers have now been initialized.

MIDI Transmission Parameters

The MIDI transmission parameters which can be set are as follows:

1 - CHANNEL INFO AVAILABLE/UNAVAILABLE - This simply turns MIDI key number transmission on or off: "CH INFO AVAIL" = MIDI key number transmission is ON, "CH INFO UNAVAIL" = MIDI key number transmission is OFF.

2 - INSTRUMENT TRANSMISSION CHANNEL (1 through 16) - Each RX11 instrument can be assigned for transmission on any of the 16 available MIDI channels. Normally, all instruments will be set to a single channel, and their key numbers will activate the appropriate notes or other events in a single MIDI receiving device set to receive on that channel. In some cases, however, it might be desirable to transmit different instrument key numbers on different MIDI channels, triggering notes or other events in two or more different receiving devices.

3 - SYSTEM EXCLUSIVE INFORMATION AVAILABLE/UNAVAILABLE - This either enables or disables RX11 SYSTEM EXCLUSIVE INFORMATION communication. SYSTEM EXCLUSIVE INFORMATION includes PARAMETER CHANGE, BULK DATA, and BULK DUMP REQUEST data. SYSTEM EXCLUSIVE INFORMATION communication is only possible with another RX11 or peripherals specifically designed to operate with the RX11.

4 - SYSTEM EXCLUSIVE TRANSMISSION CHANNEL (1 through 16) - This determines the MIDI channel via which the RX11 SYSTEM EXCLUSIVE INFORMATION will be transmitted.

5 - MIDI TRANSMIT - This function initializes MIDI bulk data transmission of the RX11's pattern and song memory.

These parameters are set in the MIDI OUT programming mode, which is entered by pressing the MIDI OUT button while holding down the **FUNCTION** button. The LCD panel will respond with "CH INFO AVAIL" (default parameter) indicating that MIDI key number transmission is ON. Transmission can be turned off by pressing the -1/NO button. The +1/YES and -1/NO buttons turn MIDI key number transmission ON and OFF, respectively. To set the displayed parameter and go on to the SYSTEM EXCLUSIVE INFORMATION AVAILABLE/UNAVAILABLE programming step, press the MIDI OUT button.

To set the instrument transmission channels, press any of the instrument buttons immediately after selecting the desired transmit parameter (do not press MIDI OUT). If, for example, the RIMSHOT button is pressed, the LCD panel will respond with "RIM TRNS CH = XX", where "XX" is the currently set transmission channel for the RIMSHOT key number. The transmission channel can then be set from 1 to 16 with the DATA ENTRY control. Other instruments can be selected and assigned a transmission channel in succession. Press the MIDI OUT button to go to the SYSTEM EXCLUSIVE INFORMATION stage. The LCD panel will read "SYS EXCL UNAVAIL" (default parameter). The +1/YES and -1/NO buttons turn SYSTEM EXCLUSIVE INFORMATION transmission ON and OFF, respectively. Set the selected mode by pressing the MIDI OUT button. If "SYS EXCL UNAVAIL" is selected, the MIDI OUT mode is exited as soon as the MIDI OUT button is pressed. If, however, "SYS EXCL AVAIL" is selected, the LCD panel will respond with "SYS EXCL CH = 01", prompting you to set the MIDI channel number on which the SYSTEM EXCLUSIVE INFORMATION is to be transmitted. Use the Data Entry control to set the desired MIDI channel number, then press the MIDI OUT button. The LCD panel will now read "MIDI TRANSMIT?", asking you if you would like to make a BULK DATA transmission, sending all RX11 pattern and song data via the MIDI OUT terminal. Press the +1/YESE button to transmit—the LCD panel will go blank for a few seconds while the bulk data is being transmitted, then return to the "MIDI TRANSMIT?" display. Press +1/YES again if you want to make another transmission, or press -1/NO to return to the SYSTEM EXCLUSIVE INFORMATION AVAILABLE/UNAVAILABLE selection step. Set SYSTEM EXCLUSIVE INFORMATION transmission to "UNAVAIL" (press the -1/NO button), and press the MIDI OUT button to exit the MIDI transmission mode.

BULK DATA transmission can be started automatically by reception of a BULK DUMP REQUEST signal from an external MIDI device while the RX11 is in the song or pattern modes, if the MIDI OUT button is pressed instead of the +1/YES button in response to the "MIDI TRANSMIT?" display, accessed as described above. If the MIDI OUT button is pressed in response to the "MIDI TRANSMIT?"

display, the RX11 will return to the pattern or song mode, but the SYSTEM EXCLUSIVE AVAILABLE mode will remain active.

MIDI Transmission Parameters

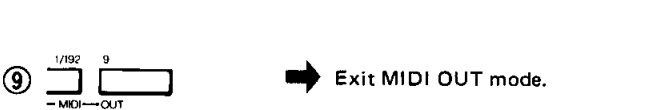
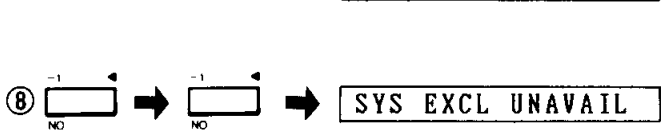
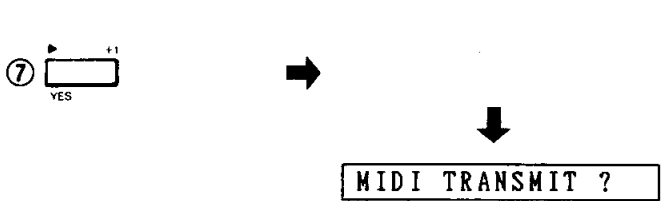
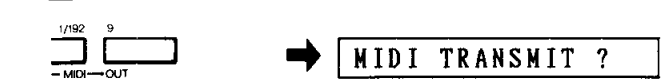
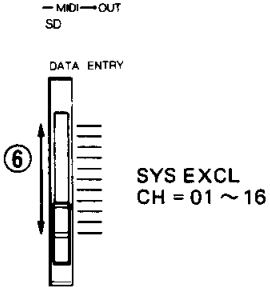
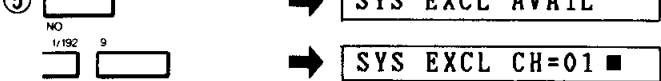
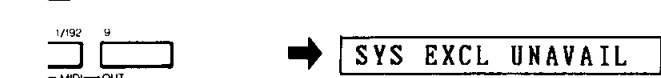
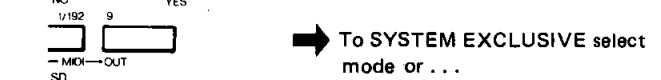
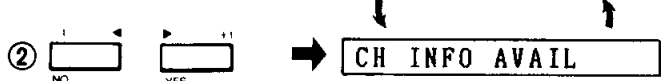
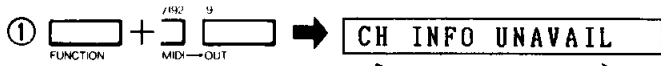

ERROR MESSAGES

No machine is unlimited, and from time to time the RX11 may present with an error message indicating that something has gone wrong—or that you have done something wrong. The error messages that you are likely to encounter are as follows:

PTN MEMORY FULL!

This error message will occur during pattern programming operations, indicating that the RX11 pattern memory is full and can accept no more data. The solution to this problem is to create more memory space by one of the following methods:

1. Delete unwanted patterns.
2. Save the RX11 memory contents onto cassette tape and then clear the memory using the CLEAR function.

SONG MEMORY FULL

This error message will occur during song programming operations, indicating that the RX11 song memory is full and can accept no more data. The solution is to create more memory space by one of the following methods:

1. Delete unwanted songs.
2. Save the RX11 memory contents onto cassette tape and then clear the song memory using the CLEAR function.

WRONG QUANTIZE!

This message will appear if you attempt to use the SWING function with QUANTIZE set to any value except 1/8 or 1/16. QUANTIZE must be reset, or the SWING function cancelled to correct this error.

WRONG SIGNATURE!

This message will appear briefly if a pattern CONNECT COPY operation is attempted, and the combined length of the patterns to be connected exceeds 100 bars, or the patterns to be connected have different time signatures. The message will appear for about 2 seconds and the copy function will be automatically cancelled.

VERIFY ERROR

This message will appear during a cassette verify operation if an error is detected in the data recorded on the tape. Re-save the data and verify again.

LOAD ERROR!

This message indicates that a data error has been encountered during a cassette load operation. Try loading again. If the error persists then check all cassette deck connections and level settings. Cleaning and demagnetizing the cassette recorder's heads might also help.

MIDI DATA ERROR

This message indicates that erroneous data has been received at the MIDI IN terminal. Such errors are generally caused at the transmitting equipment—e.g. the transmitting equipment power is turned OFF or ON while the RX11 is in the MIDI receive mode. In either case, check the RX11 MIDI receive parameters to make sure they are set to match the transmitting device's parameters.

CARTRG NOT READY

This message indicates that you have attempted to enter the cartridge control mode with no cartridge inserted in the cartridge slot, or the cartridge is not properly inserted in the cartridge slot.

FORMAT CONFLICT!

This message indicates that the cartridge loaded in the cartridge slot is not formatted for use with the RX11. Use another cartridge or use the FORMAT function to format the cartridge for the RX11.

CARTRG PROTECTED

This message indicates that you have attempted to either format or write data to a cartridge on which the memory protect switch is set to ON. Turn the cartridge memory protect switch OFF.

ALREADY USED!

This message will appear if you attempt to write a pattern to a cartridge memory location that already contains data, or load a pattern to an RX11 pattern memory location that already contains data.

SPECIFICATIONS

SOUND SOURCE

ROM: 256 KBIT WAVE ROM x 6
NO. OF VOICES: 29

MEMORY CAPACITY

NO. OF PATTERNS: 100
NO. OF SONGS: 10
MAXIMUM NO. OF PARTS WITHIN SONGS: 255

MEMORY PARAMETERS

●PATTERN: INSTRUMENT, ACCENT
●SONG: PAN, INST LEVEL, ACCENT LEVEL, EDIT (PATTERN NUMBER, REPEAT, TEMPO CHANGE)

CONTROLLERS

●SLIDER
VOLUME, TEMPO, DATA ENTRY
●BUTTON
PAN, INST LEVEL, ACCENT LEVEL, ACCENT INSTRUMENT
RIM SHOT, SD (MEDIUM/HI TUNE), TOM1, TOM2, TOM3, BD,
HH OPEN, HH CLOSED, (CLOSED/PEDAL), RIDE, CRASH,
SHAKER/COWBELL, CLAPS, START, STOP/CONTINUE.
●KEY
MODE SELECTOR (PATTERN/SONG, FUNCTION) PATTERN
MODE PARAMETER (REAL TIME WRITE, STEP WRITE,
COPY, SWING, QUANTIZE, CLICK, CLEAR, TEMPO) SONG
MODE PARAMETER (EDIT, INSERT, DELETE, REPEAT,
TEMPO CHANGE, CHAIN) FUNCTION MODE PARAMETER
(SYNC, CASSETTE, CARTRIDGE, SAVE/VERIFY, LOAD,
FORMAT, INST OUTPUT, INST CHANGE, MIDI IN, MIDI
OUT) NUMBER (0-9, 1/4-1/192) +1/YES, -1/NO
●SWITCH
POWER SWITCH

DISPLAY

●LCD: 16 CHARACTERS
●LCD DISPLAY 7 SEGMENTS x 2 COLUMNS
●LED INDICATOR: PATTERN, SONG, CARTRIDGE, EXT
CLK, RUN

CONNECTION TERMINALS AND INTERFACES

●AUDIO OUTPUT: INDIVIDUAL INSTRUMENT OUTPUT
(COWBELL AND RIDE 10 CH) OUTPUT: L/TOM4 AND R/TOM3
(phone jack), PHONES (stereo phone jack, 8-40 ohms)
●CONTROL JACK: FOOT SW
●INTERFACE: CARTRIDGE, CASSETTE (IN, OUT), MIDI (IN,
OUT)

DIMENSIONS AND WEIGHT

●400W x 68H x 270D (mm) (15-3/4" x 2-11/16" x 10-5/8")
●3.1 kg (1 lb. 7oz.)

POWER REQUIREMENTS

US & Canadian Models: 120V (50/60Hz)
General Model: 110-130/220-240V (50/60Hz) selectable

POWER CONSUMPTION

US & Canadian Models:
General Model:

SPECIFICATIONS ARE LIABLE TO CHANGE WITHOUT NOTICE

BLOCK DIAGRAM

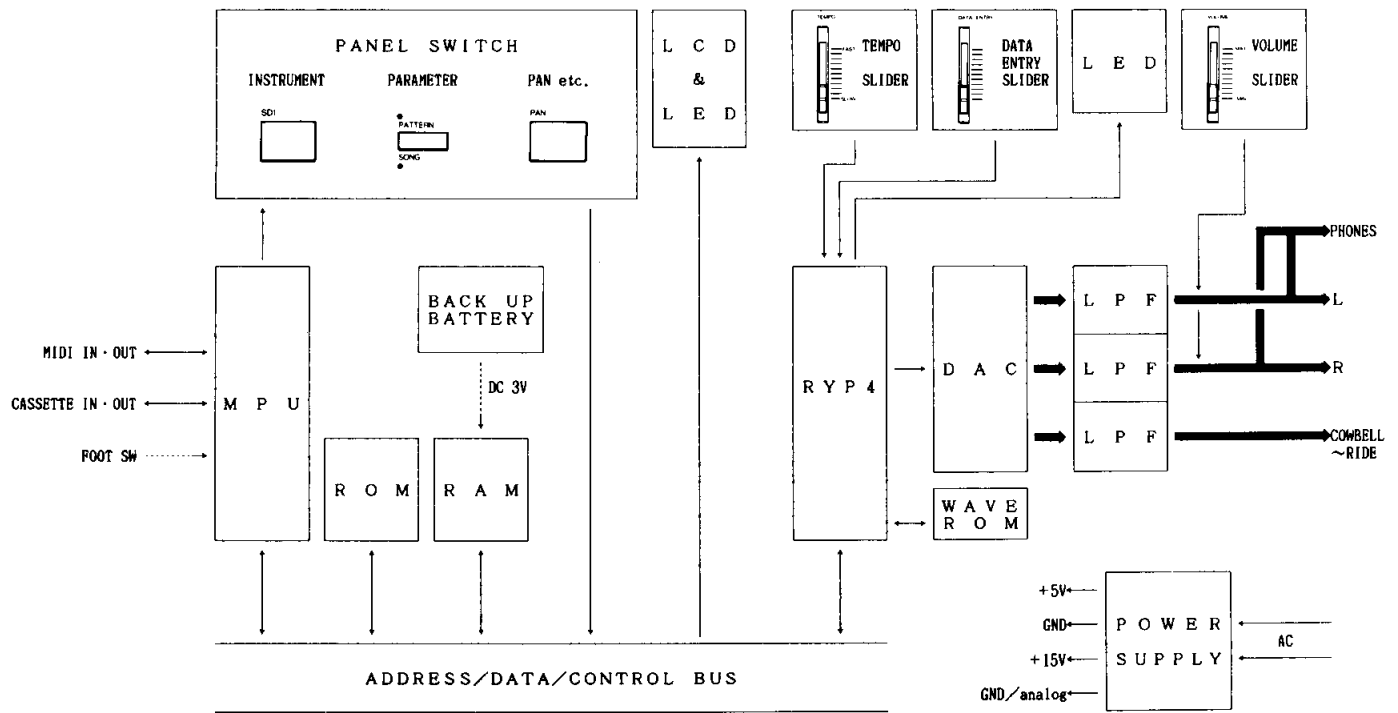

FCC INFORMATION

While the following statements are provided to comply with FCC Regulations in the United States, the corrective measures listed below are applicable world-wide.

This series of Yamaha professional music equipment uses frequencies that appear in the radio frequency range and if installed in the immediate proximity of some types of audio or video devices (within three meters), interference may occur. This series of Yamaha combo equipment has been type tested and found to comply with the specifications set for a class B computing device in accordance with those specifications listed in subpart J of part 15 of the FCC rules. These rules are designed to provide a reasonable measure of protection against such interference. However, this does not guarantee that interference will not occur. If your professional music equipment should be suspected of causing interference with other electronic devices, verification can be made by turning your combo equipment off and on. If the interference continues when your equipment is off, the equipment is not the source of interference. If your equipment does appear to be the source of the interference, you should try to correct the situation by using one or more of the following measures:

Relocate either the equipment or the electronic device that is being affected by the interference. Utilize power outlets for the professional music equipment and the device being affected that are on different branch (circuit breaker or fuse) circuits, or install AC line filters.

In the case of radio or TV interference, relocate the antenna or, if the antenna lead-in is 300 ohm ribbon lead, change the lead-in to a co-axial type cable.

If these corrective measures do not produce satisfactory results, please contact your authorized Yamaha professional products dealer for suggestions and/or corrective measures.

If you cannot locate a franchised Yamaha professional products dealer in your general area contact the Electronic Service Department, Yamaha Corporation of America, 6600 Orangethorpe Ave., Buena Park, CA 90620, U.S.A.

If for any reason, you should need additional information relating to radio or TV interference, you may find a booklet prepared by the Federal Communications Commission helpful:

"How to Identify and Resolve Radio — TV Interference Problems". This booklet is available from the U.S. Government Printing Office, Washington D.C. 20402 — Stock No. 004-000-00345-4.

YAMAHA