

# RX-5 MANUAL

*\*free copy do not pay for this!\**



*Please do Visit the RX5 center for technical info  
audio demo and much more!*

# YAMAHA



**DIGITAL RHYTHM PROGRAMMER**  
**PROGRAMMEUR DE RYTHME NUMERIQUE**  
**DIGITAL RHYTHM PROGRAMMER**

OWNER'S MANUAL  
MODE D'EMPLOI  
BEDIENUNGSANLEITUNG

# INTRODUCTION — HOW TO USE THIS MANUAL

Congratulations on your purchase of the Yamaha RX5 Digital Rhythm Programmer! Your RX5 has been developed through over a century of Yamaha research and design, using state-of-the-art electronic music technology, combined with in-depth knowledge of the art of making music. The RX5 features advanced microcomputer control plus a top-quality digital PCM sound storage and reproduction system. With the RX5 you will be able to program virtually any type of rhythm pattern as well as melodic sequences, and since the instrument sounds are digitally recorded they are virtually indistinguishable from live instruments.

To ensure that the RX5 will give you maximum performance and versatility, we urge you to read this manual carefully while operating the RX5.

The manual begins with the all-important PRECAUTIONS section. The INSTRUMENTS chapter gives you an introduction to the sounds available on the RX5. The next three chapters describe how to create Patterns, Songs and Song Chains. The following MODE chapters contain full descriptions of the operating modes of the RX5. Each chapter contains a brief OVERVIEW, a list of the JOBS (functions) in that mode, and full details of each JOB.

If you encounter any unusual messages on the LCD (Liquid Crystal Display) of your RX5, refer to the ERROR MESSAGES chapter near the end of the manual. Finally, the PATTERN CHART and SONG/CHAIN CHART enable you to keep an accurate written record of the rhythm programs you have created on your RX5, and you can use the "DRUM SET" CHART to record voice editing and key assign parameters for a complete 24-instrument drum set which you have created on your RX5.

And now—it's all up to you. Enjoy your Yamaha RX5 Digital Rhythm Programmer!

# CONTENTS

<b>INTRODUCTION—HOW TO USE THIS MANUAL</b>	
<b>PRECAUTIONS</b> .....	1
<b>CONTROL PANEL</b> .....	2
<b>REAR PANEL/CONNECTIONS</b> .....	4
<b>THE INSTRUMENTS</b> .....	5
PLAYING THE RX5'S INSTRUMENTS .....	5
INSTRUMENT VOLUME .....	6
ACCENTS .....	6
THE REVERSE FUNCTION .....	6
THE DAMP FUNCTION .....	6
THE WAVEFORM DATA CARTRIDGE .....	7
ASSIGNING OTHER VOICES TO INSTRUMENT KEYS .....	8
<b>PATTERN OPERATIONS</b> .....	9
OVERVIEW .....	9
ENTERING THE PATTERN MODE .....	9
PATTERN SELECTION .....	9
PATTERN PLAY .....	9
REAL TIME WRITE MODE .....	10
STEP WRITE MODE .....	11
PATTERN/INSTRUMENT CLEAR .....	12
QUANTIZE FUNCTION .....	12
TEMPO FUNCTION .....	14
CLICK FUNCTION .....	15
SWING FUNCTION .....	15
PATTERN COPY/APPEND .....	16
PATTERN EDITING .....	17
PATTERN MEMORY CHECK .....	19
<b>SONG OPERATIONS</b> .....	20
OVERVIEW .....	20
ENTERING THE SONG MODE .....	20
SONG SELECTION .....	20
SONG PLAY .....	20
REPEAT SONG PLAY .....	21
EDIT SONG MODE .....	21
INSERT FUNCTION .....	22
DELETE FUNCTION .....	23
PART COPY FUNCTION .....	23
REPEATS .....	25
TEMPO CHANGE FUNCTION .....	26
VOLUME CHANGE FUNCTION .....	26
SONG COPY .....	27
SONG CLEAR .....	27
SONG MEMORY CHECK .....	28
THE JOBS .....	28
JOB #01: SEARCH MARK .....	28
JOB #02: SET MARK .....	29
JOB #03: SONG NAME .....	30
JOB #04: INITIAL TEMPO .....	30
<b>SONG CHAIN MODE</b> .....	31
OVERVIEW .....	31
THE JOBS .....	31
ENTERING THE SONG CHAIN MODE .....	31
JOB #01: CHAIN PLAY .....	31
JOB #02: EDIT CHAIN .....	31
JOB #03: CHAIN NAME .....	32
JOB #04: CHAIN CLEAR .....	32
<b>EDIT VOICE MODE</b> .....	34
OVERVIEW .....	34
THE JOBS .....	34
ENTERING THE EDIT VOICE MODE .....	34
JOB #01: SELECT VOICE FOR EDIT .....	34
JOB #02: PITCH EDIT .....	35
JOB #03: ENVELOPE EDIT .....	35
JOB #04: BEND RATE/RANGE .....	36
JOB #05: VOICE LEVEL .....	37
JOB #06: LOOP ON/OFF .....	37
JOB #07: STORE VOICE .....	38
JOB #08: INITIALIZE VOICE .....	38
JOB #09: RECALL EDIT .....	39
EDIT COMPARE .....	39
<b>KEY ASSIGN MODE</b> .....	40
OVERVIEW .....	40
THE JOBS .....	40
ENTERING THE KEY ASSIGN MODE .....	40
JOB #01: VOICE ASSIGN .....	40
JOB #02: PARAMETER ASSIGN .....	41
JOB #03: MULTI VOICE .....	42
JOB #04: MULTI STEP .....	43
JOB #05: ACCENT LEVELS .....	43
JOB #06: OUTPUT CHANNEL ASSIGN .....	44
JOB #07: SAVE KEY DATA .....	44
JOB #08: LOAD KEY DATA .....	45
JOB #09: COPY VOICE .....	45

# CONTENTS

<b>CARTRIDGE MODE</b> .....	46	JOB #08: DEVICE NUMBER .....	65
OVERVIEW .....	46	JOB #09: RECEIVE BULK .....	65
THE JOBS .....	46	JOB #10: TRANSMIT BULK .....	66
ENTERING THE CARTRIDGE MODE .....	46	<b>ERROR MESSAGES</b> .....	67
SAVING DATA (JOBS #01 — #04) .....	46	GENERAL ERROR MESSAGES .....	68
LOADING DATA (JOBS #11 — #14) .....	48	CARTRIDGE MODE ERROR MESSAGES .....	69
VERIFYING DATA (JOBS #21 — 24) .....	49	CASSETTE MODE ERROR MESSAGES .....	69
FORMATTING (JOB #30) .....	51	<b>SPECIFICATIONS</b> .....	70
<b>CASSETTE MODE</b> .....	52	<b>EDIT VOICE BLOCK DIAGRAM</b> .....	71
OVERVIEW .....	52	<b>MIDI IMPLEMENTATION CHART</b>	
THE JOBS .....	52	<b>PATTERN CHART</b>	
ENTERING THE CASSETTE MODE .....	52	<b>SONG/CHAIN CHART</b>	
SAVING DATA (JOBS #01 — #05) .....	52	<b>“DRUM SET” CHART</b>	
LOADING DATA (JOBS #11 — #15) .....	53		
VERIFYING DATA (JOBS #21 — 25) .....	55		
<b>SYNC MODE</b> .....	56		
OVERVIEW .....	56		
SELECTING SYNC MODES .....	56		
TAPE SYNC APPLICATIONS .....	57		
<b>UTILITY MODE</b> .....	58		
OVERVIEW .....	58		
THE JOBS .....	58		
ENTERING THE UTILITY MODE .....	58		
JOB #01: REMAINING PATTERN MEMORY .....	58		
JOB #02: REMAINING SONG MEMORY .....	58		
JOB #03: MEMORY PROTECT .....	58		
JOB #04: CHANGE VOICE .....	59		
JOB #05: CLEAR ALL PATTERNS .....	59		
JOB #06: CLEAR ALL SONGS .....	60		
<b>MIDI MODE</b> .....	61		
OVERVIEW .....	61		
THE JOBS .....	62		
ENTERING THE MIDI MODE .....	62		
JOB #01: CHANNEL MESSAGE .....	62		
JOB #02: RECEIVE CHANNEL .....	62		
JOB #03: TRANSMIT CHANNEL .....	63		
JOB #04: NOTE NUMBER ASSIGN .....	63		
JOB #05: INITIALIZE NOTE .....	64		
JOB #06: E.G. VELOCITY .....	65		
JOB #07: GATE TIME .....	65		

# PRECAUTIONS

- Avoid placing the RX5 in locations exposed to direct sunlight or high temperatures, excessively high or low humidity, high dust concentration, or vibration.
- Be sure to connect the RX5 to an AC power supply that meets the power supply specifications listed on the accompanying PA-1210 12-volt power supply convertor.
- If there is any danger of lightning occurring nearby, turn the RX5 off, remove the power plug from the wall socket in advance.
- Be sure to make all connections properly, as shown in the REAR PANEL/ CONNECTIONS section.
- To avoid damaging your speakers and other playback equipment, turn off the power of all related equipment before making connections.
- Do not use excessive force in handling control switches and knobs.
- To avoid broken cords and short circuits, be sure to unplug all connectors by grasping the respective plugs—NOT the cords.
- Remove the power plug from the AC mains socket if the unit is not to be used for an extended period of time.
- Remove all plugs and connections if the unit is to be transported, to prevent damage to the cords and jacks.
- Do not use solvents or paint thinners to clean the unit. Do not use insecticides or other pressurized spray products in proximity to the unit. Wipe off the exterior using a mild detergent on a cloth, then dry with a soft cloth.

## EFFECTS ON OTHER ELECTRONIC EQUIPMENT

Since this unit incorporates digital circuitry, simultaneous use of other equipment such as TVs, radios, etc. in close proximity may cause noise and erroneous operation. If this occurs, separate the affected units sufficiently to eliminate the problem. It is also a good idea to use separate line filters on each piece of equipment.

# CONTROL PANEL

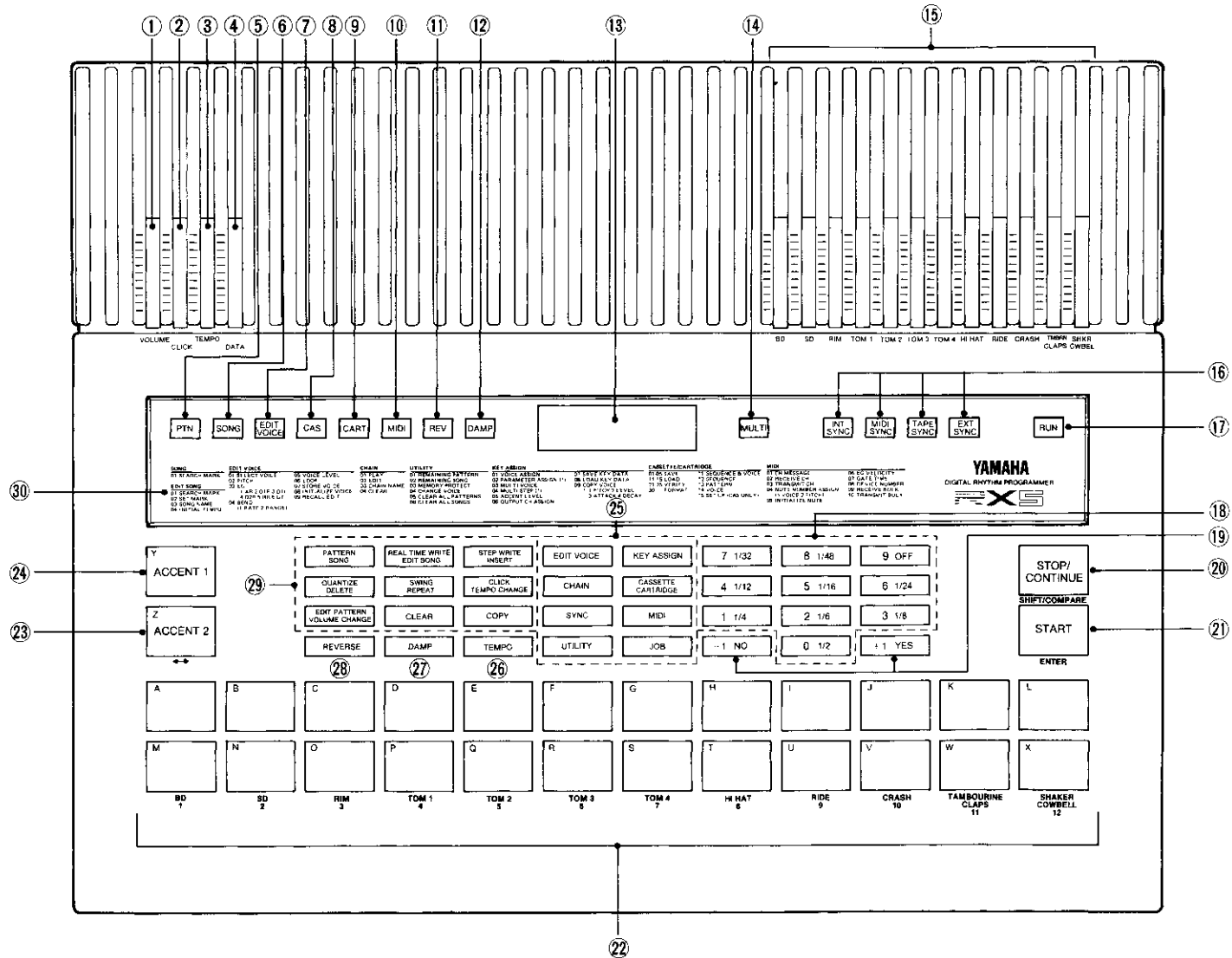

1. **MASTER VOLUME** fader control. This controls the overall level of ONLY the HEADPHONE and STEREO AUDIO OUTPUTS.
2. **CLICK VOLUME** fader control.
3. **TEMPO** slider control. When this slider is moved the tempo will jump to the value corresponding to the position of the slider.
4. **DATA ENTRY** slider control—for setting of all parameter values. When this slider is moved the selected parameter will jump to the value corresponding to the position of the slider.
5. **PTN LED**—lights when a Pattern is played or recorded.
6. **SONG LED**—lights when a Song is played or edited.
7. **EDIT VOICE LED**—lights when a voice is edited.
8. **CAS LED**—lights when the Cassette Mode is used.
9. **CART LED**—lights when the Cartridge Mode is used.
10. **MIDI LED**—lights when the MIDI Mode is used.
11. **REV LED**—lights when the Reverse function is used.
12. **DAMP LED**—lights when the Damp function is used.
13. **LCD** (Liquid Crystal Display)—shows information regarding current status of the RX5. Backlit, 16 characters X 2 lines.
14. **MULTI LED**—lights when the Multi Mode is used.
15. **INSTRUMENT VOLUME** fader controls—to adjust individual levels of outputs 1 thru 12.
16. **SYNC LED'S**—light when RX5 sync is set to Internal Clock (INT SYNC), External MIDI Clock (MIDI SYNC), External Tape Sync (TAPE SYNC) or External Non-MIDI Sync (EXT SYNC).
17. **RUN LED**—lights when a Pattern, Song or Chain is played, or when a Pattern is recorded.
18. **NUMERIC KEY PAD**—for setting all parameter values, and selection of Job, Pattern, Song and Chain numbers.
19. **-1/NO** and **+1/YES** keys—for setting of parameter values, Pattern numbers, voices, and all NO and YES entries. In most data entry operations, press and release one of these keys to change data by one step, or hold down a key for rapid continuous data change.
20. **STOP/CONTINUE** key—to stop recording or play, or continue playback. Also functions as EDIT COMPARE key (when editing voices) and SHIFT key (when writing Song names, Chain names or Search marks.)
21. **START** key. Starts play and record. Also functions as ENTER key (when entering data such as new parameter values.)
22. **INSTRUMENT KEYS**—A thru X, arranged in 12 pairs, corresponding to the 12 output channels. Also used for entering letters (A thru X) for Song names and Chain names and Search marks.
23. **ACCENT 2** key—adds a programmed level change to any voice. Also functions as CURSOR MOVE key, and to enter the letter "Z" in Song names, Chain names and Search marks.
24. **ACCENT 1** key—adds a programmed level change to any voice. Also used to enter the letter "Y" in Song names, Chain names and Search marks.
25. **MODE/JOB** keys—for selection of Modes and Jobs.
26. **TEMPO** key—for tempo setting.
27. **DAMP** key—for damping of sustained sounds. Also used as PERIOD key when entering name of Song, Chain or Search mark.
28. **REVERSE** key—reverses all instrument sounds. Also used as SPACE key when entering name of Song, Chain or Search mark.
29. **SONG/PATTERN** operation keys. Refer to the PATTERN OPERATIONS and SONG OPERATIONS chapters for details.
30. **JOB TABLE**. Lists all available Jobs, under Mode headings.



# REAR PANEL/CONNECTIONS

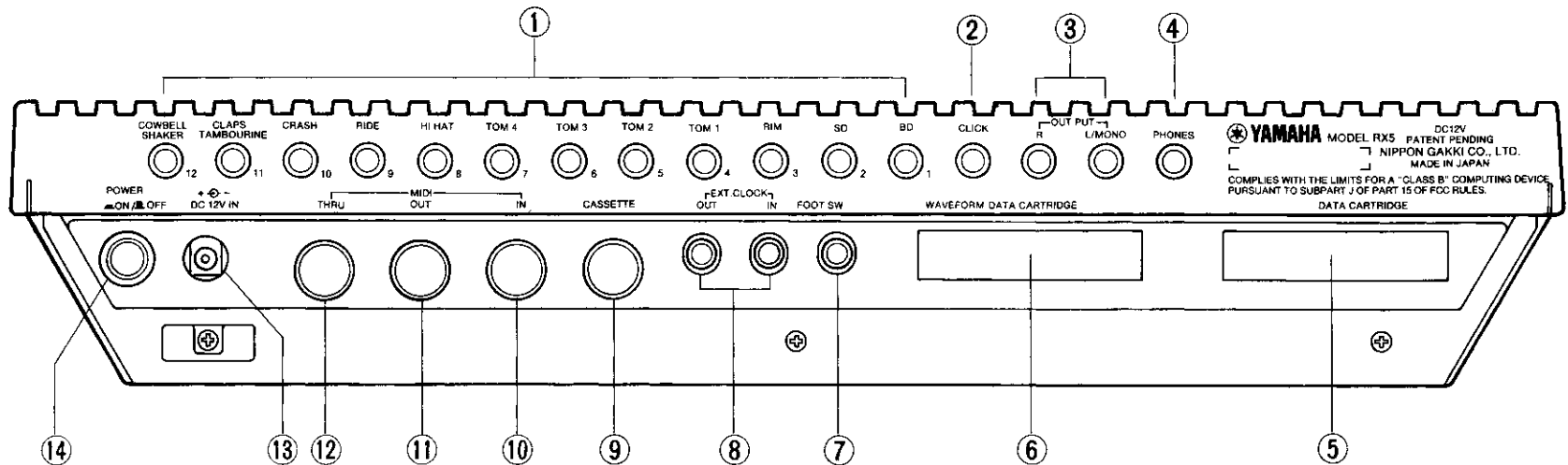

1. **INDIVIDUAL AUDIO OUTPUTS.** For output channels 1 thru 12. The instrument names on each output refer to the RX5's Internal voices.
2. **CLICK OUTPUT.** For monitoring of the Click (metronome) signal
3. **STEREO AUDIO OUTPUTS.** For stereo monitoring of the RX5. Stereo positions are fixed for each of the 12 output channels. If a cable is connected to the L/MONO output ONLY, the RX5 can be monitored in mono.
4. **PHONES OUTPUT.** For monitoring the RX5 with stereo headphones.
5. **DATA CARTRIDGE SLOT.** For the Yamaha RAM4 Data Cartridge.
6. **WAVEFORM DATA CARTRIDGE SLOT.** For the Yamaha Waveform Data Cartridge.
7. **FOOT SWITCH CONNECTION.** For a Yamaha footswitch, which can be used to control the RX5's STOP and START functions.
8. **EXTERNAL CLOCK IN and OUT CONNECTORS.** For transmission and reception of Clock signals, when using the RX5 with non-MIDI external devices such as sequencers or other drum machines.
9. **CASSETTE INTERFACE.** For connection to a cassette recorder, when saving and loading data. Also used when recording or receiving Tape Sync signals.
10. **MIDI IN** connector. For reception of MIDI signals, such as when the RX5 is controlled by an external MIDI sequencer or keyboard.
11. **MIDI OUT** connector. For transmission of MIDI signals, such as when the RX5 is controlling an external MIDI sequencer or keyboard, or sending Bulk data to another RX5.
12. **MIDI THRU** connector. MIDI signals received at the MIDI IN connector will be passed unchanged via this connector, to another MIDI device, when the RX5 is part of a chain of MIDI devices.
13. **DC 12—VOLT INPUT.** For power supply from the Yamaha PA-1210 Power Supply Unit.
14. **POWER ON/OFF SWITCH.**

# THE INSTRUMENTS

**NOTE:** A brief output pulse appears at the RX5 outputs when the power is initially turned on. To prevent this from possibly damaging your speaker system, turn the RX5 on first, then your sound system.

## PLAYING THE RX5 INSTRUMENTS

The RX5 instruments can be played in real-time (without programming patterns or songs) by tapping on the black instrument keys. Using either a pair of headphones plugged into the PHONES jack, or a sound system connected to the RX5 STEREO AUDIO OUTPUTS or INDIVIDUAL AUDIO OUTPUTS, turn the RX5 ON and tap any of the black instrument keys, while adjusting the MASTER VOLUME and/or INSTRUMENT VOLUME

faders until you can hear the RX5's instruments at a comfortable listening level. You can now "play" all the instrument keys to become familiar with their sound. The sounds you will hear initially will be RX5's internal voices. They are pre-assigned to the instrument keys as shown in the following chart.

### INSTRUMENT KEYS AND INTERNAL VOICES

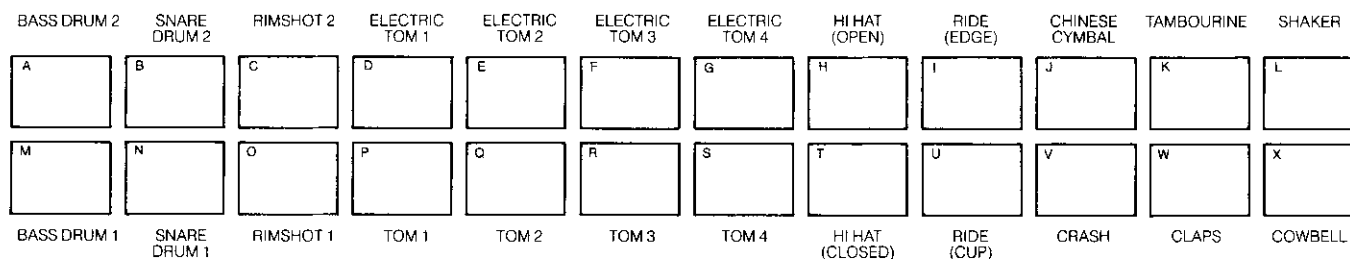

If you are using the RX5's stereo outputs, you will find that the instruments are panned to different positions in the stereo field. Each pair of instrument keys (i.e., each output channel) has a set stereo pan position. If you are using the individual outputs you can, of course, use the pan controls on your mixer to pan the instruments to any desired position. The following chart indicates the stereo positions corresponding to each pair of instrument keys.

- Stereo positions are indicated by numbers. 15 means LEFT, 1 means RIGHT, and the other numbers are equally spaced in between (8 means CENTER). These are equivalent to the stereo numbers 1/15 thru 15/1 on the Yamaha RX11 and RX15 Digital Rhythm Programmers.

### OUTPUT CHANNELS' STEREO POSITIONS

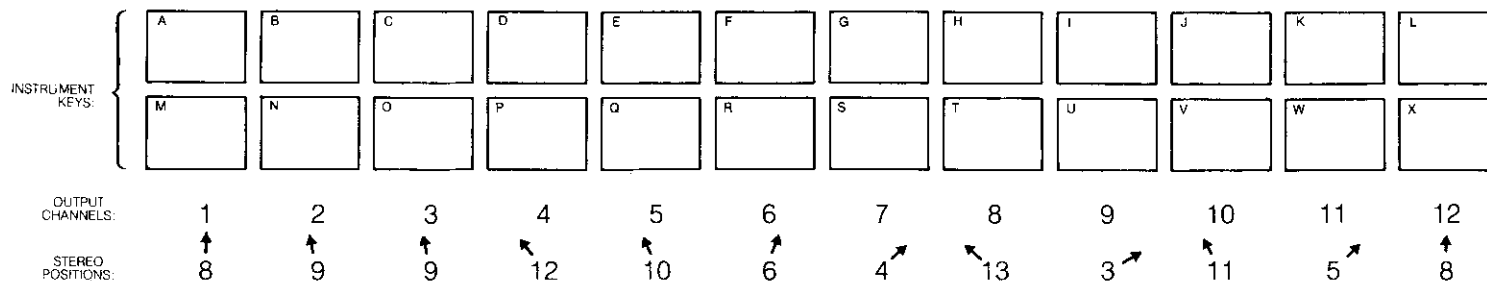

Up to 12 sounds may be played simultaneously on the RX5. However, if you press two instrument keys in the same pair (for example, **A** and **M**, or **L** and **X**) you will only hear one sound, because only one sound can be output from each of the RX5's 12 output channels.

## INSTRUMENT VOLUME

Using the **INSTRUMENT VOLUME** fader controls, you can adjust the output volume of each pair of instrument keys (**A** and **M**, **B** and **N**, etc.) and balance the overall sound of the RX5.

- The level of each voice can be independently programmed independently of the **INSTRUMENT VOLUME** fader setting. Refer to **EDIT VOICE JOB #05**.
- The level of each instrument key can also be independently programmed. Refer to **KEY ASSIGN JOB #02**.

## ACCENTS

Pressing any instrument key while holding either of the green **ACCENT** keys causes that instrument to sound at its **ACCENT 1** or **ACCENT 2** level. This applies whether the RX5 is being played in real time, or programmed in either the Real Time Write or Step Write Modes. Accents allow you to add natural dynamics to your drum patterns.

Two accent levels can be set for each instrument key. Refer to **KEY ASSIGN JOB #05**.

## THE REVERSE FUNCTION

Pressing the Reverse key allows you to play any of the RX5's voices in reverse. This applies whether the RX5 is being played in real time, or programmed in either the Real Time Write or Step Write Modes. When the Reverse key is ON, its LED will light.

**NOTE:** Using the Reverse function plays a voice with its ORIGINAL E.G. (Envelope Generator) parameter values (though of course reversed) even if these values have been edited using **VOICE EDIT JOB #03**. Also, the Reverse function does NOT reverse Pitch Bend parameters (refer to **VOICE EDIT JOB #04**) so if your voice bends UP in pitch, it will do the same when reversed.

## THE DAMP FUNCTION

The Damp function allows you to damp sustained sounds, a particularly realistic effect when used with cymbals. This function can only be used when the RX5 is in the Real Time Write Mode (refer to **REAL TIME WRITE MODE** in the **PATTERN OPERATIONS** chapter). This is the procedure for damping sounds:

1. Record a Pattern, using the Real Time or Step Write method.
2. Press **PATTERN SONG** to enter the Pattern Mode, then press **REAL TIME WRITE** and **START**. You can now listen to the Pattern you have written.

3. Press the Damp key. The **DAMP** LED will light.
4. You can now damp any note in the Pattern, by pressing the appropriate instrument key. For example, if you press the **CRASH** key just after a cymbal crash sound is heard, the sound will be damped at exactly the point at which you pressed the **CRASH** key. When the Pattern playback recycles, you will hear the effect of the Damp.

**NOTE:** The Damp function is dependent on the Quantize Rate. (Refer to the **QUANTIZE** section of the **PATTERN OPERATIONS** chapter). The Damp point will be moved to the nearest Quantize division. Also, if you damp a note during the first half of the **FIRST** quantize division following the start of the note, the note will be cleared (erased). So, for "free time" damping, it is best to turn the Quantize OFF.

5. Press **DAMP** again to exit the Damp function. The **DAMP** LED will go out. The RX5 will continue in the Real Time Write Mode. You can now exit this mode in the normal manner, or enter more notes, which can also be damped (return to Step 3 above).
- The Damp function can also be controlled from an external MIDI keyboard. The **MIDI MODE** chapter describes how to control the RX5 from a MIDI keyboard. The Damp function can be controlled as follows:

1. Connect the **MIDI OUT** of the MIDI keyboard to the **MIDI IN** of the RX5. Set the RX5 so that it can be "played" from the MIDI keyboard. Refer to **MIDI JOB #04**.
2. Start writing a Pattern in the Real Time Mode.
3. Press **DAMP**. The **DAMP** LED will light.

Now, when you "play" the RX5 from the MIDI keyboard, it will receive **NOTE OFF** signals as well as **NOTE ON** signals. When it receives a **NOTE OFF** signal (as you release a key) the instrument sound will be damped. This can be especially convenient if, for example, you are using the RX5 in its Tunable Note Mode (refer to **MIDI JOB #04**) to play an Electric Bass voice — you can play clearly articulated notes, which are held as long as you hold a key, just as with a real bass (but check the following **NOTE** when doing this!)

**NOTE:** The Damp function is dependent on the Quantize Rate. (Refer to the **QUANTIZE** section of the **PATTERN OPERATIONS** chapter). The Damp point will be moved to the nearest Quantize division. Also, if you damp (release) a note during the first half of the **FIRST** quantize division following the start of the note, the **NOTE OFF** signal will be ignored, and the note will NOT be damped. So, for "free time" damping, it is best to turn the Quantize OFF.

4. Press **DAMP** again to exit the Damp function. The **DAMP** LED will go out. The RX5 will continue in the Real Time Write Mode. You can now exit this mode in the normal manner, or enter more notes in the normal manner. At any time while in the Real Time Mode, you can press **DAMP** again to activate the Damp Mode.

**NOTE:** While using the Damp function, you can NOT enter any new notes, even though the RX5 is in the Real Time Write Mode. You can, however, clear notes during the Damp function.

## THE WAVEFORM DATA CARTRIDGE

The RX5 comes with a Yamaha Waveform Data Cartridge as standard. This cartridge contains a further 28 voices, listed below, which can be assigned to any instrument keys on the RX5.

### WAVEFORM DATA CARTRIDGE VOICE LIST

1:	<b>SD 3</b>	Snare Drum
2:	<b>BD 3</b>	Bass Drum
3:	<b>CgaHMT</b>	Conga (High Muted)
4:	<b>CgaHOP</b>	Conga (High Open)
5:	<b>CgaLO</b>	Conga (Low)
6:	<b>BgoHI</b>	Bongo (High)
7:	<b>BgoLO</b>	Bongo (Low)
8:	<b>TimblH</b>	Timbale (High)
9:	<b>TimblL</b>	Timbale (Low)
10:	<b>AgoHI</b>	Agogo (High)
11:	<b>AgoLO</b>	Agogo (Low)
12:	<b>Cuica</b>	Cuica
13:	<b>Cstnt</b>	Castanet
14:	<b>Whstl</b>	Whistle
15:	<b>Timpn</b>	Timpani
16:	<b>GlsCsh</b>	Glass Crash effect
17:	<b>Gun</b>	Gunshot effect
18:	<b>FMprc1</b>	Synth-percussion (high)
19:	<b>FMprc2</b>	Synth-percussion (medium)
20:	<b>FMprc3</b>	Synth-percussion (low)
21:	<b>EbassH</b>	Electric Bass Gtr (high)
22:	<b>EbassL</b>	Electric Bass Gtr (low)
23:	<b>DXorch</b>	Synth-orchestra
24:	<b>DXmrm</b>	Synth-marimba
25:	<b>DXclav</b>	Synth-clavinet
26:	<b>Hey</b>	Vocal Sound
27:	<b>Wao</b>	Vocal Sound
28:	<b>Ooo</b>	Vocal Sound

The cartridge should be inserted into the WAVEFORM DATA CARTRIDGE slot on the RX5's rear panel while the power is OFF. Then turn the RX5 power ON.

If this is the first time you have inserted a Waveform Data Cartridge, or if you have inserted a different Waveform Data Cartridge to the one that was previously inserted, the LCD will show:

**Different Crt !!  
Init Crt Voice?**

You can now choose to either accept the new cartridge voices, or retain the voices that are now in the RX5's Voice Edit Memory (which came from the previous cartridge that was used).

If you DO NOT wish to accept the new cartridge voices, press **-1/NO**. The RX5 will return to the Select Pattern Mode.

If you DO wish to accept the new cartridge voices, press **+1/YES**. The LCD will show

**Different Crt !!  
Are you sure ?**

You now have another chance to cancel the new cartridge voices, by pressing **-1/NO**.

To accept the new cartridge voices, press **+1/YES** again. The RX5 will return to the Select Pattern Mode.

Refer to the next section for details on how you can assign the cartridge voices to the instrument keys.

**NOTE:** If you turn on the RX5 without having inserted a Waveform Data Cartridge, keys to which a cartridge voice was assigned will not sound. Also, if you select a function in which the LCD displays voices (for example, KEY ASSIGN JOB #01, described in the next section) the LCD will show the following types of displays.

**Voice Assign  
keyA :Crt-----**

Cartridge voice was assigned to this key

**Voice Assign  
keyA :Cp1-----**

Copied Voice location assigned to this key contained a Cartridge voice

Turn the RX5 power OFF again, and insert a Waveform Data Cartridge.

## ASSIGNING OTHER VOICES TO INSTRUMENT KEYS

Using KEY ASSIGN JOB #01, you can assign any voices from the three voice memories (Internal, RAM, Cartridge) to the 24 instrument keys. The following Key Assign chart lists

all the instruments (and RAM positions) available at each pair of instrument keys, in their factory preset locations.

KEY ASSIGN CHART

		A	B	C	D	E	F	G	H	I	J	K	L
INSTRUMENT KEYS:													
		M	N	O	P	Q	R	S	T	U	V	W	X
INTERNAL VOICES:		BD 1 BD 2	SD 1 SD 2	RIM 1 RIM 2	E.Tom 1 Tom 1	E.Tom 2 Tom 2	E.Tom 3 Tom 3	E.Tom 4 Tom 4	HH clos HH open	Edge Cup	China Crash	Tambrn Claps	Shaker Cowbel
CARTRIDGE VOICES:		BD 3 Timprn	SD 3 FM prc 1	Cga HMT DX mimb	Cga Hop TimblH	Cga LO Timbl L	Bgo HI FM prc 2	Bgo LO FM prc 3	Ago HI Cstnt	Ago LO Whstl DX clav	GlsCsh Gun DX orch	Hey Wao Ooo	Cuica E bass H E bass L
RAM	Position: Voice:	Cp1 BD 1	Cp2 SD 1	Cp3 RIM 1	Cp4 Tom 1	Cp5 Tom 2	Cp6 Tom 3	Cp7 Tom 4	Cp8 HH clos	Cp9 Cup	Cp10 Crash	Cp11 Claps	Cp12 Cowbel

- The RX5's RAM allows you to copy up to 12 internal or Cartridge voices, and edit them to make new voices. Of course, you can edit voices in their original locations, but the RAM conveniently enables you to have a further 12 voices instantly available — and assign them to any key. On the LCD, RAM voice names are preceded by "Cp", which stands for "Copied". Refer to KEY ASSIGN JOB #09 to see how to copy voices into the RAM. RAM stands for Random Access Memory.

### OPERATION

- Press **KEY ASSIGN**, then select Job #01 by pressing **JOB** then "0" then "1".
- Press the instrument key to which a voice is to be assigned. Example: key "A".

**Voice assign  
keyA :Int-BD 1**

- Use the **-1/NO** and **+1/YES** keys to step through the voices which are available at the selected key. When the LCD shows the desired voice, it is automatically assigned to the selected key. Internal voices are preceded by "Int", Copied voices are preceded by "Cp" and Cartridge voices are preceded by "Crt" Example: Cartridge voice BASS DRUM 3.

**Voice assign  
keyA :Crt-BD 3**

- Press any Mode key, or the **PATTERN/SONG** key, to exit the KEY ASSIGN Mode.
- You can also assign voices to keys other than those shown in the above chart, enabling you to set any voice in any stereo position, when using the RX5's stereo outputs. Refer to KEY ASSIGN JOB #09 to see how to re-assign Internal voices to any key. Refer to KEY ASSIGN JOB #06 to see how to re-assign Copied and Cartridge voices to any key.

# PATTERN OPERATIONS

## OVERVIEW

The Pattern operations available on the RX5 let you:

- Write (record) up to 100 rhythm Patterns, using either Real Time Write or Step Write.
- Select a Pattern and play it at any tempo.
- Clear (Erase) a Pattern, or a single instrument in a Pattern.
- Alter Pattern Write functions, including Quantize, Swing and Click.
- Copy or append (connect) Patterns.
- Edit Patterns (alter 5 parameters relating to individual notes).
- Check the remaining Pattern memory of the RX5.

The RX5 contains a variety of factory-programmed Patterns in Pattern locations 00 thru 54. These include basic rock rhythms, complex fills, syn-drum type sequences, and interesting melodic Patterns. These Patterns are permanently stored in the Rx5's internal memory. So if you clear them, or edit (alter) them to make your own Patterns, the original preset Patterns are still available and can be re-loaded into the Pattern locations simply by holding the **ACCENT 1** key while you turn the RX5's power on.

**NOTE:** Some of the Song/Pattern Operation keys on the RX5 have two functions. The UPPER function written on each key applies to the Pattern Mode.

## ENTERING THE PATTERN MODE

- All Pattern operations are preceded by entering the Pattern Mode.

When you turn on the RX5, the Pattern Select Mode is automatically selected (unless you have inserted a different Waveform data Cartridge than the one that was previously used).

If the RX5 is already in use, in a different mode, press **PATTERN/SONG**. Repeated pressing of this key switches the RX5 between the Pattern Mode and the Song Mode. When the Pattern Mode is selected, the PTN (Pattern Mode) LED will light. The LCD will show the last Pattern number that was selected, plus its time signature and number of bars (measures). You'll also see a flashing cursor. Whenever this appears, it means you can enter data relating to the parameter adjacent to the cursor—in this case, the Pattern number.

You will also see a "w" in the right upper corner of the LCD if the Pattern already contains data ("w" stands for "written"). This is a more convenient way of selecting a Pattern in a distant number range.

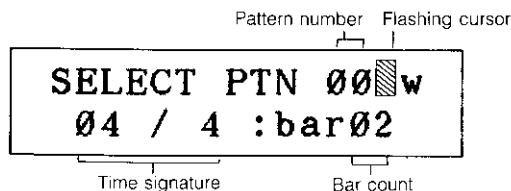

## PATTERN SELECTION

**FUNCTION** To select a Pattern for play, editing, etc. To select an empty Pattern for writing.

The RX5 can store up to 100 Patterns, numbered 00 thru 99. Once you have selected a Pattern, you can then play the Pattern, edit it, copy it, clear (erase) it and write on it (to add more notes).

You can also select an empty Pattern (one that contains no data) prior to writing a new Pattern.

**OPERATION** In the Pattern Select Mode, there are two methods of selecting Patterns.

### 1. -1/NO AND +1/YES KEYS

This is a convenient way of selecting an adjacent or nearby Pattern.

Pressing the -1/NO key selects the Pattern number immediately BELOW the current Pattern number.

Pressing the +1/YES key selects the Pattern number immediately ABOVE the current Pattern number.

### 2. NUMERIC KEY PAD

This is a convenient way of selecting a Pattern in a distant number range.

Use the Numeric Key Pad to enter a two-digit Pattern number. Pattern numbers below 10 must be preceded by a zero. For example, for Pattern 5, enter "0" then "5".

## PATTERN PLAY

**FUNCTION** Continuous play of a selected Pattern.

Once a Pattern is written, the Pattern Play function will repeatedly play the Pattern until you stop play.

## OPERATION

1. After selecting a Pattern, press **START**.

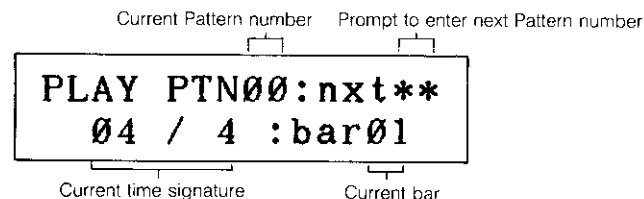

During play, the RUN LED will light. Also, as Pattern 00 is a two-bar Pattern, the LCD will alternate between bar 1 and bar 2, as these bars are played.

2. New Patterns can be selected during play, using either of the two methods described in PATTERN SELECTION. The newly selected Pattern will commence playing immediately after the last beat of the first Pattern.
3. To stop play, press **STOP/CONTINUE**. The RUN LED will go out, and the LCD will show the bar in which play was stopped.
4. To restart play, press **START** to play from the beginning of the Pattern, or **STOP/CONTINUE**, to play from the point at which play was stopped.

- During Pattern Play, you can alter the Tempo, turn on the Click function and change the Click rate. These functions are described later in this chapter.

## REAL TIME WRITE MODE

**NOTE:** The Quantize Function, described later in this chapter, needs to be understood before you can write a Pattern. We suggest that you read the Quantize section, after reading this section, before writing a Pattern.

### FUNCTION Write a Pattern using the Real Time Write function.

This is the first of two ways of writing Patterns on the RX5. It lets you “play” a Pattern on the instrument keys, while listening to a click guide. You can add instruments and rhythms until the Pattern is complete. The advantage of this method is that you can actually hear the Pattern being built up as you write it, as opposed to Step Write, where a Pattern is built up without hearing it.

## OPERATION

### SETTING PATTERN PARAMETERS

Prior to writing a new Pattern its parameters—the time signature and length (in bars)—must be set.

1. In the Pattern Mode, press **REAL TIME WRITE**. The LCD will show the “default” setting of 4/4, one bar length.

**REAL WRITE PTN00**  
**04 / 4 :bar01**

Time signature

Pattern length

**NOTE:** If the selected Pattern already contains data, the cursor will not appear, as time signature and Pattern length are already fixed. You can now write on this Pattern, to add extra notes, if desired.

- If the Memory Protect is ON, the LCD will show “MEMORY PROTECTED” when Real Time Write is selected, indicating that writing cannot be carried out. Use UTILITY JOB #03 to turn off the Memory Protect function.

2. To set the first part of the time signature of the Pattern, use the Numeric Key Pad to enter a two-digit number. Range: 01—99.
3. Press **ACCENT 2** to move the cursor to the next position, and use the Numeric Key Pad to set the second part of the time signature.

**NOTE:** This time, refer to the fraction numbers written on each key. Numbers available are 1/2, 1/4, 1/6, 1/8, 1/12, 1/16, 1/24 and 1/32. (1/48 can NOT be used for time signature).

4. Press **ACCENT 2** to move the cursor to the Pattern Length position, and use the Numeric Key Pad to enter a two-digit number, corresponding to the number of bars in the Pattern. Range: 01—99.

Example: Time Signature 6/8, Pattern Length 4 bars.

**REAL WRITE PTN00**  
**06 / 8 :bar04**

You can use the **ACCENT 2** key again to move the cursor, should you wish to change any settings prior to writing.

- If the default settings (4/4 time, 1 bar) are acceptable, steps 2 thru 4 can be omitted.
- You can exit the Real Time Write Mode at any time by pressing **STOP/CONTINUE**.

### WRITING A PATTERN

- When you write a Pattern, you will hear a Click guide, with an accent on the first beat of each bar. This can be set at different rates and Levels, as described later in this chapter.
- The Tempo can be set in a number of ways, as described later in this chapter.

1. Once the Pattern parameters have been set, press **START** to commence writing. The RUN LED will light, and the LCD will show the current bar being written (if the Pattern is over one bar in length). The RX5 will continue cycling through the Pattern, while you build up a Pattern.
2. Write the Pattern by playing on the instrument keys. You can play one instrument at a time, listen to it as the Pattern recycles, and gradually add other instruments. Accented beats can be entered by holding down one of the green **ACCENT** keys while playing an instrument. (Refer to “ACCENTS” in THE INSTRUMENTS chapter). Mistakes can be erased by holding the **CLEAR** key, and tapping the instrument key at the time of the note which is to be cleared. During Real Time Write, you can alter the Tempo, Quantize, Swing and Click functions. These functions are described later in this chapter.

- Once you've written a Pattern, press **STOP**. The RUN LED will go out. You can now play your Pattern by pressing **START**. You can also select another Pattern for writing: an empty one, to create a new Pattern, or an already-written Pattern to which you can add new instruments or notes.

**NOTE:** When adding new data to a previously-written Pattern, if you write a note where a previously-written note occurs on the same output channel, the original note will be erased. Each output channel corresponds to a pair of instrument keys (A and M, B and N, etc.) The RX5 is a polyphonic unit, with a maximum capacity of 12 notes sounding at any one time.

## STEP WRITE MODE

**NOTE:** The Quantize Function, described later in this chapter, needs to be understood before you can write a Pattern. We suggest that you read the Quantize section, after reading this section, before writing a Pattern.

### FUNCTION Write a Pattern using the Step Write function.

This is the second of two ways of writing Patterns on the RX5. It lets you create a Pattern, using the instrument keys to enter single notes at pre-selected beat intervals. You add instruments and rhythms one at a time until the Pattern is complete. This is an ideal way for creating perfectly-timed Patterns, especially if reading from a score. It also allows you to create Patterns that are too complex or rapid to be played in Real Time.

- You can keep a written record of a Pattern as you write it. Refer to the PATTERN CHART at the end of this manual.

## OPERATION

### SETTING PATTERN PARAMETERS

Prior to writing a new Pattern its parameters—the time signature and length (in bars)—must be set. This is described in the REAL TIME WRITE MODE section of this chapter. Briefly, this is the Pattern Parameter setting procedure.

- In the Pattern Mode, press **STEP WRITE**.
  - If the LCD shows "MEMORY PROTECTED" writing cannot be carried out. Use UTILITY JOB #03 to turn off the Memory Protect function.
- Set the first part of the time signature, using the 10-keys.
- Press **ACCENT 2** to move the cursor, and press one of the 10-keys to set the second part of the time signature.
- Press **ACCENT 2** to move the cursor, and use the 10-keys to enter the Pattern length.
  - If the default settings (4/4 time, 1 bar) are acceptable, steps 2 thru 4 can be omitted.
  - You can exit the Step Write Mode at any time by pressing **STOP/CONTINUE**.

### WRITING A PATTERN

- Once the Pattern parameters have been set, press **START** to commence writing.

```

STEP WRITE PTN00
bar01 : beat001
  
```

Current bar number

Current beat number

This display prompts you to input a note on the first beat of bar 1.

- You can EITHER: Write a note by tapping an instrument key.

OR: Enter a rest by pressing **+1/YES**.

In either case the beat will advance one count, and you can enter the next note. This process continues up to the last beat of the last bar of the Pattern. The number of beats in a bar is determined by the setting of the Quantize function (described later in this chapter) and is NOT necessarily the same as the number of beats in the time signature. The Pattern then starts again at the beginning, enabling you to enter more notes and instruments. As you can only enter one instrument at a time, simultaneous notes at the same beat are entered on successive cycles through the Pattern.

Accented beats can be entered by holding down one of the green **ACCENT** keys while playing an instrument. (Refer to "ACCENTS" in THE INSTRUMENTS chapter).

Mistakes can be erased by stepping through the Pattern until you locate the erroneous note, then holding the **CLEAR** key, and tapping the appropriate instrument key. You can step through a Pattern rapidly by holding down **+1/YES**—useful in the case of long or complex Patterns.

You can also use the **-1/NO** key to "back up" through the Pattern at any time. This allows you to rapidly enter several notes at the same beat, without having to cycle through the entire Pattern. Simply press **-1/NO** after entering a note, to return to the same beat and enter another note.

**NOTE:** The **-1/NO**, unlike the **+1/YES** key (which enters rests) does NOT enter any data. It is ONLY for stepping backwards through the Pattern. Holding down this key allows continuous backward stepping. You will NOT hear any sound when you use this key.

During Step Write, you can alter the Tempo, Quantize, Swing and Click functions. These functions are described later in this chapter.

- Once you've written a Pattern, press **STOP**. You can now play your Pattern by pressing **START**. You can also select another Pattern for writing: an empty one, to create a new Pattern, or an existing Pattern to which you can add new instruments or notes.

**NOTE:** When adding new data to a previously-written Pattern, if you write a note where a previously-written note occurs on the SAME output channel, the original note will be erased. Each output channel corresponds to a pair of instrument keys (A and M, B and N, etc.)



## PATTERN/INSTRUMENT CLEAR

**FUNCTION** To clear a selected Pattern, or a selected instrument in a Pattern.

You can instantly clear (erase) a whole Pattern. This would be done, for example, if the RX5's Pattern memory were full and you wanted to write another Pattern. You can also clear a selected instrument within a Pattern. This gives you an easy way of re-arranging a Pattern to make a new one. Simply remove an instrument (or several instruments) and write new parts as needed.

- You can also clear all 100 Patterns simultaneously. Refer to UTILITY MODE JOB #05.

### OPERATION

- Press PATTERN/SONG once or twice and select the Pattern you wish to clear, then press CLEAR.

```
CLEAR PTN00
█:PTN or 2:inst?
```

You can now either clear the whole Pattern, or clear a single instrument in the selected Pattern.

- If the Memory Protect is ON, the LCD will show "MEMORY PROTECTED" when the Clear function is selected, indicating that Pattern Clear cannot be carried out. Use UTILITY JOB #03 to turn off the Memory Protect function.

- To clear the whole Pattern, press "1".

```
CLEAR PTN00
Are you sure?
```

If you wish, you can now cancel the Clear operation by pressing -1/NO. To carry out the Clear operation, press +1/YES, to see:

```
CLEAR PTN00
completed!
```

Followed by

```
SELECT PTN 00█
04 / 4 :bar01
```

- To clear a selected instrument, press "2".

```
CLEAR PTN00
select inst
```

- Press the instrument key corresponding to the instrument you wish to clear.

```
CLEAR PTN00
clear Int-Cowbel
```

- To clear the instrument, press START.

```
CLEAR SONG 00
Are you sure?
```

If you wish, you can now cancel the Clear operation by pressing -1/NO. To carry out the Clear operation, press +1/YES, to see:

```
CLEAR PTN00
completed!
```

Followed by

```
SELECT PTN 00█
04 / 4 :bar01
```

## QUANTIZE FUNCTION

**FUNCTION** During Real Time Write, to automatically correct the timing of a Pattern to a pre-selected beat length. During Step Write, to set the minimum beat length for entry of notes.

Quantize determines the smallest note-values which can be written into a Pattern. Any notes played between these values will be moved to the nearest value, or "beat" These are NOT to be confused with the "beats" a bar is divided into. For example, setting the Quantize at 1/8 means that the shortest notes that can be written are 1/8th notes — i.e., the maximum number of notes that can be written in a 4/4 bar is 8. Application of the Quantize function depends on which Pattern writing mode you are using.

**REAL TIME WRITE**

In the Real Time Write mode, the Quantize function is used as a timing correction device. If the Quantize is set to OFF, your Pattern will sound exactly as you play it, with all the timing subtleties of your original performance. (Actually, when the Quantize is OFF, it is recording your performance in increments of 1/96th notes, which are short enough to capture the finest nuances of timing).

However, the Quantize function can be used to make the writing of perfectly-timed Patterns easy and rapid.

For example, you could set the Quantize Rate at 1/4, and write in a simple bass drum part. Even if you play the notes off the beat, you'll hear them sound exactly on the beat as soon as the Pattern recycles.

You could then, without stopping Real Time writing, change the Quantize rate to 1/8 and record an off-beat Snare Drum part.

Then you could reset to 1/16 Quantize and add a more complex Hi-Hat part, to complete the following basic rhythm Pattern. In this example the first Hi-Hat note is open, the rest are closed.

You could even turn the Quantize OFF and add ad-lib Tom or Latin percussion sounds, if, for example, your Pattern were to be used as an intro or fill.

**STEP WRITE**

In the Step Write mode, the Quantize function is used to set the minimum length of each beat. Although your Pattern may contain a complex arrangement of rhythms, you can save Pattern writing time by writing each instrument in at the appropriate Quantize Rate, in a similar fashion to the use of Quantize for Real Time writing.

Here's the same Pattern we gave as an example of Quantized Real Time writing, displayed as a Step Write chart. The white dots indicate notes, entered by pressing an instrument key; the black dots indicate rests, entered by pressing +1/YES.

● — Rests  
○ — Notes  
⊗ — Hi-Hat OPEN (other HI-HAT notes CLOSED)

If you wrote the whole Pattern at a Quantize rate of 1/16, the chart would look like this.

So it's easy to see that the intelligent use of Quantize can substantially cut down on the number of rests you need to enter.

You can also use the Quantize function to facilitate writing complex rhythms such as the snare drum triplets in the next example.

← HI HAT  
Quantize 1/8

← S.D.  
Quantize 1/12

← B.D.  
Quantize 1/2

Using a high Quantize Rate allows you to add subtle timing variations. For example, many rock drummers create an exciting feel by slightly delaying their off-beat on the snare drum. This is easy to create in the Step Write Mode. In this example, the Snare Drum is entered using a Quantize rate of 1/48. The 2nd and 4th quarter-notes fall at beats 13 and 37 respectively, so the Snare Drum notes are entered at beats 14 and 38 to provide the delay.

HI-HAT  
Quantize 1/8

S.D.  
Quantize 1/48

beat 13 14 37 38

delay

## OPERATION

1. Before or during Pattern writing, press **QUANTIZE/DELETE**.

Quantize rate value

**QUANTIZE= 1 / 8**

**Swing OFF**

2. Use the Numeric Key Pad to set the Quantize Rate. The fraction numbers on the Numeric Key Pad indicate the Quantize Rate. The LCD will indicate the new Quantize Rate.

Range: 1/2, 1/4, 1/6, 1/8, 1/12, 1/16, 1/24, 1/32, 1/48, OFF.

- In the Step Write Mode, if the Quantize is set to OFF, you can write a Pattern with beat lengths of 1/96th notes.
- During Step Write, if you change the Quantize Rate after the first beat of a bar, writing will continue at the old Quantize Rate until the Pattern recycles (or, in a Pattern containing more than one bar, until you reach the next bar).

**NOTE:** Quantize can be set at any time. After pressing the **QUANTIZE** key you must then press the key corresponding to the function the RX5 was using prior to setting the Quantize rate, should you wish to return to that function. For example, if you were writing in Real Time, press **REAL TIME WRITE** after setting the Quantize rate so that you can continue writing.

## TEMPO FUNCTION

**FUNCTION** To set the tempo (speed) of Pattern play, Song Play, Chain play or Pattern write.

Tempo can be set at any time. The range is 40—250 quarter-notes per minute.

**NOTE:** After pressing **TEMPO** you must then press the key corresponding to the function the RX5 was using prior to setting the Tempo, should you wish to return to that function. For example, if you were writing in Real Time, press **REAL TIME WRITE** after setting the Tempo so that you can continue writing.

**OPERATION** There are three ways to set the Tempo.

### 1. TEMPO SLIDER

When the Tempo slider is moved, the tempo will jump to the position corresponding to the position of the slider, rather than changing gradually. This is a useful way to rapidly set an approximate tempo.

If you wish to see the Tempo setting, press **TEMPO**. Example: Pattern Select Mode.

**SELECT PTN 00 w**

**TEMPO ♩ = 120**

### 2. -1/NO AND +1/YES KEYS

This is a convenient way of slightly altering, or gradually altering, the Tempo.

1. Press **TEMPO**. The LCD will show the current Tempo.
2. Press a -1/NO key or +1/YES key to decrease or increase the Tempo by one beat per minute. Holding one of these keys causes a continuous smooth change.

### 3. NUMERIC KEY PAD

This is a convenient way of entering an exact Tempo setting. If carried out during play or write, the tempo will switch to the new setting as soon as the last figure of the new tempo is entered.

1. Press **TEMPO**. The LCD will show the current Tempo.
2. Use the Numeric Key Pad to enter a two-digit tempo (in the case of a tempo of 40—99) or a three-digit Tempo (in the case of tempo of 100 to 250).

# CLICK FUNCTION

**FUNCTION** To provide a metronome-type click during Pattern play or write.

The Click function gives you an exact rhythm guide, for writing a Pattern in Real Time, or for play. It is heard via headphones or via a separate Click Output jack which can be connected to your mixer or amplifier.

The Click can be set to sound once every 1/2, 1/4, 1/6, 1/8, 1/12, 1/16, 1/24 or 1/32 note. The pitch of the Click is higher on the first beat of each bar.

The Click rate can be set before or during any Pattern operations.

**NOTE:** After setting the Click function you must then press the key corresponding to the function the RX5 was using prior to pressing **CLICK**, should you wish to return to that function. For example, if you were writing in Real Time, press **REAL TIME WRITE** after setting the Click function, so that you can continue writing.

## OPERATION

1. Press **CLICK**. The LCD will show the current Click Rate. Example: Pattern select Mode.

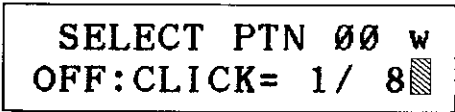

2. Use the Numeric Key Pad to set the Click Rate.
3. The Click always functions during Real Time writing. To turn the Click off or on for Pattern Play, press **-1/NO (OFF)** or **+1/YES (ON)**. Example: Click ON; 1/4 note.

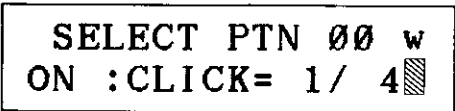

4. The level of the Click is adjusted using the **CLICK VOLUME** slider.

# SWING FUNCTION

**FUNCTION** To automatically add a swing feel to a Pattern written in Real Time.

The Swing function offers a simple and rapid way to write a Pattern that contains a jazz-type swing feel. It can ONLY be used with a Quantize rate of 1/8 or 1/16. The Swing function works by delaying the off-beats in a bar. The amount of swing is calculated by taking a quarter-note as 100%. With no swing, the off-beats will occur at 50%. You can set the amount of delay (swing) at five points between 54% (a very subtle effect) and 71% (a very pronounced swing).

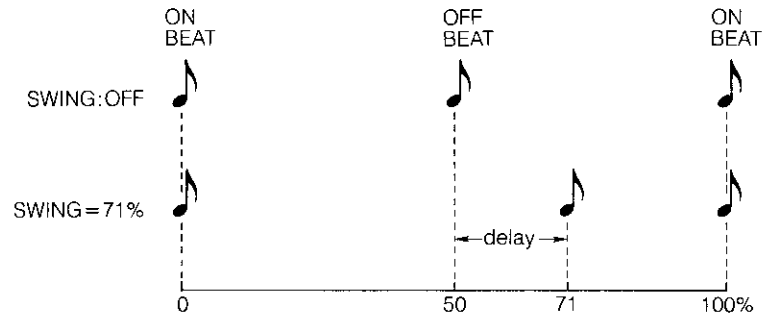

A setting of 67% creates a triplet-type shuffle effect.

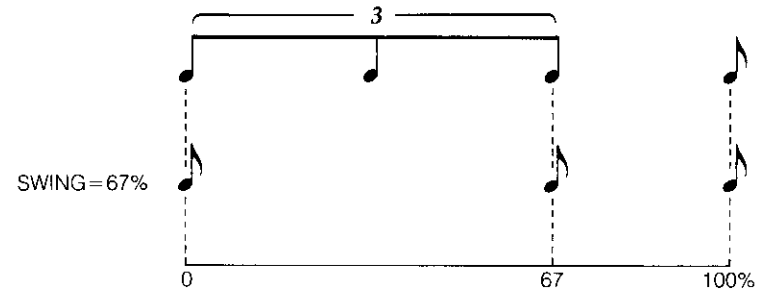

## OPERATION

1. Before or during Pattern writing, press **SWING/REPEAT**. Example: during Real Time Write.



2. Press the **+1/YES** key to step forward through the Swing Value settings, until you reach the desired setting. The **-1/NO** key moves you backwards through the Swing Value settings, until you reach the "OFF" setting.

Range: 54%, 58%, 63%, 67%, 71%.

**NOTE:** After setting the Swing function you must press the key corresponding to the function the RX5 was using prior to pressing **SWING**, should you wish to return to that function. For example, if you were writing in Real Time, press **REAL TIME WRITE** after setting the Swing function, so that you can continue writing.

## PATTERN COPY/APPEND

**FUNCTION** To copy a Pattern to another destination, or append a Pattern to another Pattern.

The Pattern Copy function lets you copy any selected Pattern to another destination in the RX5's Pattern memory. This is useful if you want to copy a Pattern in order to alter it to create a new Pattern, while retaining the original Pattern. It is also useful if you want to have the Patterns in a particular order in the RX5's memory (so that, for example, you can easily play one Pattern followed by the adjacent Pattern, by pressing the +1/YES key during play).

The Pattern Append function lets you join any Pattern onto the end of any other Pattern, to form a new, longer Pattern. The Patterns MUST have the same time signatures. You could append several Patterns to create a long Pattern which could function as part of a song. This would save on the number of parts needed to create a song — each section of the song (verse, chorus, etc.) could correspond to a different Pattern. It would then be very easy to re-arrange a song. You can even append a Pattern to itself, to create the same Pattern played twice.

**OPERATION** Operation of the Pattern Copy and Pattern Append functions is slightly different.

- If the Memory Protect is ON, the LCD will show "MEMORY PROTECTED" when the Copy key is pressed, indicating that Pattern Copy/Append cannot be carried out. Use UTILITY JOB #03 to turn off the Memory Protect function.

### PATTERN COPY

1. Press PATTERN/SONG once or twice and select the Pattern you wish to copy, then press COPY.

```
COPY   PTN 00
:copy, 2:Append?
```

2. To select the Pattern Copy function, press "1"

```
COPY   PTN 00
to     PTN **
```

Prompt to enter destination number

3. Use the Numeric Key Pad to enter the number of the Pattern destination to which the selected Pattern will be copied.

```
COPY   PTN 00
to     PTN 01
```

4. Press START. If the Pattern destination is empty, the Pattern will immediately be copied.

```
COPY   PTN 00
completed!
```

Followed by

```
SELECT PTN 00
04 / 4 :bar01
```

If the Pattern destination already contains a Pattern (which will be erased if you carry out the copy operation) the LCD will show.

```
COPY   PTN 00
rewrite ptn 01?
```

You can now press -1/NO, if you do not wish to copy to this Pattern destination. This will return you to the select Pattern Mode, from which you can once again call the Pattern Copy function, and select another destination.

If you wish to copy to the selected destination (re-writing the Pattern contained there) press START again. The LCD will show "completed" and return to the Select pattern Mode).

### PATTERN APPEND

1. Press PATTERN/SONG once or twice and select the Pattern you wish to append, then press COPY.

```
COPY   PTN 00
:copy, 2:Append?
```

2. To select the Pattern Append function, press "2".

APPEND PTN 00  
with PTN \*\*

Prompt to enter Pattern number

- Use the Numeric Key Pad to enter the number of the Pattern to which the selected Pattern will be appended.

APPEND PTN 00  
with PTN 01

- To append the Pattern, press START.

APPEND PTN 00  
completed!

Followed by

SELECT PTN 00  
04 / 4 :bar01

## PATTERN EDITING

**FUNCTION** To edit the pitch, level, attack, decay and reverse on/off parameters of individual notes in a selected Pattern.

The Pattern Edit function is an extremely useful and creative feature of the RX5. It allows you to step through a Pattern, note by note, and alter the parameters of each individual note. You can step through all instruments in the Pattern, or select a single instrument and step through only the notes that it plays.

Live drums have many nuances of level, attack, decay and even pitch, dependent on how hard they are played. With the Pattern Edit Mode, it's easy to program these small variations. You can also use this Mode to "delete" a note by setting its level to zero; add sound effects by reversing sounds; alter the pitch of tuned instruments such as the RX5's bass and synthesizer voices, to create melody lines; create a fade-in or fade-out by programming a gradual increase or decrease of levels.

- Parameters set in this mode refer to the NOTE only, and not the VOICE that is playing or the KEY to which it is assigned. They are therefore independent of the parameters set using EDIT VOICE JOBS #02, #03 #04 or the KEY ASSIGN JOB #02.

- You can also change any voice in a Pattern to another voice (refer to UTILITY JOB #04).

### OPERATION

- Press PATTERN/SONG once or twice and select the Pattern you wish to edit, then press EDIT PATTERN/VOLUME CHANGE.

EDIT PTN 00  
04 / 4 :bar01

- If the Memory Protect is ON, the LCD will show "MEMORY PROTECTED" when EDIT VOICE is pressed, indicating that Pattern editing cannot be carried out. Use UTILITY JOB #03 to turn off the Memory Protect function.
- To enter the Pattern Edit Mode, press START. The LCD will show the last Pattern Edit parameter that was selected, and the instrument that plays the first note in the Pattern.

Bar number    Clock number    "All instruments" indicator    Parameter

01:001 al pitch  
Int-BD 1 =± 0

Voice                                  Parameter value

The "al" symbol indicates that the "all instruments" note search mode is active. "Clocks" shown on the LCD are actually 96th notes. These are the smallest note-increments that can be recorded by the RX5, and enable you to exactly locate a note. For example, notes in the Real Time Write Pattern example given in the QUANTIZE section of this chapter would occur at the following clocks.

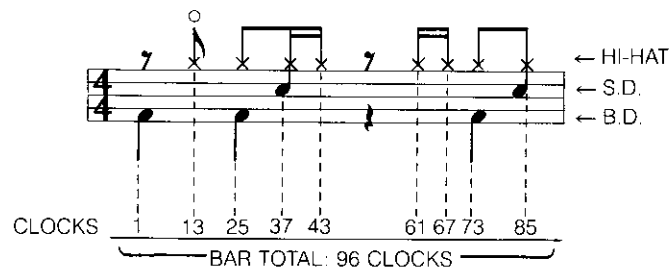

You can now "search" through the Pattern to find notes to be edited.

**NOTE SEARCH**

To locate notes for editing, you can search through all notes in a Pattern, or only notes played by a selected instrument.

1. To search through all notes in a Pattern, press +1/YES. The LCD will show the next note in the Pattern, which may occur at a different time, on a different instrument. Note the "al" symbol on the LCD, indicating that the "all instruments" note search mode is active.

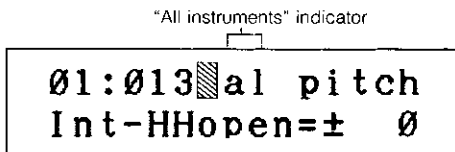

Repeated pressings of +1/YES will move you through the Pattern. If you hold down this key, you can "fast forward" through the Pattern. The -1/NO key works in the opposite direction, but you will NOT hear any notes when using it.

2. To select an instrument for note search, press its instrument key. The "al" symbol will change to "01", indicating that the first note of the selected instrument has been located.

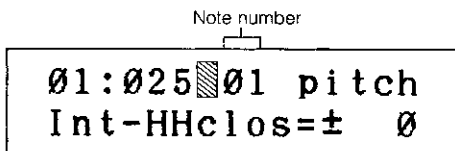

Now, when you press +1/YES to search through the Pattern, the RX5 will automatically locate the next note played by the selected instrument, and display its note number. In our Pattern example, the Hi Hat (closed) plays eight notes. Once you locate the last note (with a displayed note number of "08") the next pressing of the +1/YES key will return you to note 01.

3. At any time, you can select another instrument, by pressing its instrument key. The LCD will show the first note played by that instrument.
4. To return to the "all instruments" note search mode, press EDIT PATTERN/VOLUME CHANGE. The LCD will show the first note in the Pattern, and display the "al" symbol. Having located a note, you can now select a parameter for editing.
5. Press ACCENT 2 to move the cursor to the parameter name position in the top right corner of the LCD.

**PARAMETER 1: PITCH**

1. To select Pitch, press "1".

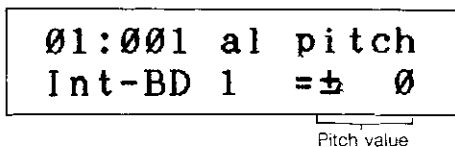

2. Use the -1/NO and +1/YES keys or the DATA ENTRY slider to change the pitch by semitone units. Holding the "0" key while using the -1/NO or +1/YES key to change pitch allows pitch change in 10-cent (1/10th semitone) units. Pitch values are shown in 10-cent (1/10th semitone) units.

Range:  $\pm 60$  semitones displayed as  $\pm 600$  units. Actual pitch range is  $+24/-36$  semitones (actual pitch cannot be set outside these limits).

3. As soon as you change this parameter value, it will start flashing on the LCD. Press START to enter the new value. The parameter value will then stop flashing.
4. You can now select another parameter for editing, or exit the Pattern edit Mode by pressing STOP/CONTINUE. The LCD will return to the Select pattern display.

**PARAMETER 2: LEVEL**

1. To select Level, press "2".

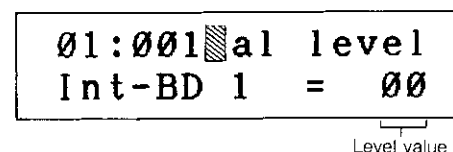

2. Use the -1/NO and +1/YES keys or the DATA ENTRY slider to change the level.

Range:  $\pm 31$ . Actual level range is  $00/+31$  (actual level cannot be set outside these limits).

3. As soon as you change this parameter value, it will start flashing on the LCD. Press START to enter the new value. The parameter value will then stop flashing.
4. You can now select another parameter for editing, or exit the Pattern edit Mode by pressing STOP/CONTINUE. The LCD will return to the Select pattern display.

**PARAMETER 3: ATTACK**

1. To select Attack, press "3".

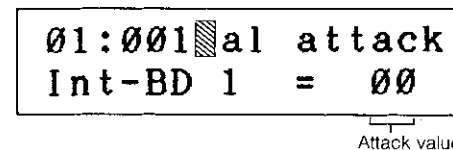

2. Use the -1/NO and +1/YES keys or the DATA ENTRY slider to change the Attack Rate.

Range:  $\pm 63$ . Actual Attack Rate range is  $01/+99$  (actual Attack Rate cannot be set outside these limits).

**NOTE:** Long attacks create "looping". Refer to EDIT VOICE JOB #03 for comments about this.

3. As soon as you change this parameter value, it will start flashing on the LCD. Press **START** to enter the new value. The parameter value will then stop flashing.
4. You can now select another parameter for editing, or exit the Pattern edit Mode by pressing **STOP/CONTINUE**. The LCD will return to the Select pattern display.

**PARAMETER 4: DECAY**

1. To select Decay, press "4".

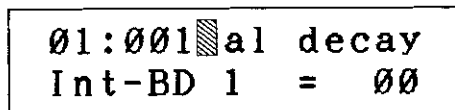

Decay value

2. Use the -1/NO and +1/YES keys or the **DATA ENTRY** slider to change the Decay Rate.

Range: ±63. Actual Decay Rate range is 01/+99 (actual Decay Rates cannot be set outside these limits).

**NOTE:** Long decays create "looping". Refer to EDIT VOICE JOB #03 for comments about this.

3. As soon as you change this parameter value, it will start flashing on the LCD. Press **START** to enter the new value. The parameter value will then stop flashing.
4. You can now select another parameter for editing, or exit the Pattern edit Mode by pressing **STOP/CONTINUE**. The LCD will return to the Select pattern display.

**PARAMETER 5: REVERSE ON/OFF**

1. To select Reverse, press "5".

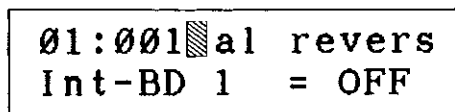

On/Off indicator

2. Use the -1/NO and +1/YES keys or the **DATA ENTRY** slider to set the Reverse function ON or OFF.
3. As soon as you select ON or OFF, it will start flashing on the LCD. Press **START** to enter the new setting. ON or OFF will then stop flashing on the LCD.
4. You can now select another parameter for editing, or exit the Pattern edit Mode by pressing **STOP/CONTINUE**. The LCD will return to the Select pattern display.

## **PATTERN MEMORY CHECK**

This function allows you to check the remaining Pattern memory of the RX5, as a percentage of its total Pattern memory capacity. Refer to UTILITY JOB #01.



# SONG OPERATIONS

## OVERVIEW

The Song operations available on the RX5 let you:

- Edit (assemble) up to 20 Songs, each consisting of up to 999 Parts. Each Song can be given a name, and an initial tempo.
  - Insert repeats, tempo changes (accelerando, ritardando), volume changes in a Song.
  - Select a Song and play it at any tempo, or from any selected Part (location).
  - Set a named "Search" mark in a song, and locate it instantly, for playback or re-editing.
  - Clear (Erase) a Song.
  - Copy a Song, or part of a Song.
  - Check the remaining Song memory of the RX5.
- The RX5 contains factory-programmed Songs in Song locations 00 thru 02, showing how you can put together interesting sequences of Patterns. These Songs are permanently stored in the RX5's internal memory. So if you clear them, or edit (alter) them to make your own Songs, the original preset Songs are still available and can be re-loaded into the Song locations simply by holding the **ACCENT 1** key while you turn the RX5's power on.
  - Song 02 shows how you can use the RX5 as a complete musical instrument, programming melodic parts and sound effects as well as rhythms. It also contains Search Marks, named "A", "B", "C", "D" and "E" to demonstrate the Search Mark function, which lets you instantly locate any selected Part of a Song. To use this convenient function, refer to **JOB #01: SEARCH MARK** later in this chapter.
  - The function of the Song Mode is to allow you to connect Patterns in order to form a drum sequence for an entire Song. Each Song can contain up to 999 "Parts". A Part can contain a Pattern, or other data such as a Repeat Command, a Tempo Change, a Volume Change or a Search Mark.

**NOTE:** Some of the Song/Pattern Operation keys on the RX5 have two functions. The **LOWER** function written on each key applies to the Song Mode.

## ENTERING THE SONG MODE

- All Song operations are preceded by entering the Song Mode.

Press **PATTERN/SONG**. Repeated pressing of this key switches the RX5 between the Pattern Mode and the Song Mode. When the Song Mode is selected, the **SONG** LED will light. The LCD will show the number of the last Song that was selected, plus its name, initial tempo and number of bars (measures).

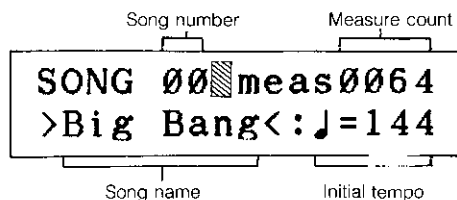

## SONG SELECTION

**FUNCTION** To select a Song for play, editing, etc. To select an empty Song for writing.

The RX5 can store up to 20 Songs, numbered 00 thru 19. Once you have selected a Song, you can then go on to play the Song, edit it, copy it, clear (erase) it. You can also select an empty Song (one that contains no data) prior to editing a new Song.

### OPERATION

Press **PATTERN/SONG** until the LCD indicates Song Mode, then use the Numeric Key Pad to enter a two-digit Song number. Song numbers below 10 must be preceded by a zero. For example, for Song 5, enter "0" then "5".

## SONG PLAY

**FUNCTION** To play a selected Song.

### OPERATION

1. Press **PATTERN/SONG** until the LCD indicates Song Mode, and use the 10—keys to select a Song.
2. Press **START** to play the Song. During play, the **RUN LED** will light. The LCD will indicate the current measure, Part number and Pattern number.

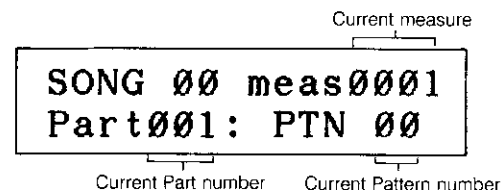

3. To stop play, press **STOP/CONTINUE**. The **RUN LED** will go out, and the LCD will show the point in the Song at which play was stopped.
4. To restart play, press **START** to play from the beginning of the Song, or **STOP/CONTINUE**, to play from the point at which play was stopped.
5. When the Song has finished playing, the LCD will again display the first measure and Part of the Song.

- During Song Play, you can alter the Tempo by moving the **TEMPO** slider control, or by pressing **TEMPO** and using the 10-keys or the +1/**YES** and -1/**NO** keys. The Click function can also be used during Song play, but it must be turned on in the Pattern Mode. Refer to the **PATTERN OPERATIONS** chapter for a full description of these functions.

## REPEAT SONG PLAY

**FUNCTION** Continuous play of a selected Song.

This function allows you to play a Song repeatedly, until you press the **STOP** key. This can be useful when you are rehearsing a song. It can also aid composition, providing a continuous rhythm track while you work on ideas for a song.

### OPERATION

1. Press **PATTERN/SONG** until the LCD indicates Song Mode, then press **SWING/REPEAT**

```
SONG 00 meas0064
repeat OFF
```

2. Use the +1/**YES** or -1/**NO** keys to turn the Repeat function On or OFF.
3. Press **PATTERN/SONG** to return to the Song Mode, then select and play a Song. The Song will play through and once it is finished, immediately recommence play. The LCD will at this point return to the beginning of the Song and restart counting of measures and Parts.
- If you wanted a pause between repeat plays of a Song, you could insert an empty Pattern (of any length) at the end of the Song.
4. The **STOP/CONTINUE** key is used in exactly the same way as normal Song play.

## EDIT SONG MODE

**FUNCTION** To connect Patterns in order to create a Song.

In the Edit Song Mode, you can connect up to 999 Patterns to form a rhythm track for an entire Song. Each Pattern, when used in a Song, is called a "Part". Parts can also contain other data such as repeats, tempo changes and volume changes. These are described later in this chapter.

### OPERATION

1. Press **PATTERN/SONG** until the LCD indicates Song Mode, then use the Numeric Key Pad to select a Song. When editing a new Song, an empty Song should be selected. This will be indicated by a zero measure count on the LCD.

```
SONG 00 meas0000
> < :♪ =---
```

- Songs that have already been edited can be selected for re-editing, in exactly the same manner.
2. Press **REAL TIME WRITE/EDIT SONG**.

```
EDIT SONG 00
Part001= PTN **
```

Pattern number prompt

- If the selected Song already contains data, the LCD will show the data of the first Part.
  - If the Memory Protect is ON, the LCD will show "MEMORY PROTECTED" when Real Time Write is selected, indicating that writing cannot be carried out. Use **UTILITY JOB #03** to turn off the Memory Protect function.
3. The LCD is prompting you to enter the Pattern number for the first Part. Use the 10-keys to enter a Pattern number.

```
EDIT SONG 00
Part001= PTN 00
```

- If the displayed Part already contains a Pattern (in the case of a Song that has already been edited) you can change the Pattern by entering a new pattern number in the same way.

4. Press +1/YES to move to the next Part, and enter another Pattern number in the same way.

EDIT SONG 00  
Part002= PTN 33

5. Continue moving through the Song, entering Pattern numbers as desired. It's a good idea to keep a written record of a Song, as you edit it. Refer to the **SONG/CHAIN CHART** at the end of this manual.
- You can move backwards through a Song using the -1/NO key. This lets you go back to check a Part. Any time a Part is displayed, you can change the Pattern contained in that Part by entering a new Pattern number.
- Holding down a -1/NO or +1/YES key lets you move rapidly through a Song.
6. Once you have entered all the Parts of your Song, press **PATTERN/SONG** to exit the Edit Song Mode. You can now play your Song.

## INSERT FUNCTION

### FUNCTION To insert new Parts into a Song.

The Insert Function lets you select any point in a Song that has already been assembled, and insert new Parts between the already-programmed Parts. For example, if you want to insert a Pattern between Parts 2 and 3 of a Song, this means that you have to insert a new Part 3.

#### BEFORE INSERTING

Part 001	Part 002	Part 003	Part 004
PTN 01	PTN 02	PTN 03	PTN 04

↑  
Insert point  
for new pattern  
E.g., Pattern 99.

#### AFTER INSERTING

Part 001	Part 002	Part 003	Part 004	Part 005
PTN 01	PTN 02	PTN 99	PTN 03	PTN 04

↑  
Pattern 99 inserted into Part 3.  
All subsequent parts moved forward  
one step.

- You can also insert Repeats, Tempo Changes, Volume Changes and Search Marks by pressing the keys corresponding to those functions after pressing the **INSERT** key.

## OPERATION

- Press **PATTERN/SONG** until the LCD indicates Song Mode, and use the Numeric Key Pad to select a song. Then press **REAL TIME WRITE/EDIT SONG** to enter the Edit Song Mode.
- Use the +1/YES key to locate the Insert point in the selected Song.

EDIT SONG 00  
Part003= PTN 03

- Press **STEP WRITE/INSERT**.

EDIT SONG 00  
Part003= PTN \*\*

↑  
Pattern number prompt

- The LCD is prompting you to insert a new Pattern number. Use the Numeric Key Pad to do this. Example: Pattern 99.

EDIT SONG 00  
Part003= PTN 99

↑  
New Pattern number

The new Pattern has now been inserted. You can, at this time, change the new Pattern number before exiting the Edit Song Mode.

If you use the +1/YES key to move forward through the Song, you will see that all following Parts have been moved forward by one step.

- Press **PATTERN/SONG** to exit the Edit Song Mode.

## DELETE FUNCTION

### FUNCTION To delete Parts from a Song.

The Delete Function works in the opposite way to the Insert Function. It lets you remove any Part from a Song that has already been assembled. For example, if you want to remove the Pattern that we inserted in our Song in the previous section, you would locate Part 3 and carry out the Delete Function.

#### BEFORE DELETING

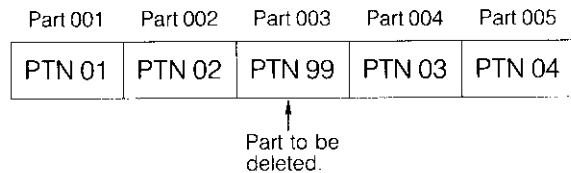

#### AFTER DELETING

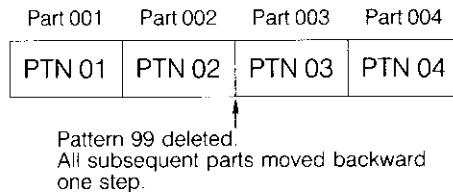

- You can also delete Parts containing Repeats, Tempo Changes, Volume Changes and Search Marks, in exactly the same way.

### OPERATION

- Press **PATTERN/SONG** until the LCD indicates Song Mode, and use the Numeric Key Pad to select a song. Then press **REAL TIME WRITE/EDIT SONG** to enter the Edit Song Mode.
- Use the **+1/YES** key to locate the Delete point in the selected Song.

EDIT SONG 00  
Part 003 = PTN 99

- Press **QUANTIZE/DELETE**

EDIT SONG 00  
Delete PTN 99?

You can now press **-1/NO** if you wish to cancel the Delete operation. The LCD will return to the previous display.

- To delete Pattern 99, press **+1/YES**. The LCD will now show that the selected Part (Part 003) has a new Pattern number. This was the pattern that was assigned to the following Part (Part 004) prior to the Delete operation.

EDIT SONG 00  
Part 003 = PTN 03

└───┘  
New Pattern number

If you use the **+1/YES** key to move forward through the Song, you will see that all following Parts have been moved backward by one step.

- Press **PATTERN/SONG** to exit the Edit Song Mode.

## PART COPY FUNCTION

### FUNCTION To copy a selected number of Parts to a subsequent point in a Song.

This function lets you choose a Part or group of Parts, and copy them to a later point in a Song, or to the end of the Song. Any Parts following the copy destination point will be cleared (erased). This function can really save time if you have programmed the Parts for a verse, for example, and want to repeat the same verse later in a Song. You can copy the entire verse in one operation, instead of having to copy each individual Part.

For example, suppose in this short Song, you want to copy Parts 2 and 3 onto the end of the Song.

#### BEFORE COPYING

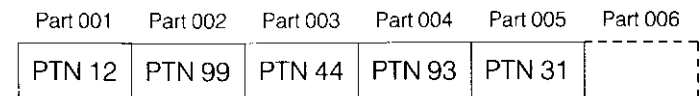

└───┘  
Part to be copied.

↑  
Copy destination

## AFTER COPYING

Part 001	Part 002	Part 003	Part 004	Part 005	Part 006	Part 007
PTN 12	PTN 99	PTN 44	PTN 93	PTN 31	PTN 99	PTN 44

New Parts

You can also copy to a destination BEFORE the end of the Song, provided it comes AFTER the Parts which are to be copied. Be careful! If you do this, ALL Parts following the selected destination will be cleared (erased). This example shows what happens if we copy Parts 2 and 3 to Part 4.

## BEFORE COPYING

Part 001	Part 002	Part 003	Part 004	Part 005
PTN 12	PTN 99	PTN 44	PTN 93	PTN 31

Parts to be copied.      Copy Destination

## AFTER COPYING

Part 001	Part 002	Part 003	Part 004	Part 005
PTN 12	PTN 99	PTN 44	PTN 99	PTN 44

New Parts

Original Parts following copy destination are cleared.

## OPERATION

1. Press **PATTERN/SONG** until the LCD indicates Song Mode, and use the Numeric Key Pad to select a song. Then press **REAL TIME WRITE/EDIT SONG** to enter the Edit Song Mode.
2. Use the **+1/YES** key to locate the Copy destination point in the Song.

EDIT    SONG 00  
Part004= PTN 04

3. Press COPY.

Prompts to enter Part numbers

from \*\*\* - \*\*\*  
Part004= PTN 04

4. Use the Numeric Key Pad to enter the number of the first Part of the section to be copied—a three-digit number.

from 002 - \*\*\*  
Part004= PTN 04

5. The cursor will move to the next prompt. Enter the number of the last Part of the section to be copied (if copying only one Part, this number would be the same as the previous number entered).

from 002 - 003  
Part004= PTN 04

6. Press **START** to carry out the Copy operation. The LCD will now display the empty Part following the last Part of the newly edited Song. In this example, it would be Part 6.

EDIT    SONG 00  
Part006= PTN \*\*

7. Press **PATTERN/SONG** to exit the Edit Song Mode.

## REPEATS

### FUNCTION To enter repeat commands in a Song.

Repeats can save a lot of editing time, by making it possible to repeat any Part or group of Parts up to 99 times. This is needed, for example, when the same rhythm plays through an entire verse.

Repeats are entered in two operations. The Begin repeat command is entered at the start of the section which is to be repeated. Then the End Repeat is entered at the end of the section to be repeated, together with a number indicating the number of times that the section is to be repeated. Remember that the number of repeats should be ONE LESS than the total number of plays of the selected section. Each repeat command counts as a Part.

In this example, Parts 3 and 4 are repeated twice, making a total of three plays of those Parts.

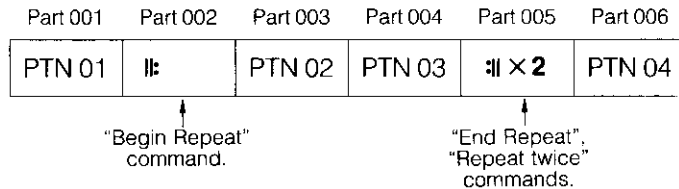

### ACTUAL PLAYING SEQUENCE

PTN 01	PTN 02	PTN 03	PTN 02	PTN 03	PTN 02	PTN 03	PTN 04
--------	--------	--------	--------	--------	--------	--------	--------

You can enter any number of repeats in a Song. You can also "nest" repeat commands, so that a short repeat section can occur within a larger repeat section. This would be done, for example, if a whole verse were to be repeated (repeat commands at start and end of the verse) AND a short section within the verse were to be repeated (repeat commands at start and end of short section in the verse). You can actually enter up to ten "nests" of repeats, one inside another.

### OPERATION

1. Press **PATTERN/SONG** until the LCD indicates Song Mode, then use the Numeric Key Pad to select a Song.
2. Press **REAL TIME WRITE/EDIT SONG** and start editing the Song. When you reach the point at which the Begin Repeat command is needed (for example, Part 2) press **SWING/REPEAT**.

```
EDIT SONG 00
1: ||: or 2: || ?
```

3. Press "1" to select a Begin Repeat command.

```
EDIT SONG 00
Part002= ||:
```

4. Continue editing (entering Pattern numbers) and when you reach the point at which the End repeat command is needed (for example, Part 5) press **SWING/REPEAT** then press "2" to select an End repeat command.

```
EDIT SONG 00
Part005= || x01
```

└───┘  
Number of repeats

The LCD will display "01"—the default number of repeats. If only one repeat is needed, you can now press **+1/YES** to continue editing the Song.

5. To enter a different number of repeats, use the Numeric Key Pad entering a two-digit number (for example, 02). Range: 01 — 99.

```
EDIT SONG 00
Part005= || x02
```

You can now continue editing.

- Repeats are often entered AFTER all the Pattern numbers have been entered for a Song. Refer to the **INSERT FUNCTION** (described earlier in this chapter) and enter the repeats in the normal way, after pressing the **INSERT** key. Remember that a Repeat Command will create a new Part, and move all subsequent Parts forward.

## TEMPO CHANGE FUNCTION

**FUNCTION** To enter gradual tempo changes into a selected Song.

This function allows you to enter a gradual change of tempo in a Song. The tempo can increase (accelerando) or decrease (ritardando). You can set the overall range of the Tempo Change, and the duration of the change.

A Tempo Change counts as a Part of a Song.

- If you enter a Tempo Change during a repeat section, the Tempo Change will also be repeated, allowing you to make a gradual Tempo Change over a long period (longer than the maximum of 99 quarter-notes which can be set for a single Tempo Change).

**NOTE:** When you play a Song that contains a Tempo Change, the final tempo of the Song will be different from the initial tempo. If you have not set an Initial Tempo for a Song, and you immediately play the Song again, it will commence play at the new tempo. Therefore, it is recommended that you always set the Initial tempo for a Song. Refer to JOB #04: INITIAL TEMPO.

### OPERATION

1. Press **PATTERN/SONG** until the LCD indicates Song Mode, then use the 10-keys to select a Song.
2. Press **REAL TIME WRITE/EDIT SONG** to enter the Edit Song Mode, and start editing a Song. When you reach the point at which the Tempo Change is needed press **CLICK/TEMPO CHANGE**.

```

EDIT   SONG 00
1:Accel or 2:Rit
  
```

3. Press "1" to select Accelerando (tempo increase) or "2" to select Ritardando (tempo decrease). As the operation is identical for both types of Tempo Change, we'll describe Accelerando only. The only difference is that the Tempo Change value is shown as a positive number for Accelerando, and a negative number for Ritardando.

```

EDIT   SONG 00
Part001= +00/00
  
```

Tempo Change value      Tempo Change duration

4. Use the Numeric Key Pad to set the value of the Tempo Change. Range: 0—99 quarter-notes/minute.

**NOTE:** The overall Tempo range of the RX5 is 40—250 quarter-notes/minute. The Tempo Change function can NOT alter the tempo beyond these limits.

5. Press **ACCENT 2** to move the cursor to the Tempo Change duration position, and use the Numeric Key Pad to enter the Tempo Change duration. Range: 0—99 quarter-notes.  
You can use the **ACCENT 2** key to move the cursor back and forth, to reset the two Tempo Change parameters, as needed.
  6. The Tempo Change is now set, and you can press **+1/YES** to move on to the next Part and continue editing, or press **PATTERN/SONG** to exit the Edit Song Mode.
- Tempo Changes can be entered AFTER all the Pattern numbers have been entered for a Song. Refer to the **INSERT FUNCTION** (described earlier in this chapter) and enter the Tempo Change in the normal way, after pressing the **INSERT** key. Remember that a Tempo Change will create a new Part, and move all subsequent Parts forward.

## VOLUME CHANGE FUNCTION

**FUNCTION** To enter a volume change at any point in a Song.

This function allows you to enter a volume change at any location in a Song. The volume can increase or decrease. This can be used to add subtle dynamics to a Song, or for more pronounced or sudden volume changes. You could also enter a Volume Change at the start of a Song, to alter the overall level of the whole Song.

A Volume Change counts as a Part of a Song.

- If you enter a Volume Change during a repeat section, the Volume Change will also be repeated, allowing you to make a gradual Volume Change over a long period. You could, for example, set a single Pattern to repeat at the end of a Song, together with a slight volume decrease. This would create a "fade-out". The opposite approach (repeating Patterns at start of a Song, with slight volume increase) would create a "fade-in".

### OPERATION

1. Press **PATTERN/SONG** until the LCD indicates Song Mode, then use the Numeric Key Pad to select a Song.
2. Press **REAL TIME WRITE/EDIT SONG** to enter the Edit Song Mode, and start editing a Song. When you reach the point at which the Volume Change is needed press **EDIT PATTERN/VOLUME CHANGE**.

```

EDIT   SONG 00
1:Up or 2:Down ?
  
```

3. Press "1" to select Up (volume increase) or "2" to select Down (volume decrease). As the operation is identical for both types of Volume Change, we'll describe volume increase only. The only difference is that the Volume Change value is shown as a positive number for volume increase, and a negative number for volume decrease.

```

EDIT   SONG 00
Part001= vol+00
  
```

Volume Change value

4. Use the Numeric Key Pad to set the value of the Volume Change. Range: 0—31.

- If more than one Volume Change command is entered into a Song, the resulting volume depends on the combination of Volume Changes. For example, if you enter a Volume Change of +5, then later in the a Song enter a Volume Change of -5, the combined Volume Change is zero, so the final level of the Song will be equal to its original level.

**NOTE:** The Volume range of the RX5 is 0–31. The Volume Change function can NOT alter the volume beyond these limits.

5. The Volume Change is now set, and you can press +1/YES to move on to the next Part and continue editing, or press PATTERN/SONG to exit the Edit Song Mode.

- Volume Changes can be entered AFTER all the Pattern numbers have been entered for a Song. Refer to the INSERT FUNCTION (described earlier in this chapter) and enter the Volume Change in the normal way, after pressing the INSERT key. Remember that a Volume Change will create a new Part, and move all subsequent Parts forward.

## SONG COPY

**FUNCTION** To copy a Song to another destination.

The Song Copy function lets you copy any selected Song to another destination in the RX5's Song memory. This is useful if you want to copy a Song in order to alter it to create a new Song, while retaining the original Song.

### OPERATION

1. Press SONG/PATTERN until the LCD indicates Song Mode, then use the Numeric Key Pad to select the Song to be copied, and press COPY.

```

COPY   SONG 00
to     SONG **
  
```

Prompt to enter copy destination number

- If the Memory Protect is ON, the LCD will show "MEMORY PROTECTED" when the Copy key is pressed, indicating that Song Copy cannot be carried out. Use UTILITY JOB #03 to turn off the Memory Protect function.
2. Use the Numeric Key Pad to enter the number of the Song destination to which the selected Song will be copied.

```

COPY   SONG 00
to     SONG 01
  
```

3. Press START. If the Song destination is empty, the Song will immediately be copied.

```

COPY   SONG 00
        completed!
  
```

Followed by

```

SONG 00 meas0064
>Big Bang<:J=144
  
```

If the Song destination already contains a Song (which will be erased if you carry out the copy operation) the LCD will show

```

COPY   SONG 00
rewrite song 01?
  
```

You can now press -1/NO, if you do not wish to copy to this Song destination. This will return you to the Select Song Mode, from which you can once again call the Song Copy function, and select another destination.

If you wish to copy to the selected destination (re-writing the Song contained there) press +1/YES. The LCD will show "completed" and return to the Select Song Mode).

## SONG CLEAR

**FUNCTION** To clear a selected Song.

You can instantly clear (erase) an entire Song. This would be done, for example, if the RX5's Song memory were full and you wanted to write another Song.

- You can also clear all 20 Songs simultaneously. Refer to UTILITY MODE JOB #06.



**OPERATION**

1. Press **PATTERN/SONG** until the LCD indicates Song Mode, and use the Numeric Key Pad to select the Song you wish to clear, then press **CLEAR**.

CLEAR SONG 00?

You can now cancel the Song Clear operation, if you wish, by pressing **-1/NO**. The LCD will return to the Song select display.

- If the Memory Protect is ON, the LCD will show "MEMORY PROTECTED" when the Clear function is selected, indicating that Song Clear cannot be carried out. Use **UTILITY JOB #03** to turn off the Memory Protect function.
2. To clear the Song, press **+1/YES**.

CLEAR SONG 00  
Are you sure?

If you wish, you can now cancel the Clear operation by pressing **-1/NO**. To carry out the Clear operation, press **+1/YES**, to see:

CLEAR SONG 00?  
completed!

Followed by

SONG 00  meas 0000  
> < : ♪ = ---

The LCD will now show that the selected Song is empty (the measure count is zero). You can now edit a new Song.

**SONG MEMORY CHECK**

This function allows you to check the remaining Song memory of the RX5, as a percentage of its total Song memory capacity. Refer to **UTILITY JOB #02**.

**THE JOBS**

Some functions in the Song Mode are called "Jobs" and appear on the **JOB TABLE** on the front panel of the RX5. Jobs are selected by first entering the Song Mode or Edit Song Mode, then pressing **JOB** and entering the Job number using the 10-key panel.

**SONG MODE JOB**

Job #01: **SEARCH MARK**. Automatically locate a Mark (a named location) or a Part in a Song, for playback.

**EDIT SONG MODE JOBS**

Job #01: **SEARCH MARK**. Automatically locate a Mark (a named location) or a Part in a Song, for editing.

Job #02: **SET MARK**. Name a selected location in a Song, so that it can be automatically located using the Search Mark function.

Job #03: **SONG NAME**. Name a selected Song.

Job #04: **INITIAL TEMPO**. Set the initial playback tempo of a Song.

**JOB #01: SEARCH MARK**

**FUNCTION** To automatically locate a selected location in a Song, for playback or editing.

This function lets you instantly locate any Part in a Song, or a Mark that has been set in a Song (refer to the **SET MARK** section of this chapter). This is extremely useful and time-saving. It allows you to play a Song from any selected point, or locate any point in the Song for editing (this can be compared to tape transport memory devices in recording studios, which allow you to "punch in" at a preselected point in a recording).

**OPERATION**

1. Press **PATTERN/SONG** until the LCD indicates Song Mode, then use the Numeric Key Pad to select a Song. If you are using the Search Mark function to find a point from which to playback ONLY, omit the next step and go to step 3.
2. If you are using the Search Mark function to find a point from which to edit a Song, press **REAL TIME WRITE/EDIT SONG** to enter the Edit Song Mode.
3. Press **JOB**. If in the Song Mode, the LCD will now show the Search function. If in the Edit Song Mode, use the Numeric Key Pad to select Job #01. Example: Edit Song Mode.

EDIT SONG 00  
Search "  "

You can now search a location either by entering a Part number or by entering a Mark name.

**SEARCH PART**

1. From the "SEARCH" display, use the Numeric Key Pad to enter a three-digit Part number. As soon as you enter the first digit, the LCD will show.

```

EDIT   SONG  00
Search Part 00*
  
```

Prompt to enter rest of Pattern number

2. When you have entered the complete Part number, the LCD will immediately show the selected Part, and the Pattern or other data contained there. Example: Part 006; Pattern 23.

```

EDIT   SONG  00
Part006= PTN 23
  
```

If you are in the Edit Song Mode, you can now continue editing from this point. If you are in the Song Mode, you can now play the Song from this point, by pressing STOP/CONTINUE.

**SEARCH MARK**

1. From the "SEARCH" display, enter the Mark name by pressing the instrument keys (for entering letters A thru X) or ACCENT 1 or 2 (for entering letters Y and Z respectively). The cursor will move to the right when a letter is entered, enabling you to enter the next letter.  
Letters are entered as upper case (capitals). Lower case letters may be entered by holding down STOP/CONTINUE while entering letters.  
Numerals may be entered by using the Numeric Key Pad.  
Spaces may be entered by using the REVERSE key.  
Periods may be entered by using the DAMP key.  
If you make a mistake, use the -1/NO and +1/YES keys to move the cursor to the erroneous character, and enter a new character.  
The LCD will now show the Mark name. Example: "Bridge".

```

EDIT   SONG  00
Search "Bridg"
  
```

2. Press START to carry out the Search Mark function. The LCD will immediately show the Part number of the selected Mark. Example: Part 3.

```

EDIT   SONG  00
Part003="Bridge"
  
```

If you are in the Edit Song Mode, you can now continue editing from this point. If you are in the Song Mode, you can now play the Song from this point, by pressing STOP/CONTINUE.

**NOTE:** During Song editing, when using either the Search Mark or Search Part operation, if the search point coincides with the end of the Song, the LCD will display an "end of song !!" message.

**JOB #02: SET MARK****FUNCTION** To name a selected location in a Song.

The Set Mark function allows you to give a name (up to six characters—letters and numerals) to any selected location (Part) of a Song. This Mark can be instantly located at any time, using the Search Mark function. You can set any number of Marks in a Song. A Mark counts as a Part in a Song.

**OPERATION**

1. Press PATTERN/SONG until the LCD indicates Song Mode, then use the Numeric Key Pad to select a Song.
2. Press REAL TIME WRITE/EDIT SONG to enter the Edit Song Mode, and start editing a Song. When you reach the point at which the Mark is needed select Job #02.

```

EDIT   SONG  00
Set mark"
  
```

3. Enter letters by pressing the instrument keys (for letters A thru X) or ACCENT 1 or 2 (for letters Y and Z respectively). The cursor will move to the right when a letter is entered, enabling you to enter the next letter.  
Letters are entered as upper case (capitals). Lower case letters may be entered by holding down STOP/CONTINUE while entering letters.  
Numerals may be entered by using the Numeric Key Pad **NOTE:** The first character of a Mark name can NOT be a numeral, because when using the Search function, entering a numeral first will activate the Search Part function instead of the Search Mark function.  
Spaces may be entered by using the REVERSE key.  
Periods may be entered by using the DAMP key.  
If you make a mistake, use the -1/NO and +1/YES keys to move the cursor to the erroneous character, and enter a new character.
4. Press START to enter the Mark name. Example: Part 3, Mark name "Bridge".

```

EDIT   SONG  00
Part003="Bridge"
  
```

5. The Mark is now set, and you can press +1/YES to move on to the next Part and continue editing, or press PATTERN/SONG to exit the Edit Song Mode.

- Marks can be entered AFTER all the Pattern numbers have been entered for a Song. Refer to the INSERT FUNCTION (described earlier in this chapter) and enter the Mark in the normal way, after pressing the INSERT key. Remember that a Mark will create a new Part, and move all subsequent Parts forward.

## JOB #03: SONG NAME

**FUNCTION** To enter a name for a selected Song.

This function lets you enter a name of up to eight characters (letters and numerals) for a Song.

### OPERATION

1. Press PATTERN/SONG until the LCD indicates Song Mode, then use the Numeric Key Pad to select the Song that is to be named.
2. Press REAL TIME WRITE/EDIT SONG to enter the Edit Song Mode, and select Job #03.

```

EDIT   SONG 00
Name-> █    <
  
```

- If the selected Song already has a name, it will be displayed, and can be changed in exactly the same way as entering a new name.
3. Enter letters by pressing the instrument keys (for letters A thru X) or ACCENT 1 or 2 (for letters Y and Z respectively). The cursor will move to the right when a letter is entered, enabling you to enter the next letter. Letters are entered as upper case (capitals). Lower case letters may be entered by holding down STOP/CONTINUE while entering letters. Numerals may be entered by using the Numeric Key Pad. Spaces may be entered by using the REVERSE key. Periods may be entered by using the DAMP key. If you make a mistake, use the -1/NO and +1/YES keys to move the cursor to the erroneous character, and enter a new character.
  4. Press START to enter the new name. The LCD will return to the EDIT SONG display.
  5. Press PATTERN/SONG to exit the Edit Song Mode.

## JOB #04 INITIAL TEMPO

**FUNCTION** To set the initial tempo of a selected Song.

This function lets you set the exact tempo for a Song, thus avoiding the need for manually changing tempos between playback of Songs. Or if you connect Songs to make a Chain, this ensures that each Song will play at its correct tempo. Of course, any Tempo Change commands you have included in the Song will function (within the limits of the RX5's tempo range) and you can also vary the Tempo manually at any time.

### OPERATION

1. Press PATTERN/SONG until the LCD indicates Song Mode, then use the Numeric Key Pad to select the Song which is to have its Initial Tempo set.
2. Press REAL TIME WRITE/EDIT SONG to enter the Edit Song Mode, and select Job #04.

```

EDIT   SONG 00
Init Tempo OFF
  
```

On/Off indicator

- If the Initial Tempo has already been set, the LCD will show "Init Tempo ON". You can now alter the Initial Tempo setting, in exactly the same way as entering the setting for the first time. Or you can press -1/NO to turn the Initial Tempo function OFF.
3. Press +1/YES to turn the Initial Tempo function ON.
  4. Press START. The LCD will show the current setting of the RX5's Tempo.
- If the Initial Tempo was already set, the LCD will show its value. Example: 120 quarter-notes per minute.

```

EDIT   SONG 00
Init Tempo ♩=120
  
```

Initial tempo value

5. Use the Numeric Key Pad to set the Initial Tempo. Range: 40—250 quarter-notes per minute.
6. Press START again to enter the Initial Tempo. The LCD will return to the EDIT SONG display, showing the first Part of the Song.

# SONG CHAIN MODE

## OVERVIEW

The Song Chain mode lets you:

- Edit (assemble) and name up to 3 Chains, each containing up to 90 Steps (each Step is a Song).
- Clear (Erase) a Chain.
- Select a Chain and play it at any tempo.
- The function of the Song Chain Mode is to allow you to connect Songs in order to form a drum sequence for an entire group of Songs, for a live performance or a recording. Each Chain can contain up to 90 Songs, which when used in a Chain are called "Steps".

## THE JOBS

- Job #01: CHAIN SELECT/PLAY. Select one of 3 Chains and play at any tempo.  
 Job #02: EDIT CHAIN. Edit (assemble) a Chain.  
 Job #03: CHAIN NAME. Name a Chain.  
 Job #04: CHAIN CLEAR. Clear (erase) a Chain

## ENTERING THE SONG CHAIN MODE

To enter the Song Chain Mode, press the **CHAIN** key. The LCD will show the last Chain that was selected in this Mode.

Now, or after setting any Chain function, press any Mode key, or the **PATTERN/SONG** key, to exit this Mode.

Jobs are selected by pressing the **JOB** key (after pressing the **CHAIN** key) then entering the job number using the Numeric Key Pad panel. Once in this Mode, there is no need to press the **CHAIN** key prior to selecting other jobs.

## JOB #01: CHAIN PLAY

**FUNCTION** To select a Chain for play. To select an empty Chain for editing.

The RX5 can store up to 3 Chains, numbered 0 thru 2. Once you have selected a Chain, you can then go on to play the Chain, edit it (if it is empty) or clear (erase) it.

### OPERATION

1. Press **CHAIN** to enter the Chain Mode. Job #01 is automatically selected. If, however, you have already selected another Job in this Mode, press **JOB** then use the 10-keys to enter "01". the LCD will show the last Chain that was selected in this Mode. Example: Chain 0, containing 256 measures and named "Concerto".

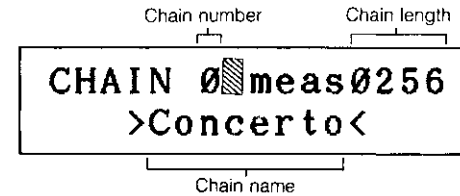

2. Use the Numeric Key Pad to enter the Chain number (0, 1 or 2).
3. Press **START** to play the Chain. During play, the RUN LED will light. The LCD will indicate the current measure, Step and Song number.

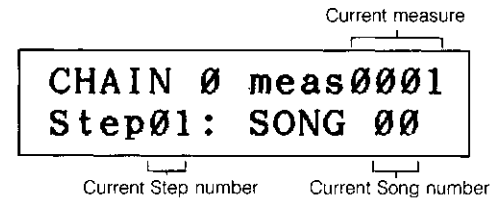

4. To stop play, press **STOP/CONTINUE**. The RUN LED will go out, and the LCD will show the point in the Chain at which play was stopped.
5. To restart play, press **START** to play from the beginning of the Chain, or **STOP/CONTINUE**, to play from the point at which play was stopped.
6. After the Chain has played, the LCD will return to the Chain select display.
- During Chain Play, you can alter the Tempo by moving the **TEMPO** slider control, or by pressing **TEMPO** and using the Numeric Key Pad or the +1/YES and -1/NO keys. The Click function can also be used during Chain play, but it must be turned on in the Pattern Mode. Refer to the PATTERN OPERATIONS chapter for full descriptions of these functions.

## JOB #02: EDIT CHAIN

**FUNCTION** To connect Songs in order to create a Chain.

### OPERATION

1. Press **CHAIN** to enter the Chain Mode, then use the 10-keys to select a Chain. When editing a new Chain, an empty Chain should be selected. This will be indicated by a zero measure count on the LCD.

CHAIN 0 meas0000  
> <

2. Select Job #02.

EDIT CHAIN 0  
Step01= SONG \*\*

Prompt to enter Song number

- If the selected Chain already contains data, the LCD will show the Song contained in the first Step.
  - If the Memory Protect is ON, the LCD will show "MEMORY PROTECTED" when this Job is selected, indicating that editing cannot be carried out. Use UTILITY JOB #03 to turn off the Memory Protect function.
3. The LCD is prompting you to enter the Song number for the first Step. Use the Numeric Key Pad to enter a Song number.

EDIT CHAIN 0  
Step01= SONG 00

- If the displayed Step already contains a Song (in the case of a Chain that has already been edited) you can change the Song by entering a new Song number in the same way.
4. Press +1/YES to move to the next Step, and enter another Song number in the same way.

EDIT CHAIN 0  
Step02= SONG 12

5. Continue moving through the Chain, entering Song numbers as desired. It's a good idea to keep a written record of a Chain, as you edit it. Refer to the SONG /CHAIN CHART at the end of this manual.

You can move backwards through a Chain using the -1/NO key. This lets you go back to check a Step. Any time a Step is displayed, you can change the Song contained in that Step by entering a new Song number.

Holding down a -1/NO or +1/YES key lets you move rapidly through a Chain.

6. Once you have entered all the Steps of your Chain, press PATTERN/SONG to exit the Edit Chain Mode, or select Job #01 to play your Chain.

## JOB #03: CHAIN NAME

**FUNCTION** To enter a name for a selected Chain.

This function lets you enter a name of up to eight characters (letters and numerals) for a Chain.

### OPERATION

1. Press CHAIN to enter the Chain Mode, then use the Numeric Key Pad keys to select the Chain that is to be named.
2. Select Job #03.

CHAIN 0 meas0256  
> <

If the selected Chain already has a name, it will be displayed, and can be changed in exactly the same way as entering a new name.

3. Enter letters by pressing the instrument keys (for letters A thru X) or ACCENT 1 or 2 (for letters Y and Z respectively). The cursor will move to the right when a letter is entered, enabling you to enter the next letter. Letters are entered as upper case (capitals). Lower case letters may be entered by holding down STOP/CONTINUE while entering letters. Numerals may be entered by using the Numeric Key Pad. Spaces may be entered by using the REVERSE key. Periods may be entered by using the DAMP key. If you make a mistake, use the -1/NO and +1/YES keys to move the cursor to the erroneous character, and enter a new character.
4. Press START to enter the new name. The LCD will then return to the Chain Play display.

## JOB #04: CHAIN CLEAR

**FUNCTION** To clear a selected Chain.

You can instantly clear (erase) an entire Chain. This would be done, for example, if the RX5's Chain memory were full and you wanted to write another Chain.

### OPERATION

1. Press CHAIN to enter the Chain Mode, and use the Numeric Key Pad to select the Chain you wish to clear.
2. Select Job #04.

CLEAR CHAIN 0 ?

You can now cancel the Chain Clear operation, if you wish, by pressing -1/NO.

- If the Memory Protect is ON, the LCD will show "MEMORY PROTECTED" when the Clear function is selected, indicating that Chain Clear cannot be carried out. Use UTILITY JOB #03 to turn off the Memory Protect function.

3. To clear the Chain, press +1/YES.

CLEAR CHAIN 0  
Are you sure?

If you wish, you can now cancel the Clear operation by pressing -1/NO. To carry out the Clear operation, press +1/YES, to see:

CLEAR CHAIN 0 ?  
completed!

Followed by

CHAIN 0  meas 0000  
> <

The LCD will now show that the selected Chain is empty (the measure count is zero). You can now edit a new Chain.

# EDIT VOICE MODE

## OVERVIEW

The Edit Voice Mode lets you:

- Edit any voice that has been assigned to an instrument key, to create a new voice.
  - Initialize any voice (automatically return its parameters to their original settings).
  - Store an edited voice to the same memory location as the selected voice.
  - Recall the last voice you were editing.
  - Compare an edited voice with its previous version.
- Refer to the EDIT VOICE BLOCK DIAGRAM near the end of this manual, for a visual explanation of how voice data is edited on the RX5.
  - Any voice selected for editing will be affected by the Parameter Assign functions corresponding to its instrument key (refer to KEY ASSIGN JOB #02). For example, if the pitch at the selected key is set to +3 semitones, any voice assigned to that key will have its pitch raised by 3 semitones. This pitch change, however, will NOT show on the LCD in this Mode. Also, if KEY ASSIGN JOB #02 has been used to set a parameter at the upper or lower limit of its range, it cannot be set beyond these limits using the Edit Voice Mode.

## THE JOBS

- Job #01: SELECT VOICE. Select any voice which has already been assigned to an instrument key, for editing.
- Job #02: PITCH. Edit the pitch of the selected voice.
- Job #03: E.G. (Envelope Generator). Edit six parameters relating to the envelope of the selected voice.
- Job #04: BEND. Alter the Pitch Bend Rate and Pitch Bend Range of the selected voice.
- Job #05: VOICE LEVEL. Alter the level of the selected voice.
- Job #06: LOOP. Turn on/off the loop section of the selected voice.
- Job #07: STORE VOICE. Store the edited voice into the RX5's Voice Edit Memory, at the same location as the selected voice.
- Job #08: INITIALIZE VOICE. Return all parameters of an edited voice to their original values.
- Job #09: RECALL EDIT.

## ENTERING THE EDIT VOICE MODE

To enter the Edit Voice Mode, press the **EDIT VOICE** key.  
The **EDIT VOICE** LED will light. The LCD will show the last instrument key, job and parameter value selected in this Mode.

```
EDIT VOICE :keyA
Pitch=± 0 cent
```

Now, or after setting any Edit Voice parameter or function, press any Mode key, or the **PATTERN/SONG** key, to exit this Mode.

- As soon as any parameter is changed, the "E" of "EDIT VOICE" will change to lower case. This will remain even if the parameter is returned to its original value.

lower case

```
eDIT VOICE :keyA
Pitch=+0100 cent
```

New Pitch setting

Jobs are selected by pressing the **JOB** key (after pressing the **EDIT VOICE** key) then entering the job number using the Numeric Key Pad. Once in this Mode, there is no need to press the **EDIT MODE** key prior to selecting other jobs.

- If the Memory Protect is ON, the LCD will show "MEMORY PROTECTED" when the Edit Mode is selected, indicating that editing cannot be carried out. Use **UTILITY JOB #03** to turn off the Memory Protect function.

## JOB #01: SELECT VOICE FOR EDIT

**FUNCTION** To select, for editing, any voice which has already been assigned to an instrument key.

### OPERATION

1. Press **EDIT VOICE** then select **JOB #01**. The LCD will show the last voice that was selected. Press the instrument key corresponding to the voice which you wish to edit.

```
EDIT VOICE :keyA
voice: Int-BD 1
```

You can now select parameters for editing the displayed voice, by selecting other Jobs in this Mode.

**NOTE:** If, when calling up this Job, a hyphen appears next to "key" on the LCD, this indicates that the voice which was last edited is now not assigned to an instrument key (i.e., another voice has since been assigned to that key).

## JOB #02: PITCH EDIT

**FUNCTION** To alter the pitch of the selected voice.

This function can be carried out on the voice that has been selected using EDIT VOICE JOB #01.

### OPERATION

1. After selecting a voice in JOB #01, select JOB #02.

EDIT VOICE :keyA  
Pitch=±  cent

2. Use the -1/NO and +1/YES keys or the DATA ENTRY slider to change the pitch by semitone units. Holding the "0" key while using the -1/NO or +1/YES key to change pitch allows pitch change in 10-cent (1/10th semitone) units. Pitch values are shown in 1-cent (1/100th semitone) units.

Range: +24/-36 semitones, displayed as +2400/-3600 cents.

## JOB #03: ENVELOPE EDIT

**FUNCTION** To edit the envelope generator of the selected voice.

This function can be carried out on the voice that has been selected using EDIT VOICE JOB #01.

Each voice on the RX5 has an envelope, with six separate parameters, as shown in the following diagram.

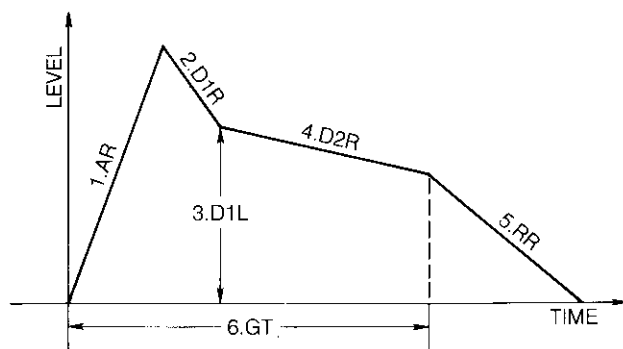

AR = Attack Rate (parameter 1)    D1R = Decay 1 Rate (parameter 2)  
D1L = Decay 1 Level (parameter 3)    D2R = Decay 2 Rate (parameter 4)  
RR = Release Rate (parameter 5)    GT = Gate Time (parameter 6)

This graph indicates visually what happens to the level of a single sound. With percussion instruments, the initial "attack" is usually very rapid—you hit the instruments, and the sound builds to a peak almost instantly. Slower attacks (where the sound takes a noticeable time to reach the maximum level) occur with violin, flute, the human voice, or a cymbal played with a soft mallet.

Then a first "decay" follows as the sound drops in level, to the first "decay level". This is followed by a second decay, and a final "release" as the sound dies away to silence. This kind of envelope can be heard clearly in the case of a cymbal played with a hard stick. The sound begins instantly (a high Attack Rate). The first bright tone decays quickly to a more muted "middle tone" as the complex harmonics of the initial impact dissipate (high Decay 1 Rate, then a lower Decay 1 Level). The middle tone slowly decreases in level (low Decay 2 Rate). Finally, the tail end of the sound consists of a few lower harmonics which die away to silence (low Release Rate). And in many other instruments, a similar envelope structure occurs, perhaps with more rapidity. Of course, each voice on the RX5 is an accurate digital recording of a real percussion instrument (or in some cases, a synthesizer sound) and contains its own built-in envelope. The Envelope Edit function allows you to modify the envelope in a very natural way, to create new, equally authentic voices.

The Gate Time indicates the overall length of the envelope, excluding the Release part of the envelope. It can be described by comparing it to what happens in a synthesizer such as a Yamaha DX7. When you hold a note down on a DX7, it's like opening a digital "gate", allowing the sound to pass. Then, when you release the key, the sound dies away gradually according to its Release Rate. So the Gate Time does NOT affect the Release Time, but as it is decreased, it will progressively cut the Decay 2 time, then the Decay 1 time.

Generally, increasing the attack or decay rate will shorten the attack or decay time, and vice versa.

**NOTE:** If envelope settings are set so as to create a long envelope, the original sound is usually lengthened by "looping"—taking a short portion of the sound and repeating it with increasing or decreasing level, for a natural extended effect. Refer to EDIT VOICE JOB #06 to see how to turn a loop off.

Also, the decay length cannot be set to more than 6.5 seconds (the maximum gate Time on the RX5). Therefore, very long decays may be cut off before they have faded to silence.

### OPERATION

1. After selecting a voice in JOB #01, select JOB #03. The LCD will show the last parameter selected in this Job. You can now select from the six parameters which can be edited.

#### PARAMETER 1: ATTACK RATE

1. To select Attack Rate, press "1".



EDIT VOICE :keyA  
Attack Rate =99

2. Use the -1/NO and +1/YES keys or the DATA ENTRY slider to change the Attack Rate.

Range: 01—99.

#### PARAMETER 2: DECAY 1 RATE

To select Decay 1 Rate, press "2".

EDIT VOICE :keyA  
Decay1 Rate =99

2. Use the -1/NO and +1/YES keys or the DATA ENTRY slider to change the Decay 1 Rate.

Range: 01—99.

#### PARAMETER 3: DECAY 1 LEVEL

1. To select Decay 1 Level, press "3".

EDIT VOICE :keyA  
Decay1 Level=60

2. Use the -1/NO and +1/YES keys or the DATA ENTRY slider to change the Decay 1 Level.

Range: 01—60.

#### PARAMETER 4: DECAY 2 RATE

1. To select Decay 2 Rate, press "4".

EDIT VOICE :keyA  
Decay2 Rate =99

2. Use the -1/NO and +1/YES keys or the DATA ENTRY slider to change the Decay 2 Rate.

Range: 01—99.

#### PARAMETER 5: RELEASE RATE

1. To select Release Rate, press "5".

EDIT VOICE :keyA  
Release Rate=99

2. Use the -1/NO and +1/YES keys or the DATA ENTRY slider to change the Release Rate.

Range: 01—99.

#### PARAMETER 6: GATE TIME

1. To select Gate Time, press "6".

EDIT VOICE :keyA  
Gate Time=6500ms

2. Use the -1/NO and +1/YES keys or the DATA ENTRY slider to change the Gate Time.

Range: 0.1—6.5 seconds, displayed as 0100—6500 ms (milliseconds.)

## JOB #04: BEND RATE/RANGE

### FUNCTION To set the pitch bend range and rate of a selected voice.

The RX5 voices have preset Bend Range and Bend Rate settings. The Bend function raises or lowers the pitch in 1/100th cent steps, resulting in a smooth pitch change starting from the original pitch. The Range setting affects the final pitch to which the note is "bent"; the Rate setting affects the "width" (time value) of each step, as shown in the following graph.

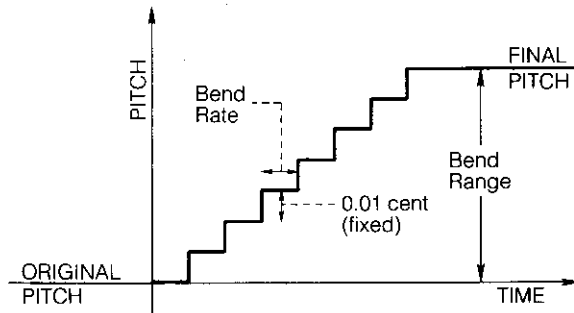

## OPERATION

- After selecting a voice in JOB #01, select JOB #04. The LCD will show the last parameter that was selected in this Job. You now have the choice of selecting Bend Rate or Bend Range. Press "1" to select Bend Rate, or press "2" to select Bend Range.

### Bend Rate

```
EDIT VOICE :keyA
Bend Rate = 00
```

Use the -1/NO and +1/YES keys or the DATA ENTRY slider to set the Bend Rate. Range 0—60. As the Bend Rate is increased, the pitch bend becomes more rapid. At the zero setting, there is no pitch bend. Also, if the Bend Range is set at zero, any setting of the Bend Rate will produce no pitch bend.

### Bend Range

```
EDIT VOICE :keyA
Bend Range = 00
```

Use the -1/NO and +1/YES keys or the DATA ENTRY slider to set the Bend Range, in semitone units. Range  $\pm 60$  semitones. Negative settings result in a downward pitch bend; positive settings result in an upward pitch bend. At the zero setting, there is no pitch bend. Also, if the Bend Rate is set at zero, any setting of the Bend Range will produce no pitch bend.

**NOTE:** The Bend Range cannot alter the pitch of a note outside the limits of its pitch range (refer to EDIT VOICE JOB #02.)

## JOB #05: VOICE LEVEL

### FUNCTION To set the level of a selected voice.

Each voice in the RX5 (and in the Waveform Data Cartridge) has a preset level setting. This Job allows you to change the level of each individual voice.

- This level is independent of the Key Level (refer to KEY ASSIGN JOB #02) which lets you "offset" the level of a selected instrument key, regardless of the voice which is assigned to that key. It is also independent of the setting of the INSTRUMENT VOLUME faders, which control the final output level of each pair of keys corresponding to an output channel.

## OPERATION

- After selecting a voice in JOB #01, select JOB #05.

```
EDIT VOICE :keyA
Voice Level = 31
```

- Use the -1/NO and +1/YES keys or the DATA ENTRY slider to set the level. Range 0—31. At the zero setting, the voice is turned off. However, if the instrument key level is set above zero (refer to KEY ASSIGN JOB #02) the instrument will still sound.

## JOB #06: LOOP ON/OFF

### FUNCTION To turn on or off the Loop section of the selected voice.

This function can be carried out on the voice that has been selected using EDIT VOICE JOB #01.

Looping of voices is a digital method for expanding a sampled sound to create an extended envelope. With longer voices (cymbals, for example) the sampled sound is expanded by taking the tail end of the sample and repeating it with decreasing level, for a natural decay effect, with the full duration of an authentic cymbal sound.

- When editing the envelope of a voice (refer to EDIT VOICE JOB #03) looping automatically occurs when you alter the Attack Rate or Decay Rate to create a sound that exceeds the envelope length of the original sample.
- This "loop" can be turned off, restoring the sound to its original sampled state, often featuring a sharp cut-off, which can be useful for special effects.

**OPERATION**

1. After selecting a voice in JOB #01, select JOB #06.

```
EDIT VOICE :keyA
Sound Loop :ON █
```

2. EITHER: Press -1/NO to turn the Loop OFF.  
OR: Press +1/YES to turn the Loop ON.

**JOB #07: STORE VOICE**

**FUNCTION** To store the edited voice.

This function can be carried out on the voice that has been selected using EDIT VOICE JOB #01, and edited.

It allows you to store the newly-edited voice. The original voice data is not lost, however. Refer to Job #08 for how to return a voice to its original state.

- If you exit the Edit Mode after editing a voice, but you have not stored the voice, the voice will remain in its edited state, until you initialize it (refer to Job #08) or re-enter the Edit Mode and select another voice for editing.

**OPERATION**

1. After selecting a voice in JOB #01, select JOB #07.

```
eDIT VOICE :keyA
Store Voice ?
```

You can now cancel the Store operation by pressing -1/NO. The LCD will display the Edit Mode Job that was selected prior to selecting this Job. You can now exit the Edit Mode, or continue editing the voice.

2. To continue the Store operation, press +1/YES.

```
eDIT VOICE :keyA
Are you sure ?
```

You now have another chance to cancel the Store operation, by pressing -1/NO.

3. To store the voice, press +1/YES again.

```
EDIT VOICE :keyA
completed!
```

**JOB #08: INITIALIZE VOICE**

**FUNCTION** To initialize all parameters of the selected voice.

This function can be carried out on the voice that has been selected using EDIT VOICE JOB #01, and edited.

It allows you to return all parameters of the selected voice to their original values.

**NOTE:** If the selected voice is not restored to its original sound, after this function has been carried out, it means that the key to which it has been assigned has had its parameters altered, using the Parameter Assign or Multi function. Refer to KEY ASSIGN JOBS #02, #03 respectively.

**OPERATION**

1. After selecting a voice in JOB #01, select JOB #08.

```
eDIT VOICE :keyA
Init Int-BD 1 ?
```

You can now cancel the Initialize operation by pressing -1/NO. The LCD will display the Edit Mode Job that was selected prior to selecting this Job. You can now exit the Edit Mode, or continue editing the voice.

2. To continue the Initialize operation, press +1/YES.

```
eDIT VOICE :keyA
Are you sure ?
```

You now have another chance to cancel the Initialize operation, by pressing -1/NO.

3. To initialize the voice, press -1/YES again.

```
eDIT VOICE :keyA
completed!
```

## JOB #09: RECALL EDIT

**FUNCTION** To recall the last voice that was in the Voice Edit buffer.

This function uses a second memory as a "back-up" function. It is used only while you are actually editing, BEFORE storing a voice and exiting the Edit Mode. It covers you in three possible situations.

1. You were editing a voice, then accidentally selected another voice for editing BEFORE storing the first voice. You can use this Job to recall the first voice.
2. You had already edited and stored a voice. You then edited it again, but decided that you wanted to return to the first edited version. BEFORE storing the newly edited version, you can use this Job to restore the voice to its previously edited state (as opposed to restoring it to its original state, which is done by using the Initialize function—refer to Job #08).
3. You had already edited and stored a voice. You then selected it for editing again, and initialized it, but decided that you did want the previously edited version. BEFORE storing the newly initialized voice, you can use this Job to restore the voice to its previously edited state.

### OPERATION

1. During editing, select JOB #09.

```
eDIT VOICE :keyA
Recall Edit ?
```

You can now cancel the Recall operation by pressing -1/NO. The LCD will display the Edit Mode Job that was selected prior to selecting this Job. You can now exit the Edit Mode, or continue editing.

2. To continue the Recall operation, press +1/YES.

```
eDIT VOICE :keyA
Are you sure ?
```

You now have another chance to cancel the Recall operation, by pressing -1/NO.

3. To carry out the Recall Edit, press +1/YES again. The LCD will show the last voice that was edited. Or if this was a previously edited version of the latest voice you selected, you will see the same voice display, but when you press the instrument key corresponding to the voice, you will hear it in its previously edited state.

```
eDIT VOICE :keyA
Voice: Int-BD 1
```

You can now continue editing, or store the recalled voice (refer to Job #07).

## EDIT COMPARE

**FUNCTION** To compare an edited voice with its previously selected state.

This function allows you to instantly compare a voice that is being edited with the state it was in when you selected it for editing (the compared state may not be the same as the initial version of the voice, as it may already have been edited and stored). It can only be used when the RX5 is in the Edit Mode. You can use it at any time during editing—a convenient way to check both aurally and visually (by reading parameter values) the effect of your editing.

### OPERATION

1. While editing a voice, press STOP/CONTINUE.

You will now be able to hear the original version of the voice, by playing the corresponding instrument key. On the LCD, a "compare mark" will appear above the "e" of "eDIT", and the cursor will disappear. The original value of the parameter that is currently being edited will be displayed. Example: Pitch.

Compare mark

```
eDIT VOICE :keyA
Pitch=± 0 cent
```

Cursor disappears

2. Press STOP/CONTINUE again to return to the edited version of the voice. The "compare mark" will disappear, and the cursor will reappear.

```
eDIT VOICE :keyA
Pitch=+0100 cent
```

You can select other parameters (Jobs #02 thru #06) and use the STOP/CONTINUE key for comparison of parameter values.

# KEY ASSIGN MODE

## OVERVIEW

The Key Assign mode lets you:

- Copy voices into the RX5's RAM.
- Assign voices to instrument keys and output channels.
- Edit parameters relating to each instrument key.
- Save and load key data.

## THE JOBS

- Job #01: KEY ASSIGN. Assign any selected voice to an instrument key. (Refer also to Jobs #06 and #09).
- Job #02: PARAMETER ASSIGN. Alter four parameters relating to each key.
- Job #03: MULTI VOICE. Assign one voice to the upper row of 12 instrument keys, to create a "drum keyboard" with an ascending or descending "Multi Step" scale of pitches, levels, attack rates and decay rates. (Refer also to Job #04).
- Job #04: MULTI STEP. If a voice is already assigned to Multi Voice, alter its Multi Step parameters. (Refer also to Job #03).
- Job #05: ACCENT LEVELS. Set accent levels (2 for each voice).
- Job #06: OUTPUT CHANNEL ASSIGN. Assign any voice to one of the 12 output channels relating to each pair of instrument keys. This is usually done prior to assigning a voice to an instrument key. (Refer to Jobs #01 and #09).
- Job #07: SAVE KEY DATA. Save up to 3 "drum sets", consisting of all data relating to instrument keys. (Refer to Jobs #01 thru #04).
- Job #08: LOAD KEY DATA. Load a "drum set" (Refer to Job #07).
- Job #09: COPY VOICE. Copy an Internal or Cartridge voice into the internal RAM.

## ENTERING THE KEY ASSIGN MODE

To enter the Key Assign Mode, press the **KEY ASSIGN** key. The LCD will show the last job that was selected in this Mode.

Now, or after setting any Key Assign parameter or function, press any Mode key, or the **PATTERN/SONG** key, to exit this Mode.

Jobs are selected by pressing the **JOB** key (after pressing the **KEY ASSIGN** key) then entering the job number using the Numeric Key Pad. Once in this Mode, there is no need to press the **KEY ASSIGN** key prior to selecting other jobs.

### JOB #01: VOICE ASSIGN

**FUNCTION** To assign voices to instrument keys.

Each output channel on the RX5 corresponds to a pair of instrument keys (for example: channel 1 corresponds to keys **A** and **M**). All voices are factory-preset to output channels

(refer to the Key Assign chart in THE INSTRUMENTS chapter). So when you select a key, it will have five or six voices (two internal voices, one copied voice, and two or three cartridge voices) from which you can select. The same voices will be available at the other key of the same pair of keys.

- You can assign voices to keys other than those shown in the Key Assign chart, enabling you to set any voice in any stereo position, when using the RX5's stereo outputs. Refer to KEY ASSIGN JOB #09 to see how to re-assign Internal voices to any key. Refer to KEY ASSIGN JOB #06 to see how to re-assign Internal and Cartridge voices to any key.

The following chart shows all the possibilities of voice/output assign.

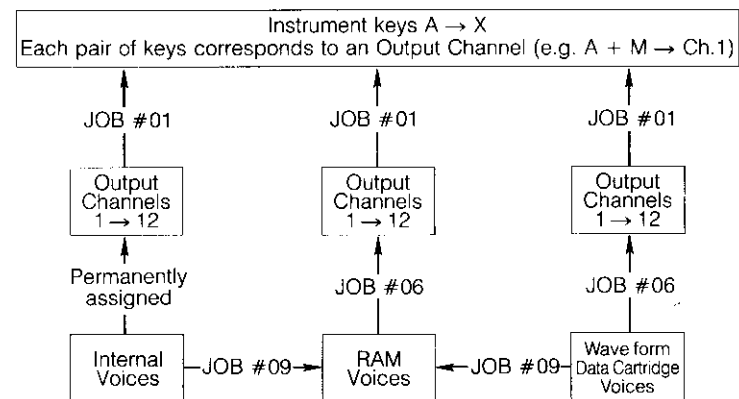

## OPERATION

1. Press **KEY ASSIGN** then select Job #01. The LCD will show the last voice that was selected in this Job.
2. Press the instrument key to which a voice is to be assigned.

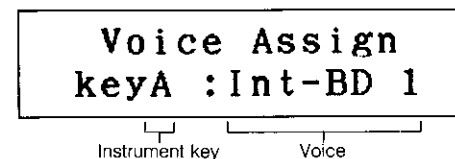

3. Use the **-1/NO** and **+1/YES** keys to step through the voices which are available at the selected key. When the LCD shows the desired voice, it is automatically assigned to the selected key.

```

Voice Assign
keyA :Crt-BD 3
  
```

New voice

## JOB #02: PARAMETER ASSIGN

**FUNCTION** To edit the pitch, level, attack and decay parameters of any selected instrument key.

This function works independently of the Edit Voice functions. It "offsets" the parameters of ANY voice assigned to a selected instrument key. If a new voice is assigned to the same key, it will be offset exactly the same amount as the previous voice. The LCD will show both the offset amount, and the actual parameter value (a combination of the parameter values set using this job and the Edit Voice Mode.) If the Edit Mode has already been used to set a parameter at the upper or lower limit of its range, it cannot be set beyond these limits using the Key Assign Mode.

- Key Assign parameters are memorized when a Pattern is written. You could then change the parameters and write more notes on the same Pattern — ideal for adding other sounds or pitches to a Pattern.

### OPERATION

1. Press **KEY ASSIGN** then select **JOB #02**. The LCD will show the last parameter selected in this Job.
2. Press the instrument key to be edited. You can now select from the four parameters which can be edited.

#### PARAMETER 1: PITCH

1. To select Pitch, press "1".

```

keyA :Int-BD 1
pitch ± 0(± 0)
  
```

Actual pitch value      Offset value

2. Use the **-1/NO** and **+1/YES** keys or the **DATA ENTRY** slider to change the pitch by semitone units. Holding the "0" key while using the **-1/NO** or **+1/YES** key to change pitch allows pitch change in 10-cent (1/10th semitone) units. Pitch values are shown in 10-cent (1/10th semitone) units.

Range:  $\pm 60$  semitones (offset) displayed as  $\pm 600$  units. Actual pitch range is  $+24/-36$  semitones (actual pitch cannot be offset outside these limits).

#### PARAMETER 2: LEVEL

1. To select Level, press "2".

```

keyA :Int-BD 1
level 27 (00)
  
```

Actual level value      Offset value

2. Use the **-1/NO** and **+1/YES** keys or the **DATA ENTRY** slider to change the instrument key level.

Range:  $\pm 31$  (offset). Actual level range is  $00/+31$  (actual level cannot be offset outside these limits).

#### PARAMETER 3: ATTACK

1. To select Attack, press "3".

```

keyA :Int-BD 1
attack 99 (00)
  
```

Actual Attack Rate value      Offset value

2. Use the **-1/NO** and **+1/YES** keys or the **DATA ENTRY** slider to change the Attack Rate.

Range:  $\pm 63$ (offset). Actual Attack Rate range is  $01/+99$  (actual Attack Rate cannot be offset outside these limits).

**NOTE:** Long attacks create "looping". Refer to **EDIT VOICE JOB #03** for comments about this.

#### PARAMETER 4: DECAY

1. To select Decay, press "4".

```

keyA :Int-BD 1
decay 35,45(00)
  
```

Actual decay 1 rate value      Offset value  
Actual decay 2 rate value

2. Use the **-1/NO** and **+1/YES** keys or the **DATA ENTRY** slider to change the Decay Rate.

Decay 1 and Decay 2 Rates are equally affected. Refer to EDIT VOICE JOB #03 for an explanation of these parameters. Decay 1 Level is NOT affected by this function.

Range:  $\pm 63$ (offset). Actual Decay Rate range is 01/+99 (actual Decay Rates cannot be offset outside these limits).

**NOTE:** Long decays create "looping". Refer to EDIT VOICE JOB #03 for comments about this.

## JOB #03: MULTI VOICE

**FUNCTION** To assign any selected voice to instrument keys A thru L, then program a sliding scale of parameters to these 12 keys.

In the Multi Voice Mode, only monophonic play of the assigned voice is possible, even if its original key is not within the range A thru L.

If using stereo outputs, the voices at keys A thru L will be set at the same stereo position as the original selected voice.

The Multi Voice Mode permits independent entry of four Multi Step values. These values measure the difference in the pitch, voice level, Attack Rate and Decay Rate of adjacent keys. This, in effect, turns instrument keys A thru L into a 12-note keyboard, using the selected voice as its sound source. The pitch, level, Attack Rate and Decay Rate can increase or decrease in equal steps from key A to key L.

- The original voice sounds at Keys A thru L will be replaced by the selected voice, while the Multi Voice Mode is ON.
- While the Multi Voice Mode is ON, another voice cannot be assigned to keys A thru L.
- To alter Multi Step parameter settings after you have already set them and exited this Job, do NOT use this Job again as that will cancel all your settings. Refer to Job #04.

### OPERATION

1. Press **KEY ASSIGN** and select **JOB #03**.

Multi voice  
push Voice or No

- If the Multi Voice Mode is already on, you can press  $-1/NO$  to turn it OFF. The LCD will return to the Decay display of the previous Job (Job #02: Parameter Assign).
2. turn the Multi Voice Mode ON, press the instrument key corresponding to the selected voice. The **MULTI** LED will light. The selected voice can now be played on keys A thru L, and Multi Step parameters can be selected and set. The LCD will show the selected voice, and the last Multi Step parameter that was selected. Example: Pitch.

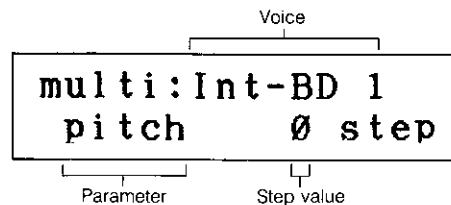

#### PARAMETER 1: PITCH

1. To select Pitch, press "1".

multi: Int-BD 1  
pitch 0 step

2. Use the  $-1/NO$  and  $+1/YES$  keys or the **DATA ENTRY** slider to change the pitch step by 10-cent (1/10th semitone) units. Pitch step values are shown in 1-cent (1/100th semitone) units.

Range:  $\pm 2$  semitones, equal to a range over the 12 instrument keys of  $\pm 2$  octaves. Displayed as  $\pm 200$  units.

3. Press **START** to enter the pitch step setting. On the LCD the word "step" will briefly change to "set!", then return to "step".

- The original pitch will be retained at key A. Keys B through L will ascend or descend in pitch, according to a positive or negative pitch step setting.

**NOTE:** The Multi Step function cannot alter a voice's pitch beyond the upper and lower limits of its pitch range (as set by the EDIT VOICE or KEY PARAMETER ASSIGN functions). If a voice's pitch is already set at or near these limits, this will result in all keys to the right of the first key that reaches this limit having the same pitch.

#### PARAMETER 2: VOICE LEVEL

1. To select Level, press "2".

multi: Int-BD 1  
level 0 step

2. Use the  $-1/NO$  and  $+1/YES$  keys or the **DATA ENTRY** slider to change the level step.

Range:  $\pm 10$ .

3. Press **START** to enter the level step setting. On the LCD the word "step" will briefly change to "set!" then return to "step".

- The original level will be retained at key **A**. Keys **B** through **L** will increase or decrease in level, according to a positive or negative level step setting.

**NOTE:** The Multi Step function cannot alter a voice's level beyond the upper and lower limits of its level range (as set by the **EDIT VOICE** or **KEY PARAMETER ASSIGN** functions). If a voice's level is already set at or near these limits, this will result in all keys to the right of the first key that reaches this limit having the same level.

#### PARAMETER 3: ATTACK RATE

1. To select Attack, press "3".

```
multi: Int-BD 1
attack 0 step
```

2. Use the **-1/NO** and **+1/YES** keys or the **DATA ENTRY** slider to change the attack step.

Range:  $\pm 10$ .

3. Press **START** to enter the attack step setting. On the LCD the word "step" will briefly change to "set!" then return to "step".

- The original Attack Rate setting will be retained at key **A**. Keys **B** through **L** will increase or decrease in Attack Rate, according to a positive or negative Attack Rate step setting.

**NOTE:** The Multi Step function cannot alter a voice's attack rate beyond the upper and lower limits of its Attack Rate range (as set by the **EDIT VOICE** or **KEY PARAMETER ASSIGN** functions). If a voice's Attack Rate is already set at or near these limits, this will result in all keys to the right of the first key that reaches this limit having the same Attack Rate.

#### PARAMETER 4: DECAY RATE

1. To select Decay press "4".

```
multi: Int-BD 1
decay 0 step
```

2. Use the **-1/NO** and **+1/YES** keys or the **DATA ENTRY** slider to change the decay step.

Range:  $\pm 10$ .

3. Press **START** to enter the decay step setting. On the LCD the word "step" will briefly change to "set!" then return to "step".

- The original Decay Rate setting will be retained at key **A**. Keys **B** through **L** will increase or decrease in Decay Rate, according to a positive or negative Decay Rate step setting.

**NOTE:** The Multi Step function cannot alter a voice's decay rate beyond the upper and lower limits of its Decay Rate range (as set by the **EDIT VOICE** or **KEY PARAMETER ASSIGN** functions). If a voice's Decay Rate is already set at or near these limits, this will result in all keys to the right of the first key that reaches this limit having the same Decay Rate.

## JOB #04: MULTI STEP

**FUNCTION** To alter the Multi Step parameters of a voice assigned to instrument keys **A** thru **L**, via the Multi Voice function.

This job carries out exactly the same functions as the Multi Step functions described in the previous Job, if a voice has **ALREADY** been assigned to instrument keys **A** thru **L** via the the Multi Voice function. It enables you to make adjustments to Multi Step parameters that you have already set. Otherwise, if you attempt to alter Multi Step settings by using Job #03, you will first have to re-assign your selected voice to the Multi Mode, and this will cancel all previous Multi Step settings.

- Multi Step parameters are memorized when a Pattern is written. You could then change the parameters and write more notes on the same Pattern — ideal for adding other sounds or pitches to a Pattern.

**NOTE:** This Job can **NOT** be selected if a voice has not first been assigned to the Multi Mode.

### OPERATION

1. After assigning a voice to the Multi Mode, press **KEY ASSIGN** and select **JOB #04**. The LCD will show the last Multi Step parameter that was selected.
2. Multi Step parameters can be selected and re-edited. Refer to Job #03 for operation details.

## JOB #05: ACCENT LEVELS

**FUNCTION** To program two different level changes to individual voices. Pressing any instrument key while holding either of the green **ACCENT** keys causes that instrument to sound at its **ACCENT 1** or **ACCENT 2** level.

The accent level range is the same as the voice level range (refer to **EDIT VOICE JOB #05**). The accent level setting is **ADDED** to the voice level setting to produce the actual accent level. Negative accent levels can also be set, for interesting effects.



**OPERATION**

1. Press **KEY ASSIGN** and select **JOB #05**. The LCD will show the last Accent Level that was selected in this Job. Example: Accent 1.

```
Accent 1 Level
-- select Voice
```

2. Press the instrument key for which the Accent Level is to be set.

```
Accent 1 Level
Int-BD 1 = 00
```

3. Accents are set by first pressing either **ACCENT 1** or **ACCENT 2**, then using the **-1/NO** and **+1/YES** keys or the **DATA ENTRY** slider to set the corresponding Accent Level.

Range:  $\pm 31$ . The voice level range is 0—31. If the Accent Level setting PLUS the original voice level setting exceeds 31 or is less than 0 (in the case of negative accent level settings) the actual Accent Level will be set to 31 or 0 (off) respectively.

**JOB #06: OUTPUT CHANNEL ASSIGN**

**FUNCTION** To assign Copied and Cartridge voices to output channels.

Each output channel (1 thru 12) corresponds to a pair of instrument keys (**A-plus-M** thru **L-plus-X**). This function facilitates assignment of any Copied or Cartridge voice to any key, by first assigning the voice to the appropriate output channel, then using **KEY ASSIGN JOB #01** to assign the voice to one of the two keys corresponding to that output channel.

- Internal voices are pre-assigned to output channels (refer to the Key Assign chart in the **PLAYING THE RX5 INSTRUMENTS** section of **THE INSTRUMENTS** chapter.) However, you can copy up to 12 of these voices into the RX5's RAM (refer to **KEY ASSIGN JOB #09**) so that they can then be assigned to any output channel.

**OPERATION**

1. Press **KEY ASSIGN** and select **JOB #06**. The LCD will show the last voice and cursor position that was selected in this Mode.

```
Output Ch Assign
Cp1-BD 1 █=01
```

Voice

Output Channel number

Pressing **ACCENT 2** moves the cursor back and forth between the Voice position and the Channel number position.

2. Move the cursor to the voice position. Use the **-1/NO** and **+1/YES** keys to select the voice to be assigned.
3. Move the cursor to the output channel number. Use the **DATA ENTRY** slider to set the output channel (1 thru 12).

**JOB #07: SAVE KEY DATA**

**FUNCTION** Store, in the RX5's memory, data relating to all 24 instrument keys. Stored data is all **KEY ASSIGN MODE** data, and includes

- **JOB #01** data (Voice Assign)
- **JOB #02** data (Parameter Assign)
- **JOB #03** data (Multi Voice)
- **JOB #04** data (Multi Step).

Three complete sets of data can be independently stored.

This function allows you to store three completely different "drum sets".

**NOTE:** When you save Key Data, any data in the selected destination will be erased. If you wish to avoid this, save the data to cassette tape first. Refer to **CASSETTE MODE JOB #05**.

**OPERATION**

1. Press **KEY ASSIGN** and select **Job #07**.

Destination number prompt

```
Save key Data#* █
select 1 to 3
```

2. Press "1", "2" or "3" to select the destination to which the key data is to be stored  
Example: 1.

Destination number

Save key Data#1   
select 1 to 3

You can, prior to saving, select another destination.

3. Press the +1/YES key to store the key data. The LCD will briefly show

Save key Data#1  
completed!

You will then see the previous display, without a cursor.

## JOB #08: LOAD KEY DATA

**FUNCTION** Load, from the RX5's memory, data relating to all 24 instrument keys.

This function allows you to rapidly load Key Data comprising one of three completely different "drum sets". For details of the actual data that is loaded, refer to Job #07.

### OPERATION

1. Press KEY ASSIGN and select Job #08.

Key Data number prompt

Load key Data##   
select 1 to 3

2. Press "1", "2" or "3" to select the key data which is to be loaded. Example: 1.

Key data number

Load key Data#1   
select 1 to 3

• You can, prior to loading, select other key data for loading.

3. Press the +1/YES key to load the key data. The LCD will briefly show

Load key Data#1  
completed!

## JOB #09: COPY VOICE

**FUNCTION** To copy Internal and Cartridge voices into the Internal RAM.

Internal voices are pre-assigned to output channels (and consequently to specific pairs of instrument keys.) By copying a voice to the RAM it can then be assigned to any output channel (refer to KEY ASSIGN JOB #06) and from there, to any key (refer to KEY ASSIGN JOB #01.)

Both Internal and Cartridge voices can be copied to the RAM (to more than one location, if desired) and edited to make new voices, while the original voice is retained and can also be played.

can also be played.

### OPERATION

1. Press KEY ASSIGN and select Job #09. The LCD will show the last voice, copy destination and cursor position that was selected.

Copy Voice Data  
Int-BD 1  →Cp1

Voice

Copy destination

2. Use ACCENT 2 to move the cursor between voice name and copy destination number. Use the No/-1 and +1/YES keys to select the voice and the copy destination.

3. Press START to carry out the copy function. The LCD will briefly show

Copy Voice Data  
completed!

then return to the previous display.

# CARTRIDGE MODE

## OVERVIEW

The Cartridge Mode lets you:

- Save Sequence (Pattern/Song/Chain) data and Voice data onto Yamaha RAM4 Data Cartridge.
  - Verify that data has been correctly saved.
  - Load data from cartridge into the RX5.
  - Format a data cartridge.
- Prior to entering this Mode, make sure that a RAM4 Data Cartridge is firmly inserted into the Data Cartridge slot on the RX5's rear panel.

- Verify operations are highly recommended after every Save operation. This will ensure that your data is correctly saved, otherwise you may lose irreplaceable data. The Verify function compares the data saved onto cartridge with the original data in the RX5.

## THE JOBS

The Cartridge Mode has 13 jobs, covering the four main functions (Save, Load, Verify and Format). These are arranged as follows.

	ALL SEQUENCE AND VOICE DATA	ALL SEQUENCE DATA	SINGLE PATTERN	ALL VOICE DATA
SAVE	# 01	# 02	# 03	# 04
LOAD	# 11	# 12	# 13	# 14
VERIFY	# 21	# 22	# 23	# 24
FORMAT	# 30 [FORMAT NEW RAM4 CARTRIDGE FOR USE IN RX5]			

## ENTERING THE CARTRIDGE MODE

To enter the Cartridge Mode, press the CASSETTE/CARTRIDGE key. Repeated pressings of this key switch the RX5 between cartridge operation and cassette operation. The CART (cartridge) LED will light when the Cartridge Mode is selected.

Now, or after executing any Cartridge function, press any Mode key, or the PATTERN/SONG key, to exit this Mode.

Jobs are selected by pressing the JOB key (after entering the Cartridge Mode) then entering the job number using the 10 — key panel. Once in this Mode, there is no need to press the CASSETTE/CARTRIDGE key prior to selecting other jobs.

## SAVING DATA

### JOB #01: SAVE SEQUENCE AND VOICE DATA

### JOB #02: SAVE SEQUENCE DATA

### JOB #04: SAVE VOICE DATA

### FUNCTION To save all sequence and/or voice data onto Yamaha RAM4 Data Cartridge.

Save operations allow you to save the sequence data for up to 100 Patterns, 20 Songs and 3 Chains and/or the voice data for all 64 voices stored in the RX5.

**NOTE (JOB #01):** If your cartridge already contains data, it will be completely erased when you perform a Save Sequence and Voice Data operation, so check that this data is not needed.

**NOTE (JOB #02):** If your cartridge already contains sequence data, it will be erased when you perform a Save Sequence Data operation, so check that this data is not needed. Voice Data contained in the cartridge will NOT be affected by this operation.

**NOTE (JOB #04):** If your cartridge already contains voice data, it will be erased when you perform a Save Voice Data operation, so check that this data is not needed. Sequence Data contained in the cartridge will NOT be affected by this operation.

### OPERATION Operation is identical for the above three Jobs.

1. Press CASSETTE/CARTRIDGE until the LCD indicates Cartridge Mode, then select Job #01, #02 or #04. Example: Job #01.

CARTRIDGE CTRL  
Save Sq&Voice?

- To continue the Save operation, press +1/YES.

CARTRIDGE CTRL  
Save sure?

You now have a chance to cancel this operation by pressing -1/NO, if you do not wish to erase data in the cartridge.

- To save the data, press +1/YES again.

CARTRIDGE CTRL  
Save executing

followed by

CARTRIDGE CTRL  
Save completed

## JOB #03: SAVE SINGLE PATTERN.

**FUNCTION** To save the data of a single selected Pattern onto Yamaha RAM4 Data Cartridge.

This operation allows you to save the sequence data for a single Pattern. Any Pattern destination may be selected.

**NOTE:** If the Pattern destination selected in your cartridge already contains data, it will be erased when you perform a Save Single Pattern operation, so check that this data is not needed. Voice Data contained in the cartridge will NOT be affected by this operation.

## OPERATION

- Press PATTERN/SONG until the LCD indicates Pattern Mode, then use the Numeric Key Pad or the -1/NO and +1/YES keys to select the pattern you wish to save.
- Press CASSETTE/CARTRIDGE until the LCD indicates Cartridge Mode, then select Job #03.

CARTRIDGE CTRL  
Save PTN 00 ?

- To continue the save operation, press +1/YES.

CARTRIDGE CTRL  
PTN 00 ▣ → Crt \*\*

Prompt to enter destination

- Press ACCENT 2 to move the cursor to the right, and use the Numeric Key Pad to select the Pattern Destination number. Example: 00.

CARTRIDGE CTRL  
PTN 00 → Crt 00 ▣

You can use the ACCENT 2 key to move the cursor backwards and forwards to allow you to reset the Pattern and Pattern destination numbers.

- Press +1/YES to continue the Save operation.

CARTRIDGE CTRL  
Save sure?

**CARTRIDGE MODE**

- You now have a chance to cancel the Save operation by pressing -1/NO, if you do not wish to erase data in the cartridge.
6. To save the data, press +1/YES again.

CARTRIDGE CTRL  
Save executing

Followed by

CARTRIDGE CTRL  
Save completed

**LOADING DATA**

- JOB #11: LOAD SEQUENCE AND VOICE DATA**  
**JOB #12: LOAD SEQUENCE DATA**  
**JOB #14: LOAD VOICE DATA**

**FUNCTION** To load sequence and voice data from Yamaha RAM4 Data Cartridge into the RX5.

Load operations allow you to load the sequence data for up to 100 Patterns, 20 Songs and 3 Chains and/or the voice data for all 64 voices stored in the RAM4 cartridge.

**NOTE (JOB #11):** If the RX5 already contains data, it will be completely erased when you perform a Load Sequence and Voice Data operation, so check that this data is not needed.

**NOTE (JOB #12):** If the RX5 already contains sequence data, it will be erased when you perform a Load Sequence Data operation, so check that this data is not needed.

**NOTE (JOB #14):** If the RX5 already contains voice data, it will be erased when you perform a Load Voice Data operation, so check that this data is not needed.

**OPERATION** Operation is identical for the above three Jobs.

1. Press CASSETTE/CARTRIDGE until the LCD indicates Cartridge Mode, then select Job #11, #12 or #14. Example: Job #11.

CARTRIDGE CTRL  
Load Sq&Voice?

2. To continue the Load operation, press +1/YES.

CARTRIDGE CTRL  
Load sure ?

You now have a chance to cancel this operation by pressing -1/NO, if you do not wish to load the data.

3. To load the data, press +1/YES again.

CARTRIDGE CTRL  
Load executing

Followed by

CARTRIDGE CTRL  
Load completed

**JOB #13: LOAD SINGLE PATTERN.**

**FUNCTION** To load the data of a single selected Pattern from Yamaha RAM4 Data Cartridge into the RX5.

This operation allows you to load the sequence data for a single Pattern. Any Pattern may be loaded into any Pattern destination.

**NOTE:** If the Pattern destination selected already contains data, it will be erased when you perform a Load Single Pattern operation, so check that this data is not needed. Voice Data contained in the RX5 will NOT be affected by this operation.

**OPERATION**

1. Press **PATTERN/SONG** until the LCD indicates Pattern Mode, then use the Numeric Key Pad or the **-1/NO** and **+1/YES** keys to select the pattern destination to which you wish to load data.
2. Press **CASSETTE/CARTRIDGE** once or twice to enter the Cartridge Mode, then select Job #13.

CARTRIDGE CTRL  
Load PTN 00 ?

3. To continue the Load operation, press **+1/YES**.

CARTRIDGE CTRL  
Crt \*\* → PTN 00

Prompt to enter Pattern number

4. Use the Numeric Key Pad to select the number of the Pattern you wish to load.  
Example: 11.

CARTRIDGE CTRL  
Crt 11 → PTN 00

5. To continue the Load operation, press **ACCENT 2**. The cursor will move to the right. You can now alter the Pattern destination number, or proceed to Step 7, to continue the Load operation.
6. To alter the Pattern destination number, use the 10-keys. You can use the **ACCENT 2** key to move the cursor backwards and forwards to allow you to reset the Pattern and Pattern destination numbers.
7. Press **+1/YES** to continue the Load operation.

CARTRIDGE CTRL  
Load sure ?

You now have a chance to cancel the Load operation by pressing **-1/NO**, if you do not wish to erase data in the Pattern destination.

8. To Load the Pattern, press **+1/YES** again.

CARTRIDGE CTRL  
Load completed

**VERIFYING DATA****JOB #21: VERIFY SEQUENCE AND VOICE DATA****JOB #22: VERIFY SEQUENCE DATA  
JOB #24: VERIFY VOICE DATA**

**FUNCTION** To verify that sequence and/or voice data has been correctly saved onto Yamaha RAM4 Data Cartridge.

**OPERATION** Operation is identical for the above three Jobs. These Jobs correspond to (and should be carried out subsequent to) Save Jobs, as follows.

JOB #21 verifies JOB #01.  
JOB #22 verifies JOB #02.  
JOB #24 verifies JOB #04.

1. After saving the data select Job #21, #22 or #24 as appropriate. Example: Job #21.

CARTRIDGE CTRL  
Verify Sq&Voice?

2. To continue the verify operation, press **+1/YES**.

CARTRIDGE CTRL  
Verify sure ?

You now have a chance to cancel this operation by pressing **-1/NO**, if you do not wish to verify the data.

3. To verify the data, press +1/YES again.

CARTRIDGE CTRL  
Verify executing

If the data has been correctly saved, the LCD will then show

CARTRIDGE CTRL  
Verify OK!!!

If any other messages appear, refer to the ERROR MESSAGES chapter.

## JOB #23: VERIFY SINGLE PATTERN.

**FUNCTION** To verify that the data of a single selected Pattern has been correctly saved onto Yamaha RAM4 Data Cartridge.

This operation actually allows you to compare any of the 100 Patterns stored in the RX5 with any of the 100 Patterns saved onto cartridge. The two Pattern numbers you will enter may be different, if you have saved a Pattern to a differently-numbered destination in the RAM4 cartridge.

**OPERATION** This Job corresponds to (and should be carried out subsequent to) Job #03, Save Single Pattern.

1. After saving a Pattern, press CASSETTE/CARTRIDGE once or twice to enter the Cartridge Mode, then select Job #23.

CARTRIDGE CTRL  
Verify PTN 00 ?

2. To continue the Verify operation, press +1/YES.

CARTRIDGE CTRL  
PTN 00 → Crt \*\*

3. Use the Numeric Key Pad to select the number of the Pattern stored in the RX5. Example: 11.

CARTRIDGE CTRL  
PTN 11 → Crt \*\*

Prompt to enter Cartridge Pattern number

4. Press ACCENT 2 to move the cursor to the right, and use the Numeric Key Pad to select the number of the Pattern saved on the cartridge. Example: 22.

CARTRIDGE CTRL  
PTN 11 → Crt 22

You can use the ACCENT 2 key to move the cursor back and forwards to allow you to reset the RX5 Pattern and cartridge Pattern numbers.

5. Once the cursor is on the right of the LCD, Press +1/YES to continue the Verify operation.

CARTRIDGE CTRL  
Verify sure ?

You now have a chance to cancel the Verify operation by pressing -1/NO.

6. To verify the data, press +1/YES again.

If the data has been correctly saved, the LCD will then show

CARTRIDGE CTRL  
Verify OK!!!

If any other messages appear, refer to the ERROR MESSAGES chapter.

## FORMATTING

### JOB #30: FORMAT CARTRIDGE

**FUNCTION** To format the RAM4 Data Cartridge for use with the RX5.

This function MUST be carried out on any new Yamaha RAM4 Data Cartridge that you purchase for use with your RX5, prior to using the cartridge for saving data.

#### OPERATION

1. Insert your new RAM4 Data cartridge into the Data Cartridge slot on the rear of the RX5.
2. Press CASSETTE/CARTRIDGE until the LCD indicates Cartridge Mode, then select Job #30.

CARTRIDGE CTRL  
Format Cartrg ?

3. To continue the Format operation, press +1/YES.

CARTRIDGE CTRL  
Format sure ?

You can now either format the cartridge, or press -1/NO to cancel the Format operation.

4. To format the cartridge, press +1/YES again.

CARTRIDGE CTRL  
Format executing

Followed by

CARTRIDGE CTRL  
Format completed

Your RAM4 cartridge is now formatted, and can be used for saving data.



# CASSETTE MODE

## OVERVIEW

The Cassette Mode lets you:

- Save Sequence (Pattern/Song/Chain) data, Voice data and Set-up (Drum set/Accent Level/MIDI) data onto a standard cassette tape.
  - Verify that data has been correctly saved.
  - Load data from cassette into the RX5.
- Prior to entering this Mode, ensure that the RX5 is correctly connected to a cassette deck (refer to the REAR PANEL/CONNECTIONS section)
  - The RX5's cassette output is rated to match with a microphone input, while its cassette input matches a normal data recorder output. Therefore, a computer data cassette recorder is recommended, but any high-quality recorder may be used.
  - Make sure that the heads on your cassette recorder are clean and demagnetized. Avoid using any noise reduction system, which could affect the accuracy of the recording. Keep record and playback levels high, to minimize tape hiss.

NOTE: All Save, Load and Verify operations can be interrupted by pressing CASSETTE/CARTRIDGE while the operation is executing. Example: Verify.

**CASSETTE CONTROL**  
**Verify break!**

Clear this display by pressing JOB, or any Mode key.

## THE JOBS

The Cassette Mode has 15 jobs, covering the three main functions (Save, Load and Verify). These are arranged as follows.

	ALL SEQUENCE AND VOICE DATA	ALL SEQUENCE DATA	SINGLE PATTERN	ALL VOICE DATA	SET-UPS
SAVE	# 01	# 02	# 03	# 04	# 05
LOAD	# 11	# 12	# 13	# 14	# 15
VERIFY	# 21	# 22	# 23	# 24	# 25

- **SAVE OPERATIONS:** Prior to all Save operations, make sure that a blank cassette is loaded into your cassette player.
- **LOAD AND VERIFY OPERATIONS:** Prior to all Load and Verify operations, make sure that the data cassette is loaded into your cassette player, and is at the beginning of the recorded data.
- **VERIFY OPERATIONS** are highly recommended after every Save operation. This will ensure that your data is correctly saved, otherwise you may lose irreplaceable data. The Verify function compares the data saved onto cassette with the original data.

## ENTERING THE CASSETTE MODE

To enter the Cassette Mode, press the CASSETTE/CARTRIDGE key. Repeated pressings of this key will switch the RX5 between cartridge operation and cassette operation. The CAS (cassette) LED will light when the Cassette Mode is selected. The LCD will show the last job that was selected in this Mode.

Now, or after carrying out any Cassette function, press any Mode key, or the PATTERN/SONG key, to exit this Mode.

Jobs are selected by pressing the JOB key (after entering the Cassette Mode) then entering the job number using the Numeric Key Pad panel. Once in this Mode, there is no need to press the CASSETTE/CARTRIDGE key prior to selecting other jobs.

## SAVING DATA

**JOB #01: SAVE SEQUENCE AND VOICE DATA**

**JOB #02: SAVE SEQUENCE DATA**

**JOB #04: SAVE VOICE DATA**

**JOB #05: SAVE SET-UPS**

**FUNCTION** To save all sequence and/or voice data, or set-up data, onto cassette tape.

Save operations allow you to save the sequence data for up to 100 Patterns, 20 Songs and 3 Chains and/or the voice data for all 64 voices stored in the RX5.

Set-Up Data can also be saved, and includes the following data:

- The 3 sets of Key data stored in the RX5 (refer to KEY ASSIGN JOB #07).
- The Accent Levels of all 64 voices.
- The MIDI Transmit channels of all 64 voices.
- The MIDI Receive channel.
- The MIDI Notes of all 64 voices.

**OPERATION** Operation is identical for the above four Jobs.

1. Press CASSETTE/CARTRIDGE until the LCD indicates Cassette Mode, then select Job #01.

CASSETTE CONTROL  
Save Sq&Voice?

2. To save the data, start the cassette player in RECORD, and press +1/YES.

CASSETTE CTRL  
Save executing

Followed by

CASSETTE CTRL  
Save completed

**JOB #03: SAVE SINGLE PATTERN.****FUNCTION** To save the data of a single selected Pattern onto cassette tape.

This operation allows you to save the sequence data for a single Pattern.

**OPERATION**

1. Press PATTERN/SONG until the LCD indicates Pattern Mode, then use the Numeric Key Pad or the -1/NO and +1/YES keys to select the pattern you wish to save.
2. Press CASSETTE/CARTRIDGE until the LCD indicates Cassette Mode, then select Job #03.

CASSETTE CTRL  
Save PTN 00 ?

2. To save the data, start the cassette player in RECORD, and press +1/YES.

CASSETTE CTRL  
Save executing

Followed by

CASSETTE CTRL  
Save completed

**LOADING DATA****JOB #11: LOAD SEQUENCE AND VOICE DATA****JOB #12: LOAD SEQUENCE VOICE DATA****JOB #14: LOAD VOICE DATA****JOB #15: LOAD SET-UP****FUNCTION** To load sequence and/or voice data, or set-up data, from cassette tape, into the RX5.

Load operations allow you to load the sequence data for up to 100 Patterns, 20 Songs and 3 Chains and/or the voice data for all 64 voices saved on cassette. Set-up data can also be loaded (refer to Job #05 for a description of Set-ups).

**NOTE (JOB #11):** If the RX5 already contains sequence and voice data, it will be erased when you perform a Load Sequence and Voice Data operation, so check that this data is not needed.

**NOTE (JOB #12):** If the RX5 already contains sequence data, it will be erased when you perform a Load Sequence Data operation, so check that this data is not needed.

**NOTE (JOB #14):** If the RX5 already contains voice data, it will be erased when you perform a Load Voice Data operation, so check that this data is not needed.

**NOTE (JOB #15):** If the RX5 already contains set-up data, it will be erased when you perform a Load Set-ups operation, so check that this data is not needed.

**OPERATION** Operation for the above four Jobs is identical. These Jobs correspond to (and should be carried out subsequent to) Save Jobs, as follows.

JOB #11 loads data that was saved in JOB #01.  
JOB #12 loads data that was saved in JOB #02.  
JOB #14 loads data that was saved in JOB #04.  
JOB #15 loads data that was saved in JOB #05.

1. Press CASSETTE/CARTRIDGE until the LCD indicates Cassette Mode, then select Job #11, #12, #14 or #15. Example: Job #11.

CASSETTE CTRL  
Load Sq&Voice?

2. To continue the Load operation, press +1/YES.

CASSETTE CTRL  
Load sure ?

You now have a chance to cancel this operation by pressing -1/NO, if you do not wish to load the data.

3. To load the data, press +1/YES again.

CASSETTE CTRL  
Load executing

Start playback of the data cassette, to commence data loading.  
After loading, the LCD will show

CASSETTE CONTROL  
Load completed

## JOB #13: LOAD SINGLE PATTERN.

**FUNCTION** To load the data of a single selected Pattern from cassette tape into the RX5.

This operation allows you to load the sequence data for a single Pattern. Any Pattern destination may be selected.

- This function can only be carried out if the data that you wish to load was saved to cassette in a Save Single Pattern operation (refer to Job #03). The number of the Pattern that was saved, however, does not affect this operation—it can be loaded into any Pattern destination.

**NOTE:** If the Pattern destination selected already contains data, it will be erased when you perform a Load Single Pattern operation, so check that this data is not needed. Voice Data contained in the RX5 will NOT be affected by this operation.

## OPERATION

1. Press PATTERN/SONG until the LCD indicates Pattern Mode, then use the 10-keys or the -1/NO and +1/YES keys to select the pattern destination to which you wish to load data.
2. Press CASSETTE/CARTRIDGE until the LCD indicates Cassette Mode, then select Job #13.

CASSETTE CTRL  
Load PTN 00 ?

3. To continue the Load operation, press +1/YES.

CASSETTE CTRL  
Load sure ?

You now have a chance to cancel this operation by pressing -1/NO, if you do not wish to load the data.

4. To load the data, press +1/YES again.

CASSETTE CTRL  
Load executing

Start playback of the cassette, to commence data loading.  
After loading, the LCD will show

CASSETTE CTRL  
Load completed

## VERIFYING DATA

**JOB #21: VERIFY SEQUENCE AND VOICE DATA**

**JOB #22: VERIFY SEQUENCE DATA**

**JOB #24: VERIFY VOICE DATA**

**JOB #25: VERIFY SET-UP DATA**

**FUNCTION** To verify that sequence and/or voice data, or set-up data, has been correctly saved onto cassette.

**OPERATION** Operation for the above four Jobs is identical. These Jobs correspond to (and should be carried out subsequent to) Save Jobs, as follows.

JOB #21 verifies JOB #01.  
 JOB #22 verifies JOB #02.  
 JOB #24 verifies JOB #04.  
 JOB #25 verifies JOB #05.

1. After saving the data, select Job #21, #22, #24 or #25 as appropriate. Example: Job #21.

CASSETTE CTRL  
 Verify Sq&Voice?

2. To verify the data, press +1/YES.

CASSETTE CTRL  
 Verify executing

Start playback of the cassette, to commence data verifying.  
 If the data has been correctly saved, the LCD will then show

CASSETTE CTRL  
 Verify OK!!!

If any other messages appear, refer to the ERROR MESSAGES chapter.

## JOB #23: VERIFY SINGLE PATTERN

**FUNCTION** To verify that the data of a single selected Pattern has been correctly saved onto cassette.

**OPERATION** This Job corresponds to (and should be carried out subsequent to) Job #03, Save Single Pattern.

1. After saving a Pattern, press PATTERN/SONG until the LCD indicates Pattern Mode, and use the Numeric Key Pad to select the number of the Pattern which was saved onto cassette.
2. Press CASSETTE/CARTRIDGE once or twice to select the Cassette Mode, and select Job #23.

CASSETTE CTRL  
 Verify PTN 00 ?

3. To verify the data, press +1/YES.

CASSETTE CTRL  
 Verify executing

Start playback of the cassette, to commence data verifying.  
 If the data has been correctly saved, the LCD will then show

CASSETTE CTRL  
 Verify OK!!!

If any other messages appear, refer to the ERROR MESSAGES chapter.

# SYNC MODE

## OVERVIEW

The Sync Mode lets you select four different ways of controlling the "Clock Rate" (speed of playback or recording) and Start/Stop/Continue functions on the RX5.

- **Internal Sync** (the RX5 runs according to its Internal Clock).
  - **MIDI Sync** (the RX5 is controlled by another MIDI device).
  - **Tape Sync** (the RX5 is controlled by a synchronization signal recorded on tape).
  - **External Sync** (the RX5 is controlled by another non-MIDI device).
- The INT SYNC (Internal Sync) setting is the normal mode for the RX5. The playback speed of Patterns, Songs and Chains, and the Real Time Pattern writing speed, are controlled by the RX5's internal Clock, the speed of which is set by the Tempo functions. Playback and writing are operated by using the RX5's STOP/CONTINUE and START keys.  
The Internal Sync Mode is also used when using the RX5 to control external MIDI devices (the MIDI signal is transmitted via the MIDI OUT terminal) or non-MIDI devices (the control signal is transmitted via the EXT. CLOCK OUT terminal) or to record a Tape Sync signal (the sync signal is transmitted via the CASSETTE terminal).
  - The MIDI SYNC setting lets you start, stop and control the speed of playback and Real Time Pattern writing on the RX5 from an external MIDI device such as a QX5 Sequence Recorder, a Music Computer, or even another RX5. The MIDI control signal is fed into the RX5 via the MIDI IN terminal.
  - The TAPE SYNC setting lets you use a Tape Sync signal to start, stop and control the speed of playback and Real Time Pattern writing. This signal, which incorporates a pre-selected tempo, is recorded onto tape from the RX5, or from MIDI devices capable of transmitting a Tape Sync signal (for example, a QX5).  
When the tape (containing the Tape Sync signal) is played it will cause the RX5 to commence play at the preselected tempo, and subsequently stop play. Refer to the TAPE SYNC APPLICATIONS section later in this chapter, for a full description of this Sync Mode.
  - The EXT SYNC (External Sync) setting lets you start, stop and control the speed of playback and Real Time Pattern writing on the RX5 from an external non-MIDI device which transmits a gate-type clock or trigger signal. The control signal is fed into the RX5 via the External Clock In terminal. The RX5 can also control this type of external device, via the External Clock Out terminal.

**NOTE:** At any time, you can instantly see which Sync Mode the RX5 is using, by checking which of the four Sync LED's is lit, on the RX5's control panel.

## SELECTING SYNC MODES

### OPERATION

1. Press **SYNC** to enter the Sync Mode. The LCD will show the current Sync status of the RX5.
2. Sync Modes are selected by using the +1/YES and -1/NO keys. Pressing the +1/YES key will step through the four Sync Modes in the following sequence.

CLOCK : Internal

CLOCK : MIDI

CLOCK : Tape

CLOCK : External

Pressing the -1/NO key will step through the Sync Modes in the opposite direction. As you select a Sync Mode, the corresponding LCD will light.

3. After setting the RX5's sync status, press any Mode key, or the **PATTERN/SONG** key, to exit the Sync Mode. The LED corresponding to the selected Sync Mode will remain lit at all times.

### CONTROLLING THE RX5 FROM AN EXTERNAL DEVICE.

1. Make sure the external device is connected to the correct terminal on the rear of the RX5 (refer to the REAR PANEL/CONNECTIONS section earlier in this manual).
2. Start play (Pattern, Song or Chain) or Real Time Pattern Write in the normal manner. The RUN LED will light, but the RX5 will not actually start until the external device sends a MIDI, Clock or Tape Sync signal causing the RX5 to start, and subsequently stop play or Real Time Write.

# TAPE SYNC APPLICATIONS

This system example shows how Tape Sync can be used with the RX5. It uses the RX5 together with a DX7 Synthesizer, an MT1X Multitrack Cassette Recorder, and an audio mixer.

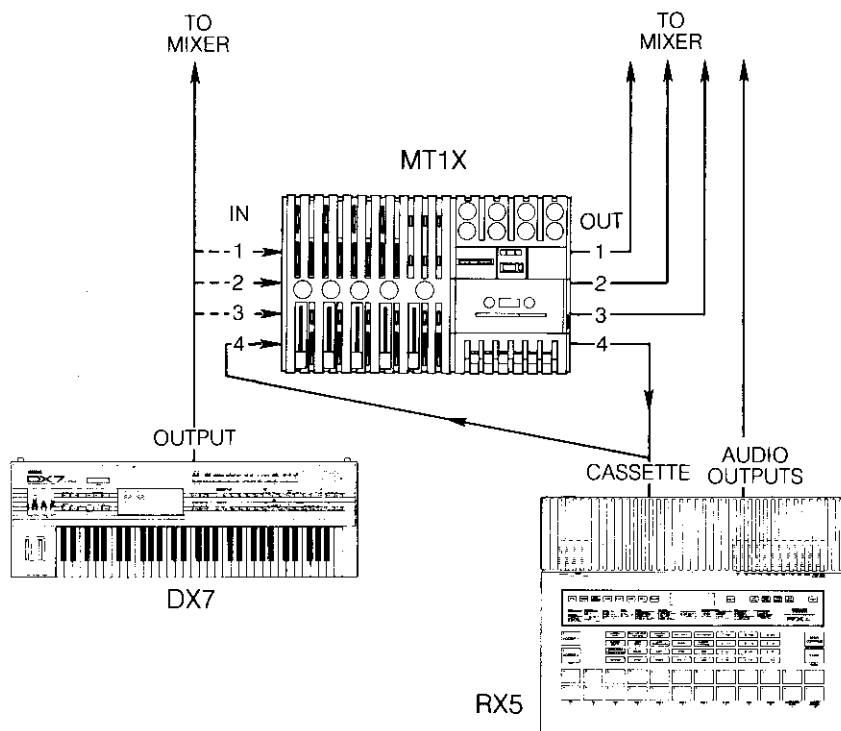

The following procedure illustrates one possible way of using this MIDI/Tape Sync system.

1. Edit a Song on the RX5. Initial Tempo or Tempo Change commands can be included.
2. With the RX5 set to Internal Sync, play the Song at the desired tempo, and record the Tape Sync signal onto track 1 of the MT1X. Tempo changes during the Song will also be recorded.
3. Set the RX5's Sync Mode to Tape Sync, and press **START**. Now, when you play the tape, it will automatically start the RX5 and run it at the correct tempo. You can now proceed to record DX7 parts onto tracks 2, 3 and 4 of the MT1X. You can also re-edit the Song on the RX5 if needed—it will still remain in synchronization.
4. Finally, playback of the finished tape will enable you to hear the three recorded DX7 tracks, while the Sync signal on the track 1 will keep the RX5 in perfect synchronization with the recorded tracks. You can still re-edit the Song on the RX5, or even create several Songs to fit the recorded music, and decide later which one you want to

keep. These new Songs will NOT need Initial Tempo or Tempo Change commands, as they are part of the recorded Tape Sync signal.

## RECORDING A TAPE SYNC SIGNAL

**NOTE:** The RX5's cassette output is rated to match a microphone input, while its cassette input matches a normal data recorder output.

1. Make sure the tape deck is connected to the RX5's CASSETTE terminal, and the RX5 is set to Internal Sync, and ready to play the selected Song or Pattern.
2. Start the tape deck in record, then press **START** on the RX5 to start playback of the Song or Pattern.
3. If playing a Pattern, press **STOP/CONTINUE** to stop playback at the desired point—the **STOP** signal will also be recorded as part of the Tape Sync signal.
4. Once play is finished, stop the tape deck. The complete Tape Sync signal is now recorded, and can be used to control the RX5 or any MIDI Clock-type device.

## TAPE SYNC PLAY/PATTERN WRITE

1. Make sure the tape deck output is connected to the RX5's CASSETTE terminal, and the tape is rewound to just before the start of the recorded sync signal.
2. Set the RX5 to Tape Sync, select the desired Song or Pattern, (and if writing a Pattern, press **REAL TIME WRITE**) then press **START**. The **RUN** LED will light, but the RX5 will not start until the tape is played.
3. Start playback of the tape. The RX5 will now play the selected Song or Pattern (or commence Real Time Write) and stop at the end of the Tape Sync signal.

# UTILITY MODE

## OVERVIEW

The Utility Mode lets you:

- Check the remaining Pattern and Song memory space.
- Turn the RX5's Memory Protect on/off.
- Change a voice in a Pattern, or in all Patterns.
- Clear (erase) all Patterns or Songs in a single operation.

## THE JOBS

Job #01: REMAINING PATTERN. Check the amount of remaining Pattern memory.

Job #02: REMAINING SONG. Check the amount of remaining Song memory

Job #03: MEMORY PROTECT. Turn the RX5's Memory Protect function on/off.

Job #04: CHANGE VOICE. Change any selected voice in a Pattern (or in all Patterns) to another selected voice.

Job #05: CLEAR ALL PATTERNS. Clear (erase) all Patterns in the RX5.

Job #06: CLEAR ALL SONGS. Clear (erase) all Songs in the RX5.

## ENTERING THE UTILITY MODE

To enter the Utility Mode, press the **UTILITY** key. The **UTILITY** LED will light. The LCD will show the last Job that was selected in this Mode.

Now, or after using any Utility Mode function, press any Mode key, or the **PATTERN/SONG** key, to exit this Mode.

Jobs are selected by pressing the **JOB** key (after pressing the **UTILITY** key) then entering the Job number using the 10-key panel. Once in this Mode, there is no need to press the **UTILITY** key prior to selecting other Jobs.

### JOB #01: REMAINING PATTERN MEMORY

**FUNCTION** Shows, as a percentage, the remaining Pattern memory space.

### OPERATION

Press **UTILITY** then select Job #01.

Remaining Memory  
PTN : 53%

### JOB #02: REMAINING SONG MEMORY

**FUNCTION** Shows, as a percentage, the remaining Song memory space.

### OPERATION

Press **UTILITY** then select Job #02.

Remaining Memory  
SONG : 96%

### JOB #03: MEMORY PROTECT

**FUNCTION** To prevent accidental erasure of Patterns, Songs, Chains, voices.

When the Memory Protect is ON, the following operations cannot be carried out. If any of these operations are attempted, the LCD will show "MEMORY PROTECTED".

PATTERN WRITE, EDIT, COPY, CLEAR.  
SONG EDIT, NAME, COPY, CLEAR.  
CHAIN EDIT, NAME, CLEAR.  
EDIT VOICE.  
CHANGE VOICE (UTILITY JOB #04)  
CLEAR ALL PATTERNS (UTILITY JOB #05)  
CLEAR ALL SONGS (UTILITY JOB #06)  
LOAD DATA (CASSETTE/CARTRIDGE JOBS 11-15)  
RECEIVE BULK (MIDI JOB #09)

- This function will remain on even if the RX5's power is turned off.

**OPERATION**

1. Press **UTILITY** then select Job #03. The LCD will show the current Memory Protect status. Example: Memory Protect OFF.

```
UTILITY
Mem. Protect:OFF
```

2. Press +1/YES to turn Memory Protect ON or press -1/NO to turn Memory Protect OFF.

**JOB #04: CHANGE VOICE**

**FUNCTION** Change a voice to another voice, in a single Pattern, or all Patterns.

- After this operation, the new voice you have selected may be assigned to a different instrument key than the original voice. Refer to KEY ASSIGN JOB #09 to see how to re-assign Internal voices to any key. Refer to KEY ASSIGN JOB #06 to see how to re-assign Copied and Cartridge voices to any key.
- If the Memory Protect is ON, the LCD will show "MEMORY PROTECTED" when this Job is selected, indicating that this operation cannot be carried out. Use UTILITY JOB #03 to turn off the Memory Protect function.

**OPERATION**

1. To change a voice of a single Pattern, select the Pattern prior to entering the Utility Mode. To change a voice in all Patterns, go on to the next step.
2. Press **UTILITY** and select Job #04.

```
Change Voice
1:PTN00 or 2:all
```

3. Press "1" for single Pattern voice change, "2" for all Pattern voice change.

```
from Int-BD 1
to Int-BD 1
```

4. The cursor will flash at the upper voice. Use the -1/NO and +1/YES keys to select the voice which is to be changed.

5. Press **ACCENT 2** to move the cursor to the lower voice. Use the -1/NO and +1/YES keys to select the new voice. The cursor can be moved up and down by pressing **ACCENT 2** at any time, to enable selection of voices.
6. Press **START**.

```
Change Voice
PTN sure ?
```

Single Pattern voice change

```
Change Voice
all sure ?
```

All Pattern voice change

7. EITHER: Press +1/YES to carry out the voice change.

```
Change Voice
completed!
```

OR: Press No/-1 to cancel the voice change. The LCD will return to the first display in this Job.

**JOB #05: CLEAR ALL PATTERNS**

**FUNCTION** To remove data from all Patterns.

**NOTE:** This function will clear (erase) every Pattern in the RX5's memory. If you wish to retain these Patterns, you should first save them onto tape or data cartridge. Refer to CASSETTE or CARTRIDGE MODE, JOB #02.

**OPERATION**

1. Press **UTILITY** and select Job #05.

```
UTILITY
Clear all PTNs ?
```



2. Press +1/YES.

UTILITY  
Clear sure ?

- If the Memory Protect is ON, the LCD will show "MEMORY PROTECTED", indicating that this operation cannot be carried out. Use UTILITY JOB #03 to turn off the Memory Protect function.

You can now press -1/NO to cancel the Clear All Patterns function. The LCD will return to the first display in this Job.

3. To clear all Patterns, press START.

UTILITY  
Clear completed!

You can now press -1/NO to cancel the Clear All Songs function. The LCD will return to the first display in this Job.

3. To clear all Songs, press START.

UTILITY  
Clear completed!

## JOB #06: CLEAR ALL SONGS

**FUNCTION** To remove data from all Songs.

**NOTE:** This function will clear (erase) every Song in the RX5's memory. If you wish to retain these Songs, you should first save them onto tape or data cartridge. Refer to CASSETTE or CARTRIDGE MODE, JOB #02.

### OPERATION

1. Press UTILITY and select Job #06.

UTILITY  
Clear all SONGs?

2. Press +1/YES.

UTILITY  
Clear sure ?

- If the Memory Protect is ON, the LCD will show "MEMORY PROTECTED", indicating that this operation cannot be carried out. Use UTILITY JOB #03 to turn off the Memory Protect function.

# MIDI MODE

## OVERVIEW

The MIDI Mode allows you to:

- Set the RX5 to receive MIDI note numbers, and assign note numbers to each instrument, so that they can be triggered from an external keyboard or sequencer (Note Number Mode).
- Set the RX5 to receive MIDI pitch signals, so that selected voices (up to 16) can be used as sound sources for up to 16 external MIDI keyboards or sequencers (Tunable Note Mode).
- Assign instruments to MIDI channels, for transmission of MIDI note numbers. A selected Gate Time will also be transmitted.
- Set the amount by which key velocity of an external MIDI device will affect the envelope parameters of all voices.
- Carry out reception and transmission of bulk data, with a second RX5 or other suitable MIDI equipment.
- The RX5 Sync Mode should be set to MIDI SYNC in order for it to be controlled by an external MIDI device. It should be set to INTERNAL SYNC if it is being used to control an external MIDI device. Refer to the SYNC MODE chapter. The RX5, when used with any other MIDI devices, should have its Channel Message function turned ON (refer to JOB #01).

### SYSTEM EXAMPLE

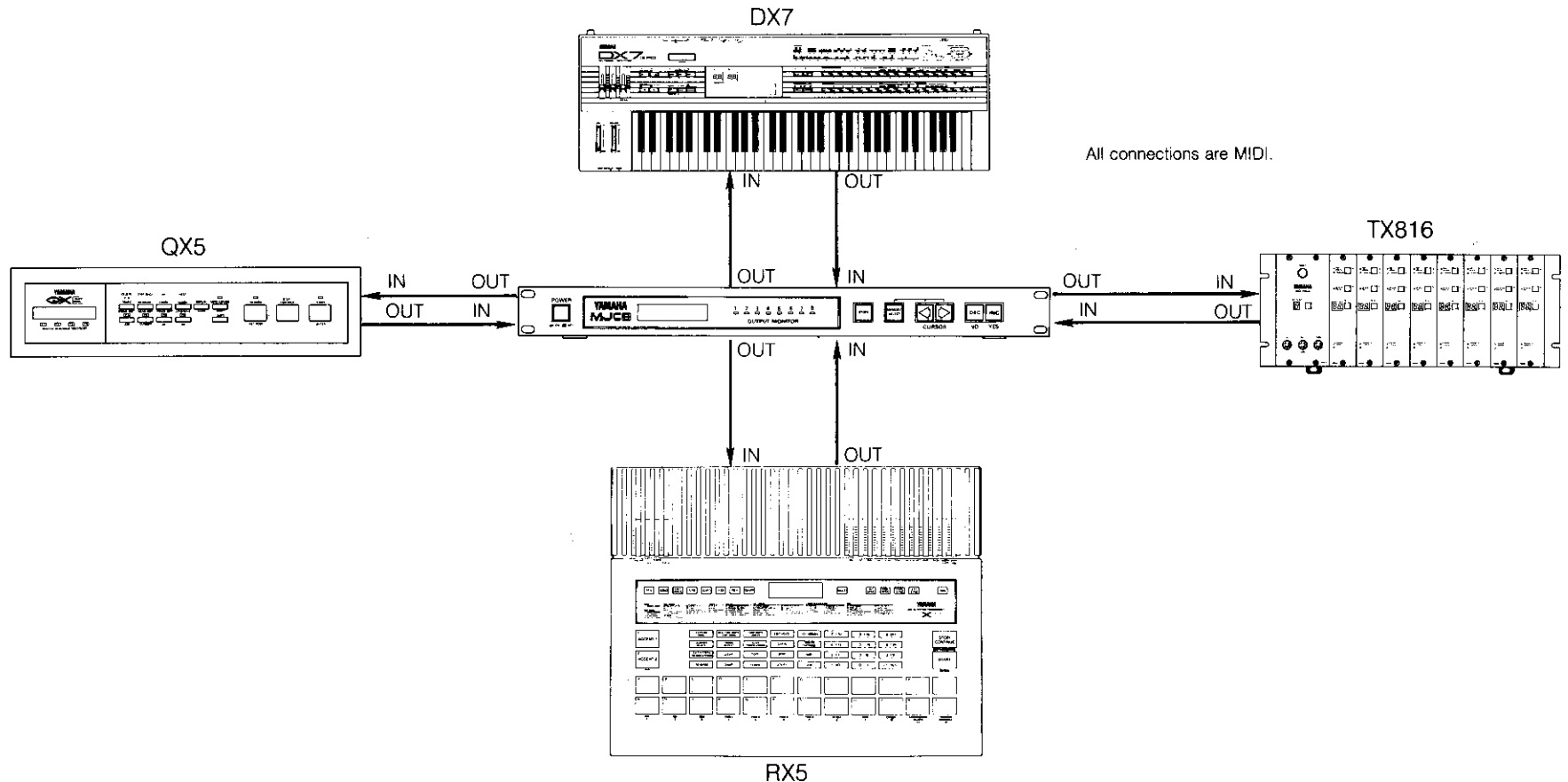

In this example, the RX5 is part of a sophisticated digital music system comprising a DX7 synthesizer, a QX5 sequence recorder, and a TX816 FM tone generator system. An MJC8 MIDI junction controller enables instant switching between a wide variety of MIDI setups, to make full use of the RX5's versatility.

- The RX5 can be controlled by the QX5 sequence recorder in two ways: (1) by receiving stop/start messages and clock signals to control its tempo (refer to JOB #01) or (2) by receiving actual note information—the drum part would be stored in the QX5 instead of in the RX5's data memory)—refer to JOB #08.
- The RX5's instrument sounds can be played by the DX7 in two ways: (1) by assigning each instrument on the RX5 to a note on the DX7, so that complete rhythm patterns could be played and recorded from the keyboard (refer to JOB #04 — Note Number Mode) or (2) by using the Tunable Note function, enabling the DX7 to play one of the RX5's voices over the entire range of its keyboard (refer to JOB #04 — Tunable Note Mode).
- The RX5 can act as a type of sequencer, sending note data (including Note Off messages) on independent MIDI channels to the DX7 and to each module in the TX816 (refer to JOB #03).

## THE JOBS

Job #01: CHANNEL MESSAGE. Set the RX5 to receive and transmit MIDI messages.

Job #02: RECEIVE CHANNEL. Set the MIDI channel(s) on which the RX5 receives MIDI messages.

Job #03: TRANSMIT CHANNEL. Assign each instrument to one of the 16 available MIDI channels, for transmission.

Job #04: NOTE NUMBER ASSIGN. Assign the RX5's voices to a selected MIDI note number, for MIDI receive and transmit (Note Number Mode). Also assign one voice to each of the 16 MIDI channels to use as sound source for external device (Tunable Note Mode).

Job #05: INITIALIZE NOTE. Return the MIDI note number settings of all 64 instruments of the RX5 to their default settings.

Job #06: E.G. VELOCITY. Set the amount by which envelope parameters can be affected by the velocity of an external MIDI device.

Job #07: GATE TIME. Set the length of the Gate Time transmitted by the RX5 to external MIDI devices.

Job #08: DEVICE NUMBER. Set the RX5 to receive or transmit System Exclusive Information, on a selected MIDI channel.

Job #09: RECEIVE BULK. Send a Bulk Dump Request to an external MIDI device.

Job #10: TRANSMIT BULK. Transmit Bulk data to an external MIDI device.

## ENTERING THE MIDI MODE

To enter the MIDI Mode, press the **MIDI** key. The MIDI LED will light. The LCD will show the last Job that was selected in this Mode.

Now, or after using any MIDI Mode function, press any Mode key, or the **PATTERN/SONG** key, to exit this Mode.

Jobs are selected by pressing the **JOB** key (after pressing the **MIDI** key) then entering the Job number using the 10-key panel. Once in this Mode, there is no need to press the **MIDI** key prior to selecting other Jobs.

## JOB #01: CHANNEL MESSAGE

**FUNCTION** To enable reception/transmission of Note Number messages.

This function lets you control the RX5 from an external MIDI device (reception of MIDI data) or use the RX5 to control an external MIDI device (transmission of MIDI data).

**NOTE:** The MIDI Receive and/or MIDI Transmit channels must be set to match the MIDI channel of the external MIDI device. Refer to Jobs #02, #03 respectively.

### OPERATION

1. Press **MIDI** and select Job #01. The LCD will show the current ON/OFF status of this Job.

MIDI INFORMATION  
Ch Message OFF 

2. Press **-1/NO** or **+1/YES** to turn the Channel Mode Message OFF or ON respectively.

## JOB #02: RECEIVE CHANNEL

**FUNCTION** To turn on or off each of the 16 MIDI Channels, for reception of MIDI control signals from external MIDI devices.

This Job is related to Job #04, NOTE NUMBER ASSIGN.

If, in Job #04, you have selected "VOICE", the RX5 is now set to the Note Number Mode. In this Mode the RX5 can receive MIDI control signals on any one of the 16 available MIDI Channels.

If, in Job #04, you have selected "PITCH", the RX5 is now set to the Tunable Note Mode. In this Mode, the RX5 can receive MIDI control signals on any or all of the 16 available MIDI channels. Each channel will have an RX5 voice assigned to it (also using JOB #04).

## OPERATION

Setting of the Receive Channel is different for the Note Number and Tunable Note Modes.

### NOTE NUMBER MODE

1. With the RX5 set to Note Number Mode, press **MIDI** and select Job #02. The LCD will show the RX5's current MIDI Receive status.

MIDI INFORMATION  
Receive Ch = 01

2. Use the +1/YES and -1/NO keys, or the **DATA ENTRY** slider to set the MIDI Receive channel. Range: 01—16.

### TUNABLE NOTE MODE

1. With the RX5 set to Tunable Note Mode, press **MIDI** and select Job #02. The LCD will show the RX5's current MIDI Receive status. The cursor will be flashing at the MIDI Receive Channel position it was last set at in this Job. Example: Channel 1.

Receive Ch  
1 2 3 4 5 6 7 8 9 10 11 12 13 14 15 16

2. Use the -1/NO key to turn OFF the channel marked by the cursor, or the 1/YES key to turn the channel ON. When a channel is turned ON, the corresponding number will be displayed. When a channel is turned OFF, an asterisk will be displayed.
3. Press **ACCENT 2** to move the cursor to the next channel position, and turn it on or off as desired. Use **ACCENT 2** to move the cursor to the right, until all channels have been set. When the cursor reaches the channel 16 position, pressing **ACCENT 2** again will return it to the channel 1 position.

## JOB #03: TRANSMIT CHANNEL

### FUNCTION

To assign each voice to a selected MIDI channel for MIDI transmission.

When using the RX5 to control external MIDI devices, this function allows you to assign each instrument to one of the 16 available MIDI channels. This means that the RX5 can control up to 16 MIDI devices simultaneously. As a simple example, you could set 12 instruments to MIDI Channel 1, to control a second RX5 for extra percussion sounds, and set the other 12 instruments to MIDI Channel 2 to play riffs on a DX7.

## OPERATION

1. Press **MIDI** and select Job #03. The LCD will show the last voice and MIDI Transmit Channel that was set in this Job.

Transmit Ch  
Int-BD 1 = 01

Instrument

MIDI channel

2. Use the **DATA ENTRY** slider or the -1/NO and +1/YES keys to select the voice.
3. Press **ACCENT 2** to move the cursor to the MIDI Channel position. Use the **DATA ENTRY** slider or the -1/NO and +1/YES keys to set the MIDI Transmit Channel. Range: 1—16.

You can now use **ACCENT 2** to move the cursor back to the voice name, and select another voice to have its MIDI Transmit Channel set.

## JOB #04: NOTE NUMBER ASSIGN

### FUNCTION

1. Assign each voice to a selected MIDI note number, for MIDI receive and transmit (Note Number Mode).
2. Assign a voice to each MIDI Receive Channel (Tunable Note Mode).

When using the RX5 with external MIDI devices, this function allows you to select either of two extremely useful Modes.

1. **NOTE NUMBER MODE.** You can assign each voice to a MIDI note number, corresponding to a note on a MIDI keyboard. Middle C, for example, is key number 60. The next note up (C#) is number 61, and so on. Note numbers range from 0 (C five octaves below middle C) to 127 (G five and a half octaves above middle C). When you play a note on a MIDI keyboard connected to the RX5, or send a note number from a connected MIDI sequencer or music computer, you will hear the RX5 voice which has been assigned to that note. You can assign more than one voice to the same note number.

- The RX5 has "default settings" for note numbers, which can automatically be set. Refer to Job #05.
2. **TUNABLE NOTE MODE.** You can use an RX5 voice as the sound source for an external MIDI keyboard or sequencer. The selected voice can be played over a full five-octave range (C1—C6). This is, of course, most suitable for pitched voices such as DX MARIMBA or ELECTRIC BASS. The voice is assigned to a MIDI channel matching the MIDI transmit channel of the external device. Each channel can have only one voice assigned to it. It is, therefore, possible to have up to 16 external devices controlling 16 voices on the RX5.

## OPERATION

1. Press **MIDI** and select Job #04. The LCD will show the last function that was selected in this Job.
2. Press "1" to select the "VOICE" function (corresponding to the Note Number Mode) or "2" to select the "PITCH" function (corresponding to the Tunable Note Mode).

### VOICE FUNCTION

Note# Asgn: VOICE  
 Int-BD 1 [ ] = A 1

Voice
Note

1. Use the **DATA ENTRY** slider or the -1/NO and +1/YES keys to select the voice.
2. Press **ACCENT 2** to move the cursor to the Note Number position. Use the **DATA ENTRY** slider or the -1/NO and +1/YES keys to set the Note Number. Range: C-2 — G8.

You can now use **ACCENT 2** to move the cursor back to the voice name, and select another voice to have its Note Number set.

### PITCH FUNCTION

Note# Asgn: PITCH  
 ch01 [ ] = Int-BD 1

MIDI Receive Channel
Voice

1. Use the **DATA ENTRY** slider or the -1/NO and +1/YES keys to select the MIDI Receive Channel. Range: 1 — 16.
2. Press **ACCENT 2** to move the cursor to the Voice position. Use the **DATA ENTRY** slider or the -1/NO and +1/YES keys to select a voice.

You can now use **ACCENT 2** to move the cursor back to the MIDI Receive Channel, and select another channel to which a voice can be assigned.

**NOTE:** When you assign a voice to a MIDI Receive Channel, the channel **MUST** be turned ON (refer to Job #02). If it is turned OFF, you will see the following display when you try to assign a voice in this Job. Example: MIDI Receive Channel 1.

Note# Asgn: PITCH  
 ch01 [ ] = \*\*\*\*\*

In this case, you cannot assign a voice. Use JOB #02 to turn the selected MIDI Receive Channel ON, then return to this Job and assign a voice to the selected MIDI Receive Channel.

## JOB #05: INITIALIZE NOTE

### FUNCTION To return the MIDI Note Numbers of all voices to their default settings.

This function allows you to instantly return the MIDI Note numbers of all 64 voices of the RX5 to their initial (default) values. 16 of the voices (and their Note Numbers) correspond to the voices of the RX11 Digital Rhythm Programmer, so this is a rapid method of setting the RX5 so that it could control an RX11, or vice-versa. The following chart shows the voices and their default settings. Voices corresponding to RX11 voices are marked with an asterisk.

#### NOTE NUMBER CHART

*BD 2	44 (G#1)	*BD 1	45 (A1)
*SD 2	49 (C#2)	*SD 1	52 (E2)
RIM 2	46 (A#1)	*RIM 1	51 (D#2)
E.TOM 1	43 (G1)	*TOM 1	53 (F2)
E.TOM 2	42 (F#1)	*TOM 2	50 (D2)
E.TOM 3	41 (F1)	*TOM 3	48 (C2)
E.TOM 4	40 (E1)	*TOM 4	47 (B1)
*HH OPEN	59 (B2)	*HH CLOSED	57 (A2)
RIDE (EDGE)	63 (D#3)	*RIDE (CUP)	62 (D3)
CHINESE	61 (C#3)	*CRASH	60 (D3)
TAMBOURINE	58 (A#2)	*CLAPS	54 (F#2)
*SHAKER	56 (G#2)	*COWBELL	55 (G2)

COPIED VOICES Cp01 — Cp12: NOTES 24 — 35.  
 CARTRIDGE VOICES 1 — 28: NOTES 65 — 92.

## OPERATION

1. Press **MIDI** and select Job #05.

MIDI INFORMATION  
 Initialize Note?

You can now exit the Initialize operation, if you wish, by selecting another Job or Mode.

2. To carry out the Initialize function, press +1/YES.

MIDI INFORMATION  
 completed!

## JOB #06: E.G. VELOCITY

**FUNCTION** Set the amount by which envelope parameters can be affected by the velocity of an external MIDI device.

When the RX5 is controlled by an external MIDI device its voices respond to the key velocity sent by an external MIDI device. Key velocity can affect not only voice level, but the envelope parameters. When you use the E.G. (Envelope Generator) Velocity function, the Attack rate increases (faster attack) as key velocity increases (louder note). The Decay 1 and Decay 2 rates decrease (longer decay) as key velocity increases. This gives a longer, more percussive note, which is exactly what happens when a drum is played harder. The amount by which the E.G. rates are affected can be varied from 01 (slight response) to 04 (strong response).

### OPERATION

1. Press **MIDI** and select Job #06. The LCD will show the current setting of the E.G. Velocity function.

MIDI INFORMATION  
EG Velocity=OFF

2. Use the **DATA ENTRY** slider or the -1/NO and +1/YES keys to turn on and set the E.G. Velocity. Range: OFF, 01 — 04.

## JOB #07: GATE TIME

**FUNCTION** Set the length of the Gate Time transmitted by the RX5 to external MIDI devices.

When using the RX5 to control an external MIDI keyboard or sequencer, NOTE OFF signals as well as NOTE ON signals are sent, allowing the RX5 to "play" notes of a selected length, using the external MIDI device as a sound source. The note pitches it will play will correspond to the Note Number settings (refer to Job #04). The overall length of each note is known as the Gate Time.

### OPERATION

1. Press **MIDI** and select Job #07.

MIDI INFORMATION  
Gate Time=1.00s

2. Use the **DATA ENTRY** slider or the -1/NO and +1/YES keys to set the Gate Time, in increments of 0.01 second. Range: 0.01 — 1 second.

## JOB #08: DEVICE NUMBER

**FUNCTION** To set the RX5 to receive or transmit System Exclusive Data (including Bulk Data) on a specified MIDI Channel.

This function MUST be turned on prior to receiving or transmitting bulk data (refer to JOBS #09, #10). It makes the RX5 available to the reception of System Exclusive MIDI data from an appropriate external MIDI device (for example, the reception of a pre-programmed drum part from a QX5 Digital Sequence recorder) or the exchange of bulk data with a second RX5, or a Yamaha QX1 or QX5 Digital Sequence Recorder.

- The Device Number MUST be set to match that of the external MIDI device.

### OPERATION

1. Press **MIDI** and select Job #08. The LCD will show the current Device Number status.

MIDI INFORMATION  
Device# =OFF

2. Use the **DATA ENTRY** slider or the -1/NO and +1/YES keys to turn on and set the Device Number. Range: OFF, 01 — 16.

## JOB #09: RECEIVE BULK

**FUNCTION** To set the RX5 to receive bulk data from an external MIDI device.

This function makes the RX5 available to receive bulk data from another RX5 or appropriate external MIDI device, such as a Yamaha QX1 or QX5 digital sequence recorder. Bulk data includes all Sequence and Voice data. Once this function is set, the next step is to transmit the data from the external device, or send a Bulk Dump request from the RX5.

**NOTE 1:** Prior to selecting this Job, the DEVICE NUMBER must be turned ON (refer to JOB #08) and the number set to match the System Exclusive Data channel of the external device.

**NOTE 2:** For this operation, the MIDI IN of the RX5 should be connected to the MIDI OUT of the external device.

**OPERATION**

1. Press **MIDI** and select Job #09.

MIDI INFORMATION  
Receive Bulk ?

2. EITHER: Press +1/YES to send a Bulk Dump Request to the external device. OR: Set the transmitting device to transmit bulk data (if it is a second RX5, use JOB #10).
- If the RX5's Memory Protect is on, the LCD will show "Memory Protected" and prevent Bulk Dump. Use UTILITY JOB #03 to turn off the Memory Protect function.

During Bulk Dump the RX5's LCD will show

MIDI INFORMATION  
Receiving Bulk

After transmission the LCD will show

MIDI INFORMATION  
Bulk Received

**NOTE:** When the RX5 receives Bulk Data, all of the Data currently in the RX5 is erased. You may wish to save the current data prior to a Bulk Dump (refer to CARTRIDGE or CASSETTE JOB "01").

**JOB #10: TRANSMIT BULK**

**FUNCTION** To transmit bulk data from the RX5 to an external MIDI device.

This function enables the RX5 to transmit bulk data to another RX5 or appropriate external MIDI device, such as a Yamaha QX1 or QX5 digital sequence recorder. Bulk data includes all Sequence and Voice data. Prior to using this function, the external device must be set to receive Bulk Data.

**NOTE 1:** Prior to selecting this Job, the DEVICE NUMBER must be turned ON (refer to JOB #08) and the number set to match the System Exclusive Data channel of the external device.

**NOTE 2:** For this operation, the MIDI OUT of the RX5 should be connected to the MIDI IN of the external device.

**OPERATION**

1. Press **MIDI** and select Job #10.

MIDI INFORMATION  
Transmit Bulk ?

2. Set the external device to receive bulk data (if it is a second RX5, use JOB #09).
3. EITHER: Press +1/YES on the RX5. OR: Send a Bulk Dump request from the external device (if it is an RX5, use JOB #09) and Bulk Data will be transmitted to the external device. During transmission, the RX5's LCD will show

Now  
Transmitting !

then return to the previous display. Bulk transmission depends on the amount of data in the RX5. For example, the factory-preset Pattern and Song data in your RX5 takes about 10 seconds to transmit.

## ERROR MESSAGES

The RX5's LCD will display an error message if:

- You have made an operating mistake (for example, tried to enter wrong data).
- Memory limits have been reached.
- You need to know about malfunctions or operational information concerning the RX5 or external MIDI devices or cassettes or cartridges.

**NOTE:** All LCD messages that indicate an error will be illustrated with the error message **ONLY**. This is because some error messages can occur in several different Modes or Jobs. The error message always appears in the lower half of the LCD.

For example, trying to record a Pattern in realtime when the RX5's Internal Memory Protect is ON, will produce the following LCD message.

A rectangular box with a thin black border containing two lines of text in a monospaced font. The first line reads "REAL WRITE PTN00" and the second line reads "Memory Protected".

REAL WRITE PTN00  
Memory Protected

In this section, the following illustration will be used.

**Memory Protected**



## GENERAL ERROR MESSAGES

MESSAGE	CAUSE	REMEDY
checksum error!	<ol style="list-style-type: none"> <li>1. During a Receive Bulk operation (MIDI JOB #09), there was a break in transmission, due to faulty cable or electrical interference.</li> <li>2. Prior to turning on the RX5 power, you have inserted a faulty Waveform Data Cartridge.</li> </ol>	<ol style="list-style-type: none"> <li>1. Check that the MIDI cable is not faulty, and repeat the operation. Also read the PRECAUTIONS section of this manual for advice on electrical interference.</li> <li>2. Turn the RX5 power off and remove the faulty Waveform data Cartridge. You can now turn the power on again and use the RX5's internal and Copied voices, until such time as you can insert a new Waveform Data Cartridge.</li> </ol>
illegal input !	Using the Part Copy function (Edit Song Mode) you entered a part number that does not appear in the Song, or the second Part number you entered was lower than the first Part number.	Enter correct Part numbers.
memory full !!	The sequence memory (Pattern, Song or Chain) is full.	Save the data presently in the RX5 to cartridge or cassette, and clear (erase) data to make room in the memory. Patterns, Songs and Chains can be cleared individually, or you can clear all Patterns or all Songs (UTILITY MODE JOBS #05 and #06 respectively).
Memory Protected	You have tried to clear or rewrite voice or sequence data (by entering or loading new data) and the Memory Protect function is turned on.	Turn the RX5's Memory Protect OFF using UTILITY JOB #03. Then carry out the data operation again.
MIDI BUFFER FULL	The RX5's MIDI Buffer is full, because too much data has been sent too rapidly from an external device. The MIDI Buffer is a kind of "waiting room" for MIDI data, where data is held for minute periods of time (of the order of .0003 seconds for one Byte) while it is being processed by the RX5.	Press any key to clear the LCD. Send less dense data, or send at a slower tempo.
MIDI DATA ERROR!	You have turned on power to a connected MIDI device, which sends a non-standard signal to the RX5. Technically, this is called a "framing" error or an "overrun" error.	Press any key to clear the LCD, and continue normal operation.
no data !	You have tried to use the Edit Pattern function to edit a Pattern that does not contain data.	
not found !	<ol style="list-style-type: none"> <li>1. You have used the Search Mark function and entered the name of a Mark that has not been set in the Song.</li> <li>2. You have used the Search Part or Copy Part function and entered a Part number that is higher than the total number of Parts in the Song.</li> </ol>	<ol style="list-style-type: none"> <li>1. Enter the correct Mark name.</li> <li>2. Enter the correct Part number.</li> </ol>
too large PART!	<ol style="list-style-type: none"> <li>1. You have tried to insert a Part in a Song that already contains 999 Parts.</li> <li>2. You are trying to use the Copy Part function with the result that the new Song will have more than 999 Parts.</li> </ol>	Edit two or more Songs, each of which forms a section of the long Song you were trying to create. Then use the Chain Edit Mode to combine these Songs into a continuous sequence.
too large PTN !	<ol style="list-style-type: none"> <li>1. A Pattern contains the maximum amount of data, and you are trying to write more data into it.</li> <li>2. You are trying to append a Pattern to another Pattern, and the two Patterns combined contain more than the maximum amount of data.</li> </ol>	Write two or more shorter Patterns, each of which forms a section of the long Pattern you were trying to create. Then use the Song Edit Mode to combine these Patterns into a continuous sequence.
wrong signature!	<ol style="list-style-type: none"> <li>1. You have tried to append two Patterns which have different time signatures.</li> <li>2. You have tried to append two Patterns which, when combined, total more than 100 bars in length.</li> </ol>	<ol style="list-style-type: none"> <li>1. Write a new Pattern which will have a time signature equivalent to the two original Patterns combined. For example, if you had wanted to append a 4/4 Pattern with a 3/4 Pattern, write a new 7/4 Pattern (<math>3/4 + 4/4 = 7/4</math>).</li> <li>2. Rewrite the same two Patterns using longer bars, then append them. For example, if the two Patterns each contained 52 bars of 4/4 time (total 104 bars), rewrite them as Patterns containing 26 bars of 8/4 time (total 52 bars), which can then be appended.</li> </ol>

## **CARTRIDGE MODE ERROR MESSAGES**

MESSAGE	CAUSE	REMEDY
<b>Cartrg not ready</b>	You have entered the Cartridge Mode, but you have not inserted a RAM4 Cartridge into the RX5.	Insert a RAM4 Cartridge, then enter the Cartridge Mode again.
<b>Cartrg other typ</b>	You have entered the Cartridge Mode, but the RX5's Sequence Data Cartridge slot contains the wrong type of cartridge (for example, a Waveform Data Cartridge).	Remove the wrong cartridge, then insert a RAM4 Cartridge, then enter the Cartridge Mode again.
<b>Cartrg protected</b>	You have tried to save data, or execute the Format operation, with the Memory Protect turned ON on your RAM4 Cartridge.	Remove the RAM4 Cartridge and turn its Memory Protect OFF by flicking the switch on the underside of the cartridge. Then insert the cartridge and enter the required Job number once more.
<b>Format conflict!</b>	You have entered the Cartridge Mode, but the RX5's Sequence Data Cartridge slot contains a cartridge with a different format.	<ol style="list-style-type: none"> <li>1. Remove the cartridge and insert a RAM4 cartridge that has been formatted for use with the RX5.</li> <li>2. Remove the cartridge and insert a RAM4 Cartridge that has not been formatted, then enter the Cartridge and execute the Format operation (JOB #30).</li> <li>3. If the data contained in the cartridge is not needed, make sure its Memory Protect is OFF, and format it for use with the RX5. (CARTRIDGE JOB #30).</li> </ol>
<b>no data !</b>	You have tried to save, load or verify a Pattern containing no data.	
<b>Verify error!</b>	You have tried to verify cartridge data, but the RX5 contains different data than that contained in the RAM4 cartridge.	<ol style="list-style-type: none"> <li>1. Save the data again, then execute the Verify operation once more.</li> <li>2. In the case of verifying a single Pattern, execute the verify operation again, making sure you have entered the correct Pattern numbers.</li> </ol>

## **CASSETTE MODE ERROR MESSAGES**

MESSAGE	CAUSE	REMEDY
<b>data error</b>	You have tried to verify cassette data. The type of data is correct (e.g., Single Pattern data) but the RX5 contains different data to that contained on the cassette.	Save the data again, then execute the Verify operation once more.
<b>Sum error</b>	There is a checksum data error in data that you have tried to verify or load from cassette.	Repeat the Load or Verify operation, making sure that the playback level is high. Also, check that the connections between the RX5 and the cassette recorder are correctly made, with cables that are functioning properly. If necessary, clean and demagnetize the tape heads.
<b>type error</b>	You have tried to load or verify data from cassette, using an incorrect Job number. For example, you used the Load Single Pattern operation (Job #13) when trying to load Voice data.	EITHER: Use the correct Job number. OR: Use the correct cassette data.

# SPECIFICATIONS

## SOUND SOURCE

- INTERNAL: 12 BIT, 24 VOICES
- RAM: 12 BIT, 12 VOICES
- WAVEFORM DATA CARTRIDGE: 28 VOICES

## MEMORY CAPACITY

- 100 PATTERNS (MAX. LENGTH: 99 MEASURES)
- 20 SONGS (MAX. LENGTH: 999 PARTS)
- 3 CHAINS (MAX. LENGTH: 999 STEPS)
- 3 SETS OF KEY DATA

## CONTROLLERS

- SLIDERS: MASTER VOLUME, CLICK VOLUME, TEMPO, DATA ENTRY, INSTRUMENT VOLUME (12)
- BUTTONS: ACCENT 1, ACCENT 2, STOP/CONTINUE/SHIFT, START/ENTER, INSTRUMENTS A THRU X (24)
- KEYS: PATTERN & SONG OPERATION KEYS (PATTERN/SONG, REAL TIME WRITE/EDIT SONG, STEP WRITE/INSERT, QUANTIZE/DELETE, SWING/REPEAT, CLICK/TEMPO CHANGE, EDIT PATTERN/VOLUME CHANGE, CLEAR, COPY), REVERSE, DAMP, TEMPO. MODE & JOB KEYS (EDIT VOICE, CHAIN, SYNC, UTILITY, KEY ASSIGN, CASSETTE/CARTRIDGE, MIDI, JOB), 10-KEY PANEL, -1/NO, +1/YES

## DISPLAY

- LCD: 16 CHARACTERS × 2 LINES
- LED: PATTERN, SONG, EDIT VOICE, CAS, CART, MIDI, REV, DAMP, MULTI, SYNC (INT, MIDI, TAPE, EXT), RUN

## CONNECTIONS

- AUDIO OUTPUT: PHONES, L/MONO, R, INDIVIDUAL OUTPUTS (12)
- MIDI: IN, OUT, THRU
- INTERFACE: CASSETTE/TAPE SYNC (IN/OUT), EXT. CLOCK IN, EXT. CLOCK OUT, WAVEFORM DATA CARTRIDGE, SEQUENCE DATA CARTRIDGE
- CONTROL: FOOT SWITCH
- POWER: DC 12V IN

## DIMENSIONS

- (W × D × H): 439 × 340 × 88mm.

## WEIGHT

- 3.8 kg.

## POWER REQUIREMENTS

(WITH PA 1210 12V VOLTAGE CONVERTOR)

- U.S./CANADA: 120V, 50/60HZ
- GENERAL MODEL: 110-130/220-240V, 50/60 HZ SELECTABLE

\* Specifications are subject to change without notice.

# EDIT VOICE BLOCK DIAGRAM

This gives a simple visual representation of how voice data is transferred and edited in the RX5. All Jobs are Edit Voice Mode Jobs.

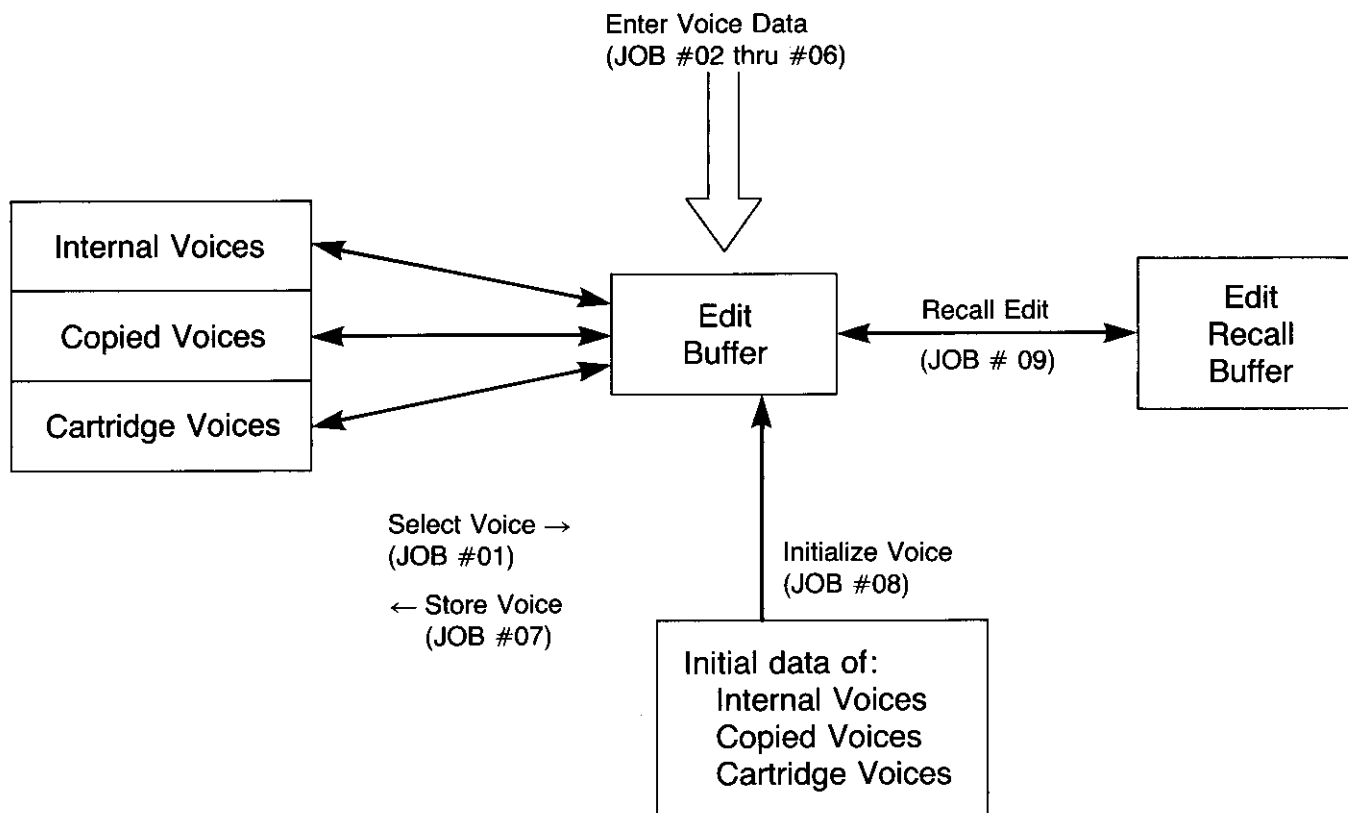

The RX5's voice editing process, from stored voice to actual sound, is described as follows:

1. A voice is selected, using EDIT VOICE JOB #01. This voice belongs to one of three types: Internal, Copied, or Cartridge.
2. "Primary data" is entered, using EDIT VOICE JOBS #2 thru #6. The Edit Voice Block Diagram shows how voice data is transferred and edited. "Primary data" affects ALL INSTRUMENT KEYS to which the voice is assigned, and ALL NOTES played by the voice in Patterns.
3. "Additional data" is entered once the voice is assigned to an instrument key, using KEY ASSIGN JOBS #02 thru #04. This data will affect sounds played AT THAT KEY ONLY. Then, once the selected voice has been used to play notes in a Pattern, further data can be entered by selecting a note and using the PATTERN EDIT function. This data will affect THAT NOTE ONLY.
4. Finally, on playback of the Pattern, the voice sound, modified by the data that has been entered, will be heard.
5. "Primary data" and "additional data" can be changed at any time, with the results described in preceding paragraphs 2 and 3.

# Digital Rythm Programmer Model RX5 MIDI Implementation Chart

Date: 11/6, 1986  
Version: 1.0

Function ...	Transmitted	Recognized	Remarks
Basic Default	1 - 16	1 - 16	memorized
Channel Changed	1 - 16	1 - 16	
Default Messages Altered	3	3	
Note Number	0 - 127	0-127/36-96	X1
Velocity Note ON	0 9nH, v=1-127	0 v=1-127	
Velocity Note OFF	x 8nH, v=64	x	
After Touch	x	x	
Pitch Bender	x	x	
Control Change	x	x	
Prog Change	x XXXXXXXXXXXXXXXXXX	o	Note# asgn: pitch
System Exclusive	o	o	voice & sequence
System Song Pos	x	o	
System Song Sel	o 0 - 19	o 0 - 19	
System Tune	x	x	
System Clock	o	o	
System Real Time Commands	o	o	
Aux Local ON/OFF	x	x	
Aux All Notes OFF	x	x	
Mes- Active Sense	o	o	
sages: Reset	x	x	

Notes: X1 = When Note number assign switch is set to VOICE, each voice sounds by each note. ( Note # range : 0 - 127 )  
When Note number assign switch is set to PITCH, each voice sounds by each channel. ( Note # range : 36 - 96 )

Mode 1 : OMNI ON, POLY      Mode 2 : OMNI ON, MONO      o : Yes  
Mode 3 : OMNI OFF, POLY      Mode 4 : OMNI OFF, MONO      x : No



# RX5 SONG/CHAIN CHART

OUTPUT CHANNEL LEVEL FADER SETTINGS: 1 2 3 4 5 6 7 8 9 10 11 12

SONG/CHAIN NUMBER:      NAME:      INIT. TEMPO: ♩ =      MEASURES:

PART/STEP	PTN/SONG	OTHER DATA	PART/STEP	PTN/SONG	OTHER DATA	PART/STEP	PTN/SONG	OTHER DATA	PART/STEP	PTN/SONG	OTHER DATA
001			033			065			097		
002			034			066			098		
003			035			067			099		
004			036			068			100		
005			037			069			101		
006			038			070			102		
007			039			071			103		
008			040			072			104		
009			041			073			105		
010			042			074			106		
011			043			075			107		
012			044			076			108		
013			045			077			109		
014			046			078			110		
015			047			079			111		
016			048			080			112		
017			049			081			113		
018			050			082			114		
019			051			083			115		
020			052			084			116		
021			053			085			117		
022			054			086			118		
023			055			087			119		
024			056			088			120		
025			057			089			121		
026			058			090			122		
027			059			091			123		
028			060			092			124		
029			061			093			125		
030			062			094			126		
031			063			095			127		
032			064			096			128		

"Other Data" includes Song Names, Volume Changes, Tempo Changes, Repeats and Search Marks.





**Litiumbatteri!**

Bör endast bytas av servicepersonal.

**VAROITUS!**

Lithiumparisto. Räjähdyksvaara.

Pariston saa vaihtaa ainoastaan alan ammattimies.

**ADVARSEL!**

Lithiumbatteri!

Eksplosionsfare. Udskitning må kun foretages af en sagkyndig, — og som beskrevet i servicemanualen.

