



SS80

MUSIC SYNTHESIZER

OWNER'S MANUAL



**MODULAR SYNTHESIS
PLUG-IN SYSTEM**

SPECIAL MESSAGE SECTION

PRODUCT SAFETY MARKINGS: Yamaha electronic products may have either labels similar to the graphics shown below or molded/stamped facsimiles of these graphics on the enclosure. The explanation of these graphics appears on this page. Please observe all cautions indicated on this page and those indicated in the safety instruction section.

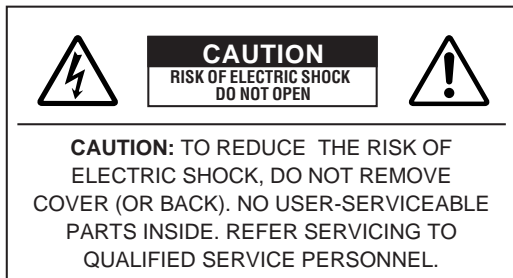

The exclamation point within the equilateral triangle is intended to alert the user to the presence of important operating and maintenance (servicing) instructions in the literature accompanying the product.



The lightning flash with arrowhead symbol, within the equilateral triangle, is intended to alert the user to the presence of uninsulated "dangerous voltage" within the product's enclosure that may be of sufficient magnitude to constitute a risk of electrical shock.

IMPORTANT NOTICE: All Yamaha electronic products are tested and approved by an independent safety testing laboratory in order that you may be sure that when it is properly installed and used in its normal and customary manner, all foreseeable risks have been eliminated. DO NOT modify this unit or commission others to do so unless specifically authorized by Yamaha. Product performance and/or safety standards may be diminished. Claims filed under the expressed warranty may be denied if the unit is/has been modified. Implied warranties may also be affected.

SPECIFICATIONS SUBJECT TO CHANGE: The information contained in this manual is believed to be correct at the time of printing. However, Yamaha reserves the right to change or modify any of the specifications without notice or obligation to update existing units.

ENVIRONMENTAL ISSUES: Yamaha strives to produce products that are both user safe and environmentally friendly. We sincerely believe that our products and the production methods used to produce them, meet these goals. In keeping with both the letter and the spirit of the law, we want you to be aware of the following:

Battery Notice: This product MAY contain a small non-rechargeable battery which (if applicable) is soldered in place. The average life span of this type of battery is approximately five years. When replacement becomes necessary, contact a qualified service representative to perform the replacement.

Warning: Do not attempt to recharge, disassemble, or incinerate this type of battery. Keep all batteries away from children. Dispose of used batteries promptly and as regulated by applicable laws. Note: In some areas, the servicer is required by law to return the defective parts. However, you do have the option of having the servicer dispose of these parts for you.

Disposal Notice: Should this product become damaged beyond repair, or for some reason its useful life is considered to be at an end, please observe all local, state, and federal regulations that relate to the disposal of products that contain lead, batteries, plastics, etc.

NOTICE: Service charges incurred due to lack of knowledge relating to how a function or effect works (when the unit is operating as designed) are not covered by the manufacturer's warranty, and are therefore the owners responsibility. Please study this manual carefully and consult your dealer before requesting service.

NAME PLATE LOCATION: The graphic below indicates the location of the name plate. The model number, serial number, power requirements, etc., are located on this plate. You should record the model number, serial number, and the date of purchase in the spaces provided below and retain this manual as a permanent record of your purchase.

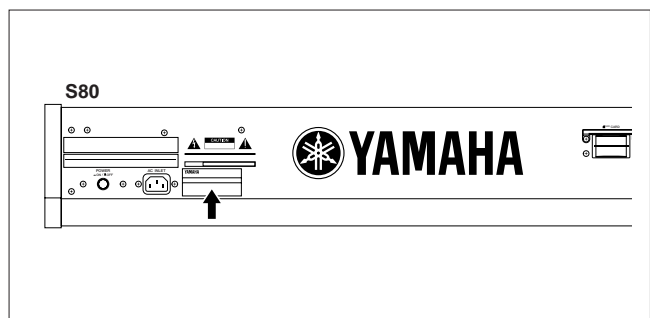

Model _____

Serial No. _____

Purchase Date _____

PRECAUTIONS

PLEASE READ CAREFULLY BEFORE PROCEEDING

* Please keep these precautions in a safe place for future reference.



WARNING

Always follow the basic precautions listed below to avoid the possibility of serious injury or even death from electrical shock, short-circuiting, damages, fire or other hazards. These precautions include, but are not limited to, the following:

- This instrument contains no user-serviceable parts. Do not attempt to disassemble or modify the internal components in any way.
- Do not expose the instrument to rain, use it near water or in damp or wet conditions, or place containers on it containing liquids which might spill into any openings.
- If the power cord or plug becomes frayed or damaged, or if there is a sudden loss of sound during use of the instrument, or if any unusual smells or smoke should appear to be caused by it, immediately turn off the power switch, disconnect the electric plug from the outlet, and have the instrument inspected by qualified Yamaha service personnel.
- Only use the voltage specified as correct for the instrument. The required voltage is printed on the name plate of the instrument.
- Always connect the three-pin attachment plug to a properly grounded power source. (For more information about the main power supply, see page 12.)
- Before cleaning the instrument, always remove the electric plug from the outlet. Never insert or remove an electric plug with wet hands.
- Check the electric plug periodically and remove any dirt or dust which may have accumulated on it.



CAUTION

Always follow the basic precautions listed below to avoid the possibility of physical injury to you or others, or damage to the instrument or other property. These precautions include, but are not limited to, the following:

- Do not place the power cord near heat sources such as heaters or radiators, and do not excessively bend or otherwise damage the cord, place heavy objects on it, or place it in a position where anyone could walk on, trip over, or roll anything over it.
 - When removing the electric plug from the instrument or an outlet, always hold the plug itself and not the cord. Pulling by the cord can damage it.
 - Do not connect the instrument to an electrical outlet using a multiple-connector. Doing so can result in lower sound quality, or possibly cause overheating in the outlet.
 - Remove the electric plug from the outlet when the instrument is not to be used for extended periods of time, or during electrical storms.
 - Before connecting the instrument to other electronic components, turn off the power for all components. Before turning the power on or off for all components, set all volume levels to minimum. Also, be sure to set the volumes of all components at their minimum levels and gradually raise the volume controls while playing the instrument to set the desired listening level.
 - Do not expose the instrument to excessive dust or vibrations, or extreme cold or heat (such as in direct sunlight, near a heater, or in a car during the day) to prevent the possibility of panel disfiguration or damage to the internal components.
 - Do not use the instrument near other electrical products such as televisions, radios, or speakers, since this might cause interference which can affect proper operation of the other products.
 - Do not place the instrument in an unstable position where it might accidentally fall over.
 - Before moving the instrument, remove all connected cables.
 - When cleaning the instrument, use a soft, dry cloth. Do not use paint thinners, solvents, cleaning fluids, or chemical-impregnated wiping cloths. Also, do not place vinyl, plastic or rubber objects on the instrument, since this might discolor the panel or keyboard.
 - Do not rest your weight on, or place heavy objects on the instrument, and do not use excessive force on the buttons, switches or connectors.
 - Use only the stand specified for the instrument. When attaching the stand or rack, use the provided screws only. Failure to do so could cause damage to the internal components or result in the instrument falling over.
 - Do not operate the instrument for a long period of time at a high or uncomfortable volume level, since this can cause permanent hearing loss. If you experience any hearing loss or ringing in the ears, consult a physician.
- #### ■ REPLACING THE BACKUP BATTERY
- This instrument contains a non rechargeable internal backup battery which permits internal data to remain stored even when the power is off. When the backup battery needs replacing, the message "Change internal battery." will display in the LCD. When this happens, immediately back up your data, then have qualified Yamaha service personnel replace the backup battery.
 - Do not attempt to replace the backup battery yourself, in order to prevent the possible serious hazards. Always have qualified Yamaha service personnel replace the backup battery.
 - Never place the backup battery in a location that a child can reach, since a child might accidentally swallow the battery. If this should happen, consult a physician immediately.
- #### ■ SAVING USER DATA
- Always save data to a Memory Card (SmartMedia) frequently, in order to help prevent the loss of important data due to a malfunction or user operating error.

Yamaha cannot be held responsible for damage caused by improper use or modifications to the instrument, or data that is lost or destroyed.

Always turn the power off when the instrument is not in use.

Introduction

Thank you for purchasing the Yamaha S80 Music Synthesizer.

Your new S80 synthesizer incorporates the highly-acclaimed AWM2 synthesis engine, allowing the creation of super-realistic sounds. You can play these sounds over the 88-note fully-weighted keyboard. It also supports optional Plug-in Boards that provide other synthesis engines of your choice, enabling the production of cutting edge synthesizer sounds.

You can play all these sounds using the synthesizer's automatic playback facilities such as the built-in Arpeggiator and Sequencer. The Quick Access feature lets you access various genres of sounds quickly and directly via the front panel.

Other features include Effects and Control Sets (for controlling various sound parameters in real time using different controllers.) These features make this synthesizer ideal for every kind of live performance or studio work.

When editing a sound, you can use the [PAGE] knob to switch between screens and five other knobs plus the [DATA] knob for changing parameter values. This makes the process of editing sounds much easier and smoother. To make the most use of your synthesizer, you are encouraged to read through this manual. After reading the manual, please keep it in a convenient and safe place for future reference.

About This Manual

This manual is basically divided into two sections:

■ Basics Section (Page 6)

Explains how to get started with the synthesizer, its overall structure, and how to use its main features and functions.

■ Reference Section (Page 64)

Explains the parameters in the synthesizer's various Modes.

Package Contents

- Owner's Manual (this book)
- Data List
- Performance List
- AC Power cord
- Installation Guide
- CD-ROM (TOOLS for S80 & CS6x/CS6R)

The Included CD-ROM

Application software for your synthesizer included on this CD-ROM. The Voice Editor application lets you edit your synthesizer's sounds through a graphical user interface. The Card Filer application lets you exchange data between your synthesizer and computer. Details are given in the separate Installation Guide or the on-line manuals included with the software.



Never attempt to play back the track1, in which the application software is located, on an audio CD player. Doing so may result in damage to your hearing as well as to your CD player/audio speakers.

Copying of the commercially available music sequence data and/or digital audio files is strictly prohibited except for your personal use.

The illustrations and LCD screens as shown in this owner's manual are for instructional purposes only, and may appear somewhat different from those on your instrument.

The company names and product names in this Owner's Manual are the trademarks or registered trademarks of their respective companies.

Table of Contents

Basics Section

The Controls & Connectors	6
Before Use	12
Power Supply	12
Connections	13
Powering Up.....	19
Basic Operations	21
Selecting a Mode	21
Selecting a Screen	23
Entering Data.....	24
Demo Playback	26
Voices and Performances	27
Playing a Voice.....	27
Playing a Performance.....	29
An Overview of the S80	31
Controller Section	31
Sequencer Section	31
Tone Generator Section	32
Effects Section	34
About the Modes	35
Voices	36
An Overview of Voices/Waves	37
Waves	38
Performances	39
Ideal for Playing Live	40
1 Arpeggiator	41
2 Using Controllers	43
Voice Edit	50
Effects.....	55
Using as a Master Keyboard (Performance Mode)	57
Using as a Multitimbral Tone Generator (Performance Mode)	62

Reference Section

Voice Mode	64
Voice Play	64
Voice Edit	68
Voice Job Mode	105
Voice Store	106
Performance Mode	107
Performance Play	107
Performance Edit	111
Performance Job Mode	130
Performance Store	131
Sequence Play Mode	132
Utility Mode	134
Utility Job Mode	141
Card Mode	142
Appendix	
About the Plug-in Boards (Optional)	148
Display Messages	151
Troubleshooting	152
Specifications	155
Index	156

Basics Section

**Reference
Section**

Voice Mode

Performance
Mode

Sequence Play
Mode

Utility Mode

Card Mode

Appendix

Basics Section

The Controls & Connectors

Front Panel

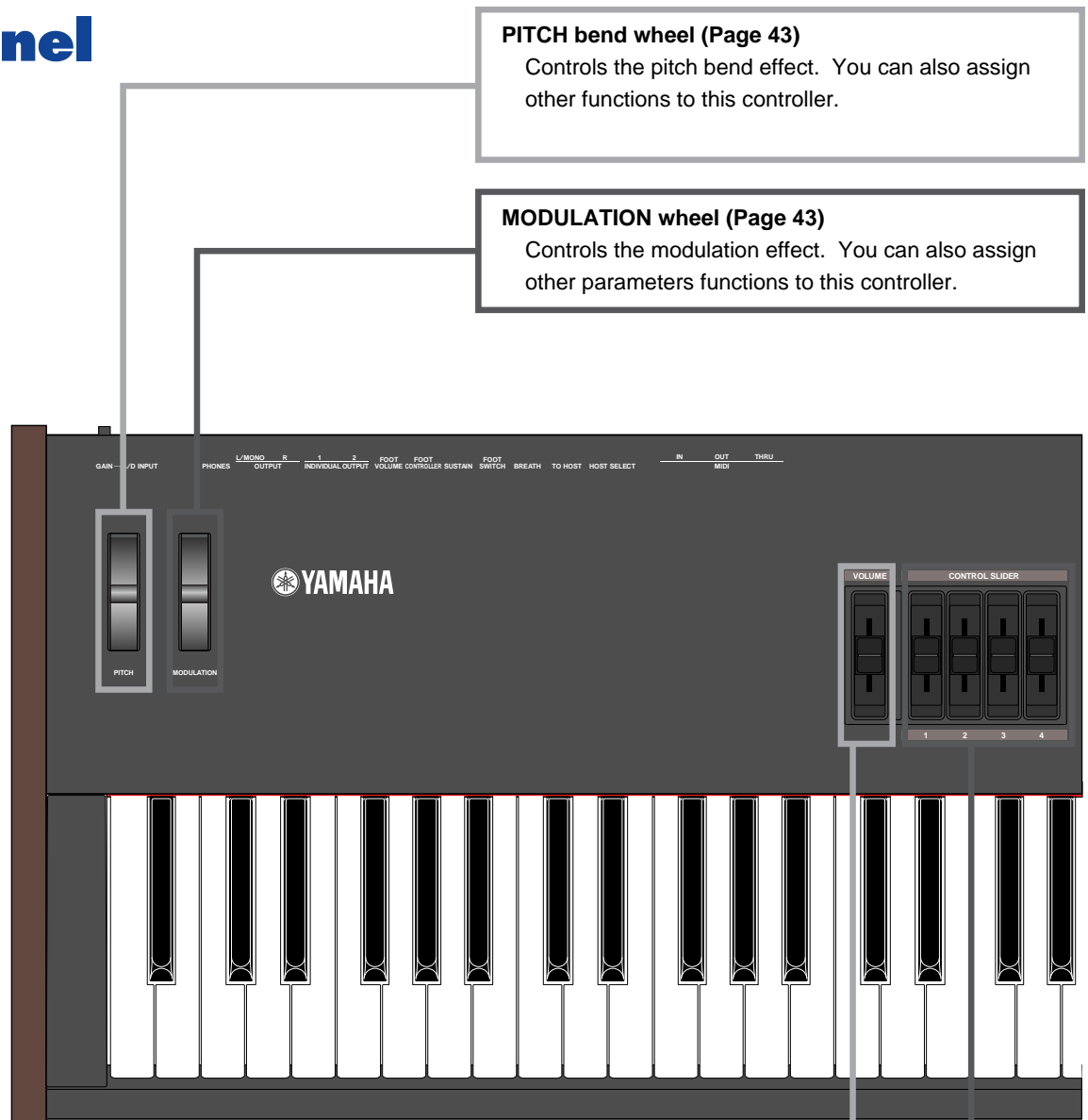

PITCH bend wheel (Page 43)

Controls the pitch bend effect. You can also assign other functions to this controller.

MODULATION wheel (Page 43)

Controls the modulation effect. You can also assign other parameters functions to this controller.

[VOLUME] Slider (Page 20)

Adjusts the master volume. Move the slider upwards to raise the output level from the OUTPUT L/R jacks and the PHONES jack.

Control Sliders (Page 61)

In Master Keyboard Mode, the sliders can be used to control various functions assigned to them (as Control Change messages). Each slider controls each of four Zones.

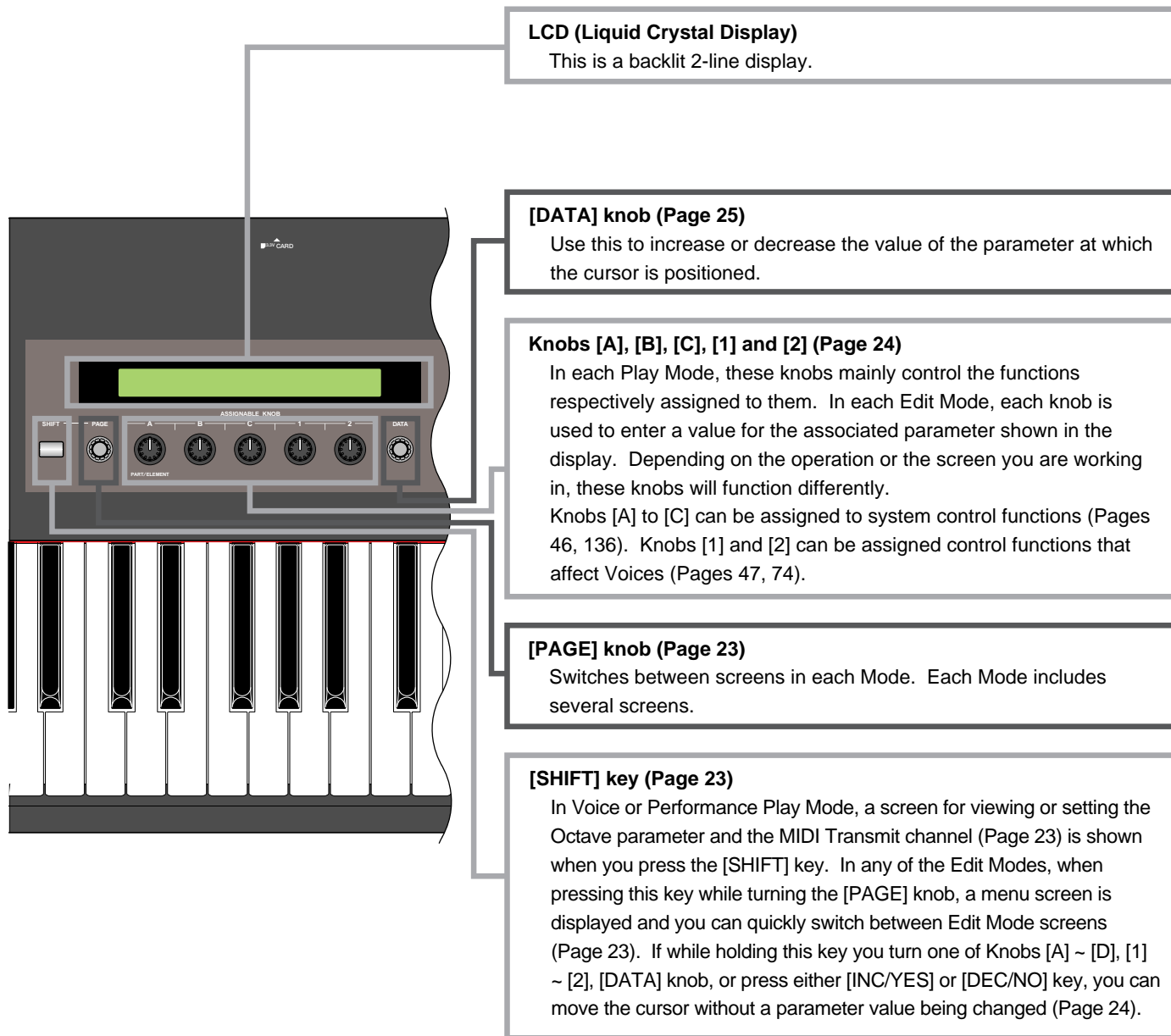

[MASTER KEYBOARD] key (pages 57, 111)

The S80 keyboard can work as MIDI master keyboard in Performance mode. When the key is pressed and switched on (the LED will light), the keyboard can play and control multiple MIDI sound modules connected to the S80.

[EF BYPASS] key (Page 56)

Enables/disables the Effect Bypass. Press the key (its LED will light) to bypass the effects used with the current Voice or Performance. The bypassed effects (Reverb, Chorus, or Insertion) are specified in Utility Mode (Page 135).

[EXIT] key (Page 23)

The menus and screens of the S80 have a hierarchical structure. Press this key exit from the current screen and return to the previous level in the hierarchy.

[ENTER] key (Pages 24, 25)

While selecting a Memory or Bank for Voice or Performance, press this key to determine such a memory location. Also, use this key to execute a Job or a Store operation.

[DEC/NO] key (Page 24)

Use this to decrease the value of the parameter at which the cursor is positioned. Also use it to cancel a Job or a Store operation.

[INC/YES] key (Page 24)

Use this to increase the value of the parameter at which the cursor is positioned. Also use it to execute a Job or a Store operation.

MODE keys (Page 21)

Press these to keys to select Voice, Performance, Utility or other Modes.

SEQ controls (Pages 26, 132)

Press the [SEQ] key to enter Sequence Play Mode. Here, you can play a MIDI file from Memory Card. Use the [PLAY/STOP] key to start or stop playback of the currently selected file.

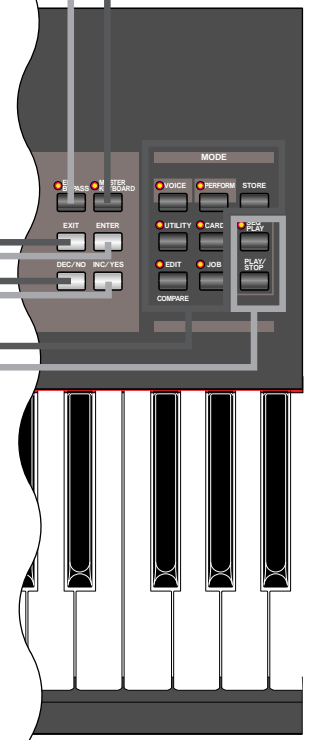

MEMORY keys (Pages 27, 29, 65, 109)

Using one of these keys, you can select a Voice or Performance Memory. Press the [ENTER] key to select the Memory. In Performance Mode, the [EXT], [PLG1] and [PLG2] keys can be used to select the A/D Part, Plug-in 1 Part and Plug-in 2 Part. The [PRE1] and [PRE2] keys select Common (for all Parts).

[QUICK ACCESS] key (Page 68)

When you press the [QUICK ACCESS] key (its LED will light), you can use BANK keys [A] to [H] to directly select Categories and PROGRAM keys [1] to [16] to quickly select Voices.

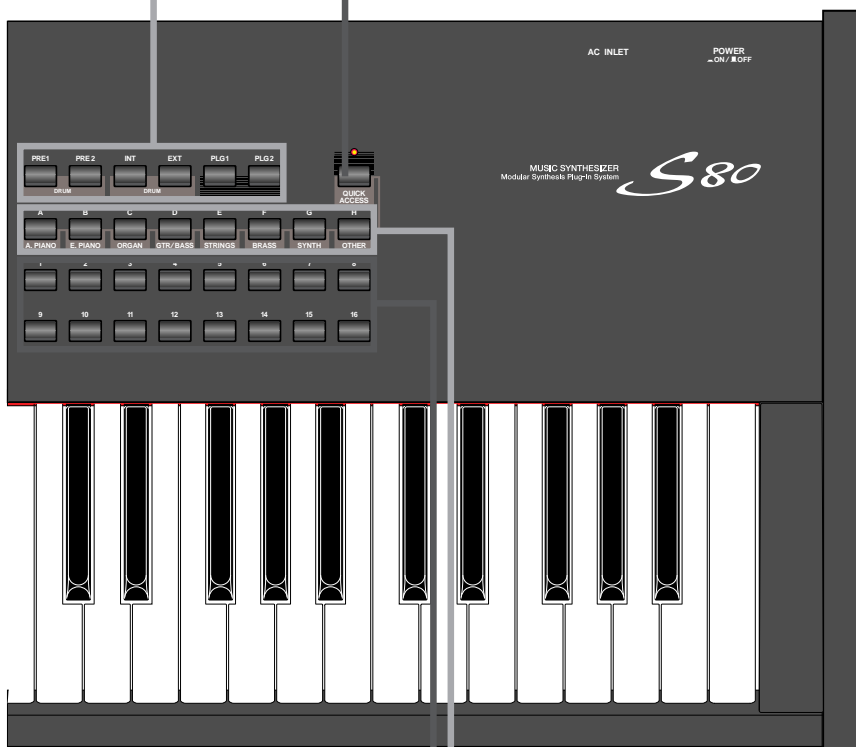

BANK [A] to [H] keys (Pages 65, 109)

Each key selects a Voice or Performance Bank. Each Bank contains sixteen Voices or Performances. In Voice Edit Mode, each of the BANK [A] to [D] keys selects a Voice s Element (ELEMENT SELECT) while each of the BANK [E] to [H] keys turns the associated Voice s Element on or off (ELEMENT ON/OFF) (Page 51). When you activate Master Keyboard Mode by pressing the [MASTER KEYBOARD] key, these key ([A] to [D]) can respectively select Zones 1 to 4 if the Master Keyboard Mode setting is 4 zone in Performance Edit Mode.

PROGRAM/PART [1] to [16] keys (Pages 65, 109)

Each key selects a Voice or Performance from the current Bank. In Voice Edit Mode, each PROGRAM/PART key selects an associated edit menu (Page 70). In Performance Mode, these keys select Parts [1] to [16], respectively.

Rear Panel

POWER switch (Page 19)

Use this to switch the synthesizer on or off.

AC INLET terminal (Page 12)

Plug the female end of the supplied AC power cord in here before plugging it into an AC wall outlet.

CARD slot (Page 142)

Insert a Memory Card here to transfer various data to/from the instrument. Read carefully the precautions on use of a Memory Card (Page 142) before using a card.

MIDI IN, OUT, and THRU connectors (Page 15)

MIDI IN receives MIDI messages from an external MIDI device. Use this connector to control the synthesizer from an external MIDI device. MIDI OUT sends out MIDI messages generated by the synthesizer, such as notes played on the keyboard or panel control/knob variations, to an external MIDI sound module or device. MIDI THRU just reflects the MIDI messages received at MIDI IN. Connect other MIDI devices here.



FOOT CONTROLLER jack (Pages 18, 44)

An optional foot controller (FC7, etc.) can be connected here. Using the foot controller, you can control tones, pitches, volumes or the like by foot.

FOOT VOLUME jack (Pages 18, 44)

An optional foot controller (FC7, etc.) can be connected here. You can control the output level from the instrument by foot. In Utility Mode, you can select Volume or Expression for this controller.

INDIVIDUAL OUTPUT 1 and 2 jacks (Page 13)

Line level audio signals are output from the synthesizer via these phone jacks (1/4" mono phone plug). The output is separated from that at the OUTPUT L/MONO and R jacks. In Performance Mode, you can specify which Parts can be output from these separate outputs.

HOST SELECT switch (Page 16)

Select the type of computer connected to the synthesizer via the TO HOST connector .

TO HOST terminal

Connect a computer here using an optional serial computer cable (Page 16).

BREATH jack (Pages 18, 44)

Connect an optional breath controller BC3 here. You can use the Breath Controller to change the output level or tone of the sounds according to the strength of your breath.

FOOT SWITCH jack (Pages 18, 44)

Connect an optional Foot switch (FC4 or FC5) here. Using the foot switch, you can control of a range of on or off a specific function by foot, as assigned on the instrument. (Pages 53, 165)

SUSTAIN jack (Pages 18, 44)

An optional Foot Switch (FC4 or FC5) can be connected here. You can use the Foot Switch as a damper pedal on the acoustic piano or for a sustained effect.

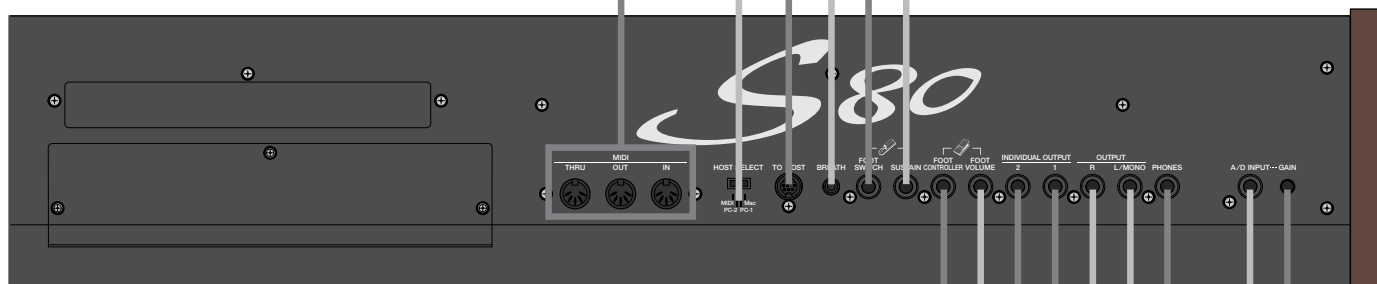

OUTPUT L/MONO and R jack (Page 13)

Line level audio signals are output via these phone jacks. For monophonic output, use just the L/MONO jack.

PHONES jack (Page 13)

Connect a pair of headphones here.

A/D INPUT jack (Page 14)

External audio signals can be input via this phone jack. When an A/D Input Part is used in a Performance, signals from devices connected to this jack can be input in mono.

GAIN knob (Pages 63)

Use this to adjust the input gain of the audio signals at the A/D INPUT jack. You may need to adjust this depending on the type of device (microphone, other instrument output, etc.) connected when using a A/D Input Part.

Before Use

This section explains how to connect to an AC power source, audio and MIDI devices, and a computer system. Only switch the synthesizer on after you have made all the necessary connections. It is recommended that you read this section before using the synthesizer.

Power Supply

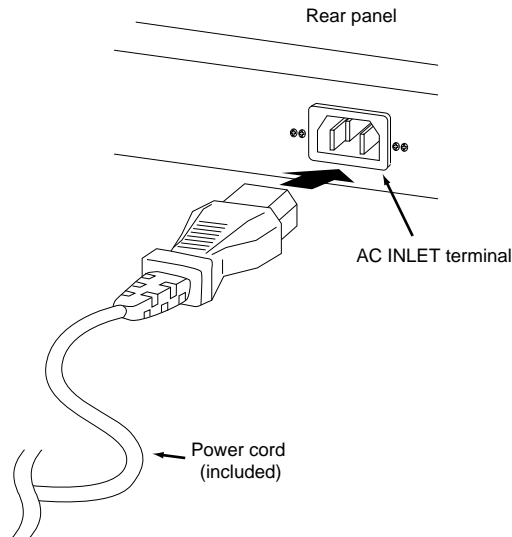

- 1 Make sure that the instrument's POWER switch is at the OFF position.
 - 2 Connect the supplied power cord to the AC INLET terminal on the instrument's rear panel.
 - 3 Connect the other end of the power cord to an AC outlet. Make sure the synthesizer meets the voltage requirement for the country or region in which it is being used.
- ⚠ Make sure your S80 is rated for the AC voltage supplied in the area in which it is to be used (as listed on the rear panel). Connecting the unit to the wrong AC supply can cause serious damage to the internal circuitry and may even pose a shock hazard!
- ⚠ Use only the AC power cord supplied with the S80. If the supplied cord is lost or damaged and needs to be replaced, contact your Yamaha dealer. The use of an inappropriate replacement can pose a fire and shock hazard!
- ⚠ The type of AC power cord provided with the S80 may be different depending on the country in which it is purchased (a third prong may be provided for grounding purposes). Improper connection of the grounding conductor can create the risk of electrical shock. Do NOT modify the plug provided with the S80. If the plug will not fit the outlet, have a proper outlet installed by a qualified electrician. Do not use a plug adapter which defeats the grounding conductor.

Connections

Connecting to External Audio Equipment

Since the synthesizer has no built-in speakers, you need to monitor its sound output via external audio equipment. Alternatively, you could use a pair of headphones. There are several methods of connecting to external audio equipment, as described in the following illustrations.

Connecting Stereo Powered Speakers

A pair of powered speakers can accurately produce the instrument's rich sounds with their own pan and effect settings. Connect your powered speakers to the OUTPUT L/MONO and R jacks on the rear panel.

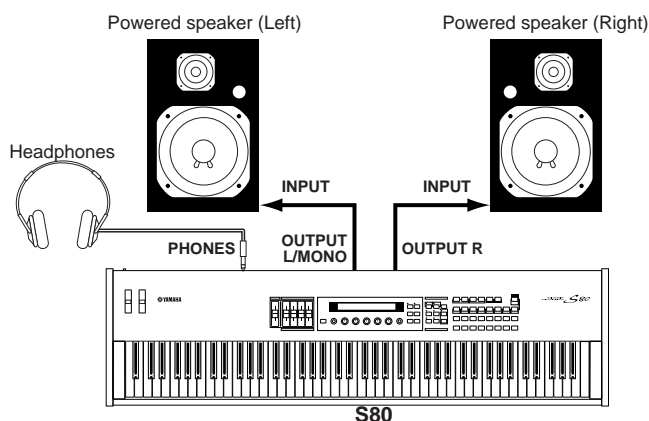

NOTE When using just one powered speaker, connect it to the OUTPUT L/MONO jack on the rear panel.

Connecting to a Mixer

There are extra audio outputs in addition to the OUTPUT (L/MONO and R) jacks. These four outputs can connect to a mixer for separately controlling the outputs of up to four Parts in Performance Mode (Page 107). You can specify the output routing of each Part in Performance Edit Mode (Page 111).

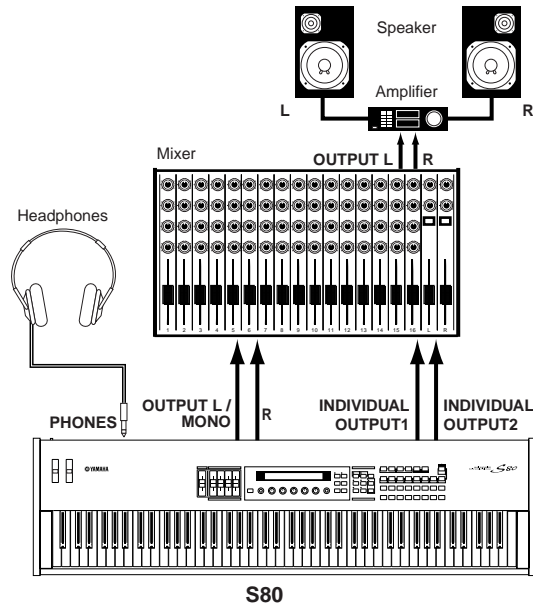

NOTE Connecting a pair of headphones does not affect audio output from the OUTPUT (L/MONO and R) jacks. You can monitor the same sounds via headphones and at the OUTPUT jacks. However, you cannot monitor the sounds from INDIVIDUAL OUTPUT 1 and 2 with headphones.

Connecting a Microphone or Other Audio Equipment

When an A/D Input Part is used in a Performance, signals from devices connected to either of these jacks can be input in mono.

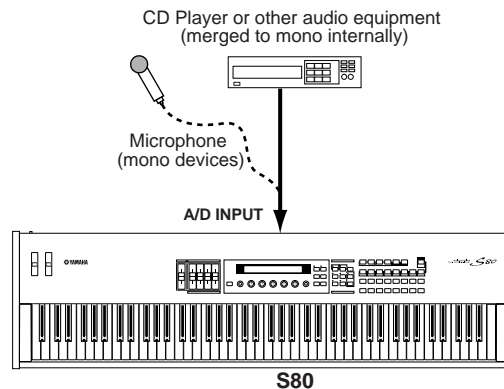

NOTE After the above connections are complete, you are ready to set up for recording. When starting a recording, you may need to adjust the input gain of the audio source using the GAIN knob. Details about A/D Input, including how to adjust the input gain, are given on Pages 63, 119.

⚠ If you choose the wrong type of input source (Pages 119, 120), you may possibly damage your hearing and/or any connected audio equipment. Make sure you set this parameter correctly.

⚠ Before connecting a device to the A/D INPUT jack, always turn the GAIN knob all the way down.

NOTE You can connect an external audio source to the A/D Input Part and use it as a Part in a Performance. Details are given on Pages 63, 119.

Connecting External MIDI Equipment

You can connect an external MIDI device using a MIDI cable (available separately) and control it from this synthesizer. You can also use an external MIDI keyboard or sequencer to control the synthesizer's internal sounds. This section introduces several different applications of MIDI.

NOTE The HOST SELECT switch on the rear panel should be set to "MIDI." Otherwise, MIDI information will not be transmitted from the synthesizer's MIDI OUT connector.

Controlling from an External MIDI Keyboard

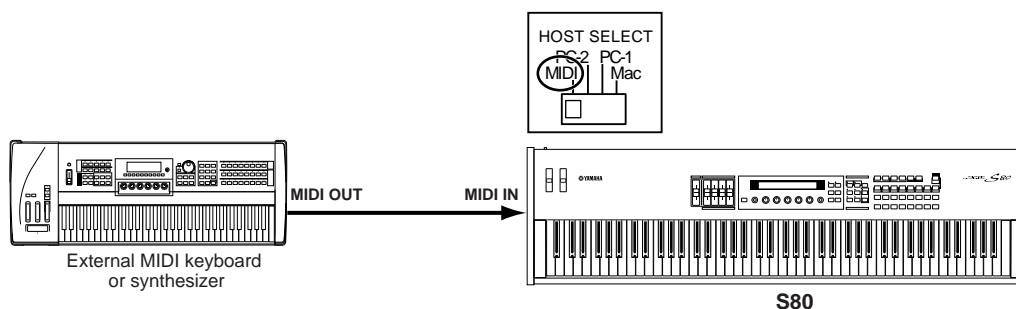

Controlling an External MIDI Keyboard

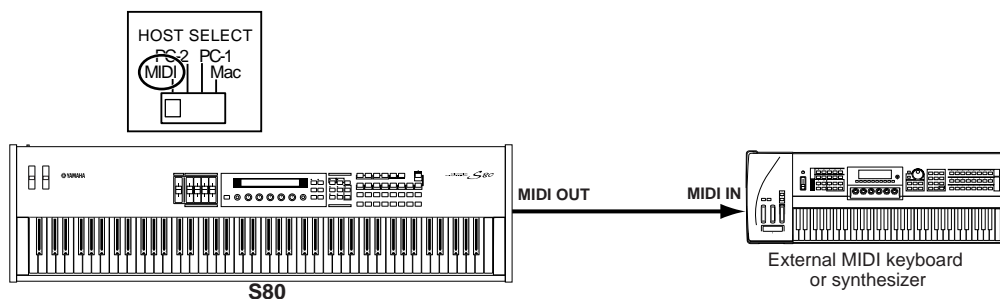

Recording and Playback using an External MIDI Sequencer

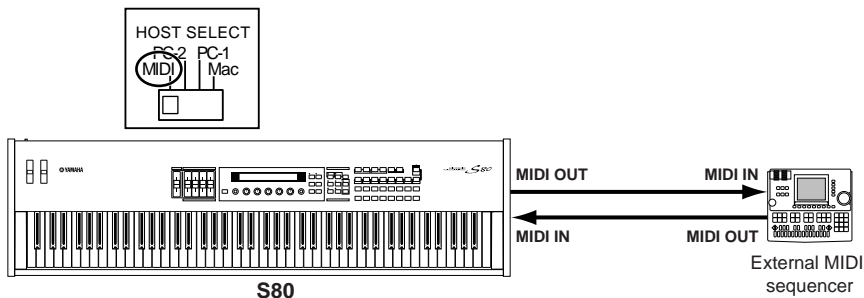

Controlling Another MIDI Device via MIDI THRU

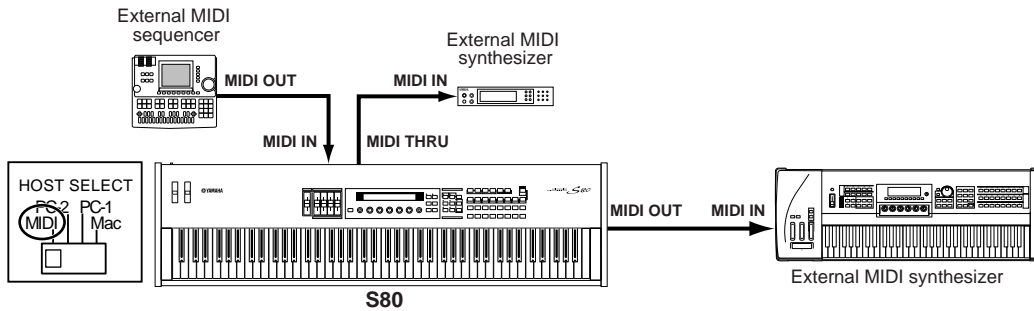

With the above MIDI connections, you can send MIDI data from the MIDI OUT connector while MIDI data from the external sequencer can be sent to an external MIDI synthesizer via the MIDI THRU jack.

NOTE The MIDI cable should be no greater than 15 meters in length, and there should be no more than three devices in a MIDI chain (chained in series via each unit's MIDI THRU). To connect more units, use a MIDI Thru Box for parallel connections. You may encounter errors if the MIDI cables are too long or if too many devices are chained together via their MIDI THRU connectors.

Connecting to a Personal Computer

When a computer is connected, it can be used to control the synthesizer and to transfer synthesizer data to/from computer via MIDI. With the included Voice Editor program, for instance, you can edit the synthesizer's Voices. Using another program – Card Filer – you can transfer files between the computer and the Memory Card inserted in the synthesizer's CARD slot.

There are two ways to connect your synthesizer to a computer:

- 1: Serial connection (the computer's serial port to the synthesizer's TO HOST terminal)
- 2: MIDI connection (the computer's MIDI interface or external MIDI interface to the synthesizer's MIDI IN and OUT)

Different computers require different connections, as follows.

1: Serial Port to TO HOST

IBM PC/AT

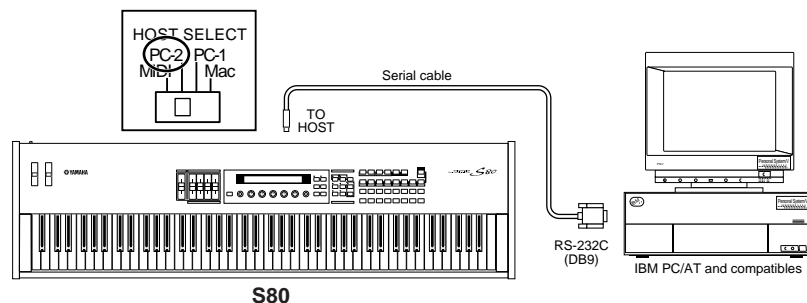

Macintosh

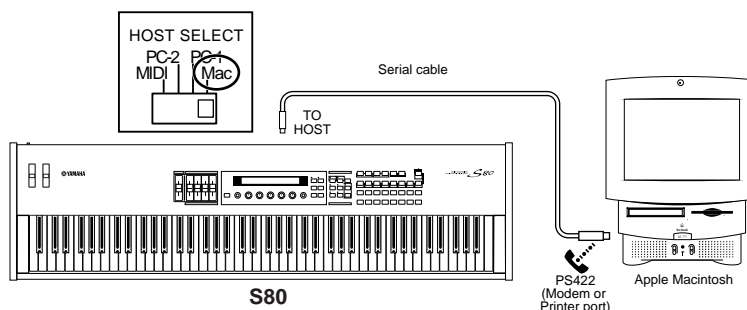

2: MIDI Interface to MIDI IN and OUT

Using the computer's MIDI interface

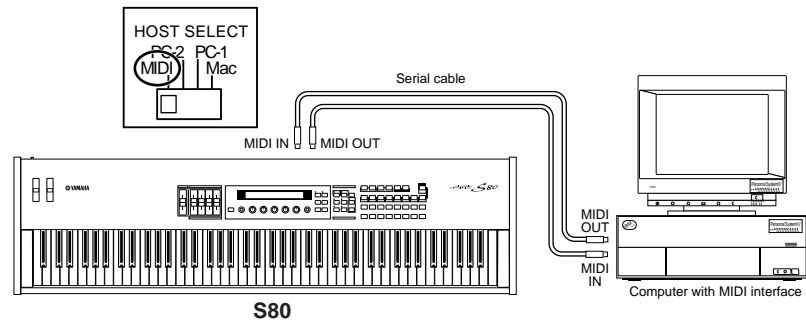

Using an external MIDI interface

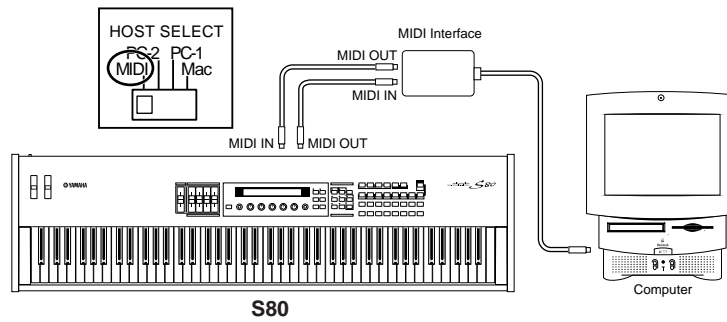

NOTE You will need to an appropriate MIDI application (sequencer, editor, etc.) for your computer platform.

Connecting Various Controllers

The S80 has several controller jacks on the rear panel, including FOOT SWITCH, SUSTAIN, FOOT CONTROLLER, FOOT VOLUME and BREATH. You can connect optional controllers like a Foot Switch (the FC4 or FC5), Foot Controller (the FC7) and Breath Controller (BC3, etc.) to control tone, volume, pitch and other parameters.

NOTE Details about how to these controllers are given on Page 44.

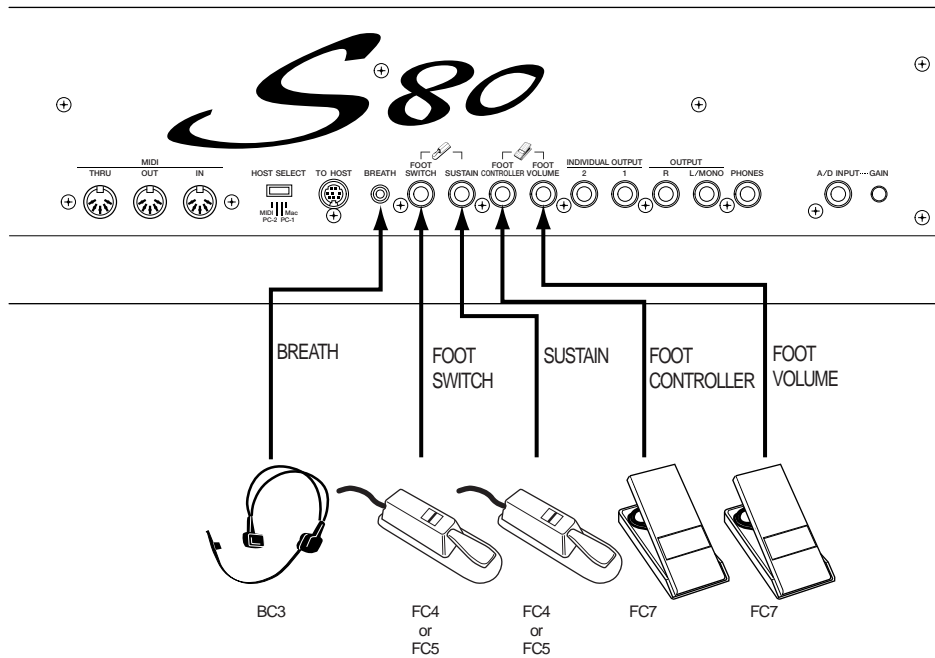

Powering Up

Power-on Procedure

When you have made all the necessary connections between your synthesizer and any other devices, make sure that all volume settings are turned down all the way to zero. Then turn on the every device in your setup in the order of MIDI masters (senders), MIDI slaves (receivers), then audio equipment (mixers, amplifiers, speakers, etc.). This ensures the smooth flow of signals from the first device to the last (first MIDI, then audio).

When powering down the setup, first turn down the volume for each audio devices, then switch off each device in the reverse order (first audio devices, then MIDI).

When the S80 as MIDI receiver:

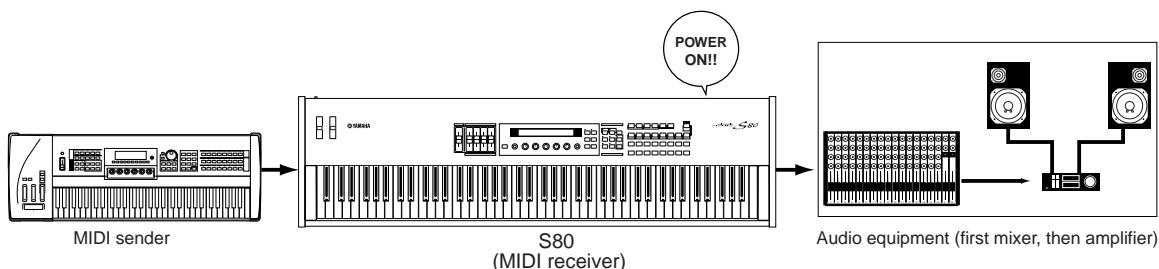

Switching the S80 On

NOTE Before you switch your synthesizer on or off, first turn down the volume of any audio equipment connected to it.

- 1 Press the POWER switch.

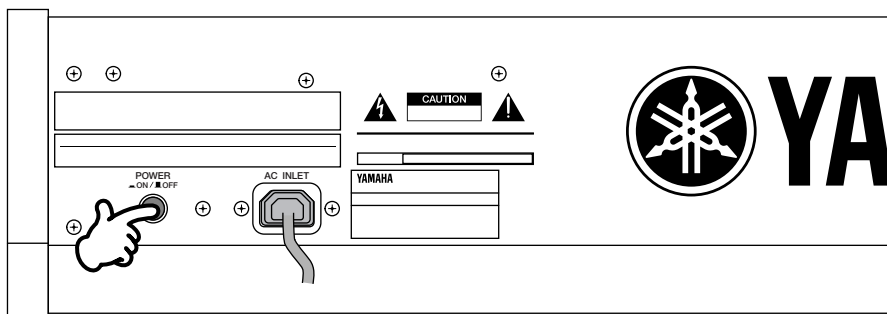

- 2 A splash screen is displayed briefly.
- 3 The Voice or Performance Play Mode screen appears next.

```
VCE Play) PRE1:001(A01)[S4:Generation]
EQLow-Q EQMid-G EQHi-G FLT-Rez HPF
```

If you have a Memory Card inserted in the instrument's CARD slot or an optional Plug-in Board installed, you may see other screens before the Voice or Performance Play Mode screen is displayed.

If a previously used Memory Card is inserted in the CARD slot, you will see a screen while files in EXT Memory are being loaded.

If a new Memory Card (one never used on the instrument) is inserted in the CARD slot, you will see a screen while a basic file is being created in EXT Memory.

If you have a Plug-in Board installed, you will see a screen that confirms the presence of the Plug-in Board.

NOTE The final screen after the power-on sequence may change depending on the Power On Mode setting available Utility Mode (Page 135).

- 4 Turn up the amplifier's volume as necessary.
- 5 Adjust the synthesizer's [VOLUME] slider to set an appropriate volume level.

About Memory Cards

You can save various kinds of data - Voice, Performance, Plug-in, Sequence Chain and so on - onto Memory Card. The built-in CARD slot can accept 3.3-volt Memory Cards (SmartMedia).

NOTE Before using a Memory Card, read through precautions on how to handle it (Page 142).

• Formatting a Memory Card

You cannot use a new Memory Card to save files immediately. The card must be formatted in Card Mode (Page 147) beforehand.

• Saving and Loading Data

You can save various kinds of data as files on a formatted Memory Card. Each file on the card can be loaded when required.

You can save and load data such as System, Voice, Performance, Plug-in, Sequence Chain or the like. Since Sequence Chain data is held temporarily in the synthesizer's buffer memory and will be lost once you switch it off, you need to save such data onto the Memory Card first.

Details about formatting a Memory Card, saving and loading data, and the recognized file types are given on Page 143.

Basic Operations

This section gives some basic explanations about operating the synthesizer.

Selecting a Mode

There are several operation Modes — Voice Play Mode, Performance Play Mode, etc. — each of which enables you to work efficiently with the synthesizer's various functions.

NOTE An overview of each Mode is given on Page 35.

There are separate Play Modes for Voices and Performances. To enter each of these Modes, use the appropriate MODE key ([VOICE] for Voice Play Mode, [PERFORM] for Performance Play Mode). There are also separate Edit and Job Modes for Voices and Performances. To enter Edit or Job Mode, simply press the [EDIT] or [JOB] key while in each respective Play Mode.

Similarly, pressing the [STORE] key in Voice or Performance Mode takes you into Store Mode where you can store Voices or Performances.

Other Modes include Utility Mode where you can specify system settings, Card Mode where you can perform tasks related to the Memory Card, and Sequence Mode where you can play back MIDI song files or create a sequence chain. (Press the [UTILITY] key for Utility Mode, the [CARD] key for Card Mode and the [SEQ] key for Sequence Mode.)

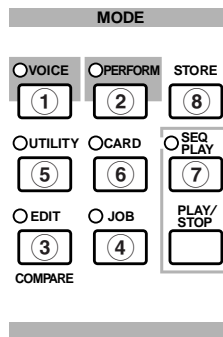

Play Modes

① Voice Play Mode (Page 64)

Press the [VOICE] key (its LED will light) to enter Voice Play Mode. To exit to another Mode, simply press the respective key for that Mode.

```
UCE Play) PRE1:001(A01)[54:Generation]
EQLow-G EQMid-G EQHi-G FLT-Rez HPF
```

② Performance Play Mode (Page 107)

Press the [PERFORM] key (its LED will light) to enter Performance Mode. To exit to another Mode, simply press the respective key for that Mode.

```
PFM Play) INT:001(A01)[---:Init Perf ]
EQLow-G EQMid-G EQHi-G -----
```

Edit Modes

When in each Play Mode, you can swiftly switch to each respective Edit Mode by simply pressing the [EDIT] key (its LED will light).

③ Voice Edit Mode (Page 68)

Press the [EDIT] key in Voice Play Mode. To exit to another Mode, simply press the respective key for that Mode or press the [EXIT] key to return to Voice Play Mode.

```
GEN_Name) Ctrny a-z 0-? Cursor
C 1234 [PF:Init Voice]
```

③ Performance Edit Mode (Page 111)

Press the [EDIT] key while in Performance Play Mode. To exit to another Mode, simply press the respective for that Mode or press the [EXIT] key to return to Performance Play Mode.

```
GEN Name) Ctrny a-z 0-? Cursor
Common [---:Init Perf ]
```

Job Modes

When in each Play Mode, you can swiftly switch to each respective Job Mode by simply pressing the [JOB] key (its LED will light).

④ Voice Job Mode (Page 105)

Press the [JOB] key in Voice Play Mode. To exit to another Mode, simply press the respective key for that Mode or press the [EXIT] key to return to Voice Play Mode.

```
UCE Initialize>
Job          Current Voice
```

④ Performance Job Mode (Page 130)

Press the [JOB] key while in Performance Play Mode. To exit to another Mode, simply press the respective for that Mode or press the [EXIT] key to return to Performance Play Mode.

```
PFM Initialize>
Job          Current Perform
```

④ Utility Job Mode (Page 141)

Press the [JOB] key in Utility Mode. To exit to another Mode, press the respective key for that Mode or press the [EXIT] key to return to Utility Mode.

```
UTIL Factory Set>
Job
```

Other Modes

⑤ Utility Mode (Page 134)

Press the [UTILITY] key (its LED will light) to enter Utility Mode. To exit to another Mode, simply press the respective key for that Mode.

```
MSTR TG>   Vol1      NoteShift   Tune
Sys       127      +63      +102.3c
```

⑥ Card Mode (Page 142)

Press the [CARD] key (its LED will light) to enter Card Mode. To exit to another Mode, simply press the respective key for that Mode.

```
Save>      Type   File      B-?   Cursor
Card      all    ***[NEWFILE .S2A]
```

⑦ Sequence Play Mode (Page 132)

Press the SEQ key (its LED will light) to enter Sequence Play Mode. To exit to another Mode, simply press the respective key for that Mode.

```
SEQ>      File: [  ] Perf
Chain00   001 J= 120 Meas=001 INT:128
```

NOTE When MIDI system exclusive messages are received from an external MIDI device, the LED for the currently selected Play Mode (VOICE or PERFORM) will blink.

⑧ Store Modes (Pages 106, 131)

When in each Play or Edit Mode, you can swiftly switch to each respective Store Mode by simply pressing the [STORE] key. To exit to another Mode, simply press the respective key for that Mode or press the [EXIT] key to return to Play Mode.

```
UCE [54:Generation] >[Pf:Slamming_]
Store INT:001(A01)
```

Selecting a Screen

You can switch between screens using the [PAGE] knob and pressing [SHIFT], [PROGRAM/PART], [EXIT] and [ENTER] keys.

[PAGE] Knob

Usually, there are several screens and sub-screens in each Mode. Use the [PAGE] knob to switch between screens.

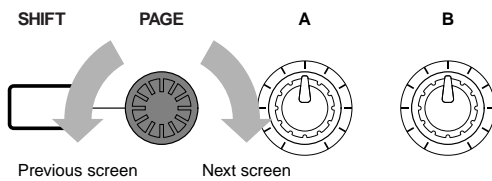
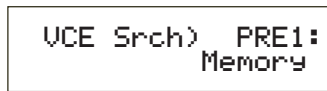

As shown below, the “◀” indicator is displayed to the left of the screen if there are more screens before and after that which you are currently viewing.

At the first in a series of screens, you will see the “▶” indicator meaning that there are more screens to follow, but none before it. At the last screen, you will see the “◀” indicator meaning that there are no more screens to follow.

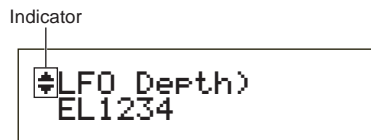

[SHIFT] Key

If you hold down the [SHIFT] key in Voice Play Mode, you can modify the parameters on screen as follows.

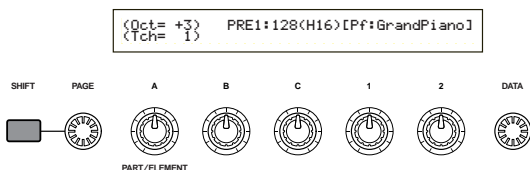

Some Modes have more screens. In this case, you can use the [PAGE] knob while holding down the [SHIFT] key to switch to a specific screen. For example, if you use the [PAGE] knob while holding down the [SHIFT] key in Voice Edit Mode, the following screen is shown. Select a specific item using the cursor (▶), then release the [SHIFT] key to switch to the parameter screen for that item.

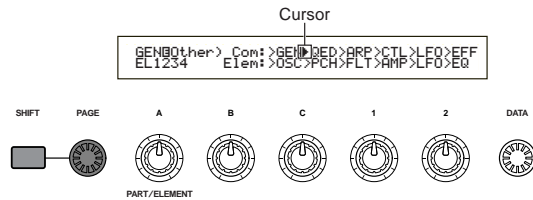

NOTE The [SHIFT] key also has other functions, as described in other sections in this manual.

PROGRAM/PART keys

In Voice Edit Mode, PROGRAM/PART keys can be used to select the items shown under the keys and to switch to their screens.

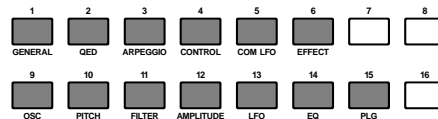

[EXIT] Key

Press the [EXIT] key to move up (exit) in the hierarchical structure and return to the previous screen.

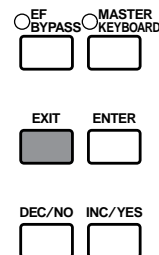

NOTE The [EXIT] key also has other more functions, as described in other sections in this manual.

[DATA] Knob

Use this knob to change the value of the parameter at which the cursor is positioned. Turn the knob clockwise to increment the value one click (step) at a time, or turn it anti-clockwise to decrement it.

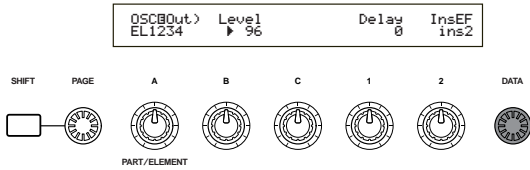

Moving the Cursor

Turn the [DATA] knob clockwise or anti-clockwise while holding down the [SHIFT] key to move the cursor to a parameter in the screen without affecting its value.

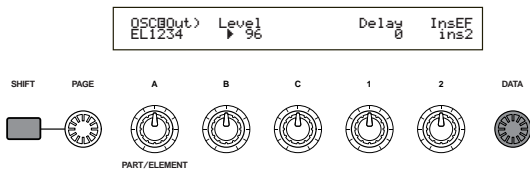

[ENTER] Key

Use this key to apply a setting (when it is blinking, for example.). The [ENTER] key is also used when executing a Job or Store operation, as described in other sections of this manual.

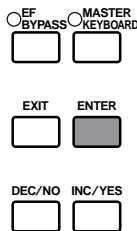

Types of Parameters (Absolute and Relative)

There are many ways to set parameters. Some parameters require you to directly enter numerical settings or alphabetic characters. With others, you can choose from a number of available settings. Furthermore, some types of parameters are “absolute” whereas others are “relative.”

For example, the absolute parameter in the following illustration can be set to either “Mono” or “Poly.” For other absolute parameters such as Volume, the setting can be any value between zero and 127. The Volume setting has a linear, on-to-one relationship with the actual volume, as shown in the graph on the left.

However, relative parameters do not follow the same relationship. The graph on the bottom shows the role of the Velocity Offset parameter. The value you have set here, known as an “offset,” is added to, or subtracted from, the actual value. With Velocity Offset, the specified offset value is added to, or subtracted from, the actual velocity of the notes you play on the keyboard. Sometimes, these types of relative parameters are set as a percentage.

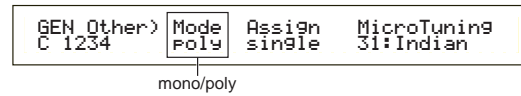

mono/poly

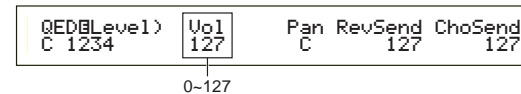

0-127

① Volume (absolute)

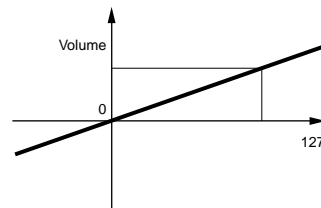

② Velocity offset (relative)

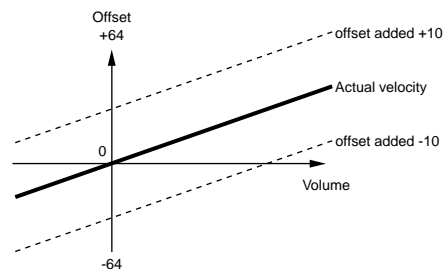

Demo Playback

Several demo songs are supplied with this synthesizer. You can play them back as follows.

NOTE Make sure synthesizer is ready for playback. Details are given in the section “Before Use” on Page 12.

NOTE At the “SEQ Demo” screen, any data in the instrument’s internal memory (System, Internal Voices or the like) will be overwritten by the data for the demo song. Important data should be saved to Memory Card (Page 144) beforehand.

1 Press the SEQ PLAY key to enter Sequence Play Mode. You will see the following screen.

```
SEQ Demo>> Are you sure? [YES]/[NO] >>
System,IntVoice will be changed.
```

NOTE There are two screens in Sequence Play Mode. Use the [PAGE] knob to switch to the screen shown above.

2 Press the [INC/YES] key to enter the SEQ Demo screen.

```
                Demo song name
                |
                v
SEQ Demo> Song:[DEMOSONG]
          |
          v
          001 | J= 120
          |
          v
          Demo song number   Playback tempo
```

NOTE To cancel demo playback, press the [DEC/NO] key.

3 Press the [PLAY/STOP] key to start playback of the song.

4 Press the [PLAY/STOP] key again to stop playback.

NOTE At the end of the song, playback is automatically looped back to the beginning.

NOTE You can change the playback tempo using the [TEMPO] knob or Knob [C]. To use the song’s original tempo, select a tempo value of “***.”

NOTE Details about Sequence Play Mode (and demo playback from Memory Card), are given on Page 132.

Voices and Performances

Playing a Voice

Based on an AWM2 synthesis engine, this synthesizer offers various kinds of preset Voices (256 Normal Voices and 8 Drum Voices). You can also create your original Voices and store them into the instrument's internal memory (INT) or an external Memory Card (EXT). The internal and external memory can each contain up to 128 Normal Voices and 2 Drum Voices. You can freely select and play Voices from both groups of memories, as explained in the following.

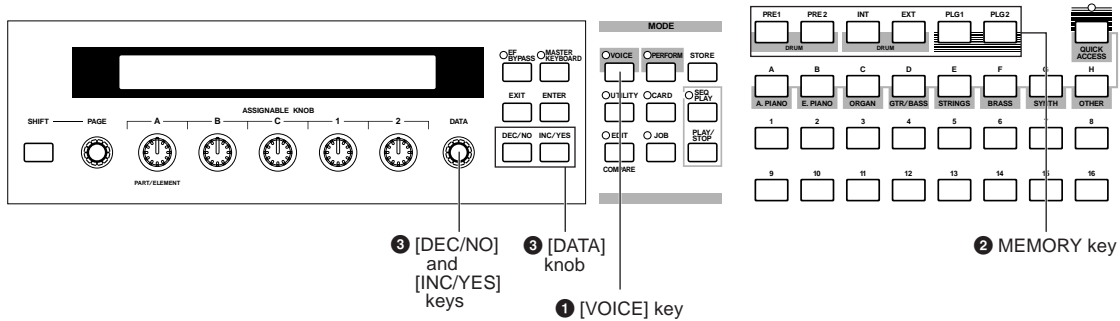

1 Press the [VOICE] key

The [VOICE] key LED will light, showing that you are now in Voice Play Mode. The following appears in the display.

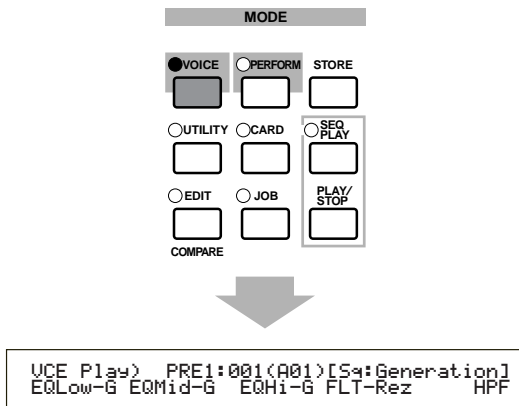

At this point, you can play the Voice (named on the screen) via keyboard.

2 Press a MEMORY key to select a Voice Memory

There are six Voice Memories: PRE1 (Preset 1), PRE2 (Preset 2), INT (Internal), EXT (External), PLG1 (Plug-in 1), and PLG2 (Plug-in 2). Within each Voice Memory are several Banks (up to eight, A to H) in which the Voices are stored. The following illustration shows how Voices are stored in a Voice Memory.

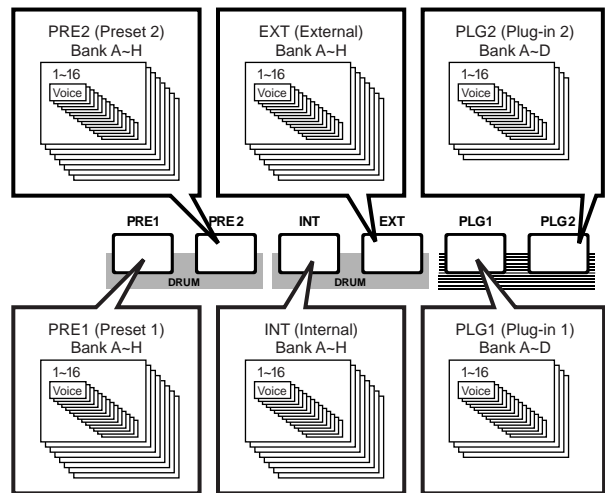

The Drum Voices are held in separate areas of each Memory, and are accessed as follows.

- **To access the Preset Drum Memories (PRE:DR1 ~ DR8):**

Press the MEMORY [PRE2] key while holding down the MEMORY [PRE1] key.

- **To access the User Drum Memories (INT:DR1/2, EXT:DR1/2):**

Press the MEMORY [EXT] key while holding down the MEMORY [INT] key.

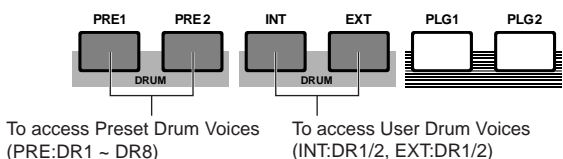

NOTE PRE1 and PRE2 (Preset 1 and 2) are stored in internal Read Only Memory (ROM) and contain preset Voices which are never overwritten. INT (internal) is stored in Random Access Memory (RAM) and contains the factory default Voices. These can be overwritten, but can be recalled from the original factory settings at any time if required.

NOTE EXT (external) is stored on a Memory Card inserted in the CARD slot. If there is no Memory Card inserted and you attempt to select an EXT Voice, “---” will be displayed and no sound will be produced. With a Memory Card inserted, you can select and play EXT Voices. PLG1 or PLG2 Voices can only be selected if a Plug-in Board is installed.

3 Select a Voice Number using the [DATA] knob or the [INC/YES] and [DEC/NO] keys

Turn the [DATA] knob clockwise or press the [INC/YES] key to increment the Voice Number. Turn it anti-clockwise or press the [DEC/NO] key to decrement the Voice Number.

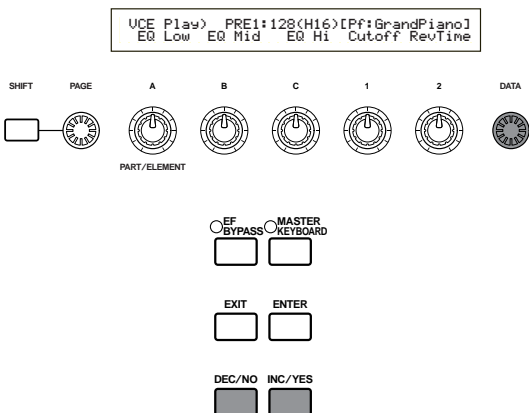

Now you can play a selected Voice when you play the keyboard.

NOTE Details about selecting Voices using the [DATA] knob or the [DEC/NO] and [INC/YES] keys are given on Page 66.

NOTE You can also select Voices using a combination of BANK and PROGRAM/PART keys, using the Quick Access feature, or using the Category Search feature. Details about selecting Voices are given on Pages 65, 67,68.

Using the Quick Access

Using Quick Access, you can quickly select any of 12 types of Preset Voices and 4 types of Internal Voices (at their factory default settings) in each Bank according to their Categories. The procedure is as follows.

NOTE Details about the Voices that can be selected using Quick Access are given in the separate Data List.

- 1 Press the [QUICK ACCESS] key in Voice Mode. Its LED will light and Quick Access will be enabled.

```
UCE Quick> INT:017(H01)[Pf:GrandPiano]
EQLow-G EQMid-G EQHi-G FLT-Fr4 ChoSend
```

Press the key again or switch to another Mode to disable Quick Access.

NOTE When you enable Quick Access, the Voice you previously selected using Quick Access is selected again.

NOTE If you enable Quick Access while editing a Voice, the Voice is not changed until you select another Voice via Quick Access.

NOTE You cannot use the MEMORY keys while Quick Access is enabled.

- 2 Use BANK keys [A] to [H] to select the Category. There are eight Categories, as listed below. The Category names are printed below the respective BANK keys.

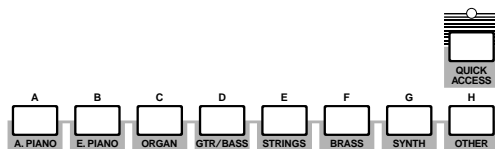

- 3 Use PROGRAM keys [1] to [16] to select the Voice within the specified Category. The name of the Voice is displayed.

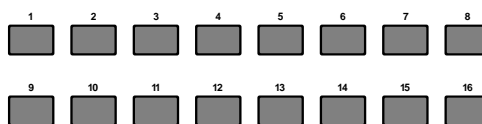

NOTE For each BANK [A] to [H], Preset Voices are accessed using PROGRAM keys [1] to [12]. The remaining four keys (PROGRAM keys [13] to [16]) are used to access each of four internal Voices. Details about Voices are given in the separate Data List. By selectively assigning your own selected Voices to the PROGRAM keys [13] to [16] in each BANK, you can make use of the Quick Access feature to quickly switch between them.

Playing a Performance

In Performance Play Mode, you can select and play any of 128 internal and 64 external (Memory Card) Performances.

A Performance is a set of Voices used with the built-in (or an external) sequencer. Performances also let you set the synthesizer up for multitimbral operation.

Each Performance can contain up to 16 Parts assigned to different Voices, plus extra Parts for A/D INPUT and Plug-in Boards. If the Layer Switch (Page 123) parameter is switched on for any Parts, those Parts can be play in unison. Also, you can assign multiple Parts to different MIDI channels so that they can be played or be controlled individually using the built-in (or an external) sequencer. Up to 128 Performances can be stored in the internal memory and up to 64 on Memory Card. These Performance settings are available in Performance Edit Mode (Page 111). Here, we will show how to get started with Performance Play after selecting a Performance.

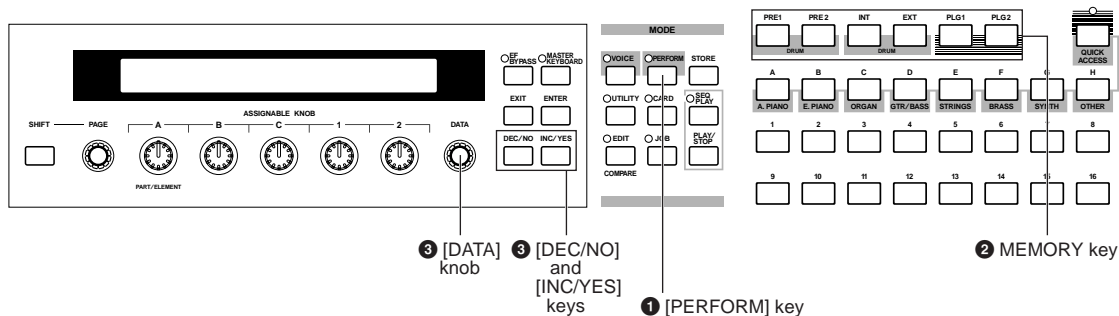

1 Press the [PERFORM] key. 2 Press a MEMORY key to select a Performance Memory

The [PERFORM] key LED will light, showing that you are now in Performance Play Mode. The following appears in the display.

There are two Performance Memories: INT (internal) and EXT (External). The INT memory is divided into eight Banks (A to H) of 8 Performances. The EXT memory is divided into four Banks (A to D) of 4 Performances.

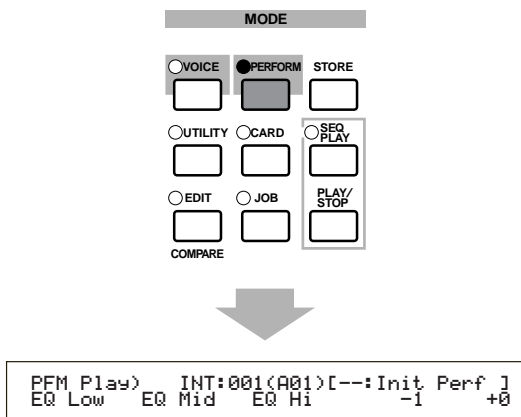

At this point, you can play the Performance (named on the screen) via keyboard.

NOTE INT (internal) is stored in internal Random Access Memory (RAM) and contains factory default Performances. These can be overwritten but can be recalled at any time.

NOTE EXT (external) is stored on a Memory Card (RAM) inserted in the CARD slot. If there is no Memory Card inserted and you attempt to select an EXT Performance, “-----” will be displayed and no sound will be produced. With a Memory Card inserted, you can select and play EXT Performances.

③ Select a Performance Number using the [DATA] knob or the [INC/YES] and [DEC/NO] keys

Turn the [DATA] knob clockwise or press the [INC/YES] key to increment the Performance Number. Turn it anti-clockwise or press the [DEC/NO] key to decrement the Performance Number.

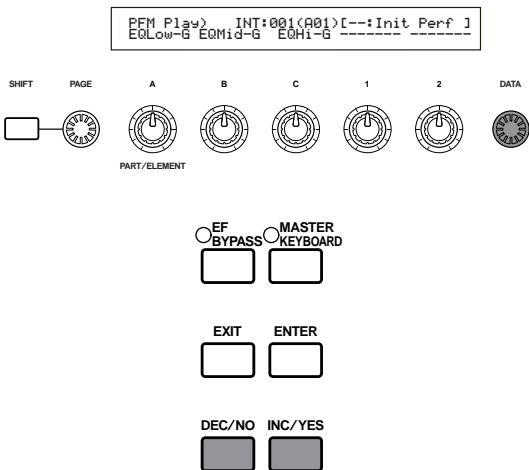

You can now play Parts in the Performance via the keyboard. If the Layer Switch (Page 123) parameter is switched on for any Parts, those Parts can be play in unison. Now try selecting other Performances.

- NOTE** Details about selecting Performances using the [DATA] knob or the [DEC/NO] and [INC/YES] keys are given on Page 66.
- NOTE** You can also select Performances using a combination of BANK and PROGRAM/PART keys, or using the Category Search feature. Details about selecting Performances are given on Page 109.
- NOTE** On selection, a Performance may take a few seconds to become ready since the settings for multiple Parts are applied.
- NOTE** With some of the Performance presets (INT), you can use Knob [2] to switch the Arpeggiator on/off. Details are given in the separate Performance List.

An Overview of the S80

In this section, an overview of the many features of the S80 is given. The S80 hardware is made up of a number of sections, as shown in the following diagram.

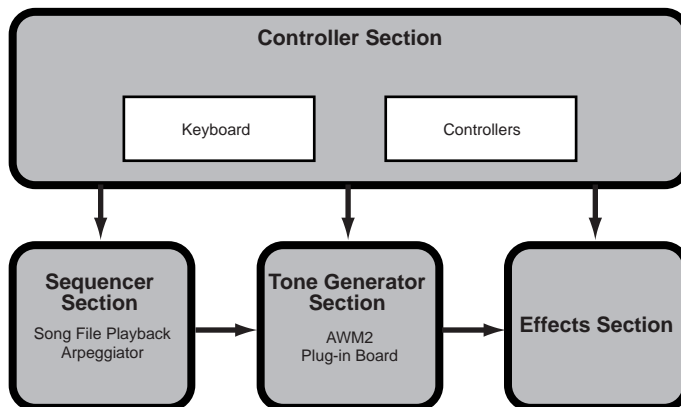

Controller Section

This section consists of the keyboard, Pitch Bend and Modulation Wheels, Control Sliders, Assignable knobs and so on. The keyboard itself doesn't generate sounds, but instead sends note, velocity and other information to the synthesizer's tone generator section when you plays notes. The controllers also send changes. Information from the keyboard and controllers can be transmitted to other external MIDI devices through the MIDI OUT connector.

Sequencer Section

This section can be used to play back Standard MIDI Files held on Memory Card. The contents of Tracks 1 to 16 correspond to MIDI channels and Parts in a Performance as shown in the following illustration. The sequencer can play back songs with a different Voice assigned to each Part.

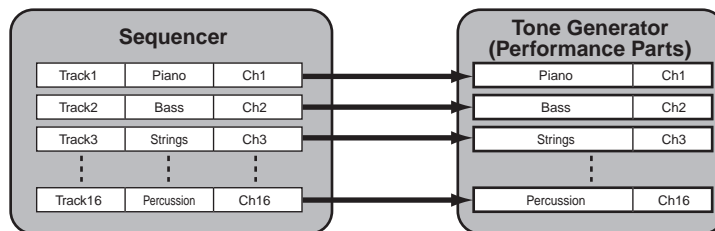

Tone Generator Section

This section plays back sounds according to information received from the keyboard and controllers. The following example illustrates the path taken by the signal from an Element in Voice Mode.

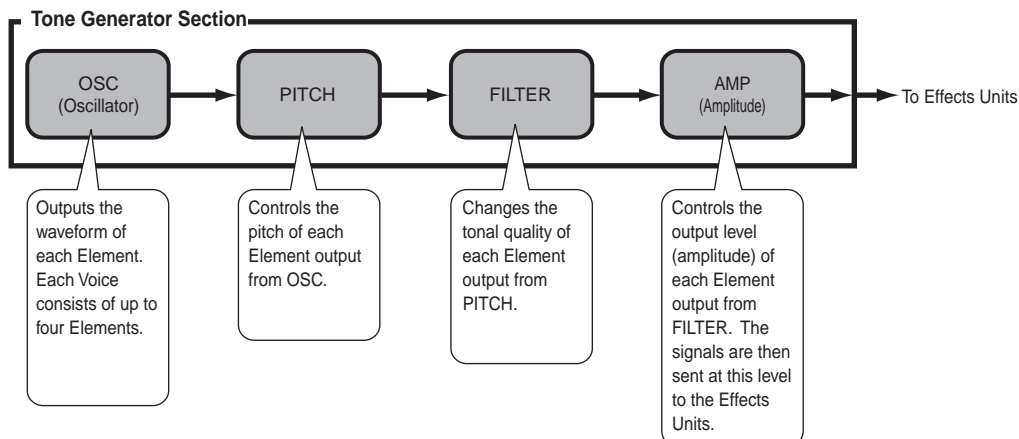

About the Tone Generator

The tone generator section in the S80 consists of AWM2 and Plug-in units.

AWM2 (Advanced Wave Memory 2) is a synthesis system based on the use of sampled waveforms, and is used in many Yamaha synthesizers. For extra realism, each AWM2 Voice uses multiple samples of a real instrument's waveform. Furthermore, a wide variety of envelope generator, filter, modulation, and other parameters can be applied to the basic waveform.

NOTE AWM2 is not just limited to general musical instruments (Normal Voices). It can also be used for setting up percussive instruments (Drum Voices). Details about Normal and Drum Voices are given on Page 37.

Plug-in Boards add more features to the system. When installed, they combine perfectly with the synthesizer's built-in tone generator section.

The following types of Plug-in Board are available, and up to two boards can be installed in the synthesizer. These boards are not simply a source of more Voices; they are also tone generators in their own right and extend the system-level specifications such as maximum polyphony. You can play Plug-in Voices just like ordinary internal Voices and use them as Parts in a Performance (Page 98).

This synthesizer is compatible with the Modular Synthesis Plug-in System (see next page). There are three types of Modular Synthesis Plug-in System-compatible Plug-in Boards: Single Part, Multi-Part and Effect Plug-in Board. Using these, you can build your own system based on the sounds you require.

Single Part Plug-in Boards

- **Analog Physical Modeling Plug-in Board (PLG150-AN)**

Using Analog Physical Modeling (AN) synthesis, the very latest digital technology is used to accurately reproduce the sound of analog synthesizers. With this board installed, you have real-time control over the playback of vintage synthesizer sounds as well as the very latest sounds heard in today's club-oriented music.

- **Piano Plug-in Board (PLG150-PF)**

A massive 16MB of waveform memory is dedicated to the reproduction of piano sounds using AWM2 synthesis. This board offers 136 stereo sounds, including a number of acoustic and electric pianos, and up to 64-note polyphony. You can even install two of these boards to double the polyphony to 128 notes.

- **Advanced DX/TX Plug-in Board (PLG150-DX)**
The sounds of the DX7 are available on this Plug-in Board. Unlike with PCM-based solutions, this does not use sampled waveforms. Instead, it uses the actual FM sound generator engine of the DX-series synthesizers to give a completely faithful reproduction. Sounds are compatible with those of the DX7, and the board can even receive DX7 data via MIDI bulk dump.
- **Virtual Acoustic Plug-in Board (PLG150-VL)**
With Virtual Acoustic (VA) synthesis, the sounds of real instruments are modeled (simulated) in real time, giving a degree of realism that cannot be achieved using conventional PCM-based synthesis techniques. When playing these sounds using an optional Breath Controller (BC3) or MIDI Wind Controller (WX5), you can even capture some of the physical feel of woodwind instruments.

Effect Plug-in Boards

- **Vocal Harmony Plug-in Board (PLG100-VH)**
With this board installed, you can add harmonies to selected parts using four types of effects. Chorus parts for vocals can be created automatically from chords that have been prepared and stored as MIDI data. You can also use the synthesizer like a vocoder by connecting and using a microphone while playing the keyboard.

Multi-Part Plug-in Board

- **XG Plug-in Board (PLG100-XG)**
This Plug-in Board is a 16-part XG sound generator. You can play back XG/GM song files using the rich variety of sounds and effects on this board.

NOTE More Plug-in Boards will be available in future.

MODULAR SYNTHESIS PLUG-IN SYSTEM

About MODULAR SYNTHESIS PLUG-IN SYSTEM

The Yamaha Modular Synthesis Plug-in System offers powerful expansion and upgrade capabilities for Modular Synthesis-Plug-in-compatible synthesizers, tone generators and sound cards. This enables you to easily and effectively take advantage of the latest and most sophisticated synthesizer and effects technology, allowing you to keep pace with the rapid and multi-faceted advances in modern music production.

Maximum Polyphony

The maximum sonic polyphony is 64 for AWM2, plus the polyphony of the Plug-in Board (if installed). The actual note polyphony will vary depending on the type of tone generator unit used, the number of Elements in the Voice, and the note polyphony of the Plug-in Board.

In the case of AWM2 Voices, the polyphony figure of 64 is divided by the number of Elements in the Voice. For instance, if a Voice consists of two Elements, the maximum note polyphony for the Voice is 32.

Effects Section

The effects can be used to change the sound of a Voice or Performance. There are two Insertion Effect Units plus a Reverb Unit (with 12 types of reverb) and a Chorus Unit (with 23 types of chorus). Each of the Insertion Effect units offers a variety of effects, and the units themselves can be connected in parallel or in series.

In Voice/Performance Mode, different Effects settings can be assigned to each Voice/Performance, though the way they are connected (series or parallel) varies slightly. As shown in the following illustration, the two Insertion Effect units can be independently switched on or off for each Element in a Voice. So basically, the Insertion Effects can be set on a per Element basis. After being passed through the Insertion Effects, the signals from all individual Elements are mixed and sent to the Reverb and Chorus Units. These Reverb and Chorus Units apply effects to the sound as a whole before it is sent to the outputs, and are therefore known as System Effects.

In Performance Mode, the Insertion Effects can be set for two Parts: a Voice or A/D Input Part, plus a Plug-in Part. However, the System Effects (Reverb and Chorus) are not applied to Parts, but to the Performance as a whole.

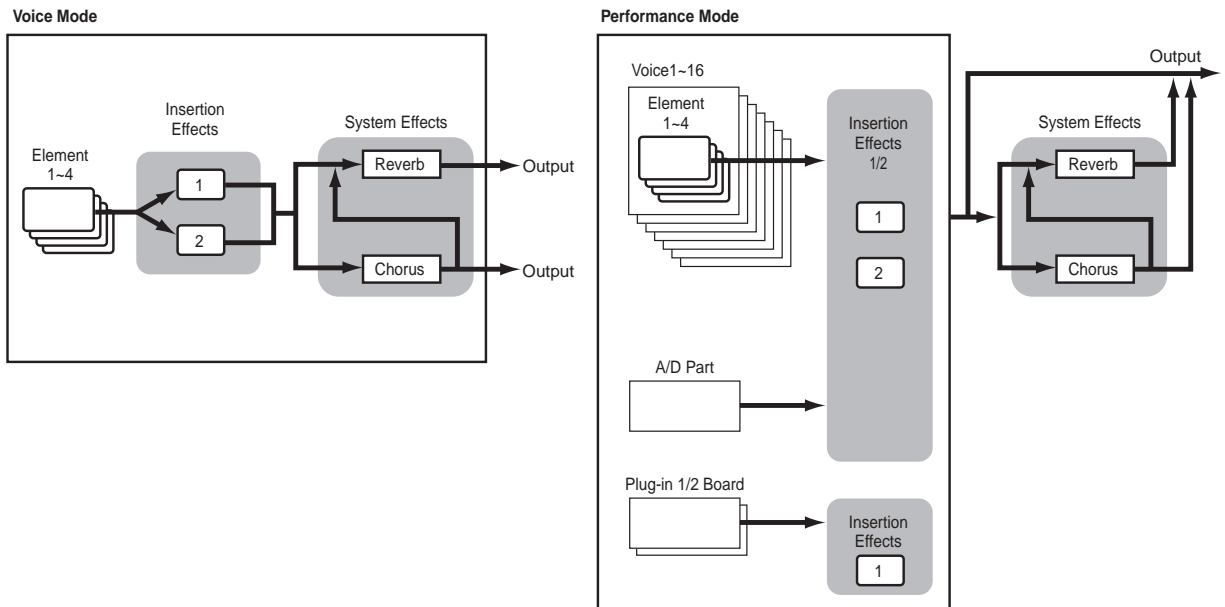

NOTE Details about Effects are given on Page 55.

About the Modes

The S80 has various Modes which you can select according to the task you wish to perform.

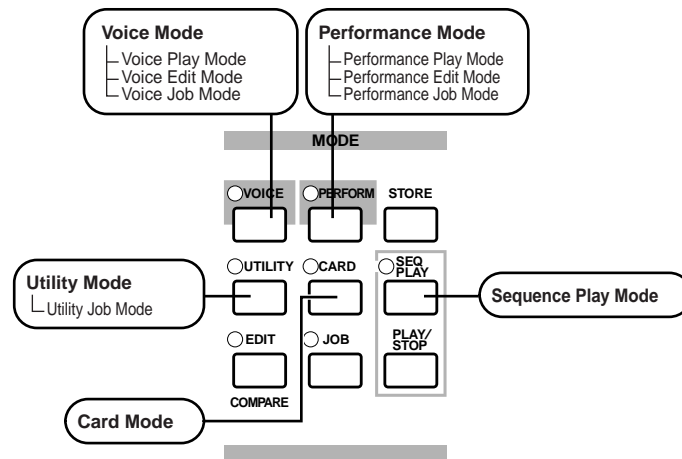

Voice Mode (Page 64)

Voice Play Mode

Normal Voices and Drum Voices can be played in this Mode. You can select from Preset Voices (256 Normal Voices plus 8 Drum Kits), Internal (User) Voices (128 Normal Voices plus 2 Drum Kits) and External (Memory Card) Voices (128 Normal Voices plus 2 Drum Kits). That is a choice of 512 Normal Voices and 12 Drum Kits. The choice is extended further still if you have an optional Plug-in Board installed.

The MIDI settings for Voices are set in Utility Mode.

Voice Edit Mode

Normal Voices and Drum Voices can be created and edited in this Mode. You can save up to 128 edited Normal Voices and 2 edited Drum Kits as User Voices in internal memory. You can also store them to Memory Card as external memory.

Voice Job Mode

In this Mode, you can copy and initialize Voices, and perform other such operations (Jobs) on them.

Performance Mode (Page 107)

Performance Play Mode

This Mode is used when playing Performances. You can layer multiple Voices (Parts) to create rich sonic textures. You can also create multitimbral setups by assigning Parts to different MIDI channels. You can layer A/D Input and Plug-in Parts, as well as AWM2-based Voices.

Performance Edit Mode

In this Mode, you can edit and create Performances. You can save up to 128 Performances to internal memory or up to 64 to external memory (Memory Card).

Performance Job Mode

In this Mode, you can copy and initialize Performances, and perform other such operations (Jobs) on them.

Sequence Play Mode (Page 132)

In this Mode, you can use the sequencer to play back Song files (Standard MIDI Files) held on Memory Card. The Songs can be played back individually or as a chain. By switching Performance, you can also change the sounds associated with each track in a Song.

Utility Mode (Page 134)

Select this Mode when setting parameters that apply to the synthesizer system as a whole. These include MIDI settings and synthesizer setup parameters.

Utility Job Mode

In this Mode, you can restore the synthesizer's factory settings.

Card Mode (Page 142)

Insert a Memory Card into the CARD slot and you can save files to it, load files from it, and do various other things with the data on the card.

Voices

A Voice is a sound created from the many parameters set in the synthesizer. In Voice Play Mode, you can select and play any of these Voices. In Performance Play Mode, several different Voices (known as Parts in this Mode) can be layered and played simultaneously via keyboard or a sequencer. Four groups of Voices are available (Preset 1, Preset 2, Internal and External). Up to two further groups of Voices are available if optional Plug-in Boards have been installed.

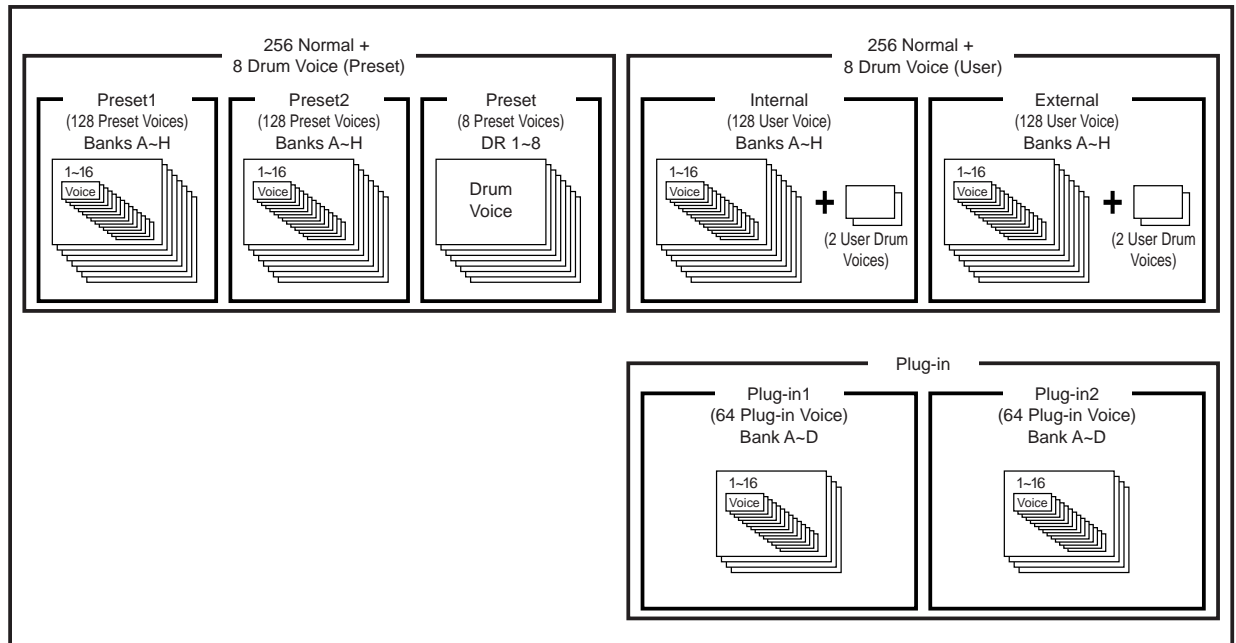
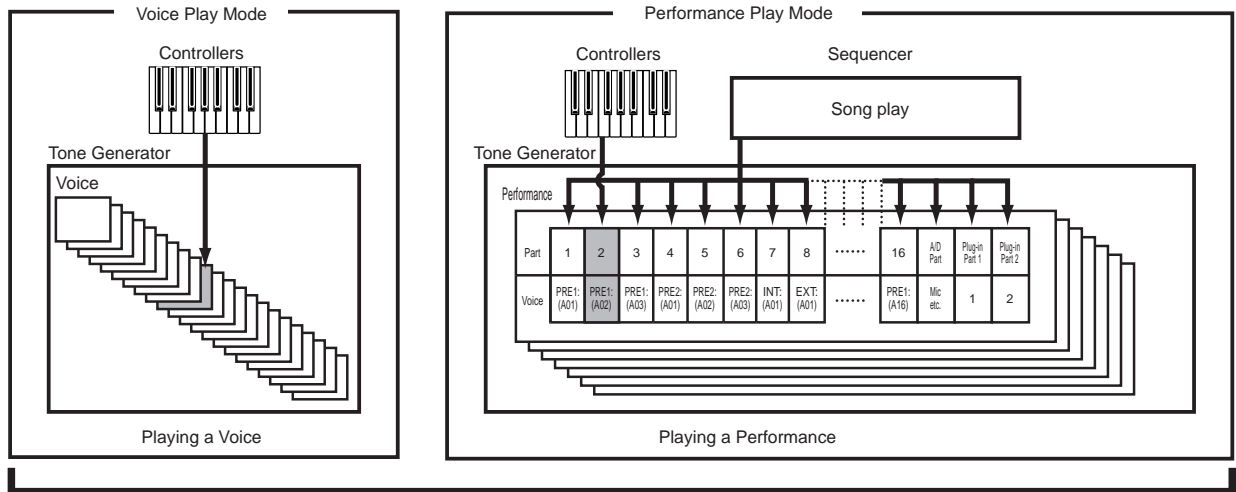

An Overview of Voices/Waves

Each Voice consists of up to four Elements. Each Element itself uses a high-quality waveform.

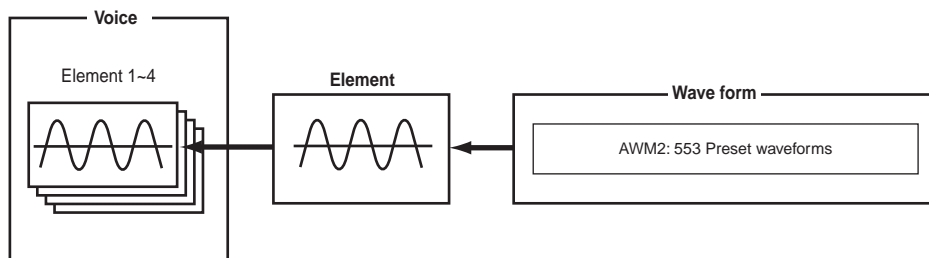

Internally, there are two Voice Types: Normal Voices and Drum Voices. Normal Voices are mainly musical instrument-type sounds that can be played over the range of the keyboard. Drum Voices are mainly percussion/drum sounds that are assigned to individual notes on the keyboard. A collection of Drum Voice assignments is known as a Drum Kit.

If you have installed an optional Plug-in Board, there will be more Voices for you to choose from. These Voices are known as Plug-in Voices, and will vary depending on the Plug-in Board you have installed (Page 32).

The Note Limit settings (Page 80) will also affect the allocation of sounds. But basically, Normal Voices (of up to four Elements) are playable across the whole keyboard range whereas with Drum Voices, any of 73 different Waves can be assigned to each Drum Key on the keyboard.

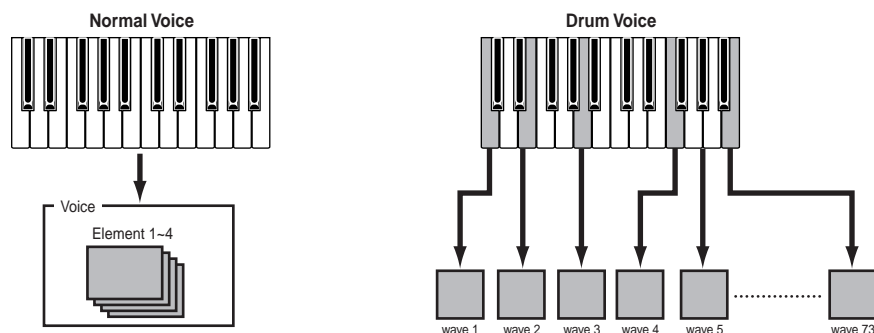

NOTE A total of eight Drum Voices (DR1 to DR8) are available as presets. You can also create your own Drum Voices and save them to internal (User) memory or to external memory (Memory Card), just as with Normal Voices.

Waves

Waves are waveforms used as Elements that make up a Voice. 553 high quality preset Waves are available. As shown in the following illustration, when creating a Voice, you can select the Wave to be used as an Element and then set its level, pitch, tone and other parameters.

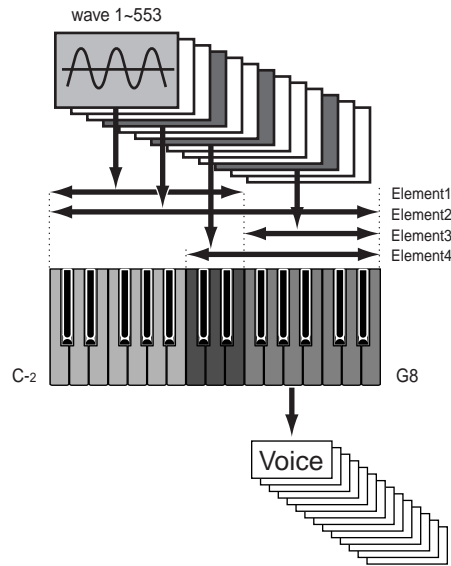

Performances

A Performance consists of up to 19 Parts, each of which can be a Normal Voice, Drum Voice, A/D Input Part or Plug-in 1/2 Part. By switching on the Layer Switch parameter for different Parts (up to four), you can play back rich layered sounds in Performance Play Mode. You can also create splits so that different Parts are assigned to different areas of the keyboard. If you assign a different MIDI channel number to each Part, each track of a sequencer can play back a different Part.

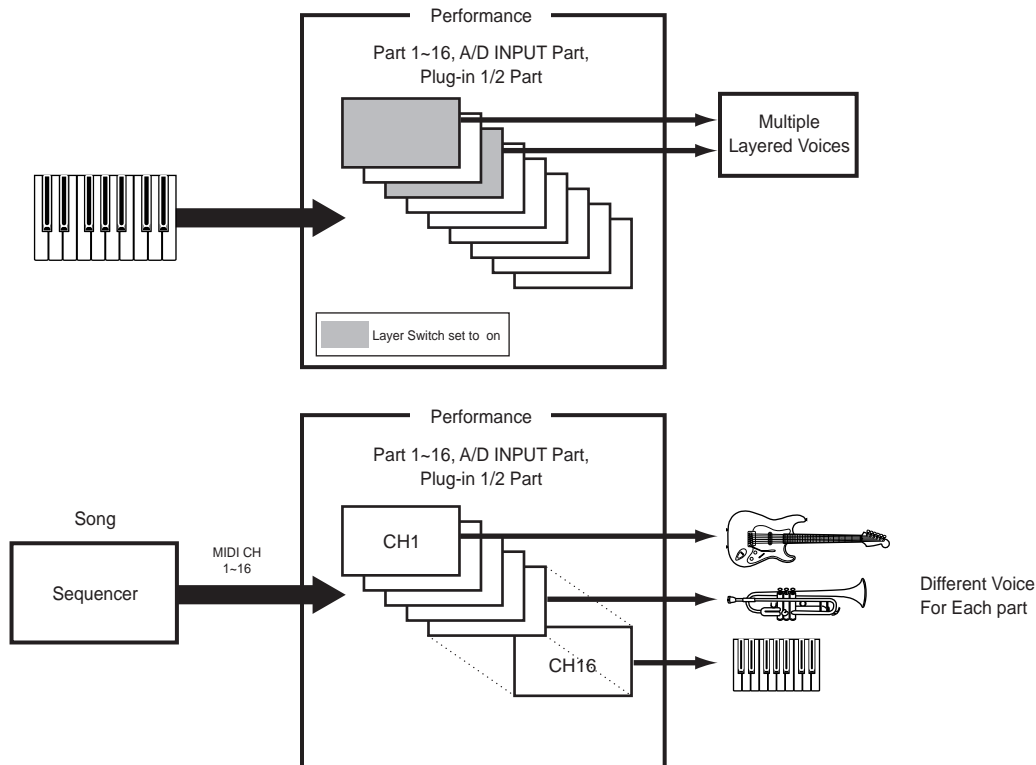

NOTE In Performance Mode, several different Voices (Parts) can be layered to create rich textures. However, this can cause note response to become slower under some circumstances.

Ideal for Playing Live

Many features of this synthesizer make it ideal for live performances. These features are explained here.

① Using the Arpeggiator (Page 41)

A wide variety of arpeggio patterns can be created automatically by just holding down a set of notes on the keyboard. You can specify the sound and the note range within which the arpeggiator is active, then use your left hand to hold down the notes being arpeggiated while using your right hand to play a melody line.

② Using the Controllers (Page 43)

The Pitch Bend Wheel, Modulation Wheel and Control Sliders can be freely assigned to control various sound parameters in real time. By connecting an optional Foot Controller or Foot Switch, you can also use your feet to control parameters, to change Program Number, and so on (Page 48). Also, you can assign parameters to Knobs [A], [B], [C], [1] and [2] on the front panel below the LCD.

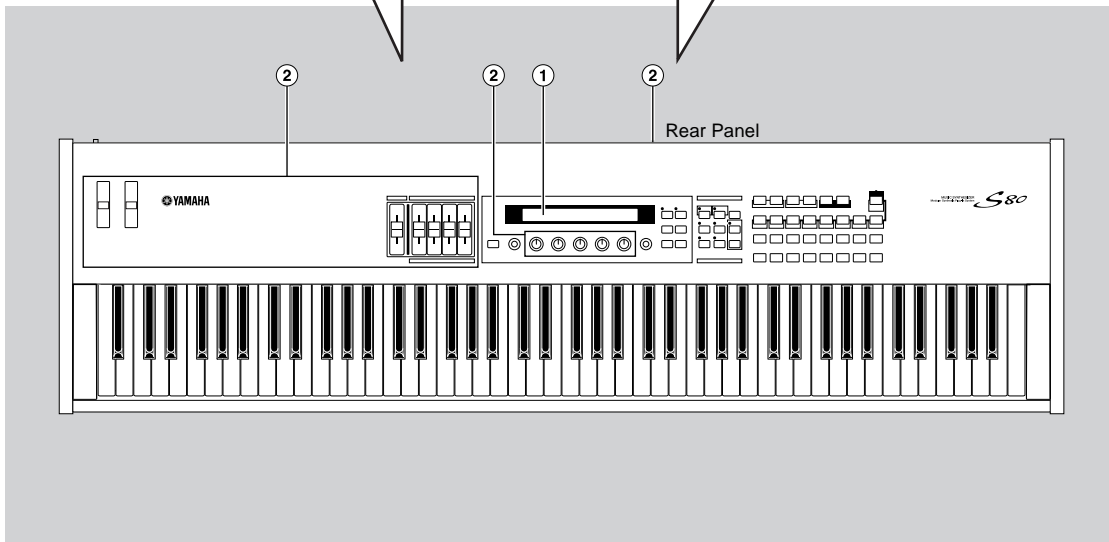

NOTE The parameters for these features can be stored per Voice/Performance.

1 Arpeggiator

The arpeggiator is particularly suited to dance/techno music genres. You can assign any of 128 Arpeggio Types to each Voice, Performance and adjust the tempo. You can also set the Arpeggio Mode (the way in which the arpeggio is played back when you press a note) and Play Effects to create your own original grooves. Arpeggio information can be transmitted through the MIDI Out.

Selecting and Playing Back an Arpeggio Type

You can choose from 128 different Arpeggio Type presets. You can also freely vary the Arpeggio Tempo to suit the song. The Note Limit parameter can be used to define the effective note range of the arpeggio.

Each parameter applies to, and is stored with, each Voice or Performance. By playing notes on the keyboard and listening to the arpeggio, you can adjust these parameters by ear.

The arpeggiator's parameters are available in each Edit Mode. In the following Voice Mode example, the Arpeggio Type is set for a Drum Voice in Preset Drum 1.

NOTE To select the Preset Drum, press the MEMORY [PRE2] key while holding down the MEMORY [PRE1] key and press a PROGRAM key. Here, we will choose Preset Drum 1 so you should press the PROGRAM [1] key.

NOTE If the Arpeggiator switch is already enabled for the Voice/Performance, this means that the Arpeggiator will be ready for use whenever you select the Voice/Performance.

NOTE The on/off state of the Arpeggiator can be stored (Pages 106, 131) for each Voice/Performance.

Selecting the Arpeggio Type

1 Press the [EDIT] key in Voice Play Mode. You will enter Voice Edit Mode at the screen where you previously exited.

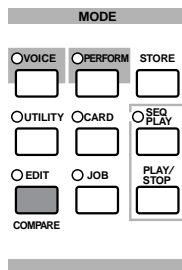

2 Turn Knob [A] fully anti-clockwise until Common is displayed on the bottom line. Voice Edit Mode consists of two different Edit screens: Common Edit (for parameters common to all Drum keys/Elements) and Drum key/Element Edit. The Arpeggiator parameters are found in the Common Edit screens that you have now selected.

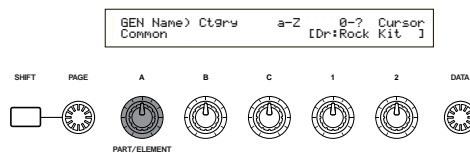

3 Use the [PAGE] knob to switch to the ARP Type (Arpeggio Type) screen.

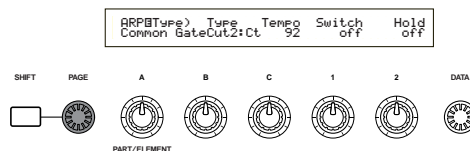

NOTE If you use the [PAGE] knob while holding down the [SHIFT] key, a menu will be displayed. You can quickly jump to the ARP screen by using the [PAGE] knob to move the cursor to the ARP item in the menu, then releasing the [SHIFT] key (Page 70).

4 Use Knob [B] to jump to the Type parameter. Now use Knob [B], the [DATA] knob or the [INC/YES] and [DEC/NO] keys to select the desired Arpeggio Type. Let's choose "BigBeat2" here.

Arpeggio Types are divided into the four following categories and applications are not just limited to drum patterns. You can also select Arpeggio Types for backing chords, basslines and so on.

NOTE When setting the Arpeggio Category to Ct (Control), you also need to set the Key Mode parameter (two screens ahead) to "direct."

Sq (Sequence):

Creates a general arpeggio phrase. Mainly octave up/down phrases.

Ph (Phrase):

Creates more musical phrases than Sq. Starting with "Techno," there are phrases for a wide variety of musical genres, and for creating backing tracks for guitar, piano and other instruments.

Dr (Drum Pattern):

Creates drum pattern-type phrases. Phrase genres covered include rock and dance. This Type is ideal for use with drum and percussion sounds.

Ct (Control):

Creates tonal changes. No note information is created. The Key Mode parameter in Arpeggio Mode must be set to "direct."

NOTE Details about Arpeggio Types are given in the separate Data List.

Using the Arpeggiator

Use Knob [1] to set the Arpeggiator Switch parameter to “on.”

NOTE You can hold down multiple notes to create complex arpeggio patterns.

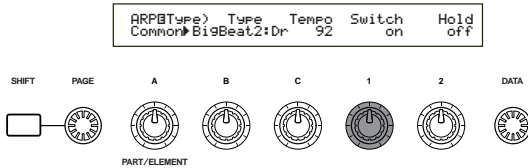

When the arpeggiator is switched on, the notes you play (and hold down) on the keyboard will be arpeggiated using the currently selected Voice or Performance, and according to the Arpeggio Type, Tempo and Note Limit settings.

In Voice Mode, the currently selected Voice will be arpeggiated.

In Performance Mode, the Voices of Parts for which both the Layer and arpeggiator are switched on, are arpeggiated (Page 123).

NOTE Only notes within the Note Limit range will be arpeggiated. Therefore, if the notes you play are not arpeggiated, they may be outside this range. Details about the Note Limit settings are given later.

NOTE The Pitch Bend and Modulation Wheels can be used while the arpeggiator is running.

Now try selecting other Arpeggio Types and arpeggiating different Voices.

NOTE You can use a Foot Switch (optional) to switch the Arpeggiator on/off. Details about assigning parameters to the Foot Switch are given on Pages 48, 136.

Setting the Tempo

You can use Knob [C] to adjust the tempo between 25 and 300 BPM. This parameter setting is used by the Arpeggiator. Use Knob [C] to jump to the Tempo parameter. Now use Knob [C], the [DATA] knob or the [INC/YES] and [DEC/NO] keys to set the tempo. You can also set the tempo using the [TEMPO] knob on the front panel.

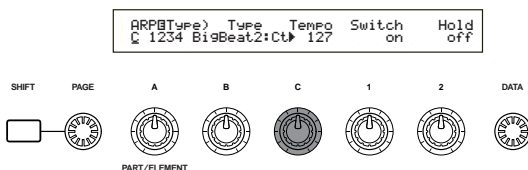

Setting the Note Limit

Using the Note Limit parameter, let's set up a Normal Voice (say, Voice Program Number 098:G02 of Internal:champ) such that the Arpeggiator is enabled in the lower part of the keyboard but the upper part can be used to play melody lines. You'll need to have already set the Arpeggio Type (say, MuteLine).

- The Note Limit parameters can be set in the ARP Limit screen, which follows immediately after the ARP Type screen mentioned in step 3 (earlier). Use the [PAGE] knob to switch to the screen.

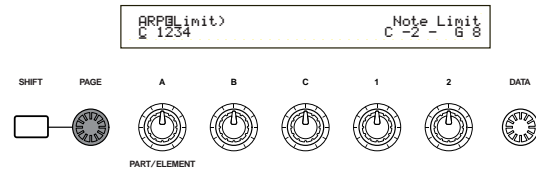

- Use Knob [2] to jump to the parameter for the highest note in the range, and to set the note. Alternatively, you can set this parameter by pressing the note (say, E3) on the keyboard while holding down the [SHIFT] key. Similarly, the lowest note in the range can be set using Knob [1], or by pressing the note while holding down the [SHIFT] key.

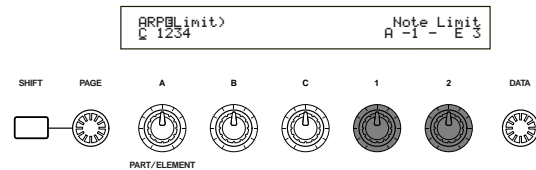

NOTE Knobs [1] and [2] are used to set the Note Limits of the keyboard range within which the arpeggiator will play back. The cursor (▶) immediately jumps to each respective parameter when Knobs [1] and [2] are used. Once the cursor is at the parameter, you can also use the [DATA] knob or the [INC/YES] and [DEC/NO] keys to enter settings.

Outside the Note Limit range, you can play the keyboard normally without the notes being arpeggiated. Therefore, you can use your left hand to play block chords used by the Arpeggiator and your right hand to play melody lines in the upper part of the keyboard.

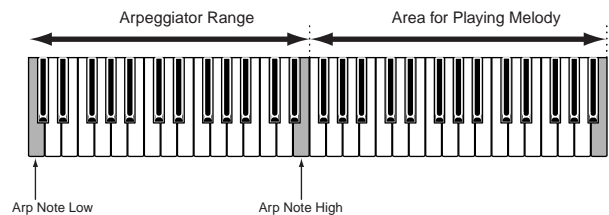

NOTE Combined with the OSC Limit parameter of the Element Edit screen, the sound used in the lower part of the keyboard can be different from that in the upper part.

NOTE Following the example in this manual, if you select Voice Program Number 098(G02) of INT, Portamento is already set for this Voice. Use the PORTAMENTO knob and [ON/OFF] keys to change the portamento time and switch portamento on/off (Page 74).

Using the Arpeggiator Hold ② Using Controllers

With Arpeggiator Hold switched on, the arpeggiator will continue to play back, even after you have released your fingers from the notes on the keyboard. The same arpeggio pattern will be played back until you press another set of notes on the keyboard.

You can switch Arpeggiator Hold on/off by using Knob [2] to change the Hold parameter of the ARP Type screen.

Press the ARPEGGIO [HOLD] key for the Voice you edited earlier (for which you set the Note Limit parameter). With Arpeggio Hold switched on, the Arpeggiator will continue to play back, even after you have released your left hand from the keyboard. This leaves your left hand free to perform other tasks, such as adjusting the Sound Control knobs.

```
ARPType> Type Tempo Switch Hold
Common BigBeat2:Dr▶ 127 on on
```

The S80 is equipped with Pitch Bend and Modulation Wheels. Either of the S80 is equipped with front panel Knobs [A], [B], [C], [1] and [2], with which you can control many different parameters.

Pitch Bend Wheel

This wheel's prime function is to control pitch. Roll the wheel upward/downward to bend the pitch upward/downward. The effect can also be reversed.

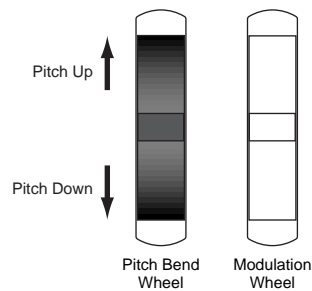

NOTE Pitch Bend Range can be set for each Voice. The wheel can also be assigned other parameters (Page 74).

NOTE Even if a different parameter is assigned to the wheel, Pitch Bend messages are still transmitted through the MIDI Out when it is being used.

Modulation Wheel

The more you roll this wheel upwards, the greater the modulation that is applied to the sound.

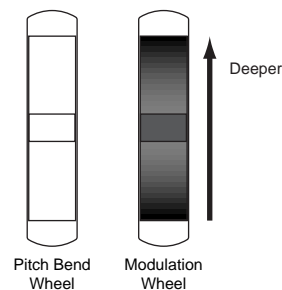

NOTE Modulation depth can also be set beforehand. Also, the wheel can be assigned different parameters, such as Volume or Pan (Page 74).

Knobs [A]/[B]/[C]/[1]/[2]

In Voice/Performance Play Mode, Knobs [A], [B], [C], [1] and [2] can be used as real-time controllers. Knobs [A], [B] and [C] are assigned to control the equalizer gain of, respectively, EQ Low, EQ Mid and EQ Hi. With Knobs [1] and [2], you are free to assign different parameters per Voice.

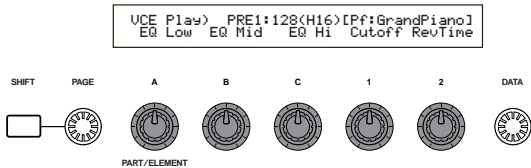

If you turn any knob clockwise, the value assigned to it is incremented. Conversely, the value is decremented if you turn it the other way.

NOTE Common system parameters are assigned to Knobs [A],[B] and [C] (Pages 46, 136). Voice-specific parameters are assigned to Knobs [1] and [2] (Pages 47, 74).

NOTE A preset of suitable parameter settings is assigned to each Voice. By using each knobs [1] and [2], you are in effect adjusting these settings by a certain amount. If these parameters are already preset at their minimum or maximum settings, the settings cannot be exceeded.

NOTE In any Edit Mode, Knobs [A], [B], [C], [1] and [2] are used for entering parameter settings on screen (Page 24).

Control Sliders

In Performance Mode, if Master Keyboard Mode is enabled, you can use the four Control Sliders to control the functions assigned to each zone. Details are given on Pages 61 and 129.

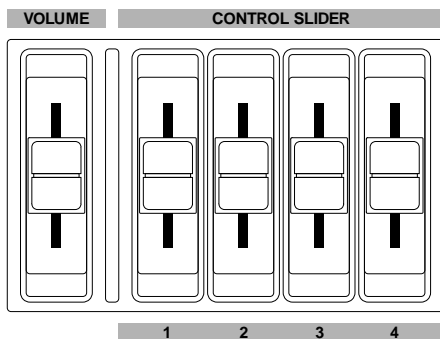

Foot Controller

An optional Foot Controller (such as the FC7), connected to the FOOT CONTROLLER jack (Page 18) on the rear panel, can be assigned a number of controller parameters. By using a foot controller for parameter control, both your hands are left free to play the keyboard (or to operate other controllers). This is very convenient if you are playing live.

NOTE Foot Controller parameters can be set for each Voice.

Foot Switch

An optional Yamaha FC4 or FC5 Foot Switch connected to the rear panel FOOT SWITCH jack (Page 18) can be assigned to a range of parameters. It is suited for a switch-type (on/off) controls such as Portamento Switch, increment/decrement of a Voice or Performance Number, start/stop of the Sequencer, holding Arpeggiator on or off. The Foot Switch is not well suited for continuous control. You could also use it to switch to between different Voices or Performances

NOTE The parameter assigned to the Foot Switch is set in the CTRL Other screen of Utility Mode (Pages 48, 136).

Sustain

With an optional Yamaha FC4 or FC5 Foot Switch connected to the SUSTAIN jack (Page 18) on the rear panel. This is useful when playing piano-type sounds.

NOTE You cannot assign a function other than Sustain to the SUSTAIN jack.

Foot Volume

Connect an optional Foot Controller (such as the FC7) to the FOOT VOLUME jack of the rear panel (Page 18). You can then use your foot to control Main Volume or Expression parameters, leaving your hands free to play the keyboard. This is very useful if you are playing live.

NOTE The parameter assigned to the Foot Volume controller is set in the CTRL Other screen of Utility Mode (Page 136).

Breath Controller

You can connect an optional Breath Controller (BC3) to the BREATH jack (Page 18) on the rear panel. Then use it to control a large number of the synthesizer's parameters, particularly those controlled by a wind player's breath: dynamics, timbre, pitch and so on. The Breath Controller is ideally suited for realistic expression with wind instrument type Voices.

NOTE Breath Controller parameters can be set for each Voice.

Aftertouch

Aftertouch lets you, for example, add vibrato to a sound by applying further pressure to a note on the keyboard while it is being held down. This allows real-time expression and control. Aftertouch can be used to control a wide variety of parameters (Page 74).

Control Sets

Aside from their default parameters, keyboard aftertouch, the controllers and some of the knobs on the front panel can be assigned with various parameters, as explained on Page 43. For example, you could assign Resonance to the Modulation Wheel and set aftertouch to apply vibrato. You are free to assign parameters to suit the kind of sound being played.

These controller assignments are known as Control Sets. As the following illustration shows, you can assign up to six different Control Sets per Voice. Within each Control Set, the controller is known as the Source (Src) and the parameter controlled by the Source is known as the Destination (Dest). There are various Dest parameters available; some will apply to the Voice as a whole, while some will be specific to each of its Elements. Details are given in the Controls List of the separate Data List.

NOTE Details about the available Dest parameter settings are given in the Destination Parameter List of the separate Data List.

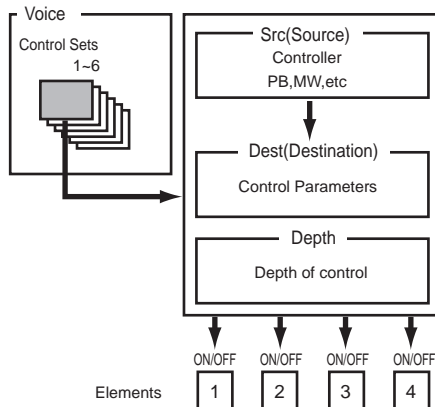

NOTE The Element Switches (Page 75) will be disabled if the Dest parameter setting is not specific for Elements (i.e., for settings 00 to 33).

By creating Control Sets, you can change sounds in a variety of ways.

For example, set the Src (Source) parameter of Control Set 1 to MW (Modulation Wheel) and the Dest (Destination) parameter to ELFO-PM (Element LFO Pitch Modulation Depth). Then set the Src parameter of Control Set 2 also to MW, but set the Dest parameter to ELM PAN (Element Pan). You will also need to specify the Element to be controlled and also the depth (amount) of control.

In this example, when you move the Modulation Wheel upward, the amount of Pitch Modulation increases accordingly, the Element is panned from left to right. So in other words, you can assign several Dest parameters to each Src controller.

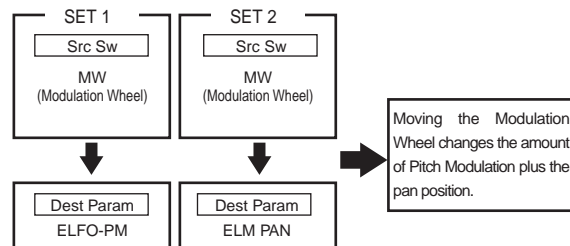

Continuing from the example above, now create another Control Set where Src is set to FC (Foot Controller) and Dest is set to ELFO-PM (Element LFO Pitch Modulation Depth). Again, specify the Element to be controlled and also the depth of control.

Now, Pitch Modulation is assigned to both the Modulation Wheel and Foot Controller. In other words, you can also assign several Src controllers to each Dest parameter.

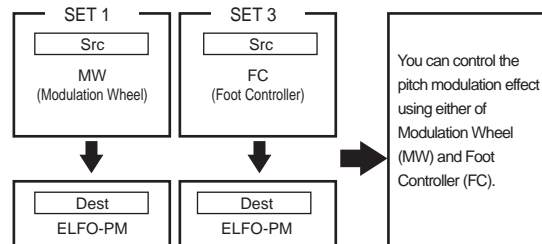

By assigning all six Control Sets, you will have a stunning degree of real-time control over the synthesizer's sounds.

Control Sets and External MIDI Control

In a Control Set, the controllers are assigned to the internal parameters of the synthesizer. However, some controllers were originally designed for a particular purpose, and send pre-defined MIDI Control Change messages when used, regardless of their Control Set allocations within the synthesizer.

For example, the Pitch Bend Wheel, Modulation Wheel and keyboard aftertouch were originally designed to control pitch bend, modulation and aftertouch. Therefore, when you use these controllers, pitch bend, modulation and aftertouch information is always sent to the MIDI Out.

Let's say the Pan parameter is assigned to the Pitch Bend Wheel in a Control Set. Now, when you move the Pitch Bend Wheel, the internal tone generator of the synthesizer will pan the sound but at the same time, the original pre-defined Pitch Bend messages will still be sent to the MIDI Out.

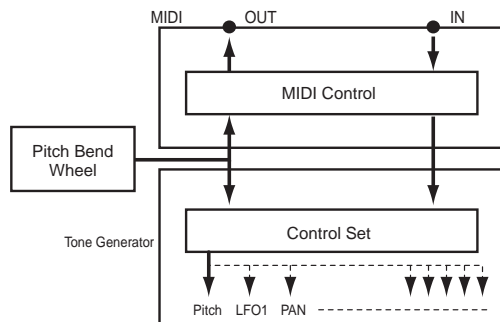

The controllers can also send MIDI Control Change messages to control the parameters of external MIDI devices. These assignments are found in the VOICE (Vce) CTRL Assign1/2 screen of Utility Mode.

NOTE As Pitch Bend Wheel, Modulation Wheel and keyboard aftertouch is pre-defined with specific MIDI controls, you cannot assign MIDI Control Changes.

You can also set up a controller such that it sends one kind of Control message to the synthesizer's internal tone generator yet another kind to the MIDI Out.

For example, in a Control Set you could assign resonance to Assignable Knob [1]. Then, in the VOICE CTRL Assign2 screen of Utility Mode, you could assign Control Change Number 1 (Modulation) to the same knob. Now, when you turn the knob, resonance will be applied to the sound of the internal tone generator but at the same time, modulation information will be sent to the external MIDI device connected to the MIDI Out.

This aspect of the synthesizer makes it ideal for use as a master controller for controlling external MIDI devices. Add an optional Foot Controller or Breath Controller for even more control.

Assigning Parameters to Knobs [A], [B] and [C]

The following procedure explains how you can assign a desired parameter to Knob [A], [B] or [C]. You can assign any parameters that are common throughout the system (for all Play Modes) and any MIDI Control Change Numbers. In the example, Knob [A] will be set up to control Reverb Return.

- 1 Press the [UTILITY] key to enter Utility Mode.

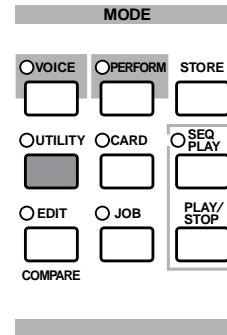

- 2 Use the [PAGE] knob to switch to the CTRL KnobA (System Control Knob A) screen.

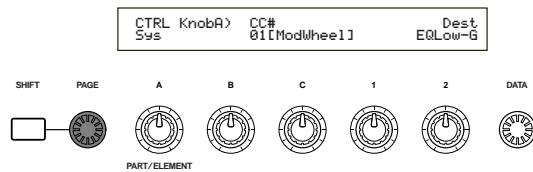

- 3 Use Knob [2] to select REV-Rtn (Reverb Return).

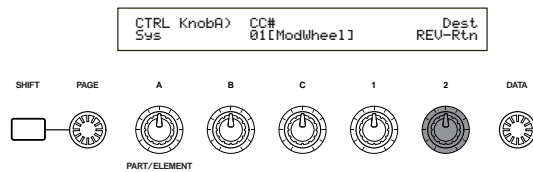

Now you can use Knob [A] for on-the-fly control of the Reverb Return level in Voice/Performance Play Mode. Note that you can also send (by turning Knob [A]) or receive Control Change messages with the Controller Number set in the CC# parameter through MIDI In and Out.

NOTE For assignable parameters, refer to "System Controller Destination Parameters" in the separate Data List.

Assigning Parameters to Knobs [1] and [2]

The following procedure explains how you can assign a desired parameter to Knob [1] or [2]. You can assign controllers to each Voice (or Part in a Performance). Control Settings can be assigned as a Control Set, and each Controller can be used to control multiple parameters (although this varies according to the type of Voice). Here we introduce an example of how to set up Control Set 1 for Internal Voice 001 (A01) by assigning PCH-Crs (Pitch: Coarse) to Knob [1].

NOTE You can also assign, separately, a different MIDI Control Change Number to the same knob in Voice Mode and Performance Mode. Details are given on Page 139.

- 1 Press the [VOICE] key to enter Voice Play Mode.

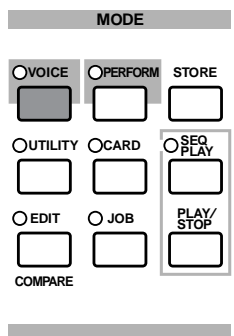

- 2 Select Internal Voice 001 (A01) and press the [EDIT] key to enter Voice Edit Mode.
- 3 Use the [PAGE] knob to switch to the CTL Set1 (Control Set 1) screen.

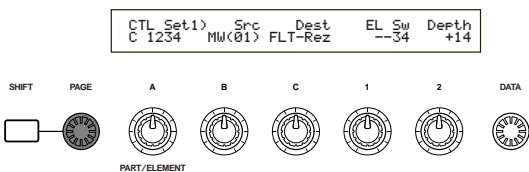

- 4 Use Knob [B] to assign “KN1 (16)” (Knob [1]) to the Src (Source) parameter.

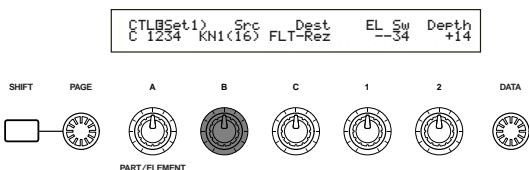

- 5 Use Knob [C] to assign PCH-Crs (Pitch:Coarse) to the Dest (Destination) parameter.

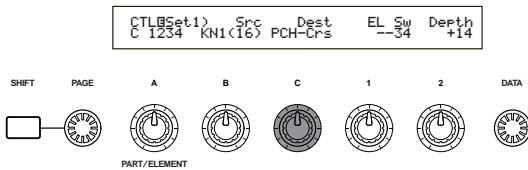

- 6 Use Knob [1] and the [DATA] knob to specify the Element to be controlled. Knob [1] moves the cursor (blinking) and the [DATA] knob displays the Element to be controlled.

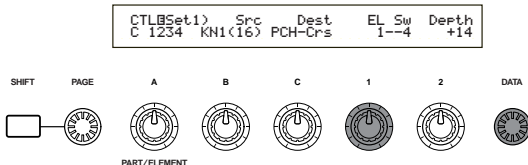

- 7 Use Knob [2] to set the Depth parameter. The larger the setting, the greater the depth of control.

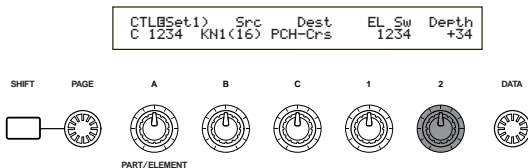

- 8 Store the edited Voice (Page 106).

Now you have Internal Voice 001 (A01) assigned PCH-Crs (Pitch:Coarse) to Knob [1]. When you select and play this Voice in Voice Play Mode, you can control the pitch of the Voice if you turn Knob [1].

NOTE Details about the assignable control functions are given in the Control Set Destination Parameters in the separate Data List.

Controlling Parameters by Foot Controller

By connecting an optional Foot Controller (such as the FC7) to the FOOT CONTROLLER jack on the rear panel of the synthesizer, you can control various parameters by foot without having to use your hands. In the following example, we introduce how to set up Foot Controller to work as Modulation Wheel.

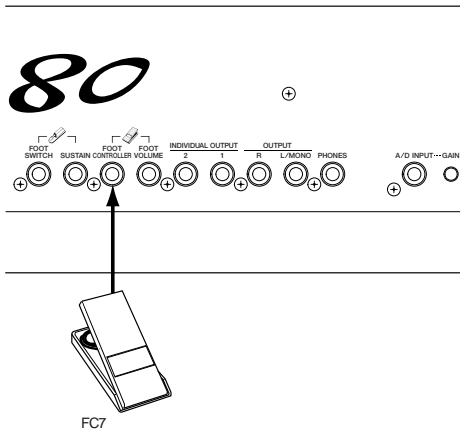

- 1 Press the [UTILITY] key to enter Utility Mode.

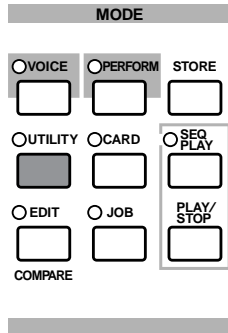

- 2 Use the [PAGE] knob to switch to the CTRL Assign2 (Voice Control Assign 2) screen.

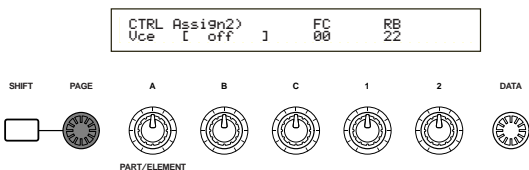

- 3 Use Knob [C] to select "01:ModWheel" (Modulation Wheel).

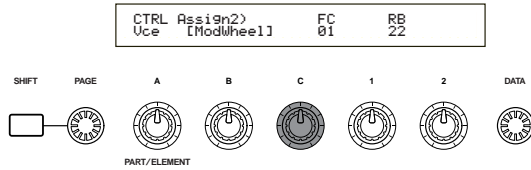

In Voice Mode, the foot controller can now be used to control the same function as that assigned to the Modulation Wheel.

NOTE If the current Voice has a Control Set with a source (Src) assigned to Modulation Wheel (MW) and receives a Control Change message of Modulation Wheel, a destination (Dest) parameter for the source (MW) will be affected with that message.

NOTE The above procedure explains how to set up the Foot Control to control Modulation in Voice Mode. To create such a setup for Performance Mode, the appropriate settings are found at the CTL Assign2 screen in Performance Edit Mode.

Switching Between Programs by Foot Switch

By connecting an optional Foot Switch (such as the FC4 or FC5) to the FOOT SWITCH jack on the rear panel of the synthesizer, you can switch between Programs without having to use your hands. For example, if you consecutively arrange the Voices/Performances in memory, you can switch between them easily in a live performance. The following procedure explains exactly how to do this.

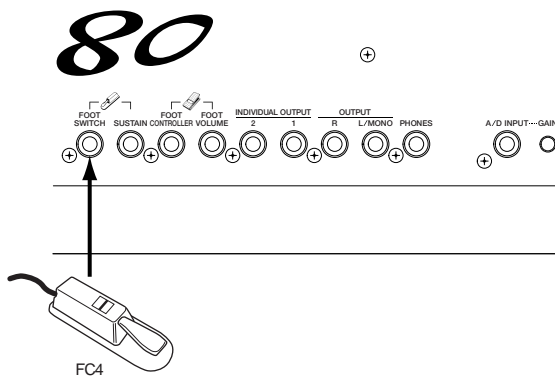

- 1 Press the [UTILITY] key to enter Utility Mode.

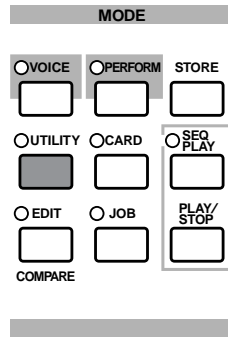

- 2 Use the [PAGE] knob to switch to the CTRL Other (System Control Other) screen.

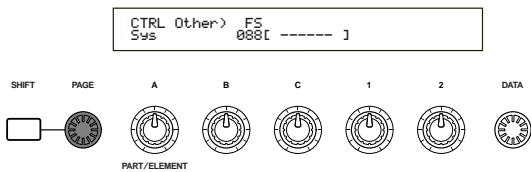

- 3 Use Knob [B] to select "099:PC Inc" (Program Change Increment).

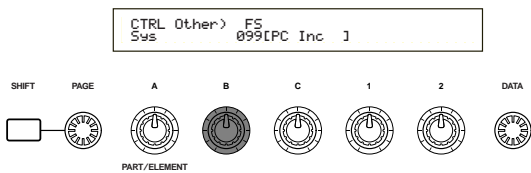

In Voice/Performance Mode, the Foot Switch can now be used to switch between programs.

NOTE Alternatively, you can assign other functions such as Arpeggio Switch (On/Off), Sequencer (Play/Stop) and so on (Page 136).

Voice Edit

There are 256 Normal Voice presets and 8 Drum Voice presets. You can edit these to create new Voices, or build completely new Voices from scratch. You can then store up to 128 of these new/edited Normal Voices and up to 2 new/edited Drum Voices to internal user memory or external Memory Card.

The following procedure gives a basic idea about how to go about creating/editing Voices.

Of course, this is just one example; you are free to set any parameters in any way you like. Details about each parameter are given in the Reference section of this manual.

NOTE All parameter settings are stored along with the Voice itself.

- 1 In Voice Play Mode, select the Voice you wish to edit.
- 2 Enter Voice Edit Mode.
- 3 In the Common Edit screens, set the parameters common to all Elements in the Voice (volume, pitch, tone, etc.) You can also set parameters related to the Arpeggiator, Controllers, Effects, and so on.
- 4 At the OSC (Oscillator) screens, select the Waves used by the Elements in the Voice, plus the volume, pan, note range and other basic parameters.
- 5 At the PCH (Pitch) and PEG (Pitch Envelope Generator) screens, set the tuning and other pitch-related parameters used by the Elements. Also set the PEG parameters as necessary.
- 6 At the FLT (Filter) and FEG (Filter Envelope Generator) screens, adjust the parameters of the filters used by the Elements. Also set the FEG parameters as necessary.
- 7 At the AMP (Amplitude) and AEG (Amplitude Envelope Generator) screens, set the volume and other output level-related parameters used by the Elements. Also set the AEG parameters as necessary.
- 8 At the LFO (Low Frequency Oscillator) screens, set the modulation-related parameters used by the Elements.
- 9 At the EQ (Equalizer) screens, adjust the equalizer parameters affecting the tonal characteristics of the Elements.
- 10 Store the edited Voice.

1 Selecting a Voice to Edit

Enter Voice Play Mode by pressing a VOICE key.

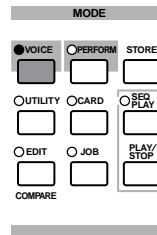

Select the Voice Number of the Voice you wish to edit (Page 65).

NOTE Before editing, first enter Voice Job Mode and copy the Voice you wish to edit to internal user memory. If you are creating a Voice from scratch, use the Initialize function to initialize a Voice in internal user memory. Details are given on Page 105.

2 Entering Voice Edit Mode

Voice creation/editing is carried out in Voice Edit Mode.

To enter Voice Edit Mode, press the [EDIT] key while in Voice Play Mode.

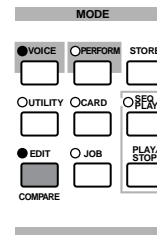

Common Edit and Element Edit

Each Voice consists of up to four Elements (Page 37). The parameters common to all four Elements are known as Common Edit parameters. Voice Edit Mode consists of Common Edit screens, plus screens for each individual Element's parameters.

In Voice Edit Mode, you can use Knob [A] to switch between Common settings and settings for Elements 1 to 4.

Common settings

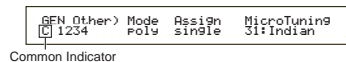

Settings for Elements 1 to 4

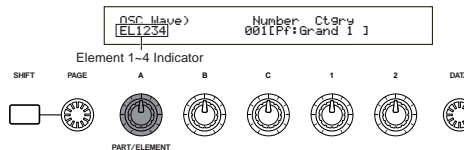

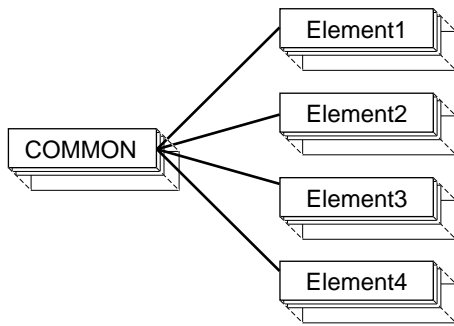

Selecting Elements

In Voice Edit Mode, you can select the Element to edit by pressing the respective BANK key ([A] to [D]). When you select an Element, the cursor moves to the respective Element Number.

Example: When “Element 2” is selected

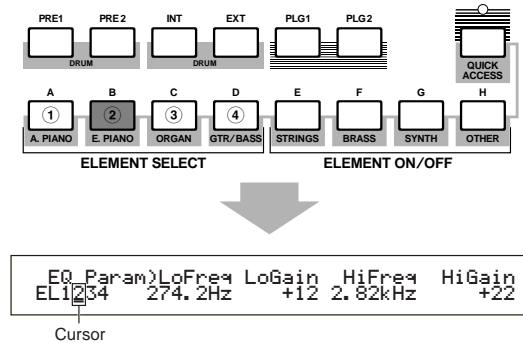

Switching Elements On/Off

In Voice Edit Mode, an Element can be switched off when you press the respective BANK key ([E] to [H]). This lets you temporarily mute other Elements in the Voice so that you can listen to the changes to the Element that you are editing. A muted (off) Element will be indicated as an asterisk (*) in the display as illustrated below.

Example: When Elements 2 and 3 are turned off

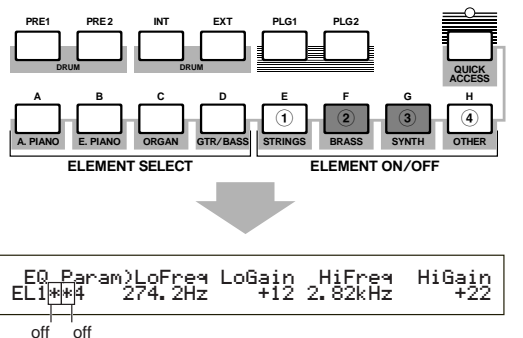

Switching Between Screens and Entering Settings

After selecting a Common Edit screen or a edit screen for an Element (1 to 4), use the [PAGE] knob to switch to other screens.

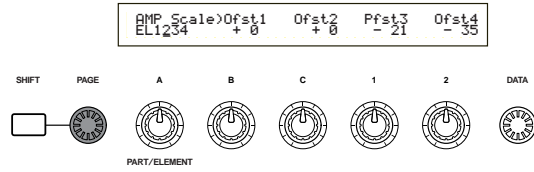

There are many parameters available within a screen. To make editing easier, the knobs below the LCD are assigned to each of the parameters in the screen.

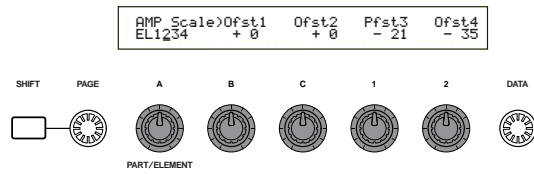

Menu Screen

If you use the [PAGE] knob while holding down the [SHIFT] key, the settings menu will be displayed. Use the [PAGE] knob to move the cursor to an item and release the [SHIFT] key to jump to the screen for that item.

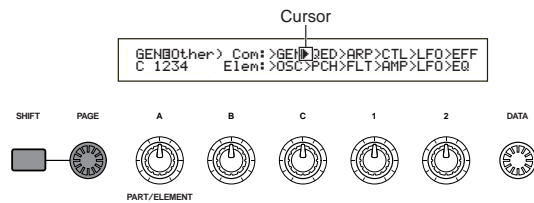

NOTE You can also use other knobs and keys to enter settings. The Compare feature allows you to compare the sound being edited against the sound prior to editing. Details are given on Pages 24, 69.

3 Common Edit Screens

Each Voice consists of up to four Elements. Here, the parameters common to all Elements are explained.

• GEN (Common General)

Here, you can set general parameters in Common Edit, such as the Voice Name.

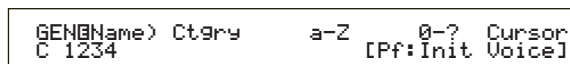

• **QED (Common Quick Edit)**

These parameters mostly control the volume and tone of the Voice and you can easily change the overall sound.

```
QED@Level> Vol Pan RevSend ChoSend
C 1234 127 C 127 127
```

• **ARP (Common Arpeggio)**

By setting these parameters, you can control how the Voice is arpeggiated. Details about how to use the Arpeggiator are given on Page 41.

```
ARP@Type> Type Tempo Switch Hold
C 1234 Up&Down1:54 120 on on
```

• **CTL (Common Controller)**

You can assign various functions to the controllers on the front/rear panel. For example, you can assign parameters to the Pitch Bend Wheel and a Foot Controller so that you can change the tone of the Voice in real time. Details about various different uses are given on Page 43.

```
CTL@Set1> Src Dest EL Sw Depth
C 1234 FC(04) RevTime:EF1 1234 +63
```

• **LFO (Common Low Frequency Oscillator)**

These are the LFO parameters. The LFO uses a low frequency waveform to vary the pitch/filter/amplitude characteristics, and can be used to create vibrato, wah, tremolo and other effect (Page 75).

```
LFO@Wave> Wave^ Speed KeyReset Phase
C 1234 trfzd 63 on 270
```

• **EFF (Common Effect)**

These are the Effects parameters for the Voice. There are two Insertion Effects plus two System Effects (Reverb and Chorus).

```
EFF@InsEF> InsEF Connect
C 1234 1=2 1=2
```

4 OSC (Oscillator) Screens

In these screens, you can mainly set the parameters controlling the waveforms on which the Voice is based. You can select the Wave used for the Element, the volume and note range of each Element and so on.

• **OSC Wave**

Select the waveform (Wave) used for each Element.

```
OSC@Wave> Number Ctrny
EL1234 001CPf:Grand 1 1
```

• **OSC Out**

• **OSC Pan**

Set the volume (output level) and stereo pan position of each Element. The following illustration shows the logic.

```
OSC@Out> Level Delay InsEF
EL1234 96 0 ins2
```

```
OSC@Pan> Pan Alter Random Scale
EL1234 C L64 63 +63
```

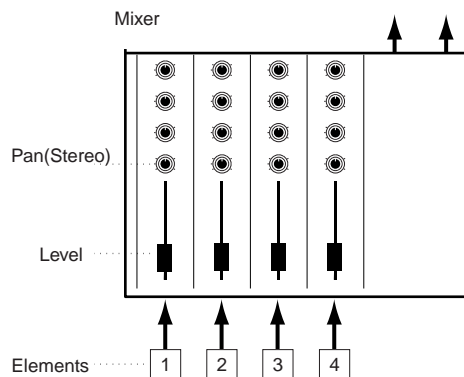

• **OSC Limit**

Set the note range for each Element (the range of notes on the keyboard over which the Element will sound) and also the velocity response (the range of note velocities within which the Element will sound). You can assign different settings for each Element. With these parameters, you can layer Elements and control their output.

For example, you could set one Element to sound in an upper range of the keyboard, and another Element to sound in a lower range. Thus, even within the same Voice, you can have two different sounds for different areas of the keyboard or you can make the two Element ranges overlap so that their sounds are layered over a set range.

Furthermore, you can set each Element to respond to different velocity ranges so that one Element sounds for lower note velocities, whereas another Element sounds for higher note velocities.

```
OSCBLimit> Note Limit Vel Limit
EL1234 C-2 - G 8 1 - 127
```

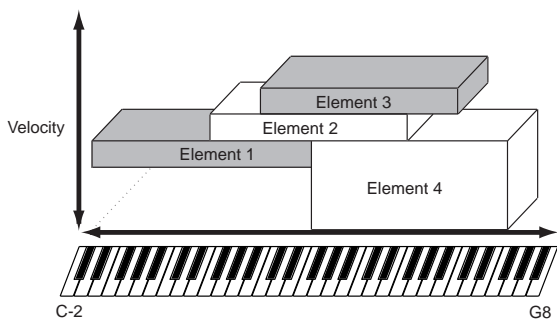

5 PCH (Pitch) and PEG (Pitch EG) Screens

Set the basic pitch parameters for each Element. You can detune Elements, apply Pitch Scaling and so on. Also, by setting the PEG (Pitch Envelope Generator), you can control how the pitch changes over time.

• PEG (Pitch Envelope Generator)

Using the PEG, you can control the transition in pitch from the moment a note is pressed on the keyboard to the point at which it is released. As illustrated below, the Pitch Envelope consists of five Time (transition speed) parameters and five Level (pitch) parameters. This is useful for creating automatic changes in pitch. Furthermore, different PEG parameters can be set for each Element.

```
PEGTime> Hold Attack Decay1 Decay2
EL1234 127 127 127 127
```

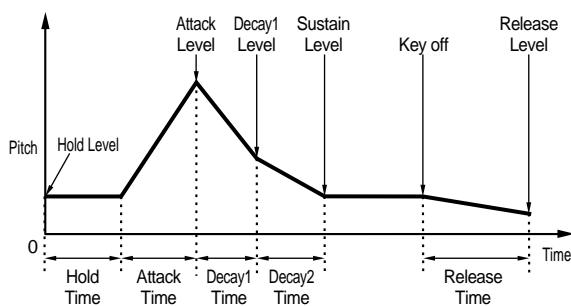

NOTE Details about PEG parameters are given on Page 81.

6 FLT (Filter) and FEG (Filter EG) Screens

You can use the filter to change the tonal characteristics of each Element, by adjusting overtones (harmonic tones) included in the waveform from the Element. There are several types of filters, but its basic idea is similar. As illustrated below, the filter is used to pass overtones at specific frequencies and cut off (does not pass) others, to alter the harmonic factor of an original waveform. You can determine such frequencies by specifying a pointing or center frequency (cutoff frequency). With some filters, you can adjust signal levels at several frequency bands. You can also set the Filter Envelope Generator (FEG) for time variance of how the filter works, which results in a dynamic change in tonal characteristics. Here we introduce how FEG works.

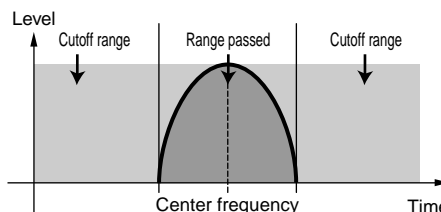

NOTE Details about Filter Types are given on Page 83.

• FEG (Filter Envelope Generator)

Using the FEG, you can control the transition in tone from the moment a note is pressed on the keyboard to the point at which it is released. As illustrated below, the Filter Envelope consists of five Time (transition speed) parameters and five Level parameters (for the amount of filtering). When you press a note on the keyboard, the cutoff frequency will change according to these envelope settings. This is useful for creating automatic wah effects, for example. Furthermore, different FEG parameters can be set for each Element.

```
FEGTime> Hold Attack Decay1 Decay2
EL1234 127 127 127 127
```

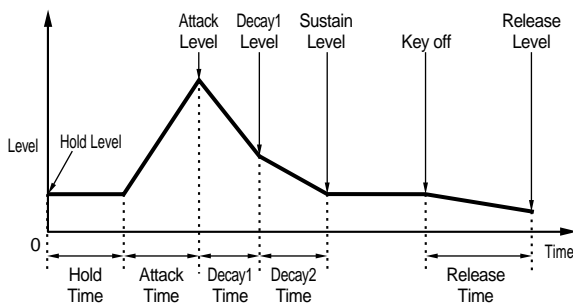

NOTE Details about FEG parameters are given on Page 85.

7 AMP (Amplitude) and AEG (Amplitude EG) Screens

Set the volume of each Element after the OSC (Oscillator), PITCH and FILT (Filter) parameters have been applied, and also the final overall volume of the signal sent to the outputs. The signal of each Element is sent at the specified volume to the next Effect Unit.

Also, by setting the AEG (Amplitude Envelope Generator), you can control how the volume changes over time.

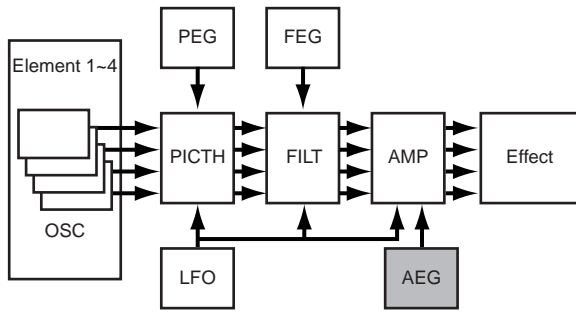

NOTE The final volume for all Elements is set in the Volume (Vol) parameter of the QED screen in Common Edit.

• Amplitude EG (Envelope Generator)

Using the AEG, you can control the transition in volume from the moment a note is pressed on the keyboard to the point at which it is released. As illustrated below, the Amplitude Envelope consists of five Time (transition speed) parameters and five Level parameters (for the amount of filtering). When you press a note on the keyboard, the volume will change according to these envelope settings. Furthermore, different AEG parameters can be set for each Element.

```
AEG[Time]    Attack  Decay1  Decay2
EL1234      127    127    127
```

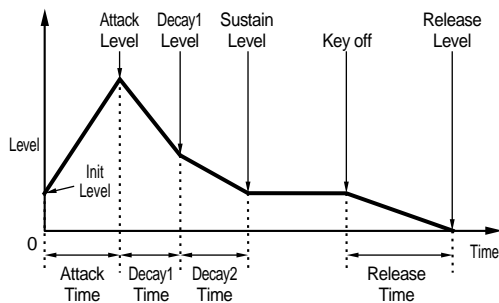

NOTE Details about AEG parameters are given on Page 88.

8 LFO (Low Frequency Oscillator) Screens

As its name suggests, the LFO creates waveforms of a low frequency. These waveforms can be used to vary the pitch, filter or amplitude of each Element to create effects such as vibrato, wah and tremolo, although the actual available LFO parameters will vary according to the type of Element.

```
LFO[Wave]   Wave^v Speed      KeySync
EL1234      tri      63          on
```

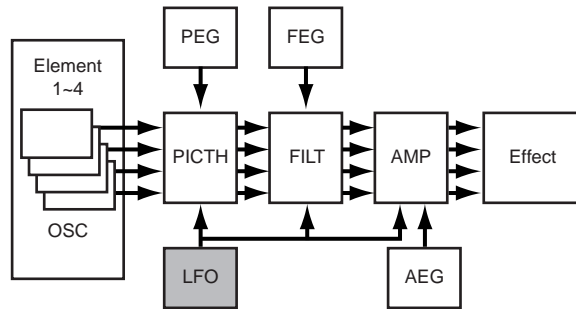

9 EQ (Equalizer) Screens

Specific frequency bands for each Element can be attenuated or boosted using an equalizer. There are many types of equalizers available. Details are given on Page 91.

10 Storing Edited Voices

Up to 128 new/edited Normal Voices and 2 new/edited Drum Voices can be stored to internal user memory or external Memory Card.

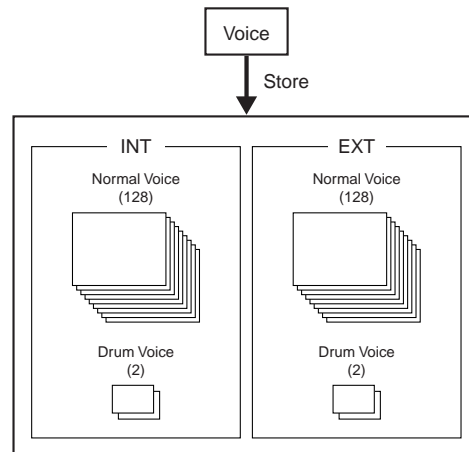

NOTE The maximum number of Plug-in Voices that can be stored to each internal memory (PLG1/2) is 64.

NOTE When storing a Voice, any existing data at the storage location will be lost. You should always back up important data to Memory Card, computer or some other storage medium beforehand.

Details about storing Voices are given on Page 106.

Effects

In the final stages of programming, you can set the effects parameters to further change the sound's character. To generalize, System Effects apply to the overall sound, whether it is a Voice, a Performance, a Song, etc. Insertion Effects, on the other hand, can be applied individually to each Voice. This synthesizer has two System Effect Units (Reverb and Chorus) plus two Insertion Effect Units. When using a Plug-in Board (PLG1 or PLG2) installed on the instrument, you can also use a separate Insertion Effect Unit that is dedicated for each Plug-in Part.

Different effects settings can be set per Voice (in Voice Mode) and per Performance (in Performance Mode), though the connection between the Effect Units will vary in each case.

Reverb Unit

The Reverb Unit includes a selection of 12 different reverb-type effects, including realistic simulations of the natural reverberation found in various halls and rooms. In Voice Mode, Reverb settings can be set for each Voice. In Performance Mode, the Reverb settings will apply to the Performance as a whole.

Chorus Unit

The Chorus Unit includes a selection of 23 chorus-type effects, including a flanger and others. Most of these effects are ideal for adding thickness to the sound. In Voice Mode, Chorus settings can be set for each Voice. In Performance Mode, the Chorus settings will apply to the Performance as a whole.

Insertion Effects

The Insertion Effect 1 Unit includes 24 effects including chorus, flanger and auto-wah. The Insertion Effect 2 Unit offers delays, reverbs, rotary speaker, amp simulation and other effects, providing a total of 92 effects. If a Plug-in Board has been installed, up to 24 Insertion Effects for the Plug-in Voices will also be available.

NOTE Details about each Effect Type are given in the Effect Type List in the separate Data List.

Effects in Voice Mode

In Voice Mode, you can set up the effect type and its value for each Effect Unit (Reverb, Chorus and Insertion Effects) and store them with each Voice. Furthermore, you can determine that each Element connects or bypasses the Insertion Effect Units. When you connect an Element to Insertion Effects, you can also specify the connecting way of two Units (series or parallel, as illustrated below). The combined signal from all Voice Elements — after application of the Insertion Effects — is sent to the Reverb and Chorus System Effect Units.

When you want to use Plug-in Voices from a Plug-in Board attached, you can also set up a dedicated Insertion Effect Unit for each Plug-in Voice. In this case, a Plug-in Voice signals processed with the Insertion Effect Unit will be then routed to Reverb and Chorus Units.

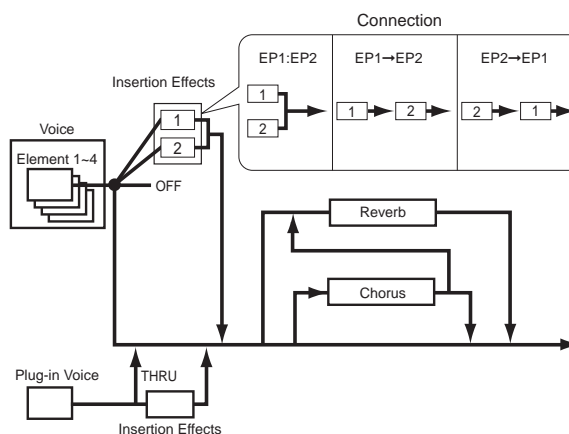

Effects in Performance Mode

In Performance Mode, you can use an Insertion Effects setting “borrowed” from ones respectively stored with Voices (Parts). For Plug-in Parts, you can select and use an Insertion Effect setting “borrowed” from ones respectively stored with Plug-in Voices.

For Reverb and Chorus, you can create new settings dedicated for an entire Performance, without “borrowing” existing Reverb and Chorus settings stored with a Voice.

In the following illustration, a mixer represents the logic behind how the different effects are applied to the sound in Performance Mode. Each Part (1 to 16) is fed to the mixer through either Insertion Effect 1 or Insertion Effect 2. The signals for all Parts are summed in the mixer and then the System Effects (Reverb and Chorus) are applied to the mix as a whole.

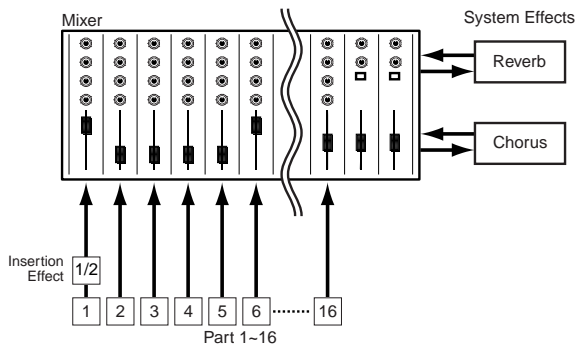

Effect Bypass

You can temporarily switch effects off or on by pressing the [EF BYPASS] key. To use this function, you will need to specify the effect to be bypassed in the MSTR EF Bypass screen of Utility Mode (Page 135). You can also specify more than one effect.

When you press the [EF BYPASS] key, its LED will light and all Effects assigned to the currently selected Voice/Performance will be bypassed.

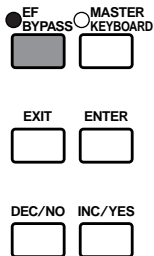

NOTE The Effect Bypass will also apply to Effects on Plug-in Boards other than the PLG100 series.

Using as a Master Keyboard (Performance Mode)

As previously explained, your Synthesizer provides several convenient features that you can make use of in a live show or the like. Here we introduce some examples to combine those features to meet your specific purposes.

The S80 has special settings in Performance Mode so that you can use the instrument as MIDI master keyboard. You can activate the function (enable those special settings) when you press the [MASTER KEYBOARD] key on the panel (its LED will light). Now your instrument can send performance on the keyboard to an external tone generator, as well as the internal tone generator, according to the master keyboard settings in Performance Mode. If you divide the keyboard into several (up to four) key ranges and assign separate MIDI transmit channels, the keyboard can control multiple parts (channels) from the internal tone generator and external MIDI devices of those channels at the same time.

There are three Master Keyboard Modes (how to make key ranges) available: Split, 4 Zones, and Layer. You can learn these Master Keyboard Modes and their functional differences in the following examples.

Split

The illustration below shows an example of a Split configuration. Split is a typical setting to divide a keyboard into two key ranges (lower and upper) by splitting at a specific key note (split point). The following example is to split the keyboard at C3 note, enabling the lower range for automatic performance with Arpeggiator and the upper range for manual solo performance. You can make this configuration in the following steps.

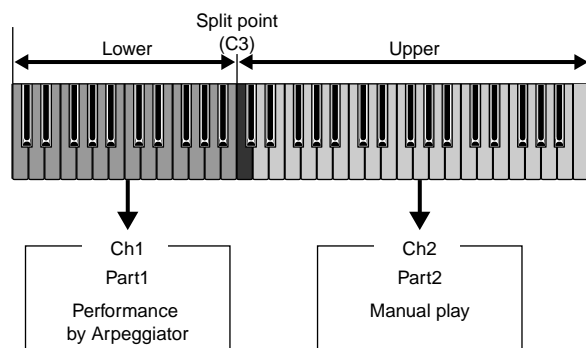

NOTE Edit and prepare Voices for Arpeggiator and manual play in Voice Edit Mode before you set up a Split setting in the following procedure (page 68).

1 Press the [PERFORM] key, followed by the [EDIT] key (each LED will light) to enter Performance Edit Mode. Then, press the [MASTER KEYBOARD] key to activate Master Keyboard Mode (its LED will light).

2 Select “Common” using the Knob [A], then open the General Master Keyboard (GEN M. Kbd) page using the [PAGE] knob.

```
GENM.Kbd> Mode   Lower   Upper   Point
Common    split  ch01   ch02   C 3
```

NOTE Turning the [PAGE] knob while holding down the [SHIFT] key enables you to scroll through parameters in the Menu screens (page 111).

3 Select “split” for the Mode parameter using the Knob [B].

NOTE If Master Keyboard Mode is deactivated (without the [MASTER KEYBOARD] key pressed), the Mode parameter value will be shown in brackets (like “(split)”).

4 Select the value (split point) for the Point parameter using the Knob [2], which determines the key note that divide the keyboard into two sections. Select “C3” for this example.

NOTE You can specify the split point by directly pressing a specific key on the keyboard while holding down the [SHIFT] key. In this example, press C3 while holding down the [SHIFT] key.

5 Specify MIDI transmit channels respectively for the lower and upper key ranges using the Knob [C] (lower) and the Knob [1] (upper). These settings can make MIDI-channel-based separate controls of the internal tone generator or an external MIDI devices from the keyboard, such as using different Voice tones in the lower and upper key ranges. Select “ch01” for “Lower” and “ch02” for “Upper” for this example.

NOTE You can also use the [PROGRAM/PART 1 to 16] keys to select MIDI channels for the Lower and Upper ranges. (Page 113)

6 Select a Part for the lower range using the Knob [A]. For this example, select “Part01”.

7 Turn the [PAGE] knob and open the MIX Vce (Mix Voice) page to select a Voice for Arpeggiator performance.

```
MIXBVce> Memory Number Ctrry Search
Part01    PRE1:128(H16)[Pf:GrandPiano]
```

8 Turn the [PAGE] knob and open the LYR Mode (Layer Mode) page. Set “on” for “Arp” (Arpeggio switch). Select “1” for “RcvCh” (MIDI Receive Channel).

```
LYRMode> Mode   Arp   Layer   RcvCh
Part01    Poly  on     off     1
```

- 9 Turn the [PAGE] knob and open the ARP Type (Arpeggio Type) page. Set “on” for “Switch.”

```

ARPType> Type Tempo Switch Hold
Part01 UfOct1:54 120 on off
    
```

In steps 6 to 9, you now complete settings for the lower range for Arpeggiator performance. It will play in a Voice assigned to Part 1 based on MIDI Receive channel 1.

NOTE Refer to page 72 for detailed settings of Arpeggiator.

NOTE You can copy (reuse) the arpeggio settings that belong to the Voice assigned to Part 1 (page 131).

- 10 As in the same manner as in steps 6 to 8, make settings for the upper range. So you can use the Knob A and select “Part02”, select a Voice for solo performance in the MIX Vce page, set “2” for “RcvCh” in the LYR Mode page.

Now you are ready for solo performance within the upper range. You can play in a Voice assigned to Part 2 based on MIDI Receive channel 2.

NOTE If you set “on” to “Layer” in the LYR Mode page, the RcvCh setting will be ignored.

NOTE For unwanted Parts in Split play, set their MIDI Receive channels (RcvCh) to other than those used for the lower and upper Parts. In the example above, the “RcvCh” values for Part 3 to 16 must be set to any other than 1 and 2.

NOTE In Performance Edit Mode, you can make detailed settings for every Part. In case that a Part does not sound, make sure the volume setting for that Part. For more information, refer to page 120.

- 11 Before exiting Performance Edit Mode, store above settings in a Performance. For storing a Performance, refer to page 131.

In Performance Play Mode, recall the Performance you have just stored. Simply pressing the [MASTER KEYBOARD] key activates or deactivates the Split configuration you made above.

4 Zones

The illustration below shows an example of a 4-Zone configuration. A zone refers to a specific key range on the keyboard. You can logically divide a keyboard into up to four key ranges with separate MIDI channels and other associated settings so that you can control multiple Parts at the same time. A Split setting can divide the entire keyboard into two absolute sections (key ranges). In a 4-zone setting, however, each section can overlap to one another. You can even set a section to cover or include other sections.

In the following example, Zone 1 is set up for performance by the Arpeggiator, Zone 2 for bass sound, Zone 3 manual solo performance, and Zone 4 for playing an external MIDI tone generator. Also in this settings, Zones 3 and 4 overlap in the same range, and entire performance in four all zones is output from the MIDI OUT connector so that you can record that performance on an external MIDI sequencer. You can make this configuration in the following steps.

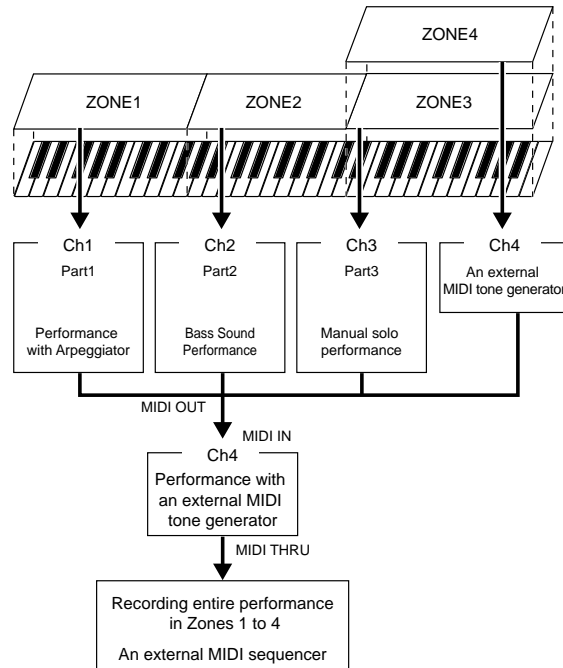

NOTE Before you set up a 4-Zone configuration in the following procedure, edit and prepare necessary Voices (for Arpeggiator and manual play) in their associated Edit Modes.

- 1 Press the [PERFORM] key, followed by the [EDIT] key (each LED will light) to enter Performance Edit Mode. Then, press the [MASTER KEYBOARD] key to activate Master Keyboard Mode (the LED will light).
- 2 Select “Common” using the Knob [A], then open the GEN M. Kbd (General Master Keyboard) screen using the [PAGE] knob.

```

GENM. Kbd> Mode Lower Upper Point
Common split ch01 ch02 C 3
    
```

NOTE Turning the [PAGE] knob while holding down the [SHIFT] key enables you to scroll through parameters in the Menu screens (page 111).

- 3 Select “4zone” for the Mode parameter using the Knob [B].

NOTE If Master Keyboard Mode is deactivated (without the [MASTER KEYBOARD] key pressed), the Mode parameter value will be shown in brackets (like “(4zone)”).

- 4 Select one of “Zone01” to “Zone04” using the Knob [A]. As we have selected “4zone” for the Mode parameter, you can now select setting screens for four Zones. Select “Zone01” to get started with the settings.

MKBTransmit)	TrnsCh	TG	MIDI
Zone01	Ch01	on	on

NOTE You can also use the BANK [A] to [D] keys to respectively select “Zone01” to “Zone04.”

Selecting a Zone opens the MKB Transmit page. You may want to select a sub screen to set up a Zone using the [PAGE] knob. But you first specify basic items in the MKB Transmit page, such as MIDI transmit channel, enabling or disabling MIDI output to the internal tone generator and to the MIDI OUT connector.

- 5 Set MIDI transmit channel (TrnsCh) to “Ch01” using the Knob [C]. Set MIDI output to the internal tone generator (TG) and MIDI OUT (MIDI) both to “on.”

These settings can differentiate each Zone from one another, to internally or externally output performance made in each Zone using a separate MIDI channel. Finally, you will separately control sound tones from four zones.

To do this, set “Ch01” to “Ch04” respectively to the “TrnsCh” parameters in the MKB Transmit pages for Zones 1 to 4. For the “TG” and “MIDI” parameters, set both “on” for Zones 1 to 3. For Zone 4, set “off” to “TG” and “on” to “MIDI.” You can switch between multiple MKB Transmit screens using the Knob [A]. Some of basic settings for four zones are now complete.

- 6 Select “Zone01” again using the Knob [A]. Open the MKB Note screen using the [PAGE] knob. In this screen, you can specify a key range for a Zone.

MKBNote)	Octave	Transpose	Note Limit
Zone01	+1	+11	C-2 - G 8

NOTE In the MKB Note page, you can also find other parameters such as Note Limit, Transpose, etc. Refer to page 128 for more information about these parameters.

- 7 Set “Note Limit” (zone key range) with the lowest and highest notes using Knobs [1] (lowest) and [2] (highest). For “Zone01”, select “C-2” for the lowest note and “B1” for the highest.
- 8 Use the Knob [A] to switch to the MKB Note page for “Zone02”. As in the same manner in step 7, select “C2” for the lowest note and “B2” for the highest.

- 9 Use again the Knob [A] to switch to the MKB Note screen for “Zone03”. As in the same manner in step 7, select “C3” for the lowest note and “G8” for the highest.

- 10 Use the Knob one more time [A] to switch to the MKB Note page for “Zone04”. As in the same manner in step 7, select “C3” for the lowest note and “G8” for the highest. Note that this key range setting will make a overlapped range with Zone 3.

NOTE For detailed settings of a Zone, refer to page 127.

- 11 Turn the Knob [A] and select a Part for a Zone. In this example, we select Part 1 for Zone 1, Part 2 and Part 3 respectively for Zone 2 and Zone 3. We don’t select any internal Part for Zone 4 since Zone 4 is set only to output performance information via MIDI Out. First, select Part 1 (Part01) for Zone 1.

NOTE You can also use the [MEMORY] or PROGRAM/PART keys to select a Part for a Zone (page 109).

- 12 Use the [PAGE] knob and open the MIX Vce screen, to set up a Voice for performance using the Arpeggiator.

MIXVce)	Memory	Number	Ctgr	Search
Part01	PRE1	128	(H16)	[Pf: GrandPiano]

- 13 Use the [PAGE] knob and open the Layer Mode (LYR Mode) screen. Set the Arpeggiator Switch (Arp) to “on,” Layer Switch (Layer) to “off,” and MIDI receive channel (RcvCh) to “1.” Finally in the Arpeggio type (ARP Type) screen, set the Switch parameter to “on.”

LYRMode)	Mode	Arp	Layer	RcvCh
Part01	Poly	on	off	1

NOTE Prepare basic Arpeggiator settings (Type, etc.) in Voice Edit Mode before you set up a Zone setting in Performance Edit Mode.

With settings made in steps 11 to 13, you can now play the Arpeggiator with a Voice assigned to “Part01” (Part 1) set to MIDI receive channel 1 (RcvCh) when you play in the key range of Zone 1.

- 14 As in the same manner in steps 11 to 13, set up for Zone 2. Turn the Knob [A] and select “Part02”. Next go to the Mix Voice (MIX Vce) screen using the [PAGE] knob, and select a Voice for the bass sound. Then, use the [PAGE] knob to open the Layer Mode (LYR Mode) screen and set MIDI receive channel (RcvCh) to “2”.

With settings made here, you can now play with the bass sound using a Voice assigned to “Part02” set to MIDI receive channel 2 (RcvCh) when you play in the key range of Zone 2.

- 15 As in the same manner in steps 11 to 13, set up for Zone 3. Turn the Knob [A] and select “Part03”. Next go to the Mix Voice (MIX Vce) page using the [PAGE] knob, and select a Voice for manual solo performance. Then, use the [PAGE] knob to open the Layer Mode (LYR Mode) page and set the MIDI receive channel (RcvCh) to “3”.

With settings made here, you can now play solo using a Voice assigned to “Part03” set to MIDI receive channel 3 (RcvCh) when you play in the key range of Zone 3.

You don’t need to make further settings for Zone 4 since it is not intended for an internal Part and has already been set to output performance information via the MIDI OUT connector in steps 5 to 10. The key range of Zone 4 matches to that of Zone 3 so that solo performance made in that range will be sent on MIDI channels 3 (from Zone 3) and 4 (from Zone 4) via [MIDI OUT] to an external MIDI device.

NOTE You can set additional Part settings in Performance Edit Mode. If you have a trouble possibly associated with these settings, such as no sound from a specific Part, confirm any Part settings related to volume, etc. Refer to page 120 for more information about Part settings.

- 16 Before exiting Performance Edit Mode, store above settings in a Performance. For storing a Performance, refer to page 131.

In Performance Play Mode, recall the Performance you have just stored. Simply pressing the [MASTER KEYBOARD] key activates or deactivates the 4-Zone configuration you made above.

Layer

The illustration below shows an example of a Layer configuration. Layer refers to two separate Parts with a overlapped key range, enabling to play unison with these Parts. The following example is to play unison with Voices selected for Part 1 and Plug-in 1 Part. You can make this configuration in the following steps.

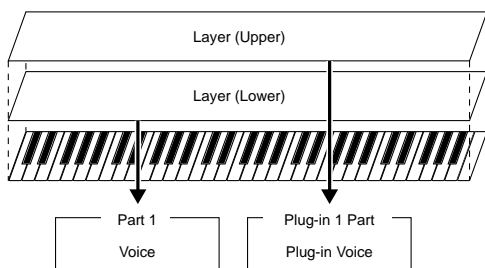

NOTE Before you set up a Layer configuration in the following procedure, edit and prepare necessary Voices for layers in associated Edit Modes.

NOTE Plug-in Voices are available only when you attach an optional Plug-in Board (page 98).

- 1 Press the [PERFORM] key, followed by the [EDIT] key (each LED will light) to enter Performance Edit Mode. Then, press the [MASTER KEYBOARD] key to activate Master Keyboard Mode (its LED will light).
- 2 Select “Common” using the Knob [A], then open the General Master Keyboard (GEN M. Kbd) screen using the [PAGE] knob.

GENM.Kbd>	Mode	Lower	Upper	Point
Common	split	ch01	ch02	C 3

NOTE Turning the [PAGE] knob while holding down the [SHIFT] key enables you to scroll through parameters in the Menu screens (Page 111).

- 3 Select “layer” for the Mode parameter using the Knob [B].

NOTE If Master Keyboard Mode is deactivated (without the [MASTER KEYBOARD] key pressed), the Mode parameter value will be shown in brackets (like “(layer)”).

- 4 Use Knobs [C] and [1] to respectively set MIDI transmit channels for the Lower and Upper parameters. Note that Lower and Upper refer to two Parts (Zones) to be layered together. These channel settings can create and send performance information on two separate channels to the internal tone generator and an external MIDI device via the MIDI OUT connector. Here we set “Ch01” for “Lower” and “Ch02” for “Upper.”

NOTE You can also use the PROGRAM/PART keys [1] to [16] to select MIDI channels for the Lower and Upper Parts (Page 113).

- 5 Turn the Knob [A] and select a Part. First select “Part01” for the Upper Part.
- 6 Use the [PAGE] knob and open the Mix Voice (MIX Vce) screen. Select a Voice for the Upper Part.

MIXBVce>	Memory	Number	Clary	Search
Part01	PRE1:	128(H16)	[Pf:GrandPiano]	

- 7 Use the [PAGE] knob to open the Layer Mode (LYR Mode) screen. Set the Layer Switch (Layer) to “off” and the MIDI Receiving Channel (RcvCh) to “1.”

LYRMode>	Mode	Arp	Layer	RcvCh
Part01	poly	on	off	1

NOTE If other Parts’ MIDI receive channels (RcvCh) are set to the same ones assigned to two Parts, those Parts will also sound when you play on the keyboard. This might be troublesome if you simply need two layered Parts. To mute unnecessary Parts while you play on the keyboard, set “RcvCh” for those Parts to “off.” You can only play Voices from layered Parts.

- 8 As in the same manner in steps 5 to 7, set up for the Upper Part. Select “PartP1” for the Lower Part, go to the Mix Voice (MIX Vce) page using the [PAGE] knob, and select another Voice (Plug-in Voice) for the Lower Part. Also, go to the Layer Mode (LYR Mode) page to set the Layer Switch (Layer) to “off” and the MIDI Receiving Channel (RcvCh) to “2.”

NOTE You can set additional Part settings in Performance Edit Mode. If you have a trouble possibly associated with these settings, such as no sound from a specific Part, confirm any Part settings related to volume, etc. Refer to page 120 for more information about Part settings.

- 9 Before exiting Performance Edit Mode, store above settings in a Performance. For storing a Performance, refer to page 131.

In Performance Play Mode, recall the Performance you have just saved. Simply pressing the [MASTER KEYBOARD] key activates or deactivates the Layer configuration you made above.

NOTE Besides the Layer/Zone configuration in Master Keyboard Modes, you can use the Layer Switch (Layer) for each Part to make a Layer configuration that consists of up to four Parts (Page 123).

About Note Limit (Key Range)

Note Limit setups are provided for setting Master Keyboard Mode, Part, and Voice. They are associated to one another as follows.

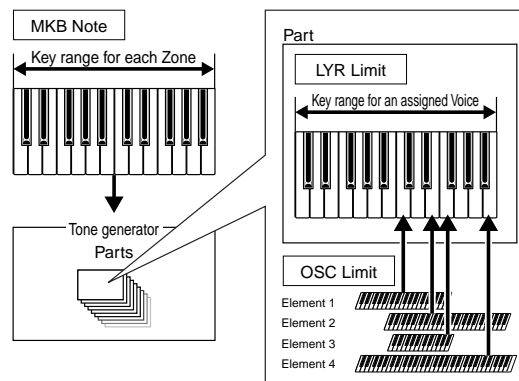

While using in Master Keyboard Mode, you can control the internal tone generator (or an external MIDI device) according to “Note Limit” in the MKB Note screen. If you limit a Zone’s key range to two octaves, it is as if you connect an external two-octaves keyboard controller to play with the tone generator. Meanwhile, the key range (playable range) of an entire Voice is determined by “Note Limit” in the LYR Limit screen (page 123) for a Part assigned with that Voice. Such a playable range of each Element of a Voice is determined by “Note Limit” in the OSC Limit screen (page 80) available in Voice Edit Mode.

About the Control Sliders

While Master Keyboard Mode is turned on, the Control Sliders [1] to [4] on the front panel are respectively linked to Zones 1 to 4. When these Sliders, for instance, are set to control volumes for their corresponding Zones, you can use them like a mixer’s channel faders to balance volumes of Zones. These Sliders can separately work so that you can assign a different control function to each of them (volume for Zone 1, pan for Zone 2, etc.). You can make such assignments in the MKB Assign screen (Page 129) in Performance Edit Mode.

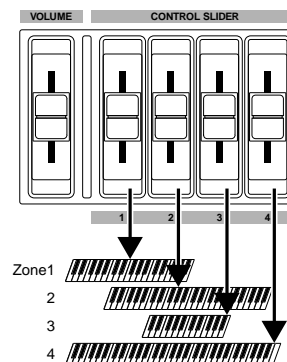

Using as a Multitimbral Tone Generator (Performance Mode)

Performance Mode lets you use your synthesizer as a multitimbral tone generator for use with computer-based music software or external sequencers. If each track in a song file uses a different MIDI channel, then the Parts in a Performance can be each assigned to those MIDI channels correspondingly. Therefore, you can play back a song file on an external sequencer and have different Voices playing on different tracks simultaneously.

In the following example, we will create a Performance suited to playing back a song file consisting of three Parts: piano, bass and drums. The piano track is assigned to MIDI channel 2, the bass track to channel 3, and the drums to channel 10.

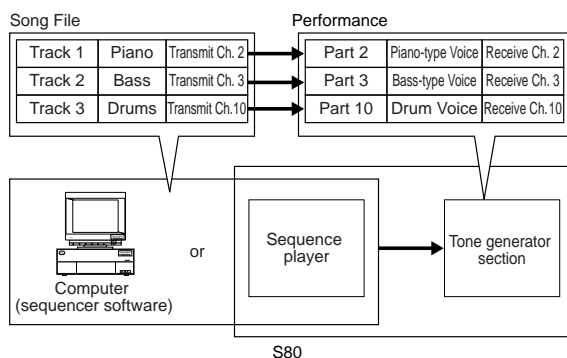

NOTE The synthesizer's internal sequencer can be used to play back the song file. The included XGworks lite computer sequencer software can also be used for this, though you need to make sure that the computer has been connected to your synthesizer correctly (Page 16).

1 After pressing the [PERFORM] key, press the [EDIT] key (the respective LEDs will light). You are now in Performance Edit Mode.

NOTE Before entering Performance Edit Mode, you need to select a Performance for editing. Also make sure that the [MASTER KEYBOARD] key LED is not lit.

2 Use Knob [A] to select Parts. Here, you can select Part 2 for the piano, Part 3 for bass and Part 10 for drums. First, we will select Part 02.

3 Use the [PAGE] knob to switch to the MIX Vce (Mix Voice) screen, then specify the Voice to be used as the piano Part.

```
MIX[Vce] Memory Number Ctrgy Search
Part:02 PRE1:128(H16) [Pf:GrandPiano]
```

4 Next, use the [PAGE] knob to switch to the Mix Level screen, then set the volume for the piano Part as well as, if necessary, its pan position, chorus and reverb Send levels. Details are given on Page 120.

5 Continue using the [PAGE] knob and switch to the LYR Mode (Layer Mode) screen. Set the Mode parameter to "poly" (polyphonic), the Layer parameter to "off," and the RcvCh parameter (MIDI receive channel) to 2.

```
LYR[Mode] Mode Arp Layer RcvCh
Part:02 Poly on off 2
```

NOTE For Parts that do not require polyphony, the Mode parameter can be set to "mono" (monophonic).

By following steps **2** to **5** above, when you play back a song file in the sequencer, the piano track is transmitted through MIDI channel 2. The MIDI data is received by the synthesizer which then plays the Voice for the Part assigned to MIDI channel 2.

6 Repeat steps **2** to **5** above, but set up Part 3 for bass and to receive on MIDI channel 3.

7 Repeat steps **2** to **5** again, setting up Part 10 for drums and to receive on MIDI channel 10.

NOTE To avoid situations where the Voices of unused Parts are suddenly played back, you should set the MIDI receive channels for unused Parts to "off."

NOTE There are many other Part-specific parameters in Performance Edit Mode. Details are given on Page 111.

8 Before exiting Performance Edit Mode, you need to store the settings for the Performance. Details about storing Performances are given on Page 131.

Now, when you select this Performance in Performance Play Mode, you can play back the song file on computer (sequencer) or internal sequencer, and the piano, bass and drum Parts will be played back according to each track's MIDI channel.

Performing Live while Playing Back a Song File

While playing back the song file with the piano, bass and drum Parts assigned earlier, you can set up the Performance so that you can also play another Part live.

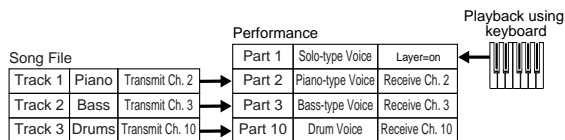

This is the same as the Performance created earlier, but with the addition of another Part for live playback. Regarding settings, the important points are as follows.

- In the Performance created earlier, Parts 2, 3 and 10 were being used. As an example, we will now assign another Part (Part 1) to a solo-type Voice.
- At the LYR Mode screen, set the Layer parameter for Part 1 to “on,” and make sure it is set to “off” for Parts 2, 3 and 10.

NOTE If you want to manually play multiple (up to four) Parts using some Voices from Parts 4 to 9, 11 to 16 and Plug-in Parts, set those Parts’ Layer Switch parameters to “on.”

- At the GEN MIDI screen, set the LayerCh (Layer Channel) parameter to BasicCh. The Voice for Part 1 can now be played live using the keyboard.

Using the A/D Input Part

If you have external sources (such as a microphone or other audio equipment) connected to the synthesizer’s A/D INPUT jack, you can use them as Parts in a Performance.

Continuing with our example, you can add another Part for vocals by assigning the A/D Input Part. Therefore, while the song is playing back the piano, bass and drums, you simultaneously play a solo live and sing into the microphone. Effects such as reverb can be added to the A/D Input Part (Pages 119 and 127), so you can assign an effect suited to the vocals for the song. These effect settings will also be saved with the Performance.

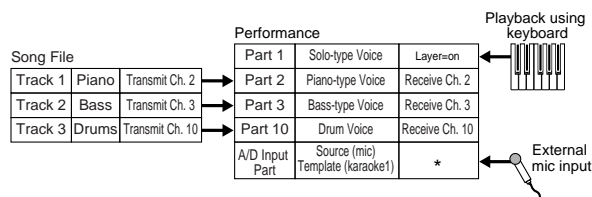

- * You need to set the receive channel to control the A/D Input Part parameters via MIDI. However, this is not vital in this example.

Regarding settings, the important points are as follows.

- Switch to the PartAD (A/D Input Part) parameters and set the external input source and template at the MIX Template screen.

```
MIX[Template]Src Number
PartAD mic 05[Karaoke1 ]
```

There are 13 templates available already with a variety of gain and effects settings for you to select from according to the input source. Here, we will be using the A/D Input Part for vocals so let’s set the Src (Source) parameter to “mic” and the Number (Template Number) parameter to “Karaoke1.”

⚠ If you choose the wrong type of input source, you may possibly damage your hearing and/or any connected audio equipment. Make sure you set this parameter correctly.

- Turn the GAIN knob (Page 11) all the way down, then connect a microphone to the A/D INPUT jack (MIC/LINE2 jack).
- Turn the GAIN knob back slowly while singing/talking into the microphone until you reach an ideal volume level.

NOTE There are other settings for controlling the A/D Input Part via MIDI. Details are given on Page 122.

NOTE When you play a song file bearing the XG/GM logo (available in the market), you may want to install an optional XG Plug-in Board on the instrument, to enjoy a best playback quality with a wide variety of Voices and Effects. Note that you can install an additional XG Plug-in Board to double polyphonic notes and Effects. In such cases, you do not only enjoy the playback of a song, but also can mute a specific Part from the song file for a “minus-one” setting, which is convenient for practice of solo performance or karaoke.

NOTE If you install the optional Effect Plug-in Board (PLG100-VH), you can create harmonies of up to three notes for your vocals. By assigning the harmony channel to the keyboard’s MIDI transmit channel, you can create vocoder-like effects. Or you could play back a harmony line using a sequencer to create a backing chorus for your vocals.

Reference Section

Voice Mode

Voice Play

This mode is used for playing individual voices stored as 256 on-board presets, as well as the Internal (User) Voices, External Voices on Memory Card, and Plug-in Board Voices (optional). This section explains how to select and play voices.

NOTE Details about the Voice types and the Voice Memories are given on Page 36.

Voice Play Mode Display

The LCD will display the following in Voice Play Mode. Voice Play Mode consists of 2 screens and the [PAGE] knob can be used to switch to the Voice Search screen.

The contents of each screen are as follows. See page 67 for details about the Voice search screen.

NOTE Details about how to enter Voice Play Mode are given on Page 21.

Voice Play Mode

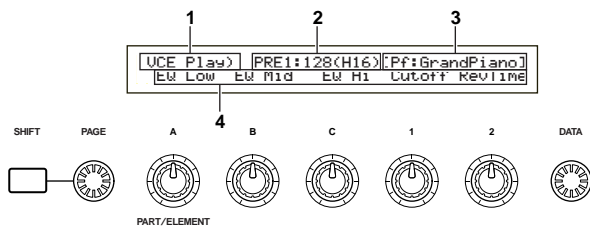

2nd Screen : Voice Search

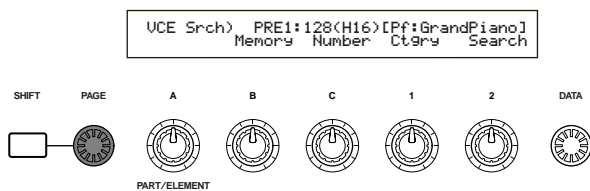

1. Screen Title

This shows that you are currently in Voice Play Mode.

2. Voice Memory/Number (Bank/Number) Display

Shows the Memory/Voice Program Number (001 to 128) or Bank ([A] to [H])/Program Number ([1] to [16]). For example, in the display shown above, "PRE1:128(H16)" means that the Memory is Preset 1, the voice Program Number is 128, the Bank is H and the Program Number within the Bank is 16.

Memory/Voice Program Number

PRE1 refers to Preset 1, PRE2 to Preset 2, PRE to Preset Drums, INT to Internal, EXT to External, PLG1 to Plug-in Board 1 and PLG2 to Plug-in Board 2. All voice Program Numbers within each memory fall in the range 001 to 128. Drum Voices are DR1 to DR8.

NOTE Details about Voice Memories are given on Page 36.

Bank/Program Number

Voice Program Numbers 001 to 128 correspond with Banks A to H and Program Numbers 01 to 16. Therefore, you can cycle through Voice Program Numbers 001 to 128 sequentially, or you can select them randomly using a combination of BANK and PROGRAM keys. The relationship between Banks/Program Numbers and Voice Program Numbers is given below.

Voice Program Number	Bank	Program Number	Voice Program Number	Bank	Program Number
001	A	1	065	E	1
002	A	2	066	E	2
003	A	3	067	E	3
004	A	4	068	E	4
005	A	5	069	E	5
006	A	6	070	E	6
007	A	7	071	E	7
008	A	8	072	E	8
009	A	9	073	E	9
010	A	10	074	E	10
011	A	11	075	E	11
012	A	12	076	E	12
013	A	13	077	E	13
014	A	14	078	E	14
015	A	15	079	E	15
016	A	16	080	E	16
017	B	1	081	F	1
018	B	2	082	F	2
019	B	3	083	F	3
020	B	4	084	F	4
021	B	5	085	F	5
022	B	6	086	F	6
023	B	7	087	F	7
024	B	8	088	F	8
025	B	9	089	F	9
026	B	10	090	F	10
027	B	11	091	F	11
028	B	12	092	F	12
029	B	13	093	F	13
030	B	14	094	F	14
031	B	15	095	F	15
032	B	16	096	F	16
033	C	1	097	G	1
034	C	2	098	G	2
035	C	3	099	G	3
036	C	4	100	G	4
037	C	5	101	G	5
038	C	6	102	G	6
039	C	7	103	G	7
040	C	8	104	G	8
041	C	9	105	G	9
042	C	10	106	G	10
043	C	11	107	G	11
044	C	12	108	G	12
045	C	13	109	G	13
046	C	14	110	G	14
047	C	15	111	G	15
048	C	16	112	G	16
049	D	1	113	H	1
050	D	2	114	H	2
051	D	3	115	H	3
052	D	4	116	H	4
053	D	5	117	H	5
054	D	6	118	H	6
055	D	7	119	H	7
056	D	8	120	H	8
057	D	9	121	H	9
058	D	10	122	H	10
059	D	11	123	H	11
060	D	12	124	H	12
061	D	13	125	H	13
062	D	14	126	H	14
063	D	15	127	H	15
064	D	16	128	H	16

3.Voice Category/Name

Voice Category

The two characters to the left of the Voice Name denote the category of instrument or sound to which the voice belongs.

NOTE Details about Category names are given on Page 70.

Voice Name

This consists of up to 10 characters.

4.Knob Parameter Display

This shows the function assigned to each knob ([A] to [C] and [1]/[2]).

NOTE Knobs [1]/[2] may be assigned with several parameters (destinations) from multiple control sets. In this case, the display will show the parameter (destination) from a control set of the smallest number.

Knob Parameter Settings

In Voice Play Mode, each knob ([A] to [C] and [1]/[2]) can be used to adjust the parameter assigned to it. The parameter value is displayed briefly when you move each knob.

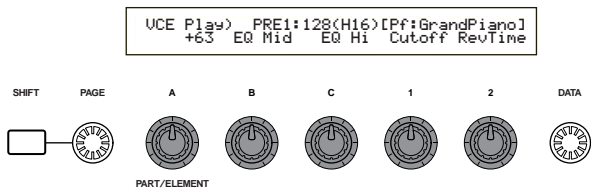

NOTE Details about assigning parameters to Knobs [A] to [C] are given on Page 46, 136. Details about assigning parameters to Knobs [1]/[2] are given on Page 47, 74.

Octave and MIDI Transmit Channel Settings

In Voice Play Mode, the Octave and MIDI Transmit Channel are shown when pressing the [SHIFT] key.

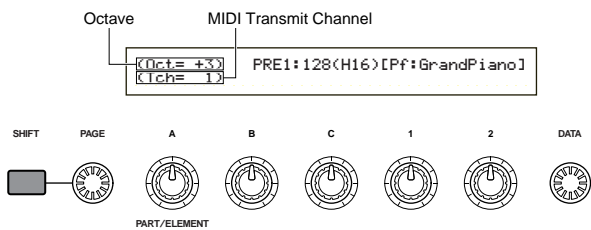

This lets you set the MIDI Transmit Channel by turning Knob [A] and holding down the [SHIFT] key. The settings for Voice Play Mode are transmitted on this MIDI channel.

NOTE The MIDI Transmit Channel can also be set in the MIDI Ch. screen of Utility Mode (Page 137).

Voice Program Selection

There are four ways in which you can choose a Voice.

- Using the BANK/PROGRAM keys
- Using the [DEC/NO] and [INC/YES] keys
- Using the [DATA] knob
- Using the Category Search

Using the BANK/PROGRAM Keys

- 1 Press a MEMORY key to select a Voice Memory. The Voice Memory indicator in the LCD will blink.

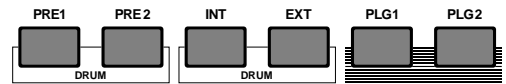

VCE Play) PRE1:128(H16)[Pf:GrandPiano]
EQ Low EQ Mid EQ Hi Cutoff RevTime

NOTE Details about Voice Memories are given on Pages 27, 36.

- 2 Press a BANK key ([A] to [H]) to select a Bank. The Bank indicator in the LCD will blink.

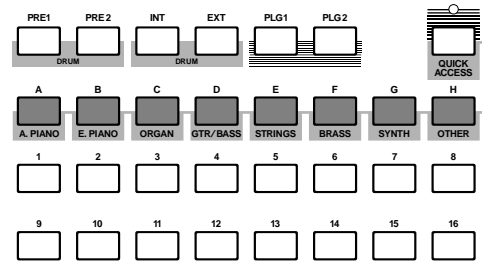

VCE Play) PRE1:128(H16)[Pf:GrandPiano]
EQ Low EQ Mid EQ Hi Cutoff RevTime

NOTE If you press the [EXIT] key here, the Voice selection process is canceled and the original Voice is reinstated.

NOTE If the Bank has already been selected, this step is not required. Details about Banks are given on Pages 27, 36.

- 3 Press a PROGRAM key ([1] to [16]) to select a Program Number.

Voices can be selected by setting the Memory, Bank and Program Number as explained in the three steps given above. The LCD also displays the selected voice.

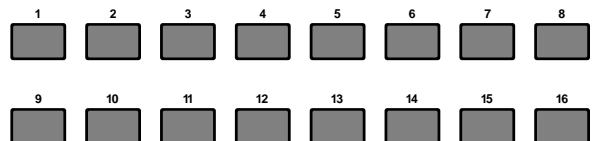

Using [INC/YES] and [DEC/NO] Keys

Press the [INC/YES] key to select the next Voice and the [DEC/NO] key to select the previous one.

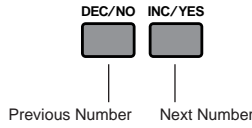

The voice is selected by pressing just the [INC/YES] or [DEC/NO] key. This method is useful when selecting a Voice that is located near the currently selected Voice.

The method can also be used to switch to the next or previous Bank. For example, if the current Voice is A16, Voice B01 is selected by pressing the [INC/YES] key. Similarly, if the current Voice is H01, Voice G16 is selected by pressing the [DEC/NO] key.

Using the Data Knob

Turn the [DATA] knob clockwise to increment the currently selected Voice number, or anti-clockwise to decrement it.

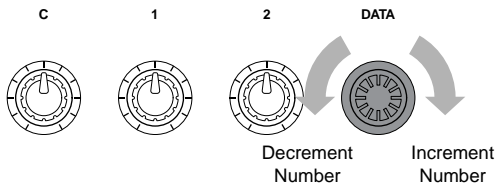

The Voice is selected directly and sequentially.

Just as with the [INC/YES] and [DEC/NO] keys, this method can be used to switch to the next or previous Bank.

Selecting Drum Voices

The procedure for selecting a Drum Voice is different to that for selecting a Normal Voice.

Selecting Preset Drums (PRE:DR1 ~DR8)

- Press the MEMORY [PRE2] key while holding down the MEMORY [PRE1] key (or vice versa) to select the Preset (PRE) Memory of the Drum Voice. Then press PROGRAM key [1] to [8] to select Drum Voice PRE:DR1 (Preset Drum 1) to DR8 (Preset Drum 8).

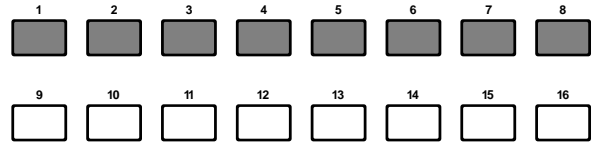
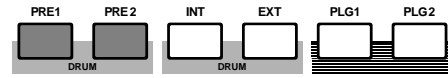

- Press the MEMORY [PRE2] key while holding down the MEMORY [PRE1] key (or vice versa) to select the Preset (PRE) Memory of the Drum Voice. Then use the [INC/YES] or [DEC/NO] keys to select the Drum Voice.

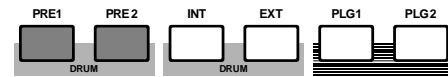

- Press the MEMORY [PRE2] key while holding down the MEMORY [PRE1] key (or vice versa) to select the Preset (PRE) Memory of the Drum Voice. Then use the [DATA] knob to select the Drum Voice.

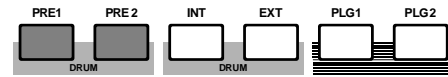

```
UCE Play) PRE:001(A01)>[Sq:Generation]
EQLow-G EQMid-G EQHi-G FLT-Rez HPF
```

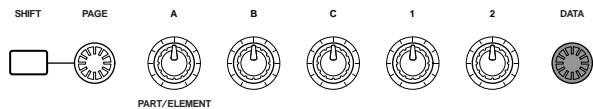

NOTE Once you have selected one Drum Voice, you can easily switch to another by simply using PROGRAM keys [1] to [8], the [INC/YES] and [DEC/NO] keys or the [DATA] knob.

Selecting User Drums (INT:DR1/2 and EXT:DR1/2)

- Press the MEMORY [EXT] key while holding down the MEMORY [INT] key (or vice versa) to select the Internal/External (INT/EXT) Memory of the User Drum Voice. Then press PROGRAM keys [1] to [4] to select, respectively, User Drum Voice INT:DR1 (Internal Drum 1), INT:DR2 (Internal Drum 2), EXT:DR1 (External Drum 1) and EXT:DR2 (External Drum 2).

NOTE User Drum Voices on external memory must be loaded from Memory Card.

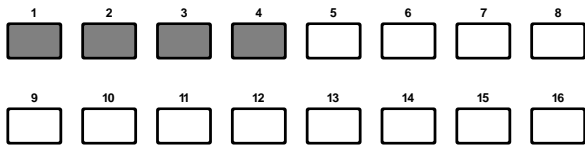
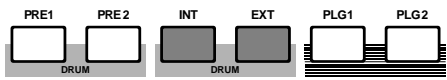

- Press the MEMORY [EXT] key while holding down the MEMORY [INT] key (or vice versa) to select the Internal/External (INT/EXT) Memory of the User Drum Voice. Then use the [INC/YES] or [DEC/NO] keys to select the Drum Voice.

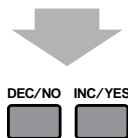
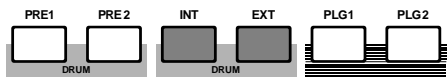

- Press the MEMORY [EXT] key while holding down the MEMORY [INT] key (or vice versa) to select the Internal/External (INT/EXT) Memory of the User Drum Voice. Then use the [DATA] knob to select the User Drum Voice.

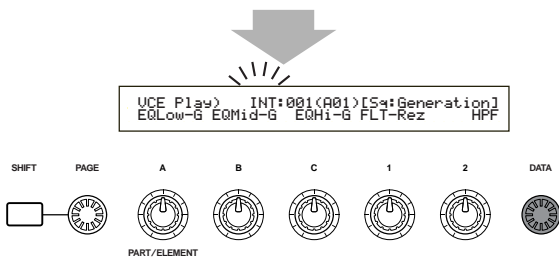
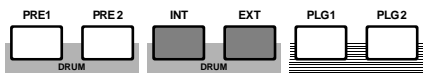

NOTE Once you have one User Drum Voice, you can easily switch to another by simply using PROGRAM keys [1] to [8], the [INC/YES] and [DEC/NO] keys or the [DATA] knob.

Using the Voice Category Search

With the Voice Category Search, you can quickly find Voices within a specified Voice Category. For example, if you specify the “Pf” (piano) Voice Category and use the Voice Category Search, you can select from all the voices which fall into the “Pf” Voice Category.

To start the Voice Category Search, first turn the PAGE knob to switch to the Voice Search screen.

NOTE If a Plug-In board Voice is currently selected in Voice Play Mode, there is no Voice Search screen available.

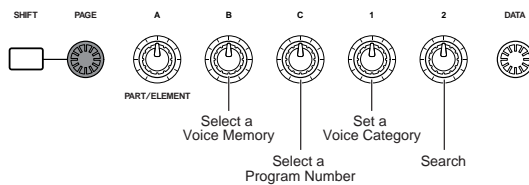
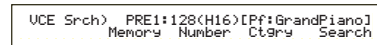

- 1 Turn Knob [B] to select a Voice Memory. You can select Voice Memories other than those on PLG1/2.
- 2 Turn Knob 1 to select a Voice Category. The Voice Category in the LCD will blink.

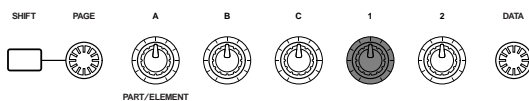
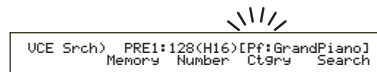

NOTE The different Voice Categories are listed on Page 70.

- 3 Use Knob [2], the [INC/YES] and [DEC/NO] keys, the [DATA] knob and Knob [C] to search for a Voice. The selected voices are called up using each knob and key. The functions of knobs and keys are given below.

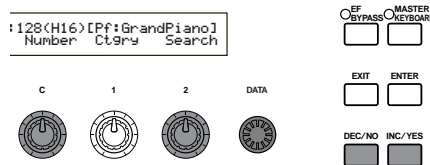

Knob [2]:

Use this to switch between Voices in the selected Category. Turn the knob clockwise to increment the voice number and anti-clockwise to decrement it.

[DATA] knob (or [INC/YES] or [DEC/NO] key)

You can scroll through Voices in the specified Category across the Memories. Turning the [DATA] knob clockwise (or press the [INC/YES] key) jumps to the next Voice number in the same Category, in ascending order. Similarly, turning the [DATA] knob anti-clockwise (or press the [DEC/NO] key) jumps to the next Voice number in the same Category, in descending order. When you reach to the last (first) Voice in a Memory, you can select the first (last) Voice in that Category in the next (previous) Memory by continuously turning the knob clockwise (anti-clockwise) or pressing the [INC/YES] ([DEC/NO]) key.

Knob [C]:

Using the Knob [C], you can select a Voice one by one in the current Memory, likewise for normal Voice selection. Turning the knob clockwise jumps to the next Voice number. Turning the knob anti-clockwise jumps to the previous Voice number.

within the current Voice Memory, [-----] is displayed in the LCD and you will not be able to use Knob [2]. Press the [ENTER] key to start searching in the next Memory.

Using the Quick Access

Using Quick Access, you can quickly select any of 12 types of Preset Voices and 4 types of Internal Voices (at their factory default settings) in each Bank according to their Categories. The procedure is as follows.

NOTE Details about the Voices that can be selected using Quick Access are given in the separate Data List.

1 Press the [QUICK ACCESS] key in Voice Mode. Its LED will light and Quick Access will be enabled.

```
VCE Quick) INT:017<H01>[Pf:GrandPiano]
EQLow-G EQMid-G EQHi-G FLT-Frq ChoSend
```

Press the key again or switch to another Mode to disable Quick Access.

NOTE When you enable Quick Access, the Voice you previously selected using Quick Access is selected again.

NOTE If you enable Quick Access while editing a Voice, the Voice is not changed until you select another Voice via Quick Access.

NOTE You cannot use the MEMORY keys while Quick Access is enabled.

2 Use BANK keys [A] to [H] to select the Category. There are eight Categories, as listed below. The Category names are printed below the respective BANK keys.

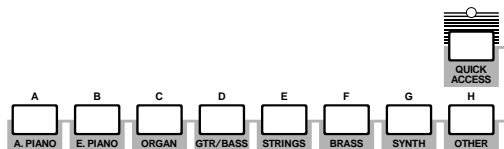

3 Use PROGRAM keys [1] to [16] to select the Voice within the specified Category. The name of the Voice is displayed.

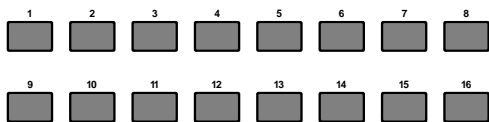

NOTE For each BANK [A] to [H], Preset Voices are accessed using PROGRAM keys [1] to [12]. The remaining four keys (PROGRAM keys [13] to [16]) are used to access each of four internal Voices. Details about Voices are given in the separate Data List. By selectively assigning your own selected Voices to the PROGRAM keys [13] to [16] in each BANK, you can make use of the Quick Access feature to quickly switch between them.

Voice Edit

There are three kinds of Voices: Normal Voices, Drum Voices and Plug-in Voices (if a Plug-in board has been installed). The following is an explanation of the parameters used to edit each kind of Voice.

NOTE Details about Voices are given on Page 36.

The following is displayed when you enter Voice Edit Mode. The displayed screens will vary according to the type of Voice being edited, but basically the [PAGE] knob is used to switch between screens and the parameters on each screen are altered using Knobs [A], [B], [C], [1] and [2]. The [DATA] knob and the [INC/YES] and [DEC/NO] keys can be used to alter parameters in small increments.

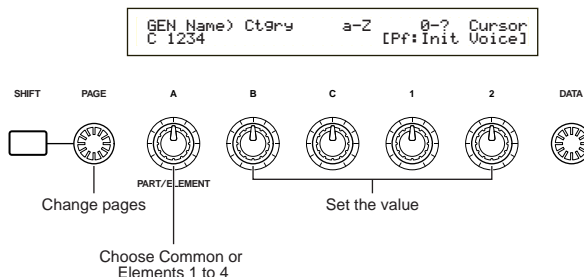

While holding down the [SHIFT] key, you can use Knobs [A], [B], [C], [1] or [2] to move the cursor to the respective parameter without changing its value. You can also move the cursor using the [DATA] knob or the [INC/YES] and [DEC/NO] keys while holding down the [SHIFT] key.

NOTE You need to select the Voice before entering Voice Edit Mode (Page 65). All parameters can be set and stored per Voice.

NOTE See page 21 on how to enter Voice Edit mode.

Common Edit and editing each Element

Voices can consist of up to four Elements (Page 37). Use Common Edit to edit the settings common to all four Elements. Voice Edit Mode can be divided into screens for Common Edit and those for editing each Element.

In Voice Edit Mode, Knob [A] is used to switch between the Common Edit screens and the screens for editing each Element.

Common Edit screens

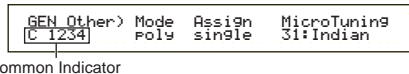

Element 1 ~ 4 Edit Screens

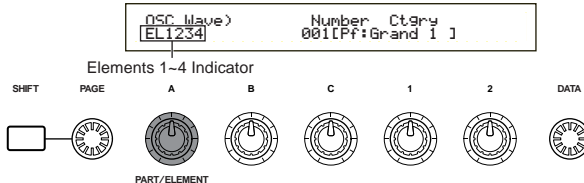

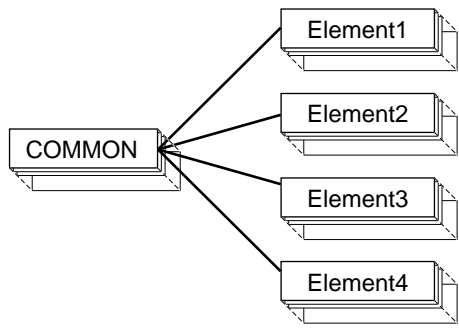

The **E** Indicator

If you alter any parameters in Voice Edit Mode, the **E** indicator will be displayed in the top left of the screen. This gives a quick indication that the current voice has been modified but not yet stored.

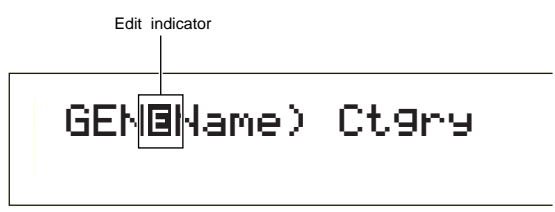

- NOTE** Even if you exit to Voice Play Mode, the edited settings for the current Voice will not be lost so long as you do not select another Voice.
- NOTE** The **E** indicator will also be displayed in Voice Play Mode, and if any Assignable knobs are used.

The “Compare” Function

Use this to listen to the difference between the Voice with your edited settings and the same Voice prior to editing.

- 1 Press the [COMPARE (EDIT)] key while in Voice Edit Mode. The **E** indicator at the top left of the screen will change to the **C** indicator and the Voice settings prior to editing will temporarily be reinstated for comparison purposes.



- NOTE** While the “Compare” function is enabled, editing will not be possible using knobs [A] to [C] or knob [1]/[2].
- 2 Press the [EDIT] key again to disable the “Compare” function and restore the settings for your edited Voice.

The ELEMENT ON/OFF Function

Use this to mute individual Elements within a Voice. For example, you could mute all Elements other than that which you are editing. Thus, you can hear how the edited settings affect just that Element. Details are given on Page 51.

Voice Store

The edited settings for the current Voice will be lost if you select another Voice or Mode. To avoid losing important data, you should always use Voice Store to store your edited Voice. Details about the Voice Store procedure are given on Page 106.

- NOTE** When creating a new Voice from scratch, it can be useful, prior to editing, to clear the settings for the current Voice using the Initialize Voice function in Voice Job Mode (Page 105).

Normal Voice

When editing Normal Voices, there are 12 settings consisting of six Common Edit settings (common to all four Elements) and six Element-specific settings.

Voice Edit Mode

- Common
 - Common General _____ 70
 - GEN Name (General Name) _____ 70
 - GEN Other (General Other) _____ 71
 - Common Quick Edit _____ 71
 - QED Level (Quick Edit Level) _____ 71
 - QED EffectCtrl (Quick Edit Effect Control) _____ 71
 - QED Filter (Quick Edit Filter) _____ 72
 - QED EG (Quick Edit Envelope Generator) _____ 72
 - Common Arpeggio _____ 72
 - ARP Type (Arpeggio Type) _____ 72
 - ARP Limit (Arpeggio Note Limit) _____ 73
 - ARP Mode (Arpeggio Mode) _____ 73
 - ARP PlayEF (Arpeggio Play Effect) _____ 73
 - Common Controller _____ 74
 - CTL Portamento _____ 74
 - CTL Bend (Pitch Bend) _____ 74
 - CTL Set1 (Control Set 1) _____ 74
 - CTL Set2 (Control Set 2) _____ 74
 - CTL Set3 (Control Set 3) _____ 74
 - CTL Set4 (Control Set 4) _____ 74
 - CTL Set5 (Control Set 5) _____ 74
 - CTL Set6 (Control Set 6) _____ 74
 - Common LFO (Low Frequency Oscillator) _____ 75
 - LFO Wave _____ 75
 - LFO Fade _____ 77
 - LFO Dest1 (LFO Destination 1) _____ 77
 - LFO Dest2 (LFO Destination 2) _____ 77
 - Common Effect _____ 78
 - EFF InsEF (Insertion Effect) _____ 78
 - EFF EF1 (Insertion Effect 1) _____ 78
 - EFF EF2 (Insertion Effect 2) _____ 78
 - EFF Rev (Reverb) _____ 79
 - EFF Cho (Chorus) _____ 79
- Element
 - Element OSC (Oscillator) _____ 79
 - OSC Wave (Oscillator Wave) _____ 79
 - OSC Out (Oscillator Out) _____ 79
 - OSC Pan (Oscillator Pan) _____ 80
 - OSC Limit (Oscillator Limit) _____ 80
 - Element Pitch _____ 80
 - PCH Tune (Pitch Tune) _____ 80
 - PEG VelSens (PEG Velocity Sensitivity) _____ 81
 - PEG Time _____ 81
 - PEG Level _____ 81
 - PEG Release _____ 81
 - PCH Scale (Pitch Scale) _____ 82
 - Element Filter _____ 83
 - FLT Type (Filter Type) _____ 83
 - FLT HPF (High Pass Filter) _____ 85

- FLT Sens (Filter Sensitivity) — 85
- FEG VelSens (FEG Velocity Sensitivity) — 85
- FEG Time — 86
- FEG Level — 86
- FEG Release — 86
- FLT KeyFlw (Filter Key Follow) — 86
- FLT Scale (Filter Scale Break Point) — 87
- FLT Scale (Filter Scale Offset) — 87
- Element Amplitude — 88
- AEG VelSens (AEG Velocity Sensitivity) — 88
- AEG Time — 88
- AEG Level — 88
- AEG Release — 88
- AEG KeyFlw (AEG Key Follow) — 89
- AEG Scale (AEG Scale Break Point) — 90
- AEG Scale (AEG Scale Offset) — 90
- Element LFO (Low Frequency Oscillator) — 90
 - LFO Wave — 90
 - LFO Depth — 91
- Element EQ (Equalizer) — 91
 - EQ Type — 91
 - EQ Param (EQ Parameter) — 91

Menu Display

You will see the following if you use the [PAGE] knob while holding down the [SHIFT] key. Use the [PAGE] knob to move the cursor to the parameter you wish to edit, then release the [SHIFT] key to jump to the screen you were previously at.

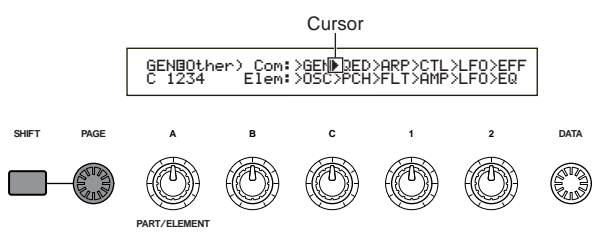

Selecting a Menu

On the S80 in Voice Edit Mode, you can directly select a Menu using the PROGRAM/PART keys, [1] to [6] and [9] to [15]. Each key has an associated Menu name shown below it.

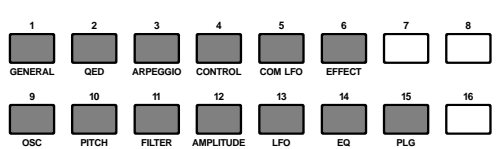

Common General

You can set the Voice Name, Voice output settings and other general parameters in the Common Edit screens. The following two screens are available for general settings.

- GEN Name (General Name)
- GEN Other (General Other)

GEN Name (General Name)

You can set a Voice Name consisting of up to 10 characters. You can also select the Category Name to the left of the Voice Name.

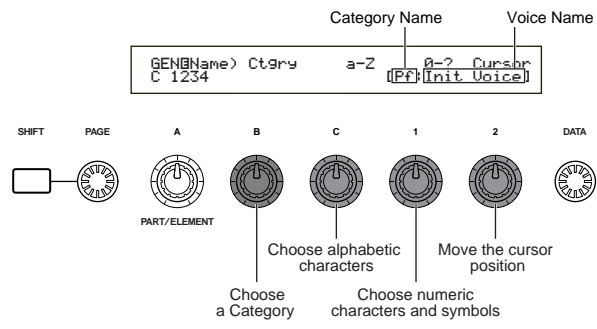

Setting the Voice Name

- 1 Use Knob [2] to move the cursor to the position of the first character. The selected character will blink.
- 2 Use Knob [C] to enter an alphabetic character or Knob [1] to enter a numeric character/symbol.
- 3 Use Knob [2] to move the cursor to the position of the next character.
- 4 Repeat Steps 2 and 3 until all the characters have been set for your Voice Name.

You can also use the [INC/YES] and [DEC/NO] keys or the [DATA] knob to enter alphabetic and numeric characters as well as symbols.

- 5 Use Knob [B] to set the Category Name if necessary.

By setting the Category Name, it will be easier to identify the Voice later. The Category Search function (Page 67) can also be used to search for it. If you do not wish to set a Category Name, the Category will be shown as two hyphens.

Settings for alphabetic and numeric characters and Category Names :

a	b	c	d	e	f	g	h	i	j	k	l	m	n	o	p	q	r	s
t	u	v	w	x	y	z	A	B	C	D	E	F	G	H	I	J	K	L
M	N	O	P	Q	R	S	T	U	V	W	X	Y	Z	0	1	2	3	4
5	6	7	8	9	!	"	#	\$	%	&	'	()	*	+	,	-	.
/	:	;	<	=	>	?	@	[¥]	^	_	`	{		}	~	

LCD	Category	LCD	Category
--	Unassigned	Pd	Synth Pad
Pf	Piano	Fx	Synth Sound Effects
Cp	Chromatic Percussion	Et	Ethnic
Or	Organ	Pc	Percussive
Gt	Guitar	Se	Sound Effects
Ba	Bass	Dr	Drums
St	Strings/Orchestral	Sc	Synth Comping
En	Ensemble	Vo	Vocal
Br	Brass	Co	Combination
Rd	Reed	Wv	Material Wave
Pi	Pipe	Sq	Sequence
Ld	Synth Lead		

GEN Other (General Other)

There are various parameters for Micro Tuning and for controlling how the generated sound is output.

```
GENOther) Mode Assign MicroTuning
C 1234 Poly single 31:Indian
```

■ Mode

Select monophonic or polyphonic playback. Select whether the Voice is played back monophonically (single notes only) or polyphonically (multiple simultaneous notes).

Settings: mono, poly

■ Assign

If you set Key Assign to “single,” the doubled playback of the same note is prevented. The synthesizer will terminate a note when the same note is received again. If you select “multi,” the synthesizer will consecutively assign each instance of the same received note to a separate channel, making multiple part tone generation possible.

Settings: single, multi

■ MicroTuning

Set the Micro Tuning (tuning system, or temperament) used for the Voice. Normally you would use “Equal Temperament” but there are also 31 other tuning systems available.

Settings: (see the following list)

No.	Type	Key	Comments
00	Equal temperament		The “compromise” tuning used for most of the last 200 years of Western music, and found on most electronic keyboards. Each half step is exactly 1/12 of an octave, and music can be played in any key with equal ease. However, none of the intervals are perfectly in tune.
01-12	Pure major	C-B	This tuning is designed so that most of the intervals (especially the major third and perfect fifth) in the major scale are pure. This means that other intervals will be correspondingly out of tune. You need to specify the key (C-B) you will be playing in.
13-24	Pure minor	A-G#	The same as Pure Major, but designed for the minor scale.
25	Werckmeister		Andreas Werckmeister, a contemporary of Bach, designed this tuning so that keyboard instruments could be played in any key. Each key has a unique character.
26	Kirnberger		Johan Philipp Kirnberger was also concerned with tempering the scale to allow performances in any key.
27	Vallotti & Young		Francescantonio Vallotti and Thomas Young (both mid-1700s) devised this adjustment to the Pythagorean tuning in which the first six fifths are lower by the same amount.
28	1/4 shifted		This is the normal equal tempered scale shifted up 50 cents.
29	1/4 tone		Twenty-four equally spaced notes per octave. (Play twenty-four notes to move one octave.)
30	1/8 tone		Forty-eight equally spaced notes per octave. (Play forty-eight notes to move one octave.)
31	Indian	C-B	Usually observed in the Indian music (white keys [C-B] only).

Common Quick Edit

Various parameters control the sonic properties of the Voice. There are four screens.

QED Level (Quick Edit Level)
 QED EffectCtrl (Quick Edit Effect)
 QED Filter (Quick Edit Filter)
 QED EG (Quick Edit Envelope Generator)

QED Level (Quick Edit Level)

These parameters control the output level (volume) and pan position of the Voice.

```
QEDLevel) Vol Pan RevSend ChoSend
C 1234 127 C 127 127
```

■ Vol (Volume)

Set the output level of the Voice.

Settings: 0 ~ 127

■ Pan

Set the stereo pan position of the Voice.

Settings: L63 (Left) ~ C (Center) ~ R63 (Right)

■ RevSend (Reverb Send)

Set the Send level of the signal sent from Insertion Effect 1/2 (or the bypassed signal) to the Reverb effect.

Settings: 0 ~ 127

■ ChoSend (Chorus Send)

Set the Send level of the signal sent from Insertion Effect 1/2 (or the bypassed signal) to the Chorus effect.

Settings: 0 ~ 127

QED EffectCtrl (Quick Edit Effect)

Set the amount of Chorus applied to the entire Voice.

```
QEDEffectCtrl) Chorus
C 1234 +63
```

■ Chorus

Set an offset value for the parameters used by each type of Chorus.

Settings: -64 ~ 0 ~ +63

QED Filter (Quick Edit Filter)

These parameters control filters which affect the tonal quality of the Voice. If you are using LPF (Low Pass Filter) and HPF (High Pass Filter) combined together, the parameters in the QED Filter page only affects LPF.

QED(Filter)	Cutoff	Reso
C 1234	+63	+63

■ Cutoff

Set the cutoff frequency. The frequency set here will be a center frequency for signals to be filtered when they pass through each filter.

□ Settings: -64 ~ 0 ~ +63

■ Reso (Resonance)

Set the amount of Resonance (harmonic boost) applied to the signal around the Cutoff frequency. This is a useful way of adding further character to the sound.

□ Settings: -64 ~ 0 ~ +63

QED EG (Quick Edit Envelope Generator)

These four parameters control the change in the output level of a Voice over the time that a note is played.

QED(EG)	Attack	Decay	Sustain	Release
C 1234	+63	+63	+63	+63

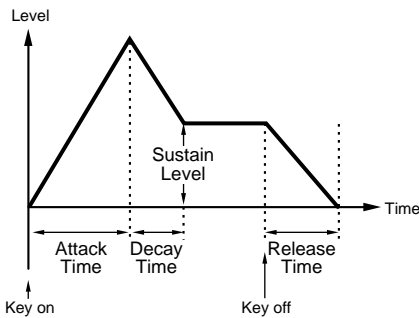

■ Attack

Set the transition time from the moment a key on the keyboard is pressed to the point at which the level of the Voice reaches its peak.

□ Settings: -64 ~ 0 ~ +63

■ Decay

Set the transition time from the point at which the level of the Voice reaches its peak to the point at which it levels off.

□ Settings: -64 ~ 0 ~ +63

■ Sustain

Set the level of the Voice maintained while the note on the keyboard is being held down.

□ Settings: -64 ~ 0 ~ +63

■ Release

Set the transition time from the point at which the note on the keyboard is released to the point at which the level of the Voice reaches zero.

□ Settings: -64 ~ 0 ~ +63

Common Arpeggio

The following four parameters control the behavior of the Arpeggiator.

ARP Type (Arpeggio Type)
 ARP Limit (Arpeggio Note Limit)
 ARP Mode (Arpeggio Mode)
 ARP PlayEF (Arpeggio Play Effect)

ARP Type (Arpeggio Type)

These are the basic parameters of the Arpeggiator.

ARPTType)	Type	Tempo	Switch	Hold
C 1234	U=Oct1:54	120	on	on

■ Type

Set the Arpeggio Type.

□ Settings: (see the separate Data List)

Sq (Sequence):

Creates a general arpeggio phrase. Mainly octave up/down phrases.

Ph (Phrase):

Creates more musical phrases than Sq. Starting with "Techno," there are phrases for a wide variety of musical genres, and for creating backing tracks for guitar, piano and other instruments.

Dr (Drum Pattern):

Creates drum pattern-type phrases. Phrase genres covered include rock and dance. This Type is ideal for use with drum and percussion sounds.

Ct (Control):

Creates tonal changes. No note information is created. The Key Mode parameter in Arpeggio Mode must be set to "direct."

■ Tempo

Set the Arpeggio Tempo.

□ Settings: 25 ~ 300

NOTE [MIDI] is displayed here and the parameter cannot be altered if MIDI sync is enabled (Page 138).

■ Switch

Switch the Arpeggiator on or off.

□ **Settings:** off, on

■ Hold

Switch the Arpeggiator Hold on or off.

□ **Settings:** syncoff, off, on

NOTE Details about this are given on Page 43.

ARP Limit (Arpeggio Note Limit)

```
ARPBLimit>           Note Limit
C 1234             C-2 - G 8
```

■ Note Limit

Set the lowest and highest notes in the Arpeggiator's note range.

□ **Settings:** C-2 ~ G8 (lowest and highest set separately)

NOTE If you specify the highest note first and the lowest note second, for example "C5 to C4," then the note range covered will be "C-2 to C4" and "C5 to G8."

NOTE You can set the lowest and highest notes in the range by pressing notes on the keyboard while holding down the [SHIFT] key.

ARP Mode (Arpeggio Mode)

These parameters control the way in which notes are played back by the Arpeggiator.

```
ARPBMode>      Key Mode      Vel Mode
C 1234         sort          thru
```

■ Key Mode

Set how the Arpeggio is played back when keys on the keyboard are pressed. There are 3 modes.

□ **Settings:**

sort:

Plays back notes in ascending order from the lowest key pressed to the highest.

thru:

Plays back notes in the order in which the keys are pressed.

direct:

Plays back the notes exactly as you play them. If changes to Voice parameters (such as Pan or Cutoff frequency) are included in the Arpeggio sequence data, they will be applied and reproduced whenever the Arpeggio plays back.

NOTE If the Arpeggio Category is set to Ct, you will not hear any sounds unless you select "direct" here.

NOTE With the "sort" and "thru" settings, the order in which notes are played back will depend on the Arpeggio sequence data.

■ Vel Mode (Velocity Mode)

Set the playback velocity of the Arpeggio. There are 2 modes.

□ **Settings:**

original:

Preset velocities are used in the Arpeggio sequence.

thru:

Velocities of the notes you play are used in the Arpeggio sequence.

ARP PlayEF (Arpeggio Play Effects)

You can set Play Effects for the Arpeggio. Play Effects can be used to temporarily adjust the timing and velocity of MIDI notes, thus affecting the groove of the Arpeggio pattern.

```
ARPBPlayEF>      Unit      Vel      Gate
C 1234           50%     200%    200%
```

■ Unit

Adjust the Arpeggio playback time. For example, if you set a value of 200%, the playback time will be doubled and the tempo halved. Alternatively, if you set a value of 50%, the playback time will be halved and the tempo doubled. Normal playback time is 100%.

□ **Settings:** 50%, 66%, 75%, 100%, 133%, 150%, 200%

■ Vel (Velocity)

Set the Velocity offset value (the strength at which the keyboard is played). This determines how the original Velocities are increased or decreased during Arpeggio playback. A setting of 100% means the original values are used. Settings below 100% will reduce the velocity of the Arpeggio notes, whereas settings above 100% will increase the velocities.

□ **Settings:** 0% ~ 200%

NOTE If the Velocity value falls below 1, it will be limited to 1. If it exceeds 127, it will be limited to 127.

■ Gate (Gate Time)

Set the Gate Time Rate value (the length of a note). This determines how the original Gate Times are increased or decreased during Arpeggio playback. A setting of 100% means the original values are used. Settings below 100% will shorten the gate times of the Arpeggio notes, whereas settings above 100% will lengthen them.

□ **Settings:** 0% ~ 200%

NOTE If the Gate Time value falls below 1, it will be limited to 1.

Common Controller

There are eight Control Settings. You can set the Controller parameters for Portamento, the Pitch Bend Wheel, and for each Element in a Voice.

CTL Portamento
 CTL Bend (Pitch Bend)
 CTL Set1 (Control Set 1)
 CTL Set2 (Control Set 2)
 CTL Set3 (Control Set 3)
 CTL Set4 (Control Set 4)
 CTL Set5 (Control Set 5)
 CTL Set6 (Control Set 6)

CTL Portamento

Set the Portamento parameters. Portamento will create a smooth transition in pitch from the first note played to the next.

```
CTLPortamento) Switch  Time  Mode
C 1234           on     127  fulltime
```

■ Switch

Switch Portamento on or off.

□ Settings: off, on

■ Time

Set the pitch transition time. Higher values mean longer transition times.

□ Settings: 0 ~ 127

■ Mode

Set the Portamento mode. The behavior of the Portamento varies depending on whether Mode in GEN Other is set to “mono” or “poly.”

□ Settings: fingered, fulltime

If the Mode in GEN Other is set to “mono”:
fingered:

Portamento is only applied when you play legato (playing the next note before releasing the previous one).

fulltime:

Portamento is always applied.

If the Mode in GEN Other is set to “poly”:

This is the same as for “mono,” except that Portamento is applied to multiple notes.

CTL Bend (Pitch Bend)

You can set the amount by which the Pitch Bend Wheel changes the pitch of the Voice.

```
CTLBPitchBend) Lower  Upper
C 1234         -12   +12
```

■ Lower

Set the amount (in semitones) by which the Voice pitch changes when the Pitch Bend Wheel is moved downwards. For example, a value of -12 means that the pitch of the Voice drops by up to an octave when the Pitch Bend Wheel is moved downwards.

□ Settings: -48 ~ 0 ~ +24

■ Upper

Set the amount (in semitones) by which the Voice pitch changes when the Pitch Bend Wheel is moved upwards. For example, a value of +12 means that the pitch of the Voice rises by up to an octave when the Pitch Bend Wheel is moved upwards.

□ Settings: -48 ~ 0 ~ +24

CTL Set1 (Control Set 1) to CTL Set6 (Control Set 6)

The controllers and knobs on the front panel, the keyboard, and so on can be assigned a variety of uses. For example, keyboard aftertouch can be used to control vibrato and the Modulation Wheel could be used to control Resonance. They can even be used to control parameters within individual Elements. These control assignments are called “Control Sets.” You can assign up to six different Control Sets per Voice. Thus there are six screens, each for a separate controller: CTL Set1 to CTL Set6.

```
CTLSet1) Src  Dest  EL Sw  Depth
C 1234  FC(04) ELFSpd 1234  +63
```

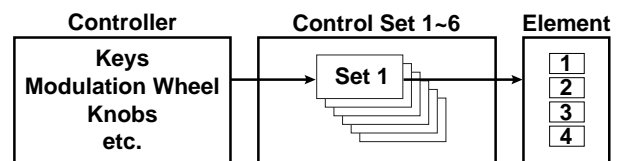

■ Src (Source)

Set the Controller used to control the function chosen in Dest. The following nine controllers are available.

□ Settings: PB (Pitch Bend Wheel), MW (Modulation Wheel), AT (Aftertouch), FC (Foot Controller), FS (Foot Switch), RB (Ribbon Controller), BC (Breath Controller), KN1/2 (Knobs 1/2)

■ Dest (Destination)

Set the parameter to be controlled by the Control Set in Src.

□ **Settings:** (see the separate “Controls” list)

■ ElemSw (Element Switch)

Select whether the Controller will affect each individual Element. Move the cursor (blinking) using Knob [1] and use the [DATA] knob or the [INC/YES] and [DEC/NO] keys to enable/disable the Elements which the Controller will affect. Affected Elements are shown by number.

□ **Settings:** Elements 1 to 4 enabled (“1” to “4” displayed) or disabled (“-” displayed)

NOTE This is disabled if the Dest parameter is set to 00 to 33.

■ Depth

Set the amount by which the parameter selected in Dest can be controlled.

□ **Settings:** -64 ~ 0 ~ +63

Example of Control Set Assignment

Using Control Sets 1 to 6, you can assign individual Src (Source) controllers to multiple Dest (Destination) parameters, or multiple Src controllers to individual Dest parameters.

Ex.1: Use a single Src controller to control multiple Dest parameters.

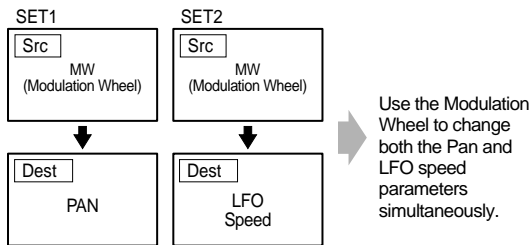

Ex.2: Use multiple Src controllers to control a single Dest parameter.

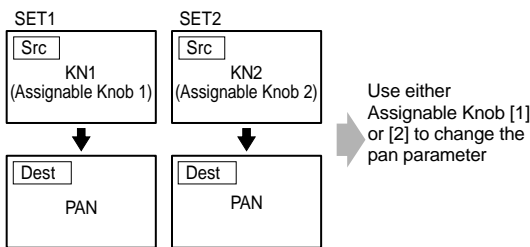

NOTE Details about Control Set Assignments are given in the Basics Section of this manual (Page 45).

Common LFO (Low Frequency Oscillator)

There are various settings for the LFO. The LFO is used to generate low frequency signals and can be used to create vibrato, wah, tremolo and other effects when applied to pitch/filter/amplitude/etc. parameters. For example, variations can be simultaneously applied to both pitch and filter parameters, and to parameters specific to individual Elements. The following four settings are available.

- LFO Wave
- LFO Fade
- LFO Dest1 (LFO Destination 1)
- LFO Dest2 (LFO Destination 2)

LFO Wave

```
LFO(Wave) Wave^v Speed KeyReset Phase
C 1234 trfzd 63 on 270
```

■ Wave

Select the LFO Wave. Depending on the Wave selected, you can create different kinds of modulated sounds. The following 12 LFO waveforms are available.

□ **Settings:** tri, tri+, saw up, saw dw, squ1/4, squ1/3, squ, squ2/3, squ3/4, trpzd, S/H 1, S/H 2

tri

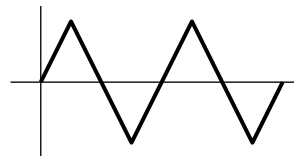

saw up

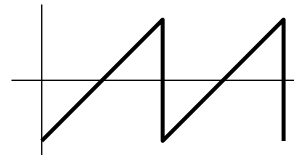

saw dw

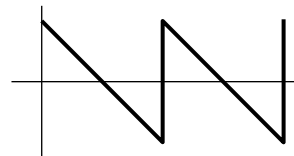

squ

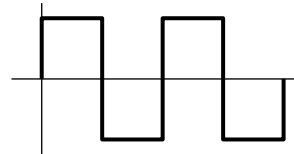

trpzd

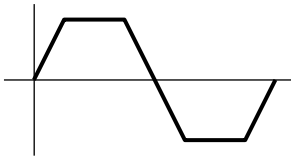

S/H 1

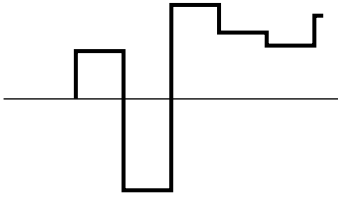

S/H 2

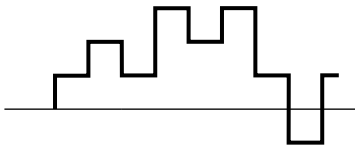

Speed

Set the speed of the LFO Wave modulation. Higher values mean faster modulation speeds.

- **Settings:** 0 ~ 63, 16th (16th note), 16th/3 (16th note-triplet), 16th. (16th dot-note), 8th (8th note), 8th/3 (8th note-triplet), 8th. (8th dot-note), 4th (4th note), 4th/3 (4th note-triplet), 4th. (4th dot-note), 2nd (half note), 2nd/3 (half note-triplet), 2nd. (half dot-note), 4thx4 (whole note), 4thx5 (5x4th notes), 4thx6 (6x4th notes), 4thx7 (7x4th notes), 4thx8 (8x4th notes)

Speed = Slow

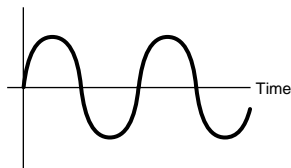

Speed = Fast

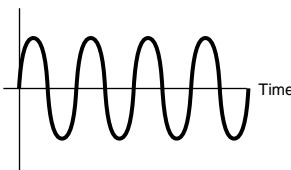

NOTE The length of the note depends on the internal or external MIDI tempo setting.

KeyReset (Key on Reset)

Set whether the LFO is reset each time a note is pressed. The following three settings are available.

- **Settings:** off, each-on, 1st-on

off

The LFO is self-running (no synchronization) and starts a waveform at any phase when you play on the keyboard.

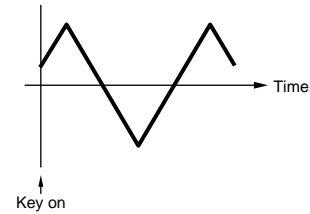

each-on

The LFO resets with each note you play and starts a waveform at the phase specified by the Phase parameter (see below).

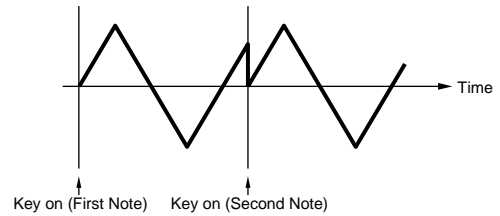

1st-on

The LFO resets with every note you play and starts the waveform at the phase specified by the Phase parameter (Show below). If you play a second note while the first note is being played (Note Off has not been received), the LFO does not reset to the specified phase (no synchronization) with the second note and after.

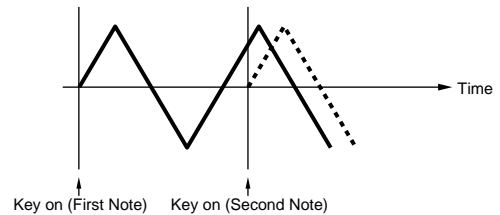

Phase

Set the phase at which the LFO Wave starts whenever a note is played. Phases of 0/90/120/180/240/270 degrees are available.

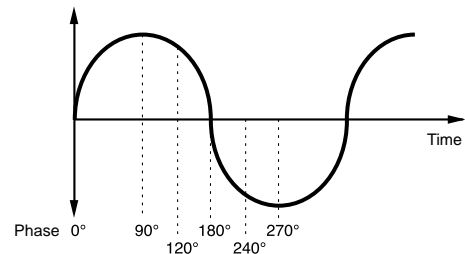

- **Settings:** 0, 90, 120, 180, 240, 270

LFO Fade

```
LFOBFade) Delay FadeIn Hold FadeOut
C 1234      127  127  127  127
```

Delay

Set the delay time before the LFO comes into effect. A higher value means a longer delay time.

Settings: 0 ~ 127

Short delay

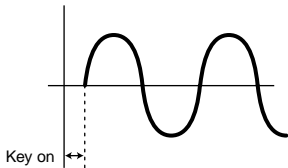

Long delay

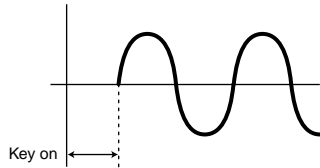

FadeIn (Fade-In)

Set the time taken for the LFO effect to be faded in (after the Delay time has elapsed). A higher value means a slower fade-in.

Settings: 0 ~ 127

Low FadeIn value

Faster fade-in

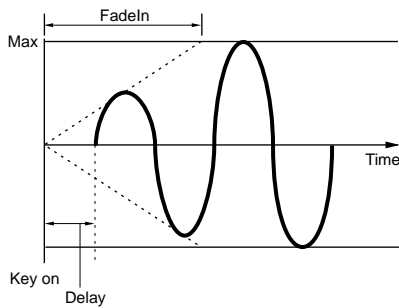

High FadeIn value

Slower fade-in

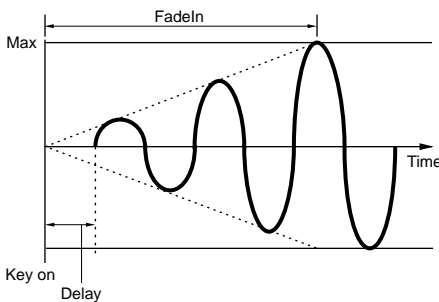

Hold

Set the length of time during which the LFO is held at its maximum level. A higher value means a longer Hold time.

Settings: 0 ~ 127

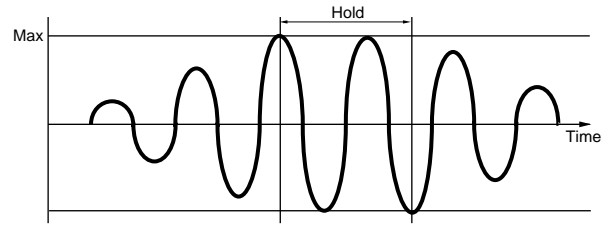

FadeOut (Fade-Out)

Set the time taken for the LFO effect to be faded out (after the Hold time has elapsed). A higher value means a slower fade-out.

Settings: 0 ~ 127

Low FadeOut value

Faster fade-out

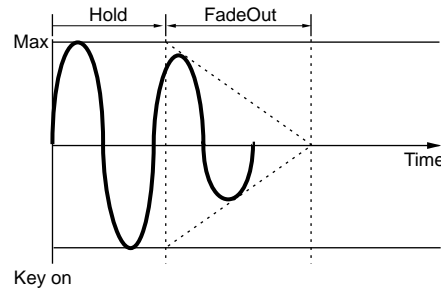

High FadeOut value

Slower fade-out

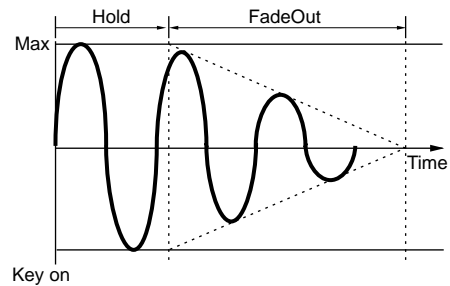

LFO Dest1 (LFO Destination 1)

LFO Dest2 (LFO Destination 2)

You can assign parameters to be controlled by the LFO Wave and set the LFO Wave Depth (amplitude). Two Destinations can be assigned, and you can choose from several parameters per Destination.

```
LFOBDest1) Dest ElemSw Depth
C 1234      AMD  1234  127
```

■ Dest (Destination)

Set the parameters which will be controlled (modulated) by the LFO Wave.

- ❑ **Settings:** AMD, PMD, FMD, RESO (Resonance), PAN, ELFOspd (Element LFO Speed)

■ ElemSw (Element Switch)

Select whether to allow variations in the LFO Wave for each Element. Move the cursor (blinking) using Knob [1] and use the [DATA] knob or the [INC/YES] and [DEC/NO] keys to enable/disable LFO Wave variations for Elements 1 to 4. Enabled Elements are shown by number.

- ❑ **Settings:** Elements 1 to 4 enabled (“1” to “4” displayed) or disabled (“-” displayed)

■ Depth

Set the LFO Wave Depth (amplitude).

- ❑ **Settings:** 0 ~ 127

Common Effect

You can set two types of Insertion Effects, plus two System Effects (Reverb and Chorus). The following five screens are available.

- EFF InsEF (Insertion Effect)
- EFF EF1 (Insertion Effect 1)
- EFF EF2 (Insertion Effect 2)
- EFF Rev (Reverb)
- EFF Cho (Chorus)

EFF InsEF (Insertion Effect)

■ InsEF Connect (Insertion Effect Connect)

Set up the connection between Insertion Effects 1 and 2. If you change this setting, the symbol denoting the signal routing (to the left of the setting) also changes to reflect the new signal flow.

Signal routing symbols

EFF InsEF
C 1234

InsEF Connect
1=2

1=2	1=2 (parallel)
1→2	1→2 (serial)
2→1	2→1 (serial)

- ❑ **Settings:** 1 = 2 (parallel), 1→2 (Insertion Effect 1 to 2), 2→1 (Insertion Effect 2 to 1)

EFF EF1/2 (Insertion Effect 1/2)

You can select the Effect Category for Insertion Effect 1/2 with the CtgrY parameter and the Effect Type with the Type parameter. After selecting the Effect Type, you can set its parameters by pressing the [ENTER] key.

```

EFFBEF2> CtgrY Type Dry/Wet [ENTER]
C 123- DLV:DelayLCR D<W63 to Edit
    
```

■ CtgrY (Effect Category)

Set the Category of the Effect. Select a desired Category and press the [ENTER] key. The first Effect Type in that Category will automatically be recalled.

- ❑ **Settings:** Details are given in the Effect Types list of the separate Data List.

■ Type (Effect Type)

Set the type of Effect. While the Category indicator is blinking in the display, you can press the [ENTER] key to recall the first Effect Type in that Category.

- ❑ **Settings:** Details are given in the Effect Types list of the separate Data List.

■ Dry/Wet

Set the mix level of the wet signal (which has been passed through the Effects Unit) and the dry signal (which has not been passed through the Effects Unit). This may be unavailable, depending on the selected Effect Type.

- ❑ **Settings:** D63 > W ~ D = W ~ D < W63

Effect Parameter Settings

These parameters are available when you press the [ENTER] key for certain Effect Types. Use the [PAGE] knob to switch between screens, and use the other knobs and the [INC/YES] and [DEC/NO] keys to set each parameter. When you press the [EXIT] key, you will be returned to the Effect Type selection screen.

Effect Type selection screen

```

EFFBEF2> CtgrY Type Dry/Wet [ENTER]
C 123- DLV:DelayLCR D<W63 to Edit
    
```



Parameter settings screen

```

EFFBEF2> TimeL TimeR TimeC Dry/Wet
DelayLCR 333.3m 166.7m 500.0m D<W63
    
```

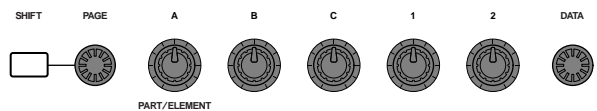

- NOTE** The number of Parameters and the contents of each screen will vary depending on the selected Effect Type. Details are given in the Effect Type list of the separate Data List.

EFF Rev (Reverb)

You can select the Reverb Effect Type, then press the [ENTER] key to set its parameters.

```
EFFBRev) Type          Return [ENTER]
C 1234  Basement      127 to Edit
```

■ Type (Reverb Effect Type)

Set the Reverb Effect Type.

- **Settings:** Details are given in the Effect Types list of the separate Data List.

■ Return

Set the Return level of the Reverb Effect.

- **Settings:** 0 ~ 127

EFF Cho (Chorus)

You can select the Chorus Effect Type, then press the [ENTER] key to set its parameters.

```
EFFBCho) Type      toRev  Return [ENTER]
C 1234  Chorus1    127    127 to Edit
```

■ Type (Chorus Effect Type)

Set the Chorus Effect Type.

- **Settings:** Details are given in the Effect Types list of the separate Data List.

■ toRev (To Reverb)

Set the Send level of the signal sent from the Chorus Effect to the Reverb Effect.

- **Settings:** 0 ~ 127

■ Return

Set the Return level of the Chorus Effect.

- **Settings:** 0 ~ 127

Element OSC (Oscillator)

You can set the parameters for the Elements (Waves) which make up the Voice. Each Voice can consist of up to four Elements, and the following four screens are available for each.

OSC Wave (Oscillator Wave)
 OSC Out (Oscillator Out)
 OSC Pan (Oscillator Pan)
 OSC Limit (Oscillator Limit)

OSC Wave (Oscillator Wave)

You can use Knob [A] to select each Element and Knob [C] to assign a Wave to it.

```
OSCBWave)          Number  Ctgry
EL1234             001[Pf:Grand 1 ]
```

■ Number (Wave Number)

Select the Wave Number. The Category and Wave Name are displayed to the right of the selected Wave Number. You can assign a different Wave Number to each of the Elements.

- **Settings:** 000 (off) ~ 553 (Details about each Wave are given in the separate Data List.)

■ Ctgry (Category)

Select the Category containing the Wave you wish to use. Specify a desired Category and press the [ENTER] key. The first Wave in that Category will automatically be selected.

- **Settings:** Details about Wave Categories are given on Page 70.

OSC Out (Oscillator Out)

You can set the following output parameters for each Element of a Voice.

```
OSCBOut)  Level      Delay  InsEF
EL1234    96         0      ins2
```

■ Level

Set the output level of each Element.

- **Settings:** 0 ~ 127

■ Delay (Key On Delay)

Set the time (delay) between the moment you press a note on the keyboard and the point at which the sound is played. You can set different delay times for each Element.

- **Settings:** 0 ~ 127

Short Delay

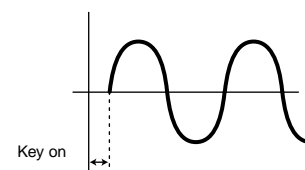

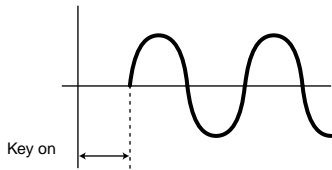
Long Delay**■ InsEF (Insertion Effect)**

Set the Insertion Effect to which the output signal from each Element is sent. The Insertion Effect is bypassed if you select Thru.

- Settings:** thru, ins1 (Insertion Effect 1), ins2 (Insertion Effect 2)

OSC Pan (Oscillator Pan)

You can set the following Pan parameters for each Element in the Voice.

OSCPan)	Pan	Alter	Random	Scale
EL1234	C	L64	63	+63

■ Pan

Set the stereo Pan position for each Element (Wave). This will also be used as the basic Pan position for the Alternate, Random and Scale settings.

- Settings:** L63 (Left) ~ C (Center) ~ R63 (Right)

■ Alter (Alternate)

Set the amount by which the sound is panned alternately left and right for each note you press. The Pan setting is used as the basic Pan position.

- Settings:** L64 ~ 0 ~ R63

■ Random

Set the amount by which the sound is panned randomly left and right for each note you press. The Pan setting is used as the basic Pan position.

- Settings:** 0 ~ 127

■ Scale

Set the amount by which the sound is panned left and right according to the position of the note on the keyboard. The Pan setting is used as the basic Pan position at note C3.

- Settings:** -64 ~ 0 ~ +63

OSC Limit (Oscillator Limit)

You can set parameters controlling the note range of each Element and the velocity.

OSCLimit)	Note Limit	Vel Limit
EL1234	C-2 - G 8	1 - 127

■ Note Limit

Set the lowest and highest notes of the keyboard range for each Element. Each Element will only sound for notes played within its specified range.

- Settings:** C-2 ~ G8 (for the lowest and highest notes)

NOTE If you specify the highest note first and the lowest note second, for example “C5 to C4,” then the note range covered will be “C-2 to C4” and “C5 to G8.”

NOTE You can set the lowest and highest notes in the range by pressing notes on the keyboard while holding down the [SHIFT] key.

■ Vel Limit (Velocity Limit)

Set the minimum and maximum values of the velocity range within which each Element will respond. Each Element will only sound for notes played within its specified velocity range.

- Settings:** 1 ~ 127 (for the minimum and maximum values)

NOTE If you specify the maximum value first and the minimum value second, for example “93 to 34,” then the velocity range covered will be “1 to 34” and “93 to 127.”

Element Pitch

You can set parameters governing the pitch of each Element. The Pitch Envelope Generator (PEG) controls the change in pitch from the moment a note is pressed on the keyboard to the point at which the sound has faded out completely. The following six screens are available.

- PCH Tune (Pitch Tune)
- PEG VelSens (PEG Velocity Sensitivity)
- PEG Time (PEG Time)
- PEG Level (PEG Level)
- PEG Release (PEG Release)
- PCH Scale (Pitch Scale)

PCH Tune (Pitch Tune)

You can set the tuning parameters and the effectiveness of the Envelope Generator (EG) for each Element.

PCHTune)	EGDepth	Coarse	Fine	Random
EL1234	+63	+ 0	+ 0	+7

■ EGDepth

Set the amount of change applied by the PEG. A setting of zero means the original pitch is not changed.

- Settings:** -64 ~ 0 ~ +63

■ Coarse

Adjust the pitch of each Element in semitones.

□ **Settings:** -48 ~ 0 ~ +48

■ Fine

Fine-tune the pitch of each Element.

□ **Settings:** -64 ~ 0 ~ +63

■ Random

Set the amount by which the pitch of each Element is varied at random for each note you press. A setting of zero means the original pitch is not changed.

□ **Settings:** 0 ~ 127

PEG VelSens (PEG Velocity Sensitivity)

You can determine how the Pitch Envelope Generator (PEG) responds to note velocity.

```
PEGVelSens>      Level  Time-Segment
EL1234           +63      +63  attack
```

■ Level

Set the velocity sensitivity of the PEG Level. Positive settings will cause the level to rise the harder you play the keyboard, and negative values will cause it to fall.

□ **Settings:** -64 ~ 0 ~ +63

■ Time-Segment

Set the velocity sensitivity of the PEG's Time parameters. Use Knob [2] to select the Segment, then use Knob [1] to set its Time parameter. Positive Time settings will play back the specified Segment faster and negative values will play it back slower.

□ **Settings (Time):** -64 ~ 0 ~ +63

□ Settings (Segment):

attack: Affects the Hold Time/Attack Time/Decay 1 Time

all: Affects all PEG Time parameters

PEG Time

You can set various Time parameters for the Pitch Envelope Generator (PEG). Combined with the PEG Level and PEG Release settings, these can be used control the change in sound from the moment a note is pressed on the keyboard to the moment it is released (Page 82). You can set different values for each Element.

```
PEGTime> Hold  Attack  Decay1  Decay2
EL1234   127    127    127    127
```

■ Hold (Hold Time)

Set the Hold Time.

□ **Settings:** 0 ~ 127

■ Attack (Attack Time)

Set the Attack Time.

□ **Settings:** 0 ~ 127

■ Decay1 (Decay 1 Time)

Set the Decay 1 Time.

□ **Settings:** 0 ~ 127

■ Decay2 (Decay 2 Time)

Set the Decay 2 Time.

□ **Settings:** 0 ~ 127

PEG Level

You can set various Level parameters for the Pitch Envelope Generator (PEG). Combined with the PEG Time and PEG Release settings, these can be used control the change in sound from the moment a note is pressed on the keyboard to the moment it is released (Page 82).

You can set different values for each Element.

```
PEGLevel> Hold  Attack  Decay1  Sustain
EL1234    +127    -128    +127    + 0
```

■ Hold (Hold Level)

Set the Hold Level.

□ **Settings:** -128 ~ 0 ~ +127 (-4800 cents ~ 0 ~ +4800 cents)

■ Attack (Attack Level)

Set the Attack Level.

□ **Settings:** -128 ~ 0 ~ +127 (-4800 cents ~ 0 ~ +4800 cents)

■ Decay1 (Decay 1 Level)

Set the Decay 1 Level.

□ **Settings:** -128 ~ 0 ~ +127 (-4800 cents ~ 0 ~ +4800 cents)

■ Sustain (Sustain Level)

Set the Sustain Level.

□ **Settings:** -128 ~ 0 ~ +127 (-4800 cents ~ 0 ~ +4800 cents)

PEG Release

You can set Release Time and Release Level parameters for the Pitch Envelope Generator (PEG). Combined with the PEG Time and PEG Level settings, these can be used control the change in sound from the moment a note is released. You can set different values for each Element.

```
PEGRelease>      Time  Level
EL1234          127  +127
```

■ Time (Release Time)

Set the Release Time.

□ **Settings:** 0 ~ 127

■ Level (Release Level)

Set the Release Level.

□ **Settings:** -128 ~ 0 ~ +127 (-4800 cents ~ 0 ~ +4800 cents)

Pitch Envelope Generator Settings

There are five Time settings (controlling the speed of changes to the sound) and five Level settings (controlling the pitch). The pitch of a note is held at the Hold Level for the length of time defined by the Hold Time. After the Hold Time has elapsed, the pitch changes in accordance with the Attack Time/Level, Decay 1/2 Time and the Decay 1 Level, then settles at the Sustain Level. When the note is released, the change in pitch is governed by the Release Time/Level settings. Velocity Sensitivity and other parameters can also be set if required.

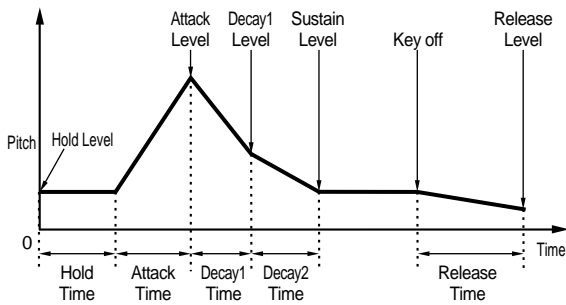

PCH Scale (Pitch Scale)

You can set the Pitch Scaling for each Element. Pitch Scaling is used to vary the Element pitch, PEG Levels and PEG Times according to the positions of the notes on the keyboard.

```
PCH(KeyFlw)Pitch-Center EGTime--Center
EL1234 100% C 3 +7 C 3
```

■ Pitch

Adjust the sensitivity of the Pitch Scaling for each Element according to the position of the note on the keyboard. The Center parameter is used as the basic pitch for this parameter.

A positive setting will cause the pitch of lower notes to change less and that of higher notes to change more. Negative values will have the opposite effect.

□ **Settings:** -200% ~ 0 ~ +200% (At +100%, neighboring notes are pitched one semitone (100 cents) apart.)

■ Center (Center Key)

Set the basic pitch used by the Pitch parameter.

□ **Settings:** C-2 ~ G8

NOTE You can also set this parameter by pressing the respective note on the keyboard while holding down the [SHIFT] key.

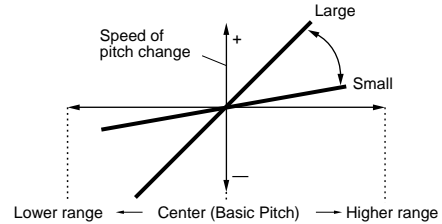

■ EGTime

The EGTime parameter controls the PEG Times for each Element according to the positions of the notes on the keyboard. The Center parameter is used as the basic pitch for this parameter.

A positive setting will cause the pitch of lower notes to change slower and that of higher notes to change faster. Negative values will have the opposite effect.

□ **Settings:** -64 ~ 0 ~ +63

■ Center (Center Key)

Set the basic pitch used by the EGTime parameter. When the Center Key note is played, the PEG behaves according to its actual settings. The pitch change characteristics for other notes will vary in proportion to the EGTime settings.

□ **Settings:** C-2 ~ G8

NOTE You can also set this parameter by pressing the respective note on the keyboard while holding down the [SHIFT] key.

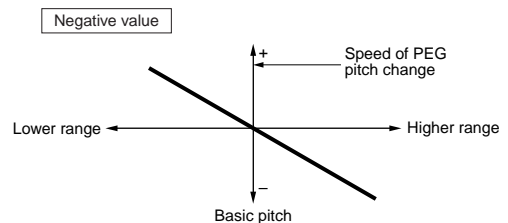
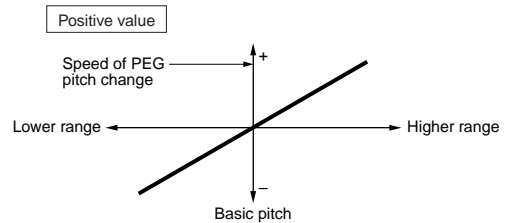

Element Filter

You can set Filter parameters to change the tonal characteristics of each Element. The following ten screens are available.

- FLT Type (Filter Type)
- FLT HPF (High Pass Filter)
- FLT Sens (Filter Sensitivity)
- FEG VelSens (FEG Velocity Sensitivity)
- FEG Time
- FEG Level
- FEG Release
- FLT KeyFlw (Filter Key Follow)
- FLT Scale (Filter Scale Break Point)
- FLT Scale (Filter Scale Offset)

FLT Type (Filter Type)

■ Type

Set the Filter Type. Parameters will vary according to the Type.

FLTType)	Type	Gain	Cutoff	Reso
EL1234	LPF12+HPF	255	255	31

□ Settings:

- LPF12 + HPF (Low Pass Filter 12dB/oct + High Pass Filter),
- LPF24D (Low Pass Filter 24dB/oct Digital),
- LPF24A (Low Pass Filter 24dB/oct Analog),
- LPF18 (Low Pass Filter 18dB/oct),
- LPF18S (Low Pass Filter 18dB/oct Staggered),
- LPF6 + HPF (Low Pass Filter 6dB/oct + High Pass Filter),
- HPF24D (High Pass Filter 24dB/oct Digital),
- HPF12 (High Pass Filter 12dB/oct),
- BPF6 (Band Pass Filter 6dB/oct),
- BPF12D (Band Pass Filter 12dB/oct Digital),
- BPFW (Band Pass Filter Wide),
- BEF6 (Band Elimination Filter 6dB/oct)
- THRU (Bypass)

Filters

To generalize, there are basically four types of filter: an LPF (Low Pass Filter), an HPF (High Pass Filter), a BPF (Band Pass Filter) and a BEF (Band Elimination Filter). Each available filter has a different frequency response. There are also combinations of LPF and HPF.

• LPF (Low Pass Filter):

This only passes signals below the Cutoff frequency. You can then use the Reso (Resonance) parameter to add further character to the sound. Six types of LPF are available.

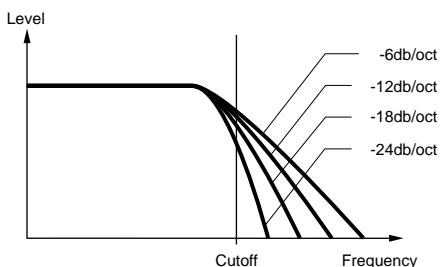

LPF24D (Low Pass Filter 24dB/oct Digital)

A 4-pole (-24db/oct) dynamic LPF with a strong Resonance.

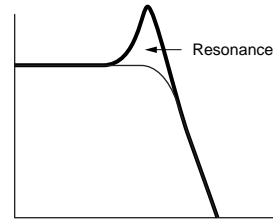

LPF24A (Low Pass Filter 24dB/oct Analog)

A 4-pole (-24db/oct) dynamic LPF with a character similar to those found on analog synthesizers.

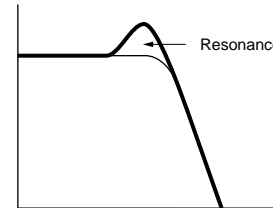

LPF18 (Low Pass Filter 18dB/oct)

A 3-pole (-18db/oct) dynamic LPF.

LPF18S (Low Pass Filter 18dB/oct Staggered)

Also a 3-pole (-18db/oct) dynamic LPF, but with a shallower frequency curve.

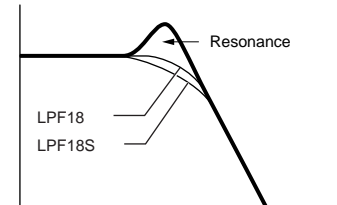

LPF12 (Low Pass Filter 12dB/oct)

A 2-pole (-12db/oct) dynamic LPF, designed to be used in combination with an HPF (High Pass Filter).

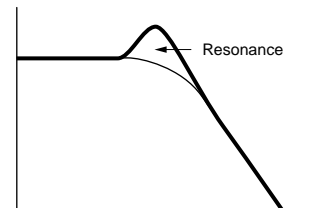

LPF6 (Low Pass Filter 6dB/oct)

A 1-pole (-6db/oct) dynamic LPF with no Resonance, designed to be used in combination with an HPF (High Pass Filter).

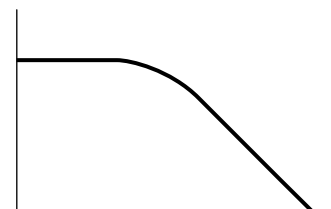

• **HPF (High Pass Filter)**

This only passes signals above the Cutoff frequency. You can then use the Reso (Resonance) parameter to add further character to the sound. Two types of HPF are available.

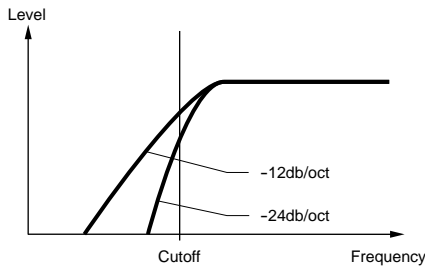

HPF24D (High Pass Filter 24dB/oct Digital),
A 4-pole (-24db/oct) dynamic HPF with a strong Resonance.

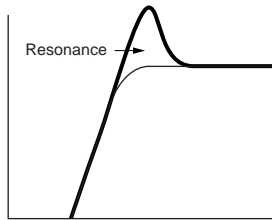

HPF12 (High Pass Filter 12dB/oct),
A 2-pole (-12db/oct) dynamic HPF.

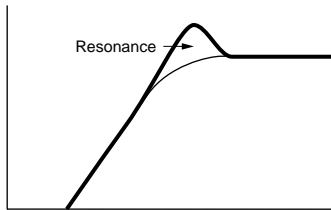

• **BPF (Band Pass Filter)**

This only passes a band of signals around the Cutoff frequency. The width of this band can be varied. Three types of BPF are available.

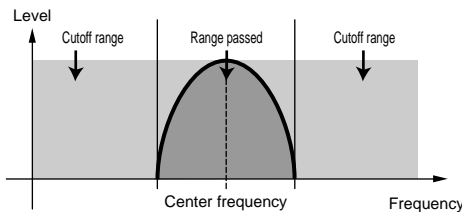

BPF6 (Band Pass Filter 6dB/oct)

The combination of a -6dB/oct HPF and LPF.

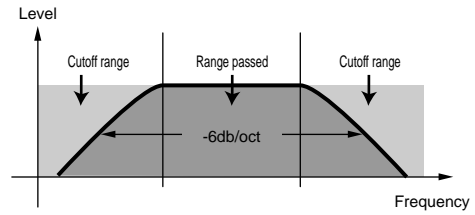

BPF12D (Band Pass Filter 12dB/oct Digital)

The combination of a -12dB/oct HPF and LPF.

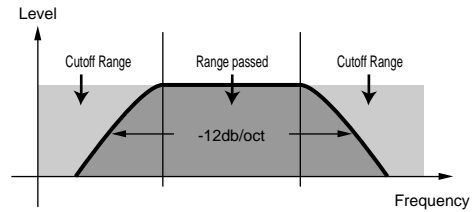

BPFW (Band Pass Filter Wide)

Also the combination of a -12dB/oct HPF and LPF, but can have a wider frequency band than the BPF12D filter.

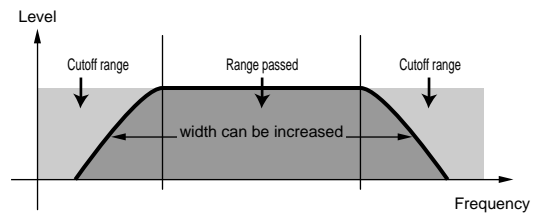

• **BEF (Band Elimination Filter)**

This attenuates a band of signals around the Cutoff frequency, but passes everything else.

BEF6 (Band Elimination Filter 6dB/oct)

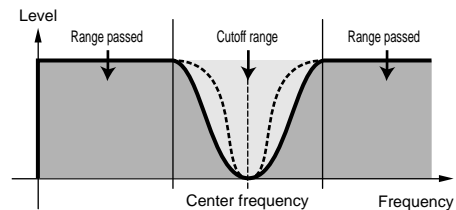

• **THRU**

The filters are bypassed and the entire signal is unaffected.

■ **Gain**

Set the Gain (the amount of boost applied to the signal sent to the Filter Unit).

□ **Settings:** 0 ~ 255

■ Cutoff

Set the Cutoff frequency. This is used as the basic frequency for the selected Filter Type.

□ **Settings:** 0 ~ 255

■ Reso (Resonance)/Band/Width

This parameter's function varies according to the selected Filter Type. If an LPF or HPF has been selected, this parameter is used to set the Resonance. For the BPF (excluding the BPFW) and the BEF, it is used to select the Band. For the BPFW, it is used to adjust the Width of the band.

With the LPF and HPF, the Reso parameter is used to set the amount of Resonance (harmonic emphasis) applied to the signal at the Cutoff frequency. This can be used in combination with the Cutoff frequency parameter to add further character to the sound.

With the BPF, the Band parameter is used to set the range (band) of signal frequencies passed by the filter. With the BEF, it is used to set the band of signal frequencies attenuated by the filter. In both cases, the Cutoff frequency is the center frequency of the band.

With the BPFW, the Width parameter is used to adjust the width of the band of signal frequencies passed by the filter.

□ **Settings:** 0 ~ 31

FLT HPF (High Pass Filter)

You can set the Key Follow parameters for the High Pass Filter. This screen is available only when you have one of the "LPF + HPF" settings for the Type parameter in the Filter Type (FLT Type) screen.

FLT@HPF> EL1234	Cutoff 255	KeyFlw +200%
--------------------	---------------	-----------------

■ Cutoff

Set the center frequency of the Key Follow parameter.

□ **Settings:** 0 ~ 255

■ KeyFlw (Key Follow)

Set the Key Follow for the HPF Cutoff. This parameter varies the center frequency according to the position of the notes played on the keyboard. A positive setting will raise the center frequency for higher notes and lower it for lower notes. A negative setting will have the opposite effect.

□ **Settings:** -200% ~ 0 ~ +200%

FLT Sens (Filter Sensitivity)

You can set Filter Sensitivity parameters for each Element.

FLT@Sens>EGDepth	VelCutoff	VelReso
EL1234 +63	+7	+7

■ EGDepth

Set the sensitivity of the Filter to note velocity. A positive setting will produce large filter changes for notes played harder, and a setting of zero will produce no filter changes at all. With a negative setting, the EG envelope will be inverted.

□ **Settings:** -64 ~ 0 ~ +63

■ VelCutoff (Velocity Cutoff)

Set the sensitivity of the Cutoff frequency to note velocity. A positive setting will raise the Cutoff frequency for notes played harder, and lower it for notes played more softly. A negative setting will have the opposite effect.

□ **Settings:** -64 ~ 0 ~ +63

■ VelReso (Velocity Resonance)

Set the sensitivity of the selected Resonance parameter to note velocity. A positive setting will produce large Resonance changes for notes played harder, and smaller changes for notes played more softly. A negative setting will have the opposite effect.

□ **Settings:** -64 ~ 0 ~ +63

FEG VelSens (FEG Velocity Sensitivity)

You can set parameters controlling the sensitivity of the Filter Envelope Generator (FEG) to note velocity.

FEG@VelSens>	Level	Time-Segment
EL1234	+63	+63 attack

■ Level

Set the sensitivity of the FEG's Level (its effectiveness) to note velocity. A positive setting will cause larger tonal changes for notes played harder and smaller changes for notes played more softly. A negative setting will have the opposite effect.

□ **Settings:** -64 ~ 0 ~ +63

■ Time-Segment

Set the velocity sensitivity of the FEG's Time parameters. Use Knob [2] to select the Segment, then use Knob [1] to set its Time parameter. Positive Time settings will play back the specified Segment faster and negative values will play it back slower.

□ **Settings (Time):** -64 ~ +63

□ Settings (Segment):

attack:

Affects the Hold Time/Attack Time/Decay 1 Time

all:

Affects all FEG Time parameters

FEG Time

You can set various Time parameters for the Filter Envelope Generator (FEG). Combined with the FEG Level and FEG Release settings, these can be used control the change in sound from the moment a note is pressed on the keyboard to the moment it is released. You can set different values for each Element.

```
FEG@Time> Hold  Attack  Decay1  Decay2
EL1234    127    127    127    127
```

■ Hold (Hold Time)

Set the Hold Time.

□ Settings: 0 ~ 127

■ Attack (Attack Time)

Set the Attack Time.

□ Settings: 0 ~ 127

■ Decay1 (Decay 1 Time)

Set the Decay 1 Time.

□ Settings: 0 ~ 127

■ Decay2 (Decay 2 Time)

Set the Decay 2 Time.

□ Settings: 0 ~ 127

FEG Level

You can set a Level parameter for the Filter Envelope Generator (FEG). Combined with the FEG Time and FEG Release settings, these can be used control the change in sound from the moment a note is pressed on the keyboard to the moment it is released. You can set different values for each Element.

```
FEG@Level> Hold  Attack  Decay1  Sustain
EL1234    +127  -128    +127    + 0
```

■ Hold (Hold Level)

Set the Hold Level.

□ Settings: -128 ~ 0 ~ +127 (-9600 cents ~ +9600 cents)

■ Attack (Attack Level)

Set the Attack Level.

□ Settings: -128 ~ 0 ~ +127 (-9600 cents ~ +9600 cents)

■ Decay1 (Decay 1 Level)

Set the Decay 1 Level.

□ Settings: -128 ~ 0 ~ +127 (-9600 cents ~ +9600 cents)

■ Sustain (Sustain Level)

Set the Sustain Level.

□ Settings: -128 ~ 0 ~ +127 (-9600 cents ~ +9600 cents)

FEG Release

You can set Release Time and Release Level parameters for the Filter Envelope Generator (FEG). Combined with the FEG Time and FEG Level settings, these can be used control the change in sound from the moment a note is released.

```
FEG@Release> Time  Level
EL1234      127  +127
```

■ Time (Release Time)

Set the Release Time.

□ Settings: 0 ~ 127

■ Level (Release Level)

Set the Release Level.

□ Settings: -128 ~ 0 ~ +127 (-9600 cents ~ 0 ~ +9600 cents)

Filter Envelope Generator Settings

There are five Time settings (controlling the speed of changes to the sound) and five Level settings (controlling the amount of filtering applied). The tone of a note is held at the Hold Level for the length of time defined by the Hold Time. After the Hold Time has elapsed, the tone changes in accordance with the Attack Time/Level, Decay 1/2 Time and the Decay 1 Level, then settles at the Sustain Level. When the note is released, the change in tone is governed by the Release Time/Level settings.

Velocity Sensitivity and other parameters can also be set if required.

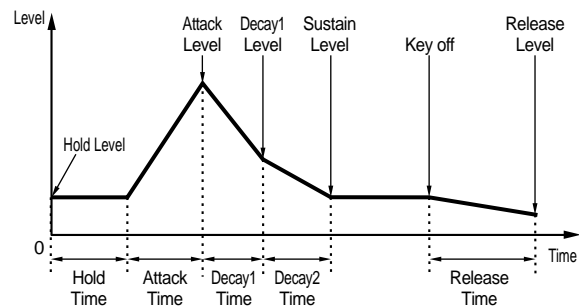

FLT KeyFlw (Filter Key Follow)

You can set Filter Key Follow parameters for each Element. This parameter controls the Filter Cutoff and FEG behavior according to the position of the notes played on the keyboard.

NOTE The availability of the Filter Key Follow parameter depends on the Break Point and Offset settings in the FLT Scale screen.

```
FLT@KeyFlw>Cutoff-Center EGTime--Center
EL1234    +200%  (C 3)    63    C 3
```

■ Cutoff

Set the Filter Key Follow ratio (the amount by which the Filter Cutoff varies according to note position) for each Element. A Center Key setting of C3 is used as the basic setting by the Cutoff parameter. A positive setting will lower the Cutoff frequency for lower notes and raise it for higher notes. A negative setting will have the opposite effect.

□ **Settings:** -200 % ~ 0 ~ +200 %

■ Center (Center Key)

This shows that the basic Level is at note C3. At this note, the tone remains unchanged. For other notes, the tone varies according to the Level settings. The Center setting cannot be changed. This parameter is for information only.

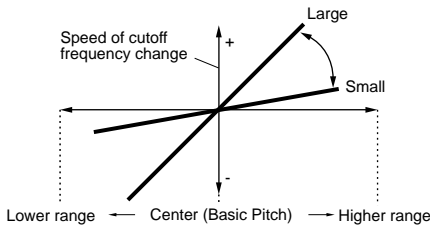

■ EGTime

Set the Time Scale (the speed of change in the FEG over the range of the keyboard) for each Element. The basic speed of change for the FEG is at the note specified in the Center parameter. A positive setting will cause slower changes for lower notes and faster changes for higher notes. A negative setting will have the opposite effect.

□ **Settings:** -64 ~ 0 ~ +63

■ Center (Center Key)

Set the basic note used by the EGTime parameter. When the Center Key note is played, the FEG behaves according to its actual settings. The pitch change characteristics for other notes will vary in proportion to the EGTime settings.

□ **Settings:** C-2 ~ G8

NOTE You can also set this parameter by pressing the respective note on the keyboard while holding down the [SHIFT] key.

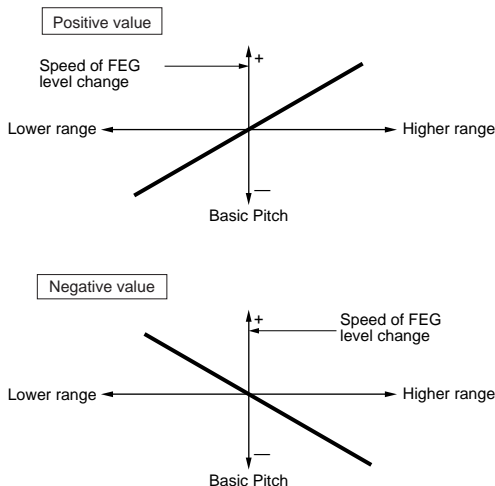

FLT Scale (Filter Scale Break Point)

You can set four Filter Scaling Break Points for each Element. Filter Scaling controls the filter cutoff frequency according to the positions of the notes on the keyboard. There are four Break Points used to divide and assign different settings across the keyboard. The Levels (Offsets) at each of Break Point are set in the FLT Scale screen.

NOTE Details about Filter Scaling are given later in the section “Filter Scaling Settings.”

```
FLTBScale> BP1 BP2 BP3 BP4
EL1234 C-2 C 3 C#5 G 8
```

■ BP1/BP2/BP3/BP4 (Break Point 1/2/3/4)

Set the Break Points for each Element. BP1 to BP4 will be automatically be arranged in ascending order across the keyboard.

□ **Settings:** BP1 to BP4: C-2 ~ G8

FLT Scale (Filter Scale Offset)

```
FLTBScale>Ofst1 Ofst2 Ofst3 Ofst4
EL1234 + 0 +127 -128 + 0
```

■ Ofst1/Ofst2/Ofst3/Ofst4 (Offset 1/2/3/4)

Set the Filter Scaling Offset Levels. These Offsets are used by the Break Points (BP1/BP2/BP3/BP4).

NOTE Details about Filter Scaling are given below in the section “Filter Scaling Settings.”

□ **Settings:** Ofst1 to Ofst4: -128 ~ 0 ~ +127

Filter Scaling Settings

By way of example, you could set the Levels (Offsets) and Break Points (BP1 to BP4) as follows.

```
FLTBScale> BP1 BP2 BP3 BP4
EL1234 E 1 B 2 G 4 A 5
```

```
FLTBScale>Ofst1 Ofst2 Ofst3 Ofst4
EL1234 - 4 + 10 + 17 + 4
```

Here, the current Cutoff setting is 64. The Offsets are -4 at BP1 (set to note E1), +10 at BP2 (set to note B2), +17 at BP3 (set to note G4) and +4 at BP4 (set to A5). That is, the Cutoff frequencies at each Break Point are 60, 74, 81 and 68, respectively. For other notes, the Cutoff frequencies will be on the straight line connecting the two adjacent Break Points.

NOTE The Break Points are automatically arranged in ascending order across the keyboard. For example, BP2 cannot be set to a lower note than that of BP1.

NOTE The Break Point Levels are Offsets used to increase or decrease the current Cutoff setting at the specified notes. Regardless of the size of these Offsets, the minimum and maximum Cutoff limits (values of 0 and 127, respectively) cannot be exceeded.

NOTE A note set below the BP1 will become the BP1 Level. A note set above BP4 will become the BP4 Level.

Element Amplitude

You can set Amplitude parameters to affect the output level of each Element. The following seven screens are available.

AEG VelSens (AEG Velocity Sensitivity)
 AEG Time
 AEG Level
 AEG Release
 AMP KeyFlw (AMP Key Follow)
 AMP Scale (AMP Scale Break Point)
 AMP Scale (AMP Scale Offset)

AEG VelSens (AEG Velocity Sensitivity)

You can set the sensitivity of the Amplitude Envelope Generator (AEG) to note velocity.

```
AEG@VelSens)      Level      Time-Segment
EL1234             +7          +63  attack
```

■ Level

Set the sensitivity of the AEG's Level (its effectiveness) to note velocity. A positive setting will cause larger output level changes for notes played harder and smaller changes for notes played more softly. A negative setting will have the opposite effect.

□ Settings: -64 ~ 0 ~ +63

■ Time-Segment

Set the velocity sensitivity of the AEG's Time parameters. Use Knob [2] to select the Segment, then use Knob [1] to set its Time parameter. Positive Time settings will play back the specified Segment faster and negative values will play it back slower.

□ Settings (Time): -64 ~ 0 ~ +63

□ Settings (Segment):

attack:

Affects the Hold Time/Attack Time/Decay 1 Time

all:

Affects all AEG Time parameters

AEG Time

You can set various Time parameters for the Amplitude Envelope Generator (AEG). Combined with the AEG Level and AEG Release settings, these can be used control the change in output level from the moment a note is pressed on the keyboard to the moment it is released. You can set different values for each Element.

```
AEG@Time)         Attack    Decay1    Decay2
EL1234            127      127      127
```

■ Attack (Attack Time)

Set the Attack Time.

□ Settings: 0 ~ 127

■ Decay1 (Decay 1 Time)

Set the Decay 1 Time.

□ Settings: 0 ~ 127

■ Decay2 (Decay 2 Time)

Set the Decay 2 Time.

□ Settings: 0 ~ 127

AEG Level

You can set various Level parameters for the Amplitude Envelope Generator (AEG). Combined with the AEG Time and AEG Release settings, these can be used control the change in output level from the moment a note is pressed on the keyboard to the moment it is released. You can set different values for each Element.

```
AEG@Level)  Init  Attack  Decay1  Sustain
EL1234      127  (<127>  127      0
```

■ Init (Initial Level)

Set the Initial Level. (The Level when a key is pressed.)

□ Settings: 0 ~ 127

■ Attack (Attack Level)

This shows the Attack Level. (Fixed at 127.)

■ Decay1 (Decay 1 Level)

Set the Decay 1 Level.

□ Settings: 0 ~ 127

■ Sustain (Sustain Level)

Set the Sustain Level.

□ Settings: 0 ~ 127

AEG Release

You can set Release Time and Release Level parameters for the Amplitude Envelope Generator (AEG). Combined with the AEG Time and AEG Level settings, these can be used control the change in output level from the moment a note is released. You can set different values for each Element.

```
AEG@Release)          Time  Level
EL1234                127  (0)
```

■ Time (Release Time)

Set the Release Time.

□ Settings: 0 ~ 127

■ **Level (Release Level)**

This shows the Release Level. (Fixed at zero.)

Amplitude Envelope Generator Settings

There are four Time settings (controlling the speed of changes in output level) and five Level settings (controlling the output level). The output level changes from the Initial Level to the Attack Level (127) within the Attack Time. It then changes in accordance with the Decay 1/2 Time and the Decay 1 Level, and settles at the Sustain Level. When the note is released, the output level falls to the Release Level (zero) within the Release Time. Velocity Sensitivity and other parameters can also be set if required.

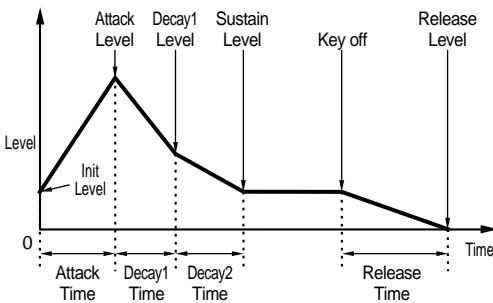

AMP KeyFlw (AMP Key Follow)

You can set Amplitude Key Follow parameters for each Element. This parameter controls the AEG behavior according to the positions of notes on the keyboard.

NOTE The availability of the Amplitude Key Follow parameter depends on the Break Point and Offset settings in the AEG Scale screen.

```
AMPB(KeyFlw)Level-Center  EGTime--Center
EL1234      +200% (C 3)  +63      C 3
```

■ **Level**

Set the Amplitude Key Follow ratio (the amount by which the output level varies according to note position) for each Element. A Center setting of C3 is used as the basic setting. A positive setting will lower the output level for lower notes and raise it for higher notes. A negative setting will have the opposite effect.

□ **Settings:** -200% ~ 0 ~ +200%

■ **Center (Center Key)**

This shows that the basic Level is at note C3. At this note, the output level remains unchanged. For other notes, the output levels vary according to the Level settings. The Center setting cannot be changed.

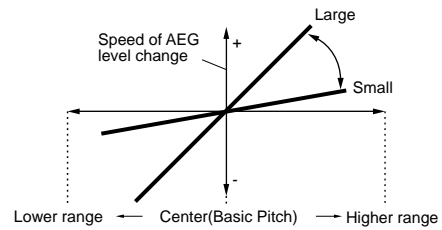

■ **EGTime**

The EGTime parameter controls the AEG Times for each Element according to the positions of the notes on the keyboard. The Center parameter is used as the basic amplitude for this parameter.

A positive setting will cause the amplitude of lower notes to change slower and that of higher notes to change faster. Negative values will have the opposite effect.

□ **Settings:** -64 ~ 0 ~ +63

■ **Center (Center Key)**

Set the basic pitch used by the EGTime parameter. When the Center note is played, the AEG behaves according to its actual settings. The amplitude change characteristics for other notes will vary in proportion to the EGTime settings.

□ **Settings:** C-2 ~ G8

NOTE You can also set this parameter by pressing the respective note on the keyboard while holding down the [SHIFT] key.

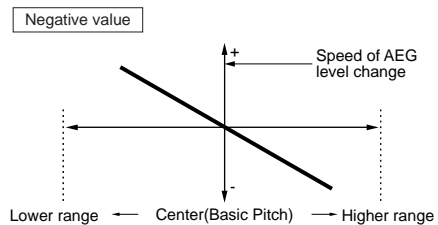
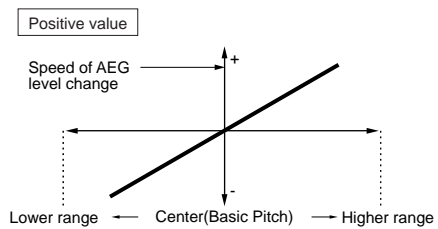

AMP Scale (AMP Scaling Break Point)

You can set four Amplitude Scaling Break Points for each Element. Amplitude Scaling controls the amplitude according to the positions of the notes on the keyboard. There are four Break Points used to divide and assign different settings across the keyboard. The Levels (Offsets) at each of Break Point are set in the AMP Scale screen.

NOTE Details about Amplitude Scaling are given later in the section “Amplitude Scaling Settings.”

NOTE The Levels of the Elements themselves are set in the OSC Out screen (Page 79).

AMPBScale>	BP1	BP2	BP3	BP4
EL1234	C-2	C 3	C#5	G 8

■ BP1/BP2/BP3/BP4 (Break Point1/2/3/4)

Set the Break Points for each Element. BP1 to BP4 will automatically be arranged in ascending order across the keyboard.

Settings: BP1 to BP4: C-2 ~ G8

NOTE You can also set each Break Point by pressing the respective note on the keyboard while holding down the [SHIFT] key.

AMP Scale (AMP Scaling Offset)

AMPBScale>	Ofst1	Ofst2	Ofst3	Ofst4
EL1234	+ 0	+127	-128	+ 0

■ Ofst1/Ofst2/Ofst3/Ofst4 (Offset 1/2/3/4)

Set the Amplitude Scaling Offset Levels. These Offsets are used by the Break Points (BP1/BP2/BP3/BP4).

NOTE Details about Amplitude Scaling are given later in the section “Amplitude Scaling Settings.”

Settings: Ofst1 to Ofst4: -128 ~ 0 ~ +127

Amplitude Scaling Settings

By way of example, you could set the Levels (Offsets) and Break Points (BP1 to 4) as follows.

AMPBScale>	BP1	BP2	BP3	BP4
EL1234	E 1	B 2	G 4	A 5

AMPBScale>	Ofst1	Ofst2	Ofst3	Ofst4
EL1234	- 4	+ 10	+ 17	+ 4

Here, the current amplitude is 80. The Offsets are -4 at BP1 (set to note E1), +10 at BP2 (set to note B2), +17 at BP3 (set to note G4) and +4 at BP4 (set to A5). That is, the amplitudes at each Break Point are 76, 90, 97 and 84, respectively. For other notes, the amplitudes will be on the straight line connecting the two adjacent Break Points.

NOTE The Break Points are automatically arranged in ascending order across the keyboard. For example, BP2 cannot be set to a lower note than that of BP1.

NOTE The Break Point Levels are Offsets used to increase or decrease the current amplitude at the specified notes. Regardless of the size of these Offsets, the minimum and maximum amplitude limits (values of 0 and 127, respectively) cannot be breached.

NOTE A note set below the BP1 will become the BP1 Level. A note set above BP4 will become the BP4 Level.

Element LFO (Low Frequency Oscillator)

There are various settings for the LFO. The LFO is used to generate low frequency signals and can be used to create vibrato/wah/tremolo/etc. effects when applied to pitch/filter/amplitude parameters. Different LFO parameters can be set for each Element. The following two screens are available.

LFO Wave
LFO Depth

LFO Wave

You can set various parameters controlling the LFO waveform. Select the waveform used by the LFO and set the speed of change.

LFOBWave>	Wave^v	Speed	KeySync
EL1234	tri	63	on

■ Wave

Select the LFO waveform used to vary the sound. There are three waveforms available.

Settings: saw, tri, squ

saw (sawtooth wave)

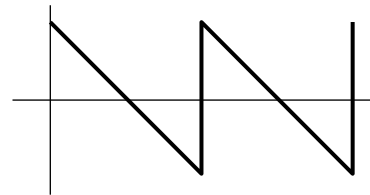

tri (triangle wave)

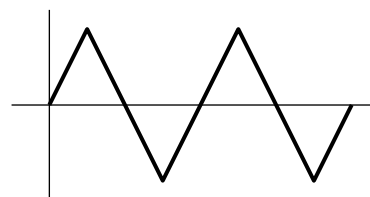

squ (square wave)

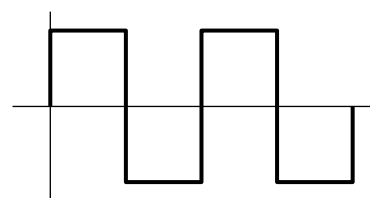

Speed

Set the speed of the LFO waveform. A larger setting means a faster speed.

Settings: 0 ~ 63

Speed = Fast

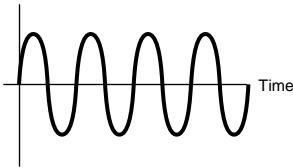

Speed = Slow

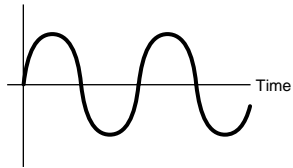

KeySync

Switch Key Sync on or off. When switched on, the LFO waveform is reset every time a note is played.

Settings: off, on

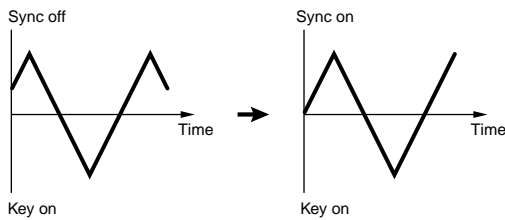

LFO Depth

Set the amount by which the LFO waveform controls changes in Pitch/Filter/Amp settings.

```
LFOBDepth)      PMod      FMod      AMod
EL1234          127       127       127
```

PMod (Pitch Modulation Depth)

Set the amount (depth) by which the LFO waveform varies (modulates) the pitch of the sound. A larger setting means a larger modulation depth.

Settings: 0 ~ 127

FMod (Filter Modulation Depth)

Set the amount (depth) by which the LFO waveform varies (modulates) the Filter Cutoff frequency. A larger setting means a larger modulation depth.

Settings: 0 ~ 127

AMod (Amplitude Modulation Depth)

Set the amount (depth) by which the LFO waveform varies (modulates) the amplitude of the sound. A larger setting means a larger modulation depth.

Settings: 0 ~ 127

Element EQ (Equalizer)

You can set the following two Equalizer parameters for each Element.

EQ Type

EQ Param (EQ Parameter)

EQ Type

```
EQBType)      Type
EL1-3*        EQ L/H
```

Type

Select the Equalizer Type. Various Equalizers are available which can be used not just for altering existing sounds, but also in generating completely new sounds.

Some items in the following EQ Param (EQ Parameter) screen may or may not be available, depending on the selected Equalizer Type

Settings: EQ L/H (EQ Low/High), P.EQ (Parametric EQ), Boost6 (Boost 6dB), Boost12 (Boost 12dB), Boost18 (Boost 18dB), thru

The parameters for the Filter Type are as follows.

EQ L/H (EQ Low/High)

This is a Shelving Equalizer which combines a High Frequency and Low Frequency Band to adjust the signal Level. If you select this Filter, the EQ Parameter screen will be available with the following parameters.

```
EQBParam)LoFreq LoGain HiFreq HiGain
EL1-3* 257.0Hz +32 6.25kHz +32
```

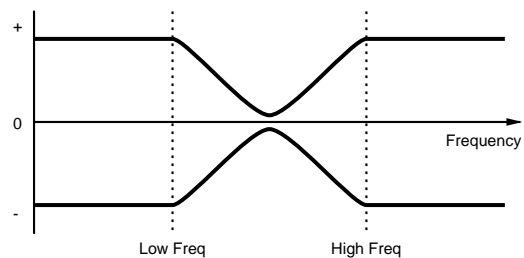

LoFreq (Low Frequency)

Set the low frequency of the Shelving filter. Frequencies below this point are attenuated or boosted by the Low Gain parameter.

□ Settings: 50.1Hz ~ 2.00kHz

LoGain (Low Gain)

Set the amount by which the frequencies below the Low Frequency setting are attenuated or boosted.

□ Settings: -32 ~ 0 ~ +32

HiFreq (High Frequency)

Set the high frequency of the Shelving filter. Frequencies above this point are attenuated or boosted by the High Gain parameter.

□ Settings: 503.8Hz ~ 10.1kHz

HiGain (High Gain)

Set the amount by which the frequencies above the High Frequency setting are attenuated or boosted.

□ Settings: -32 ~ 0 ~ +32

P.EQ (Parametric EQ)

The Parametric EQ is used to attenuate or boost signal levels around the Frequency setting by the amount specified in the Gain setting. 32 different Frequency Characteristics are available. The following parameters are available for this type of Equalizer.

EQBParam)	Freq	Gain	Q
EL1-3*	255	+32	31

EQ Param (EQ Parameter)

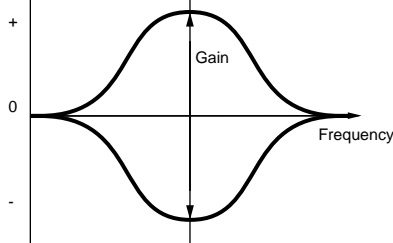

Freq (Frequency)

Set the center frequency. Frequencies around this point are attenuated/boosted by the Gain setting.

□ Settings: 139.7Hz ~ 12.9kHz

Gain

Set the Gain. This attenuates or boosts frequencies around the Frequency setting.

□ Settings: -32 ~ 0 ~ +32

Q (Frequency Characteristic)

Set the Q (Frequency Characteristic). 32 different Characteristics are available.

□ Settings: 0 ~ 31

Boost6 (Boost 6dB)/Boost12 (Boost 12dB)/Boost18 (Boost 18dB)

These can be used to boost the level of the entire signal by 6dB, 12dB and 18dB, respectively. The EQ Parameters will be unavailable.

thru

If you select this, the equalizers are bypassed and the entire signal is unaffected.

Drum Voices

With Drum Voices, different drum and percussion Waves or Normal Voices are assigned to notes across the keyboard (from C0 to C6) forming an entire drum kit. For editing Drum Voices, there are five Common Edit screens (affecting all the Drum Voices together) and the five Drum Key screens.

When you select a Drum Voice and enter Voice Edit Mode, you will see the Drum Voice Edit screen at which you were previously editing.

NOTE An overview of the Drum Voices is given on Page 37.

Most parameters have already been explained for Normal Voices. (The gray items in the tree diagram.) Those parameters not previously covered are explained here.

NOTE Details about the functions common to both Drum Voices and Normal Voices are given in the section “Normal Voices” (Page 69).

Voice Edit (Drum)

- Drum Common
 - Drum Common General _____ 70
 - GEN Name (General Name) _____ 70
 - Drum Common Quick Edit _____ 71
 - QED Level (Quick Edit Level) _____ 71
 - QED EffectCtrl (Quick Edit Effect) _____ 71
 - QED Filter (Quick Edit Filter) _____ 72
 - QED EG (Quick Edit Envelope Generator) _____ 93
 - Drum Common Arpeggio _____ 72
 - ARP Type (Arpeggio Type) _____ 72
 - ARP Limit (Arpeggio Note Limit) _____ 73
 - ARP Mode (Arpeggio Mode) _____ 73
 - ARP PlayEF (Arpeggio Play Effects) _____ 73
 - Drum Common Controllers _____ 74
 - CTL Bend (Pitch Bend) _____ 74
 - CTL Set1 (Control Set 1) _____ 74
 - CTL Set2 (Control Set 2) _____ 74
 - CTL Set3 (Control Set 3) _____ 74
 - CTL Set4 (Control Set 4) _____ 74
 - CTL Set5 (Control Set 5) _____ 74
 - CTL Set6 (Control Set 6) _____ 74
 - Drum Common Effects _____ 78
 - EFF InsEF (Insertion Effects) _____ 78
 - EFF EF1 (Insertion Effect 1) _____ 78
 - EFF EF2 (Insertion Effect 2) _____ 78
 - EFF Rev (Reverb) _____ 79
 - EFF Cho (Chorus) _____ 79
- Drum Key
 - Drum Key OSC (Oscillator) _____ 94
 - OSC Wave (Oscillator Wave) _____ 94
 - OSC Out (Oscillator Out) _____ 95
 - OSC Pan (Oscillator Pan) _____ 95
 - OSC Other (Oscillator Other) _____ 95

- Drum Key Pitch _____ 96
 - └ PCH Tune (Pitch Tune) _____ 96
- Drum Key Filter _____ 96
 - └ FLT Cutoff (Filter Cutoff) _____ 96
- Drum Key Amplitude _____ 96
 - └ AMP AEG (Amplitude Envelope Generator) _____ 97
 - └ AMP VelSens (Amplitude Velocity Sensitivity) _____ 97
- Drum Key EQ (Equalizer) _____ 91
 - └ EQ Type (EQ Type) _____ 91
 - └ EQ Param (EQ Parameter) _____ 91

Drum Common Edit and Drum Key Edit

Each Drum Voice consists of multiple Waves or Normal Voices assigned to notes across the keyboard (C0 to C6) (Page 37). You can use Drum Common Edit for settings that apply to all Drum Keys in the Drum Voice. For individual Waves or Normal Voices settings, Drum Key Edit consists of Edit screens for each Wave or Normal Voice. With Drum Voice Edit, you can use Knob [A] to switch between the Drum Common Edit and Drum Key Edit screens.

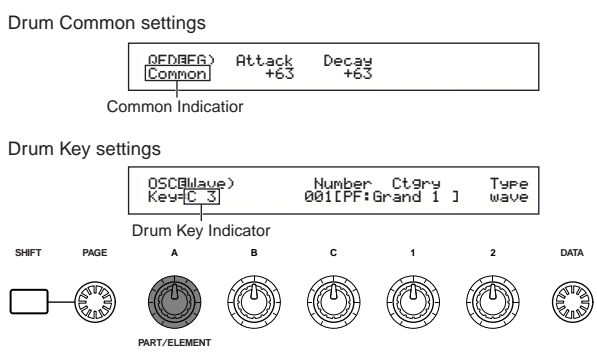

Menu Display

The following is displayed if you turn the [PAGE] knob while holding down the [SHIFT] key. The menus for the settings are shown below. Use the [PAGE] knob to move the cursor to the item you are looking for. Then release the [SHIFT] key to jump to the screen at which you were previously editing the item.

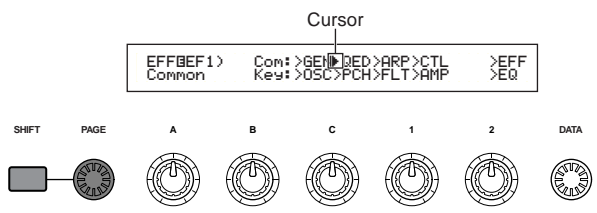

NOTE The [PROGRAM/PART] keys on the S80 can directly select Menus associated to them (Page 70).

Drum Common General

For Drum Voices, there is only the one type of Common General shown below. The parameters and settings are the same as for Normal Voices. Details are given on Page 70.

GEN Name (General Name)

Drum Common Quick Edit

The following four screens are available for Drum Voice output level and timbre parameters.

- QED Level (Quick Edit Level)
- QED EffectCtrl (Quick Edit Effect)
- QED Filter (Quick Edit Filter)
- QED EG (Quick Edit Envelope Generator)

QED Level (Quick Edit Level)

Most parameters and settings have already been explained for Normal Voices. Details are given on Page 71.

QED EffectCtrl (Quick Edit Effect)

Most parameters and settings have already been explained for Normal Voices. Details are given on Page 71.

QED Filter (Quick Edit Filter)

Most parameters and settings have already been explained for Normal Voices. Details are given on Page 72.

QED EG (Quick Edit Envelope Generator)

The EG (Envelope Generator) can be used to set the transition in the Drum Voice output level over time. The EG has two parameters determining how the output level of the sound changes from the point at which a note is pressed to the point at which the sound has completely faded out.

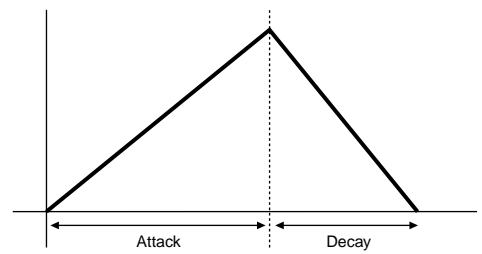
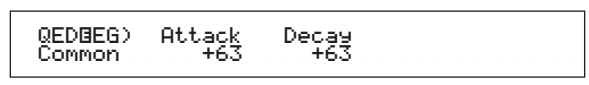

■ Attack

Set the Attack time (the time from the moment the note is pressed to the point at which the maximum sound output level is reached).

□ **Settings:** -64 ~ 0 ~ +63

■ Decay

Set the Decay time (the time from the point of maximum sound output level to the point at which it has completely faded out).

□ **Settings:** -64 ~ 0 ~ +63

Drum Common Arpeggio

The following four screens are available for Drum Voice arpeggio parameters. The parameters and settings are the same as for Normal Voices. Details are given on Page 72.

ARP Type (Arpeggio Type)

ARP Limit (Arpeggio Note Limit)

ARP Mode (Arpeggio Mode)

ARP PlayEF (Arpeggio Play Effect)

Drum Common Controllers

Set your Control Settings here. Up to six controllers plus the Pitch Bend wheel can be assigned to each Drum Voice. The following seven screens are available. (The parameter names for all Control Set screens are the same.)

CTL Bend (Pitch Bend)

CTL Set1 (Control Set 1)

CTL Set2 (Control Set 2)

CTL Set3 (Control Set 3)

CTL Set4 (Control Set 4)

CTL Set5 (Control Set 5)

CTL Set6 (Control Set 6)

The parameters are the same as for Normal Voices. Details are given on Page 74. (The Elem Sw parameter is only available for Normal Voices.)

Drum Common Effects

For Drum Voice Effects, there are two Insertion Effects, plus System Effects (Reverb and Chorus). The following five screens are available. The parameters and settings are the same as for Normal Voices. Details are given on Page 78.

EFF InsEF (Insertion Effect)

EFF EF1 (Insertion Effect 1)

EFF EF2 (Insertion Effect 2)

EFF Rev (Reverb)

EFF Cho (Chorus)

Drum Key OSC (Oscillator)

You can change your Drum Voice waveform settings. Each Drum Voice can consist of up to 73 Drum Keys (Page 37), assigned to notes spread across the keyboard (C0 to C6). You can assign waveforms to Drum Keys and set their parameters. The following four screens are available.

OSC Wave (Oscillator Wave)

OSC Out (Oscillator Out)

OSC Pan (Oscillator Pan)

OSC Other (Oscillator Other)

OSC Wave (Oscillator Wave)

Assign a Wave/Normal Voice to each Drum Key. Use Knob [A] (or press a note on the keyboard) to select the Drum Key, and use Knob [C] to select the Wave/Normal Voice assigned to it.

OSC(Wave)	Mem	Number	Ctgr	Type
Key=C 3	PRE1	001	PF:Grand 1	vce

■ Mem (Memory)

This is displayed when you have selected “vce” (Normal Voice) as the Type parameter. Select the Voice Memory for the Normal Voice.

□ **Settings:** PRE1, PRE2, INT, EXT

NOTE You cannot select Plug-in Voices.

■ Number (Wave Number)

Select a Wave/Normal Voice Number. The Category and Name are shown to the right of the selected Wave/Normal Voice Number. The selection of Waves/Normal Voices varies according to the Type.

□ **Settings:** 000(off) ~ 553 for wave, 001 ~ 128 for Normal Voice (Details about each Wave/Normal Voice are given in the separate Data List).

NOTE If you choose “off,” no Wave/Normal Voice will be assigned to the Drum Key.

■ Ctgr (Category)

Select the Category of the Wave/Normal Voice. If you switch to another Category, the first Wave/Normal Voice in that Category will be selected.

□ **Settings:** Details about the Categories are given as a list on Page 70.

■ Type

Select Wave or Normal Voice as the Type. With the Number and Ctgr parameters (above), you can specify the waveform or Normal Voice used by the Type.

□ **Settings:** wave, vce (Normal Voice)

OSC Out (Oscillator Out)

Set the Wave or Normal Voice output settings for each Drum Key.

```
OSCBOut)  Level  InsEF RevSend ChoSend
Key=C 3    127 thru    64    127
```

■ Level

Set the output level for each Wave or Normal Voice. This can be used to adjust the output of each Drum Key.

□ **Settings:** 0 ~ 127

■ InsEF (Insertion Effect)

Select the Insertion Effect to which the output of each Drum Key will be sent. If Thru is selected, the Insertion Effects are bypassed.

□ **Settings:** thru, ins1 (Insertion Effect 1), ins2 (Insertion Effect 2)

■ RevSend (Reverb Send)

Set the Send level of the Drum Key signal sent from Insertion Effect 1/2 (or the bypassed signal) to the Reverb effect.

□ **Settings:** 0 ~ 127

NOTE This setting plus the Reverb Send level set in the QED Level screen (Page 71) are the final Reverb Send level settings.

NOTE Details about the Effects are given on Page 55.

■ ChoSend (Chorus Send)

Set the Send level of the Drum Key signal sent from Insertion Effect 1/2 (or the bypassed signal) to the Chorus effect.

□ **Settings:** 0 ~ 127

NOTE This setting plus the Chorus Send level set in the QED Level screen (Page 71) are the final Chorus Send level settings.

NOTE For a Drum Key with the Insertion Effect set to other than Thru, the Chorus Send level will be determined by the QED Level screen.

NOTE Details about the Effects are given on Page 55.

OSC Pan (Oscillator Pan)

Assign Pan settings for each Drum Key in the Drum Voice. Different Pan types are available.

NOTE The Pan, Alter (Alternate) and Random settings will be ignored if you set the output to “ind1” to “ind6.”

```
OSCBPan)  Pan  Alter  Random  Output
Key=C 3    C    L63    63    L&R
```

■ Pan

Set the Pan position for each sound in a Drum Voice (Drum Kit). This will also be used as the basic Pan position for the Alternate and Random settings.

□ **Settings:** L63 (Left) ~ C (Center) ~ R63 (Right)

■ Alter (Alternate)

Set the amount by which the sound is panned alternately left and right for each note you press. The Pan setting is used as the basic Pan position.

□ **Settings:** L64 (Left) ~ 0 (Center) ~ R63 (Right)

NOTE This parameter is only available if the Type parameter in the OSC Wave screen is set to “wave.” If set to “vce” (Normal Voice), this parameter is unavailable.

■ Random

Set the amount by which the sound is panned randomly left and right for each note you press. The Pan setting is used as the basic Pan position.

□ **Settings:** 0 ~ 127

NOTE This parameter is only available if the Type parameter in the OSC Wave screen is set to “wave.”

■ Output

Assign each Drum Key to an output.

□ **Settings:** L&R (OUTPUT L & R), ind1&2 (INDIVIDUAL OUTPUT 1 & 2), ind1 (INDIVIDUAL OUTPUT 1), ind2, ind3, ind4, ind5, ind6

NOTE Settings “ind3” to “ind6” are for future expansion purposes and are currently not available.

NOTE For example, if you choose “ind1&2,” the left channel will be output through INDIVIDUAL OUTPUT1 and the right channel will be output through INDIVIDUAL OUTPUT2.

OSC Other (Oscillator Other)

You can set parameters which govern the sound of each Drum Key making up the Drum Voice.

```
OSCBOther)  Assign  RcvNtOff  AltGrp
Key=C 3      single    on        off
```

■ Assign

Set Key Assign to “single” to prevent the doubled playback of the same received notes. Select “multi” to consecutively assign each instance of the same received note to a separate channel.

□ **Settings:** single, multi

NOTE When the Alternate Group (AltGrp) parameter is set to other than “off,” you cannot set this parameter (shown as “----”).

■ RevNtOff (Receive Note Off)

Select whether MIDI Note Off messages are received by each Drum Key.

Settings: off, on

NOTE This parameter depends on the Type of Drum Key Wave chosen in the OSC Wave screen.

■ AltGrp (Alternate Group)

Set the Alternate Group to which the Wave is assigned. In a real drum kit, some drum sounds cannot physically be played simultaneously, such as open and closed hi-hats. You can prevent Waves from playing back simultaneously by assigning them to the same Alternate Group. Up to 127 Alternate Groups can be defined. You can also select “off” here if you wish to allow the simultaneous playback of sounds.

Settings: off, 1 ~ 127

Drum Key Pitch

Set the pitch of each Drum Key. The tunings and Pitch EG parameters can be set for each Drum Key.

PCH Tune (Pitch Tune)

PCHBTune>	Coarse	Fine	VelSens
Key=C 3	+ 0	+ 0	+63

■ Coarse

Adjust the pitch of each Drum Key Wave (or Normal Voice) in semitones.

Settings: -48 ~ +48

NOTE For a Normal Voice, this parameter adjusts the position of its note (not its pitch) relative to note C3. For example, let's assume the original Voice consists of a two-Element piano-like sound up to note C3 and a two-Element string-like sound from note C#3 upwards. Adjusting this Coarse setting by +1 would not change the pitch of the piano-like sound to C#3. Instead, note C#3 of the original Voice (i.e., the string-like sound) would be used.

■ Fine

Fine-tune the pitch of each Drum Key Wave (or Normal Voice).

Settings: -64 ~ +63

■ VelSens (Velocity Sensitivity)

Set the velocity sensitivity of the pitch. Positive settings will cause the pitch to rise the harder you play the keyboard and negative settings will cause it to fall.

Settings: -64 ~ 0 ~ +63

NOTE This parameter is only available if the Type parameter in the OSC Wave screen is set to “wave.”

Drum Key Filter

You can apply filter settings to the Drum Voice. A Low Pass Filter and High Pass Filter can be applied per Wave to change its tonal characteristics.

NOTE This parameter is only available if the Type parameter in the OSC Wave screen is set to “wave.”

FLT Cutoff (Filter Cutoff)

FLTBCutoff>	LPF	VelSens	Reso	HPF
Key=C 3	255	+63	31	0

■ LPF (Low Pass Filter)

Set the Cutoff frequency of the Low Pass Filter. Only frequencies below this point are passed. You can then use the Reso (Resonance) parameter to add further character to the sound.

Settings: 0 ~ 255

NOTE Details about the Low Pass Filter are given on Page 83.

■ VelSens (Velocity Sensitivity)

Set the velocity sensitivity of the Low Pass Filter Cutoff frequency. Positive settings will cause the cutoff frequency to rise the harder you play the keyboard and negative settings will cause it to fall.

Settings: -64 ~ 0 ~ +63

■ Reso (Resonance)

Set the amount of Resonance (harmonic emphasis) applied to the signal at the Cutoff frequency. This can be used in combination with the Cutoff frequency of the Low Pass Filter to add further character to the sound.

Settings: 0 ~ 31

NOTE Details about Resonance are given on Page 85.

■ HPF (High Pass Filter)

Set the Cutoff frequency of the High Pass Filter. Only frequencies above this point are passed.

Settings: 0 ~ 255

NOTE Details about the High Pass Filter are given on Page 84.

Drum Key Amplitude

You can set amplitude (output level) parameters for each Drum Key. The following two parameters are available.

NOTE This parameter is only available if the Type parameter in the OSC Wave screen is set to “wave.”

AMP AEG (Amplitude Envelope Generator)
AMP VelSens (Amplitude Velocity Sensitivity)

■ AMP AEG (Amplitude Envelope Generator)

The Amplitude Envelope Generator controls the change in amplitude from the moment a note is pressed on the keyboard to the moment it is released. By setting the Attack Time, Decay 1 Time and the Decay 1/2 Level, you can determine how fast the sound reaches its peak amplitude and how it fades out. Parameters can be set for each Drum Key.

NOTE This parameter is only available if the Type parameter in the OSC Wave screen is set to “wave.”

```
AMPBAEG) Attack  Decay1---Level  Decay2
Key=C 3      127      127      127      126
```

■ Attack (Attack Time)

Set the Attack Time.

□ Settings: 0 ~ 127

■ Decay1 (Decay 1 Time)

Set the Decay Time.

□ Settings: 0 ~ 127

■ Level (Decay 1 Level)

Set the Decay 1 Level.

□ Settings: 0 ~ 127

■ Decay2 (Decay 2 Time)

Set the Decay 2 Time.

If you select “hold,” the level amplitude will be held until you release the note.

□ Settings: 0 ~ 126, hold

AMP VelSens (Amplitude Velocity Sensitivity)

You can define how the amplitude (output level) varies according to the velocity of the received notes.

```
AMPBVelSens) Level
Key=C 3      +63
```

■ Level

Set the velocity sensitivity of the Amplitude Envelope Generator’s output level. Positive settings will cause the output level to rise the harder you play the keyboard and, conversely, negative values will cause it to fall.

□ Settings: -64 ~ 0 ~ +63

Amplitude Envelope Generator Settings

The Amplitude Envelope Generator has three Time parameters and one Level parameter. These govern the transitions between output levels for the duration of a note. The Attack Time is the time taken for the sound to reach its peak output level from the moment a note is played on the keyboard. The Decay 1/2 Time and the Decay 1 Level parameters are used to set the behavior of the remainder (between the sound’s peak output level and the point at which it fades to zero). Furthermore, you can set these parameters to be sensitive to note velocity.

NOTE The Attack Level is fixed at its maximum value.

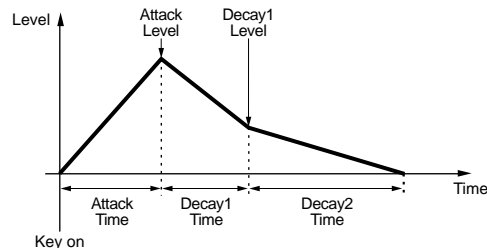

Decay2 = hold

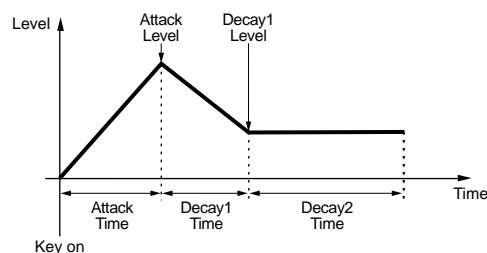

Drum Key EQ (Equalizer)

You can set Equalizer parameters for each Drum Key. The following two screens are available. These parameters are the same as for Normal Voices; details are given on Page 91.

EQ Type

EQ Param (EQ Parameter)

NOTE This parameter is only available if the Type parameter in the OSC Wave screen is set to “wave.”

Plug-in Voices

The Voices held on Plug-in Boards (Single Part) are known as Board Voices. A Plug-in Voice is a Board Voice that has been processed in the synthesizer in Voice Edit Mode. There are six Common Edit screens and four screens for editing the Element of a Plug-in Voice. You can save up to 64 edited Plug-in Voices in Banks A to D of Memory PLG1/2.

After selecting the Plug-in Voice you wish to edit (in Banks A to D of Memory PLG1/2), when you enter Voice Edit Mode, you will see the Voice Edit Mode screen that you had exited from previously.

Monitoring Board Voices

You can monitor Board Voices without having to enter Edit Mode. Also, if you press the [EDIT] key while monitoring, you will enter Edit Mode with the oscillators of the Board Voice already assigned.

- While holding down the [PLG1] or [PLG2] key, use Knob [C] to select the Board Voice's Bank. "PLG INT" is the Bank of the Plug-in Voice (Plug-in Internal) stored in Memory PLG1/2.
- Release the [PLG1] or [PLG2] key. Select the Board Voice using the BANK/PROGRAM keys or [DATA] knob as in the same way to select a Voice from another memory.

NOTE If there is no Voice at the Program Number corresponding with the selected Bank, no sound will be produced.

NOTE To edit the Board Voices on the Plug-in Board, you need to use a computer and the included editor software.

NOTE Details about Plug-in Voices and Board Voices are given on Pages 32, 104.

Many parameters are the same as for Normal Voices (the gray items in the tree diagram). Only those items that differ are explained here.

NOTE Details about the other parameters are given in the Normal Voice explanation on Page 69.

Plug-in Voices

- Plug-in Common
 - Plug-in Common General 70
 - GEN Name (General Name) 70
 - GEN Other (General Other) 99
 - Plug-in Common Quick Edit 71
 - QED Level (Quick Edit Level) 71
 - QED EffectCtrl (Quick Edit Effect) 71
 - QED Filter (Quick Edit Filter) 72
 - QED EG (Quick Edit Envelope Generator) 99
 - Plug-in Common Arpeggio 72
 - ARP Type (Arpeggio Type) 72
 - ARP Limit (Arpeggio Note Limit) 73
 - ARP Mode (Arpeggio Mode) 73
 - ARP PlayEF (Arpeggio Play Effect) 73
 - Plug-in Common Controller 100
 - CTL Pitch (Pitch Bend) 100
 - CTL Set1 (Control Set 1) 100
 - CTL Set2 (Control Set 2) 100
 - CTL MW Control (MW Control Depth) 100
 - CTL MW Modulation (MW Modulation Depth) 100
 - CTL AT Control (AT Control Depth) 100
 - CTL AT Modulation (AT Modulation Depth) 101
 - CTL AC Control (AC Control Depth) 101

- CTL AC Modulation (AC Modulation Depth) 101
- Plug-in Common LFO (Low Frequency Oscillator) 101
 - LFO Param (LFO Parameter) 101
- Plug-in Common Effect 78
 - EFF InsEF1 (Insertion Effect) 78
 - EFF Rev (Reverb) 79
 - EFF Cho (Chorus) 79
- Plug-in Element
 - Plug-in Element OSC (Oscillator) 102
 - OSC Assign (Oscillator Assign) 102
 - OSC Velocity (Oscillator Velocity) 102
 - Plug-in Element Pitch 102
 - PCH PEG (Pitch Envelope Generator) 103
 - Plug-in Element EQ (Equalizer) 103
 - EQ Param (EQ Parameter) 103
 - Plug-in Element Native 103
 - PLG-NATIVE (Plug-in Native) 103

Plug-in Common Edit and Editing Each Element

There are two edit screens for a Plug-in Voice. One is for general Voice settings called Plug-in Common, and the other is for element settings called Plug-in Element. There is only one element available for a Plug-in Voice, but you can make access to parameters in Plug-in Common and Element screens, which are similar to ones for a normal Voice.

In Plug-in Voice editing, you can switch between the Common and Element screens using the Knob [A].

Plug-in Common Edit Screens

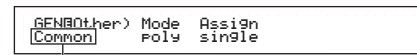

Common Indicator

Plug-in Element Edit Screens



Plug-in Element Indicator

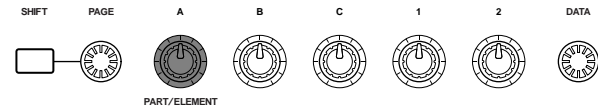

Menu Display

When you use the [PAGE] knob while holding down the [SHIFT] key, you will see the following Menu Display. Then use the [PAGE] knob to move the cursor to the desired item and release the [SHIFT] key to jump to the Edit screen for the selected item.

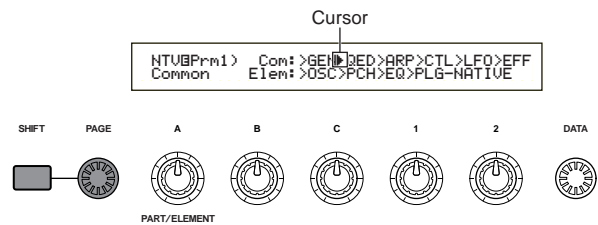

NOTE The [PROGRAM/PART] keys on the S80 can directly select Menus associated to them (page 70).

Plug-in Common General

The General parameters are shown in the following two screens.

GEN Name (General Name)
GEN Other (General Other)

GEN Name (General Name)

The parameters and settings are the same as for Normal Voices. See Page 70 for further details.

GEN Other (General Other)

There are parameters available for Plug-in Board.

```
GENBOther> Mode Assign
Common      Poly single
```

■ Mode

Select monophonic or polyphonic playback. Select whether the Voice is played back monophonically (single notes only) or polyphonically (multiple simultaneous notes).

□ **Settings:** mono, poly

■ Assign

If you set Key Assign to “single,” the doubled playback of the same note is prevented. The synthesizer will terminate a note when the same note is received again. If you select “multi,” the synthesizer will consecutively assign each instance of the same received note to a separate channel, making multiple part tone generation possible.

□ **Settings:** single, multi

Plug-in Common Quick Edit

The parameters here are primarily for Plug-in Voice volume and tone. The following four screens are available.

QED Level (Quick Edit Level)
QED EffectCtrl (Quick Edit Effect)
QED Filter (Quick Edit Filter)
QED EG (Quick Edit Envelope Generator)

QED Level (Quick Edit Level)

The parameters and settings are the same as for Normal Voices. Details are given on Page 71.

QED EffectCtrl (Quick Edit Effect)

The parameters and settings are the same as for Normal Voices. Details are given on Page 71.

QED Filter (Quick Edit Filter)

The parameters and settings are the same as for Normal Voices. Details are given on Page 72.

QED EG (Quick Edit Envelope Generator)

The EG (Envelope Generator) can be used to control the change in Plug-in Voice volume over time. There are three parameters for this EG, controlling the change in volume from the moment a note is pressed on the keyboard to the moment it is released, or to the point where it has faded to zero.

```
QEDBEG> Attack Decay Release
Common  +63 +63 +63
```

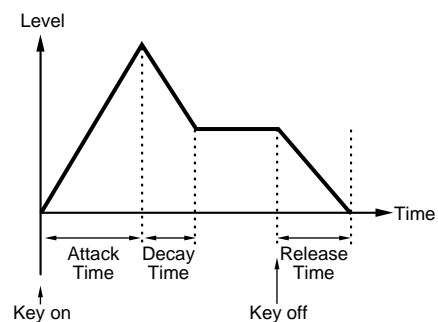

■ Attack

Set the Attack Time (the time taken for the volume to reach its peak after a note is pressed on the keyboard).

□ **Settings:** -64 ~ 0 ~ +63

■ Decay

Set the Decay Time (the time taken for the volume to change from its peak to a steady level).

□ **Settings:** -64 ~ 0 ~ +63

■ Release

Set the Release Time (the time taken for the volume to fade to zero after the note is released).

□ **Settings:** -64 ~ 0 ~ +63

Plug-in Common Arpeggio

In the following four screens, you can set parameters for the Arpeggiator used by the Plug-in Voice. The parameters are the same as for Normal Voices. Details are given on Page 72.

ARP Type (Arpeggio Type)
ARP Limit (Arpeggio Note Limit)
ARP Mode (Arpeggio Mode)
ARP PlayEF (Arpeggio Play Effect)

Plug-in Common Controller

You can set Pitch Bend Wheel, Modulation Wheel and other Controller parameters for the Plug-in Voices in the following nine screens.

CTL Pitch (Pitch Bend)
 CTL Set1 (Control Set 1)
 CTL Set2 (Control Set 2)
 CTL MW Control (MW Control Depth)
 CTL MW Modulation (MW Modulation Depth)
 CTL AT Control (AT Control Depth)
 CTL AT Modulation (AT Modulation Depth)
 CTL AC Control (AC Control Depth)
 CTL AC Modulation (AC Modulation Depth)

CTL Pitch (Pitch Bend)

You can set the Pitch Bend Range and Portamento for the Plug-in Voice here. Portamento creates a smooth transition from the pitch of the first note played to the pitch of the next.

```
CTLPitch)  Pitch Bend  Portamento Time
Common    -24         on          127
```

■ Pitch Bend

Set the amount (in semitones) by which the pitch of the note is varied when you move the Pitch Bend Wheel up/down. For example, if you set a value of +12, the pitch will change up by up to an octave when you move the wheel up. Conversely, if you set a negative value, the pitch falls when you move the wheel down.

□ Settings: -24 ~ 0 ~ +24

■ Portamento

Switch Portamento on or off.

□ Settings: off, on

■ Time

Set the Portamento Time, which is the speed of the transition in pitch from the first note to the next.

□ Settings: 0 ~ 127

CTL Set1 (Control Set 1)

CTL Set2 (Control Set 2)

These parameters are the same as for Normal Voices. Details are given on Page 74 (The Elem SW parameter is only available for Normal Voices).

CTL MW Control (MW Control Depth)

Here, you can set the depth of control the Modulation Wheel has over the filter.

```
CTLMW Control)  Filter
Common          -64
```

■ Filter

Set the depth of control of the Modulation Wheel over the filter cutoff frequency.

□ Settings: -64 ~ 0 ~ +63

CTL MW Modulation (MW Modulation Depth)

Here, you can set the depth of control the Modulation Wheel has over the pitch, filter and amplitude modulation of the Plug-in Voice.

```
CTLMW Modulation) PMod  FMod  AMod
Common           127   127   127
```

■ PMod (Pitch Modulation Depth)

Set the depth of control the Modulation Wheel has over the pitch modulation. The larger the setting, the greater the depth of control.

□ Settings: 0 ~ 127

■ FMod (Filter Modulation Depth)

Set the depth of control the Modulation Wheel has over the filter cutoff modulation. The larger the setting, the greater the depth of control.

□ Settings: 0 ~ 127

■ AMod (Amplitude Modulation Depth)

Set the depth of control the Modulation Wheel has over the amplitude modulation. The larger the setting, the greater the depth of control.

□ Settings: 0 ~ 127

CTL AT Control (AT Control Depth)

Here, you can set the depth of control keyboard aftertouch has over the pitch and filter of the Plug-in Voice.

```
CTLAT Control)  Pitch  Filter
Common         +24   -64
```

■ Pitch

Set the depth of control of keyboard aftertouch over the pitch. You can set a value (in semitones) of up to two octaves.

□ Settings: -24 ~ 0 ~ +24

■ Filter

Set the depth of control of keyboard aftertouch over the filter cutoff frequency.

□ Settings: -64 ~ 0 ~ +63

CTL AT Modulation (AT Modulation Depth)

Here, you can set the depth of control that keyboard aftertouch has over the pitch, filter and amplitude modulation of the Plug-in Voice.

CTLABAT Modulation> Common	PMod 127	FMod 127	AMod 127
-------------------------------	-------------	-------------	-------------

■ PMod (Pitch Modulation Depth)

Set the depth of control that keyboard aftertouch has over the filter pitch modulation. The larger the setting, the greater the depth of control.

□ Settings: 0 ~ 127

■ FMod (Filter Modulation Depth)

Set the depth of control that keyboard aftertouch has over the filter cutoff modulation. The larger the setting, the greater the depth of control.

□ Settings: 0 ~ 127

■ AMod (Amplitude Modulation Depth)

Set the depth of control that keyboard aftertouch has over the amplitude modulation. The larger the setting, the greater the depth of control.

□ Settings: 0 ~ 127

CTL AC Control (AC Control Depth)

You can set the depth of control the Control Change messages (Assignable Control) have over the filter of the Plug-in Voice.

CTLABAC Control> Common	Source 04[FootCtrl]	Filter -64
----------------------------	------------------------	---------------

■ Source

Set the MIDI Control Change number used to control the filter.

□ Settings: 0 ~ 95

■ Filter

Set the depth of the filter cutoff frequency controlled by the Control Change set above.

□ Settings: -64 ~ 0 ~ +63

CTL AC Modulation (AC Modulation Depth)

Here, you can set the depth of control the Control Change messages (Assignable Control) have over the pitch, filter and amplitude of the Plug-in Voice.

CTLABAC Modulation> Common	PMod 127	FMod 127	AMod 127
-------------------------------	-------------	-------------	-------------

■ PMod (Pitch Modulation Depth)

Set the depth of control the Control Change messages (selected in the Source parameter) have over the pitch modulation. The larger the setting, the greater the depth of control.

□ Settings: 0 ~ 127

■ FMod (Filter Modulation Depth)

Set the depth of control the Control Change messages (selected in the Source parameter) have over the filter cutoff modulation. The larger the setting, the greater the depth of control.

□ Settings: 0 ~ 127

■ AMod (Amplitude Modulation Depth)

Set the depth of control the Control Change messages (selected in the Source parameter) have over the amplitude modulation. The larger the setting, the greater the depth of control.

□ Settings: 0 ~ 127

Plug-in Common LFO (Low Frequency Oscillator)

You can set the LFO parameters here. The LFO uses a low-frequency waveform to vary (modulate) the pitch of the sound. The vibrato effect, for example, makes use of the LFO.

LFO Param (LFO Parameter)

LFO Param> Common	Speed +63	Delay -64	PMod +63
----------------------	--------------	--------------	-------------

■ Speed

Set the speed of the LFO waveform. A positive setting will increase the speed and a negative setting will reduce it.

□ Settings: -64 ~ 0 ~ +63

Speed = Slow

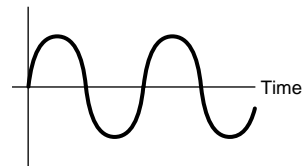

Speed = Fast

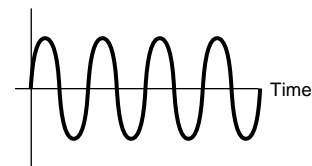

■ Delay

Set the delay time between the moment you press a note on the keyboard and the moment the LFO comes into effect. As shown in the illustration, a positive setting will lengthen the delay and a negative setting will shorten it.

□ **Settings:** -64 ~ 0 ~ +63

Short Delay

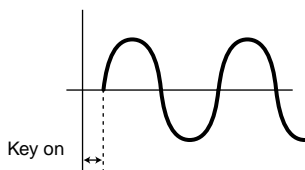

Long Delay

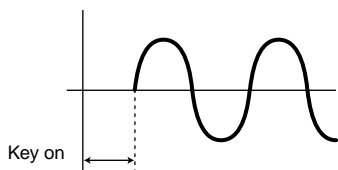

■ PMod (Pitch Modulation Depth)

Set the amount by which the LFO waveform controls the pitch. A positive setting will increase the amount and a negative value will decrease it.

□ **Settings:** -64 ~ 0 ~ +63

Plug-in Common Effect

In the following three screens, you can set the parameters for the Insertion and System Effects used by the Plug-in Voice. The parameters are the same as for Normal Voices. The EFF EF1 (Insertion Effect) parameter is the same as the EFF EF1 (Insertion Effect 1) parameter of the Normal Voices. Details are given on Page 78.

EFF EF1 (Insertion Effect)
EFF Rev (Reverb)
EFF Cho (Chorus)

Plug-in Element OSC (Oscillator)

Here, you can set the Element-related parameters for the Plug-in Voice. In the following two screens, you can select the Element's waveform, then its velocity parameters.

OSC Assign (Oscillator Assign)
OSC Velocity (Oscillator Velocity)

OSC Assign (Oscillator Assign)

You can select the Board Voice that make up the Element in a Plug-in Voice. Use Knob [C] to select the Bank and Knob [1] to select the Board Voice.

OSCBAssign) Elem	Bank NORM/001	Number 128[GndPiano]
---------------------	------------------	-------------------------

■ Bank

Select the Board Voice Bank of the Plug-in Voice.

□ **Settings:** (Depends on the Plug-in Board. Refer to the Owner's Manual for your Plug-in Board.)

■ Number

Select the Board Voice Number. The Board Voice Name is displayed to the right of this number.

□ **Settings:** (Depends on the Plug-in Board. Refer to the Owner's Manual for your Plug-in Board.)

OSC Velocity (Oscillator Velocity)

Here, you can set the velocity and note shift for the Board Voice.

OSCBVelocity) Elem	Depth 127	Offset 0	NoteSft -24
-----------------------	--------------	-------------	----------------

■ Depth

Set the velocity sensitivity of the Board Voice. If you set a larger value, the volume increase will be greater the harder you play the keyboard.

□ **Settings:** 0 ~ 127

■ Offset

Set an offset value for the velocity sensitivity of the Board Voice. When you press a note on the keyboard, this offset value is added to the note velocity.

□ **Settings:** 0 ~ 127

■ NoteSft (Note Shift)

Set the amount (in semitones) by which the pitch of the Board Voice is shifted. You can set a value of up to 2 octaves.

□ **Settings:** -24 ~ 0 ~ +24

Plug-in Element Pitch

You can set the Pitch Envelope Generator parameters for the Board Voice. The Pitch Envelope Generator controls the change in pitch from the moment a note is pressed on the keyboard to the moment it is released.

PCH PEG (Pitch Envelope Generator)

```
PCHPEG>InitLvl  Attack  Release---Level
Elem          +63    +63    +63    -64
```

■ InitLvl (Initial Level)

Set the Initial Level.

□ Settings: -64 ~ 0 ~ +63

■ Attack

Set the Attack Time.

□ Settings: -64 ~ 0 ~ +63

■ Release

Set the Release Time.

□ Settings: -64 ~ 0 ~ +63

■ Level

Set the Release Level.

□ Settings: -64 ~ 0 ~ +63

Pitch Envelope Generator Settings

You can set two time (speed) parameters and two level (pitch) parameters controlling the change in pitch from the moment you press a note on the keyboard to the moment you release it. When you press a note on the keyboard, the initial pitch is defined by the InitLvl parameter setting. The pitch then changes from the InitLvl value to the peak pitch within the time set in the Attack parameter. Thereafter, the pitch change is defined by the Release Time/Level settings.

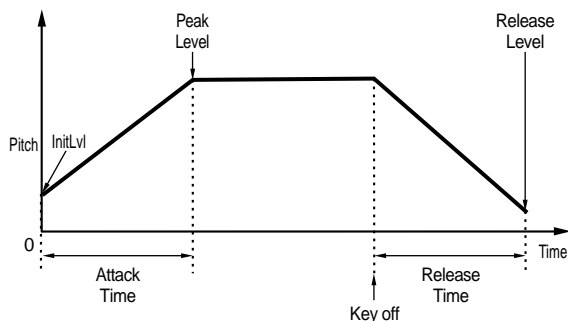

Plug-in Element EQ (Equalizer)

You can set the equalizer settings for the Wave. This is a shelving equalizer with two bands; one for high frequencies and another for low frequencies.

EQ Param (EQ Parameter)

```
EQParam>LoFreq  LoGain  HiFreq  HiGain
Elem          2.0k   +12dB  16.0k  -12dB
```

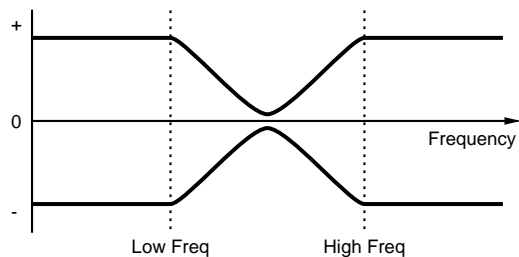

■ LoFreq (Low Frequency)

Set the shelving point for the low frequencies. The levels of signals below this frequency will be boosted/attenuated by the amount set in the LoGain parameter.

□ Settings: 32Hz ~ 2.0kHz

■ LoGain (Low Gain)

Set the amount by which signals below the LoFreq frequency will be boosted/attenuated.

□ Settings: -64 ~ 0 ~ +63

■ HiFreq (High Frequency)

Set the shelving point for the high frequencies. The levels of signals above this frequency will be boosted/attenuated by the amount set in the HiGain parameter.

□ Settings: 500Hz ~ 16.0kHz

■ HiGain (High Gain)

Set the amount by which signals above the HiFreq frequency will be boosted/attenuated.

□ Settings: -64 ~ 0 ~ +63

Plug-in Element Native

With a Plug-in Board installed, you have native and unique parameters to set up a Board Voice from the Plug-in Board.

PLG-NATIVE (Plug-in Native)

Native Part Parameters are displayed. Use the [PAGE] knob to switch to the screen for the desired parameter, then use Knob [C] and Knob [2] to enter the settings.

The parameters and number of screens will vary depending on the Plug-in Board. For details about each parameter and its functions, refer to the Owner's Manual or the on-line help that came with your Plug-in Board.

Editing Plug-in Board Voices

Plug-in Voices are based on Board Voices. However, the Board Voices themselves can be edited via computer, using the included editor software. Different editors are available for different Plug-in Boards.

NOTE When using the editor while the synthesizer is in Voice Mode, set the “Part No.” in the editor to “1.” Also, make sure the synthesizer’s Basic Receive channel is the same as that set in the editor’s MIDI channel.

Your edits made to a Board Voice will be retained in the Custom Bank until you turn off the instrument. Note that the Custom Bank is a temporary memory so that edits in the Bank will be erased when you turn off the instrument. Therefore, it may be necessary to save Board Voice data using a computer.

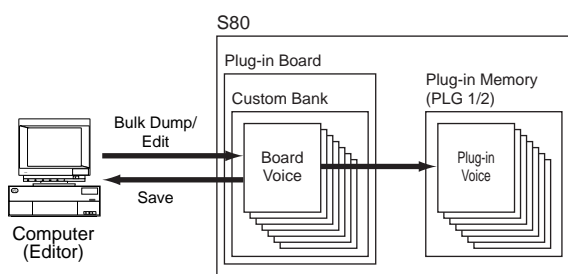

NOTE Details about how to use the editor are given in the on-line help.

When bulk-dumping Board Voice data, the edited Board Voices is received in the Custom Bank according to the Bank Select Message (MSB/LSB) unique to each Plug-in Board. Therefore, to play back these Board Voices, you need to select the appropriate Banks in the synthesizer.

- 1 In Voice Play Mode, select any Voice in a Plug-in Memory (PLG1 or PLG2).
- 2 The Board Voice you have edited can now be played back if a Custom Bank has been selected at this screen.

NOTE For details about Custom Banks, Bank Select Numbers (MSB/LSB) and Board Voices, refer to the Owner’s Manual or the on-line help that came with your Plug-in Board.

NOTE Once you have transmitted the edited Board Voice data to the synthesizer and saved it to Memory Card as a “plugin” file type, you can load the file without having to connect the computer.

If a Board Voice in the Custom Bank has been edited in Voice Edit Mode, you can store it as a Plug-in Voice in Memory Bank A to D of PLG1 or PLG2. Up to 64 can be stored in each Bank.

However, only the Voice Edit parameters can be stored. The edited Board Voice parameters cannot be stored. Therefore, you will lose all Board Voice edits when you switch your synthesizer off.

To avoid this situation, you should save your Board Voice edits to Memory Card and then load the data as a Plug-in Voice.

After loading Board Voice data, if you select Plug-in Voice Memories (PLG1/PLG2) A to D, the stored sound (the edited Plug-in Voice based on the Board Voice) is loaded.

NOTE The “all” setting is not available when saving Board Voice data; it is saved as a “plugin” file type. If the file name is set such that the file loads automatically (Page 143), the Board Voice data can also be loaded up when the synthesizer is switched on.

NOTE It may take a while to save or load the Board Voice data using Memory Card.

NOTE Details about saving/loading data to/from Memory Card are given on Page 144.

NOTE The editor for the PLG150-AN/PF Plug-in Board is a plug-in program for XGworks(lite). You will need to be running Windows and XGworks(lite) in order to use it. XGworks lite is included on the CD-ROM included with this synthesizer.

Voice Job Mode

You can perform various operations (Jobs) in Voice Job Mode. For example, you can “Initialize” Voices (including those currently being edited) or “Recall” previous edits.

When you enter Voice Job Mode, you will first see the Initialize screen. The following four screens are available for each Voice Job.

NOTE Before entering Voice Job Mode and using the Initialize or Recall function, you must select the Voice you wish to operate on (Page 65).

1st screen: VCE Initialize
2nd screen: VCE Edit Recall
3rd screen: VCE Copy
4th screen: VCE Bulk Dump

NOTE Details about how to enter Voice Job Mode are given on Page 22.

Performing a Job

- 1 In Voice Play Mode, select the Voice Number you wish to perform the Job on.
- 2 Press the [JOB] key to enter Voice Job Mode.
- 3 Use the [PAGE] knob and switch to the screen showing the Job you wish to perform.

```
VCE Initialize)
Job      Current Voice
```

- 4 Use Knobs [B]/[C] and Knobs [1]/[2] to select the parameter you wish to perform the Job on. (Alternatively, use the [DATA] knob and the [DEC/NO] and [INC/YES] keys.)

NOTE This step is not applicable for Recall and Bulk Dump Jobs.

- 5 When you press the [ENTER] key, you will be prompted for confirmation.

```
VCE Initialize)
<<   Are You sure? [YES]/[NO]   >>
```

- 6 Press the [INC/YES] key to confirm. The message “Completed.” will be displayed when the Job has completed, and you will be returned to the original screen.

Press the [DEC/NO] key to cancel the Job.

NOTE For Jobs that take longer to process, you will see the message “Executing...” during processing. If you switch off the power to your synthesizer while this message is displayed, you risk corrupting your data.

- 7 Press the [VOICE] key to exit Voice Job Mode and return to Voice Play Mode.

VCE Initialize

You can reset (initialize) all parameters of a Voice to their default settings. You can also selectively initialize certain parameters, such as Common settings, settings for each Element/Drum Key, and so on. Note that this does not return the Voice to its original state prior to editing. Instead, it is useful when building a completely new Voice from scratch.

```
VCE Initialize)
Job      Current Voice
```

Select type of parameter to Initialize

Use Knob [C], the [DATA] knob or the [DEC/NO] and [INC/YES] keys to select the parameter to be initialized. The parameters available for initialization will vary depending on the type of Voice currently selected (Normal/Drum/Plug-in).

Settings:

normal Voice:

Current Voice, Current Common, Current Element 1 ~ 4

Drum Voice:

Current Voice, Current Common (data common to all Drum Keys), Current Key C0 ~ C6 (Drum Key C0 ~ C6)

Plug-in Voice:

Current Voice, Current Common, Current Element

VCE Edit Recall

If you are editing a Voice but you do not store it before switching to another Voice, the edits you have made will be cleared. In such a situation, you can use the Recall function to reinstate the edits for the Voice.

```
VCE Edit Recall)
Job
```

VCE Copy

You can copy Common and Element/Drum Key parameter settings from any Voice to the Voice you are editing. This is useful if you are creating a Voice and wish to use some parameter settings from another Voice.

NOTE This function is not used for copying whole Voices from one location to another. It is used for copying parameter settings from an existing Voice to the current Voice you are editing.

```
VCE Copy)  [Pf:GrandPiano]  Current
Job        [PRE1]#128:H16)  EL1  >  EL1
```

① ② ③ ④

■ ① Source Voice Memory

Select the Voice Memory containing the Voice (source) from which you will copy parameter settings.

- **Settings:** PRE1/2 (Preset 1/2), INT (Internal Normal), EXT (External Normal), PLG1/2 (Plug-in 1/2), PRE (Preset Drum), INT (Internal Drum), EXT (External Drum)

■ ② Source Voice Number

Select the Voice Number of the source Voice. The Voice Name is shown in the top line of the display.

- **Settings:** 001 ~ 128 (for Preset/Internal/External Normal), 1 ~ 64 (for Plug-in 1/2), DR1 ~ DR8 (for Preset Drum), DR1 ~ DR2 (for Internal/External Drum)

■ ③ Source Voice Parameter

Select the parameter of the source Voice. You can copy parameter settings common to all Elements or those used by individual Elements.

- **Settings:**
 - normal Voice:**
Common (all Elements), EL1 ~ EL4
 - Drum Voice:**
Common (all Drum Keys), C0 ~ C6
 - Plug-in Voice:**
Common, EL (Element)

NOTE If the parameters of the source Voice (Normal/Drum/Plug-in) differ from those of the Voice you are currently editing (destination), you will only be able to copy Common parameters.

■ ④ Destination Element/Drum Key

Set the Element/Drum Key of the destination Voice. If the source is a Normal or Drum Voice, you can only choose a destination if the Element/Drum Key has been set.

- **Settings:**
 - normal Voice:**
EL1 ~ EL4
 - Drum Voice:**
C0 ~ C6

NOTE If you choose to copy Common parameters from the source, this screen will change to “Common.”

VCE Bulk Dump

You can send all the parameter settings for the current Voice to your computer or some other external MIDI device using Bulk Dump.

```
VCE Bulk Dump>
Job          Current Voice
```

NOTE You must set the correct MIDI Device Number in order to perform a Bulk Dump. Details are given on Page 137.

Voice Store

You can store (save) the parameter settings for up to 128 Voices to each of your synthesizer's Memories (INT: Internal) or to its Memory Card (EXT: External). The procedure is as follows.

NOTE Up to 64 plug-in voices can be stored in Banks A to D of PLG 1/2.

NOTE When you perform this, the settings for the destination Voice will be overwritten. Important data should always be backed up to computer, a separate Memory Card or some other storage device.

- 1 Press the [STORE] key after editing a Voice. You will see the Voice Store screen.

```
VCEB [Pf:GrandPiano] >[Pf:Init Voice]
Store EXT:128(H16)
```

- 2 Use Knob [1] to select the destination Voice Memory (INT or EXT).

NOTE This is fixed to PLG 1/2 when storing a Plug-in Voice.

- 3 Use Knob [2] to select the destination Voice Number. This will set the Voice Memory/Number to which your Voice will be stored.

NOTE You can also use the [DATA] knob or [DEC/NO] and [INC/YES] keys to perform this operation.

- 4 When you press the [ENTER] key, you will be prompted for confirmation.

```
VCEB [Pf:GrandPiano] >[Pf:Init Voice]
<< Are You sure? [YES]/[NO] >>
```

- 5 Press the [INC/YES] key to confirm. The message “Executing...” will be displayed while the Job is being processed. When it has completed, you will see the message “Completed.” and you will be returned to Voice Play Mode.

NOTE You can press the [DEC/NO] key to cancel the Job. This will return you to the original screen.

Performance Mode

Performance Play

In Performance Play Mode, multiple Voices (up to four Parts) can be layered to create thick sounds which you can play in real-time or using a sequencer.

In Performance Mode, up to 19 Parts can be combined in a single Performance, including Voices for the 16 Parts plus A/D Input and Plug-in 1/2 Parts.

Depending on the Performance Edit settings (Page 111), you can assign a Normal Voice or Drum Voice (Drum Kit) to each Part. Multiple Parts can be assigned to the same MIDI channel for real-time playback. Alternatively, you can assign each Part to a different MIDI channel for playback using an external sequencer or the synthesizer's internal sequencer (in Sequence Play Mode). The synthesizer can hold up to 256 Performances, consisting of 128 Internal Performances plus another 64 External Performances on Memory Card.

The displayed screens, the method of selecting Performances and the Multi Part Edit process in Performance Play Mode are explained here.

NOTE If a multitimbral Plug-in board is installed, up to 34 Parts can be combined in a single Performance. However, the settings for the Plug-in Parts cannot be stored in memory.

NOTE An overview of Performances is given on Page 39.

Performance Play Mode Display

You will see the following screen when you enter Performance Play Mode. There are seven Performance Play Mode screens, as explained below. Use the [PAGE] knob to switch between screens.

NOTE Details about how to enter Performance Play Mode are given on Page 21.

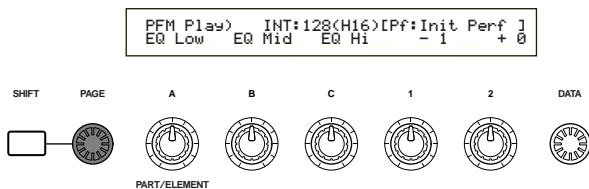

1st screen: PFM Play (Performance Play)
Main Performance screen

2nd screen: PFM Srch (Performance Search)
You can quickly search for a Performance by specifying the Performance Memory and Category.

In the 3rd to 7th screens, you can set the output levels, stereo pan position and other general parameters for each Part (Multi Part Edit). These are useful when using the synthesizer with a sequencer. Details are given on Page 109.

3rd screen: PFM Mlt) Volume (Performance Multi: Volume)

4th screen: PFM Mlt) Pan (Performance Multi: Pan)

5th screen: PFM Mlt) RevSend (Performance Multi: Reverb Send)

6th screen: PFM Mlt) ChoSend (Performance Multi: Chorus Send)

7th screen: PFM Mlt) NoteSft (Performance Multi: Note Shift)

1st Screen: PFM Play (Performance Play)

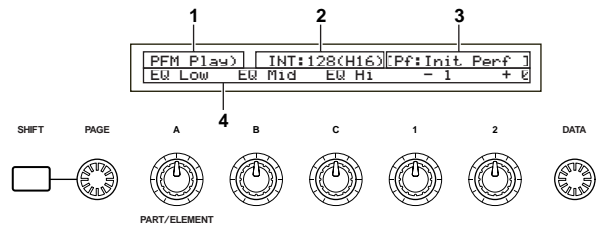

1. Screen Title

This shows that you are currently in Performance Play Mode.

2. Performance Memory/Number (Bank/Number)

The Memory/Performance Program Number (001 to 128) and Bank ([A] to [H])/Program Number ([1] to [16]) are shown for the selected Performance. For example, "INT: 128(H16)" shows that the Memory is "Internal," the Performance/Program Number is "128," the Bank is "H," and the Bank's Program Number is "16."

Memory/Performance Program Number

Internal Memories are shown as "INT" and External Memories are shown as "EXT." Each Voice within a Memory is assigned a Performance Program Number of 001 to 128.

NOTE Details about Performance Memories are given on Page 29.

Bank/Program Number

Performance Program Numbers 001 to 128 are related to Banks A to H and Program Numbers 1 to 16 (for the Bank) as explained below. For example, you can select a Performance either directly by its Performance Program Number or by using a combination of Bank and Program keys.

Performance Number	Bank	Program Number	Performance Number	Bank	Program Number
001	A	1	065	E	1
002	A	2	066	E	2
003	A	3	067	E	3
004	A	4	068	E	4
005	A	5	069	E	5
006	A	6	070	E	6
007	A	7	071	E	7
008	A	8	072	E	8
009	A	9	073	E	9
010	A	10	074	E	10
011	A	11	075	E	11
012	A	12	076	E	12
013	A	13	077	E	13
014	A	14	078	E	14
015	A	15	079	E	15
016	A	16	080	E	16
017	B	1	081	F	1
018	B	2	082	F	2
019	B	3	083	F	3
020	B	4	084	F	4
021	B	5	085	F	5
022	B	6	086	F	6
023	B	7	087	F	7
024	B	8	088	F	8
025	B	9	089	F	9
026	B	10	090	F	10
027	B	11	091	F	11
028	B	12	092	F	12
029	B	13	093	F	13
030	B	14	094	F	14
031	B	15	095	F	15
032	B	16	096	F	16
033	C	1	097	G	1
034	C	2	098	G	2
035	C	3	099	G	3
036	C	4	100	G	4
037	C	5	101	G	5
038	C	6	102	G	6
039	C	7	103	G	7
040	C	8	104	G	8
041	C	9	105	G	9
042	C	10	106	G	10
043	C	11	107	G	11
044	C	12	108	G	12
045	C	13	109	G	13
046	C	14	110	G	14
047	C	15	111	G	15
048	C	16	112	G	16
049	D	1	113	H	1
050	D	2	114	H	2
051	D	3	115	H	3
052	D	4	116	H	4
053	D	5	117	H	5
054	D	6	118	H	6
055	D	7	119	H	7
056	D	8	120	H	8
057	D	9	121	H	9
058	D	10	122	H	10
059	D	11	123	H	11
060	D	12	124	H	12
061	D	13	125	H	13
062	D	14	126	H	14
063	D	15	127	H	15
064	D	16	128	H	16

3. Performance Category/Name

Performance Category

A two-letter abbreviation of the Performance Category is shown to the left of the Performance Name. This gives you a rough idea of the Performance's sound.

Performance Name

The name of a Performance can consist of up to 10 characters.

4. Knob Parameter Display

This shows the function/Parameter value assigned to each knob ([A] to [C] and [1]/[2]).

Setting/Viewing Knob Parameters

In Performance Play Mode, you can use Knobs [A] to [C] and Knob [1]/[2] to adjust parameters assigned to them. When you use each knob, the value of its assigned parameter is displayed briefly ([knob [A] to [C]).

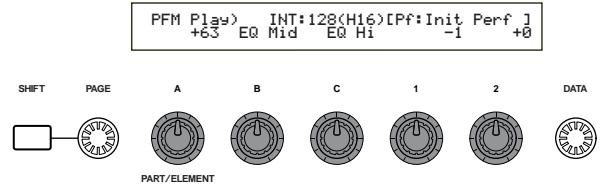

NOTE Details about assigning parameters to Knobs [A] to [C] are given on Pages 46, 136. Details about assigning parameters to Knob [1]/[2] are given on Pages 47, 74.

Setting/Viewing Octave and MIDI Transmit Channel Parameters

In Performance Play Mode, the current Octave and MIDI Transmit Channel settings are shown while you hold down the [SHIFT] key. The display varies, depending on whether Master Keyboard Mode is on or off.

NOTE Details about Master Keyboard Mode are given on Page 113.

Master Keyboard Mode is off

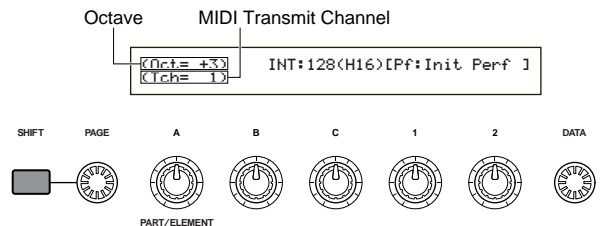

Use Knob [A] while holding down the [SHIFT] key to select the MIDI Transmit Channel (1 to 16).

Master Keyboard Mode is on

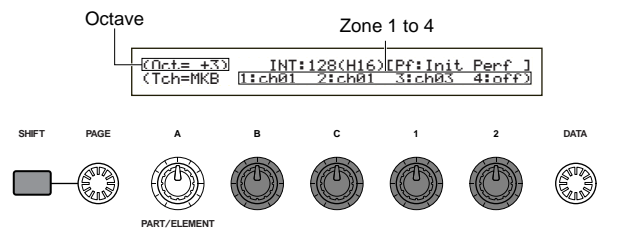

Use Knob [B]/[C]/[1]/[2] while holding down the [SHIFT] key to select the MIDI Transmit Channel (1 to 16).

The notes you play in Performance Play Mode will be transmitted on this MIDI channel.

NOTE When the master keyboard mode is turned off, you can use the MIDI Ch screen in Utility Mode to set MIDI transmission channels (Page 137).

Performance Program Selection

There are four ways in which you can select a Performance.

- Using the BANK/PROGRAM keys
- Using the [DEC/NO] and [INC/YES] keys
- Using the [DATA] knob
- Using the Category Search

Using the [INC/YES] and [DEC/NO] keys, the [DATA] knob or the Category Search function is the same as selecting the Voice directly in Voice Play Mode. Refer to Page 65, replacing the word “Voice” with “Performance.”

Using the BANK/PROGRAM Keys

- Press the MEMORY [INT] or [EXT] key and select the Performance Memory. The selected Performance Memory indicator in the display will blink.

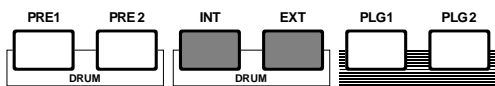

```
PFM Play> INT:128(H16) [Pf: Init Perf ]
EQ Low EQ Mid EQ Hi -1 +0
```

NOTE Details about Performance Memories are given on Page 29.

- Press a BANK key ([A] to [H]) to select a Bank. The Bank indicator in the display will blink.

NOTE Press Bank keys [A] to [D] when selecting an EXT Performance.

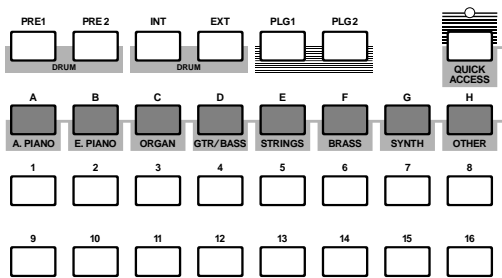

```
PFM Play> INT:128(H16) [Pf: Init Perf ]
EQ Low EQ Mid EQ Hi -1 +0
```

NOTE If you press the EXIT key here, the Performance selection process is canceled and the original Performance is reinstated.

NOTE If the Bank has already been selected, this step is not required.

NOTE Details about Banks are given on Page 29.

- Press a PROGRAM key ([1] to [16]) to select a Program Number.

Performances can be selected by setting the Memory, Bank and Program Number as explained in the three steps given above. The display also shows the selected Performance.

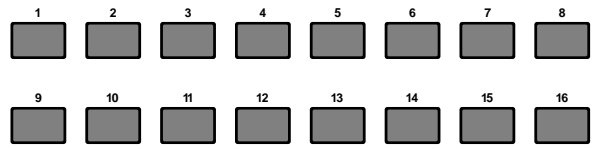

Multi Edit (Volume, Pan, Reverb/Chorus Send, Note Shift)

You can set the output level (volume), stereo pan and other parameters for each Part using the graphic editors on screens 3 to 7. You can, for example, adjust each Part's Volume and Pan parameters in real-time while using the synthesizer as a multitimbral tone generator with a sequencer.

Method of Setting Up

The same procedure applies to screens 3 to 7.

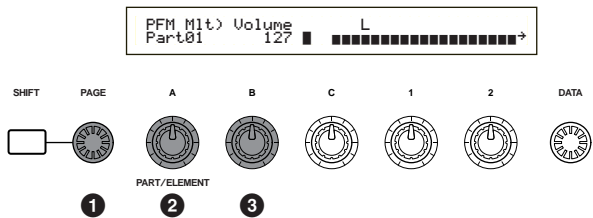

- Use the [PAGE] knob to select the screen.
- Use Knob [A] to select the Part. You can choose from, PartAD (A/D Input Part), PartP1 (Plug-in 1 Part), PartP2 (Plug-in 2 Part), Part01 to Part16 (Voice Part 1 to 16). Apart from the 7th screen (Note Shift), the Common (Layer Common) parameters are the same for all Layer Parts.

The parameter settings for each Part are shown as a bar graph, giving you an idea of the overall sound balance.

You can also use the MEMORY and PART keys on the front panel to select each Part. The keys relate to each Part as follows.

- [PRE1/2] key**Common (Layer Common)
- [EXT] key**PartAD (A/D Input Part)
- [PLG1] key**PartP1 (Plug-in 1 Part)
- [PLG2] key**PartP2 (Plug-in 2 Part)
- PART keys [1] to [16]**Part01 to Part16 (Voice Parts 1 to 16)

- Use Knob [B] or the [DATA] knob or the [DEC/NO] and [INC/YES] keys to adjust the parameter settings for each Part.

4 Repeat steps 2 and 3 for each of the other Parts.

NOTE To avoid losing the settings, make sure you store the Performance before exiting to another Mode or selecting another Performance. Details about how to store Performances are given on Page 131.

Reading the Displayed Settings

Screens 3 to 7 have the following functions.

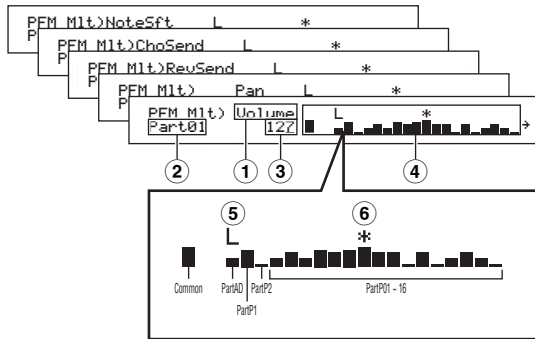

- ① **Parameter:** shows the parameter settings
- ② **Part:** shows the currently selected Part
- ③ **Value:** shows the setting for the currently selected Part
- ④ **Bar graph:** shows the settings for each Part as a bar graph
 Common (Layer Common)
 PartAD (A/D Input Part)
 PartP1 (Plug-in 1 Part)
 PartP2 (Plug-in 2 Part)
 Part01 ~ Part16 (Voice Parts 1 ~ 16)
- ⑤ **Layer Switch on/off:** displays a “L” mark above the bar graph for Parts which have their Layer Switch set to “on.”
- ⑥ **Mute on/off:** displays a “*” mark above the bar graph for Parts which are muted. Press the [ENTER] key to switch mute on/off for the currently selected Part.

NOTE If a multitimbral Plug-in board is installed in Plug-in Slot 2, PartP2 (Plug-in 2 Part) will no longer be available. However, you will now be able to select Part17 to Part32 (Voice Parts 17 to 32). A “→” mark is displayed to the right of the bar graph, indicating that there are more Parts available. If you select Part17 to Part32, the bar graph shows the settings for those Parts.

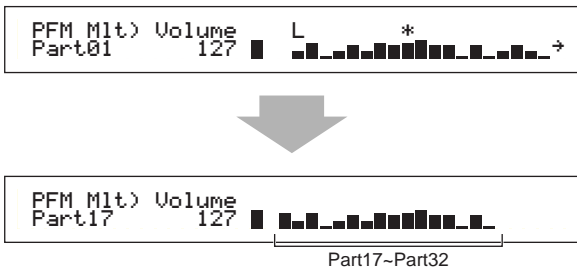

3rd Screen: PFM Mlt) Volume (Performance Multi: Volume)

Set the output level (volume) of each Part.



□ Settings: 0 ~ 127

4th Screen: PFM Mlt) Pan (Performance Multi: Pan)

Set the stereo pan position for each Part.



□ Settings: L63 ~ C ~ R63

5th Screen: PFM Mlt) RevSend (Performance Multi: Reverb Send)

For each Part, set the Send level of the signal sent from Insertion Effect 1/2 (or the bypassed signal) to the Reverb effect.



□ Settings: 0 ~ 127

6th Screen: PFM Mlt) ChoSend (Performance Multi: Chorus Send)

For each Part, set the Send level of the signal sent from Insertion Effect 1/2 (or the bypassed signal) to the Chorus effect.



□ Settings: 0 ~ 127

7th Screen: PFM Mlt) NoteSft (Performance Multi: Note Shift)

Set the amount (in semitones) by which the pitch of each Part is offset. You can adjust the offset up or down by up to two octaves.



□ Settings: -24 ~ 0 ~ +24

Performance Edit

You can set Performance Edit parameters. These can roughly be divided into Common parameters, which apply to all Parts, and Part-specific parameters. Also, there are various zone settings for Master Keyboard Mode (Page 113).

When you enter Performance Edit Mode, you will see the following screen. The actual display (number of screens) will vary depending on the Part selected. Basically, Knob [A] is used to select the type of parameter you wish to edit (Common/Part/Zone), the [PAGE] knob is used to switch between the parameter screens, and Knobs [B], [C], [1] and [2] are used to enter parameter settings. Alternatively, you can use the [DATA] knob, and [DEC/NO] and [INC/YES] keys to enter settings.

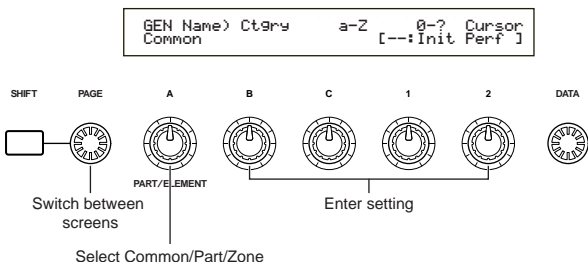

You can use Knobs [A] to [C] and Knob [1]/[2] while holding down the [SHIFT] key to move the cursor to each respective parameter. The cursor can also be moved using the [DATA] knob or the [DEC/NO] and [INC/YES] keys while holding down the [SHIFT] key.

- NOTE** You must select the Performance you wish to edit before entering Performance Edit Mode (Page 109). All parameter settings for each Performance can be stored.
- NOTE** If a multitimbral Plug-in Board has been installed, the parameters for its Parts will not be stored.
- NOTE** Details about how to enter Performance Edit Mode are given on Page 21.

Menu Display

When you use the [PAGE] knob while holding down the [SHIFT] key, the following menu will be displayed. Use the [PAGE] knob to move the cursor between items, then release the [SHIFT] key to jump to the selected item.

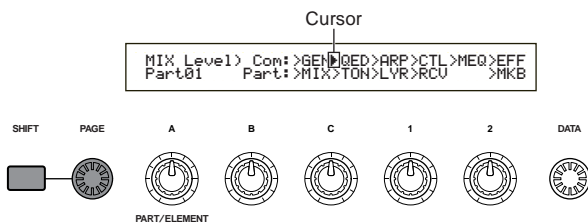

Common/Part/Zone Edit

A Performance can consist of 16 Voice Parts, an A/D Input Part or a Plug-in Part 1/2 (Page 39). The parameters common to all Parts are known as a Common Edit. The Performance Edit Mode screens can be divided into the Common Edit screen and screens for editing each Part individually.

When editing individual Parts, the screens you see will vary depending on the Part selected. If the synthesizer is in Master Keyboard Mode (Pages 8, 57), you will be able to set parameters for each Zone.

In Performance Edit Mode, use Knob [A] to switch between the screens for Common, Part and Zone settings.

Common settings

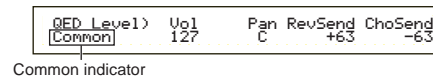

Part settings

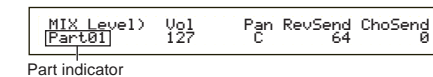

Zone settings

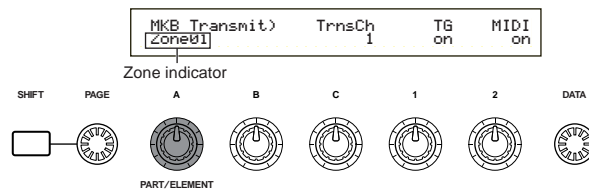

Master Keyboard/Tone Generator Mode

In Performance Mode, the connection with the S80's internal tone generator (the signal flow) can be changed by pressing the [MASTER KEYBOARD] key on the front panel. If the [MASTER KEYBOARD] key LED is on, the S80 enters Master Keyboard Mode and becomes useful for controlling external tone generators. If the LED is off, the S80 exits Master Keyboard Mode and becomes useful for controlling its internal Parts from the internal tone generator. The signal flow for each Mode is as follows.

Master Keyboard Mode: [MASTER KEYBOARD] key LED on

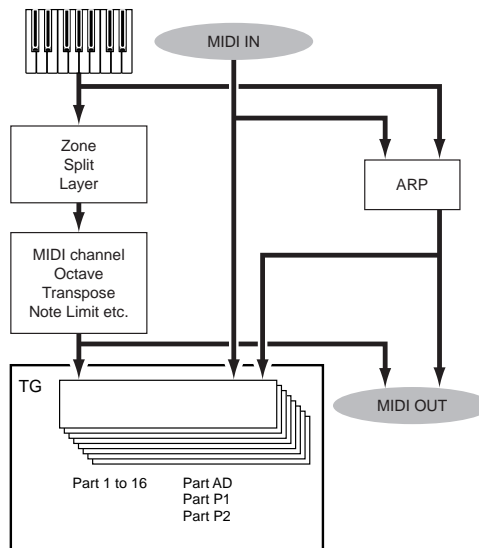

Tone Generator Mode: [MASTER KEYBOARD] key LED off

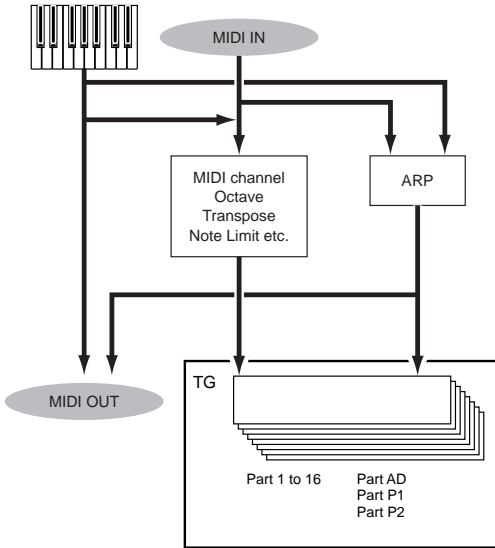

The [E] Indicator

If you alter any parameters in Performance Edit Mode, the [E] indicator will be displayed in the top left of the screen. This gives a quick indication that the current Performance has been modified but not yet stored.

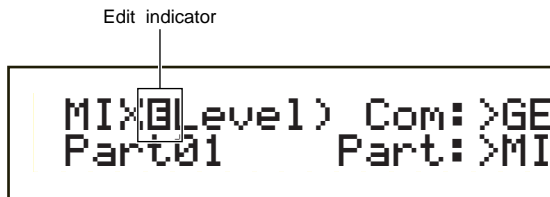

- NOTE** Even if you exit to Performance Play Mode, the edited settings for the current Performance will not be lost so long as you do not select another Performance.
- NOTE** The [E] indicator will also be displayed in Performance Play Mode.
- NOTE** The [E] indicator will also be displayed in Voice Play Mode if any Assignable knobs are used.

The “Compare” Function

Use this to listen to the difference between the Performance with your edited settings and the same Performance prior to editing.

- 1 Press the [EDIT/COMPARE] key while in Performance Edit Mode. The [E] indicator at the top left of the screen will change to the [C] indicator and the [EDIT/COMPARE] key LED will blink. The Performance settings prior to editing will temporarily be reinstated for comparison purposes.

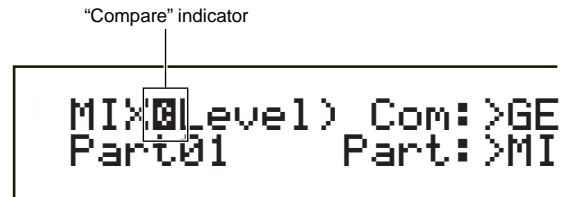

- NOTE** Editing will not be possible while the “Compare” function is enabled.
- 2 Press the [EDIT] key again to disable the “Compare” function and restore the settings for your edited Performance.

Performance Store

The edited settings for the current Performance will be lost if you exit to Performance Play Mode and then select another Performance or Mode. To avoid losing important data, you should always use Performance Store to store your edited Performances after exiting Performance Edit Mode. Details about the Performance Store procedure are given on Page 131.

- NOTE** When creating a new Performance from scratch, it is useful, prior to editing, to clear the settings for the current Performance using the Initialize Performance function in Performance Job Mode (Page 130).

Common (Settings for all Parts)

Here we explain how to edit common settings for all Parts in a Performance. There are six Menus available, each of which consists of multiple pages.

- Common General
- Common Quick Edit
- Common Arpeggio
- Common Controller
- Common Master EQ
- Common Effect

Common General

You can set the Performance Name, MIDI channel and other general parameters in the Common Edit screens. The following three screens are available for general settings.

GEN Name (General Name)

GEN MIDI (General MIDI)

GEN M.Kbd (General Master Keyboard)

GEN Name (General Name)

You can set a Performance Name consisting of up to 10 characters (alphabetic or numeric) and/or symbols. You can also select the Category Name to the left of the Performance Name.

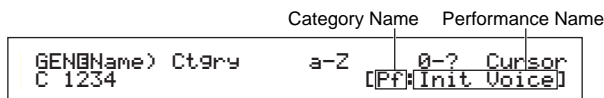

NOTE The method of setting the Performance Name is the same as for the Voice Name. Details are given on Page 70.

GEN MIDI (General MIDI)

You can set the MIDI In/Out channel parameters for the Performance.

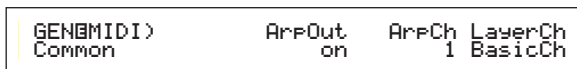

■ ArpOut (Arpeggio Out)

Switch the Arpeggiator phrase MIDI output on or off.

Settings: off, on

■ ArpCh (Arpeggio Channel)

Set the Arpeggiator's MIDI Channel. The arpeggio will play to Parts and Voices set to this MIDI Channel. If you choose kbd-ch (Keyboard Channel), the Arpeggiator will use the MIDI Transmit Channel set in Utility Mode (Page 137).

Settings: 1 ~ 16, kbdCh (Keyboard Channel)

■ LayerCh (Layer Channel)

Set the MIDI Channel of the Layer Part. All Layer Parts (up to four) will use the same MIDI Channel set here. If you choose BasicCh (Basic Receive Channel), all Layer Parts will use the Basic Receive Channel set in Utility Mode (Page 137).

Settings: 1 ~ 16, BasicCh (Basic Receive Channel)

GEN M.Kbd (General Master Keyboard)

You can set keyboard splits and layers when using a Performance in Master Keyboard Mode.

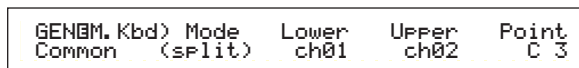

■ Mode

Set the keyboard Mode. The following three Modes are available. If the [MASTER KEYBOARD] key LED on the front panel is off, these Modes are not available and brackets are shown in the display.

Settings: split, 4zone, layer

split:

Splits the keyboard into a left-hand (lower) section and a right-hand (upper) section, assigning a different MIDI channel and Part to each section.

4zone:

Splits the keyboard into a maximum of four zones, assigning a different MIDI channel and Part to each zone. Parameters can be set separately for each zone (Page 127) when you press the [ENTER] key.

layer:

Layers up to two Zone (Part) over the keyboard. This is useful for creating rich and thick sounds.

■ Lower

When the Mode (see above) has been set to “split,” this sets the MIDI channel assigned to notes at and below the split point. The Part or Voice set to this MIDI channel will be played when you press notes at and below the split point. When the Mode is set to “layer,” the MIDI channel for one layered Zone (Part) is set here.

Settings: ch01 ~ ch16

■ Upper

When the Mode (see above) has been set to “split,” this sets the MIDI channel assigned to notes above the split point. The Part or Voice set to this MIDI channel will be played when you press notes above the split point. When the Mode is set to “layer,” the MIDI channel for the other layered Zone (Part) is set here.

Settings: ch01 ~ ch16

NOTE You can also quickly set the Upper/Lower MIDI channels using the PART keys [1] to [16]. Press and hold one PART key, then press another. The number of the first key is set as the Upper MIDI channel while the number of the second key is set as the Lower MIDI channel.

Point

When the Mode (see earlier) has been set to “split,” this sets the split point. The actual note of the split point will be assigned to the upper section.

NOTE You can also select the split point by pressing the note while holding down the [SHIFT] key.

□ **Settings:** C-2 ~ G8

Master keyboard setting list (on split/layer)

Parameter Name	Split				Layer			
	Zone1	Zone2	Zone3	Zone4	Zone1	Zone2	Zone3	Zone4
TrnsCh	ch	ch+1	ch	ch	ch	ch+1	ch	ch
TG	on	on	off	off	on	on	off	off
MIDI	on	on	off	off	on	on	off	off
Octave	+0	+0	+0	+0	+0	+0	+0	+0
Transpose	+0	+0	+0	+0	+0	+0	+0	+0
Note Limit Low	C-2	p	C-2	C-2	C-2	C-2	C-2	C-2
Note Limit High	p	G8	G8	G8	G8	G8	G8	G8
Transmit Switch PB	on	on	on	on	on	on	on	on
Transmit Switch MW	on	on	on	on	on	on	on	on
Transmit Switch KnobA-C	on	on	on	on	on	on	on	on
Transmit Switch Knob1/2	on	on	on	on	on	on	on	on
Transmit Switch RB	on	on	on	on	on	on	on	on
Transmit Switch FC	on	on	on	on	on	on	on	on
Transmit Switch BC	on	on	on	on	on	on	on	on
Transmit Switch AT	on	on	on	on	on	on	on	on
Transmit Switch FS	on	on	on	on	on	on	on	on
Transmit Switch Sus	on	on	on	on	on	on	on	on
Transmit Switch Vol/FV	on	on	on	on	on	on	on	on
Transmit Switch Pan	on	on	on	on	on	on	on	on
Transmit Switch Bank Select	off	off	off	off	off	off	off	off
Transmit Switch Program Change	off	off	off	off	off	off	off	off
Transmit Preset Volume	100	100	100	100	100	100	100	100
Transmit Preset Pan	40	40	40	40	40	40	40	40
Transmit Preset Bank MSB	0	0	0	0	0	0	0	0
Transmit Preset Bank LSB	0	0	0	0	0	0	0	0
Transmit Preset PC	0	0	0	0	0	0	0	0
CS Control Number Assign	7	7	7	7	7	7	7	7

ch: Keyboard transmit channel
 p: split point
 Details about each parameter are given on page 127

NOTE For more information about the master keyboard mode, refer to page 57 in Basics Section.

Common Quick Edit

You can set various parameters governing the sonic properties of the Layer Part. The following four screens are only available when the Layer switch (Page 123) for each Part is set to on.

- QED Level (Quick Edit Level)
- QED EF (Quick Edit Effect)
- QED Filter (Quick Edit Filter)
- QED EG (Quick Edit Envelope Generator)

QED Level (Quick Edit Level)

You can set output level and pan parameters for each Layer Part. The settings are also available in the Part Edit screens.

QEDLevel)	Vol1	Pan	RevSend	ChoSend
Common	127	C	63	63

Vol (Volume)

Set the output level of the Layer Part.

□ **Settings:** 0 ~ 127

Pan

Set the stereo pan position of the Layer Part.

□ **Settings:** L63 (Left) ~ C (Center) ~ R63(Right)

RevSend (Reverb Send)

Set the Send level of the signal sent from Insertion Effect 1/2 (or the by-passed signal) to the Reverb effect.

□ **Settings:** 0 ~ 127

ChoSend (Chorus Send)

Set the Send level of the signal sent from Insertion Effect 1/2 (or the by-passed signal) to the Chorus effect.

□ **Settings:** 0 ~ 127

QED EF (Quick Edit Effect)

You can set the amount of Chorus applied to the Layer Part, as well as Portamento settings.

QEDBEF)	Chorus	Portamento-Time
Common	-63	off 127

Chorus

Set the Return level of the Chorus effect as an offset value.

□ **Settings:** -64 ~ 0 ~ +63

Portamento

Switch Portamento on or off.

□ **Settings:** off, on

Time

Set the pitch transition time. Higher values mean longer transition times.

□ **Settings:** -64 ~ 0 ~ +63

QED Filter (Quick Edit Filter)

These parameters control filters which govern the tonal quality of the Voice. If you are using LPF (Low Pass Filter) and HPF (High Pass Filter) combined together, the parameters in the QED Filter screen only affects LPF.

QEDFilter> Common	Cutoff +63	Reso +63
----------------------	---------------	-------------

■ Cutoff

Raise or lower the Cutoff frequency for each Voice of a Layer Part.

□ Settings: -64 ~ 0 ~ +63

■ Reso (Resonance)

Set the amount of Resonance (harmonic emphasis) applied to the signal at the Cutoff frequency.

□ Settings: -64 ~ 0 ~ +63

QED EG (Quick Edit Envelope Generator)

The EG (Envelope Generator) controls the transition in output level over time for each Voice in a Layer Part. There are four parameters governing the transition in output level from the moment a note is pressed on the keyboard to the moment it is released or the point at which the output level has faded to zero. These Layer Part settings make use of the each of the Part Edit settings.

QEDBEG> Common	Attack +63	Decay +63	Sustain +63	Release +63
-------------------	---------------	--------------	----------------	----------------

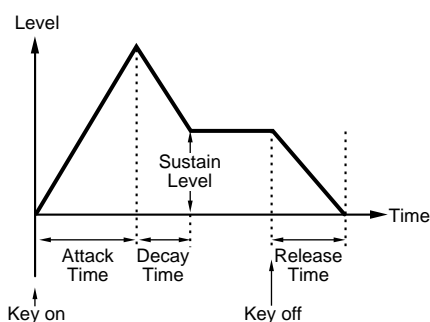

■ Attack

Set the transition time from the moment a key on the keyboard is pressed to the point at which the output level of the Layer Part reaches its peak.

□ Settings: -64 ~ 0 ~ +63

■ Decay

Set the transition time from the point at which the output level of the Layer Part reaches its peak to the point at which it levels off.

□ Settings: -64 ~ 0 ~ +63

■ Sustain

Set the output level of the Layer Part maintained while the key on the keyboard is being held down.

□ Settings: -64 ~ 0 ~ +63

■ Release

Set the transition time from the point at which the key on the keyboard is released to the point at which the output level of the Layer Part reaches zero.

□ Settings: -64 ~ 0 ~ +63

Common Arpeggio

The following four screens govern the behavior of the Arpeggiator. The parameters are the same as those used in Voice Edit Mode. Details are given on Page 72.

NOTE To use the Arpeggiator in Performance Mode, the Arpeggio and Layer Switches (Page 123) must be set to “on.”

- ARP Type (Arpeggio Type)
- ARP Limit (Arpeggio Note Limit)
- ARP Mode (Arpeggio Mode)
- ARP PlayEF (Arpeggio Play Effect)

Common Controller

You can assign MIDI Control Change Numbers to the controls and front panel knobs. For example, Knob [1]/[2] can be set to control the amount of effect applied to a sound and the Foot Controller can be set to control modulation. You can set different Control Set assignments for each Performance.

The following two Control Set screens are available.

- CTL Assign1 (Controller Assign 1)
- CTL Assign2 (Controller Assign 2)

CTL Assign 1 (Controller Assign 1)

Use Knobs [C], [1] and [2] to assign Control Numbers to the Breath Controller, Knob [1] and Knob [2], respectively. The selected function is shown on the left of the display.

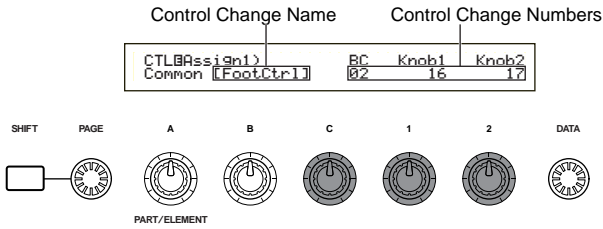

■ BC (Breath Controller)

Set Control Change Number assigned to the Breath Controller. The Breath Controller is connected to the BREATH jack (Page 18).

□ **Settings:** Details are given in the separate Control List.

■ Knob1/2

Set Control Change Numbers assigned to Knobs [1] and [2] on the front panel.

CTL Assign 2 (Controller Assign 2)

Use Knobs [C] and [1] to assign Control Change Numbers to the Foot Controller and Ribbon Controller, respectively. The selected function is shown on the left of the display.

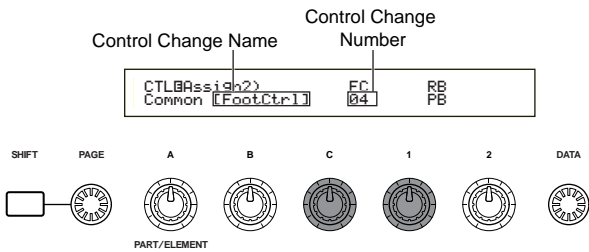

■ FC (Foot Controller)

Assign a Controller Change Number to the Foot Controller. The Foot Controller is connected to the FOOT CONTROLLER jack on the rear panel (Page 18).

□ **Settings:** Details are given in the separate Control List.

■ RB (Ribbon Controller)

Assign a Control Change Number to the Ribbon Controller.

□ **Settings:** Details are given in the separate Control List.

Common EQ (Equalizer)

You can assign any of five different Equalizer bands to the entire Performance. The following five screens are available.

- EQ Low
- EQ LowMid (Low-Middle Range)
- EQ Mid (Middle Range)
- EQ HighMid (High-Middle Range)
- EQ High

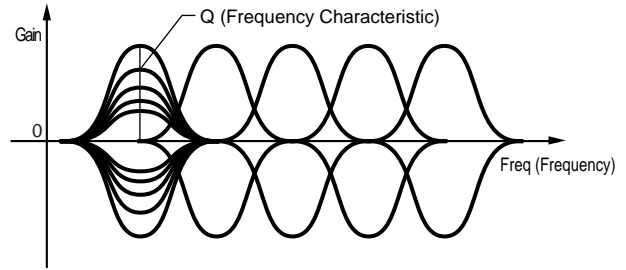

EQ Low

This Equalizer covers low frequencies. You can adjust the signal level at the specified frequency. You can also select different Equalizer types (Shapes).

MEQBLow)	Shape	Gain	Freq	
Common	Peak	+12dB	50Hz	12.0

■ Shape

Select either a Shelving or Peaking equalizer. The Peaking type attenuates/boosts the signal at the specified Frequency setting, whereas the Shelving type attenuates/boosts the signal at frequencies above or below the specified Frequency setting.

□ **Settings:** shelv (Shelving), peak (Peaking)

shelv (Shelving)

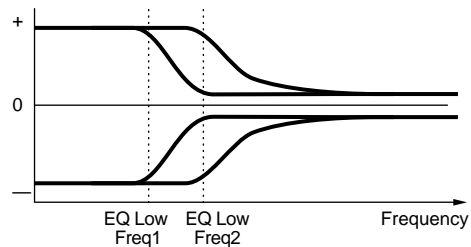

peak (Peaking)

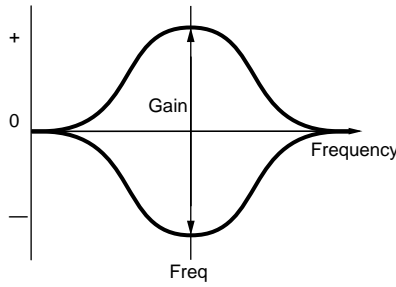

■ **Gain**

Set the Gain. This attenuates or boosts frequencies around the Frequency setting.

□ **Settings:** -12dB ~ 0dB ~ +12dB

■ **Freq (Frequency)**

Set the center frequency. Frequencies around this point are attenuated/boosted by the Gain setting.

□ **Settings:** 32Hz ~ 2.0kHz

■ **Q (Frequency Characteristic)**

This varies the signal level at the Frequency setting to create various frequency curve characteristics.

□ **Settings:** 0.1 ~ 12.0

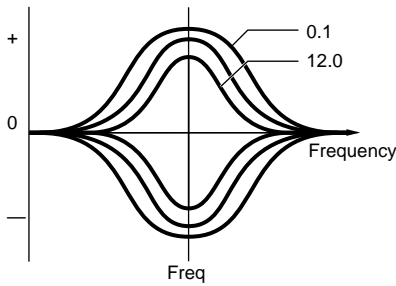

EQ LowMid (Low-Middle Range)

EQ Mid (Middle Range)

EQ HighMid (High-Middle Range)

These Equalizers cover low-to-middle, middle and high-to-middle frequency ranges. They can be used to adjust the signal level around the specified frequency.

Low Mid

MEQBLowMid)	Gain	Freq	12.0
Common	+12dB	100Hz	12.0

Mid

MEQBMid)	Gain	Freq	12.0
Common	+12dB	100Hz	12.0

High Mid

MEQBHighMid)	Gain	Freq	12.0
Common	+12dB	100Hz	12.0

■ **Gain**

Set the Gain. This attenuates or boosts frequencies around the Frequency setting.

□ **Settings:** -12dB ~ 0dB ~ +12dB

■ **Freq (Frequency)**

Set the center frequency. Frequencies around this point are attenuated/boosted by the Gain setting.

□ **Settings:** 100Hz ~ 10.0kHz

■ **Q (Frequency Characteristic)**

This varies the signal level at the Frequency setting to create various frequency curve characteristics.

□ **Settings:** 0.1 ~ 12.0

EQ High

This Equalizer covers high frequencies. You can adjust the signal level at the specified frequency. You can also select different Equalizer types (Shapes).

MEQBHigh)	Shape	Gain	Freq	12.0
Common	Peak	+12dB	0.5kHz	12.0

■ **Shape**

Select either a Shelving or Peaking equalizer. The Peaking type attenuates/boosts the signal at the specified Frequency setting, whereas the Shelving type attenuates/boosts the signal at frequencies above or below the specified Frequency setting.

□ **Settings:** shelv (Shelving), peak (Peaking)

■ **Gain**

Set the Gain. This attenuates or boosts frequencies around the Frequency setting.

□ **Settings:** -12dB ~ 0dB ~ +12dB

■ **Freq (Frequency)**

Set the center frequency. Frequencies around this point are attenuated/boosted by the Gain setting.

□ **Settings:** 500Hz ~ 16.0kHz

■ **Q (Frequency Characteristic)**

This varies the signal level at the Frequency setting to create various frequency curve characteristics.

□ **Settings:** 0.1 ~ 12.0

Common Effect

You can set two types of Insertion Effects, plus two System Effects (Reverb and Chorus). The following three screens are available.

EFF Part

EFF Rev (Reverb)

EFF Cho (Chorus)

EFF Part

EFFBPart)	---- InsEF ----	PLG-EF
Common	part16 partP1	part10

■ InsEF (Insertion Effect)

Assign a Part to an Insertion Effect. Select “off” if you do not wish to assign the Part to an Insertion Effect. Furthermore, if Plug-in Boards have been installed, they will also be selectable as Plug-in Parts 1 and 2.

- ❑ **Settings:**
normal Part:
 Part01 ~ Part16, PartAD (A/D Input Part), off
- Plug-in Part (if installed):**
 PartP1 (Plug-in Part 1), PartP2 (Plug-in Part 2), off

■ PLG-EF (Plug-in Effect)

Assign a Part to the Plug-in Effect. Select “off” if you do not wish to assign the Part to a Plug-in Effect. These parameters are only available if an Insertion Effect Plug-in board has been installed.

- ❑ **Settings:**
normal Part:
 Part01 ~ Part16, PartAD (A/D Input Part), off

EFF Rev (Reverb)

You can select the Reverb Effect Type and set its parameters by pressing the [ENTER] key.

```
EFFBRev) Type      Return [ENTER]
Common  Basement  127 to Edit
```

■ Type (Reverb Effect Type)

Set the Reverb Effect Type.

- ❑ **Settings:** Details are given in the Effect Types list of the separate Data List.

■ Return

Set the Return level of the Reverb Effect.

- ❑ **Settings:** 0 ~ 127

EFF Cho (Chorus)

You can select the Chorus Effect Type and set its parameters by pressing the [ENTER] key.

```
EFFBCho) Type      toRev  Return [ENTER]
Common  Chorus1    127    127 to Edit
```

■ Type (Chorus Effect Type)

Set the Chorus Effect Type.

- ❑ **Settings:** Details are given in the Effect Types list of the separate Data List.

■ toRev (To Reverb)

Set the Send level of the signal sent from the Chorus Effect to the Reverb Effect.

- ❑ **Settings:** 0 ~ 127

■ Return

Set the Return level of the Chorus Effect.

- ❑ **Settings:** 0 ~ 127

NOTE If an Insertion Effect Plug-in Board has been installed, you will see the EFF Plg (Plug-in) screen following the EFF Cho (Chorus) screen.

Effect Parameter Settings

The EFF Rev and EFF Cho parameter screens are available when you select the Effect and press the [ENTER] key. If an Insertion Effect Plug-in Board has been installed, you can enter the parameters for the Plug-in Effect at the EFF Plg (Plug-in) screen. Use the [PAGE] knob to switch between screens, and use the other knobs and the [INC/YES] and [DEC/NO] keys to set each parameter. When you press the [EXIT] key, you will be returned to the Effect Type selection screen.

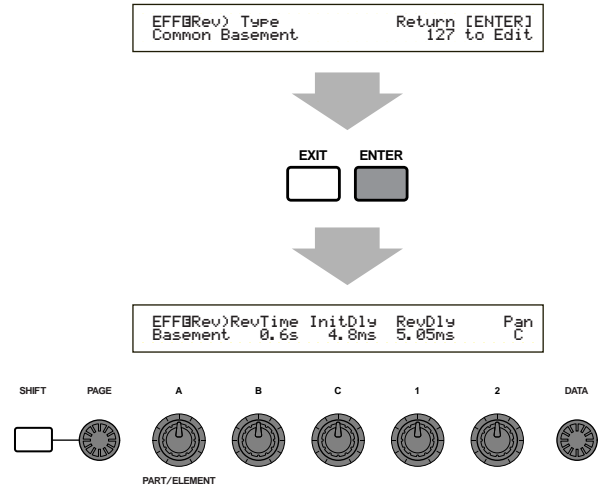

NOTE The number of Parameters and the contents of each screen will vary depending on the selected Effect Type. Details are given in the Effect Types list of the separate Data List.

Part (Settings for each Part)

You can edit each Part in a Performance. Use Knob [A] to select the Part, then set its parameters. The following six screens are available, though their contents will vary according to the Part selected.

- Part Mixer
- Part Tone
- Part Layer
- Part Receive switch
- Part Controller
- Part Insertion Effect

Part Mixer

You can set various Voice output parameters for each Part. The following two screens are available.

MIX Vce (Mix Voice)
MIX Level

- NOTE** The MIX Vce (Mix Voice) screen will change to the Mix Template screen if PartAD (A/D Input Part) has been selected.

MIX Vce/Template (Mix Voice/Template)

You can assign a Voice/Template to each Part. Use Knob [A] to select the Part, then set its Voice/Template parameters. The display will vary as follows according to the Part selected.

• If Part01 to Part16 has been selected

You can use the same method as the Category Search (Page 67) to set the Voice.

```
MIX[Vce] Memory Number Ctgry Search  
Part01 PRE1:128(H16)[Pf:GrandPiano]
```

■ Memory (Voice Memory)

- Settings:**
PRE1 (Preset 1), PRE2 (Preset 2), INT (Internal Normal), EXT (External Normal), PRE (Preset Drum), INT (Internal Drum), EXT (External Drum)

■ Number (Program Number)

- Settings:**
1 ~ 128 (for Normal Voices), DR1 ~ DR8 (for Preset Drum), DR1 ~ DR2 (for Internal/External Drum)

- NOTE** Details about Categories are given in the Category List on Page 70.

• If PartP1/PartP2 (Plug-in 1/2) has been selected

Set the Voice for the Plug-in 1/2 Part. This screen is only displayed if a Plug-in Board has been installed. Use Knob [B] to select PLG1/2INT (internal memory) and the MSB/LSB (Plug-in Board's Bank), and use Knob [C] to select the Program Number.

```
MIX[Vce] Bank Number Ctgry Search  
PartP1 NORM/001:128(H16)[Pf:GrandPiano]
```

■ Bank

- Settings:**
PartP1/P2 (Plug-in 1/2): PLG1/2 INT (Plug-in 1/2 Internal), MSB/LSB (Plug-in Bank)

- NOTE** For details about Plug-in Banks (Bank Select MSB/LSB), refer to the Owner's Manual that came with your Plug-in Board.

■ Number (Program Number)

- Settings:**
PLG1/2 INT (Plug-in 1/2 Internal): 1 ~ 64
MSB/LSB (Plug-in Bank): 1 ~ 128

- NOTE** There may be a delay when changing programs for Plug-in Parts (since voice data and default settings need to be sent). To change Voices for Plug-in Parts in a song, you should insert the Program Changes in the less data-intensive areas of the song. When selecting a Plug-in Board Voice, you should use the Program Number of the Parameter Change (multi-part). Details are given in the Owner's Manual that comes with the Plug-in Board.
- NOTE** In Performance Mode, the Part assignments for Plug-in Boards are fixed at "16" for PLG1 and "15" for PLG2.
- NOTE** For details about Plug-in Voices, refer to the Owner's Manual that came with your Plug-in Board.

• If Part17 to Part32 has been selected

You can set Voices for Parts 17 to 32 if you have a multitimbral Plug-in board installed. Use Knob [B] to select the Voice Bank and Knob [C] to select the Program Number.

```
MIX[Vce] Bank Number  
Part17 NORM/001:001(A01)[Pf:GrandPno]
```

■ Bank/Number (Bank/Program Number)

- Settings:** Refer to the Owner's Manual that came with the Plug-in board.
- NOTE** This setting is only held temporarily and cannot be stored with the Performance.

• If PartAD (A/D Input Part) has been selected

An audio source connected to the A/D INPUT jack can be used as a Part. There are 13 different templates for Effect Type and Gain settings. Select the A/D Input Part source and the template.

```
MIX[Template]Src Number  
PartAD keyboard --[InsEF off]
```

■ **Src (Source)**

Select the source connected to the A/D INPUT jack.

□ **Settings:** mic (microphone), guitar, keyboard, audio

■ **Number (Template Number)**

Select the Template Number. You can choose from 13 templates for each source.

□ **Settings:** 0 ~ 12

Number Src		0	1	2	3	4	5	6
MIC	PresetName InputGain VariType	Off mic -	Mic mic -	Reverb mic -	Chorus mic -	Cho+Rev mic -	Karaoke1 mic Karaoke1	Karaoke2 mic Karaoke2
GUITAR	PresetName InputGain VariType	Off mic -	Guitar mic -	Reverb mic -	Chorus mic -	Cho+Rev mic -	Tube mic AmpSim.	Stack mic AmpSim.
KEYBOARD	PresetName InputGain VariType	Off line -	Keyboard line -	Reverb line -	Chorus line -	Cho+Rev line -	PhaserEP line Phaser1	PanEP line AutoPan
AUDIO	PresetName InputGain VariType	Off line -	Audio line -	Reverb line -	Chorus line -	Cho+Rev line -	Audio line -	Audio line -

Number Src		7	8	9	10	11	12
MIC	PresetName InputGain VariType	Karaoke3 mic Karaoke3	Echo mic Echo	Vocal mic Stage1	Studio mic Exciter	OctUp mic PitChange1	OctDown mic PitChange1
GUITAR	PresetName InputGain VariType	FlangGtr mic Flanger1	CleanGtr mic Celeste3	FuncGtr mic TouchWah2	Tremolo mic Tremolo	Phaser mic Phaser1	5thGuitar mic PitChange1
KEYBOARD	PresetName InputGain VariType	WahClavi line TouchWah1	RotaryOrg line RotarySp.	SynthStr line Symphonic	SynthPad line Flanger2	SynthLead line DelayLCR	SFX line PitChange1
AUDIO	PresetName InputGain VariType	Audio line -	Audio line -	Audio line -	Audio line -	Audio line -	Audio line -

NOTE If you attempt to select a Number from within “5” to “12” while you have a setting other than “PartAD” for the Insert Effect (Ins EF) parameter in the Effect Part (EFF Part) page, it will be disabled with “InsEF off” shown for the Number parameter.

MIX Level

You can set output level, pan, effect send and other parameters for each Part. This is useful when setting up the levels of each Part in a mix.

MIXLevel1> Part01	Vol1 127	Pan C	RevSend 64	ChoSend 0
----------------------	-------------	----------	---------------	--------------

■ **Vol (Volume)**

Set the output level of the Part.

□ **Settings:** 0 ~ 127

■ **Pan**

Set the stereo pan position of the Part.

□ **Settings:** L63 (Left) ~ C (Center) ~ R63 (Right)

■ **RevSend (Reverb Send)**

Set the Send level of the signal sent from Insertion Effect 1/2 (or the bypassed signal) to the Reverb effect.

□ **Settings:** 0 ~ 127

■ **ChoSend (Chorus Send)**

Set the Send level of the signal sent from Insertion Effect 1/2 (or the bypassed signal) to the Chorus effect.

□ **Settings:** 0 ~ 127

Part Tone

You can set Filter, Envelope Generator and other parameters controlling the tonal characteristics of each Part. The following four screens are available.

- TON Filter (Tone Filter)
- TON EG (Tone Envelope Generator)
- TON Portamento (Tone Portamento)
- TON Other (Tone Other)

TON Filter (Tone Filter)

You can use filters to adjust the tone of each Part. If the filter is an LPF and HPF combination, the Cutoff parameter applies to the LPF. These parameters are also available in the Common Quick Edit screens.

TONFilter> Part01	Cutoff +63	Reso +63
----------------------	---------------	-------------

NOTE This screen is not available for the A/D Input Part.

NOTE Details about the Filter are given on Page 83.

■ **Cutoff**

Raise or lower the Cutoff frequency for each Element of a Part.

NOTE For each Element, if a combined Low Pass and High Pass Filter is being used, this parameter adjusts the Cutoff frequency of the Low Pass Filter.

□ **Settings:** -64 ~ 0 ~ +63

■ **Reso (Resonance)**

Set the amount of Resonance (harmonic emphasis) applied to the signal at the Cutoff frequency. This adds further character to the sound.

□ **Settings:** -64 ~ 0 ~ +63

TON EG (Tone Envelope Generator)

You can set EG (Envelope Generator) parameters for each Part. There are four parameters governing the transition in output level from the moment a note is pressed on the keyboard to the moment it is released or the point at which the output level has faded to zero.

NOTE This screen is not available for the A/D Input Part.

NOTE For more information, refer to a diagram that illustrates the concept of Envelope Generator, which you can find in Voice Edit Mode sections.

Part 1 to 16

```
TONBEG) Attack Decay Sustain Release
Part01  + 0 + 0 + 0 + 0
```

Plug-in 1/2 Part

Multi Plug-in Part

```
TONBEG) Attack Decay Release
PartP1  + 0 + 0 + 0
```

Drum Voice Part

```
TONBEG) Attack Decay
Part10  + 0 + 0
```

■ Attack

Set the transition time from the moment a key on the keyboard is pressed to the point at which the output level of the Part reaches its peak. A positive value will lengthen the transition time and a negative value will shorten it.

□ **Settings:** -64 ~ 0 ~ +63

■ Decay

Set the transition time from the point at which the output level of the Part reaches its peak to the point at which it levels off. A positive value will lengthen the transition time and a negative value will shorten it.

□ **Settings:** -64 ~ 0 ~ +63

■ Sustain

Set the output level of the Part maintained while the key on the keyboard is being held down.

NOTE This parameter is not available for Plug-in or Drum Voice Parts.

□ **Settings:** -64 ~ 0 ~ +63

■ Release

Set the transition time from the point at which the note on the keyboard is released to the point at which the output level of the Part reaches zero. A positive value will lengthen the transition time and a negative value will shorten it.

NOTE This parameter is not available for Drum Voice Parts.

□ **Settings:** -64 ~ 0 ~ +63

TON Portamento (Tone Portamento)

You can set the following three Portamento parameters for each Part.

NOTE This screen is not available for A/D Input or Drum Voice Parts.

Part 1 to 16

```
TONBPortamento) Switch Time Mode
Part01           on 127 fulltime
```

Plug-in 1/2 Part

Multi Plug-in Part

```
TONBPortamento) Switch Time
Part17           on 127
```

■ Switch (Portamento switch)

Switch Portamento on or off. With Portamento switched on, there will be a smooth transition in pitch from the first note played to the next note.

□ **Settings:** off, on

■ Time (Portamento Time)

Set the pitch transition time. Higher values mean longer transition times.

□ **Settings:** 0 ~ 127

■ Mode (Portamento Mode)

Select the Portamento Mode. The Portamento Mode behavior varies according to the Part Mode (mono/poly) setting in the LYR Mode screen (Page 123).

NOTE This parameter is not available for Plug-in 1/2 and Multi Plug-in Parts.

□ **Settings:** fingered, fulltime

If Part Mode is set to “mono”:

fingered:

Portamento is applied when the keyboard is played legato (a note is played before the previous note is released).

full:

Portamento is applied for all playing styles.

If Part Mode is set to “poly”:

Portamento is applied to multiple notes.

TON Other (Tone Other)

You can set Pitch Bend Range and Velocity Sensitivity parameters for each Part.

NOTE These screens are not available for the A/D Input Part.

Part 1 to 16

```
TONOther) Pitch Bend VelDepth-Offset
Part01    -12 - +12    127    64
```

Plug-in 1/2 Part

Multi Plug-in Part

Drum Voice Part

```
TONOther) Pitch Bend VelDepth-Offset
PartP1    +12    127    64
```

■ Pitch Bend

Set the amount (in semitones) by which the Voice pitch changes when the Pitch Bend Wheel is moved. For example, a Lower setting of -12 means that the pitch of the Voice drops by up to an octave when the Pitch Bend Wheel is moved downwards. An Upper setting of +12 means that the pitch of the Voice rises by up to an octave when the Pitch Bend Wheel is moved upwards.

The Lower parameter is only available for Normal Voice Parts (Parts 1 to 16).

□ Settings:

Lower (Left):

-48 ~ 0 ~ +24

Upper (Right):

-48 ~ 0 ~ +24 (or -24 ~ 0 ~ +24 for Plug-in 1/2 and Multi Plug-in Parts)

■ VelDepth-Offset (Velocity Sensitivity Depth/Offset)

Set the velocity sensitivity and velocity offset for each Part.

□ Settings:

VelDepth (Velocity Sensitivity): 0 ~ 127

offset (Velocity Offset): 0 ~ 127

VelDepth (Velocity Sensitivity Depth)

As illustrated below, a large setting will cause large changes in velocity when you play the keyboard.

Changes to velocity curve according to VelDepth (with offset set to 64)

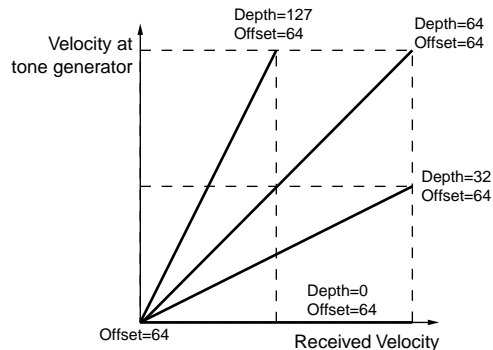

offset (Velocity Offset)

As illustrated below, the velocity will be increased by the specified amount.

Changes to velocity curve according to VelDepth (with offset set to 64)

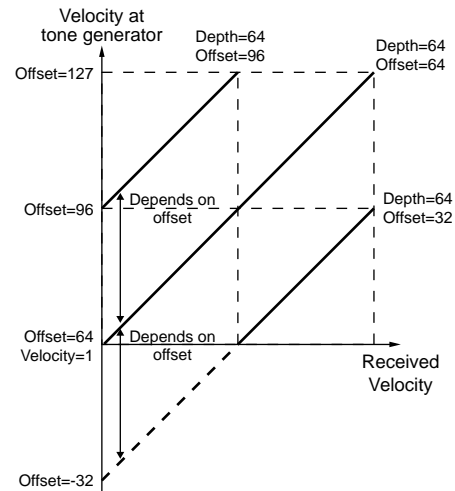

Part Layer

You can set various MIDI parameters for each Part, including MIDI Receive Channel, Arpeggiator switch, note limit and velocity. These parameters are largely used when layering multiple Parts. The following four screens are available.

LYR Mode (Layer Mode)

LYR Limit (Layer Limit)

LYR Tune (Layer Tune)

LYR Out (Layer Out)

LYR Mode (Layer Mode)

You can set the method by which each Part is output. The parameters will vary according to the Part selected.

Part 1 to 16

Plug-in 1/2 Part

```
LYRMode) Mode Arpeg Layer RcvCh
Part01    Poly on   off   1
```

Drum Voice Part

```
LYRMode)           Arpeg Layer RcvCh
Part01            on   off   1
```

A/D Input Part

Multi Plug-in Part

```
LYRMode)           RcvCh
PartAD            1
```

■ Mode

Select whether each Part is played back monophonically (single notes only) or polyphonically (multiple simultaneous notes).

NOTE This parameter is only available for Normal Voice Parts 1 to 16 and Plug-in 1/2 Parts.

Settings: mono, poly

■ Arp (Arpeggio switch)

Switch the Arpeggiator for the currently selected Part on or off.

NOTE This parameter is not available for A/D Input and Multi Plug-in Parts.

Settings: off, on

■ Layer (Layer switch)

When switched on, you can layer up to four Parts.

NOTE This parameter is not available for A/D Input and Plug-in Parts.

Settings: off, on

NOTE You can also set the overall output level and stereo pan position of the Layer when this is switched on (Page 109).

NOTE Layers may be slow to sound, depending on their component Parts.

NOTE If you turn five or more Layer Switches “on”, only four Parts are enabled for the layer. These four Parts are determined in the priority of Part01 to Part16, PartAD, PartP1, then PartP2. For disabled Parts, their Layer switch values will be shown in brackets like “(on).”

■ RcvCh (MIDI Receive Channel)

Set the MIDI Receive Channel for each Part. Select “off” for Parts that you do not want to respond to MIDI.

Settings: 1 ~ 16, off

LYR Limit (Layer Limit)

You can set note ranges and velocity limits for each Part.

NOTE These parameters are not available for the A/D Input Part.

LYRBLimit)	Note Limit	Vel Limit
Part01	C-2 - G8	1 - 127

■ Note Limit

Set the lowest and highest notes of the keyboard range for each Part. Each Part will only sound for notes played within its specified range.

Settings: C-2 ~ G8 (for the lowest and highest notes)

NOTE If you specify the highest note first and the lowest note second, for example “C5 to C4,” then the note range covered will be “C-2 to C4” and “C5 to G8.”

NOTE You can set the lowest and highest notes in the range by pressing notes on the keyboard while holding down the [SHIFT] key.

■ Vel Limit

Set the minimum and maximum values of the velocity range within which each Part will respond. Each Part will only sound for notes played within its specified velocity range.

Settings: 1 ~ 127 (for the minimum and maximum values)

NOTE If you specify the maximum value first and the minimum value second, for example “93 to 34,” then the velocity range covered will be “1 to 34” and “93 to 127.”

LYR Tune (Layer Tune)

You can set note shift and tuning parameters for each Part.

NOTE These parameters are not available for the A/D Input Part.

LYRB Tune)	NoteShift	Detune
Part01	+24	+12.7

■ NoteShift

Adjust the pitch of each Part in semitones.

Settings: -24 ~ +24

■ Detune

Offset (detune) the pitch of each Part by a very small amount.

Settings: -12.8Hz ~ +12.7Hz

LYR Out (Layer Out)

You can select outputs for each Part.

LYR B Out)	Output	InseF
Part01	L&R	(off)

■ Output

Assign each Part to an output.

Settings: L&R (Left and Right outputs), ind 1&2 (Individual Output 1&2) ind1 (Individual Output 1), ind2, ind3, ind4, ind5, ind6, drum

NOTE For example, if you choose “L&R,” the left channel will be output through OUTPUT L and the right channel will be output through OUTPUT R. Alternatively, if you choose “ind1,” the left and right signals will be merged and output monaurally through INDIVIDUAL OUTPUT 1.

NOTE Settings “ind3 to “ind6” are for future expansion purposes and are currently not available.

NOTE You can select “drum” for Drum Voice Parts. If you select “drum” for a Drum Voice Part, the output settings for each Drum Key (Page 95) are used.

■ InsEF (Insertion Effect)

Shows the on/off status of the Insertion Effects. If “on” is displayed, this means that the Part’s signal is being sent to the Insertion Effect Unit.

NOTE Insertion Effect switches for each Part are set in the EFF Part screen (Page 117).

Part Receive Switch

Each Part can be set to receive Control Change and Program Change messages. The following four screens are available.

RCV Sw1 (Receive Switch 1)
RCV Sw2 (Receive Switch 2)
RCV Sw3 (Receive Switch 3)
RCV Sw4 (Receive Switch 4)

RCV Sw1 (Receive Switch 1)

When set to “on,” each Voice in each Part will receive Control Settings (PB, MW, RB,AT) and Control Change messages. The Controller parameters will vary according to the Part selected.

NOTE This screen is not available for the A/D Input Part.

Parts 1 to 16

Drum Voice Part

RCVSw1) Part01	PB on	MW off	RB on	AT off
-------------------	----------	-----------	----------	-----------

Plug-in 1/2 Part

Multi Plug-in Part

RCVSw1) PartP1	PB on	MW off	AT off
-------------------	----------	-----------	-----------

□ Settings:

PB (Pitch Bend Wheel): off, on
MW (Modulation Wheel): off, on
RB (Ribbon Controller): off, on
AT (Aftertouch): off, on

RCV Sw2 (Receive Switch 2)

When set to “on,” each Voice in each Part will receive messages from Knob [1]/[2], plus Breath Controller, Foot Controller and Control Change messages.

NOTE This screen is only available for Parts 1 to 16 (including Drum Voice Parts).

Parts 1 to 16

Drum Voice Part

RCVSw2) Part01	Knob1 on	Knob2 off	BC on	FC off
-------------------	-------------	--------------	----------	-----------

□ Settings:

Knob1 (Knob [1]): off, on
Knob2 (Knob [2]): off, on
BC (Breath Controller): off, on
FC (Foot Controller): off, on

RCV Sw3 (Receive Switch 3)

When set to “on,” each Voice in each Part will receive volume, pan, sustain pedal, foot switch and Control Change messages.

Parts 1 to 16

RCVSw3) Part01	Vol on	Pan off	Sus on	FS off
-------------------	-----------	------------	-----------	-----------

Plug-in 1/2 Part

Multi Plug-in Part

RCVSw3) Part01	Vol on	Pan off	Sus on
-------------------	-----------	------------	-----------

Drum Voice Part

A/D Input Part

RCVSw3) PartAD	Vol on	Pan off	FS off
-------------------	-----------	------------	-----------

□ Settings:

Vol (Volume): off, on
Pan: off, on
Sus (Sustain): off, on
FS (Foot Switch): off, on

RCV Sw4 (Receive Switch 4)

When set to “on,” each Voice in each Part will receive Program Change and Control Change messages when you change Performance Bank/Program.

RCVSw4) Part01	BankSel off	PgmChng on	CtrChng off
-------------------	----------------	---------------	----------------

□ Settings:

BankSel (Bank Select): off, on
PgmChng (Program Change): off, on
CtrChng (Control Change): off, on

Part Controller

You can set various Controller parameters for the A/D Input Part and Multi Plug-in Parts 17 to 32. The following two screens for A/D Input Part parameters and six screens for the Multi Plug-in Part parameters are available.

CTL Set1 (Controller Set 1) (A/D Input Part only)
 CTL Set2 (Controller Set 2) (A/D Input Part only)

CTL MW Control (MW Control Depth) (Multi Plug-in Parts only)
 CTL MW Modulation (MW Modulation Depth) (Multi Plug-in Parts only)
 CTL AT Control (AT Control Depth) (Multi Plug-in Parts only)
 CTL AT Modulation (AT Modulation Depth) (Multi Plug-in Parts only)
 CTL AC Control (AC Control Depth) (Multi Plug-in Parts only)
 CTL AC Modulation (AC Modulation Depth) (Multi Plug-in Parts only)

CTL Set1/CTL Set2 (Control Set 1/2) (A/D Input Part only)

The controllers and knobs on the front panel, the keyboard, and so on can be assigned a variety of uses. For example, keyboard aftertouch can be used to control vibrato and the Modulation Wheel could be used to control Resonance. These control assignments are called “Control Sets.” You can assign up to two different Control Sets to the A/D Input Part. Thus there are two screens, each for a separate controller: CTL Set1 and CTL Set2.

```

    CTLSet1)  Src  Dest  Depth
    Part:AD  FC(04) off  +63
    
```

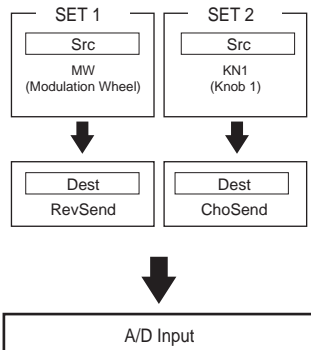

■ Src (Source)

Set the Controller used to control the parameter specified in Dest. The following controllers are available.

- **Settings:** PB (Pitch Bend Wheel), MW (Modulation Wheel), AT (Aftertouch), FC (Foot Controller), FS (Foot Switch), RB (Ribbon Controller), BC (Breath Controller), KN1/2 (Knob [1]/[2])

■ Dest (Destination)

Set the parameter to be controlled by the Controller specified in Src.

- **Settings:** see the separate Control List.

■ Depth (Depth)

Set the amount by which the parameter selected in Dest can be controlled.

- **Settings:** -64 ~ 0 ~ +63

NOTE Using Voice Control Sets 1 and 2, you can assign individual Src (Source) controllers to multiple Dest (Destination) parameters, or multiple Src controllers to individual Dest parameters. Details are given on Page 75.

CTL MW Control (MW Control Depth) (Multi Plug-in Parts only)

The Modulation Wheel can be used to control Filter and Amp parameters for each Multi Plug-in Part (17 to 32).

```

    CTLMW Control)  Filter  Amp
    Part:17        +63     +63
    
```

■ Filter

Set the amount by which the Modulation Wheel can be used to adjust the filter’s Cutoff frequency.

- **Settings:** -64 ~ +63

■ Amp

Set the amount by which the Modulation Wheel can be used to adjust the output level (amplitude).

- **Settings:** -64 ~ +63

CTL MW Modulation (MW Modulation Depth) (Multi Plug-in Parts only)

The Modulation Wheel can be used to control the amount of pitch/filter/amplitude modulation applied to each Multi Plug-in Part (17 to 32).

```

    CTLMW Modulation) PMod  FMod  AMod
    Part:17          127   127   127
    
```

■ PMod (Pitch Modulation Depth)

Set the amount by which the pitch modulation changes when the Modulation Wheel is used.

- **Settings:** 0 ~ 127

■ FMod (Filter Modulation Depth)

Set the amount by which the filter Cutoff frequency changes when the Modulation Wheel is used.

□ Settings: 0 ~ 127

■ AMod (Amplitude Modulation Depth)

Set the amount by which the amplitude modulation changes when the Modulation Wheel is used.

□ Settings: 0 ~ 127

CTL AT Control (AT Control Depth) (Multi Plug-in Parts only)

Keyboard aftertouch can be used to control the pitch/filter/amplitude parameters for each Multi Plug-in Part (17 to 32).

CTLBAT Control)	Pitch	Filter	Amp
Part17	+24	+63	+63

■ Pitch

Set the amount (in semitones) by which the pitch changes when aftertouch is applied.

□ Settings: -24 ~ +24

■ Filter

Set the amount by which the filter Cutoff frequency changes when aftertouch is applied.

□ Settings: -64 ~ +63

■ Amp

Set the amount by which the output level (amplitude) changes when aftertouch is applied.

□ Settings: -64 ~ +63

CTL AT Modulation (AT Modulation Depth) (Multi Plug-in Parts only)

Keyboard aftertouch can be used to control the amount of pitch/filter/amplitude modulation applied to each Multi Plug-in Part (17 to 32).

CTLBAT Modulation)	PMod	FMod	AMod
Part17	127	127	127

■ PMod (Pitch Modulation Depth)

Set the amount by which the pitch modulation changes when aftertouch is used.

□ Settings: 0 ~ 127

■ FMod (Filter Modulation Depth)

Set the amount by which the filter Cutoff frequency changes when aftertouch is used.

□ Settings: 0 ~ 127

■ AMod (Amplitude Modulation Depth)

Set the amount by which the amplitude modulation changes when aftertouch is used.

□ Settings: 0 ~ 127

CTL AC Control (AC Control Depth) (Multi Plug-in Parts only)

Control Changes (Assignable Controllers) can be used to control the filter/amplitude parameters for each Multi Plug-in Part (17 to 32).

CTLBAC Control)	Source	Filter	Amp
Part17	04[FootCtrl]	+63	+63

■ Source

Set the MIDI Control Change number used to control the Filter/Amp parameters.

□ Settings: off, 1 ~ 95

■ Filter

Set the amount by which the filter Cutoff frequency changes when the controller (Source) is used.

□ Settings: -64 ~ +63

■ Amp

Set the amount by which the output level (amplitude) changes when the controller (Source) is used.

□ Settings: -64 ~ +63

CTL AC Modulation (AC Modulation Depth) (Multi Plug-in Parts only)

Control Changes (Assignable Controllers) can be used to control the amount of pitch/filter/amplitude applied to each Multi Plug-in Part (17 to 32).

CTLBAC Modulation)	PMod	FMod	AMod
Part17	127	127	127

■ PMod (Pitch Modulation Depth)

Set the amount by which the pitch modulation changes when the controller (Source) is used.

□ Settings: 0 ~ 127

■ **FMod (Filter Modulation Depth)**

Set the amount by which the filter Cutoff frequency changes when the controller (Source) is used.

□ **Settings:** 0 ~ 127

■ **AMod (Amplitude Modulation Depth)**

Set the amount by which the amplitude modulation changes when the controller (Source) is used.

□ **Settings:** 0 ~ 127

Part Insertion Effect (A/D Input Part only)

You can set parameters for the Insertion Effects used by the A/D Input Part. If you have selected the A/D Input Part, as the InsEF (Insertion Effect) in the EFF Part screen, the following screens will be available.

EFF EF1/2 (Insertion Effect 1/2)

Choose the type of effect used for the A/D Input Part. You can select the Effect Category for Insertion Effect 1/2 with the Ctgr parameter and the Effect Type with the Type parameter. After selecting the Effect Type, you can start setting its parameters by pressing the [ENTER] key.

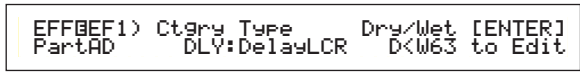

NOTE The connection between Insertion Effects 1 and 2 is fixed as 1 → 2 (Serial).

■ **Ctgr (Effect Category)**

Set the Category of the Effect. The first Effect Type of the selected Category will blink.

□ **Settings:** Details are given in the Effect Types list of the separate Data List.

■ **Type (Effect Type)**

Set the type of Effect. This depends on the selected Category. For certain Categories, the Effect Type will blink. In this case, you can press the [ENTER] key to set the Effect Type.

□ **Settings:** Details are given in the Effect Types list of the separate Data List.

■ **Dry/Wet**

Set the mix level of the wet signal (which has been passed through the Effects Unit) and the dry signal (which has not been passed through the Effects Unit). This may be unavailable, depending on the selected Effect Type.

□ **Settings:** D63 > W ~ D = W ~ D < W63

Effect Parameter Settings

These parameters are available when you press the [ENTER] key for certain Effect Types. Use the [PAGE] knob to switch between screens, and use the other knobs and the [INC/YES] and [DEC/NO] keys to set each parameter. When you press the [EXIT] key, you will be returned to the Effect Type selection screen.

Select Effect Type

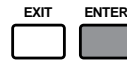
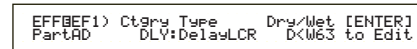

Parameters

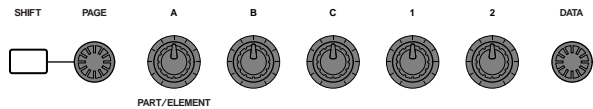
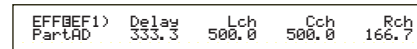

NOTE The number of parameters and the contents of each screen will vary depending on the selected Effect Type. Details are given in the Effect Type list of the separate Data List.

Zones

You can edit the zones used by Performances in Master Keyboard Mode. Use Knob [A] (or BANK [A] ~ [D] keys) to select the zone (1 to 4), then set the zone's parameters. The following eight screens are available for Master Keyboard parameters.

You can choose zones if "4zone" has been selected as the Mode at the GEN M.Kbd screen (Page 113), and if the [MASTER KEYBOARD] key LED is lit.

- Master keyboard
 - MKB Transmit (Master Keyboard Transmit)
 - MKB Note (Master Keyboard Note)
 - MKB TxSw1 (Master Keyboard Transmit Switch 1)
 - MKB TxSw2 (Master Keyboard Transmit Switch 2)
 - MKB TxSw3 (Master Keyboard Transmit Switch 3)
 - MKB TxSw4 (Master Keyboard Transmit Switch 4)
 - MKB TxPreset1 (Master Keyboard Transmit Preset 1)
 - MKB TxPreset2 (Master Keyboard Transmit Preset 2)
 - MKB Assign (Master Keyboard Assign)

Master keyboard

MKB Transmit (Master Keyboard Transmit)

You can set parameters for transmitting keyboard data when in Master Keyboard Mode.

MKBBTransmit> Zone01	TrnsCh 1	TG on	MIDI on
-------------------------	-------------	----------	------------

■ TrnsCh (Transmit Channel)

Set the MIDI Transmit Channel for each zone.

□ Settings: 1 ~ 16

■ TG (Tone Generator)

Select whether or not to transmit MIDI messages for each zone to each Part's tone generator.

□ Settings: off, on

■ MIDI (MIDI Transmit)

Select whether or not to transmit MIDI messages to each zone's MIDI Out port.

□ Settings: off, on

MKB Note (Master Keyboard Note)

You can set Octave, Transpose, Note Limit (key range) for each zone in Master Keyboard Mode.

MKBBNote> Zone01	Octave +1	Transpose +11	Note Limit C-2 - G 8
---------------------	--------------	------------------	-------------------------

■ Octave

Shift the note range of each zone up or down (in octaves).

□ Settings: -3 ~ 0 (Default) ~ +3

■ Transpose

Transpose the note range of each zone up or down (in semitones).

□ Settings: -11 ~ 0 (Default) ~ +11

■ Note Limit

Set the upper and lower notes in each zone's note range.

□ Settings: C-2 ~ G8 (for both upper and lower notes)

NOTE You can also select this parameter by pressing each note while holding down the [SHIFT] key.

MKB TxSw1 (Master Keyboard Transmit Switch 1)

For each zone, you can enable/disable the transmission of messages for the Pitch Bend Wheel, Modulation Wheel, Knobs [A] to [C] and Knob [1]/[2].

MKBBTxSw1> Zone01	PB off	MW on	KnobA-C on	Knob1-2 on
----------------------	-----------	----------	---------------	---------------

□ Settings:

PB (Pitch Bend Wheel): off, on

MW (Modulation Wheel): off, on

KnobA-C (Knobs [A] to [C]): off, on

Knob1/2 (Knob [1]/[2]): off, on

MKB TxSw2 (Master Keyboard Transmit Switch 2)

For each zone, you can enable/disable the transmission of messages for the Ribbon Controller, Foot Controller, Breath Controller and Aftertouch.

MKBBTxSw2> Zone01	RB on	FC on	BC on	AT on
----------------------	----------	----------	----------	----------

□ Settings:

RB (Ribbon Controller): off, on

FC (Foot Controller): off, on

BC (Breath Controller): off, on

AT (Aftertouch): off, on

MKB TxSw3 (Master Keyboard Transmit Switch 3)

For each zone, you can enable/disable the transmission of messages for the Sustain Pedal, Foot Switch, Volume/Foot Volume and Pan knob.

MKBBTxSw3> Zone01	Sus on	FS on	Vol/FV on	Pan on
----------------------	-----------	----------	--------------	-----------

□ Settings:

Sus (Sustain): off, on

FS (Foot Switch): off, on

Vol/FV (Volume/Foot Volume): off, on

Pan: off, on

MKB TxSW4 (Master keyboard Transmit Switch 4)

For each zone, you can enable or disable the transmission of Bank Select and Program Change messages when you switch Performance Banks or Programs.

MKBBTxSw4> Zone01	Bank on	PC on
----------------------	------------	----------

□ Settings:

Bank (Bank Select): off, on

PC (Program Change): off, on

MKB TxPreset1 (Master Keyboard Transmit Preset 1)

You can set each zone's initial volume and stereo pan settings when changing Performance Bank/Program.

MKBBTxPreset1)	Volume	Pan
Zone01	127	C

■ Vol (Volume)

Set the output level of the zone.

□ **Settings:** 0 ~ 127

NOTE This setting is not transmitted if the Vol/FV (Volume/Foot Volume) parameter of the MKB TxSw3 screen has been set to “off.”

■ Pan

Set the stereo pan position of the zone.

□ **Settings:** L64 (Left) ~ C (Center) ~ R63 (Right)

NOTE This setting is not transmitted if the Pan parameter at the MKB TxSw3 screen has been set to “off.”

MKB TxPreset2 (Master Keyboard Transmit Preset 2)

For each zone, you can set the Bank Select and Program Change parameters transmitted when changing Bank/Program in a Performance.

MKBBTxPreset2)	BankMSB	BankLSB	PC
Zone01	127	127	1

■ BankMSB (MIDI Bank Select MSB)

Set the Bank Select MSB transmitted when changing Bank/Program.

□ **Settings:** 0 ~ 127

■ BankLSB (MIDI Bank Select LSB)

Set the Bank Select LSB transmitted when changing Bank/Program.

□ **Settings:** 0 ~ 127

NOTE “Bank Select” is a type of MIDI message transmitted when changing Voice Bank. Control Change MSB and LSB messages are combined to form Bank Select messages, which are used to specify the Voice Bank. These message values will vary according to synthesizer. For more details, refer to the documentation that came with your synthesizer.

NOTE This setting is not transmitted if the Bank (Bank Select) parameter at the MKB TxSw4 screen has been set to “off.”

■ PC (MIDI Program Change)

Set the Program Number transmitted when changing Bank/Program.

□ **Settings:** 1 ~ 128

NOTE Program Numbers 001 to 128 directly relate to MIDI Program Change Numbers 000 to 127. That is, Program Numbers and Program Change Numbers differ by a value of 1. Remember to take this into consideration.

NOTE This setting is not transmitted if the PC (Program Change) parameter at the MKB TxSw4 screen has been set to “off.”

MKB Assign (Master Keyboard Assign)

You can assign a different Control Slider function (Control Change) to each zone.

MKBBAssign)	CS
Zone01	07[Main Vol]

□ **Settings:** off, 1 ~ 95

Performance Job Mode

You can execute various actions (Jobs) in Performance Job Mode. For example, you can “Initialize” Performances (including those currently being edited) or “Recall” previous edits.

When you enter Performance Job Mode, you will first see the Initialize screen. The following four screens are available for each Performance Job.

NOTE Before entering Performance Job Mode and using the Initialize or Recall function, you must select the Performance you wish to operate on (Page 109).

- 1st screen: PFM Initialize
- 2nd screen: PFM Edit Recall
- 3rd screen: PFM Copy
- 4th screen: PFM Bulk Dump

NOTE Details about how to enter Performance Job Mode are given on Page 22.

Executing a Job

- 1 In Performance Play Mode, select the Performance Number on which you will execute the Job.
- 2 Press the [JOB] key to enter Performance Job Mode.
- 3 Use the [PAGE] knob and switch to the screen showing the Job you wish to execute.

```
PFM Initialize)
Job          Current Perform
```

- 4 Use Knobs [B]/[C] and Knobs [1]/[2] to select the parameter on which you will execute the Job. (Alternatively, use the [DATA] knob and the [DEC/NO] and [INC/YES] keys.)

NOTE This step is not applicable for Recall and Bulk Dump Jobs.

- 5 When you press the [ENTER] key, you will be prompted for confirmation.

```
^PFM Bulk Dump)
<< Are you sure? [YES]/[NO] >>
```

- 6 Press the [INC/YES] key to confirm. The message “Completed.” will be displayed when the Job has completed, and you will be returned to the original screen.

Press the [DEC/NO] key to cancel the Job.

NOTE For Jobs that take longer to process, you will see the message “Executing...” during processing. If you switch off the power to your synthesizer while this message is displayed, you risk corrupting your data.

- 7 Press the [PERFORM] key to exit Performance Job Mode and return to Performance Play Mode.

PFM Initialize

You can reset (initialize) all parameters of a Performance to their default settings. You can also selectively initialize certain parameters, such as Common settings, settings for each Part, and so on. Note that this is not the same as editing an existing Performance. Instead, it is useful when building a completely new Performance from scratch.

```
PFM Initialize)
Job          Current Perform
```

Select type of parameter to Initialize

Use Knob [B], the [DATA] knob or the [DEC/NO] and [INC/YES] keys to select the parameter to be initialized.

Settings: Current Perform, Current Common (Common Data: Data common to all Layer Parts), Current Part01 to Part16, Current PartAD (A/D Input Part), Current PartP1/P2 (Plug-in Part 1/2), Zone1 to Zone4

PFM Edit Recall

If you are editing a Performance but you do not store it before switching to another Performance, the edits you have made will be cleared. In such a situation, you can use the Recall function to reinstate the edits for the Performance.

```
PFM Edit Recall)
Job
```

PFM Copy

You can copy each Part’s parameters and Effects parameters from any Performance to the Performance you are editing. This is useful if you are creating a Performance and wish to use some parameter settings from another Performance.

NOTE This function is not used for copying whole Performances from one location to another. It is used for copying parameter settings from an existing Performance to the current Performance you are editing.

```
PFM Copy) [Pf:GrandPiano] Current
Job       [INT:]128(H16) Part10 > Part16
          ①           ②           ③           ④
```

1 Source Performance Memory

Select the Performance Memory containing the Performance (source) from which you will copy parameter settings.

Settings: INT (Internal), EXT (External)

② Source Performance Number

Select the Performance Number of the source Performance. The Performance Name is shown in the top line of the display.

□ **Settings:** 001 ~ 128 (INT), 001 ~ 064 (EXT)

NOTE When copying, you can set the current Performance number (destination) for the source Performance number. In this case, if you have edited several settings of the current Performance, you will copy those recent settings, not stored ones (before editing). Therefore, you can edit a Part and copy all edits to another Part.

③ Source Performance Part

Select the Part of the source Performance.

□ **Settings:** Part01 to Part16, PartAD (A/D Input Part), PartP1/P2 (Plug-in Part 1/2)

NOTE The Memory, Bank Select and Program Number settings cannot be copied if you have set the source or destination to something other than Part01 to Part16.

④ Destination Part

Set the Part of the destination Performance.

□ **Settings:** Part01 to Part16, Arp (Arpeggio), Effect, PartAD (A/D Input Part), PartP1/P2 (Plug-in Part 1/2).

NOTE If you choose Arp (Arpeggio) or Effect, the Arpeggio and Effect settings for the Voice assigned to the source Part will be copied.

NOTE The Memory, Bank Select and Program Number settings cannot be copied if you have set the source or destination to something other than Part01 to Part16.

PFM Bulk Dump

You can send all the parameter settings for the current Performance to your computer or some other external MIDI device using Bulk Dump.

```
PRF Bulk Dump)
Job          Current Perform
```

NOTE You must set the correct MIDI Device Number in order to execute a Bulk Dump. Details are given on Page 137.

Performance Store

You can store the parameter settings for up to 128 Performances to each of your synthesizer's Memories (INT: Internal) or up to 64 Performances to Memory Card (EXT: External). The procedure is as follows.

NOTE When you execute this, the settings for the destination Performance will be overwritten. Important data should always be backed up to computer, a separate Memory Card or some other storage device.

- 1 Press the [STORE] key after editing a Performance. You will see the Performance Store display.

```
PFMB [Pf:GrandPiano] >[Pf:Init Perf ]
Store INT:128(H16)
```

- 2 Use Knob [1] to select the destination Performance Memory (INT or EXT).

- 3 Use Knob [2] to select the destination Performance Number. This will set the Performance Memory/Number to which your Performance will be stored.

NOTE You can also use the [DATA] knob or [DEC/NO] and [INC/YES] keys to execute this operation.

- 4 When you press the [ENTER] key, you will be prompted for confirmation.

```
PFMB [Pf:GrandPiano] >[Pf:Init Perf ]
<< Are you sure? [YES]/[NO] >>
```

- 5 Press the [INC/YES] key to confirm. The message "Executing..." will be displayed while the Job is being processed. When it has completed, you will see the message "Completed." and you will be returned to Performance Play Mode.

NOTE You can press the [DEC/NO] key to cancel the Job. This will return you to the original screen.

Sequence Play Mode

In this Mode, you can play back the built-in demo songs and Song files stored on Memory Card. Up to 100 Song files can be played back end-to-end by using the Chain Step feature. This Chain Step data can also be saved to Memory Card.

NOTE A Memory Card containing Song files must already be slotted in the Card Slot.

NOTE Basic details about the sequencer are given on Page 31.

When you enter Sequence Play Mode, you will see the 1st screen (Demo Song). The following two screens are available.

1st screen: SEQ Demo (Sequence Demo)

2nd screen: SEQ (Sequence Chain)

NOTE If you load Sequence Chain data in Card Mode (Page 145) or using the Auto Loading feature (Page 143), the 2nd screen will be displayed first.

NOTE Details about how to enter Sequence Play Mode are given on Page 22.

SEQ Demo (Sequence Demo)

The Demo Song data is contained in internal memory.

When you attempt to enter the SEQ Demo (Sequence Demo) screen, you will have an alert screen shown below, since you lose your data for System, internal Voices by loading the demo song.

```
SEQ Demo)<< Are you sure? [YES]/[NO] >>
System.IntVoice will be changed.
```

Press the [YES] key to accept the alert and proceed to the SEQ Demo screen. You can play the demo song in this screen.

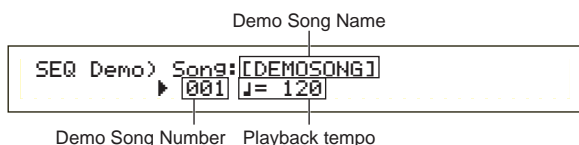

■ Playback Tempo

□ **Settings:** *** (default tempo), 25 ~ 300

① Use Knob [B] and the [ENTER] key to select the Demo Song Number.

② Set the tempo (if necessary).

NOTE The Demo Songs contain preset tempos by default. When you switch to another Demo Song, its preset tempo will be used. You can change the playback tempo. To restore the default tempo, select “***” as the tempo setting.

③ Press the [PLAY/STOP] key to play back the selected Demo Song from the beginning.

④ Press the [PLAY/STOP] key again to stop the Demo Song playback.

NOTE If you press the [PLAY/STOP] key once again, playback will resume from the current position.

NOTE Demo Songs will playback continuously until stopped.

SEQ (Sequence Chain)

You can set up to 100 Steps in a Chain here. Each Chain Step is assigned a Song file and a Performance (Voices for each Part used in the Song). You can play back one particular Chain Step or multiple Chain Steps end-to-end.

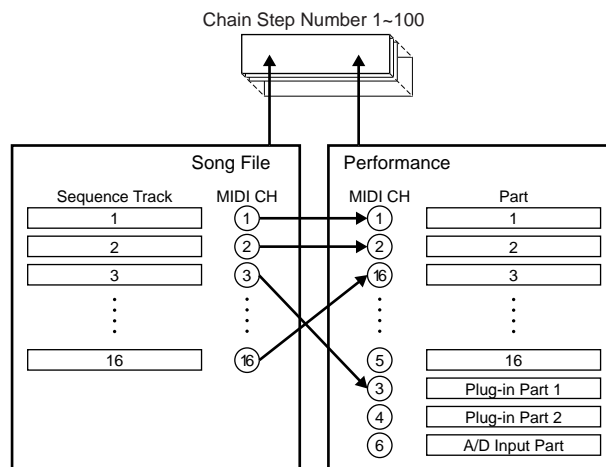

NOTE Chain settings can be saved to Memory Card.

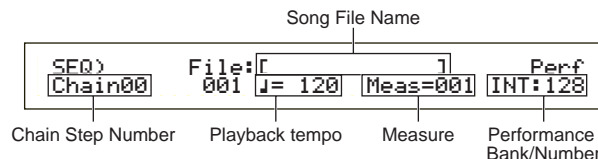

■ Chain Step Number

Change each Chain Step. If you choose a Step Number here, the screen for the selected Chain Step will be displayed.

□ **Settings:** 00 ~ 99

NOTE You can jump to the next Chain Step screen and change the Chain settings in advance, even while a Song is being played back.

NOTE A “**I**” indicator is displayed to the right of the Chain Step Number at the Chain Step screen of the Song file currently being played back.

■ Song File Number

Assign a Song file to the Chain Step. Any Song files with the “.MID” extension can be selected. When you select a file Number here, the file name is shown in the top line of the display.

For continuous (chained) playback of multiple Chain Steps, you can specify how to play this Chain Step after playback of a previous one by selecting an option from among “skip,” “end” and “stop.” If you select “skip,” the Chain Step is skipped and playback will jump to the next Chain Step. If you choose to skip the 99th Chain Step, playback will jump back to the first Chain Step after the 98th Chain Step.

If you select “end,” when the Song reaches this Chain Step, chained playback is stopped and you are returned to the first Chain Step.

If you select “stop,” the Song stops when it reaches this Chain Step. When the Song playback is resumed, it starts at the next Chain Step.

□ **Settings:** skip, end, stop, 001 ~ 997

■ Playback Tempo

Set the playback tempo of the Chain Step. When you start playback of the song, it is normal that a tempo value contained in the song file is automatically set to this parameter. If necessary, you can change the playback tempo here. To restore the Song’s own playback tempo, select “***.”

□ **Settings:** *** (default tempo), 25 ~ 300

NOTE When playing back a Song file using its own tempo data, the tempo setting is shown in brackets. These brackets disappear when you change the tempo.

■ Meas (Measure)

The Song measure in the current Chain Step is shown during playback. If you stop playback, you can use Knob [1] to enter a measure number and press the [ENTER] key to resume playback at that measure.

□ **Settings:** 001 ~ 999

■ Performance Bank/Number

Set the Performance (Bank/Program Number) to be used in the Chain Step. The Voices of each Part in the selected Performance will be used when playing back the Song file.

Use Knob [2], the MEMORY [INT]/[EXT] keys, BANK keys [A] to [H] and PROGRAM keys [1] to [16] to select the Memory Bank and Program Number of the Performance.

□ **Settings:** *** (not set), INT/EXT (Bank), 1 ~ 128 (Program Number)

NOTE If no Performance changes are contained within a Song file, “***” is displayed as the Bank/Number when the Song File is selected. In this case, the Song file will use the Program set in the currently selected Mode (Voice Mode/Performance Mode).

NOTE Performances can be changed while Songs are playing or have been stopped. However, it does not change in real time during playback if you specify a Chain Step other than the current one. In stead, it changes when playback reaches the song at the specified Chain Step.

Song File Playback

1 Use Knob [B] to select the Song file you wish to play back.

NOTE When playing back a single Song, you do not need to select a Chain Step Number (You can have any Chain Step screen open).

2 Set the tempo (if necessary).

3 Set the starting point (measure) for the Song (if necessary).

4 Select the Performance Bank/Number (if necessary).

5 Press the [PLAY/STOP] key to playback the Song from the set position (or from the beginning).

6 Press the [PLAY/STOP] key again to stop the Song playback.

Chained Playback

1 Use Knob [A] to select the Chain Step Number of the first Song you wish to play back.

2 Set the tempo (if necessary).

3 Set the starting point (measure) for the Song (if necessary).

4 Select the Performance Bank/Number (if necessary).

5 Press the [PLAY/STOP] key to play back the Song from the set position (or from the beginning).

When the Chain Step playback has finished, the Song of the next Chain Step Number will automatically be started. Songs can be played back continuously this way.

6 Press the [PLAY/STOP] key again to stop the chained playback.

Also, if an “end” or “stop” Chain Step is reached, playback will stop.

Utility Mode

The parameters in Utility Mode are explained here. Utility Mode can roughly be divided into a screen for settings common to the entire system, a screen for Voice Mode settings and a screen for Plug-in Board settings.

You will first see the following screen when you enter Utility Mode. Each of the three Utility Mode screens contain further sub-screens. Basically the [PAGE] knob is used to switch between parameter screens and Knobs [B], [C] and [1]/[2] are used to set the values for each parameter. You can also use the [DATA] knob or the [DEC/NO] and [INC/YES] keys to enter values.

Sys (System): System settings

MSTR TG)	Vol	NoteShift	Tune
Sys	127	+24	+102.3c

- Master
- Control
- MIDI

Vce (Voice): Voice Mode settings

M.EQ Low)	Shape	Gain	Freq	
Vce	Peak	+12dB	50Hz	12.0

- Master Equalizer
- Control

Plg (Plug-in): Plug-in Settings

PLG_Status)	PLG1:PLG100-UH	Expand
Plugin	PLG2:PLG150-AN	Part

- Plug-in Board Status
- Plug-in Board 1 System
- Plug-in Board 2 System

NOTE Details about how to enter Utility Mode are given on Page 22.

Menu Display

When you use the [PAGE] knob while holding down the [SHIFT] key, the following menu will be displayed. Use the [PAGE] knob to move the cursor (▶) between items, then release the [SHIFT] key to jump to the selected item.

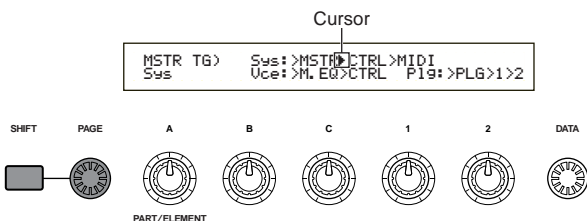

MSTR (System Master)

You can set the overall parameters, including volume and pitch, which mainly relate to the synthesizer's tone generator section. The following four screens are available.

- MSTR TG (Master Tone Generator)
- MSTR Kbd (Master Keyboard)
- MSTR EF Bypass (Master Effect By-pass)
- MSTR Other (Master Other)

MSTR TG (Master Tone Generator)

Set the parameters which control the synthesizer's tone generator section.

MSTR TG)	Vol	NoteShift	Tune
Sys	127	+24	+102.3c

■ Vol (Master Volume)

Set the synthesizer's overall volume.

□ Settings: 0 ~ 127

■ NoteShift (Master Note Shift)

Set the amount (in semitones) by which the note pitch is shifted. This parameter only affects the synthesizer's internal tone generator. It does not affect information transmitted via MIDI.

□ Settings: -24 ~ 0 ~ +24

■ Tune (Master Tune)

Adjust the keyboard tuning (in 0.1 cent steps).

□ Settings: -102.4 ~ +102.3

MSTR Kbd (Master Keyboard)

Set the parameters related to the keyboard.

MSTR Kbd)	Oct	Trnspose	Vel	
Sys	+3	+11	fixed =	127

■ Oct (Master Octave Shift)

Shift the octave range of the keyboard up or down.

□ Settings: -3 ~ 0 ~ +3

■ Trnspose (Master Transpose)

Transpose the pitch of the keyboard up or down (in semitones). This affects information transmitted via MIDI.

□ Settings: -11 ~ +11

NOTE If you transpose beyond the note range limits (C-2 and G8), the notes will be wrapped over.

■ Vel (Keyboard Velocity Curve)

Set the Velocity Curve determining how the strength of the notes played will affect the sound output.

□ **Settings:** norm, soft, hard, wide, fixed

norm (Normal)

The velocity is in proportion to the strength.

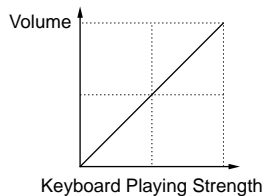

soft

A softer playing style increases the volume level.

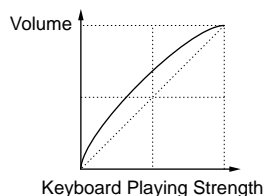

hard

A stronger playing style increases the volume level.

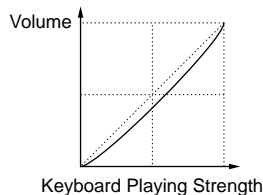

wide

A softer playing style lowers the volume level and a stronger playing style increases the volume level. As a result, you feel a wider dynamic range.

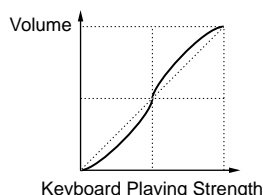

fixed

Select this curve when you want the tone generator to respond (sound) in a specific volume, tone or the like. With this setting, any velocity value will be changed into a fixed one you specify with the Fixed (Keyboard Fixed Velocity) parameter below.

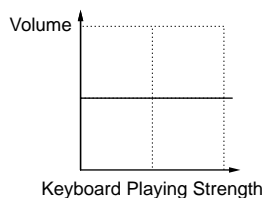

■ Fixed (Keyboard Fixed Velocity)

The velocity is fixed at the Vel setting. The sound output is always the same, regardless of how hard or gently you play the keyboard. The Vel parameter is only available if you select the “fixed” Velocity Curve.

□ **Settings:** 1 ~ 127 (Only available if Vel is set to “fixed”)

MSTR EF Bypass (Master Effect By-pass)

Set the parameters related to the [EF BYPASS] key on the front panel.

MSTR EF Bypass)	Insert	Reverb	Chorus
Sys	off	on	on

■ Insert (Insertion), Reverb, Chorus

When the [EF BYPASS] key is pressed (its LED is lit), various effects can be bypassed.

□ **Settings:** off, on (for Insert (Insertion), Reverb and Chorus effects)

NOTE Plug-in Board Variations (Variation Effects) will be bypassed according to the Insert setting.

MSTR Other (Other Setup)

Set other parameters common throughout the system.

MSTR Other)	PowerOnMode	Ctrl	BCCurve
Sys	Voice(INT)	hold	thru

■ PowerOnMode

Select the Mode entered when you switch the synthesizer on.

□ **Settings:**

Performance:

Performance Play Mode is entered and the first Program Number (INT: 001) is selected automatically.

Voice (INT):

Voice Play Mode is entered and the first Program Number of the Internal Memory (INT: 001) is selected automatically.

Quick Access:

Voice Play Mode is entered with Quick Access enabled, and the first Program Number (A.PIANO) is automatically selected.

last:

The Voice/Performance Program selected before you switched the power off is recalled.

■ Ctrl (Controller)

Select whether or not the controller (Modulation Wheel, Aftertouch, Foot Controller, Breath Controller, Knobs) state/position is maintained (hold) or reset when you switch between Voices.

□ **Settings:** hold, reset

If you select “reset,” the controllers will be reset to the following states/positions:

Pitch BendCenter
Modulation WheelMinimum
AftertouchMinimum
Foot ControllerMaximum
Breath ControllerMaximum
Foot SwitchOff
ExpressionMaximum

■ **BCCurve (TG Breath Curve)**

Set the Breath Curve determining how the strength with which you blow into the Breath Controller will affect the sound output.

□ **Settings:** thru, soft, hard, wide

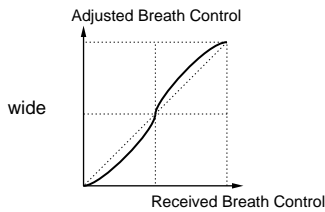
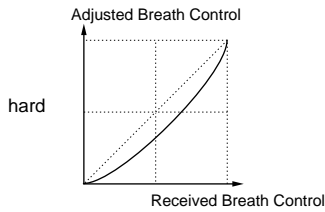
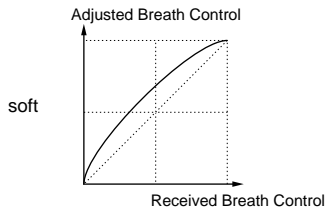
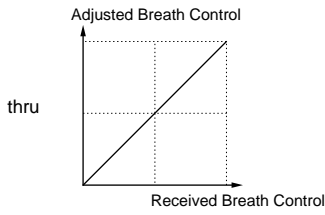

CTRL (System Controller)

In Voice Mode, you can set parameters for Controllers. The following four screens are available.

- CTRL KnobA (Control Knob [A])
- CTRL KnobB (Control Knob [B])
- CTRL KnobC (Control Knob [C])
- CTRL Other (Control Other)

CTRL Knobs [A] to [C]

You can assign various control functions to Assignable Knobs [A] to [C] on the front panel.

```
CTRL KnobA)  CC#      Dest
Sys         67[-----]  EQLow-G
```

■ **CC# (Control Number)**

Assign MIDI Control Change Numbers to Assignable Knobs [A] to [C].

□ **Settings:** 000 ~ 095 (see the separate Data List for details)

■ **Dest (Control Destination)**

Set the function to be controlled by Assignable Knobs [A] to [C].

□ **Settings:** see the separate Data List for details

NOTE The positions of Knobs [A]/[B]/[C] can be memorized for each Voice, Performance.

NOTE If a Master Equalizer parameter is selected as the destination, the M.EQ settings of “vce” (in Utility Mode) are increased/decreased Using Knobs [A]/[B]/[C].

CTRL Other (Controller Other)

Set the Foot Switch and Foot Volume parameters.

```
CTRL Other)  FS      FV
Sys         65[Porta Sw]  volume
```

■ **FS (Foot Switch)**

Assign a Control Change message to the Foot Switch.

□ **Settings:** 000 ~ 100 (000/032 = off, 096 = Arp Sw, 097 = Arpeggio Hold, 098 = Sequence PLAY/STOP, 099/100 = Program Change INC/DEC)

NOTE Details about Control Numbers and Control Changes are given in the separate Data List.

■ **FV (Foot Volume)**

Select whether Foot Volume controls the Main Volume or Expression parameter.

□ **Settings:** volume (Main Volume), expression

NOTE Details about the Main Volume and Expression parameters are given in the separate Data List.

MIDI (System MIDI)

You can set overall MIDI parameters for the system. The following five screens are available.

MIDI Ch (MIDI Channel)
MIDI Arp (MIDI Arpeggio)
MIDI RxSW (MIDI Receive Switch)
MIDI Other
MIDI GM/XG Receive

MIDI Ch (MIDI Channel)

Set the MIDI Channel parameters.

```
MIDI Ch)  Recv  Trans  Local  DevNo  
Sys      omni   1      on     all
```

■ Recv (Basic Receive Channel)

Set the MIDI Receive channel for using the synthesizer with an external sequencer, computer and so on, and for using it as a MIDI tone generator.

□ **Settings:** 1 ~ 16, omni (all channels), off

■ Trans (Keyboard Transmit Channel)

Set the MIDI Transmit channel for transmitting MIDI from the keyboard, controllers and so on.

□ **Settings:** Ch1 ~ Ch16, off

■ Local (Local On/Off)

If you set Local to “off,” the keyboard and controllers are internally disconnected from the synthesizer’s tone generator section so that no sound is output when you play the keyboard or use the controllers. However, the data will be transmitted through the MIDI OUT. Also, the tone generator section will respond to messages received at the MIDI IN.

□ **Settings:** off on,

■ DevNo (Device Number)

Set the MIDI Device Number. This number must match the Device Number of the external MIDI device when transmitting/receiving bulk data, parameter changes or other system exclusive messages to/from it.

□ **Settings:** 1 ~ 16, all, off

MIDI Arp (MIDI Arpeggio)

Set the arpeggiator’s MIDI parameters.

```
MIDI Arp)  Switch  Hold  Out(Vce)Ch(Vce)  
Sys1     1 67    68    off      16
```

■ Switch

Select the Control Change Number used to control the ARPEGGIO [ON/OFF] key.

□ **Settings:** 000 ~ 095 (000, 032 = off)

■ Hold

Select the Control Change Number used to control the ARPEGGIO [HOLD] key.

□ **Settings:** 000 ~ 095 (000/032 = off)

■ Out (Vce)

Enable/disable the output or Arpeggiator data to external MIDI devices through the MIDI Out.

□ **Settings:** off (disabled), on (enabled)

■ Ch (Vce) (Arpeggio Transmit Channel)

Select the MIDI channel through which Arpeggio data will be sent.

□ **Settings:** 1 ~ 16

MIDI Sw (MIDI Receive Switch)

Set the MIDI Receive parameters.

```
MIDI Sw)RcvBulk  BankSel  PgmChng  Control  
Sys          on Perform  off      model
```

■ RcvBulk (Receive Bulk)

Select whether or not Bulk Dump data can be received.

□ **Settings:** protect (off), on

■ BankSel (Bank Select)

Set to enable or disable transmission and reception of Bank Select messages between the instrument and an external MIDI device. With any setting other than “off,” the instrument can receive a Bank Select message coming in, and it can also send a Bank Select message out to an external MIDI device when you select a Bank using a MEMORY key or the like on its front panel.

□ **Settings:** off, all, part, perform

off:

Ignores (does not receive) a Bank Select message. The instrument does not send this message, either.

all:

Receives all Bank Select messages coming in. When the instrument receives only a Program Change message in Performance Mode, that message selects a Part’s Voice.

part:

Receives only Bank Select messages for selecting a Voice Bank, whichever mode you are working in.

perform:

Receives only Bank Select messages for selecting a Performance Bank when you are working in Performance Mode. When you are working in Voice Mode, the instrument only receives Bank Select messages for selecting a Voice Bank.

■ PgmChng (Program Change)

Set to enable or disable reception of a Program Change message coming in. With this parameter set to “on,” the instrument can receive a Program Change message coming in, and it can also send a Program Change out to an external MIDI device when you select a Voice or Performance (using a [PROGRAM/PART] key, etc.) on its front panel.

❑ **Settings:** off (disable), on (enable)

■ Control

Set the MIDI transmit/receive parameters controlling the Sustain parameter of the QED EG.

❑ **Settings:** mode1, mode2

mode1:

Messages are received as Parameter Change messages.

mode2:

Messages are received as Control Change messages.

MIDI Other

Set other MIDI parameters.

```
MIDI Other> In ThruPort  Sync SeqCtrl
Sys        MIDI        1    int      on
```

■ In (MIDI Input)

Select whether to use the MIDI In/Out/Thru connectors or other (future) connectors. At present, you can only select “MIDI.”

❑ **Settings:** MIDI

■ ThruPort

You can connect your synthesizer to a computer via a dedicated serial cable on the TO HOST connector. In which case, MIDI messages received via the TO HOST connector can be passed through the MIDI OUT connector of the synthesizer. Set the port number here.

❑ **Settings:** 1 ~ 8

■ Sync

To synchronize playback with an external MIDI device, you can use either the synthesizer’s internal clock (int) or MIDI clock signals from the external device (midi). Select “int” if you are using the synthesizer as the master, or if you have no other MIDI devices connected to it. Select “MIDI” when slaving your synthesizer to another MIDI Clock source connected to the MIDI IN connector.

❑ **Settings:** MIDI, int (internal)

■ SeqCtrl (Sequencer Control)

Select whether or not to transmit/receive Song Start, Stop and Continue messages via MIDI. This also switches the transmission of MIDI Clock messages on and off.

❑ **Settings:** off, on

MIDI GM/XG Receive (if a Multi-Part Plug-in Board has been installed)

Set GM On and XG Reset Receive parameters. This screen is only available if a Multi-Part XG Plug-in Board has been installed.

```
MIDI GM/XG Receive> Sw InternalPart
Sys                on  layer-part
```

■ Sw (Receive Switch)

Select whether or not to receive GM On and XG Reset messages. The XG Plug-in Board will receive GM On and XG Reset messages if you set this to “on.”

❑ **Settings:** off, on

■ InternalPart

The sound for each of the synthesizer’s Parts can be output in the following three ways. When a GM On/XG Reset message is received. Whichever setting you choose, the Parts of the XG Plug-in Board will always be output.

❑ **Settings:**

all part:

All Parts of the synthesizer and the Plug-in Board will be output when MIDI messages are received.

layer part:

Parts which have their Layer Switch parameters set to “on” and all XG Plug-in Board Parts will be output when MIDI messages are received.

all off:

No Parts of the synthesizer will be output but all XG Plug-in Board Parts will be output when MIDI messages are received.

NOTE By default the Sw parameter is set to “on” and the InternalPart parameter is set to “all off.” If you play a song file containing a GM On message, the XG Plug-in Board will be used to play back the song.

M.EQ (Voice Master Equalizer)

You can assign any of five different Equalizer bands in Voice Mode. The following five screens are available.

M.EQ Low
M.EQ LowMid (Low-Middle)
M.EQ Mid (Middle)
M.EQ HighMid (High-Middle)
M.EQ High

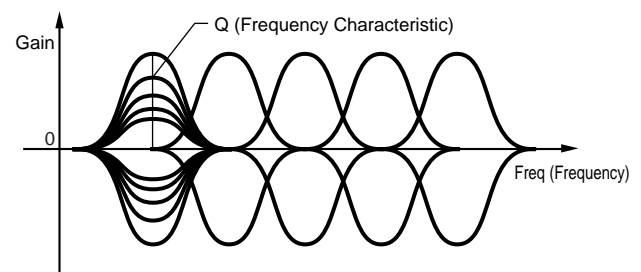

M.EQ Low (Master EQ Low)

This Equalizer covers low frequencies. You can adjust the signal level at the specified frequency. You can also select different Equalizer types (Shapes).

M.EQ Low)	Shape	Gain	Freq	Q
Vce	Peak	+12dB	50Hz	12.0

■ Shape

Select either a Shelving or Peaking equalizer. The Peaking type attenuates/boosts the signal at the specified Frequency setting, whereas the Shelving type attenuates/boosts the signal at frequencies above or below the specified Frequency setting.

□ **Settings:** shelv (Shelving), peak (Peaking)

NOTE Details about the shapes of the Shelving and Peaking Types are given on Page 116.

■ Gain

Set the Gain. This attenuates or boosts frequencies around the Frequency setting.

□ **Settings:** -12dB ~ 0dB ~ +12dB

■ Freq (Frequency)

Set the center frequency. Frequencies around this point are attenuated/boosted by the Gain setting.

□ **Settings:** 32Hz ~ 2.0kHz

■ Q (Frequency Characteristic)

This varies the signal level at the Frequency setting to create various frequency curve characteristics.

□ **Settings:** 0.1 ~ 12.0

M.EQ LowMid (Master EQ Low-Middle Range)

M.EQ Mid (Master EQ Middle Range)

M.EQ HighMid (Master EQ High-Middle Range)

These Equalizers cover low-to-middle, middle and high-to-middle frequency ranges. They can be used to adjust the signal level around the specified frequency.

M.EQ LowMid)	Gain	Freq	Q
Vce	+12dB	100Hz	12.0

M.EQ Mid)	Gain	Freq	Q
Vce	+12dB	100Hz	12.0

M.EQ HighMid)	Gain	Freq	Q
Vce	+12dB	100Hz	12.0

■ Gain

Set the Gain. This attenuates or boosts frequencies around the Frequency setting.

□ **Settings:** -12dB ~ 0dB ~ +12dB

■ Freq (Frequency)

Set the center frequency. Frequencies around this point are attenuated/boosted by the Gain setting.

□ **Settings:** 100Hz ~ 10kHz

■ Q (Frequency Characteristic)

This varies the signal level at the Frequency setting to create various frequency curve characteristics.

□ **Settings:** 0.1 ~ 12.0

M.EQ High (Master EQ High)

This Equalizer covers high frequencies. You can adjust the signal level at the specified frequency. You can also select different Equalizer types (Shapes).

M.EQ High)	Shape	Gain	Freq	Q
Vce	Peak	+12dB	0.5kHz	12.0

■ Shape

Select either a Shelving or Peaking equalizer. The Peaking type attenuates/boosts the signal at the specified Frequency setting, whereas the Shelving type attenuates/boosts the signal at frequencies above or below the specified Frequency setting.

□ **Settings:** shelv (Shelving), peak (Peaking)

■ Gain

Set the Gain. This attenuates or boosts frequencies around the Frequency setting.

□ **Settings:** -12dB ~ 0dB ~ +12dB

■ Freq (Frequency)

Set the center frequency. Frequencies around this point are attenuated/boosted by the Gain setting.

□ **Settings:** 500Hz ~ 16kHz

■ Q (Frequency Characteristic)

This varies the signal level at the Frequency setting to create various frequency curve characteristics.

□ **Settings:** 0.1 ~ 12.0

CTRL (Voice Controller)

You can assign MIDI Control Change Numbers to the controllers and front panel knobs. For example, Knob [1]/[2] can be set to control the amount of effect applied to a sound and the Foot Controller can be set to control modulation. These Control Change Number assignments are known as “Controller Assign.” The following two screens are available.

CTRL Assign1 (Controller Assign 1)

CTRL Assign2 (Controller Assign 2)

CTRL Assign1 (Controller Assign 1)

Use Knobs [C], [1] and [2] to assign Control Change Numbers to the Breath Controller, Knob [1] and Knob [2], respectively. The selected Control Change Name is shown on the left of the display.

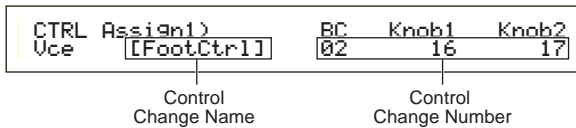

■ BC (Breath Controller)

Assign Control Change Number to the Breath Controller. The Breath Controller is connected to the BREATH connector (Page 18) on the rear panel. When the Breath Controller is used, this Control Change Number is transmitted. Also, if this Control Change Number is received, the destination parameter of the Breath Controller is controlled.

□ **Settings:** 00 ~ 95 (see the separate Data List for details)

■ Knob1/2 (Knob [1]/[2])

Assign Control Change Numbers to Knobs [1] and [2] on the front panel.

□ **Settings:** 00 ~ 95 (see the separate Data List for details)

CTRL Assign2 (Controller Assign 2)

Use Knobs [C] and [1] to assign Control Change Numbers to the Foot Controller and Ribbon Controller, respectively. The selected function is shown on the left of the display. Use Knob [2] to select the Ribbon Controller Mode.

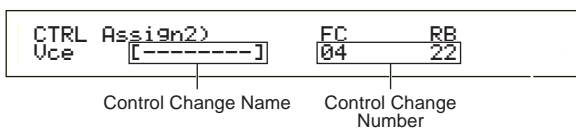

■ FC (Foot Controller)

Assign a Control Change Number to the Foot Controller. The Foot Controller is connected to the FOOT CONTROLLER connector on the rear panel (Page 18).

□ **Settings:** 00 ~ 95 (see the separate Data List for details)

■ RB (Ribbon Controller)

Assign a Control Change Number to the Ribbon Controller.

□ **Settings:** 00 ~ 95 (see the separate Data List for details)

NOTE Details about Controller Assign settings in Performance Mode are given on Page 116.

PLG (Plug-in) (if a Plug-in Board has been installed)

If you have a Plug-in Board installed, the following three screens are available for setting its parameters. However, the number of sub-screens and parameters will vary depending on the type of Plug-in Board installed.

PLG Status (Plug-in Status)

PLG1/2 MIDI (Plug-in 1/2 MIDI)

PLG1/2 System (Plug-in 1/2 System)

PLG Status (Plug-in Status)

The name of the Plug-in Board is displayed.

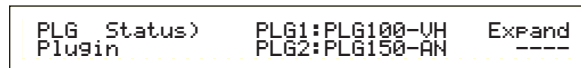

■ PLG1 (Plug-in 1)

The name of the Plug-in Board in the Plug-in 1 slot is displayed.

■ PLG2 (Plug-in 2)

The name of the Plug-in Board in the Plug-in 2 slot is displayed.

NOTE Nothing is displayed for vacant Plug-in slots.

■ Expand

This parameter is accessible only when you have two identical Plug-in boards installed on the instrument. The “part” setting enables two boards to work separately (you can select them in two different Parts). The “poly” setting enables two boards to work together to double polyphonic notes (you can only use them in a single Part with double polyphony).

□ **Settings:** part, poly

PLG1 MIDI (Plug-in 1 MIDI)

PLG2 MIDI (Plug-in 2 MIDI)

Set the MIDI parameters of the Plug-in Board.

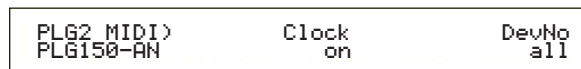

■ Clock

Select whether or not to transmit MIDI Clock messages to the Plug-in Board.

□ **Settings:** off, on

■ DevNo (Device Number)

Set the MIDI Device Number of the Plug-in Board. This number must match the Device Number of the external MIDI device when transmitting/receiving bulk data, parameter changes or other system exclusive messages to/from it.

□ **Settings:** 1 ~ 16, all, off

PLG1/2 System (Plug-in 1/2 System)

Set the system parameters for each Plug-in Board. Use Knob [C]/[2] to change the parameter. The number of screens and parameters will vary depending on the type of Plug-in Board installed. In the following example, a PLG150-AN Plug-in Board has been installed in the Plug-in 2 slot.

```
PLG2 System> Vel Curve  Mrph Ctr1No
                norm      off
```

NOTE The system settings for the PLG100-VH Plug Board (Harmony Channel and Melody Channel) are set in Performance Mode. Select an effect type using knob [1] in the EFF plg screen of Common Effect. Then press the [ENTER] key to enter the settings screen.

NOTE Part Assign (assignment) for a Single-Part Plug-in Board is fixed as follows:

- Voice Mode: 1
- Performance Mode: PLG1:16
PLG2:15

Synchronize the tempo settings of the S80 and the Plug-in Board.

If you are using a Plug-in Board capable of generating arpeggio patterns, you can synchronize its tempo with that of the S80.

- 1 Enter Utility Mode and select either PLG1 MIDI screen or the PLG2 MIDI screen for the respective Plug-in Board. Then use the appropriate knob to set the Clock parameter to “on.”
- 2 Enter Voice Mode, select the Plug-in Voice of the respective Plug-in Memory, then enter Voice Edit Mode.
- 3 Use knob [A] to select “Elem,” as shown at the bottom left of the screen.
- 4 Use the [PAGE] knob to select the name of the Plug-in Board, as shown at the bottom left of the screen. Then enter the Plug-in native part parameter screen.
- 5 Use the [PAGE] knob to select the Plug-in native part parameter for the tempo. Then use the appropriate knob to select MIDI (midi).

Now, the tempo of the Plug-in Board is synchronized with the MIDI clock signal received from the S80.

NOTE To synchronize with an external MIDI clock source, enter Utility Mode and set the Sync parameter of the MIDI Other screen to “MIDI.”

Utility Job Mode

In Utility Job Mode, you can restore your synthesizer’s factory default settings (Factory Set). There is only one screen in this Mode.

Factory Set (Restore Factory Defaults)

You can restore the synthesizer’s default Internal Voices and Performances, as well as its System and other settings.

Once you edit any settings, their factory defaults will be overwritten and lost.

You can restore the factory default settings as follows.

! When you restore the factory default settings, all the current settings for the all the Internal Voices and Performances will be overwritten with the factory defaults. Make sure you are not overwriting any important data. You should back up any important data to Memory Card, or to some external device beforehand.

- 1 Press the [JOB] key in Utility Mode. You will see the Factory Set screen.

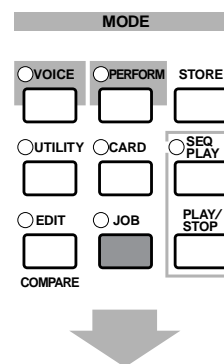

```
UTIL Factory Set>
Job
```

- 2 When you press the [ENTER] key, you will see a confirmation message.
- 3 Press the [INC/YES] key to execute the Factory Set job. You will see the “Completed.” message displayed after the job has completed. You can cancel a job while it is being executed by pressing the [DEC/NO] key.
- 4 Press the [EXIT] key to return to Utility Mode.

Card Mode

In Card Mode, you can use Memory Card, a SmartMedia™ card available at a consumer electronics shop, etc., to save or load data from/to the instrument or perform other data exchange operations between memories on the instrument and the Card. Using the included Card Filer software, you can use a computer to manage data on Memory Card. You can also use it to exchange data between the computer and Memory Card.

Handling the Memory Card(SmartMedia™*)

Be sure to handle Memory Cards with care. Follow the important precautions below.

* SmartMedia is a trademark of Toshiba Corporation.

■ Compatible Memory Card Type

3.3V(3V) Memory Cards can be used. 5V type Memory Cards are not compatible with this instrument.

■ Memory Capacity

There are five types of Memory Cards: 2MB/4MB/8MB/16MB/32MB. A Memory Card with the memory capacity exceeding 32MB can also be used if it conforms to the standards of SSFDC (Solid State Memory Card Card: another name of SmartMedia) Forum.

■ Inserting/Removing Memory Cards

• To insert a Memory Card:

Hold the Memory Card so that the connector section (gold) of the Memory Card is facing downward and forward, towards the Memory Card slot. Carefully insert the Memory Card into the slot, slowly pushing it all the way in until it is fitted in place.

- Don't insert the Memory Card in wrong direction.
- Don't insert anything other than a Memory Card in the slot.

• To remove a Memory Card:

Make sure to turn the instrument off and pull the Memory Card out of the slot.

 Always the instrument must be turned off before removing the Memory Card.

However, if the Memory Card's memory is full and you want to exchange it with a new one to save your currently edited data, follow the following procedure: Before removing the Memory Card, be sure to confirm that the Memory Card is not in use, or it is not being accessed by the instrument. Then pull the Memory Card out slowly by hand. If the Memory Card is being accessed*, a message indicating that it is in use appears on the instrument's display.

* It includes saving, loading, formatting, deleting and making directory. Also, be aware that the instrument will automatically access the Memory Card to check the media type when it is inserted while the instrument is turned on.

 Never attempt to remove the Memory Card or turn the power off during accessing. Doing so can damage the data on the instrument/Memory Card and possibly the Memory Card itself.

■ Formatting Memory Cards

Before using a Memory Card with your instrument it must first be formatted. Once it is formatted all data on it will be erased. Be sure to check if the data is unnecessary for you or not, beforehand.

 **NOTE** The Memory Cards formatted with this instrument may become unusable with other instruments.

■ About the Memory Cards

• To handle Memory Cards with care:

There are times when static electricity affects Memory Cards. Before you handle Memory Cards, to reduce the possibility of static electricity, touch the metal parts such as a door knob and aluminum sash.

Be sure to remove the Memory Card from the Memory Card slot when it is not in use for a long time.

Do not expose the Memory Card to direct sunlight, extremely high or low temperatures, or excessive humidity, dust or liquids.

Do not place heavy objects on a Memory Card or bend or apply pressure to the Memory Card in any way.

Do not touch the metal part (gold) of the Memory Card or put any metallic plate onto the metal part.

Do not expose the Memory Card to magnetic fields, such as those produced by televisions, speakers, motors, etc., since magnetic fields can partially or completely erase data on the Memory Card, rendering it unreadable.

Do not attach anything other than the provided labels to a Memory Card. Also make sure that labels are attached in the proper location.

• To protect your data (Write-protect):

To prevent inadvertent erasure of important data, stick the write-protect seal (provided in the Memory Card package) onto the designated area (within a circle) of the Memory Card.

Conversely speaking, to save data on the Memory Card, make sure to remove the write-protect seal from the Card. Do not reuse the seal that is peeled off.

■ Data Backup

For maximum data security Yamaha recommends that you keep two copies of important data on separate Memory Cards. This gives you a backup if one Memory Card is lost or damaged.

■ Burglarproof Lock

This instrument is equipped with a burglarproof lock for the Memory Card. If necessity arises, mount the burglarproof lock onto the instrument.

To mount the burglarproof lock:

- 1 Remove the metallic part using a Phillips screwdriver.
- 2 Turn the metallic part upside down and then mount it again.

You will see the 1st screen (Status) when you enter Card Mode. The following seven screens are available, each for a different operation.

- 1st screen: Status
- 2nd screen: Save
- 3rd screen: Load
- 4th screen: Rename
- 5th screen: Delete
- 6th screen: Mkdir (Make Directory)
- 7th screen: Format

NOTE Details about how to enter Card Mode are given on Page 22.

File Types

You can handle the following five types of files to your synthesizer.

■ all (All Data)

All data in the synthesizer and in External Memory data are treated as a single file, and can be saved/loaded as such.

□ **Extension:** “.S2A”

NOTE Plug-in Board data cannot be saved.

NOTE System, Performance and Plug-in voice data can only be saved in this format.

■ all-voice (All Voice Data)

All Voice data in the synthesizer (128 Normal Voices + 2 Drum Voices) and in External Memory (128 Normal Voices + 2 Drum Voices) are treated as a single file, and can be saved/loaded as such. Plug-in Voice data is not included.

□ **Extension:** “.S2V”

■ plugin

All Plug-in Board data is treated as a single file, and can be saved/loaded as such. Data for Plug-in Voice settings are not included.

□ **Extension:** “.S2B”

■ chain (Sequence Chain)

Chain data for Standard MIDI Files (SMFs) are treated as a single file, and can be saved/loaded as such. This data is used for playing back multiple songs in succession.

□ **Extension:** “.S2C”

■ SMF (Standard MIDI Files)

Format 0 Standard MIDI Files (SMFs) can be played back in Song Mode. However, they cannot be saved.

□ **Extension:** “.MID”

NOTE The SMF is a standardized sequence file format used by musical instrument manufacturers, computer software companies and other parties. An SMF can easily be exchanged between SMF-compatible sequencers, regardless of the manufacturer. The following two types of SMF exist, though this synthesizer will only play back Format 0 SMFs.

• **Format 0:**

Data for multiple MIDI channels is contained within a single track.

• **Format 1:**

Data for multiple MIDI channels is contained within multiple tracks.

If the SMF you wish to play back is in Format 1, use the included Card Filer software to convert to Format 0 via computer. Details of how to convert SMFs are given in the Card Filer documentation (in PDF format). Details about installing the Card Filer software are given in the separate Installation Guide.

Automatically Loading Files

The synthesizer can automatically load certain files (All/Plug-in data) when you switch it on.

Name the file to be loaded automatically as follows, then save it to the highest directory of the Memory Card. Insert the card into the CARD slot before switching the synthesizer on.

NOTE To prevent the automatic loading of files, hold down the [EXIT] key when powering up the synthesizer. Release the key when the “Now checking plug-in board.” message is displayed.

■ **All (all data):**

Name the file “AUTOLOAD.S2A” to automatically load all data.

■ **Plugin (Plug-in data):**

Name the file “AUTOLD1.S2B” to automatically load Plug-in 1 Board data, or “AUTOLD2.S2B” for Plug-in 2 Board data.

Card Mode Operations

- 1 Insert the Memory Card into the CARD slot.
- 2 Press the [CARD] key to enter Card Mode.
- 3 Use the [PAGE] knob to switch to the screen for the operation you wish to perform.

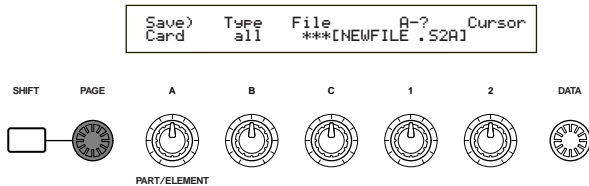

NOTE In the first “Status” screen, you don’t need any further operation described in step 2 and after.

- 4 Use Knobs [B], [C], [1] and [2] to set each parameter. Alternatively, you can use the [DATA] knob and the [DEC/NO] and [INC/YES] keys.

NOTE To save, load, rename or delete a file, use Knob [B] to select the File Type and Knob [C] to select the File Number.

File Directories

Directories are denoted by “DIR” next to the directory name. To open a directory, use Knob [C] to move the cursor to it and press the [ENTER] key. All the files in the directory are displayed. If you select File Number 000, “up dir” will be displayed. By pressing the [ENTER] key, you will be returned to the parent directory (i.e., moved up one directory level).

NOTE When saving or renaming, the directory for the currently selected file is displayed if you press the [SHIFT] key.

- 5 When you press the [ENTER] key, you will see a confirmation message.

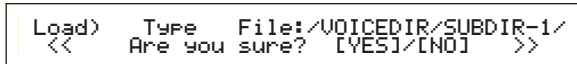

- 6 Press the [INC/YES] key to execute the operation. The message “Completed.” will be displayed after it has executed, and you will be returned to the previous screen.

The operation will be canceled if you press the [DEC/NO] key during execution.

NOTE If the operation takes some time to execute, you will see the message “Executing...” If you switch the power off in this state, the data may be damaged.

NOTE The steps in the procedure may vary slightly, depending on the operation being performed. Refer to the explanation of each operation for details.

Status

You can view the amount of free and used on the Memory Card. There are no settings.

Status> Card	Used 2.9MB(70%)	Free 1.1MB
-----------------	--------------------	---------------

Used

Shows the amount of Memory Card memory used. The amount is shown as a percentage in parentheses.

Free

Shows the amount of free memory on the Memory Card.

Save

You can save files to Memory Card as follows.

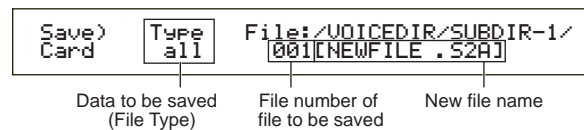

Type (File Type)

Settings: all (all data), all-voice, chain (Sequence Chain), plugin1, plugin2

NOTE Details about each File Type are given on Page 143.

NOTE The Memory Card must be formatted before you can save data to it (Page 147).

- 1 Use Knob [B] to select the File Type to which the data will be saved.
- 2 To overwrite an existing file, use Knob [C] to select the File Number. To save a file with a new name, use Knob [2] to move the cursor. Then use Knob [1] or the [DATA] knob or [DEC/NO] and [INC/YES] keys to enter the new file name (see next Page).
 - NOTE** If you press the [SHIFT] key, the directory for the currently selected file is displayed. Further details are given in the section “Card Mode Operations”.
- 3 When you press the [ENTER] key, the file will be saved. If an existing file will be overwritten when saving, a confirmation message will be displayed and the following step will be necessary.

- 4 Press the [INC/YES] key to save the file. The message “Completed.” will be displayed after it has been saved, and you will be returned to the previous screen.

The save operation will be canceled if you press the [DEC/NO] key during execution.

- NOTE** When saving a file, the “Card full” message will be displayed if the space left on the Memory Card is insufficient. Free up space by deleting unwanted data and so on, then try saving the file again.
- NOTE** If you enter the name of a file that already exists, you will see the “Overwrite? Are you sure?” confirmation message before saving.
- NOTE** Take care not to overwrite important data held on Memory Card.

File Name Settings

The procedure for renaming files is basically the same as for renaming Voices. However, you cannot use symbols or lower case characters, and the name can only be up to eight characters in length. Details about renaming Voices are given on Page 70.

- NOTE** Files are named according to the MS-DOS naming convention. If the file name contains spaces and other characters unrecognized in MS-DOS, these characters will automatically be replaced by “_” (underscore) characters when saving.

Load

You can load files from Memory Card to the synthesizer as follows.

```
Load> Type File:/VOICEDIR/SUBDIR-1/
Card all-voice 001[NEWFILE .S2U]
```

Data to be loaded (File Type) File Number of file to be loaded

■ Type (File Type)

- **Settings:** all (all data), perf (Performance), all-voice, voice, chain (Sequence Chain), plugin1, plugin2,

- 1 Use Knob [B] to select the File Type of the data to be loaded.
- 2 Use Knob [C] to select the File Number.
- 3 When you press the [ENTER] key, the following will be displayed, depending on the selected File Type.

- **If you have selected a File Type other than “perf” or “voice”:**

A confirmation message is displayed before loading.

```
Load> Type File:/VOICEDIR/SUBDIR-1/
<< Are you sure? [YES]/[NO] >>
```

- NOTE** The synthesizer will automatically select an appropriate location in its internal memory, according to the file type being loaded.

- **If you have selected “perf” or “voice” as the File Type:**

You will further have to specify the type of data and the location to which the file will be loaded.

Use Knobs [B], [C], [1] and [2] to select the file and the location to which it will be loaded. Alternatively, you can use the [DATA] knob and the [DEC/NO] and [INC/YES] keys. When you press the [ENTER] key, you will see a confirmation message.

The types of data that you can select for each File Type, and the locations to which they will be loaded, are as follows.

perf (Performance)

```
Load> [Pfi:Init Perf 1 [Pfi:Init Perf 1
Card [EXT:064(D16) > [INT:128(H16)]
```

Performance Memory of file to be loaded (source) Performance Memory to which file will be loaded (target)

Performance Number of file to be loaded (source) Performance Number to which file will be loaded (target)

- **Settings:**

Source Performance Memory:

INT (Internal), EXT (External)

Source Performance Number:

all (all Performances), 1 ~ 128 (INT), 1 ~ 64 (EXT)

Target Performance Memory:

INT (Internal), EXT (External)

Target Performance Number:

all (all Performances), 1 ~ 128 (INT), 1 ~ 64 (EXT)

- NOTE** If you set the source Performance Number to “all,” the target Performance Number will also be set to “all.”

voice

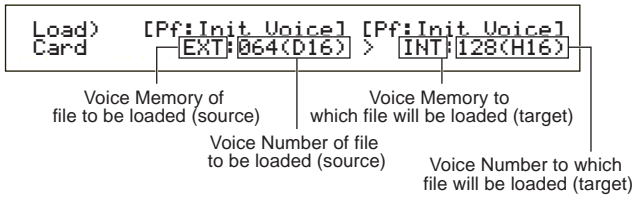

Settings:

Source Voice Memory:

INT (Internal), EXT (External), PLG1 (Plug-in 1), PLG2 (Plug-in 2)

Source Voice Number:

all (all Voices), 1 ~ 128 ~ DR1/2 (INT/EXT), 1 ~ 64 (PLG1/PLG2)

Target Voice Memory:

INT (Internal), EXT (External), PLG1 (Plug-in 1), PLG2 (Plug-in 2)

Target Voice Number:

all (all Voices), 1 ~ 128 ~ DR1/2 (INT/EXT), 1 ~ 64 (PLG1/PLG2)

NOTE If you select PLG1/PLG2 as the source (or target) Voice Memory, the target (or source) Voice Memory will also be set to PLG1/PLG2.

NOTE If you set the source Voice Number to "all," the target Voice Number will also be set to "all."

- Press the [INC/YES] key to load the file. The message "Completed." will be displayed after it has been loaded, and you will be returned to the previous screen. The load operation will be canceled if you press the [DEC/NO] key during execution.

NOTE The synthesizer can automatically load files when you switch it on. (You will need to insert the card into the CARD slot before switching the synthesizer on.) Details are given in the section "Automatically Loading Files" (Page 143).

! If there is already data in the synthesizer, it will be completely lost when you load a file.

! Take care not to erase important data when performing operations.

NOTE When loading a file, the "Memory full!" message will be displayed if the space left in your synthesizer's internal memory is insufficient. Free up space by deleting unwanted data and so on, then try loading the file again.

NOTE When loading a file, the "File not found!" message will be displayed if the File Type you have selected does not exist on the Memory Card.

Rename

You can rename files using up to eight alphabetic and numeric characters.

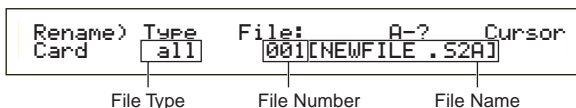

Type (File Type)

Settings: all (all data), all-voice, chain (Sequence Chain), plugin, other

NOTE Details about File Types are given on Page 143.

- Use Knob [B] to select the File Type and Knob [C] to select the File Number.

NOTE If you press the [SHIFT] key, the directory for the currently selected file is displayed. Further details are given in the section "Card Mode Operations" (Page 144).

- To rename the file, use Knob [2] to move the cursor. Then use Knob [1] or the [DATA] knob and [DEC/NO] and [INC/YES] keys to enter the new file name. The procedure for renaming files is basically the same as for renaming Voices. However, you cannot use symbols or lower case characters, and the name can only be up to eight characters in length. Details about renaming Voices are given on Page 70.

- Press the [ENTER] key to rename the file. The message "Completed." will be displayed after it has been renamed, and you will be returned to the previous screen.

NOTE Files are named according to the MS-DOS naming convention. If the file name contains spaces and other characters unrecognized in MS-DOS, these characters will automatically be replaced by "_" (underscore) characters when saving.

Delete

You can delete files saved on Memory Card.

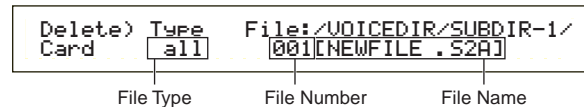

Type (File Type)

Settings: all (all data), all-voice, chain (Sequence Chain), plugin, other

NOTE Details about File Types are given on Page 143.

- Use Knob [B] to select the File Type and Knob [C] to select the File Number.

- When you press the [ENTER] key, you will see a confirmation message.

- Press the [INC/YES] key to delete the file. The message "Completed." will be displayed after it has been deleted, and you will be returned to the previous screen. The delete operation will be canceled if you press the [DEC/NO] key during execution.

MkDir (Make Directory)

You can create new directories and subdirectories (new directories within existing ones). This allows you to store files in separate directories according to File Type.

```
MkDir> /VOICEDIR/SUBDIR-1/ A-? Cursor
Card                               Dir:***[NEWDIR-3]
```

Directory Name

- NOTE** The directory hierarchy can have up to 27 levels.
- NOTE** You cannot create a directory with the same name as one that already exists.
- NOTE** The hierarchy display (directory path) will not be shown if the Memory Card has no directory other than the “root” directory.

- 1 Use Knob [C] to select an existing directory and repeat until you have reached the level in the hierarchy at which you wish to create a new directory.
- 2 To create a new directory, use Knob [2] to move the cursor. Then use Knob [1] or the [DATA] knob and [DEC/NO] and [INC/YES] keys to enter the new directory name.

The procedure for renaming files is basically the same as for renaming Voices. However, you cannot use symbols or lower case characters. Details about renaming Voices are given on Page 70. Directory names can only be up to 8 characters long.

- 3 Press the [ENTER] key to create the directory. The message “Completed” will be displayed after it has been created, and you will be returned to the previous screen.

- NOTE** Directories are denoted by “Dir” next to the directory name. To open a subdirectory, use Knob [C] to move the cursor to it and press the [ENTER] key. All the files in the subdirectory are displayed. If you select File Number 000, “up dir” will be displayed. By pressing the [ENTER] key, you will be returned to the parent directory (i.e., moved up one directory level).

Format

Before you can use a new Memory Card with the synthesizer, you will need to format it.

```
Format.)                               Press
Card                                    [ENTER]
```

Insert a new Memory Card into the CARD slot. When you press the [ENTER] key, you will see a confirmation message. Press the [INC/YES] key to start formatting the Card. You will see the “Executing...” message while the Card is being formatted.

- ⚠** If there is already data on the Memory Card, it will be completely lost when you format it.
- ⚠** Do not remove the Memory Card while it is being formatted, since this could result in damage to the synthesizer and the card.

After formatting, an EXT Memory file will automatically be created. During this process, the message “Now saving...” will be displayed.

About the Plug-in Boards (Optional)

A variety of optional Plug-in boards sold separately let you expand the voice library of your instrument. The following types of Plug-in boards can be used with your instrument.

- **PLG150-AN**
- **PLG150-PF**
- **PLG100-XG**
- **PLG150-VL**
- **PLG150-DX**
- **PLG100-VH**

NOTE See page 32 for detailed explanations for each board.

Available slot (PLG1, PLG2) differs depending on the type of the Plug-in boards. Please take it into consideration before installation.

PLG1/PLG2	Single-part Plug-in Boards (PLG150-AN, PLG150-PF, PLG150-VL, PLG150-DX)
PLG1 only	Effect Plug-in Board (PLG100-VH)
PLG2 only	Multi-part Plug-in Board (PLG100-XG)

NOTE Although the PLG100-VL and PLG100-DX can also be installed, some of the functions are not available.

Precautions When Installing the Optional Boards

! Remember the following precautions and install the Plug-in boards properly by following the steps as written.

- Handle the Plug-in boards with care. Dropping or subjecting the Plug-in board to any kind of shock may cause damage or result in a malfunction.
- Be careful of static electricity. There are times when static electricity affects the IC chips on the Plug-in board. Before you lift the optional Plug-in board, to reduce the possibility of static electricity, touch the metal parts other than the painted area or a ground wire on the devices that are grounded.
- Do not touch the exposed metal parts in the circuit board. Touching these parts may result in a faulty contact.
- When moving a cable, be careful not to let it catch on the circuit Plug-in board. Forcing the cable in anyway may cut the cable, cause damage, or result in a malfunction.
- Before starting installation, be sure that you have a coin or a Phillips screwdriver at hand.
- Be careful not to misplace any of the screws since all of them are used.
- Do not use any screws other than what are installed on the instrument.
- When inserting Plug-in boards and connecting cables, make sure that you check that they are inserted and connected properly. Improperly inserted Plug-in boards and cables may cause faulty contacts and an electrical short circuit which may cause damage or result in a malfunction.
- After mounting the Plug-in board be sure to tighten the screws as directed so it is completely stable and does not move in any way.

How to Install the Optional Plug-in Board

- 1 Turn the keyboard power off, and disconnect the power cord. Also, if the keyboard is connected with other external device(s), disconnect the device(s).
- 2 Move to a position facing the rear panel of the keyboard, and remove the screws from the Plug-in board cover at the bottom center side with a coin or a Phillips screwdriver (three SILVER screws only). Do not remove the other screws.

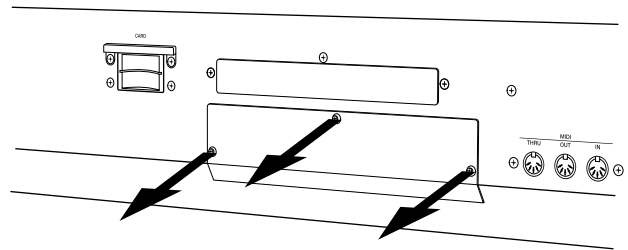

NOTE Keep the removed screws in a safe place. They will be used when attaching the Plug-in board cover to the keyboard again.

- 3 Remove the Plug-in board cover by pulling it to your side. The plate incorporated with the Plug-in board cover will appear. The plate can accommodate two Plug-in boards, on its top and bottom: PLG1 (top) and PLG2 (bottom).

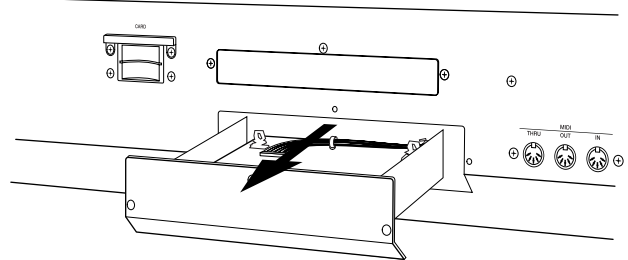

Those two can be identified by the color of the connector cable.

PLG1: One of the cables is **ORANGE** and the others are blue.

PLG2: One of the cables is **YELLOW** and the others are blue.

IMPORTANT Available slot (PLG1, PLG2) differs depending on the type of the Plug-in boards. For details, refer to the table above in the left column.

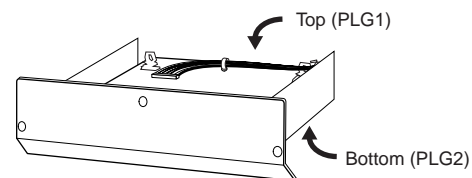

! When installing the optional Plug-in board (from when you remove the cover to when the cover is replaced securely) all operations must be done with the AC power cord disconnected.

- 4 Remove the tape which is used to fasten the cable to the plate.

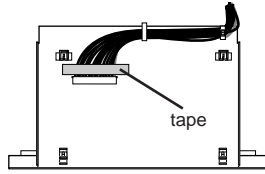

- 5 Take out the Plug-in board from the anti-static bag. When installing the board, the side with a connector and ICs must be on top.
- 6 Mount the Plug-in board onto the plate as detailed in the following steps.

- 6.1 Insert one side of the Plug-in board (the side opposite to the connector) into the hooks 1 as shown in the illustration.

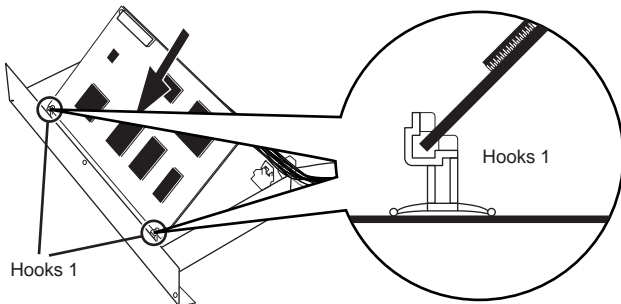

- 6.2 Press down the other side until it is securely settled on the hooks 2.

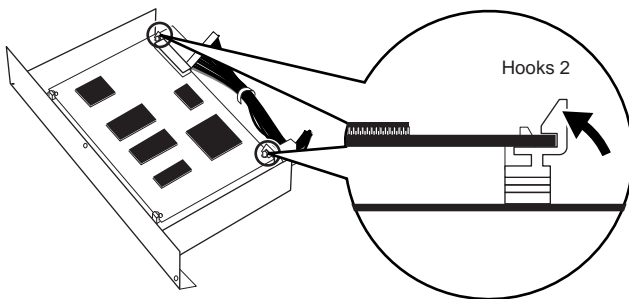
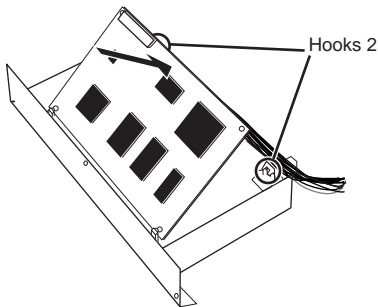

- 6.3 Carefully plug the cable connector into the Plug-in board connector until the two notches on the cable connector lock into the sockets on the board.

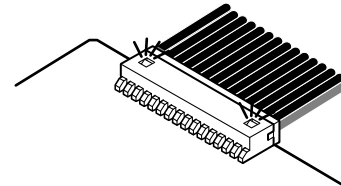
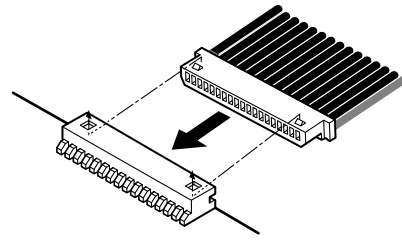

Removing the Plug-in board from the keyboard

- 1 Pull out the cable connector from the Plug-in board connector.

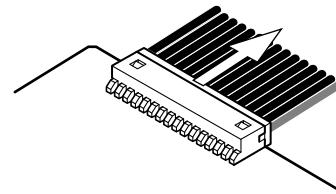

- 2 Press down the hooks 2 in the direction as shown in the illustration and take the board out from the hooks 2 by lifting up the one side.

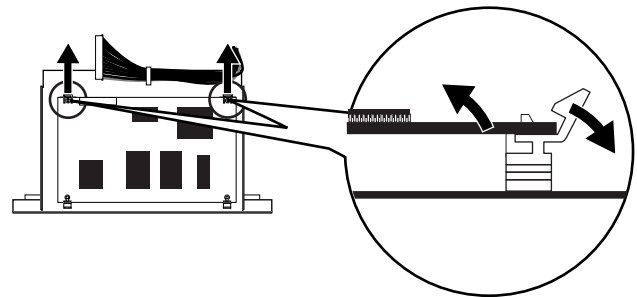

- 3 Pull out the other side of the board from the hooks 1.

- 7 Insert the plate into the keyboard.

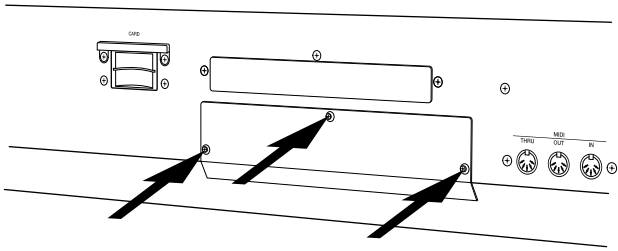
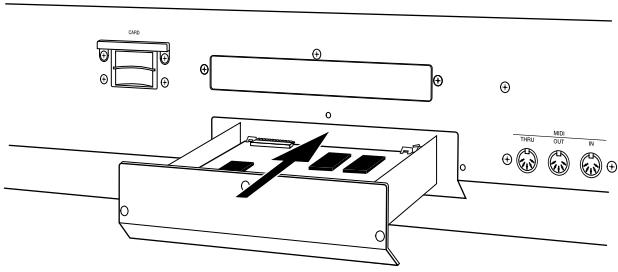

- 8 Replace the Plug-in board cover by fastening the three SILVER screws you removed in the step 2 above.

Display Messages

Message	Meaning
<< ! MIDI buffer full. >>	Failed to process the MIDI data because too much data was received at once.
<< ! MIDI data error. >>	Error occurred when receiving MIDI data.
<< ! MIDI checksum error. >>	Error occurred when receiving bulk data.
<< ! Change internal battery. >>	Internal backup battery needs to be replaced.
<< ! Card full. >>	No more available memory on the Memory Card.
<< ! File not found. >>	Can't find the specified type of file.
<< ! Bad card. >>	Memory Card is faulty.
<< ! Card not ready. >>	Memory Card has not been inserted, or an incompatible card (5V type) has been inserted.
<< ! Card unformatted. >>	Memory Card has not been formatted.
<< ! Card write protected. >>	Memory Card is write protected.
<< ! Illegal card. >>	Memory Card has been wrongly formatted.
<< ! File already exists. >>	File with the same name already exists.
<< ! Illegal file. >>	Data in the file is corrupted and cannot be used.
<< ! Illegal file name. >>	The specified file name is not in MS-DOS format.
<< ! Read only file. >>	File is a read-only type, and cannot be deleted, renamed or saved.
<< ! Can't make "EXT" file. >>	A file could not be created on the Memory Card.
<< ! Can't make directory. >>	No further directories can be created.
<< ! Too deep directory. >>	Directory cannot be entered because it is too deep.
<< ! Unknown file format. >>	File format is not recognized.
<< ! Bulk protected. >>	Bulk data cannot be received because protection is enabled.
<< ! Device number is off. >>	Bulk data cannot be transmitted/received because the device number is set to "off."
<< ! Device number mismatch. >>	Bulk data cannot be transmitted/received because the device numbers don't match.
<< ! Multi Plugin in slot 1. >>	Cannot be used because Slot 1 contains a Multi-Part Plug-in Board.
<< ! Effect plugin in slot 2. >>	Cannot be used because Slot 2 contains a Effect Plug-in Board.
<< ! Plugin1 communication error. >>	Plug-in Board in Slot 1 is not working properly.
<< ! Plugin2 communication error. >>	Plug-in Board in Slot 2 is not working properly.
<< ! Plugin1 type mismatch. >>	Sound requires a different Plug-in Board to that inserted in Slot 1.
<< ! Plugin2 type mismatch. >>	Sound requires a different Plug-in Board to that inserted in Slot 2.
<< ! PLG100 not supported. >>	When used with a PLG100 series Plug-in Board, a data file of which File Type is plugin cannot be stored on a Memory Card.
<< Executing... >>	Operation is being executed.
<< Now working... >>	Memory Card operation is being executed.
<< Now loading... >>	File is being loaded from Memory Card.
<< Now saving... >>	File is being saved to Memory Card.
<< Now checking Plug-in board. >>	Plug-in Board(s) is/are being checked (after powering up the synthesizer).
<< MIDI bulk receiving... >>	MIDI Bulk data is being received.
<< MIDI bulk transmitting... >>	MIDI Bulk data is being transmitted.
<< C 3:128[] Stored. >>	Sound has been stored.
<< Completed. >>	Operation has completed.
<< Are you sure ? [YES]/[NO] >>	Final confirmation.
<< Overwrite? [YES]/[NO] >>	There is a file already stored with the same name. Replace it with a newer one with that name?

Troubleshooting

The following table provides troubleshooting hints and page references for some common problems. Most problems may be simply the result of incorrect settings. Before calling for professional service, refer to the troubleshooting advice below to see if you can find and correct the cause of the problem.

No sound.

- Is the volume set appropriately? (Pages 6 and 20)
- With the S80, if a Foot Controller has been connected to the FOOT VOLUME jack, has it been fully depressed? (Page 18)
- Is the Vol (volume) parameter of the QED Level screen of Voice Edit Common sufficiently high? (Page 71)
- Has the WaveNumber parameter of the OSC Wave screen of Voice Edit Element been set to 000 (off)? (Page 79)
- Is the Level parameter of the OSC Out screen in Voice Edit Element sufficiently high? (Page 79)
- Have the note range/velocity (note) range of the ZONE, OSC screen in Voice Edit been set appropriately? (Page 80)
- Are any of the Elements muted? (Page 51)
- Have the Element filters been set to cut almost all the sound? (Page 83)
- Have the effects parameters been set appropriately? (Pages 71, 78, 79, 117, 120)
- Have the MIDI receive channels been set correctly? (Pages 123 and 137)
- Has the audio equipment been connected correctly? (Page 13)
- Has the Local switch been set to OFF? (Page 137)
- Have the Velocity Sensitivity, Note Limit and Velocity Limit parameters been set appropriately? (Pages 80, 102, 123 and 128)
- When playing back a song using the internal sequencer or an external MIDI device, have the volume and expression parameters been set appropriately?
- When playing performances using the internal sequencer or an external MIDI device, have the transmit channels for each sequencer track and the receive channels for each Part in the Performance, been set correctly? (Page 123)
- For Performances, is the volume of each Part sufficiently high? (Page 120)
- For Performances, has the output for each Part been set correctly? (Page 123)
- Have you selected EXT Memory without having inserted a Memory Card? (Page 28)
- With the Arpeggiator enabled, has the Arpeggio Category parameter been set to “Ct” and the Key Mode parameter set to something other than “direct”? (Page 72)

There is no arpeggiator sound.

- Has the Arpeggiator’s note range been set appropriately? (Page 73)
- In Performance Mode, have the Layer Switch and Arpeggio Switch parameters for the Part(s) been set to ON? (Page 123)
- Has the Tempo parameter in the ARP Type screen been set to “MIDI,” despite no MIDI clock signals being received?

Arpeggiator settings (On/Off, Hold, Tempo) cannot be changed.

- Plug-in Boards feature their own built-in arpeggio pattern generators. Details are given on Page 141, and also in the Owner’s Manual that comes with each Plug-in Board. (For the PLG150-AN Plug-in Board the settings are found in the Arp/SEQ Sw screen. Details are given on Page 29 of the PLG150-AN Owner’s Manual.)

Sounds are distorted sounds.

- Have the effects been set appropriately? (Pages 71, 78, 79, 117, 120)
- Has the volume been set too high? (Pages 6 and 20)
- Has the GAIN knob of the A/D INPUT been turned up too high? (Page 11)

Sound is very quiet.

- Has the MIDI volume or MIDI expression been set too low?
- Has the filter cutoff frequency been set too high/low? (Pages 72, 96, 115, 120)

The pitch is wrong.

- Have the NoteShift and Tune parameters in the MSTR TG screen of Utility Mode been set correctly? (Page 134)
- Have the Oct and Trnspose parameters in the MSTR Kbd screen of Utility Mode been set appropriately? (Page 134)
- Have the pitch related parameters in PITCH menu (Voice Edit) been set appropriately? (Page 80)
- Has the Micro Tuning parameter in Voice Edit Mode been set to an unconventional scale? (Page 71)
- Has the Pitch Modulation Depth in the LFO screen (Voice Edit Mode) been set too high? (Page 91)
- For Performances, has the Note Shift parameter in the LYR (Layer) screen been set to a value other than 0? (Page 123)
- For Performances, has the Detune parameter for each Part been set to a value other than 0? (Page 123)

Sound is choppy and intermittent.

- Has the maximum polyphony been exceeded? (Page 33)

Only one note sounds at a time.

- Has the Mode parameter in the GEN Other screen of Voice Edit Common been set to “mono”? (Page 71)
- In Performance Mode, has the Mode parameter in the LYR Mode screen been set to “mono” for each Part? (Page 122)

No effects are applied.

- Has the [EF BYPASS] key been set to OFF? (Page 56)
- Has the Insertion Effect Element Switch parameter in the EFF screen of Voice Edit been set to ON? Also in this Mode, has the effect type been set to something other than “thru” or “off”? (Page 78)
- For Performances, have the Insertion Effect Parts been specified? (Page 117)
- For Reverb and Chorus, have the effect types in the Common Edit screens been set to ON? (Pages 79, 118)
- If an Effect Plug-in Board has been installed, has the PLG-EF parameter in the EFF Part screen of the Performance been set to something other than OFF? (Page 117)
- If an Effect Plug-in Board has been installed, has the setting in the EFF Plg screen of the Performance been set to something other than “THRU”? (Page 118)

The Element switches do not work for the Control Set

- Have Element-specific parameters been selected as Dest (Destination)? (Page 75)

The Plug-in Board does not work.

- Has the Effect Plug-in Board been installed in PLG2? (Page 148)
- Has the Multi-Part-type Plug-in Board been installed in PLG1? (Page 148)
- If an Effect Plug-in Board has been installed, has the PLG-EF parameter in the EFF Part screen of the Performance’s Common Effect been set to something other than “off”? (Page 118)
- If an Effect Plug-in Board has been installed, has the setting in the EFF Plg screen of the Performance’s Common Effect been set to something other than “THRU”? (Page 118)

Cannot find the Drum Voice.

- Drum Voices are selected differently to Normal Voices (Page 66).

Cannot enter small values.

- Have you only tried entering values using Assignable Knobs [A] to [C] or Knob [1]/[2]? (Page 24)

Cannot move the cursor without the settings being affected.

- Hold down the [SHIFT] key while using Knobs [A] to [C], Knob [1]/[2], and the [DATA] knob or the [INC/YES] and [DEC/NO] keys (Page 24).

Cannot receive bulk data.

- When using the S80 Voice Editor, have you set a sufficient Dump Interval? The Dump Interval in the Voice Editor Setup dialog must be set to 10ms or greater.

Macintosh users: Card Filer for Macintosh does not work correctly.

- Are you using MIDI Time Piece?
Card Filer is not compatible with MIDI Time Piece. You need to disable the use of MIDI Time Piece on the Macintosh.

Specifications

KEYBOARD	Number of Keys	88
	Touch	Initial touch, After touch
TONE GENERATION SYSTEM	Tone Generators	AWM2, Modular Synthesis Plug-in System
	Polyphony	64
VOICE	Number of Voice	Normal voices (256 Presets, 128 Internals [Users], 128 Externals [Memory Cards]), Drum voices (8 presets, 2 Internals [Users], 2 Externals [Memory Cards]), Plug-in voices (64 x 2 Plug-in Boards [If installed])
	Wave ROM	24 MByte
PERFORMANCE	Multi-Timbres	19 (16 Voice Parts, A/D Input Part, Plug-in 1/2 Parts)
	Number of Performance	128 Internals, 64 Externals
	Master Keyboard Mode	4 Zones
EFFECT	Reverb	12
	Chorus	23
	Insertion	24 (Insertion 1), 92 (Insertion 2), 24 (Insertion for Plug-in Voices)
	Master EQ	4
SEQUENCE PLAY	Format	SMF Format 0 (Direct Play only), Sequence Chain (Load/Save)
	Number of Sequence Chains	100 Steps (100 Songs)
ARPEGGIATOR	Number of Arpeggios	128
Card	File Type	All Data, All Voice, Plug-in, Sequence Chain, SMF
	Functions	Save, Load, Rename, Delete, Make Directory, Format
CONTROLS	Volume Slider, 4 Control Sliders, Pitch, Modulation, Shift, Page, Knob A/B/C/1/2, Data, Effect Bypass, Master Keyboard, Exit, Enter, Dec/No, Inc/Yes, 7 Mode Keys, Sequence Play, Sequence PLAY/STOP, 6 Memory Keys, Quick Access, 8 Bank Keys, 16 Program/Part Keys, Power, Card Slot, Gain, Host Select	
CONNECTORS & TERMINALS	MIDI In, Out, Thru, To Host, Breath, Footswitch, Sustain, Foot Controller, Foot Volume, Individual Output 1, 2, Output L/Mono R, Phones, A/D Input, AC Inlet, 2 Connectors for Plug-in Boards	
DISPLAY	40 x 2 (Backlit)	
INCLUDED ACCESSORIES	Owner's Manual, Data List, CD-ROM, AC Power Cord	
OPTIONAL ACCESSORIES	PLG150 Plug-in Boards Series, PLG100 Plug-in Boards Series, FC4/5 Footswitch, FC7 Foot Controller, BC3 Breath Controller	
POWER CONSUMPTION	16W	
OUTPUT IMPEDANCE	Output: +18.1 –2dbm (10k ohms), Phones: +17.2 –2dbm (33 ohms)	
DIMENSIONS	1329(W) x 371(D) x 157(H) mm	
WEIGHT	24.3 kg	

* Specifications and descriptions in this owner's manual are for information purposes only. Yamaha Corp. reserves the right to change or modify products or specifications at any time without prior notice. Since specifications, equipment or options may not be the same in every locale, please check with your Yamaha dealer.

Index

0~9

4 Zones.....58

A

A/D INPUT jack11
About Memory Cards20, 142
About Modular Synthesis Plug-in System33
About Note Limit (Key Range)61
About the Modes35
About the Plug-in Boards (Optional)32, 148
About the Tone Generator32
AC Control Depth101, 126
AC INLET terminal10
AC Modulation Depth101, 126
AEG Level88
AEG Release88
AEG Time88
AEG VelSens (AEG Velocity Sensitivity)88
Aftertouch45
AMP AEG (Amplitude Envelope Generator)97
AMP KeyFlw (AMP Key Follow)89
AMP Scale (AMP Scaling Break Point)90
AMP Scale (AMP Scaling Offset)90
AMP VelSens (Amplitude Velocity Sensitivity)97
An Overview of the S8031
An Overview of Voices/Waves37
ARP Limit (Arpeggio Note Limit)73
ARP Mode (Arpeggio Mode)73
ARP PlayEF (Arpeggio Play Effects)73
ARP Type (Arpeggio Type)72
Arpeggiator41
Assigning Parameters to Knobs [1] and [2]47
Assigning Parameters to Knobs [A], [B] and [C]46
AT Control Depth100, 126
AT Modulation Depth101, 126
Automatically Loading Files143

B

BANK [A] to [H] keys9
Bank/Program Number64, 107
Breath Controller44
BREATH jack11

C

Card Mode22, 35, 142
CARD slot10
Chained Playback133
Chorus Unit55, 79, 118
Common (Settings for all Parts)112
Common Arpeggio72, 115
Common Controller74, 115
Common Edit and editing each Element50, 68
Common Effect78, 117
Common EQ (Equalizer)116
Common General70, 115
Common LFO (Low Frequency Oscillator)75
Common Quick Edit71, 114
Common/Part/Zone Edit111
Connecting a Microphone or Other Audio Equipment14
Connecting External MIDI Equipment15
Connecting to a Mixer13
Connecting to a Personal Computer16
Connecting to External Audio Equipment13
Connecting Various Controllers18

Connections13
Control Sets45
Control Sets and External MIDI Control46
Controller Section31, 43
Controlling Parameters by Foot Controller48
CONTROL SLIDER6, 44, 61
CTL AC Control (AC Control Depth)101
CTL AC Control (AC Control Depth) (Multi Plug-in Parts only)126
CTL AC Modulation101
CTL AC Modulation (AC Modulation Depth) (Multi Plug-in Parts only)126
CTL Assign1 (Controller Assign 1)116
CTL Assign2 (Controller Assign 2)116
CTL AT Control (AT Control Depth)100
CTL AT Control (AT Control Depth) (Multi Plug-in Parts only)126
CTL AT Modulation101
CTL AT Modulation (AT Modulation Depth) (Multi Plug-in Parts only)126
CTL Bend (Pitch Bend)74
CTL MW Control (MW Control Depth)100
CTL MW Control (MW Control Depth) (Multi Plug-in Parts only)125
CTL MW Modulation100, 124
CTL Pitch (Pitch Bend)100
CTL Portamento74
CTL Set1 (Control Set 1) to CTL Set6 (Control Set 6)74
CTL Set1 (Control Set 1)/CTL Set2 (Control Set 2)100
CTL Set1/CTL Set2 (Control Set 1/2) (A/D Input Part only)125
CTRL (System Controller)136
CTRL (Voice Controller)139
CTRL Assign1 (Controller Assign 1)140
CTRL Assign2 (Controller Assign 2)140
CTRL Knobs [A] to [C]136
CTRL Other (Controller Other)136

D

[DATA] Knob7, 25, 66
[DEC/NO] key8, 24, 66
Delete146
Demo Playback26
Display Messages151
Drum Common Arpeggio94
Drum Common Controllers94
Drum Common Edit and Drum Key Edit93
Drum Common Effects94
Drum Common General93
Drum Common Quick Edit93
Drum Key Amplitude96
Drum Key EQ (Equalizer)97
Drum Key Filter96
Drum Key OSC (Oscillator)94
Drum Key Pitch96
Drum Voices66, 92

E

Edit Modes21
Editing Plug-in Board Voices104
[EF BYPASS] key8
EFF Cho (Chorus)79, 118
EFF EF1/2 (Insertion Effect 1/2)78, 127
EFF InsEF (Insertion Effect)78
EFF Part117
EFF Rev (Reverb)79, 118
Effect Bypass56
Effect Parameter Settings78, 118, 127
Effect Plug-in Boards33
Effects34, 55
Effects in Performance Mode55

Effects in Voice Mode	55
Element Amplitude	88
Element Filter	83
Element Pitch	80
Element EQ (Equalizer)	91
Element LFO (Low Frequency Oscillator)	90
Element OSC (Oscillator)	79
Entering Data	24
[ENTER] Key	8, 24, 25
EQ High	117
EQ HighMid (High-Middle Range)	117
EQ Low	116
EQ LowMid (Low-Middle Range)	117
EQ Mid (Middle Range)	117
EQ Param (EQ Parameter)	103
EQ Type	91
Example of Control Set Assignment	75
[EXIT] Key	8, 23

F

Factory Set (Restore Factory Defaults)	141
FEG Level (FEG Level)	86
FEG Release (FEG Release)	86
FEG Time	86
FEG VelSens (FEG Velocity Sensitivity)	85
File Name Settings	145
File Types	143
Filter Envelope Generator Settings	86
Filter Scaling Settings	87
FLT Cutoff (Filter Cutoff)	96
FLT HPF (High Pass Filter)	85
FLT KeyFlw (Filter Key Follow)	86
FLT Scale (Filter Scale Break Point)	87
FLT Scale (Filter Scale Offset)	87
FLT Sens (Filter Sensitivity)	85
FLT Type (Filter Type)	83
Foot Controller	44
FOOT CONTROLLER jack	10
Foot Switch	44
FOOT SWITCH jack	11
Foot Volume	44
FOOT VOLUME jack	10
Format	147

G

GAIN knob	11
GEN M.Kbd (General Master Keyboard)	113
GEN MIDI (General MIDI)	113
GEN Name (General Name)	70, 90, 113
GEN Other (General Other)	71, 99

H

HOST SELECT switch	11
--------------------------	----

I

[INC/YES] key	8, 24, 66
INDIVIDUAL OUTPUT 1 and 2 jacks	10
Insertion Effects	55, 78

J

Job Modes	22
-----------------	----

K

Knob Parameter	65, 108
Knobs [A], [B], [C], [1] and [2]	7, 24, 44

L

Layer (Master keyboard Mode)	60
Layer (Performance Mode)	122
LCD (Liquid Crystal Display)	7
LFO Depth	91
LFO Dest1 (LFO Destination 1)	77
LFO Dest2 (LFO Destination 2)	77
LFO Fade	77
LFO Param (LFO Parameter)	101
LFO Wave	75, 90
Load	145
LYR Limit (Layer Limit)	123
LYR Mode (Layer Mode)	122
LYR Out (Layer Out)	123
LYR Tune (Layer Tune)	123

M

M.EQ (Voice Master Equalizer)	138
M.EQ High (Master EQ High)	139
M.EQ HighMid (Master EQ High-Middle Range)	139
M.EQ Low (Master EQ Low)	139
M.EQ LowMid (Master EQ Low-Middle Range)	139
M.EQ Mid (Master EQ Middle Range)	139
Master keyboard	57, 128, 134
Master Keyboard/Tone Generator Mode	111
[MASTER KEYBOARD] key	8
Maximum Polyphony	33
MEMORY keys	9
Memory/Performance Program Number	107
Memory/Voice Program Number	64
Menu Display	51, 70, 93, 98, 111, 134
Micro Tuning	71
MIDI (System MIDI)	137
MIDI Arp (MIDI Arpeggio)	137
MIDI Ch (MIDI Channel)	137
MIDI GM/XG Receive (if a Multi-Part Plug-in Board has been installed)	138
MIDI IN, OUT, and THRU connectors	10
MIDI Interface to MIDI IN and OUT	17
MIDI Other	138
MIDI Sw (MIDI Receive Switch)	137
MIX Level	120
MIX Vce/Template	119
MKB Assign (Master Keyboard Assign)	129
MKB Note (Master Keyboard Note)	128
MKB Transmit (Master Keyboard Transmit)	128
MKB TxPreset1 (Master Keyboard Transmit Preset 1)	129
MKB TxPreset2 (Master Keyboard Transmit Preset 2)	129
MKB TxSw1 (Master Keyboard Transmit Switch 1)	128
MKB TxSw2 (Master Keyboard Transmit Switch 2)	128
MKB TxSw3 (Master Keyboard Transmit Switch 3)	128
MKB TxSW4 (Master keyboard Transmit Switch 4)	128
MkDir (Make Directory)	147
MODE keys	8
MODULAR SYNTHESIS PLUG-IN SYSTEM	33
MODULATION wheel	6
Monitoring Board Voices	98
Moving the Cursor	24, 25
MSTR (System Master)	134
MSTR EF Bypass (Master Effect By-pass)	135
MSTR Kbd (Master Keyboard)	134
MSTR Other (Other Setup)	135
MSTR TG (Master Tone Generator)	134
Multi Edit	109
Multi-Part Plug-in Board	33
MW Control Depth	100, 125
MW Modulation Depth	100, 125

N

Normal Voice69

O

Octave and MIDI Transmit Channel Settings65, 108
OSC Assign (Oscillator Assign)102
OSC Limit (Oscillator Limit)80
OSC Other (Oscillator Other)95
OSC Out (Oscillator Out)79, 95
OSC Pan (Oscillator Pan)80, 95
OSC Velocity (Oscillator Velocity)102
OSC Wave (Oscillator Wave)79, 94
OUTPUT L/MONO and R jack11

P

[PAGE] Knob7, 23
Part (Settings for each Part)119
Part Controller125
Part Insertion Effect (A/D Input Part only)127
Part Layer122
Part Mixer119
Part Receive Switch124
Part Tone120
PCH PEG (Pitch Envelope Generator)103
PCH Scale (Pitch Scale)82
PCH Tune (Pitch Tune)80, 96
PEG Level81
PEG Release81
PEG Time81
PEG VelSens (PEG Velocity Sensitivity)81
Performance Category108
Performance Edit21, 111
Performance Job Mode22, 130
Performance Memory/Number (Bank/Number)107
Performance Name108
Performance Play Mode Display107
Performance Program Selection109
Performance Store112, 131
Performances29, 39
PFM Bulk Dump131
PFM Copy130
PFM Edit Recall130
PFM Initialize130
PFM Play (Performance Play)107
PHONES jack11
PITCH bend wheel6
Pitch Envelope Generator Settings82, 103
Play Modes21
PLG (Plug-in) (if a Plug-in Board has been installed)140
PLG Status (Plug-in Status)140
PLG-NATIVE (Plug-in Native)103
PLG1 MIDI (Plug-in 1 MIDI)140
PLG1/2 System (Plug-in 1/2 System)141
PLG2 MIDI (Plug-in 2 MIDI)140
Plug-in Common Arpeggio99
Plug-in Common Controller100
Plug-in Common Effect102
Plug-in Common General99
Plug-in Common LFO (Low Frequency Oscillator)101
Plug-in Common Quick Edit99
Plug-in Element EQ (Equalizer)103
Plug-in Element Native103
Plug-in Element OSC (Oscillator)102
Plug-in Element Pitch102
Plug-in Voices98
Power Supply12
POWER switch10
Powering Up19
PROGRAM/PART [1] to [16] keys9, 23

Q

[Quick Access] key9
QED EF (Quick Edit Effect)114
QED EffectCtrl (Quick Edit Effect)71, 93, 99
QED EG (Quick Edit Envelope Generator)72, 93, 99, 115
QED Filter (Quick Edit Filter)72, 93, 99, 115
QED Level (Quick Edit Level)71, 93, 99, 114

R

RCV Sw1 (Receive Switch 1)124
RCV Sw2 (Receive Switch 2)124
RCV Sw3 (Receive Switch 3)124
RCV Sw4 (Receive Switch 4)124
Reading the Displayed Settings110
Rename146
Reverb Unit55, 79, 118

S

Save144
Screen Title64, 107
Selecting a Menu70
Selecting a Mode21
Selecting a Screen23
Selecting Preset Drums (PRE:DR1 ~ DR8)66
Selecting the Arpeggio Type41, 72
Selecting User Drums (INT:DR1/2 and EXT:DR1/2)66
SEQ (Sequence Chain)132
SEQ controls8
SEQ Demo (Sequence Demo)132
Sequence Play Mode22, 35, 132
Setting the Note Limit42
Setting the Tempo42
Setting the Voice Name70
Setting/Viewing Knob Parameters65, 108
[SHIFT] Key7, 23
Single Part Plug-in Boards32
SmartMedia™20, 142
Song File Playback63, 133
Split57
Status144
Sustain44
SUSTAIN jack11
Switching Between Programs by Foot Switch48
Switching Elements On/Off51

T

The “Compare” Function69, 112
The  Indicator69, 112
TO HOST connector11, 16
TON EG (Tone Envelope Generator)121
TON Filter (Tone Filter)120
TON Other (Tone Other)122
TON Portamento (Tone Portamento)121
Tone Generator Section32
Types of Parameters (Absolute and Relative)25

U

Using the A/D Input Part63
Using the Arpeggiator Hold43
Using the BANK/PROGRAM Keys65, 109
Using the Voice Category Search67
Using the Quick Access28, 68
Utility Job Mode22, 141
Utility Mode22, 35, 134

V

VCE Bulk Dump.....	106
VCE Copy.....	105
VCE Edit Recall.....	105
VCE Initialize.....	105
Voice Category.....	65
Voice Edit.....	21, 50, 68
Voice Job Mode.....	22, 105
Voice Memory/Number (Bank/Number) Display.....	64
Voice Mode.....	35, 64
Voice Name.....	65
Voice Play Mode Display.....	21, 64
Voice Program Selection.....	65
Voice Store.....	69, 106
Voices.....	27, 36
[VOLUME] Slider.....	6

W

Waves.....	38
------------	----

Z

Zones.....	127
------------	-----

For details of products, please contact your nearest Yamaha or the authorized distributor listed below.

Pour plus de détails sur les produits, veuillez-vous adresser à Yamaha ou au distributeur le plus proche de vous figurant dans la liste suivante.

Die Einzelheiten zu Produkten sind bei Ihrer unten aufgeführten Niederlassung und bei Yamaha Vertragshändlern in den jeweiligen Bestimmungsländern erhältlich.

Para detalles sobre productos, contacte su tienda Yamaha más cercana o el distribuidor autorizado que se lista debajo.

NORTH AMERICA

CANADA

Yamaha Canada Music Ltd.
135 Milner Avenue, Scarborough, Ontario,
M1S 3R1, Canada
Tel: 416-298-1311

U.S.A.

Yamaha Corporation of America
6600 Orangethorpe Ave., Buena Park, Calif. 90620, U.S.A.
Tel: 714-522-9011

CENTRAL & SOUTH AMERICA

MEXICO

Yamaha de Mexico S.A. De C.V.,
Departamento de ventas
Javier Rojo Gomez No.1149, Col. Gpe Del
Moral, Deleg. Iztapalapa, 09300 Mexico, D.F.
Tel: 686-00-33

BRAZIL

Yamaha Musical do Brasil LTDA.
Av. Rebouças 2636, São Paulo, Brasil
Tel: 011-853-1377

ARGENTINA

Yamaha Music Argentina S.A.
Viamonte 1145 Piso2-B 1053,
Buenos Aires, Argentina
Tel: 1-371-7021

PANAMA AND OTHER LATIN AMERICAN COUNTRIES/ CARIBBEAN COUNTRIES

Yamaha de Panama S.A.
Torre Banco General, Piso 7, Urbanización Marbella,
Calle 47 y Aquilino de la Guardia,
Ciudad de Panamá, Panamá
Tel: 507-269-5311

EUROPE

THE UNITED KINGDOM

Yamaha-Kemble Music (U.K.) Ltd.
Sherbourne Drive, Tilbrook, Milton Keynes,
MK7 8BL, England
Tel: 01908-366700

IRELAND

Danfay Ltd.
61D, Sallynoggin Road, Dun Laoghaire, Co. Dublin
Tel: 01-2859177

GERMANY/SWITZERLAND

Yamaha Europa GmbH.
Siemensstraße 22-34, 25462 Rellingen,
F.R. of Germany
Tel: 04101-3030

AUSTRIA

Yamaha Music Austria
Schleiergasse 20, A-1100 Wien Austria
Tel: 01-60203900

THE NETHERLANDS

Yamaha Music Nederland
Kanaalweg 18G, 3526KL, Utrecht, The Netherlands
Tel: 030-2828411

BELGIUM

Yamaha Music Belgium
Keiberg Imperiastraat 8, 1930 Zaventem, Belgium
Tel: 02-7258220

FRANCE

Yamaha Musique France,
Division Professionnelle
BP 70-77312 Marne-la-Vallée Cedex 2, France
Tel: 01-64-61-4000

ITALY

Yamaha Musica Italia S.P.A.,
Combo Division
Viale Italia 88, 20020 Lainate (Milano), Italy
Tel: 02-935-771

SPAIN/PORTUGAL

Yamaha-Hazen Electronica Musical, S.A.
Jorge Juan 30, 28001, Madrid, Spain
Tel: 91-577-7270

GREECE

Philippe Nakas S.A.
Navarinou Street 13, P.Code 10680, Athens, Greece
Tel: 01-364-7111

SWEDEN

Yamaha Scandinavia AB
J. A. Wettergrens Gata 1
Box 30053
S-400 43 Göteborg, Sweden
Tel: 031 89 34 00

DENMARK

YS Copenhagen Liaison Office
Generatorvej 8B
DK-2730 Herlev, Denmark
Tel: 44 92 49 00

FINLAND

F-Musikki Oy
Kluuvikatu 6, P.O. Box 260,
SF-00101 Helsinki, Finland
Tel: 09 618511

NORWAY

Norsk filial av Yamaha Scandinavia AB
Grini Næringspark 1
N-1345 Østerås, Norway
Tel: 67 16 77 70

ICELAND

Skifan HF
Skeifan 17 P.O. Box 8120
IS-128 Reykjavik, Iceland
Tel: 525 5000

OTHER EUROPEAN COUNTRIES

Yamaha Europa GmbH.
Siemensstraße 22-34, 25462 Rellingen, F.R. of Germany
Tel: 04101-3030

AFRICA

Yamaha Corporation,
International Marketing Division
Nakazawa-cho 10-1, Hamamatsu, Japan 430-8650
Tel: 053-460-2312

MIDDLE EAST

TURKEY/CYPRUS

Yamaha Europa GmbH.
Siemensstraße 22-34, 25462 Rellingen,
F.R. of Germany
Tel: 04101-3030

OTHER COUNTRIES

Yamaha Music Gulf FZE
LB21-128 Jebel Ali Freezone
P.O.Box 17328, Dubai, U.A.E.
Tel: 971-4-81-5868

ASIA

HONG KONG

Tom Lee Music Co., Ltd.
11/F., Silvercord Tower 1, 30 Canton Road,
Tsimshatsui, Kowloon, Hong Kong
Tel: 2737-7688

INDONESIA

PT. Yamaha Music Indonesia (Distributor)
PT. Nusantik
Gedung Yamaha Music Center, Jalan Jend. Gatot Subroto
Kav. 4, Jakarta 12930, Indonesia
Tel: 21-520-2577

KOREA

Cosmos Corporation
1461-9, Seocho Dong, Seocho Gu, Seoul, Korea
Tel: 02-3486-0011

MALAYSIA

Yamaha Music Malaysia, Sdn., Bhd.
Lot 8, Jalan Perbandaran, 47301 Kelana Jaya,
Petaling Jaya, Selangor, Malaysia
Tel: 3-703-0900

PHILIPPINES

Yupango Music Corporation
339 Gil J. Puyat Avenue, P.O. Box 885 MCPO,
Makati, Metro Manila, Philippines
Tel: 819-7551

SINGAPORE

Yamaha Music Asia Pte., Ltd.
11 Ubi Road #06-00, Meiban Industrial Building, Singapore
Tel: 65-747-4374

TAIWAN

Yamaha KHS Music Co., Ltd.
10F, 150, Tun-Hwa Northroad,
Taipei, Taiwan, R.O.C.
Tel: 02-2713-8999

THAILAND

Siam Music Yamaha Co., Ltd.
121/60-61 RS Tower 17th Floor,
Ratchadaphisek RD., Dindaeng,
Bangkok 10320, Thailand
Tel: 02-641-2951

THE PEOPLE'S REPUBLIC OF CHINA AND OTHER ASIAN COUNTRIES

Yamaha Corporation,
International Marketing Division
Nakazawa-cho 10-1, Hamamatsu, Japan 430-8650
Tel: 053-460-2317

OCEANIA

AUSTRALIA

Yamaha Music Australia Pty. Ltd.
17-33 Market Street, South Melbourne, Vic. 3205, Australia
Tel: 3-699-2388

NEW ZEALAND

Music Houses of N.Z. Ltd.
146/148 Captain Springs Road, Te Papapa, Auckland, New
Zealand
Tel: 9-634-0099

COUNTRIES AND TRUST TERRITORIES IN PACIFIC OCEAN

Yamaha Corporation,
International Marketing Group
Nakazawa-cho 10-1, Hamamatsu, Japan 430-8650
Tel: 053-460-2312

HEAD OFFICE Yamaha Corporation, Electronic Musical Instrument Division
Nakazawa-cho 10-1, Hamamatsu, Japan 430-8650
Tel: 053-460-2445

IMPORTANT SAFETY INSTRUCTIONS

INFORMATION RELATING TO PERSONAL INJURY, ELECTRICAL SHOCK, AND FIRE HAZARD POSSIBILITIES HAS BEEN INCLUDED IN THIS LIST.

WARNING- When using any electrical or electronic product, basic precautions should always be followed. These precautions include, but are not limited to, the following:

- 1.** Read all Safety Instructions, Installation Instructions, Special Message Section items, and any Assembly Instructions found in this manual BEFORE making any connections, including connection to the main supply.
- 2.** Do not attempt to service this product beyond that described in the user-maintenance instructions. All other servicing should be referred to qualified service personnel.
- 3.** Main Power Supply Verification: Yamaha products are manufactured specifically for the supply voltage in the area where they are to be sold. If you should move, or if any doubt exists about the supply voltage in your area, please contact your dealer for supply voltage verification and (if applicable) instructions. The required supply voltage is printed on the name plate. For name plate location, please refer to the graphic found in the Special Message Section of this manual.
- 4.** DANGER-Grounding Instructions: This product must be grounded and therefore has been equipped with a three pin attachment plug. If this product should malfunction, the ground pin provides a path of low resistance for electrical current, reducing the risk of electrical shock. If your wall socket will not accommodate this type plug, contact an electrician to have the outlet replaced in accordance with local electrical codes. Do NOT modify the plug or change the plug to a different type!
- 5.** WARNING: Do not place this product or any other objects on the power cord or place it in a position where anyone could walk on, trip over, or roll anything over power or connecting cords of any kind. The use of an extension cord is not recommended! If you must use an extension cord, the minimum wire size for a 25' cord (or less) is 18 AWG. NOTE: The smaller the AWG number, the larger the current handling capacity. For longer extension cords, consult a local electrician.
- 6.** Ventilation: Electronic products, unless specifically designed for enclosed installations, should be placed in locations that do not interfere with proper ventilation. If instructions for enclosed installations are not provided, it must be assumed that unobstructed ventilation is required.
- 7.** Temperature considerations: Electronic products should be installed in locations that do not seriously contribute to their operating temperature. Placement of this product close to heat sources such as; radiators, heat registers etc., should be avoided.
- 8.** This product was NOT designed for use in wet/damp locations and should not be used near water or exposed to rain. Examples of wet /damp locations are; near a swimming pool, spa, tub, sink, or wet basement.
- 9.** This product should be used only with the components supplied or; a cart ,rack, or stand that is recommended by the manufacturer. If a cart, rack, or stand is used, please observe all safety markings and instructions that accompany the accessory product.
- 10.** The power supply cord (plug) should be disconnected from the outlet when electronic products are to be left unused for extended periods of time. Cords should also be disconnected when there is a high probability of lightening and/or electrical storm activity.
- 11.** Care should be taken that objects do not fall and liquids are not spilled into the enclosure through any openings that may exist.
- 12.** Electrical/electronic products should be serviced by a qualified service person when:
 - a. The power supply cord has been damaged; or
 - b. Objects have fallen, been inserted, or liquids have been spilled into the enclosure through openings; or
 - c. The product has been exposed to rain; or
 - d. The product does not operate, exhibits a marked change in performance; or
 - e. The product has been dropped, or the enclosure of the product has been damaged.
- 13.** This product, either alone or in combination with an amplifier and headphones or speaker/s, may be capable of producing sound levels that could cause permanent hearing loss. DO NOT operate for a long period of time at a high volume level or at a level that is uncomfortable. If you experience any hearing loss or ringing in the ears, you should consult an audiologist.

IMPORTANT: The louder the sound, the shorter the time period before damage occurs.
- 14.** Some Yamaha products may have benches and/or accessory mounting fixtures that are either supplied as a part of the product or as optional accessories. Some of these items are designed to be dealer assembled or installed. Please make sure that benches are stable and any optional fixtures (where applicable) are well secured BEFORE using. Benches supplied by Yamaha are designed for seating only. No other uses are recommended.

PLEASE KEEP THIS MANUAL

FCC INFORMATION (U.S.A.)

1. IMPORTANT NOTICE: DO NOT MODIFY THIS UNIT!

This product, when installed as indicated in the instructions contained in this manual, meets FCC requirements. Modifications not expressly approved by Yamaha may void your authority, granted by the FCC, to use the product.

2. IMPORTANT:

When connecting this product to accessories and/or another product use only high quality shielded cables. Cable/s supplied with this product MUST be used. Follow all installation instructions. Failure to follow instructions could void your FCC authorization to use this product in the USA.

3. NOTE:

This product has been tested and found to comply with the requirements listed in FCC Regulations, Part 15 for Class "B" digital devices. Compliance with these requirements provides a reasonable level of assurance that your use of this product in a residential environment will not result in harmful interference with other electronic devices. This equipment generates/uses radio frequencies and, if not installed and used according to the instructions found in the users manual, may cause interference harmful to the operation of other electronic devices. Compliance with FCC regulations does not guarantee that interference will not occur in all installations.

If this product is found to be the source of interference, which can be determined by turning the unit "OFF" and "ON", please try to eliminate the problem by using one of the following measures:

Relocate either this product or the device that is being affected by the interference.

Utilize power outlets that are on different branch (circuit breaker or fuse) circuits or install AC line filter/s.

In the case of radio or TV interference, relocate/reorient the antenna. If the antenna lead-in is 300 ohm ribbon lead, change the lead-in to co-axial type cable.

If these corrective measures do not produce satisfactory results, please contact the local retailer authorized to distribute this type of product. If you can not locate the appropriate retailer, please contact Yamaha Corporation of America, Electronic Service Division, 6600 Orangethorpe Ave, Buena Park, CA90620

The above statements apply ONLY to those products distributed by Yamaha Corporation of America or its subsidiaries.

* This applies only to products distributed by YAMAHA CORPORATION OF AMERICA.

(class B)

IMPORTANT NOTICE FOR THE UNITED KINGDOM Connecting the Plug and Cord

WARNING: THIS APPARATUS MUST BE EARTHED

IMPORTANT. The wires in this mains lead are coloured in accordance with the following code:

GREEN-AND-YELLOW	:EARTH
BLUE	:NEUTRAL
BROWN	:LIVE

As the colours of the wires in the mains lead of this apparatus may not correspond with the coloured markings identifying the terminals in your plug proceed as follows:

The wire which is coloured GREEN-and-YELLOW must be connected to the terminal in the plug which is marked by the letter E or by the safety earth symbol or colored GREEN or GREEN-and-YELLOW.

The wire which is coloured BLUE must be connected to the terminal which is marked with the letter N or coloured BLACK.

The wire which is coloured BROWN must be connected to the terminal which is marked with the letter L or coloured RED.

* This applies only to products distributed by Yamaha-Kemble Music (U.K.) Ltd. (3 wires)

ADVARSEL!

Lithiumbatteri—Eksplussionsfare ved fejlagtig håndtering. Udskiftning må kun ske med batteri af samme fabrikat og type. Levér det brugte batteri tilbage til leverandoren.

VARNING

Explosionsfara vid felaktigt batteribyte. Använd samma batterityp eller en ekvivalent typ som rekommenderas av apparattillverkaren. Kassera använt batteri enligt fabrikantens instruktion.

VAROITUS

Paristo voi räjähtää, jos se on virheellisesti asennettu. Vaihda paristo ainoastaan laitevalmistajan suosittelemaan tyyppiin. Hävitä käytetty paristo valmistajan ohjeiden mukaisesti.

(lithium caution)

NEDERLAND / THE NETHERLANDS

- Dit apparaat bevat een lithium batterij voor geheugen back-up.
- This apparatus contains a lithium battery for memory back-up.
- Raadpleeg uw leverancier over de verwijdering van de batterij op het moment dat u het apparaat aan het einde van de levensduur afdankt of de volgende Yamaha Service Afdeling:

Yamaha Music Nederland Service Afdeling
Kanaalweg 18-G, 3526 KL UTRECHT
Tel. 030-2828425

- For the removal of the battery at the moment of the disposal at the end of the service life please consult your retailer or Yamaha Service Center as follows:

Yamaha Music Nederland Service Center
Address : Kanaalweg 18-G, 3526 KL UTRECHT
Tel : 030-2828425

- Gooi de batterij niet weg, maar lever hem in als KCA.
- Do not throw away the battery. Instead, hand it in as small chemical waste.

(lithium disposal)



Analog Physical Modeling Plug-in Board **PLG150-AN**

Reproduce the fat and funky sounds of vintage analog synths! This board gives you a synth engine similar to the one featured in Yamaha's amazing AN1x Analog Physical Modeling Synthesizer. On top of its full array of wave algorithms, resonant filters, LFOs, and envelope generators, it also has distortion and a 3-band equalizer. With the PLG150-AN, project and professional studios alike will be able to produce the killer synth sounds featured in today's hot dance tracks.

Tone Generator Type	AN (Analog Physical Modeling Synthesis)
Polyphony	5 notes
Voice	256 Preset 128 User
Effect	Guitar Amp. Simulator (Distortion), 3-Band EQ, XG Part EQ
Interface	Plug-in Connector (15-pin digital I/F connector)
Dimensions (W) x (D) x (H)	138.5 x 89.0 x 8.5 mm (5 9/16" x 3 5/8" x 3/8")
Weight	65g (2.3oz)



Piano Plug-in Board **PLG150-PF**

For the serious piano player, this Plug-in Board is loaded with hundreds of painstakingly sampled piano and keyboard voices—from concert grands and uprights to electric pianos and harpsichords. Two piano boards can be used together, effectively doubling piano polyphony to an incredible 128 notes! For professional recording studios that demand authentic piano sound but don't want to bother with a real piano, an S80 loaded with the PLG150-PF makes a perfect solution.

Tone Generator Type	AWM2
Polyphony	64 notes
Voice	136 Preset
Effect	Reverb, Chorus, Insertion, 2-Band EQ
Interface	Plug-in Connector (15-pin digital I/F connector)
Dimensions (W) x (D) x (H)	138.5 x 89.0 x 8.5 mm (5 9/16" x 3 5/8" x 3/8")
Weight	72g (2.5oz)



Virtual Acoustic Plug-in Board **PLG150-VL**

The Virtual Acoustic Modular Synthesis Plug-in Board lets you create incredibly expressive, natural-sounding voices by digitally simulating the physical characteristics of acoustic instruments. Thanks to its fabulous synthesis architecture, extensive realtime performance control of the voices is possible, making it the ideal Plug-in Board for keyboard soloists.

Tone Generator Type	SVA (Self-oscillating Virtual Acoustic Synthesis)
Polyphony	1 note monophonic
Voice	256 Preset 70 User
Interface	Plug-in Connector (15-pin digital I/F connector)
Dimensions (W) x (D) x (H)	138.5 x 89.0 x 8.5 mm (5 9/16" x 3 5/8" x 3/8")
Weight	56g (2.0oz)



Advanced DX/TX Plug-in Board **PLG150-DX**

Add the classic sounds of Yamaha's world-famous DX-7 synthesizer to the S80. The PLG150-DX features the same 6-operator 16-note polyphonic FM tone generation system that took the synthesizer industry by storm. This board is a must-have for performing keyboard players and producers of contemporary music.

Tone Generator Type	FM Synthesis
Polyphony	16 notes
Voice	912 Preset 64 User
Effect	Part EQ, Lowpass, Highpass
Interface	Plug-in Connector (15-pin digital I/F connector)
Dimensions (W) x (D) x (H)	138.5 x 89.0 x 8.5 mm (5 9/16" x 3 5/8" x 3/8")
Weight	63g (2.2oz)



Vocal Harmony Plug-in Board **PLG100-VH**

The PLG100-VH adds powerful harmony or vocoder effects to your voice by simply plugging a microphone into the S80's A/D input and playing chords on the keyboard. Harmony interval changes can be recorded in a sequencer track for automated playback—a dream tool for performing vocalists or for singer/songwriters who want to compose and record songs at home.

Maximum Harmony	3 voices
Effect	Vocoder Harmony, Detune Harmony Chordal Harmony, Chromatic Harmony
Voice Control	Gender change (male → female, female → male) Vibrato, Volume, Pan, Detune
Interface	Plug-in Connector (15-pin digital I/F connector)
Dimensions (W) x (D) x (H)	138.5 x 89.0 x 8.5 mm (5 9/16" x 3 5/8" x 3/8")
Weight	53g (1.9oz)



XG Tone Generator Plug-in Board **PLG100-XG**

This Plug-in Board gives you over 400 professional-quality sampled voices and 21 drum kits as well as 32 additional notes of polyphony. Plus it fully supports XG MIDI specifications, so you can use it to play back XG SMF MIDI song files from an external sequencer or the S80's internal sequencer. Home recording hobbyists in particular will find this Plug-in Board an indispensable addition to the S80.

Tone Generator Type	AWM2
Polyphony	32 notes
Voice	Preset normal: 424, drum kits: 21
Effect	Reverb, Chorus, Variation
Connector	Plug-in Connector (15-pin digital I/F connector)
Dimensions (W) x (D) x (H)	138.5 x 89.0 x 8.5 mm (5 9/16" x 3 5/8" x 3/8")
Weight	64g (2.3oz)

