



SPX2000

PROFESSIONAL MULTI-EFFECT PROCESSOR

Owner's Manual



Keep This Manual For Future Reference.

PRECAUTIONS

PLEASE READ CAREFULLY BEFORE PROCEEDING

* Please keep this manual in a safe place for future reference.

WARNING

Always follow the basic precautions listed below to avoid the possibility of serious injury or even death from electrical shock, short-circuiting, damages, fire or other hazards. These precautions include, but are not limited to, the following:

Power supply/Power cord

- Only use the voltage specified as correct for the device. The required voltage is printed on the name plate of the device.
- Use only the included power cord.
If you intend to use the device in an area other than in the one you purchased, the included power cord may not be compatible. Please check with your Yamaha dealer.
- Do not place the power cord near heat sources such as heaters or radiators, and do not excessively bend or otherwise damage the cord, place heavy objects on it, or place it in a position where anyone could walk on, trip over, or roll anything over it.

Do not open

- Do not open the device or attempt to disassemble the internal parts or modify them in any way. The device contains no user-serviceable parts. If it should appear to be malfunctioning, discontinue use immediately and have it inspected by qualified Yamaha service personnel.

Water warning

- Do not expose the device to rain, use it near water or in damp or wet conditions, or place containers on it containing liquids which might spill into any openings.
- Never insert or remove an electric plug with wet hands.

If you notice any abnormality

- If the power cord or plug becomes frayed or damaged, or if there is a sudden loss of sound during use of the device, or if any unusual smells or smoke should appear to be caused by it, immediately turn off the power switch, disconnect the electric plug from the outlet, and have the device inspected by qualified Yamaha service personnel.
- If this device should be dropped or damaged, immediately turn off the power switch, disconnect the electric plug from the outlet, and have the device inspected by qualified Yamaha service personnel.

CAUTION

Always follow the basic precautions listed below to avoid the possibility of physical injury to you or others, or damage to the device or other property. These precautions include, but are not limited to, the following:

Power supply/Power cord

- Remove the electric plug from the outlet when the device is not to be used for extended periods of time, or during electrical storms.
- When removing the electric plug from the device or an outlet, always hold the plug itself and not the cord. Pulling by the cord can damage it.

Location

- Before moving the device, remove all connected cables.
- When setting up the product, make sure that the AC outlet you are using is easily accessible. If some trouble or malfunction occurs, immediately turn off the power switch and disconnect the plug from the outlet. Even when the power switch is turned off, electricity is still flowing to the product at the minimum level. When you are not using the product for a long time, make sure to unplug the power cord from the wall AC outlet.
- Do not expose the device to excessive dust or vibrations, or extreme cold or heat (such as in direct sunlight, near a heater, or in a car during the day) to prevent the possibility of panel disfiguration or damage to the internal components.
- Do not place the device in an unstable position where it might accidentally fall over.
- Do not use the device in the vicinity of a TV, radio, stereo equipment, mobile phone, or other electric devices. Otherwise, the device, TV, or radio may generate noise.

Connections

- Before connecting the device to other devices, turn off the power for all devices. Before turning the power on or off for all devices, set all volume levels to minimum.
- Be sure to connect to a properly grounded power source. A ground screw terminal is provided on the rear panel for safely grounding the device and preventing electrical shock.

Handling caution

- Do not insert your fingers or hand in any gaps or openings on the device.
- Avoid inserting or dropping foreign objects (paper, plastic, metal, etc.) into any gaps or openings on the device. If this happens, turn off the power immediately and unplug the power cord from the AC outlet. Then have the device inspected by qualified Yamaha service personnel.
- Do not rest your weight on the device or place heavy objects on it, and avoid use excessive force on the buttons, switches or connectors.

Backup battery

- This device has a built-in backup battery. When you unplug the power cord from the AC outlet, the internal data is retained. However, if the backup battery fully discharges, this data will be lost. When the backup battery is running low, the LCD indicates "Low Battery!". In this case, immediately save the data to a computer or other external device, then have qualified Yamaha service personnel replace the backup battery.

XLR-type connectors are wired as follows (IEC60268 standard): pin 1: ground, pin 2: hot (+), and pin 3: cold (-).

Yamaha cannot be held responsible for damage caused by improper use or modifications to the device, or data that is lost or destroyed.

Always turn the power off when the device is not in use.

The performance of components with moving contacts, such as switches, volume controls, and connectors, deteriorates over time. Consult qualified Yamaha service personnel about replacing defective components.

FCC INFORMATION (U.S.A.)

1. IMPORTANT NOTICE: DO NOT MODIFY THIS UNIT!

This product, when installed as indicated in the instructions contained in this manual, meets FCC requirements. Modifications not expressly approved by Yamaha may void your authority, granted by the FCC, to use the product.

2. IMPORTANT: When connecting this product to accessories and/or another product use only high quality shielded cables. Cable/s supplied with this product MUST be used. Follow all installation instructions. Failure to follow instructions could void your FCC authorization to use this product in the USA.

3. NOTE: This product has been tested and found to comply with the requirements listed in FCC Regulations, Part 15 for Class "B" digital devices. Compliance with these requirements provides a reasonable level of assurance that your use of this product in a residential environment will not result in harmful interference with other electronic devices. This equipment generates/uses radio frequencies and, if not installed and used according to the instructions found in the users manual, may cause interference harmful to the operation of other electronic devices. Compliance with FCC regulations does

not guarantee that interference will not occur in all installations. If this product is found to be the source of interference, which can be determined by turning the unit "OFF" and "ON", please try to eliminate the problem by using one of the following measures:

Relocate either this product or the device that is being affected by the interference.

Utilize power outlets that are on different branch (circuit breaker or fuse) circuits or install AC line filter/s.

In the case of radio or TV interference, relocate/reorient the antenna. If the antenna lead-in is 300 ohm ribbon lead, change the lead-in to co-axial type cable.

If these corrective measures do not produce satisfactory results, please contact the local retailer authorized to distribute this type of product. If you can not locate the appropriate retailer, please contact Yamaha Corporation of America, Electronic Service Division, 6600 Orangethorpe Ave, Buena Park, CA90620

The above statements apply ONLY to those products distributed by Yamaha Corporation of America or its subsidiaries.

* This applies only to products distributed by YAMAHA CORPORATION OF AMERICA.

(class B)

IMPORTANT NOTICE FOR THE UNITED KINGDOM

Connecting the Plug and Cord

WARNING: THIS APPARATUS MUST BE EARTHED
IMPORTANT. The wires in this mains lead are coloured in accordance with the following code:

GREEN-AND-YELLOW : EARTH
BLUE : NEUTRAL
BROWN : LIVE

As the colours of the wires in the mains lead of this apparatus may not correspond with the coloured markings identifying the terminals in your plug proceed as follows:

The wire which is coloured GREEN-and-YELLOW must be connected to the terminal in the plug which is marked by the letter E or by the safety earth symbol  or colored GREEN or GREEN-and-YELLOW.

The wire which is coloured BLUE must be connected to the terminal which is marked with the letter N or coloured BLACK.

The wire which is coloured BROWN must be connected to the terminal which is marked with the letter L or coloured RED.

• This applies only to products distributed by Yamaha-Kemble Music (U.K.) Ltd. (3 wires)

COMPLIANCE INFORMATION STATEMENT (DECLARATION OF CONFORMITY PROCEDURE)

Responsible Party : Yamaha Corporation of America
Address : 6600 Orangethorpe Ave., Buena Park, Calif.
90620

Telephone : 714-522-9011

Type of Equipment : PROFESSIONAL MULTI-EFFECT PROCESSOR
Model Name : SPX2000

This device complies with Part 15 of the FCC Rules.

Operation is subject to the following two conditions:

- 1) this device may not cause harmful interference, and
- 2) this device must accept any interference received including interference that may cause undesired operation.

See user manual instructions if interference to radio reception is suspected.

* This applies only to products distributed by
YAMAHA CORPORATION OF AMERICA.

(FCC DoC)

NEDERLAND / THE NETHERLANDS

- Dit apparaat bevat een lithium batterij voor geheugen back-up.
- This apparatus contains a lithium battery for memory back-up.
- Raadpleeg uw leverancier over de verwijdering van de batterij op het moment dat u het apparaat aan het einde van de levensduur of gelieve dan contact op te nemen met de vertegenwoordiging van Yamaha in uw land.
- For the removal of the battery at the moment of the disposal at the end of life please consult your retailer or Yamaha representative office in your country.
- Gooi de batterij niet weg, maar lever hem in als KCA.
- Do not throw away the battery. Instead, hand it in as small chemical waste.

(lithium disposal)

ADVARSEL!

Lithiumbatteri—Eksplodingsfare ved fejlagtig håndtering. Udskiftning må kun ske med batteri af samme fabrikat og type. Levér det brugte batteri tilbage til leverandøren.

VARNING

Explosionsfara vid felaktigt batteribyte. Använd samma batterityp eller en ekvivalent typ som rekommenderas av apparattillverkaren. Kassera använt batteri enligt fabrikantens instruktion.

VAROITUS

Paristo voi räjähtää, jos se on virheellisesti asennettu. Vaihda paristo ainoastaan laitevalmistajan suosittelemaan tyyppiin. Hävitä käytetty paristo valmistajan ohjeiden mukaisesti.

(lithium caution)

CAUTIONS:

- This unit is a CLASS I device. Connect the unit to a mains socket outlet that features a protective ground terminal.
- This unit is not completely disconnected from the mains when you turn off the POWER switch, which is a single pole switch.

This product contains a battery that contains perchlorate material. Perchlorate Material—special handling may apply, See www.dtsc.ca.gov/hazardouswaste/perchlorate.

* This applies only to products distributed by YAMAHA CORPORATION OF AMERICA.

(Perchlorate)

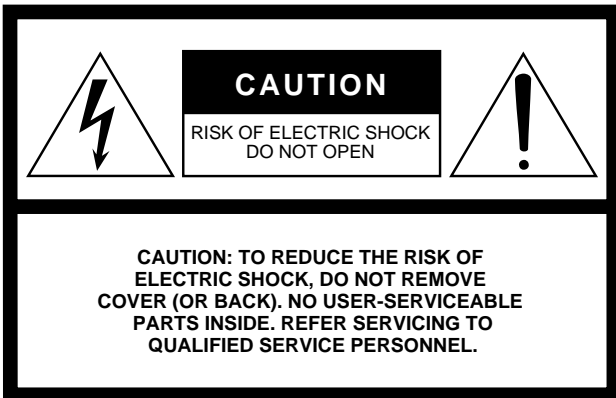

Explanation of Graphical Symbols

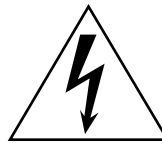

The lightning flash with arrowhead symbol within an equilateral triangle is intended to alert the user to the presence of uninsulated “dangerous voltage” within the product’s enclosure that may be of sufficient magnitude to constitute a risk of electric shock to persons.



The exclamation point within an equilateral triangle is intended to alert the user to the presence of important operating and maintenance (servicing) instructions in the literature accompanying the product.

The above warning is located on the top of the unit.

IMPORTANT SAFETY INSTRUCTIONS

- 1 Read these instructions.
- 2 Keep these instructions.
- 3 Heed all warnings.
- 4 Follow all instructions.
- 5 Do not use this apparatus near water.
- 6 Clean only with dry cloth.
- 7 Do not block any ventilation openings. Install in accordance with the manufacturer’s instructions.
- 8 Do not install near any heat sources such as radiators, heat registers, stoves, or other apparatus (including amplifiers) that produce heat.
- 9 Do not defeat the safety purpose of the polarized or grounding-type plug. A polarized plug has two blades with one wider than the other. A grounding type plug has two blades and a third grounding prong. The wide blade or the third prong are provided for your safety. If the provided plug does not fit into your outlet, consult an electrician for replacement of the obsolete outlet.

WARNING

TO REDUCE THE RISK OF FIRE OR ELECTRIC SHOCK, DO NOT EXPOSE THIS APPARATUS TO RAIN OR MOISTURE.

- 10 Protect the power cord from being walked on or pinched particularly at plugs, convenience receptacles, and the point where they exit from the apparatus.
- 11 Only use attachments/accessories specified by the manufacturer.
- 12 Use only with the cart, stand, tripod, bracket, or table specified by the manufacturer, or sold with the apparatus. When a cart is used, use caution when moving the cart/apparatus combination to avoid injury from tip-over.
- 13 Unplug this apparatus during lightning storms or when unused for long periods of time.
- 14 Refer all servicing to qualified service personnel. Servicing is required when the apparatus has been damaged in any way, such as power-supply cord or plug is damaged, liquid has been spilled or objects have fallen into the apparatus, the apparatus has been exposed to rain or moisture, does not operate normally, or has been dropped.



Table of contents

Features of the SPX2000	6
Parts and their functions	7
Front panel	7
Rear panel	9
Operation	10
Basic operation	10
Editing an effect	13
Other functions	17
Effects	25
Reverb	27
Early Reflection	35
Delay, Echo	38
Modulation	47
Pitch Change	61
Composite effects	66
Freeze	77
Other effects	82
MIDI	88
Preparations for using MIDI	88
What you can do using MIDI	88
MIDI data format	89
MIDI Control Change Parameter Assignment Table	95
Error message list	97
Troubleshooting	98
Specifications	99
Index	104

- All illustrations in this owner's manual are for explanatory purposes; they may differ from the actual specifications.
- Company names and product names appearing in this manual are the trademarks or registered trademarks of their respective owners.

Features of the SPX2000

- **High-quality sound**

High quality is guaranteed by 96 kHz 24-bit digital processing.

- **Flexible support for a variety of situations and applications**

122 different effects are provided as presets, meeting the needs of a wide variety of situations and applications. You can edit these preset effects to create your own unique sounds.

- **Control effects remotely**

You can use the SPX2000 Editor^(*) or MIDI messages to control effects remotely. You can not only switch effects, but also modify the effect parameters to make fine adjustments, or make the effect vary in conjunction with your performance on a MIDI keyboard.

* Refer to “Controlling the SPX2000 from your computer,” below.

- **Manage effect data on your computer**

You can use the SPX2000 Editor to manage or back up your original effects and data. For example you could create a separate library for each live performance or recording project, and store effects for just that event. Then you can simply swap the data (USER bank) for each occasion, allowing you to use effects efficiently.

Hardware features

- ★ **Digital input/output**

By connecting an AES/EBU format compatible device you can input/output audio in digital form.

- ★ **Intuitive operation**

Operation is intuitive; use the [STORE] button to store an effect, the [RECALL] button to recall an effect, and the [▲ INC]/[▼ DEC] buttons to increment/decrement a parameter value.

- ★ **Instant recognition of effect types**

The SPX2000's display shows a different background color (by default) for each type of effect. You can tell the general effect type at a glance; e.g., cyan (light blue) for reverb and early reflection, white for delay, magenta for modulation, and green for effects of the Classic bank.

Controlling the SPX2000 from your computer

You can use the SPX2000 Editor to remotely control the SPX2000 from your computer. The SPX2000 Editor is expected to be available for downloading from the following website. For the latest information, please visit the website.

Yamaha Pro Audio Website:
<http://www.yamahaproaudio.com/>

For details on the SPX2000 Editor, refer to the operating manual for the software.

Software features

- ★ **New reverb algorithms**

New reverbs feature the newly-developed REV-X algorithm, delivering rich, high-density reverberation with smooth decay, spaciousness, and depth that brings out the best in the original signal.

- ★ **Classic SPX effects revived with new algorithms**

Favorite effects such as gate reverb, freeze, and flanger have been carried over from previous SPX-series models, with newly developed algorithms.

- ★ **Stereo input/output**

The SPX2000 provides full stereo operation; 2 IN/2 OUT.

- ★ **Tempo synchronization**

Some effects can be synchronized to a specified note length and tempo. The tempo can be set using the front panel [TAP] button, from a foot switch such as the FC5, or via MIDI messages.

- ★ **A full range of MIDI functionality**

You can use MIDI to switch effects, modify parameter values, or transmit/receive bulk data. Effects and tempo synchronization can also be controlled via MIDI.

Parts and their functions

Front panel

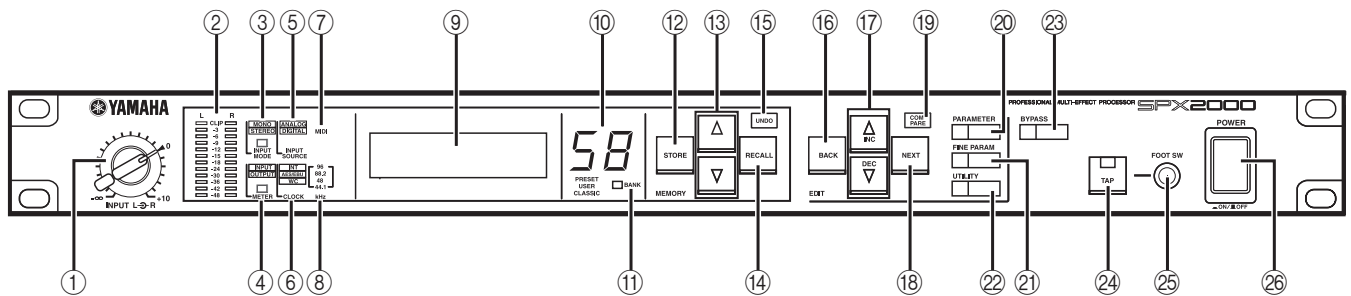

- ① **[INPUT L ↔ R] control**
This concentric pair of knobs adjusts the level of the analog input signal. The inner knob controls the L channel, and the outer knob controls the R channel.
- ② **Level meters**
These indicate the signal level pre-effect or post-effect (page 103).
- ③ **[INPUT MODE] button/indicator**
This button selects monaural input or stereo input. The indicator will light to indicate the currently selected input mode.
- ④ **[METER] button/indicator**
This button selects either pre-effect or post-effect as the signal whose level will be shown in the level meter (②). The indicator will light to indicate the currently selected signal.
- ⑤ **[INPUT SOURCE] indicator**
This indicates the currently selected input source. Use “INPUT SOURCE” (page 19) to select the input source.
- ⑥ **[CLOCK] indicator**
This indicates the currently selected word clock source. Use “CLOCK SOURCE” (page 18) to select the word clock source.
- ⑦ **[MIDI] indicator**
This will light when the SPX2000 receives MIDI data.
- ⑧ **[kHz] indicator**
This indicates the currently-operating word clock frequency.
- ⑨ **Display**
This displays information about the currently-recalled effect or the selected utility function.
- ⑩ **Effect number indicator**
This indicates the effect number of the currently selected effect. If the selected effect is different than the recalled effect, the number will blink. When you store or recall an effect, the blinking number will change to steadily lit.
- ⑪ **[BANK] button/indicator**
This button selects the effect bank. The indicator for the selected bank will light. For details on banks, refer to “Three banks” (page 12).
- ⑫ **[STORE] button**
This button stores the selected effect.
- ⑬ **[▲]/[▼] buttons**
These buttons select an effect.
- ⑭ **[RECALL] button**
This button recalls the selected effect.
- ⑮ **[UNDO] button/LED**
Use this button when you want to undo the preceding store/recall/erase operation (page 16). The LED will light if the [UNDO] button is available.
- ⑯ **[BACK] button**
This button selects the preceding parameter.
- ⑰ **[▲ INC]/[▼ DEC] buttons**
Use these buttons to edit parameter values.

⑱ **[NEXT] button**

This button selects the next parameter.

⑲ **[COMPARE] button/LED**

Use this button to compare the effect before editing (immediately after recall) and after editing. If you edit a parameter after recalling an effect, this LED will light. The LED will go dark when you store or recall an effect (page 16).

⑳ **[PARAMETER] button/LED**

This button selects the basic parameters of the effect. This LED will light if basic parameters are selected.

㉑ **[FINE PARAM] button/LED**

This button selects the FINE parameters of the effect. The FINE parameters supplement the basic parameters. This LED will light if FINE parameters are selected.

㉒ **[UTILITY] button/LED**

This button selects the SPX2000's utility functions. For details, refer to "Other functions" (page 17). This LED will light if a utility function is selected.

NOTE: The following buttons will be inoperable when the [UTILITY] LED (㉒) is lit.

- [BANK] button (⑪)
- [STORE] button (⑫)
- [▲]/[▼] buttons (⑬)
- [RECALL] button (⑭)
- [UNDO] button (⑮)
- [COMPARE] button (⑲)

㉓ **[BYPASS] button/LED**

This button switches the effect on/off. When the [BYPASS] button is off (LED dark), the effect will be applied to the input signal and output from the output jacks. When the [BYPASS] button is on (LED lit), the input signal will be sent from the output jacks without modification.

NOTE: The [BYPASS] button will turn off when you recall an effect.

㉔ **[TAP] button/LED**

Use this to set the tempo value of the effect. When you press this button twice or more, the tempo value will be calculated from the average interval at which you press the button. If the effect SYNC parameter is on, the LED will blink at the interval of the tempo value.

㉕ **[FOOT SW] jack**

You can connect an optional foot switch (such as the FC5) to this jack and the foot switch to input the tempo as an alternative to using the [TAP] button (㉔) (page 23).

㉖ **[POWER ON/OFF] button**

This button turns the power of the SPX2000 on/off.

Rear panel

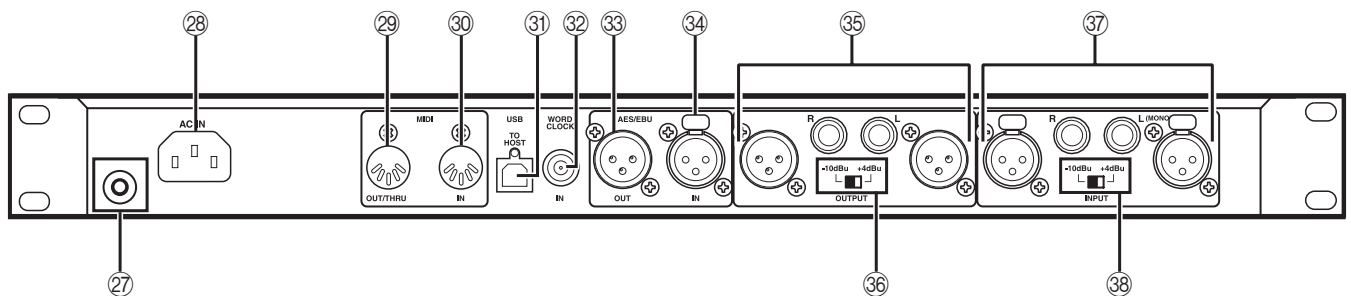

27 Grounding screw

For safety, use this screw to ground the SPX2000. The included power cable has a three-prong plug; if the electrical outlet you use is correctly grounded, the SPX2000 will be appropriately grounded. If the electrical outlet is not grounded, use this screw to ground the SPX2000. Correctly grounding the SPX2000 will effectively reduce hum and interference.

28 [AC IN] jack

Connect the power cable to this jack. First connect the power cable to the SPX2000, and then connect the other end to the electrical outlet.



Use only the supplied power cord.

29 [MIDI OUT/THRU] connector

You can connect a MIDI device to this connector and use MIDI messages to send SPX2000 data to it. You can bulk-dump SPX2000 data via MIDI, or re-transmit MIDI data received at the [MIDI IN] connector (30) from this connector without change. Use “MIDI OUT SETUP” (page 21) to specify whether this connector functions as “MIDI OUT” or “MIDI THRU.”

30 [MIDI IN] connector

You can connect a MIDI device to this connector and use messages transmitted from that device to remotely control the SPX2000 (page 88).

31 [TO HOST USB] connector

You can use a USB cable to connect your computer here. You can use SPX2000 Editor or your MIDI application to remotely control the SPX2000 from your computer (page 6).

32 [WORD CLOCK IN] jack

Connect this jack to a device that supplies a word clock signal. This jack is terminated with a 75-ohm resistor. Connect this jack in a one-to-one connection with the device supplying the word clock.

33 [AES/EBU OUT] jack

Connect an AES/EBU format device to this jack. This XLR-3-32 jack outputs an AES/EBU format digital signal.

34 [AES/EBU IN] jack

Connect an AES/EBU format device to this jack. This XLR-3-31 jack inputs an AES/EBU format digital signal.

35 [OUTPUT] jacks

Connect these jacks to the effect return of your mixer or to the input of your power amp. These jacks output analog signals. Use either the XLR-3-32 jacks or the TRS phone jacks, as appropriate for the device you are connecting.

36 [OUTPUT -10 dBu/+4 dBu] switch

Set this to either -10 dBu or +4 dBu according to the input level of the device connected to the [OUTPUT] jacks (35).

37 [INPUT] jacks

Connect these jacks to the effect send of your mixer or to the output of an electronic musical instrument. These jacks input analog signals. Use either the XLR-3-31 jacks or the TRS phone jacks, as appropriate for the device you are connecting.

In order to enable these jacks, you must set the input source setting to “ANALOG” (page 19).

38 [INPUT -10 dBu/+4 dBu] switch

Set this to either -10 dBu or +4 dBu according to the output level of the device connected to the [INPUT] jacks (37).

Operation

Basic operation

This section provides a simple explanation of how to input signals to the SPX2000, apply effects, and output the result. The overall steps are as follows.

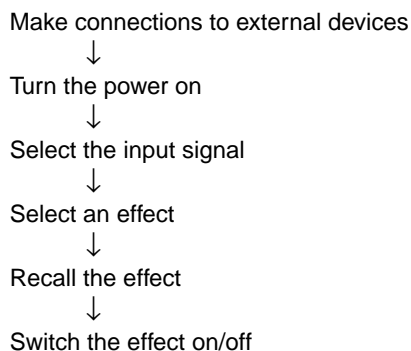

Make connections to external devices

The connectors you use will depend on whether the input/output signals are analog or digital.

- **Analog input:**
Connect your device to the [INPUT] jacks (37).
- **Digital input:**
Connect your device to the [AES/EBU IN] jack (34).
- **Analog output:**
Connect your device to the [OUTPUT] jacks (35).
- **Digital output:**
Connect your device to the [AES/EBU OUT] jack (33).

NOTE: If you are inputting/outputting analog signals, you must set the [INPUT -10 dBu/+4 dBu] switch (39) and the [OUTPUT -10dBu/+4dBu] switch (36) appropriately for the signal level of the connected devices.



You must turn off the power of all devices before you make connections.

Related items

- Selecting the word clock source..... page 18
- Using your computer to control the SPX2000 page 6
- Using MIDI messages to control the SPX2000 page 88

Turn the power on

Here's how to turn on the power of a system that includes the SPX2000.

1 Protect your monitor system

Before you turn on the power of the SPX2000, turn off the power of the device that is connected to the [OUTPUT] jacks (35) or [AES/EBU OUT] jack (33). Also turn the [INPUT L ↔ R] control (1) to minimize the L/R input signal level (the inner knob controls the L channel, and the outer knob controls the R channel).

2 Turn on the power of the SPX2000

Press the [POWER ON/OFF] button (26) to turn the power on.

→ The front panel display and LEDs will light.

3 Turn on your external devices

Turn on the power of devices connected to the SPX2000.

NOTE: To prevent high-volume noise from being output from your speakers, turn on the power starting with the device that is closest to the audio source.

Example: sound modules → mixer → SPX2000 → power amp

Reverse this order when turning the power off.

Select the input signal

You will need to make several selections regarding the input signal.

Select monaural or stereo input

Use the [INPUT MODE] button (③) to select either monaural input or stereo input. Each time you press the [INPUT MODE] button the indicator will alternate between **MONO** and **STEREO**.

The signal flow will change as follows depending on whether the input is monaural or stereo, and on the number of inputs/outputs for the effect you recall.

Monaural input 1IN 2OUT

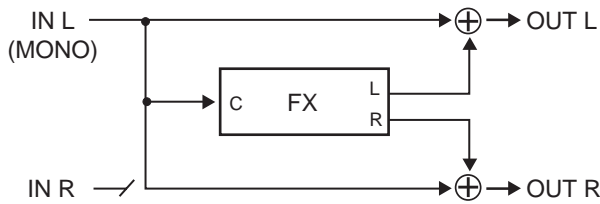

Monaural input 2IN 2OUT

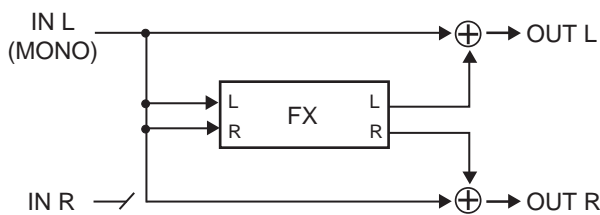

Stereo input 1IN 2OUT

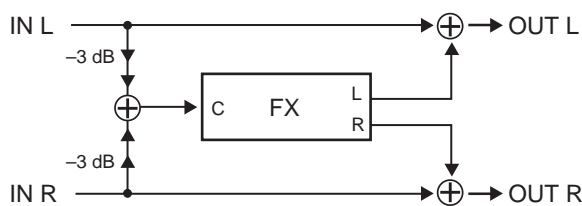

Stereo input 2IN 2OUT

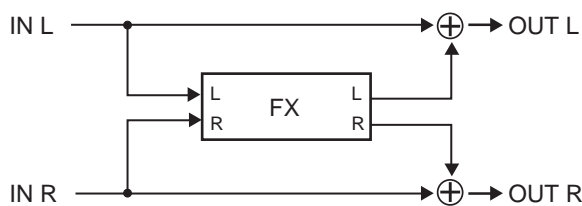

Select the signal for metering

Use the [METER] button (④) to select either the pre-effect signal or the post-effect signal for display in the level meter (②). Each time you press the [METER] button the indicator will alternate between **INPUT** and **OUTPUT**.

Check the status of the input signal

The following indicators will light to indicate the state of the input signal.

- **INPUT SOURCE (⑤):**
This will indicate whether the input signal is **ANALOG** or **DIGITAL**. If you want to change input sources, use “INPUT SOURCE” (page 19) to select the desired input source.
- **MIDI (⑦):**
This indicator will light when MIDI data is received.
- **CLOCK (⑥):**
This indicates the word clock source. Use “CLOCK SOURCE” (page 18) to select the word clock source.

INT	The SPX2000's internal clock The SPX2000 will operate as the clock master. You will need to set other connected devices to be clock slaves.
AES/EBU	Clock data received at the [AES/EBU IN] jack (③④) The SPX2000 will operate as a clock slave.
WC	Clock will be received at the [WORD CLOCK IN] jack (③②) The SPX2000 will operate as a clock slave.

- **kHz (⑧)**
This indicates the word clock frequency (44.1/48/88.2/96 kHz). If you are using the SPX2000's internal clock, you can use “CLOCK SOURCE” (page 18) to select the frequency.

Adjust the input level

Use the [INPUT L ↔ R] control (①) to adjust the analog input signal levels (L/R); the inner knob controls the L channel, and the outer knob controls the R channel.

Three banks

The SPX2000 has three effect banks; PRESET, USER, and CLASSIC. These banks are organized as follows.

PRESET bank

This bank contains a total of 97 effects; 80 effects based on new algorithms and ranging from standard to distinctive, and 17 newly-developed reverb (REV-X) effects.

The effects in this bank are read-only.

CLASSIC bank

This bank contains 25 simple and easy-to-use effects based on early models of the SPX series.

The effects in this bank are read-only.

USER bank

When shipped, this bank does not contain effects. You can edit effects from the PRESET bank or CLASSIC bank and store them as your own original effects in the USER bank. Once you have stored an effect, you can recall and use it in the same way as the effects of the PRESET bank or CLASSIC bank.

You can store 99 effects in this bank.

NOTE: The following buttons will be inoperable when the [UTILITY] LED (22) is lit

- [BANK] button (11)
- [STORE] button (12)
- [▲]/[▼] buttons (13)
- [RECALL] button (14)
- [UNDO] button (15)
- [COMPARE] button (19)

NOTE: While you are selecting an effect (i.e., while the effect number indicator is blinking), pressing any of the following buttons will cancel the effect selection; the currently-recalled effect will appear in the display.

- [UNDO] button (15)
- [BACK] button (16)
- [▲ INC]/[▼ DEC] buttons (17)
- [NEXT] button (18)
- [COMPARE] button (19)
- [PARAMETER] button (20)
- [FINE PARAM] button (21)

Recall the effect

Press the [RECALL] button (14) to recall the effect.

→ The recalled effect will be applied to the output signal.

NOTE: You can press the [UNDO] button (15) to undo the preceding Recall operation. The [UNDO] LED will light if UNDO is available.

Select an effect

Here's how to select the effect that you want to apply to the input signal.

1 Select a bank

Press the [BANK] button (11) several times to select the bank that contains the desired effect.

→ The [BANK] indicator (11) shows the currently selected bank.

2 Select an effect

Use the [▲]/[▼] buttons (13) to select the effect you want to use.

→ The number of the currently-selected effect will blink in the effect number indicator (10).

[▲] button	Press	to move to the following effect.
	Hold	to continue moving through the following effects.
	Hold down [▲] and press [▼]	to move more rapidly through the following effects.
[▼] button	Press	to move to the preceding effect.
	Hold	to continue moving through the preceding effects.
	Hold down [▼] and press [▲]	to move more rapidly through the preceding effects.

Switch the effect on/off

You can use the [BYPASS] button (23) to switch the effect on/off.

→ Each time you press the button the effect will be switched on/off. When the [BYPASS] button is on, the effect will be off and the input signal will be output without modification.

Editing an effect

This section explains the process of editing a selected effect and storing it. The overall steps are as follows.

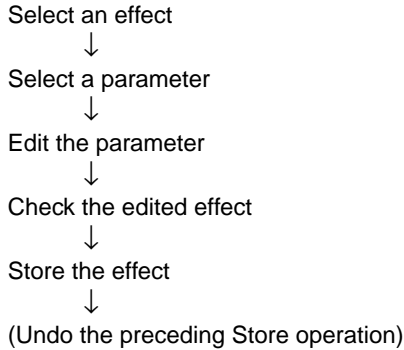

Select an effect

Select the effect that you want to edit.

1 Select a bank

Use the [BANK] button (11) to select the bank containing the effect you want to edit.

→ The [BANK] indicator (11) shows the currently selected bank.

2 Select an effect (page 12)

Use the [▲]/[▼] buttons (13) to select the effect you want to edit.

→ The number of the currently selected effect will blink in the effect number indicator (10).

NOTE: While you are selecting an effect (i.e., while the effect number indicator is blinking), pressing any of the following buttons will cancel the effect selection; the currently-recalled effect will appear in the display.

- [UNDO] button (15)
- [BACK] button (16)
- [▲ INC]/[▼ DEC] buttons (17)
- [NEXT] button (18)
- [COMPARE] button (19)
- [PARAMETER] button (20)
- [FINE PARAM] button (21)

3 Recall the effect

Press the [RECALL] button (14) to recall the effect.

→ The effect number indicator (10) will change from blinking to steadily lit.

NOTE: The following buttons will be inoperable when the [UTILITY] LED (22) is lit

- [BANK] button (11)
- [STORE] button (12)
- [▲]/[▼] buttons (13)
- [RECALL] button (14)
- [UNDO] button (15)
- [COMPARE] button (19)

Basic parameters and Fine parameters

Each of the SPX2000's effects consists of two types of parameter: Basic parameters and Fine parameters.

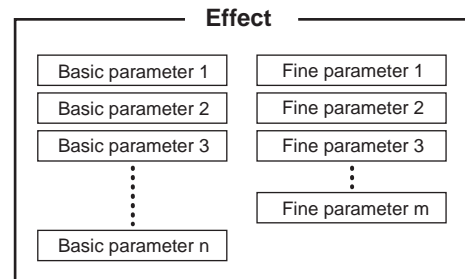

Since some effects have a rather large number of parameters, the parameters that you will probably need to edit most often are grouped as “Basic parameters,” and supplementary parameters are grouped as “Fine parameters.”

The number and type of Basic parameters and Fine parameters will differ for each effect.

Select a parameter

To edit a parameter, you must first select it. The editable parameters will differ for each effect. For details, refer to the explanation of each parameter in the “Effects” section (page 25 and following).

1 Select a Basic parameter or Fine parameter

Press either the [PARAMETER] button (20) or the [FINE PARAM] button (21) to select the type of parameter that you want to edit.

→ The LED of the button you pressed will light.

2 Select a parameter

Use the [BACK] button (16) or [NEXT] button (18) to select the parameter that you want to edit.

→ The currently selected parameter is shown in the display (9).



Selecting Basic parameters

Press the [BACK] button

to move to the preceding parameter.

Press and hold the [BACK] button

to continue moving through the preceding parameters.

Press the [NEXT] button or [PARAMETER] button

to move to the following parameter.

Press and hold the [NEXT] button or [PARAMETER] button

to continue moving through the following parameters.

Selecting FINE parameters

Press the [BACK] button

to move to the preceding parameter.

Press and hold the [BACK] button

to continue moving through the preceding parameters.

Press the [NEXT] button or [FINE PARAM] button

to move to the following parameter.

Press and hold the [NEXT] button or [FINE PARAM] button

to continue moving through the following parameters.

NOTE: If the display indicates “NO FINE PARAMETER,” an effect from the CLASSIC bank is recalled. The effects of the CLASSIC bank do not have Fine parameters. Use the [PARAMETER] button to select the Basic parameters.

Edit the parameter

Use the [▲ INC]/[▼ DEC] button (17) to edit the value of the parameter.

→ The parameter value shown in the display (9) will change, and the [COMPARE] LED (19) will light.

The [COMPARE] LED (19) indicates that the currently-recalled effect has been edited since it was recalled.

[▲ INC] button	Press	to increment the parameter value.
	Hold	to continue incrementing the parameter value.
	Hold down [▲ INC] and press [▼ DEC]	to continue incrementing the parameter value faster.
[▼ DEC] button	Press	to decrement the parameter value.
	Hold	to continue decrementing the parameter value.
	Hold down [▼ DEC] and press [▲ INC]	to continue decrementing the parameter value faster.

Setting the tempo

Some effects have a Tempo parameter. You can edit the Tempo parameter in any of the following five ways.

- **Use the [▲ INC]/[▼ DEC] button (17)**

This is the same method as when editing other parameters.

- **Use the [TAP] button (24)**

When you press the [TAP] button (24) two or more times, the average interval will be calculated and set as the Tempo value. If you want to use this method, set “TEMPO SOURCE” (page 23) to specify “TAP” as the synchronization source.

- **Use the foot switch**

When you press the foot switch (optional) two or more times, the average interval will be calculated and set as the Tempo value. If you want to use this method, use the following procedure.

1. Connect an optional foot switch (e.g., FC5) to the [FOOT SW] jack (25).
2. Set the “TEMPO SOURCE” setting (page 23) to specify “TAP” as the synchronization source.

- **Use MIDI clock**

The interval of MIDI Clock messages can be used to set the Tempo value. If you want to use this method, set “TEMPO SOURCE” (page 23) to specify “MIDI” as the synchronization source.

- **Use MIDI control changes**

The value specified by a MIDI Control Change message can be used to set the Tempo value. By using this method you can control the SPX2000's Tempo value from a connected external MIDI device.

Effects and tempo synchronization

Some of the SPX2000's effects allow you to synchronize the effect with the tempo. There are two such types of effect; delay-type effects and modulation-type effects. For delay-type effects, the delay time will change according to the tempo. For modulation-type effects, the frequency of the modulation signal will change according to the tempo.

• Parameters related to tempo synchronization

The following five parameters are related to tempo synchronization.

1) SYNC 2) NOTE 3) TEMPO 4) DELAY 5) FREQ.

SYNC: This is the on/off switch for tempo synchronization.

NOTE and TEMPO: These are the basic parameters for tempo synchronization.

DELAY and FREQ.: DELAY is the delay time, and FREQ. is the frequency of the modulation signal. These directly affect the way in which the effect sound will change. DELAY is relevant only for delay-type effects, and FREQ. is relevant only for modulation-type effects.

• How the parameters are related

Tempo synchronization uses TEMPO and NOTE to calculate a value that will be the basis for the tempo, and continues making adjustments so that this tempo basis stays essentially the same as the DELAY (or FREQ.). This means that when TEMPO, NOTE, and DELAY (or FREQ.) are synchronized, and you change any of these values, the other parameters will be re-set in order to maintain the correct relationship. The parameters that are re-set and the calculation method^(*) used are as follows.

If you turn SYNC on → NOTE will be set

If you edit DELAY (or FREQ.) → NOTE will be set

In this case, the NOTE value is calculated as follows.

$$\text{NOTE} = \text{DELAY (or FREQ.)} / (4 \times (60/\text{TEMPO}))$$

If you edit NOTE → DELAY (or FREQ.) will be set

In this case, the DELAY (or FREQ.) value is calculated as follows.

$$\text{DELAY (or FREQ.)} = \text{NOTE} \times 4 \times (60/\text{TEMPO})$$

If you edit TEMPO → DELAY (or FREQ.) will be set

In this case, the DELAY (or FREQ.) value is calculated as follows.

$$\text{DELAY (or FREQ.)} = \text{original DELAY (or FREQ.)} \times (\text{previous TEMPO/new TEMPO})$$

Example 1: When SYNC=ON, DELAY=250 ms, TEMPO=120, you change NOTE from 8th note to quarter note

$$\begin{aligned} \text{DELAY} &= \text{new NOTE} \times 4 \times (60/\text{TEMPO}) \\ &= (1/4) \times 4 \times (60/120) \\ &= 0.5 \text{ (sec)} \\ &= 500 \text{ ms} \end{aligned}$$

Thus, the DELAY will change from 250 ms to 500 ms.

Example 2: When SYNC=ON, DELAY=250 ms, NOTE=8th note, you change TEMPO from 120 to 121

$$\begin{aligned} \text{DELAY} &= \text{original DELAY} \times (\text{previous TEMPO/new TEMPO}) \\ &= 250 \times (120/121) \\ &= 247.9 \text{ (ms)} \end{aligned}$$

Thus, the TEMPO will change from 250 ms to 247.9 ms.

^{*)} Rounded values are used for the calculation results.

• Ranges of the NOTE and TEMPO values

The ranges of the NOTE and TEMPO values are limited by the ranges of the DELAY or FREQ. values. You cannot set NOTE or TEMPO values that would cause DELAY or FREQ. to exceed their maximum possible values when synchronized to tempo. This limitation also applies even when SYNC is OFF.

• Special characteristics of the TEMPO parameter















The TEMPO parameter has the following characteristics that are unlike other parameters.

- It is a common value shared by all effects
- It cannot be stored/recalled (the value is not saved)

This means that the TEMPO value may not necessarily be the same when an effect is recalled as when that effect was stored. Here is an example.

Store the effect: TEMPO=120 → Change TEMPO to 60 → Recall the effect: TEMPO=60

Normally when you change the TEMPO, the DELAY (or FREQ.) will be re-set accordingly. However if the DELAY (or FREQ.) were changed, the effect would sound differently when recalled than when it was stored. To prevent the effect from changing in this way between store and recall, the SPX2000 does not update the DELAY (or FREQ.) value when an effect is recalled, even if the TEMPO is no longer the same as when that effect was stored.

 = 1/48	 = 1/24	 = 1/16	 = 1/12	 = 3/32	 = 1/8	 = 1/6
 = 3/16	 = 1/4	 = 3/8	 = 1/2	 = 3/4	 = 1/1	 = 2/1

Check the edited effect

Press the [COMPARE] button (19) to compare the original effect with the edited version.

→ Each time you press this button, the [COMPARE] LED will alternate between lit and blinking. The LED will light if the edited effect is selected, and will blink if the unedited effect is selected.

NOTE: The following buttons are inoperable while the [COMPARE] LED is blinking.

- [▲ INC]/[▼ DEC] buttons (17)
- [UTILITY] buttons (22)
- [TAP] button (24)

Store the effect

Here's how to specify a location in the USER bank and store the edited effect.

1 Select the USER bank

Press the [BANK] button (11) several times to select the USER bank.

→ The [BANK] indicator (11) will indicate "USER."

2 Select a store-destination for the effect

Use the [▲]/[▼] buttons (13) to specify the effect number in which you will store the effect you edited.

→ The effect number indicator (10) shows the currently selected effect number.

3 Store the effect

Press the [STORE] button (12) to store the effect.

→ The [COMPARE] LED (19) will go dark, and the [UNDO] LED (15) will light.

Undoing the previous operation

You can return settings to their prior state by "undoing" the previous Store, Recall, or Clear Effect operation. You can also "undo" the previous "undo" operation; this is called "redo."

Undo

When the [UNDO] LED (15) is lit, press the [UNDO] button to undo the previous Store, Recall, or Clear Effect operation.

→ The [UNDO] LED will blink.

Redo

When the [UNDO] LED (15) is blinking, press the [UNDO] button to cancel the previous Undo operation.

→ The [UNDO] LED will light.

NOTE: Undo/Redo will no longer be available if you switch parameters.

Other functions

Editing the effect name

Here's how to edit the name of the recalled effect. You can edit the name only for effects in the USER bank.

1 Select the USER bank

Use the [BANK] button (Ⓘ) to select the USER bank.

2 Select an effect

Select the effect whose name you want to edit, and recall it (page 12).

3 Select the "TITLE EDIT" function

Press the [UTILITY] button (Ⓔ) several times to select "TITLE EDIT."



4 Edit the effect name

Use the following buttons to edit the effect name.



[BACK] button:

Moves the cursor toward the left.

[NEXT] button:

Moves the cursor toward the right.

[▲ INC] button:

Changes the character at the cursor location (A→B→C).

[▼ DEC] button:

Changes the character at the cursor location (C→B→A).

The effect name can be up to 16 characters long. You can use the following characters.

	!	"	#	\$	%	&	'	()	*	+	,	-	.	/
0	1	2	3	4	5	6	7	8	9	:	;	<	=	>	?
@	A	B	C	D	E	F	G	H	I	J	K	L	M	N	O
P	Q	R	S	T	U	V	W	X	Y	Z	[¥]	^	_
`	a	b	c	d	e	f	g	h	i	j	k	l	m	n	o
p	q	r	s	t	u	v	w	x	y	z					

Protecting an effect

You can switch the Protect setting on/off for the recalled effect. Only effects in the USER bank can be protected. By turning Protect ON for important effects, you can prevent them from being overwritten accidentally.

1 Select the USER bank

Use the [BANK] button (Ⓘ) to select the USER bank.

2 Select an effect

Select the effect whose Protect setting you want to change, and recall it (page 12).

3 Select the "USER PGM PROTECT" function

Press the [UTILITY] button (Ⓔ) several times to select "USER PGM PROTECT."



4 Turn Protect on or off

Use the [▲ INC]/[▼ DEC] buttons (Ⓙ) to turn Protect on/off.



If you turn the setting ON, you will be unable to perform the following operations on that effect.

- Store
- Edit the effect name
- Delete
- Change the background color

If you turn the setting OFF, protect will be defeated and you will again be able to perform Store operations, etc.

Changing the display background color

Here's how to change the background color for the recalled effect. You can change the background color only for USER bank effects.

1 Select the USER bank

Use the [BANK] button (⑪) to select the USER bank.

2 Select an effect

Select the effect whose background color you want to change, and recall it (page 12).

3 Select the "LCD BACK" function

Press the [UTILITY] button (②) several times to select "LCD BACK."



4 Select the display background color

Use the [▲ INC]/[▼ DEC] buttons (⑰) to select the display background color.



You can choose one of the following five colors.

WHITE
CYAN
MAGENTA
YELLOW
GREEN

Selecting the Utility function

Press the [BACK] button

to move to the preceding function.

Press and hold the [BACK] button

to continue moving through the preceding functions.

Press the [NEXT] button or [UTILITY] button

to move to the following function.

Press and hold the [UTILITY] button

to continue moving through the functions.

* For some functions, the [BACK] button and [NEXT] button are used to move the cursor.

Selecting the word clock source

1 Select the "CLOCK SOURCE" function

Press the [UTILITY] button (②) several times to select "CLOCK SOURCE."



2 Select the word clock source

Use the [▲ INC]/[▼ DEC] buttons (⑰) to select the word clock source.



→ The [CLOCK] indicator (⑥) and [kHz] indicator (⑧) will light according to your selection.

NOTE: If the display indicates "WRONG WORD CLOCK!", the word clock signal from the external device has either been interrupted or is a frequency to which the SPX2000 cannot synchronize. Check whether there might be a problem with the connection from the device supplying the word clock, or an incorrect word clock setting.

If this occurs, the word clock source will automatically switch to one of the SPX2000's internal clocks until an acceptable word clock is supplied from the external device.

You can choose one of the following six word clock sources.

- **WORD CLOCK:** Clock data received from the [WORD CLOCK IN] jack (⑳)
- **AES/EBU:** Clock data received from the [AES/EBU IN] jack (㉑)
- **INT44.1kHz:** Internal clock (44.1 kHz)
- **INT48kHz:** Internal clock (48 kHz)
- **INT88.2kHz:** Internal clock (88.2 kHz)
- **INT96kHz:** Internal clock (96 kHz)

NOTES:

- The SPX2000 extracts the sampling frequency from the clock frequency. This means that the word clock frequency = the sampling frequency.
- When INT44.1 kHz–INT 96 kHz is selected, noise may occur or the output may be muted if the word clock and the input signal cannot be synchronized correctly

About word clock

The signal used to synchronize digital audio signal processing is called “word clock.”

When two or more digital devices are connected in order to send and receive digital audio signals, each digital device must process the signal at the same timing. Even if all connected devices are set to the same clock frequency, the signals will not be transmitted and received correctly if the processing timing does not match, or you may hear noise.

In order for digital audio signals to be synchronized, one digital device must transmit the clock (synchronization data), and the other devices must be set to receive this clock. In such a setup, the device that supplies the synchronization reference clock is called the “CLOCK MASTER,” and the receiving devices are called “CLOCK SLAVES.”

To use the SPX2000 as the clock master, set the “CLOCK SOURCE” function (page 18) to either INT96kHz, INT88.2kHz, INT48kHz, or INT44.1.

To use the SPX2000 as a clock slave, use either of the following two methods.

- ① Set the “CLOCK SOURCE” function (page 18) to AES/EBU, and connect the AES/EBU format compatible device supplying the clock data to the [AES/EBU IN] jack (34).
- ② Set the “CLOCK SOURCE” function (page 18) to WORD CLOCK, and connect the device supplying the clock to the [WORD CLOCK IN] jack (32). When doing so, the device supplying the clock must be connected one-to-one with the SPX2000.

Selecting the input source

Here’s how to select either the signal from the [INPUT] jacks (37) or the signal from the [AES/EBU IN] jack (34) as the input source.

1 Select the “INPUT SOURCE” function

Press the [UTILITY] button (22) several times to select “INPUT SOURCE.”



2 Select the input source

Press the [▲ INC] button (17) to select DIGITAL ([AES/EBU IN] jack), or press the [▼ DEC] button (17) to select ANALOG ([INPUT] jacks).



→ The [INPUT SOURCE] indicator (5) indicates your selection.

NOTE: If the display indicates “Sync Error!” or if the DIGITAL [INPUT SOURCE] indicator blinks, the incoming digital input signal does not match the clock on which the SPX2000 is operating.
Try changing the setting of the device that is supplying the word clock.

Restricting operation of the SPX2000

To prevent undesired changes from being made accidentally, you can selectively disable certain operations.

1 Select the “OPERATION LOCK” function

Press the [UTILITY] button (22) several times to select “OPERATION LOCK.”



2 Select the operation lock level

Use the [▲ INC]/[▼ DEC] buttons (17) to select the operation lock level.



Level 1: Utility functions other than Operation Lock will be disabled

Level 2: In addition to Level 1, effect store and undoing of store operations will be disabled

Level 3: In addition to Level 2, effect recall and editing will be disabled

NOTE: If you attempt to use the front panel buttons to perform an operation that has been disabled by Operation Lock, a message of "Operation Locked!" will appear in the display. However, this message will not appear if such an operation is attempted by remote control.

The following table shows the operations that are disabled for each level.

O: Operable X: Inoperable

OPERATION LOCK		OFF	1	2	3
Button operations or equivalent remote control					
[INPUT MODE] button (③)		O	O	O	X
[METER] button (④)		O	O	O	O
[BANK] button (⑪)		O	O	O	X
[STORE] button (⑫)		O	O	X	X
[▲]/[▼] buttons (⑬)		O	O	O	X
[RECALL] button (⑭)		O	O	O	X
[UNDO] button (⑮)	Undo of Store operations	O	O	X	X
	Undo of Recall operations	O	O	O	X
[BACK] button (⑯)/ [NEXT] button (⑰)		O	O	O	O
[▲ INC]/ [▼ DEC] buttons (⑰)	Editing of Basic parameters and Fine parameters	O	O	O	X
	Editing of Utility settings	O	X*1	X*1	X*1
[PARAMETER] button (⑳)		O	O	O	O
[FINE PARAM] button (㉑)		O	O	O	O
[UTILITY] button (㉒)		O	O*2	O*2	O*2
[COMPARE] button (㉓)		O	O	O	X
[BYPASS] button (㉔)		O	O	O	X
[TAP] button (㉕)/foot switch		O	O	O	X
[POWER ON/OFF] button (㉖)		O	O	O	O
MIDI	Note on/off (Start/stop recording or playback for Freeze)	O	O	O	O

*1 Only the Operation Lock level can be changed.

*2 If the Operation Lock level is 1 or higher, Utility functions other than Operation Lock cannot be selected.

Erasing an effect

Here's how to erase (clear) the recalled effect. You can only erase USER bank effects.

You cannot erase the effects in the PRESET bank or CLASSIC bank.

1 Select the USER bank

Use the [BANK] button (⑪) to select the USER bank.

2 Select an effect

Select the effect that you want to erase (page 12).

3 Select the "U## CLEAR?" function

Press the [UTILITY] button (㉒) several times to select "U## CLEAR?" (## will be an effect number).



4 Erase the effect

Press the [▲ INC] button (⑰) to erase the recalled effect.

→ When the effect has been erased, the display will indicate "Completed!"

NOTES:

- The effect will be erased when you press the [▲ INC] button. After the effect has been erased, you can use the [UNDO] button (⑮) to recover the erased effect.
- If the display indicates "This Program is Protected!", the protect setting has been turned on for that effect. Turn off the protect setting, and then erase the effect (page 17).

Selecting the port for MIDI transmission/reception

The SPX2000 uses two ports to transmit and receive MIDI data.

One port (“MIDI PORT GENERAL”) is used to transmit and receive conventional MIDI data, and the other port (“MIDI PORT EDITOR”) is used for communication between the SPX2000 and the SPX2000 Editor. You cannot use the same setting for both ports. A port you selected for one setting will not appear as a selection for the other setting.

1 Select either the “MIDI PORT GENERAL” function or the “MIDI PORT EDITOR” function

Press the [UTILITY] button (22) several times to select either “MIDI PORT GENERAL” or “MIDI PORT EDITOR.”



2 Select the port you will use for MIDI transmission and reception

Use the [▲ INC]/[▼ DEC] buttons (17) to select a port.

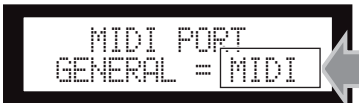

“MIDI PORT GENERAL” setting

You can select one of nine ports: MIDI (the [MIDI IN] (30) and [MIDI OUT/THRU] (29) connectors), or USB 1–USB 8 (ports 1–8^(*) of the [TO HOST USB] connector (31)). If you select OFF, it will not be possible to transmit or receive MIDI data.

“MIDI PORT EDITOR” setting

You can select one of eight ports: USB 1–USB 8 (ports 1–8^(*) of the [TO HOST USB] connector (31)).

If you select OFF, it will not be possible to transmit or receive MIDI data.

(*) The [TO HOST USB] connector lets you use eight separate ports on this single connector.

NOTE: In order to connect the SPX2000 to your computer via USB, you will need to install the Yamaha USB-MIDI driver on your computer.

You can download the Yamaha USB-MIDI driver from the following website.

Yamaha Pro Audio website:

<http://www.yamahaproaudio.com/>

NOTE: If the display indicates “MIDI OUT is NOT Selected!” and you are unable to select the port, the [MIDI OUT/THRU] connector (29) is set to “THRU.”

In order to select a port, you must first set the “MIDI OUT SETUP” parameter so that the [MIDI OUT/THRU] connector is set to “OUT.”

Switching MIDI OUT/THRU

You can use the [MIDI OUT/THRU] connector (29) as either MIDI OUT or MIDI THRU.

1 Select the “MIDI OUT SETUP” function

Press the [UTILITY] button (22) several times to select “MIDI OUT SETUP.”



2 Select either “MIDI OUT” or “MIDI THRU”

Press either the [▲ INC] button (17) to select “MIDI THRU” or the [▼ DEC] button (17) to select “MIDI OUT.”



- **MIDI THRU:**

MIDI data entering the [MIDI IN] connector (30) will be retransmitted without change. With this setting, MIDI data from the SPX2000 itself cannot be transmitted.

- **MIDI OUT:**

Internal data of the SPX2000 can be bulk-dumped, or data can be transmitted in response to a request received from an external device.

Selecting the MIDI transmission/reception channel

Here’s how to select the channel that will be used to transmit/receive MIDI data on the port you chose for the “MIDI PORT GENERAL” setting (page 21).

1 Select the “MIDI CHANNEL” function

Press the [UTILITY] button (22) several times to select “MIDI CHANNEL.”



2 Select the channel

Use the [▲ INC]/[▼ DEC] buttons (17) to select the channel used for MIDI transmission/reception.

You can choose one of 17 choices: CH1—CH16 (channels 1—16) or OMNI (all channels).



Selecting the ID number for use with the SPX2000 Editor

You can select an ID number that will identify the SPX2000 Editor. In order to allow communication with the SPX2000 Editor, you must set this to the same ID number as you specified in the SPX2000 Editor.

1 Select the "EDITOR ID" function

Press the [UTILITY] button (2) several times to select "EDITOR ID."



2 Specify the ID number for use with the SPX2000 Editor

Use the [▲ INC]/[▼ DEC] buttons (17) to specify the ID number for identifying the SPX2000 Editor. You can select an ID number in the range of 1—8.



Editing the MIDI program change table

You can create a MIDI program change table to specify the effect that will be recalled when the SPX2000 receives a program change message.

The SPX2000 provides three tables (A—C), and each table lets you make 128 effect assignments (a total of 384 assignments).

1 Select the "MIDI PGM CHANGE" function

Press the [UTILITY] button (2) several times to select "MIDI PGM CHANGE."



Cursor

2 Edit the MIDI program change table

Use the following buttons to select the Table (TBL A—C), Program Change Number (PGM1—128), and Effect (---, P01—U99^(*)).



Table Effect
Program Change Number

[BACK] button:

Moves the cursor toward the left.

[NEXT] button:

Moves the cursor toward the right.

[▲ INC] button:

Changes the character at the cursor location (e.g., A→B→C, 1→2→3).

[▼ DEC] button:

Changes the character at the cursor location (e.g., C→B→A, 3→2→1).

NOTE: If you specify "---" as the effect, no effect will be recalled when the SPX2000 receives that program change message. For example, suppose that you made the following settings in Table A:

TABLE A: PGM107=P02

TABLE A: PGM108=---

TABLE A: PGM109=U05

When the SPX2000 receives the Table A:107 or 109 program change messages, it will recall the corresponding effect. However, nothing will be recalled when the Table A:108 message is received.

(*) This abbreviation indicates the bank and effect number; e.g., P01 is effect number 01 of the PRESET bank, C10 is effect number 10 of the CLASSIC bank, and U05 is effect number 5 of the USER bank.

Transmitting SPX2000 data to another device

You can transmit the SPX2000's system settings, MIDI program change tables, and effect data to another device. This data will be transmitted from the port specified by the "MIDI PORT GENERAL" setting (page 21).

1 Select the "BULK OUT (ALL)" function

Press the [UTILITY] button (22) several times to select "BULK OUT (ALL)."



2 Start transmission

Press the [▲ INC] button (17) to start transmission.

While the data is being transmitted, the display will indicate "Transmitting..."

When transmission is completed, the display will indicate "Completed!" for approximately one second.

NOTE: The INPUT MODE and METER settings are not included with the transmitted data.

Selecting the tempo synchronization source

1 Select the "TEMPO SOURCE" function

Press the [UTILITY] button (22) several times to select "TEMPO SOURCE."



2 Select the tempo synchronization source

Use the [▲ INC]/[▼ DEC] buttons (17) to select the tempo synchronization source.



You can select one of the following three sources for tempo synchronization.

- **TEMPO VALUE ONLY:**
The TEMPO value specified using the [▲ INC]/[▼ DEC] buttons
- **MIDI CLOCK:**
MIDI Clock messages from the device connected to the [MIDI IN] connector (30) or [TO HOST USB] connector (31)
- **TAP:**
The TEMPO value specified using the [TAP] button (24), [FOOT SW] jack (25), or [▲ INC]/[▼ DEC] buttons

Enabling/disabling MIDI message reception

You can individually enable/disable reception for some types of MIDI message. Reception can be enabled/disabled for the following MIDI messages.

- NOTE ON/OFF (Note on/off)
- PGM CHANGE (Program change)
- CTL CHANGE (Control change)
- SYSEX BLKDMP (Bulk dump)
- SYSEX PRMCHG (Parameter change)

1 Select the "MIDI RECEIVE" function

Press the [UTILITY] button (22) several times to select "MIDI RECEIVE."



2 Select a type of MIDI message

Use the [BACK] button (16)/[NEXT] button (18) to select the type of MIDI message for which you want to enable/disable reception.



3 Enable or disable MIDI message reception

Press the [▲ INC] button (17) to select ON (enable), or press the [▼ DEC] button (17) to select OFF (disable).



Initializing the SPX2000

Here's how to return the SPX2000 to its factory-set condition.



The following procedure will erase all effects in the USER bank. If necessary, use the "BULK OUT (ALL)" function to back up your data before you proceed.

1 Turn off the power

If the SPX2000 is powered-on, turn the power off.

2 Prepare for initialization

While holding down the [STORE] button (⓫), turn on the power.

→ The following screen will appear.



3 Initialize

Press the [▲ INC] button (⓬) to initialize the SPX2000.

If you decide not to initialize, press any button other than [▲ INC].

Effects

PRESET bank

No.	Effect name	Type	Page	Category	Display background color		
1	REV-X LARGE HALL	REV-X	27	HALL	CYAN		
2	REV-X MED HALL						
3	REV-X SMALL HALL						
4	REV-X TINY HALL						
5	REV-X WARM HALL						
6	REV-X BRITE HALL						
7	REV-X HUGE HALL						
8	AMBIENCE	Reverb	31	HALL	CYAN		
9	STEREO HALL	Stereo reverb	30				
10	VOCAL CHAMBER						
11	BRIGHT HALL	Reverb	31				
12	BREATHY REVERB						
13	CONCERT HALL						
14	REVERB FLANGE	Composite effect	69			PLATE	CYAN
15	REVERB STAGE	Reverb	31				
16	REV-X VOCAL PLT	REV-X	27				
17	REV-X BRIGHT PLT						
18	REV-X SNARE PLT						
19	VOCAL PLATE	Reverb	31				
20	ECHO ROOM 1						
21	ECHO ROOM 2						
22	PRESENCE REVERB						
23	ARENA						
24	THIN PLATE			Stereo reverb	30		
25	OLD PLATE			Reverb	31		
26	DARK PLATE						
27	REV-X CHAMBER	REV-X	27	ROOM	CYAN		
28	REV-X WOOD ROOM						
29	REV-X WARM ROOM						
30	REV-X LARGE ROOM						
31	REV-X MED ROOM						
32	REV-X SMALL ROOM						
33	REV-X SLAP ROOM						
34	FAT REFLECTIONS					Early Reflection	35
35	BIG SNARE					Gate reverb	
36	BAMBOO ROOM					Reverb	31
37	REFLECTIONS	Early Reflection	35				
38	STONE ROOM	Reverb	31				
39	CONCRETE ROOM	Gate reverb	35				
40	REVERSE PURPLE						
41	FULL METAL GATE						
42	REVERSE GATE	Reverse gate	30	DRUM MACHINE REVERBS	CYAN		
43	DRUM MACH. AMB S	Stereo reverb					
44	DRUM MACH. AMB L	Reverb					
45	ELECT.SNR PLATE	Reverse gate	35	DELAYS	WHITE		
46	MONO DELAY	Mono delay	38				
47	120 BPM MONO DDL						
48	120 BPM X-DDL	Echo	44				
49	STEREO DELAY	Stereo delay	40				
50	DELAY L,C,R	Delay L,C,R	43				
51	KARAOKE ECHO	Echo	44				
52	GOOD OL P.CHANGE	Dual pitch	62	PITCH EFFECTS	MAGENTA		
53	VOCAL SHIFT						
54	STEREO PITCH						
55	PITCH SLAP						
56	HALO COMB						
57	GRUMPY FLUTTER						
58	ROGER ON THE 12					High quality pitch	61
59	BOTTOM WHACKER					Dual pitch	62
60	VOICE DOUBLER						

No.	Effect name	Type	Page	Category	Display background color						
61	SYMPHONIC	Symphonic	52	MODULATION	MAGENTA						
62	REV+SYMPHONIC	Composite effect	71								
63	DETUNE CHORUS	Chorus	51								
64	CHORUS & REVERB	Composite effect	68								
65	BASS CHORUS	Dual pitch	62								
66	STEREO PHASING	Modulation delay	41								
67	CLASSY GLASSY	Chorus	51								
68	SILKY SWEEP	Modulation delay	41								
69	UP DOWN FLANGE	Flanger	47								
70	TREMOLO	Tremolo	53								
71	ROTARY SPEAKER	Rotary Speaker	85								
72	AUTO PAN	Auto pan	55								
73	PHASER	Phaser	49								
74	RING MODULATION	Ring modulator	57								
75	MOD FILTER	Modulation filter	56								
76	DYNA FLANGE	Dynamic flanger	59								
77	DYNA PHASER	Dynamic phaser	60								
78	DYNA FILTER	Dynamic filter	58								
79	M. BAND DYNA	Multi-band dynamics processor	83	FILTER	YELLOW						
80	MULTI FILTER	Multi-filter	82								
81	FILTERED VOICE	Multi-band dynamics processor	83								
82	DISTORTION	Distortion	86	DISTORTION		YELLOW					
83	AMP SIMULATOR	Amp simulator	87								
84	DIST->FLANGE	Composite effect	66	MULTIPLE			YELLOW				
85	DIST->DELAY										
86	REV->CHORUS		68								
87	REV+FLANGE		69								
88	REV->SYMPHONIC		71								
89	REV->PAN		72								
90	DELAY+ER 1		73					MULTIPLE	YELLOW		
91	DELAY+ER 2										
92	DELAY->ER 1										
93	DELAY->ER 2										
94	DELAY+REV	75	MULTIPLE	YELLOW							
95	DELAY->REV										
96	RESO DRONE										
97	FREEZE	Freeze			77					SAMPLING	YELLOW

CLASSIC bank

No.	Effect name	Type	Page	Display background color										
1	REV 1 HALL	Reverb	29	GREEN										
2	REV 2 ROOM													
3	REV 3 VOCAL													
4	REV 4 PLATE													
5	EARLY REF 1	Early reflection	37		GREEN									
6	EARLY REF 2													
7	DELAY L,R	Delay L,R	46			GREEN								
8	STEREO ECHO	Stereo echo												
9	STEREO FLANGE A	Stereo flanger	50				GREEN							
10	STEREO FLANGE B													
11	CHORUS A	Chorus	54					GREEN						
12	CHORUS B													
13	STEREO PHASING	Stereo phasing	50						GREEN					
14	TREMOLO	Tremolo	54											
15	SYMPHONIC	Symphonic	54							GREEN				
16	GATE REVERB	Gate reverb	37								GREEN			
17	REVERSE GATE	Reverse gate												
18	REVERB & GATE	Reverb & gate	33									GREEN		
19	PITCH CHANGE A	Pitch change A, D	64										GREEN	
20	PITCH CHANGE B	Pitch change B	65											
21	PITCH CHANGE C	Pitch change C	65											
22	PITCH CHANGE D	Pitch change A, D	64											
23	FREEZE A	Freeze A	78											GREEN
24	FREEZE B	Freeze B	79											
25	PAN	Pan	56											

Reverb

These effects add reverberation. Reverberation varies in a complex way according to factors such as the size of the room and the material of the walls. You can use this type of effect to simulate these changes, producing a wide range of reverberation. Reverberation can be divided into two categories of sound; early reflections and the subsequent reverberation. Early reflections are the sounds that reach your ear after being reflected only once from the walls or ceiling. The subsequent reverberation is the “wash” of sound that reaches your ear after reflecting multiple times from the walls and ceiling. The SPX2000 provides two types of reverb; those that allow you to independently control the early reflections and the reverberation, and those that control these two as a single unit.

The SPX2000 also provides gated reverbs. These effects pass the signal through a gate so that reverb is added only while the gate is open. One way to use these effects is to add only reverb that exceeds a specified level, and close the gate to cut the slowly decaying reverberation.

The differences between the various types of reverb are as follows.

Type	Bank	No. of INs/OUTs	Early reflections and subsequent reverberation	Gated	Controllable envelope	Page
REV-X	PRESET	2IN/2OUT	Unified	No	Yes	27
Reverb	CLASSIC	1IN/2OUT				29
Stereo reverb	PRESET	2IN/2OUT	Separate	Yes	No	30
Reverb		1IN/2OUT				31
Reverb & Gate	CLASSIC		Unified			33

REV-X (PRESET bank)

These are reverbs that use a new algorithm. You can modify the envelope of the reverberation.

Each aspect of the sound is controlled by the following effect parameters.

Reverberation:

REV TIME, HI.RATIO, LO.RATIO, INI.DLY, DIFF., LO.FREQ., DECAY

Overall effect sound: ROOMSIZE

Filter/equalizer: HPF, LPF

Output level: OUT LVL, MIX BAL.

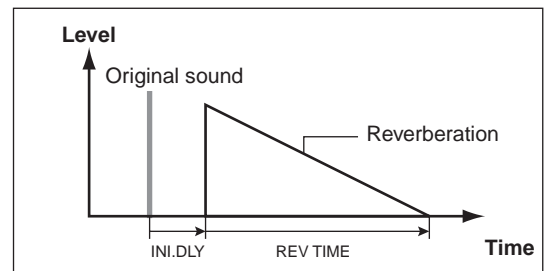

Reverb

Parameter details

■ Basic parameters

Parameter name	Range	Explanation
REV TIME	0.10–46.92s	Time over which the reverberation will decay and disappear.
HI.RATIO	0.1–1.0	Length of the high-frequency or low-frequency reverberation. These times are specified as a proportion of the REV TIME. If this value is set to 1.0, the length will be the same as REV TIME. You can use these values to simulate the absorptiveness of the walls and ceiling. HI.RATIO indicates the decay of the high-frequency range, and LO.RATIO indicates the decay of the low-frequency range.
LO.RATIO	0.1–1.4	
INI.DLY	0.0–125.0 ms	Delay of the reflections relative to the original sound.
DIFF.	0–10	Density and left/right diffusion of the reverberation. Increasing this value will increase the density, and produce a stronger sense of spaciousness.
ROOMSIZE	0–28	Size of the reverberant space. Increasing this value simulates a larger space. You can use this to simulate the absorptiveness of the walls and ceiling. Changing this value will change the REV TIME value.

■ Fine parameters

Parameter name	Range	Explanation
MIX BAL.	0—100%	Balance between the original sound and effect sound. At a setting of 0% only the original sound will be output; at a setting of 100% only the effect sound will be output.
OUT LVL	0—100%	Output level after the original sound and effect sound have been mixed. Decrease this value if you want to lower the output. At a setting of 0% there will be no output.
HPF	Thru, 22.0 Hz—8.00 kHz	A filter that cuts the low-frequency portion of the effect. Frequency components lower than the frequency specified here will be cut. With a setting of Thru this filter will do nothing. This filter does not affect the original sound.
LPF	1.00—18.0 kHz, Thru	A filter that cuts the high-frequency portion of the effect. Frequency components above the frequency specified here will be cut. With a setting of Thru this filter will do nothing. This filter does not affect the original sound.
LO.FREQ.	22.0 Hz—18.0 kHz	The frequency that will be the basis for the LO.RATIO (Basic parameter). Frequencies lower than the value specified here will be affected by LO.RATIO.
DECAY	0—53	Shapes the envelope of the reverberation. This changes the way in which the reverberation decays.

Effect list

The following table shows the default parameter values for the effects belonging to the REV-X type (PRESET bank).

■ Basic parameters

NO.	Effect name	REV TIME	HI.RATIO	LO.RATIO	INI.DLY	DIFF.	ROOMSIZE
1	REV-X LARGE HALL	2.70 s	0.6	1.2	20.0 ms	10	28
2	REV-X MED HALL	2.01 s	0.6	1.2	15.0 ms	10	25
3	REV-X SMALL HALL	1.40 s	0.6	1.2	9.0 ms	9	23
4	REV-X TINY HALL	0.75 s	0.6	1.2	5.0 ms	7	22
5	REV-X WARM HALL	2.70 s	0.6	1.2	32.0 ms	10	28
6	REV-X BRITE HALL	2.79 s	0.7	1.2	25.0 ms	10	28
7	REV-X HUGE HALL	6.98 s	0.9	1.1	0.1 ms	10	28
16	REV-X VOCAL PLT	2.44 s	0.3	1.1	30.0 ms	10	18
17	REV-X BRIGHT PLT	2.44 s	0.5	1.0	30.0 ms	10	18
18	REV-X SNARE PLT	2.22 s	0.3	1.1	0.0 ms	10	18
27	REV-X CHAMBER	1.04 s	0.6	0.9	0.0 ms	10	20
28	REV-X WOOD ROOM	1.66 s	0.8	0.7	0.0 ms	10	24
29	REV-X WARM ROOM	0.70 s	0.4	1.0	5.0 ms	9	19
30	REV-X LARGE ROOM	1.66 s	0.8	0.9	0.0 ms	9	22
31	REV-X MED ROOM	1.04 s	0.7	0.9	0.0 ms	9	20
32	REV-X SMALL ROOM	0.68 s	0.7	0.8	0.0 ms	9	18
33	REV-X SLAP ROOM	1.33 s	0.5	0.9	100.0 ms	9	22

■ Fine parameters

NO.	Effect name	MIX BAL.	OUT LVL	HPF	LPF	LO.FREQ.	DECAY
1	REV-X LARGE HALL	100%	80%	Thru	5.60 kHz	800 Hz	50
2	REV-X MED HALL	100%	90%	Thru	5.00 kHz	800 Hz	47
3	REV-X SMALL HALL	100%	100%	Thru	5.60 kHz	800 Hz	10
4	REV-X TINY HALL	100%	100%	Thru	5.60 kHz	800 Hz	8
5	REV-X WARM HALL	100%	80%	Thru	3.20 kHz	800 Hz	50
6	REV-X BRITE HALL	100%	70%	Thru	Thru	800 Hz	53
7	REV-X HUGE HALL	100%	100%	160 Hz	2.80 kHz	800 Hz	53
16	REV-X VOCAL PLT	100%	80%	140 Hz	6.30 kHz	800 Hz	25
17	REV-X BRIGHT PLT	100%	75%	180 Hz	8.00 kHz	800 Hz	25
18	REV-X SNARE PLT	100%	80%	125 Hz	7.00 kHz	800 Hz	25
27	REV-X CHAMBER	100%	100%	80.0 Hz	Thru	800 Hz	10
28	REV-X WOOD ROOM	100%	100%	56.0 Hz	8.00 kHz	800 Hz	30
29	REV-X WARM ROOM	100%	100%	Thru	6.30 kHz	800 Hz	12
30	REV-X LARGE ROOM	100%	100%	80.0 Hz	10.0 kHz	800 Hz	53
31	REV-X MED ROOM	100%	100%	Thru	10.0 kHz	800 Hz	35
32	REV-X SMALL ROOM	100%	100%	Thru	10.0 kHz	800 Hz	20
33	REV-X SLAP ROOM	100%	100%	Thru	5.60 kHz	800 Hz	26

Reverb (CLASSIC bank)

These reverbs are based on effects of earlier models in the SPX series. There is no distinction between early reflections and subsequent reverberation.

Each aspect of the sound is controlled by the following effect parameters.

Reverberation: REV TIME, HI.RATIO, DELAY

Filter/equalizer: HPF, LPF

Output level: OUT LVL, MIX BAL.

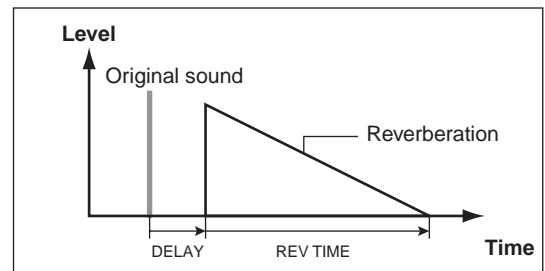

Parameter details

■ Basic parameters

Parameter name	Range	Explanation
REV TIME	0.3—99.0 s	Reverb time. This is expressed as the time over which reverberation at 1 kHz will decay by 60 dB.
HI.RATIO	0.1—1.0	Reverb time for the high-frequency range, expressed as a proportion of REV TIME. If this value is 0.1 the time will be 1/10th the REV TIME; if it is 1.0 the time will be the same as the REV TIME. You can adjust these values to simulate the absorptiveness of the walls or ceiling. HI.RATIO is the decay of the high-frequency range.
DELAY	0.0—500.0 ms	Delay of the reverberation relative to the original sound.
HPF	THRU, 32 Hz—1.0 kHz	A filter that cuts the low-frequency portion of the effect. Frequency components lower than the frequency specified here will be cut. With a setting of THRU this filter will do nothing. This filter does not affect the original sound.
LPF	1.0—11 kHz, THRU	A filter that cuts the high-frequency portion of the effect. Frequency components above the frequency specified here will be cut. With a setting of THRU this filter will do nothing. This filter does not affect the original sound.
OUT LVL	0—100%	Output level after the original sound and effect sound have been mixed. Decrease this value if you want to lower the output. At a setting of 0% there will be no output.
MIX BAL.	0—100%	Balance between the original sound and effect sound. At a setting of 0% only the original sound will be output; at a setting of 100% only the effect sound will be output.

Effect list

The following table show the default parameter values for the effects belonging to the Reverb type (CLASSIC bank).

NO.	Effect name	REV TIME	HI.RATIO	DELAY	HPF	LPF	OUT LVL	MIX BAL.
1	REV 1 HALL	2.6 s	0.2	0.0 ms	50 Hz	7.0 kHz	90%	100%
2	REV 2 ROOM	1.5 s	0.2	4.0 ms	90 Hz	8.0 kHz	90%	100%
3	REV 3 VOCAL	2.5 s	0.2	25.0 ms	90 Hz	8.0 kHz	100%	100%
4	REV 4 PLATE	1.8 s	0.2	10.0 ms	56 Hz	8.0 kHz	90%	100%

Stereo Reverb (PRESET bank)

These are stereo reverbs; they allow two-channel input. Each aspect of the sound is controlled by the following effect parameters.

Early reflections: INI.DLY

Reverberation: REV TIME, HI.RATIO, LO.RATIO, DIFF., DENSITY

Overall effect sound: REV TYPE, E/R BAL.

Filter/equalizer: HPF, LPF

Output level: OUT LVL, MIX BAL.

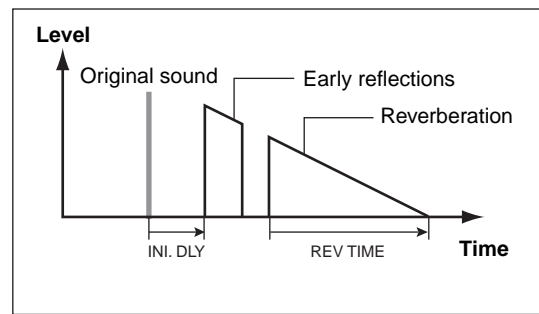

Parameter details

Basic parameters

Parameter name	Range	Explanation
REV TYPE	Hall, Room, Stage, Plate	The pattern of reverb; this determines the basic character of the effect. The characteristics of the reverberation will depend on the type you select here.
REV TIME	0.3—99.0 s	Reverb time. This is expressed as the time over which reverberation at 1 kHz will decay by 60 dB.
HI.RATIO	0.1—1.0	Reverb time for the high-frequency range or low-frequency range, expressed as a proportion of REV TIME. If this value is 0.1 the time will be 1/10th the REV TIME; if it is 1.0 the time will be the same as the REV TIME. You can adjust these values to simulate the absorptiveness of the walls or ceiling. HI.RATIO is the decay of the high-frequency range, and LO.RATIO is the decay of the low-frequency range.
LO.RATIO	0.1—2.4	
INI.DLY	0.0—100.0 ms	Delay of the early reflections relative to the original sound. This also affects the delay until the reverberation is heard.
DIFF.	0—10	Diffusion of the sound to left and right. Increasing this value will make the reverberation more spaciousness.
DENSITY	0—100%	Density of the reverberation. Increasing this value will make the reverberation smoother. You can create unique effects by lowering this value.

Fine parameters

Parameter name	Range	Explanation
MIX BAL.	0—100%	Balance between the original sound and effect sound. At a setting of 0% only the original sound will be output; at a setting of 100% only the effect sound will be output.
OUT LVL	0—100%	Output level after the original sound and effect sound have been mixed. Decrease this value if you want to lower the output. At a setting of 0% there will be no output.
E/R BAL.	0—100%	Balance of the early reflections and subsequent reverberation. At a setting of 100% only the early reflections will be output; at a setting of 0% only the reverberation will be output.
HPF	Thru, 21.2 Hz—8.00 kHz	A filter that cuts the low-frequency portion of the effect. Frequency components lower than the frequency specified here will be cut. With a setting of Thru this filter will do nothing. This filter does not affect the original sound.
LPF	50.0 Hz—16.0 kHz, Thru	A filter that cuts the high-frequency portion of the effect. Frequency components above the frequency specified here will be cut. With a setting of Thru this filter will do nothing. This filter does not affect the original sound.

Effect list

The following tables show the default parameter values for the effects belonging to the Stereo Reverb type (PRESET bank).

Basic parameters

NO.	Effect name	REV TYPE	REV TIME	HI.RATIO	LO.RATIO	INI.DLY	DIFF.	DENSITY
9	STEREO HALL	Stage	2.2 s	0.3	1.1	15.5 ms	3	80%
10	VOCAL CHAMBER	Stage	1.9 s	0.3	1.1	49.8 ms	3	94%
24	THIN PLATE	Room	1.8 s	0.5	1.0	44.5 ms	3	96%
43	DRUM MACH. AMB S	Room	1.2 s	0.3	0.8	9.1 ms	1	80%

Fine parameters

NO.	Effect name	MIX BAL.	OUT LVL	E/R BAL.	HPF	LPF
9	STEREO HALL	100%	100%	45%	Thru	9.50 kHz
10	VOCAL CHAMBER	100%	85%	30%	Thru	7.50 kHz
24	THIN PLATE	100%	100%	54%	50.0 Hz	10.6 kHz
43	DRUM MACH. AMB S	100%	100%	70%	Thru	8.00 kHz

Reverb (PRESET bank)

These are gated reverbs. The early reflections and subsequent reverberation can be controlled separately. By using the gate you can cause only a portion of the reverberation to be heard. Each aspect of the sound is controlled by the following effect parameters.

Early reflections: INI.DLY

Reverberation:

REV TIME, HI.RATIO, LO.RATIO, DIFF., DENSITY, E/R DLY

Gating: GATE LVL, ATTACK, HOLD, DECAY

Overall effect sound: E/R BAL.

Filter/equalizer: HPF, LPF

Output level: OUT LVL, MIX BAL.

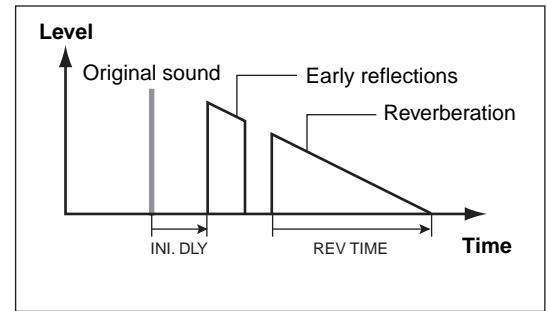

Parameter details

Basic parameters

Parameter name	Range	Explanation
REV TIME	0.3—99.0 s	Reverb time. This is expressed as the time over which reverberation at 1 kHz will decay by 60 dB.
HI.RATIO	0.1—1.0	Reverb time for the high-frequency range or low-frequency range, expressed as a proportion of REV TIME. If this value is 0.1 the time will be 1/10th the REV TIME; if it is 1.0 the time will be the same as the REV TIME. You can adjust these values to simulate the absorptiveness of the walls or ceiling. HI.RATIO is the decay of the high-frequency range, and LO.RATIO is the decay of the low-frequency range.
LO.RATIO	0.1—2.4	
INI.DLY	0.0—500.0 ms	Delay of the early reflections relative to the original sound. This also affects the delay until the reverberation is heard.
DIFF.	0—10	Diffusion of the sound to left and right. Increasing this value will make the reverberation more spaciousness.
DENSITY	0—100%	Density of the reverberation. Increasing this value will make the reverberation smoother. You can create unique effects by lowering this value.

Fine parameters

Parameter name	Range	Explanation
MIX BAL.	0—100%	Balance between the original sound and effect sound. At a setting of 0% only the original sound will be output; at a setting of 100% only the effect sound will be output.
OUT LVL	0—100%	Output level after the original sound and effect sound have been mixed. Decrease this value if you want to lower the output. At a setting of 0% there will be no output.
E/R DLY	0.0—100.0 ms	Delay of the subsequent reverberation relative to the early reflections. The delay from the original sound until the beginning of the subsequent reverberation will be INI.DLY + E/R DLY.
E/R BAL.	0—100%	Balance of the early reflections and subsequent reverberation. At a setting of 100% only the early reflections will be output; at a setting of 0% only the reverberation will be output.
HPF	Thru, 21.2 Hz—8.00 kHz	A filter that cuts the low-frequency portion of the effect. Frequency components lower than the frequency specified here will be cut. With a setting of Thru this filter will do nothing. This filter does not affect the original sound.
LPF	50.0 Hz—16.0 kHz, Thru	A filter that cuts the high-frequency portion of the effect. Frequency components above the frequency specified here will be cut. With a setting of Thru this filter will do nothing. This filter does not affect the original sound.
GATE LVL	OFF, -60—0 dB	The level at which the gate is triggered. The gate will begin opening when the level of the original sound exceeds this value, and will remain open as long as the level remains above this value.
ATTACK	0—120 ms	The attack time of the gate. This is the time from when the gate begins to open until it is completely open. Higher settings of this value will make the gate open more slowly; i.e., the volume that passes through the gate will rise more slowly. With a setting of 0 ms, the gate will open completely the moment the original sound reaches the GATE LVL.
HOLD ^{*a}	44.1 kHz: 0.02 ms—2.13 s 48 kHz: 0.02 ms—1.96 s 88.2 kHz: 0.01 ms—1.06 s 96 kHz: 0.01—981 ms	The minimum time that the gate remains open. Even when the original sound falls below the GATE LVL, the gate will remain open for the time specified by this value.
DECAY ^{*a}	44.1 kHz: 6 ms—46.0 s 48 kHz: 5 ms—42.3 s 88.2 kHz: 3 ms—23.0 s 96 kHz: 3 ms—21.1 s	The decay time of the gate. This is the time from when the gate begins to close until it is completely closed. Higher settings of this value will make the gate close more slowly; i.e., the volume that passes through the gate will decrease more slowly.

*a. The range of this parameter depends on the sampling frequency at which the SPX2000 is operating.

Effect list

The following tables show the default parameter values for the effects belonging to the Reverb type (PRESET bank).

■ Basic parameters

NO.	Effect name	REV TIME	HI.RATIO	LO.RATIO	INI.DLY	DIFF.	DENSITY
8	AMBIENCE	2.8 s	0.2	1.2	30.0 ms	5	100%
11	BRIGHT HALL	2.6 s	0.9	1.1	42.0 ms	4	98%
12	BREATHY REVERB	2.9 s	1.0	0.9	52.0 ms	10	100%
13	CONCERT HALL	3.4 s	0.2	1.2	112.0 ms	10	100%
15	REVERB STAGE	1.8 s	0.7	1.0	16.0 ms	8	90%
19	VOCAL PLATE	2.4 s	0.3	1.2	35.0 ms	10	100%
20	ECHO ROOM 1	2.2 s	0.2	1.0	25.0 ms	7	90%
21	ECHO ROOM 2	1.0 s	0.2	1.0	0.0 ms	7	90%
22	PRESENCE REVERB	1.4 s	1.0	0.9	35.0 ms	10	100%
23	ARENA	1.8 s	0.2	1.0	10.0 ms	8	87%
25	OLD PLATE	1.8 s	0.3	1.0	26.0 ms	7	94%
26	DARK PLATE	2.2 s	0.1	1.0	28.8 ms	5	94%
36	BAMBOO ROOM	1.0 s	0.1	1.3	0.1 ms	10	96%
38	STONE ROOM	0.5 s	0.5	1.3	0.0 ms	0	92%
44	DRUM MACH. AMB L	1.0 s	0.4	1.4	13.8 ms	5	88%

■ FINE parameters

NO.	Effect name	MIX BAL.	OUT LVL	E/R DLY	E/R BAL.	HPF	LPF
8	AMBIENCE	100%	75%	25.0 ms	50%	Thru	10.0 kHz
11	BRIGHT HALL	100%	70%	0.1 ms	44%	Thru	10.0 kHz
12	BREATHY REVERB	100%	70%	0.1 ms	29%	50.0 Hz	Thru
13	CONCERT HALL	100%	80%	4.0 ms	32%	Thru	Thru
15	REVERB STAGE	100%	70%	8.0 ms	20%	80.0 Hz	7.10 kHz
19	VOCAL PLATE	100%	90%	22.1 ms	46%	80.0 Hz	10.6 kHz
20	ECHO ROOM 1	100%	90%	20.2 ms	40%	Thru	7.10 kHz
21	ECHO ROOM 2	100%	90%	20.2 ms	40%	Thru	6.70 kHz
22	PRESENCE REVERB	100%	90%	12.0 ms	40%	Thru	14.0 kHz
23	ARENA	100%	90%	0.0 ms	40%	Thru	9.50 kHz
25	OLD PLATE	100%	80%	17.0 ms	44%	Thru	7.10 kHz
26	DARK PLATE	100%	90%	6.4 ms	62%	Thru	5.60 kHz
36	BAMBOO ROOM	100%	100%	4.6 ms	45%	Thru	4.25 kHz
38	STONE ROOM	100%	85%	0.0 ms	0%	Thru	3.75 kHz
44	DRUM MACH. AMB L	100%	100%	9.5 ms	40%	Thru	8.00 kHz

NO.	Effect name	GATE LVL	ATTACK	HOLD ^a	DECAY ^a
8	AMBIENCE	OFF	10 ms	725 ms	83 ms
11	BRIGHT HALL	OFF	0 ms	85.3 ms	3 ms
12	BREATHY REVERB	OFF	5 ms	3.68 ms	3 ms
13	CONCERT HALL	OFF	0 ms	82.6 ms	6 ms
15	REVERB STAGE	OFF	0 ms	18.6 ms	3 ms
19	VOCAL PLATE	OFF	0 ms	69.3 ms	3 ms
20	ECHO ROOM 1	OFF	48 ms	106 ms	3 ms
21	ECHO ROOM 2	OFF	48 ms	106 ms	3 ms
22	PRESENCE REVERB	OFF	10 ms	1.93 ms	3 ms
23	ARENA	OFF	10 ms	101 ms	3 ms
25	OLD PLATE	OFF	1 ms	66.6 ms	3 ms
26	DARK PLATE	OFF	0 ms	37.3 ms	8 ms
36	BAMBOO ROOM	OFF	0 ms	69.3 ms	3 ms
38	STONE ROOM	OFF	2 ms	53.3 ms	3 ms
44	DRUM MACH. AMB L	OFF	18 ms	181 ms	3 ms

*a. The default value of this parameter depends on the sampling frequency at which the SPX2000 is operating. The value shown in the table is for $f_s = 96$ kHz.

Reverb & Gate (CLASSIC bank)

This is a gated reverb (also called gate echo). You can use this effect to add only a portion of the reverberation. Each aspect of the sound is controlled by the following effect parameters.

Reverberation: REV TIME, HI.RATIO, DELAY

Gating: TRG. LVL, HOLD, RELEASE, MIDI TRG

Filter/equalizer: HPF, LPF

Output level: OUT LVL, MIX BAL.

Parameter details

Basic parameters

Parameter name	Range	Explanation
REV TIME	0.3—99.0 s	Reverb time. This is expressed as the time over which reverberation at 1 kHz will decay by 60 dB.
HI.RATIO	0.1—1.0	Reverb time for the high-frequency range, expressed as a proportion of REV TIME. If this value is 0.1 the time will be 1/10th the REV TIME; if it is 1.0 the time will be the same as the REV TIME. You can adjust these values to simulate the absorptiveness of the walls and ceiling. HI.RATIO is the decay of the high-frequency range.
DELAY	0.0—500.0 ms	Delay of the reverberation relative to the original sound.
HPF	THRU, 32 Hz—1.0 kHz	A filter that cuts the low-frequency portion of the effect. Frequency components lower than the frequency specified here will be cut. With a setting of THRU this filter will do nothing. This filter does not affect the original sound.
LPF	1.0 —11 kHz, THRU	A filter that cuts the high-frequency portion of the effect. Frequency components above the frequency specified here will be cut. With a setting of THRU this filter will do nothing. This filter does not affect the original sound.
TRG. LVL	1—61	The level at which the gate is triggered. Increasing this value will raise the level of original sound required to open the gate.
HOLD ^{*a}	44.1 kHz: 0.02 ms—2.13 s 48 kHz: 0.02 ms—1.96 s 88.2 kHz: 0.01 ms—1.06 s 96 kHz: 0.01—981 ms	The minimum time that the gate remains open. Even when the original sound falls below the TRG. LVL, the gate will remain open for the time specified by this value.
RELEASE ^{*a}	44.1 kHz: 6—32000 ms 48 kHz: 6—29400 ms 88.2 kHz: 3—16000 ms 96 kHz: 3—14700 ms	The release time of the gate. This is the time from when the gate begins to close until it is completely closed. Higher settings of this value will make the gate close more slowly; i.e., the volume that passes through the gate will decrease more slowly.
MIDI TRG	ON, OFF	Specifies whether MIDI messages will be used to trigger the gate. If this is ON, the gate will open when a Note-on message with note number C1 or higher is received. In order to enable MIDI message reception, you must specify the MIDI port and MIDI channel. For details, refer to “Preparations for using MIDI” on page 88.
OUT LVL	0—100%	Output level after the original sound and effect sound have been mixed. Decrease this value if you want to lower the output. At a setting of 0% there will be no output.
MIX BAL.	0—100%	Balance between the original sound and effect sound. At a setting of 0% only the original sound will be output; at a setting of 100% only the effect sound will be output.

*a. The range of this parameter depends on the sampling frequency at which the SPX2000 is operating.

Effect list

The following table shows the default parameter values for the effect belonging to the Reverb & Gate type (CLASSIC bank).

NO.	Effect name	REV TIME	HI.RATIO	DELAY	HPF	LPF	TRG.LVL	HOLD ^{*a}	RELEASE ^{*a}	MIDI TRG
18	REVERB & GATE	2.0 s	0.2	10.0 ms	THRU	11 kHz	37	149 ms	6 ms	OFF
		OUT LVL	MIX BAL.							
		100%	100%							

*a. The default value of this parameter depends on the sampling frequency at which the SPX2000 is operating. The value shown in the table is for fs = 96 kHz.

What is a Gate?

A “gate” is a device or circuit that passes or blocks a signal. Gates are provided on the SPX2000’s Reverb (PRE-SET bank) and Reverb & Gate (CLASSIC bank) effects, and can be used to control the reverberation.

For example you can use a gate to apply reverberation only to signals that exceed a specified level, or to suddenly cut the decaying “tail” of the reverberation so that the reverberation ends suddenly.

The various gate-related parameters are explained below.

- **Threshold Level**

This is the signal level at which the gate will open. The gate will open when the input signal exceeds this level, and will remain open as long as the signal remains above this level.

On the SPX2000, this is controlled by parameters such as GATE LVL, TRG.LVL.

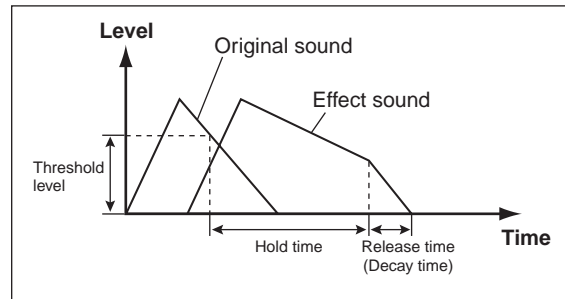

- **Attack Time/Release Time (Decay Time)**

To prevent sudden “jumps” in the sound when the input signal exceeds or falls below the threshold level, you can make the gate open or close gradually over a specified length of time. The time from when the gate begins to open until it opens completely is called the Attack Time, and the time from when it begins to close until it closes completely is called the Release Time (or Decay Time).

On the SPX2000, the Attack Time is controlled by parameters such as ATTACK, and the Release Time is controlled by parameters such as DECAY, RELEASE.

- **Hold Time**

This is the time that the gate will remain open after the signal falls below the threshold level.

If the level of the signal changes irregularly, the gate will open and close at short intervals. This will cause the sound to be alternately interrupted and passed, making it sound unsteady and jumpy.

In such cases, you can adjust the Hold Time so that the gate will remain open for a time even after the signal falls below the threshold level; this will prevent the gate from opening and closing so frequently. However, be aware that if you set the Hold Time longer than necessary, the gate will remain open all the time, and will therefore have no effect on the sound.

On the SPX2000, the Hold Time is controlled by the HOLD parameter.

Early Reflection

These effects add early reflections. Early reflections are the sounds that reach your ear after being reflected only once from the walls or ceiling. In contrast, the “wash” of sound that reaches your ear after reflecting multiple times from the walls and ceiling is called “subsequent reverberation.” In nature, early reflections will be followed by subsequent reverberation, but the Early Reflection effects omit this, producing a tighter sound. These effects can produce interesting results when applied to drums, percussion, or guitar.

The differences between the effects are summarized below.

Type	Bank	No. of INs/OUTs	Explanation
Early Reflection, Gate Reverb, Reverse Gate	PRESET	1IN/2OUT	Parameters can be controlled in detail
Early Reflection, Gate Reverb, Reverse Gate	CLASSIC		Simpler operation; fewer controllable parameters than the PRESET bank effects

Early Reflection, Gate Reverb, Reverse Gate (PRESET bank)

Early Reflection is the basic effect of this type, and Gate Reverb is based on the popular effect of the same name. Reverse Gate is also known as “backwards reverb.”

Each aspect of the sound is controlled by the following effect parameters.

Early reflections: TYPE, ROOMSIZE, LIVENESS, INI.DLY, DIFF, DENSITY, ER NUM, FB.GAIN, HI.RATIO

Filter/equalizer: HPF, LPF

Output level: OUT LVL, MIX BAL.

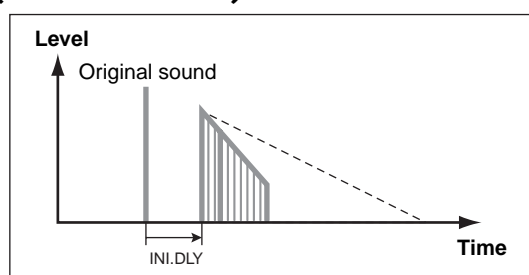

Parameter details

Basic parameters

Parameter name	Range	Explanation
TYPE	*a	The pattern of early reflections; this determines the basic character of the effect. The characteristics of the early reflections will depend on the type you select here.
ROOMSIZE	0.1—20.0	Size of the reverberant space. Increasing this value simulates a larger space. You can use this to simulate the absorptiveness of the walls and ceiling.
LIVENESS	0—10	Decay characteristics of the early reflections. Increasing this value will reduce the decay, causing the repeats to continue. You can use this to simulate the absorptiveness of the walls and ceiling.
INI.DLY	0.0—500.0 ms	Delay of the early reflections relative to the original sound.
DIFF.	0—10	Diffusion of the sound to left and right. Increasing this value will make the reverberation more spaciousness.
DENSITY	0—100%	Density of the early reflections. Increasing this value will make the reverberation smoother. You can create unique effects by lowering this value.

*a. For Early Reflection effects, choose from S-Hall, L-Hall, Random, Revers, Plate, and Spring.
For Gate Reverb and Reverse Gate effects, choose from Type-A and Type-B.

Fine parameters

Parameter name	Range	Explanation
MIX BAL.	0—100%	Balance between the original sound and effect sound. At a setting of 0% only the original sound will be output; at a setting of 100% only the effect sound will be output.
OUT LVL	0—100%	Output level after the original sound and effect sound have been mixed. Decrease this value if you want to lower the output. At a setting of 0% there will be no output.
ER NUM.	1—19	The number of early reflections. Increasing this value will increase the number of reflections.
HPF	Thru, 21.2 Hz—8.00 kHz	A filter that cuts the low-frequency portion of the effect. Frequency components lower than the frequency specified here will be cut. With a setting of Thru this filter will do nothing. This filter does not affect the original sound.
LPF	50.0 Hz—16.0 kHz, Thru	A filter that cuts the high-frequency portion of the effect. Frequency components above the frequency specified here will be cut. With a setting of Thru this filter will do nothing. This filter does not affect the original sound.
FB.GAIN	−99%—+99%	Amount of feedback for the early reflections. This indicates the ratio by which the level is reduced for each repetition of the effect. For example with a setting of +50, the level of the reflections will decay to 50% → 25% → 12.5% as they are repeated. Negative (−) values invert the phase of the feedback.
HI.RATIO	0.1—1.0	Amount of feedback for the high-frequency portion of the reflections. This is specified as a proportion of FB.GAIN. If this value is 0.1, the feedback amount will be 1/10th of FB.GAIN; if this value is 1.0, the feedback amount will be the same as FB.GAIN.

Effect list

The following tables show the default parameter values for the effects belonging to the Early Reflection, Gate Reverb, and Reverse Gate types (PRESET bank).

■ Basic parameters

NO.	Effect name	TYPE	ROOMSIZE	LIVENESS	INI.DLY	DIFF.	DENSITY
34	FAT REFLECTIONS	S-Hall	5.1	10	10.6 ms	10	100%
35	BIG SNARE	Type-A	1.2	10	10.0 ms	9	80%
37	REFLECTIONS	L-Hall	1.0	4	11.8 ms	10	0%
39	CONCRETE ROOM	Type-A	0.4	4	5.0 ms	5	80%
40	REVERSE PURPLE	Type-A	1.3	8	62.5 ms	10	100%
41	FULL METAL GATE	Type-A	0.6	2	33.7 ms	7	88%
42	REVERSE GATE	Type-A	0.2	6	10.0 ms	10	100%
45	ELECT.SNR PLATE	Type-A	0.6	9	8.7 ms	10	88%

■ Fine parameters

NO.	Effect name	MIX BAL.	OUT LVL	ER NUM.	HPF	LPF	FB.GAIN	HI.RATIO
34	FAT REFLECTIONS	100%	60%	19	Thru	10.0 kHz	0%	0.6
35	BIG SNARE	100%	65%	19	Thru	9.50 kHz	0%	0.8
37	REFLECTIONS	100%	80%	10	40.0 Hz	Thru	0%	1.0
39	CONCRETE ROOM	100%	80%	19	Thru	7.50 kHz	0%	0.6
40	REVERSE PURPLE	100%	80%	18	100 Hz	Thru	+26%	1.0
41	FULL METAL GATE	100%	100%	19	30.0 Hz	2.80 kHz	+26%	0.1
42	REVERSE GATE	100%	100%	19	Thru	8.50 kHz	0%	0.7
45	ELECT.SNR PLATE	100%	70%	19	Thru	3.35 kHz	0%	1.0

Early Reflection, Gate Reverb, Reverse Gate (CLASSIC bank)

These effects are based on the effects of earlier models in the SPX series. They have a simpler parameter structure than the identically-named effects of the PRESET bank.

Each aspect of the sound is controlled by the following effect parameters.

Early reflections: TYPE, ROOMSIZE, LIVENESS, DELAY

Filter/equalizer: LPF

Output level: OUT LVL, MIX BAL.

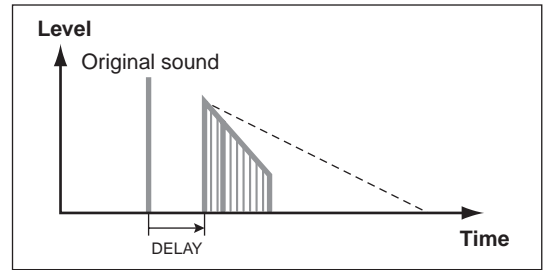

Parameter details

■ Basic parameters

Parameter name	Range	Explanation
TYPE	HALL, RANDOM, REVERS, PLATE	The pattern of early reflections; this determines the basic character of the effect. The characteristics of the early reflections will depend on the type you select here.
ROOMSIZE	0.1—20.0	Size of the reverberant space. Increasing this value simulates a larger space. You can use this to simulate the absorptiveness of the walls and ceiling.
LIVENESS	0—10	Decay characteristics of the early reflections. Increasing this value will reduce the decay, causing the repeats to continue. You can use this to simulate the absorptiveness of the walls and ceiling.
DELAY	0.0—500.0 ms	Delay of the early reflections relative to the original sound.
LPF	1.0—11 kHz, THRU	A filter that cuts the high-frequency portion of the effect. Frequency components above the frequency specified here will be cut. With a setting of THRU this filter will do nothing. This filter does not affect the original sound.
OUT LVL	0—100%	Output level after the original sound and effect sound have been mixed. Decrease this value if you want to lower the output. At a setting of 0% there will be no output.
MIX BAL.	0—100%	Balance between the original sound and effect sound. At a setting of 0% only the original sound will be output; at a setting of 100% only the effect sound will be output.

Effect list

The following table shows the default parameter values for the effects belonging to the Early Reflection, Gate Reverb, and Reverse Gate types (CLASSIC bank).

NO.	Effect name	TYPE	ROOMSIZE	LIVENESS	DELAY	LPF	OUT LVL	MIX BAL.
5	EARLY REF 1	HALL	1.1	3	3.5 ms	9.0 kHz	75%	100%
6	EARLY REF 2	HALL	1.6	6	3.5 ms	8.0 kHz	75%	100%
15	GATE REVERB	HALL	0.8	6	15.0 ms	3.2 kHz	80%	100%
17	REVERSE GATE	HALL	2.3	7	0.0 ms	5.6 kHz	80%	100%

Delay, Echo

These effects add one or more delayed sound. Karaoke echo is a typical example, used to add depth to the sound. The delay can repeat while diminishing. Some of these effects let you synchronize the delay to the tempo.

The differences between the effects are summarized below.

Type	Bank	No. of INs/OUTs	Number of delay sounds	Modulate the delay	Feedback delay	Tempo synchronized delay	Page
Mono delay	PRESET	1IN/2OUT	1	No	No	Yes	38
Stereo delay		2IN/2OUT	2 (L, R)	No			40
Modulation delay		1IN/2OUT	1	Yes	41		
Delay L,C,R		3 (L, C, R)	Yes	43			
Echo	CLASSIC	2IN/2OUT	2 (L, R)	No	No	No	44
Delay L,R					Yes		46
Stereo echo					No		

Mono Delay (PRESET bank)

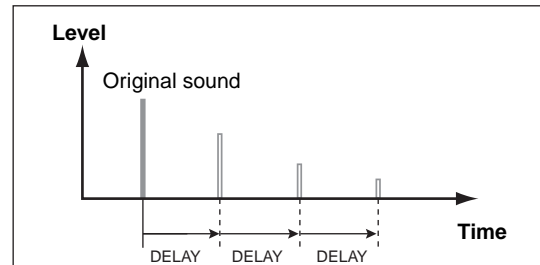
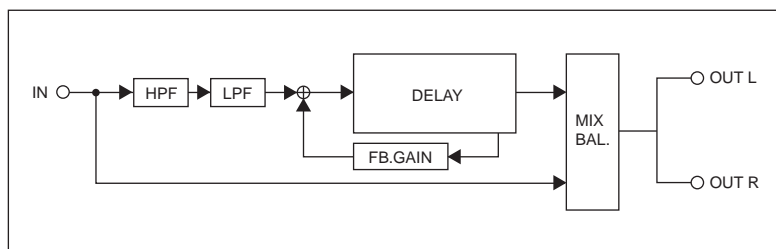

These are basic delay effects. A monaural delayed sound will follow the original sound.

Each aspect of the sound is controlled by the following effect parameters.

Delay sound: DELAY, FB.GAIN, HI.RATIO

Tempo synchronization: SYNC, NOTE, TEMPO

Filter/equalizer: HPF, LPF

Output level: OUT LVL, MIX BAL.

Parameter details

Basic parameters

Parameter name	Range	Explanation
DELAY	0.0—2730.0 ms	Delay relative to the original sound.
FB.GAIN	-99%—+99%	Amount of feedback for the delay sound. This indicates the ratio by which the level is reduced when repeating the effect. For example with a setting of +50, the level of the delay sound will decay to 50% → 25% → 12.5% as it is repeated. Negative (-) values invert the phase of the feedback.
HI.RATIO	0.1—1.0	Amount of feedback for the high-frequency portion of the delay sound. This is specified as a proportion of FB.GAIN. If this value is 0.1, the feedback amount will be 1/10th of FB.GAIN; if this value is 1.0, the feedback amount will be the same as FB.GAIN.

■ Fine parameters

Parameter name	Range	Explanation
MIX BAL.	0—100%	Balance between the original sound and effect sound. At a setting of 0% only the original sound will be output; at a setting of 100% only the effect sound will be output.
OUT LVL	0—100%	Output level after the original sound and effect sound have been mixed. Decrease this value if you want to lower the output. At a setting of 0% there will be no output.
HPF	Thru, 21.2 Hz—8.00 kHz	A filter that cuts the low-frequency portion of the effect. Frequency components lower than the frequency specified here will be cut. With a setting of Thru this filter will do nothing. This filter does not affect the original sound.
LPF	50.0 Hz—16.0 kHz, Thru	A filter that cuts the high-frequency portion of the effect. Frequency components above the frequency specified here will be cut. With a setting of Thru this filter will do nothing. This filter does not affect the original sound.
SYNC	ON, OFF	Switches tempo synchronization on/off. If this is ON, the delay will synchronize to the tempo synchronization source specified by “TEMPO SOURCE” (page 23). The NOTE value will be set to the synchronized tempo value.
NOTE	*a	This parameter is used for tempo synchronization. If SYNC is ON, the DELAY value will be set according to this value and TEMPO. If SYNC is OFF, this value is ignored.
TEMPO	25—300	This parameter is used for tempo synchronization. If SYNC is ON, the DELAY value will be set according to this value and NOTE. If SYNC is OFF, this value is ignored.

*a.

Effect list

The following tables show the default parameter values for the effects belonging to the Mono Delay type (PRESET bank).

■ Basic parameters

NO.	Effect name	DELAY	FB.GAIN	HI.RATIO
46	MONO DELAY	375.0 ms	+42%	0.6
47	120 BPM MONO DDL	250.0 ms	+32%	0.6

■ Fine parameters

NO.	Effect name	MIX BAL.	OUT LVL	HPF	LPF	SYNC	NOTE	TEMPO
46	MONO DELAY	100%	70%	Thru	12.5 kHz	OFF		—
47	120 BPM MONO DDL	100%	85%	Thru	12.5 kHz	OFF		—

Effect list

The following tables show the default parameter values for the effect belonging to the Stereo Delay type (PRESET bank).

■ Basic parameters

NO.	Effect name	DELAY L	DELAY R	FB.G L	FB.G R	HI.RATIO
49	STEREO DELAY	250.0 ms	375.0 ms	+44%	+28%	0.6

■ Fine parameters

NO.	Effect name	MIX BAL.	OUT LVL	HPF	LPF	SYNC	NOTE L	NOTE R	TEMPO
49	STEREO DELAY	100%	90%	Thru	12.5 kHz	OFF	♪	♪	—

Modulation Delay (PRESET bank)

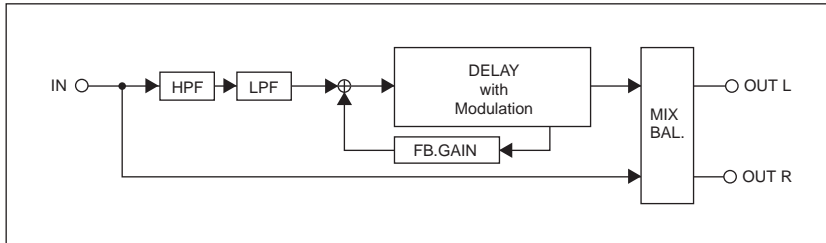

These effects modulate the delay sound.

Each aspect of the sound is controlled by the following effect parameters.

Delay sound: DELAY, FB.GAIN, HI.RATIO

Modulation signal: FREQ., DEPTH, WAVE

Tempo synchronization: SYNC, DLY.NOTE, MOD.NOTE, TEMPO

Filter/equalizer: HPF, LPF

Output level: OUT LVL, MIX BAL.

Parameter details

■ Basic parameters

Parameter name	Range	Explanation
DELAY	0.0—2725.0 ms	Delay relative to the original sound.
FB.GAIN	−99%—+99%	Amount of feedback for the delay sound. This indicates the ratio by which the level is reduced when repeating the effect. For example with a setting of +50, the level of the delay sound will decay to 50% → 25% → 12.5% as it is repeated. Negative (−) values invert the phase of the feedback.
HI.RATIO	0.1—1.0	Amount of feedback for the high-frequency portion of the delay sound. This is specified as a proportion of FB.GAIN. If this value is 0.1, the feedback amount will be 1/10th of FB.GAIN; if this value is 1.0, the feedback amount will be the same as FB.GAIN.
FREQ.	0.05—40.00 Hz	Speed of modulation. Increasing this value will cause the delay sound to be modulated in a shorter cycle.
DEPTH	0—100%	Depth of modulation. Increasing this value will make the modulation deeper.
WAVE	Sine, Tri	Waveform of the modulation signal. This will affect the character of the modulation. You can choose Sine (sine wave) or Tri (triangle wave).

■ Fine parameters

Parameter name	Range	Explanation
MIX BAL.	0—100%	Balance between the original sound and effect sound. At a setting of 0% only the original sound will be output; at a setting of 100% only the effect sound will be output.
OUT LVL	0—100%	Output level after the original sound and effect sound have been mixed. Decrease this value if you want to lower the output. At a setting of 0% there will be no output.
HPF	Thru, 21.2 Hz—8.00 kHz	A filter that cuts the low-frequency portion of the effect. Frequency components lower than the frequency specified here will be cut. With a setting of Thru this filter will do nothing. This filter does not affect the original sound.
LPF	50.0 Hz—16.0 kHz, Thru	A filter that cuts the high-frequency portion of the effect. Frequency components above the frequency specified here will be cut. With a setting of Thru this filter will do nothing. This filter does not affect the original sound.
SYNC	ON, OFF	Switches tempo synchronization on/off. If this is ON, the delay will synchronize to the tempo synchronization source specified by “TEMPO SOURCE” (page 23). The DLY.NOTE and the MOD.NOTE value will be set to the synchronized tempo value.
DLY.NOTE	*a	This parameter is used for tempo synchronization. If SYNC is ON, the DELAY value will be set according to this value and TEMPO. If SYNC is OFF, this value is ignored.
MOD.NOTE	*b	This parameter is used for tempo synchronization. If SYNC is ON, the FREQ. value will be set according to this value and TEMPO. If SYNC is OFF, this value is ignored.
TEMPO	25—300	This parameter is used for tempo synchronization. If SYNC is ON, the DELAY value will be set according to the DLY.NOTE and TEMPO values, and the FREQ. value will be set according to the MOD.NOTE and TEMPO values. If SYNC is OFF, this value is ignored.

*a. 

*b. 





Effect list

The following tables show the default parameter values for the effects belonging to the Modulation Delay type (PRESET bank).

■ Basic parameters

NO.	Effect name	DELAY	FB.GAIN	HI.RATIO	FREQ.	DEPTH	WAVE
66	STEREO PHASING	2.0 ms	+38%	0.9	0.90 Hz	46%	Sine
68	SILKY SWEEP	0.2 ms	-40%	1.0	0.30 Hz	80%	Sine

■ Fine parameters

NO.	Effect name	MIX BAL.	OUT LVL	HPF	LPF	SYNC	DLY.NOTE	MOD.NOTE	TEMPO
66	STEREO PHASING	100%	100%	45.0 Hz	9.00 kHz	OFF			—
68	SILKY SWEEP	100%	100%	125 Hz	Thru	OFF			—

Effect list

The following tables show the default parameter values for the effect belonging to the Delay L,C,R type (PRESET bank).

Basic parameters

NO.	Effect name	DELAY L	DELAY C	DELAY R	FB.DLY	LEVEL L	LEVEL C	LEVEL R	FB.GAIN	HI.RATIO
50	DELAY L,C,R	142.8 ms	428.5 ms	285.7 ms	142.8 ms	+70%	+70%	+70%	0%	1.0

Fine parameters

NO.	Effect name	MIX BAL.	HPF	LPF	SYNC	NOTE L	NOTE C	NOTE R	NOTE FB	TEMPO
50	DELAY L,C,R	100%	Thru	Thru	OFF	♪	♪	♪	♪	—

Echo (PRESET bank)

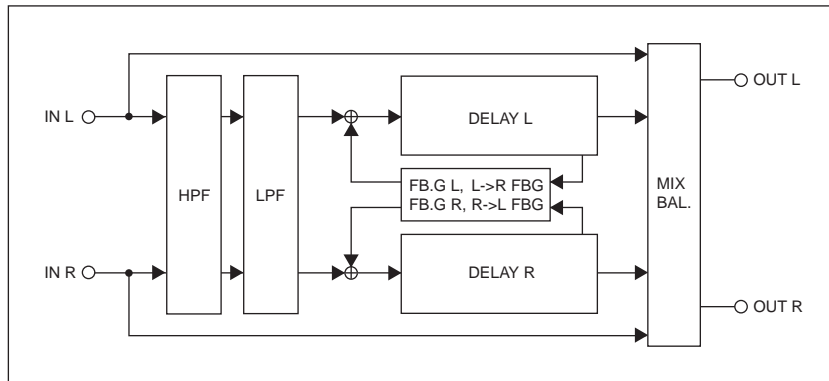

These effects add two delays; one each to the L and R channels. This is similar to Stereo Delay (page 40), but Echo mixes the L/R channel delay sounds for feedback. You can specify the amount of feedback sent from the L channel to the R channel, and from the R channel to the L channel.

Each aspect of the sound is controlled by the following effect parameters.

Delay sound: DELAY L, DELAY R, FB.DLYL, FB.DLYR, FB.G L, FB.G R, L→R FBG, R→L FBG, HI.RATIO

Tempo synchronization: SYNC, NOTE L, NOTE R, NOTE.FBL, NOTE.FBR, TEMPO

Filter/equalizer: HPF, LPF

Output level: OUT LVL, MIX BAL.

Parameter details

Basic parameters

Parameter name	Range	Explanation
DELAY L DELAY R	0.0—1350.0 ms	Delay relative to the original sound. DELAY L indicates the L channel delay, and DELAY R indicates the R channel delay.
FB.DLYL FB.DLYR	0.0—1350.0 ms	Delay added to the feedback. FB.DLYL indicates the L channel delay, and FB.DLYR indicates the R channel delay. The delay from the original sound to the first delay sound is DELAY L or DELAY R; the delay of the subsequently repeated sound will be DELAYL+FB.DLYL or DELAY R+FB.DLYR.
FB.G L FB.G R	-99%—+99%	Amount of feedback for the delay sounds. This indicates the ratio by which the level is reduced when repeating the effect. For example with a setting of +50, the level of the delay sound will decay to 50% → 25% → 12.5% as it is repeated. Negative (-) values invert the phase of the feedback. FB.G L indicates the feedback amount for the L channel, and FB.G R for the R channel.
L->R FBG	-99%—+99%	Amount of feedback from the L channel to the R channel. Negative (-) values invert the phase of the feedback.
R->L FBG	-99%—+99%	Amount of feedback from the R channel to the L channel. Negative (-) values invert the phase of the feedback.
HI.RATIO	0.1—1.0	Amount of feedback for the high-frequency portion of the delay sound. This is specified as a proportion of FB.G. If this value is 0.1, the high-frequency feedback amount for the L channel will be 1/10th of FB.G L, and the high-frequency feedback amount for the R channel will be 1/10th of FB.G R. If this value is 1.0, the feedback amount will be the same as FB.G L/FB.G R.

NOTE: If the FB.G L, FB.G R, L->R FBG, or R->L FBG values are raised excessively, oscillation will occur, and the signal will not decay. Please use caution.

Delay L,R, Stereo Echo (CLASSIC bank)

These effects are based on earlier models of the SPX series. Delay L,R is equivalent to the Echo effects of the PRESET bank, and Stereo Echo is equivalent to the Stereo Delay effects of the PRESET bank. These effects have a simpler parameter structure than the equivalent PRESET bank effects.

Each aspect of the sound is controlled by the following effect parameters.

Delay sound: Lch DLY, Rch DLY, FB.G L, FB.G R, HI.RATIO

Output level: OUT LVL, MIX BAL.

Parameter details

■ Basic parameters

Parameter name	Range	Explanation
Lch DLY Rch DLY	0.0—1350.0 ms	Delay relative to the original sound. Lch DLY indicates the L channel delay, and Rch DLY indicates the R channel delay.
FB.G L FB.G R	-99%—+99%	Amount of feedback for the delay sounds. This indicates the ratio by which the level is reduced when repeating the effect. For example with a setting of +50, the level of the delay sound will decay to 50% → 25% → 12.5% as it is repeated. Negative (-) values invert the phase of the feedback. FB.G L indicates the feedback amount for the L channel, and FB.G R for the R channel.
HI.RATIO	0.1—1.0	Amount of feedback for the high-frequency portion of the delay sound. This is specified as a proportion of FB.G. If this value is 0.1, the high-frequency feedback amount for the L channel will be 1/10th of FB.G L, and the high-frequency feedback amount for the R channel will be 1/10th of FB.G R. If this value is 1.0, the feedback amount will be the same as FB.G L/FB.G R.
OUT LVL	0—100%	Output level after the original sound and effect sound have been mixed. Decrease this value if you want to lower the output. At a setting of 0% there will be no output.
MIX BAL.	0—100%	Balance between the original sound and effect sound. At a setting of 0% only the original sound will be output; at a setting of 100% only the effect sound will be output.

NOTE: If the FB.G L or FB.G R values of Delay L,R are raised excessively, oscillation will occur, and the signal will not decay. Please use caution.

Effect list

The following table shows the default parameter values for the effects belonging to the Delay L,R and Stereo Echo types (CLASSIC bank).

■ Basic parameters

NO.	Effect name	Lch DLY	FB.G L	Rch DLY	FB.G R	HI.RATIO	OUT LVL	MIX BAL.
7	DELAY L,R	100.0 ms	0%	200.0 ms	0%	1.0	90%	100%
8	STEREO ECHO	170.0 ms	+60%	178.0 ms	+58%	0.9	90%	100%

Modulation

These effects modulate the input signal in various ways. Using one signal to vary another signal is called “modulation.” The signal that is being varied is called the “carrier,” and the signal that is creating the modulation is called the “modulator.” Modulation-type effects can vary the volume, the pitch, or the delay time of the effect sound to produce “swooshing” or “twisting” sounds (flanger, phaser) or cyclic changes in volume (tremolo) or position (auto pan). The SPX2000 can use the signal of an oscillator as the modulator to apply cyclic change, or use the input signal itself or MIDI messages to apply change.

Type	Bank	No. of INs/OUTs	Modulation effect	Modulator signal	Page	
Flanger	PRESET	2IN/2OUT	Twisting	Oscillator signal	47	
Phaser					49	
Stereo Flanger/Stereo Phasing					50	
Chorus	PRESET		Chorus		51	
Symphonic					52	
Tremolo					53	
Chorus	CLASSIC		Volume change		Chorus	54
Symphonic						54
Auto Pan						55
Pan	CLASSIC		Positional change		Twisting	56
Modulation Filter						56
Ring Modulation						57
Dynamic Filter	PRESET	Twisting	Input signal or MIDI message	58		
Dynamic Flanger				59		
Dynamic Phaser				60		

Flanger (PRESET bank)

These effects add a “swooshing” character that is reminiscent of a jet airplane taking off and landing. For delay-type effects, the delay time relative to the original sound does not change; however for a flanger, the delay time is modulated cyclically. It is this change in the delay time that produces the “swooshing” character of a flanger. Each aspect of the sound is controlled by the following effect parameters.

Modulation signal: FREQ., DEPTH, WAVE

Effect sound: MOD.DLY, FB.GAIN

Tempo synchronization: SYNC, NOTE, TEMPO

Filter/equalizer: LSH G, LSH F, EQ G, EQ F, EQ Q, HSH G, HSH F

Output level: OUT LVL, MIX BAL.

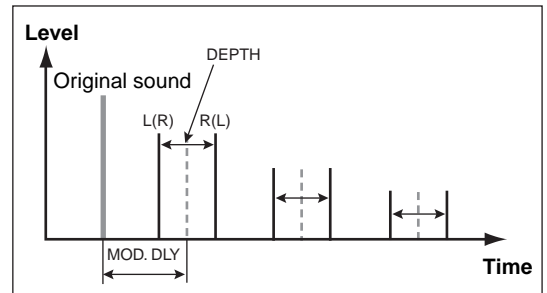

Parameter details

Basic parameters

Parameter name	Range	Explanation
FREQ.	0.05—40.00 Hz	Speed of modulation. Increasing this value will make the modulation repeat at a shorter interval.
DEPTH	0—100%	Modulation depth. Increasing this value will make the modulation deeper.
MOD.DLY	0.0—500.0 ms	Delay of the effect sound relative to the original sound. The delay time will be modulated around this value. FREQ. sets the speed of this change, and DEPTH sets the depth.
FB.GAIN	-99%—+99%	Amount of feedback for the modulated sound. Raising this value will increase the amount of feedback, emphasizing the modulation. Negative (-) settings will invert the phase of the feedback.
WAVE	Sine, Tri	Waveform of the modulation signal. This will affect the character of the modulation. You can choose Sine (sine wave) or Tri (triangle wave).

■ Fine parameters

Parameter name	Range	Explanation
MIX BAL.	0—100%	Balance between the original sound and effect sound. At a setting of 0% only the original sound will be output; at a setting of 100% only the effect sound will be output.
OUT LVL	0—100%	Output level after the original sound and effect sound have been mixed. Decrease this value if you want to lower the output. At a setting of 0% there will be no output.
LSH G	-12.0—+12.0 dB	Gain of the low shelving filter. This adjusts the volume of the low-frequency region. Positive (+) settings will boost the low-frequency region, and negative (-) settings will attenuate it.
LSH F	21.2 Hz—8.00 kHz	Frequency of the low shelving filter. The LSH G gain applies to the frequency region below this setting.
EQ G	-12.0—+12.0 dB	Gain of the equalizer (peaking type). This adjusts the gain of the frequency region specified by EQ F. Positive (+) settings will boost the region, and negative (-) settings will attenuate it.
EQ F	100 Hz—8.00 kHz	Frequency of the equalizer (peaking type). The EQ G gain setting will affect the region around this frequency.
EQ Q	10.0—0.10	Q (sharpness) of the equalizer (peaking type). This indicates the sharpness of the equalizer frequency response curve. Higher values will produce a sharper curve.
HSH G	-12.0—+12.0 dB	Gain of the high shelving filter. This adjusts the volume of the high-frequency region. Positive (+) settings will boost the high-frequency region, and negative (-) settings will attenuate it.
HSH F	50.0 Hz—16.0 kHz	Frequency of the high shelving filter. The HSH G gain applies to the frequency region above this setting.
SYNC	ON, OFF	Switches tempo synchronization on/off. If this is ON, the speed of modulation will synchronize to the tempo synchronization source specified by “TEMPO SOURCE” (page 23). The NOTE value will be set to the synchronized tempo value.
NOTE	*a	This parameter is used for tempo synchronization. If SYNC is ON, the FREQ. value will be set according to this value and the TEMPO value. This value is ignored if SYNC is OFF.
TEMPO	25—300	This parameter is used for tempo synchronization. If SYNC is ON, the FREQ. value will be set according to this value and NOTE. This value is ignored if SYNC is OFF.

*a. 

Effect list

The following tables show the default parameter values for the effect belonging to the Flanger type (PRESET bank).

■ Basic parameters

NO.	Effect name	FREQ.	DEPTH	MOD. DLY	FG. GAIN	WAVE
89	UP DOWN FLANGE	1.00 Hz	75%	0.9 ms	+60%	Sine

■ Fine parameters

NO.	Effect name	MIX BAL.	OUT LVL	LSH G	LSH F	EQ G	EQ F	EQ Q	HSH G	HSH F	
89	UP DOWN FLANGE	100%	100%	-0.5 dB	140 Hz	+12.0 dB	4.50 kHz	3.5	0.0 dB	8.00 kHz	
		SYNC	NOTE	TEMPO							
		OFF	♩	—							

Phaser (PRESET bank)

By cyclically varying the frequencies whose phase is shifted, this effect creates a sense of space and movement. A phase shift circuit is used to delay the phase of specific frequencies.

Each aspect of the sound is controlled by the following effect parameters.

Modulation signal: FREQ., DEPTH, PHASE

Phase shift: FB.GAIN, OFFSET, STAGE

Tempo synchronization: SYNC, NOTE, TEMPO

Filter/equalizer: LSH G, LSH F, HSH G, HSH F

Output level: OUT LVL, MIX BAL.

Parameter details

Basic parameters

Parameter name	Range	Explanation
FREQ.	0.05—40.00 Hz	Speed of modulation. Increasing this value will make the modulation repeat at a shorter interval.
DEPTH	0—100%	Modulation depth. Increasing this value will make the modulation deeper.
FB.GAIN	-99%—+99%	Amount of feedback for the modulated sound. Raising this value will increase the amount of feedback, emphasizing the modulation. Negative (-) settings will invert the phase of the feedback.
OFFSET	0—100	Offset value for the frequency whose phase is shifted. Raising this value will move the frequency upward, and lowering it will move the frequency downward. The frequency being phase-shifted will change around this value. FREQ. sets the speed of change, and DEPTH sets the amount of change.
PHASE	0.00—354.38 dg	Phase difference between the modulation signals of the L channel and R channel. This lets you control the spaciousness of the sound.
STAGE	2, 4, 6, 8, 10, 12, 14, 16	Number of stages in the phase shift circuitry. Raising this value will produce a more complex sense of modulation.

Fine parameters

Parameter name	Range	Explanation
MIX BAL.	0—100%	Balance between the original sound and effect sound. At a setting of 0% only the original sound will be output; at a setting of 100% only the effect sound will be output.
OUT LVL	0—100%	Output level after the original sound and effect sound have been mixed. Decrease this value if you want to lower the output. At a setting of 0% there will be no output.
LSH G	-12.0—+12.0 dB	Gain of the low shelving filter. This adjusts the volume of the low-frequency region. Positive (+) settings will boost the low-frequency region, and negative (-) settings will attenuate it.
LSH F	21.2 Hz—8.00 kHz	Frequency of the low shelving filter. The LSH G gain applies to the frequency region below this setting.
HSH G	-12.0—+12.0 dB	Gain of the high shelving filter. This adjusts the volume of the high-frequency region. Positive (+) settings will boost the high-frequency region, and negative (-) settings will attenuate it.
HSH F	50.0 Hz—16.0 kHz	Frequency of the high shelving filter. The HSH G gain applies to the frequency region above this setting.
SYNC	ON, OFF	Switches tempo synchronization on/off. If this is ON, the speed of modulation will synchronize to the tempo synchronization source specified by "TEMPO SOURCE" (page 23). The NOTE value will be set to the synchronized tempo value.
NOTE	*a	This parameter is used for tempo synchronization. If SYNC is ON, the FREQ. value will be set according to this value and the TEMPO value. This value is ignored if SYNC is OFF.
TEMPO	25—300	This parameter is used for tempo synchronization. If SYNC is ON, the FREQ. value will be set according to this value and NOTE. This value is ignored if SYNC is OFF.

*a. 

Effect list

The following tables show the default parameter values for the effect belonging to the Phaser type (PRESET bank).

Basic parameters

NO.	Effect name	FREQ.	DEPTH	FB.GAIN	OFFSET	PHASE	STAGE
73	PHASER	0.50 Hz	36%	+70%	58	0.00 dg	6

Fine parameters

NO.	Effect name	MIX BAL.	OUT LVL	LSH G	LSH F	HSH G	HSH F	SYNC	NOTE	TEMPO
73	PHASER	100%	100%	0.0 dB	125 Hz	0.0 dB	10.0 kHz	OFF	a	—

Stereo Flanger, Stereo Phasing (CLASSIC bank)

These effects are based on earlier models of the SPX series. Stereo Flanger is equivalent to the Flanger effects of the PRESET bank, and Stereo Phasing is equivalent to the Phaser effects of the PRESET bank. These effects have a simpler parameter structure than the equivalent PRESET bank effects.

Each aspect of the sound is controlled by the following effect parameters.

Modulation signal: MOD. FRQ., DEPTH

Effect sound: MOD. DLY, FB.GAIN

Output level: OUT LVL, MIX BAL.

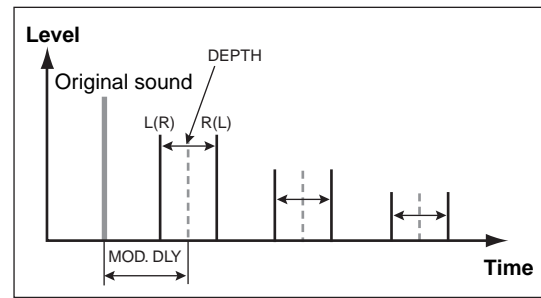

Parameter details

■ Basic parameters

Parameter name	Range	Explanation
MOD. FRQ	0.1—40.0 Hz	Speed of modulation. Increasing this value will make the modulation repeat at a shorter interval.
DEPTH	0—100%	Modulation depth. Increasing this value will make the modulation deeper.
MOD. DLY	0.0—500.0 ms	Delay of the effect sound relative to the original sound. The delay time will change around this value. MOD.FRQ. sets the speed of this change, and DEPTH sets the depth.
F.B.GAIN	0—99%	Amount of feedback for the modulated sound. Raising this value will increase the amount of feedback, emphasizing the modulation. Negative (–) settings will invert the phase of the feedback.
OUT LVL	0—100%	Output level after the original sound and effect sound have been mixed. Decrease this value if you want to lower the output. At a setting of 0% there will be no output.
MIX BAL.	0—100%	Balance between the original sound and effect sound. At a setting of 0% only the original sound will be output; at a setting of 100% only the effect sound will be output.

Effect list

The following table shows the default parameter values for the effects belonging to the Stereo Flanger and Stereo Phasing types (CLASSIC bank).

NO.	Effect name	MOD. FRQ	DEPTH	MOD. DLY	F.B. GAIN	OUT LVL	MIX BAL.
9	STEREO FLANGE A	2.5 Hz	50%	1.2 ms	35%	100%	100%
10	STEREO FLANGE B	0.5 Hz	89%	1.0 ms	40%	100%	100%
13	STEREO PHASING	1.1 Hz	100%	1.1 ms	44%	100%	100%

■ Fine parameters

NO.	Effect name	MIX BAL.	OUT LVL	LSH G	LSH F	EQ G	EQ F	EQ Q	HSH G	HSH F
70	TREMLO	100%	100%	0.0 dB	125 Hz	0.0 dB	1.00 kHz	10.0	0.0 dB	10.0 kHz
		SYNC	NOTE	TEMPO						
		OFF		—						

Chorus, Tremolo (CLASSIC bank)

These effects are based on earlier models of the SPX series. These effects have a simpler parameter structure than the correspondingly-named effects of the PRESET bank.

Each aspect of the sound is controlled by the following effect parameters.

Modulation signal: MOD.FREQ., AM DEPTH, PM DEPTH

Output level: OUT LVL, MIX BAL.

Parameter details

■ Basic parameters

Parameter name	Range	Explanation
MOD. FRQ	0.1—40.0 Hz	Speed of modulation (AM, PM). Increasing this value will make the modulation repeat at a shorter interval.
PM DEPTH	0—100%	Pitch modulation (PM) depth. Increasing this value will make the pitch modulation deeper.
AM DEPTH	0—100%	Amplitude modulation (AM) depth. Increasing this value will make the volume modulation deeper.
OUT LVL	0—100%	Output level after the original sound and effect sound have been mixed. Decrease this value if you want to lower the output. At a setting of 0% there will be no output.
MIX BAL.	0—100%	Balance between the original sound and effect sound. At a setting of 0% only the original sound will be output; at a setting of 100% only the effect sound will be output.

Effect list

The following table shows the default parameter values for the effects belonging to the Chorus and Tremolo types (CLASSIC bank).

NO.	Effect name	MOD.FRQ	PM DEPTH	AM DEPTH	OUT LVL	MIX BAL.
71	CHORUS A	0.2 Hz	100%	55%	100%	100%
72	CHORUS B	0.3 Hz	96%	10%	100%	100%
74	TREMLO	6.0 Hz	50%	50%	100%	100%

Symphonic (CLASSIC bank)

This effect is based on earlier models of the SPX series. This effect has a simpler parameter structure than the correspondingly-named effects of the PRESET bank.

Each aspect of the sound is controlled by the following effect parameters.

Modulation signal: MOD.FREQ., DEPTH

Output level: OUT LVL, MIX BAL.

Parameter details

■ Basic parameters

Parameter name	Range	Explanation
MOD. FRQ	0.1—40.0 Hz	Speed of modulation. Increasing this value will make the modulation repeat at a shorter interval.
DEPTH	0—100%	Modulation depth. Increasing this value will make the modulation deeper.
OUT LVL	0—100%	Output level after the original sound and effect sound have been mixed. Decrease this value if you want to lower the output. At a setting of 0% there will be no output.
MIX BAL.	0—100%	Balance between the original sound and effect sound. At a setting of 0% only the original sound will be output; at a setting of 100% only the effect sound will be output.

Effect list

The following table shows the default parameter values for the effect belonging to the Symphonic type (CLASSIC bank).

NO.	Effect name	MOD.FRQ	DEPTH	OUT LVL	MIX BAL.
75	SYMPHONIC	0.7 Hz	94%	100%	100%

Auto Pan (PRESET bank)

This effect cyclically moves the pan position of the sound.

Each aspect of the sound is controlled by the following effect parameters.

Modulation: FREQ., DEPTH, WAVE, DIR.

Filter/Equalizer: LSH G, LSH F, EQ G, EQ F, EQ Q, HSH G, HSH F

Tempo synchronization: SYNC, NOTE, TEMPO

Output level: OUT LVL, MIX BAL.

Parameter details

Basic parameters

Parameter name	Range	Explanation
FREQ.	0.05—40.00 Hz	Speed of modulation (panning movement). Increasing this value will make the panning movement faster.
DEPTH	0—100%	Modulation depth. Increasing this value will produce greater movement between left and right.
WAVE	Sine, Tri, Square	Waveform of the modulation signal. This will affect the character of the modulation. You can choose Sine (sine wave), Tri (triangle wave), or Square (square wave).
DIR.	L<->R, L->R, L<-R, Turn L, Turn R	Direction of panning movement. L<->R makes the sound move alternately between the L and R channels. L->R makes the sound move from L to R and then jump back to L; L<-R does the opposite. Turn L or Turn R makes the sound rotate toward the left or right.

Fine parameters

Parameter name	Range	Explanation
MIX BAL.	0—100%	Balance between the original sound and effect sound. At a setting of 0% only the original sound will be output; at a setting of 100% only the effect sound will be output.
OUT LVL	0—100%	Output level after the original sound and effect sound are mixed. Decrease this value if you want to lower the output. At a setting of 0% there will be no output.
LSH G	-12.0—+12.0 dB	Gain of the low shelving filter. This adjusts the volume of the low-frequency region. Positive (+) settings will boost the low-frequency region, and negative (-) settings will attenuate it.
LSH F	21.2 Hz—8.00 kHz	Frequency of the low shelving filter. The LSH G gain applies to the frequency region below this setting.
EQ G	-12.0—+12.0 dB	Gain of the equalizer (peaking type). This adjusts the gain of the frequency region specified by EQ F. Positive (+) settings will boost the region, and negative (-) settings will attenuate it.
EQ F	100 Hz—8.00 kHz	Frequency of the equalizer (peaking type). The EQ G gain setting will affect the region around this frequency.
EQ Q	10.0—0.10	Q (sharpness) of the equalizer (peaking type). This indicates the sharpness of the equalizer frequency response curve. Higher values will produce a sharper curve.
HSH G	-12.0—+12.0 dB	Gain of the high shelving filter. This adjusts the volume of the high-frequency region. Positive (+) settings will boost the high-frequency region, and negative (-) settings will attenuate it.
HSH F	50.0 Hz—16.0 kHz	Frequency of the high shelving filter. The HSH G gain applies to the frequency region above this setting.
SYNC	ON, OFF	Switches tempo synchronization on/off. If this is ON, the modulation speed will synchronize to the tempo synchronization source specified by "TEMPO SOURCE" (see page 23). The NOTE value will be set to the synchronized tempo value.
NOTE	*a	This parameter is used for tempo synchronization. If SYNC is ON, the FREQ. value will be set according to this value and the TEMPO value. This value is ignored if SYNC is OFF.
TEMPO	25—300	This parameter is used for tempo synchronization. If SYNC is ON, the FREQ. value will be set according to this value and NOTE. This value is ignored if SYNC is OFF.

*a. 

Effect list

The following tables show the default parameter values for the effect belonging to the Auto Pan type (PRESET bank).

Basic parameters

NO	Effect name	FREQ.	DEPTH	WAVE	DIR.
72	AUTO PAN	1.55 Hz	100%	Sine	L<->R

Fine parameters

NO	Effect name	MIX BAL.	OUT LVL	LSH G	LSH F	EQ G	EQ F	EQ Q	HSH G	HSH F
72	AUTO PAN	100%	100%	0.0 dB	125 Hz	0.0 dB	1.00 kHz	10.0	0.0 dB	10.0 kHz
		SYNC	NOTE	TEMPO						
		OFF	♩.	—						

Pan (CLASSIC bank)

This effect is based on earlier models of the SPX series. It cyclically varies the panning of the sound. Each aspect of the sound is controlled by the following effect parameters.

Modulation signal: MOD.FREQ., DIR., DEPTH

Output level: OUT LVL, MIX BAL.

Parameter details

Basic parameters

Parameter name	Range	Explanation
MOD. FRQ	0.1—40.0 Hz	Speed of modulation (panning movement). Increasing this value will make the panning move more quickly.
DIR.	L->R, L<->R, L<->R	Direction of panning movement. You can specify that the panning move back and forth between LR, or from L to R and then jump back to L (or vice versa).
DEPTH	0—100%	Modulation depth. Increasing this value will broaden the movement between L and R.
OUT LVL	0—100%	Output level after the original sound and effect sound have been mixed. Decrease this value if you want to lower the output. At a setting of 0% there will be no output.
MIX BAL.	0—100%	Balance between the original sound and effect sound. At a setting of 0% only the original sound will be output; at a setting of 100% only the effect sound will be output.

Effect list

The following table shows the default parameter values for the effect belonging to the Pan type (CLASSIC bank).

NO.	Effect name	MOD. FRQ	DIR.	DEPTH	OUT LVL	MIX BAL.
25	PAN	0.7 Hz	L->R	75%	100%	100%

Modulation Filter (PRESET bank)

This effect cyclically moves the frequency band of a filter to modulate a specific frequency region. Each aspect of the sound is controlled by the following effect parameters.

Modulation signal: FREQ., DEPTH, PHASE

Filter: TYPE, OFFSET, RESO.

Tempo synchronization: SYNC, NOTE, TEMPO

Output level: OUT LVL, MIX BAL.

Parameter details

Basic parameters

Parameter name	Range	Explanation
FREQ.	0.05—40.00 Hz	Speed of modulation. Increasing this value will make the modulation repeat at a shorter interval.
DEPTH	0—100%	Modulation depth. Increasing this value will make the modulation deeper.
PHASE	0.00—354.38 dg	Phase difference between the modulation signal of the L channel and R channel. This controls the sense of spaciousness.
TYPE	LPF, HPF, BPF	Type of filter. Choose from LPF (Low Pass Filter), HPF (High Pass Filter), and BPF (Band Pass Filter).
OFFSET	0—100	Offset value for the filter frequency. Increasing this value will raise the frequency; decreasing this value will lower the frequency. The filter frequency will change around this value. FREQ. sets the speed of change, and DEPTH sets the amount of change.
RESO.	0—20	This is the resonance. Higher values will sharpen the frequency response curve of the filter.

Fine parameters

Parameter name	Range	Explanation
MIX BAL.	0—100%	Balance between the original sound and effect sound. At a setting of 0% only the original sound will be output; at a setting of 100% only the effect sound will be output.
OUT LVL	0—100%	Output level of the effect sound. Decrease this value if you want to lower the output. At a setting of 0% there will be no output.
SYNC	ON, OFF	Switches tempo synchronization on/off. If this is ON, the speed of modulation will synchronize to the tempo synchronization source specified by “TEMPO SOURCE” (page 23). The NOTE value will be set to the synchronized tempo value.
NOTE	*a	This parameter is used for tempo synchronization. If SYNC is ON, the FREQ. value will be set according to this value and the TEMPO value. This value is ignored if SYNC is OFF.
TEMPO	25—300	This parameter is used for tempo synchronization. If SYNC is ON, the FREQ. value will be set according to this value and NOTE. This value is ignored if SYNC is OFF.

*a. 

Dynamic Filter (PRESET bank)

This effect uses the input signal or MIDI messages to vary the frequency band of a filter, creating modulation in a specific frequency region.

Each aspect of the sound is controlled by the following effect parameters.

Modulation signal: SOURCE

Filter: SENSE, TYPE, OFFSET, RESO., DIR., DECAY

Output level: OUT LVL, MIX BAL.

Parameter details

■ Basic parameters

Parameter name	Range	Explanation
SOURCE	INPUT, MIDI	Source of the modulating signal. If you select INPUT, the effect sound will change according to the input signal. If you select MIDI, the modulated sound will change according to the received MIDI messages (velocity). If you want the effect to vary according to your keyboard performance, select MIDI.
SENSE	0—100	The sensitivity to SOURCE. Higher settings of this value will cause the filter frequency to follow the SOURCE more faithfully. With lower settings, the filter frequency will follow more loosely.
TYPE	LPF, HPF, BPF	Type of filter. Choose from LPF (Low Pass Filter), HPF (High Pass Filter), and BPF (Band Pass Filter).
OFFSET	0—100	Offset value for the filter frequency. This affects the frequency of the filter when a control signal is not being received. Lowering this value if DIR. is UP (or raising it if DIR. is DOWN) will extend the variable range of the filter, producing a greater width of modulation.
RESO.	0—20	This is the resonance. Higher values will sharpen the frequency response curve of the filter.

■ Fine parameters

Parameter name	Range	Explanation
MIX BAL.	0—100%	Balance between the original sound and effect sound. At a setting of 0% only the original sound will be output; at a setting of 100% only the effect sound will be output.
OUT LVL	0—100%	Output level of the effect sound. Decrease this value if you want to lower the output. At a setting of 0% there will be no output.
DIR.	UP, DOWN	Direction in which the filter will move in response to the SOURCE signal.
DECAY ^a	44.1 kHz: 6 ms—46.0 s 48 kHz: 5 ms—42.3 s 88.2 kHz: 3 ms—23.0 s 96 kHz: 3 ms—21.1 s	Decay time of the filter. This indicates the time from when the SOURCE signal is received and the filter moves until it returns to its original position. Higher settings of this parameter will make the filter return more slowly.

^aa. The range of this parameter depends on the sampling frequency at which the SPX2000 is operating.

Effect list

The following tables show the default parameter values for the effect belonging to the Dynamic Filter type (PRESET bank).

■ Basic parameters

NO.	Effect name	SOURCE	SENSE	TYPE	OFFSET	RESO.
78	DYNA FILTER	INPUT	48	BPF	4	5

■ Fine parameters

NO.	Effect name	MIX BAL.	OUT LVL	DIR.	DECAY ^a
78	DYNA FILTER	100%	100%	UP	35 ms

^aa. The default value of this parameter depends on the sampling frequency at which the SPX2000 is operating. The value shown in the table is for $f_s = 96$ kHz.

Dynamic Flanger (PRESET bank)

This effect uses the input signal or MIDI messages to vary the delay time of the effect sound, creating modulation in a specific frequency region.

Each aspect of the sound is controlled by the following effect parameters.

Modulation signal: SOURCE

Effect sound: SENSE, OFFSET, FB.GAIN

Filter/equalizer: LSH G, LSH F, EQ G, EQ F, EQ Q, HSH G, HSH F

Output level: OUT LVL, MIX BAL.

Parameter details

Basic parameters

Parameter name	Range	Explanation
SOURCE	INPUT, MIDI	Source of the modulating signal. If you select INPUT, the effect sound will change according to the input signal. If you select MIDI, the modulated sound will change according to the received MIDI messages (velocity). If you want the effect to vary according to your keyboard performance, select MIDI.
SENSE	0—100	The sensitivity to SOURCE. Higher settings of this value will cause the delay time to follow the SOURCE more faithfully. With lower settings, the delay time will follow more loosely.
OFFSET	0—100	Offset value of the delay time. This affects the delay time when a control signal is not being received.
FB.GAIN	-99%—+99%	Amount of feedback for the modulated sound. Raising this value will increase the amount of feedback, emphasizing the modulation. Negative (-) settings will invert the phase of the feedback.

Fine parameters

Parameter name	Range	Explanation
MIX BAL.	0—100%	Balance between the original sound and effect sound. At a setting of 0% only the original sound will be output; at a setting of 100% only the effect sound will be output.
OUT LVL	0—100%	Output level after the original sound and effect sound have been mixed. Decrease this value if you want to lower the output. At a setting of 0% there will be no output.
DIR.	UP, DOWN	Direction in which the delay time will move in response to the SOURCE signal.
DECAY ^a	44.1 kHz: 6 ms—46.0 s 48 kHz: 5 ms—42.3 s 88.2 kHz: 3 ms—23.0 s 96 kHz: 3 ms—21.1 s	Decay time of the flanger. This indicates the time from when the SOURCE signal is received and the delay time changes until it returns to its original position. Higher settings of this parameter will make the delay time return more slowly.
LSH G	-12.0—+12.0 dB	Gain of the low shelving filter. This adjusts the volume of the low-frequency region. Positive (+) settings will boost the low-frequency region, and negative (-) settings will attenuate it.
LSH F	21.2 Hz—8.00 kHz	Frequency of the low shelving filter. The LSH G gain applies to the frequency region below this setting.
EQ G	-12.0—+12.0 dB	Gain of the equalizer (peaking type). This adjusts the gain of the frequency region specified by EQ F. Positive (+) settings will boost the region, and negative (-) settings will attenuate it.
EQ F	100 Hz—8.00 kHz	Frequency of the equalizer (peaking type). The EQ G gain setting will affect the region around this frequency.
EQ Q	10.0—0.10	Q (sharpness) of the equalizer (peaking type). This indicates the sharpness of the equalizer frequency response curve. Higher values will produce a sharper curve.
HSH G	-12.0—+12.0 dB	Gain of the high shelving filter. This adjusts the volume of the high-frequency region. Positive (+) settings will boost the high-frequency region, and negative (-) settings will attenuate it.
HSH F	50.0 Hz—16.0 kHz	Frequency of the high shelving filter. The HSH G gain applies to the frequency region above this setting.

^aa. The range of this parameter depends on the sampling frequency at which the SPX2000 is operating.

Effect list

The following tables show the default parameter values for the effect belonging to the Dynamic Flanger type (PRESET bank).

Basic parameters

NO.	Effect name	SOURCE	SENSE	OFFSET	FB. GAIN
75	DYNA FLANGE	INPUT	85	48	-78%

Fine parameters

NO.	Effect name	MIX BAL.	OUT LVL	DIR.	DECAY ^a	LSH G	LSH F	EQ G	EQ F	EQ Q
75	DYNA FLANGE	100%	100%	UP	158 ms	0.0 dB	125 Hz	0.0 dB	1.00 kHz	2.0
		HSH G	HSH F							
		0.0 dB	10.0 kHz							

^aa. The default value of this parameter depends on the sampling frequency at which the SPX2000 is operating. The value shown in the table is for fs = 96 kHz.

Dynamic Phaser (PRESET bank)

This effect uses the input signal or MIDI messages to vary the phase-shifted frequency, creating modulation in a specific frequency region.

Each aspect of the sound is controlled by the following effect parameters.

Modulation signal: SOURCE

Phase shift: SENSE, OFFSET, FB.GAIN, STAGE, DIR., DECAY

Filter/equalizer: LSH G, LSH F, HSH G, HSH F

Output level: OUT LVL, MIX BAL.

Parameter details

Basic parameters

Parameter name	Range	Explanation
SOURCE	INPUT, MIDI	Source of the modulating signal. If you select INPUT, the effect sound will change according to the input signal. If you select MIDI, the modulated sound will change according to the received MIDI messages (velocity). If you want the effect to vary according to your keyboard performance, select MIDI.
SENSE	0—100	The sensitivity to SOURCE. Higher settings of this value will cause the phase shift frequency to follow the SOURCE more faithfully. With lower settings, the phase shift frequency will follow more loosely.
OFFSET	0—100	Offset value of the phase shift frequency. This affects the basic frequency when a control signal is not being received.
FB.GAIN	-99%—+99%	Amount of feedback for the effect sound. Raising this value will increase the amount of feedback, emphasizing the modulation. Negative (-) settings will invert the phase of the feedback.
STAGE	2, 4, 6, 8, 10, 12, 14, 16	Number of stages in the phase shift circuitry. Raising this value will produce a more complex sense of modulation.

Fine parameters

Parameter name	Range	Explanation
MIX BAL.	0—100%	Balance between the original sound and effect sound. At a setting of 0% only the original sound will be output; at a setting of 100% only the effect sound will be output.
OUT LVL	0—100%	Output level after the original sound and effect sound have been mixed. Decrease this value if you want to lower the output. At a setting of 0% there will be no output.
DIR.	UP, DOWN	Direction in which the phase-shifted frequency will move in response to the SOURCE signal.
DECAY ^a	44.1 kHz: 6 ms—46.0 s 48 kHz: 5 ms—42.3 s 88.2 kHz: 3 ms—23.0 s 96 kHz: 3 ms—21.1 s	Decay time of the phaser. This indicates the time from when the SOURCE signal is received and the phaser moves until it returns to its original position. Higher settings of this parameter will make the phase shift frequency return more slowly.
LSH G	-12.0—+12.0 dB	Gain of the low shelving filter. This adjusts the volume of the low-frequency region. Positive (+) settings will boost the low-frequency region, and negative (-) settings will attenuate it.
LSH F	21.2 Hz—8.00 kHz	Frequency of the low shelving filter. The LSH G gain applies to the frequency region below this setting.
HSH G	-12.0—+12.0 dB	Gain of the high shelving filter. This adjusts the volume of the high-frequency region. Positive (+) settings will boost the high-frequency region, and negative (-) settings will attenuate it.
HSH F	50.0 Hz—16.0 kHz	Frequency of the high shelving filter. The HSH G gain applies to the frequency region above this setting.

^aa. The range of this parameter depends on the sampling frequency at which the SPX2000 is operating.

Effect list

The following tables show the default parameter values for the effect belonging to the Dynamic Phaser type (PRESET bank).

Basic parameters

NO.	Effect name	SOURCE	SENSE	OFFSET	FB.GAIN	STAGE
77	DYNA PHASER	INPUT	50	32	+70%	8

Fine parameters

NO.	Effect name	MIX BAL.	OUT LVL	DIR.	DECAY ^a	LSH G	LSH F	HSH G	HSH F
77	DYNA PHASER	100%	100%	UP	184 ms	0.0 dB	125 Hz	0.0 dB	10.0 kHz

^aa. The default value of this parameter depends on the sampling frequency at which the SPX2000 is operating. The value shown in the table is for $f_s = 96$ kHz.

Effect list

The following tables show the default parameter values for the effect belonging to the High Quality Pitch type (PRESET bank).

■ Basic parameters

NO.	Effect name	PITCH	FINE	DELAY	FB.GAIN
58	ROGER ON THE 12	+12	0	0.0 ms	0%

■ Fine parameters

NO.	Effect name	MIX BAL.	OUT LVL	MODE	SYNC	NOTE	TEMPO
58	ROGER ON THE 12	100%	90%	6	OFF		—

Dual Pitch (PRESET bank)

This is essentially the same as High Quality Pitch, but there are two effect sounds whose pitch can be specified independently. Each aspect of the sound is controlled by the following effect parameters.

Effect sound 1: PITCH 1, FINE 1, DELAY 1, FB.G 1, MODE

Effect sound 2: PITCH 2, FINE 2, DELAY 2, FB.G 2, MODE

Tempo synchronization: SYNC, NOTE 1, NOTE 2, TEMPO

Output level: LEVEL 1, LEVEL 2, MIX BAL.

Parameter details

■ Basic parameters

Parameter name	Range	Explanation
PITCH 1 PITCH 2	-24—+24	Amount of pitch change, adjusted in semitone steps. Positive (+) settings make the pitch higher than the original sound, and negative (-) settings make it lower.
FINE 1 FINE 2	-50—+50	Amount of pitch change, adjusted in steps of one cent (1/100th of a semitone). Positive (+) settings make the pitch higher than the original sound, and negative (-) settings make it lower.
DELAY 1 DELAY 2	0.0—1000.0 ms	Delay of the effect sound relative to the original sound.
FB.G 1 FB.G 2	-99%—+99%	Amount of feedback for the effect sound. Raising this value will increase the amount of feedback, emphasizing the pitch change. Negative (-) settings will invert the phase of the feedback.
LEVEL 1 LEVEL 2	-100%—+100%	Output levels of the effect 1 and effect 2 sounds. LEVEL 1 is the output level for effect sound 1, and LEVEL 2 is the output level for effect sound 2. Negative (-) settings invert the phase.
PAN 1 PAN 2	L63—R63	Position of each effect sound. L63 is far left, and R63 is far right.

■ Fine parameters

Parameter name	Range	Explanation
MIX BAL.	0—100%	Balance between the original sound and effect sound. At a setting of 0% only the original sound will be output; at a setting of 100% only the effect sound will be output.
MODE	1—10	Precision of the pitch change. Higher settings produce a more accurate pitch change, but the delay error will be greater.
SYNC	ON, OFF	Switches tempo synchronization on/off. If this is ON, the delay time will synchronize to the tempo synchronization source specified by the "TEMPO SOURCE" setting (page 23). The NOTE 1 and the NOTE 2 value will be set to the synchronized tempo value.
NOTE 1 NOTE 2	*a	These parameters are used for tempo synchronization. If SYNC is ON, the DELAY 1 value will be set according to the NOTE 1 and TEMPO values, and the DELAY 2 value will be set according to the NOTE 2 and TEMPO values. If SYNC is OFF, this value is ignored.
TEMPO	25—300	These parameters are used for tempo synchronization. If SYNC is ON, the DELAY 1 value will be set according to the NOTE 1 and TEMPO values, and the DELAY 2 value will be set according to the NOTE 2 and TEMPO values. If SYNC is OFF, this value is ignored.

*a. 

Effect list

The following tables show the default parameter values for the effects belonging to the Dual Pitch type (PRESET bank).

■ Basic parameters

NO.	Effect name	PITCH 1	FINE 1	DELAY 1	FB.G 1	LEVEL 1	PAN 1
52	GOOD OL P.CHANGE	0	+8	10.0 ms	0%	+90%	R63
53	VOCAL SHIFT	0	+12	13.1 ms	+18%	+90%	L32
54	STEREO PITCH	-4	0	0.0 ms	0%	+100%	L63
55	PITCH SLAP	0	+9	25.0 ms	0%	+90%	L63
56	HALO COMB	+12	0	250.0 ms	+57%	+90%	R63
57	GRUMPY FLUTTER	-12	0	500.0 ms	+79%	+90%	CENTER
59	BOTTOM WHACKER	-20	+8	25.1 ms	+58%	+100%	CENTER
60	VOICE DOUBLER	0	+2	4.0 ms	0%	+100%	R63
65	BASS CHORUS	0	+9	2.0 ms	0%	+100%	L63
NO.	Effect name	PITCH 2	FINE 2	DELAY 2	FB.G 2	LEVEL 2	PAN 2
52	GOOD OL P.CHANGE	0	-8	20.0 ms	0%	+90%	L63
53	VOCAL SHIFT	0	-12	27.2 ms	+24%	+90%	R32
54	STEREO PITCH	-4	0	0.0 ms	0%	+100%	R63
55	PITCH SLAP	0	-9	275.0 ms	0%	+90%	R63
56	HALO COMB	+12	0	500.0 ms	+35%	+90%	L63
57	GRUMPY FLUTTER	0	-10	125.0 ms	+79%	+90%	CENTER
59	BOTTOM WHACKER	-20	+8	25.1 ms	+58%	+100%	CENTER
60	VOICE DOUBLER	0	-2	7.0 ms	0%	+100%	L63
65	BASS CHORUS	0	-9	0.0 ms	0%	+100%	R63

■ Fine parameters

NO.	Effect name	MIX BAL.	MODE	SYNC	NOTE 1	NOTE 2	TEMPO
52	GOOD OL P.CHANGE	100%	3	OFF	♩	♩	—
53	VOCAL SHIFT	100%	3	OFF	♩	♩	—
54	STEREO PITCH	100%	3	OFF	♩	♩	—
55	PITCH SLAP	100%	3	OFF	♩	♩	—
56	HALO COMB	100%	2	OFF	♩	♩	—
57	GRUMPY FLUTTER	100%	2	OFF	♩	♩	—
59	BOTTOM WHACKER	100%	2	OFF	♩	♩	—
60	VOICE DOUBLER	100%	2	OFF	♩	♩	—
65	BASS CHORUS	100%	3	OFF	♩	♩	—

Pitch Change A, D (CLASSIC bank)

These are pitch change effects based on earlier models of the SPX series. They are equivalent to the High Quality Pitch effects of the PRESET bank, but have a simpler parameter structure than the PRESET bank effects. Since MIDI note-on messages can be used to change the pitch, you can connect a MIDI keyboard and change the pitch according to your accompaniment. Each aspect of the sound is controlled by the following effect parameters.

Effect sound: PITCH, FINE, DELAY, F.B.GAIN

MIDI control: BASE KEY

Output level: OUT LVL, MIX BAL.

Parameter details

■ Basic parameters

Parameter name	Range	Explanation
PITCH	-12—+12	Amount of pitch change, set in semitone steps. Positive (+) settings make the pitch higher than the original sound, and negative (-) settings make it lower.
FINE	-50—+50	Amount of pitch change, set in cents (1/100th of a semitone). Positive (+) settings make the pitch higher than the original sound, and negative (-) settings make it lower.
DELAY	0.0—1000.0 ms	Delay of the effect sound relative to the original sound.
F.B.GAIN	0%—99%	Amount of feedback for the effect sound. Raising this value will increase the amount of feedback, emphasizing the pitch change. Negative (-) settings will invert the phase of the feedback.
BASE KEY	OFF, C 1—C 6	Base key for when receiving MIDI note-on messages. When a MIDI Note-on message with note number C1 or higher is received, its distance from this setting will be used to update the PITCH value. For example if you set this parameter as C4, a received note-on message of C3 will cause PITCH to be set to -12, making the effect sound one octave lower than the original pitch. If you set this parameter as C2, a received note-on message of D2 will cause PITCH to be set to +2, making the effect sound two semitones higher than the original pitch. If this parameter is OFF, MIDI note-on messages will not be received.
OUT LVL	0—100%	Output level after the original sound and effect sound have been mixed. Decrease this value if you want to lower the output. At a setting of 0% there will be no output.
MIX BAL.	0—100%	Balance between the original sound and effect sound. At a setting of 0% only the original sound will be output; at a setting of 100% only the effect sound will be output.

Effect list

The following table shows the default parameter values for the effects belonging to the Pitch Change A, D types (CLASSIC bank).

■ Basic parameters

NO.	Effect name	PITCH	FINE	DELAY	F.B.GAIN	BASE KEY	OUT LVL	MIX BAL.
19	PITCH CHANGE A	0	0	0.0 ms	0%	C 3	80%	100%
22	PITCH CHANGE D	0	0	0.0 ms	0%	C 3	80%	100%

Pitch Change B (CLASSIC bank)

This is a pitch change effect based on earlier models of the SPX series. It is equivalent to the Dual Pitch effect of the PRESET bank. The two effect sounds will be mixed and output.

Each aspect of the sound is controlled by the following effect parameters.

Effect sound 1: 1 PITCH, 1 FINE, 1 DLY

Effect sound 2: 2 PITCH, 2 FINE, 2 DLY

Output level: OUT LVL, MIX BAL.

Parameter details

■ Basic parameters

Parameter name	Range	Explanation
1 PITCH 2 PITCH	-12→+12	Amount of pitch change, set in semitone steps. Positive (+) settings make the pitch higher than the original sound, and negative (-) settings make it lower.
1 FINE 2 FINE	-100→+100	Amount of pitch change, set in cents (1/100th of a semitone). Positive (+) settings make the pitch higher than the original sound, and negative (-) settings make it lower.
1 DLY 2 DLY	0.0—1000.0 ms	Delay of the effect sound relative to the original sound.
OUT LVL	0—100%	Output level after the original sound and effect sound have been mixed. Decrease this value if you want to lower the output. At a setting of 0% there will be no output.
MIX BAL.	0—100%	Balance between the original sound and effect sound. At a setting of 0% only the original sound will be output; at a setting of 100% only the effect sound will be output.

Effect list

The following table shows the default parameter values for the effect belonging to the Pitch Change B type (CLASSIC bank).

NO.	Effect name	1 PITCH	1 FINE	1 DLY	2 PITCH	2 FINE	2 DLY	OUT LVL	MIX BAL.
20	PITCH CHANGE B	0	+8	0.1 ms	0	-8	20.0 ms	100%	100%

Pitch Change C (CLASSIC bank)

This is a pitch change effect based on earlier models of the SPX series. It is equivalent to the Dual Pitch effect of the PRESET bank. The two effect sounds will be output separately from the L and R channels.

Each aspect of the sound is controlled by the following effect parameters.

L channel effect sound: L PITCH, L FINE, L DLY

R channel effect sound: R PITCH, R FINE, R DLY

Output level: OUT LVL, MIX BAL.

Parameter details

■ Basic parameters

Parameter name	Range	Explanation
L PITCH R PITCH	-12→+12	Amount of pitch change, set in semitone steps. Positive (+) settings make the pitch higher than the original sound, and negative (-) settings make it lower.
L FINE R FINE	-100→+100	Amount of pitch change, set in cents (1/100th of a semitone). Positive (+) settings make the pitch higher than the original sound, and negative (-) settings make it lower.
L DLY R DLY	0.0—1000.0 ms	Delay of the effect sound relative to the original sound.
OUT LVL	0—100%	Output level after the original sound and effect sound have been mixed. Decrease this value if you want to lower the output. At a setting of 0% there will be no output.
MIX BAL.	0—100%	Balance between the original sound and effect sound. At a setting of 0% only the original sound will be output; at a setting of 100% only the effect sound will be output.

Effect list

The following table shows the default parameter values for the effect belonging to the Pitch Change C type (CLASSIC bank).

NO.	Effect name	L PITCH	L FINE	L DLY	R PITCH	R FINE	R DLY	OUT LVL	MIX BAL.
21	PITCH CHANGE C	0	+8	0.1 ms	0	-8	0.1 ms	100%	100%

Composite effects

These are combinations of two different effects. Types listed as Effect 1 + Effect 2 process the original sound separately and then mix the result. Types listed as Effect 1 → Effect 2 process the original sound first through Effect 1 and then process the result through Effect 2.

Type	Bank	No. of INs/OUTs	Page
Distortion → Flanger	PRESET	1 IN/2 OUT	66
Distortion → Delay			
Reverb + Chorus			68
Reverb → Chorus			
Reverb + Flanger			69
Reverb → Flanger			
Reverb + Symphonic			71
Reverb → Symphonic			
Reverb → Pan			72
Delay + Early Reflection			
Delay → Early Reflection			73
Delay + Reverb			
Delay → Reverb			75

Distortion → Flanger (PRESET bank)

Distortion → Delay (PRESET bank)

These effects apply distortion to the original sound, and then apply flanger or delay. Each aspect of the sound is controlled by the following effect parameters.

Distortion: DST TYPE, DRIVE, TONE

Modulation: FREQ., DEPTH

Applicable to both Distortion and Modulation: DELAY, FB.GAIN, HI.RATIO, DLY.BAL

Noise gate: N.GATE

Tempo synchronization: SYNC, DLY.NOTE, MOD.NOTE, TEMPO

Output level: MIX.BAL, MASTER

Parameter details

■ Basic parameters

Parameter name	Range	Explanation
DST TYPE	DST1, DST2, OVD1, OVD2, CRUNCH	Type of distortion; this determines the basic character of the effect. The character of the distortion will depend on the type you select.
DRIVE	0—100	Distortion depth. Raising this value will produce stronger distortion.
TONE	-10—+10	Controls the level of the high-frequency range. Positive (+) settings produce a more piercing tone, and negative (-) settings produce a more mellow tone.
DELAY	0.0—2725.0 ms	Delay of the effect sound relative to the original sound. The delay time will vary around this value. FREQ. sets the speed of variation, and DEPTH sets the depth of variation.
FB.GAIN	-99%—+99%	Amount of feedback for the effect sound. Raising this value will increase the amount of feedback, emphasizing the modulation. Negative (-) settings will invert the phase of the feedback.
HI.RATIO	0.1—1.0	Amount of feedback for the high-frequency range. This is specified as a proportion of FB.GAIN. If this value is 0.1, the feedback amount will be 1/10th of FB.GAIN; if this value is 1.0, the feedback amount will be the same as FB.GAIN.
FREQ.	0.05—40.00 Hz	Speed of modulation. Increasing this value will make the modulation repeat at a shorter interval.
DEPTH	0—100%	Depth of modulation. Increasing this value will make the modulation deeper.

■ Fine parameters

Parameter name	Range	Explanation
MIX BAL.	0—100%	Balance between the original sound and effect sound. At a setting of 0% only the original sound will be output; at a setting of 100% only the effect sound will be output.
N.GATE	0—20	Noise gate depth. Raising this value will raise the level of the signals that will be allowed through the gate. This is a useful way to remove noise.
MASTER	0—100	Output level of the effect sound. Turn down this value if you want to reduce the effect sound.
DLY.BAL	0%—100%	Amount of delay. Raising this value will strengthen the delay effect. At a setting of 0% only distortion will be heard.
SYNC	ON, OFF	Switches tempo synchronization on/off. If this is ON, the delay and the speed of modulation will synchronize to the tempo synchronization source specified by “TEMPO SOURCE” (page 23). The DLY.NOTE and the MOD.NOTE value will be set to the synchronized tempo value.
DLY.NOTE	*a	This parameter is used for tempo synchronization. If SYNC is ON, the DELAY value will be set according to this value and TEMPO. If SYNC is OFF, this value is ignored.
MOD.NOTE	*b	This parameter is used for tempo synchronization. If SYNC is ON, the FREQ. value will be set according to this value and TEMPO. If SYNC is OFF, this value is ignored.
TEMPO	25—300	This parameter is used for tempo synchronization. If SYNC is ON, the DELAY value will be set according to the DLY.NOTE and TEMPO values, and the FREQ. value will be set according to the MOD.NOTE and TEMPO values. If SYNC is OFF, this value is ignored.

*a. 





*b. 

Effect list

■ Basic parameters

NO.	Effect name	DST TYPE	DRIVE	TONE	DELAY	FB.GAIN	HI.RATIO	FREQ.	DEPTH
84	DIST->FLANGE	DST2	80	+9	0.6 ms	-78%	0.9	0.35 Hz	40%
85	DIST->DELAY	OVD1	15	+6	250.0 ms	-52%	0.2	2.65 Hz	18%

■ Fine parameters

NO.	Effect name	MIX BAL.	N.GATE	MASTER	DLY.BAL	SYNC	DLY.NOTE	MOD.NOTE	TEMPO
84	DIST->FLANGE	100%	1	25	100%	OFF			—
85	DIST->DELAY	100%	1	75	40%	OFF			—

Reverb + Chorus (PRESET bank)

Reverb → Chorus (PRESET bank)

Reverb + Chorus separately applies reverb and chorus to the original sound, and then mixes the results.

Reverb → Chorus applies reverb to the original sound and then applies chorus.

Each aspect of the sound is controlled by the following effect parameters.

Reverb: REV TIME, HI.RATIO, INI.DLY, DIFF., DENSITY

Chorus: FREQ., AM DEPTH, PM DEPTH, MOD.DLY, WAVE

Balance of reverb and chorus: REV/CHO, REV.BAL

Filter/equalizer: HPF, LPF

Tempo synchronization: SYNC, NOTE, TEMPO

Output level: OUT LVL, MIX BAL.

Parameter details

■ Basic parameters

Parameter name	Range	Explanation
FREQ.	0.05—40.00 Hz	Speed of modulation (AM, PM). Increasing this value will make the modulation repeat at a shorter interval.
AM DEPTH	0—100%	Amplitude modulation (AM) depth. Increasing this value will produce greater volume change.
PM DEPTH	0—100%	Pitch modulation (PM) depth. Increasing this value will produce greater pitch change.
MOD.DLY	0.0—500.0 ms	Delay of the effect sound relative to the original sound.
WAVE	Sine, Tri	Waveform of the modulation signal. This will affect the character of the modulation. You can choose Sine (sine wave) or Tri (triangle wave).
REV TIME	0.3—99.0 s	Reverb time. This is expressed as the time over which reverberation at 1 kHz will decay by 60 dB.
HI.RATIO	0.1—1.0	Reverb time for the high-frequency range, expressed as a proportion of REV TIME. If this value is 0.1 the time will be 1/10th the REV TIME; if it is 1.0 the time will be the same as the REV TIME. You can adjust these values to simulate the absorptiveness of the walls or ceiling. HI.RATIO is the decay of the high-frequency range.
INI.DLY	0.0—500.0 ms	Delay of the early reflections relative to the original sound. This also affects the delay until the reverberation is heard.
DIFF.	0—10	Diffusion of the sound to left and right. Increasing this value will make the reverberation more spaciousness.
DENSITY	0—100%	Density of the reverberation. Increasing this value will make the reverberation smoother. You can create unique effects by lowering this value.

■ Fine parameters

Parameter name	Range	Explanation
MIX BAL.	0—100%	Balance between the original sound and effect sound. At a setting of 0% only the original sound will be output; at a setting of 100% only the effect sound will be output.
OUT LVL	0—100%	Output level after the original sound and effect sound have been mixed. Decrease this value if you want to lower the output. At a setting of 0% there will be no output.
HPF	Thru, 21.2 Hz—8.00 kHz	A filter that cuts the low-frequency portion of the effect. Frequency components lower than the frequency specified here will be cut. With a setting of Thru this filter will do nothing. This filter does not affect the original sound.
LPF	50.0 Hz—16.0 kHz, Thru	A filter that cuts the high-frequency portion of the effect. Frequency components above the frequency specified here will be cut. With a setting of Thru this filter will do nothing. This filter does not affect the original sound.
REV/CHO	0—100%	(Reverb + Chorus only) Balance between the reverb and chorus. A setting of 0% outputs only the reverb; a setting of 100% outputs only the chorus.
REV.BAL	0—100%	(Reverb → Chorus only) Amount of chorus. Raising this value will strengthen the chorus effect. At a setting of 0% only reverb will be heard.
SYNC	ON, OFF	Switches tempo synchronization on/off. If this is ON, the speed of modulation will synchronize to the tempo synchronization source specified by “TEMPO SOURCE” (page 23). The NOTE value will be set to the synchronized tempo value.
NOTE	*a	This parameter is used for tempo synchronization. If SYNC is ON, the FREQ. value will be set according to this value and TEMPO. If SYNC is OFF, this value is ignored.
TEMPO	25—300	This parameter is used for tempo synchronization. If SYNC is ON, the FREQ. value will be set according to this value and NOTE. If SYNC is OFF, this value is ignored.

*a. 

Effect list

■ Basic parameters

NO.	Effect name	FREQ.	AM DEPTH	PM DEPTH	MOD.DLY	WAVE	REV TIME	HI.RATIO	INI.DLY	DIFF.
54	CHORUS & REVERB	0.65 Hz	30%	58%	5.2 ms	Sine	2.4 s	0.1	10.0 ms	9
85	REV->CHORUS	2.00 Hz	74%	18%	17.0 ms	Tri	2.1 s	0.4	17.0 ms	7
NO.	Effect name	DENSITY								
54	CHORUS & REVERB	100%								
85	REV->CHORUS	100%								

■ Fine parameters

NO.	Effect name	MIX BAL.	OUT LVL	HPF	LPF	REV/CHO	REV.BAL	SYNC	NOTE	TEMPO
54	CHORUS & REVERB	100%	100%	Thru	10.0 kHz	78%		OFF	♪	—
85	REV->CHORUS	100%	100%	Thru	8.00 kHz		65%	OFF	♪	—

Reverb + Flanger (PRESET bank) Reverb → Flanger (PRESET bank)

Reverb + Flanger separately applies reverb and flanger to the original sound, and then mixes the results.

Reverb -> Flanger applies reverb to the original sound and then applies flanger.

Each aspect of the sound is controlled by the following effect parameters.

Reverb: REV TIME, HI.RATIO, INI.DLY, DIFF., DENSITY

Flanger: FREQ., DEPTH, MOD.DLY, FB GAIN, WAVE

Balance of reverb and flanger: REV/FLG, REV.FLG

Filter/equalizer: HPF, LPF

Tempo synchronization: SYNC, NOTE, TEMPO

Output level: OUT LVL, MIX BAL.

Parameter details

■ Basic parameters

Parameter name	Range	Explanation
FREQ.	0.05—40.00 Hz	Speed of modulation. Increasing this value will make the modulation repeat at a shorter interval.
DEPTH	0—100%	Modulation depth. Increasing this value will produce deeper modulation.
MOD.DLY	0.0—500.0 ms	Delay of the effect sound relative to the original sound. The delay time will be modulated around this value. FREQ. sets the speed of this change, and DEPTH sets the depth.
FB.GAIN	-99%—+99%	Amount of feedback for the effect sound. Raising this value will increase the amount of feedback, emphasizing the modulation. Negative (-) settings will invert the phase of the feedback.
WAVE	Sine, Tri	Waveform of the modulation signal. This will affect the character of the modulation. You can choose Sine (sine wave) or Tri (triangle wave).
REV TIME	0.3—99.0 s	Reverb time. This is expressed as the time over which reverberation at 1 kHz will decay by 60 dB.
HI.RATIO	0.1—1.0	Reverb time for the high-frequency range, expressed as a proportion of REV TIME. If this value is 0.1 the time will be 1/10th the REV TIME; if it is 1.0 the time will be the same as the REV TIME. You can adjust these values to simulate the absorptiveness of the walls or ceiling. HI.RATIO is the decay of the high-frequency range.
INI.DLY	0.0—500.0 ms	Delay of the early reflections relative to the original sound. This also affects the delay until the reverberation is heard.
DIFF.	0—10	Diffusion of the sound to left and right. Increasing this value will make the reverberation more spaciousness.
DENSITY	0—100%	Density of the reverberation. Increasing this value will make the reverberation smoother. You can create unique effects by lowering this value.

■ Fine parameters

Parameter name	Range	Explanation
MIX BAL.	0—100%	Balance between the original sound and effect sound. At a setting of 0% only the original sound will be output; at a setting of 100% only the effect sound will be output.
OUT LVL	0—100%	Output level after the original sound and effect sound have been mixed. Decrease this value if you want to lower the output. At a setting of 0% there will be no output.
HPF	Thru, 21.2 Hz—8.00 kHz	A filter that cuts the low-frequency portion of the effect. Frequency components lower than the frequency specified here will be cut. With a setting of Thru this filter will do nothing. This filter does not affect the original sound.
LPF	50.0 Hz—16.0 kHz, Thru	A filter that cuts the high-frequency portion of the effect. Frequency components above the frequency specified here will be cut. With a setting of Thru this filter will do nothing. This filter does not affect the original sound.
REV/FLG	0—100%	(Reverb + Flanger only) Balance between the reverb and flanger. A setting of 0% outputs only the reverb; a setting of 100% outputs only the flanger.
REV.BAL	0—100%	(Reverb → Flanger only) Amount of flanger. Raising this value will strengthen the flanger effect. At a setting of 0% only reverb will be heard.
SYNC	ON, OFF	Switches tempo synchronization on/off. If this is ON, the speed of modulation will synchronize to the tempo synchronization source specified by “TEMPO SOURCE” (page 23). The NOTE value will be set to the synchronized tempo value.
NOTE	*a	This parameter is used for tempo synchronization. If SYNC is ON, the FREQ. value will be set according to this value and TEMPO. If SYNC is OFF, this value is ignored.
TEMPO	25—300	This parameter is used for tempo synchronization. If SYNC is ON, the FREQ. value will be set according to this value and NOTE. If SYNC is OFF, this value is ignored.



*a.                                            

Effect list

■ Basic parameters

NO.	Effect name	FREQ.	DEPTH	MOD.DLY	FB.GAIN	WAVE	REV TIME	HI.RATIO	INI.DLY	DIFF.	DENSITY
14	REVERB FLANGE	1.10 Hz	80%	1.2 ms	+10%	Sine	2.4 s	0.4	0.1 ms	5	95%
87	REV+FLANGE	0.25 Hz	88%	0.3 ms	-84%	Tri	1.9 s	0.7	2.4 ms	10	100%

■ Fine parameters

NO.	Effect name	MIX BAL.	OUT LVL	HPF	LPF	REV/FLG	REV.BAL	SYNC	NOTE	TEMPO
14	REVERB FLANGE	76%	100%	Thru	4.25 kHz		60%	OFF		—
87	REV+FLANGE	100%	100%	Thru	Thru	67%		OFF		—

Reverb + Symphonic (PRESET bank)

Reverb → Symphonic (PRESET bank)

Reverb + Symphonic separately applies reverb and symphonic to the original sound, and then mixes the results.

Reverb → Symphonic applies reverb to the original sound and then applies symphonic.

Each aspect of the sound is controlled by the following effect parameters.

Reverb: REV TIME, HI.RATIO, INI.DLY, DIFF., DENSITY

Symphonic: FREQ., DEPTH, MOD.DLY, WAVE

Balance of reverb and symphonic: REV/SYM, REV.BAL

Filter/equalizer: HPF, LPF

Tempo synchronization: SYNC, NOTE, TEMPO

Output level: OUT LVL, MIX BAL.

Parameter details

Basic parameters

Parameter name	Range	Explanation
FREQ.	0.05—40.00 Hz	Speed of modulation. Increasing this value will make the modulation repeat at a shorter interval.
DEPTH	0—100%	Modulation depth. Increasing this value will produce deeper modulation.
MOD.DLY	0.0—500.0 ms	Delay of the effect sound relative to the original sound.
WAVE	Sine, Tri	Waveform of the modulation signal. This will affect the character of the modulation. You can choose Sine (sine wave) or Tri (triangle wave).
REV TIME	0.3—99.0 s	Reverb time. This is expressed as the time over which reverberation at 1 kHz will decay by 60 dB.
HI.RATIO	0.1—1.0	Reverb time for the high-frequency range, expressed as a proportion of REV TIME. If this value is 0.1 the time will be 1/10th the REV TIME; if it is 1.0 the time will be the same as the REV TIME. You can adjust these values to simulate the absorptiveness of the walls or ceiling. HI.RATIO is the decay of the high-frequency range.
INI.DLY	0.0—500.0 ms	Delay of the early reflections relative to the original sound. This also affects the delay until the reverberation is heard.
DIFF.	0—10	Diffusion of the sound to left and right. Increasing this value will make the reverberation more spaciousness.
DENSITY	0—100%	Density of the reverberation. Increasing this value will make the reverberation smoother. You can create unique effects by lowering this value.

Fine parameters

Parameter name	Range	Explanation
MIX BAL.	0—100%	Balance between the original sound and effect sound. At a setting of 0% only the original sound will be output; at a setting of 100% only the effect sound will be output.
OUT LVL	0—100%	Output level after the original sound and effect sound have been mixed. Decrease this value if you want to lower the output. At a setting of 0% there will be no output.
HPF	Thru, 21.2 Hz—8.00 kHz	A filter that cuts the low-frequency portion of the effect. Frequency components lower than the frequency specified here will be cut. With a setting of Thru this filter will do nothing. This filter does not affect the original sound.
LPF	50.0 Hz—16.0 kHz, Thru	A filter that cuts the high-frequency portion of the effect. Frequency components above the frequency specified here will be cut. With a setting of Thru this filter will do nothing. This filter does not affect the original sound.
REV/SYM	0—100%	(Reverb + Symphonic only) Balance between the reverb and symphonic. A setting of 0% outputs only the reverb; a setting of 100% outputs only the symphonic.
REV.BAL	0—100%	(Reverb → Symphonic only) Amount of symphonic. Raising this value will strengthen the symphonic effect. At a setting of 0% only reverb will be heard.
SYNC	ON, OFF	Switches tempo synchronization on/off. If this is ON, the speed of modulation will synchronize to the tempo synchronization source specified by “TEMPO SOURCE” (page 23). The NOTE value will be set to the synchronized tempo value.
NOTE	*a	This parameter is used for tempo synchronization. If SYNC is ON, the FREQ. value will be set according to this value and TEMPO. If SYNC is OFF, this value is ignored.
TEMPO	25—300	This parameter is used for tempo synchronization. If SYNC is ON, the FREQ. value will be set according to this value and NOTE. If SYNC is OFF, this value is ignored.

*a. 

Effect list

Basic parameters

NO.	Effect name	FREQ.	DEPTH	MOD.DLY	WAVE	REV TIME	HI.RATIO	INI.DLY	DIFF.	DENSITY
52	REV+SYMPHONIC	0.95 Hz	63%	3.2 ms	Sine	0.6 s	0.9	40.0 ms	10	100%
88	REV->SYMPHONIC	2.50 Hz	30%	14.0 ms	Sine	1.6 s	1.0	7.0 ms	10	98%

■ Fine parameters

NO.	Effect name	MIX BAL.	OUT LVL	HPF	LPF	REV/SYM	REV.BAL	SYNC	NOTE	TEMPO
62	REV+SYMPHONIC	100%	100%	Thru	Thru	78%		OFF	↓	—
88	REV->SYMPHONIC	100%	100%	Thru	Thru		45%	OFF	↓	—

Reverb → Pan (PRESET bank)

This applies reverb to the original sound and then applies panning. Each aspect of the sound is controlled by the following effect parameters.

Reverb: REV TIME, HI.RATIO, INI.DLY, DIFF., DENSITY

Pan: FREQ., DEPTH, WAVE, DIR.

Balance of reverb and pan: REV.BAL

Filter/equalizer: HPF, LPF

Tempo synchronization: SYNC, NOTE, TEMPO

Output level: OUT LVL, MIX BAL.

Parameter details

■ Basic parameters

Parameter name	Range	Explanation
FREQ.	0.05—40.00 Hz	Speed of modulation (panning movement). Increasing this value will make the modulation repeat at a shorter interval.
DEPTH	0—100%	Modulation depth. Increasing this value will produce deeper modulation.
WAVE	Sine, Tri, Square	Waveform of the modulation signal. This affects the character of the modulation. You can select Sine (sine wave), Tri (triangle wave), or Square (square wave).
DIR.	L<->R, L->R, L<-R, Turn L, Turn R	Direction of panning movement. L<->R makes the sound move alternately between the L and R channels. L->R makes the sound move from L to R and then jump back to L; L<-R does the opposite. Turn L or Turn R makes the sound rotate toward the left or right.
REV TIME	0.3—99.0 s	Reverb time. This is expressed as the time over which reverberation at 1 kHz will decay by 60 dB.
HI.RATIO	0.1—1.0	Reverb time for the high-frequency range, expressed as a proportion of REV TIME. If this value is 0.1 the time will be 1/10th the REV TIME; if it is 1.0 the time will be the same as the REV TIME. You can adjust these values to simulate the absorptiveness of the walls or ceiling. HI.RATIO is the decay of the high-frequency range.
INI.DLY	0.0—500.0 ms	Delay of the early reflections relative to the original sound. This also affects the delay until the reverberation is heard.
DIFF.	0—10	Diffusion of the sound to left and right. Increasing this value will make the reverberation more spaciousness.
DENSITY	0—100%	Density of the reverberation. Increasing this value will make the reverberation smoother. You can create unique effects by lowering this value.

■ Fine parameters

Parameter name	Range	Explanation
MIX BAL.	0—100%	Balance between the original sound and effect sound. At a setting of 0% only the original sound will be output; at a setting of 100% only the effect sound will be output.
OUT LVL	0—100%	Output level after the original sound and effect sound have been mixed. Decrease this value if you want to lower the output. At a setting of 0% there will be no output.
HPF	Thru, 21.2 Hz—8.00 kHz	A filter that cuts the low-frequency portion of the effect. Frequency components lower than the frequency specified here will be cut. With a setting of Thru this filter will do nothing. This filter does not affect the original sound.
LPF	50.0 Hz—16.0 kHz, Thru	A filter that cuts the high-frequency portion of the effect. Frequency components above the frequency specified here will be cut. With a setting of Thru this filter will do nothing. This filter does not affect the original sound.
REV.BAL	0—100%	Amount of auto pan. Raising this value will strengthen the auto pan effect. At a setting of 0% only reverb will be heard.
SYNC	ON, OFF	Switches tempo synchronization on/off. If this is ON, the speed of modulation will synchronize to the tempo synchronization source specified by “TEMPO SOURCE” (page 23). The NOTE value will be set to the synchronized tempo value.
NOTE	*a	This parameter is used for tempo synchronization. If SYNC is ON, the FREQ. value will be set according to this value and TEMPO. If SYNC is OFF, this value is ignored.
TEMPO	25—300	This parameter is used for tempo synchronization. If SYNC is ON, the FREQ. value will be set according to this value and NOTE. If SYNC is OFF, this value is ignored.

*a. 

Effect list

■ Basic parameters

NO.	Effect name	FREQ.	DEPTH	WAVE	DIR.	REV TIME	HI.RATIO	INI.DLY	DIFF.	DENSITY
89	REV->PAN	1.00 Hz	100%	Tri	L<->R	3.8 s	1.0	18.8 ms	10	90%

■ Fine parameters

NO.	Effect name	MIX BAL.	OUT LVL	HPF	LPF	REV.BAL	SYNC	NOTE	TEMPO
89	REV->PAN	100%	100%	Thru	14.0 kHz	25%	OFF	♪	—

Delay + Early Reflections (PRESET bank)

Delay → Early Reflections (PRESET bank)

Delay + Early Reflection separately applies delay and early reflection to the original sound, and then mixes the results.

Delay → Early Reflections applies delay to the original sound, and then applies early reflections.

Each aspect of the sound is controlled by the following effect parameters.

Delay: DELAY L, DELAY R, FB.DLY, FB.GAIN, HI.RATIO

Early reflections: TYPE, ROOMSIZE, LIVENESS, INI.DLY, DIFF., DENSITY, ER NUM.

Balance between delay and early reflections: DLY/ER, DLY.BAL

Filter/equalizer: HPF, LPF

Tempo synchronization: SYNC, NOTE L, NOTE R, NOTE FB, TEMPO

Output level: OUT LVL, MIX BAL.

Parameter details

■ Basic parameters

Parameter name	Range	Explanation
TYPE	S-Hall, L-Hall, Random, Revers, Plate, Spring	The pattern of early reflections; this determines the basic character of the effect. The characteristics of the early reflections will depend on the type you select here.
ROOMSIZE	0.1—20.0	Size of the reflective space. Increasing this value simulates a larger space. You can use this to simulate the absorptiveness of the walls and ceiling.
LIVENESS	0—10	Decay characteristics of the early reflections. Increasing this value will reduce the decay, causing the repeats to continue. You can use this to simulate the absorptiveness of the walls and ceiling.
INI.DLY	0.0—500.0 ms	Delay of the early reflections relative to the original sound.
DIFF.	0—10	Diffusion of the sound to left and right. Increasing this value will make the reflections more spaciousness.
DENSITY	0—100%	Density of the early reflections. Increasing this value will make the sound smoother. You can create unique effects by lowering this value.
DELAY L DELAY R	0.0—1000.0 ms	Delay relative to the original sound. DELAY L is the L channel delay, and DELAY R is the R channel delay.
FB.DLY	0.0—1000.0 ms	Delay added when the signal is fed back. The delay from the original sound to the first delay is set by the DELAY L and DELAY R values, but the delay of subsequent repeats will be each DELAY + FB.DLY.
FB.GAIN	-99%—+99%	Amount of feedback for the delay sound. This indicates the ratio by which the level is reduced for each repetition of the effect. For example with a setting of +50, the level of the delay will decay to 50% → 25% → 12.5% as it is repeated. Negative (-) values invert the phase of the feedback.
HI.RATIO	0.1—1.0	Amount of feedback for the high-frequency portion of the delay. This is specified as a proportion of FB.GAIN. If this value is 0.1, the feedback amount will be 1/10th of FB.GAIN; if this value is 1.0, the feedback amount will be the same as FB.GAIN.

Effect list

■ Basic parameters

NO.	Effect name	REV TIME	REV HI	INI.DLY	DIFF.	DENSITY	DELAY L	DELAY R	FB.DLY	FB.GAIN	DELAY HI
94	DELAY+REV	3.8 s	0.7	75.2 ms	6	100%	493.0 ms	507.0 ms	500.0 ms	-40%	0.2
95	DELAY->REV	1.2 s	0.4	25.0 ms	10	100%	500.0 ms	250.0 ms	500.0 ms	-40%	0.4
96	RESO DRONE	55.0 s	1.0	0.0 ms	7	100%	2.0 ms	0.0 ms	0.1 ms	-78%	0.7

■ Fine parameters

NO.	Effect name	MIX BAL.	OUT LVL	HPF	LPF	DLY/REV	DLY.BAL
94	DELAY+REV	100%	100%	Thru	3.15 kHz	40%	
95	DELAY->REV	100%	100%	Thru	3.35 kHz		30%
96	RESO DRONE	100%	100%	Thru	Thru		0%

NO.	Effect name	SYNC	NOTE L	NOTE R	NOTE FB	TEMPO
94	DELAY+REV	OFF	↓	↓	↓	—
95	DELAY->REV	OFF	↓	↓	↓	—
96	RESO DRONE	OFF	↓	↓	↓	—

Freeze

These are sampling effects that let you record the input signal and play it back.

Type	Bank	No. of INs/OUTs	Page
Freeze	PRESET	1 IN/2 OUT	77
Freeze A	CLASSIC		78
Freeze B			79

Freeze (PRESET bank)

This allows up to 2970.5 ms of recording (sampling). You can freeze the recorded data, repeat it as many times as desired, or modify the pitch.

Each aspect of the sound is controlled by the following effect parameters.

Recording: REC MODE, REC DLY, RECORD

Playback: PLAY, PLY MODE, START, END, LOOP, LOOP NUM

Playback pitch: PITCH, FINE

Recording/playback trigger: MIDI TRG, TRG LVL, TRG MASK

Output level: OUT LVL, MIX BAL.

Parameter details

■ Basic parameters

Parameter name	Range	Explanation
REC MODE	MANUAL, AUTO	Recording method. Choose MANUAL (manual) or AUTO (automatic).
REC DLY	-1000—+1000 ms	Delay from when recording is triggered until recording actually begins.
RECORD	---	When REC MODE is MANUAL, press the [▼ DEC] button (Ⓔ) to enter record-ready mode; then press the [▲ INC] button (Ⓕ) to begin recording.
PLAY	---	Press the [▲ INC]/[▼ DEC] buttons (Ⓕ) to play back as specified by the PLY MODE setting.
PLY MODE	MOMENT, CONTI., INPUT	This is the method by which the sampled data will be played back. MOMENT: Playback will continue while you hold down the [▲ INC]/[▼ DEC] button (Ⓕ). CONTI.: Playback will begin when you press the [▲ INC]/[▼ DEC] button (Ⓕ), and will continue for the number of times specified by LOOP NUM. If you press the [▲ INC]/[▼ DEC] button during playback, playback will start again from the beginning. INPUT: Playback will begin when the input signal level exceeds TRG LVL, and will continue for the number of times specified by LOOP NUM. If a signal exceeding the TRG LVL is input again during playback, playback will start again from the beginning.
START	*a	Playback start point for the sampled data.
END	*a	Playback end point for the sampled data.
LOOP	*a	Playback start point when loop playback is used. If you use loop playback, the first pass will play the START—END region, and the second and subsequent passes will play the LOOP—END region.
LOOP NUM	0—100	Number of times the loop will play. Once the START—END region has played, the LOOP—END region will play the number of times specified here.
PITCH	-12—+12	Amount of pitch change for the playback, in units of one semitone. Positive (+) settings will make the playback pitch higher than the original pitch, and negative (-) settings will lower it.
MIDI TRG	OFF, C 1—C 6, ALL	MIDI trigger setting. When the SPX2000 receives a MIDI note-on message whose note number matches this value, it will play back the sampled data. If this setting is OFF, MIDI note-on messages will not be received. If this is ALL, any note-on message of C1 or higher will trigger playback.
TRG LVL	-60—0 dB	The level that will trigger recording/playback. If REC MODE is AUTO and the SPX2000 is in record-ready mode, recording of the input signal will begin when the input signal exceeds this level. If PLY MODE is INPUT, playback will begin when the input signal exceeds this level.

*a. At 44.1 kHz or 88.2 kHz, this will be 0.0—2970.5 ms. At 48 kHz or 96 kHz, this will be 0.0—2729.2 ms.

■ Fine parameters

Parameter name	Range	Explanation
MIX BAL.	0—100%	Balance between the original sound and effect sound. At a setting of 0% only the original sound will be output; at a setting of 100% only the effect sound will be output.
OUT LVL	0—100%	Output level after the original sound and effect sound have been mixed. Decrease this value if you want to lower the output. At a setting of 0% there will be no output.
FINE	-50—+50	Amount of pitch change for the playback, in units of one cent (1/100th of a semitone). Positive (+) settings will raise the playback pitch higher than the original, and negative (-) settings will lower it.
TRG MASK	0—1000 ms	The time from when a trigger is received until the next trigger will be allowed.

Effect list

The following tables show the default parameter values for the effect belonging to the Freeze type (PRESET bank).

■ Basic parameters

NO.	Effect name	REC MODE	REC DLY	RECORD	PLAY	PLY MODE	START	END	LOOP	LOOP NUM
97	FREEZE	MANUAL	-50 ms	—	—	CONTI.	0.0 ms	*a	0.0 ms	100
		PITCH	MIDI TRG	TRG LVL						
		0	OFF	-14 dB						

*a. At 44.1 kHz or 88.2 kHz, this will be 2970.5 ms. At 48 kHz or 96 kHz, this will be 2729.2 ms.

■ Fine parameters

NO.	Effect name	MIX BAL.	OUT LVL	FINE	TRG MASK
97	FREEZE	100%	100%	0	1000 ms

Freeze A (CLASSIC bank)

This is a freeze effect based on earlier models of the SPX series. You can specify the start/end points of the playback. The parameter structure is simpler than the corresponding effect of the PRESET bank.

Each aspect of the sound is controlled by the following effect parameters.

Recording: REC MODE, TRG. DLY, RECORD

Playback: PLAY, START, END

Recording trigger: INP. TRG

Output level: OUT LVL, MIX BAL.

Parameter details

■ Basic parameters

Parameter name	Range	Explanation
REC MODE	MANUAL, AUTO	Recording method. Choose MANUAL (manual) or AUTO (automatic).
TRG. DLY	-1000—+1000 ms	Delay from when recording is triggered until recording actually begins.
INP. TRG	ON, OFF	This setting specifies whether the input signal will trigger the playback. If this is ON, an input signal of -14 dB or higher will trigger the playback. If this is OFF, you can start playback by pressing the [▲ INC] or [▼ DEC] button or by operating a MIDI device.
RECORD	---	When REC MODE is MANUAL, press the [▼ DEC] button (17) to enter record-ready mode; then press the [▲ INC] button (17) to begin recording.
PLAY	---	If INP. TRG is OFF, pressing the [▲ INC] or [▼ DEC] buttons (17) will start playback.
START	*a	Playback start point for the sampled data.
END	*a	Playback end point for the sampled data.
OUT LVL	0—100%	Output level after the original sound and effect sound have been mixed. Decrease this value if you want to lower the output. At a setting of 0% there will be no output.
MIX BAL.	0—100%	Balance between the original sound and effect sound. At a setting of 0% only the original sound will be output; at a setting of 100% only the effect sound will be output.

*a. At 44.1 kHz or 88.2 kHz, this will be 0.0—2970.5 ms. At 48 kHz or 96 kHz, this will be 0.0—2729.2 ms.

Effect list

The following table shows the default parameter values for the effect belonging to the Freeze A type (CLASSIC bank).

■ Basic parameters

NO.	Effect name	REC MODE	TRG. DLY	INP. TRG	RECORD	PLAY	START	END	OUT LVL	MIX BAL.
23	FREEZE A	AUTO	-5 ms	OFF	—	—	0.0 ms	*a	100%	100%

*a. At 44.1 kHz or 88.2 kHz, this will be 2970.5 ms. At 48 kHz or 96 kHz, this will be 2729.2 ms.

Freeze B (CLASSIC bank)

This is a freeze effect based on earlier models of the SPX series. You can specify the pitch of the playback. The parameter structure is simpler than the corresponding effect of the PRESET bank.

Each aspect of the sound is controlled by the following effect parameters.

Recording: REC MODE, TRG. DLY, RECORD

Playback: PLAY

Playback pitch: PITCH, FINE, BASE KEY

Output level: OUT LVL, MIX BAL.

Parameter details

■ Basic parameters

Parameter name	Range	Explanation
REC MODE	MANUAL, AUTO	Recording method. Choose MANUAL (manual) or AUTO (automatic).
TRG. DLY	-1000—+1000 ms	Delay from when recording is triggered until recording actually begins.
RECORD	---	When REC MODE is MANUAL, press the [▼ DEC] button (17) to enter record-ready mode; then press the [▲ INC] button (17) to begin recording.
PLAY	---	Playback will continue while you press the [▲ INC] or [▼ DEC] button (17).
PITCH	-12—+12	Amount of pitch change for the playback, in units of one semitone. Positive (+) settings will make the playback pitch higher than the original pitch, and negative (-) settings will lower it.
FINE	-50—+50	Amount of pitch change for the playback, in units of one cent (1/100th of a semitone). Positive (+) settings will make the playback pitch higher than the original pitch, and negative (-) settings will lower it.
BASE KEY	OFF, C 1—C 6	This specifies the base key for incoming MIDI note-on messages. When a note-on message is received, the PITCH value will be set by the difference between this setting and the value of the note-on. For example if you set BASE KEY as C4, a received note-on message of C3 will cause PITCH to be set to -12, making the sample play one octave lower than the original pitch. If you set this parameter as C2, a received note-on message of D2 will cause PITCH to be set to +2, making the sample play two semitones higher than the original pitch. If this parameter is OFF, MIDI note-on messages will not be received.
OUT LVL	0—100%	Output level after the original sound and effect sound have been mixed. Decrease this value if you want to lower the output. At a setting of 0% there will be no output.
MIX BAL.	0—100%	Balance between the original sound and effect sound. At a setting of 0% only the original sound will be output; at a setting of 100% only the effect sound will be output.

Effect list

The following table shows the default parameter values for the effect belonging to the Freeze B type (CLASSIC bank).

■ Basic parameters

NO.	Effect name	REC MODE	TRG. DLY	RECORD	PLAY	PITCH	FINE	BASE KEY	OUT LVL	MIX BAL.
24	FREEZE B	MANUAL	-50 ms	—	—	0	0	C 3	100%	100%

Freeze recording

The sampled data will be erased when you perform any of the following operations.

- Enter record-ready mode
- Press the [UNDO] button
- Press the [INPUT MODE] button
- Press the [RECALL] button
- Press the [COMPARE] button
- Use the “INPUT SOURCE” setting to change the input source
- Use the “CLOCK SOURCE” setting to change the word clock source

If the SPX2000 is the clock slave, the sampled data will also be erased if the supplied word clock frequency changes.

You can use either AUTO or MANUAL recording modes.

AUTO:

—Use an input signal to trigger the recording—

1. **Set REC MODE to AUTO.**
2. **Set TRG LVL (only for Freeze (PRESET bank)).**
TRG LVL sets the signal level that will trigger recording.
3. **Set REC DLY (TRG.DLY).**
REC DLY (TRG.DLY) is the delay from when recording is triggered until recording will actually begin. With a setting of 0 ms, recording will begin the instant trigger occurs. With positive (+) settings, recording will begin the specified time after triggering. With negative (–) settings, recording will begin the specified time before triggering.

NOTE: The CLASSIC bank Freeze A and Freeze B effects do not have this setting; recording will begin when the input signal level exceeds –14 dB.

4. **Enter record-ready mode.**
Select RECORD and press the [▼ DEC] button (Ⓐ). The display will change to “REC.READY”.
In this state, recording will begin automatically when the input signal exceeds the trigger level.

NOTES:

- The previously-sampled data will be erased when you enter record-ready mode.
- Recording will be cancelled if you press any button other than [▲ INC] (Ⓑ) during recording. In this case, the data that had been sampled up to that point will also be lost.
- The recorded sample will be erased when you turn off the power of the SPX2000.
- Recording can be performed regardless of the Operation Lock level.

MANUAL:

—Record manually—

1. **Set REC MODE to MANUAL.**
2. **Set REC DLY (TRG.DLY).**
REC DLY (TRG.DLY) is the delay from when recording is triggered until recording will actually begin. In the case of MANUAL recording, triggering will occur when you press the button to begin recording. With a setting of 0 ms, recording will begin the instant you press the button. With positive (+) settings, recording will begin the specified time after you press the button. With negative (–)

settings, recording will begin the specified time before you press the button.

3. **Enter record-ready mode.**

Select RECORD and press the [▼ DEC] button (Ⓐ). The display will change to “REC.READY”.

NOTE: The previously-recorded sample data will be erased when you enter record-ready mode.

4. **Begin recording.**

While the display indicates “REC. READY”, press the [▲ INC] button (Ⓑ).

The display will show a meter to indicate the recording status, and will indicate “OK” when recording ends.

NOTES:

- Recording will be cancelled if you press [▼ DEC] button during recording. In this case, the data that had been sampled up to that point will also be lost.
- The recorded sample will be erased when you turn off the power of the SPX2000.
- If the Operation Lock level is set to 3, recording will not be possible since the [▲ INC] button is inoperable.

—Recording with a MIDI message as the trigger—

- 1 **Set REC MODE to MANUAL.**
- 2 **Set REC DLY (TRG.DLY).**
- 3 **Set MIDI TRG (Freeze (PRESET bank) only).**
- 4 **Enter record-ready mode.**
Select RECORD, and press the [▼ DEC] button (Ⓐ). The display will change to “REC.READY”.

NOTE: The previously-recorded sample data will be erased when you enter record-ready mode.

- 5 **Transmit a MIDI note-on message**

If you are using Freeze (PRESET bank), transmit the note-on message you specified for MIDI TRG. If you are using Freeze A (CLASSIC bank) or Freeze B (CLASSIC bank), transmit any note-on message of C1 or higher. Recording will begin automatically.

NOTES:

- Recording will be cancelled if you press the [▼ DEC] button during recording. In this case, the partially-recorded sample will also be discarded.
- The recorded sample data will be erased when the SPX2000 is powered-off.
- You can record regardless of the Operation Lock level.

Freeze Playback

You can use one of the following three methods to play back the freeze sample.

—Play back the sample manually—

1. Select **PLAY**, and press the [**▲ INC**] button (17) or [**▼ DEC**] button (17).

Playback will begin.

NOTES:

- If the Freeze (PRESET bank) parameter **PLY MODE** is set to **MOMENT** or the Freeze B (CLASSIC bank), the sample will play only while you continue holding the [**▲ INC**]/[**▼ DEC**] button.
- If Operation Lock is set to Level 3, playback will not be possible since the [**▲ INC**] button will be disabled.

—Use an input signal to trigger the playback—

■ Only for Freeze (PRESET bank)

1. Set **PLY MODE** to **INPUT**.
2. Set **TRG LVL**.
3. **Input a signal.**

Playback will begin when the input signal level exceeds the **TRG LVL**. If the input signal exceeds **TRG LVL** during playback, the sample will start playing again from the beginning.

NOTE: Recording can be performed regardless of the Operation Lock level.

■ When using Freeze A (CLASSIC bank)

1. Turn **INP.TRG** “ON.”
2. **Input a signal.**

Playback will start when the input signal level exceeds –14 dB. Playback will start again from the beginning if the input signal level exceeds –14 dB during playback.

NOTE: You can play back regardless of the Operation Lock level.

—Use a MIDI message to trigger the playback—

■ When using Freeze (PRESET bank)

1. Set **MIDI TRG**.
2. **Transmit a MIDI note-on message.**
When the note-on message specified by **MIDI TRG** is received, playback will start automatically.
3. **If PLY MODE is set to MOMENT, transmit a MIDI note-off message.**
When the note-off message is received, playback will end automatically.

■ When using Freeze A (CLASSIC bank)

1. Turn **INP.TRG** “OFF.”
2. **Transmit a MIDI note-on message.**
When a note-on message of C1 or higher is received, playback will start automatically.

■ When using Freeze B (CLASSIC bank)

1. Set **BASE KEY** to other than “OFF.”
2. **Transmit a MIDI note-on message.**
When a note-on message of C1 or higher is received, playback will start automatically.

NOTES:

- For details about enabling MIDI message transmission/reception, refer to “Preparations for using MIDI” on page 88.
- Recording can be performed regardless of the Operation Lock level.

Playback options

- **Specify the playback start/end points (only for Freeze (PRESET bank) or Freeze A (CLASSIC bank))**

You can use **START/END** to specify the playback start and playback end points.

If you set the end point earlier than the start point, the sample will play backward.

- **Play back repeatedly (only for Freeze (PRESET bank))**

By setting **LOOP** and **LOOP NUM** you can cause the sample to play repeatedly for the specified number of times.

The first pass will play the **START—END** region, and the second and subsequent passes will play the **LOOP—END** region for the **LOOP NUM** number of times.

- **Change the playback pitch (only for Freeze (PRESET bank) or Freeze B (CLASSIC bank))**

By setting **PITCH** and **FINE** you can change the playback pitch of the sampling data (Freeze (PRESET bank)).

By using a MIDI note-on message to trigger the sampling data, you can control the playback start time and the pitch (Freeze B (CLASSIC bank)).

Other effects

The SPX2000 also provides an effect that lets you apply three different filters simultaneously, an effect that combines a compressor, expander, and limiter to make your sound tighter and more finished, and guitar-type effects such as distortion and amp simulator.

Type	Bank	No. of INs/OUTs	Page
Multi Filter	PRESET	2 IN/2 OUT	82
Multi-band Dynamics Processor			83
Rotary Speaker			85
Distortion		1 IN/2 OUT	86
Amp Simulator			87

Multi Filter (PRESET bank)

This effect lets you simultaneously apply three different filters.

Filter 1: TYPE 1, FREQ. 1, RESO. 1

Filter 2: TYPE 2, FREQ. 2, RESO. 2

Filter 3: TYPE 3, FREQ. 3, RESO. 3

Output level: MIX BAL., LEVEL 1, LEVEL 2, LEVEL 3

Parameter details

Basic parameters

Parameter name	Range	Explanation
TYPE 1 TYPE 2 TYPE 3	LPF, HPF, BPF	Filter type. Choose from LPF (Low Pass Filter), HPF (High Pass Filter), and BPF (Band Pass Filter).
FREQ.1 FREQ.2 FREQ.3	28.0 Hz—16.0 kHz	Filter frequency. The affected region will depend on the selected TYPE. If TYPE is LPF, frequency components above this frequency will be cut. If TYPE is HPF, frequency components below this frequency will be cut. If TYPE is BPF, frequency components in the region near this frequency will pass through the filter more readily.
RESO.1 RESO.2 RESO.3	0—20	Resonance. This indicates the sharpness of the frequency response curve. This parameter is valid if TYPE is set to BPF. Higher settings will sharpen the curve, narrowing the width of the filter.

Fine parameters

Parameter name	Range	Explanation
MIX BAL.	0—100%	Balance between the original sound and effect sound. At a setting of 0% only the original sound will be output; at a setting of 100% only the effect sound will be output.
LEVEL 1 LEVEL 2 LEVEL 3	0—100	Output level. LEVEL 1 is the output level of the Filter 1 region, LEVEL 2 is the output level of the Filter 2 region, and LEVEL 3 is the output level of the Filter 3 region.

Effect list

The following tables show the default parameter values for the effect belonging to the Multi Filter type (PRESET bank).

Basic parameters

NO.	Effect name	TYPE 1	FREQ. 1	RESO. 1	TYPE 2	FREQ. 2	RESO. 2	TYPE 3	FREQ. 3	RESO. 3
80	MULTI FILTER	LPF	160 Hz	9	BPF	630 Hz	8	HPF	1.60 kHz	9

Fine parameters

NO.	Effect name	MIX BAL.	LEVEL 1	LEVEL 2	LEVEL 3
80	MULTI FILTER	100%	100	100	65

Multi-band Dynamics Processor (PRESET bank)

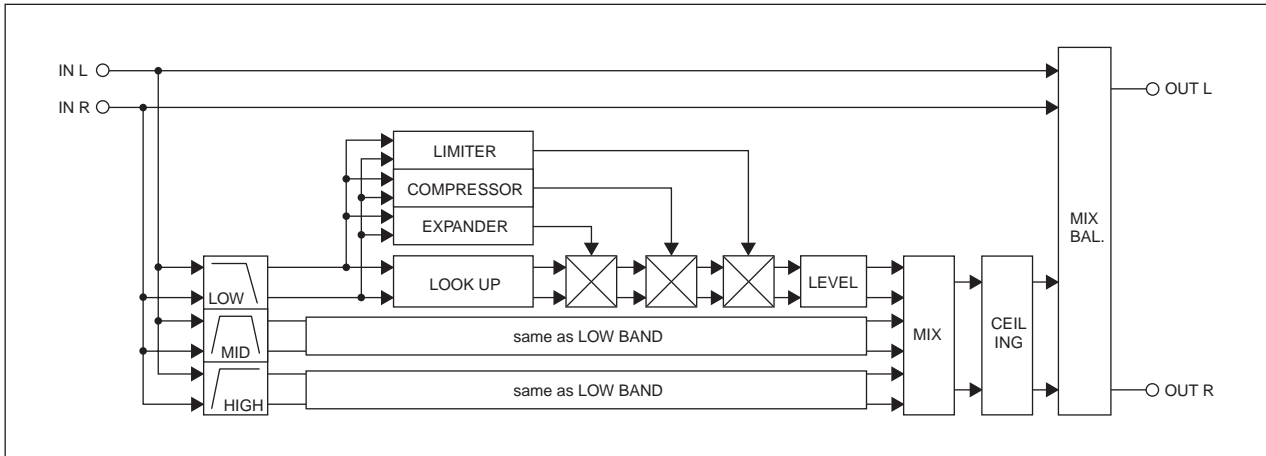

This effect splits the signal into three frequency bands, and individually controls the dynamic range of each band. It lets you use three types of processor — a compressor, expander, and limiter — in combination. The signal is sent through the expander, compressor, and limiter in that order.

Compressor: CMP.THRE, CMP.RAT, CMP.ATK, CMP.REL, CMP.KNEE, CMP.BYP

Expander: EXP.THRE, EXP.RAT, EXP.REL, EXP.BYP

Limiter: LIM.THRE, LIM.ATK, LIM.REL, LIM.BYP, LIM.KNEE

Applicable to Compressor, Expander, and Limiter: PRESENCE, LOOKUP

Filter/equalizer: LOW GAIN, MID GAIN, HI. GAIN, L-M XOVR, M-H XOVR, SLOPE

Output level: CEILING, MIX BAL., SOLO LOW, SOLO MID, SOLO HI

Parameter details

Basic parameters

Parameter name	Range	Explanation
LOW GAIN	-96.0—+12.0 dB	Low range gain. Raising this value will boost the low-frequency range.
MID GAIN	-96.0—+12.0 dB	Mid range gain. Raising this value will boost the mid-frequency range.
HI. GAIN	-96.0—+12.0 dB	High range gain. Raising this value will boost the high-frequency range.
PRESENCE	-10—+10	This setting varies the effect separately for each range. Positive (+) settings of this value will lower the high-frequency threshold level and raise the low-frequency. Negative (-) settings will raise the high-frequency and lower the low-frequency. With a setting of 0, all ranges will have the same threshold level.
CMP.THRE	-24.0—0.0 dB	Compressor threshold level. When the level of the input signal (original sound) exceeds this level, the portion above this level will be compressed by the CMP.RAT.
CMP.RAT	1:1—20:1	Compression ratio. When the input signal level exceeds CMP.THRE, the portion of the signal above that level will be compressed by this ratio.
CMP.ATK	0—120 ms	Compressor attack time. This is the time from when the input signal level exceeds CMP.THRE until the maximum compression is reached. You can use this when you want to retain the attacks of the original signal.
CMP.REL ^a	44.1 kHz: 6 ms—46.0 s 48 kHz: 5 ms—42.3 s 88.2 kHz: 3 ms—23.0 s 96 kHz: 3 ms—21.1 s	Compressor release time. The original signal level is not resumed the instant the input signal falls below CMP.THRE; the signal will gradually return to its original level over the duration of this value.
CEILING	-6.0—0.0 dB, OFF	Upper limit of the output level. Signals that exceed this value will be restricted to this value. If you select OFF, this restriction will be defeated.
EXP.THRE	-54.0—24.0 dB	Expander threshold level. When the input signal falls below this level, it will be compressed by the EXP.RATIO.
EXP.RAT	1:1—∞:1	Expander ratio. When the input signal level falls below EXP.THRE, it will be compressed by this ratio.
EXP.REL ^a	44.1 kHz: 6 ms—46.0 s 48 kHz: 5 ms—42.3 s 88.2 kHz: 3 ms—23.0 s 96 kHz: 3 ms—21.1 s	Expander release time. This is the time from when the input signal falls below EXP.THRE until the maximum expander effect is reached.
LIM.THRE	-12.0—0.0 dB	Limiter threshold level. When the input signal (original sound) exceeds this level, it will be restricted to this value.
LIM.ATK	0—120 ms	Limiter attack time. This is the time from when the input signal exceeds LIM.THRE until maximum limiting is reached. You can use this when you want to retain the attacks of the original signal.
LIM.REL ^a	44.1 kHz: 6 ms—46.0 s 48 kHz: 5 ms—42.3 s 88.2 kHz: 3 ms—23.0 s 96 kHz: 3 ms—21.1 s	Limiter release time. This is the time from when the input signal falls below LIM.THRE until limiting is removed.

^aa. The range of this parameter depends on the sampling frequency at which the SPX2000 is operating.

■ Fine parameters

Parameter name	Range	Explanation
MIX BAL.	0—100%	Balance between the original sound and effect sound. At a setting of 0% only the original sound will be output; at a setting of 100% only the effect sound will be output.
CMP.KNEE	0—5	Compressor knee. If this is set to 0, compression will begin immediately when the input signal exceeds CMP.THRE; i.e., the level will begin changing suddenly. With a setting of 1 or above, compression will begin before the point at which the signal exceeds CMP.THRE, so that the compression produces a smoother change in level. This will produce a less obtrusive transition for the level change produced by the compressor.
LOOKUP	0.0—100.0 ms	Lookup delay. Normally you will leave this at 0.0 ms. If you want the input signal to be read ahead of time so that the level can be controlled more quickly, set this to a value of 0.1 ms or greater; the compressor, expander, and limiter will begin functioning ahead of the input signal.
CMP.BYP	ON, OFF	Compressor bypass. If this is ON, the compressor will be bypassed, and will not do anything.
L-M XOVR	21.2 Hz—8.00 kHz	Crossover frequency between the low and mid ranges. This parameter specifies the frequency that will be the boundary between the low-frequency and mid-frequency ranges.
M-H XOVR	21.2 Hz—8.00 kHz	Crossover frequency between the mid and high ranges. This parameter specifies the frequency that will be the boundary between the mid-frequency and high-frequency ranges.
SLOPE	−6 dB, −12 dB	Attenuation of the filter that divides the frequency bands. −12 dB produces greater attenuation than −6 dB, dividing the frequency bands more sharply.
EXP.BYP	ON, OFF	Expander bypass. If this is ON, the expander will be bypassed, and will not do anything.
LIM.BYP	ON, OFF	Limiter bypass. If this is ON, the limiter will be bypassed, and will not do anything.
LIM.KNEE	0—5	Limiter knee. If this is set to 0, limiting will begin immediately when the input signal exceeds LIM.THRE; i.e., the level will begin changing suddenly. With a setting of 1 or above, limiting will begin before the point at which the signal exceeds LIM.THRE, so that the limiting produces a smoother change in level. This will produce a less obtrusive transition for the level change produced by the limiter.
SOLO LOW SOLO MID SOLO HI	ON, OFF	These are Solo settings. Only the bands that are turned ON will be output. If all are ON or if all are OFF, all bands will be output.

Effect list

The following tables show the default parameter values for the effects belonging to the Multi-band Dynamics Processor type (PRESET bank).

■ Basic parameters

NO.	Effect name	LOW GAIN	MID GAIN	HI. GAIN	PRESENCE	CMP.THRE	CMP.RAT	CMP.ATK	CMP.REL ^{*a}	CEILING
79	M.BAND DYNA	+3.0 dB	+3.0 dB	+3.0 dB	0	−6.0 dB	2:1	20 ms	64 ms	0.0 dB
87	FILTERED VOICE	−96.0 dB	0.0 dB	−96.0 dB	0	−24.0 dB	20:1	0 ms	3 ms	OFF
NO.	Effect name	EXP.THRE	EXP.RAT	EXP.REL ^{*a}	LIM.THRE	LIM.ATK	LIM.REL ^{*a}			
79	M.BAND DYNA	−54.0 dB	1:1	110 ms	0.0 dB	0 ms	14 ms			
87	FILTERED VOICE	−54.0 dB	1:1	110 ms	−6.0 dB	0 ms	14 ms			

*a. The default value of this parameter depends on the sampling frequency at which the SPX2000 is operating. The value shown in the table is for $f_s = 96$ kHz.

■ Fine parameters

NO.	Effect name	MIX BAL.	CMP.KNEE	LOOKUP	CMP.BYP	L-M XOVR	M-H XOVR	SLOPE	EXP.BYP
79	M.BAND DYNA	100%	3	0.0 ms	OFF	180 Hz	2.00 kHz	−12 dB	OFF
87	FILTERED VOICE	100%	5	0.0 ms	OFF	900 Hz	950 Hz	−12 dB	OFF
NO.	Effect name	LIM.BYP	LIM.KNEE	SOLO LOW	SOLO MID	SOLO HI			
79	M.BAND DYNA	OFF	1	OFF	OFF	OFF			
87	FILTERED VOICE	OFF	1	OFF	OFF	OFF			

Rotary Speaker (PRESET bank)

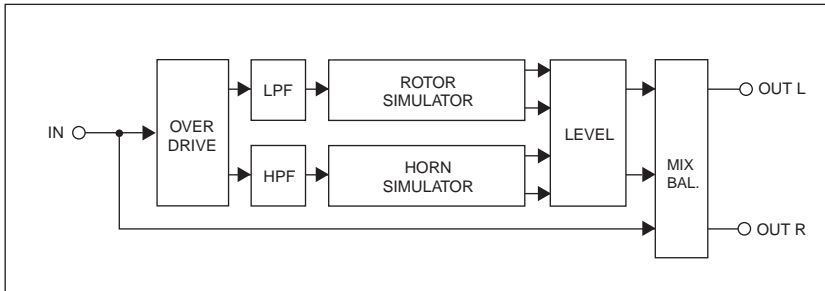

This effect simulates a rotary speaker. A rotary speaker physically turns its internal speaker and horn to produce a Doppler effect, giving a distinctive character to the sound.

Each aspect of the sound is controlled by the following effect parameters.

Rotary speaker simulation: ROTATE, SPEED, SLOW, FAST, DRIVE, ACCEL

Output level: MIX BAL., LOW, HIGH

Parameter details

Basic parameters

Parameter name	Range	Explanation
ROTATE	START, STOP	Speaker rotation start/stop control.
SPEED	SLOW, FAST	Speaker rotation speed. Select either SLOW or FAST.
SLOW	0.05—10.00 Hz	Speaker rotation speed when SPEED is set to SLOW.
FAST	0.05—10.00 Hz	Speaker rotation speed when SPEED is set to FAST.
DRIVE	0—100	Overdrive depth. Raising this value will produce stronger distortion.

Fine parameters

Parameter name	Range	Explanation
MIX BAL.	0—100%	Balance between the original sound and effect sound. At a setting of 0% only the original sound will be output; at a setting of 100% only the effect sound will be output.
ACCEL	0—10	Rate of acceleration when switching between rotation speeds (SLOW, FAST). With higher settings, the transition between speeds will occur more quickly. Since an actual rotary speaker must accelerate or decelerate an object (the speaker) that has a given amount of mass, a certain length of time is required for the change to occur. This parameter simulates this phenomenon.
LOW	0—100	Low-frequency output level. Raising this value will boost the low-frequency range.
HIGH	0—100	High-frequency output level. Raising this value will boost the high-frequency range.

Effect list

The following tables show the default parameter values for the effect belonging to the Rotary Speaker type (PRESET bank).

Basic parameters

NO.	Effect name	ROTATE	SPEED	SLOW	FAST	DRIVE
77	ROTARY SPEAKER	START	SLOW	0.35 Hz	3.50 Hz	68

Fine parameters

NO.	Effect name	MIX BAL.	ACCEL	LOW	HIGH
77	ROTARY SPEAKER	100%	3	92	92

Distortion (PRESET bank)

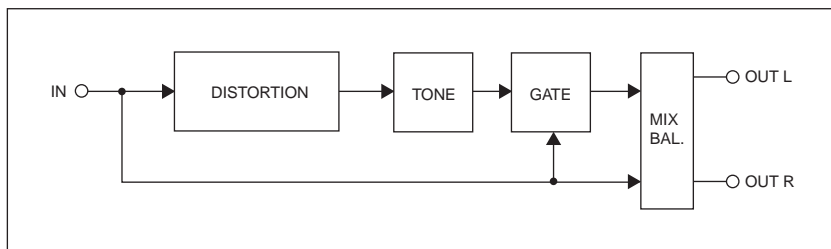

This effect distorts the sound. It is used mainly on electric guitar. Each aspect of the sound is controlled by the following effect parameters.

Effect sound: DST TYPE, DRIVE, TONE

Noise gate: N.GATE

Output level: MIX BAL., MASTER

Parameter details

■ Basic parameters

Parameter name	Range	Explanation
DST TYPE	DST1, DST2, OVD1, OVD2, CRUNCH	Type of distortion; this determines the basic character of the effect. The character of the distortion will depend on the type you select.
DRIVE	0—100	Distortion depth. Raising this value will produce stronger distortion.
TONE	-10—+10	Controls the level of the high-frequency range. Positive (+) settings produce a more piercing tone, and negative (-) settings produce a more mellow tone.

■ Fine parameters

Parameter name	Range	Explanation
MIX BAL.	0—100%	Balance between the original sound and effect sound. At a setting of 0% only the original sound will be output; at a setting of 100% only the effect sound will be output.
N.GATE	0—20	Noise gate depth. Raising this value will raise the level of the signals that will be allowed through the gate. This is a useful way to remove noise. Excessively high settings of this parameter will weaken the forcefulness of the sound.
MASTER	0—100	Output level. Decrease this value if you want to lower the output of the effect sound; only the original sound will be heard.

Effect list

The following tables show the default parameter values for the effect belonging to the Distortion type (PRESET bank).

■ Basic parameters

NO.	Effect name	DST TYPE	DRIVE	TONE
82	DISTORTION	DST2	70	+7

■ Fine parameters

NO.	Effect name	MIX BAL.	N.GATE	MASTER
82	DISTORTION	100%	1	30

Amp Simulator (PRESET bank)

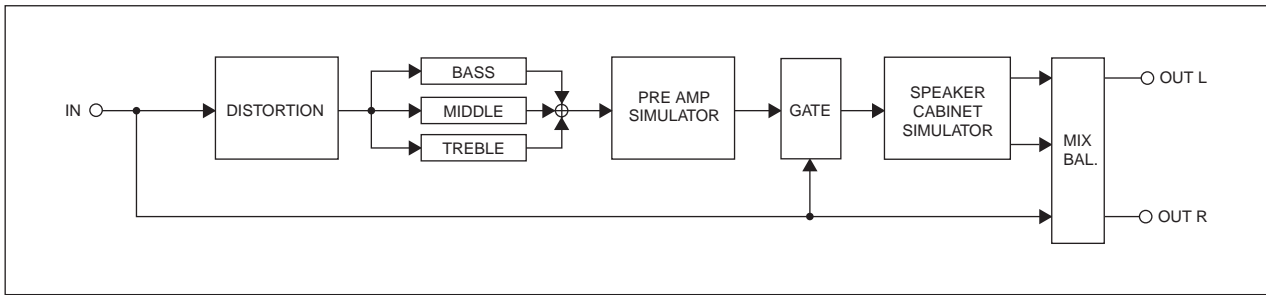

This effect simulates the characteristics of a guitar amp. Previously when recording an electric guitar in a studio, it was usual to play the guitar through an amp and then mic the amp in order to obtain the tonal character typical of the amp. This effect simulates the result without requiring you to use an amp.

Each aspect of the sound is controlled by the following effect parameters.

Amp simulation: AMP TYPE, BASS, MIDDLE, TREBLE, DIST TYPE, DRIVE, CAB DEP

Filter/equalizer: EQ G, EQ F, EQ Q

Noise gate: N.GATE

Output level: MIX BAL., MASTER

Basic parameters

Parameter name	Range	Explanation
AMP TYPE	*a	Type of amp to be simulated; The character of the amp will depend on the type you select.
BASS	0—100	Simulates the BASS control of the preamp, controlling the low-frequency range tone. Raising this value will make the low range stand out.
MIDDLE	0—100	Simulates the MIDDLE control of the preamp, controlling the mid-frequency range tone. Raising this value will make the mid range stand out.
TREBLE	0—100	Simulates the TREBLE control of the preamp, controlling the high-frequency range tone. Raising this value will make the high range stand out.
DST TYPE	DST1, DST2, OVD1, OVD2, CRUNCH	Type of distortion; The character of the distortion will depend on the type you select.
DRIVE	0—100	Distortion depth. Raising this value will produce stronger distortion.

*a. STK-M1, STK-M2, THRASH, MIDBST, CMB-PG, CMB-VR, CMB-DX, CMB-TW, MINI, FLAT

Fine parameters

Parameter name	Range	Explanation
MIX BAL.	0—100%	Balance between the original sound and effect sound. At a setting of 0% only the original sound will be output; at a setting of 100% only the effect sound will be output.
CAB DEP	0—100%	Strength of the speaker cabinet simulation. Raising this value will cause the idiosyncrasies of the speakers to be heard more strongly.
EQ G	-12.0—+12.0 dB	Gain of the equalizer (peaking type). This adjusts the gain of the frequency region specified by EQ F. Positive (+) settings will boost the region, and negative (-) settings will attenuate it.
EQ F	100 Hz—8.00 kHz	Equalizer (peaking type) frequency. The EQ G gain will be applied to a region centered on this frequency.
EQ Q	10.0—0.10	Equalizer (peaking type) Q. This indicates the sharpness of the frequency response curve of the equalizer. Raising this value produces a sharper curve.
N.GATE	0—20	Noise gate depth. Raising this value will raise the level of the signals that will be allowed through the gate. This is a useful way to remove noise. Excessively high settings of this parameter will weaken the forcefulness of the sound.
MASTER	0—100	Output level. Decrease this value if you want to lower the output of the effect sound; only the original sound will be heard.

Effect list

The following tables show the default parameter values for the effect belonging to the Amp Simulator type (PRESET) bank.

Basic parameters

NO.	Effect name	AMP TYPE	BASS	MIDDLE	TREBLE	DST TYPE	DRIVE
83	AMP SIMULATOR	STK-M1	94	100	82	DST1	50

Fine parameters

NO.	Effect name	MIX BAL.	CAB DEP	EQ G	EQ F	EQ Q	N.GATE	MASTER
83	AMP SIMULATOR	100%	42%	+1.5 dB	750 Hz	2.0	1	40

MIDI

You can use MIDI to remotely control the SPX2000. This chapter explains how to make preparations for using MIDI, what you can do using MIDI, and the MIDI data format.

Preparations for using MIDI

In order to use the SPX2000's MIDI functionality, you must make the following preparations.

1 Connect your MIDI device

Connect your device using either of the following connectors.

- [MIDI IN] connector (30) and [MIDI OUT/THRU] connector (29)
- [TO HOST USB] connector (31)

2 If you are using the [MIDI OUT/THRU] connector, set it to "MIDI OUT" (page 21)

3 Select the MIDI port that you want to use

Use the Utility setting "MIDI PORT GENERAL" to make this selection (page 21).

4 Select the MIDI channel that you want to use (page 21).

5 Enable MIDI message reception (page 23)

What you can do using MIDI

On the SPX2000 you can use MIDI to do the following six things.

• Recall effects

You can remotely select/recall effects from a MIDI device connected to the [MIDI IN] connector (30) or [TO HOST USB] connector (31).

In order to do this, you must first create a MIDI program change table on the SPX2000. For details, refer to "Editing the MIDI program change table" (page 22).

MIDI messages used:

Control change (Bank select) + Program change

• Control parameters

You can control the SPX2000's effect parameters from a MIDI device connected to the [MIDI IN] connector (30) or [TO HOST USB] connector (31).

The control method and content will depend on the MIDI messages you use.

MIDI messages used:

Note on/off, Control change, Parameter change

• Bulk dump SPX2000 internal data

You can transmit the SPX2000's data to a MIDI device connected to the [MIDI OUT/THRU] connector (29) or [TO HOST USB] connector (31) (page 23). Conversely, the SPX2000 can receive data from a MIDI device connected to the [MIDI IN] connector to overwrite the SPX2000's internal data.

MIDI messages used: Bulk dump

• Synchronize with another MIDI device

The SPX2000 can synchronize to MIDI Clock messages received from a MIDI device connected to the [MIDI IN] connector (30) or [TO HOST USB] connector (31).

In order to do this, you must set the tempo synchronization source to "MIDI CLOCK" (page 23).

MIDI messages used: MIDI clock

• Check the MIDI connection status

The SPX2000 can check whether there is a correctly functioning connection with a MIDI device connected to the [MIDI IN] connector (30), [MIDI OUT/THRU] connector (29), or [TO HOST USB] connector (31).

MIDI messages used: Active sensing

• Initialize MIDI communication

You can initialize MIDI communication, for example if a communication error has occurred.

MIDI messages used: Reset

MIDI data format

1. Format summary

'tx' indicates that the SPX2000 can transmit the message. 'rx' indicates that the SPX2000 can receive the message.

1.1 CHANNEL MESSAGE

Command	rx/tx	function
8n NOTE OFF	rx	Control internal effects
9n NOTE ON	rx	Control internal effects
Bn CONTROL CHANGE	rx	Control parameters
Cn PROGRAM CHANGE	rx	Change programs

1.2 SYSTEM REALTIME MESSAGE

Command	rx/tx	function
F8 TIMING CLOCK	rx	MIDI clock
FE ACTIVE SENSING	rx	Check MIDI cable connections
FF RESET	rx	Clear running status

1.3 EXCLUSIVE MESSAGE

1.3.1 Bulk dump

Command	rx/tx	function
F0 43 0n 7E ... F7 BULK DUMP DATA	rx/tx	Bulk dump data
F0 43 2n 7E ... F7 BULK DUMP REQUEST	rx	Bulk dump request

The SPX2000 handles the following types of data as bulk dumps.

Data name	rx/tx	function
S	rx/tx	System setup data and request
E	rx/tx	Effect program and request
P	rx/tx	Program change table and request

1.3.2 Parameter Change

Command	rx/tx	function
F0 43 1n 1E 09 ... F7 PARAMETER CHANGE	rx/tx	Parameter changes specific to the SPX2000
F0 43 3n 1E 09 ... F7 PARAMETER REQUEST	rx	Parameter requests specific to the SPX2000

The SPX2000 handles the following types of data as parameter changes.

Type (HEX)	rx/tx	function
1 (01)	rx/tx	Edit buffer
3 (03)	rx/tx	System setup data
4 (04)	rx/tx	System backup data
16 (10)	rx/tx	Functions (recall, store, title, clear)
17 (11)	rx/tx	Functions (undo, compare)
18 (12)	rx	Functions (effect)
20 (14)	rx/tx	Functions (attribute (Protect), LCD Back Color)
33 (21)	rx/tx	Remote Meter

2. Format details

2.1 NOTE OFF (8n)

If the SPX2000 receives this message when a freeze-type effect has been recalled, it will stop playing the sampled data.

• Reception conditions

This message is received if the following two conditions are satisfied.

- 1) The "MIDI RECEIVE" setting (page 23) is "NOTE ON/OFF = ON".
- 2) The channel on which the MIDI message is transmitted matches the SPX2000's MIDI channel, or the SPX2000's MIDI channel is set to OMNI.

• Format

```
STATUS 1000nnnn 8n Note off message
DATA 0nnnnnnn nn Note number
0vvvvvvv vv Velocity (ignored)
```

2.2 NOTE ON (9n)

When the SPX2000 receives this message, it will control the recalled effect.

The effects that respond to this message and the controlled content are as follows.

DYNA.FILTER (P76) DYNA.FLANGE (P77) DYNA.PHASER (P78)	Modulation
FREEZE (P97) FREEZE A (C23) FREEZE B (C24)	Start recording, playing the sampled data
PITCH CHANGE A (C19) PITCH CHANGE D (C22)	Change pitch
REVERB & GATE (C18)	Open the gate

• Reception conditions

This message is received if the following two conditions are satisfied.

- 1) The "MIDI RECEIVE" setting (page 23) is "NOTE ON/OFF = ON".
- 2) The channel on which the MIDI message is transmitted matches the SPX2000's MIDI channel, or the SPX2000's MIDI channel is set to OMNI.

• Format

```
STATUS 1001nnnn 9n Note on message
DATA 0nnnnnnn nn Note number
0vvvvvvv vv Velocity (1-127:on, 0:off)
```

2.3 CONTROL CHANGE (Bn)

When the SPX2000 receives this message, it will operate in one of two ways. The operation will depend on the content of the first two bytes of data. If the data begins with a value of 01h-1Fh, the parameter specified by the control change parameter list will be controlled. If the data begins with a value of either 00h or 20h, the program change table (A/B/C) will be switched.

• Reception conditions

This message is received if the following two conditions are satisfied.

- 1) The "MIDI RECEIVE" setting (page 23) is "CTL CHANGE = ON".
- 2) The channel on which the MIDI message is transmitted matches the SPX2000's MIDI channel, or the SPX2000's MIDI channel is set to OMNI.

• Format

If the data begins with 01h-1Fh

```
STATUS 1011nnnn Bn Control change
DATA 000nnnnn nn Control number (1-31)
0vvvvvvv vv Control Value (0-127)
```

For details on control numbers, refer to "MIDI Control Change Parameter Assignment Table" (page 95).

Equation for converting the control value into parameter data (CurValue)

paramSteps = paramMax - paramMin;
 curValue = (Control Value * paramSteps)/127;

If the data begins with 00h or 20h

STATUS	1011nnnn	Bn	Control change
DATA	00000000	00	Bank Select MSB
	00000000	00	Bank number MSB (0); fixed at 0
STATUS	1011nnnn	Bn	Control change
DATA	00100000	20	Bank Select LSB
	000000vv	vv	Bank number LSB (0, 1, 2); 0: table A, 1: table B, 2: table C
STATUS	1100nnnn	Cn	Program change
DATA	0vvvvvvv	vv	Program number (0-127)

2.4 PROGRAM CHANGE (Cn)

When the SPX2000 receives this message, it will recall the effect specified by the content of the program change table (page 22).

• Reception conditions

- This message is received if the following two conditions are satisfied.
- 1) The "MIDI RECEIVE" setting (page 23) is "PGM CHANGE = ON".
 - 2) The channel on which the MIDI message is transmitted matches the SPX2000's MIDI channel, or the SPX2000's MIDI channel is set to OMNI.

• Format

STATUS	1100nnnn	Cn	Program change
DATA	0nnnnnnn	nn	Program number (0-127)

2.5 TIMING CLOCK (F8)

This message is used for tempo synchronization of the effect. Twenty-four of these messages are received per quarter note.

• Reception conditions

This message is received if the "TEMPO SOURCE" setting (page 23) is set to a tempo synchronization source of "MIDI."

• Format

STATUS	11111000	F8	Timing clock
--------	----------	----	--------------

2.6 ACTIVE SENSING (FE)

Once the SPX2000 has received this message, failure to receive a message of any kind for an interval longer than 400 ms will cause it to initialize MIDI communication settings such as running status.

• Format

STATUS	11111110	FE	Active sensing
--------	----------	----	----------------

2.7 SYSTEM RESET (FF)

When the SPX2000 receives this message, it will initialize MIDI communication settings such as running status.

• Format

STATUS	11111111	FF	System reset
--------	----------	----	--------------

2.8 SYSTEM EXCLUSIVE MESSAGE (F0)

■ 2.8.1 BULK DUMP/BULK DUMP REQUEST

Bulk Dump messages are used to bulk dump SPX2000 data to a connected MIDI device (see page 23), or to receive data from a connected MIDI device to overwrite internal settings of the SPX2000. Bulk Dump Request messages request a bulk dump of data from the SPX2000.

• Reception conditions

- This message is received if the following two conditions are satisfied.
- 1) The "MIDI RECEIVE" setting (page 23) is "SYSEX BLKDMP = ON".
 - 2) The device number within the MIDI message matches the SPX2000's MIDI channel, or the SPX2000's MIDI channel is set to OMNI.

• Transmission conditions

This message is transmitted when either of the following conditions are met.

- The "BULK OUT (ALL)" function is executed to perform a bulk dump.
- A Bulk Dump Request message is received.

• Data conversion

The data portion is handled by converting seven words of 8-bit data into eight words of 7-bit data.

[Converting actual data into bulk data]

```
d[0~6]: Actual data
b[0~7]: Bulk data
b[0] = 0;
for( I=0; I<7; I++){
  if( d[I]&0x80){
    b[0] |= 1<<(6-I);
  }
  b[I+1] = d[I]&0x7F;
}
```

[Restoring bulk data into actual data]

```
d[0~6]: Actual data
b[0~7]: Bulk data
for( I=0; I<7; I++){
  b[0] <<= 1;
  d[I] = b[I+1]+(0x80&b[0]);
}
```

■ 2.8.1.1 System Setup Data Bulk Dump Format

This bulk-dumps the SPX2000's setup memory except for the program change table.

• Format

STATUS	11110000	F0	System exclusive message
ID No.	01000011	43	Manufacture's ID number (YAMAHA)
SUB STATUS	0000nnnn	0n	n=0-15 (Device number=Device No-1)
FORMAT No.	01111110	7E	Universal bulk dump
COUNT HIGH	0ccccccc	ch	data count = ch * 128 + cl
COUNT LOW	0ccccccc	cl	
	01001100	4C	'L'
	01001101	4D	'M'
	00100000	20	' '
	00100000	20	' '
	00111000	38	'8'
	01000100	44	'D'
	00110001	31	'1'
	00110001	31	'1'
DATA NAME	01010011	53	'S'
	00000010	02	
	00000000	00	No.256 = Current
BLOCK INFO.	0ttttttt	tt	total block number(minimum number is 0)
	0bbbbbbb	bb	current block number(0-total block number)
DATA	0ddddddd	ds	Setup data of block[bb]
	:	:	
	0ddddddd	de	
CHECK SUM	0eeeeeee	ee	ee=(Invert('L'+ c+de)+1)&0x7F
EOX	11110111	F7	End of exclusive

■ 2.8.1.2 System Setup Data Bulk Dump request Format

• Format

STATUS	11110000	F0	System exclusive message
ID No.	01000011	43	Manufacture's ID number (YAMAHA)
SUB STATUS	0010nnnn	2n	n=0-15 (Device number=Device No-1)
FORMAT No.	01111110	7E	Universal bulk dump
	01001100	4C	'L'
	01001101	4D	'M'
	00100000	20	' '
	00100000	20	' '
	00111000	38	'8'
	01000100	44	'D'
	00110001	31	'1'
	00110001	31	'1'
DATA NAME	01010011	53	'S'
	00000010	02	
	00000000	00	No.256 = Current
EOX	11110111	F7	End of exclusive

2.8.1.3 System Setup Data Bulk Dump request Format

This bulk-dumps the data of the specified effect.

Format

```

STATUS      11110000  F0 System exclusive message
ID No.      01000011  43 Manufacture's ID number
              (YAMAHA)
SUB STATUS  0000nnnn  0n n=0-15 (Device number=Device
              No-1)
FORMAT No.  01111110  7E Universal bulk dump
COUNT HIGH 00000000  00 data count = ch(0x00) * 128
              + cl(0x72) = 114
COUNT LOW  01110010  72
              01001100  4C 'L'
              01001101  4D 'M'
              00100000  20 ' '
              00100000  20 ' '
              00111000  38 '8'
              01000100  44 'D'
              00110001  31 '1'
              00110001  31 '1'
DATA NAME   01000101  45 'E'
              0mmmmmmmm mh 0-220(Program no.P1-97,C1-
              25,U1-99),256(EDIT BUFFER)
              0mmmmmmmm ml
BLOCK INFO. 0ttttttt  tt total block number(minimum
              number is 0)
              0bbbbbbb  bb current block number(0-total
              block number)
DATA        0ddddd    ds Effect Program data of
              block[bb]
              :
              :
CHECK SUM   0eeeeeee  ee ee=(Invert('L'+...de)
              +1)&0x7F
EOX        11110111  F7 End of exclusive
    
```

The second and third byte of DATA NAME specify the program number.

```

0:PRESET1 - 96:PRESET97
97:CLASSIC1 - 121:CLASSIC25
122:USER1 - 220:USER99
256:EDIT BUFFER
    
```

For reception by the SPX2000, only USER 1-99 or EDIT BUFFER are valid. (120-220, 256)

2.8.1.4 Effect Program Bulk Dump request Format

The second and third byte of DATA NAME specify the program number.

Format

```

STATUS      11110000  F0 System exclusive message
ID No.      01000011  43 Manufacture's ID number
              (YAMAHA)
SUB STATUS  0010nnnn  2n n=0-15 (Device number=Device
              No-1)
FORMAT No.  01111110  7E Universal bulk dump
              01001100  4C 'L'
              01001101  4D 'M'
              00100000  20 ' '
              00100000  20 ' '
              00111000  38 '8'
              01000100  44 'D'
              00110001  31 '1'
              00110001  31 '1'
DATA NAME   01000101  45 'E'
              0mmmmmmmm mh 0-220(Program no.P1-97,C1-
              25,U1-99),
              256(EDIT BUFFER)
              0mmmmmmmm ml
EOX        11110111  F7 End of exclusive
    
```

The second and third byte of DATA NAME specify the program number.

```

122:USER1 - 220:USER99
256:EDIT BUFFER
    
```

2.8.1.5 Program change table Bulk Dump Format

This bulk-dumps the program change table data.

Format

```

STATUS      11110000  F0 System exclusive message
ID No.      01000011  43 Manufacture's ID number
              (YAMAHA)
SUB STATUS  0000nnnn  0n n=0-15 (Device number=Device
              No-1)
FORMAT No.  01111110  7E Universal bulk dump
COUNT HIGH 0ccccccc  ch data count = ch * 128 + cl
COUNT LOW  0ccccccc  cl
    
```

```

              01001100  4C 'L'
              01001101  4D 'M'
              00100000  20 ' '
              00100000  20 ' '
              00111000  38 '8'
              01000100  44 'D'
              00110001  31 '1'
              00110001  31 '1'
DATA NAME   01010000  50 'P'
              00000010  02
              00000000  00 No.256 = Current
BLOCK INFO. 0ttttttt  tt total block number
              (minimum number is 0)
              0bbbbbbb  bb current block number
              (0 - total block number)
DATA        0ddddd    ds Program change table data of
              block[bb]
              :
              :
CHECK SUM   0eeeeeee  ee ee=(Invert
              ('L'+...+de)+1) &0x7F
EOX        11110111  F7 End of exclusive
    
```

2.8.1.6 Program change table Bulk Dump request Format

Format

```

STATUS      11110000  F0 System exclusive message
ID No.      01000011  43 Manufacture's ID number
              (YAMAHA)
SUB STATUS  0010nnnn  2n n=0-15 (Device number=Device
              No-1)
FORMAT No.  01111110  7E Universal bulk dump
              01001100  4C 'L'
              01001101  4D 'M'
              00100000  20 ' '
              00100000  20 ' '
              00111000  38 '8'
              01000100  44 'D'
              00110001  31 '1'
              00110001  31 '1'
DATA NAME   01010000  50 'P'
              00000010  02
              00000000  00 No.256 = Current
EOX        11110111  F7 End of exclusive
    
```

2.8.2 Program change table Bulk Dump request Format

When the SPX2000 receives a Parameter Change message, the SPX2000 setting specified by the content will be controlled. When the SPX2000 receives a Parameter Change Request message, it will transmit a Parameter Change message in reply.

Reception conditions

This message is received if the following two conditions are satisfied.

- 1) The "MIDI RECEIVE" setting (page 23) is "SYEX PRMCHG = ON".
- 2) The device number within the MIDI message matches the SPX2000's MIDI channel, or the SPX2000's MIDI channel is set to OMNI.

Transmission conditions PARAMETER CHANGE only

This message is transmitted when either of the following conditions are met.

- The SPX2000's state has changed due to a received Parameter Change
- A Parameter Change Request message is received

2.8.2.1 Parameter change (Edit Buffer)

This message modifies the value of a parameter in the edit buffer.

Format

```

STATUS      11110000  F0 System exclusive message
ID No.      01000011  43 Manufacture's ID number
              (YAMAHA)
SUB STATUS  0001nnnn  1n n=0-15 (Device number=Device
              No-1)
GROUP ID    00011110  1E MODEL ID (signal processor)
MODEL ID    00001001  09 SPX2000
ADDRESS     00000001  01 Edit Buffer
              0eeeeeee  ee Element no.(if 'ee' is 0,
              'ee' will be expanded to two
              bytes)
              0pppppppp  pp Parameter no.
              0ccccccc  cc Channel no.
DATA        0ddddd    dd data
              :
EOX        11110111  F7 End of exclusive
    
```

2.8.2.2 Parameter request (Edit Buffer)

Format

```

STATUS      11110000  F0 System exclusive message
ID No.      01000011  43 Manufacture's ID number
              (YAMAHA)

SUB STATUS   0011nnnn  3n n=0-15 (Device number=
              Device No-1)

GROUP ID     00011110  1E MODEL ID (signal processor)
MODEL ID     00001001  09 SPX2000
ADDRESS      00000001  01 Edit Buffer
              00000000  ee Element no.(if 'ee' is 0,
              'ee' will be expanded to two
              bytes)
              0pppppppp  pp Parameter no.
              0ccccccc  cc Channel no.
EOX          11110111  F7 End of exclusive
    
```

2.8.2.3 Parameter change (System Setup Memory)

This message modifies the value of a parameter in system setup memory.

Format

```

STATUS      11110000  F0 System exclusive message
ID No.      01000011  43 Manufacture's ID number
              (YAMAHA)

SUB STATUS   0001nnnn  1n n=0-15 (Device number=
              Device No-1)

GROUP ID     00011110  1E MODEL ID (signal processor)
MODEL ID     00001001  09 SPX2000
ADDRESS      00000011  03 System Setup data
              00000000  ee Element no.(if 'ee' is 0,
              'ee' will be expanded to two
              bytes)
              0pppppppp  pp Parameter no.
              0ccccccc  cc Channel no.
              0ddddd  dd data
              :
              :
EOX          11110111  F7 End of exclusive
    
```

2.8.2.4 Parameter request (System Setup Memory)

```

STATUS      11110000  F0 System exclusive message
ID No.      01000011  43 Manufacture's ID number
              (YAMAHA)

SUB STATUS   0011nnnn  3n n=0-15 (Device number=
              Device No-1)

GROUP ID     00011110  1E MODEL ID (signal processor)
MODEL ID     00001001  09 SPX2000
ADDRESS      00000011  03 System Setup data
              00000000  ee Element no.(if 'ee' is 0,
              'ee' will be expanded to two
              bytes)
              0pppppppp  pp Parameter no.
              0ccccccc  cc Channel no.
EOX          11110111  F7 End of exclusive
    
```

2.8.2.5 Parameter change (System Backup Memory)

This message modifies the value of a parameter in system backup memory.

Format

```

STATUS      11110000  F0 System exclusive message
ID No.      01000011  43 Manufacture's ID number
              (YAMAHA)

SUB STATUS   0001nnnn  1n n=0-15 (Device number=
              Device No-1)

GROUP ID     00011110  1E MODEL ID (signal processor)
MODEL ID     00001001  09 SPX2000
ADDRESS      00000011  04 System Backup data
              00000000  ee Element no.(if 'ee' is 0,
              'ee' will be expanded to two
              bytes)
              0pppppppp  pp Parameter no.
              0ccccccc  cc Channel no.
              0ddddd  dd data
              :
              :
EOX          11110111  F7 End of exclusive
    
```

2.8.2.6 Parameter request (System Backup Memory)

Format

```

STATUS      11110000  F0 System exclusive message
ID No.      01000011  43 Manufacture's ID number
              (YAMAHA)

SUB STATUS   0011nnnn  3n n=0-15 (Device number=
              Device No-1)

GROUP ID     00011110  1E MODEL ID (signal processor)
MODEL ID     00001001  09 SPX2000
ADDRESS      00000011  04 System Backup data
    
```

```

00000000  ee Element no.(if 'ee' is 0,
              'ee' will be expanded to two
              bytes)
0pppppppp  pp Parameter no.
0ccccccc  cc Channel no.
EOX        11110111  F7 End of exclusive
    
```

2.8.2.7 Parameter change (Function call : Program store/recall)

When the SPX2000 receives this message, it will store or recall the specified effect, and will then use this message to transmit the state following the change. At this time, the device number will be the MIDI channel of the SPX2000. If the MIDI channel is OMNI, the device number will be 1.

Format

```

STATUS      11110000  F0 System exclusive message
ID No.      01000011  43 Manufacture's ID number
              (YAMAHA)

SUB STATUS   0001nnnn  1n n=0-15 (Device number=
              Device No-1)

GROUP ID     00011110  1E MODEL ID (signal processor)
MODEL ID     00001001  09 SPX2000
ADDRESS      00010000  10 Function call
              00ffffff  ff function
              0mmmmmmmm  mh number High
              0mmmmmmmm  ml number Low
DATA        0ccccccc  ch channel High
              0ccccccc  cl channel Low
EOX          11110111  F7 End of exclusive
    
```

function	number	channel	rx/tx
Effect Program Recall	0x04	1-221	0 rx/tx
Effect Program Store	0x24	123-221	0 rx/tx

2.8.2.8 Parameter change (Function call : title)

When the SPX2000 receives this message, it will edit the specified effect name, and will then use this message to transmit the state following the change. At this time, the device number will be the MIDI channel of the SPX2000. If the MIDI channel is OMNI, the device number will be 1.

Format

```

STATUS      11110000  F0 System exclusive message
ID No.      01000011  43 Manufacture's ID number
              (YAMAHA)

SUB STATUS   0001nnnn  1n n=0-15 (Device number=
              Device No-1)

GROUP ID     00011110  1E MODEL ID (signal processor)
MODEL ID     00001001  09 SPX2000
ADDRESS      00010000  10 Function call
              01000100  44 Effect Program title
              0mmmmmmmm  mh number High
              0mmmmmmmm  ml number Low
DATA        0ddddd  dd title 1
              :
              :
              0ddddd  dd title x(depend on the pro-
              gram)
EOX          11110111  F7 End of exclusive
    
```

function	number	size	
Effect Program Title	0x44	1-221 (1-122:response only)	16

2.8.2.9 Parameter request (Function call : title)

Format

```

STATUS      11110000  F0 System exclusive message
ID No.      01000011  43 Manufacture's ID number
              (YAMAHA)

SUB STATUS   0011nnnn  3n n=0-15 (Device number=Device
              No-1)

GROUP ID     00011110  1E MODEL ID (signal processor)
MODEL ID     00001001  09 SPX2000
ADDRESS      00010000  10 Function call
              01000100  44 Effect Program title
              0mmmmmmmm  mh number High
              0mmmmmmmm  ml number Low
EOX          11110111  F7 End of exclusive
    
```

For the function and number, refer to the table in "2.8.2.8 Parameter change (Function call: title)."

■ 2.8.2.10 Parameter change (Function call : Program clear)

When the SPX2000 receives this message, it will erase the specified effect name, and will then use this message to transmit the state following the change. At this time, the device number will be the MIDI channel of the SPX2000. If the MIDI channel is OMNI, the device number will be 1.

• Format

```

STATUS      11110000  F0 System exclusive message
ID No.      01000011  43 Manufacture's ID number
              (YAMAHA)

SUB STATUS   0001nnnn  1n n=0-15 (Device number=Device
              No-1)

GROUP ID    00011110  1E MODEL ID (signal processor)
MODEL ID    00001001  09 SPX2000
ADDRESS     00010000  10 Function call
              01100100  64 Effect Program clear func-
              tion

              0mmmmmmmm  mh number High
              0mmmmmmmm  ml number Low
EOX         11110111  F7 End of exclusive
    
```

function	number
Effect Program Clear	0x64 123-221

■ 2.8.2.11 Parameter change (Function call : Undo)

When the SPX2000 receives this message, it will perform the same operation as if the [UNDO] button had been pressed, and will then use this message to transmit the state following the change. At this time, the device number will be the MIDI channel of the SPX2000. If the MIDI channel is OMNI, the device number will be 1.

• Format

```

STATUS      11110000  F0 System exclusive message
ID No.      01000011  43 Manufacture's ID number
              (YAMAHA)

SUB STATUS   0001nnnn  1n n=0-15 (Device number=Device
              No-1)

GROUP ID    00011110  1E MODEL ID (signal processor)
MODEL ID    00001001  09 SPX2000
ADDRESS     00010001  11 Function call
              00100010  24 Undo
              00000000  00
              00000000  00
              00000000  00
              00000000  00
DATA        00000000  00
              00000000  00
EOX         11110111  F7 End of exclusive
    
```

■ 2.8.2.12 Parameter change (Function call : Compare)

When the SPX2000 receives this message, it will perform the same operation as if the [COMPARE] button had been pressed, and will then use this message to transmit the state following the change. At this time, the device number will be the MIDI channel of the SPX2000. If the MIDI channel is OMNI, the device number will be 1.

• Format

```

STATUS      11110000  F0 System exclusive message
ID No.      01000011  43 Manufacture's ID number
              (YAMAHA)

SUB STATUS   0001nnnn  1n n=0-15 (Device number=Device
              No-1)

GROUP ID    00011110  1E MODEL ID (signal processor)
MODEL ID    00001001  09 SPX2000
ADDRESS     00010001  11 Function call
              01000100  44 Compare
              00000000  00
              00000000  00
              00000000  00
DATA        00000000  00
              00000000  00
EOX         11110111  F7 End of exclusive
    
```

■ 2.8.2.13 Parameter change (Function call : Event Effect)

When the SPX2000 receives this message while a freeze-type effect is recalled, it will perform the same operation as if the RECORD parameter or PLAY parameter is selected and the [▼DEC] button pressed. The contents of the function will determine whether the RECORD parameter or the PLAY parameter is selected.

• Format

```

STATUS      11110000  F0 System exclusive message
ID No.      01000011  43 Manufacture's ID number
              (YAMAHA)

SUB STATUS   0001nnnn  1n n=0-15 (Device number=Device
              No-1)

GROUP ID    00011110  1E MODEL ID (signal processor)
    
```

```

MODEL ID    00001001  09 SPX2000
ADDRESS     00010010  12 Function call Effect Event
              0000ffff  0f function
              00000000  00
              0pppppppp  pp Release:0, Press:1
DATA        00000000  00
              0eeeeeee  ee Effect number (0)
EOX         11110111  F7 End of exclusive
    
```

function	channel
Freeze Play button	0x00 0
Freeze Record button	0x01 0

*This will not function if the effect type is wrong.

■ 2.8.2.14 Parameter change (Function call: attribute(Protect))

When the SPX2000 receives this message, it will switch Protect on/off for the specified effect, and will then use this message to transmit the state following the change. At this time, the device number will be the MIDI channel of the SPX2000. If the MIDI channel is OMNI, the device number will be 1.

• Format

```

STATUS      11110000  F0 System exclusive message
ID No.      01000011  43 Manufacture's ID number
              (YAMAHA)

SUB STATUS   0001nnnn  1n n=0-15 (Device number=Device
              No-1)

GROUP ID    00011110  1E MODEL ID (signal processor)
MODEL ID    00001001  09 SPX2000
ADDRESS     00010100  14 Function call
              00000100  04 attribute
              0mmmmmmmm  mh number High
              0mmmmmmmm  ml number Low
DATA        0tttttttt  tt attribute(protect:0x0001,
              normal:0x0000)

              0tttttttt  tt
EOX         11110111  F7 End of exclusive
    
```

function	number
Effect Program Attribute	0x04 1-221(1-122:response only)

■ 2.8.2.15 Parameter request (Function call: attribute(Protect))

• Format

```

STATUS      11110000  F0 System exclusive message
ID No.      01000011  43 Manufacture's ID number
              (YAMAHA)

SUB STATUS   0011nnnn  3n n=0-15 (Device number=Device
              No-1)

GROUP ID    00011110  1E MODEL ID (signal processor)
MODEL ID    00001001  09 SPX2000
ADDRESS     00010100  14 Function call
              00000100  04 attribute
              0mmmmmmmm  mh number High
              0mmmmmmmm  ml number Low
EOX         11110111  F7 End of exclusive
    
```

For the function and number, refer to the table in "2.8.2.14 Parameter change (Function call: attribute (Protect))."

■ 2.8.2.16 Parameter change (Function call: LCD Back Color)

When the SPX2000 receives this message, it will change the display background color of the specified effect, and will then use this message to transmit the state following the change. At this time, the device number will be the MIDI channel of the SPX2000. If the MIDI channel is OMNI, the device number will be 1.

• Format

```

STATUS      11110000  F0 System exclusive message
ID No.      01000011  43 Manufacture's ID number
              (YAMAHA)

SUB STATUS   0001nnnn  1n n=0-15 (Device number=Device
              No-1)

GROUP ID    00011110  1E MODEL ID (signal processor)
MODEL ID    00001001  09 SPX2000
ADDRESS     00010100  14 Function call
              01100100  64 LCD Back Color
              0mmmmmmmm  mh number High
              0mmmmmmmm  ml number Low
DATA        0ccccccc  cc color(0:Green,1:Yellow,
              2:Magenta,3:Cyan,4:White)

              0ccccccc  cc
    
```

EOX	11110111	F7	End of exclusive
function		number	
Effect Program LCD Back Color	0x64	1-221(1-122:response only)	

■ 2.8.2.17 Parameter request (Function call: LCD Back Color)

• Format

STATUS	11110000	F0	System exclusive message
ID No.	01000011	43	Manufacture's ID number (YAMAHA)
SUB STATUS	0011nnnn	3n	n=0-15 (Device number=Device No-1)
GROUP ID	00011110	1E	MODEL ID (signal processor)
MODEL ID	00001001	09	SPX2000
ADDRESS	00010100	14	Function call
	01100100	64	LCD Back Color
	0mmmmmmmm	mh	number High
	0mmmmmmmm	ml	number Low
EOX	11110111	F7	End of exclusive

For the function and number, refer to the table in "2.8.2.16 Parameter change (Function call: LCD Back Color)."

■ 2.8.2.18 Parameter change (Remote Meter)

When the SPX2000 receives a Parameter Request (Remote Meter) message, it will transmit this message. The content is data for the specified meter. This is transmitted at 50 msec intervals for ten seconds. If you want meter data to continue being transmitted, you must transmit a Request message at intervals of less than ten seconds. However if the port is being used for other communication, transmission of meter data may be interrupted.

The device number used when transmitting meter data will be the MIDI channel of the SPX2000. If the MIDI channel is OMNI, the device number will be 1.

When the SPX2000 receives a Request message with an Address UL = 0x7F, transmission of all meter data will be halted immediately. Transmission will also stop if the power is turned off and on again while transmitting meter data, or if the MIDI port setting is changed.

• Format

STATUS	11110000	F0	System exclusive message
ID No.	01000011	43	Manufacture's ID number (YAMAHA)
SUB STATUS	0001nnnn	1n	n=0-15 (Device number=Device No-1)
GROUP ID	00011110	1E	MODEL ID (signal processor)
MODEL ID	00001001	09	SPX2000
ADDRESS	00100001	21	Remote meter
	0mmmmmmmm	mm	ADDRESS UL
	0mmmmmmmm	mm	ADDRESS LU
	0mmmmmmmm	mm	ADDRESS LL
DATA	0ddddddd	dd	Data1 H
	0ddddddd	dd	Data1 L
	:	:	
EOX	11110111	F7	End of exclusive

■ 2.8.2.19 Parameter request (Remote Meter)

• Format

STATUS	11110000	F0	System exclusive message
ID No.	01000011	43	Manufacture's ID number (YAMAHA)
SUB STATUS	0011nnnn	3n	n=0-15 (Device number=Device No-1)
GROUP ID	00011110	1E	MODEL ID (signal processor)
MODEL ID	00001001	09	SPX2000
ADDRESS	00100001	21	Remote meter
	0mmmmmmmm	mm	ADDRESS UL
	0mmmmmmmm	mm	ADDRESS LU
	0mmmmmmmm	mm	ADDRESS LL
	0ccccccc	ch	Count H
	0ccccccc	cl	Count L
EOX	11110111	F7	End of exclusive

MIDI Control Change Parameter Assignment Table

PRESET bank

CC #	REV-X	Stereo reverb	Reverb	Early Reflection	Mono delay	Stereo delay	Modulation delay	Delay L,C,R
1	REV TIME	REV TIME	INI.DLY	TYPE	DELAY	DELAY L	DELAY	DELAY L
2	INI.DLY	REV TYPE	REV TIME	ROOMSIZE		DELAY R		
3	HI.RATIO	INI.DLY	HI.RATIO	LIVENESS	FB.GAIN	FB.G L	FB.GAIN	DELAY C
4	LO.RATIO	HI.RATIO	LO.RATIO	INI.DLY	HI.RATIO	FB.G R	HI.RATIO	
5	DIFF.	LO.RATIO	DIFF.	DIFF.	HPF	HI.RATIO	FREQ.	DELAY R
6	ROOMSIZE	DIFF.	DENSITY	DENSITY	LPF	HPF	DEPTH	
7	DECAY	DENSITY	HPF	ER NUM.	SYNC	LPF	WAVE	FB.DLY
8	LO.FREQ	HPF	LPF	FB.GAIN	NOTE	SYNC	HPF	
9	HPF	LPF	E/R DLY	HI.RATIO	OUT LVL	NOTE L	LPF	LEVEL L
10	LPF	E/R BAL.	E/R BAL.	HPF		NOTE R	SYNC	LEVEL C
11	OUT LVL	OUT LVL	GATE LVL	LPF		OUT LVL	DLY.NOTE	LEVEL R
12			ATTACK	OUT LVL			MOD.NOTE	FB.GAIN
13			HOLD				OUT LVL	HI.RATIO
14			DECAY					HPF
15			OUT LVL					LPF
16								SYNC
17								NOTE L
18								NOTE C
19								NOTE R
20								NOTE FB
21								
31	MIX BAL.	MIX BAL.	MIX BAL.	MIX BAL.	MIX BAL.	MIX BAL.	MIX BAL.	MIX BAL.

CC #	Echo	Flanger	Phaser	Chorus	Symphonic	Tremolo	Auto pan	Modulation filter
1	DELAY L	FREQ.	FREQ.	FREQ.	FREQ.	FREQ.	FREQ.	FREQ.
2	DELAY R	DEPTH	DEPTH	AM DEPTH	DEPTH	DEPTH	DEPTH	DEPTH
3	FB.DLY	MOD.DLY	FB.GAIN	PM DEPTH	MOD.DLY	WAVE	DIR.	PHASE
4	FB.DLYR	FB.GAIN	OFFSET	MOD.DLY	WAVE	LSH F	WAVE	TYPE
5	FB.G L	WAVE	PHASE	WAVE	LSH F	LSH G	LSH F	OFFSET
6	FB.G R	LSH F	STAGE	LSH F	LSH G	EQ F	LSH G	RESO.
7	L->R FBG	LSH G	LSH F	LSH G	EQ F	EQ G	EQ F	OUT LVL
8	R->L FBG	EQ F	LSH G	EQ F	EQ G	EQ Q	EQ Q	SYNC
9	HI.RATIO	EQ G	SHS F	EQ Q	EQ Q	SHS F	EQ Q	NOTE
10	HPF	EQ Q	SHS F	EQ Q	SHS F	SHS G	SHS F	
11	LPF	SHS F	SYNC	SHS F	SHS G	SYNC	SHS G	
12	SYNC	SHS G	NOTE	SHS G	SYNC	NOTE	SYNC	
13	NOTE L	SYNC	OUT LVL	SYNC	NOTE	OUT LVL	NOTE	
14	NOTE R	NOTE		NOTE	OUT LVL		OUT LVL	
15	NOTE FBL	OUT LVL		OUT LVL				
16	NOTE FBR							
17	OUT LVL							
18								
19								
20								
21								
31	MIX BAL.	MIX BAL.	MIX BAL.	MIX BAL.	MIX BAL.	MIX BAL.	MIX BAL.	MIX BAL.

CC #	Ring modulation	Dynamic filter	Dynamic flanger	Dynamic phaser	High quality pitch	Dual pitch	Distortion → Flanger Distortion → Delay	Reverb + Chorus
1	SOURCE	SOURCE	SOURCE	SOURCE	PITCH	PITCH 1	DST TYPE	INI.DLY
2	OSC FRQ	SENSE	SENSE	SENSE	FINE	FINE 1	DRIVE	REV TIME
3		DIR.	DIR.	DIR.	DELAY	LEVEL 1	MASTER	HI.RATIO
4	FM FREQ.	DECAY	DECAY	DECAY	FB.GAIN	PAN 1	STONE	DIFF.
5	FM DEPTH	TYPE	OFFSET	OFFSET	MODE	DELAY 1	N.GATE	DENSITY
6	SYNC	OFFSET	FB.GAIN	FB.GAIN	SYNC	FB.G 1	DELAY	HPF
7	NOTE FM	RESO.	LSH F	STAGE	NOTE	PITCH 2		LPF
8	OUT LVL	OUT LVL	LSH G	LSH F	OUT LVL	FINE 2	FB.GAIN	REV/CHO
9			EQ F	LSH G		LEVEL 2	HI.RATIO	FREQ.
10			EQ G	SHS F		PAN 2	FREQ.	AM DEPTH
11			EQ Q	SHS G		DELAY 2	DEPTH	PM DEPTH
12			SHS F	OUT LVL		FB.G 2	DLY.BAL	MOD.DLY
13			SHS G			MODE	SYNC	WAVE
14			OUT LVL			SYNC	DLY.NOTE	SYNC
15						NOTE 1	MOD.NOTE	NOTE
16						NOTE 2		OUT LVL
17								
18								
19								
20								
21								
31	MIX BAL.	MIX BAL.	MIX BAL.	MIX BAL.	MIX BAL.	MIX BAL.	MIX BAL.	MIX BAL.

MIDI

CC #	Reverb → Chorus	Reverb + Flanger	Reverb → Flanger	Reverb + Symphonic	Reverb → Symphonic	Reverb → Pan	Delay + Early Reflection	Delay → Early Reflection
1	INI.DLY	INI.DLY	DELAY L	DELAY L	INI.DLY	INI.DLY	DELAY L	DELAY L
2	REV.TIME	REV.TIME	DELAY R	DELAY R	REV.TIME	REV.TIME	DELAY R	DELAY R
3	HI.RATIO	HI.RATIO	FB.DLY	FB.DLY	HI.RATIO	HI.RATIO	FB.DLY	FB.DLY
4	DIFF.	DIFF.	FB.GAIN	FB.GAIN	DIFF.	DIFF.	FB.GAIN	FB.GAIN
5	DENSITY	DENSITY	HI.RATIO	HI.RATIO	DENSITY	DENSITY	HI.RATIO	HI.RATIO
6	HPF	HPF	HPF	HPF	HPF	HPF	HPF	HPF
7	LPF	LPF	LPF	LPF	LPF	LPF	LPF	LPF
8	REV.BAL	REV.BAL	DLY/ER	DLY.BAL	REV.BAL	REV.BAL	DLY/ER	DLY.BAL
9	FREQ.	FREQ.	TYPE	TYPE	FREQ.	FREQ.	TYPE	TYPE
10	DEPTH	DEPTH	ROOMSIZE	ROOMSIZE	DEPTH	DEPTH	ROOMSIZE	ROOMSIZE
11	MOD.DLY	DIR.	LIVENESS	LIVENESS	MOD.DLY	DIR.	LIVENESS	LIVENESS
12	WAVE	WAVE	INI.DLY	INI.DLY	WAVE	WAVE	INI.DLY	INI.DLY
13	SYNC	SYNC	DIFF.	DIFF.	SYNC	SYNC	DIFF.	DIFF.
14	NOTE	NOTE	DENSITY	DENSITY	NOTE	NOTE	DENSITY	DENSITY
15	OUT LVL	OUT LVL	ER NUM.	ER NUM.	OUT LVL	OUT LVL	ER NUM.	ER NUM.
16			SYNC	SYNC			SYNC	SYNC
17			NOTE L	NOTE L			NOTE L	NOTE L
18			NOTE R	NOTE R			NOTE R	NOTE R
19			NOTE FB	NOTE FB			NOTE FB	NOTE FB
20			OUT LVL	OUT LVL			OUT LVL	OUT LVL
21								
31	MIX BAL.	MIX BAL.	MIX BAL.	MIX BAL.	MIX BAL.	MIX BAL.	MIX BAL.	MIX BAL.

CC #	Delay + Reverb	Delay → Reverb	Freeze	Multi Filter	Multi-band Dynamics Processor	Rotary Speaker	Distortion	Amp Simulator
1	DELAY L	DELAY L	REC MODE	TYPE 1	LOW GAIN	ROTATE	DST TYPE	AMP TYPE
2	DELAY R	DELAY R	REC DLY	TYPE 2	MID GAIN	SPEED	DRIVE	DST TYPE
3	FB.DLY	FB.DLY	TRG LVL	TYPE 3	HI.GAIN	SLOW	MASTER	DRIVE
4	FB.GAIN	FB.GAIN	TRG MASK	FREQ. 1	PRESENCE	FAST	STONE	MASTER
5	DELAY HI	DELAY HI	PLY MODE	FREQ. 2	EXP.THRE	DRIVE	N.GATE	BASS
6	HPF	HPF	START	FREQ. 3	EXP.RAT	ACCEL		MIDDLE
7	LPF	LPF		LEVEL 1	EXP.REL	LOW		TREBLE
8	DLY/REV	DLY.BAL	END	LEVEL 2	EXP.BYP	HIGH		CAB DEP
9	INI.DLY	INI.DLY		LEVEL 3	CMP.THRE			EQ F
10	REV TIME	REV TIME	LOOP	RESO. 1	CMP.RAT			EQ G
11	REV HI	REV HI		RESO. 2	CMP.REL			EQ Q
12	DIFF.	DIFF.	LOOP NUM	RESO. 3	CMP.ATK			N.GATE
13	DENSITY	DENSITY	PITCH		CMP.KNEE			
14	SYNC	SYNC	FINE		CMP.BYP			
15	NOTE L	NOTE L	MIDI TRG		LIM.THRE			
16	NOTE R	NOTE R	OUT LVL		LIM.REL			
17	NOTE FB	NOTE FB			LIM.ATK			
18	OUT LVL	OUT LVL			LIM.KNEE			
19					LIM.BYP			
20					LOOKUP			
21					L-M XOVR			
22					M-H XOVR			
23					SLOPE			
24					CEILING			
31	MIX BAL.	MIX BAL.	MIX BAL.	MIX BAL.	MIX BAL.	MIX BAL.	MIX BAL.	MIX BAL.

CLASSIC bank

CC #	Reverb	Reverb & gate	Early reflection Gate reverb Reverse gate	Delay L,R Stereo echo	Stereo flanger Stereo phasing	Chorus Tremolo	Symphonic	Pan
1	REV TIME	REV TIME	TYPE	Lch DLY	MOD. FRQ	MOD. FRQ	MOD. FRQ	MOD. FRQ
2	HI.RATIO	HI.RATIO	ROOMSIZE	FB.G L	DEPTH	PM DEPTH	DEPTH	DIR.
3	DELAY	DELAY	LIVENESS	Rch DLY	MOD. DLY	AM DEPTH	OUT LVL	DEPTH
4	HPF	HPF	DELAY	FB.G R	F.B.GAIN	OUT LVL		OUT LVL
5	LPF	LPF	LPF	HI.RATIO	OUT LVL			
6	OUT LVL	TRG. LVL	OUT LVL	OUT LVL				
7		HOLD						
8		RELEASE						
9		MIDI TRG						
10		OUT LVL						
31	MIX BAL.	MIX BAL.	MIX BAL.	MIX BAL.	MIX BAL.	MIX BAL.	MIX BAL.	MIX BAL.

CC #	Pitch Change A Pitch Change D	Pitch Change B	Pitch Change C	Freeze	Freeze B
1	PITCH	1 PITCH	L PITCH	REC MODE	REC MODE
2	FINE	1 FINE	L FINE	TRG. DLY	TRG. DLY
3	DELAY	1 DLY	L DLY	INP. TRG	PITCH
4	FB.GAIN	2 PITCH	R PITCH	START	FINE
5	BASE KEY	2 FINE	R FINE		BASE KEY
6	OUT LVL	2 DLY	R DLY	END	OUT LVL
7		OUT LVL	OUT LVL		
8				OUT LVL	
9					
10					
31	MIX BAL.	MIX BAL.	MIX BAL.	MIX BAL.	MIX BAL.

Error message list

Error message	Message content/Action
Low Battery!	The internal backup battery has run down. If the battery goes dead, the internal data will be lost. Press any button to cancel the error message. Then immediately use the “BULK OUT (ALL)” function (page 23) to save the internal data on your computer or on external device. After you have saved the data, contact your Yamaha dealer to have the backup battery replaced.
MIDI Framing Error!	A MIDI framing error has occurred. Press any button to cancel the error message. Then try transmitting the MIDI data once again.
MIDI OUT is NOT Selected!	Since the “MIDI OUT/THRU” connector (29) is set to “THRU,” MIDI messages cannot be transmitted. If you want to transmit MIDI messages, use the “MIDI OUT SETUP” (page 21) function to set the [MIDI OUT/THRU] connector to “OUT.”
MIDI Overrun Error!	A MIDI overrun error has occurred. Press any button to cancel the error message. Then try transmitting the MIDI data once again.
MIDI Parity Error!	A MIDI parity error has occurred. Press any button to cancel the error message. Then try transmitting the MIDI data once again.
MIDI Rx Buffer Full!	The MIDI reception buffer is full. Press any button to cancel the error message. Then try transmitting the MIDI data once again. If the error occurs again, try increasing the spacing between the MIDI data that is transmitted, or take other measures to prevent a large amount of MIDI data from being transmitted at once.
NO FINE PARAMETER	This effect has no Fine parameters. Effects of the CLASSIC bank have no Fine parameters; this message will appear if you press the [FINE PARAM] button for an effect of the CLASSIC bank. Use the [PARAMETER] button to select Basic parameters.
Not Available in Compare Mode!	You pressed an unavailable button while comparing the effect (while the [COMPARE] LED is blinking). Press the [COMPARE] button to defeat Compare before you perform the desired operation.
Operation Locked!	The button etc. you attempted to operate has been disabled by the “OPERATION LOCK” function. Defeat the restriction as necessary. For details, refer to “Restricting operation of the SPX2000” on page 19.
PORT GENERAL is Selected OFF!	MIDI messages cannot be transmitted because the MIDI port (GENERAL) is turned OFF. If you want to transmit MIDI messages, set the “MIDI PORT GENERAL” setting (page 21) to the port that you want to use for MIDI message transmission and reception.
U## Program is Empty!	There is no effect to recall. Please re-select an effect to recall.
Sync Error!	The clock of the received digital input signal differs from the SPX2000’s operating clock. For details, refer to “About word clock” (page 19).
This BANK is Protected!	You selected the PRESET bank or CLASSIC bank as the effect store-destination. Since the PRESET bank and CLASSIC bank are read-only, you cannot change store to these effects, or change the effect name, protect setting, or display background color. Press any button to cancel the error message. Then select a store-destination from the USER bank.
This Program is Protected!	The effect store-destination is protected. Press any button to cancel the error message. Then defeat the protect setting as desired. For details, refer to “Protecting an effect” on page 17.
USB Rx Buffer Full!	The USB reception buffer is full. Press any button to cancel the error message. Then try transmitting the MIDI data once again. If the error occurs again, try increasing the spacing between the MIDI data that is transmitted, or take other measures to prevent a large amount of MIDI data from being transmitted at once.
WRONG WORD CLOCK!	The word clock signal from an external device has been interrupted, or is a frequency to which the SPX2000 cannot synchronize. Check whether there are any problems with the connection from the device supplying the word clock, and verify that the word clock settings are correct. For details, refer to “About word clock” (page 19).

Troubleshooting

If the SPX2000 does not function as you expect, or if you suspect a problem, please check the following points.

Power does not turn on	<ul style="list-style-type: none"> • Is the power cable connected to an AC outlet of the correct voltage? • Is the POWER switch turned ON?
The input sound is not sent from the outputs	<ul style="list-style-type: none"> • Is your external equipment correctly connected with the SPX2000? • Could the cables connected to/from your external equipment be broken? • Is a signal being input from your external device? • Is the [INPUT L  R] control (①) set to an appropriate level? • Is the INPUT SOURCE set appropriately? (For details, refer to page 19.) • Is the CLOCK SOURCE set appropriately? (For details, refer to page 18.) • Could output-related parameters such as OUT LVL and LEVEL be set to 0%? • Is the signal output when you turn the [BYPASS] button (②) on? (Some effects do not output a signal at all times.)
Noise is heard in the output	<ul style="list-style-type: none"> • Is the CLOCK SOURCE set appropriately? (For details, refer to page 18.)
Signal level does not match the external device	<ul style="list-style-type: none"> • Are the rear panel [OUTPUT -10 dBu/+4 dBu] switch and the [INPUT -10 dBu/+4 dBu] switch set correctly?
Some buttons are inoperable	<ul style="list-style-type: none"> • Could the [UTILITY] button be on (LED lit)? (see page 8) • Could the [COMPARE] button be on (LED blinking)? (see page 16)
TEMPO and NOTE settings do not produce the timing you expect	<ul style="list-style-type: none"> • Is the SYNC setting turned on? (For details, refer to page 15.)
Can't transfer MIDI data	<ul style="list-style-type: none"> • Have you made the correct preparations for using MIDI? (see page 88) • Is the MIDI cable (USB cable) connected correctly? • Could the MIDI cable (USB cable) be broken?

Specifications

General Specifications

Analog Input/Output	INPUT L,R	XLR-3-31	Balanced
		Phone jack	Balanced
		AD converter, 24-bit linear	128-times oversampling (@Fs=44.1, 48 kHz) 64-times oversampling (@Fs=88.2, 96 kHz)
		Level SW	+4/-10 dBu
	OUTPUT L,R	XLR-3-32	Balanced
		Phone jack	Balanced
		DA converter, 24-bit linear	128-times oversampling (@Fs=44.1, 48 kHz) 64-times oversampling (@Fs=88.2, 96 kHz)
		Level SW	+4/-10 dBu
Digital Input/Output	AES/EBU IN	XLR-3-31	Balanced
	AES/EBU OUT	XLR-3-32	Balanced
Controls	WORD CLOCK IN		
	MIDI IN		
	MIDI OUT/THRU		
	USB TO HOST	USB 1.1	
	INPUT L, R for VOLUME		
	FOOT SW for TAP		
Keys	[INPUT MODE], [METER], [BANK]		
	MEMORY	[UNDO], [▲], [▼], [RECALL], [STORE]	
	EDIT	[COMPARE], [▲ INC], [▼ DEC], [NEXT], [BACK]	
		[PARAMETER], [FINE PARAM], [UTILITY]	
	[BYPASS], [TAP]		
	[POWER ON/OFF]		
LEDs	Level Meter L, R	2 × 12 Segments LED	
	Effect No.	2 × 7 Segments LED	
	INPUT MODE	[MONO]/[STEREO]	
	METER	[INPUT]/[OUTPUT]	
	INPUT SOURCE	[ANALOG]/[DIGITAL]	
	CLOCK	[INT]/[AES/EBU]/[WC]	
	kHz	[96]/[88.2]/[48]/[44.1]	
	MIDI	[MIDI]	
BANK	[PRESET]/[USER]/[CLASSIC]		
LCD	16 characters × 2 rows back-lit LCD		
	Back-lit color	Green, Yellow, Magenta, Cyan, White, Red (Error Message only)	
Effects	PRESET	97	
	USER	99	
	CLASSIC	25	
Power Requirements	U.S./Canada	120V 25W 60Hz	
	Others	230V 25W 50Hz	
Dimensions	Height	45 mm	
	Depth	372.5 mm	
	Width	480 mm	
Net Weight	4kg		
Operating free-air temperature range	5—40°C		
Storage temperature range	-20—60°C		
Accessories	Power cable		
Option	Foot Switch FC5		

Input/Output Characteristics

Analog Input Characteristics

Input Terminals	Level SW	Input Level VR.	Actual Load Impedance	For Use With Nominal	Input Level			Connector
					Sensitivity	Nominal	Max. before clip	
INPUT L, R	+4 dBu	Max.: +10 dB	10 k Ω	600 Ω Lines	-6 dBu (0.388 V)	—	+14 dBu (3.88 V)	XLR-3-31 type (Balanced)
	-10 dBu	Max.: +10 dB			-20 dBu (0.0775 V)	—	0 dBu (0.775 V)	Phone jack (TRS: Balanced)
Input Terminals	Level SW	Input Level VR.	Actual Load Impedance	For Use With Nominal	Input Level			Connector
					Sensitivity	Nominal	Max. before clip	
INPUT L, R	+4 dBu	Nominal: 0 dB	10 k Ω	600 Ω Lines	—	+4 dBu (1.23V)	+24 dBu (12.28 V)	XLR-3-31 type (Balanced)
	-10 dBu	Nominal: 0 dB			—	-10 dBu (0.245V)	+10 dBu (2.45 V)	Phone jack (TRS: Balanced)

*1 Sensitivity is the lowest level that will produce an output of +4dB(1.23V) or the nominal output level when the unit is set to maximum gain.(level control is maximum position.)

*2 XLR-3-31 type connectors are balanced. (1=GND, 2=HOT, 3=COLD)

*3 Phone jacks are balanced. (Tip=HOT, Ring=COLD, Sleeve=GND)

*4 In these specifications, when dBu represents are specific voltage, 0 dBu is referenced to 0.775 Vrms.

*5 AD converter is 24-bit linear,128-times oversampling @Fs=44.1, 48 kHz, 64-times oversampling @Fs=88.2, 96 kHz

Analog Output Characteristics

Output Terminals	Actual Source Impedance	For Use With Nominal	Level SW	Output Level		Connector
				Nominal	Max. before clip	
OUTPUT L, R	75 Ω	600 Ω Lines	+4 dBu	+4 dBu (1.23V)	+24 dBu (12.28V)	XLR-3-32 type (Balanced) Phone jack (TRS: Balanced)
			-10 dBu	-10 dBu (0.245V)	+10 dBu (2.45V)	

*1 XLR-3-32 type connectors are balanced. (1=GND, 2=HOT, 3=COLD)

*2 Phone jacks are balanced. (Tip=HOT, Ring=COLD, Sleeve=GND)

*3 In these specifications, when dBu represents are specific voltage, 0 dBu is referenced to 0.775 Vrms.

*4 DA converter is 24-bit, 128-times oversampling @Fs=44.1, 48 kHz, 64-times oversampling @Fs=88.2, 96 kHz

Digital Input Characteristics

Input Terminals	Format	Data Length	Level	Connector
AES/EBU IN	AES/EBU	24-bit	RS422	XLR-3-31 type (Balanced)

*1 XLR-3-31 type connectors are balanced. (1=GND, 2=HOT, 3=COLD)

Digital Output Characteristics

Output Terminals	Format	Data Length	Level	Connector
AES/EBU OUT	AES/EBU Professional use	24-bit	RS422	XLR-3-32 type (Balanced)

*1 channel status of AES/EBU OUT
type: 2 audio channels
emphasis: NO
sampling frequency: depends on the internal configuration

*2 dither: word length 16 - 24-bit

*3 XLR-3-32 type connector is balanced. (1=GND, 2=HOT, 3=COLD)

Control I/O Characteristics

Terminals		Format	Level	Connector
USB	TO HOST	USB 1.1	0 to 3.3 V	B type USB Connector
MIDI	IN	MIDI	—	DIN Connector 5P
	OUT/THRU	MIDI	—	DIN Connector 5P
WORD CLOCK	IN	—	TTL/75 Ω	BNC Connector

Electrical Characteristics

Input Level VR is nominal when measured. Output impedance of signal generator:600ohms

Frequency Response

Fs=48 kHz: @20 Hz-20 kHz, reference to the nominal output level @1 kHz

Fs=96 kHz: @20 Hz-40 kHz, reference to the nominal output level @1 kHz

Input	Output	RL	Conditions	Min	Typ	Max	Units
INPUT L, R	OUTPUT L, R	600 Ω	—	-3.0	0.0	+1.0	dB

Gain Error

@1 kHz

Input	Output	RL	Conditions	Min	Typ	Max	Units
INPUT L, R	OUTPUT L, R	600 Ω	INPUT LEVEL SW: +4, OUTPUT LEVEL SW: +4	+2.0	+4.0	+6.0	dBu
			INPUT LEVEL SW: -10, OUTPUT LEVEL SW: -10	-12.0	-10.0	-8.0	dBu

*1 In these specifications, when dBu represents are specific voltage, 0 dBu is referenced to 0.775 Vrms.

Total Harmonic Distortion

Input	Output	RL	Conditions	Min	Typ	Max	Units
INPUT L, R	OUTPUT L, R	600Ω	Fs=48kHz: +14 dBu @20Hz-20kHz, INPUT LEVEL SW: +4, OUTPUT LEVEL SW: +4			0.05	%
			Fs=96kHz: +14 dBu @20Hz-40kHz, INPUT LEVEL SW: +4, OUTPUT LEVEL SW: +4			0.05	%

*1 In these specifications, when dBu represents are specific voltage, 0 dBu is referenced to 0.775 Vrms.

*2 Total Harmonic Distortion is measured with a 18 dB/octave filter @80 kHz.

Hum & Noise

Fs=48/96 kHz

Input	Output	RL	Conditions	Min	Typ	Max	Units
INPUT L, R	OUTPUT L, R	600 Ω	Rs=600 Ω, INPUT LEVEL VR: nominal INPUT LEVEL SW: +4 /OUTPUT LEVEL SW: +4			-80	dBu

*1 Hum & Noise are measured with a 6 dB/octave filter @12.7 kHz;
equivalent to a 20 kHz filter with infinite dB/octave attenuation.

*2 In these specifications, when dBu represents are specific voltage, 0 dBu is referenced to 0.775 Vrms.

Dynamic Range

Fs=48/96 kHz

Input	Output	RL	Conditions	Min	Typ	Max	Units
INPUT L, R	OUTPUT L, R	600 Ω	AD + DA, INPUT LEVEL VR: max		106		dB

*1 Dynamic range are measured with a 6 dB/octave filter @12.7 kHz;
equivalent to a 20 kHz filter with infinite dB/octave attenuation.

Crosstalk

@1 kHz

From/To	To/From	Conditions	Min	Typ	Max	Units
INPUT L, R	OUTPUT L, R	INPUT to OUTPUT			-80	dB

Maximum voltage gain

@1 kHz

Input	Output	RL	Conditions	Min	Typ	Max	Units
INPUT L, R	OUTPUT L, R	600 Ω	Rs=600 Ω, INPUT LEVEL VR: max INPUT LEVEL SW: +4 /OUTPUT LEVEL SW: +4		+10		dB

PARAMETER		CONDITIONS	MIN	TYP	MAX	UNITS
Sampling Frequency						
External Clock	Frequency Range	Normal Rate	39.69		50.88	kHz
		Double Rate	79.38		101.76	kHz
	Jitter of PLL	DIGITAL IN Fs=44.1 kHz, Jitter \leq 2ns			10	ns
		DIGITAL IN Fs=48 kHz, Jitter \leq 2ns			10	ns
		DIGITAL IN Fs=39.69-50.88 kHz, Jitter \leq 2ns			20	ns
		DIGITAL IN Fs=88.2 kHz, Jitter \leq 2ns			10	ns
		DIGITAL IN Fs=96 kHz, Jitter \leq 2ns			10	ns
DIGITAL IN Fs=79.38-101.76 kHz, Jitter \leq 2ns			20	ns		
Internal Clock	Frequency	word clock: int 44.1 kHz		44.1		kHz
		word clock: int 48 kHz		48		kHz
		word clock int 88.2 kHz		88.2		kHz
		word clock: int 96 kHz		96		kHz
	accuracy	word clock int 44.1 kHz			50	ppm
		word clock: int 48 kHz			50	ppm
		word clock: int 88.2 kHz			50	ppm
		word clock: int 96 kHz			50	ppm
	jitter	word clock: int 44.1 kHz			5	ns
		word clock: int 48 kHz			5	ns
		word clock : int 88.2 kHz			5	ns
		word clock: int 96 kHz			5	ns
Signal Delay		INPUT to OUTPUT (@Delay time=0.0 ms / Fs=96 kHz)			426	μ s

Block Diagram

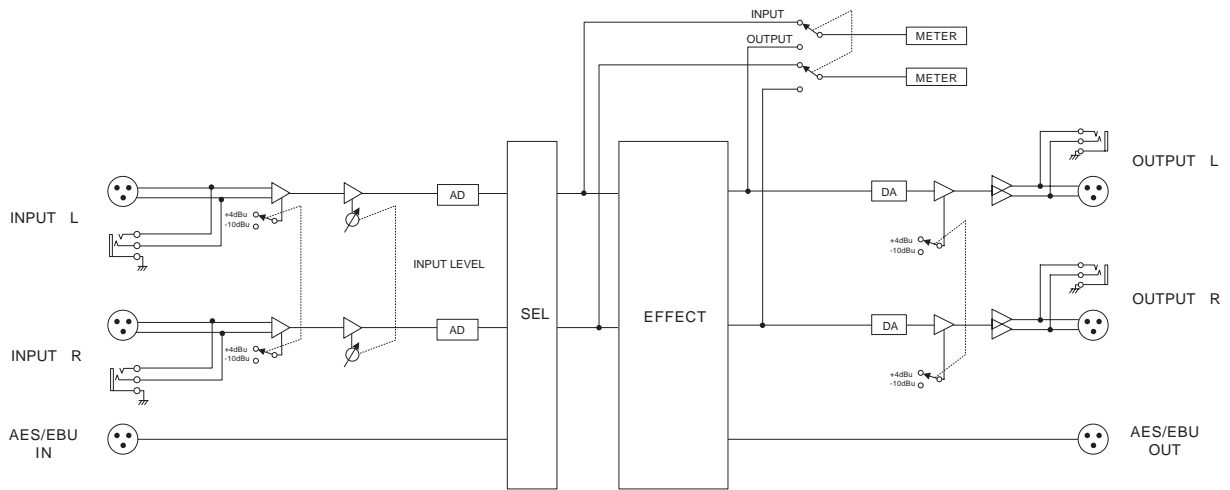

Dimensions

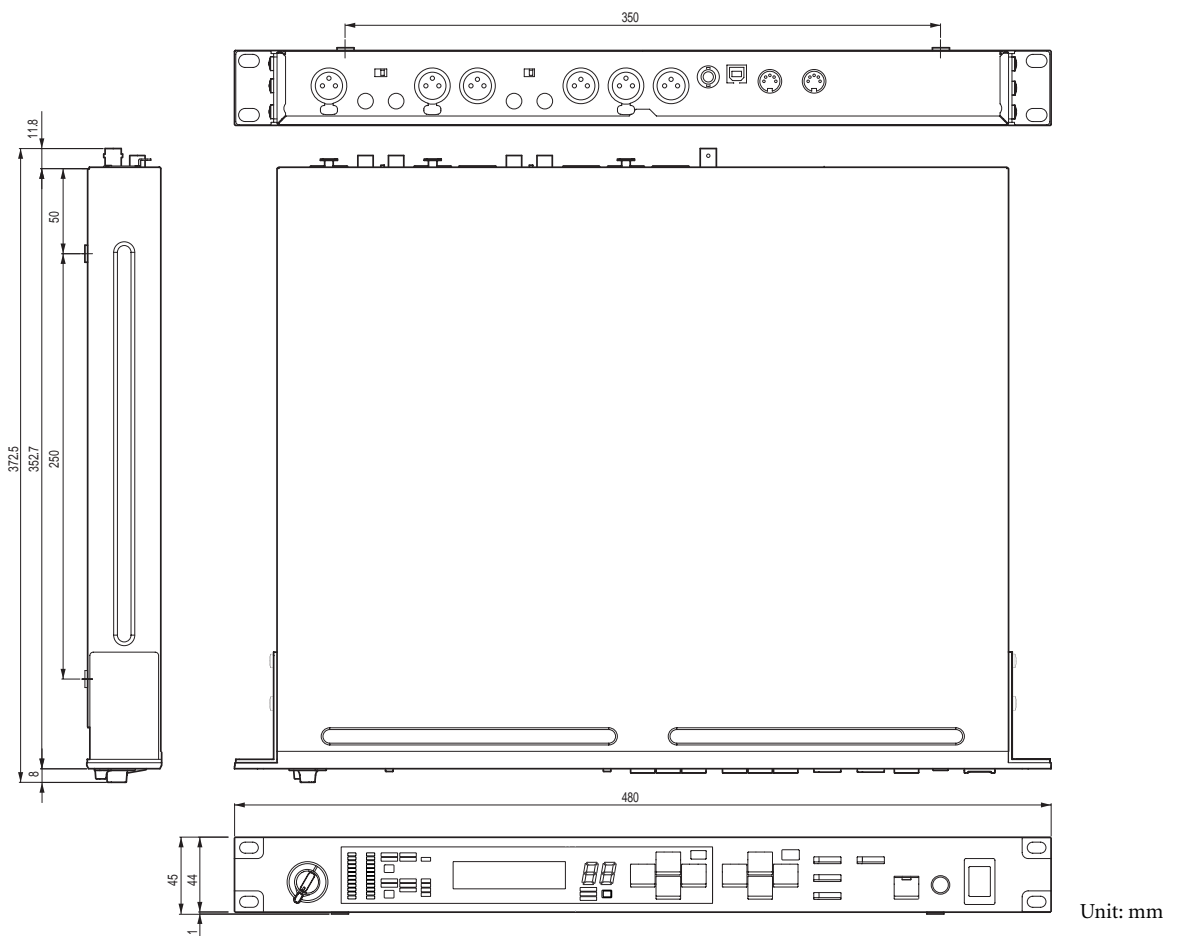

Unit: mm

* Specifications and descriptions in this owner's manual are for information purposes only. Yamaha Corp. reserves the right to change or modify products or specifications at any time without prior notice. Since specifications, equipment or options may not be the same in every locale, please check with your Yamaha dealer.

European models
 Purchaser/User Information specified in EN55103-1 and EN55103-2.
 Inrush Current: 45 A
 Conforms to Environments: E1, E2, E3 and E4

Index

Symbols

[▲ INC]/[▼ DEC] button7, 14
[▲]/[▼] buttons 7, 12, 13, 16

A

[AC IN] jack 9
Adjust
 input level 11
[AES/EBU IN] jack9, 19
[AES/EBU OUT] jack 9
ANALOG 19
Attack Time 34

B

[BACK] button7, 14
[BANK] button7, 12
[BANK] indicator 7, 12, 13
Basic parameter 13
BULK OUT (ALL) 23
[BYPASS] button8, 12
[BYPASS] LED 8

C

Cancel
 effect selection 12, 13
 Recall operation 12
carrier 47
Characteristics of the Tempo parameter 15
CLASSIC bank 12, 26
[CLOCK] indicator 18
clock master 19
clock slave 19
CLOCK SOURCE 18
[COMPARE] button8, 16
[COMPARE] LED8, 16
Composite effects 66
 Delay + Early Reflections (PRESET bank)
 Delay → Early Reflections (PRESET bank) 73
 Delay + Reverb (PRESET bank)
 Delay → Reverb (PRESET bank) 75
 Distortion → Flanger (PRESET bank)
 Distortion → Delay (PRESET bank) 66
 Reverb + Chorus (PRESET bank)
 Reverb → Chorus (PRESET bank) 68
 Reverb + Flanger (PRESET bank)
 Reverb → Flanger (PRESET bank) 69
 Reverb + Symphonic (PRESET bank)
 Reverb → Symphonic (PRESET bank) 71
 Reverb → Pan (PRESET bank) 72
computer 6

D

Decay Time 34
Delay, Echo 38
 Delay L,R, Stereo Echo (CLASSIC bank) 46

 Delay L,C,R (PRESET bank) 43
 Echo (PRESET bank) 44
 Modulation Delay (PRESET bank) 41
 Mono Delay (PRESET bank) 38
 Stereo Delay (PRESET bank) 40
DIGITAL 19
Display 7

E

Early Reflection 35
 Early Reflection, Gate Reverb,
 Reverse Gate (CLASSIC bank) 37
 Early Reflection, Gate Reverb,
 Reverse Gate (PRESET bank) 35
early reflections 27
Edit
 effect 13
 effect name 17
 MIDI program change table 22
 parameter 14
EDITOR ID 22
Effect 12
 Check the edited effect 16
 Editing 13
 Editing the effect name 17
 effect 16
 Erasing 20
 Recall 13
 Select 12, 13
 Store 16
 store-destination 16
 Undoing the previous operation 16
effect name 17
Effect number indicator 7
effect on/off 12
Effects 25
Enabling/disabling
 Button operations or equivalent remote control 20
 MIDI message reception 23

F

Features 6
[FINE PARAM] button 8, 14
[FINE PARAM] LED 8, 14
Fine parameter 13
[FOOT SW] jack 8, 14, 23
foot switch 14
Freeze 77
 Freeze (PRESET bank) 77
 Freeze A (CLASSIC bank) 78
 Freeze B (CLASSIC bank) 79

G

Gate 34
 Attack Time 34
 Decay Time 34
 Release Time 34

Threshold Level	34
Grounding screw	9

H

Hold Time	34
-----------------	----

I

[INPUT -10 dBu/+4 dBu] switch	9
[INPUT] jacks	9, 19
[INPUT L  R] control	7, 11
[INPUT MODE] button/indicator	7
INPUT SOURCE	19
input source	19
[INPUT SOURCE] indicator	7, 11, 19

K

[kHz] indicator	7, 11
-----------------------	-------

L

Level meters	7
--------------------	---

M

MIDI	
MIDI message reception	23
MIDI port	21
MIDI program change table	22
Selecting the MIDI channel	21
MIDI CHANNEL	21
MIDI clock	14
MIDI control changes	14
[MIDI IN] connector	9
[MIDI] indicator	7, 11
MIDI OUT	21
MIDI OUT SETUP	21
[MIDI OUT/THRU] connector	9, 21
MIDI PGM CHANGE	22
MIDI PORT EDITOR	21
MIDI PORT GENERAL	21
MIDI RECEIVE	23
MIDI THRU	21
Modulation	47
Auto Pan (PRESET bank)	55
Chorus (PRESET bank)	51
Chorus, Tremolo (CLASSIC bank)	54
Dynamic Filter (PRESET bank)	58
Dynamic Flanger (PRESET bank)	59
Dynamic Phaser (PRESET bank)	60
Flanger (PRESET bank)	47
Modulation Filter (PRESET bank)	56
Pan (CLASSIC bank)	56
Phaser (PRESET bank)	49
Ring Modulation (PRESET bank)	57
Stereo Flanger, Stereo Phasing (CLASSIC bank)	50
Symphonic (CLASSIC bank)	54
Symphonic (PRESET bank)	52
Tremolo	53
modulation	47
modulator	47

N

[NEXT] button	8, 14
---------------------	-------

O

OPERATION LOCK	19
Other effects	82
Amp Simulator (PRESET bank)	87
Distortion (PRESET bank)	86
Multi Filter (PRESET bank)	82
Multi-band Dynamics Processor (PRESET bank)	83
Rotary Speaker (PRESET bank)	85
[OUTPUT -10 dBu/+4 dBu] switch	9
[OUTPUT] jacks	9

P

Parameter	
Basic parameter	13
Fine parameter	13
[PARAMETER] button	8, 14
[PARAMETER] LED	8, 14
Pitch Change	61
Dual Pitch (PRESET bank)	62
High Quality Pitch (PRESET bank)	61
Pitch Change A, D (CLASSIC bank)	64
Pitch Change B (CLASSIC bank)	65
Pitch Change C (CLASSIC bank)	65
[POWER ON/OFF] button	8, 10
PRESET bank	12
Protect on or off	17

R

Recall	12
[RECALL] button	7, 12, 13
Redo	16
Release	34
Release Time	34
Restricting operation of the SPX2000	19
Reverb	27
Reverb & Gate (CLASSIC bank)	33
Reverb (CLASSIC bank)	29
Reverb (PRESET bank)	31
REV-X (PRESET bank)	27
Stereo Reverb (PRESET bank)	30
Rotary Speaker	85

S

Selecting	
bank	12, 13
Basic parameters	14
effect	12, 13
FINE parameters	14
parameter	14
tempo synchronization source	23
word clock source	18
Setting the tempo	14
Specifications	99
[STORE] button	7, 16
subsequent reverberation	27
Switching MIDI OUT/THRU	21

T

[TAP] button	8, 14, 23
TEMPO SOURCE	23
Threshold Level	34
TITLE EDIT	17
[TO HOST USB] connector	9

U

U## CLEAR?	20
Undo	16
[UNDO] button	7
[UNDO] LED	7, 16
USER bank	12
USER PGM PROTECT	17
UTILITY	
BULK OUT (ALL)	23
CLOCK SOURCE	18
EDITOR ID	22
INPUT SOURCE	19
MIDI CHANNEL	21
MIDI OUT SETUP	21
MIDI PGM CHANGE	22
MIDI PORT EDITOR	21
MIDI PORT GENERAL	21
TEMPO SOURCE	23
TITLE EDIT	17
U## CLEAR?	20
USER PGM PROTECT	17
[UTILITY] button	8
[UTILITY] LED	8, 12, 13

W

Website	6
word clock	19
[WORD CLOCK IN] jack	9
word clock source	11

Y

Yamaha Website	6
----------------------	---

MIDI Implementation Chart

Function...		Transmitted	Recognized	Remarks
Basic Channel	Default	X	1-16	Memorized
	Changed	X	1-16	
Mode	Default	X	OMNI OFF/OMNI ON	Memorized
	Messages	X	X	
	Altered	*****	X	
Note Number	True Voice	X	0-127*1	*4
		*****	X	
Velocity	Note On	X	0 9nH, v=1-127*1	*4
	Note Off	X	X	
After	Key's	X	X	
	Ch's	X	X	
Pitch Bend		X	X	
Control Change	0-32	X	0*1	0:Bank Select MSB 1-30:*4 31:Mix Balance 32:Bank Select LSB
Program Change	:True#	X *****	0 0-127*1	Assignable Program Change Table
System Exclusive		0*2	0*2	*3
Common	:Song Pos.	X	X	
	:Song Sel.	X	X	
	:Tune	X	X	
System Real Time	:Clock	X	0	*4
	:Commands	X	X	
Aux Messages	:All Sound Off	X	X	
	:Reset All Cntrls	X	X	
	:Local ON/OFF	X	X	
	:All Notes OFF	X	X	
	:Active Sense	X	0	
	:Reset	X	0	
Notes	*1 receive if switch is on. *2 transmit/receive if exclusive switch is on. *3 Bulk Dump/Request, Parameter Change/Request *4 Effect Control(Depend On Program)			

For details of products, please contact your nearest Yamaha representative or the authorized distributor listed below.

Pour plus de détails sur les produits, veuillez-vous adresser à Yamaha ou au distributeur le plus proche de vous figurant dans la liste suivante.

Die Einzelheiten zu Produkten sind bei Ihrer unten aufgeführten Niederlassung und bei Yamaha Vertragshändlern in den jeweiligen Bestimmungsländern erhältlich.

Para detalles sobre productos, contacte su tienda Yamaha más cercana o el distribuidor autorizado que se lista debajo.

NORTH AMERICA

CANADA

Yamaha Canada Music Ltd.
135 Milner Avenue, Scarborough, Ontario,
M1S 3R1, Canada
Tel: 416-298-1311

U.S.A.

Yamaha Corporation of America
6600 Orangethorpe Ave., Buena Park, Calif. 90620,
U.S.A.
Tel: 714-522-9011

CENTRAL & SOUTH AMERICA

MEXICO

Yamaha de México S.A. de C.V.
Calz. Javier Rojo Gómez #1149,
Col. Guadalupe del Moral
C.P. 09300, México, D.F., México
Tel: 55-5804-0600

BRAZIL

Yamaha Musical do Brasil Ltda.
Rua Joaquim Floriano, 913 - 4º andar, Itaim Bibi,
CEP 04534-013 Sao Paulo, SP. BRAZIL
Tel: 011-3704-1377

ARGENTINA

**Yamaha Music Latin America, S.A.
Sucursal de Argentina**
Olga Cossetini 1553, Piso 4 Norte
Madero Este-C1107CEK
Buenos Aires, Argentina
Tel: 011-4119-7000

PANAMA AND OTHER LATIN AMERICAN COUNTRIES/ CARIBBEAN COUNTRIES

Yamaha Music Latin America, S.A.
Torre Banco General, Piso 7, Urbanización Marbella,
Calle 47 y Aquilino de la Guardia,
Ciudad de Panamá, Panamá
Tel: +507-269-5311

EUROPE

THE UNITED KINGDOM

Yamaha Music U.K. Ltd.
Sherbourne Drive, Tilbrook, Milton Keynes,
MK7 8BL, England
Tel: 01908-366700

GERMANY

Yamaha Music Europe GmbH
Siemensstraße 22-34, 25462 Rellingen, Germany
Tel: 04101-3030

SWITZERLAND/LIECHTENSTEIN

**Yamaha Music Europe GmbH
Branch Switzerland in Zürich**
Seefeldstrasse 94, 8008 Zürich, Switzerland
Tel: 01-383 3990

AUSTRIA

Yamaha Music Europe GmbH Branch Austria
Schleiergasse 20, A-1100 Wien, Austria
Tel: 01-60203900

CZECH REPUBLIC/SLOVAKIA/ HUNGARY/SLOVENIA

Yamaha Music Europe GmbH Branch Austria
Schleiergasse 20, A-1100 Wien, Austria
Tel: 01-602039025

POLAND

**Yamaha Music Europe GmbH
Branch Sp.z o.o. Oddzial w Polsce**
ul. 17 Stycznia 56, PL-02-146 Warszawa, Poland
Tel: 022-500-2925

THE NETHERLANDS/ BELGIUM/LUXEMBOURG

Yamaha Music Europe Branch Benelux
Clarissenhof 5-b, 4133 AB Vianen, The Netherlands
Tel: 0347-358 040

FRANCE

Yamaha Musique France
BP 70-77312 Marne-la-Vallée Cedex 2, France
Tel: 01-64-61-4000

ITALY

**Yamaha Musica Italia S.P.A.
Combo Division**
Viale Italia 88, 20020 Lainate (Milano), Italy
Tel: 02-935-771

SPAIN/PORTUGAL

Yamaha Música Ibérica, S.A.
Ctra. de la Coruna km. 17, 200, 28230
Las Rozas (Madrid), Spain
Tel: 91-639-8888

SWEDEN

Yamaha Scandinavia AB
J. A. Wettergrens Gata 1, Box 30053
S-400 43 Göteborg, Sweden
Tel: 031 89 34 00

DENMARK

YS Copenhagen Liaison Office
Generatorvej 6A, DK-2730 Herlev, Denmark
Tel: 44 92 49 00

NORWAY

Norsk filial av Yamaha Scandinavia AB
Grini Næringspark 1, N-1345 Østerås, Norway
Tel: 67 16 77 70

RUSSIA

Yamaha Music (Russia)
Room 37, bld. 7, Kievskaya street, Moscow,
121059, Russia
Tel: 495 626 5005

OTHER EUROPEAN COUNTRIES

Yamaha Music Europe GmbH
Siemensstraße 22-34, 25462 Rellingen, Germany
Tel: +49-4101-3030

AFRICA

**Yamaha Corporation,
Asia-Pacific Sales & Marketing Group**
Nakazawa-cho 10-1, Naka-ku, Hamamatsu,
Japan 430-8650
Tel: +81-53-460-2303

MIDDLE EAST

TURKEY/CYPRUS

Yamaha Music Europe GmbH
Siemensstraße 22-34, 25462 Rellingen, Germany
Tel: 04101-3030

OTHER COUNTRIES

Yamaha Music Gulf FZE
LOB 16-513, P.O.Box 17328, Jubel Ali,
Dubai, United Arab Emirates
Tel: +971-4-881-5868

ASIA

THE PEOPLE'S REPUBLIC OF CHINA

Yamaha Music & Electronics (China) Co.,Ltd.
2F, Yunhedasha, 1818 Xinzha-lu, Jingan-qu,
Shanghai, China
Tel: 021-6247-2211

INDIA

Yamaha Music India Pvt. Ltd.
5F Ambience Corporate Tower Ambience Mall Complex
Ambience Island, NH-8, Gurgaon-122001, Haryana, India
Tel: 0124-466-5551

INDONESIA

**PT. Yamaha Musik Indonesia (Distributor)
PT. Nusantik**
Gedung Yamaha Music Center, Jalan Jend. Gatot
Subroto Kav. 4, Jakarta 12930, Indonesia
Tel: 021-520-2577

KOREA

Yamaha Music Korea Ltd.
8F, 9F, Dongsung Bldg. 158-9 Samsung-Dong,
Kangnam-Gu, Seoul, Korea
Tel: 02-3467-3300

MALAYSIA

Yamaha Music (Malaysia) Sdn., Bhd.
Lot 8, Jalan Perbandaran, 47301 Kelana Jaya,
Petaling Jaya, Selangor, Malaysia
Tel: 03-78030900

SINGAPORE

Yamaha Music (Asia) Pte., Ltd.
#03-11 A-Z Building
140 Paya Lebar Road, Singapore 409015
Tel: 6747-4374

TAIWAN

Yamaha KHS Music Co., Ltd.
3F, #6, Sec.2, Nan Jing E. Rd. Taipei.
Taiwan 104, R.O.C.
Tel: 02-2511-8688

THAILAND

Siam Music Yamaha Co., Ltd.
4, 6, 15 and 16th floor, Siam Motors Building,
891/1 Rama 1 Road, Wangmai,
Pathumwan, Bangkok 10330, Thailand
Tel: 02-215-2622

OTHER ASIAN COUNTRIES

**Yamaha Corporation,
Asia-Pacific Sales & Marketing Group**
Nakazawa-cho 10-1, Naka-ku, Hamamatsu,
Japan 430-8650
Tel: +81-53-460-2303

OCEANIA

AUSTRALIA

Yamaha Music Australia Pty. Ltd.
Level 1, 99 Queensbridge Street, Southbank,
Victoria 3006, Australia
Tel: 3-9693-5111

COUNTRIES AND TRUST TERRITORIES IN PACIFIC OCEAN

**Yamaha Corporation,
Asia-Pacific Sales & Marketing Group**
Nakazawa-cho 10-1, Naka-ku, Hamamatsu,
Japan 430-8650
Tel: +81-53-460-2303

HEAD OFFICE

Yamaha Corporation, Pro Audio Division
Nakazawa-cho 10-1, Naka-ku, Hamamatsu, Japan 430-8650
Tel: +81-53-460-2441

Yamaha Pro Audio Global Web Site
<http://www.yamahaproaudio.com/>
Yamaha Manual Library
<http://www.yamaha.co.jp/manual/>