



**Digital Sound Projector**

**YSP-1600**

**Owner's Manual**

---

**Read the supplied booklet "Quick Reference Guide" before using the unit.**

**English**

# CONTENTS

<b>Supplied accessories</b> .....	4
Preparing remote control .....	4

## FEATURES 5

---

<b>What you can do with this unit</b> .....	5
Mastering useful apps .....	6
<b>Controls and functions</b> .....	7

## PREPARATIONS 11

---

<b>General setup procedure</b> .....	11
<b>1 Installation</b> .....	12
Raising the antenna .....	13
Mounting the unit on a wall .....	14
<b>2 Connecting a TV</b> .....	15
<b>3 Connecting playback devices</b> .....	16
<b>4 Other connections</b> .....	17
Connecting an external subwoofer .....	17
Wired network connections .....	17
<b>5 Connecting the power cable</b> .....	17
<b>6 Initial settings</b> .....	18
Displaying the menu screen on the TV .....	18
Selecting the language for menu display .....	19
Setting a surround sound effect for the installation position .....	19
Operating the unit by TV's remote control (HDMI control) .....	20

## PLAYBACK 22

---

<b>Basic operation for playback</b> .....	22
<b>Enjoying sound based on your preference</b> .....	23
Selecting a surround sound effect .....	23
2-channel playback (stereo playback mode) .....	23
Adjusting volume for each channel .....	24
Viewing audio information .....	24
Clear playback of human voices (CLEAR VOICE) .....	25
<b>Wireless playback of audio via Bluetooth connection</b> .....	26
Listening to music from a Bluetooth device .....	27
Listening to audio through Bluetooth speakers or headphones (transmitting) .....	29
Terminating Bluetooth connection .....	30

## NETWORKS 31

---

<b>Connecting to a network</b> .....	31
Wired network connections .....	31
Wireless network .....	32
Connecting the unit to a wireless network .....	32
Connecting a mobile device to the unit directly (Wireless Direct) .....	40
<b>Playing back music stored on media servers (PCs/NAS)</b> .....	42
Media sharing setup .....	42
Playing music files .....	42
<b>Listening to Internet radio</b> .....	43
Playback of Internet radio .....	43
Registering favorite Internet radio stations .....	43
<b>Playing back music with AirPlay</b> .....	45
Playback of iTunes/iPod music contents .....	45
<b>Playing back music stored on mobile devices</b> .....	47
Using a mobile device to play songs .....	47

## SETTINGS 48



<b>Setup menu</b> .....	<b>48</b>
Setting the setup menu .....	48
Setup menu list .....	49
Sound .....	50
HDMI .....	51
Function .....	52
Information .....	53
Network .....	54
Bluetooth .....	57
<b>Operating a TV via the TV Remote Repeater function of the unit</b> ...	<b>58</b>
<b>Updating the unit's firmware</b> .....	<b>59</b>
Using "Network Update" in the setup menu to update firmware .....	59
Updating firmware with connection of a USB flash drive .....	60
<b>Initializing the unit's settings</b> .....	<b>61</b>
Initializing basic unit settings .....	61
Initializing network settings .....	61

## APPENDIX 62

<b>Troubleshooting</b> .....	<b>62</b>
General .....	62
<i>Bluetooth</i> .....	64
Remote control .....	65
Network .....	66
<b>When surround effect is not enough</b> .....	<b>68</b>
How to install YRB-100 .....	68
<b>Basic Knowledge of Surround Sound</b> .....	<b>69</b>
What is Surround Sound? .....	69
What is a Digital Sound Projector? .....	69
Yamaha's Audio Technologies .....	69
<b>Glossary</b> .....	<b>70</b>
Audio/video information .....	70
Network information .....	70
<b>Specifications</b> .....	<b>71</b>
Available signal information .....	72
<b>Index</b> .....	<b>74</b>

## About this manual

- In this manual, operations that can be performed using either the front panel keys or the remote control are explained using the remote control.

-  indicates supplementary explanations for better use.
-  indicates precautions for use of the unit and its feature limitations.

## Supplied accessories

Before connecting, make sure you have received all of the following items.

### YSP-1600

The unit



### Supplied accessories

Remote control



Batteries  
(AAA, R03, UM-4; x2)

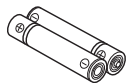

Optical cable  
(1.5 m (4.9 ft))



### Accessories for mounting the unit on a wall

Template



Brackets (x2)

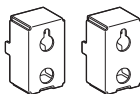

Screws (M4 x 12mm; x4)



Owner's Manual CD-ROM

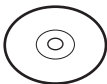

Quick Reference Guide



MusicCast Setup Guide



- The supplied optical cable may not be needed depending upon connections.

## Preparing remote control

Before installing batteries or using the remote control, be sure to read battery and remote control precautions in "Quick Reference Guide" (separate booklet).

### Installing the batteries

Peel off the protection sheet before use.

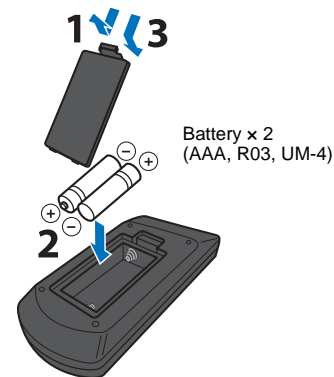
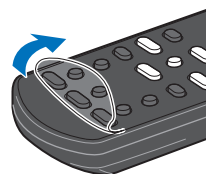

### Operation range

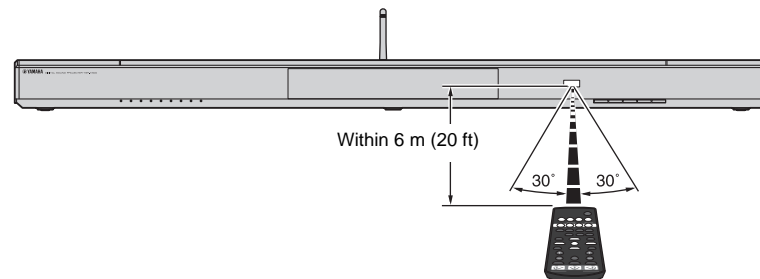

# FEATURES

## What you can do with this unit

Sound beams are reflected off walls using unique real surround sound formats and techniques, allowing listeners to enjoy their preferred acoustic environment.

- Enjoy realistic surround sound with five surround modes: MOVIE, MUSIC, SPORTS, GAME, TV PROGRAM (CINEMA DSP) [p. 23](#)
- Clear playback of speech (dialog, narration, etc.; CLEAR VOICE) [p. 25](#)

Sequential operation of a TV, this unit, and BD/DVD player (HDMI Control)

[p. 20](#)

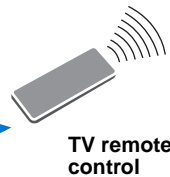

TV remote control



The unit

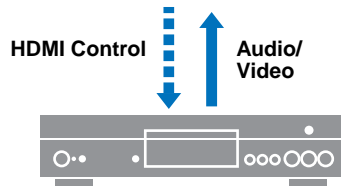

BD/DVD player



This unit's remote control

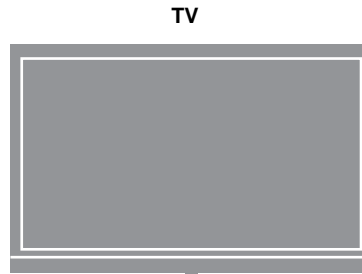

TV

HDMI Control

Audio

Audio/Video

HDMI Control

Audio/Video

Wide variety of supported content

- Media server (PC/NAS) [p. 42](#)
- Internet radio [p. 43](#)
- AirPlay [p. 45](#)
- Music stored on mobile devices [p. 47](#)

Mastering dedicated apps

[p. 6](#)

Audio  
Control



Mobile devices



Network contents

Control

Audio



Mobile devices

Plays back audio content from *Bluetooth*® devices

[p. 27](#)

Audio



*Bluetooth* headphones

Listen to audio input to the unit with *Bluetooth* headphones or speakers

[p. 29](#)

## Mastering useful apps

---

You can operate and program the unit, or play streaming services via the unit, by installing the free dedicated apps, MusicCast CONTROLLER and HOME THEATER CONTROLLER (WLAN) on a mobile device such as a smartphone. For details, search for MusicCast CONTROLLER and HOME THEATER CONTROLLER (WLAN) on the App Store or Google Play.

### MusicCast CONTROLLER

This app allows you to play distributed content and streaming services via the unit.

#### MusicCast CONTROLLER capabilities

- Play songs stored on computers (servers)
- Select an Internet radio station
- Play music stored on mobile devices
- Distribute and receive audio between the unit and other Yamaha network A/V devices  
See MusicCast Setup Guide for details.



- In this manual, iOS and Android mobile devices are collectively referred to as "mobile devices". The specific type of mobile device is noted in explanations as needed.

### HOME THEATER CONTROLLER (WLAN)

This app allows you to configure specific settings such as sound beams.

# Controls and functions

## Front panel

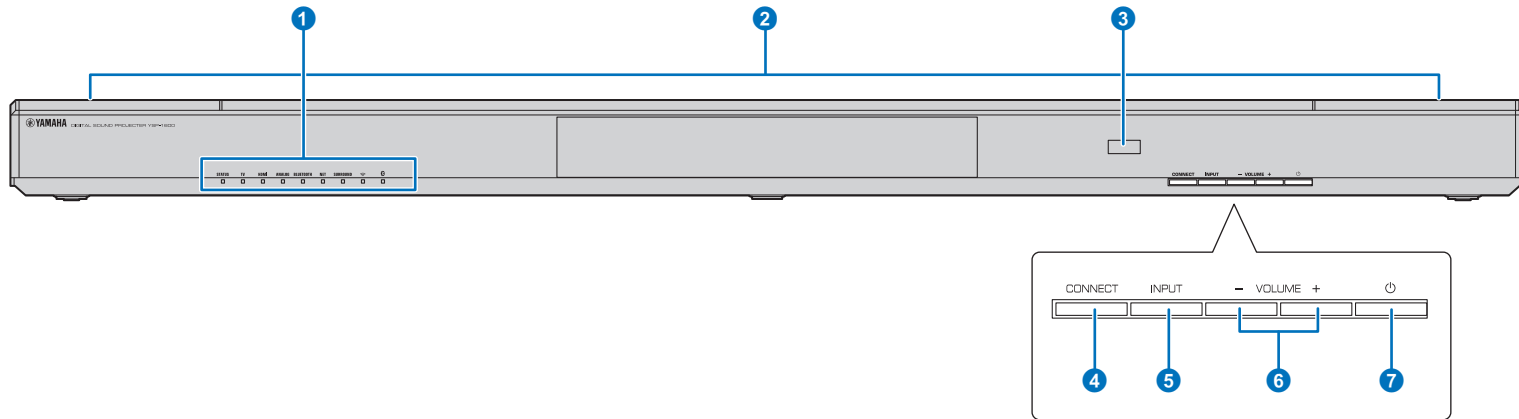

### 1 Indicators

Indicate the status of the unit (p. 8). The indicators will dim automatically if no operations are performed for 5 seconds.



- “Dimmer” can adjust the brightness of the front panel display in the setup menu (p. 52).

### 2 Dual built-in subwoofers

The built-in subwoofers are located in the top part of the unit.

### 3 Remote control sensor

Receive infrared signals from the remote control (p. 10).  
Receive infrared signals from the TV remote control when the TV Remote Repeater function is enabled (p. 58).

### 4 CONNECT key

Use to control the unit using the dedicated MusicCast CONTROLLER app for mobile devices. See the MusicCast Setup Guide for details.

### 5 INPUT key

Select an audio input source (p. 22).

### 6 VOLUME (+/-) keys

Adjust the volume of the unit (p. 22).

### 7 key

Turn on/off the unit.



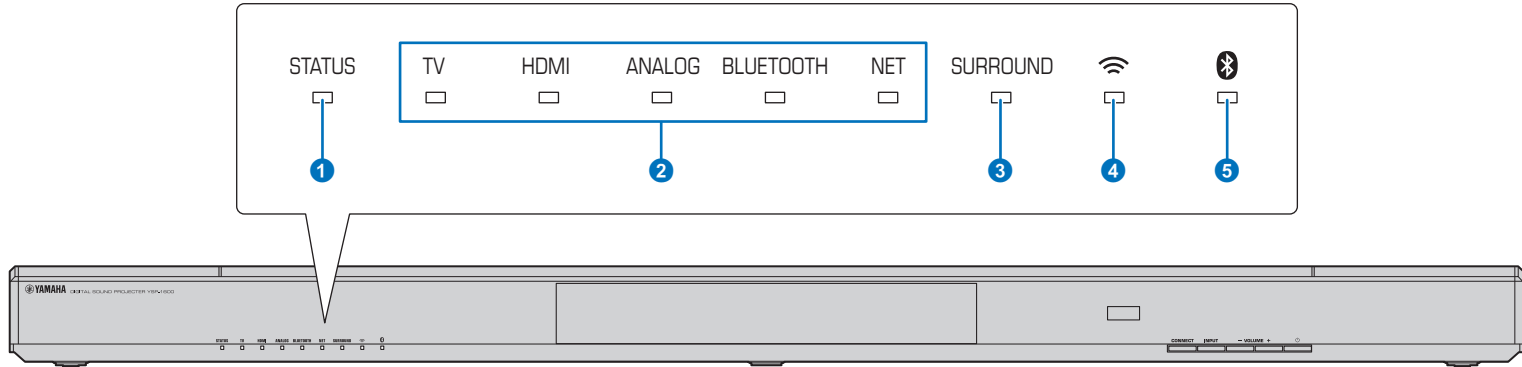

- When the unit is turned off, this unit consumes a small amount of power in order to search for HDMI signals or to receive infrared signals from the remote control.

# Indicators



## 1 STATUS indicator

The STATUS indicator shows the unit's power status.

-  Glows green: The unit is on
-  Glows red: The unit is off (with HDMI control or network standby activated)
-  Off: The unit is off

## 2 Audio input indicator

The corresponding indicator glows to show the input source to which audio is selected.



**Example: when TV is selected**



Glows	Input source to be played back
TV	TV audio
HDMI	Audio from a device connected to the HDMI IN jack
ANALOG	Audio from a device connected to the ANALOG input jack
BLUETOOTH	Audio from a <i>Bluetooth</i> device
NET	Audio input via a network

## 3 SURROUND indicator

Glows when surround playback is selected and turns off when stereo playback is selected.

-  Glows when the MOVIE, MUSIC, SPORTS, GAME, or TV PROGRAM key on the remote control is pressed (surround playback).
-  Turns off when the STEREO key on the remote control is pressed (stereo playback).

## 4 Wi-Fi indicator

Glows when connected to a wireless network; turns off when the connection is terminated (p. 32).

## 5 Bluetooth indicator

Glows blue when connected to a *Bluetooth* device; turns off when the *Bluetooth* connection is terminated (p. 26).

## Other indications

In addition to indications explained 1–5, other indicators on the front panel may glow or flash to indicate operation and setting status. In this manual, illustrations of the nine in-line indicators are used for explanation.

-  : Off
-  : Glows
-  : Flashes

**Example: When the STATUS indicator flashes and the TV indicator glows**





## Rear panel

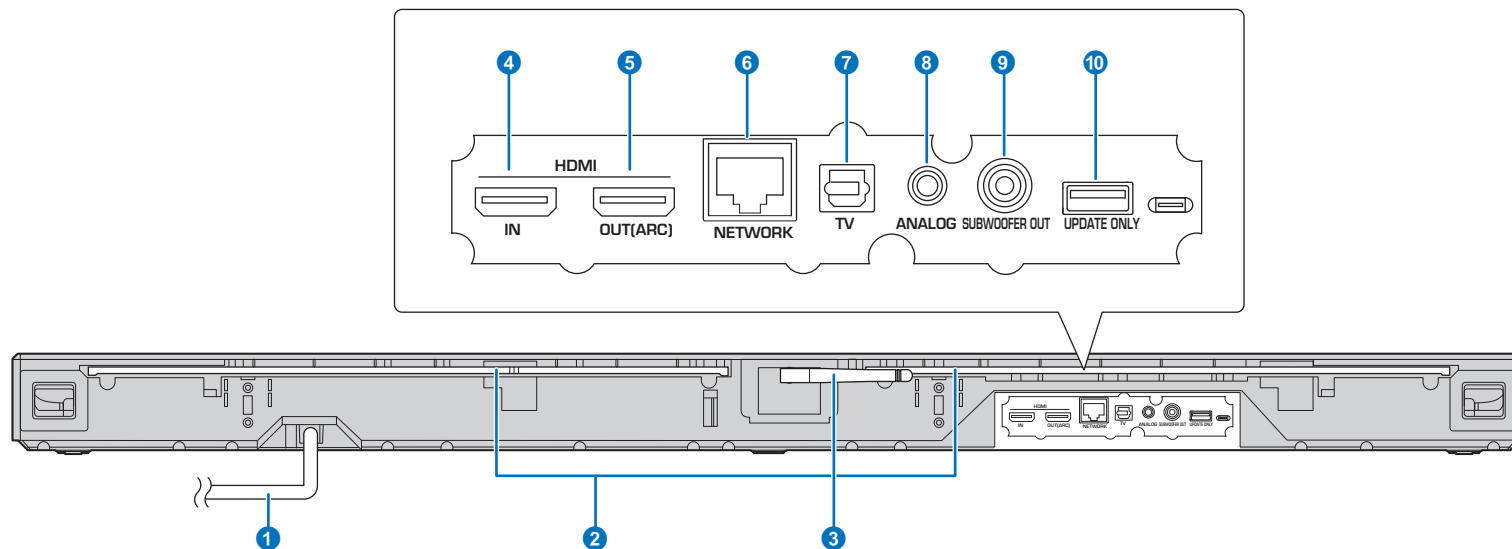

### 1 Power cable

For connecting to an AC wall outlet (p. 17).

### 2 TV Remote Repeater

Transmit signals from the TV's remote control received by the remote control sensor on the unit's front panel to the TV (p. 58).

### 3 Antenna

Raise the antenna after the unit is installed (p. 13).

### 4 HDMI IN jack

For connecting an HDMI-compatible playback device such as a BD/DVD player, a satellite and cable TV tuner, and a game console (p. 16).

### 5 HDMI OUT (ARC) jack

For connecting to an HDMI-compatible TV and outputting video/audio signals (p. 15).

### 6 NETWORK jack

For connecting to a network with a network cable (p. 17).

### 7 TV (digital optical) jack

For connecting to a playback device equipped with a digital optical audio output jack (p. 15).

### 8 ANALOG jack

For connecting an external device with a 3.5 mm RCA stereo cable (p. 16).

### 9 SUBWOOFER OUT jack

For connecting an external subwoofer (p. 17).

### 10 UPDATE ONLY jack

Use to update this unit's firmware (p. 60).

## Remote control

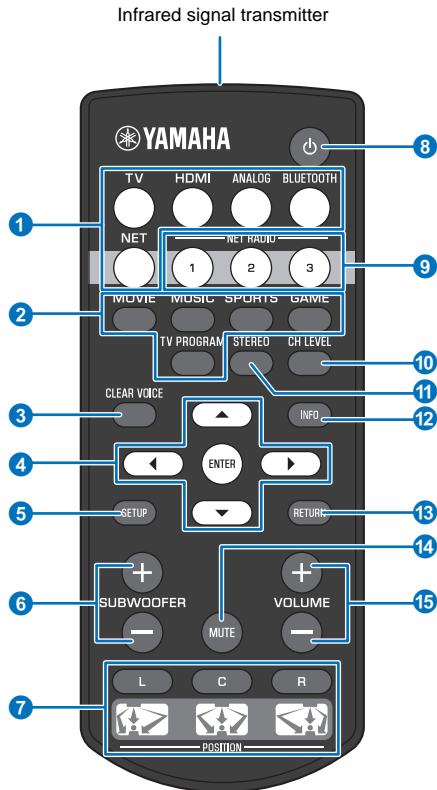

### 1 Input selector keys

Select an audio input source to be played back (p. 22).

TV	TV
HDMI	Device connected via the HDMI IN jack
ANALOG	Device connected via the ANALOG input jack
BLUETOOTH	Bluetooth device
NET	Audio last input via a network

### 2 Surround mode key

Choose a surround playback mode from MOVIE, MUSIC, SPORTS, GAME, TV PROGRAM (p. 23).

### 3 CLEAR VOICE key

Turns the CLEAR VOICE function on or off (p. 25).

### 4 ▲/▼/◀/▶ keys, ENTER key

Change the setting (p. 48).

### 5 SETUP key

Displays the setup menu (p. 48).

### 6 SUBWOOFER (+/-) key

Adjust the volume of the subwoofer (p. 22).

### 7 POSITION (L/C/R) keys

For optimum surround sound effect, select a preset position mode according to where the unit is installed (p. 19).

### 8 ⏻ key

Turn on/off the unit (p. 22).

### 9 NET RADIO (1–3) keys

Register and play streaming services such as Internet radio stations via the unit (p. 43).

### 10 CH LEVEL key

Adjust the volume balance during playback (p. 24).

### 11 STEREO key

Switch to stereo playback mode (p. 23).

### 12 INFO key

Use the indicator on the front panel to show information for audio currently playing (p. 24).

### 13 RETURN key

Return to the previous menu screen.

### 14 MUTE key

Mute the sound (p. 22).

### 15 VOLUME (+/-) key

Adjust the volume of the unit (p. 22).

# PREPARATIONS

## General setup procedure

### 1 Installation (p. 12)

Position the unit to achieve the optimal surround sound effects. The unit can also be mounted on a wall.

Raise the wireless antenna in preparation for network connection using a wireless router (access point).

### 2 Connecting a TV (p. 15)

Connect a TV to the unit.

### 3 Connecting playback devices (p. 16)

Connect video devices (such as BD/DVD players) to the unit.

### 4 Other connections (p. 17)

Connect an external subwoofer.

Use a network cable to connect the unit to a router in preparation for wired network connection.

### 5 Connecting the power cable (p. 17)

After all the connections are complete, plug in the power cable.

### 6 Initial settings (p. 18)

Specify unit settings before use to adjust surround sound effects based on position and conditions.

This completes all the preparations. Enjoy playing movies, music and other content with the unit!



- See "NETWORKS" (p. 31) for information regarding network connection and audio playback via a network.

## 1 Installation

Place the unit on a flat surface. When installing this unit on a rack behind which there is limited space, for example, it may be easier to connect external devices to this unit first. See pages 15 to 17 for information regarding the connection of external devices.

### Notes

- Be sure to install this unit on a large, stable stand where it does not fall subject to vibrations, such as from an earthquake, and where it is out of the reach of children.
- The unit's speakers are not magnetically shielded. Do not install hard disk drives or similar devices near the unit.
- Do not stack the unit directly on top of other playback devices, or vice versa. Heat and vibrations may result in damage or malfunction.

## Recommended place for installation

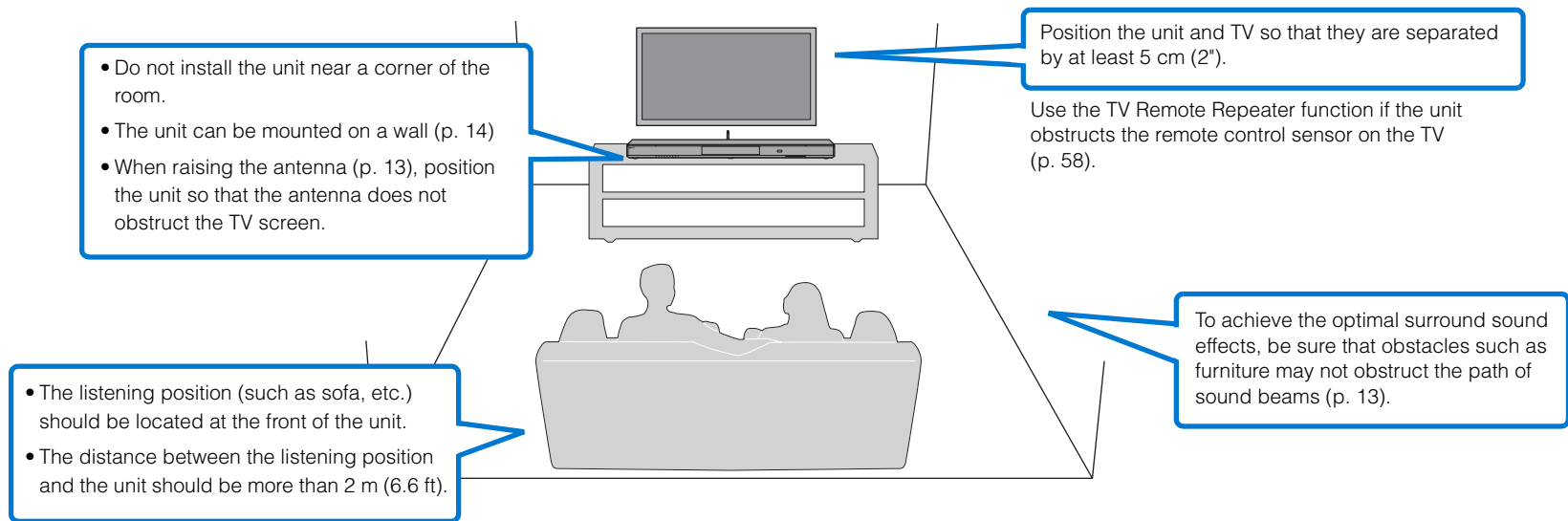

## Unit installation position and surround sound effects

The unit achieves surround sound by reflecting sound beams off walls.

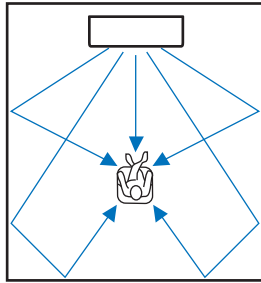

Effective surround effect may not be achieved in the following environment.

- Sound beams are blocked by obstacles such as furniture.
- The room size is not within the following dimensions;
  - Width: 3 meters to 7 meters (9.8 ft to 23 ft)
  - Depth: 3 meters to 7 meters (9.8 ft to 23 ft)
  - Height: 2 meters to 3.5 meters (6.6 ft to 11.5 ft)
- Listening position is too close to the unit.
- The unit is installed too close to the left or right wall.
- The unit is installed in the corner of the room.
- There is no wall for reflecting sound beam on the path of the sound beams.



- The optimum surround sound effect is achieved by setting a position according to the installation position of the unit. For details, refer to "Setting a surround sound effect for the installation position" (p. 19).

## Raising the antenna

Raise the antenna on the rear panel of the unit when connecting a wireless router (access point) to use a network.

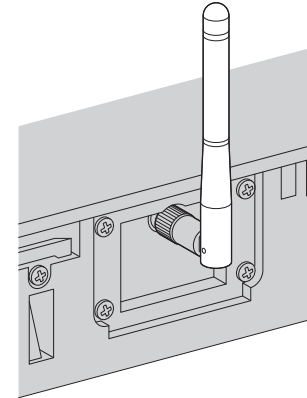

Hold the base of the antenna while raising it to its upright position.



- Do not apply excessive force on the antenna. Doing so may damage it.
- Be sure to check the direction in which the antenna moves, and angle it in the proper direction.
- Do not remove the antenna.



- For details on the wireless connection, refer to p. 32.

## Mounting the unit on a wall

The unit can be mounted on a wall.

If the antenna will be used (p. 13), raise it before mounting the unit on a wall.

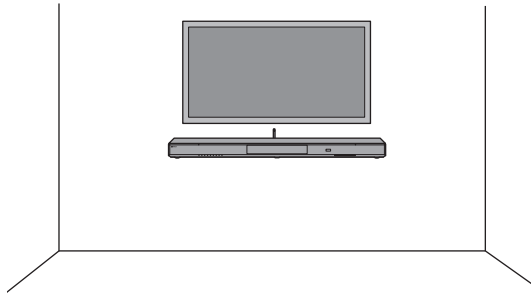

- When installing the unit on a wall, all installation work must be performed by a qualified contractor or dealer. The customer must never attempt to perform this installation work. Improper or inadequate installation could cause the unit to fall, resulting in personal injury.
- To prevent the unit from falling, attach it to a wall constructed of drywall (plasterboard).
- Make sure you use commercially available screws that can support the weight of the installation (in step 2). Using clamps other than specified screws, such as short screws, nails, and two-sided tape, may cause the unit to fall.
- Fix the cables in place where they will not become loose. If your foot or hand accidentally gets caught on a loose cable, the unit may fall.
- Check that the unit is fixed securely after the installation. Yamaha will bear no responsibility for any accidents caused by improper installations.
- Do not lean on the unit or apply excessive force to the top of the unit. Doing so may cause the unit to fall.

### 1 Attach the mounting template on a wall and mark for the screw holes.

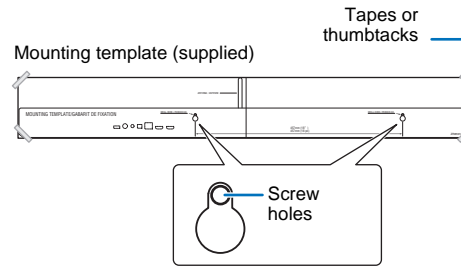

### 2 Remove the mounting template from the wall and install the commercially available screws at the marks on the wall.

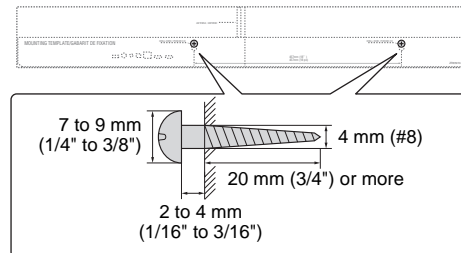

### 3 Use the screws to attach the brackets (both supplied).

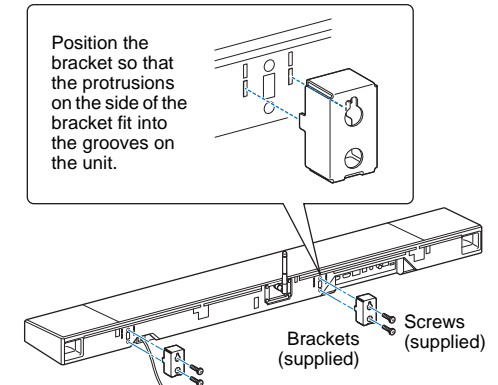

### 4 Hang the unit on the screws.

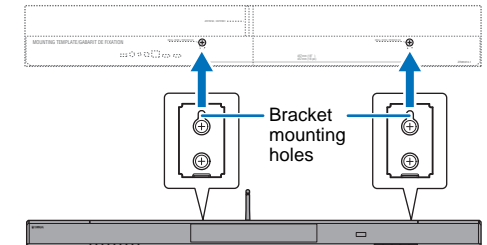

## 2 Connecting a TV

Connect a TV to the unit so that video input to the unit can be output to the TV. You can also enjoy playback of TV audio on the unit.



- Use a 19-pin HDMI cable with the HDMI logo printed on it. A cable with a maximum length of 5 m is recommended to prevent degradation of signal quality.
- For playback of 3D and 4K video content, use a high-speed HDMI cable.

### TVs that support Audio Return Channel (ARC)

Connect the TV to the unit with an HDMI cable (not supplied).



- This unit supports HDCP version 2.2, a copy protection technology. To enjoy playback of 4K video, connect the unit to the HDMI IN jack (one compatible with HDCP 2.2) on an HDCP 2.2-compliant TV.

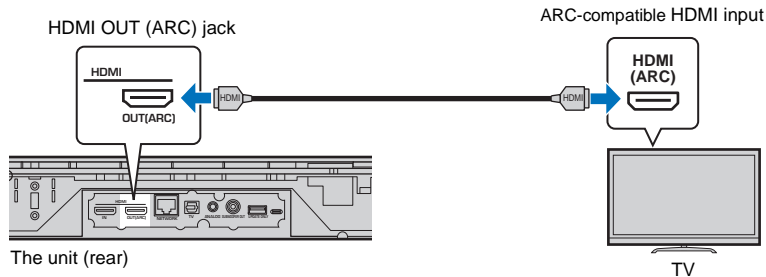

When connecting a TV that supports Audio Return Channel (ARC), enable the HDMI control function (p. 51).

#### Audio Return Channel (ARC)

ARC enables input and output of audio signals via a single HDMI cable. If the TV supports ARC, audio signals from the TV can be input to this unit via the same HDMI cable used to output video signals from this unit to the TV.



- Use an ARC-compatible HDMI cable.

### TVs that do not support Audio Return Channel (ARC)

Connect the TV to the unit with an HDMI cable (not supplied) and an optical cable.

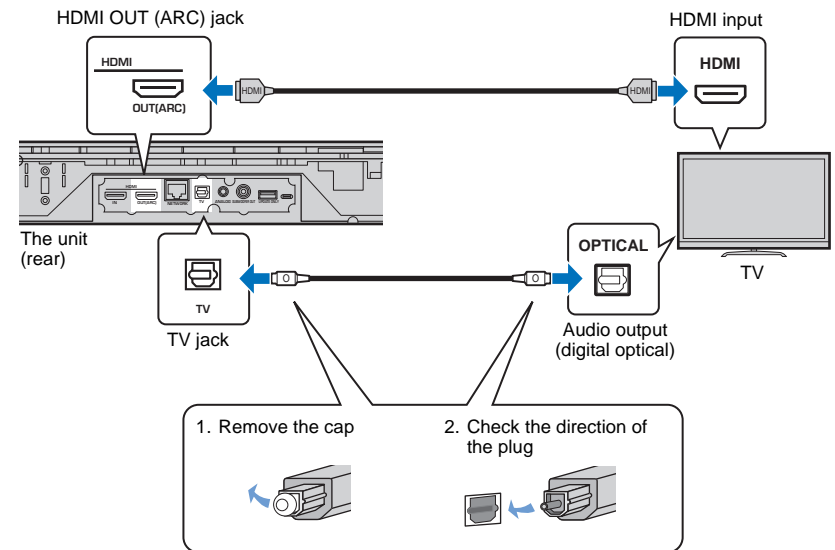

#### If the TV has no optical jack

- Use a 3.5 mm stereo mini plug cable to connect the unit to the TV via the ANALOG input jack on the unit and the audio output jack on the TV. TV audio can be played through this unit by switching input to ANALOG using the ANALOG key on the remote control.

### 3 Connecting playback devices

Connect video devices such as BD/DVD players, set-top boxes (STBs) and game consoles to the unit. Depending on the video/audio output jacks available on your video device, choose one of the following connections. We recommend using an HDMI connection if the video device has an HDMI output jack.

#### HDMI connection

Connect a video device to the unit with an HDMI cable (not supplied).

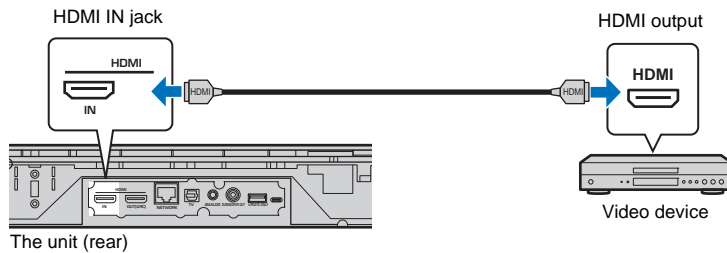

TV audio can be played through this unit by switching input to HDMI using the HDMI key on the remote control.



- Once the HDMI control function has been activated (p. 20), video and audio content from playback devices can be output from the TV even when this unit is off (HDMI signal pass-through).
- Use a 19-pin HDMI cable with the HDMI logo printed on it. A cable with a maximum length of 5 m is recommended to prevent degradation of signal quality.
- For playback of 3D and 4K video content, use a high-speed HDMI cable.
- If the video device has an HDCP 2.2-compliant HDMI output jack, connect the unit to that jack.
- Audio from the video device can be input via the TV (digital optical) jack, not via the HDMI IN jack. Use an optical cable to connect the video device to the unit via the digital optical output jack on the video device and the TV jack on the unit. If the video device is connected to the unit in this way, change the "HDMI" setting in the setup menu from "Audio Assign" to "Optical".

#### Analog connection

Connect a video device to this unit via a 3.5 mm stereo mini plug cable (not supplied). Next, connect the video device's video output to the TV's video input.

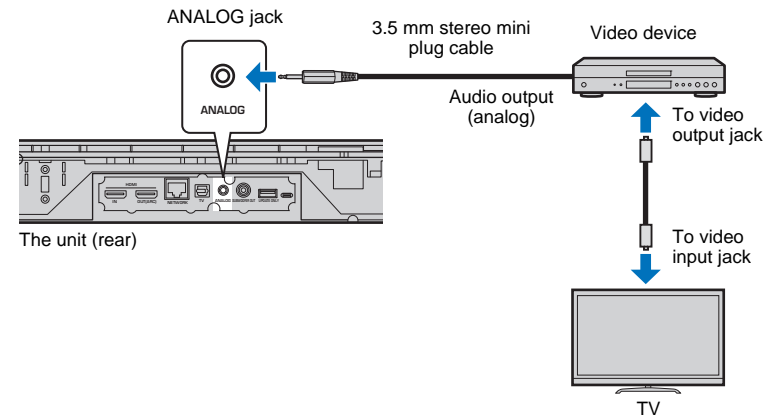

TV audio can be played through this unit by switching input to ANALOG using the ANALOG key on the remote control.



## 4 Other connections

### Connecting an external subwoofer

The unit has built-in subwoofers. However, you can connect an external subwoofer to enhance low-frequency sounds. Connect a subwoofer via the SUBWOOFER OUT jack on this unit.

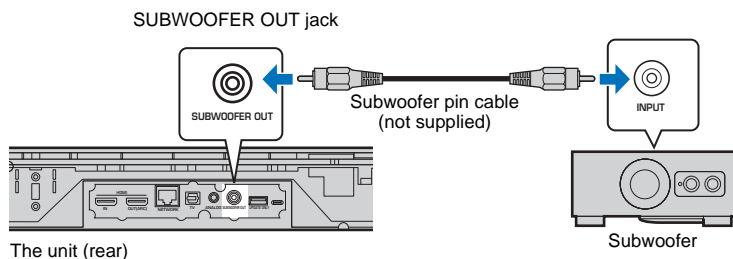

- Use an external subwoofer with a built-in amplifier.

### Wired network connections

For a wired connection, connect one end of the network cable to the NETWORK jack on the rear panel of the unit and the other end to a router. For details, refer to "NETWORKS" (p. 31).

## 5 Connecting the power cable

After all the connections are complete, plug in the power cable.

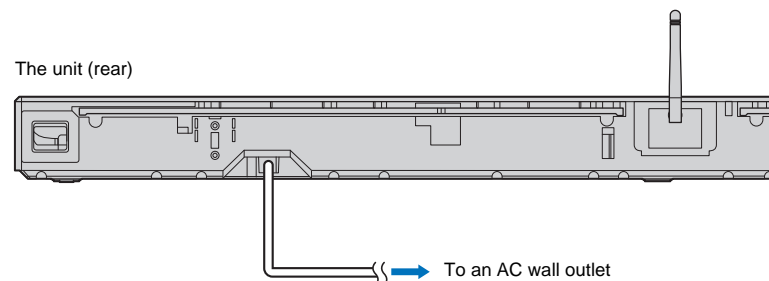

## 6 Initial settings

### Displaying the menu screen on the TV

Visual operation of this unit is possible by displaying its menu screen on the TV.

Turn on the unit and the TV, and then use the input button on the TV's remote control so that video input from this unit is displayed.

When this unit and the TV are connected as shown below, select "HDMI 1".

TV remote control (example)

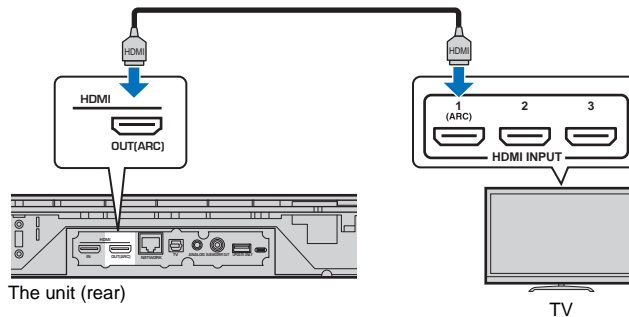
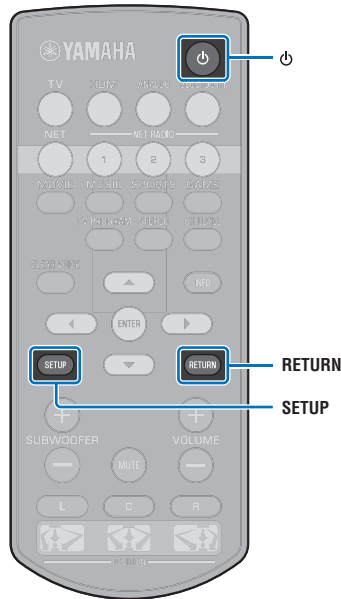
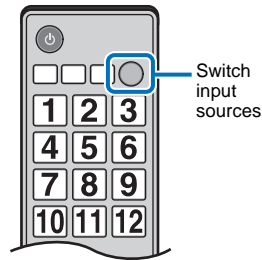

#### The menu display

The menu is displayed on the TV screen when the SETUP key is pressed. When the TV is receiving HDMI signals, the menu is superimposed over video content. Press the SETUP key twice to cancel menu display.

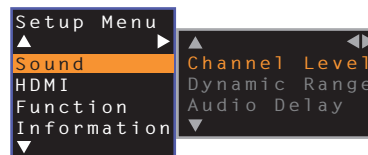

#### Initial screen display

When the unit is turned on for the first time after purchase, the screen below will be displayed and the indicator on the front panel will flash slowly.

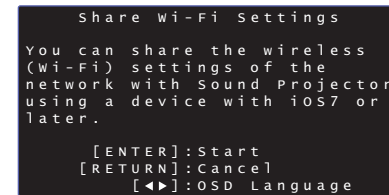

While this screen is displayed, an iOS device (such as an iPhone) can be used to easily connect the unit to a wireless network. See the Quick Reference Guide.

If you will not use an iOS device to connect to a wireless network, press the RETURN key.



- You can use this function to connect to a wireless network at any time by selecting "Share Wi-Fi Settings (iOS)" from the setup menu. However, be aware that if a different wireless network, or a Bluetooth device, has already been configured, doing so will erase any previous settings.



- This screen will not be displayed and the indicator will not flash if the unit is connected to a router via its NETWORK jack (wired connection).

## Selecting the language for menu display

- 1 Turn the unit and TV on.
- 2 Switch the TV's input to display video input from this unit (p. 18).
- 3 Press and hold the **SETUP** key until the "OSD Language" menu appears on the TV.



### When the menu is not displayed

- Confirm the following cases.
  - The HDMI input jack of your TV and the HDMI OUT (ARC) jack of the unit are connected.
  - The input of your TV is set to "HDMI 1" (example).

- 4 Use the **▲/▼** key to select the desired language and press the **ENTER** key.

### Settings

日本語, ENGLISH (default), DEUTSCH, FRANÇAIS, ESPAÑOL, ITALIANO, NEDERLANDS, РУССКИЙ, SVENSKA, TÜRK

- 5 Press the **SETUP** key to exit the setup menu.

## Setting a surround sound effect for the installation position

The surround sound is achieved by reflecting the sound beams off walls as shown in the illustration below. For optimum surround effect, turn on the unit and select the **POSITION** key according to the installation position of the unit.

- 1 Hold down the **POSITION** key that corresponds to the installation position of the unit for more than 3 seconds.

The indicators on the front panel flash according to the set position.

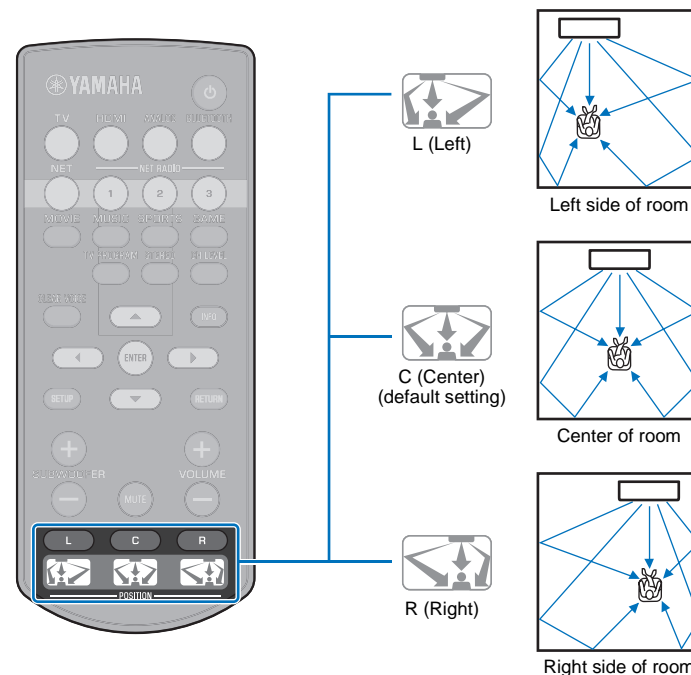
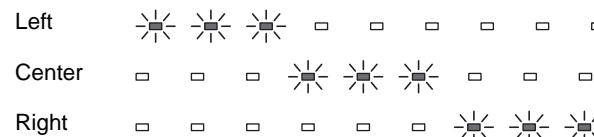

## Operating the unit by TV's remote control (HDMI control)

### What is the HDMI control function?

HDMI Control allows you to operate external devices via HDMI. If you connect a TV that supports HDMI Control to the unit with an HDMI cable, you can control the unit (such as power and volume) with TV remote control operations. You can also control playback devices (such as HDMI Control-compatible BD/DVD players) connected to the unit with an HDMI cable.

### Coordinated functions via the TV remote control

Remote control of TV (Example)

#### 1. Turn on/off

Both the TV and this unit turn on/off at the same time.

#### 2. Switch input sources

- The input source for this unit switches accordingly when the TV's input source is switched. The input source for this unit also switches when a BD/DVD player is selected as the input source from the TV's menu display.
- The input source can be switched while this unit is turned off.

#### 3. Control volume

This unit's volume can be adjusted when the TV's audio output is set to the external device.

#### 4. Switch the audio output device (TV or this unit)

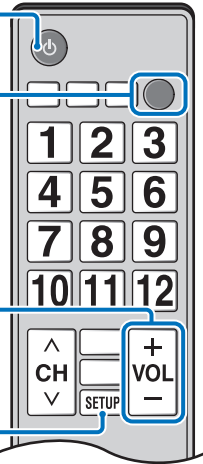

With some TVs, navigating this unit's menus displayed on the TV can be controlled.



- Even if your TV supports the HDMI control function, some functions may not be available. For details, refer to the manual supplied with your TV.
- We suggest using devices (TV, BD/DVD player, etc.) from the same manufacturer.

First, try the operations described above with your TV's remote control. If you are able to perform these operations, you may continue operating this unit with your TV's remote control. The HDMI control function can be used with some HDMI devices by simply activating the function. If you are not able to perform these operations, configure HDMI control settings (p. 21).



## Setting the HDMI control function

- 1 Turn on the unit, TV, and playback devices.
- 2 Activate the HDMI control function on the unit, TV, and playback devices such as BD/DVD players that support this function.

For this unit, be sure that “HDMI Control” is set to “On” (default; p. 51).

For playback devices, refer to the instructions supplied with each device.

- 3 Turn off the main power of the TV and then turn off the unit and playback devices.
- 4 Turn on the unit and playback devices and then turn on the TV.
- 5 Switch the TV input to display the video from the unit.
- 6 Press the HDMI key to select HDMI input, and check that video from the playback device is properly displayed.

HDMI  
  
 Glows (green)

- 7 Check that the unit is properly coordinated with the TV by turning off the TV or adjusting the TV volume with the TV remote control.

### If devices are not coordinated

Be sure that all devices are correctly connected to this unit, and that settings are properly configured as described below.

- “HDMI Control” (p. 51) is set to “On” in the setup menu.
- The HDMI control function is enabled on the TV.

### The example of TV settings

- From the setup menu on your TV, select “Link setting” → “HDMI control setting”, then set a setting such as “HDMI control function” to “ON”.
- Set audio output to any option other than TV.

If devices fail to coordinate even after the settings described above have been applied correctly:

- Turn off this unit and the TV, and then turn them back on again.
- Disconnect the power cable of the unit and external devices connected to the unit via HDMI cable. Plug them in again after about 30 seconds.
- If devices fail to coordinate after ANALOG is input, repeat steps 5 and 6 under “Setting the HDMI control function”.

## Changing the connection method and connected devices

When the connected devices and jacks are changed, configure the settings again with the following procedure.

- 1 Disable the HDMI control function of the TV and BD/DVD player, turn off all connected devices, and change the connections.
- 2 Follow steps 1 to 7 of “Setting the HDMI control function”.

# PLAYBACK

## Basic operation for playback

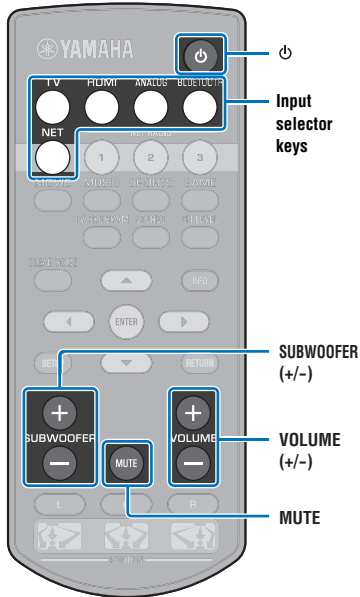

- 1 Press the key to turn on this unit.
- 2 Turn on devices (TV, BD/DVD player, game console, etc.) connected to this unit.
- 3 Select a device by pressing the input selector key corresponding to the connection of external devices.

Press the HDMI key to play audio/video content from a BD/DVD player connected via the HDMI IN jack.

### Indicator on the front panel

HDMI  
  
 Glows

For playback from a *Bluetooth* device, refer to p. 26. For audio playback via a network, refer to p. 42 to 47.

- 4 Play back a device selected in step 3.



- When listening to audio or watching video from a playback device connected to the TV, select the device as the TV's input source.

- 5 Press the VOLUME (+/-) key to adjust the volume. Press the SUBWOOFER (+/-) key to adjust the volume of the subwoofer.

When the volume is adjusted, indicators on the front panel indicate volume level.

### Volume display

The number of lighted indicators increases when the volume is turned up, and decreases when the volume is turned down.

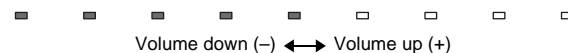

### Subwoofer volume display

The lighted indicator moves to the right when the volume is turned up, and to the left when the volume is turned down.

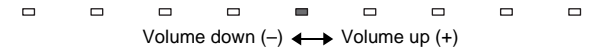

- When audio is output from both TV speaker and this unit, mute the TV sound.
- When sound input to HDMI IN jack is output from the TV, the volume level does not change even if you press the VOLUME (+/-) key or the MUTE key.

### To mute the audio output

To mute the sound, press the MUTE key.



To resume the volume, press the MUTE key again or press the VOLUME (+/-) key.



- The subwoofer volume can be adjusted separately from the whole volume.
- Lowering the subwoofer volume is recommended at night.

- 6 Select from surround playback or stereo playback mode, and configure sound setting according to your preferences (p. 23).

Press the key to turn off this unit after use.

## Enjoying sound based on your preference

### Selecting a surround sound effect

Select the surround mode to enjoy realistic surround effects that closely resemble a movie theater, the middle of a music concert, or a sports field event, by Yamaha's sound field program, "CINEMA DSP." You can select a surround mode that best suits the source from MOVIE, MUSIC, SPORTS, GAME, or TV PROGRAM.

- 1 Press one of the surround mode keys (MOVIE, MUSIC, SPORTS, GAME, or TV PROGRAM).

Indicator on the front panel

SURROUND  
■  
Glow

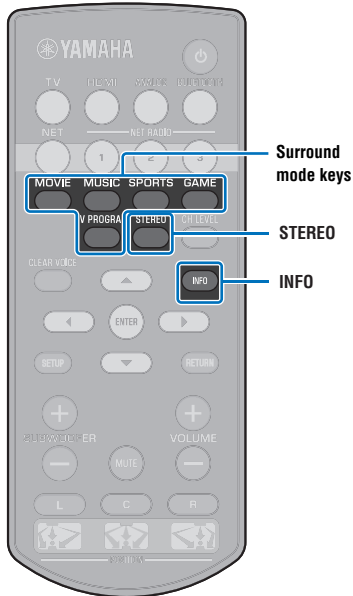

### 2-channel playback (stereo playback mode)

The front channels are the primary channel sources for output of stereo sound.

- 1 Press the STEREO key to switch to stereo playback mode.

Indicator on the front panel

SURROUND  
□  
Off

### Surround mode

The features of surround modes are described below.

Select the surround mode that best suits the playback source and your personal taste.

Sound field program	Features
<b>MOVIE</b>	Creates a broad and expansive cinematic space. With Dolby or DTS surround effects, this program enriches your cinematic experience.
<b>MUSIC</b>	Creates the palpable excitement, as if you were standing at the front center of a live concert hall event.
<b>SPORTS</b>	Creates the realistic atmosphere of a live sports event or talk show.
<b>GAME</b>	Enjoy three-dimensional sound effects with computer or video games.
<b>TV PROGRAM</b>	Creates optimum surround sound for TV programs.



- When the source is a 2-channel stereo signal, the sound is played back as surround sound.

## Adjusting volume for each channel

Adjust the volume of playback for each channel (audio in each direction) so that sounds are evenly distributed in their respective directions.



- Refer to "Channel Level" (p. 50) when adjusting the volume of each channel with the test sound.

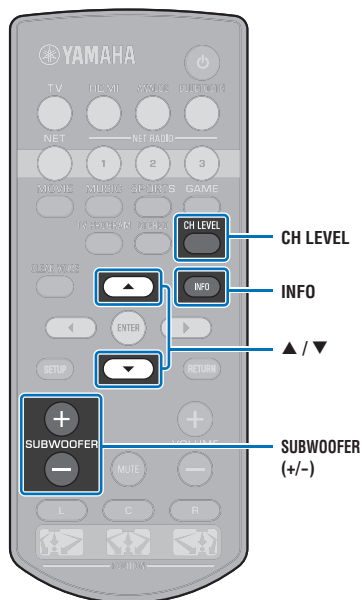

**1 Hold down the CH LEVEL key for more than 3 seconds.**

**2 Press the CH LEVEL key to select adjustable channel from the followings.**

The output channel changes as follows each time the CH LEVEL key is pressed.

### Indicators on the front panel

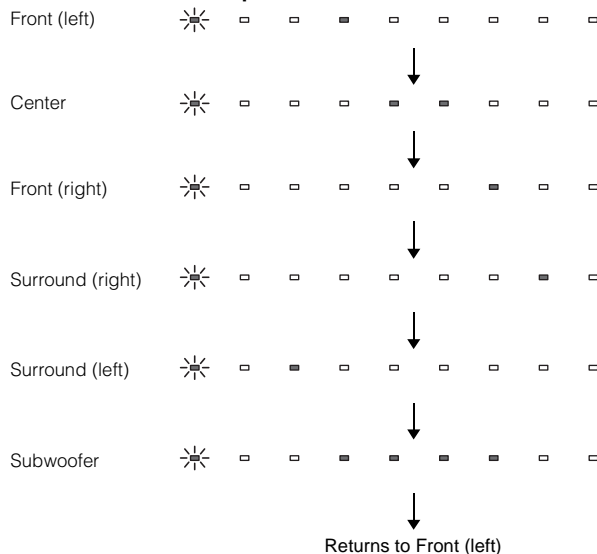

- Subwoofer volume can only be adjusted in stereo playback mode (p. 23).

**3 Press the ▲/▼ key to adjust the volume.**

### Display while volume is adjusted

The lighted indicator moves to the right when the volume is turned up, and to the left when the volume is turned down.



### Example of volume balance

- If you have problems hearing words: Select C (center) to increase the level. When the sound is not like surround sound: Select SL (surround left) and SR (surround right) to increase the level.
- The volume of the subwoofer also can be adjusted by using the SUBWOOFER (+/-) key.
- When the position setting is changed (p. 19), the channel level setting will be overwritten.

## Viewing audio information

Information regarding audio currently playing can be viewed.

**1 Press the INFO key.**

The following information regarding audio currently playing is displayed via indicators on the front panel while the INFO key is held down.



- Audio from a TV that supports ARC is currently being input to the unit via the HDMI cable
- Input signal: DTS
- Input signal: Dolby Digital
- Dolby Pro Logic II is currently in use (2-channel audio signal is input)
- CLEAR VOICE is enabled (p. 25)



## Clear playback of human voices (CLEAR VOICE)

Human voices, such as lines in movies and TV shows, or news and sports commentary, are played back very clearly.

- 1 Press the **CLEAR VOICE** key to turn on the **CLEAR VOICE** function.

### Indicators on the front panel



Flashes three times and then turns off

Press the key again to turn off the function.



Flashes once and then turns off

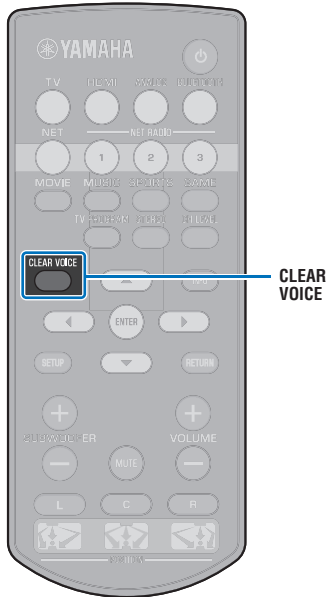

## Wireless playback of audio via *Bluetooth* connection

You can receive and play audio from a *Bluetooth* device, such as a mobile device or digital music player, over a wireless connection. Yamaha's exclusive Compressed Music Enhancer technology improves sound quality characteristics for the richness and depth of original audio before it is compressed.

You can also transmit audio input to the unit to *Bluetooth* speakers or headphones.

See documentation supplied with your *Bluetooth* device for more information.

Receive and play audio with the unit



Transmit and play audio from the unit



- Audio cannot be received by the unit from mobile devices and the like, and transmitted to speakers or headphones at the same time.



- "Bluetooth" in the setup menu must be set to "On" (default; p. 57) to use *Bluetooth* functions.

Perform the following steps on the *Bluetooth* device to be connected.

**For the first *Bluetooth* connection**

**For subsequent *Bluetooth* connection**



**Pair the unit and *Bluetooth* device**

When connecting to a *Bluetooth* device for the first time, "pairing" between the device and unit is required. Pairing is required for connecting a *Bluetooth* device for the first time.



**Connect *Bluetooth* device and play back**

## Listening to music from a *Bluetooth* device

### Pairing a *Bluetooth* device with the unit

- 1 Press the **BLUETOOTH** key on the remote control.  
*Bluetooth* is selected as the input.



BLUETOOTH  
■  
Glow



- If you are unable to select *Bluetooth* as an input source, be sure that the following settings have been applied.
  - “Bluetooth” in the setup menu is set to “On” (p. 57)
  - “Transmission” in the setup menu is set to “Off” (p. 57)

- 2 Turn on the *Bluetooth* device to be paired, and perform pairing.

The operation varies depending on the device. Refer to the instruction manual supplied with the device.

- 3 Select “YSP-1600” in the *Bluetooth* device list on the device.

If a passkey (PIN) is required, enter the number “0000”.

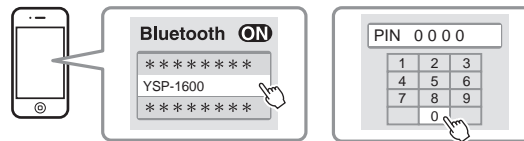

When pairing is completed,  or a completion message appears on the *Bluetooth* device.

The  indicator on the unit's front panel flashes while the unit and *Bluetooth* device are being paired, and glows steadily when pairing is complete.

- 4 Play back a song on the *Bluetooth* device.

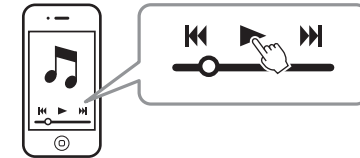

- Perform pairing with the *Bluetooth* device and unit within 10 m (33 ft) of each other.
- The unit can be paired with up to 20 *Bluetooth* devices for receiving and transmitting audio. If a new device is successfully paired with the unit after 20 other devices have already been paired, the device with the earliest connecting date will have been unpaired to make room for the new device.
- If a *Bluetooth* device has been connected before, the unit will connect to the last connected device when the **BLUETOOTH** key is pressed with step 1. Terminate this connection to pair a new device.
- Refer to “Bluetooth” (p. 64) in “Troubleshooting” if pairing is not possible.



## Playing back audio from a *Bluetooth* device on the unit

### 1 Press the BLUETOOTH key on the remote control when the unit is turned on.

*Bluetooth* is selected as the input.

BLUETOOTH  
■  
Glow



- If you are unable to select *Bluetooth* as an input source, be sure that the following settings have been applied.
  - “Bluetooth” in the setup menu is set to “On” (p. 57)
  - “Transmission” in the setup menu is set to “Off” (p. 57)

### 2 Turn on the *Bluetooth* device.



### 3 Select “YSP-1600” in the *Bluetooth* device list on the device.

### 4 Play back a song on the *Bluetooth* device.

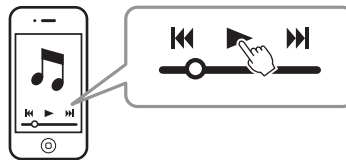

- Perform *Bluetooth* connection with the device and unit within 10 m (33 ft) of each other.
- Adjust the volume level of the *Bluetooth* device as required.
- If a *Bluetooth* device has been connected before, the unit will connect to the last connected device when the BLUETOOTH key is pressed with step 1. Terminate this connection to connect to a different *Bluetooth* device.
- Setting “Network Standby” in the setup menu to “On” allows the unit to be turned on and off with *Bluetooth* device operations.

## Terminating *Bluetooth* connection

*Bluetooth* connection is terminated in the following cases.

The  indicator on the unit's front panel turns off when the connection is terminated.

- The *Bluetooth* device is turned off.
- The BLUETOOTH key is pressed for more than 3 seconds.
- The unit is turned off.

## Listening to audio through *Bluetooth* speakers or headphones (transmitting)

### ■ Pairing a *Bluetooth* device with the unit

- 1 Turn on the *Bluetooth* device.
- 2 Select the input source (other than **BLUETOOTH**) with the input selector keys.
- 3 Press the **SETUP** key twice.  
The setup menu is displayed on the TV screen.
- 4 Use the **▲/▼** keys to select “Bluetooth”, and then press the **ENTER** key.
- 5 Use the **▲/▼** keys to select “Transmission”, and then press the **ENTER** key.
- 6 Use the **▲/▼** keys to select “On”, and then press the **ENTER** key.
- 7 Use the **▲/▼** keys to select “Device Search”, and then press the **ENTER** key.

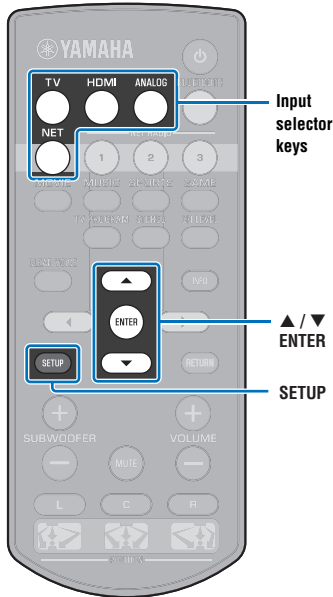

- 8 Use the **▲/▼** keys to select a *Bluetooth* device, and then press the **ENTER** key.

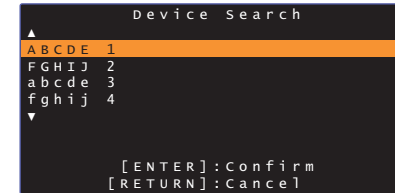

When a connection has been established (the device has been paired with the unit), “Completed” will be displayed on the TV screen.

The  indicator on the unit’s front panel flashes while the unit and *Bluetooth* device are being paired, and glows steadily when pairing is complete.



- A *Bluetooth* device that has been assigned a passkey (PIN) other than “0000” cannot be connected to the unit.
- The unit cannot connect to a *Bluetooth* device if “Bluetooth” in the setup menu is not set to “On” (p. 57).
- Perform pairing with the *Bluetooth* device and unit within 10 m (33 ft) of each other.
- The unit can be paired with up to 20 *Bluetooth* devices for receiving and transmitting audio. If a new device is successfully paired with the unit after 20 other devices have already been paired, the device with the earliest connecting date will have been unpaired to make room for the new device.
- “Not found” is displayed on the screen with step 8 when the unit cannot recognize the name of the device.
- Refer to “Bluetooth” (p. 64) in “Troubleshooting” if pairing is not possible.

## Playing back audio input from the unit through *Bluetooth* speakers or headphones



- Be sure that “Transmission” in the setup menu is set to “On” (p. 57).
- Connection to a *Bluetooth* device is not possible during playback using AirPlay (p. 45).



**1** Turn on the *Bluetooth* device.

**2** Select the input source (other than **BLUETOOTH**) with the input selector keys.

If a *Bluetooth* device has been connected before, the unit will connect to the last connected device. Proceed to step 4.

To connect to a different device, proceed to step 3.

**3** Follow steps 3 through 8 under “Pairing a **Bluetooth** device with the unit” to pair the device with the unit.

When a connection has been established (the device has been paired with the unit), “Completed” will be displayed on the TV screen.

The  indicator on the unit’s front panel flashes while the unit and *Bluetooth* device are being paired, and glows steadily when pairing is complete.

**4** Audio from the input source will play.



- Perform *Bluetooth* connection with the device and unit within 10 m (33 ft) of each other.
- Adjust *Bluetooth* device volume as needed.
- Audio will also be output from the unit.

## Terminating *Bluetooth* connection

*Bluetooth* connection is terminated in the following cases.

The  indicator on the unit’s front panel turns off when the connection is terminated.

- **The connection is terminated from the *Bluetooth* device, or the *Bluetooth* device is turned off.**
- **“Transmission” in the setup menu is set to “Off”.**
- **The unit is turned off.**

# NETWORKS

## Connecting to a network

You can choose between wired network connection and wireless network connection (p. 32) depending upon your network environment.

Network connection allows you to listen to Internet radio stations and play music files with AirPlay or your computer (media service) via this unit. You can operate the unit with a mobile device to which the MusicCast CONTROLLER app has been installed, allowing you to enjoy listening to a variety of audio sources via this unit.



- Some security software installed on your computer, or network device settings (such as a firewall), may block the unit's access to your computer or Internet radio stations. Should this occur, change security software and/or network device settings.
- A network connection cannot be established if the MAC address filter on your router is enabled. Check your router's settings.
- To configure your router's subnet mask manually, apply the same subnet used by this unit to all devices.
- Use of a broadband connection is recommended when using Internet services.



- If your router supports DHCP, network settings for the unit need not be configured. Network parameters (such as the IP address) will be assigned automatically. If your router does not support DHCP, or if you prefer to configure network parameters manually, you must configure network settings yourself (p. 54).
- You can verify that network parameters (such as the IP address) have been properly assigned to the unit by selecting "Information" (p. 54) from the setup menu.
- See our website for more information on the MusicCast CONTROLLER app.

## Wired network connections

To use a wired network connection, connect the unit to a router via an STP network cable (category 5 or higher straight cable; not supplied).

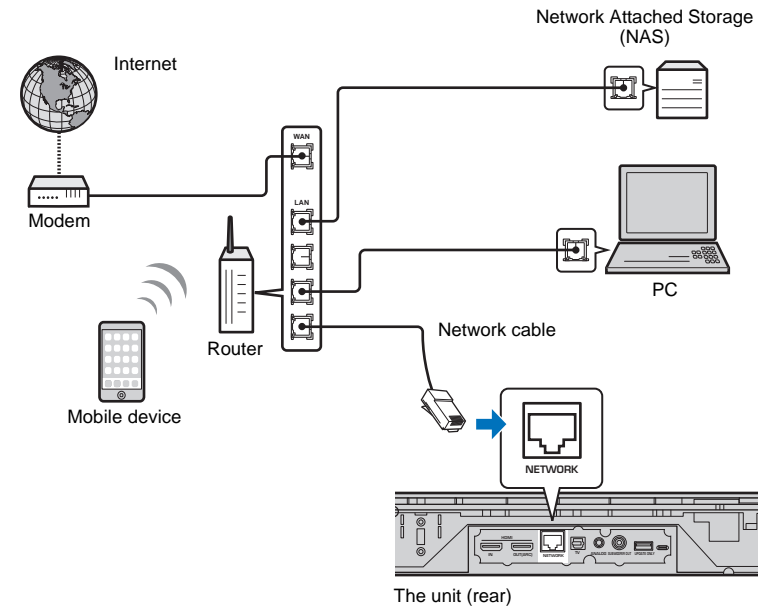

- If the unit is already connected to a wireless network and you would like to switch to a wired connection, change "Network" in the setup menu to "Wired".

## Wireless network

Connect the unit to a wireless router (access point).

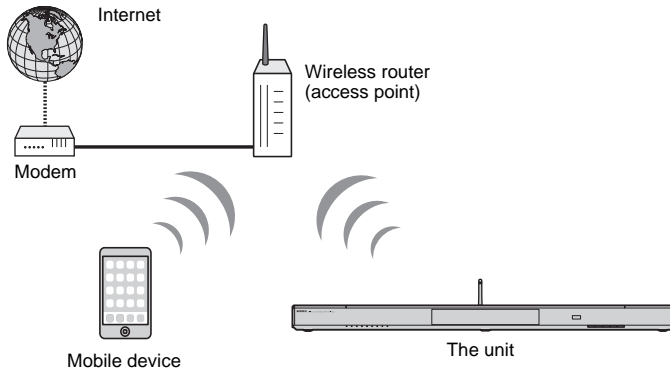

For details on connection, see “Connecting the unit to a wireless network”.

The  indicator on the front panel glows when the unit is connected to a wireless network.



- You cannot use the wireless network connection simultaneously with the wired network connection (p. 31) or Wireless Direct (p. 40).
- If the unit and the wireless router (access point) are too far apart, the unit may not connect to a wireless router (access point). In such case, place them close to each other.



- If the unit will not be connected to a wireless router (access point), Wireless Direct (p. 40) can be used to play music files stored on your mobile device via the unit.

## Connecting the unit to a wireless network

Select the connection method appropriate for your network environment from “Wireless (Wi-Fi)” in the setup menu.

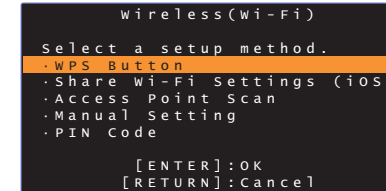

Connection method	Operation
<b>WPS Button</b>	Use the WPS button on your wireless router (access point) to establish a wireless connection.
<b>Share Wi-Fi Settings (iOS)</b>	Apply network settings from an iOS device (such as an iPhone).
<b>Access Point Scan</b>	Select an access point from a list displayed after a search of available access points.
<b>Manual Setting</b>	Establish a wireless network connection by entering required information, such as the SSID, manually.
<b>PIN Code</b>	Establish a wireless connection by registering the unit's PIN with your wireless router (access point). This method can be used if the wireless router (access point) supports the WPS PIN feature.

### Choosing a connection method

If you want to:	Use this connection method
<b>Use an iOS device to easily connect to a network</b>	Share Wi-Fi Settings (iOS) (p. 33)
<b>Connect to a wireless router (access point) that supports the WPS (push button) feature</b>	WPS Button (p. 34)
<b>Connect to a wireless router (access point) that supports the WPS PIN feature</b>	PIN Code (p. 39)
<b>Connect to a network by search for a nearby access point</b>	Access Point Scan (p. 35)
<b>Connect directly to an access point that cannot be located</b>	Manual Setting (p. 37)



## Sharing the iOS device setting

You can easily setup a wireless connection by applying the connection settings on iOS devices (such as an iPhone).

Before proceeding, confirm that your iOS device is connected to a wireless router (access point).



- You need iOS device with iOS 7.1 or later.
- The connection settings on iOS devices cannot be applied to the unit to establish a wireless connection if your wireless router (access point) uses WEP encryption. See “Searching for a wireless router (access point)” (p. 35) to establish a connection.

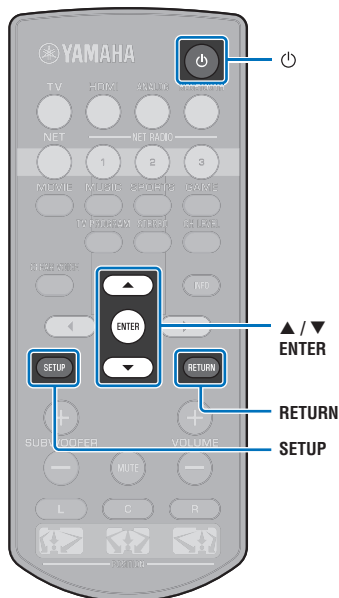

- 1 Press the key to turn on this unit.
- 2 Turn on the TV and switch the TV input to display video from the unit (HDMI OUT jack; p. 18).
- 3 Press the SETUP key twice.  
The setup menu is displayed on the TV screen.
- 4 Use the keys to select “Network”, and then press the ENTER key.
- 5 Use the keys to select “Network Connection”, and then press the ENTER key.
- 6 Use the keys to select “Wireless (Wi-Fi)”, and then press the ENTER key.

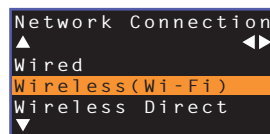

- 7 Use the keys to select “Share Wi-Fi Settings (iOS)”, and then press the ENTER key.

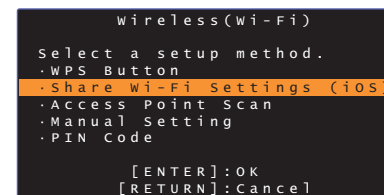

- 8 When the following screen is displayed, press the ENTER key.

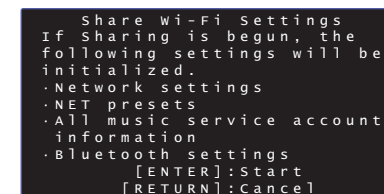

- The settings to be deleted (initialized) will be displayed. If you do not want to delete these settings, press the RETURN key to terminate the connection.

- 9 When the following screen is displayed, press the ENTER key.

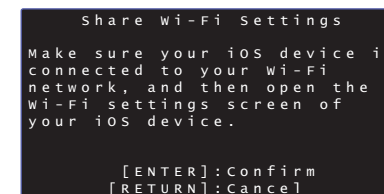

## 10 Display the Wi-Fi setup screen on the iOS device and select the unit from “SETUP A NEW AIRPLAY SPEAKER...”.

Follow the on-screen instructions displayed on the iOS device.

### Using the WPS push button configuration

You can easily set up a wireless connection with one push of the WPS button.

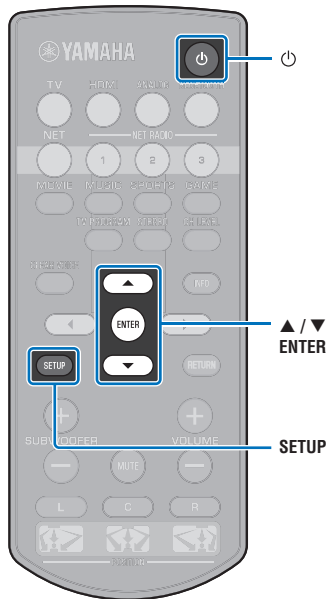

- 1 Press the key to turn on this unit.
- 2 Turn on the TV and switch the TV input to display video from the unit (HDMI OUT jack; p. 18).
- 3 Press the **SETUP** key twice.  
The setup menu is displayed on the TV screen.
- 4 Use the keys to select “Network”, and then press the **ENTER** key.
- 5 Use the keys to select “Network Connection”, and then press the **ENTER** key.
- 6 Use the keys to select “Wireless (Wi-Fi)”, and then press the **ENTER** key.

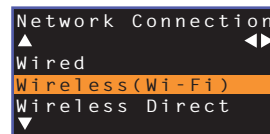

## 7 Use the keys to select “WPS Button”, and then press the **ENTER** key.

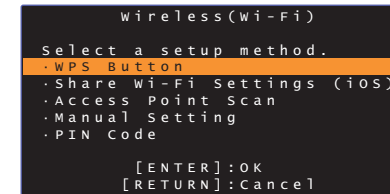

- 8 Push the WPS button on the wireless router (access point).
- 9 Press the **ENTER** key.

When a connection has been established (the device has been paired with the unit), “Completed” will be displayed on the TV screen.

If “Not connected” is displayed, press the **ENTER** key to repeat the process beginning with step 6, or see the information below to try another connection method.



- The WPS button cannot be used to establish a wireless connection if your wireless router (access point) uses WEP encryption, or if the router’s MAC address filter is enabled. See “Searching for a wireless router (access point)” (p. 35) to establish a connection.
- The WPS button cannot be used to establish a wireless connection if your wireless router (access point) is configured so that it does not broadcast its SSID. See “Setting up the wireless connection manually” (p. 37) to establish a connection.

#### About WPS

WPS (Wi-Fi Protected Setup) is a standard established by the Wi-Fi Alliance, which allows easy establishment of a wireless home network.

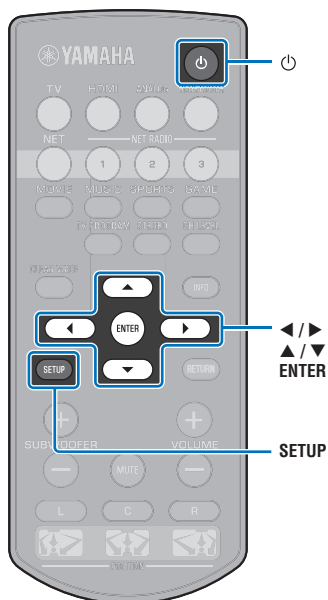

## Searching for a wireless router (access point)

Find and connect to a nearby wireless router (access point).

- 1 Press the key to turn on this unit.
- 2 Turn on the TV and switch the TV input to display video from the unit (HDMI OUT jack; p. 18).
- 3 Press the SETUP key twice.  
The setup menu is displayed on the TV screen.
- 4 Use the keys to select “Network”, and then press the ENTER key.
- 5 Use the keys to select “Network Connection”, and then press the ENTER key.
- 6 Use the keys to select “Wireless (Wi-Fi)”, and then press the ENTER key.
- 7 Use the keys to select “Access Point Scan”, and then press the ENTER key.

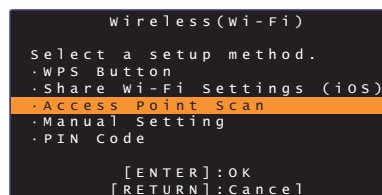
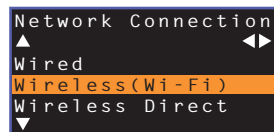

The list of available access points appears on the TV screen.

- 8 Use the keys to select the desired access point and press the ENTER key.

The wireless connection setting screen appears on the TV.

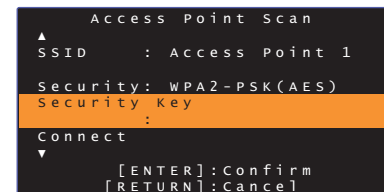

- 9 Press the ENTER key.

- 10 Use the / and ENTER keys to enter the security key.

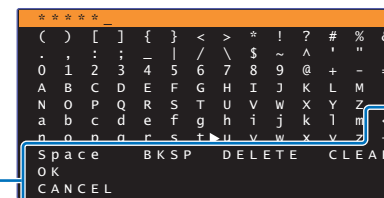

[←]/[→]: Move the cursor left and right.

[Space]: Enter a space.

[BKSP]: Delete the character to the left of the selected one.

[DELETE]: Delete the selected character.

[CLEAR]: Delete all characters entered.

[CANCEL]: Cancel character entry, and return to the previous screen.

Once the security key been entered, select “OK”, and then press the ENTER key. The screen will return to that displayed in step 8.

**11 Use the ▲/▼ keys to select “Connect” and press the ENTER key to start the connection process.**

When a connection has been established (the device has been paired with the unit), “Completed” will be displayed on the TV screen.

If “Not connected” is displayed press the ENTER key to repeat the process beginning with step 6, or see the information below to try another connection method.



- “Access Point Scan” cannot be used to establish a wireless connection if your wireless router (access point) is configured so that it does not broadcast its SSID. See “Setting up the wireless connection manually” (p. 37) to establish a connection.

**12 Press the SETUP key to exit the setup menu.**

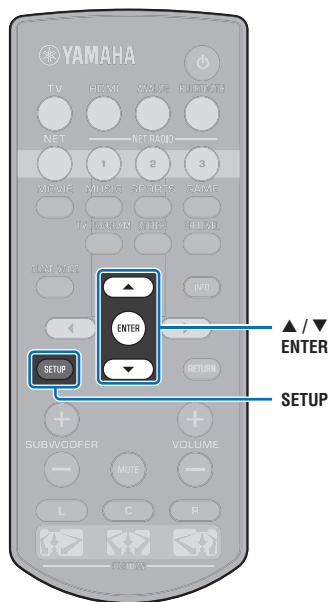

## Setting up the wireless connection manually

Setup the SSID (network name), encryption method and security key for your network manually.

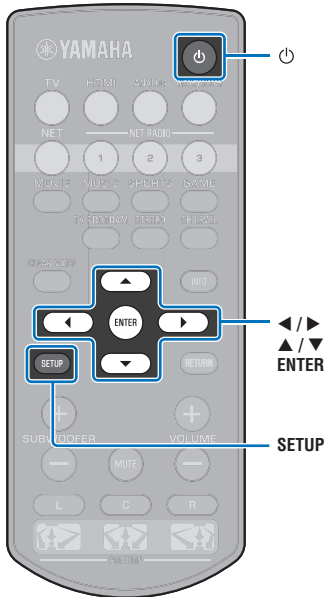

- 1 Press the key to turn on this unit.
- 2 Turn on the TV and switch the TV input to display video from the unit (HDMI OUT jack; p. 18).
- 3 Press the SETUP key twice.  
The setup menu is displayed on the TV screen.
- 4 Use the keys to select “Network”, and then press the ENTER key.
- 5 Use the keys to select “Network Connection”, and then press the ENTER key.
- 6 Use the keys to select “Wireless (Wi-Fi)”, and then press the ENTER key.

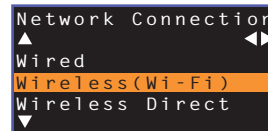

- 7 Use the keys to select “Manual Setting”, and then press the ENTER key.

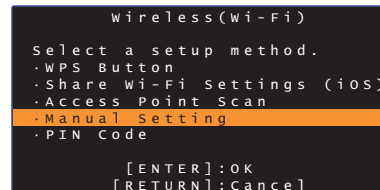

- 8 Use the keys to select “SSID”.

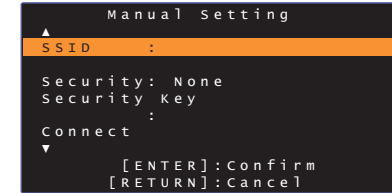

- 9 Use the / keys and the ENTER key to enter the SSID of the access point.



[←]/[→]: Move the cursor left and right.  
 [Space]: Enter a space.  
 [BKSP]: Delete the character to the left of the selected one.  
 [DELETE]: Delete the selected character.  
 [CLEAR]: Delete all characters entered.  
 [CANCEL]: Cancel character entry, and return to the previous screen.

Once the security key been entered, select “OK”, and then press the ENTER key. The screen will return to that displayed in step 8.

- 10 Use the keys to select “Security” and the keys to select the encryption method.

### Settings

None, WEP, WPA2-PSK (AES), Mixed Mode



- As communications are not encrypted when “None” is selected, selecting this option poses the risk that third parties may access the unit without your permission.

**11** Use the ▲/▼ keys to select “Security Key” and press the ENTER key.



- If you select “None” in step 10, this item is not available.

**12** Use the ◀/▶/▲/▼ and ENTER keys to enter the security key.

If you select “WEP” in step 10, enter either 5 or 13 character string, or 10 or 26 hexadecimal (base 16) keys.

If you select the method other than “WEP”, enter either 8 to 63 character string, or 64 hexadecimal (base 16) keys.



- Hexadecimal (base 16) keys use combinations of the numbers 0 through 9 and the letters a through f. Letters are not case sensitive.

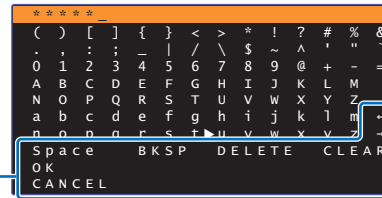

- [←]/[→]: Move the cursor left and right.
- [Space]: Enter a space.
- [BKSP]: Delete the character to the left of the selected one.
- [DELETE]: Delete the selected character.
- [CLEAR]: Delete all characters entered.
- [CANCEL]: Cancel character entry, and return to the previous screen.

Once the security key been entered, select “OK”, and then press the ENTER key. The screen will return to that displayed in step 8.

**13** Use the ▲/▼ keys to select “Connect” and press the ENTER key to start the connection process.

When a connection has been established (the device has been paired with the unit), “Completed” will be displayed on the TV screen.





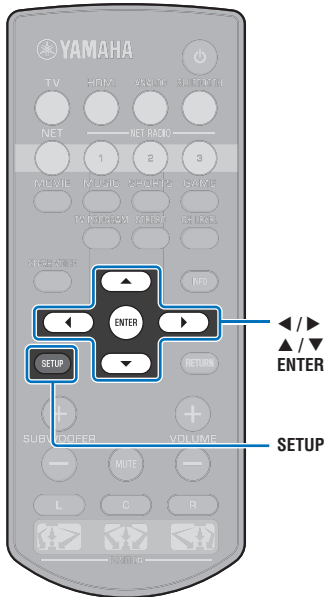

If “Not connected” is displayed press the ENTER key to repeat the process beginning with step 6.

**14** Press the SETUP key to exit the setup menu.





## Using the WPS PIN code

Register the unit's PIN code with your wireless router (access point) to establish a connection.

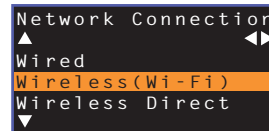
- 1 Press the  key to turn on this unit.
- 2 Turn on the TV and switch the TV input to display video from the unit (HDMI OUT jack; p. 18).
- 3 Press the SETUP key twice.  
The setup menu is displayed on the TV screen.
- 4 Use the / keys to select "Network", and then press the ENTER key.
- 5 Use the / keys to select "Network Connection", and then press the ENTER key.
- 6 Use the / keys to select "Wireless (Wi-Fi)", and then press the ENTER key.



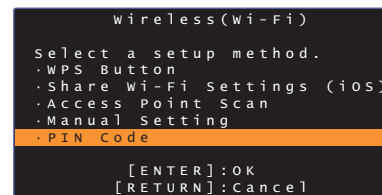

```
Network Connection
▲
Wired
Wireless (Wi-Fi)
▼
Wireless Direct
```

- 7 Use the / keys to select "PIN Code", and then press the ENTER key.



```
wireless (wi-fi)
Select a setup method.
· WPS Button
· Share Wi-Fi Settings (iOS)
· Access Point Scan
· Manual Setting
· PIN Code
[ENTER]:OK
[RETURN]:Cancel
```

The list of available access points appears on the TV screen.

- 8 Use the / keys to select the desired access point and press the ENTER key.

The PIN code of the unit appears on the TV screen.

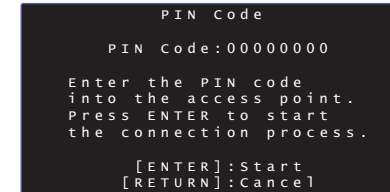

```
PIN Code
PIN Code:00000000
Enter the PIN code
into the access point.
Press ENTER to start
the connection process.
[ENTER]:Start
[RETURN]:Cancel
```

- 9 Enter the unit's PIN code into the wireless router (access point).

For details on settings, refer to the instruction manual of the wireless router (access point).

- 10 Press the ENTER key to start the connection process.

When a connection has been established (the device has been paired with the unit), "Completed" will be displayed on the TV screen.

If "Not connected" is displayed press the ENTER key to repeat the process beginning with step 6, or see the information below to try another connection method.



- The PIN code cannot be used to establish a wireless connection if your wireless router (access point) uses WEP encryption, or if the router's MAC address filter is enabled. See "Searching for a wireless router (access point)" (p. 35) to establish a connection.

- 11 Press the SETUP key to exit the setup menu.

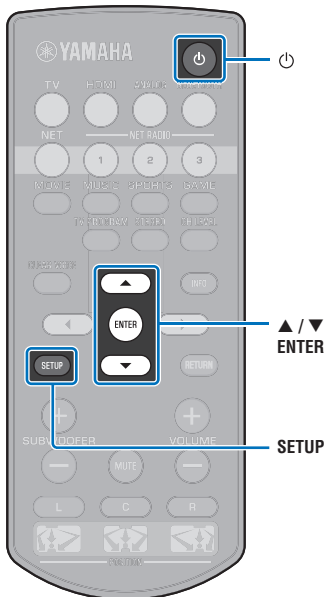

## Connecting a mobile device to the unit directly (Wireless Direct)

Connect a mobile device directly to the unit without using a wireless router (access point).

Wireless Direct supports the following.



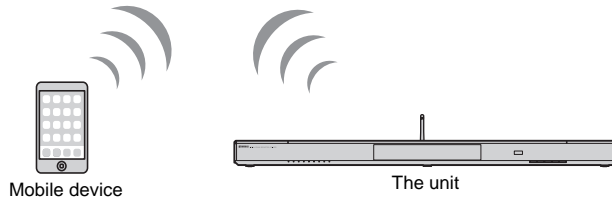
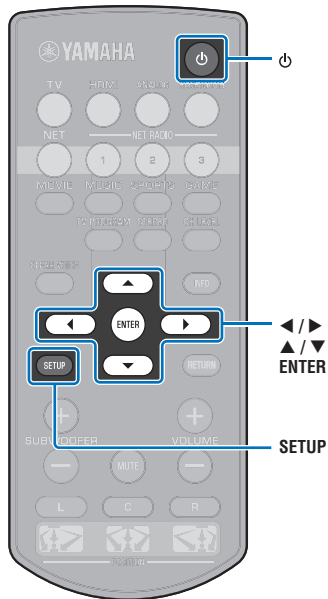



- Operation of the unit using a mobile device to which the dedicated MusicCast CONTROLLER or HOME THEATER CONTROLLER (WLAN) app has been installed.
- Use of AirPlay to play music files stored on an iOS device.







- You cannot use Wireless Direct simultaneously with the wired network connection (p. 31) or the wireless network connection (p. 32).
- When Wireless Direct is enabled, the unit cannot connect to the Internet. Therefore, you cannot use any kind of Internet service such as Internet radio.

- 1 Press the  key to turn on this unit.**
- 2 Turn on the TV and switch the TV input to display video from the unit (HDMI OUT jack; p. 18).**
- 3 Press the SETUP key twice.**

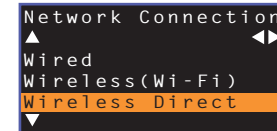
The setup menu is displayed on the TV screen.

- 4 Use the / keys to select “Network”, and then press the ENTER key.**
- 5 Use the / keys to select “Network Connection”, and then press the ENTER key.**
- 6 Use the / keys to select “Wireless Direct”, and then press the ENTER key.**



- 7 Use the / keys to select “Security” and the / keys to select the encryption method.**



### Settings

None, WPA2-PSK (AES)

In most cases, “WPA2-PSK (AES)” should be selected. If your mobile device does not support “WPA2-PSK (AES)”, select “None”.



- As communications are not encrypted when “None” is selected, selecting this option poses the risk that third parties may access the unit without your permission.

- 8 Use the / keys to select “Security Key” and press the ENTER key.**



- If you select “None” in step 7, this item is not available.



## 9 Use the ◀/▶/▲/▼ and ENTER keys to enter the security key.

Enter either 8 to 63 character string, or 64 hexadecimal (base 16) keys.



- Hexadecimal (base 16) keys use combinations of the numbers 0 through 9 and the letters a through f. Letters are not case sensitive.

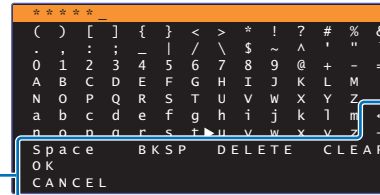

- [←][→]: Moves the cursor left and right.
- [Space]: Enter a space.
- [BKSP]: Delete the character to the left of the selected one.
- [DELETE]: Delete the selected character.
- [CLEAR]: Delete all characters entered.
- [CANCEL]: Cancel character entry, and return to the previous screen.

Once the security key been entered, select “OK”, and then press the ENTER key. The screen below will be displayed.

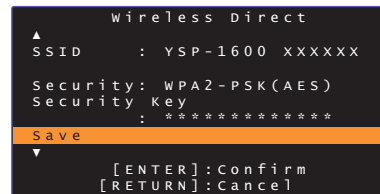

- Before proceeding to the next step, record the following information. These information will be needed to configure the Wi-Fi setting of a mobile device.
  - SSID displayed on the TV screen
  - Security key you have just entered

## 10 Use the ▲/▼ keys to select “Save” and press the ENTER key to save the setting.

This completes the settings and “Set the mobile device.” will be displayed on the TV screen. The unit functions as an access point.

Next, configure the Wi-Fi settings of a mobile device.

## 11 Configure the Wi-Fi settings of a mobile device.

For details on settings of your mobile device, refer to the instruction manual of the mobile device.

- Enable the Wi-Fi function on the mobile device.
- Select the SSID displayed in step 9 from the list of available access points.
- When you are prompted for a password, enter the security key displayed in step 9.

## 12 Press the SETUP key to exit the setup menu.

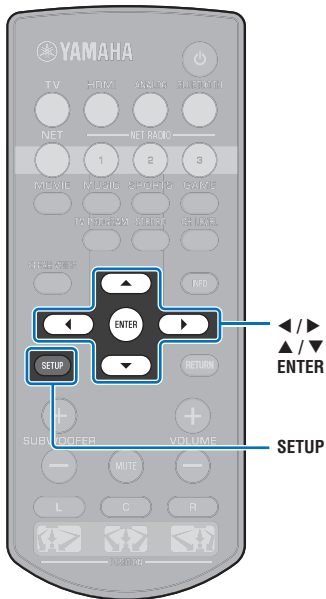

## Playing back music stored on media servers (PCs/NAS)

You can play back music files stored on your PC or DLNA-compatible NAS on the unit.



- To use this function, the unit and your PC must be connected to the same router (p. 31). You can check whether the network parameters (such as the IP address) are properly assigned to the unit in "Information" (p. 54) in the setup menu.
- The audio may be interrupted while using the wireless network connection. In this case, use the wired network connection.



- The following file formats are supported.
  - The unit supports playback of WAV (PCM format only), MP3, WMA, MPEG-4 AAC, FLAC and ALAC (Apple Lossless Audio Codec) files (1- or 2-channel audio only).
  - The unit is compatible with sampling rates of up to 192 kHz for WAV and FLAC files, 96 kHz for ALAC files, and 48 kHz for other files.
  - The unit supports gapless playback of WAV, FLAC and ALAC files.
  - To play back FLAC files, you need to install server software that supports sharing of FLAC files via DLNA on your PC or use a NAS that supports FLAC files.
  - Digital Rights Management (DRM) contents cannot be played back.

### Media sharing setup

To play back music files stored on your PC or DLNA-compatible NAS, first you need to configure the media sharing setting on each music server.

#### For a PC with Windows Media Player installed

This unit supports Windows Media Player 11 or later. This section explains Windows Media Player 12 setup as an example.

- 1 Start Windows Media Player 12 on your PC.**
- 2 Select "Stream", then "Turn on media streaming".**
- 3 Click "Turn on media streaming".**
- 4 Select "Allowed" from the drop-down list next to the unit's model name.**
- 5 Click "OK" to exit.**

#### For a PC or a NAS with other DLNA server software installed

Refer to the instruction manual for the device or software and configure the media sharing settings.

### Playing music files

Use the MusicCast CONTROLLER app installed on your mobile device to play music files.



- Configure basic settings for the MusicCast CONTROLLER app before playing music files.
- Refer to the supplied "MusicCast Setup Guide" for details.

## Listening to Internet radio

You can listen to Internet radio stations from all over the world.



- To use this function, the unit must be connected to the Internet (p. 31). You can check whether the network parameters (such as the IP address) are properly assigned to the unit in "Information" (p. 54) in the setup menu.
- You may not be able to receive some Internet radio stations.
- The unit uses the vTuner Internet radio station database service.
- This service may be discontinued without notice.

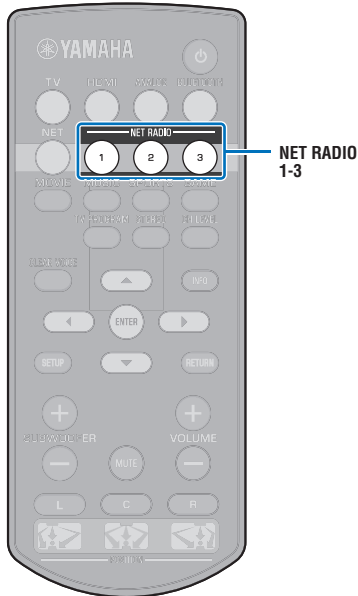

### Playback of Internet radio

Use the MusicCast CONTROLLER app installed on your mobile device to select an Internet radio station.



- Configure basic settings for the MusicCast CONTROLLER app before selecting an Internet radio station.
- Refer to the supplied "MusicCast Setup Guide" for details.

### Registering favorite Internet radio stations

Assign Internet radio stations to the NET RADIO keys on the remote control, or save them in the vTuner Bookmarks folder.

#### ■ Assigning a station to a NET RADIO key

- 1 Select the desired Internet radio station.**
- 2 Press and hold one of the NET RADIO keys (1–3) for at least 3 seconds.**

#### □ Tuning into assigned Internet radio stations

- 1 Press the NET RADIO key (1–3) to which the desired Internet radio station has been assigned.**

The input source switches to NET, and streaming begins.



Glows

## Registering the station on the vTuner website

You can also register your favorite Internet radio stations on the vTuner website.

### 1 Select any of Internet radio stations on the unit.

This operation is necessary to register the radio station for the first time.

### 2 Check the vTuner ID of the unit.

You can find the vTuner ID in "Information" (p. 54) in the setup menu.

### 3 Access the vTuner website (<http://yradio.vtuner.com/>) with the web browser on your PC and enter the vTuner ID.

You can switch the language.

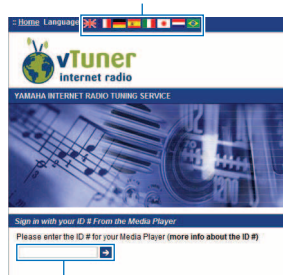

Enter the vTuner ID in this area.



- To use this feature, you need to create your personal account. Create your account using your e-mail address.

### 4 Register your favorite radio stations.

Click the "Add" icon (♥+) next to the station name.



- To remove the station from the "Bookmarks" folder, select "Bookmarks" in the Home screen, and then click the "Remove" icon (♥-) next to the station name.

# Playing back music with AirPlay

The AirPlay function allows you to play back iTunes or iPod music on the unit via network.



- This section describes "iPod touch", "iPhone" and "iPad" as the "iPod". "iPod" refers to "iPod touch", "iPhone" and "iPad", unless otherwise specified.

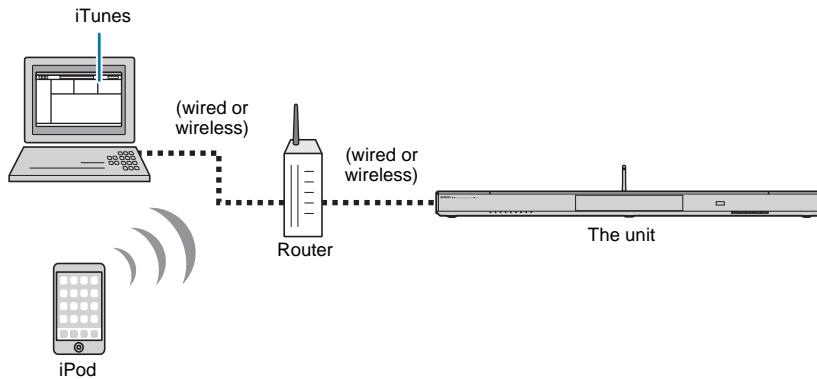

- To use this function, the unit and your PC or iPod must be connected to the same router (p. 31). You can check whether the network parameters (such as the IP address) are properly assigned to the unit in "Information" (p. 54) in the setup menu.
- When using a multiple SSID router, access to the unit might be restricted depending on the SSID to connect. Connect the unit and iPod to the same SSID.
- The AirPlay function can be used with an iPhone, iPad, or iPod touch running iOS 4.3.3 or later, a Mac running OS X version 10.8 "Mountain Lion" or later, or a Mac or Windows computer with iTunes 10.2.2 or later installed.

## Playback of iTunes/iPod music contents

Follow the procedure below to play back iTunes/iPod music contents on the unit.

### 1 Turn on the unit, and start iTunes on the PC or display the playback screen on the iPod.

If the iTunes/iPod recognizes the unit, the AirPlay icon () appears.

iTunes (example)

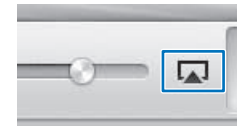

iPod iOS7/iOS8 (example)



iPod iOS6 (example)

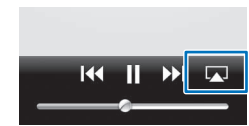

- If the icon does not appear, check whether the unit and PC/iPod are connected to the router properly.

### 2 On the iTunes/iPod, click (tap) the AirPlay icon and select the unit (network name of the unit) as the audio output device.

iTunes (example)

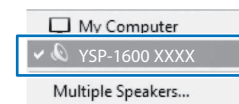

iPod (example)

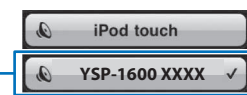

Network name of the unit

### 3 Select a song and start playback.

To operate playback, use the Music app on the iPod or iTunes on the PC.

The input source switches to NET, and playback begins.

NET  
■  
Glow



- You can turn on the unit automatically when starting playback on iTunes or iPod by setting “Network Standby” (p. 56) in the setup menu to “On”.
- You can edit the network name (the unit’s name on the network) displayed on iTunes/iPod in “Network Name” (p. 56) in the setup menu.
- You can adjust the unit’s volume from the iTunes/iPod during playback.

#### Caution

- When you use iTunes/iPod controls to adjust volume, the volume may be unexpectedly loud. This could result in damage to the unit or speakers. If the volume suddenly increases during playback, stop playback on the iTunes/iPod immediately.

## Playing back music stored on mobile devices

Use this function to play music stored on your mobile device over a network.

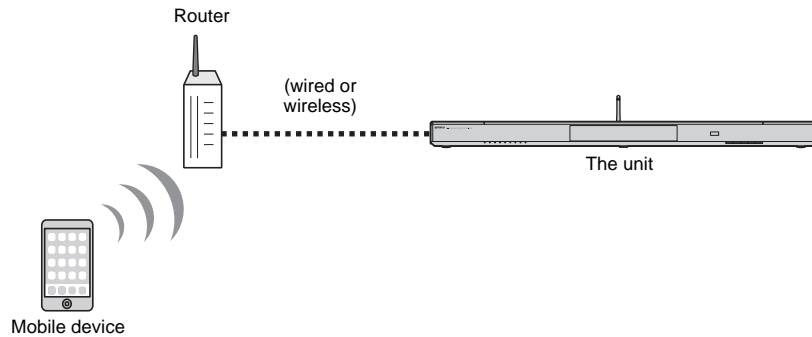

- To use this function, the unit and your PC or mobile device must be connected to the same router (p. 31). You can check whether the network parameters (such as the IP address) are properly assigned to the unit in "Information" (p. 54) in the setup menu.
- When using a multiple SSID router, access to the unit might be restricted depending on the SSID to connect. Connect the unit and mobile device to the same SSID.

## Using a mobile device to play songs

Use the MusicCast CONTROLLER app installed on your mobile device to operate playback.



- Configure basic settings for the MusicCast CONTROLLER app before playing music.
- Refer to the supplied "MusicCast Setup Guide" for details.

### Caution

- When you use mobile device controls to adjust volume, the volume may be unexpectedly loud. This could result in damage to the unit or speakers. If the volume suddenly increases during playback, stop playback on the mobile device immediately.

# SETTINGS

## Setup menu

A variety of settings for this unit can be specified and adjusted from the setup menu. Among the options available are channel volume control, HDMI settings, and network settings.

The setup menu is displayed on, and operated from, the TV screen. See “Displaying the menu screen on the TV” (p. 18) for instructions on displaying the setup menu on the TV.

## Setting the setup menu

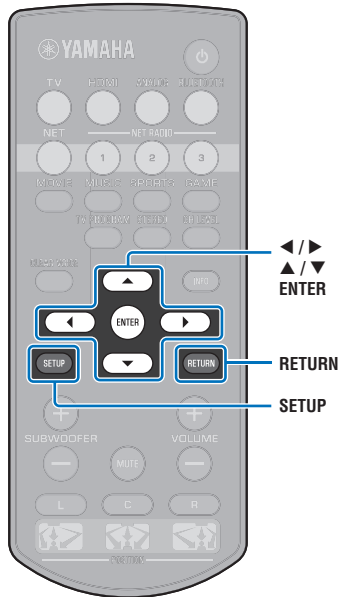

### 1 Press the SETUP key.

To display the Network or Bluetooth menu, press the SETUP key again.

Setup menu

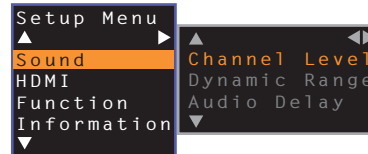

- Hold down the SETUP key for more than 3 seconds to display “OSD Language” directly on the screen (p. 19, 52).
- If an update for the unit’s firmware is available, an envelope icon (✉) will be displayed in the setup menu (p. 59).

### 2 Use the ▲/▼ key to select a menu and then press the ENTER key.

Repeat these steps to display the desired menu.

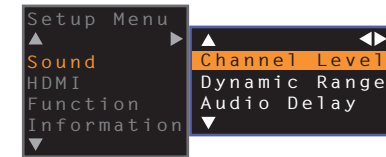

The ► key can be used in place of the ENTER key.

Press the ◀ key or RETURN key to return to the previous menu.

### 3 Use the ▲/▼ key to change the setting value of each menu.

### 4 Press the SETUP key again to exit the setup menu.



## Setup menu list

Menu	Item	Function	Page	
Sound	Channel Level	Front L, Front R, Center, Surround L, Surround R, Subwoofer	Adjust the volume of each channel.	50
	Dynamic Range		Specify dynamic range.	50
	Audio Delay		Adjust the delay between video and audio output.	50
HDMI	HDMI Control		Turn HDMI control on or off.	51
	HDMI Audio Out		Choose whether HDMI audio input is played via this unit or the TV.	51
	Audio Assign		Specify the audio input from the TV jack or HDMI IN jack when HDMI is selected as the input source.	51
Function	Dimmer		Adjust the brightness of indicators on the front panel.	52
	OSD Language		Change the language used for menus displayed on the TV screen.	52
	Auto Power Standby		Turn Auto Power Standby on or off.	52
	TV Remote Repeater		Enable/disable the TV Remote Repeater function.	58
Information	Audio		Display audio input signal information.	53
	Video		Display video input signal information.	53
	System		Display this unit's firmware version.	53
Network	Information		Display the unit's network information.	54
	Network Connection		Select the network connection method.	54
	IP Address	DHCP, IP Address, Subnet Mask, Default Gateway, DNS Server (P), DNS Server (S)	Configure the network parameters (such as IP address).	55
	MAC Address Filter	Filter, MAC Address 1–10	Set the MAC address filter to limit access to the unit from other network devices.	55
	Network Standby		Enable/disable the function that turns on the unit from other network devices.	56
	Network Name		Edit the network name (the unit's name on the network) displayed on other network devices.	56
	Network Update	Perform Update	Update the firmware via the network.	56
	Bluetooth		Enable/disable the <i>Bluetooth</i> functions.	57
Bluetooth	Transmission		Turn the function that transmits audio to a <i>Bluetooth</i> device, such as <i>Bluetooth</i> speakers, on or off.	57
	Device Search		Search for the <i>Bluetooth</i> device, such as <i>Bluetooth</i> speakers, to which audio will be transmitted.	57
	MAC Address		Display the MAC address for the <i>Bluetooth</i> connection.	57

# Sound

## Channel Level



Adjust the volume of each channel to balance output levels. Use test sounds output from each channel to adjust volume for optimal balance.

### Item

Front L, Front R, Center, Surround L, Surround R, Subwoofer

### Adjustable range

-10 to +10

## Dynamic Range



Adjust this unit's dynamic range (difference between maximum and minimum volumes).

### Settings

Auto (default)	Set dynamic range at a level that supports comfortable listening at low volumes.
Standard	The dynamic range recommended for regular home use.
Max	Output sound without adjusting the dynamic range of the input signals.

## Audio Delay



TV images sometimes lag behind the sound. You can use this function to delay the sound output to synchronize it with the video image.

### Settings

0 ms–500 ms	Specify audio output timing in increments of 5 ms.
Auto (default)	Adjust the delay between video and audio output automatically when a TV that supports an automatic lipsync function is connected to the unit via HDMI.

# HDMI

Use to configure the settings related to HDMI signals and the HDMI control function.

## HDMI Control



Turn HDMI control (p. 20) on or off.

### Settings

Off (default)	Disable the HDMI control function. The standby power consumption of this unit decreases.
On	Enable the HDMI control function.

## HDMI Audio Out

This setting can be configured only when “HDMI Control” is set to “Off”.



Use to select a device to play back HDMI audio signals.

### Settings

AMP (default)	Play back the input sound signal.
TV	Plays audio content from the TV connected to the HDMI OUT (ARC) jack. Volume cannot be adjusted from the unit. Use the TV to adjust volume.



- When “HDMI Control” is set to “On”, select the audio output device based on the settings configured for the TV connected to this unit.
- HDMI video signals input to the HDMI IN jack of this unit are always output from the HDMI OUT (ARC) jack of this unit.

## Audio Assign



Specify whether audio is input via the HDMI IN jack or the TV (digital optical) jack of the unit when HDMI is selected as the input source.

### Settings

HDMI (default), Optical

# Function

## Dimmer



Adjust the brightness of indicators on the front panel.

### Settings

-2 (off), -1 (normal; default), 0 (bright)



- If this function is set to “-2” or “-1”, the display brightens only when operations are performed with this unit.

## OSD Language



Use to select the language used for menus displayed on the TV screen.

### Settings

日本語	Menus are displayed in Japanese.
ENGLISH (default)	Menus are displayed in English.
DEUTSCH	Menus are displayed in German.
FRANÇAIS	Menus are displayed in French.
ESPAÑOL	Menus are displayed in Spanish.
ITALIANO	Menus are displayed in Italian.
NEDERLANDS	Menus are displayed in Dutch.
РУССКИЙ	Menus are displayed in Russian.
SVENSKA	Menus are displayed in Swedish.
TÜRK	Menus are displayed in Turkish.



- Hold down the SETUP key for more than 3 seconds to display “OSD Language” directly on the TV screen.
- The settings may be changed automatically when using the TV which supports the HDMI control function.

## Auto Power Standby



Turn Auto Power Standby on or off.

When this function is activated, the unit turns off when it is not in use.

### Settings

Off (default setting other than U.K., Europe and Russia models), On (default setting for U.K., Europe and Russia models)

When “Auto Power Standby” is set to “On”, the unit automatically turns off as indicated below

- Audio is input to the unit, but no operations have been performed with the unit for more than 8 hours.
- HDMI, BLUETOOTH or NET is selected as the input source, but no audio has been input to the unit or no operations have been performed with the unit for more than 20 minutes.
- HDMI is selected as the input source, but no playback device has been connected to the unit’s HDMI IN jack for more than 20 minutes.

5 minutes before the auto power standby function automatically turns the unit off, the indicators on the front panel indicate a countdown until the unit is turned off.

5 minutes before



One indicator turns off for every minute that passes.

10 seconds before



The blinking indicator moves to the left for every second that passes.  
... ← 9 seconds before ← 10 seconds before



- Auto Power Standby can also be turned on or off using the keys on the front panel (p. 62).

## TV Remote Repeater

Setup Menu



Function



TV Remote Repeater

Turn the TV Remote Repeater function on or off.

### Settings

Off (default)	Disable the TV Remote Repeater function.
On	Enable the TV Remote Repeater function.

For details, see “Operating a TV via the TV Remote Repeater function of the unit” (p. 58).

## Information

Display information for the audio and video signal input to this unit.

### Audio

Setup Menu



Information



Audio

The following information on the current audio input signal is displayed.

Format	Digital audio format
Number of channels	The number of channels contained within the input signal—front/surround/low frequency effects (LFE). Example: “3/2/0.1” means signal contains 3 front channels, 2 surround channels, and LFE. If the signal contains channels other than front, surround, and LFE, the total number of channels may be displayed. Example: “5.1ch”.
Sampling frequency	The sampling frequency of the digital input signal
Bit rate	The per-second bit rate of the input signal



- The audio bit rate or sampling frequency may not be displayed for some input signals.

### Video

Setup Menu



Information



Video

The following information on the current video input signal is displayed.

Type	HDMI or DVI
Resolution	Video signal resolution

### System

Setup Menu



Information



System

Display the version of firmware currently installed on this unit.

# Network

Configures the network settings.



- Some menus are not superimposed over video content on the TV screen.

## Information



Display the network information on the unit.



- The options displayed vary according to the type of network connection (Wired/Wireless (Wi-Fi)/Wireless Direct).

Status	The connection status of the NETWORK jack
Connection	Connection method
MC Network	The connection status of MusicCast Network
SSID	The access point to which the unit is connected
Security	The encryption method for your network
MAC Address	MAC address (Ethernet/Wi-Fi)
IP Address	IP address
Subnet Mask	Subnet mask
Default Gateway	The IP address of the default gateway
DNS Server (P)	The IP address of the primary DNS server
DNS Server (S)	The IP address of the secondary DNS server
vTuner ID	The ID of the Internet radio (vTuner)

## Network Connection

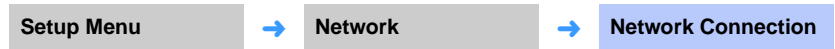

Select the network connection method.

### Settings

Wired	Select this option when connecting the unit to a network with a network cable (not supplied).
Wireless (Wi-Fi)	Select this option when connecting the unit to a network via the wireless router (access point).
Wireless Direct	Select this option when connecting a mobile device to the unit directly.

## IP Address



Configure the network parameters (such as IP address).

### □ DHCP

Select whether to use a DHCP server.

#### Settings

Off	The DHCP server is not used. Configure the network parameters manually. For details, see “Manual network settings”.
On (default)	The DHCP server is used to automatically obtain the unit's network parameters (such as IP address).

#### Manual network settings

### 1 Set “DHCP” to “Off”.

### 2 Use the ▲/▼ keys to select a parameter type.

IP Address	Specify an IP address.
Subnet Mask	Specify a subnet mask.
Default Gateway	Specify the IP address of the default gateway.
DNS Server (P)	Specify the IP address of the primary DNS server.
DNS Server (S)	Specify the IP address of the secondary DNS server.

### 3 Use the ◀/▶ keys to move the edit position and the ▲/▼ keys to select a value.

### 4 Press the ENTER key.

## MAC Address Filter



The MAC address filter limits network devices that can be used to operate the unit. When operating the unit via an app on a mobile device, specify the MAC address of the device.



- Operation of the AirPlay function (p. 45) or DLNA-compatible device (p. 42) is not limited by this setting.

### □ Filter

Enable/disable the MAC address filter.

#### Settings

Off (default)	Disable the MAC address filter.
On	Enable the MAC address filter. In “MAC Address 1–10”, specify the MAC addresses of the network devices that will operate the unit.

### □ MAC Address 1–10

Specify the MAC addresses (up to 10) of the network devices that will operate the unit when “Filter” is set to “On”.

### 1 Use the ▲/▼ keys to select an MAC address number (1 to 10).

### 2 Use the ◀/▶ keys to move the edit position and the ▲/▼ keys to select a value.

### 3 Press the ENTER key.

## Network Standby

Setup Menu → Network → Network Standby

Turn the function that controls the unit's power (Network Standby) when a network device or *Bluetooth* device is operated on or off.

### Settings

Off	Disable the network standby function.	The unit's power can be controlled using the MusicCast CONTROLLER or HOME THEATER CONTROLLER (WLAN) app installed on your mobile device.
On (default)	Enable the network standby function.	<p>The unit will turn on and off in accordance with the following <i>Bluetooth</i> device operations.</p> <p><b>Coordinated power on</b> When a <i>Bluetooth</i> device is connected to this unit while it is off, this unit turns on and the input source switches to BLUETOOTH.</p> <p><b>Coordinated power off</b> When a <i>Bluetooth</i> device is disconnected from this unit while it is on, this unit turns off. (Only when BLUETOOTH is selected as the input source.)</p>



- The unit consumes more power when "Network Standby" is set to "On" than when it is set to "Off".

## Network Name

Setup Menu → Network → Network Name

Edit the name displayed for this device (the unit's name on the network) on other network devices. A name up to 15 characters in length may be specified.

- 1 Use the ◀▶ keys to move the edit position and the ▲▼ keys to select a character.

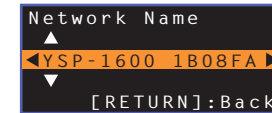

- The following alphanumeric characters and symbols may be used.  
( ) [ ] { } < > \* ! ? # % & . , ; \_ | / \ \$ ~ ^ ' " ` 0-9 @ + - = A-Z a-z

- 2 Press the RETURN key.

## Network Update

Setup Menu → Network → Network Update

Update the firmware via the network.

### Perform Update

This option is available after firmware has been updated. For details, see "Updating the unit's firmware" (p. 59).



# Bluetooth

Configures the *Bluetooth* settings.



- Some menus are not superimposed over video content on the TV screen.

## Bluetooth



Enables/disables the *Bluetooth* function.

### Settings

Off	Disable the <i>Bluetooth</i> function.
On (default)	Enable the <i>Bluetooth</i> function.

## Transmission

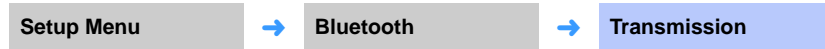

Transmit audio from the unit to *Bluetooth* speakers or headphones.

### Settings

Off (default)	Audio can not be transmitted.
On	Audio input to the unit can be transmitted to <i>Bluetooth</i> speakers or headphones.

## Device Search



Select the *Bluetooth* speakers or headphones to which audio will be transmitted, and the pair the speakers or headphones with the unit to establish a connection.

## MAC Address

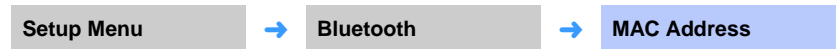

Display the MAC address for the *Bluetooth* connection.

## Operating a TV via the TV Remote Repeater function of the unit

When the TV Remote Repeater function is enabled, the unit receives TV remote control signals at the remote control sensor (on front) and transmits the signals from the TV Remote Repeater (on rear). This function is useful when you cannot operate your TV from the remote control because the remote control sensor of the TV is blocked by the unit.



- This function can be used while the TV remote control is using infrared signals.
- Position the unit and TV so that they are separated by at least 5 cm (2").

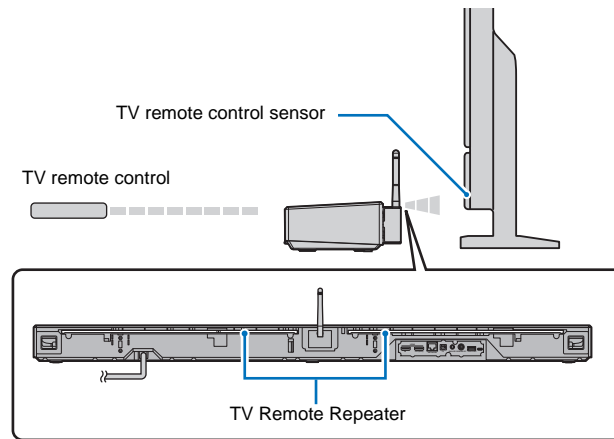
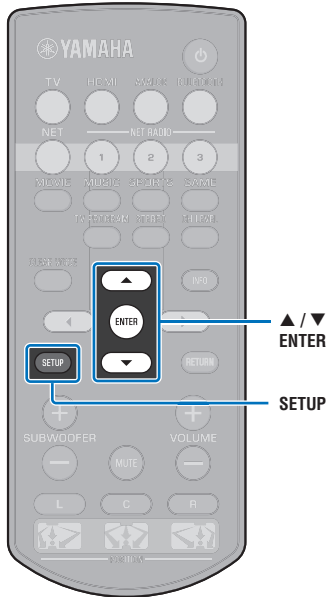

Follow the steps below to enable the TV Remote Repeater function.

- 1 Press the SETUP key.**  
The setup menu is displayed.
- 2 Use ▲/▼ key to select “Function”, and then press the ENTER key.**
- 3 Use ▲/▼ key to select “TV Remote Repeater”, and then press the ENTER key.**
- 4 Use ▲/▼ key to select “On”, and then press the ENTER key.**
- 5 Press the SETUP key to exit the setup menu.**

## Updating the unit's firmware

New firmware that provides additional features or product improvements will be released as needed. If the unit is connected to the Internet, you can download the firmware via the network and update it.

When the unit is turned on for the first time after a new version of the unit's firmware has been released, a message indicating that a firmware update is available will be displayed on the TV screen, and an envelope icon (✉) will be displayed in the setup menu (p. 48)

The unit's firmware can be updated as follows.

- Update firmware from "Network Update" in the setup menu.
- Update firmware by connecting a USB flash drive to which the unit's firmware update has been saved (p. 60).
- Update firmware using the dedicated MusicCast CONTROLLER app installed on a mobile device. Follow MusicCast CONTROLLER guides to operate the app and update the firmware.

### Notes

- Do not operate the unit or disconnect the power cable or network cable during firmware update. Firmware update takes about 20 minutes or more (depending on your Internet connection speed).
- If the Internet connection speed is slow, or the unit is connected to the wireless network, network update may not be possible depending on the condition of the network connection. In this case, update the firmware using the USB flash drive (p. 60).
- To perform the following procedure, your TV must be connected to the unit via HDMI.
- For details on update, visit the Yamaha website.

## Using "Network Update" in the setup menu to update firmware

### 1 Press the SETUP key twice.

The setup menu is displayed on the TV screen.

### 2 Use the ▲/▼ keys to select "Network", and then press the ENTER key.

### 3 Use the ▲/▼ keys to select "Network Update", and then press the ENTER key.

The following screen is displayed when firmware updates are available.



- To cancel the operation without updating the firmware, press the SETUP key.

### 4 Press the ENTER key.

The TV screen goes black and firmware update begins.

The indicators on the front panel glow to indicate progress during the update.



- If there are multiple firmware updates, the indicators will start glowing as each firmware update begins.

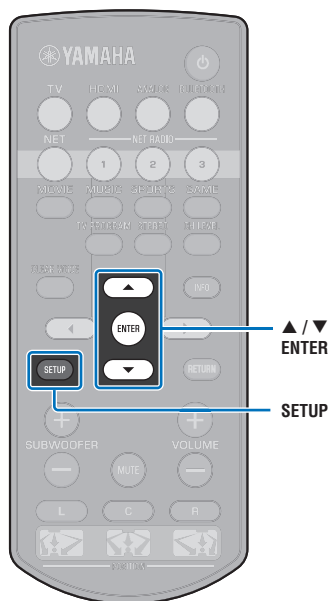

- 5** When the indicators on the front panel glow alternately as shown below, press the **⏻** (power) key on the unit's front panel.

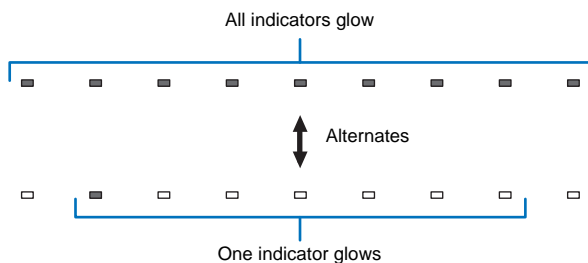

The firmware update is complete.



- If the firmware update fails, the indicator at far right will flash blue. Use the **⏻** (power) key to turn the unit off and then on again, and repeat the procedure from step 1 again. If the firmware update fails again, confirm that the unit is properly connected to a network.

## Updating firmware with connection of a USB flash drive

Download the latest firmware version from the Yamaha website to a USB flash drive, which can then be used to update the unit's firmware.

See information provided when updating firmware for details.

- 1** Save this unit's firmware to a USB flash drive.
- 2** Turn off the unit.
- 3** Connect the USB flash drive to the **UPDATE ONLY** jack on the unit's rear panel.

- 4** Press the **⏻** key on the front panel while pressing the **VOLUME –** key on the unit.

The firmware update will begin.

The indicators on the front panel glow to indicate progress during the update.

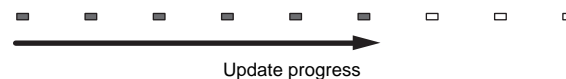

- If there are multiple firmware updates, the indicators will start glowing as each firmware update begins.

- 5** When the indicators on the front panel glow alternately as shown below, press the **⏻** (power) key on the unit's front panel.

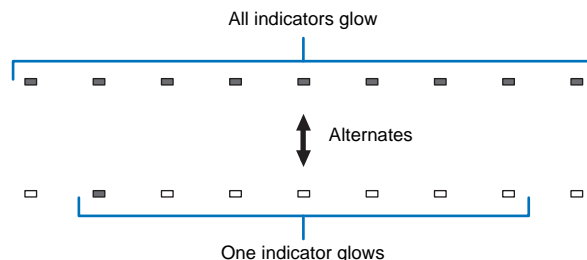

The firmware update is complete.



- If the firmware update fails, the indicator at far right will flash blue. Use the **⏻** (power) key to turn the unit off and then on again, and repeat the procedure from step 1 again. If the firmware update fails again, confirm the following.
  - The USB flash drive is correctly connected to the **UPDATE ONLY** jack.
  - See information provided as firmware updates are performed, and be sure that the USB flash drive contains the firmware update for this unit.
  - The unit is properly connected to a network.

## Initializing the unit's settings

Various settings for the unit can be initialized. You can choose to initialize basic unit settings (does not initialize network settings), or to initialize only network settings.

### Initializing basic unit settings

The basic unit settings other than network settings will be initialized.

- 1 Turn off the unit.
- 2 Hold down the  (power) key for more than 3 seconds on the front panel of the unit.

Once settings have been initialized, the unit turns on, all indicators on the front panel flash for a moment, and then the unit can be operated.



### Initializing network settings

The following settings will be initialized.

- Settings for "Network" and "Bluetooth" in the setup menu
- Internet radio stations assigned to the NET RADIO 1–3 keys
- *Bluetooth* pairing information



- Follow the instructions for "Initializing basic unit settings" at left to initialize the following two settings.
  - Network Standby (p. 56)
  - *Bluetooth* function (p. 57)

- 1 Turn off the unit.
- 2 Press the  (power) key while pressing the **CONNECT** key on the front panel of the unit.

Once settings have been initialized, the unit turns on, all indicators on the front panel flash for a moment, and then the unit can be operated.





- When network settings are initialized, the "Share Wi-Fi Settings (iOS)" screen will be displayed the next time the unit is turned on (p. 18).

# APPENDIX

## Troubleshooting

Refer to the chart below when this unit does not function properly. If the problem you are experiencing is not listed below or if the instruction below does not help, turn off the unit, disconnect the AC power supply cable, and contact the nearest authorized Yamaha dealer or service center.

### General

Problem	Cause	Remedy	See page
<b>This unit does not operate properly.</b>	The internal microcomputer has been frozen by an external electric shock (such as lightning or excessive static electricity) or by a power supply with low voltage.	Disconnect the AC power supply cable from the outlet and plug it again in after 30 seconds.	–
<b>This unit fails to turn on when  key is pressed (the STATUS indicator flashes red), or the unit is turned off soon after the power has been turned on.</b>	The AC power supply cable is not firmly connected to the AC wall outlet.	Connect the AC power supply cable firmly to the AC wall outlet.	17
	The internal microcomputer has been frozen by an external electric shock (such as lightning or excessive static electricity) or by a power supply with low voltage.	Disconnect the AC power supply cable from the outlet and plug it again in after 30 seconds.	–
<b>This unit is suddenly turned off.</b>	The internal temperature becomes too high and the overheat protection circuitry has been activated.	Wait for about 1 hour for this unit to cool down, turn it back on after confirming an adequate amount of ventilation space and not to cover this unit with a cloth.	12
	When the Auto Power Standby function is enabled, this unit turns off automatically in any of the following situations: – Audio is coming from the selected input source. However, no operations have been performed for 8 hours or more. – HDMI, BLUETOOTH or NET is selected as the input source, but no audio has been input to the unit or no operations have been performed with the unit for more than 20 minutes. – HDMI is selected as the input source, but no playback device has been connected to the unit's HDMI IN jack for more than 20 minutes.	Turn on the power of the unit and play back the source again. If the Auto Power Standby function is not used, set "Auto Power Standby" to "Off" from the setup menu. Auto Power Standby can also be turned on or off using the keys on the front panel. With the unit turned off, hold down the INPUT key and press the  key, both on the front panel. The Auto Power Standby setting will be reversed and the unit will turn on. The  indicator on the front panel will glow for a few seconds when Auto Power Standby is switched off, and will not glow when Auto Power Standby is switched on.	52
	The network standby function is enabled, and the <i>Bluetooth</i> connection is terminated.	Resume the <i>Bluetooth</i> connection using the <i>Bluetooth</i> device, or turn on this unit and set "Network Standby" to "Off".	56
<b>The indicator at far right flashes blue.</b>	Firmware update has failed.	Turn the unit off and then on again, and try updating the firmware again. If the firmware update fails again, confirm that the unit is properly connected to a network.  If firmware update using a USB flash drive fails, be sure that the USB flash drive is properly connected to the UPDATE ONLY jack, and that it contains the firmware update for this unit.	59

Problem	Cause	Remedy	See page
<b>No sound.</b>	Incorrect input or output cable connections.	Connect the cable properly.	16
	No appropriate input source has been selected.	Select an appropriate input source with the input selector keys.	22
	The volume is turned down.	Turn up the volume.	22
	The sound is muted.	Press the MUTE or VOLUME (+/-) key to resume audio output and adjust the volume level.	22
	There is input signal cannot be played back by this unit.	Play a source whose signals can be reproduced by this unit. Change the system settings of the source device.	72
	"HDMI Audio Out" is set to "TV".	Set to "AMP".	51
	"HDMI Control" is set to "Off".	When connecting ARC (Audio Return Channel) supported TV and this unit using an HDMI cable only, set "HDMI Control" to "On".	51
		To use this unit with "HDMI Control" set to "Off", connect the TV's audio output jack to this unit's TV (digital optical) jack via the optical cable.	15
Sound from an HDMI control-enabled TV is set for output from the TV's built-in speakers.	Use the TV's HDMI settings to set audio output to any option other than the TV's built-in speakers.	-	
<b>No sound or too small sound from a specific channel.</b>	The output level of the channel is muted.	Raise the output level of the channel.	24, 50
	Position is not properly specified.	Specify position in accordance with the unit's installation position.	19
	The source is played in stereo playback mode.	Switch to surround playback mode.	23
<b>Surround sound effects are insubstantial.</b>	When connecting this unit with playback device and TV digitally, the output setting of the playback device and TV is not valid.	Refer to the manual supplied with your device and check the setting.	-
	The playback device is set for constant output from 2 channels (PCM, etc.).	Change the playback device's audio output setting.	-
	Position is not properly specified.	Specify position in accordance with the unit's installation position.	19
	There is no wall in the path of the sound beam.	Place the sound reflection board in the path of the sound beam.	68
<b>No sound is coming from the subwoofer.</b>	The volume of the subwoofer is low.	Increase the volume of the subwoofer with the SUBWOOFER + key.	22
<b>The volume of low (bass) tones from the subwoofer is low.</b>	The volume of the subwoofer is low.	Increase the volume of the subwoofer with the SUBWOOFER + key.	22
	Content from an input source with a limited support for low tones is playing.	Play content from an input source with broader support for low tones to see if volume is still low.	-

Problem	Cause	Remedy	See page
The image is not displayed on TV screen.	The HDMI cable is not securely connected.	Connect the HDMI cable properly.	15, 16
The “This content can not be viewed on your TV. Please connect the TV which corresponds to HDCP2.2 with HDMI OUT of this unit.” message is displayed on the TV screen and the input source does not play.	The HDMI IN jack on the TV, which is connected to the HDMI OUT (ARC) jack on the unit, is not compatible with HDCP 2.2.	Connect the unit to the HDMI IN jack that is compatible with HDCP 2.2 on a TV.	15
Menu screen of this unit is not displayed.	The input switch of TV is not set correctly.	Set the TV's input source to this unit.	18
A digital or high-frequency equipment produces noises.	The unit may be placed close to digital equipment or high-frequency equipment.	Move the equipment away from the unit.	–
The HDMI control function does not work properly.	“HDMI Control” is set to “Off”.	Set “HDMI Control” to “On”.	51
	The HDMI control function is disabled on your TV.	Refer to the manual supplied with your TV and check the setting.	–
	The number of the connected HDMI devices exceeds the limit.	Disconnect some of the HDMI devices.	–
Audio delay control function is not effective even “Audio Delay” is set to “Auto”.	The TV does not support the audio delay auto adjustment feature.	Adjust timing of sound output manually from “Audio Delay”.	50

## Bluetooth

Problem	Cause	Remedy	See page
<b>Cannot make the unit paired with the <i>Bluetooth</i> device.</b>			
<b>Receiving/transmitting</b>	“Bluetooth” is set to “Off”.	Set it to “On”.	57
	The device does not support A2DP.	Perform pairing operations with a device which supports A2DP.	71
	The unit and device are too far apart.	Position the <i>Bluetooth</i> device so that it is less than 10 m (33 ft) from this unit and pair the device with this unit.	27, 29
	There is a device (microwave oven, wireless LAN, etc.) outputs signals in the 2.4 GHz frequency band nearby.	Move this unit away from the device that is emitting radio frequency signals.	–
	Another <i>Bluetooth</i> device is connected.	Terminate current <i>Bluetooth</i> connection, and perform pairing with the new device.	28
<b>Receiving</b>	<i>Bluetooth</i> is not selected as the input source.	Select <i>Bluetooth</i> as the input source.	22
	A <i>Bluetooth</i> adaptor, etc. that you want to pair with the unit has a password other than “0000”.	Use a <i>Bluetooth</i> adaptor, etc. whose password is “0000”.	27
<b>Transmitting</b>	“Transmission” is set to “Off”.	Set it to “On”.	57



Problem	Cause	Remedy	See page
<b>Cannot make a <i>Bluetooth</i> connection.</b>			
<b>Receiving/transmitting</b>	"Bluetooth" is set to "Off".	Set it to "On".	57
	Another <i>Bluetooth</i> device is connected.	The unit cannot make multiple <i>Bluetooth</i> connections. Terminate current <i>Bluetooth</i> connection, and make connection for the desired device.	28
	More than 20 devices are paired and the oldest pairing information is deleted.	Perform pairing again. The unit can be paired with up to 20 <i>Bluetooth</i> devices for receiving and transmitting audio. If a new device is successfully paired with the unit after 20 other devices have already been paired, the device with the earliest connecting date will have been unpaired to make room for the new device.	27
<b>Transmitting</b>	Attempted to establish a connection during playback with AirPlay.	Terminate AirPlay playback and try again to establish a connection.	30
<b>No sound is produced or the sound is intermittent during playback.</b>			
<b>Receiving/transmitting</b>	The <i>Bluetooth</i> connection of the unit with the device is disconnected.	Perform <i>Bluetooth</i> connection operations again.	28
	The unit and device are too far apart.	Move the <i>Bluetooth</i> device so that it is less than 10 m (33 ft) from this unit.	27, 29
	There is a device (microwave oven, wireless LAN, etc.) outputs signals in the 2.4 GHz frequency band nearby.	Move this unit away from the device that is emitting radio frequency signals.	-
	The device's <i>Bluetooth</i> function is off.	Enable the <i>Bluetooth</i> function of the device.	-
	The device's volume is set to minimum.	Turn up the volume level on the device.	-
<b>Receiving</b>	The device is not set to send <i>Bluetooth</i> audio signals to the unit.	Check that the <i>Bluetooth</i> function of the device is set properly.	-
	Playback on the device has not been performed.	Perform playback on the device.	-
<b>Transmitting</b>	Transmitted audio does not play.	Play audio from the device selected with the input selector key.	30

## Remote control

Problem	Cause	Remedy	See page
<b>The remote control does not work and/or function properly.</b>	The wrong distance or angle.	The remote control functions within a maximum range of 6 m (20 ft) and no more than 30 degrees off-axis from the front panel.	4
	Direct sunlight or lighting (from an inverter type of fluorescent lamp, etc.) is striking the remote control sensor of this unit.	Reposition this unit.	-
	The batteries are weak.	Replace all batteries.	4
<b>The TV cannot be operated using the TV Remote Repeater function.</b>	The TV Remote Repeater function is disabled.	Enable the TV Remote Repeater function.	58
	A remote control using technology other than infrared is used (this unit may not support some infrared remote controls).	The TV Remote Repeater function cannot be used. Move the unit so that it does not block the remote control sensor on the TV, and use the TV's remote control to operate the TV.	-
	The unit and TV are too close together or too far apart.	Move the unit away from the TV more than 5 cm (2").	12
	The unit's power cable is unplugged.	Plug in the power cable.	17
	There is an object, such as a power cable, between the unit and TV.	Remove the obstacle.	-

## Network

Problem	Cause	Remedy	See page
<b>The network feature does not function.</b>	The network parameters (IP address) have not been obtained properly.	Enable the DHCP server function on your router and set "DHCP" in the setup menu to "On" on the unit. If you want to configure the network parameters manually, check that you are using an IP address which is not used by other network devices in your network.	55
<b>"Not connected" is displayed with "Wireless (Wi-Fi)" configuration; unable to connect to wireless router (access point).</b>	The wireless router's MAC address filter is enabled.	A connection cannot be established if the wireless router's MAC address filter is enabled. Check wireless router (access point) settings and try a different connection method.	31, 32
<b>"Not connected" is displayed with "Wireless (Wi-Fi)" configuration using the WPS function ("WPS Button" and "PIN Code") and "Access Point Scan"; unable to connect to wireless router (access point).</b>	The wireless router (access point) does not broadcast its SSID.	A connection cannot be established if the wireless router (access point) is configured so that it does not broadcast its SSID. Check wireless router (access point) settings and try a different connection method.	34, 35, 39
<b>"Not connected" is displayed with "Wireless (Wi-Fi)" configuration using the WPS function ("WPS Button" and "PIN Code"); unable to connect to wireless router (access point).</b>	The wireless router (access point) uses WEP encryption.	A connection cannot be established using the WPS function. Try a different connection method.	34, 39
<b>Playback stops unexpectedly and files cannot be played continuously.</b>	The folder contains some files that cannot be played via the unit.	Delete or move files (including video or hidden files) that cannot be played via the unit from the folder.	–
<b>The unit does not detect the PC.</b>	The media sharing setting is not correct.	Configure the sharing setting and select the unit as a device to which music contents are shared.	42
	Some security software installed on your PC is blocking the access of the unit to your PC.	Check the settings of security software installed on your PC.	–
	The unit and PC are not in the same network.	Check the network connections and your router settings, and then connect the unit and the PC to the same network.	–
	The MAC address filter is enabled on the unit.	In "MAC Address Filter" in the setup menu, disable the MAC address filter or specify the MAC address of your PC to allow it to access to the unit.	55
<b>The files in the PC cannot be viewed or played back.</b>	The files are not supported by the unit or the media server.	Use the file format supported by both the unit and the media server.	42

Problem	Cause	Remedy	See page
<b>The Internet radio cannot be played.</b>	The selected Internet radio station is currently not available.	There may be a network problem at the radio station, or the service may have been stopped. Try the station later or select another station.	–
	The selected Internet radio station is currently broadcasting silence.	Some Internet radio stations broadcast silence at certain times of the day. Try the station later or select another station.	–
	Access to the network is restricted by the firewall settings of your network devices (such as the router).	Check the firewall settings of your network devices. The Internet radio can be played only when it passes through the port designated by each radio station. The port number varies depending on the radio station.	–
<b>The dedicated apps for mobile device does not detect the unit.</b>	The MAC address filter is enabled on the unit.	In "MAC Address Filter" in the setup menu, disable the MAC address filter or specify the MAC address of your mobile device to allow it to access to the unit.	55
	The unit and mobile device are not in the same network.	Check the network connections and your router settings, and then connect the unit and mobile device to the same network.	–
<b>Firmware update via the network (Network Update) fails.</b>	It may not be possible depending on the condition of the network.	Update the firmware via the network (Network Update) again or use a USB flash drive.	59
<b>The iPod does not recognize the unit when using AirPlay.</b>	The unit and iPod/mobile device are connected to different SSIDs on the same access point.	Connect them to the same SSID.	–
<b>The app installed on a mobile device does not recognize the unit.</b>			
<b>The unit cannot connect to the Internet via a wireless router (access point).</b>	The wireless router (access point) is turned off.	Turn on the wireless router (access point).	–
	The unit and the wireless router (access point) are too far apart.	Place the unit and the wireless router (access point) closer to each other.	–
	There is an obstacle between the unit and the wireless router (access point).	Move the unit and the wireless router (access point) in a location where there are no obstacles between them.	–
<b>Wireless network is not found.</b>	There is a device (microwave oven, wireless LAN, etc.) outputs signals in the 2.4 GHz frequency band nearby.	Move this unit away from the device that is emitting radio frequency signals.	–
	Access to the network is restricted by the firewall settings of the wireless router (access point).	Check the firewall setting of the wireless router (access point).	–

## When surround effect is not enough

The unit achieves its surround sound effects by projecting sound beams which reflect off walls. The sound beams are not reflected toward to the listening position caused by furniture, etc., in the path of sound beams, or the room shape. In this case, the sound may become unbalanced.

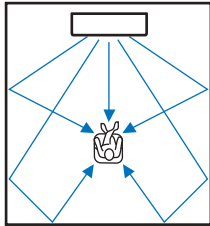

Figure 1. Ideal condition

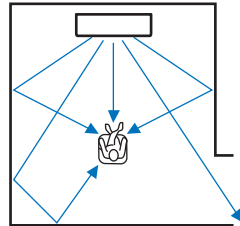

Figure 2. Surround right beam is not being reflected because there is no wall.

Surround right is quieter than surround (left), or surround right is in front of its proper location.

If the sound beams are not reflected toward to the listening position (figure 2), you can adjust for this by installing the optional sound reflection board YRB-100.

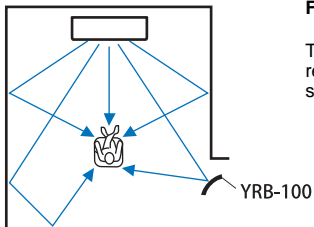

Figure 3. With a sound reflection board installed

The sound beam for surround right is reflected correctly, and correct surround sound effect is achieved.



• YRB-100 may not be available in some countries or regions.

## How to install YRB-100

The unit outputs sound beams according to the “Position” settings (p. 19) as shown in the following illustrations.

Install the YRB-100 in the path of the sound beam.

● shows the recommended install position.

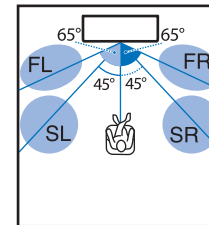

Position: Center

FL: Front left  
FR: Front right  
SL: Surround left  
SR: Surround right

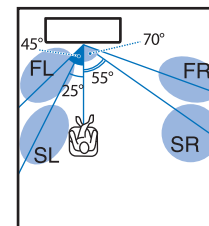

Position: Left

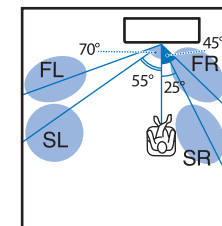

Position: Right

- After installing the sound reflection board, refer to the YRB-100 owner's manual to adjust the height and angle. Playing test-tones from “Channel Level” in the setup menu is recommended when adjusting the board (p. 50).
- By installing the board close to your listening position, you can achieve clear surround sound positioning.

### Note

- This unit does not have the function to automatically adjust sound beam angles. It is not necessary to adjust the sound beam angles, although the procedure is described in the owner's manual.

# Basic Knowledge of Surround Sound

## What is Surround Sound?

Surround sound offers the sense of being surrounded by sounds, an experience common in concert halls and movie theaters. This can be achieved by surrounding the audience with numerous speakers from which sound is output uniformly in all directions. This "surround sound" technology immerses the listener in sound with speakers positioned not only in front of the listener, but also behind and to the sides of the listener, making him or her feel as if they are actually in the situation.

For precise directional control and quality of sound reproduction, sounds must be split into separate audio channels for output to each speaker. Surround sound systems for regular home use (5.1-channel speaker systems) produce surround sound using five speakers and a subwoofer, as shown below:

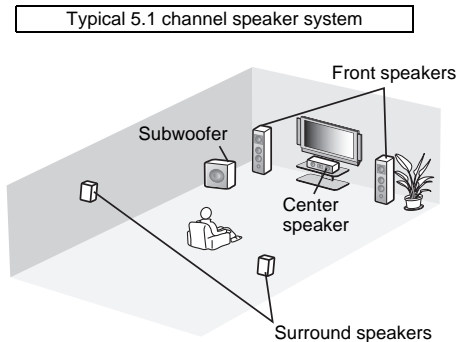

As explained above, sounds can be reproduced for a great sense of presence by installing multiple speakers. However, this can be difficult to do in a living room. This unit utilizes "digital sound projector" technology to provide a realistic and engaging surround sound experience using only a slim center unit and subwoofer.

## What is a Digital Sound Projector?

A digital sound projector separately controls compact speakers installed in orderly rows, so that optimized audio signals are output from each speaker and synthesized as highly focused sounds (sound beams).

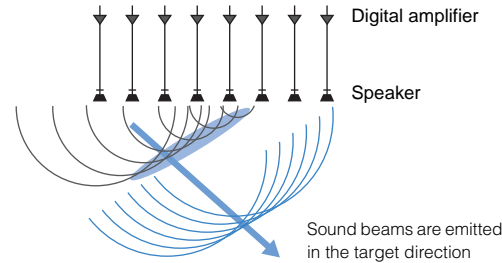

When these focused sounds hit a hard wall, they are reflected off of the wall. A digital sound projector outputs sound beams from five channels, including front (left/right), center, and surround (left/right) channels, by reflecting these beams off of walls so that sounds reach the listener from the appropriate direction. It features a technology that enables true surround sound without requiring the installation of speakers in front of, or behind, the listener.

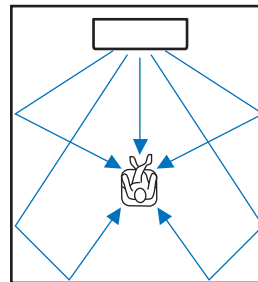

## Yamaha's Audio Technologies

This unit features many more functions based on Yamaha's superior audio technologies.

### Compressed Music Enhancer

This technology enhances and extends bass and treble, which tend to be weak in digitally compressed formats such as MP3 used with portable digital audio players and computers. This makes compressed audio sound more musically dynamic.

With this unit, Compressed Music Enhancer is automatically activated when audio is input from a *Bluetooth* device.

### CINEMA DSP

This technology enables precise digital recreation of actual acoustic environments found in well-known concert halls and movie theaters. This is achieved using Yamaha's exclusive sound field programs, and with which the amplitude, depth, and volume of sounds have been adjusted.

### Clear Voice

This technology enables clear playback of speech (dialog, narrations, etc.) while maintaining the quality of background sound (music, sound effects, etc.). It enhances the acoustic characteristics of speech sounds and increases the perceived volume level.

## Audio/video information

---

### Sampling Frequency and Bit Depth

These are values that represent the amount of information used to convert analog signals to digital signals. They may be expressed as 48kHz/24bit, for example.

- **Sampling Frequency**

This defines the number of samples per second (sampling a finite set of discrete values in an analog signal). The higher the sampling rate, the broader the range of frequencies that can be played back.

- **Bit Depth**

This defines the amplitude value of sounds when quantifying analog signals as finite values. The higher the bit depth, the deeper sounds are reproduced.

### Deep Color

This is a video technology supported by the HDMI standard. It processes RGB or YCbCr signals at bit depths of 10, 12, or 16 bits per color, whereas conventional formats utilize only 8-bit processing, enabling reproduction of more colors. Its gamut is comprised of a billion or more colors, while the gamuts of conventional formats are comprised of only millions of colors or less. This broader gamut results in more precise reproduction of colors and greater detail in darker portions.

### Dolby Digital

This is a compressed audio format for 5.1 channels. It was developed by Dolby Laboratories, and is widely used with DVD discs.

### Dolby Pro Logic II

This technology converts audio signal recorded in 2 channels to 5-channel signal.

### DTS Digital Surround

This is a compressed audio format for 5.1 channels developed by DTS. It is widely used with DVD discs.

### FLAC

FLAC is a file format for lossless audio data compression. FLAC is inferior to lossy compressed audio formats in compression rate but provides higher audio quality.

### HDMI

High-Definition Multimedia Interface (HDMI) is a digital audio/video interface that has become an industry standard around the world. It is capable of transmitting both digital video and audio signals intact via a single cable. It is also compliant with the High-bandwidth Digital Content Protection (HDCP) standard. See <http://www.hdmi.org> for more information.

### MP3

One of the compressed digital audio format used by MPEG. With psychoacoustic technologies, this compression method achieves a high compression rate. Reportedly, it is capable of compressing data quantity by about 1/10 maintaining a certain level of audio quality.

### MPEG-4 AAC

An MPEG-4 audio standard. It is used for mobile telephones, portable audio players, and audio streaming services on Internet because it allows a high compression rate of data while maintaining better audio quality than MP3.

### Pulse Code Modulation (PCM)

This technology records analog audio signals in digital form, converts analog audio signals to digital audio signals, and transmits analog audio signals in digital form. It is the underlying technology for all digital audio signal systems, and is widely used with CDs, Blu-ray Discs, and many other types of media as a uncompressed audio format known as Linear PCM.

### WAV

Windows standard audio file format, which defines the method of recording the digital data obtained by converting audio signals. By default, the PCM method (no compression) is used, but you can also use other compression methods.

### WMA (Windows Media Audio)

One of the compressed digital audio formats developed by Microsoft Corporation. With psychoacoustic technologies, this compression method achieves a high compression rate. Reportedly, it is capable of compressing data quantity by about 1/20 maintaining a certain level of audio quality.

### x.v.Color

This is a color space supported by HDMI. It has become an international standard for video and offers a broader gamut than does the sRGB standard for expression of colors never before possible. It expands the color space while ensuring compatibility with the sRGB standard for more natural and vivid images.

## Network information

---

### SSID

SSID (Service Set Identifier) is a name that identifies a particular wireless LAN access point.

### Wi-Fi

Wi-Fi is a technology that allows an electronic device to exchange data or connect to the Internet wirelessly using radio waves. Wi-Fi offers the advantage of eliminating the complexity of making connections with network cables by using wireless connection. Only products that complete Wi-Fi Alliance interoperability tests can carry the "Wi-Fi Certified" trademark.

### WPS

WPS (Wi-Fi Protected Setup) is a standard established by the Wi-Fi Alliance, which allows easy establishment of a wireless home network.

# Specifications

Item		Specifications
Amplifier	Maximum Rated Output Power	Array speakers 2.5 W x 8
		Subwoofer 30 W x 2
Array speakers	Type	Acoustic suspension type
	Driver	Full range 2.8 cm (1-1/8") cone magnetic shielding type x 8
	Frequency Response	500 Hz to 22 kHz
	Impedance	4 Ω
Subwoofer	Type	Bass reflex type
	Driver	8.5 cm (3-1/4") cone non-magnetic shielding type x 2
	Frequency Response	50 Hz to 500 Hz
	Impedance	6 Ω
Decoder	Supported audio signal (TV, BD/DVD)	PCM (5.1ch), Dolby Digital, DTS Digital Surround
Input Jacks	HDMI	1 (HDMI IN)
	Digital (Optical)	1 (TV)
	Analog (RCA/stereo)	1 (ANALOG)
Output Jacks	HDMI	1 (HDMI OUT (ARC))
	Analog (RCA/monaural)	1 (SUBWOOFER OUT)
Other Jacks	NETWORK	1 (100BASE-T, 10BASE-T)
	UPDATE ONLY	1
Network		Compatible with DLNA ver. 1.5 AirPlay supported Internet Radio
Wireless LAN (Wi-Fi)	Wireless LAN Standards	IEEE802.11b/g/n
	Radio Frequency Band	2.4 GHz
	WPS (Wi-Fi Protected Setup)	Push-Button-Method, PIN Method
	Security Type	WEP, WPA2-PSK (AES), Mixed Mode

Direct connection with mobile devices		Wireless Direct
Bluetooth	Bluetooth version	Ver. 2.1 +EDR
	Supported protocols	A2DP, AVRCP
	Supported codecs	Receiving: SBC, MPEG-4 AAC Transmitting: SBC
	Wireless output	Bluetooth Class 2
	Maximum communication distance	10 m ([33 ft] without obstructions)
	Supported content protection method	SCMS-T (receiving)
General	Power Supply	U.S.A. and Canada models: AC 120 V, 60 Hz China model: AC 220 V, 50 Hz Taiwan model: AC 110-120 V, 50/60 Hz Other models: AC 220-240 V, 50/60 Hz
	Power Consumption	25 W
	Standby Power Consumption	<ul style="list-style-type: none"> <li>• HDMI Control Off, Network Standby Off..... 0.4 W</li> <li>• HDMI Control On, Network Standby Off ..... 1.5 W</li> <li>• HDMI Control Off, Network Standby On (Wired/Wi-Fi/Wireless direct/Bluetooth) ..... 1.9/1.8/2.0/1.9 W</li> <li>• HDMI Control On, Network Standby On ..... 3.0 W</li> </ul>
	Dimensions (W x H x D)	With antenna: 1000 x 134 x 152 mm (39-3/8" x 5-1/4" x 6") Without antenna: 1000 x 65 x 130 mm (39-3/8" x 2-1/2" x 5-1/8")
	Weight	4.7 kg (10.4 lbs)

Specifications are subject to change without notice.

## Available signal information

### HDMI signal compatibility

#### Receivable audio signals

Audio signal types	Audio signal formats	Compatible media
2ch Linear PCM	2ch, 32–192 kHz, 16/20/24 bit	CD, DVD-Video, DVD-Audio, etc.
Multi-ch Linear PCM	6ch, 32–192 kHz, 16/20/24 bit	DVD-Audio, Blu-ray disc, HD DVD, etc.
Bitstream	Dolby Digital, DTS	DVD-Video, etc.



- Refer to the supplied instruction manuals of the input source device, and set the device appropriately.
- When CPPM copy-protected DVD-Audio is played back, video and audio signals may not be output depending on the type of the DVD player.
- This unit is not compatible with HDCP-incompatible HDMI or DVI devices. Refer to the supplied instruction manuals of HDMI or DVI devices for HDCP compatibility.
- To decode audio bitstream signals on this unit, set the input source device appropriately so that the device outputs the bitstream audio signals directly (does not decode the bitstream signals on the device). Refer to the supplied instruction manuals for details.

#### Repeatable video signals

This unit is compatible with the following video signals.

- Deep Color
- x.v.Color
- 3D video signal

This unit is compatible with the following resolutions.

- VGA
- 480i/60 Hz
- 480p/60 Hz
- 576i/50 Hz
- 576p/50 Hz
- 720p/60 Hz, 50 Hz
- 1080i/60 Hz, 50 Hz
- 1080p/60 Hz, 50 Hz, 30 Hz, 25 Hz, 24 Hz
- 4K/60 Hz, 50 Hz, 30 Hz, 25 Hz, 24 Hz



- The resolution of transmitted video signal varies according to specifications of the TV connected to this unit.

### Digital audio signal (optical)

Audio signal types	Audio signal formats	Compatible media
2ch Linear PCM	2ch, 32–96 kHz, 16/20/24 bit	CD, DVD-Video, DVD-Audio, etc.
Bitstream	Dolby Digital, DTS	DVD-Video, etc.





The "CINEMA DSP" logo and "Cinema DSP" are registered trademarks of Yamaha Corporation.

## DOLBY AUDIO

Manufactured under license from Dolby Laboratories.

Dolby, Pro Logic, and the double-D symbol are trademarks of Dolby Laboratories.



For DTS patents, see <http://patents.dts.com>. Manufactured under license from DTS Licensing Limited.

DTS, the Symbol, & DTS and the Symbol together are registered trademarks, and DTS Digital Surround is a trademark of DTS, Inc. © DTS, Inc. All Rights Reserved.

## HDMI

"HDMI," the "HDMI" logo and "High-Definition Multimedia Interface" are trademarks, or registered trademarks of HDMI Licensing LLC.

## x.v.Color

"x.v.Color" is a trademark of Sony Corporation.



The *Bluetooth*® word mark and logos are registered trademarks owned by *Bluetooth* SIG, Inc. and any use of such marks by Yamaha Corporation is under license.

### Bluetooth

*Bluetooth* is a technology for wireless communication employing the 2.4 GHz frequency band, which can be used without a license.

### Handling *Bluetooth* communications

- The 2.4 GHz band used by *Bluetooth* compatible devices is a radio band shared by many types of equipment. While *Bluetooth* compatible devices use a technology minimizing the influence of other components using the same radio band, such influence may reduce the speed or distance of communications and in some cases interrupt communications.
- The speed of signal transfer and the distance at which communications is possible differs according to the distance between the communicating devices, the presence of obstacles, radio wave conditions and type of equipment.
- Yamaha does not guarantee all wireless connections between this unit and devices compatible with *Bluetooth* function.

iTunes, AirPlay, iPad, iPhone, iPod, and iPod touch are trademarks of Apple Inc., registered in the U.S. and other countries.



MusicCast is a trademark or registered trademark of Yamaha Corporation.



DLNA™ and DLNA CERTIFIED™ are trademarks or registered trademarks of Digital Living Network Alliance. All rights reserved. Unauthorized use is strictly prohibited.

### Windows™

Windows is a registered trademark of Microsoft Corporation in the United States and other countries.

Internet Explorer, Windows Media Audio and Windows Media Player are either registered trademarks or trademarks of Microsoft Corporation in the United States and/or other countries.

### Android™

Android is a trademark of Google Inc.



The Wi-Fi CERTIFIED Logo is a certification mark of Wi-Fi Alliance. The Wi-Fi Protected Setup Identifier Mark is a certification mark of Wi-Fi Alliance.

Wi-Fi, Wi-Fi Alliance, Wi-Fi CERTIFIED, Wi-Fi Protected Setup, WPA and WPA2 are trademark or registered trademark of Wi-Fi Alliance.

"Blu-ray Disc™", "Blu-ray™", and the logos are trademarks of the Blue-ray Disc Association

### Explanations regarding GPL

This product utilizes GPL/LGPL open-source software in some sections. You have the right to obtain, duplicate, modify, and redistribute this open-source code only. For information on GPL/LGPL open source software, how to obtain it, and the GPL/LGPL license, refer to the Yamaha Corporation website (<http://download.yamaha.com/sourcecodes/musiccast/>).

### Bluetooth protocol stack (Blue SDK)

Copyright 1999-2014 OpenSynergy GmbH  
All rights reserved. All unpublished rights reserved.

## Numerics

- 2-channel playback 23
- 3D video 15
- 4K video 15
- 5.1-channel 69

## A

- Access point scan 35
- AirPlay 45
- Antenna 9, 13
- App HOME THEATER CONTROLLER (WLAN) 6
- App MusicCAST CONTROLLER 6
- Audio assign 51
- Audio information 24
- Audio input signal information 53
- Audio Return Channel (ARC) 15
- Auto power standby 52

## B

- Bit depth 70
- Bluetooth* 26
- Bluetooth* (receiving audio) 27
- Bluetooth* (transmitting audio) 29
- Bluetooth* function (on/off) 57
- Brightness of indicators 52

## C

- Channel level 50
- CINEMA DSP 23
- Compressed Music Enhancer 69

## D

- Deep Color 70
- Default gateway 54, 55

- Delay between video and audio output 50
- DHCP 31, 55
- DLNA 42
- DNS server (P) 54, 55
- DNS server (S) 54, 55
- Dolby Digital 70
- Dolby Pro Logic II 70
- DTS Digital Surround 70
- Dynamic range 50

## E

- Encryption method 34, 37, 39, 40

## F

- File format (computers/NAS) 42
- Firmware update 56, 59
- Firmware version 53

## H

- HDCP version 2.2 15
- HDMI 70
- HDMI audio out 51
- HDMI cable 15, 16
- HDMI control 20, 51

## I

- Indicators 7, 8
- Information (audio/video/firmware) 53
- Initialization 61
- Installation (Mounting the unit on a wall) 14
- Installation position of the unit 19
- Internet radio 43
- IP address 54, 55
- iPod music (AirPlay) 45
- iTunes music (AirPlay) 45

## L

- Language (OSD) 19

## M

- MAC address 54
- MAC address filter 31, 55
- Manual setting (wireless connection) 37
- Media sharing setup 42
- Menu display 18
- Mobile device music 47
- MP3 70
- MPEG-4 AAC 70

## N

- Network information 54
- Network name 56
- Network standby 56

## O

- OSD language 52

## P

- Pairing 27, 29
- Power cable 9, 17
- Pulse Code Modulation (PCM) 70

## R

- Reflection board 68
- Remote control 4, 10
- Remote control sensor 7

## S

- Sampling frequency 70

Security 54  
Security key 38, 40  
Security software 31  
Setup menu 48  
Sharing Wi-Fi settings (iOS device) 18, 33  
SSID 34, 36, 54, 70  
Stereo playback 23  
Subnet mask 31, 54  
Subwoofer volume 22, 24  
Surround mode 23  
Surround sound effect 19

## **T**

Test sounds 50  
TV 18, 20, 22  
TV Remote Repeater 58

## **V**

Video input signal information 53  
Volume 22  
Volume for each channel 24, 50  
vTuner 43  
vTuner ID 54

## **W**

Wi-Fi 70  
Wired network connections 17, 31  
Wireless Direct 40  
Wireless network 32  
WPS 70  
WPS PIN code 39

## **X**

x.v.Color 70

YAMAHA CORPORATION

© 2015 Yamaha Corporation YH260C0/EN