

# Yealink



**SIP-T58V**

## Smart Media Phone User Guide SIP-T58V & T58A

# Copyright

## **Copyright © 2017 YEALINK(XIAMEN) NETWORK TECHNOLOGY**

Copyright © 2017 Yealink (Xiamen) Network Technology CO., LTD. All rights reserved. No parts of this publication may be reproduced or transmitted in any form or by any means, electronic or mechanical, photocopying, recording, or otherwise, for any purpose, without the express written permission of Yealink (Xiamen) Network Technology CO., LTD. Under the law, reproducing includes translating into another language or format.

When this publication is made available on media, Yealink (Xiamen) Network Technology CO., LTD. gives its consent to downloading and printing copies of the content provided in this file only for private use but not for redistribution. No parts of this publication may be subject to alteration, modification or commercial use. Yealink (Xiamen) Network Technology CO., LTD. will not be liable for any damages arising from use of an illegally modified or altered publication.

# Trademarks

Yealink®, the logo and the name and marks is trademark of Yealink (Xiamen) Network Technology CO., LTD, which are registered legally in China, the United States, EU (European Union) and other countries.

All other trademarks belong to their respective owners. Without Yealink's express written permission, recipient shall not reproduce or transmit any portion hereof in any form or by any means, with any purpose other than personal use.

# Warranty

## **(1) Warranty**

THE SPECIFICATIONS AND INFORMATION REGARDING THE PRODUCTS IN THIS GUIDE ARE SUBJECT TO CHANGE WITHOUT NOTICE. ALL STATEMENTS, INFORMATION, AND RECOMMENDATIONS IN THIS GUIDE ARE BELIEVED TO BE ACCURATE AND PRESENTED WITHOUT WARRANTY OF ANY KIND, EXPRESS OR IMPLIED. USERS MUST TAKE FULL RESPONSIBILITY FOR THEIR APPLICATION OF PRODUCTS.

## **(2) Disclaimer**

YEALINK (XIAMEN) NETWORK TECHNOLOGY CO., LTD. MAKES NO WARRANTY OF ANY KIND WITH REGARD TO THIS GUIDE, INCLUDING, BUT NOT LIMITED TO, THE IMPLIED WARRANTIES OF MERCHANTABILITY AND FITNESS FOR A PARTICULAR PURPOSE. Yealink (Xiamen) Network Technology CO., LTD. shall not be liable for errors contained herein nor for incidental or consequential damages in connection with the furnishing, performance, or use of this guide.

## **(3) Limitation of Liability**

Yealink and/or its respective suppliers are not responsible for the suitability of the information contained in this document for any reason. The information is provided "as is", and Yealink does not provide any warranty and is subject to change without notice. All risks other than risks caused by use of the information are borne by the recipient. In no event, even if Yealink has been suggested the occurrence of

---

damages that are direct, consequential, incidental, special, punitive or whatsoever (Including but not limited to loss of business profit, business interruption or loss of business information), shall not be liable for these damages.

## End User License Agreement

This End User License Agreement ("EULA") is a legal agreement between you and Yealink. By installing, copying or otherwise using the Products, you: (1) agree to be bounded by the terms of this EULA, (2) you are the owner or an authorized user of the device, and (3) you represent and warrant that you have the right, authority and capacity to enter into this agreement and to abide by all its terms and conditions, just as if you had signed it. The EULA for this product is available on the Yealink Support page for the product.

## Patent Information

China, the United States, EU (European Union) and other countries are protecting one or more patents of accompanying products and/or patents being applied by Yealink.

## Customer Feedback

We are striving to improve our documentation quality and we appreciate your feedback. Email your opinions and comments to [DocsFeedback@yealink.com](mailto:DocsFeedback@yealink.com).

## Technical Support

Visit Yealink WIKI (<http://support.yealink.com/>) for the latest firmware, guides, FAQ, Product documents, and more. For better service, we sincerely recommend you to use Yealink Ticketing system (<https://ticket.yealink.com>) to submit all your technical issues.

## GNU GPL INFORMATION

Yealink SIP-T58V/A smart media phone firmware contains third-party software under the GNU General Public License (GPL). Yealink uses software under the specific terms of the GPL. Please refer to the GPL for the exact terms and conditions of the license.

The original GPL license, source code of components licensed under GPL and used in Yealink products can be downloaded online:

<http://www.yealink.com/GPLOpenSource.aspx?BaseInfoCateId=293&NewsCateId=293&CateId=293>.

## About This Guide

Thank you for choosing the SIP-T58V/SIP-T58A (hereinafter referred to as SIP-T58V/A) IP phone, a smart media phone for which is exquisitely designed to provide business telephony features, such as Call Hold, Call Transfer, Busy Lamp Field, Call Recording, Multicast Paging and Conference over an IP network. SIP-T58V/A is a smart media phone with a 7 inch capacitive touch screen that runs on Android OS version 5.1.1. The difference between the SIP-T58V and SIP-T58A smart media phones is that the Yealink USB camera CAM50 is an optional accessory for the SIP-T58A IP phone. With the CAM50, you can easily turn your SIP-T58A into a video phone.

This guide provides everything you need to quickly use your new phone. First, verify with your system administrator that the IP network is ready for phone configuration. Also be sure to read the Packaging Contents section in this guide before you set up and use the SIP-T58V/A smart media phone.

Read the [Yealink Products Regulatory Notices guide](#) for all regulatory and safety guidance.

## In This Guide

Topics provided in this guide include:

- Chapter 1 [Overview](#)
- Chapter 2 [Getting Started](#)
- Chapter 3 [Customizing Your Phone](#)
- Chapter 4 [System Applications](#)
- Chapter 5 [Basic Phone Features](#)
- Chapter 6 [Advanced Phone Features](#)

## Summary of Changes

This section describes the changes to this guide for each release and guide version.

### Changes for Release 80, Guide Version 80.40

The following sections are new for this versions:

- [Audio-only/Video Selection](#) on page 268
- [Automatic Call Distribution \(ACD\)](#) on page 358

Major updates have occurred to the following sections:

- [Phone Status](#) on page 55
- [Power Saving](#) on page 79
- [Placing Calls](#) on page 264
- [Call Park/Retrieve](#) on page 314
- [Appendix A - Time Zones](#) on page 381

# Table of Contents

<b>About This Guide .....</b>	<b>v</b>
In This Guide .....	v
Summary of Changes .....	v
Changes for Release 80, Guide Version 80.40 .....	v
<b>Table of Contents.....</b>	<b>vii</b>
<b>Overview .....</b>	<b>13</b>
Hardware Component Instructions .....	13
Icon Instructions .....	16
Feature Status Icons.....	16
Line Key Icons.....	17
Other Icons.....	21
LED Instructions.....	22
User Interfaces .....	23
Phone User Interface.....	23
Web User Interface.....	23
Documentations .....	27
<b>Getting Started.....</b>	<b>29</b>
Packaging Contents .....	29
Optional Accessories .....	31
Phone Installation .....	31
Network Connection.....	36
Connecting to the Wired Network.....	36
Connecting to the Wireless Network.....	36
Phone Initialization.....	36
Registration .....	37
Using the Touch Screen .....	37
Idle Screen .....	37
Navigating Menus and Fields .....	41
Control Center/Notification Center .....	41
Configuration Screen Display .....	44
Dialing Screen Display .....	45
Video Call Screen Display .....	47
Video Call Full-Screen Display (Both Far- and Near-Site Videos Exist) .....	49

Entering Data and Editing Fields.....	50
Using the Onscreen Keyboard.....	51
Using the Phone Keypad and Onscreen Dial Pad.....	55
Phone Status.....	55
Basic Network Settings.....	58
Wireless Network Settings.....	60
Connecting to the Wireless Network.....	60
Viewing the Connected Wireless Network Information.....	67
Disconnecting the Wireless Network Connection.....	67
Disabling Wi-Fi Feature.....	68
<b>Customizing Your Phone.....</b>	<b>71</b>
General Settings.....	71
Wallpaper.....	71
Screen Saver.....	76
Power Saving.....	79
Backlight.....	82
Language.....	84
Input Method.....	85
Time & Date.....	87
Administrator Password.....	90
Key As Send.....	90
Phone Lock.....	91
Audio Settings.....	94
Volume.....	94
Ring Tones.....	97
Key Tone.....	99
Touch Sounds.....	100
Notification Sound.....	101
Silent Mode.....	101
Contact Management.....	102
Local Directory.....	103
Blacklist.....	120
Remote Phone Book.....	121
Mobile Contacts.....	123
Call History Management.....	126
Viewing History Records.....	126
Placing a Call from History Records.....	127
Adding a Contact to the Blacklist.....	128
Deleting History Records.....	129
Disabling History Records.....	131
Search Source List in Dialing.....	131
System Customizations.....	133
Headset Use.....	133



Bluetooth Headset.....	136
Bluetooth-Enabled Mobile Phone.....	143
DSS Keys.....	151
Account Management.....	168
Dial Plan.....	171
Emergency Number.....	177
Live Dialpad.....	177
Hotline.....	178
<b>System Applications .....</b>	<b>181</b>
Managing Applications and Widgets.....	181
Adding a Widget to the Idle Screen.....	181
Resizing a Widget.....	183
Moving an Application or Widget.....	184
Removing a Widget from the Idle Screen.....	185
Creating a Folder .....	185
Managing Running Applications .....	188
APP Accounts.....	188
Adding APP Accounts .....	188
Syncing APP Account Information.....	192
Removing APP Accounts .....	194
FileManager.....	195
Viewing Files .....	196
Searching Files .....	199
Copying Files .....	200
Cutting Files (Moving Files).....	202
Deleting Files .....	203
Sharing Pictures/Videos/Audios .....	204
Gallery.....	208
Viewing Pictures/Videos .....	209
Editing Pictures.....	212
Setting a Picture as Wallpaper .....	213
Printing Pictures .....	215
Viewing Detail Information of the Pictures/Videos.....	215
Deleting Pictures/Videos .....	217
Taking a Picture/Video .....	218
Sharing Pictures/Videos .....	219
Recorder .....	223
Recording Audios .....	224
Managing Recorded Audios.....	225
Camera .....	228
Taking Pictures.....	229
Recording Videos.....	229
Camera Settings .....	230

Email.....	232
Signing In Email.....	232
Sending Emails.....	232
Reading Emails.....	234
Deleting Emails.....	235
Email Options.....	236
Multiple Email Accounts.....	237
Email Widget.....	238
Sending Files via Email.....	239
Browser.....	239
Browsing a Web Page.....	239
Managing Bookmarks.....	240
Setting a Home Page.....	244
Clearing the Navigation History.....	246
Modifying Browser Settings.....	247
Calendar.....	247
Signing In Calendar.....	248
Creating an Event.....	249
Checking Events.....	249
Modifying the Calendar Settings.....	251
Calculator.....	251
Clock.....	252
Alarm.....	252
Clock.....	256
Timer.....	259
Stopwatch.....	260

## **Basic Phone Features .....263**

Placing Calls.....	264
Answering Calls.....	267
Answering When Not in Another Call.....	267
Answering When in Another Call.....	268
Audio-only/Video Selection.....	268
Choosing to Place an Audio-only/Video Call.....	269
Choosing to Answer the Video Call with Audio-only/Video.....	269
Ending Calls.....	270
Performing Operations during a Call.....	270
Going to the Idle Screen during a Call.....	271
Returning to the Talking Screen.....	272
Changing Video Call Settings.....	272
Stopping Transmitting Video during a Call.....	272
Changing the Video Layout during Calls.....	273
Previewing the Near-Site Video.....	277
Redialing Numbers.....	277

Recent Call In Dialing .....	277
Auto Answer.....	279
Auto Redial .....	280
Call Completion .....	282
Recall.....	283
Call Mute/Un-mute .....	284
Call Hold/Resume .....	286
Do Not Disturb (DND).....	287
Call Forward .....	292
Static Forwarding .....	293
Dynamic Forwarding .....	303
Call Transfer.....	304
Blind Transfer.....	304
Semi-Attended Transfer.....	306
Attended Transfer.....	307
Call Waiting .....	308
Conference .....	309
Local Conference .....	309
Network Conference.....	312
Call Park/Retrieve.....	314
FAC Mode .....	314
Transfer Mode.....	317
Call Pickup .....	319
Directed Call Pickup.....	319
Group Call Pickup .....	321
Anonymous Call .....	322
Anonymous Call Rejection .....	323
<b>Advanced Phone Features.....</b>	<b>327</b>
Busy Lamp Field (BLF).....	327
Configuring the BLF Feature on the Phone .....	327
Using BLF Feature on the Phone .....	331
BLF List .....	333
Screenshot .....	335
Call Recording .....	337
Call and Conference Recording Using a Softkey.....	337
Call Recording Using a Record Key .....	340
Hot Desking .....	343
Intercom .....	345
Configuring the Intercom Feature on the Phone.....	345
Using Intercom Feature on the Phone .....	348
Multicast Paging.....	349
Sending RTP Stream .....	349
Receiving RTP Stream .....	354

Using Multicast Paging.....	356
Music on Hold.....	357
Automatic Call Distribution (ACD) .....	358
Shared Call Appearance (SCA).....	359
Configuring SCA Feature on the IP Phone .....	361
Using SCA Feature on the IP Phone .....	368
Message.....	376
Video/Voice Mail.....	376
Message Waiting Indicator (MWI) .....	378
<b>Appendix A - Time Zones.....</b>	<b>381</b>
<b>Index .....</b>	<b>383</b>

## Overview

This chapter provides the overview of the SIP-T58V/A smart media phone. Topics include:

- [Hardware Component Instructions](#)
- [Icon Instructions](#)
- [LED Instructions](#)
- [User Interfaces](#)
- [Documentations](#)

If you require additional information or assistance with your new phone, contact your system administrator.

## Hardware Component Instructions

The main hardware components of the phone are the touch screen, the keypad and the USB camera CAM50.

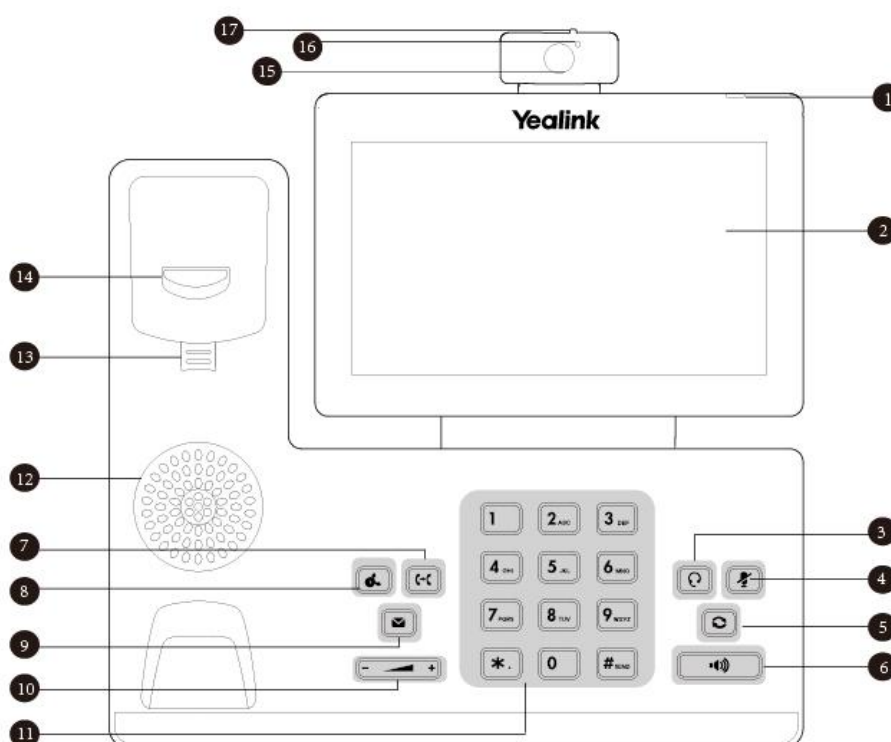

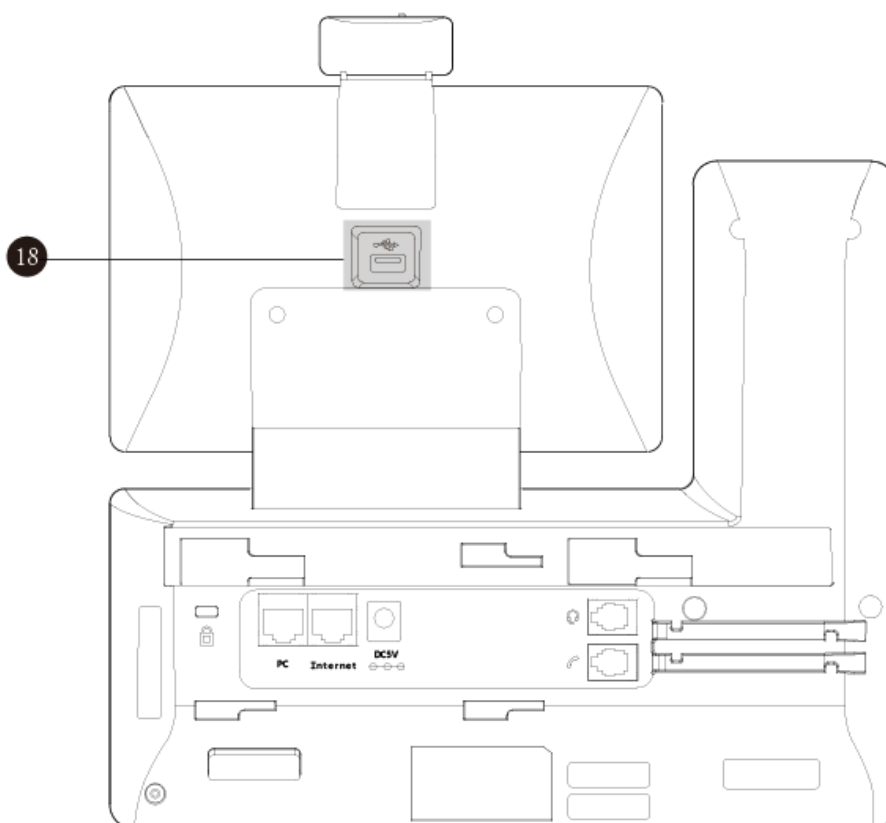

Hardware component instructions of the phone are:

















	Item	Description
①	Power Indicator LED	Indicates call status, message status and phone's system status. <ul style="list-style-type: none"> <li>• Receives an incoming call—Fast-flashing</li> <li>• Receives a voice mail—Slow-flashing</li> </ul>
②	Touch Screen	7 inch (1024 x 600) capacitive (5 point) touch screen. Tap to select and highlight screen items. The IP phone supports three idle screens by default. Shows information about calls, messages, time, date and other relevant data: <ul style="list-style-type: none"> <li>• Default account</li> <li>• Call information—caller ID, call duration</li> <li>• Icons (for example, )</li> <li>• Missed call list or second incoming caller information</li> <li>• Prompt text (for example, "Save successfully!")</li> <li>• Time and date</li> </ul>
③	HEADSET Key	Toggles and indicates the headset mode. The key LED illuminates solid green when headset mode is activated.
④	MUTE Key	Toggles and indicates mute feature. The key LED illuminates solid red when the call is muted.

	Item	Description
⑤	REDIAL Key	Redials a previously dialed number.
⑥	Speakerphone Key	Toggles and indicates the hands-free (speakerphone) mode. The key LED illuminates solid green when the hands-free (speakerphone) mode is activated.
⑦	TRANSFER Key	Transfers a call to another party.
⑧	HOLD Key	Places a call on hold or resumes a held call.
⑨	MESSAGE Key	<ul style="list-style-type: none"> <li>• Accesses voice mails.</li> <li>• Captures screenshots during a video call.</li> </ul>
⑩	Volume Key	Adjusts the volume of the handset, headset, speaker, ringer or media.
⑪	Keypad	Provides the digits and special characters in context-sensitive applications.
⑫	Speaker	Provides hands-free (speakerphone) audio output.
⑬	Reversible Tab	Secures the handset in the handset cradle when the IP phone is mounted vertically. For more information on how to adjust the reversible tab, refer to <a href="#">Yealink Wall Mount Quick Installation Guide for Yealink IP Phones</a> .
⑭	Hookswitch	<ul style="list-style-type: none"> <li>• Picking up the handset from the handset cradle, the hookswitch bounces and the phone connects to the line.</li> <li>• Laying the handset down on the handset cradle, the phone disconnects from the line.</li> </ul>
⑮	Camera Lens	2 Mega-pixel camera. Provides near-site video. The better distance between camera and images you want to capture should be in the range of 0.35 meters (1 foot) to 2 meters (6 feet).
⑯	Camera Indicator LED	Indicates video call status and camera status. <ul style="list-style-type: none"> <li>• Receives a video call—Flashing green</li> <li>• The camera is inserted and detected successfully on the phone—Solid green</li> </ul>
⑰	Shutter Switch	Covers and uncovers the camera. When the camera is switched off, the video image is black.
⑱	USB2.0 Port	Allows you to connect an optional USB flash drive/EXP50/USB headset to your phone.









## Icon Instructions

### Feature Status Icons

Icons appearing on the status bar are described in the following table:









Icons	Description
	Wired network is unavailable
	Hands-free (speakerphone) mode
	Handset mode
	Headset mode
	Voice Mail
	Auto Answer
	Do Not Disturb
	Call Forward
	Silent mode
	Camera is not detected
	Keep Mute
	Phone Lock
	Missed Calls
	Bluetooth mode is on
	Bluetooth headset is both paired and connected
	Bluetooth-Enabled mobile phone is both paired and connected
	Wi-Fi mode is on















Icons	Description
	Wi-Fi is connected successfully and the signal strength is weak to strong
	The USB flash drive is detected
	Screenshot captured
	Downloading file
	Uploading file
	Upcoming alarm
	Unread email
	Warning







## Line Key Icons

**Icon indicator** (associated with line key features):



Icons	Description
	Hold/Public Hold Private Hold
	DND
	Voice Mail
	Direct Pickup
	Group Pickup
	DTMF Prefix
	LDAP Local Group XML Group
	XML Browser
	Conference

Icons	Description
	Forward
	Transfer
	ReCall
	Record URL Record
	Recording starts successfully (Record/URL Record)
	Multicast Paging Group Listening Paging List
	Hot Desking
	Zero Touch
	URL
	Phone Lock
	Directory
	Speed Dial





**Icon indicator** (associated with line)

Icons	Description
	The private line registers successfully
	Register failed
 (Flashing)	Registering
	The shared line registers successfully
	DND is enabled on this line
	Call forward is enabled on this line







**Icon indicator** (associated with mobile account)

Icons	Description
	Mobile Account (Bluetooth-Enabled mobile phone is both paired and connected)
	Mobile Account (Bluetooth-Enabled mobile phone fails to connect)
 (Flashing)	Mobile Account (Bluetooth-Enabled mobile phone is connecting)





**Icon indicator** (associated with call park/retrieve park)

Icons	Description
	Call Park (Park successfully; Call park idle state)
	Call Park (Park failed)
	Call Park (Call park ringing state)
	Retrieve Park





**Icon indicator** (associated with BLF/BLF List)

Icons	Description
	BLF/BLF list idle state
 (Flashing)	BLF/BLF list ringing state
 (Flashing)	BLF/BLF list callout state
	BLF/BLF list talking state
	BLF hold state
	BLF list call park state
	BLF/BLF list failed state

**Icon indicator** (associated with Intercom)



Icons	Description
	Intercom idle state
	Intercom ringing state
 Callout	Intercom callout state
 Talking	Intercom talking state
	Intercom failed state







**Icon indicator** (associated with ACD)

Icon	Description
	Log in the ACD system
	The ACD status is available
	The ACD state is Wrap up
	The ACD status is unavailable
	Log out of the ACD system

**Icon indicator** (associated with a shared line)





The local SCA phone indicates the phone is involved in an SCA call, while the monitoring SCA phone indicates the phone is not involved in the SCA call.

Icon	Description
	The shared line is idle.
 (for monitoring SCA phone)	The shared line is seized.
 (Flashing)	The shared line receives an incoming call.



Icon	Description
 (Flashing)	The shared line is dialing.
	The shared line is in conversation.
	The shared line conversation is placed on public hold.
 (for local SCA phone)  (for monitoring SCA phone)	The shared line conversation is placed on private hold.
	The shared line conversation is barged in by the other shared line party.
	For a multi-party call, all the shared line parties participating in this call place the shared line conversation on hold.



## Other Icons

**Icon indicator** (associated with an active call)





Icon	Description
	Call Hold (video)
	Call Hold (audio-only)
	Call Mute
	Call is encrypted

**Icon indicator** (associated with call recording)



Icons	Description
	Recording box is full (Using a record key)
	A call cannot be recorded (Using a record key)

Icons	Description
	Recording starts successfully (Using a record key)
	Recording cannot be started (Using a record key)
	Recording cannot be stopped (Using a record key)

**Icon indicator** (associated with call history)

Icons	Description
	Received Calls
	Placed Calls
	Missed Calls
	Forwarded Calls

**Icon indicator** (associated with contact)

Icons	Description
	The default local caller photo and local contact icon
	The default mobile caller photo and mobile contacts icon

## LED Instructions

### Power Indicator LED

LED Status	Description
Solid red	The phone is initializing.
Fast-flashing red	The phone is ringing.
Slow-flashing red	The phone receives a video/voice mail.
Off	The phone is powered off. The phone is idle. The phone is busy. The call is placed on hold or is held. The call is muted.

**Note**

The above introduces the default power indicator LED status. The status of the power indicator LED is configurable via web user interface. For more information, refer to [Yealink\\_SIP-T5\\_Series\\_CP960\\_Smart\\_Media\\_Phones\\_Administrator\\_Guide](#).

### Camera Indicator LED

LED Status	Description
Solid green	The phone is powered on and the camera is properly connected to the phone. The camera is idle. The phone receives an audio-only call.
Flashing green	The phone receives a video call.
Solid red	There is an active video call. The video call is muted. The video call is held.
Slow-flashing red	The shutter switch is open, but the near-site video is stopped transmitting during a video call. The video call is placed on hold.
Off	The phone is powered off. The camera is not properly connected to the phone. The shutter switch is closed.

## User Interfaces

Two ways to customize configurations of your SIP-T58V/A smart media phone:

- The user interface on the IP phone.
- The user interface in a web browser on your PC.

The hardware components keypad and touch screen constitute the phone user interface, which allows the user to execute all call operation tasks and basic configuration changes directly on the phone. In addition, you can use the web user interface to access all configuration settings. In many cases, it is possible to use either the phone user interface and/or the web user interface interchangeably. However, in some cases, it is only possible to use one or the other interface to operate the phone and change settings.

### Phone User Interface

You can swipe down from the top of the screen or swipe left/right to go to the second idle screen and then tap **Settings** to customize your phone. The **Advanced** option is only accessible to the administrator, and the default administrator password is "admin" (case-sensitive). For more information on customizing your phone with the available options via phone user interface, refer to [Customizing Your Phone](#) on page 71.

### Web User Interface

In addition to the phone user interface, you can also customize your phone via web user interface. In order to access the web user interface, you need to know the IP address of your

new phone. To obtain the IP address, swipe down from the top of the screen or swipe left/right to go to the second idle screen and then tap **Settings**->**Status** on the phone. Enter the IP address (e.g., http://192.168.0.10 or 192.168.0.10 for IPv4; http://[2005:1:1:1:215:65ff:fe64:6e0a] or [2005:1:1:1:215:65ff:fe64:6e0a] for IPv6) in the address bar of a web browser on your PC. The default administrator user name and password are both "admin" (case-sensitive).

**Note** The access to the Advanced settings of the Account or Network via web user interface may be blocked by the web browser (e.g., Chrome, Firebox) if you have installed "Adblock Plus plugin".

The main options you can use to customize the IP phone via phone user interface and/or via web user interface are listed in the following table:

Options	Phone User Interface	Web User Interface
<b>Status</b>		
--IPv4		
--MAC		
--Wi-Fi MAC		√
--Firmware	√	√
--Network		
--Phone		
--Accounts		
--Storage		×
<b>Basic Phone Settings</b>		
--Wallpaper	√	√
--Screen Saver	√	×
--Power Saving	×	
--Backlight	√	√
--Language	√	
--Input Method	√	×
--Time & Date	√	
--Administrator Password	√	
--Key As Send	√	
--Phone Lock	√	√
--Audio Settings		
--Ring Tones	√	
--Key Tone	√	
--Touch Sounds	√	
--Notification Sound	√	×
--Silent Mode	√	
--Contact Management		
--Local Directory	√	√
--Blacklist	√	
--Remote Phone Book	×	



Options	Phone User Interface	Web User Interface
--Mobile Contacts	√	×
--Call History Management	√	√
--Search Source List in Dialing	×	
--Headset Use	√	
--Bluetooth Headset	√	
--Bluetooth-Enabled Mobile Phone	√	
--DSS Keys	√	
--Account Management	√	
--Dial Plan	×	
--Emergency Number	×	
--Live Dialpad	×	
--Hotline	√	
--APP Accounts	√	×
--FileManager	√	
--Gallery	√	
--Recorder	√	
--Camera	√	
--Email	√	×
--Browser	√	
--Calendar	√	
--Calculator	√	
--Clock	√	
<b>Basic Call Features</b>		√
--Recent Call In Dialing	×	
--Auto Answer	√	
--Auto Redial	√	
--Call Completion	√	
--ReCall	√	
--Do Not Disturb (DND)	√	
--Call Forward	√	
--Call Transfer	√	
--Call Waiting	√	
--Conference	√	
--Call Park	√	
--Call Pickup	√	
--Anonymous Call	√	
--Anonymous Call Rejection	√	
<b>Advanced Phone Features</b>		√
--Busy Lamp Field (BLF)	√	
--BLF List	×	
--Call Recording	√	

Options	Phone User Interface	Web User Interface
--Hot Desking	√	
--Intercom	√	
--Multicast Paging	×	
--Music on Hold	×	
--Shared Call Appearance (SCA)	×	
--Automatic Call Distribution (ACD)	√	
--Message	√	
<b>SIP Account</b>		√
--User Options		
--Activation	√	
--Label	√	
--Display Name	√	
--Register Name	√	
--User Name	√	
--Password	√	
--Server Options		
--SIP Server1/2	√	
--Register Port	×	
--Outbound Status	√	
--Outbound Proxy1/2	√	
--Proxy Fallback Interval	√	
--NAT Status	√	

**Note** The table above lists most of the feature options. Please refer to the relevant sections for more information.

## Documentations

The following table shows documentations available for the SIP-T58V/A smart media phone.

Name	Contents	Where found	Language
Quick Start Guide	Basic call features and phone customizations	In the package/On the website	English/Chinese
User Guide	Phone/Web user interface settings Basic call features and advanced phone features	On the website	English/Chinese

**Note**

You can also download the latest documentations online:  
<http://support.yealink.com/documentFront/forwardToDocumentDetailPage>.



## Getting Started

This chapter provides the following basic installation instructions and information for obtaining the best performance with the SIP-T58V/A smart media phone. Topics include:

- [Packaging Contents](#)
- [Phone Installation](#)
- [Network Connection](#)
- [Phone Initialization](#)
- [Registration](#)
- [Using the Touch Screen](#)
- [Entering Data and Editing Fields](#)
- [Phone Status](#)
- [Basic Network Settings](#)
- [Wireless Network Settings](#)

If you require additional information or assistance with your new phone, contact your system administrator.

## Packaging Contents

The following components are included in your SIP-T58V/A smart media phone package:

- **SIP-T58V/A Smart Media Phone**

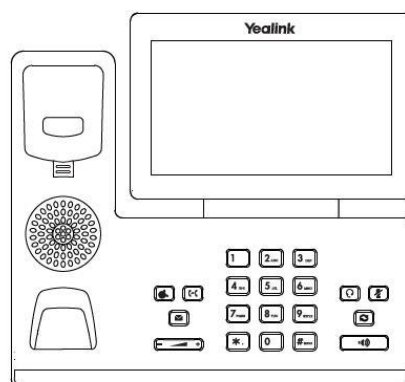

- **Phone Stand**

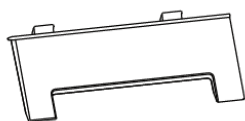

- **Handset & Handset Cord**

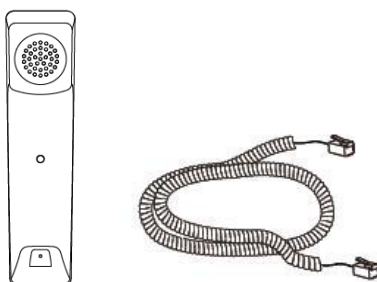

- **CAM50 (an optional accessory for the SIP-T58A)**

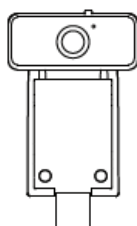

- **Ethernet Cable (2m CAT5E FTP cable)**

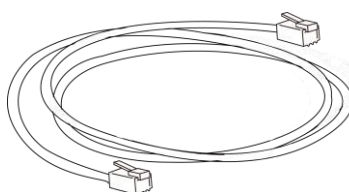

- **Quick Start Guide**

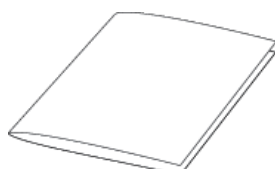

Check the list before installation. If you find anything missing, contact your system administrator.

## Optional Accessories

The following items are optional accessories for your SIP-T58V/A smart media phone. You need to purchase them separately if required.

- **Wall Mount Bracket**

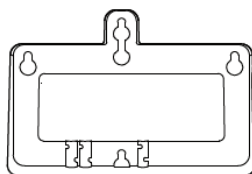

- **Power Adapter (5.5mm DC plug)**

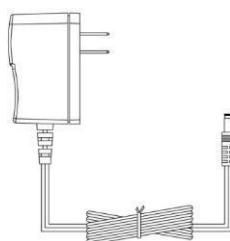

- **Headset YHS32/YHS33**

**Note**

We recommend that you use the accessories provided or approved by Yealink. The use of unapproved third-party accessories may result in reduced performance.

## Phone Installation

If your phone is already installed, proceed to [Phone Initialization](#) on page 36.

This section introduces how to install the phone:

- 1) Insert the camera
- 2) Attach the stand
- 3) Adjust angle of the touch screen
- 4) Attach the optional wall mount bracket

- 5) Connect the handset and optional headset
- 6) Connect the power
- 7) Connect the optional USB flash drive

**1) Insert the camera**

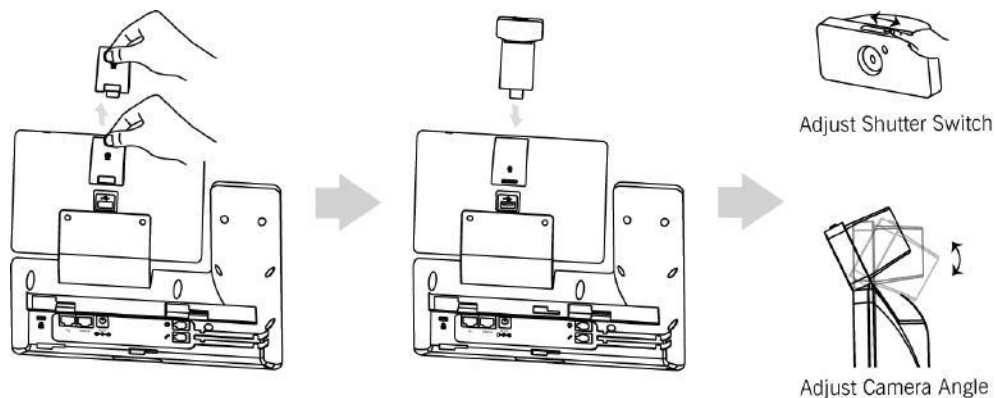

**Note** The camera is connected to the USB port on the top of the phone. And the IP phone only supports the Yealink original USB camera CAM50. You should purchase it separately for SIP-T58A smart media phone.

**2) Attach the stand**

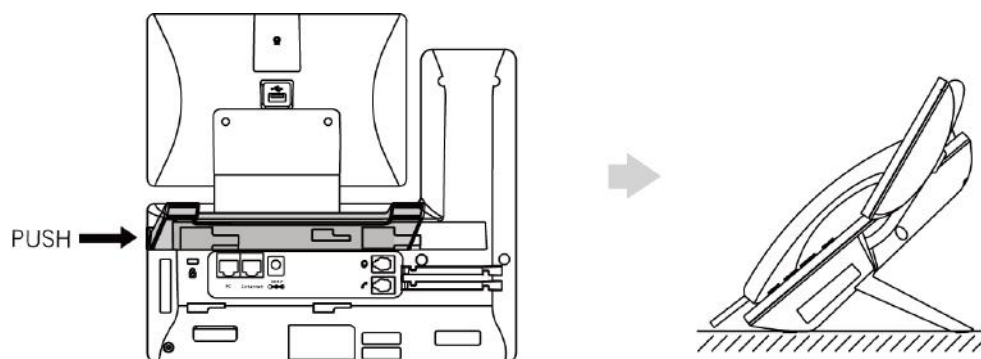

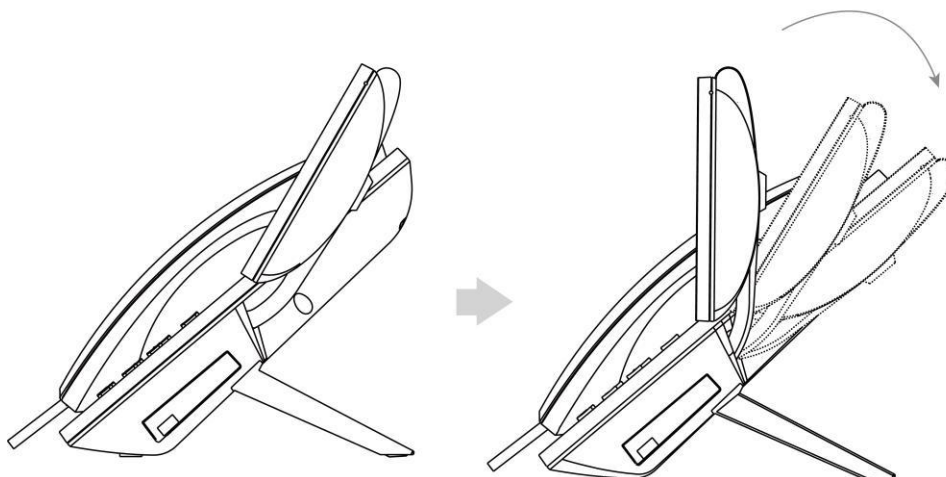
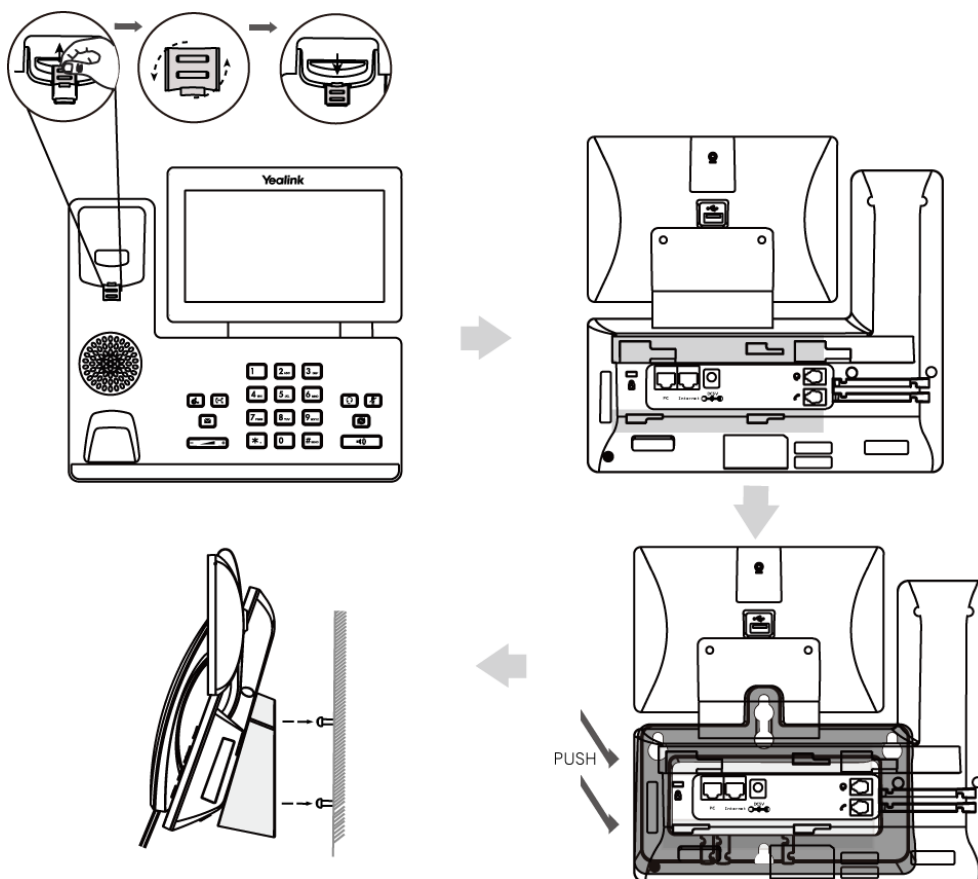

**3) Adjust the angle of touch screen****4) Attach the optional wall mount bracket****Note**

The reversible tab has a lip which allows the handset to stay on-hook when the IP phone is mounted vertically. For more information, refer to [Yealink Wall Mount Quick Installation Guide for Yealink IP Phones](#).

### 5) Connect the handset and optional headset

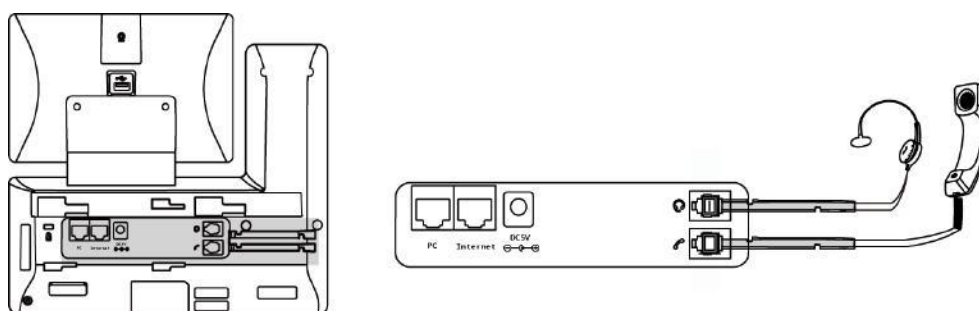

### 6) Connect the power

You have two options for power connections. Your system administrator will advise you which one to use.

- AC power (Optional)
- Power over Ethernet (PoE)

### AC Power (Optional)

#### To connect the AC power:

1. Connect the DC plug on the power adapter to the DC5V port on the phone and connect the other end of the power adapter into an electrical power outlet.

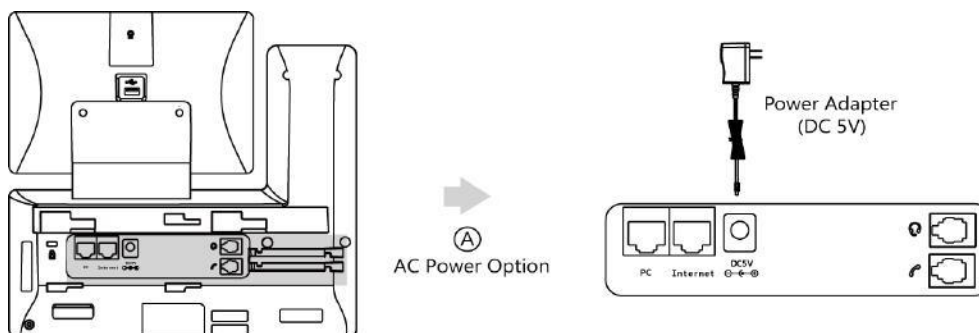

**Note** The IP phone should be used with Yealink original power adapter (5V/2A) only. The use of the third-party power adapter may cause the damage to the phone.

### Power over Ethernet

With the included or a regular Ethernet cable, the SIP-T58V/A smart media phone can be powered from a PoE-compliant switch or hub.

**To connect the PoE:**

1. Connect the Ethernet cable between the Internet port on the phone and an available port on the in-line power switch/hub.

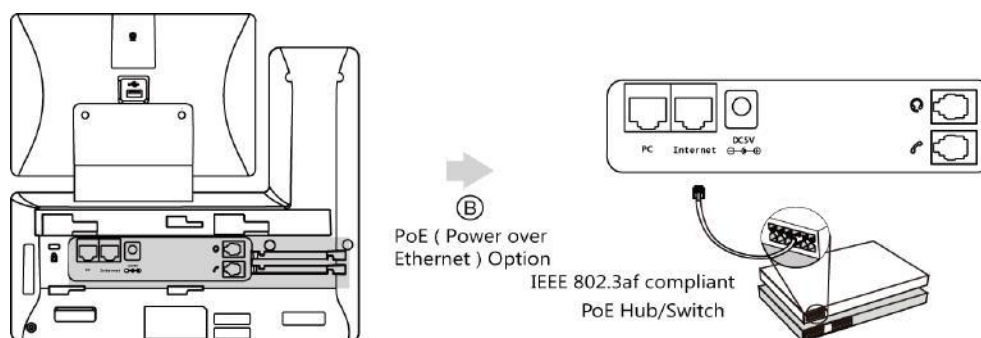
**Note**

If in-line power is provided, you don't need to connect the phone to the power adapter. Make sure the switch/hub is PoE-compliant.

**Important!** Do not remove power to the phone while it is updating firmware and configurations.

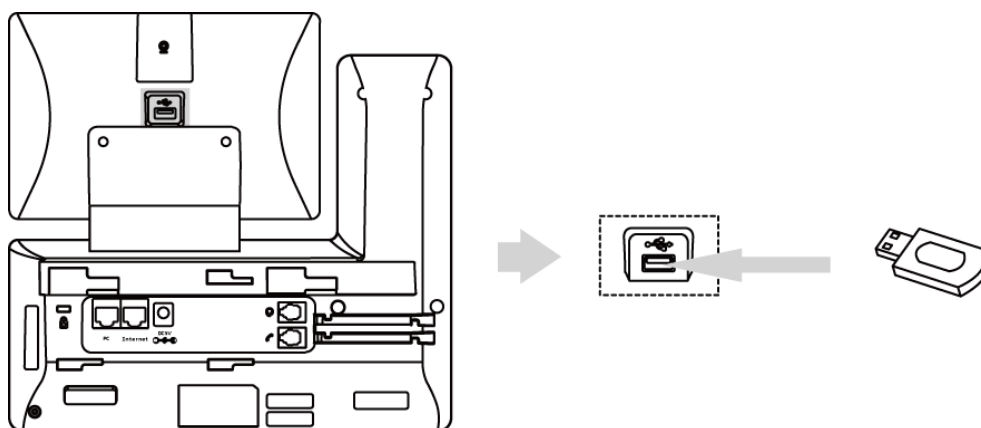
**7) Connect the optional USB flash drive**

When you attach a USB flash drive to your phone, the touch screen will prompt "USB device connected successfully!", the icon  will display on the status bar. You can access and manage photo/video/audio files in USB flash drive by **FileManager** application. For more information, refer to [FileManager](#) on page 195.

**Note**

The USB port (on the rear of the phone) can also be used to connect color-screen expansion module EXP50 or USB headset. The SIP-T58V/A smart media phone officially supports certain USB headset models. For more information, refer to [Tested headset list compatible with Yealink IP Phone](#).

For more information on how to use EXP50, refer to [Yealink EXP50 User Guide](#). For more information on how to use USB headset, refer to the documentation from the manufacturer.

## Network Connection

You have two options for network connection. You can select one of them according to the current office environment.

- Connecting to the wired network
- Connecting to the wireless network

### Connecting to the Wired Network

You can connect your phone to a wired network.

Before connecting your phone to the wired network, it is important to note that the Wi-Fi feature should be disabled. For more information, refer to [Connecting to the Wireless Network](#) on page 36.

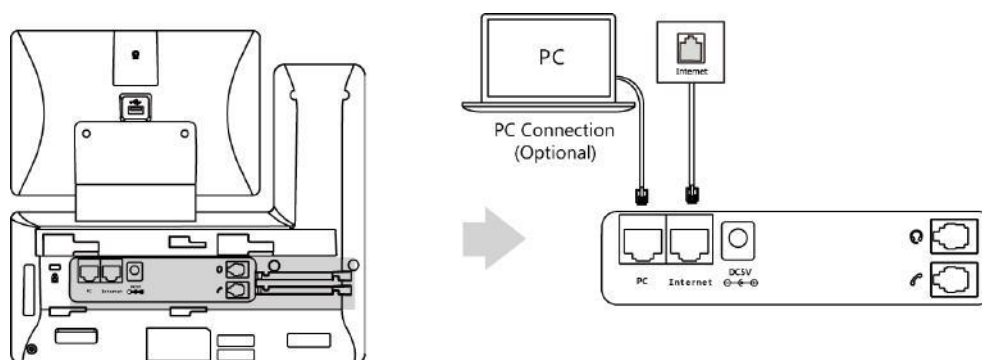

#### Note

The phone can also share the network with another network device such as a PC (personal computer). This is an optional connection. We recommend that you use the Ethernet cable provided by Yealink. For more information on this function, contact your system administrator.

### Connecting to the Wireless Network

Yealink SIP-T58V/A smart media phone supports Wi-Fi feature. You can connect your phone to a wireless network. The wireless network is more convenient and cost-effective than wired network. The PC port is unavailable when using wireless network. For more information on how to connect to a wireless network, refer to [Wireless Network Settings](#) on page 60.

## Phone Initialization

After your phone is powered on, the system boots up and performs the following steps:

#### Automatic Phone Initialization

The phone finishes the initialization by loading the saved configuration. The touch screen

displays “Welcome Initializing...Please wait” during the initialization.

### **DHCP (Dynamic Host Configuration Protocol)**

The phone attempts to contact a DHCP server in your network to obtain valid IPv4 network settings (e.g., IP address, subnet mask, default gateway address and DNS address) by default.

#### **Note**

If your network does not use DHCP, proceed to [Basic Network Settings](#) on page 58.

## **Registration**

Generally, your phone will be deployed with multiple other phones. In this case, your system administrator will configure the phone parameters beforehand, so that after you start up your phone, the phone will be registered and ready for use. The SIP-T58V/A smart media phone supports up to 16 accounts. If your phone is not registered, you may have to register it. For more information on how to register your phone, refer to [Account Management](#) on page 168.

## **Using the Touch Screen**

### **Idle Screen**

The SIP-T58V/A smart media phone supports multiple idle screens. You can swipe left or right to switch among different idle screens. The IP phone supports three idle screens by default.

You can add a new idle screen by moving an application or widget to the right side of the third idle screen. The idle screen will be deleted automatically if there is no application or widget on the screen. For more information, refer to [Managing Applications and Widgets](#) on page 181.

## The Home Screen

The home screen displays as below:

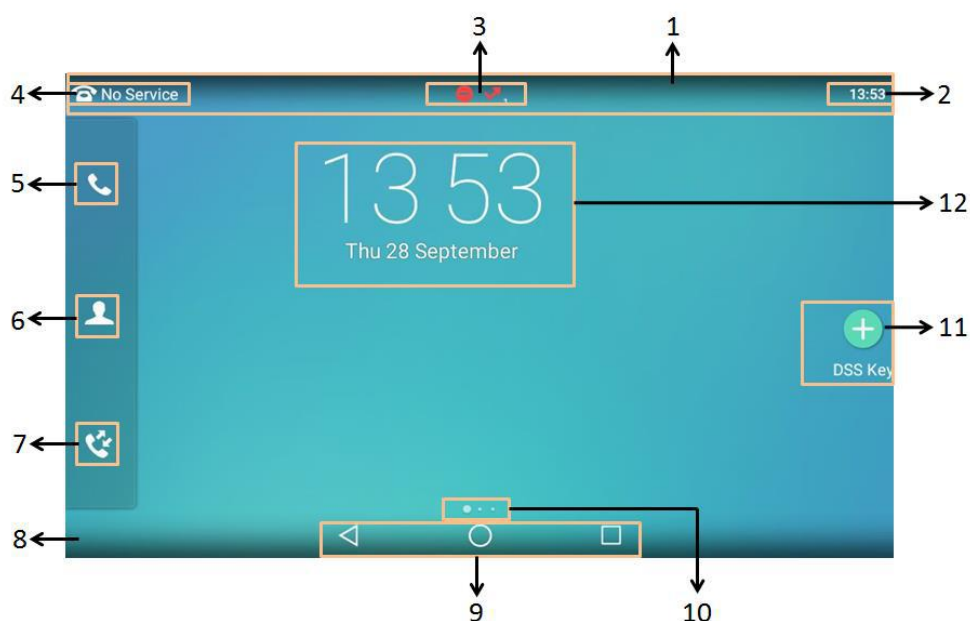

No.	Name	Description
1	Status Bar	Displays the phone's default account, icons and time.
2	Time	The phone's time is displayed on the right of the status bar. For more information, refer to <a href="#">Time &amp; Date</a> on page 87.
3	Icons	Icons are displayed in the middle of the status bar. For more information, refer to <a href="#">Icon Instructions</a> on page 16.
4	Default account	The label of the default account is displayed on the left of the status bar. For more information, refer to <a href="#">Default Account</a> on page 170. If there is no account registered on the IP phone, this field will display <b>No Service</b> .
5	Phone Dialer	Tap to enter the dialing screen. For more information, refer to <a href="#">Dialing Screen Display</a> on page 45.
6	Directory	Tap to enter the Directory screen and view contacts. For more information, refer to <a href="#">Contact Management</a> on page 102.
7	History	Tap to enter the History screen and view call history. For more information, refer to <a href="#">Call History Management</a> on page 126.
8	Wallpaper	Shows the specified wallpaper, which can be customized. For more information, refer to

No.	Name	Description
		<a href="#">Wallpaper</a> on page 71.
9	Android Keys	<p>◀ : tap to go back to the previous screen.</p> <p>○ : tap to return to the idle screen.</p> <p>□ : tap to view and manage the list of recently used applications.</p>
10	Screen Indicator	Indicates which idle screen is displayed.
11	DSS Key	Tap to add a line key, and then line key list will be displayed on the right of the home screen. For more information, refer to <a href="#">DSS Keys</a> on page 151.
12	Digital Clock Widget	Displays the phone's time and date. For more information, refer to <a href="#">Clock</a> on page 252.

## The Second Idle Screen

The second idle screen displays phone's system applications by default.

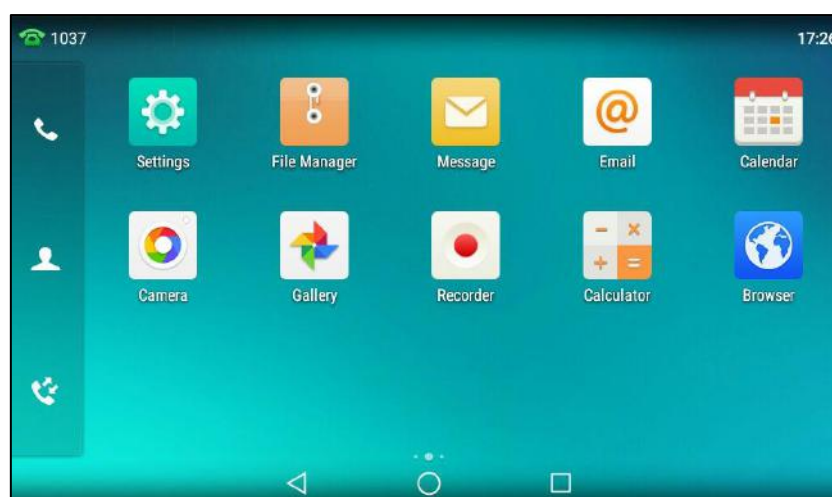

No.	Application	Description
1	Settings	You can use this application to access phone settings and features. You can also swipe down from the top of the screen and then tap <b>Settings</b> to access phone settings and features.
2	FileManager	You can use this application to manage files in internal SD card as well as USB flash drive. For more information, refer to <a href="#">FileManager</a> on page 195.
3	Message	You can use this application to access the video/voice mails or leave video/voice mails for someone. For more information, refer to <a href="#">Message</a> on page 376.
4	Email	You can use this application to send and receive emails. For more information, refer to <a href="#">Email</a> on page

No.	Application	Description
		<a href="#">232.</a>
5	Calendar	You can use this application as a reminder or to manage and arrange your events. For more information, refer to <a href="#">Calendar</a> on page 247.
6	Camera	You can use this application to take pictures or record videos. For more information, refer to <a href="#">Camera</a> on page 228.
7	Gallery	You can use this application to view photos and videos. For more information, refer to <a href="#">Gallery</a> on page 208.
8	Recorder	You can use this application to record audio. For more information, refer to <a href="#">Recorder</a> on page 223.
9	Calculator	You can use this application to calculate. For more information, refer to <a href="#">Calculator</a> on page 251.
10	Browser	You can use this application to present and explore content on the World Wide Web. For more information, refer to <a href="#">Browser</a> on page 239.

### The Third Idle Screen

The third idle screen displays the calendar and email widgets by default.

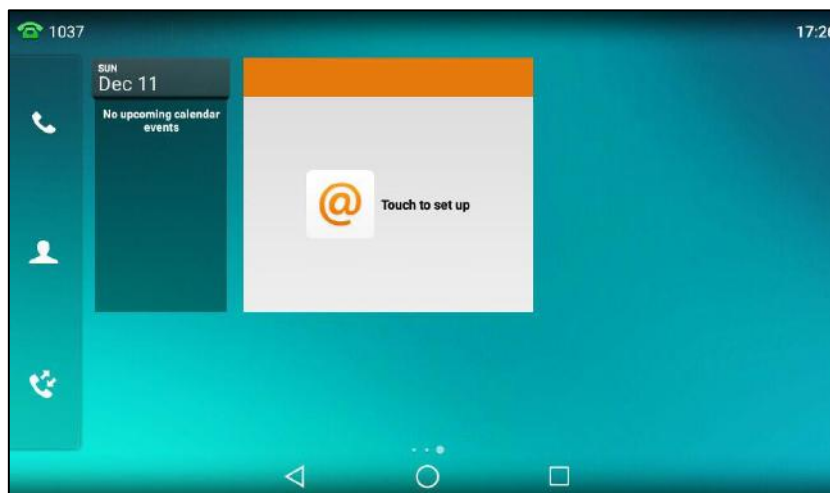

No.	Widget	Description
1	Calendar Widget	Displays the data and upcoming events. For more information, refer to <a href="#">Calendar</a> on page 247.
2	Email Widget	Displays email list of the specified folder. For more information, refer to <a href="#">Email</a> on page 232.









## Navigating Menus and Fields

To navigate menus and fields, you can:

- Tap corresponding keys on the touch screen.
- Tap menu items, fields, and arrows on the touch screen.
- Press keys on the phone keypad.

To operate your phone using gestures, follow these tips:

Gesture		Action
Tap		Touch an item on the screen with your finger, and then lift your finger.
Long Tap		Touch an item for about 2 seconds without lifting your finger from the screen till an action occurs.
Swipe		Touch and move. When you want to scroll quickly, swipe your finger across the screen, either up, down, left or right.
Drag		Touch and hold, then move. To stop scrolling, stop the dragging motion.
Pinch Open		Touch the screen with two or more fingers, and then move the fingers away from each other (stretch).
Pinch Close		Touch the screen with two or more fingers, and then move the fingers towards each other (pinch).



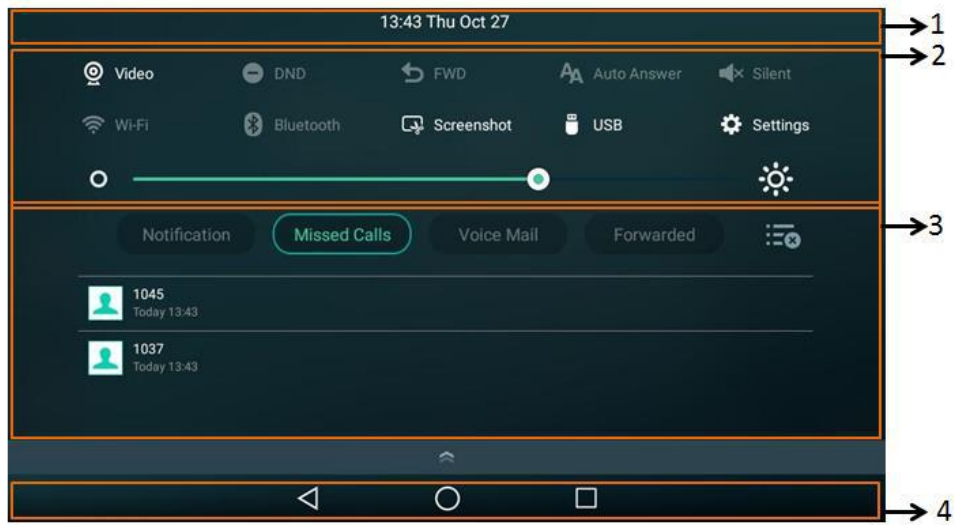

## Control Center/Notification Center

Control center or notification center allows you to access common features or view important notifications quickly.

**Swipe down from the top of the screen to enter the control center and the notification center:**



No.	Name	Description	
1	Time and date	Display the phone's time and date. For more information, refer to <a href="#">Time &amp; Date</a> on page 87.	
2	Control Center	Video	<ul style="list-style-type: none"> <li>• Tap to access <b>Camera</b> application when the IP phone is idle. For more information, refer to <a href="#">Camera</a> on page 228.</li> <li>• Tap to stop transmitting video during a video call. For more information, refer to <a href="#">Stopping Transmitting Video during a Call</a> on page 272.</li> </ul>
		DND	Tap to turn on/off DND feature quickly. For more information, refer to <a href="#">Do Not Disturb (DND)</a> on page 287.
		FWD	Tap to enter Call Forward setting screen. For more information, refer to <a href="#">Call Forward</a> on page 292.
		Auto Answer	Tap to enter Auto Answer setting screen. For more information, refer to <a href="#">Auto Answer</a> on page 279.
		Silent	Tap to turn on/off silent feature quickly.
		Wi-Fi	<ul style="list-style-type: none"> <li>• Tap to turn on/off Wi-Fi feature quickly. For more information, refer to <a href="#">Wireless Network Settings</a> on page 60.</li> <li>• Long tap to enter Wi-Fi setting screen.</li> </ul>

No.	Name	Description	
		Bluetooth	<ul style="list-style-type: none"> <li>• Tap to turn on/off Bluetooth feature quickly. For more information, refer to <a href="#">Bluetooth Headset</a> on page 136.</li> <li>• Long tap to enter Bluetooth setting screen.</li> </ul>
		Screenshot	Tap to capture a screenshot. For more information, refer to <a href="#">Screenshot</a> on page 335.
		USB	Tap to access the <b>FileManager</b> application to manage the files in the USB flash drive. For more information, refer to <a href="#">FileManager</a> on page 195.
		Settings	Tap to enter the Settings screen.
		Backlight Slider	Drag the slider to adjust the screen brightness quickly. You can also enter the Backlight setting screen to adjust the screen brightness. For more information, refer to <a href="#">Backlight</a> on page 82.
3	Notification Center	<ul style="list-style-type: none"> <li>• Tap <b>Notification/Missed Calls/Voice Mail/Forwarded</b> to view the corresponding notification list.</li> <li>• Tap the desired notification message to view the details.</li> <li>• Swipe left or right to delete a specific notification.</li> <li>• Tap  to delete all notifications.</li> </ul>	
4	Android Keys	<ul style="list-style-type: none"> <li> : tap to go back to the previous screen.</li> <li> : tap to return to the idle screen.</li> <li> : tap to view and manage the list of recently used applications.</li> </ul>	

You can swipe up from the bottom of the screen to hide this screen.



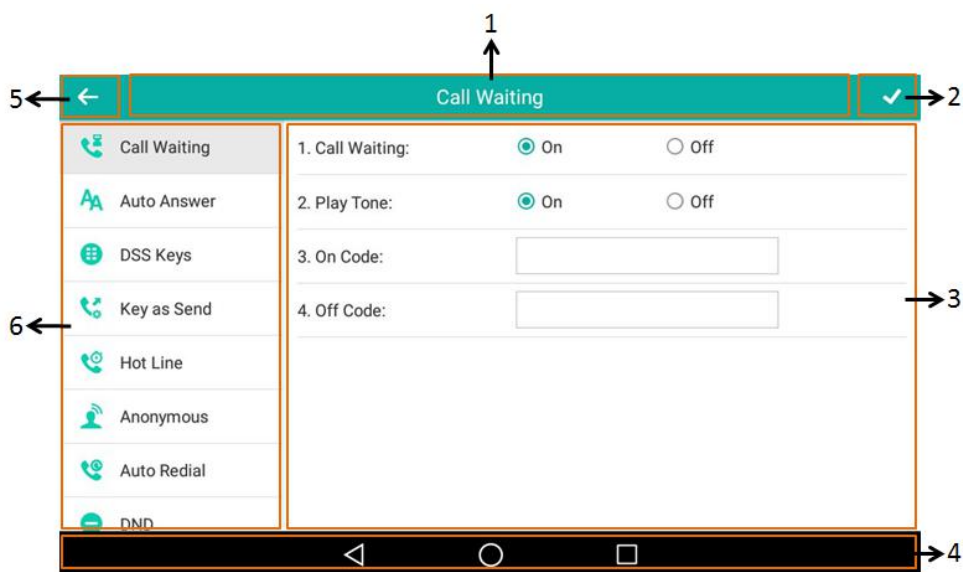

## Configuration Screen Display



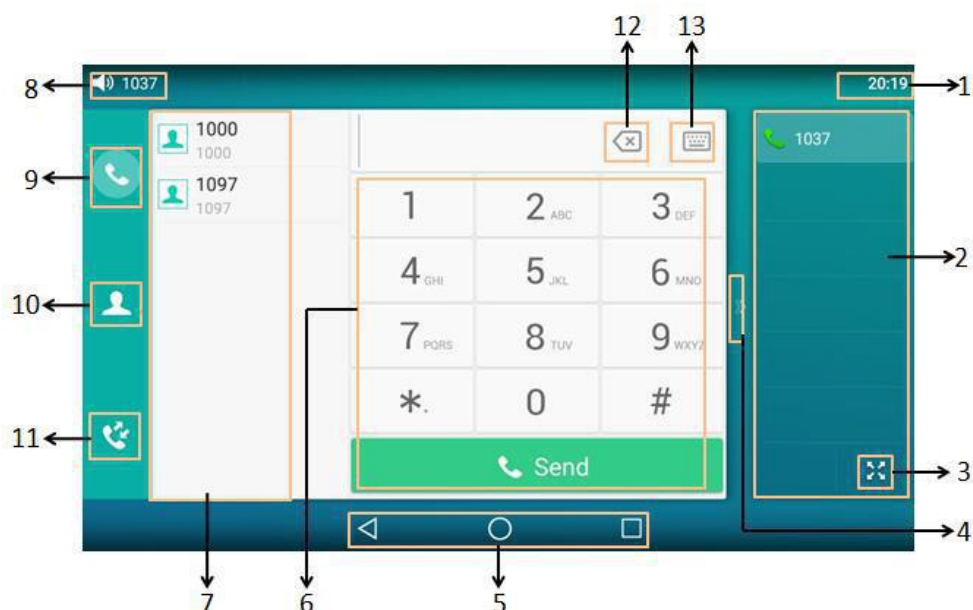

No.	Name	Description
1	Title Area	Displays the title of the current menu screen.
2	✓	Tap to accept the settings.
3	Configuration Area	Displays configuration items of the highlighted menu item in the menu tree area.
4	Android Keys	◀ : tap to go back to the previous screen. ○ : tap to return to the idle screen. ◻ : tap to view and manage the list of recently used applications.
5	←	Tap to go back to previous screen.
6	Menu Tree Area	<ul style="list-style-type: none"> <li>• Displays menu items.</li> <li>• Tap the desired menu item to enter the corresponding configuration screen.</li> </ul>

## Dialing Screen Display





No.	Name	Description
1	Time	The phone's time is displayed on the right of the status bar. For more information, refer to <a href="#">Time &amp; Date</a> on page 87.
2	Line Key List	The line key list displays 6 line keys by default. You can drag up and down to scroll through the line keys. Various features can be assigned to line keys. Each line key can display the label and indicate the status of the assigned feature. <b>Note:</b> The line key list appears only if you have added at least one line key.
3		Tap to unfold line key list and display all line keys. For more information, refer to <a href="#">DSS Keys</a> on page 151.
4		Tap it or swipe right to hide the line key list.
5	Android Keys	 : tap to go back to the idle screen.  : tap to return to the idle screen.  : tap to view and manage the list of recently used applications.
6	Dial Pad	Tap the desired character(s) and then tap Send to dial out the number.
7	Placed Calls List	You should enable the recent call in dialing feature to view the placed calls list. For more information, refer to <a href="#">Recent Call In Dialing</a> on

No.	Name	Description
		page <a href="#">277</a> .
8	Talking Mode and Default Account	<ul style="list-style-type: none"><li>Shows which account and talking mode you are using to make a call. The talking mode includes handset, speakerphone or headset; you can alternate among the three modes when making a call.</li><li>Tap to change the default account. For more information, refer to <a href="#">Default Account</a> on page <a href="#">170</a>.</li></ul>
9		Tap to go back to the idle screen.
10	Directory	Tap to enter the Directory screen and view contacts.
11	History	Tap to enter the History screen and view call history.
12		<ul style="list-style-type: none"><li>Tap to delete the entered characters one by one.</li><li>Long tap to delete two or more characters.</li></ul>
13		Tap to display/hide the onscreen keyboard. For more information, refer to <a href="#">Using the Onscreen Keyboard</a> on page <a href="#">51</a> .

## Video Call Screen Display



No.	Name	Description
1	Time	The phone's time is displayed on the right of the status bar. For more information, refer to <a href="#">Time &amp; Date</a> on page 87.
2	Line Key List	The line key list displays 6 line keys by default. You can drag up and down to scroll through the line keys. Various features can be assigned to line keys. Each line key can display the label and indicate the status of the assigned feature. <b>Note:</b> The line key list appears only if you have added at least one line key.
3		Tap to unfold line key list and display all line keys. For more information, refer to <a href="#">DSS Keys</a> on page 151.
4		Tap it or swipe right to hide the line key list.
5	Full Screen	Tap to show the video on the phone in full screen. Only the near site and far site are shown. For more information on full screen, refer to <a href="#">Video Call Full-Screen Display (Both Far- and Near-Site Videos Exist)</a> on page 49.
6	Soft Keys	<ul style="list-style-type: none"> <li>Label automatically to identify their context-sensitive features.</li> <li>Swipe left to see other soft keys.</li> </ul>
7	Far-Site Information	Shows the information (name or number) of the

No.	Name	Description
		far site.
8	Active Call Window	<p>Shows the video of far site and near site. By default, a small window (near site) is located on the top-right of the touch screen, and a larger window (far site) is centered in the middle of the touch screen.</p> <p><b>Note:</b> If you do not connect the CAM50 to your phone or turn off the near-site video during the call, the IP phone will stop transmitting the near-site video. For more information on turn off the near-site video, refer to <a href="#">Stopping Transmitting Video during a Call</a> on page 272.</p>
9	Call Duration Timer	Shows the duration time of current call.
10	Talking Mode	Shows that you are talking using the handset, speakerphone or headset. You can alternate among the three modes during calls.
11	Phone Dialer	Tap to enter the dialing screen. For more information, refer to <a href="#">Dialing Screen Display</a> on page 45.
12	Directory	Tap to enter the Directory screen and view contacts.
13	History	Tap to enter the History screen and view call history.
14		<ul style="list-style-type: none"> <li>• A number under the icon indicates the number of call(s) on the phone. For example, 1 indicates that there is a call on the phone.</li> <li>• Tap to exit or return to the talking screen.</li> </ul>
15	Android Keys	<p>◀ : tap to go back to the idle screen.</p> <p>○ : tap to return to the idle screen.</p> <p>□ : tap to view and manage the list of recently used applications.</p>



## Video Call Full-Screen Display (Both Far- and Near-Site Videos Exist)



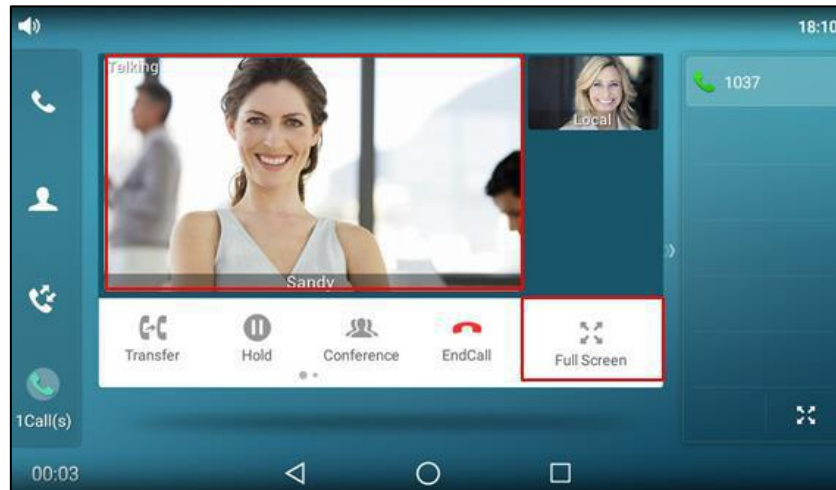

From the video call screen, do one of the following to view full-screen video:



- Tap the big size image.
- Tap **Full Screen**.

- The phone will enter the full screen automatically within 5 seconds during a call.



No.	Name	Description
1	Video Display Area	Shows video in different layout. For more information, refer to <a href="#">Changing the Video Layout during Calls</a> on page 273. <b>Note:</b> If you do not connect the CAM50 to your phone or turn off the near-site video during the call, the IP phone will stop transmitting the near-site video. For more information on turn off the near-site video, refer to <a href="#">Stopping Transmitting Video during a Call</a> on page 272.
2	Blank Area	Tap to exit the full-screen display.
3	Far-Site Information	Shows the information (name or number) of the far site by default.
4		Tap to exit the full-screen display.
5	Call Duration Timer	Shows the duration time of current call.
6	Android Keys	 : tap to exit the full-screen display.  : tap to return to the idle screen.  : tap to view and manage the list of recently used applications.

## Entering Data and Editing Fields

SIP-T58V/A smart media phone provides onscreen keyboard, phone keypad and onscreen dial pad to enter data. Phone keypad and onscreen dial pad provide standard key layout, which enable users to use existing or familiar key positions. You can enter data and edit fields using

the onscreen keyboard, phone keypad or onscreen dial pad.



## Using the Onscreen Keyboard

Before using the onscreen keyboard to enter data, you need to know the function of the keys on the onscreen keyboard. SIP-T58V/A smart media phone supports two kinds of input methods: Android Keyboard (AOSP) – English (US) and Google Pinyin. For more information, refer to [Input Method](#) on page 85.

### Android Keyboard (AOSP) – English (US) Input Method

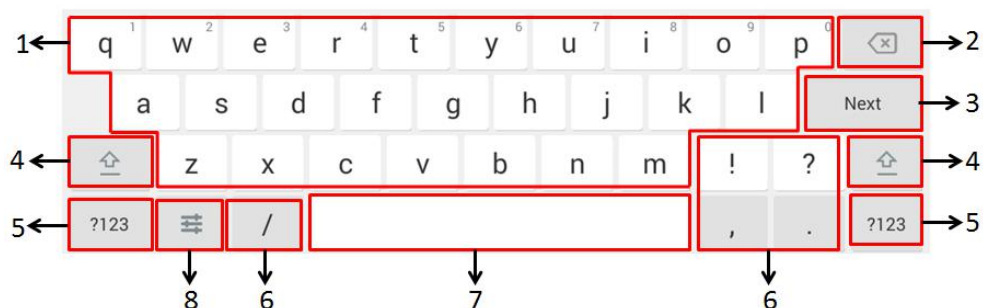
The English (US) input method supports multiple languages onscreen keyboard. The following takes English keyboard of the English (US) input method as an example:





No.	Item	Description	
1	26 English Letters	<ul style="list-style-type: none"> <li>• Tap to enter letters.</li> <li>• Long tap a key then slide to choose one of the options to enter an alternate character.</li> </ul>	
2	Delete Key	<ul style="list-style-type: none"> <li>• Tap to delete the entered characters one by one.</li> <li>• Long tap to delete two or more characters.</li> </ul>	
3	Label automatically to identify the context-sensitive features.	Next Key	Tap to go to the next field.
		Done Key	Tap to confirm the settings.
		Send Key	Tap to dial out the number.
		Go Key	Tap to browse the web page.
4		Tap to switch to the uppercase input mode.	
5		Tap to switch to the numeric&symbolic input mode.	
6	Five Special Characters	Tap to enter the corresponding character.	
7	Space Key	<ul style="list-style-type: none"> <li>• Tap to enter spaces.</li> <li>• Long tap to change input method.</li> </ul>	

No.	Item	Description
8		Tap to access input options to configure Input languages or Android Keyboard Settings (AOSP). You can use AOSP to configure Android keyboard including Input languages, Auto-capitalization, Sound on keypress and so on.

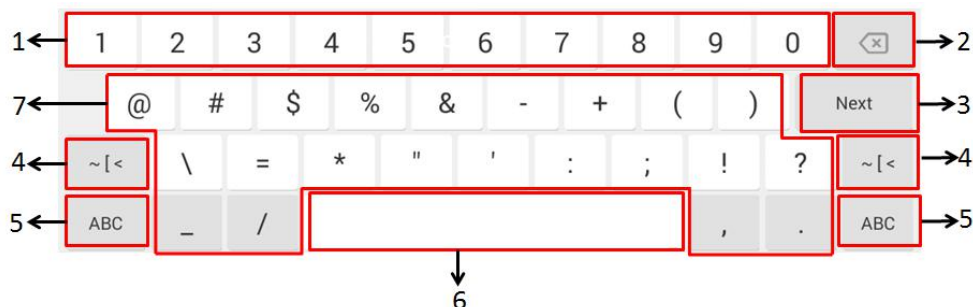
Tap  to switch to the numeric&symbolic input mode as shown below:



No.	Item	Description	
1	Numbers	<ul style="list-style-type: none"> <li>• Tap to enter numbers.</li> <li>• Long tap a key then slide to choose one of the options to enter an alternate character.</li> </ul>	
2	Delete Key	<ul style="list-style-type: none"> <li>• Tap to delete the entered characters one by one.</li> <li>• Long tap to delete two or more characters.</li> </ul>	
3	Label automatically to identify the context-sensitive features.	Next Key	Tap to go to the next field.
		Done Key	Tap to confirm the settings.
		Send Key	Tap to dial out the number.
		Go Key	Tap to browse the web page.
4		Tap to switch to the symbolic input mode.	
5		Tap to switch to the lowercase input mode.	
6	Space Key	<ul style="list-style-type: none"> <li>• Tap to enter spaces.</li> <li>• Long tap to change input method.</li> </ul>	
7	Special Characters	<ul style="list-style-type: none"> <li>• Tap to enter special characters.</li> <li>• Long tap a key then slide to choose one of the options to enter an alternate character.</li> </ul>	

Tap **~[<** to switch to the symbolic input mode as shown below:



No.	Item		Description
1	Special Characters		<ul style="list-style-type: none"> <li>• Tap to enter special characters.</li> <li>• Long tap a key then slide to choose one of the options to enter an alternate character.</li> </ul>
2	Delete Key		<ul style="list-style-type: none"> <li>• Tap to delete the entered characters one by one.</li> <li>• Long tap to delete two or more characters.</li> </ul>
3	Label automatically to identify the context-sensitive features.	Next Key	Tap to go to the next field.
		Done Key	Tap to confirm the settings.
		Send Key	Tap to dial out the number.
		Go Key	Tap to browse the web page.
4	123		Tap to switch to the numeric&symbolic input mode.
5	ABC		Tap to switch to the lowercase input mode.
6	Space Key		<ul style="list-style-type: none"> <li>• Tap to enter spaces.</li> <li>• Long tap to change input method.</li> </ul>

## Google Pinyin Input Method

You can use Google Pinyin input method to enter Chinese. For operating instructions on how to use the Google Pinyin input method, refer to the operating instructions above.

When you change the input method to Google Pinyin, the onscreen keyboard displays the English input mode as shown below by default:



Tap **英文** to switch to the Chinese input mode as shown below:

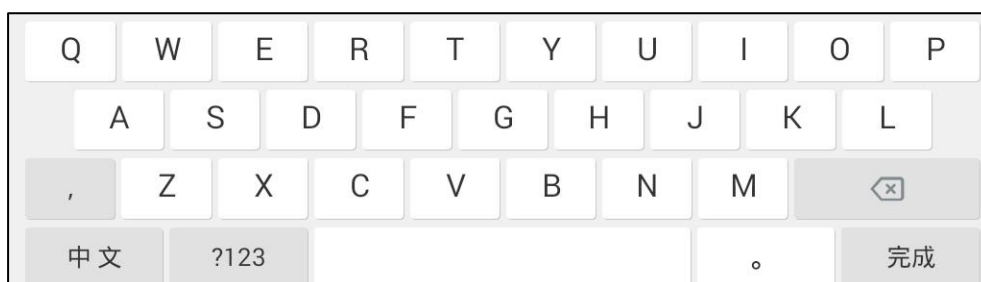

Tap **?123** to switch to the numeric&symbolic input mode as shown below:

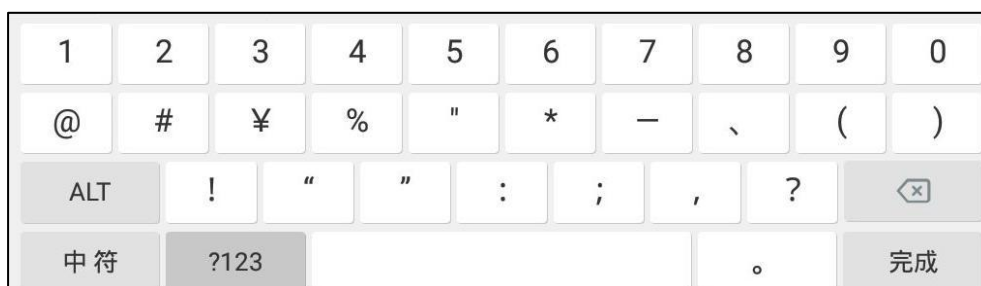



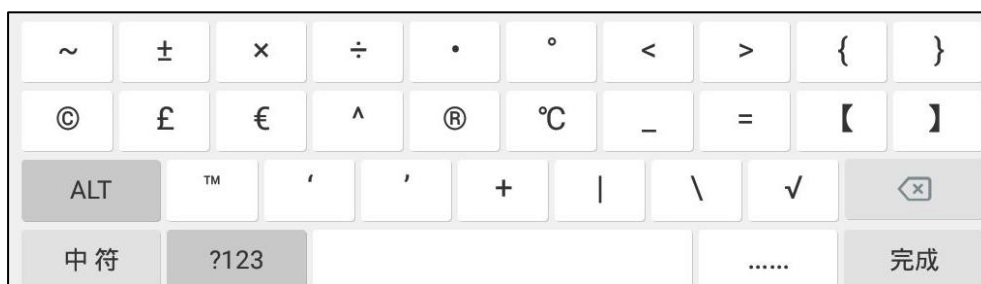





Tap **ALT** to switch to the symbolic input mode as shown below:



**The other things you need to know:**

If you want to	Action
Position the cursor.	Tap to position.
Select all characters.	1) Long tap the entered character(s). 2) Do one of the following: <ul style="list-style-type: none"> <li>• Tap <b>SELECT ALL</b> on the top of the touch screen.</li> </ul>

If you want to	Action
	<ul style="list-style-type: none"> <li>• Drag  /  to select all characters.</li> </ul>
Cut/Copy characters.	<ol style="list-style-type: none"> <li>1) Long tap the entered character(s).</li> <li>2) Drag  /  to select the characters you want to cut/copy.</li> <li>3) Tap <b>CUT/COPY</b> on the top of the touch screen.</li> <li>4) Long tap the desired field.</li> <li>5) Tap <b>PASTE</b>.</li> </ol>
Delete more characters at a time.	<ul style="list-style-type: none"> <li>• Long tap the entered character(s).</li> <li>• Drag  /  to select the characters you want to delete.</li> <li>• Tap  .</li> <li>• Long tap  .</li> </ul>
Replace characters.	<ol style="list-style-type: none"> <li>1) Drag your finger to highlight the characters you want to replace.</li> <li>2) Tap the desired character.</li> </ol>

## Using the Phone Keypad and Onscreen Dial Pad

Instead of using the onscreen keyboard, you can also use the keypad on your phone or dial pad on the dialing screen to enter data. The phone keypad and onscreen dial pad only provide digit keys, # key and \* key.

**Note** When using the onscreen dial pad, you can tap  to use the onscreen keyboard. For more information, refer to [Using the Onscreen Keyboard](#) on page 51.

## Phone Status

You can view phone status via phone user interface or web user interface.

Available information of phone status includes:

- General information (IP address, MAC address, Wi-Fi MAC address and firmware version)
- Network status (IPv4 status or IPv6 status, IP mode, MAC address and Wi-Fi MAC address)
  - IPv4 uses a 32-bit address.
  - IPv6 is an updated version of the current Internet Protocol to meet the increased demands for unique IP addresses, using a 128-bit address.
- Phone status (product name, hardware version, firmware version, product ID, MAC address, Wi-Fi MAC address, device certificate status and Android version)
- Account status (register status of SIP accounts)
- Storage information (internal storage, internal SD and USB storage)

The storage information is sorted and displayed with different categories. The following table lists usage of each category:

Category	Usage
Apps	Display the memory cost of the application data and media content.
Cached data	Tap to clear cached data for all apps.
Pictures, videos	Tap to view the pictures/videos by <b>Gallery</b> application.
Audio	Tap to open the file system of the storage. You can browse the file system to view all audios in the internal SD card or USB flash drive.
Downloads	Display the memory cost of the downloaded files.
Misc.	Tap to display all folders on the IP phone. You can then select the folders to be cleaned up.

The operating system and system applications occupy some storage space. Therefore, the actual available space will be smaller than the nominal space. Updates on the operating system and firmware version may cause changes to the available space.

**To view the phone status via phone user interface:**

1. Swipe down from the top of the screen or swipe left/right to go to the second idle screen.
2. Tap **Settings**->**Status**.

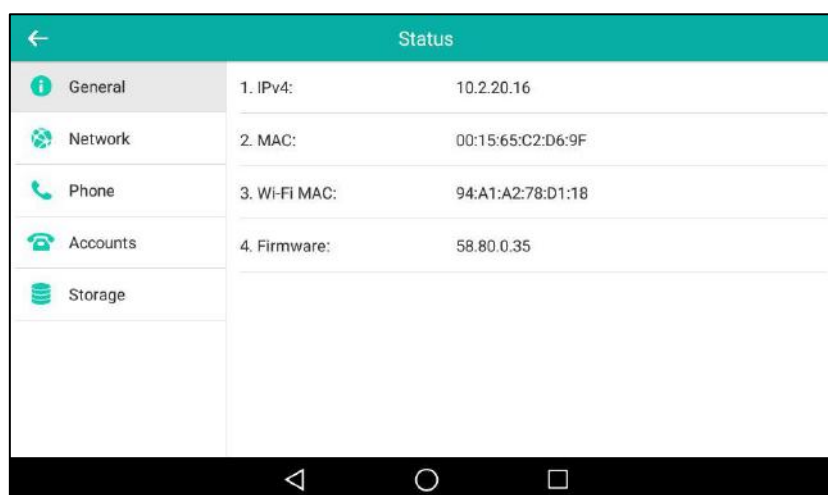

3. Tap the desired item to view the desired information.

**Note** You can view the device certificate status and storage information via phone user interface only.



**To view the phone status via web user interface:**

1. Open a web browser on your computer.
2. Enter the IP address in the browser's address bar, and then press the **Enter** key.  
(e.g., "http://192.168.0.10" for IPv4 or "http://[2005:1:1:1:215:65ff:fe64:6e0a]" for IPv6).
3. Enter the user name (admin) and password (admin) in the login page.

4. Click **Confirm** to login.

The phone status is displayed on the first page of the web user interface.

Category	Item	Value
<b>Version</b> ?	Firmware Version	58.80.0.35
	Hardware Version	55.2.2.0.0.0.0
<b>Network</b> ?	Internet Port	IPv4
	<b>IPv4</b> ?	
<b>Network Common</b> ?	WAN Port Type	DHCP
	WAN IP Address	10.2.20.32
	Subnet Mask	255.255.255.0
	Gateway	10.2.20.254
	Primary DNS	192.168.1.22
	Secondary DNS	192.168.1.20
	MAC Address	00:15:65:C1:93:6B
<b>Account Status</b> ?	Wi-Fi MAC	44:2C:05:AA:73:A2
	Link Status	Connected
	Device Type	Bridge
	Account1	Disabled
	Account2	Disabled

**NOTE**

**Version**  
It shows the version of firmware.

**Network**  
It shows the information of WAN port.

You can click here to get more guides.

**Note**

If IP mode of the phone is configured as **IPv4 & IPv6**, you can enter either of them in the browser's address bar to view the phone status. IPv6 is not available on all servers. Contact your system administrator for more information.

## Basic Network Settings

If your phone cannot contact a DHCP server for any reason, you need to configure network settings manually. The IP phone can support either or both IPv4 and IPv6 addresses.

### To configure the IP mode via phone user interface:

1. Swipe down from the top of the screen or swipe left/right to go to the second idle screen.
2. Tap **Settings**->**Advanced** (default password: admin) ->**Network**->**WAN Port**.
3. Tap the **IP Mode** field.
4. Tap the desired value (**IPv4**, **IPv6** or **IPv4 & IPv6**) in the pop-up dialog box.

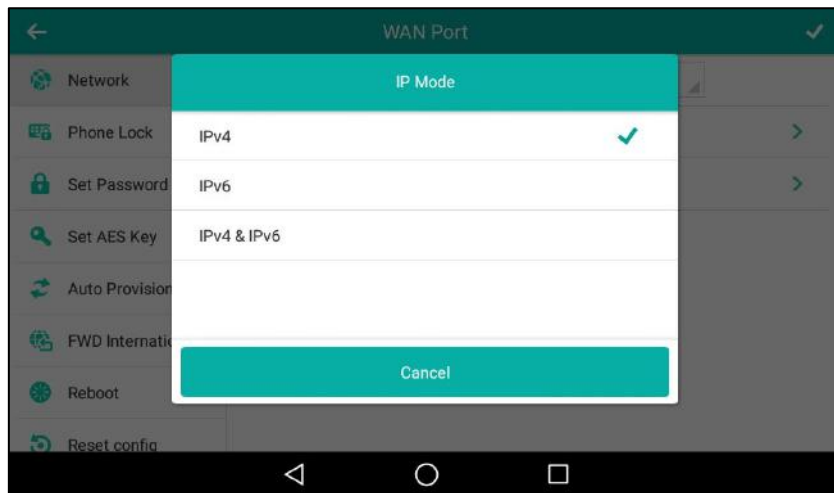

5. Tap  to accept the change or  to cancel.

You can configure a static IPv4 address for the IP phone. Before configuring it, make sure that the IP mode is configured as **IPv4** or **IPv4 & IPv6**.

### To configure a static IPv4 address via phone user interface:

1. Swipe down from the top of the screen or swipe left/right to go to the second idle screen.
2. Tap **Settings**->**Advanced** (default password: admin) ->**Network**->**WAN Port**->**IPv4**.
3. Tap the **Type** field.
4. Tap **Static IP** in the pop-up dialog box.

5. Enter the desired value in the **IP Address**, **Subnet Mask**, **Gateway**, **Primary DNS** and **Secondary DNS** field respectively.

IPv4 WAN Port		
Network	1. Type:	Static IP
Phone Lock	2. IP Address:	192.168.1.20
Set Password	3. Subnet Mask:	255.255.255.0
Set AES Key	4. Gateway:	192.168.1.254
Auto Provision	5. Primary DNS:	202.101.103.55
FWD International	6. Secondary DNS:	202.101.103.56
Reboot		
Reset config		

6. Tap ✓ to accept the change or ◀ to cancel.

You can configure a static IPv6 address for the IP phone. Before configuring it, make sure that the IP mode is configured as **IPv6** or **IPv4 & IPv6**.

#### To configure a static IPv6 address via phone user interface:

1. Swipe down from the top of the screen or swipe left/right to go to the second idle screen.
2. Tap **Settings**->**Advanced** (default password: admin) ->**Network**->**WAN Port**->**IPv6**.
3. Tap the **Type** field.
4. Tap **Static IP** in the pop-up dialog box.
5. Enter the desired value in the **IP Address**, **IPv6 IP Prefix**, **Gateway**, **Primary DNS** and **Secondary DNS** field respectively.

IPv6 WAN Port		
Network	1. Type:	Static IP
Phone Lock	2. IP Address:	2005:1:1:1::12
Set Password	3. IPv6 IP Prefix:	64
Set AES Key	4. Gateway:	2005:1:1:1::1
Auto Provision	5. Primary DNS:	2005:1:1:1::88
FWD International	6. Secondary DNS:	2005:1:1:1::89
Reboot		
Reset config		

6. Tap ✓ to accept the change or ◀ to cancel.

If you are using an xDSL modem for IPv4 network connection, you can connect your phone to the Internet via PPPoE mode. Set the WAN port as a PPPoE port. The PPPoE port will perform a PPP negotiation to obtain the IP address. Contact your system administrator for the PPPoE user

name and password.

**To configure PPPoE via phone user interface:**

1. Swipe down from the top of the screen or swipe left/right to go to the second idle screen.
2. Tap **Settings**->**Advanced** (default password: admin) ->**Network**->**WAN Port**->**IPv4**.
3. Tap the **Type** field.
4. Tap **PPPoE** in the pop-up dialog box.
5. Enter the PPPoE user name and password in the corresponding fields.

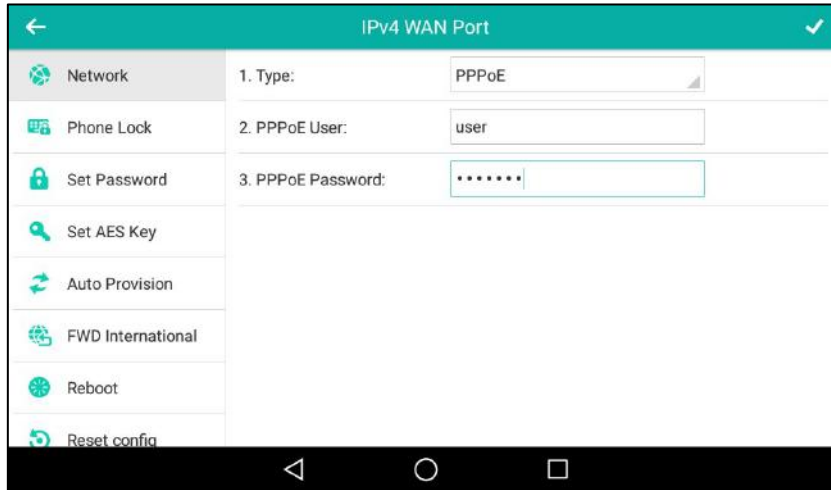

6. Tap ✓ to accept the change or ✗ to cancel.

**Note** The wrong network settings may result in inaccessibility of your phone and may also have an impact on your network performance. For more information on these parameters, contact your system administrator.

## Wireless Network Settings

Yealink SIP-T58V/A smart media phone supports Wi-Fi feature. The IP phone can be connected to wireless network if Wi-Fi is available within the area. For more information, contact your system administrator.

**Note** Enabling Bluetooth may degrade your wireless network connection. For improved wireless network performance, you should disable Bluetooth when it is not in use. For more information, refer to [Activating/Deactivating the Bluetooth Mode](#) on page 136.

## Connecting to the Wireless Network

Three ways to connect SIP-T58V/A smart media phone to the wireless network:

- Manually connect to an available wireless network

- Wi-Fi Protected Setup (WPS)
- Manually add a wireless network

When the phone is connected to a wireless network, the Wi-Fi icon  will display on the status bar. The Wi-Fi icon indicates the signal strength. The more green arcs you see, the stronger the signal strength is. For more information, refer to [Icon Instructions](#) on page 16. And the Wi-Fi label on the control center will change to the SSID of the connected wireless network.

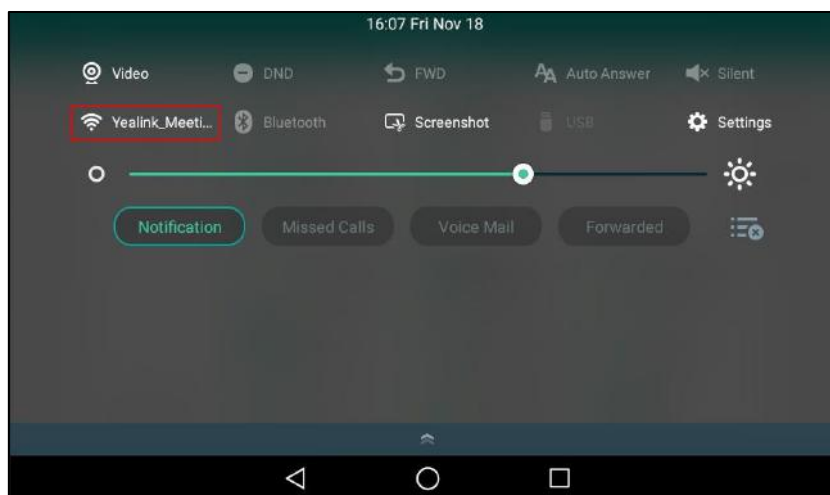

## Manually Connect to an Available Wireless Network

You can manually connect your phone to a wireless network.

**To manually connect to an available wireless network via phone user interface:**

1. Swipe down from the top of the screen or swipe left/right to go to the second idle screen.
2. Tap **Settings**->**Basic**->**Wi-Fi**.
3. Tap the **On** radio box in the **Wi-Fi** field.

The phone will automatically search for available wireless networks in your area.

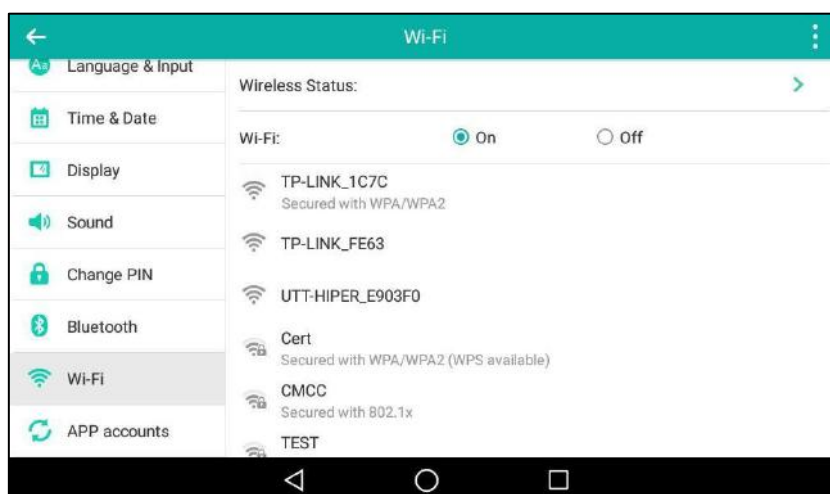

4. (Optional.) To re-search the available network, tap  and then tap **Scan**.
5. Tap the desired wireless network (SSID) to connect to it.

6. If the network is secure, enter its password in the **Password** field.  
Contact your network administrator for the Wi-Fi password.  
You can do the following:
  - Tap the **Show password** radio box to make the password visible.
  - Tap the **Show advanced options** radio box to configure the HTTP proxy for **Browser** application.

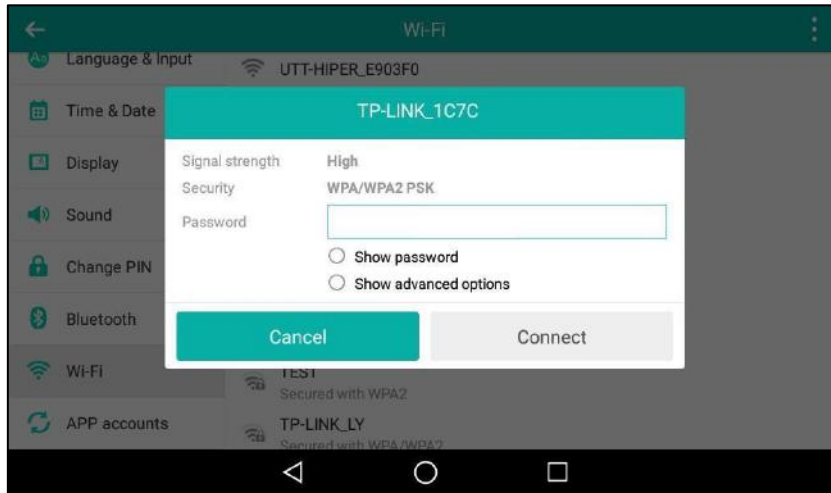

7. Tap **Connect** to connect to the wireless network.  
Once the connection has completed successfully, the prompt “Connected” appears under the corresponding SSID.

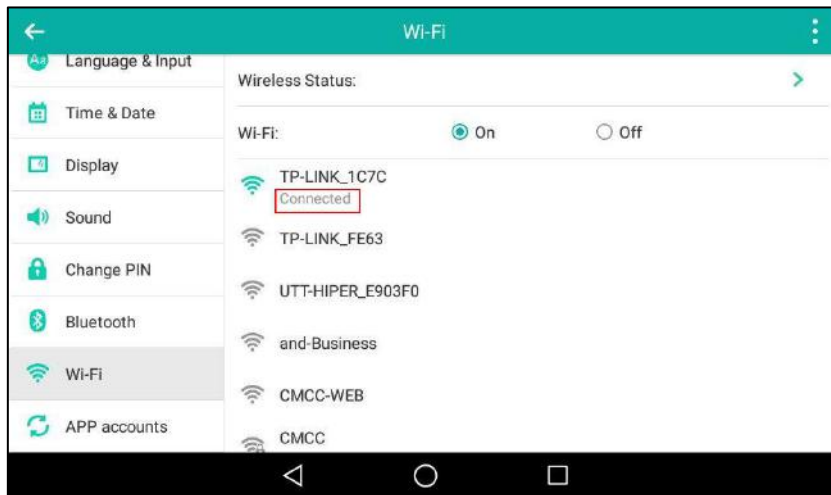

You can also swipe down from the top of the screen to enter the control center, and toggle **Wi-Fi** on. The phone will automatically search for wireless network in your area, and try to connect the wireless network that you have connected last time. If there are no available wireless networks or the phone cannot connect the wireless network that you have connected last time, you will get a notification “Wi-Fi networks available”. Swipe down from the top of the screen to enter the notification center, tap the notification. Repeat steps 4 to 7 to connect to the desired wireless network.

## Wi-Fi Protected Setup (WPS)

Wi-Fi Protected Setup (WPS) provides simplified mechanisms to configure secure wireless networks. WPS can automatically configure a wireless network with a network name (SSID) and strong WPA data encryption and authentication.

Two methods supported by Yealink IP phones in the Wi-Fi protected setup:

- Push Button Configuration (PBC): The user simply has to push the WPS key on both the IP phone and gateway/router to connect.
- Personal Identification Number (PIN): The user has to enter a WPS PIN generated randomly by the IP phone on the gateway/router to connect.

### Push Button Configuration (PBC)

**To connect to the wireless network using PBC method:**

1. Swipe down from the top of the screen or swipe left/right to go to the second idle screen.
2. Tap **Settings->Basic->Wi-Fi**.
3. Tap the **On** radio box in the **Wi-Fi** field.

The phone will automatically search for available wireless networks in your area.

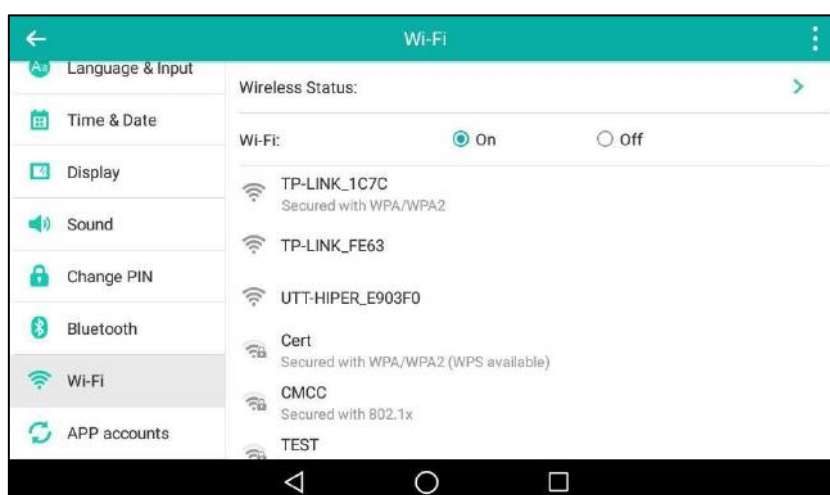

4. Tap  and then tap **WPS**.

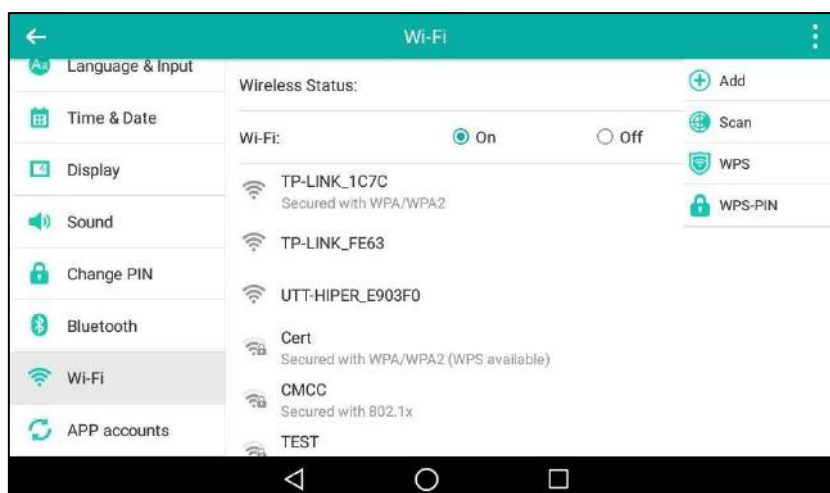

The touch screen prompts "Press the Wi-Fi Protected Setup button on your router. It may be called "WPS" or contain this symbol:".

5. Long press the WPS key on your gateway/router.

Once WPS setup has completed successfully, the touch screen will prompt "Connected".

## Personal Identification Number (PIN)

**To connect to the wireless network using PIN method:**

1. Swipe down from the top of the screen or swipe left/right to go to the second idle screen.
2. Tap **Settings->Basic->Wi-Fi**.
3. Tap the **On** radio box in the **Wi-Fi** field.

The phone will automatically search for available wireless networks in your area.

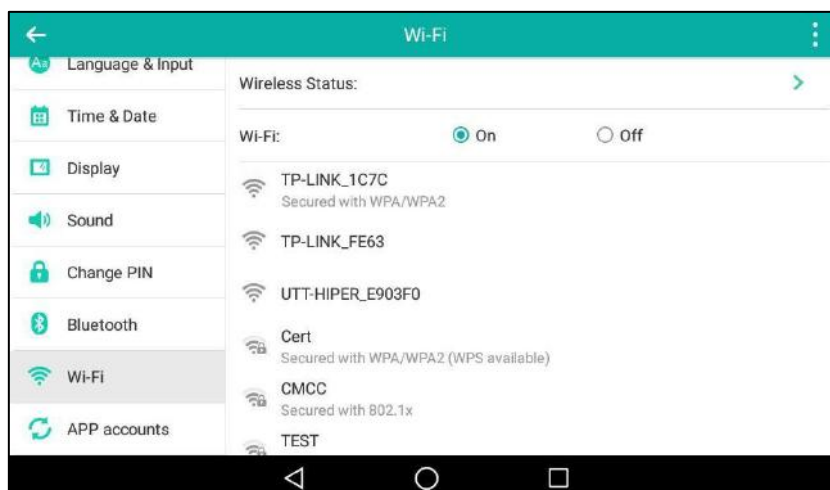



4. Tap  and then tap **WPS-PIN**.

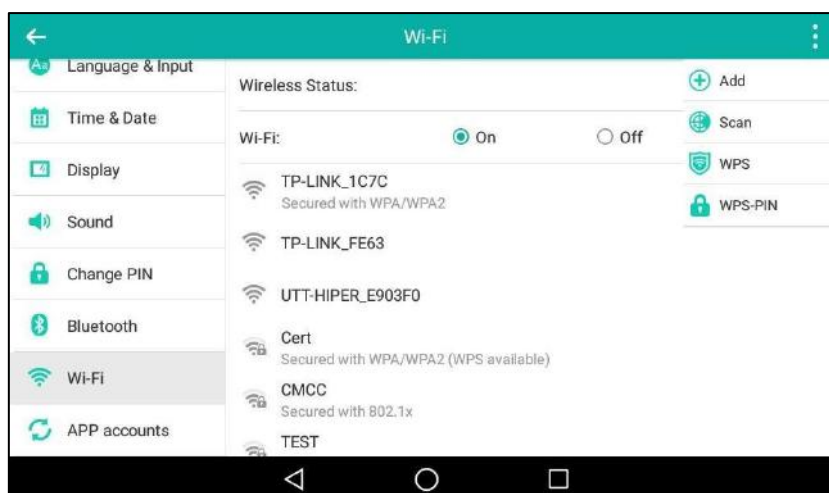

The touch screen prompts "Enter pin XXX on your Wi-Fi router. The setup can take up to two minutes to complete."

5. Note the PIN code.
6. Enter the gateway/router address in the address bar of a web browser on your PC connected to the gateway/router.
7. Enter the user name and password in the login page.
8. Locate the **WPS Wizard** configuration menu.
9. Enter the PIN code in the field that allows you to setup wireless devices by using a PIN.
10. Click the corresponding button in the gateway/router's web interface to search WPS clients.

Once WPS setup has completed successfully, the touch screen will prompt "Connected".

#### Note

Contact your gateway/router provider for more information.

## Manually Add a Wireless Network

If your gateway/router has SSID broadcast disabled, it might not appear in the scanning results. In that case, you must manually add a wireless network.

#### To add a wireless network:

1. Swipe down from the top of the screen or swipe left/right to go to the second idle screen.
2. Tap **Settings->Basic->Wi-Fi**.
3. Tap the **On** radio box in the **Wi-Fi** field.

4. Tap  and then tap **Add**.

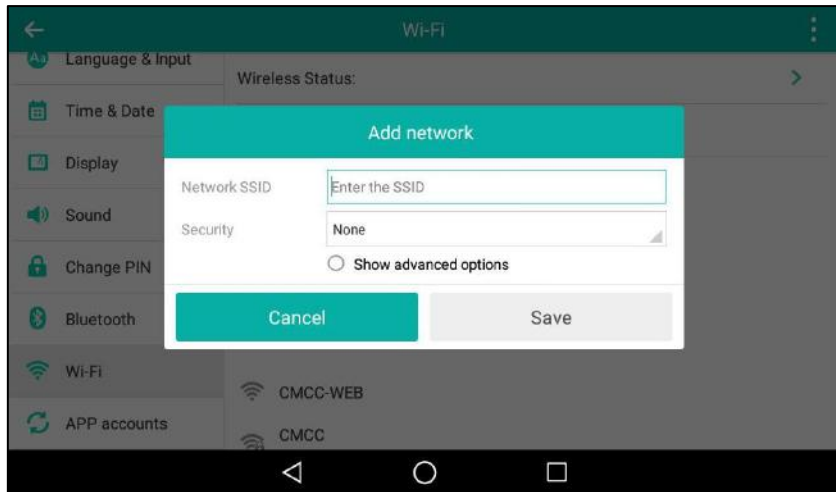

5. Enter the desired value in the **Network SSID** field.
6. Tap the **Security** field.

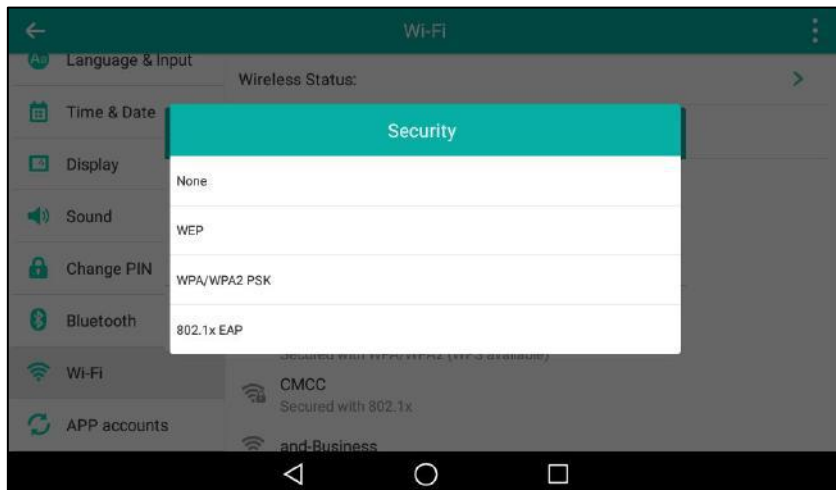

7. Tap the desired value.
  - If you select **WEP** or **WPA/WPA2 PSK**:
    - 1) Enter the password in the **Password** field.
  - If you select **802.1x EAP**:
    - 1) Tap the **EAP method** field.
    - 2) Tap the desired EAP method in the pop-up dialog box.
  - If you select **PEAP/TTLS**:
    - a) Tap the **Phase-2 authentication** field.
    - b) Tap the desired Phase-2 authentication method in the pop-up dialog box.
    - c) Enter the identity (username) in the **Identity** field.
    - d) Enter the anonymous identity (username) in the **Anonymous identity** field (to be used as the unencrypted identity).

- e) Enter the password in the **Password** field.
  - If you select **TLS**:
    - a) Enter the username in the **Identity** field
    - If you select **PWD**:
      - a) Enter the username in the **Identity** field.
      - b) Enter the password in the **Password** field.
- 8. You can do the following:
  - Tap the **Show password** radio box to make the password visible.
  - Tap the **Show advanced options** radio box to configure the HTTP proxy for **Browser** application.
- 9. Tap **Save** to accept the change.

## Viewing the Connected Wireless Network Information

### To view the connected wireless network information:

1. Swipe down from the top of the screen or swipe left/right to go to the second idle screen.
2. Tap **Settings**->**Basic**->**Wi-Fi**.
3. Tap **Wireless Status** to view the detailed wireless network information (e.g., Profile Name, SSID or Signal Strength).



4. (Optional.) Drag up and down to scroll through the list of wireless network information.

## Disconnecting the Wireless Network Connection

You can disconnect the wireless network connection from your phone.

### To disconnect the wireless network:

1. Swipe down from the top of the screen or swipe left/right to go to the second idle screen.

2. Tap **Settings**->**Basic**->**Wi-Fi**.
3. Tap the connected SSID (the top one).

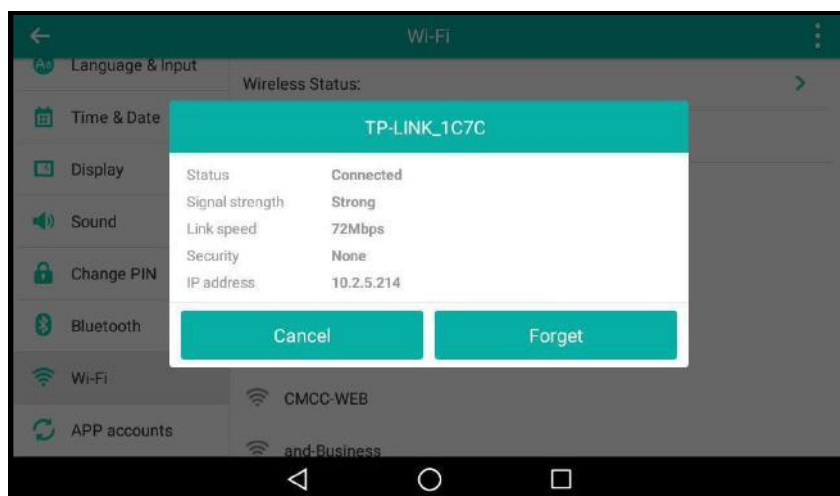

4. Tap **Forget**.

## Disabling Wi-Fi Feature

**To disable Wi-Fi feature, do one of the following:**

- Swipe down from the top of the screen or swipe left/right to go to the second idle screen.

Tap **Settings**->**Basic**->**Wi-Fi**.

Tap the **Off** radio box in the **Wi-Fi** field.

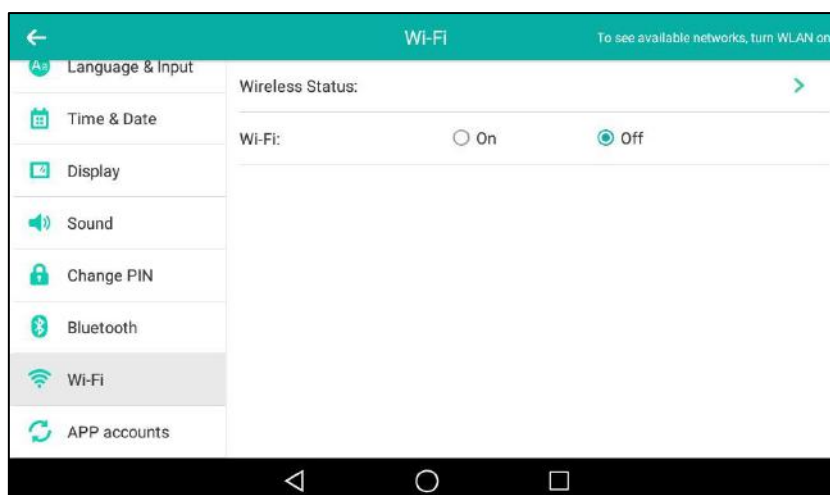

- Swipe down from the top of the screen to enter the control center, and then tap .

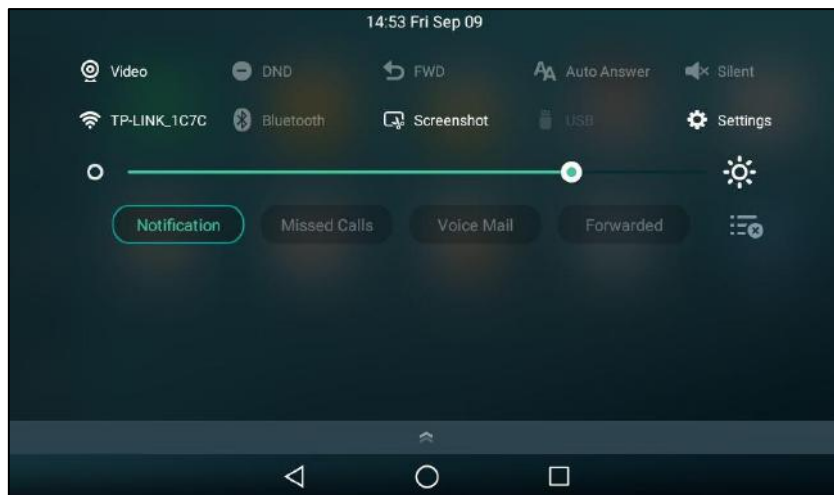

The icon  disappears from the status bar, and the Wi-Fi label resumes to Wi-Fi.



---

## Customizing Your Phone

---

You can customize your SIP-T58V/A smart media phone by personally configuring certain settings, for example, wallpaper, time & date and ring tones. You can add contacts to the phone's local directory manually or from call history. You can also personalize different ring tones for different callers.

This chapter provides basic operating instructions for customizing your phone. Topics include:

- [General Settings](#)
- [Audio Settings](#)
- [Contact Management](#)
- [Call History Management](#)
- [Search Source List in Dialing](#)
- [System Customizations](#)

If you require additional information or assistance with your new phone, contact your system administrator.

## General Settings

### Wallpaper

You can customize the wallpaper of the SIP-T58V/A smart media phone and color-screen expansion module EXP50 (if connected). You can also change the wallpaper image via phone user interface or web user interface. The custom wallpaper can be a built-in image, a picture stored in internal SD card/USB flash drive (if connected) or a picture uploaded via web user interface. For more information on how to connect the USB flash drive, refer to [Phone Installation](#) on page 31.

You can select a wallpaper from different categories:

- **Wallpapers:** Set a recently used picture as the wallpaper, or tap "Pick image" to display the available pictures from the Recent/Images/Downloads/Gallery list and then select a desired picture as the wallpaper.
- **Gallery:** Launch **Gallery** application, tap a Gallery albums and then select a desired picture as the wallpaper.

## Uploading the Custom Wallpaper

The wallpaper image format must meet the following:

Format	Resolution	Single File Size	Screen Size
*.jpg	<=2.0 megapixels	<=5MB	7 inches (Resolution: 1024*600)

**To upload the custom wallpaper via web user interface:**

1. Click on **Settings->Preference**.
2. In the **Upload Wallpaper** field, click **Browse** to locate and upload the picture from your local system.

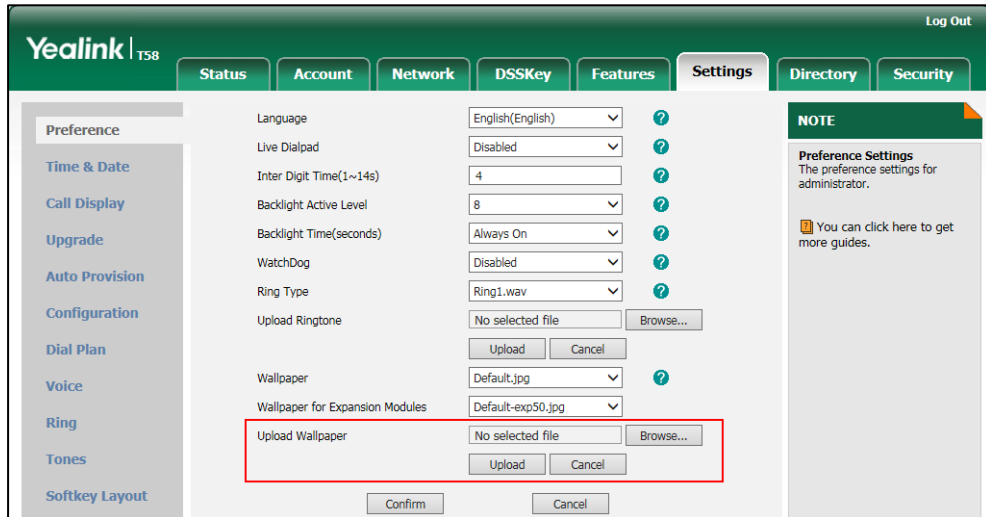

3. Click **Upload** to upload the file.

The uploaded custom picture will apply to SIP-T58V/A smart media phone and EXP50, and appear in the pull-down lists of **Wallpaper** and **Wallpaper for Expansion Modules** synchronously. You can delete the custom wallpaper by clicking **Del** when selecting the desired custom wallpaper in the **Wallpaper** or **Wallpaper for Expansion Modules** field.

## Changing the Wallpaper

**To change the phone wallpaper or EXP50 wallpaper via phone user interface:**

1. Swipe down from the top of the screen or swipe left/right to go to the second idle screen.
2. Tap **Settings->Basic->Display**.
3. Do one of the following:
  - If you change the phone wallpaper, tap **Wallpaper**.
  - If you change EXP wallpaper, tap **EXP Background**.



4. Do one of the following:

- Tap **Gallery**.

The touch screen displays all Gallery albums.

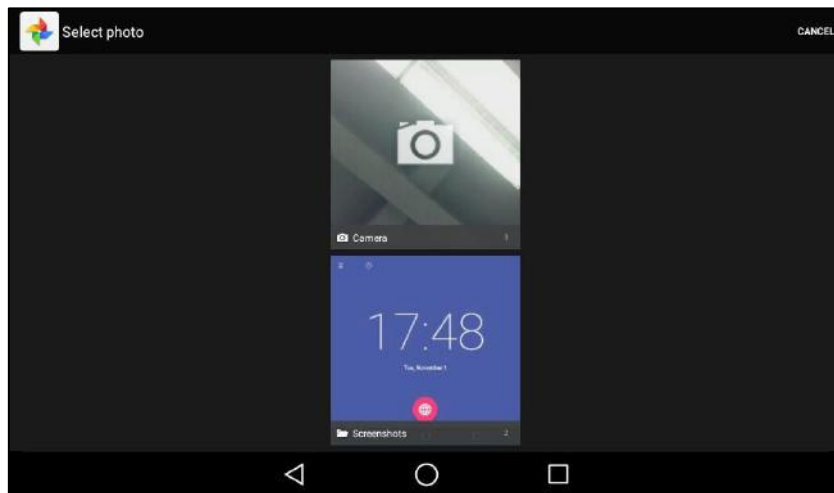

Select a desired Gallery album.

Tap a desired picture to preview, and then tap **Set wallpaper** or **Set as exp background**.

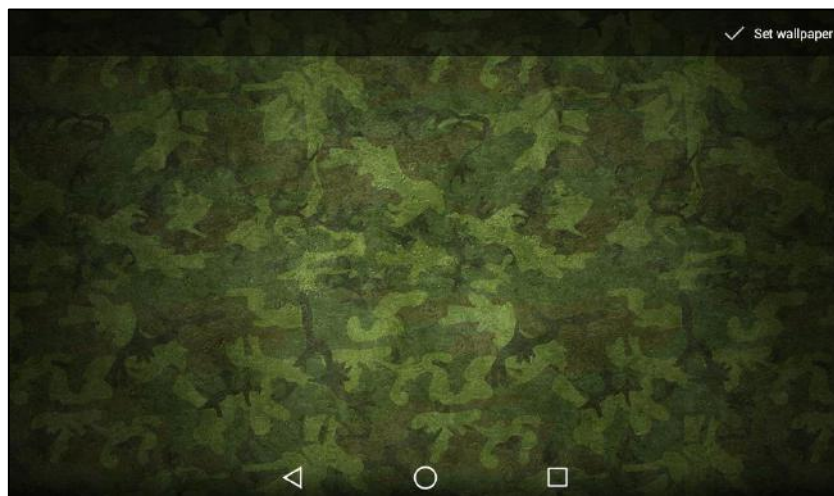

- Tap **Wallpapers**.

The touch screen displays the current used wallpaper in the background, built-in wallpapers and the recently used wallpapers list on the bottom of the touch screen.

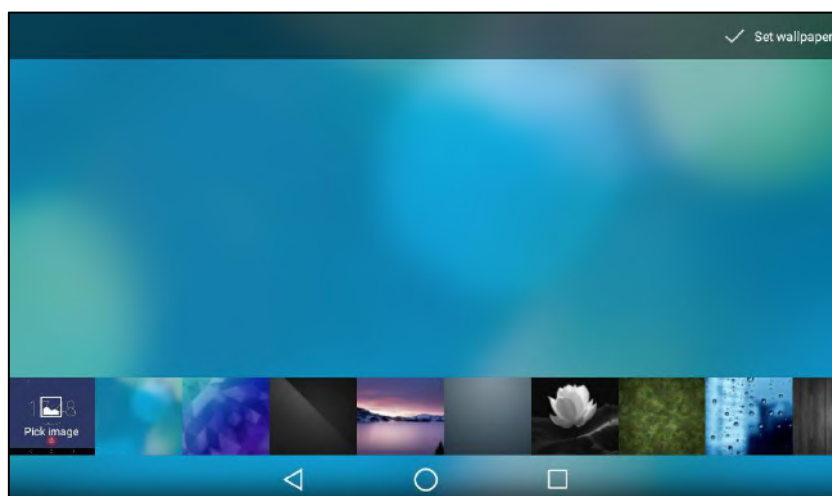

Do one of the following:

- Select a desired wallpaper from the build-in wallpapers and recently used wallpapers list, and then tap **Set wallpaper** or **Set as exp background**.
- Tap **Pick image**.

The touch screen displays the recently saved pictures.

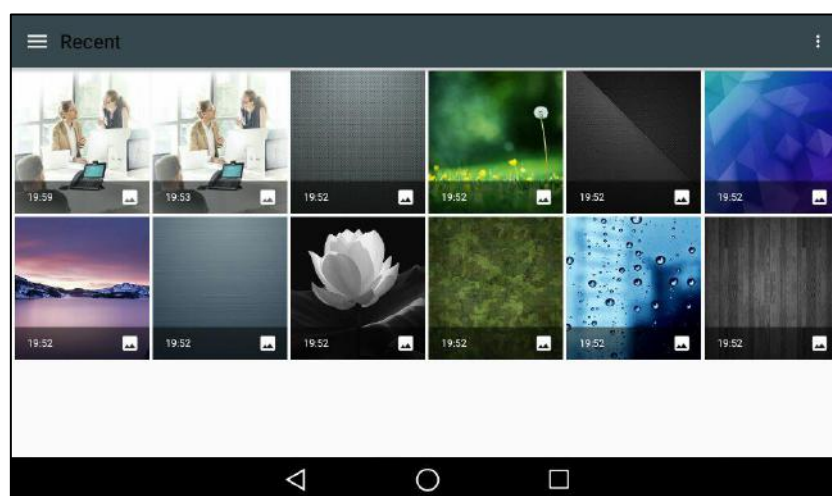

Tap  on the top-left of the touch screen.

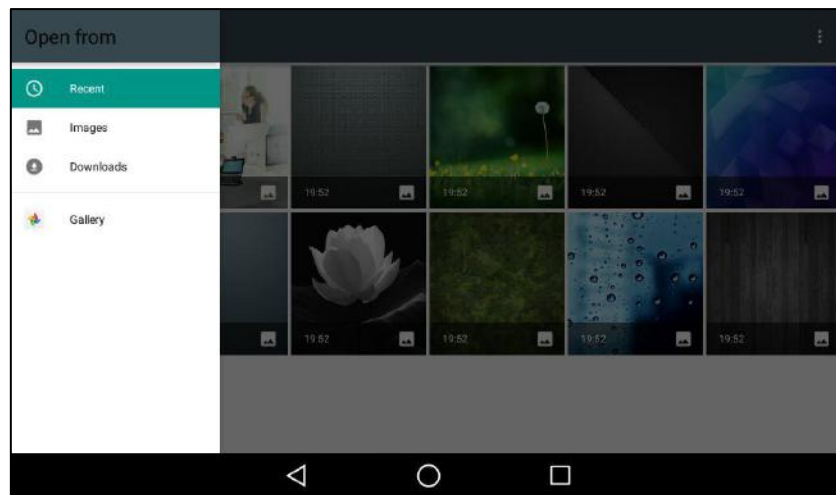

Do one of the following:

- Tap **Images** to see all pictures stored in internal SD card or USB flash drive (if connected).
- Tap **Downloads** to see all pictures you have downloaded.
- Tap **Gallery** to see all pictures by **Gallery** application.

Select a desired picture to preview.

The picture will appear in the recently used wallpapers list.

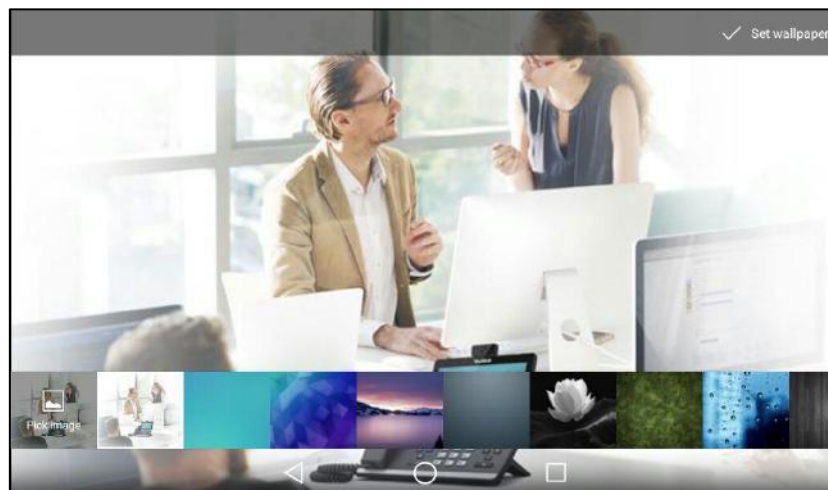

Tap **Set wallpaper** or **Set as exp background**.

You can long tap the empty spot on the idle screen and then tap **WALLPAPERS**, the effect is equal to tapping **Settings->Basic->Display->Wallpaper->Wallpapers**. Then you can change the phone wallpaper as the operating instructions described above.

You can also change the phone/EXP wallpaper when viewing pictures by **FileManager** or **Gallery** application. For more information, refer to [FileManager](#) on page 195 and [Gallery](#) on page 208.

The phone and EXP wallpaper are configurable via web user interface at the path

### Settings->Preference.

#### Note

The SIP-T58V/A smart media phone screen size is 7 inches (Resolution: 1024x600). The EXP50 screen size is 4.3 inches (Resolution: 272x480). If the size of the custom picture doesn't meet the IP phone/expansion module screen size, the wallpaper will be stretched or/and zoomed out according to the screen size.

## Screen Saver

The screen saver will automatically start each time your phone is idle for a certain amount of time. The screen saver is used to blank the screen or fill it with moving images or patterns. If you connect a color-screen expansion module EXP50 to the IP phone, the screen saver will start or stop on the phone and EXP50 synchronously.

#### The screen saver will be stopped when:

- Press any key.
- Tap the touch screen.
- Pick up or hang up the handset.
- There is an incoming call.
- A new prompt (e.g., missed call, new voice mail or forwarded call).
- The status of BLF key changes.

If your phone is idle again for a specified period of time, the screen saver will start again.

The SIP-T58V/A smart media phone supports four screen saver types: Clock, Colors, Photo Frame and Photo Table.

If you set the screen saver type to **Clock**, the touch screen will display as below when screen saver starts:

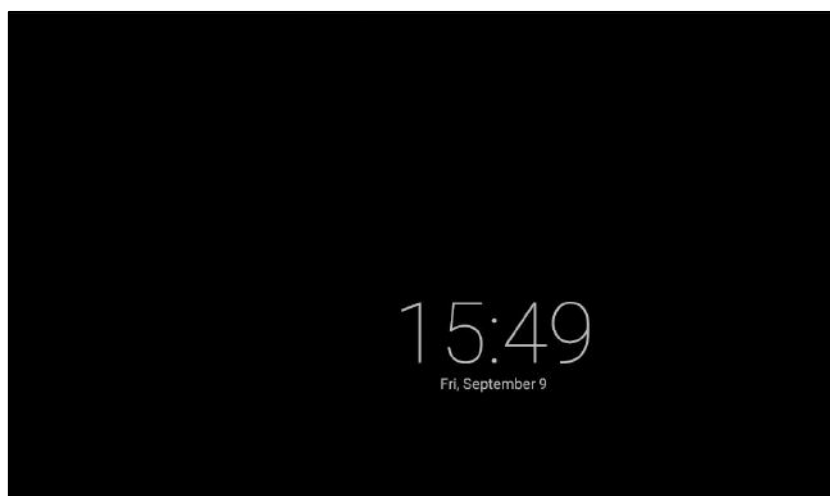

If you set the screen saver type to **Colors**, the touch screen will display as below when screen saver starts:



If you set the screen saver type to **Photo Frame**, the touch screen will display the selected pictures one by one when screen saver starts:



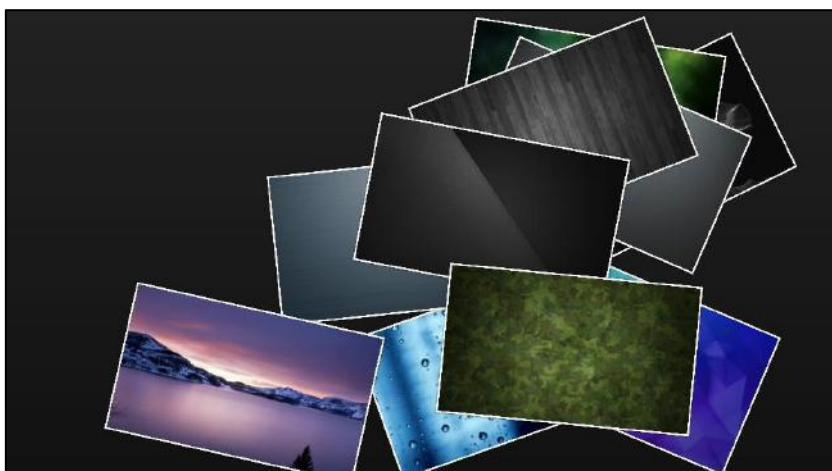

If you set the screen saver type to **Photo Table**, the touch screen will display the selected pictures as below when screen saver starts:

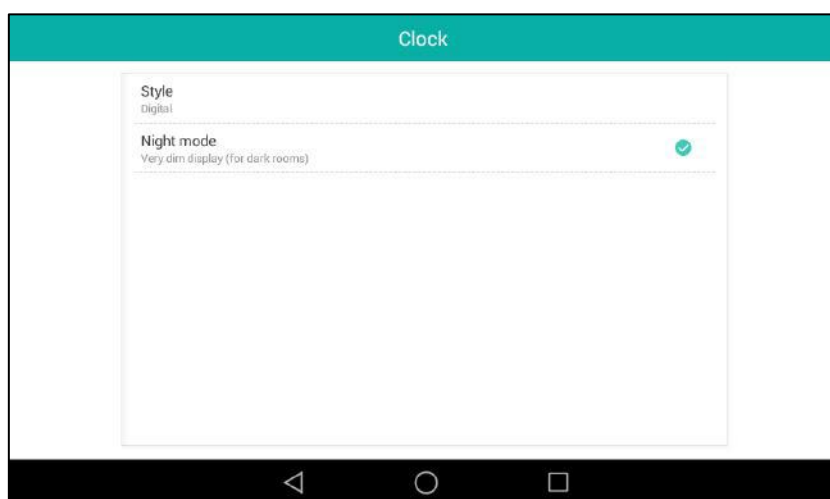

**To configure the screen saver via phone user interface:**

1. Swipe down from the top of the screen or swipe left/right to go to the second idle screen.
2. Tap **Settings->Basic->Display->Screen Saver.**
3. Tap the **Screen Saver Wait Time** field.
4. Tap the desired time in the pop-up dialog box.
5. Do one of the following:
  - Tap the **Clock** radio box.
  - (Optional.) Tap  next to the radio box.



- Tap the **Style** field to set the clock type to **Analog** or **Digital**.
  - Tap the **Night mode** radio box to display the screen saver dimly for dark rooms.
- Tap  to return to the Screen Saver setting screen.

- Tap the **Colors** radio box.
  - Tap the **Photo Frame** radio box.
- Tap  next to the radio box to select the desired Gallery album(s).
- Tap the desired checkbox or **SELECT ALL** on the top-right of the touch screen.

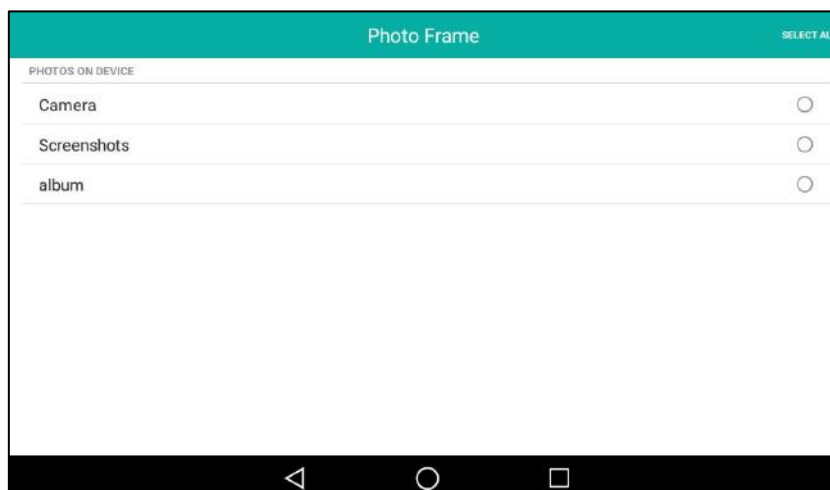

Tap  to return to the Screen Saver setting screen.



- Tap the **Photo Table** radio box.

Tap  next to the radio box to select the desired Gallery album(s).

Tap the desired checkbox or **SELECT ALL** on the top-right of the touch screen.

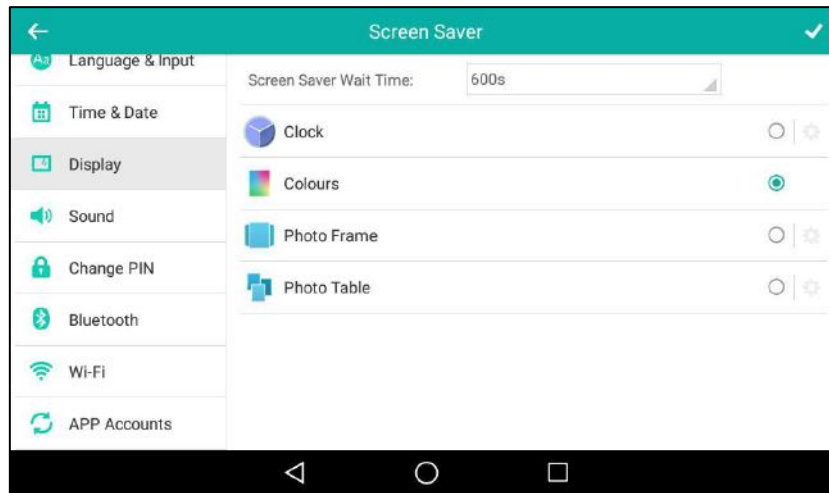
Tap  to return to the Screen Saver setting screen.



6. Tap  to accept the change or  to cancel.

**Note** Screen saver is configurable via phone user interface only.

## Power Saving

The power saving feature is used to turn off the backlight and screen to conserve energy. The IP phone enters power-saving mode after it has been idle for a certain period of time.

If you connect a color-screen expansion module EXP50 to the IP phone, the IP phone and EXP50 will enter or exit power-saving mode synchronously.

### The IP phone will exit power-saving mode when:

- Press any key.
- Tap the touch screen.
- Pick up or hang up the handset.
- There is an incoming call.
- A new prompt (e.g., missed call, new voice mail or forwarded call).
- The status of BLF key changes.

You can configure the following power-saving settings:

- Office Hour
- Idle TimeOut (minutes)

**Note** Power saving is configurable via web user interface only.

## Enabling the Power Saving

The office hour and idle timeout (minutes) settings work only if the power saving feature is enabled.

**To enable the power saving feature via web user interface:**

1. Click on **Settings->Power Saving**.
2. Select **Enabled** from the pull-down list of **Power Saving**.

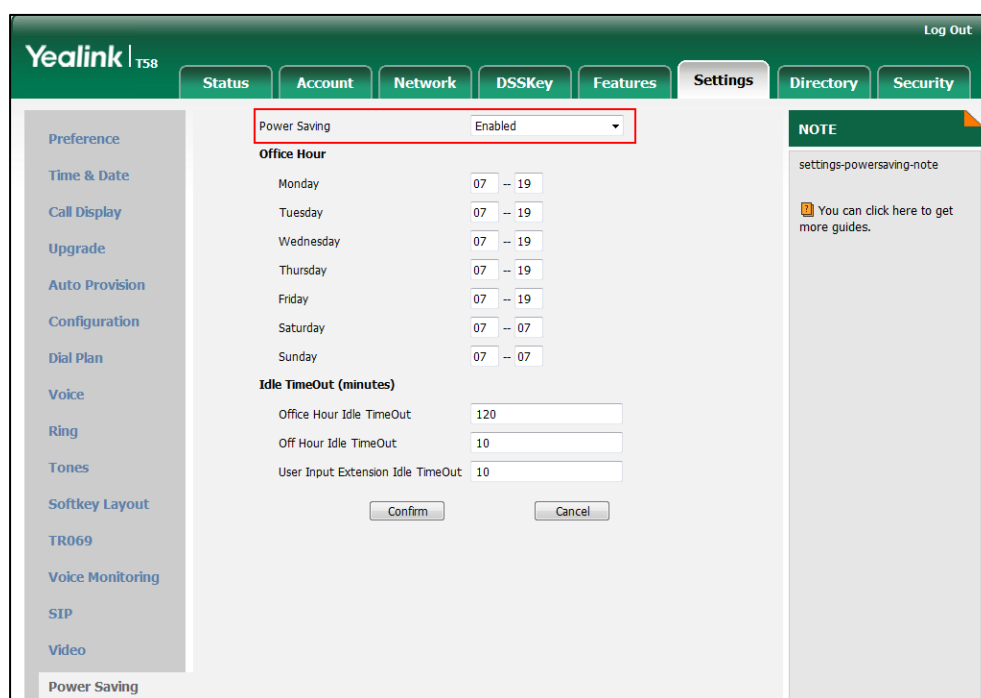

3. Click **Confirm** to accept the change.

## Configuring the Office Hour

Office Hour specifies the starting time and ending time in the office each day.

**To configure the office hour via web user interface:**

1. Click on **Settings->Power Saving**.
2. Select a desired day of the week.



- Enter the starting time and ending time respectively in the desired day field.

The screenshot shows the Yealink T58 web interface. The 'Settings' tab is active, and the 'Power Saving' section is expanded. The 'Power Saving' dropdown is set to 'Enabled'. A table for 'Office Hour' is highlighted with a red box, showing the following times:

Day	Start Time	End Time
Monday	07	19
Tuesday	07	19
Wednesday	07	19
Thursday	07	19
Friday	07	19
Saturday	07	07
Sunday	07	07

Below the table, the 'Idle TimeOut (minutes)' section is visible, with the following values:

- Office Hour Idle TimeOut: 120
- Off Hour Idle TimeOut: 10
- User Input Extension Idle TimeOut: 10

Buttons for 'Confirm' and 'Cancel' are located at the bottom of the form. A 'NOTE' box on the right side of the interface contains the text: 'settings-powersaving-note' and 'You can click here to get more guides.'

- Click **Confirm** to accept the change.

## Configuring the Idle TimeOut

Idle TimeOut specifies the period of time before the IP phone enters power-saving mode. The following three types of idle timeout you can configure:

- **Office Hour Idle TimeOut:** Configures the idle timeout for office hours.
- **Off Hour Idle TimeOut:** Configures the idle timeout for non-office hours.
- **User Input Extension Idle TimeOut:** Configures the idle timeout that applies after you use the IP phone (for example, press a key on the phone, pick up/hang up the handset or tap the touch screen).

By default, the Office Hour Idle TimeOut is much longer than the Off Hour Idle TimeOut. If you use the IP phone, the idle timeout that applies (User Input Extension Idle TimeOut or Office Hour/Off Hour Idle TimeOut) is the timeout with the highest value. If the phone has an incoming call or message, the User Input Extension Idle TimeOut is ignored.

### To configure the idle timeout via web user interface:

- Click on **Settings->Power Saving**.
- Enter the desired value in the **Office Hour Idle TimeOut** field.  
The default value is 120, you can set to 1-240.
- Enter the desired value in the **Off Hour Idle TimeOut** field.  
The default value is 10, you can set to 1-10.
- Enter the desired value in the **User Input Extension Idle TimeOut** field.

The default value is 10, you can set to 1-30.

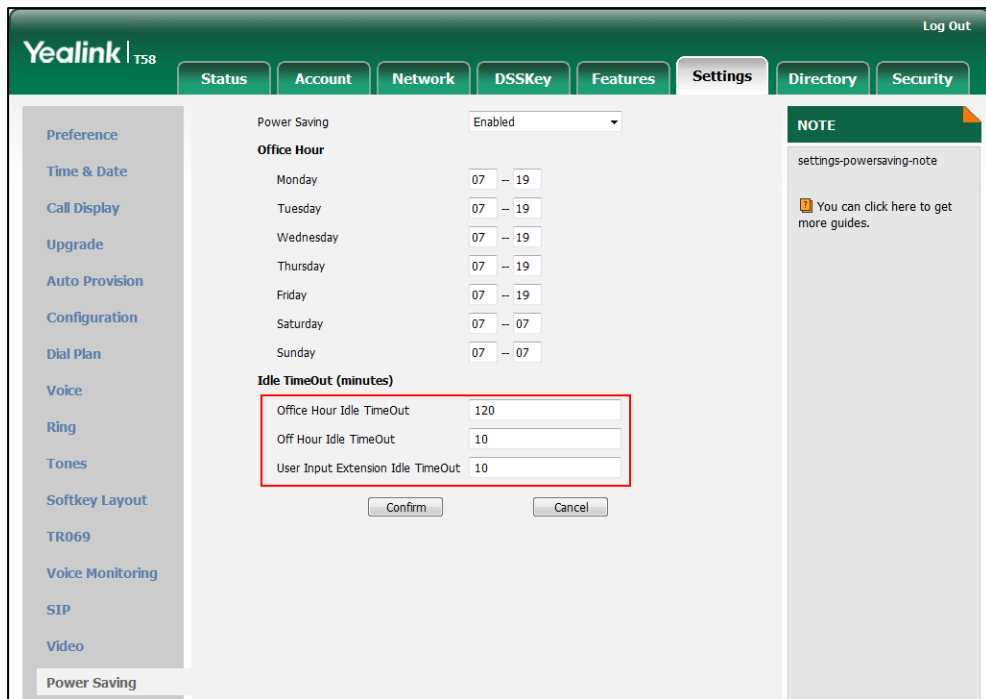

5. Click **Confirm** to accept the change.

## Backlight

Backlight has two options:

**Backlight Active Level:** The intensity of the touch screen when the phone is active. You can change the intensity of the touch screen by dragging the backlight active level slider.

**Backlight Time:** The delay time to change the intensity of the touch screen when the phone is inactive. You can select a desired time to change the intensity or turn on the backlight permanently.

- **Always On:** Backlight is on permanently.
- **15s, 30s, 60s, 120s, 300s, 600s or 1800s:** Backlight is changed when the phone is inactive after the designated time (in seconds).

If you connect a color-screen expansion module EXP50 to the IP phone, the screen's intensity of both the phone and EXP50 will change synchronously.

### To configure the backlight via phone user interface:

1. Swipe down from the top of the screen or swipe left/right to go to the second idle screen.
2. Tap **Settings->Basic->Display->Backlight**.
3. Drag the **Backlight Active Level** slider to change the intensity of the touch screen.
4. Tap the **Backlight Time** field.

5. Tap the desired time in the pop-up dialog box.

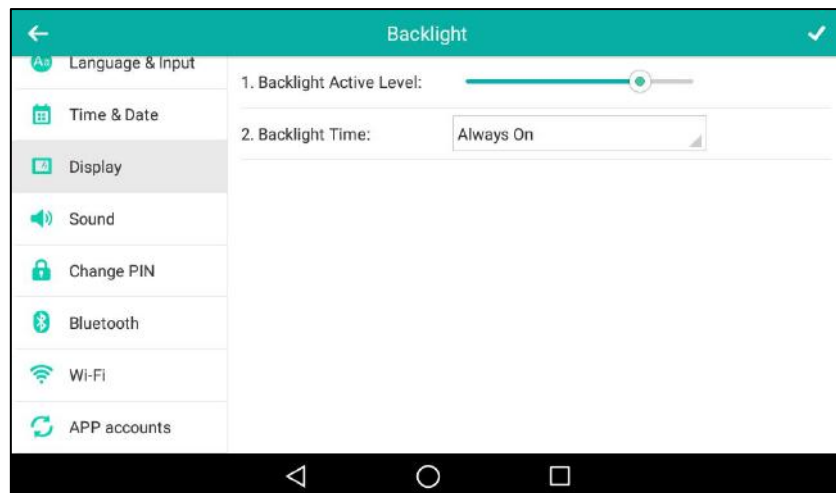

6. Tap ✓ to accept the change or ◀ to cancel.

You can also drag the backlight slider on the control center to change the intensity of the touch screen.

**To configure the backlight active level on the control center:**

1. Swipe down from the top of the screen to enter the control center.

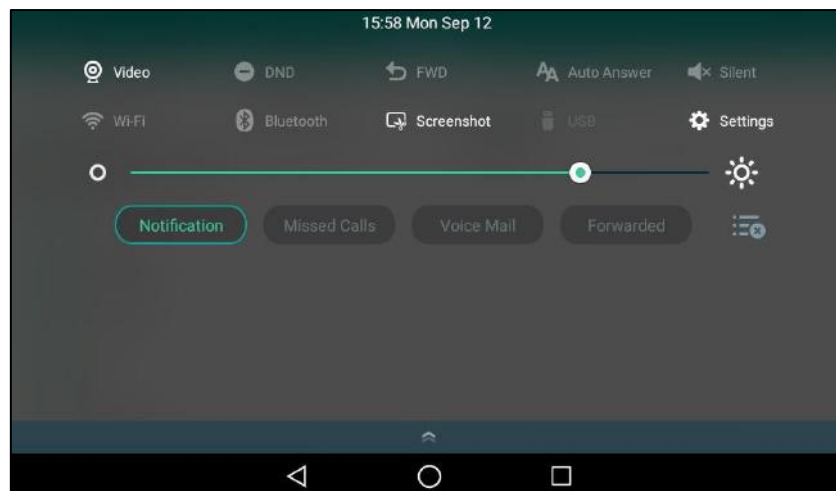

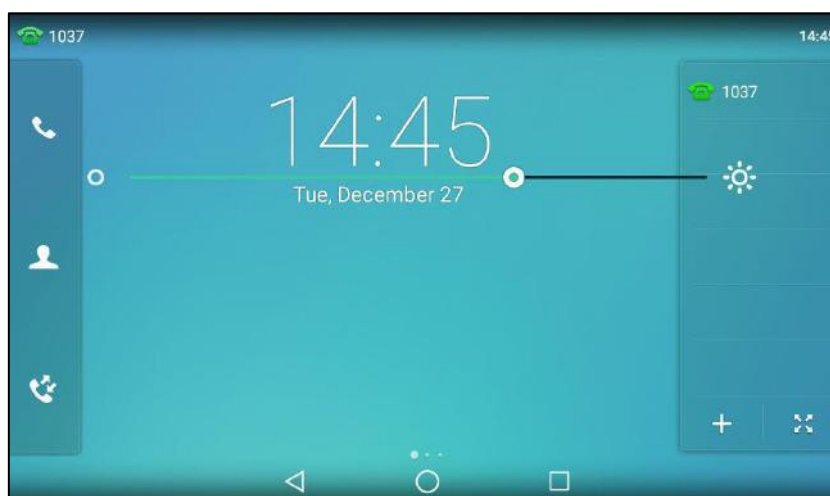

2. You can do one of the following:
  - Drag the backlight slider.

When dragging the slider, the control center (except the backlight slider) and notification center will be hidden. You can view the intensity changes of the touch screen in real-time.



If you lift your finger, the control center and notification center will be shown again.

- Tap  .  
The intensity of the touch screen is changed to the highest.
- Tap  .  
The intensity of the touch screen is changed to the lowest.

Backlight is configurable via web user interface at the path **Settings->Preference**.

## Language



The default language of the phone user interface is English. If the language of your web browser is not supported by the phone, the web user interface will use English by default. You can change the language for the phone user interface and the web user interface respectively.

### To change the language for the phone user interface:

1. Swipe down from the top of the screen or swipe left/right to go to the second idle screen.
2. Tap **Settings->Basic->Language & Input->Language**.
3. Drag up and down to scroll through the list of available languages.

4. Tap the desired language.



5. Tap  to accept the change or  to cancel.  
Text displayed on the phone user interface will change to the selected language.

#### To change the language for the web user interface:

1. Click on **Settings->Preference**.
2. Select the desired language from the pull-down list of **Language**.

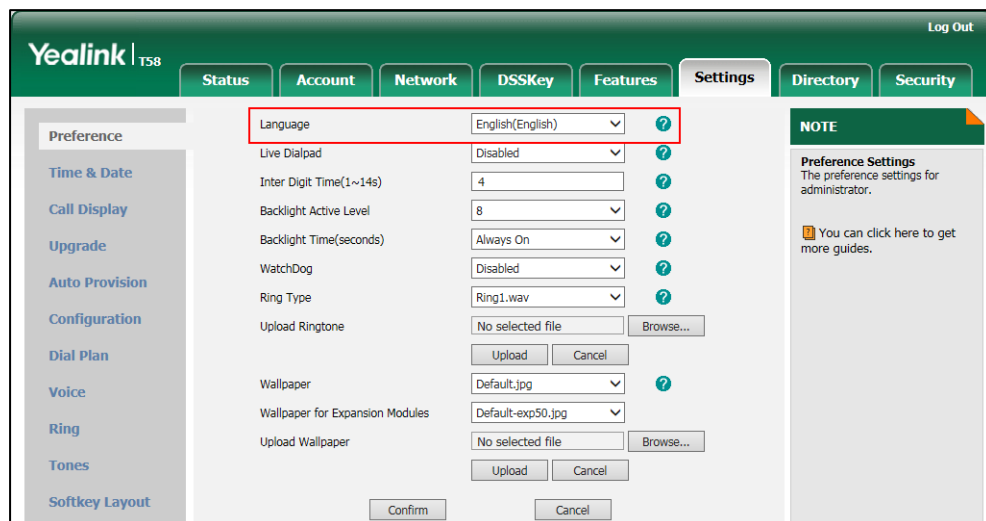

3. Click **Confirm** to accept the change.  
Text displayed on the web user interface will change to the selected language.

## Input Method

SIP-T58V/A smart media phone supports two kinds of input methods: Android Keyboard (AOSP) - English (US) and Google Pinyin. The default input method is English (US). You can change the current used input method.

**To change the input method:**

1. Swipe down from the top of the screen or swipe left/right to go to the second idle screen.
2. Tap **Settings->Basic->Language & Input->Current Input**.
3. Tap the desired input method in the pop-up dialog.

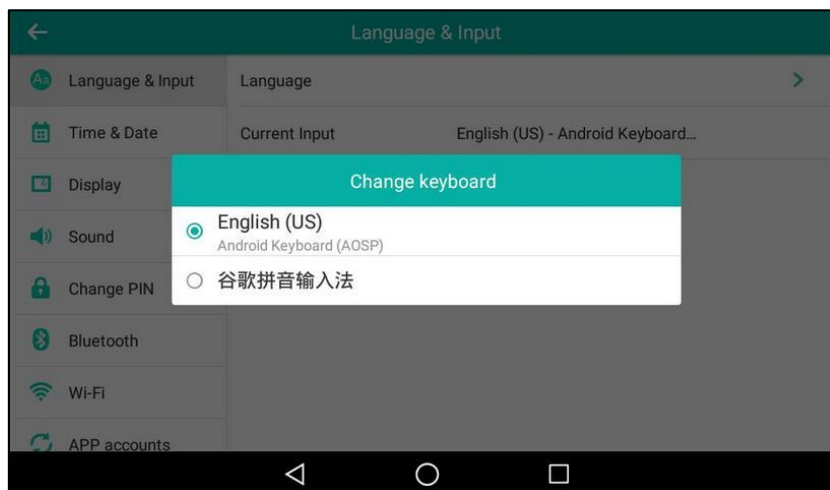

You can also long tap the following keys on the onscreen keyboard to change the input method:

For Android Keyboard (AOSP) - English (US) input method:

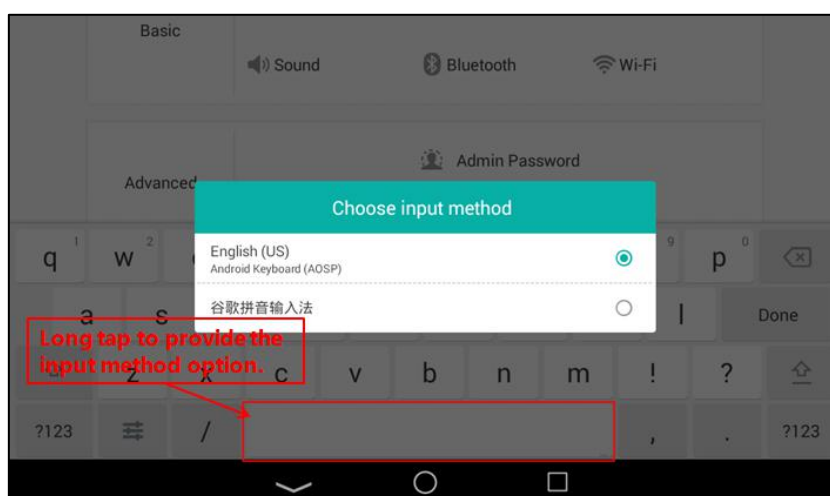

For Google Pinyin input method:

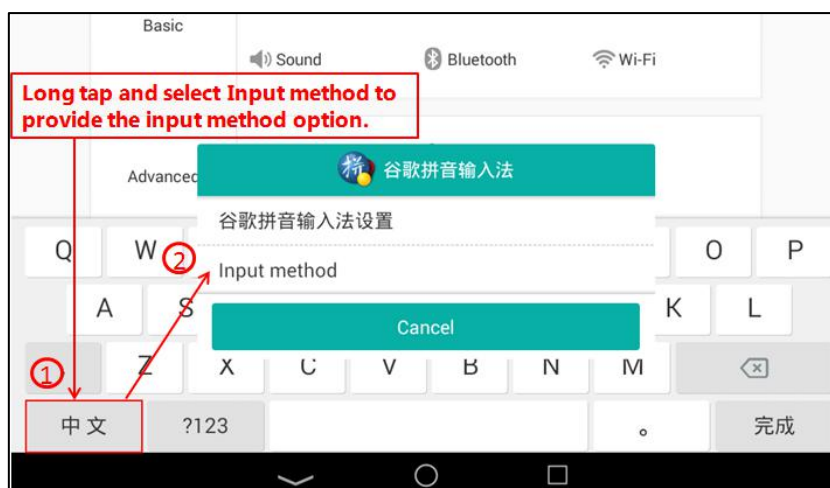

**Note** Input method is configurable via phone user interface only.

## Time & Date

There are three ways to view the time and date via phone user interface:

- Viewing phone's time on the status bar.
- Viewing phone's time and date by digital clock widget (refer to [Clock](#)).
- Viewing phone's time and date in the control center.

You can configure the phone to obtain the time and date from the SNTP server automatically, or configure the time and date manually. If the phone cannot obtain the time and date from the Simple Network Time Protocol (SNTP) server, contact your system administrator for more information.

**To configure the SNTP setting via phone user interface:**

1. Swipe down from the top of the screen or swipe left/right to go to the second idle screen.
2. Tap **Settings**->**Basic**->**Time & Date**->**General**.
3. Tap the **Type** field.
4. Tap **SNTP Settings** in the pop-up dialog box.
5. Tap the **Time Zone** field.
6. Tap the time zone that applies to your area in the pop-up dialog box.  
The default time zone is "+8".
7. Enter the domain name or IP address of SNTP server in the **NTP Server1** and **NTP Server2** field respectively.
8. Tap the **Daylight Saving** field.
9. Tap the desired value in the pop-up dialog box.

10. Tap the **Location** field.  
This field appears only if **Daylight Saving** field is selected to **Automatic**.
11. Tap the desired time zone name in the pop-up dialog box.  
The default time zone name is "China(Beijing)".

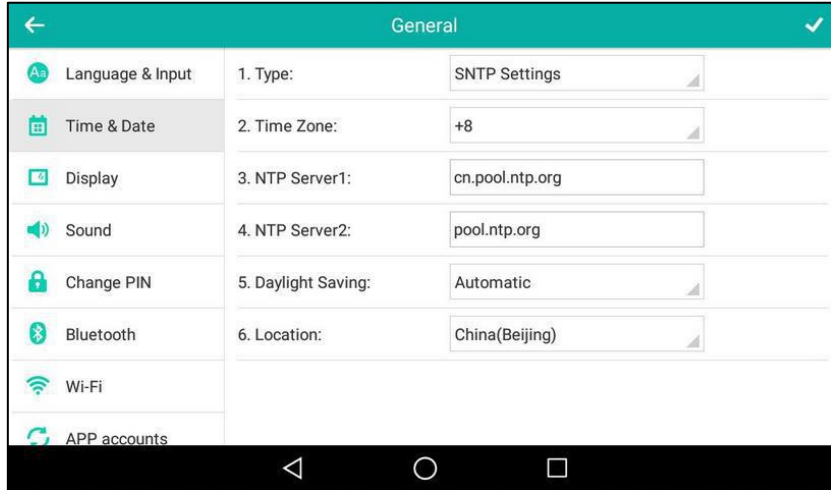

12. Tap ✓ to accept the change or ◀ to cancel.

**Note**

Please refer to [Appendix A - Time Zones](#) for the list of available time zones on the IP phone.

**To configure the time and date manually via phone user interface:**

1. Swipe down from the top of the screen or swipe left/right to go to the second idle screen.
2. Tap **Settings**->**Basic**->**Time & Date**->**General**.
3. Tap the **Type** field.
4. Tap **Manual Settings** in the pop-up dialog box.
5. Enter the specific date and time in the corresponding fields.

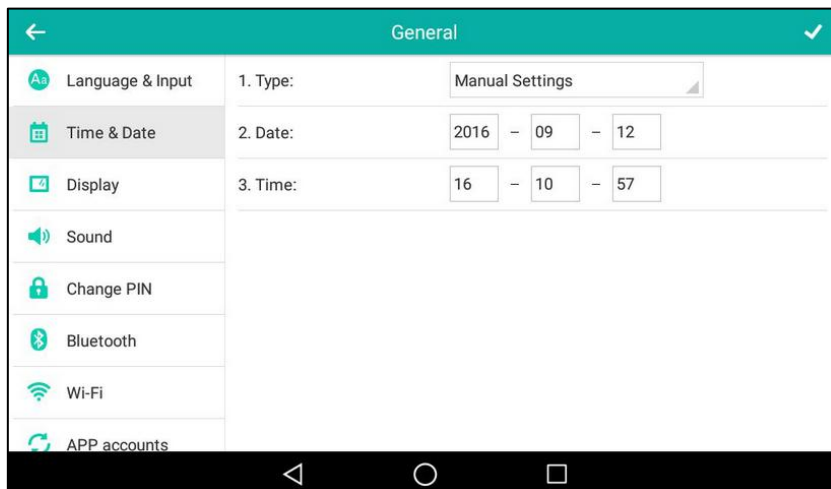

6. Tap ✓ to accept the change or ◀ to cancel.  
The time and date displayed on the touch screen will change accordingly.



You can configure the time format to display the time in 12 Hour format or 24 Hour format. This operation will affect the configuration of Alarm. For more information, refer to [Alarm](#) on page 252.

You can also configure the date format for the time and date that displays on the control center. There are 7 available date formats. For example, for the date format “WWW DD MMM”, “WWW” denotes the abbreviation of the weekday, “DD” denotes the two-digit day, and “MMM” denotes the first three letters of the month.

The date formats available:

Date Format	Example (2016-09-12)
WWW MMM DD	Mon Sep 12
DD-MMM-YY	12-Sep-16
YYYY-MM-DD	2016-09-12
DD/MM/YYYY	12/09/2016
MM/DD/YY	09/12/16
DD MMM YYYY	12 Sep 2016
WWW DD MMM	Mon 12 Sep

#### To configure the date and time format via phone user interface:

1. Swipe down from the top of the screen or swipe left/right to go to the second idle screen.
2. Tap **Settings->Basic->Time & Date->Time & Date Format**.
3. Tap the **Date Format** field.
4. Tap the desired date format in the pop-up dialog box.
5. Tap the **Time Format** field.
6. Tap the desired time format (**12 Hour** or **24 Hour**) in the pop-up dialog box.

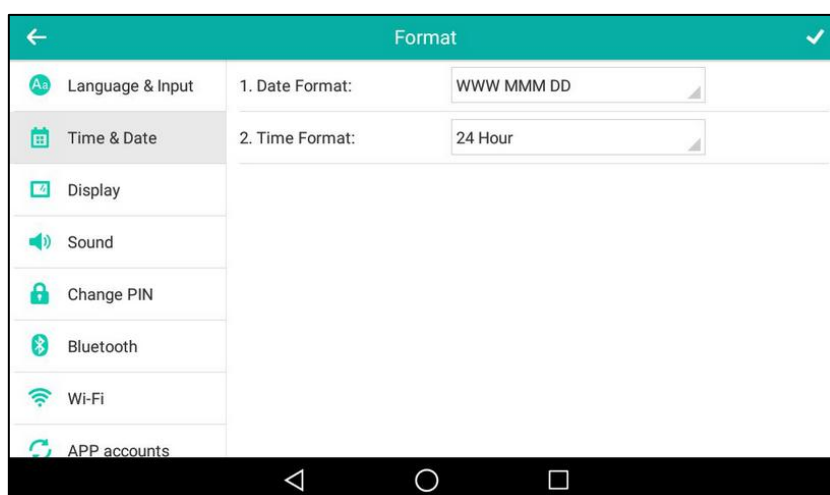

7. Tap to accept the change or to cancel.

Time and date are configurable via web user interface at the path **Settings->Time & Date**.



## Administrator Password

The **Advanced** option is only accessible to the administrator. The default administrator password is "admin". For security reasons, you should change the default administrator password as soon as possible.

### To change the administrator password via phone user interface:

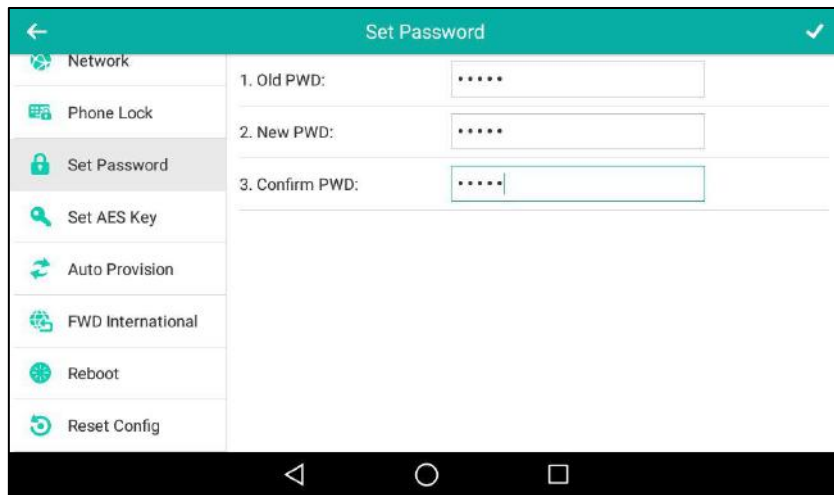
1. Swipe down from the top of the screen or swipe left/right to go to the second idle screen.
2. Tap **Settings->Advanced** (default password: admin) ->**Set Password**.
3. Enter the current password in the **Old PWD** field.
4. Enter the new password in the **New PWD** field.
5. Re-enter the new password in the **Confirm PWD** field.



6. Tap  to accept the change or  to cancel.

Administrator password is configurable via web user interface at the path **Security->Password**.

## Key As Send

You can set the "#" key or "\*" key to perform as a send key while dialing.

### To configure key as send via phone user interface:

1. Swipe down from the top of the screen or swipe left/right to go to the second idle screen.
2. Tap **Settings->Features->Key As Send**.
3. Tap the **Key As Send** field.

4. Tap # or \* in the pop-up dialog box, or tap **Disabled** to disable this feature.

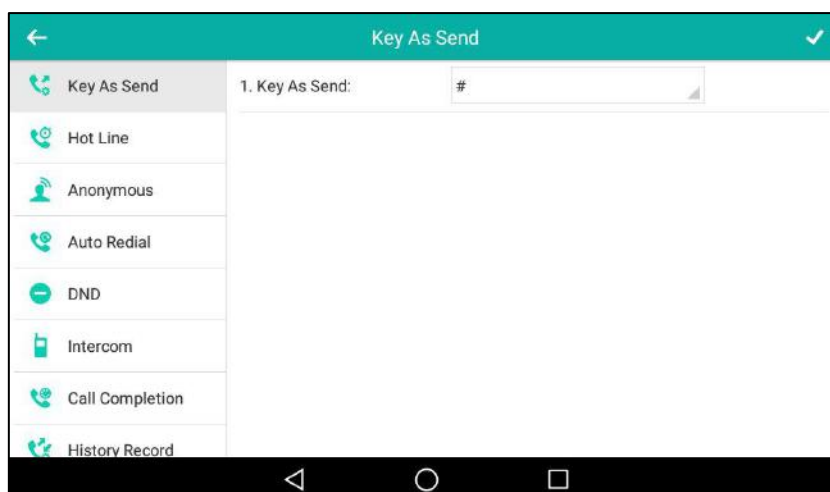

5. Tap ✓ to accept the change or ◀ to cancel.

Key as send is configurable via web user interface at the path **Features->General Information**.

## Phone Lock

You can lock your phone temporarily when you are not using it. This feature helps to protect your phone from unauthorized use.

When the phone is locked, the following you need to know:

All keys and screen are locked except the HEADSET key, Volume key, digit keys, # key, \* key and Speakerphone key. You are only allowed to dial emergency numbers, reject incoming calls by tapping the **Reject** soft key, answer incoming calls by lifting the handset, pressing the Speakerphone key, the HEADSET key or tapping the **Answer** soft key, and end the call by hanging up the handset, pressing the Speakerphone key or tapping the **EndCall** soft key.

### Note

The emergency number setting, if desired, must be made before lock activation. For more information, refer to [Emergency Number](#) on page 177.

### To activate the phone lock via phone user interface:

1. Swipe down from the top of the screen or swipe left/right to go to the second idle screen.
2. Tap **Settings->Advanced** (default password: admin) -> **Phone Lock**.
3. Tap the **Lock Enable** field.
4. Tap **Enabled** in the pop-up dialog box to enable this feature.
5. Enter the desired interval of automatic phone lock in the **Auto Lock** field.

The default timeout is 0. It means the phone will not be automatically locked. You need to long press  to lock it immediately when the phone is idle.

If set to other values except 0 (e.g., 5), the phone will be locked when the phone is inactive in idle screen for the designated time (in seconds).

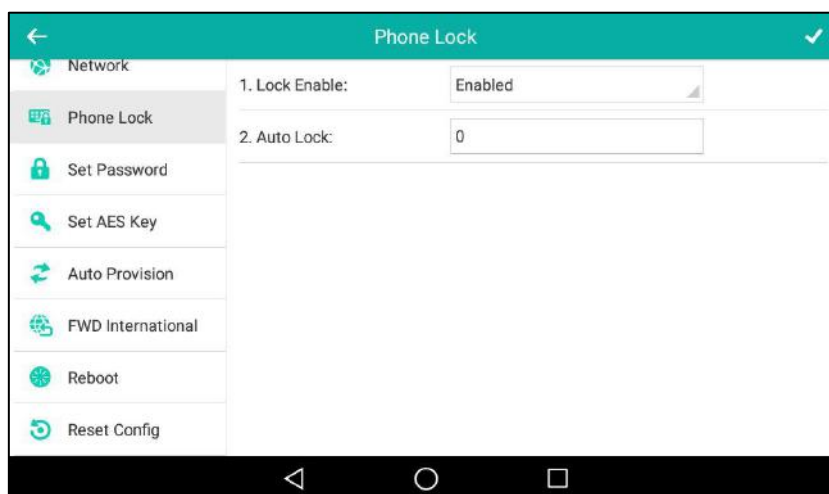

6. Tap ✓ to accept the change.

When the phone is locked, the touch screen prompts "Phone locked." and displays the icon  on the status bar.

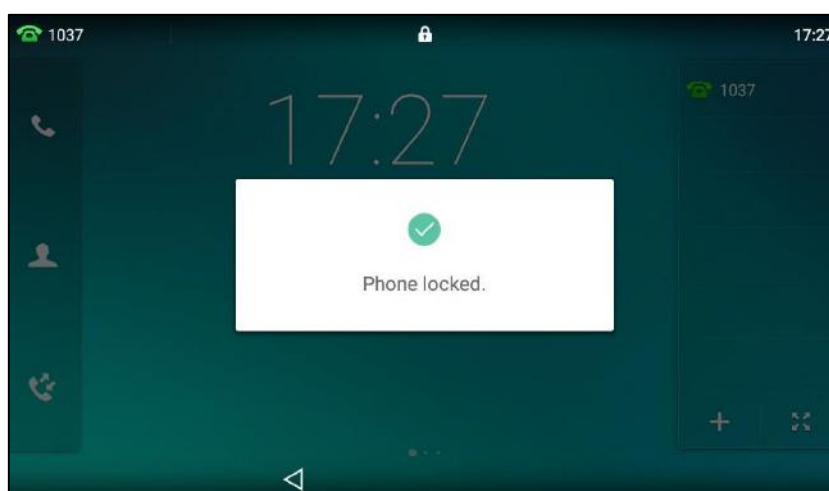



To unlock the phone, you must know the phone unlock PIN. The default phone unlock PIN is "123".

**To unlock the phone via phone user interface:**

1. Tap the screen or tap the locked key, the touch screen prompts "Unlock PIN".

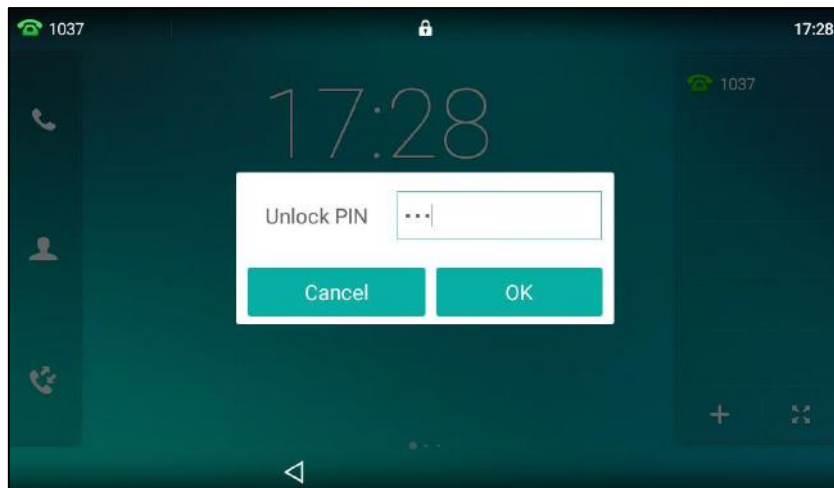
2. Enter the PIN in the **Unlock PIN** field.



3. Press **OK** to unlock the phone.  
The icon  disappears from the status bar.  
You can long press  or wait for a period of time (if configured) to lock the phone again.



**Note**

You can also unlock the phone by administrator password. When you enter the administrator password to unlock the phone, the phone will turn to the Change PIN screen.

**To change the phone unlock PIN via phone user interface:**

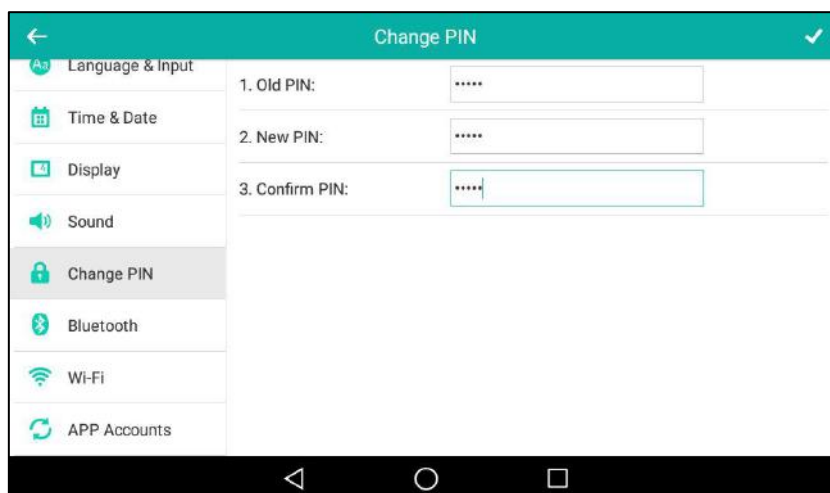
1. Swipe down from the top of the screen or swipe left/right to go to the second idle screen.
2. Tap **Settings**->**Basic**->**Change PIN**.
3. Enter the desired value in the **Old PIN**, **New PIN** and **Confirm PIN** field respectively.



4. Tap  to accept the change or  to cancel.

**Note**

The unlock PIN length must be within 15 digits.

**To deactivate the phone lock via phone user interface:**

1. Swipe down from the top of the screen or swipe left/right to go to the second idle screen.
2. Tap **Settings->Advanced** (default password: admin) ->**Phone Lock**.
3. Tap the **Lock Enable** field.
4. Tap **Disabled** in the pop-up dialog box to disable this feature.

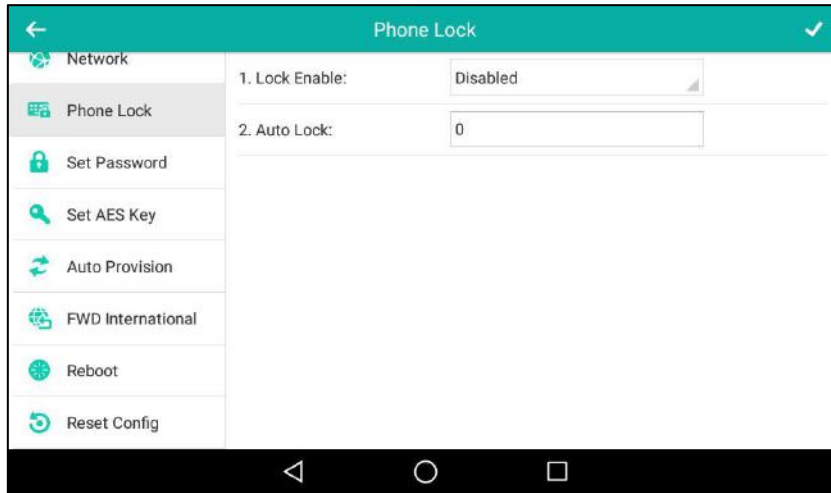

5. Tap  to accept the change.

Phone lock is configurable via web user interface at the path **Features->Phone Lock**.

## Audio Settings

### Volume

For SIP-T58V/A smart media phone, you can adjust the following volume level:

- **Ringer volume:** Press the Volume key to adjust the ringer volume when the phone is idle or ringing. When adjusting ringer volume, the touch sound and notification sound volume will change as well. For more information on ring tones, touch sounds and/or notification sound, refer to [Ring Tones](#) on page 97, [Touch Sounds](#) on page 100 and/or [Notification Sound](#) on page 101.
- **Talking volume:** Press the Volume key to adjust the receiver volume of currently engaged audio devices (handset, speakerphone or headset) when the phone is in use.
- **Key tone volume:** Press the Volume key to adjust the key tone volume when the phone is on the dialing screen. For more information on key tone, refer to [Key Tone](#) on page 99.
- **Media volume:** Press the Volume key to adjust the media volume when playing audios/videos.

**To adjust the ringer volume when the phone is idle:**

1. Press  to adjust the ringer volume.

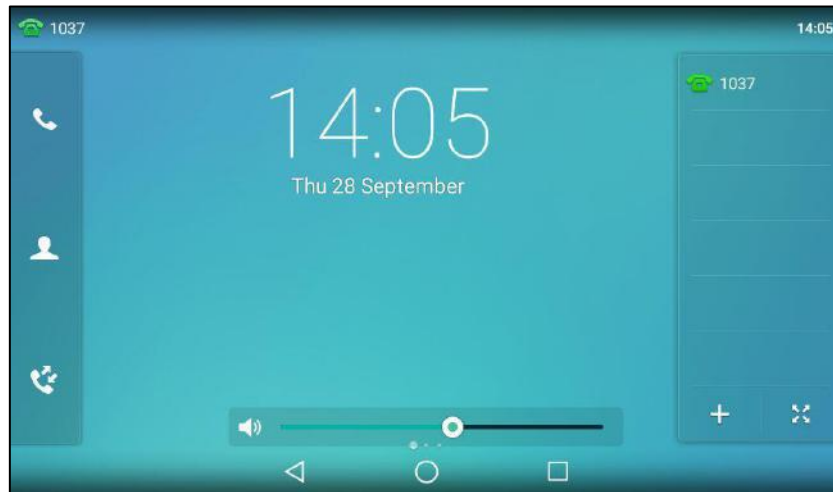
**To adjust the ringer volume when the phone is ringing:**

1. Press  to adjust the ringer volume.



You can also press  to adjust the ringer volume when selecting a ring tone. For more information, refer to [Ring Tones](#) on page 97.

**Note**

If the ringer volume is adjusted to minimum, the icon  will appear on the status bar.

You can also drag the volume slider to adjust the ringer volume.

**To adjust the talking volume:**

When the phone is during a call:

1. Press  to adjust the volume of currently engaged audio device (handset, speakerphone or headset).

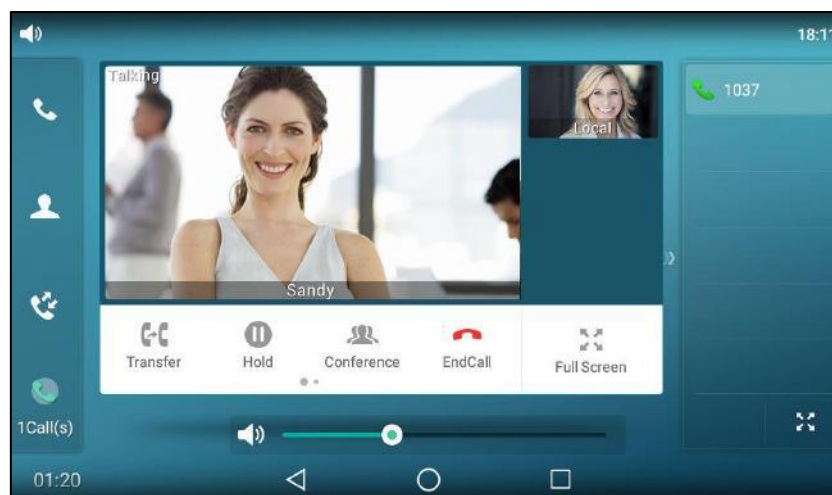

You can also drag the volume slider to adjust the talking volume.

**To adjust the key tone volume:**

When the phone is on the dialing screen:

1. Press  to adjust the key tone volume.

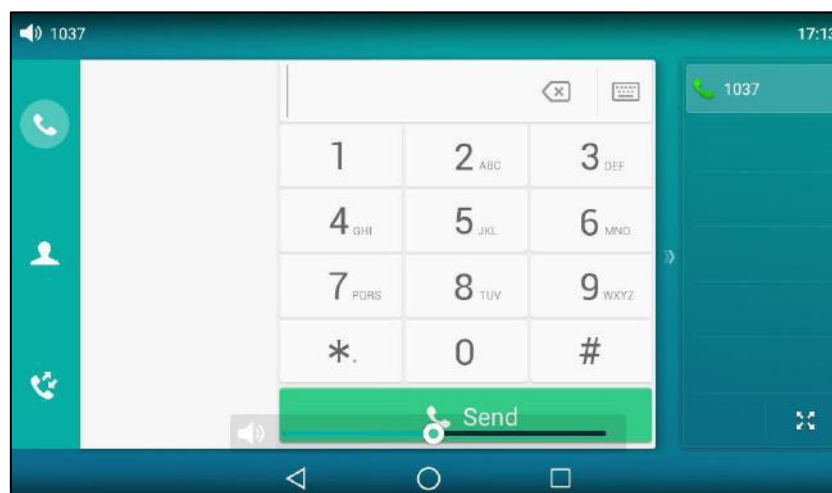

You can also drag the volume slider to adjust the key tone volume.



**To adjust the media volume:**

You can adjust the media volume in multiple scenarios. The following takes playing the audios by **FileManager** application as example:

1. Press  to adjust the media volume.

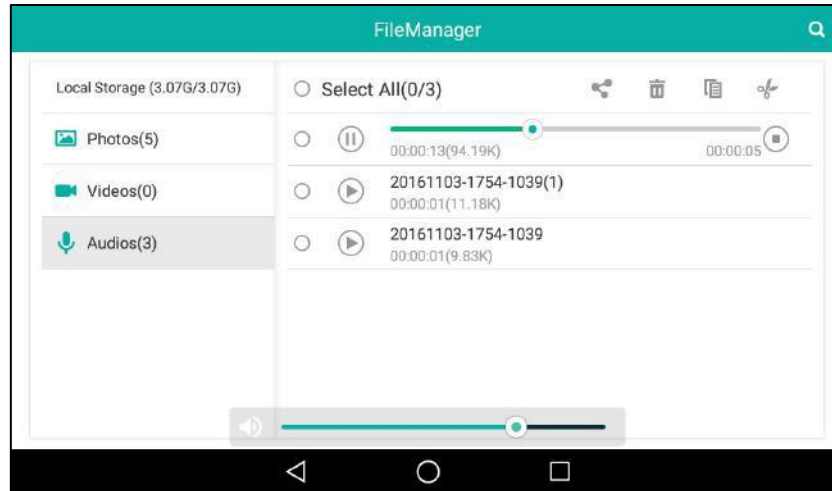

You can also drag the volume slider to adjust the media volume.

## Ring Tones

Ring tones are used to indicate incoming calls. You can select different ring tones to distinguish different accounts registered on your phone, or to distinguish your phone from your neighbor's.

**To select a ring tone for the phone via phone user interface:**

1. Swipe down from the top of the screen or swipe left/right to go to the second idle screen.
2. Tap **Settings->Basic->Sound->Ring Tones->Common**.
3. Drag up and down to scroll through the list of available ring tones.
4. Tap the desired ring tone.

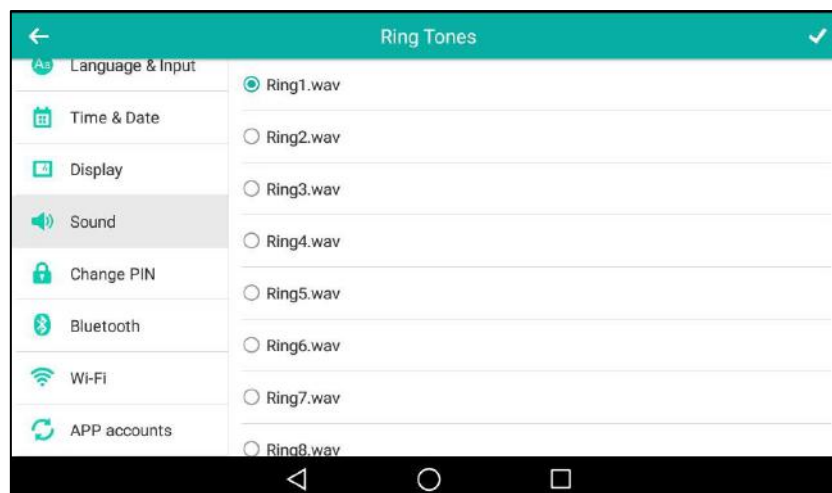

5. (Optional.) Press  to adjust the ringer volume.

6. Tap ✓ to accept the change or ◀ to cancel.

A ring tone for the phone is configurable via web user interface at the path

**Settings->Preference->Ring Type.**

**To select a ring tone for the account via phone user interface:**

1. Swipe down from the top of the screen or swipe left/right to go to the second idle screen.
2. Tap **Settings->Basic->Sound->Ring Tones.**
3. Tap the desired account.
4. Drag up and down to scroll through the list of available ring tones.
5. Tap the desired ring tone.

If **Common** is selected, this account will use the ring tone selected for the phone.

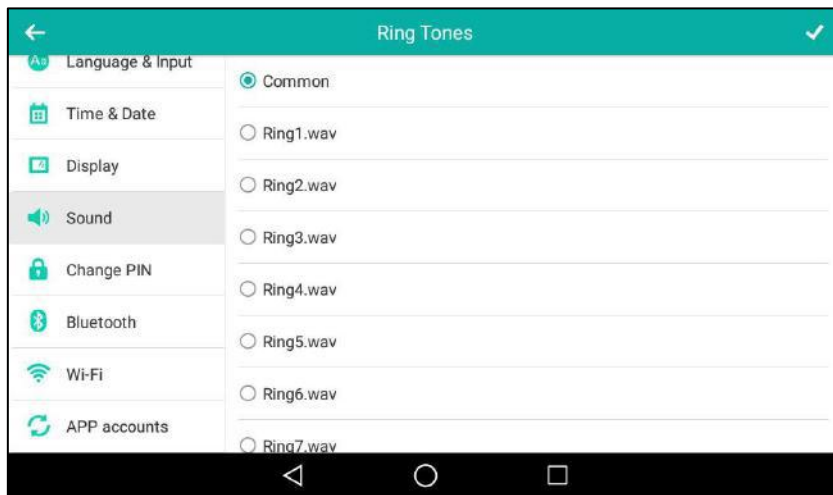

6. (Optional.) Press  to adjust the ringer volume.
7. Tap ✓ to accept the change or ◀ to cancel.

A ring tone for the account is configurable via web user interface at the path

**Account->Basic->Ring Type.**

**To upload a custom ring tone for your phone via web user interface:**

1. Click on **Settings->Preference.**

- In the **Upload Ringtone** field, click **Browse** to locate a ring tone file (the file format must be \*.wav) from your local system.

The screenshot shows the Yealink T58 web interface. The 'Settings' tab is active. On the left, a navigation menu lists various settings categories. The main content area shows several configuration options. The 'Upload Ringtone' field is highlighted with a red box, showing 'No selected file' and a 'Browse...' button. Below it are 'Upload' and 'Cancel' buttons. The 'Ring Type' field is set to 'Ring1.wav'. Other settings include Language (English), Live Dialpad (Disabled), Inter Digit Time (4), Backlight Active Level (8), Backlight Time (Always On), WatchDog (Disabled), Wallpaper (Default.jpg), and Wallpaper for Expansion Modules (Default-exp50.jpg). A 'NOTE' box on the right states: 'Preference Settings: The preference settings for administrator. You can click here to get more guides.'

- Click **Upload** to upload the file.

The custom ring tone appears in the pull-down list of **Ring Type**.

You can only delete the custom ringtone by clicking **Del** in the **Ring Type** field.

#### Note

The priority of ring tone for an incoming call on the phone is as follows:  
Contact ring tone (refer to [Adding Contacts](#)) > Group ring tone (refer to [Adding Groups](#)) > Account ring tone > Phone ring tone.

Single custom ring tone file must be within 8MB. Uploading custom ring tones for your phone is configurable via web user interface only.

## Key Tone

If you enable key tone, the phone will produce a sound when you press the keypad or tap any key on the onscreen dial pad.

#### To enable key tone via phone user interface:

- Swipe down from the top of the screen or swipe left/right to go to the second idle screen.
- Tap **Settings**->**Basic**->**Sound**->**Key Tone**.

3. Tap the **On** radio box in the **Key Tone** field.

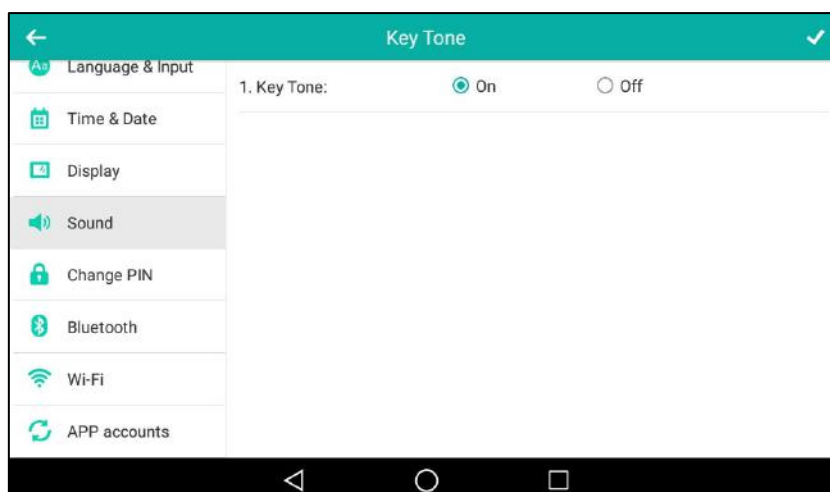

4. Tap ✓ to accept the change or ◀ to cancel.

Key tone is configurable via web user interface at the path **Features->Audio**.

## Touch Sounds

If you enable touch sounds, the phone will produce a sound when you tap an option on the touch screen.

**To enable touch sounds via phone user interface:**

1. Swipe down from the top of the screen or swipe left/right to go to the second idle screen.
2. Tap **Settings->Basic->Sound->Touch Sounds**.
3. Tap the **On** radio box in the **Touch Sounds** field.

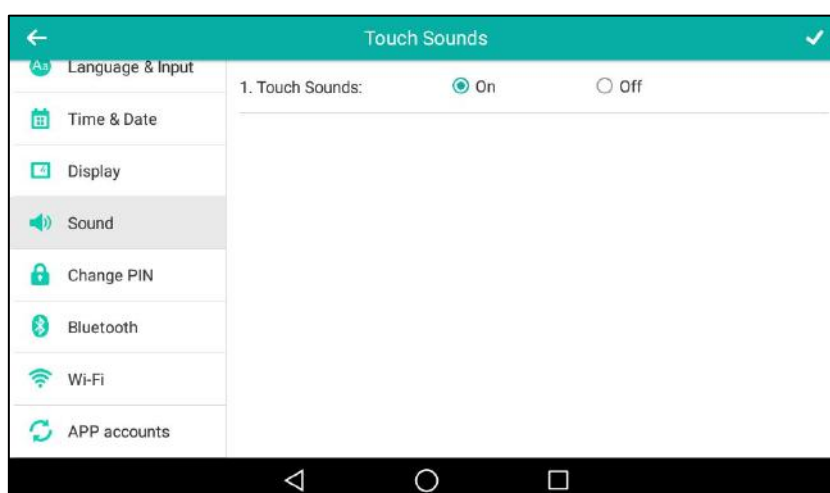

4. Tap ✓ to accept the change or ◀ to cancel.

**Note** Touch sound is configurable via phone user interface only.

## Notification Sound

The phone will produce a notification sound when receiving a notification (e.g., incoming email notification).

**To select a notification sound for the phone via phone user interface:**

1. Swipe down from the top of the screen or swipe left/right to go to the second idle screen.
2. Tap **Settings**->**Basic**->**Sound**.
3. Tap the **Notification Sound** field.
4. Tap the desired notification sound in the pop-up dialog box.

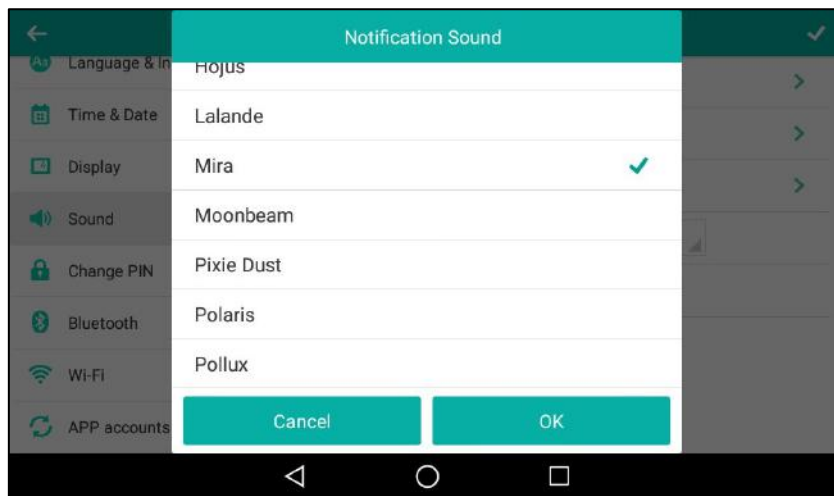

5. (Optional.) Press  to adjust the notification sound.
6. Tap **OK** to accept the change or **Cancel** to cancel.

### Note

Notification sound is configurable via phone user interface only.

## Silent Mode

If you turn on the silent mode, the IP phone won't produce ring tone/key tone/touch sound/notification sound from phone's speaker.

**To enable the silent mode via phone user interface, do one of the following:**

- Swipe down from the top of the screen or swipe left/right to go to the second idle screen.  
Tap **Settings**->**Basic**->**Sound**.

Tap the **On** radio box in the **Silent Mode** field.

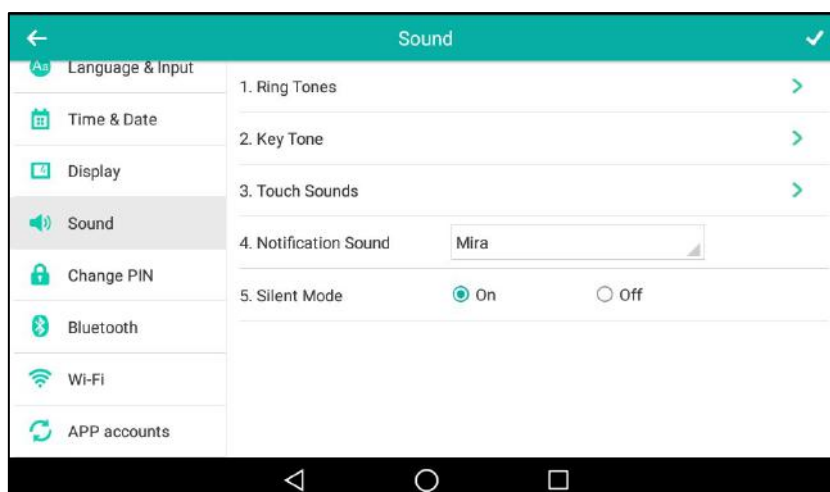

Tap to accept the change or to cancel.

- Press to adjust the ringer volume to minimum.
- Swipe down from the top of the screen to enter the control center and toggle **Silent** on.

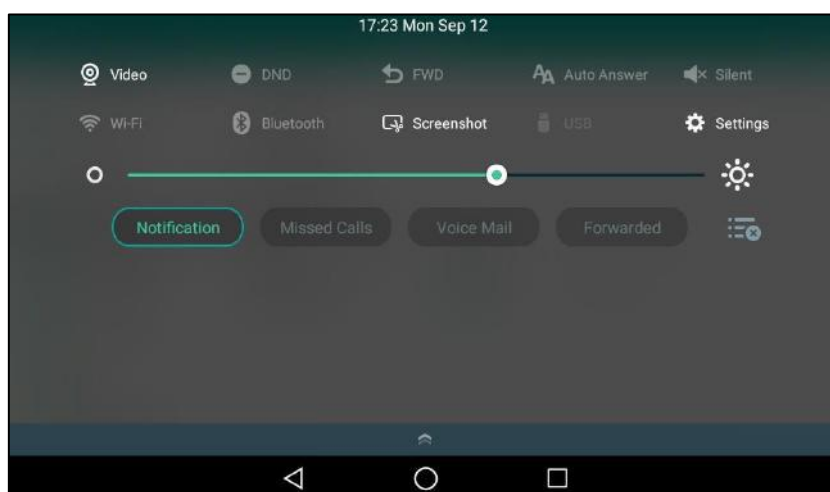

**Note** Silent mode is configurable via phone user interface only.  
 You may have no permission to turn on the silent mode. Contact your system administrator for more information.

## Contact Management

This section provides the operating instructions for managing contacts. Topics include:

- [Local Directory](#)
- [Blacklist](#)
- [Remote Phone Book](#)
- [Mobile Contacts](#)

## Local Directory

The built-in phone directory can store the names and phone numbers of your contacts. You can store up to 1000 contacts and 48 groups in your phone's local directory. You can add new groups and contacts, edit, delete or search for a contact, or simply dial a contact number from the local directory.

## Adding Groups

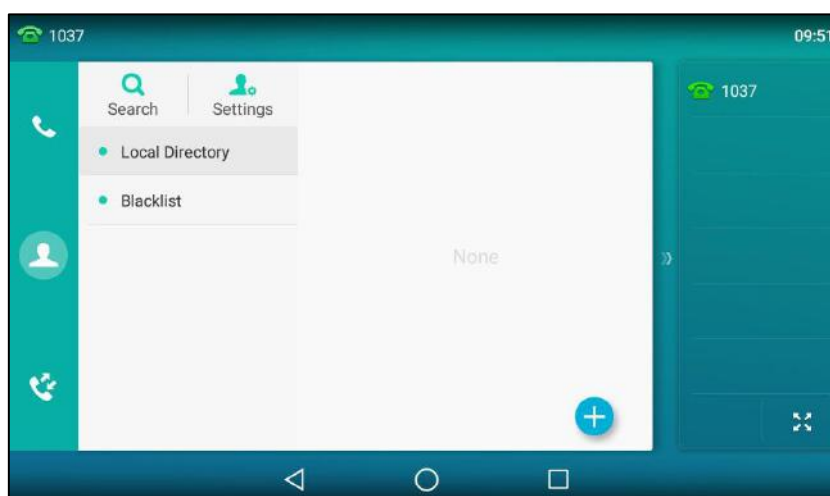

**To add a group to the local directory:**

1. Tap  .

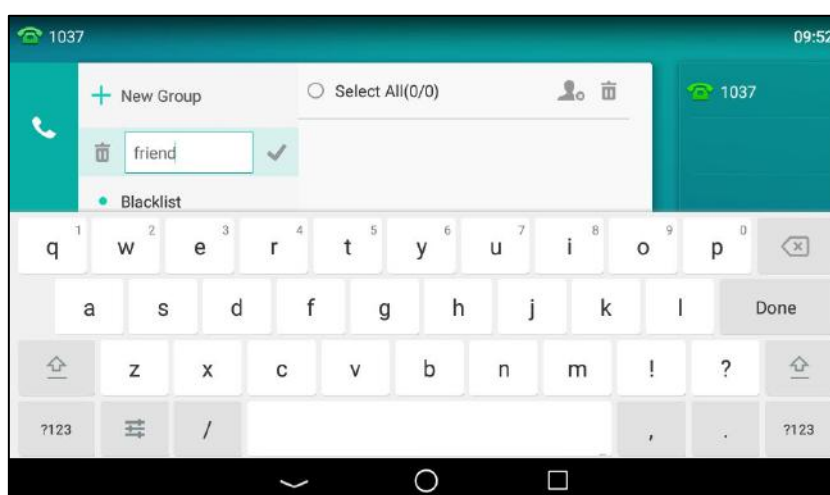

2. Tap **Settings**.
3. Tap **New Group**.
4. Enter the desired group name in the highlighted field.



5. Tap  to accept the change.
6. Tap  after the group name to specify a ring tone for the group.

7. Tap the desired ring tone in the pop-up dialog box.

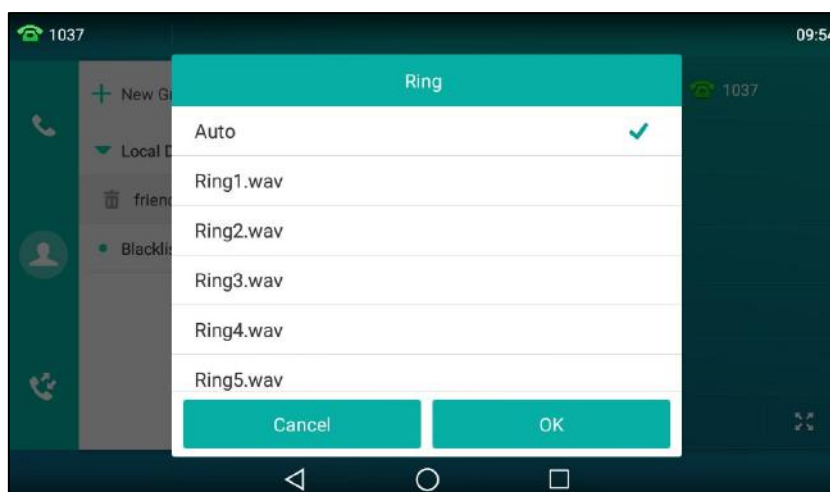

If **Auto** is selected, this group will use the ring tone according to the priority: Contact ring tone (refer to [Adding Contacts](#)) >Account ring tone (refer to [Ring Tones](#)) >Phone ring tone (refer to [Ring Tones](#)). If a specific ring tone is selected, this group will use the ring tone according to the priority: Contact ring tone (refer to [Adding Contacts](#)) >Group ring tone.

8. Tap **OK** to accept the change.

## Editing Groups

**To edit a group in the local directory:**

1. Tap .

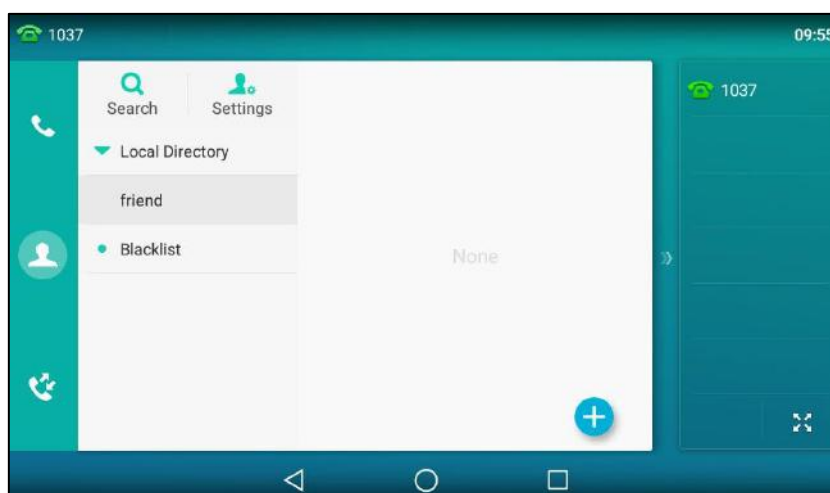

2. Tap **Settings**.
3. Tap the desired group.



4. Tap  after the group name.

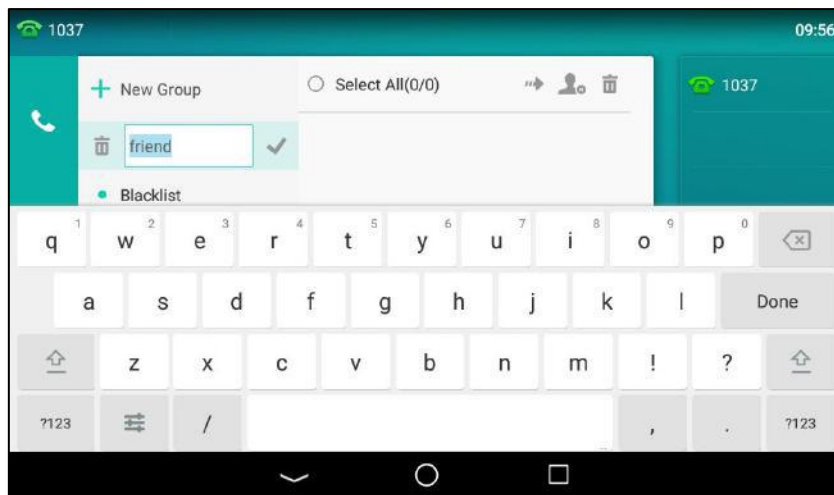

5. Edit the group name in the highlighted field.
6. Tap  to accept the change.

## Deleting Groups

To delete a group from the local directory:

1. Tap .

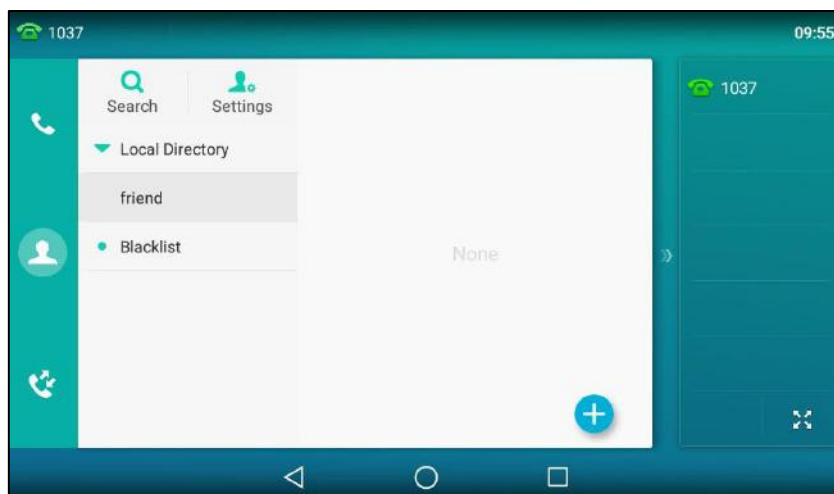

2. Tap **Settings**.

3. Tap  before the desired group name.  
The touch screen prompts the following warning:

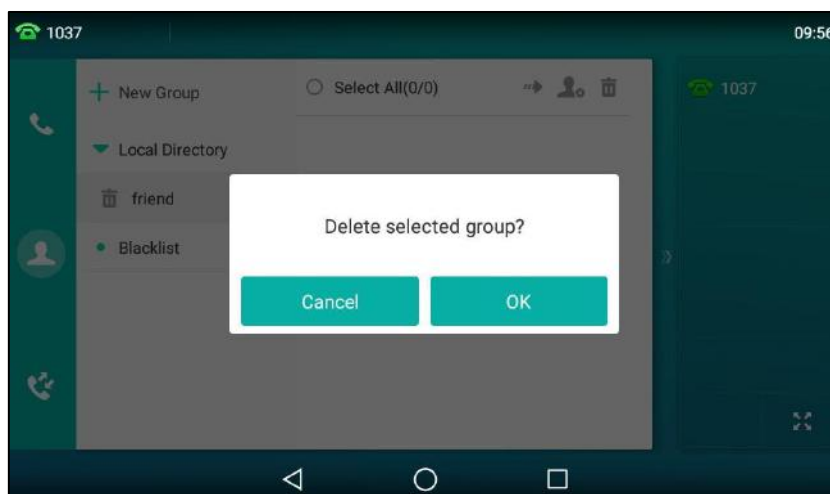

4. Tap **OK** to accept the change or **Cancel** to cancel.

## Adding Contacts

You can add contacts to the local directory in one of the following ways:

- Manually
- From call history
- From a remote phone book

### Adding Contacts Manually

**To add a contact to the local directory manually:**

1. Tap  .

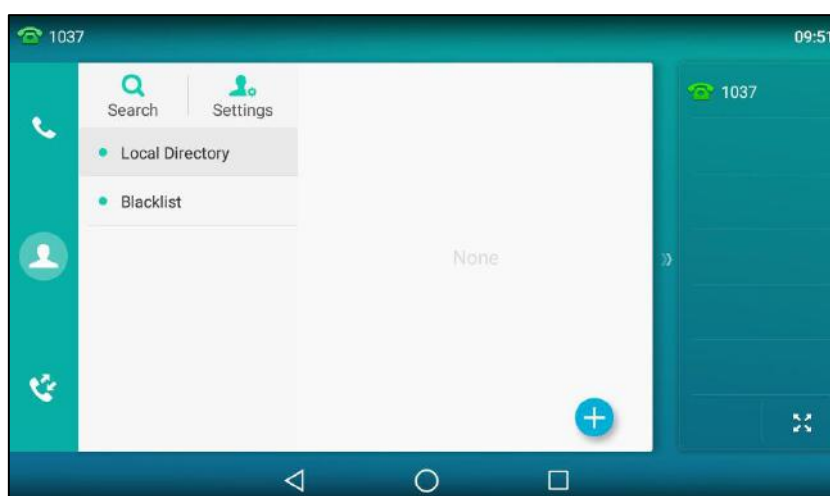



2. Tap  .

If you want to add a contact to the specified contact group, you can tap the contact group

first, and then tap .

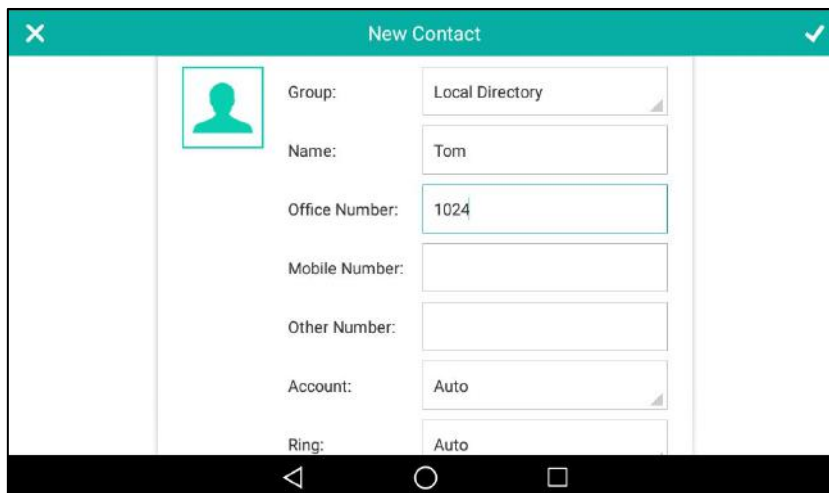
3. Enter the name and the office, mobile or other numbers in the corresponding fields.



4. Tap the **Account** field.
5. Tap the desired account in the pop-up dialog box.  
If **Auto** is selected, the phone will use the default account when placing calls to the contact from the local directory.
6. Tap the **Ring** field.
7. Tap the desired ring tone in the pop-up dialog box.  
If **Auto** is selected, this contact will use the ring tone according to the priority: Group ring tone (refer to [Adding Groups](#)) > Account ring tone (refer to [Ring Tones](#)) > Phone ring tone (refer to [Ring Tones](#)).
8. Tap the **Photo** field.
9. Tap the desired photo in the pop-up dialog box.
10. Tap  to accept the change or tap  and then tap **Discard** to cancel.

#### Note

If the contact already exists in the directory, the touch screen will prompt "Contact name already exists!".

## Adding Contacts from Call History

**To add a contact to the local directory from call history:**

1. Tap .
2. Drag up and down to view the list of call history.

3. Tap  after the desired entry.

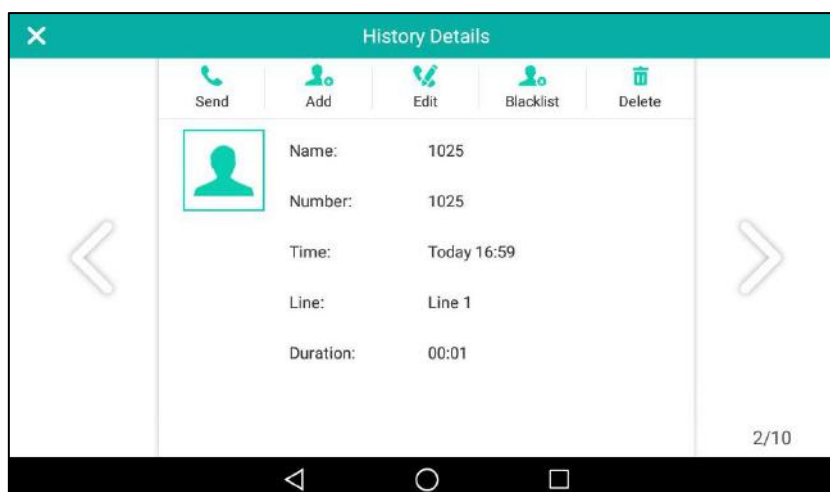

4. Tap **Add**.
5. Edit the corresponding fields.

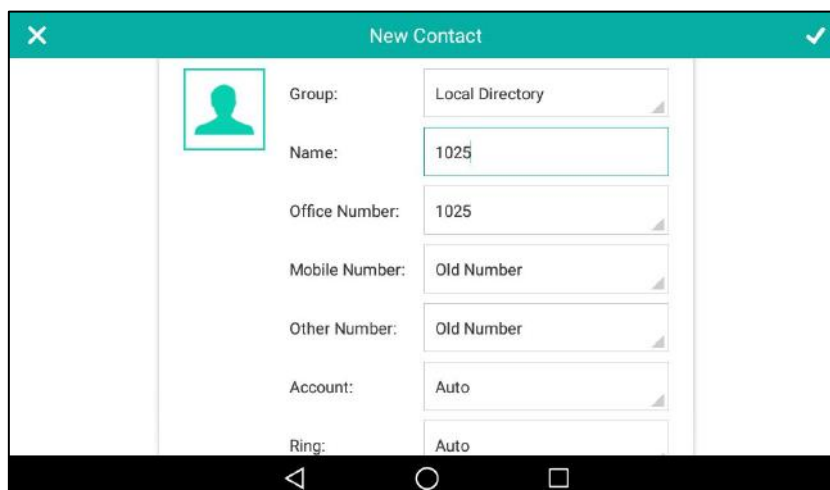



6. Tap  to accept the change.  
The entry is successfully saved to the local directory.

## Adding Contacts from a remote phone book

To add a contact to the local directory from a remote phone book:

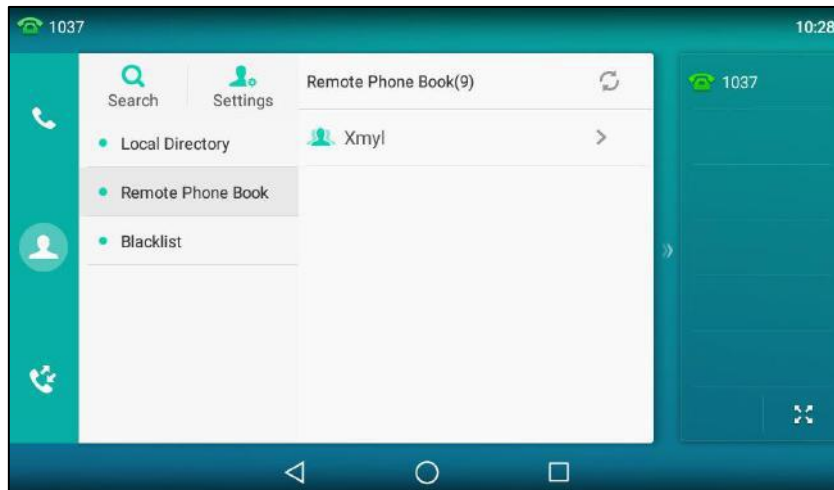
1. Tap  -> **Remote Phone Book**.



2. Tap the desired remote phone book.  
The phone then connects to the remote phone book and proceeds to load it. The contacts in the remote phone book are displayed on the touch screen.
3. Tap  after the desired contact in the remote phone book.

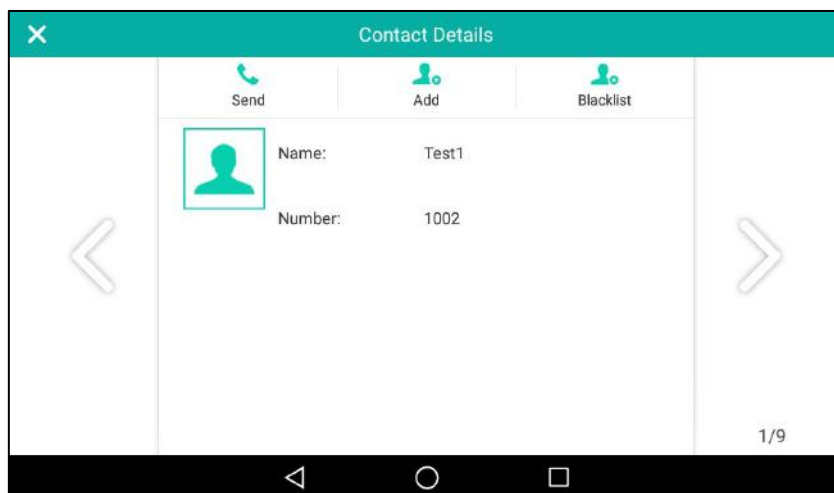

4. Tap **Add**.

5. Edit the corresponding fields.

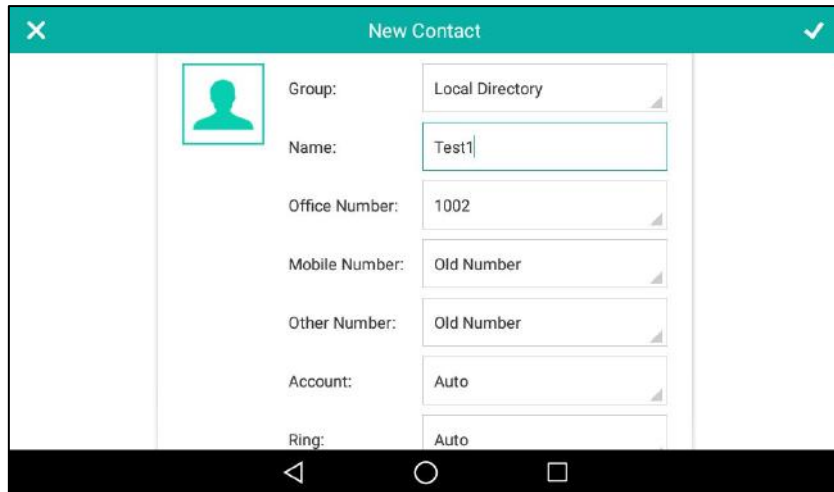

6. Tap to accept the change or tap and then tap **Discard** to cancel.  
If the contact already exists in the local directory, the touch screen will prompt "Overwrite the original contact?". Tap **OK** to overwrite the original contact in the local directory or **Cancel** to cancel.

For more information on remote phone book operation, refer to [Remote Phone Book](#) on page 121.

## Editing Contacts

**To edit a contact in the local directory:**

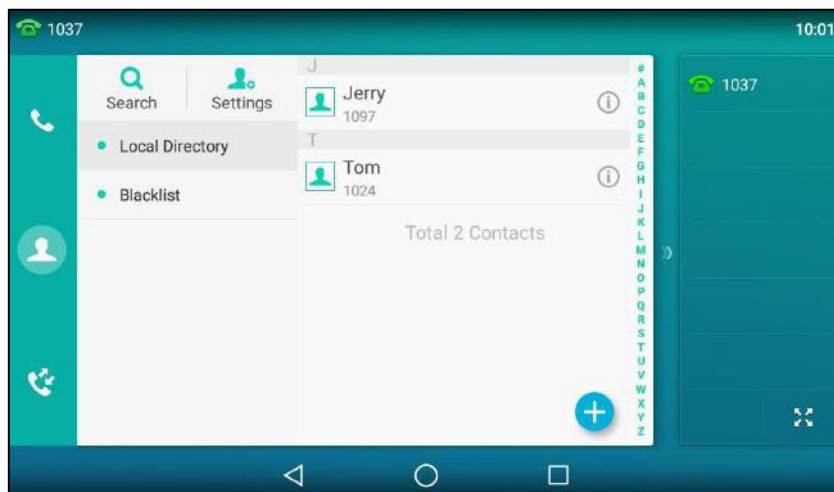

1. Tap .



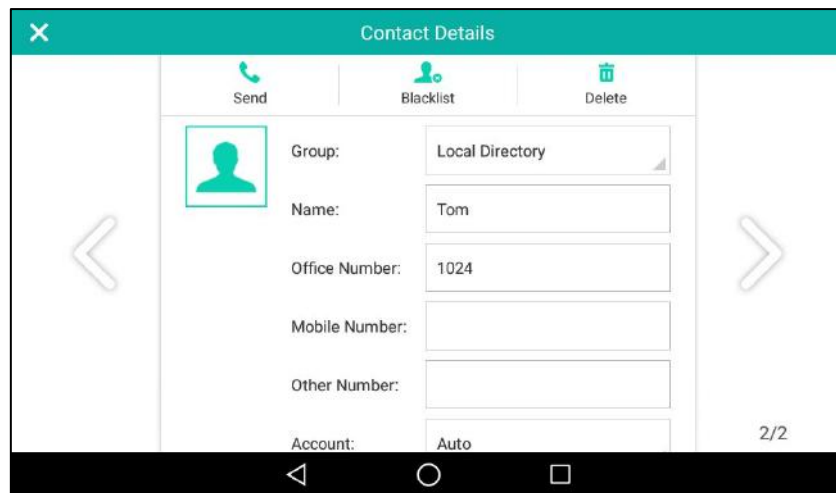

2. Tap after the desired contact.  
If the contact was added to a specified contact group, you can tap the contact group first, and then tap after the desired contact.

3. Tap the desired field to edit the contact information.



You can tap  or  to change the contact you want to edit.



4. Tap  to accept the change or tap  and then tap **Discard** to cancel.

## Deleting Contacts

**To delete a contact from the local directory:**

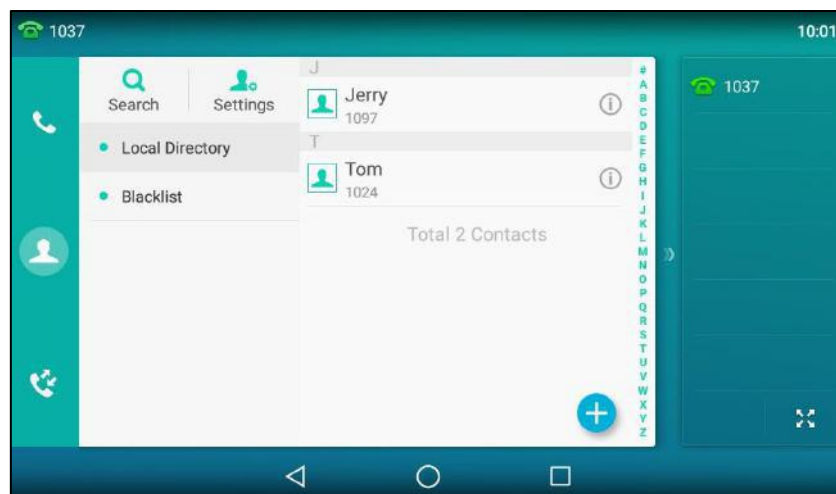
1. Tap .



2. Tap  after the desired contact.  
If the contact was added to a specified contact group, you can tap the contact group first, and then tap  after the desired contact.
3. Tap **Delete**.

The touch screen prompts the following warning:

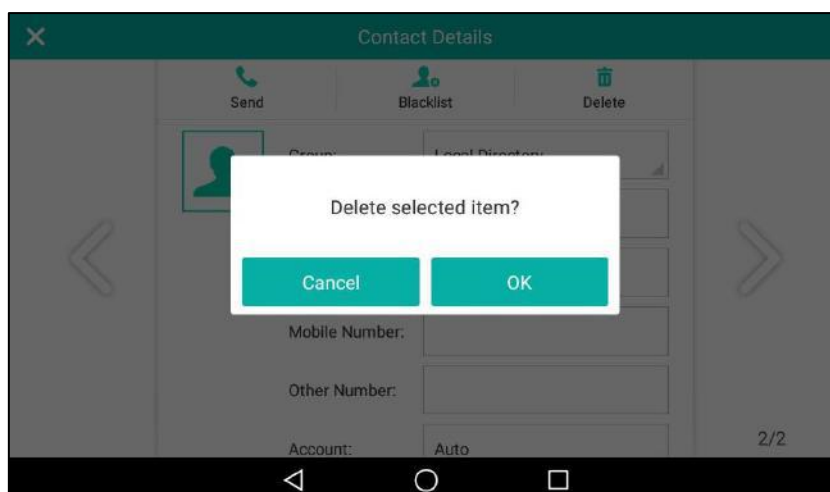

4. Tap **OK** to accept the change or **Cancel** to cancel.

**To delete all contacts:**

1. Tap  .

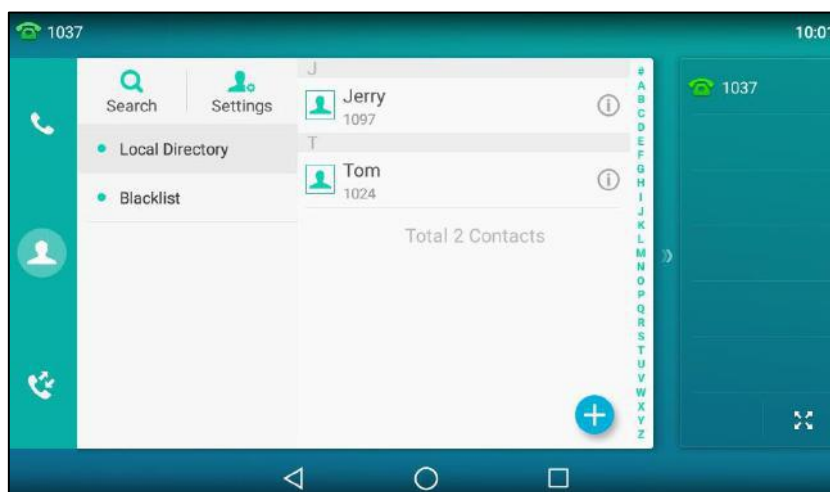

2. Tap **Settings**.
3. Tap the **Select All** radio box.
4. Tap  .



The touch screen prompts the following warning:

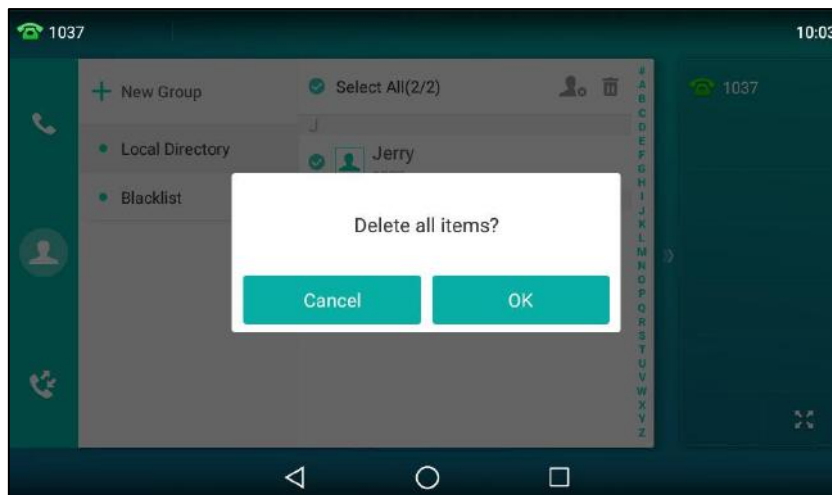

5. Tap **OK** to accept the change or **Cancel** to cancel.

## Uploading Contact Photos

To upload a new custom photo for the contact via web user interface:

1. Click on **Directory**->**Local Directory**.
2. Click **Upload Photo**, and then locate and upload a photo file from your local computer.

The web user interface prompts "Upload success!".

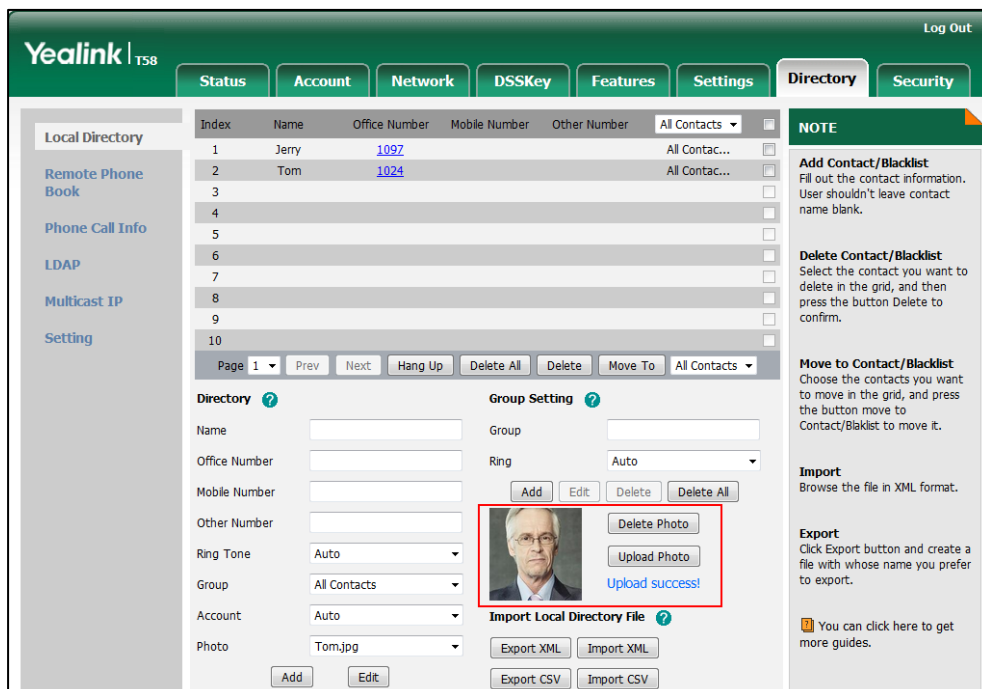

You can click **Delete Photo** to delete the custom photo.

**Note**

The phone only supports \*.png, \*.jpg, \*.jpeg and \*.bmp format files. The file size must be less than 2M.

You can only delete custom photos.

**To change the custom photo for the contact via web user interface:**

1. Click on **Directory**->**Local Directory**.
2. Click the desired contact you want to edit.
3. Select the desired photo from the pull-down list of **Photo**.

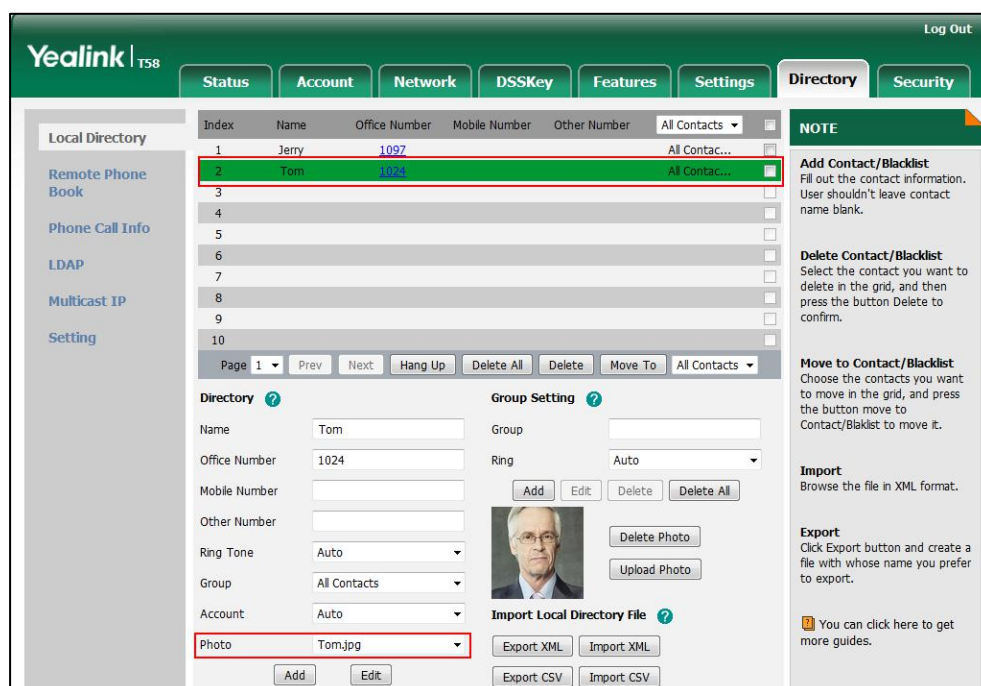

4. Click **Edit** to accept the change.

When you place a call to the contact or receive a call from the contact, the touch screen will display the contact photo.

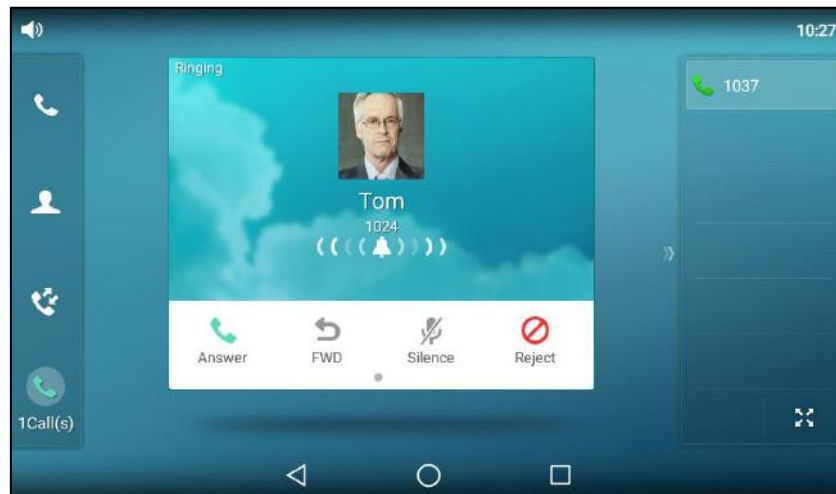

## Placing Calls to Contacts

To place a call to a contact from the local directory:

1. Tap .

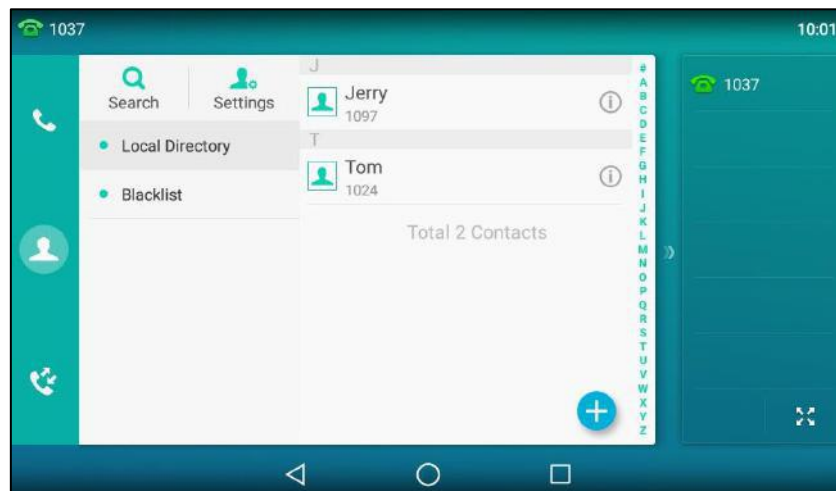

2. If the contact was added to a specified contact group, you can tap the contact group first, and then do one of the following:
  - Tap the desired contact.
    - If only one number for the contact is stored in the local directory, the IP phone will dial out the number.
    - If multiple numbers for the contact are stored in the local directory, tap the desired number to dial out.
  - Tap  after the desired contact.
    - If only one number for the contact is stored in the local directory, tap **Send** to dial out the number.

- If multiple numbers for the contact are stored in the local directory, tap **Send** to display all numbers.

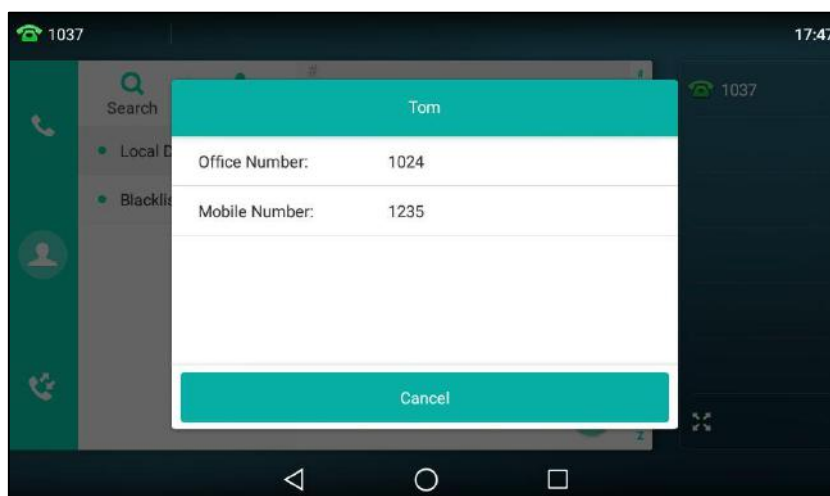

Tap the desired number to dial out.

## Searching for Contacts

To search for a contact in the local directory:

1. Tap  .

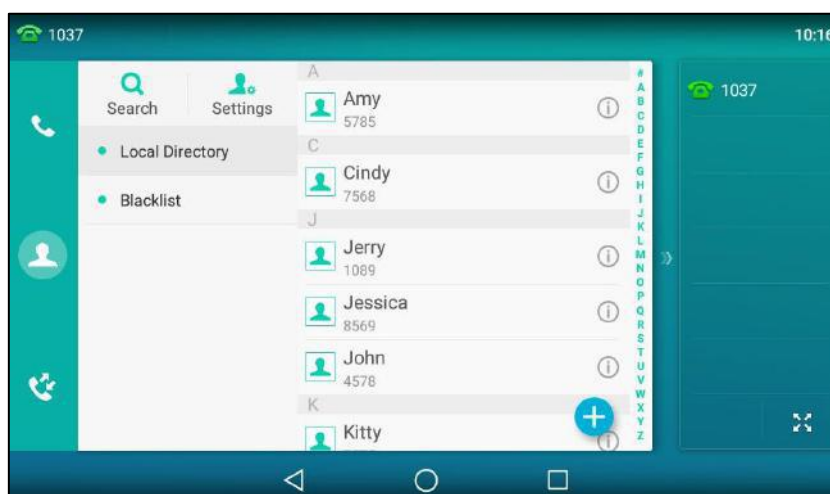

2. Do one of the following :
  - Tap **Search**.

Enter a few continuous characters of the contact name or continuous numbers of the contact number (office, mobile or other number) using the onscreen keyboard.

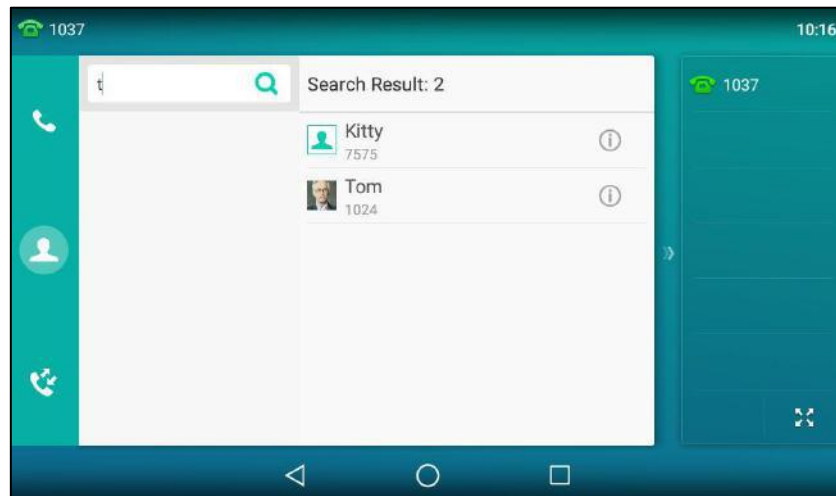

The contacts whose name or phone number matches the characters entered will appear on the touch screen. You can dial from the result list.

- Tap the desired letter (e.g., T) along the right side to jump to contacts whose names start with T or t.

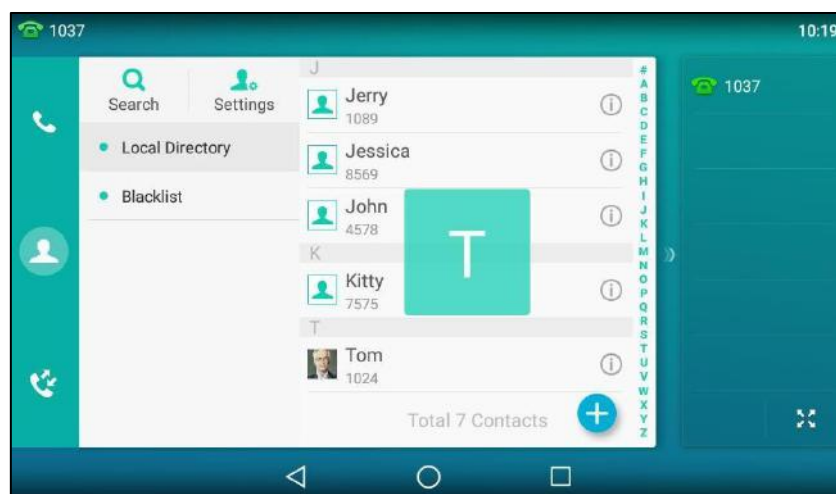

Drag up and down to select the desired contact to view or dial out.

## Importing/Exporting Contact Lists

You can manage your phone's local directory via phone user interface or web user interface. But you can only import or export the contact list via web user interface.

**To import an XML contact list file via web user interface:**

1. Click on **Directory**->**Local Directory**.

- Click **Import XML** to locate and upload a contact list file (the file format must be \*.xml) from your local system.

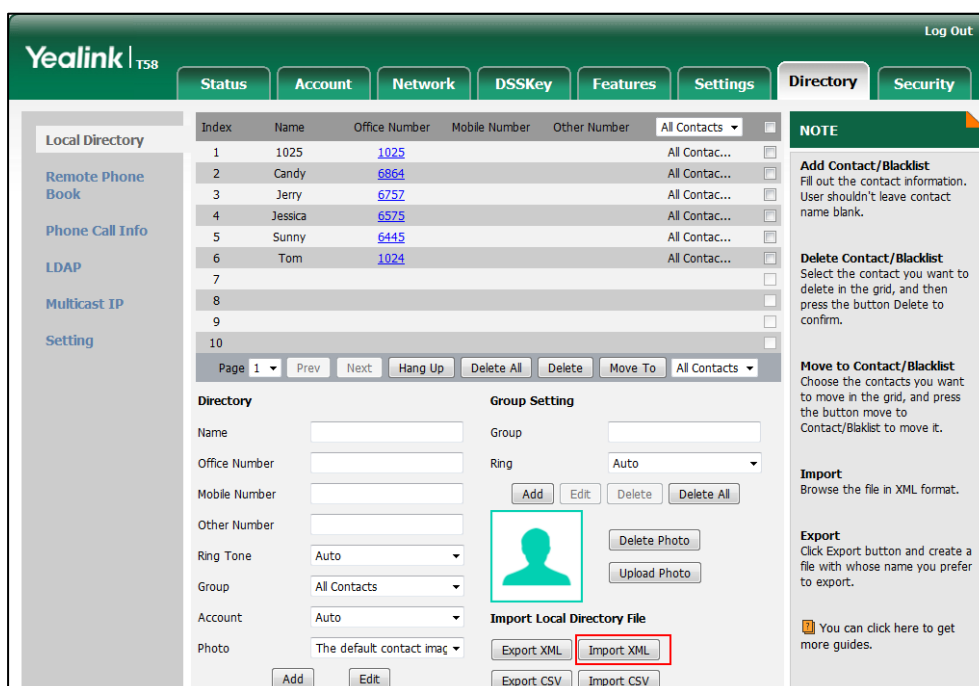

The web user interface prompts "The original contact will be covered, continue?".

- Click **OK** to complete importing the contact list.

**To import a CSV contact list file via web user interface:**

- Click on **Directory**->**Local Directory**.
- Click **Import CSV** to locate and upload a contact list file (the file format must be \*.csv) from your local system.

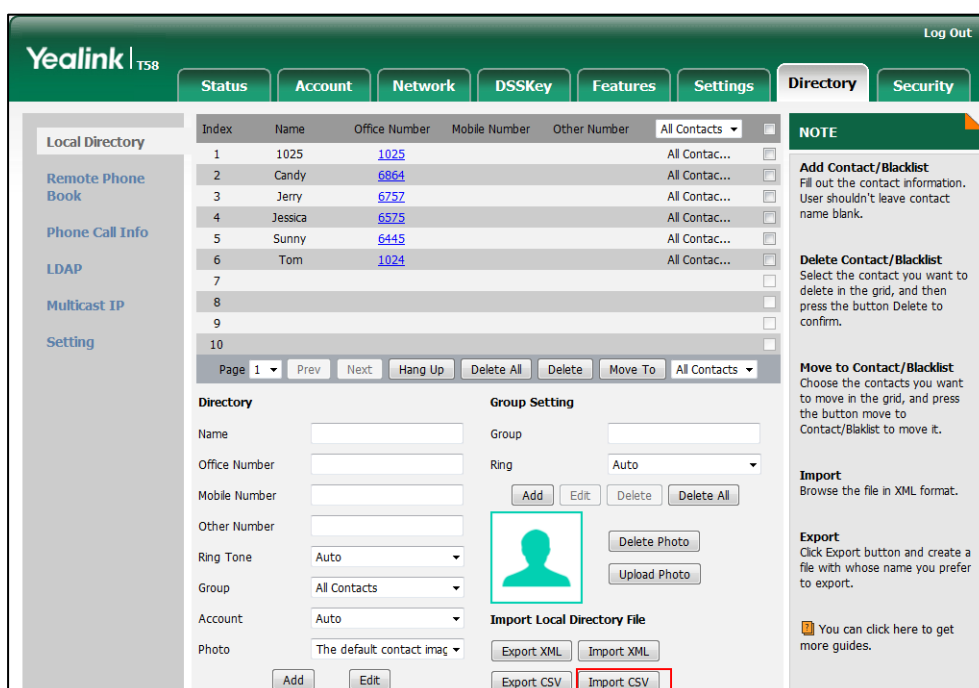

3. (Optional.) Check the **Show Title** checkbox.  
It will prevent importing the title of the contact information which is located in the first line of the CSV file.
4. (Optional.) Check the **Delete Old Contacts** checkbox.  
It will delete all existing contacts while importing the contact list.

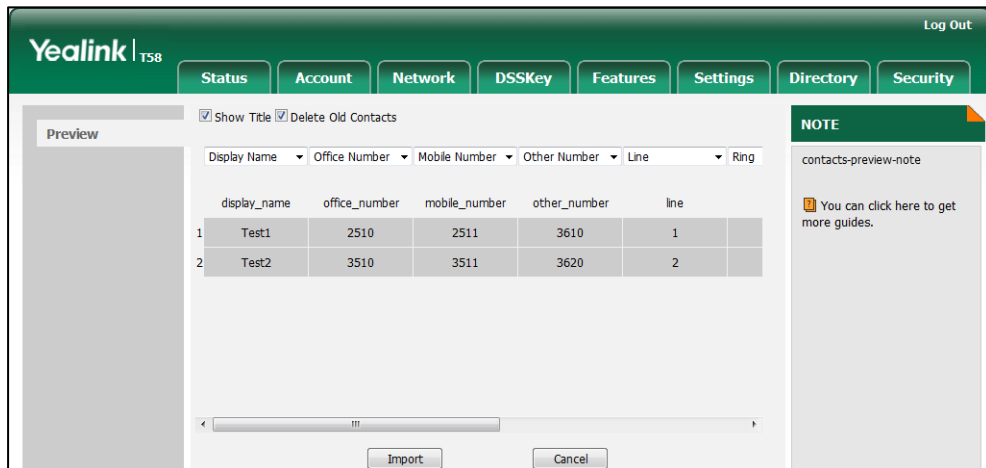

5. Click **Import** to complete importing the contact list.

**To export a contact list via web user interface:**

1. Click on **Directory**->**Local Directory**.
2. Click **Export XML** (or **Export CSV**).

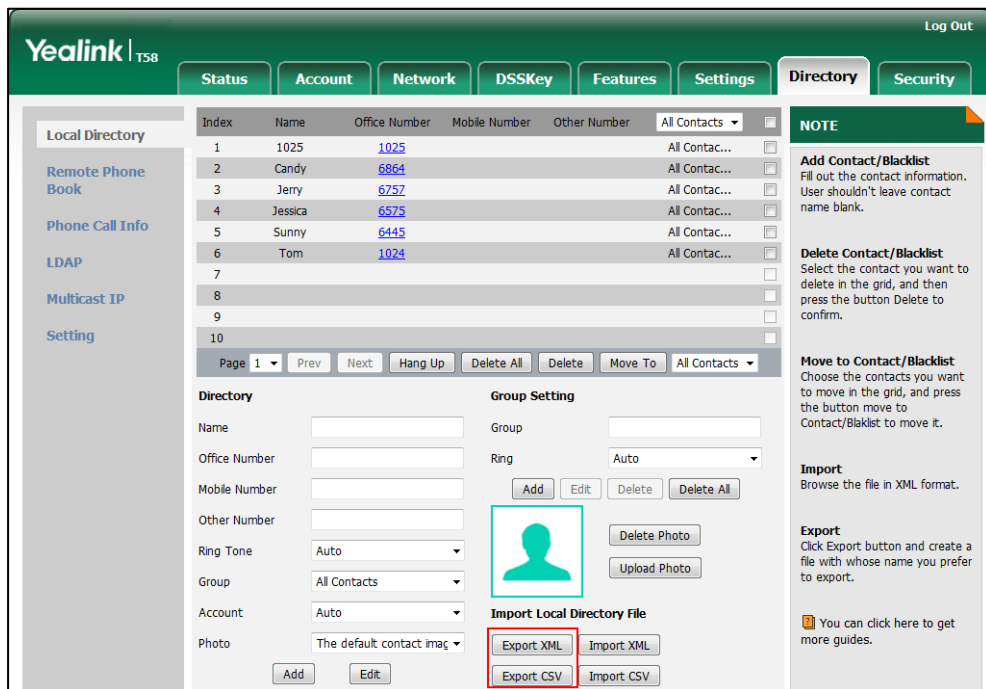

3. Click **Save** to save the contact list to your local system.

**Note**

Importing/exporting contact lists is available via web user interface only.

## Blacklist

The built-in phone directory can store names and phone numbers for a blacklist. You can store up to 30 contacts; add, edit, delete or search for a contact in the blacklist directory, and even call a contact from the blacklist directory. Incoming calls from the blacklist directory contacts will be rejected automatically.

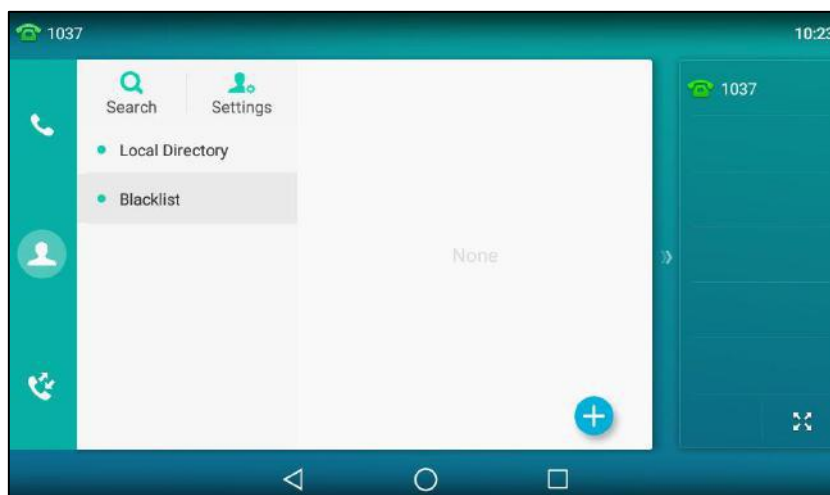

### To add a contact to the blacklist directory manually:

1. Tap  -> **Blacklist**.



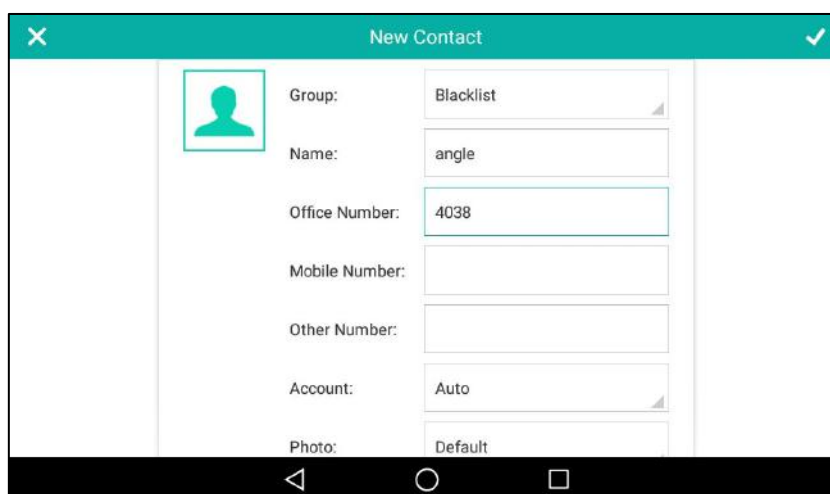

2. Tap .
3. Enter the contact's name and the office, mobile or other numbers in the corresponding fields.



4. Tap the **Account** field.
5. Tap the desired account in the pop-up dialog box.  
If **Auto** is selected, the phone will use the default account when placing calls to the contact from the blacklist directory.
6. Tap  to accept the change or tap  and then tap **Discard** to cancel.



**To add a contact to the blacklist directory from the local directory:**

1. Tap .
2. Tap  after the desired contact.

If the contact was added to a specified contact group, you can tap the contact group first, and then tap  after the desired contact.

3. Tap **Blacklist**.

The touch screen prompts the following warning:

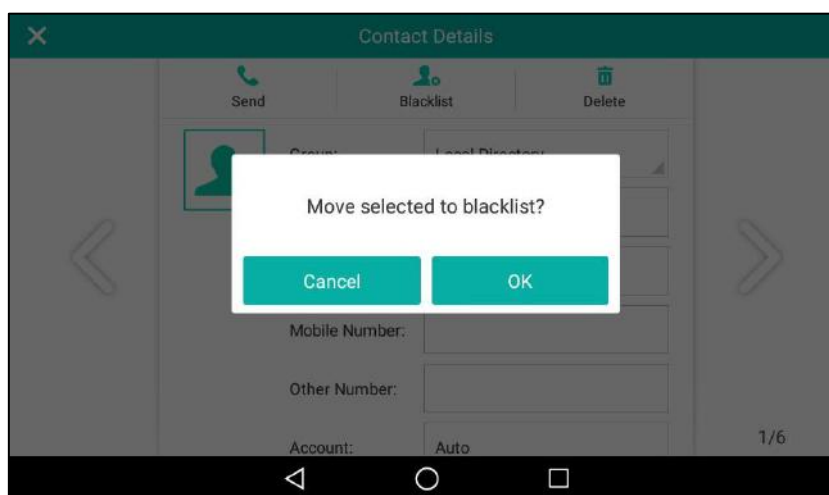

4. Tap **OK** to accept the change.

For operating instructions on editing, deleting, placing calls to and/or searching for contacts in the blacklist directory, refer to the operating instructions of [Editing Contacts](#) on page 110, [Deleting Contacts](#) on page 111, [Placing Calls to Contacts](#) on page 115 and/or [Searching for Contacts](#) on page 116.

## Remote Phone Book

You can add contacts to the local directory, search for a contact, or simply dial a contact number from the remote phone book.

You can configure your new phone to access up to 5 remote phone books. The phone supports up to 5000 remote phone book entries. For the access URL of the remote phone book, contact your system administrator.

For operating instructions on placing calls to and/or searching for contacts in the remote phone book, refer to the operating instructions of [Placing Calls to Contacts](#) on page 115 and/or [Searching for Contacts](#) on page 116.

## Configuring an Access URL

**To configure an access URL for a remote phone book via web user interface:**

1. Click on **Directory**->**Remote Phone Book**.
2. Enter the access URL in the **Remote URL** field.

- Enter the name in the **Display Name** field.

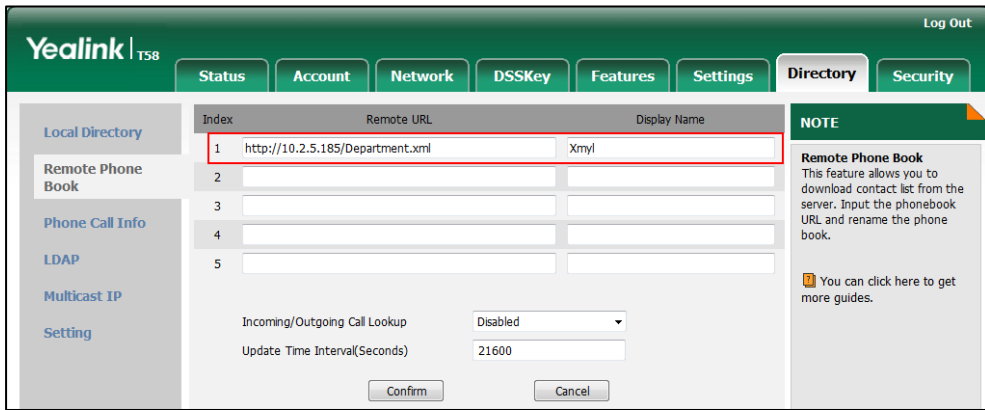

- Click **Confirm** to accept the change.

**Note** An access URL for a remote phone book is configurable via web user interface only.

## Accessing the Remote Phone Book

**To access your remote phone book via phone user interface:**

- Tap  -> **Remote Phone Book**.
- Tap the desired remote phone book.

The phone then connects to the remote phone book and proceeds to load it. The contacts in the remote phone book are displayed on the touch screen.

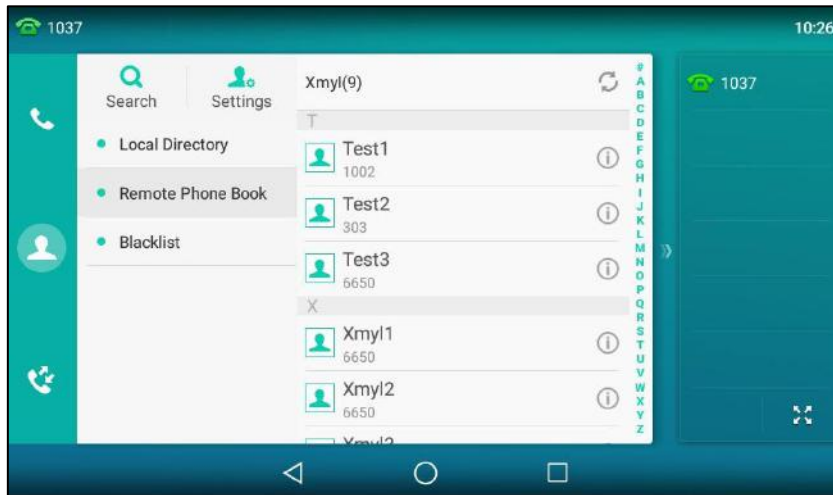

You can tap  to go back to the idle screen.

## Incoming/Outgoing Call Lookup

You can enable the phone to present the caller/callee identity stored in the remote phone book when receiving/placing a call.

**To configure incoming/outgoing call lookup and update time interval via web user interface:**

1. Click on **Directory**->**Remote Phone Book**.
2. Select **Enabled** from the pull-down list of **Incoming/Outgoing Call Lookup**.
3. Enter the desired refresh period in the **Update Time Interval(Seconds)** field.

The default value is 21600.

Index	Remote URL	Display Name
1	http://10.2.5.185/Department.xml	Xmyl
2		
3		
4		
5		

Incoming/Outgoing Call Lookup: Enabled

Update Time Interval(Seconds): 21600

NOTE: Remote Phone Book. This feature allows you to download contact list from the server. Input the phonebook URL and rename the phone book.

4. Click **Confirm** to accept the change.

## Mobile Contacts

The first time your IP phone pairs and connects to your Bluetooth-enabled mobile phone, you will be asked if you would like to sync phone contacts temporarily. If allowed, the phone contacts will be imported to the mobile contacts directory of your IP phone. For more information, refer to [Bluetooth-Enabled Mobile Phone](#) on page 143.

You can add a contact to the local directory or blacklist directory from mobile contacts. You cannot add a contact to the mobile contacts directory on your IP phone.

### Note

If you disconnect the Bluetooth-enabled mobile phone from IP phone or disable the IP phone to sync phone contacts, the mobile contacts directory will disappear.

For operating instructions on placing calls to and/or searching for contacts in the mobile contacts directory, refer to the operating instructions of [Placing Calls to Contacts](#) on page 115 and/or [Searching for Contacts](#) on page 116.

**To add a contact to the local directory from mobile contacts directory:**

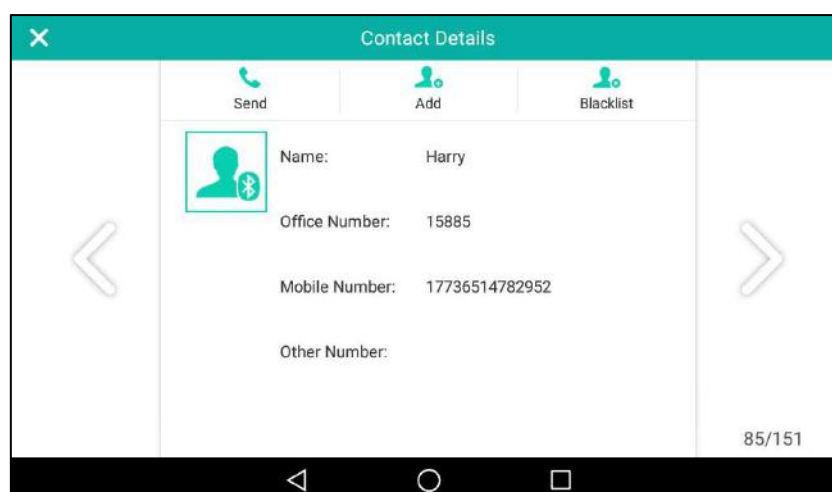

1. Tap  -> **Mobile Contacts**.
2. Drag up and down to view the list of Mobile Contacts.

3. Tap  after the desired entry.



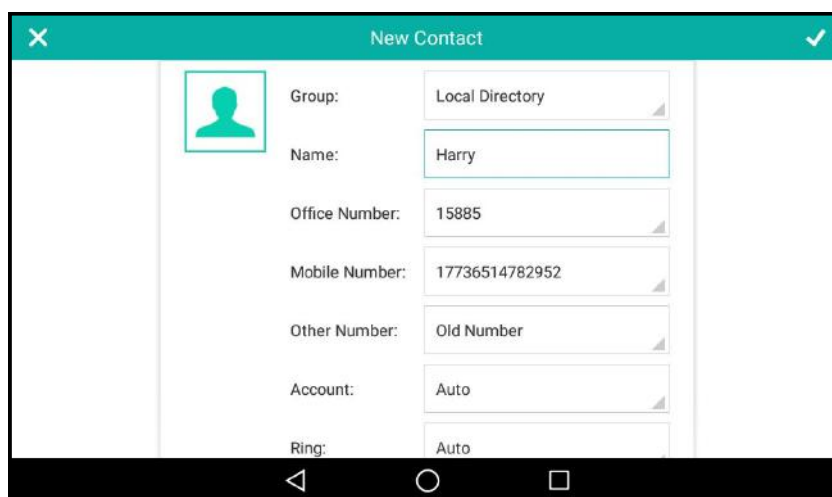

4. Tap **Add**.
5. Edit the corresponding fields.



6. Tap  to accept the change or tap  and then tap **Discard** to cancel.  
The entry is successfully saved to the local directory.

**To add a contact to the blacklist directory from the mobile contacts directory:**

1. Tap  -> **Mobile Contacts**.
2. Tap  after the desired contact.
3. Tap **Blacklist**.

4. Edit the corresponding fields.

5. Tap ✓ to accept the change or tap ◀ and then tap **Discard** to cancel.  
The entry is successfully saved to the blacklist directory.

**Note**

The contact that be added to the local directory or blacklist directory will not disappear, after you disconnect the mobile phone from the IP phone.

**To update the mobile contacts directory:**

1. Tap -> **Mobile Contacts**.
2. Tap .

The touch screen will prompt "Updating, please wait...", you need to authorize the IP phone to sync the contacts temporarily on the mobile phone.

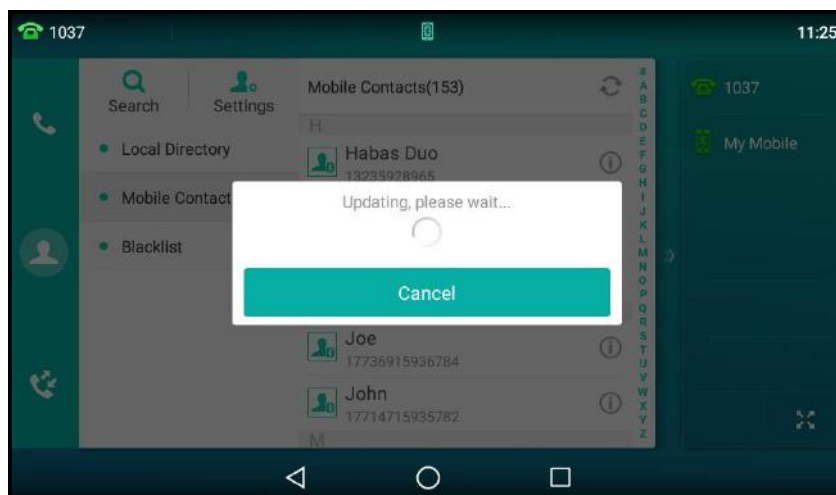

After updating, the contacts you add, edit, delete on the mobile phone will sync to the mobile contacts directory.

**Note**

If you disconnect the mobile phone from IP phone while the IP phone is updating the mobile phone book. The touch screen will prompt "Fail to download mobile contacts!", and the mobile contacts directory will disappear from the IP phone directory list.

## Call History Management

The SIP-T58V/A smart media phone maintains call history lists of Missed calls, Placed calls, Received calls and Forwarded calls. Each call history list supports up to 100 entries. You can view call history, place a call, add a contact or delete an entry from the call history list.

History record feature is enabled by default, if you don't want to save the call history, you can disable the feature.

## Viewing History Records

**To view call history:**

1. Tap .

The touch screen displays all call records.

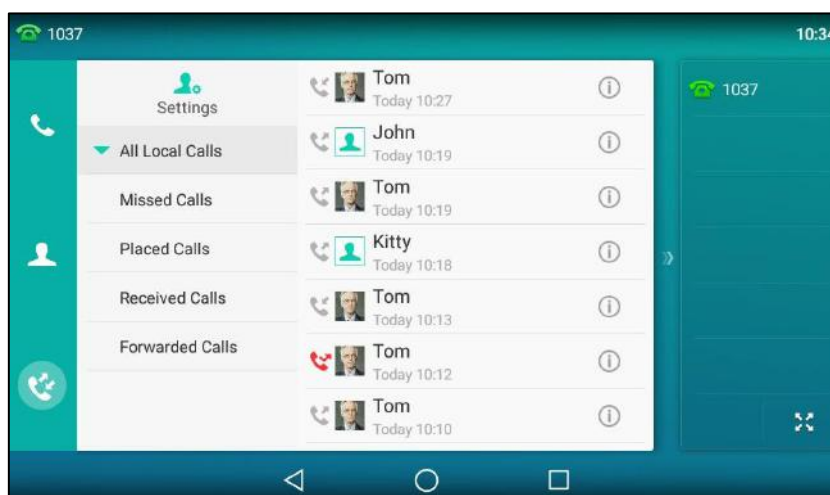

2. Drag up and down to scroll.

You can tap **Missed Calls**, **Placed Calls**, **Received Calls** or **Forwarded Calls** to view entries in each call list directly.

- Tap  after the desired entry.  
The detailed information of the entry appears on the touch screen.

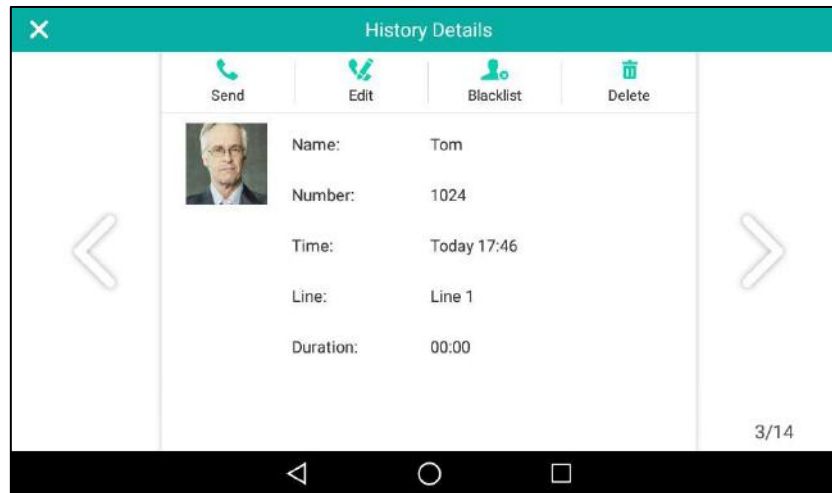

## Placing a Call from History Records

**To place a call from the call history list:**

- Tap .  
The touch screen displays all call records.

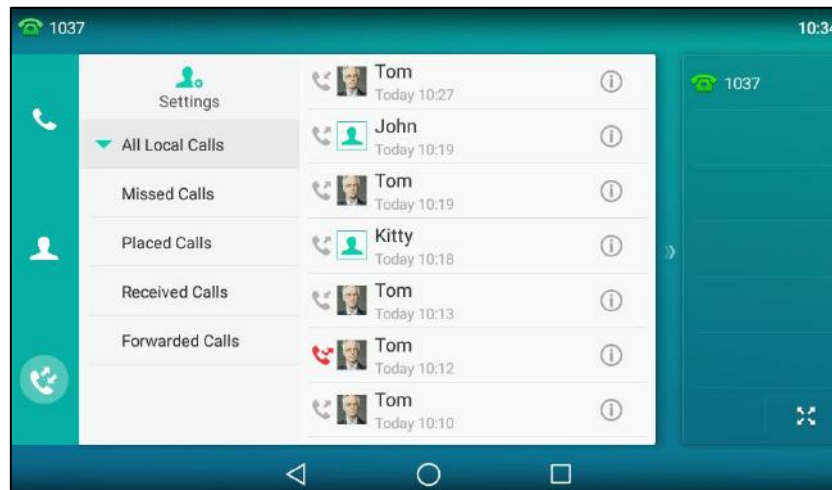



- Drag up and down to scroll.  
You can tap **Missed Calls**, **Placed Calls**, **Received Calls** or **Forwarded Calls** to view entries in each call list directly.
- Tap the desired entry.

## Adding a Contact to the Blacklist

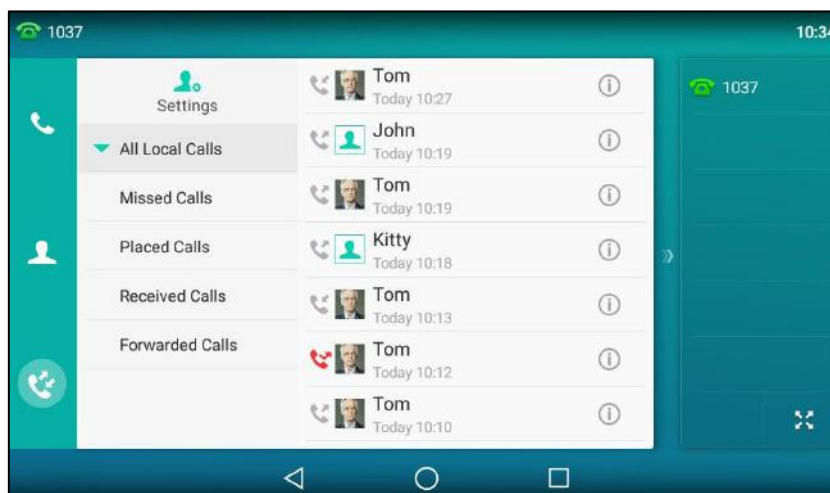

To add a contact to the blacklist directory from the call history list:

1. Tap .  
The touch screen displays all call records.

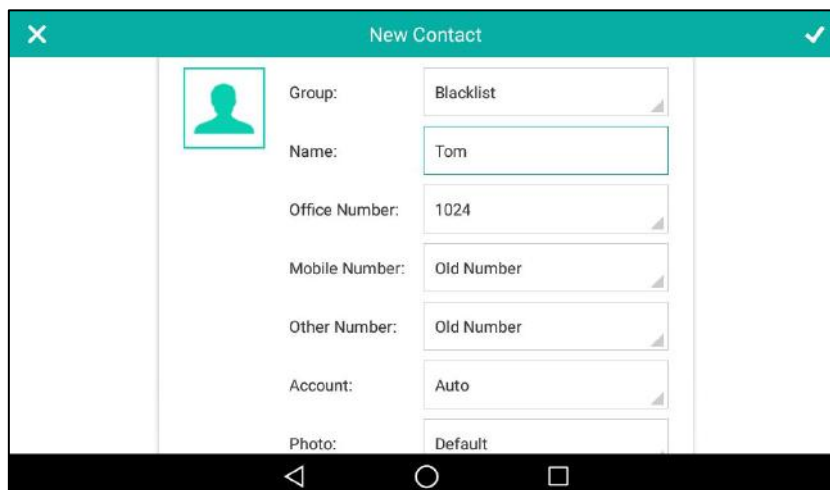

2. Drag up and down to scroll.  
You can tap **Missed Calls**, **Placed Calls**, **Received Calls** or **Forwarded Calls** to view entries in each call list directly.
3. Tap  after the desired entry.
4. Tap **Blacklist**.



5. Enter the desired values in the corresponding fields.
6. Tap  to accept the change or tap  and then tap **Discard** to cancel.

For more information, refer to [Blacklist](#) on page 120.



## Deleting History Records

**To delete an entry from the call history list:**

1. Tap .  
The touch screen displays all call records.

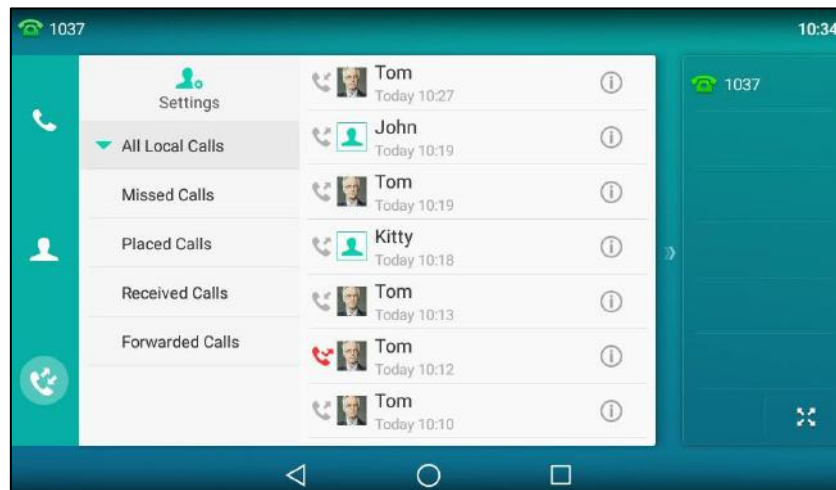

2. Drag up and down to scroll.  
You can tap **Missed Calls**, **Placed Calls**, **Received Calls** or **Forwarded Calls** to view entries in each call list directly.
3. Tap  after the desired entry.
4. Tap **Delete**.  
The touch screen prompts the following warning:

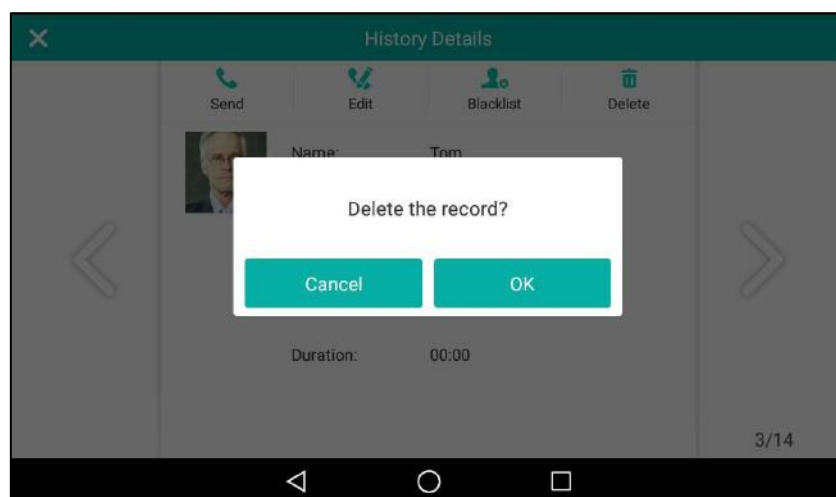

5. Tap **OK** to confirm the deletion or **Cancel** to cancel.

**To delete all entries from the call history list:**

1. Tap .

The touch screen displays all call records.

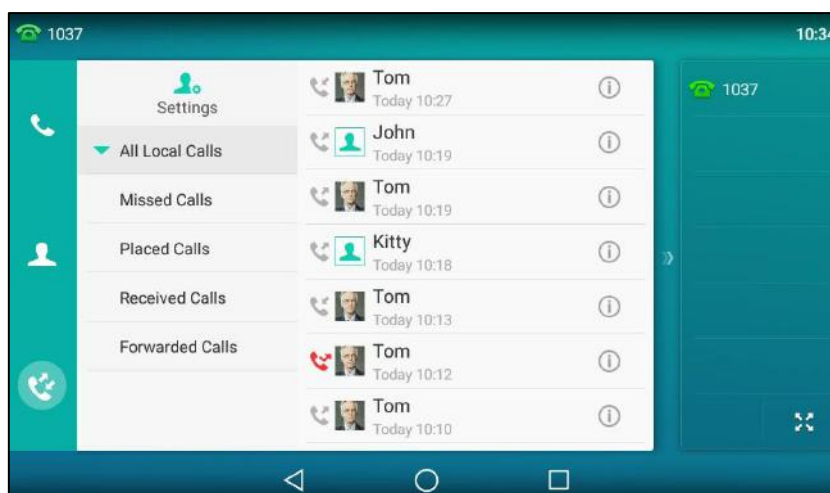

2. Drag up and down to scroll.  
You can tap **Missed Calls**, **Placed Calls**, **Received Calls** or **Forwarded Calls** to view entries in each call list directly.
3. Tap **Settings**.
4. Tap the **Select All** radio box.

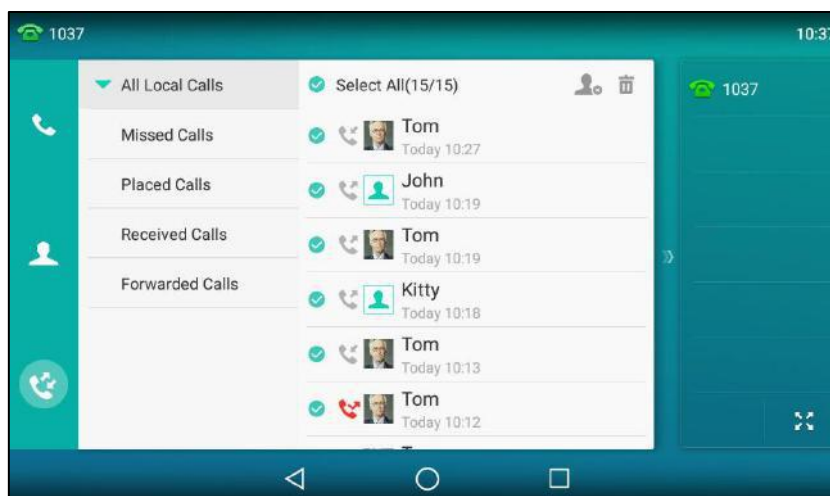

5. Tap .

The touch screen prompts the following warning:

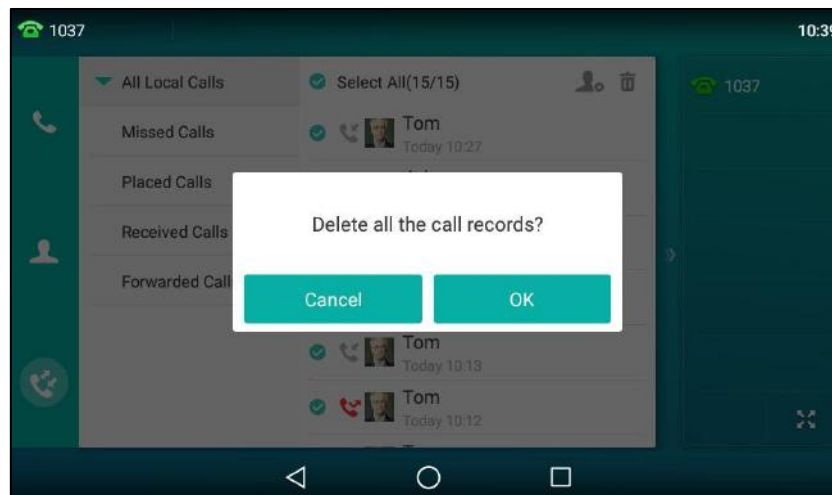



6. Tap **OK** to confirm the deletion or **Cancel** to cancel.

## Disabling History Records

**To disable history record via phone user interface:**

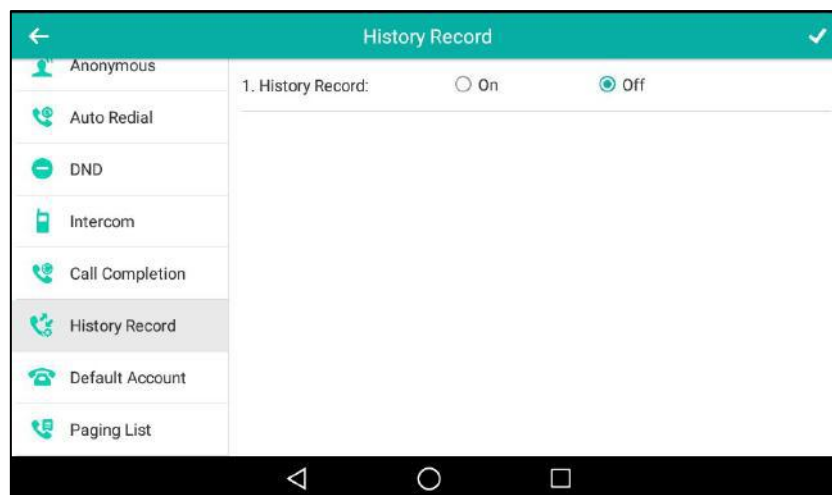
1. Swipe down from the top of the screen or swipe left/right to go to the second idle screen.
2. Tap **Settings->Features->History Record**.
3. Tap the **Off** radio box in the **History Record** field.







4. Tap  to accept the change or  to cancel.

## Search Source List in Dialing

You can search for a contact from the desired lists when the phone is in the dialing screen. The lists can be Local Directory, History, Remote Phone Book and LDAP.

**To configure search source list in dialing via web user interface:**

1. Click on **Directory**->**Setting**.
2. In the **Search Source List In Dialing** block, select the desired list from the **Disabled** column and click  .  
The selected list appears in the **Enabled** column.
3. Repeat the step 2 to add more lists to the **Enabled** column.
4. (Optional.) To remove a list from the **Enabled** column, select the desired list and then click  .
5. To adjust the display order of the enabled list, select the desired list, and click  or  .

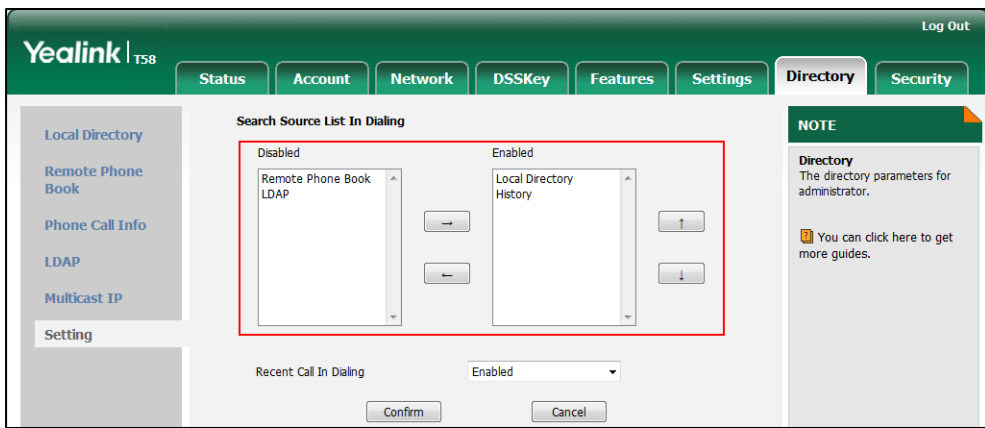

6. Click **Confirm** to accept the change.  
The touch screen will display search results in the adjusted order.

**Note** Search source list in dialing is configurable via web user interface only.

**To search for an entry in the enabled search source lists:**

1. Pick up the handset, press the Speakerphone key or tap the line key.
2. Enter a few continuous characters of the entry’s name or continuous numbers of the entry’s phone number (office, mobile or other number).  
The entries in the enabled search source lists whose name or phone number matches the characters entered will appear on the touch screen.

You can tap the desired entry to place a call to the entry.

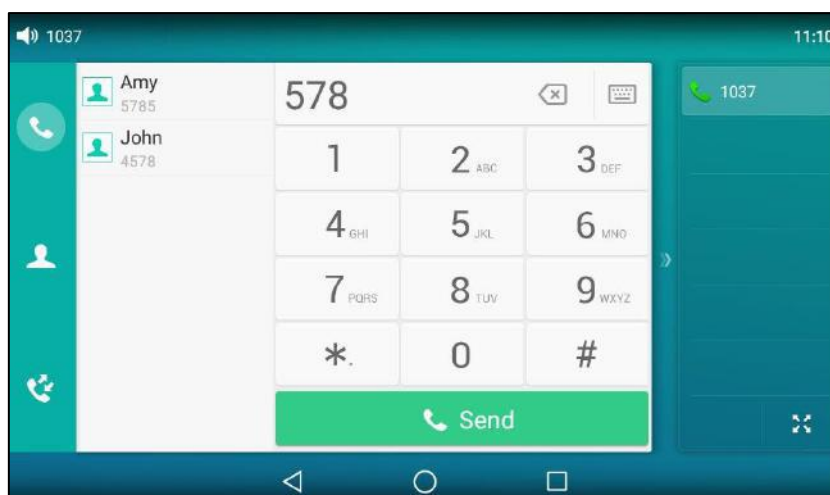

**Note** If you connect a Bluetooth-Enabled mobile phone to the IP phone, and enable the IP phone to sync phone contacts. The IP phone will first search the contacts in the mobile contacts directory then placed calls list. For more information, refer to [Mobile Contacts](#) on page 123.

## System Customizations

### Headset Use

If you want to use a YHS32/YHS33/USB headset, physically connect your headset to the phone and activate the headset mode for use. For more information on physically connecting a headset, refer to [Phone Installation](#) on page 31.

If you want to use a Bluetooth headset, activate the Bluetooth mode and then pair and connect the Bluetooth headset with your phone. For more information on using a Bluetooth headset, refer to [Bluetooth Headset](#) on page 136.

This section provides an introduction to wired headset use.

**Note** The SIP-T58V/A smart media phone supports three types of headsets: YHS32/YHS33 headset, USB headset and Bluetooth headset. You can connect up to three types of headsets at once. The IP phone will use the headset by the priority: USB/Bluetooth headset>YHS32/YHS33 headset. If both a Bluetooth headset and a USB headset are connected, only the last connected headset can be used.

You can use USB headset to answer an incoming call directly without activating the headset mode.

## Headset Mode Activation/Deactivation

### To activate the headset mode:

1. Press  on the phone.

The HEADSET key LED illuminates solid green, and the icon  appears on the status bar.

When you tap the line key or the **Answer** soft key to answer an incoming call, the call is connected to your headset automatically. For more information on using the headset to answer a call, refer to [Answering Calls](#) on page 267.

With the handset on-hook, enter the desired number and tap **Send**, the phone will then place a call using the headset automatically. For more information on using the headset to place a call, refer to [Placing Calls](#) on page 264.

### To deactivate the headset mode:

1. Press  again on the phone.

The HEADSET key LED goes out, and the icon  disappears from the status bar.

## Headset Prior

You can use headset in priority when headset prior feature is enabled. This feature is especially useful for permanent or full-time headset users.

### To enable headset prior via web user interface:

1. Click on **Features->General Information**.
2. Select **Enabled** from the pull-down list of **Headset Prior**.

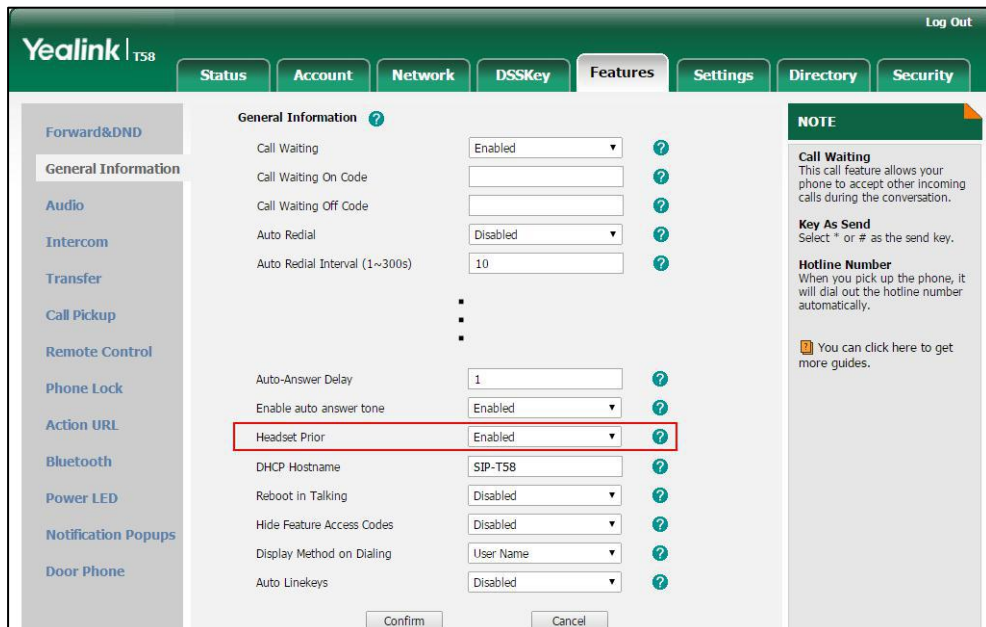

3. Click **Confirm** to accept the change.

**To use headset prior, you should activate the headset mode in advance:**

1. Physically connect the headset.
2. Press  to activate the headset mode.

**Note**

If headset prior is enabled, the headset mode will not be deactivated until you press the **HEADSET** key again.

If headset prior is disabled, the headset mode can be deactivated by pressing the Speakerphone key or the **HEADSET** key.

Headset prior is configurable via web user interface only.

**Dual Headset**

You can use two headsets when dual headset feature is enabled. To use this feature, you must physically connect headsets to the headset jack and handset jack respectively. Once the phone connects to a call, the headset connected to the headset jack will have full-duplex capabilities, while the one connected to the handset jack will only be able to listen.

**Note**

Dual headset is only applicable to YHS32/YHS33 headset.

**To enable dual headset via web user interface:**

1. Click on **Features->General Information**.
2. Select **Enabled** from the pull-down list of **Dual-Headset**.

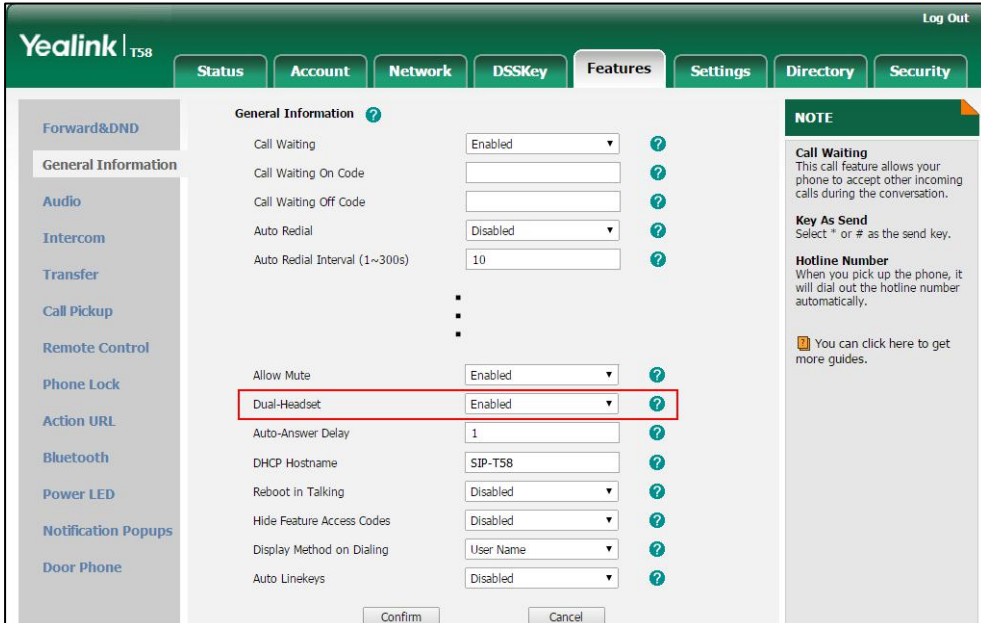

The screenshot shows the Yealink T58 web user interface. The 'Features' tab is selected, and the 'General Information' sub-tab is active. The 'Dual-Headset' option is highlighted with a red box and is set to 'Enabled'. Other settings include Call Waiting (Enabled), Auto Redial (Disabled), and Allow Mute (Enabled). A 'NOTE' panel on the right provides information about Call Waiting, Key As Send, and Hotline Number.

Setting	Value
Call Waiting	Enabled
Call Waiting On Code	
Call Waiting Off Code	
Auto Redial	Disabled
Auto Redial Interval (1~300s)	10
Allow Mute	Enabled
<b>Dual-Headset</b>	<b>Enabled</b>
Auto-Answer Delay	1
DHCP Hostname	SIP-T58
Reboot in Talking	Disabled
Hide Feature Access Codes	Disabled
Display Method on Dialing	User Name
Auto Linekeys	Disabled

3. Click **Confirm** to accept the change.

**Note**

Dual headset is configurable via web user interface only.

## Bluetooth Headset

The SIP-T58V/A smart media phone supports Bluetooth. Bluetooth enables low-bandwidth wireless connections within a range of 10 meters (32 feet). The best performance is in the 1 to 2 meters (3 to 6 feet) range.

You can activate/deactivate the Bluetooth mode, and then pair and connect the Bluetooth device with your phone. You can pair up to countless Bluetooth devices with your phone; however, only one Bluetooth device can be connected at a time. You can also share files with friends via Bluetooth.

You can pair and connect a Bluetooth headset/speakerphone/microphone or a Bluetooth-enabled mobile phone to your IP phone. And the Bluetooth operating instructions on different Bluetooth devices are the same. The following take Bluetooth headset as example. For more information on Bluetooth-enabled mobile phone, refer to [Bluetooth-Enabled Mobile Phone](#) on page 143.

## Activating/Deactivating the Bluetooth Mode

**To activate the Bluetooth mode via phone user interface:**

1. Swipe down from the top of the screen or swipe left/right to go to the second idle screen.
2. Tap **Settings**->**Basic**->**Bluetooth**.
3. Tap the **On** radio box in the **Bluetooth** field.

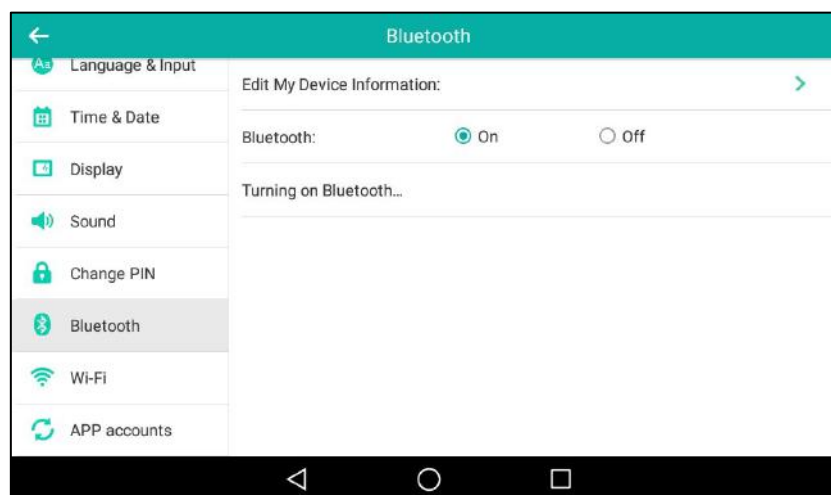



The IP phone scans the available Bluetooth device automatically. After scanning, the touch screen displays the Bluetooth device information (device type and device name).

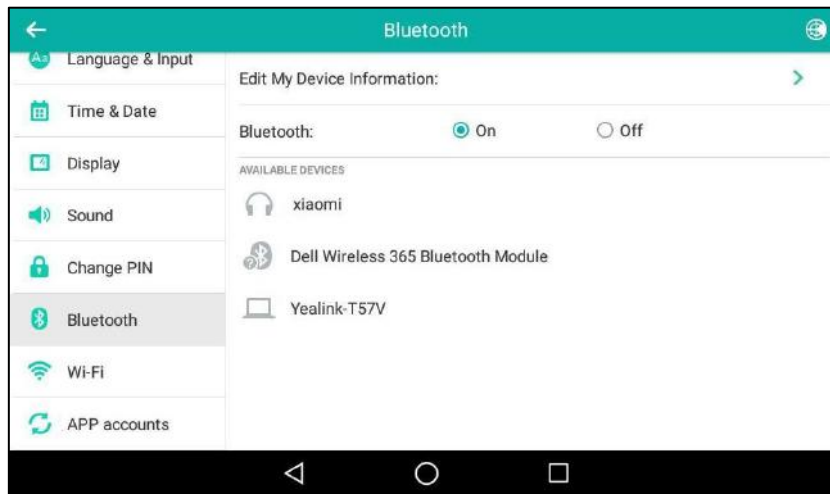

The touch screen displays the Bluetooth icon .

You can also swipe down from the top of the screen to enter the control center, and toggle **Bluetooth** on.

**To deactivate the Bluetooth mode via phone user interface:**

1. Swipe down from the top of the screen or swipe left/right to go to the second idle screen.
2. Tap **Settings**->**Basic**->**Bluetooth**.
3. Tap the **Off** radio box in the **Bluetooth** field.

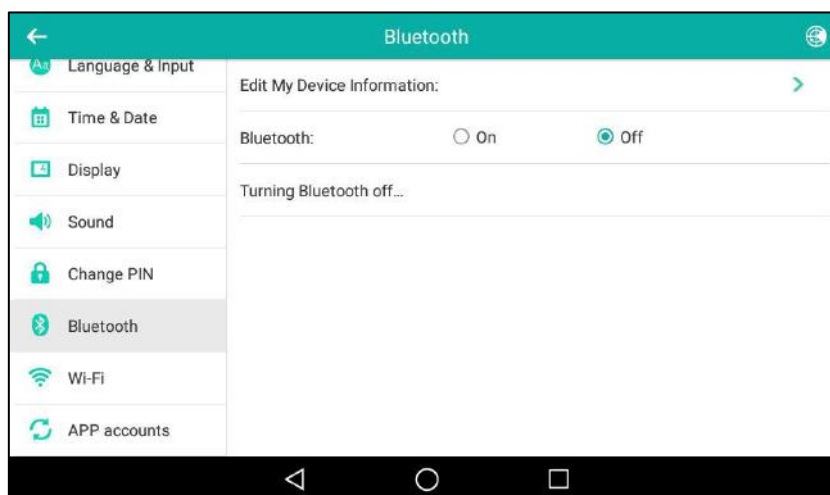

The Bluetooth icon disappears from the status bar.

Bluetooth mode is configurable via web user interface at the path **Features**->**Bluetooth**.

## Pairing and Connecting the Bluetooth Headset

Before you pair a Bluetooth headset, check the indicator on the Bluetooth headset to make sure that the Bluetooth headset is discoverable. For more information, refer to the documentation from the Bluetooth headset manufacturer.

**To pair and connect your Bluetooth headset to your phone:**

1. Swipe down from the top of the screen or swipe left/right to go to the second idle screen.
2. Tap **Settings->Basic->Bluetooth**.
3. Tap the **On** radio box in the **Bluetooth** field.

If there is no Bluetooth device found on the touch screen, tap  to search for the Bluetooth device.

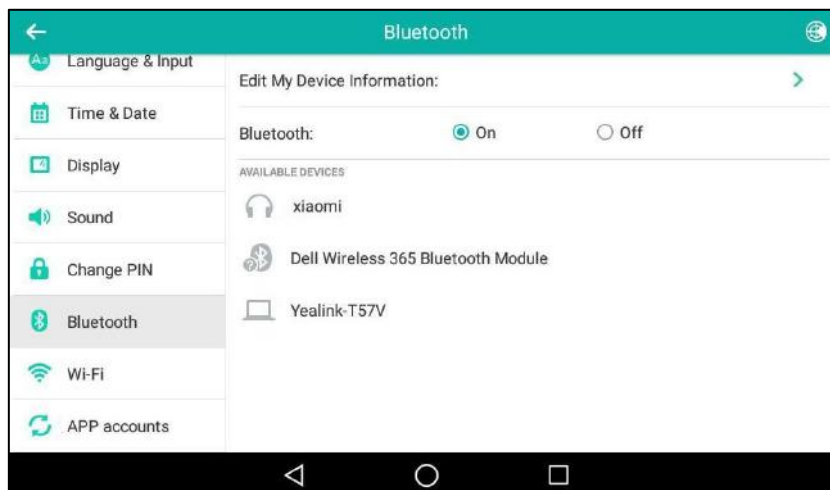

4. Tap the desired Bluetooth headset to connect to your phone.  
Once the connection has completed successfully, the prompt "Connected" appears under the Bluetooth headset name.

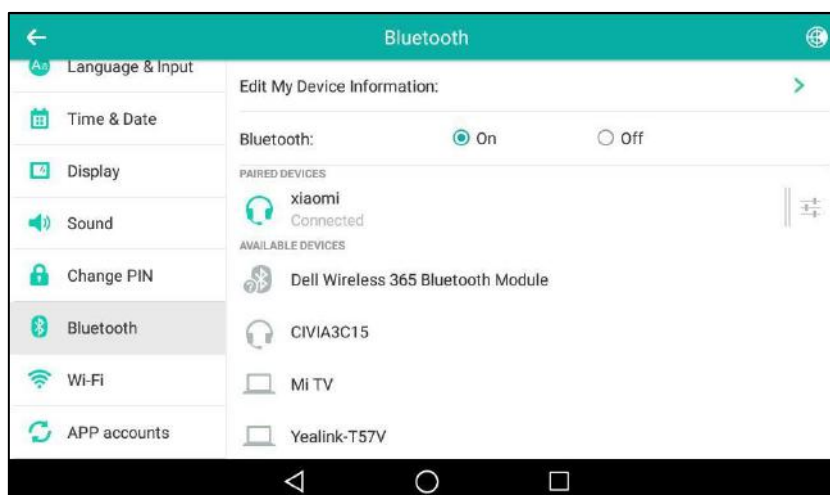

The Bluetooth icon  appears on the status bar.



With the Bluetooth headset paired and connected, you can use the Bluetooth headset to place and answer calls. For more information, refer to the documentation from the Bluetooth headset manufacturer.

## Making the Phone Discoverable

If you make your IP phone visible to other Bluetooth devices, the other Bluetooth devices can scan and find your IP phone. But if your IP phone is not visible to other Bluetooth devices, your IP phone's device name will not display in scanning list of other device.

### To make the phone discoverable:

1. Swipe down from the top of the screen or swipe left/right to go to the second idle screen.
2. Tap **Settings**->**Basic**->**Bluetooth**.
3. Tap the **On** radio box in the **Bluetooth** field.
4. Tap **Edit My Device Information**.
5. Tap the **On** radio box in the **Open Discover** field.

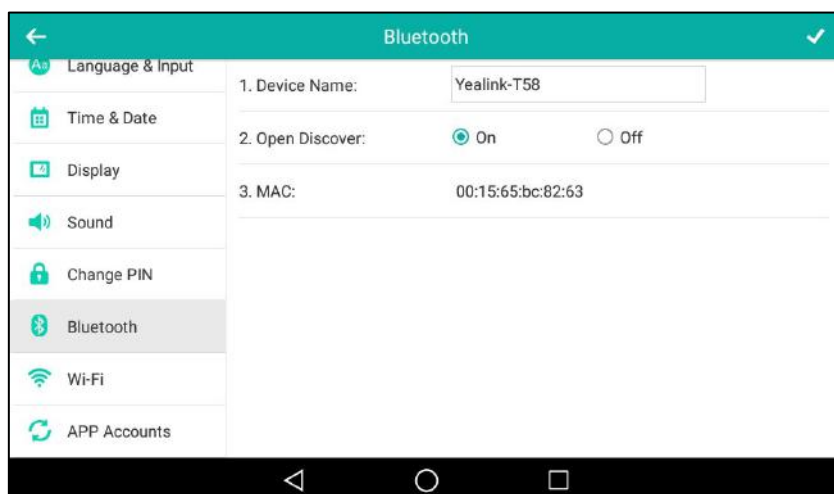

The IP phone will be visible to all Bluetooth devices nearby.

## Editing Device Information

### To edit device information via phone user interface:

1. Swipe down from the top of the screen or swipe left/right to go to the second idle screen.
2. Tap **Settings->Basic->Bluetooth->Edit My Device Information**.
3. Enter the desired name in the **Device Name** field.

The default device name is "Yealink-T58".

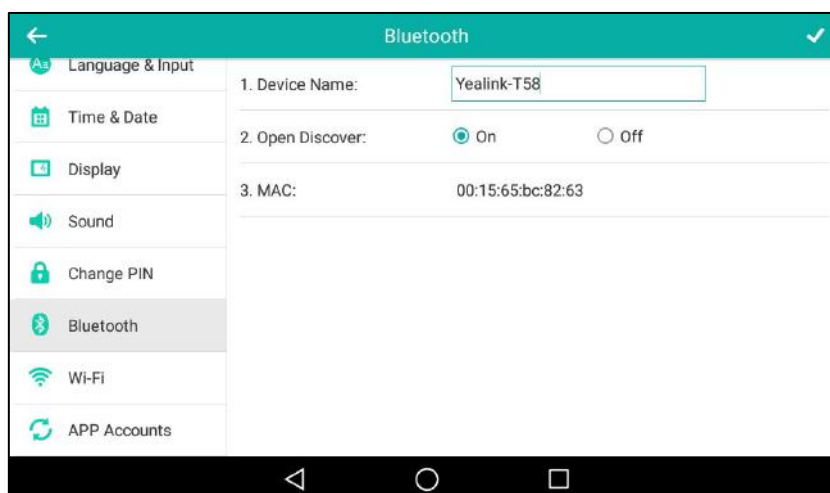

4. Tap to accept the change or to cancel.

You should make your phone discoverable first, and then the pre-configured Bluetooth device name will display in scanning list of other device.

## Renaming the Paired Bluetooth Device

### To rename the paired Bluetooth device:

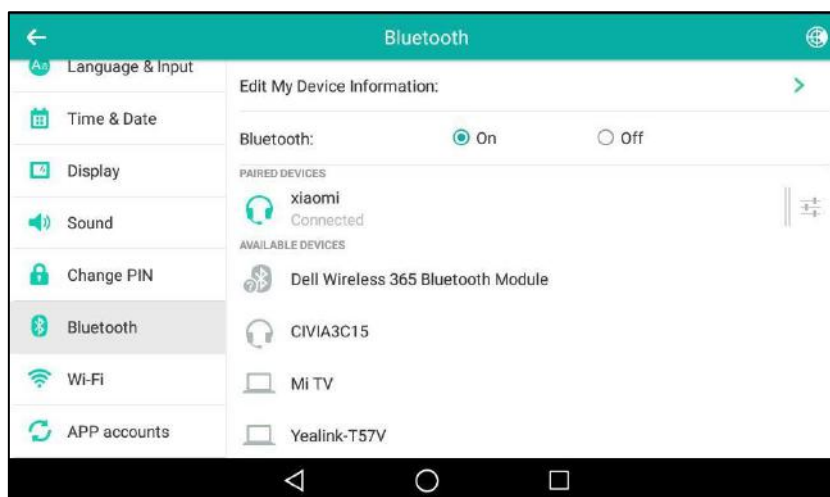

1. Swipe down from the top of the screen or swipe left/right to go to the second idle screen.
2. Tap **Settings->Basic->Bluetooth**.

The touch screen displays the paired and connected Bluetooth headset.

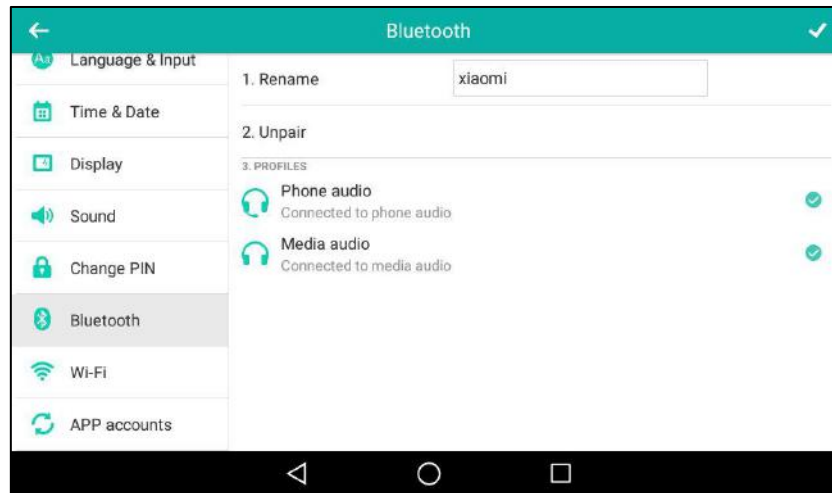

3. Tap  after the connected Bluetooth headset name.
4. Enter the desired headset name in the **Rename** field.



5. Tap  to accept the change or  to cancel.

The configured Bluetooth headset name will display in the **PAIRED DEVICES** list on your phone. The Bluetooth headset name displayed in scanning list of other devices will not be changed.

#### Note

The icon  only appears after the device name of the Bluetooth device that you are connecting or have connected.

## Disconnecting the Bluetooth Headset

**To disconnect your Bluetooth headset from your phone:**

1. Swipe down from the top of the screen or swipe left/right to go to the second idle screen.
2. Tap **Settings->Basic->Bluetooth**.
3. Tap the connected Bluetooth headset.

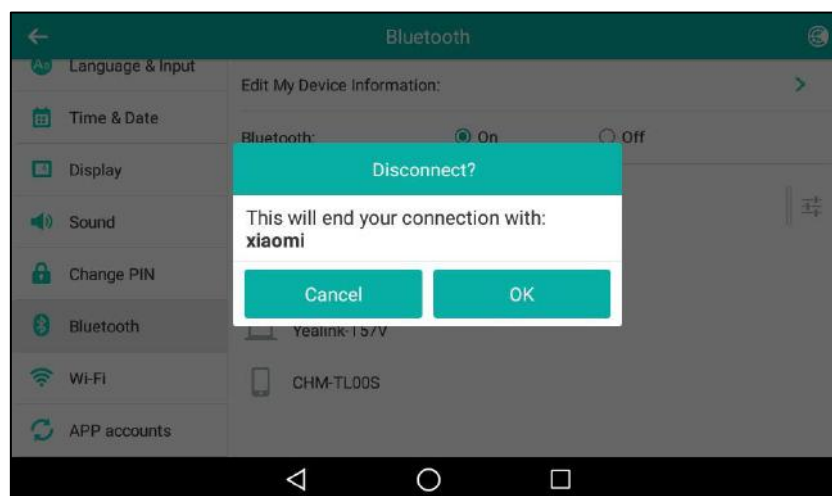

4. Tap **OK** to accept the change or **Cancel** to cancel.

The Bluetooth headset is disconnected. To connect it to your phone again, tap the Bluetooth headset again.

## Unpairing the Bluetooth Headset

You can unpair your Bluetooth headset and your phone. When you unpair the Bluetooth headset, it disappears from the **PAIRED DEVICES** list. To connect it to your phone again, you just need to tap the desired Bluetooth headset in the **AVAILABLE DEVICES** list.

### To unpair Bluetooth headset via phone user interface:

1. Swipe down from the top of the screen or swipe left/right to go to the second idle screen.
2. Tap **Settings**->**Basic**->**Bluetooth**.

The touch screen displays the paired and connected Bluetooth headset.

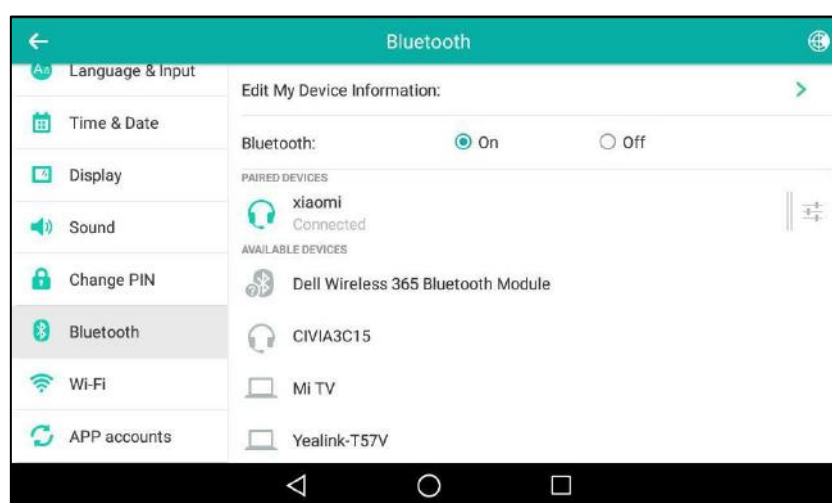

3. Tap  after the connected Bluetooth headset name.

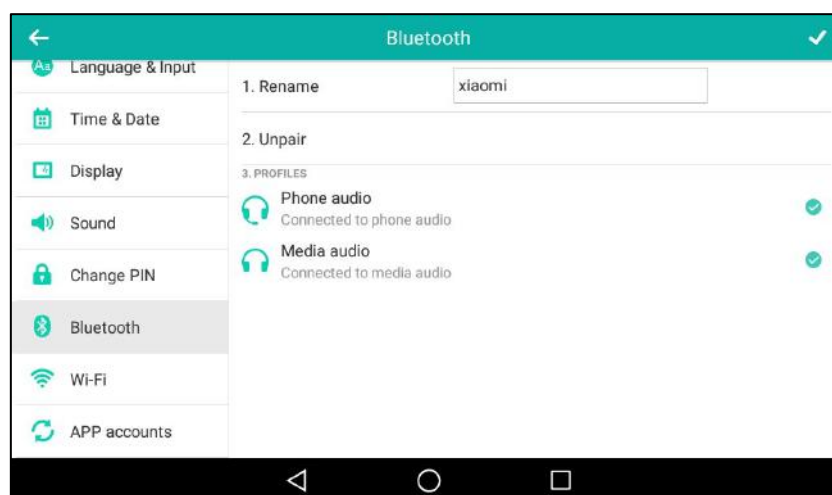

#### 4. Tap **Unpair**.

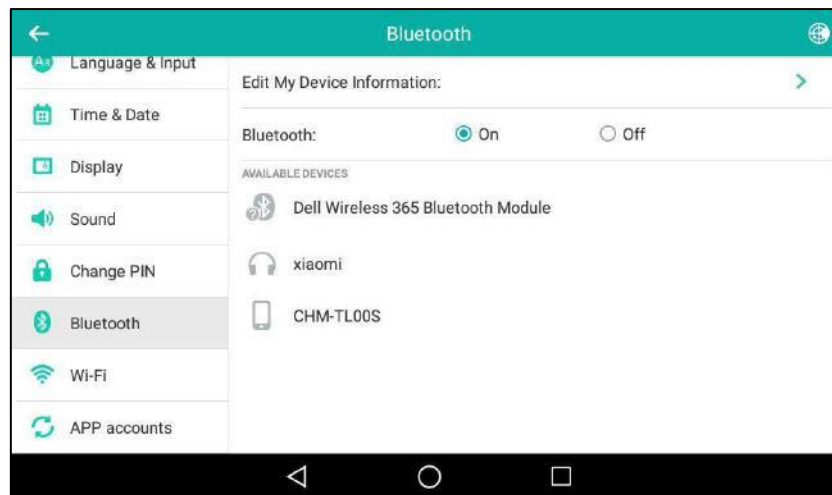

The Bluetooth headset disappears from the **PAIRED DEVICES** list.

## Bluetooth-Enabled Mobile Phone

Yealink SIP-T58V/A smart media phone supports the use of your IP phone in conjunction with Bluetooth-enabled mobile phone. You can do the following:

- Pair and connect your IP phone with a Bluetooth-enabled mobile phone to make and receive mobile calls. Your mobile phone is automatically assigned a line key on your IP phone.
- Import your mobile contacts into the IP phone.
- Use your IP phone as a hands free device for your mobile phone.

For operating instructions on activating/deactivating the Bluetooth mode, making the phone discoverable, editing device information, renaming the paired Bluetooth device and disconnecting/unpairing the paired Bluetooth-enabled mobile phone, refer to the operating instructions of [Bluetooth Headset](#) on page 136.

### Note

Not all mobile phones support this function. Contact your system administrator for more information.

## Pairing and Connecting the Bluetooth-Enabled Mobile Phone

You can only connect one Bluetooth device at a time. After connection, the IP phone will automatically find an available line key and assign the line key for Mobile Account. The Mobile Account key's default label is "My Mobile". If there is no available line key, you may assign it manually.

The mobile phone will disconnect from your phone in the following introduced scenarios:

- Deactivate the Bluetooth mode from the IP phone.

- Connect a Bluetooth headset to the IP phone.
- Deactivate the Bluetooth mode from mobile phone.
- The distance between mobile phone and IP phone is out of the range of 10 meters.

Before you pair a Bluetooth-Enabled mobile phone, check the Bluetooth mode on the Bluetooth-Enabled mobile phone to make sure that the Bluetooth-Enabled mobile phone is discoverable.

**To pair and connect the Bluetooth-Enabled Mobile Phone with your phone:**

1. Swipe down from the top of the screen or swipe left/right to go to the second idle screen.
2. Tap **Settings->Basic->Bluetooth**.
3. Tap the **On** radio box in the **Bluetooth** field.  
If there is no Bluetooth-Enabled mobile phone found on the touch screen, tap the **Scan** soft key to search for the Bluetooth-Enabled mobile phone.
4. Tap the desired Bluetooth-Enabled mobile phone in the Bluetooth devices list to connect the mobile phone to your phone.

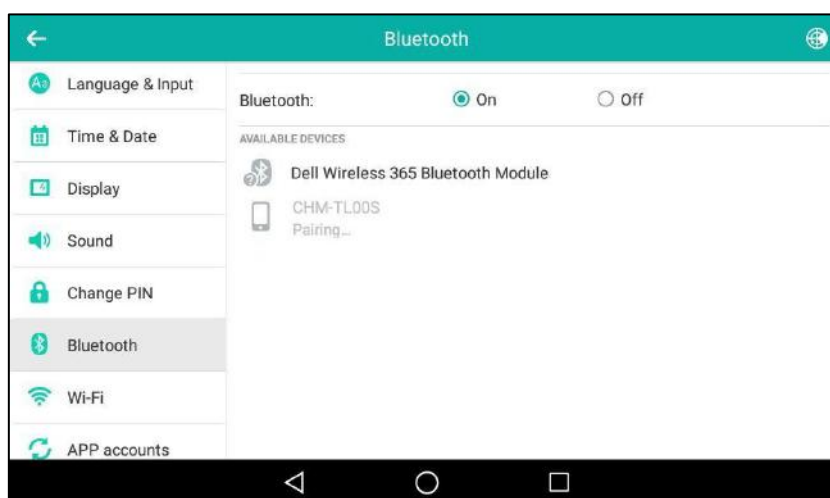

5. Tap **Pair** on both mobile phone and IP phone.

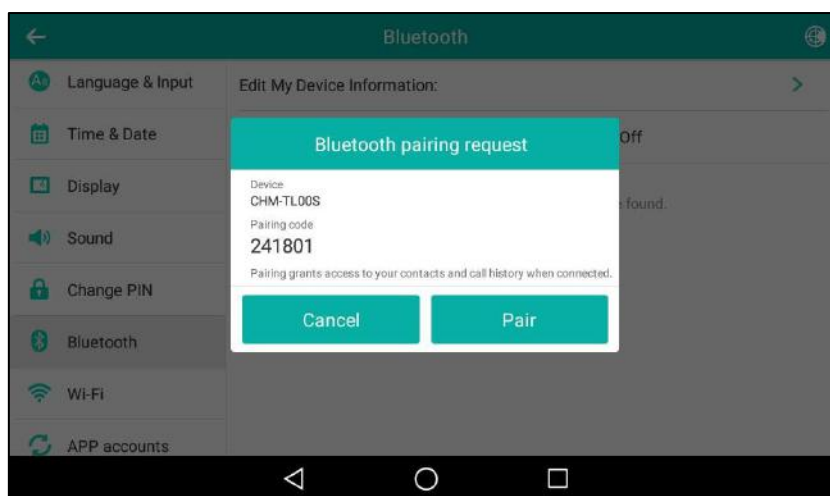



Then the IP phone will prompt “Would you like to sync phone contacts temporarily?”.

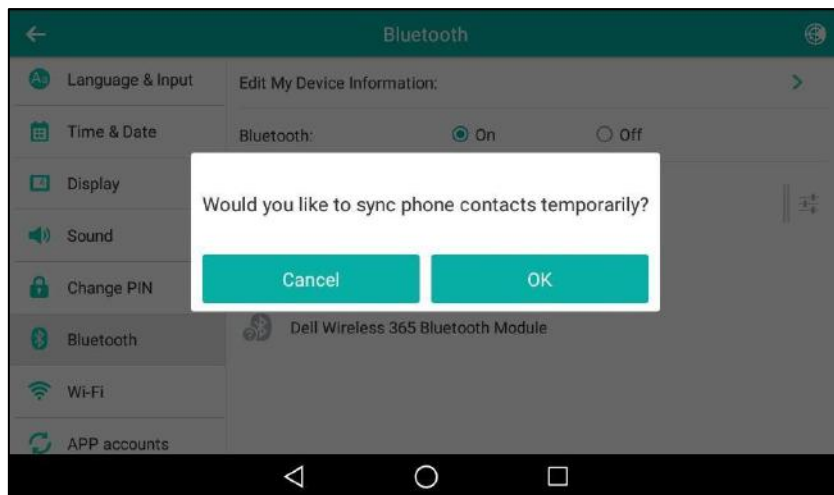

- (Optional.) Tap **OK** to enable the mobile contacts sync feature and the IP phone will sync the mobile contacts temporarily, or tap **Cancel** to disable mobile contacts sync feature and the IP phone will not sync the mobile contacts. If you tap **Cancel**, you can also manually enable the mobile contacts sync feature on the IP phone. For more information, refer to [Syncing the Mobile Contacts to the IP Phone](#) on page 146.

If you enable mobile contacts sync feature, you also need to authorize the IP phone to sync the contacts temporarily on the mobile phone.

Once the connection has completed successfully, the prompt “Connected” appears under the Bluetooth-Enabled mobile phone name.

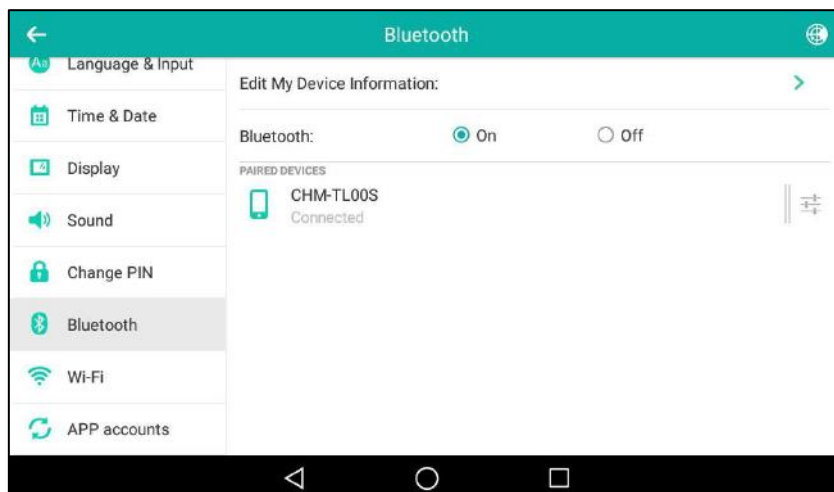

The Bluetooth icon  will display on the status bar.

And the IP phone automatically assigns a Mobile Account key.



For more information on how to configure the Mobile Account key, refer to [Mobile Account](#) on page 165. Before you configure the Mobile Account key, make sure the Bluetooth-Enabled mobile phone is connected. Otherwise the IP phone will prompt "Mobile Account is not connected!". If the distance between mobile phone and IP phone is more than 10 meters or the Bluetooth mode on the mobile phone is deactivated, you can tap the Mobile Account key to reconnect the last paired Bluetooth-Enabled mobile phone.

## Syncing the Mobile Contacts to the IP Phone

If you disable the mobile contacts sync feature when you pair and connect the Bluetooth-Enabled mobile phone to the IP phone (refer to [Pairing and Connecting the Bluetooth-Enabled Mobile Phone](#)), you need to enable the mobile contacts sync feature manually when you want to sync the mobile contacts the IP phone.

### Note

Not all mobile phones support syncing the mobile contacts to IP phone. For more information, contact your system administrator.

### To enable the mobile contacts sync feature manually:

1. Swipe down from the top of the screen or swipe left/right to go to the second idle screen.
2. Tap **Settings->Basic->Bluetooth**.
3. Tap  after the desired Bluetooth-Enabled mobile phone name.

4. Mark the **Mobile Contacts Sync** radio box.

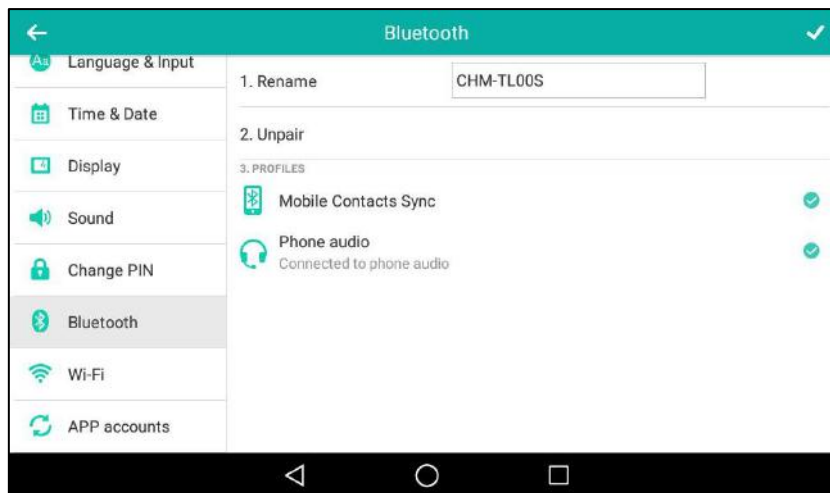

You need to authorize the IP phone to sync the contacts temporarily on the mobile phone. And then the mobile contacts directory will appear in the IP phone directory list.

**To view your mobile contacts on the IP phone:**

1. Swipe down from the top of the screen or swipe left/right to go to the second idle screen.
2. Tap  -> **Mobile Contacts**.

The contacts in the mobile phone will display in the **Mobile Contacts** list.

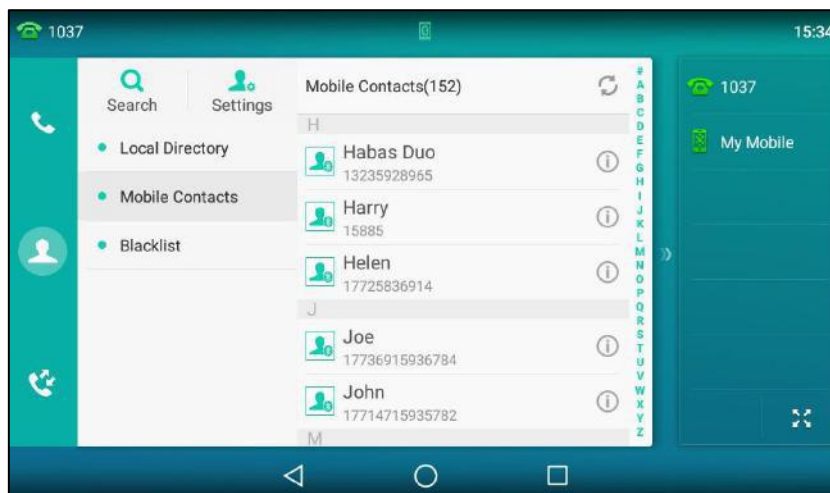

For operating instructions on adding contact to local/blacklist directory from mobile contacts directory, update the mobile contacts directory or placing calls to and searching for contacts in the mobile contacts directory, refer to the operating instructions of [Mobile Contacts](#) on page 123.

**Note**

If the mobile phone disconnects from the IP phone while the IP phone is loading the mobile contacts, the touch screen will prompt "Fail to download mobile contacts!", and the mobile contacts directory will not appear at the IP phone directory list.

## Making a Mobile Phone Call by Using the IP Phone

When you make a mobile phone call by using your IP phone, the IP phone acts as a hands free device for your mobile phone. The call is made through your mobile phone, but the audio is present on and the call control is done by using the IP phone. You can have both mobile phone call and IP phone call on your IP phone, and two types of calls will not affect each other.

### To make a call through a mobile phone:

1. Tap the **My Mobile** line key.



2. Enter the desired number.
3. Tap **Call from Mobile**.

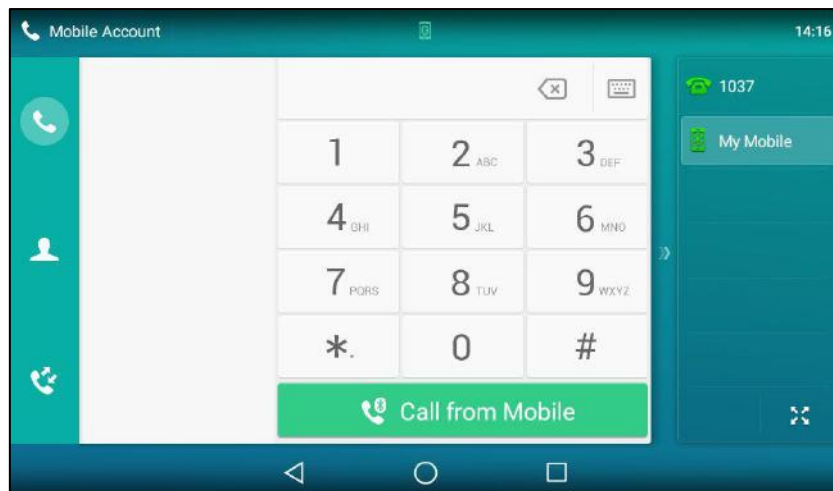

The outgoing call information will appear on both your IP phone and mobile phone screen. After the call is picked up, the audio goes through the IP phone, although the mobile phone screen also shows a connected call. You can hold, mute or end the call on the IP phone, and after you hold the call you can resume the call or place a new call.

### Note

You can control the call's audio to go through the mobile phone or IP phone on your mobile phone. For example, if you choose Bluetooth, the audio will go through the IP phone; if you choose Handset earpiece or Speaker, the audio will go through the mobile phone.

The phone will first match the contacts in the mobile contacts directory to present the caller/callee identity when receiving/placing a mobile phone call.

## Receiving Mobile Phone Calls by Using the IP Phone

If your mobile phone is paired and connected with the IP phone, an incoming call to your mobile phone is also shown on the IP phone.

**To handle a mobile phone call by using the IP phone, do one of the following:**

- Press , tap the **Answer** soft key or pick up the handset to connect to the call.
- Tap the **Reject** soft key to reject the call.

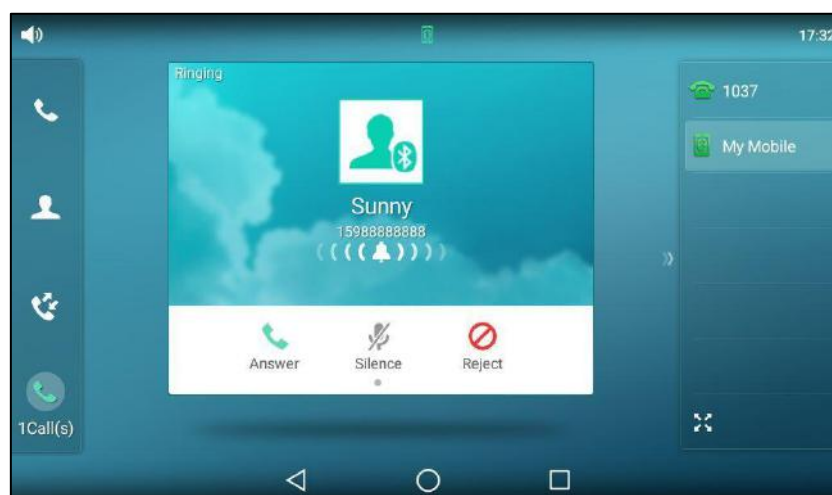

## Sending Files via Bluetooth

The **Gallery** and **FileManager** applications support sending files via Bluetooth. You can send pictures, videos or audios to a Bluetooth-enabled mobile phone or other Bluetooth devices displayed in the **AVAILABLE DEVICES** list. For more information, refer to [Sharing Pictures/Videos/Audios](#) on page 204 and [Sharing Pictures/Videos](#) on page 219.

## Receiving Files via Bluetooth

The Bluetooth-enabled mobile phone or other Bluetooth devices can share files with your IP phone. The file type is not restricted, you can receive pictures, audios, videos, documents, and so on. You can use the corresponding system applications to view the files. You can only receive files from the Bluetooth devices displayed in the in the **AVAILABLE DEVICES** list.

**To receive file via Bluetooth:**

1. Share a file with the IP phone on your Bluetooth device.

For more information, refer to the documentation from the Bluetooth device manufacturer.

The IP phone will play a notification sound, and the touch screen prompts "Accept incoming file?".

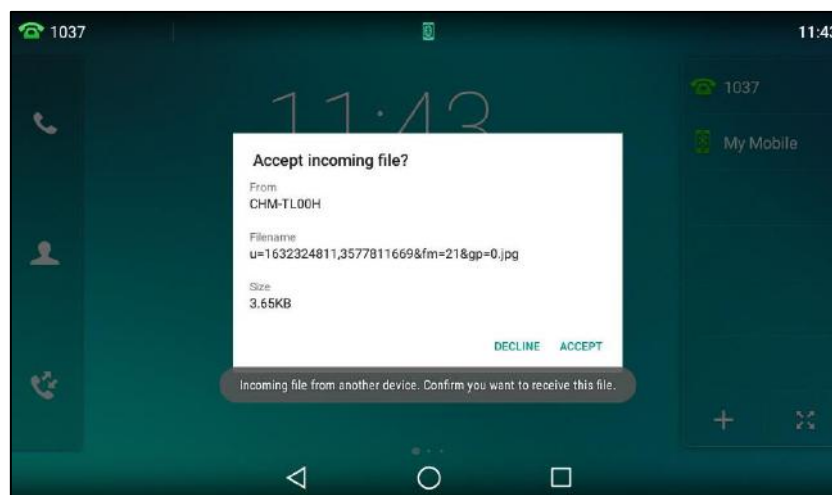

2. Tap **Accept** to start receiving the file.

The touch screen prompts "The file will be received. Check progress in the Notification panel.". The icon  will display on the status bar.

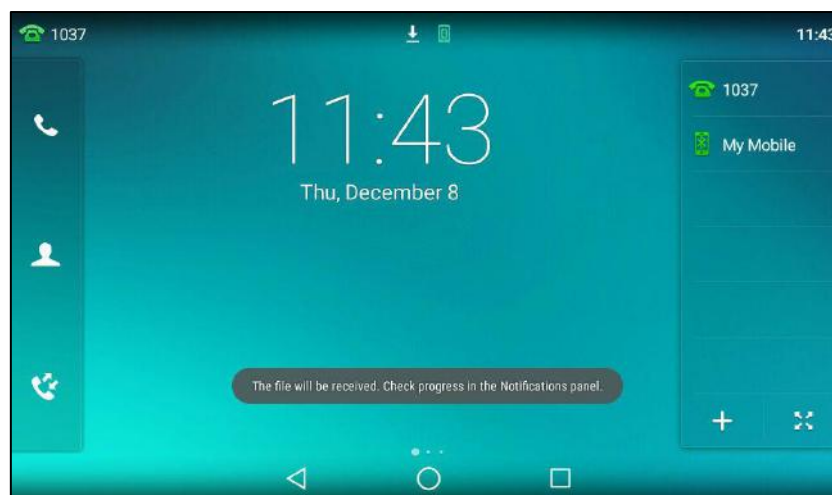

- (Optional.) Swipe down from the top of the screen to enter the notification center.

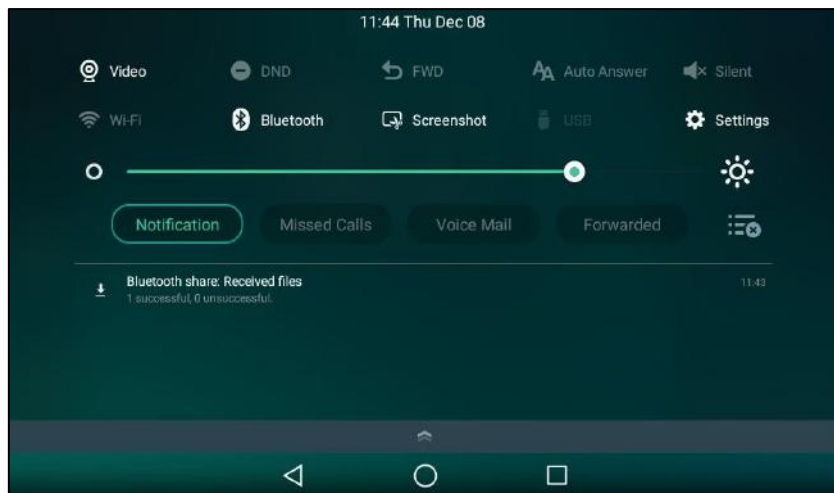

Tap the notification "Bluetooth share: Received file".

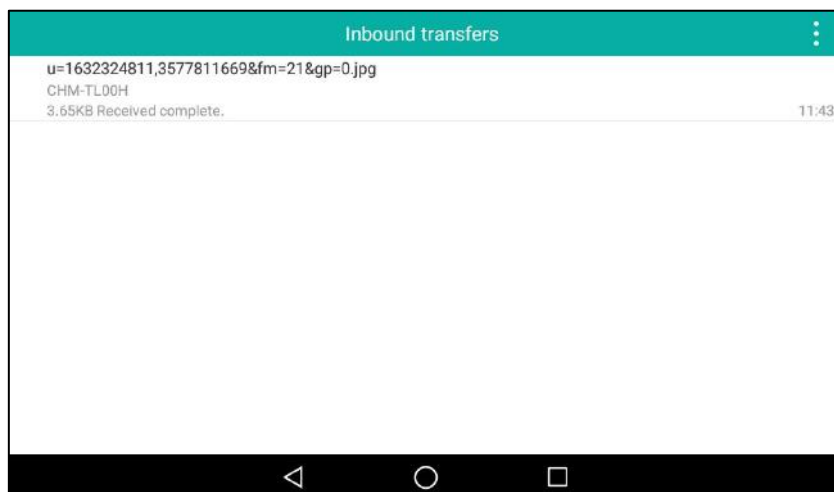

You can use the corresponding system applications to view the file.

## DSS Keys

There are two types of DSS keys: Line Keys and Programable Keys. Details will be introduced in the following. The SIP-T58V/A smart media phone supports 27 line keys and 3 programable keys.

### Line Keys

You can assign predefined functionalities to line keys. You can also define a label for a line key feature which will appear on the touch screen. Line keys allow you to quickly access features such as recall and voice mail. The line key can indicate the monitored status when the line keys are assigned with particular features, such as BLF. The default key type of line key 1-16 is Line. The default key type of line key 17-27 is N/A, which indicates that this line key provides no functionality until configuration.

## Assigning Functionality to a Line Key

**To assign functionality to a line key via phone user interface:**

1. Do one of the following:
  - Tap **+** on the home screen, when there is no line key configured on your phone.



- Drag up and down to scroll through the line key list if required.  
Drag the line key to the **Edit** field.

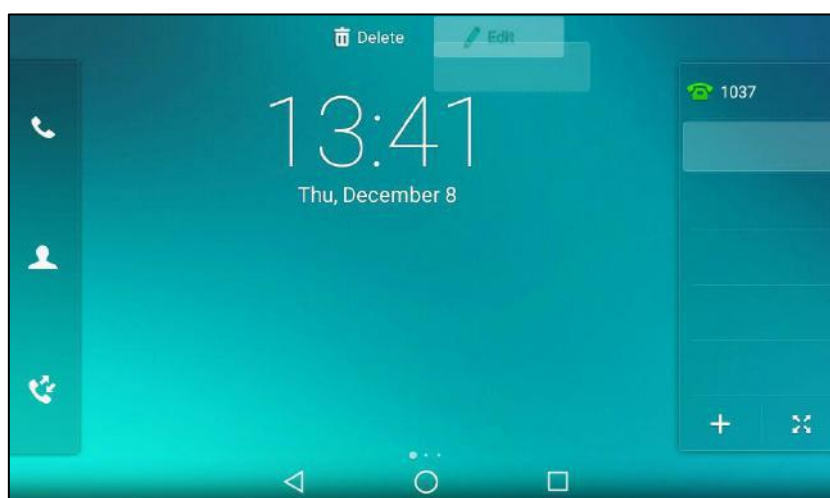

- Tap **+** on the bottom-left of the line key list.



- Tap  on the bottom-right of the line key list.  
The touch screen will display all the line keys.

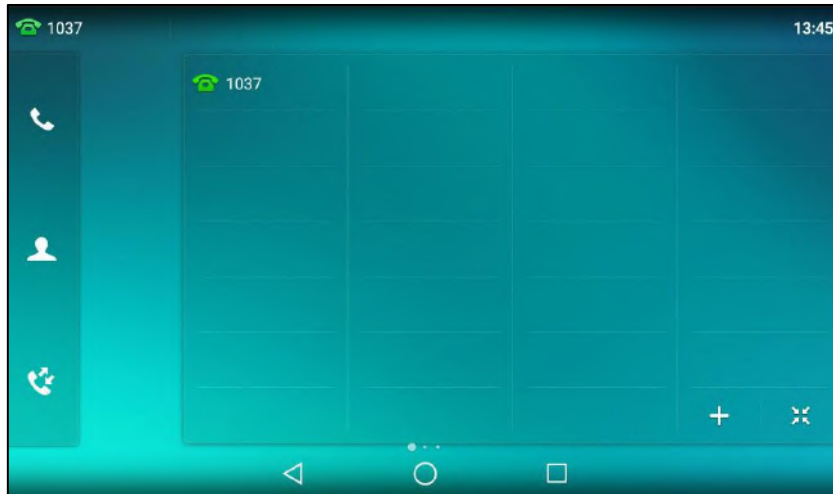



Drag the line key to the **Edit** field.

- Swipe down from the top of the screen or swipe left/right to go to the second idle screen.

Tap **Settings->Features->DSS Keys**.

Tap the desired line key.

2. Select the desired key type from the **Type** field.
3. (Optional.) Select the desired key event type from the **Key Type** field.
4. (Optional.) Select the desired line from the **Account ID** field.
5. (Optional.) Enter the string that will appear on the touch screen in the **Label** field.
6. (Optional.) Enter the corresponding value in the **Value** field.
7. (Optional.) Enter the corresponding value in the **Extension** field.
8. Tap  to accept the change or  to cancel.

## Changing the Location of the Line Keys

You can change the line key's location to a blank area on the Line keys field. You can also change the location of two line keys. And the operating instructions are almost the same. The following take how to change the location of two line keys as example.

### To change the locations of two line keys:

1. Do one of the following:
  - Drag up and down to scroll through the line keys list if required.
  - Tap  on the bottom-right of the line key list.

2. Drag a line key to the desired location at which another line key locates.

For example, exchange the locations of line key 1 and line key 2:



The following shows the locations of two line keys after exchange:



## Deleting a Line Key

### To delete a line key:

1. Do one of the following:
  - Drag up and down to scroll through the line keys if required.



- Tap  on the bottom-left of the line key list. The touch screen will display all the line keys.

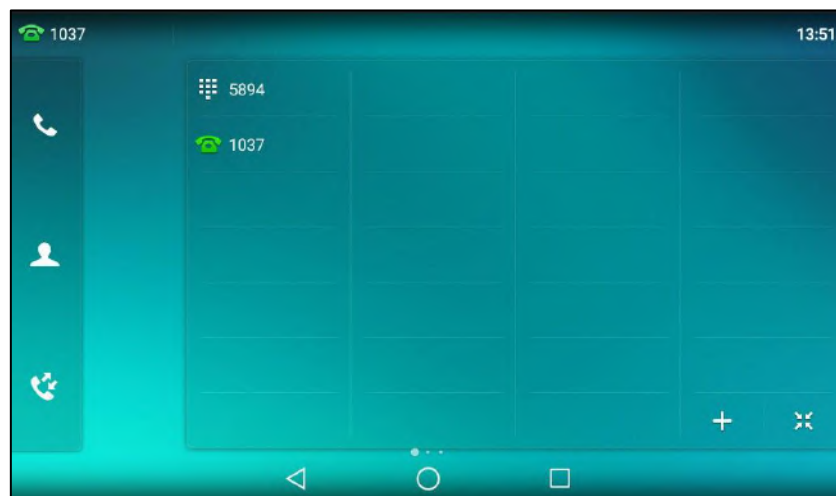

2. Drag the desired line key to the **Delete** field.



The touch screen will prompt "Delete the DSS key?".

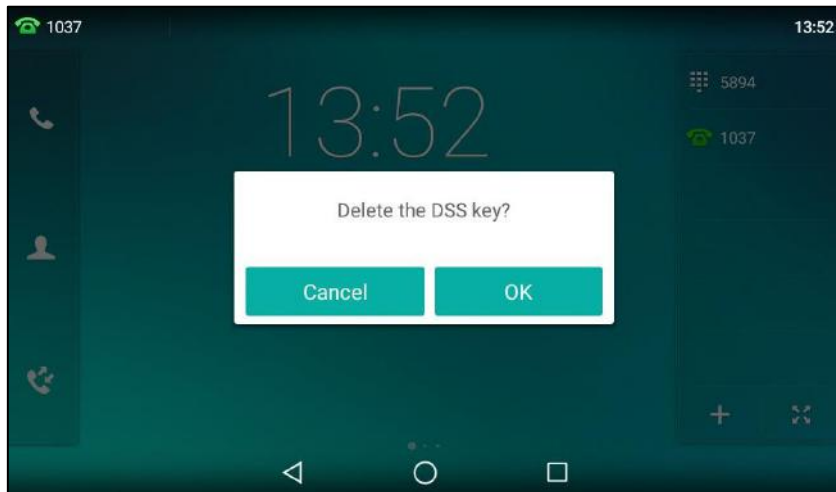

3. Tap **OK** to accept the change or **Cancel** to cancel.

## Page Tips

The line key list can only display 6 line keys on one page. If the BLF monitored user receives an incoming call on non-current page, you may miss the call because there is no notification on the current page.

If page tips feature is enabled, the breathing light will appear at the top/bottom of the line key list when the status of particular feature (e.g., BLF, Line, Intercom) assigned to the line key on the non-current page changes. You can drag the line key list up or down to view the line key, and the breathing light will disappear.

**Note** The breathing light may differ in color. For more information, contact your system administrator.

The following figure shows an example of the breathing light appears at the top of the line key list:



The following figure shows an example of the breathing light appears at the bottom of the line key list:



**To configure the page tips feature via web user interface:**

1. Click on **DSSKey->Line key**.

2. Select **Enabled** from the pull-down list of **Enable Page Tips**.

The screenshot shows the Yealink T58 web interface. At the top, there are navigation tabs: Status, Account, Network, **DSSKey**, Features, Settings, Directory, and Security. The 'DSSKey' tab is active. Below the tabs, there is a sidebar on the left with options: Line Key1-10, Line Key11-20, Line Key21-27, Programable Key, and Ext Key. The main content area shows a table for configuring line keys. At the top of this area, there is a dropdown menu labeled 'Enable Page Tips' which is currently set to 'Enabled' and is highlighted with a red box. Below this is a table with columns: Key, Type, Value, Label, Line, and Extension. The table lists 10 line keys (Line Key1 to Line Key10). The 'Type' column for all keys is set to 'Line'. The 'Value' column for Line Key1 contains the number '1037'. The 'Line' column for each key is set to a corresponding line number (Line 1 to Line 10). At the bottom of the table area, there are 'Confirm' and 'Cancel' buttons. On the right side of the interface, there is a 'NOTE' section with the following text:

**NOTE**

**Key Type**  
The free function key 'Types' Speed Dial, Key Event, Intercom.

**Key Event**  
Key events are predefined shortcuts to phone and call functions.

**Intercom**  
Enable the 'Intercom' mode and it is useful in an office environment as a quick access to connect to the operator or the secretary.

You can click here to get more guides.

3. Click **Confirm** to accept the change.

**Note** Page tips feature is configurable via web user interface only.

## Line Key Features

Line key features are explained in the following subchapters in detail:

- Line
- Speed Dial
- Voice Mail
- Direct Pickup
- Group Pickup
- DTMF
- Prefix
- Local Group
- XML Group
- XML Browser
- LDAP
- Conference
- Forward
- Transfer
- Hold
- DND
- Group Listening

- Zero Touch
- URL
- Phone Lock
- Directory
- Mobile Account
- Call Park
- Retrieve Park

For the features not listed above, refer to [Basic Phone Features](#) on page 263 and [Advanced Phone Features](#) on page 327. For more information, contact your system administrator.

### Line

You can use this key feature to accept incoming calls, place active calls on hold or resume a held call.

**Dependencies:** *Type (Line)*

**Account ID** *(the account this feature will be applied to)*

**Label** *(key label displayed on the touch screen)*

**Usage:** When the phone receives an incoming call,

1. Tap the line key to accept the incoming call.
2. Tap the line key to place a new call and the active call is placed on hold.
3. Tap the line key again to resume the held call.

### Speed Dial

You can use this key feature to speed up dialing the numbers frequently used/hard to remember or perform blind transfer conveniently during the call.

**Dependencies:** *Type (Speed Dial)*

**Account ID** *(the account this feature will be applied to)*

**Label** *(key label displayed on the touch screen)*

**Value** *(the number you want to dial out/transfer to)*

**Usage:**

- When the IP phone is idle, tap the speed dial key to dial out the number specified in the **Value** field, using the account selected from the **Account ID** field.
- When there is an active call on the line selected from the **Account ID** field, drag the far-site window to the speed dial key field to perform blind transfer to the number that specified in the **Value** field.

### Voice Mail

You can use this key feature to quickly connect voice mail. For more information, refer to [Message](#) on page 376.

**Dependencies:** *Type (Key Event)*

**Key Type (Voice Mail)**

**Account ID** (the account this feature will be applied to)

**Label** (key label displayed on the touch screen)

**Value** (the voice mail access code)

**Usage:** Tap the voice mail key to dial out the voice mail access code. Then follow the voice prompt to listen to the voice mails.

**Direct Pickup**

You can use this key feature to answer someone else's incoming call on the phone.

**Dependencies: Type (Key Event)**

**Key Type (DPickup)**

**Account ID** (the account this feature will be applied to)

**Label** (key label displayed on the touch screen)

**Value** (the directed call pickup code followed by the target phone number)

**Usage:** Tap the direct pickup key on your phone when the target phone number receives an incoming call. The call is then answered on your phone.

**Group Pickup**

You can use this key feature to answer incoming calls in a group that is associated with their own group.

**Dependencies: Type (Key Event)**

**Key Type (GPickup)**

**Account ID** (the account this feature will be applied to)

**Label** (key label displayed on the touch screen)

**Value** (the group pickup code)

**Usage:** Tap the group pickup key on your phone when a phone number in the group receives an incoming call. The call is answered on your phone.

**DTMF**

You can use this key feature to send the specification of arbitrary key sequences via DTMF.

**Dependencies: Type (Key Event)**

**Key Type (DTMF)**

**Label** (key label displayed on the touch screen)

**Value** (DTMF sequence)

**Usage:** Tap the DTMF key during an active call to send the key sequence specified in the **Value** field.

**Note**

DTMF sequence can only contain "0-9", "\*", "#" and "A-D".



**Prefix**

You can use this key feature to add a specified prefix number before the dialing number.

**Dependencies: Type (Key Event)**

**Key Type (Prefix)**

**Label** (key label displayed on the touch screen)

**Value** (the prefix number)

**Usage:** Tap the prefix key when the phone is idle, the phone will then enter the dialing screen and display the prefix number that you specified in the **Value** field. You can enter the remaining digits and then dial out.

**Local Group**

You can use this key feature to quickly access a contact group in the local directory. For more information, refer to [Local Directory](#) on page 103.

**Dependencies: Type (Key Event)**

**Key Type (Local Group)**

**Local Group** (the contact group name you want to access)

**Label** (key label displayed on the touch screen)

**Usage:** Tap the local group key to access the contact group specified in the **Local Group** field.

**XML Group**

You can use this key feature to quickly access a remote group in your remote phone book. You should configure a remote phone book in advance. For more information, refer to [Remote Phone Book](#) on page 120.

**Dependencies: Type (Key Event)**

**Key Type (XML Group)**

**PhoneBook Name** (the remote group name you want to access if the remote phone book is configured)

**Label** (key label displayed on the touch screen)

**Usage:** Tap the XML group key to access the remote group specified in the **XML Group** field.

**XML Browser**

You can use this key feature to quickly access an XML browser. The XML browser allows you to create custom services which meet your functional requirements on the server. You can customize practical applications, such as weather report, stock information, Google search, etc.

**Dependencies: Type (Key Event)**

**Key Type (XML Browser)**

**Label** (key label displayed on the touch screen)

**Value** (the access URL for XML browser)

**Usage:** Tap the XML Browser key to access the XML browser specified in the **Value** field.

## LDAP

You can use this key feature to quickly access a LDAP search screen.

**Dependencies:** *Type (Key Event)*

*Key Type (LDAP)*

*Label (key label displayed on the touch screen)*

**Usage:**

1. Tap the LDAP key to access the LDAP search screen.
2. Enter a few continuous characters of the contact name or continuous numbers of the contact number.

The contacts whose name or phone number matches the characters entered will appear on the touch screen.

## Conference

You can use this key feature to set up a conference call. For more information, refer to [Conference](#) on page 309.

**Dependencies:** *Type (Key Event)*

*Key Type (Conference)*

*Label (key label displayed on the touch screen)*

*Value (the number added to the conference)*

**Usage:** Tap the conference key during an active call to set up a conference with the number specified in the **Value** field.

### Note

If the **Value** field is left blank, the conference key performs the same function as **Conference** during a call.

## Forward

You can use this key feature to forward an incoming call to someone else. For more information, refer to [Call Forward](#) on page 292.

**Dependencies:** *Type (Key Event)*

*Key Type (FWD)*

*Label (key label displayed on the touch screen)*

*Value (the number you want to forward to)*

**Usage:** Tap the forward key to forward an incoming call to the number specified in the **Value** field.

### Note

If the **Value** field is left blank, the forward key performs the same function as the **FWD** soft key when receiving an incoming call.

## Transfer

When there is an active call on the phone, you can use this key feature to handle the call differently depending on the transfer mode assigned to the DSS key.

**Dependencies:** *Type (Key Event)*

*Key Type (Transfer)*

*Label (key label displayed on the touch screen)*

*Value (the number you want to transfer to)*

**Usage:**

- When the transfer mode via Dsskey is **Blind Transfer**, tap the transfer key to complete the blind transfer to the number specified in the **Value** field.
- When the transfer mode via Dsskey is **Attended Transfer**, tap the transfer key to dial out the number specified in the **Value** field, and then perform the attended or semi-attended transfer.
- When the transfer mode via Dsskey is **New Call**, tap the transfer key to place a new call to the number specified in the **Value** field.

### Note

Transfer mode via Dsskey is configurable via web user interface at the path **Features->Transfer->Transfer Mode via Dsskey**.

If the **Value** field is left blank, the transfer key performs the same function as the **TRANSFER** key or the **Transfer** soft key during a call. For more information, refer to [Call Transfer](#) on page 304.

## Hold

You can use this key feature to place an active call on hold or retrieve a held call.

**Dependencies:** *Type (Key Event)*

*Key Type (Hold)*

*Label (key label displayed on the touch screen)*

**Usage:**

1. Tap the hold key during an active call to place the call on hold.
2. Tap the hold key again to retrieve the held call.

## DND

You can use this key feature to enable or disable DND. You can also use this key feature to access the custom DND screen. For more information, refer to [Do Not Disturb \(DND\)](#) on page 287.

**Dependencies:** *Type (Key Event)*

*Key Type (DND)*

*Label (key label displayed on the touch screen)*

**Usage:**

When DND is in phone mode:

1. Tap the DND key to enable DND.
2. Tap the DND key again to disable DND.

When DND is in custom mode:

1. Tap the DND key to access the custom DND screen. You can enable or disable DND for one or all accounts.

**Group Listening**

You can use this key feature to activate the Speakerphone and Handset/Headset mode at the same time. It is suitable for group conversations which have more than one person at one side. You are able to speak and listen through the handset/headset, while the others nearby can only listen through the speaker.

**Dependencies:** *Type (Key Event)*

*Key Type (Group Listening)*

*Label (key label displayed on the touch screen)*

**Usage:**

1. During a call, tap the group listening key to activate the group listening mode.
2. You can then speak and listen through the handset/headset, while other people at your side can only listen through the speaker at the same time.
3. Tap the group listening key again to deactivate the group listening mode.

**Zero Touch**

You can use this key feature to quickly configure auto provision and network parameters.

**Dependencies:** *Type (Key Event)*

*Key Type (Zero Touch)*

*Label (key label displayed on the touch screen)*

**Usage:**

1. Tap the zero touch key to access the zero touch screen.
2. Tap the **OK** soft key within a few seconds.
3. Configure the network parameters in the corresponding fields.
4. Tap the **Next** soft key.
5. Configure the auto provision parameters in the corresponding fields.
6. Tap the **Next** soft key.

The phone will reboot to update configurations.

**URL**

You can use this key feature to trigger the phone to send an HTTP GET request containing a specific URL.

**Dependencies:** *Type (URL)*

**Label** (key label displayed on the touch screen)

**URL** (the URL contained in the HTTP GET request)

**Usage:** Tap the URL key to trigger the phone to send an HTTP GET request containing the URL specified in the **URL** field.

### Phone Lock

You can use this key feature to immediately lock your phone instead of long pressing . For more information, refer to [Phone Lock](#) on page 91.

**Dependencies:** *Type (Key Event)*

**Key Type (Phone Lock)**

**Label** (key label displayed on the LCD screen)

**Usage:** When the phone lock feature is enabled, tap the phone lock key to immediately lock your phone instead of long pressing .

### Directory

You can use this key feature to easily access frequently used lists. For more information, refer to [Local Directory](#) on page 103.

**Dependencies:** *Type (Key Event)*

**Key Type (Directory)**

**Label** (key label displayed on the touch screen)

**Usage:** Tap the directory key to immediately access frequently used lists.

### Note

The directory key performs the same function as the .

### Mobile Account

You can use this key feature to accept incoming mobile calls, place active mobile calls on hold on your IP phone. For more information, refer to [Bluetooth-Enabled Mobile Phone](#) on page 143.

**Dependencies:** *Type (Mobile Account)*

**Label** (key label displayed on the touch screen)

**Usage:** When the IP phone receives an incoming mobile call,

1. Tap the mobile account key to accept the incoming call.
2. Tap the mobile account key to place a new call and the active call is placed on hold.

### Call Park

You can use this key to park a call directly during a call. For more information, refer to [Call Park/Retrieve](#) on page 314.

**Dependencies:** *Type (Key Event)*

**Key Type (Call Park)**

**Account ID** (the account this feature will be applied to)

**Label** (key label displayed on the touch screen)

**Value** (the park destination number or call park code)

**Usage:** Tap the call park key during a call to park the call.

**Note**

If the **Value** field is left blank, the Call Park key performs the same as the **Park** soft key during a call.

**Retrieve Park**

You can use this key to retrieve a parked call directly when the IP phone is idle. For more information, refer to [Call Park/Retrieve](#) on page 314.

**Dependencies: Type (Retrieve)**

**Account ID** (the account this feature will be applied to)

**Label** (key label displayed on the touch screen)

**Value** (the parked call destination number or retrieve code)

**Usage:** Tap the retrieve park key when the IP phone is idle to retrieve a parked call.

**Note**

If the **Value** field is left blank, the Park Retrieve key performs the same as the **Retrieve** key on the dialing screen.

**Programmable Keys**

You can customize the function keys.

**To customize a programmable key via web user interface:**

1. Click on **DSSKey->Programmable Key**.
2. Customize specific features for these keys.

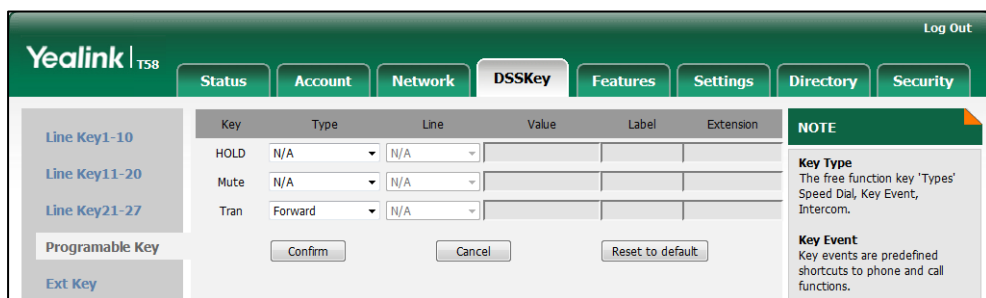

3. Click **Confirm** to accept the change.

You can click **Reset to default** to reset custom settings to defaults.

Then you can press the keys on the phone to perform the features you configured.

For example:

### Switch Account Up

You can press **Switch Account Up** key to change the default account.

**Dependencies: Type** (*Switch Account Up*)

**Usage:** Press the **Switch Account Up** key to scroll up the account list to select the desired default account.

### Switch Account Down

You can press **Switch Account Down** key to change the default account.

**Dependencies: Type** (*Switch Account Down*)

**Usage:** Press the **Switch Account Down** key to scroll down the account list to select the desired default account.

#### Note

Programable keys are configurable via web user interface only.

## Ext Keys

If EXP50 is connected to the phone, you can customize features for ext keys.



### To customize ext keys via phone user interface:

1. Long press the desired key on the EXP50.

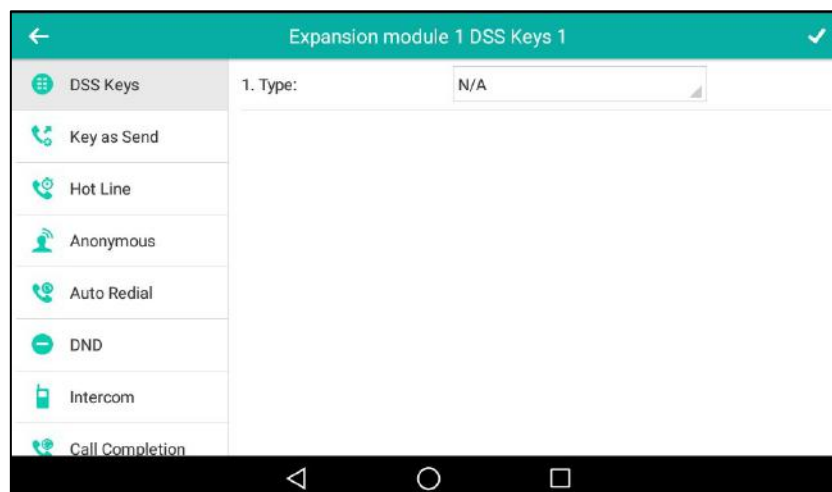
The IP phone touch screen will enter the user setting interface of this key.



2. Select the desired key type from the **Type** field.
3. (Optional.) Select the desired key event type from the **Key Type** field.
4. (Optional.) Select the desired line from the **Account ID** field.
5. (Optional.) Enter the string that will appear on the touch screen in the **Label** field.
6. (Optional.) Enter the corresponding value in the **Value** field.

7. (Optional.) Enter the corresponding value in the **Extension** field.
8. Tap  to accept the change or  to cancel.

Ext keys are configurable via web user interface at the path **DSSKey->Ext Key**.

For more information, refer to [Yealink EXP50 User Guide](#).

## Account Management



You can register one or multiple accounts on the SIP-T58V/A smart media phone. You can also configure each line key to associate with an account or configure multiple line keys to associate with an account.

### Account Registration

**To register an account via phone user interface:**

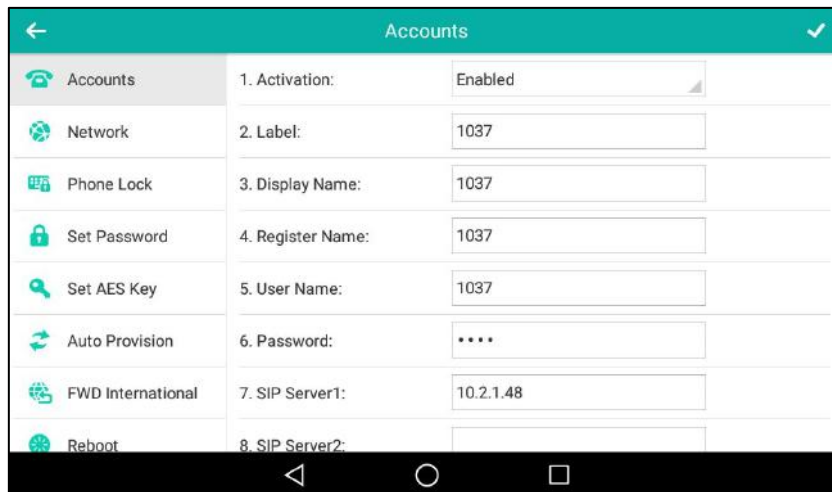
1. Swipe down from the top of the screen or swipe left/right to go to the second idle screen.
2. Tap **Settings->Advanced** (default password: admin) ->**Accounts**.
3. Tap the desired account.
4. Tap the **Activation** field.
5. Tap **Enabled** in the pop-up dialog box.
6. Enter the desired value in the **Label, Display Name, Register Name, User Name, Password** and **SIP Server1/2** field respectively. Contact your system administrator for more information.



7. If you use the outbound proxy servers, do the following:
  - 1) Tap the **Outbound Status** field.
  - 2) Tap **Enabled** in the pop-up dialog box.
  - 3) Enter the desired value in the **Outbound Proxy1/2** and **Proxy Fallback Interval** field respectively. Contact your system administrator for more information.
8. Tap  to accept the change or  to cancel.



You can repeat steps 3 to 8 to register more accounts.

The following figures demonstrate single or multiple accounts registered on the phone:

**Single account:**



**Multiple accounts:**



**To disable an account via phone user interface:**

1. Swipe down from the top of the screen or swipe left/right to go to the second idle screen.
2. Tap **Settings**->**Advanced** (default password: admin) ->**Account**.
3. Tap the desired account.
4. Tap the **Activation** field.
5. Tap **Disabled** in the pop-up dialog box.
6. Tap  to accept the change or  to cancel.

Account registration is configurable via web user interface at the path **Account**->**Register**.

## Default Account

**To configure the default account via phone user interface:**

1. Swipe down from the top of the screen or swipe left/right to go to the second idle screen.
2. Tap **Settings->Features->Default Account**.
3. Tap the **Default Account** field.
4. Tap the desired account in the pop-up dialog box.

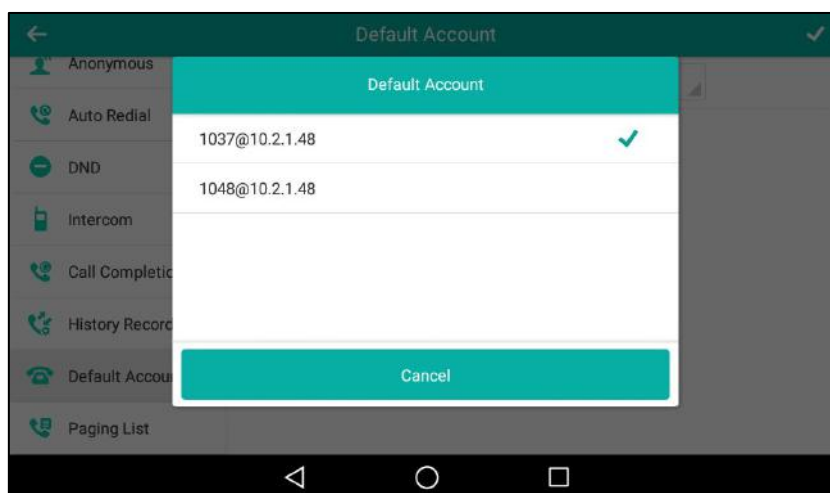

5. Tap  to accept the change or  to cancel.

The label of the default account is displayed on the left of the status bar. The IP phone will use this account by default when dialing out.

You can also tap the label of the default account, and then tap the desired account to be the new default account.

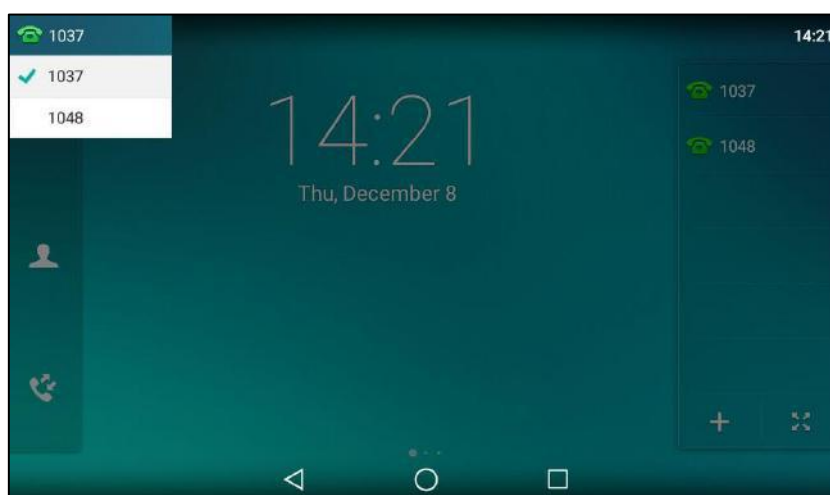

**Note**

Default account is configurable via phone user interface only.

## Multiple Line Keys per Account

You can configure multiple line keys to associate with an account. This enhances call visualization and simplifies call handling.

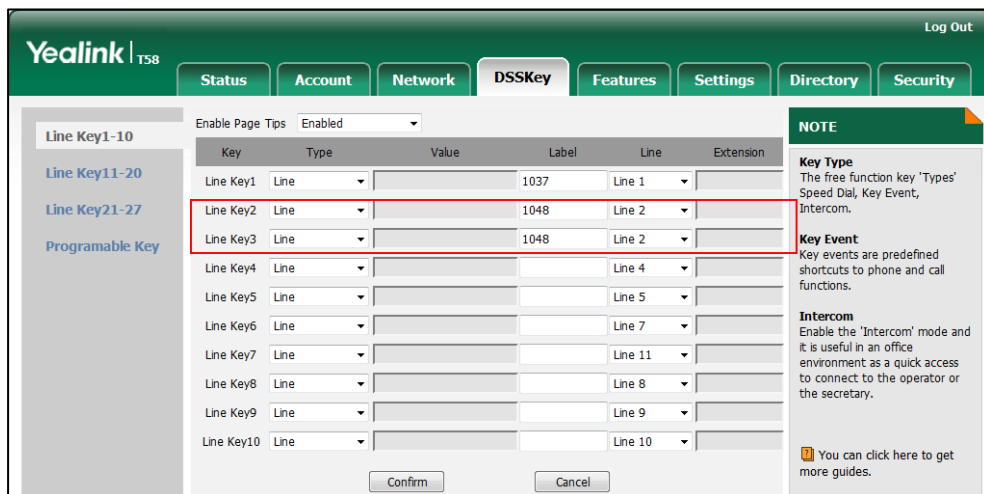

If this is the case, the touch screen will resemble the following figure:



Incoming calls to this account will be distributed evenly among the available line keys. Outgoing calls will be distributed similarly.

Your phone can be configured to have a combination of accounts with a single line key and accounts with multiple line keys.

## Dial Plan

Dial plan is a string of characters that governs the way your SIP-T58V/A smart media phone processes the inputs received from your phone keypad. The SIP-T58V/A smart media phone supports the following dial plan features:

- [Replace Rule](#)
- [Dial-now](#)

- [Area Code](#)
- [Block Out](#)

Basic expression syntaxes you need to know:

.	The dot "." can be used as a placeholder or multiple placeholders for any character. Example: "12." would match "123", "1234", "12345", "12abc", etc.
x	An "x" can be used as a placeholder for any character. Example: "12x" would match "121", "122", "123", "12a", etc.
-	Numeric ranges are allowed within the brackets: Digit "-" Digit. Example: "[5-7]" would match the number "5", "6" or "7".
[]	The square brackets "[]" can be used as a placeholder for a single character which matches any of a set of characters. Example: "91[5-7]1234" would match "9151234", "9161234", "9171234".
()	The parentheses "()" can be used to group together patterns, for instance, to logically combine two or more patterns. Example: "([1-9])([2-7])3" would match "923", "153", "773", etc.
\$	The "\$" should be followed by the sequence number of a parenthesis. The "\$" plus the sequence number means the whole character or characters placed in the parenthesis. The number directs to the right parenthesis when there are more than one. Example: A replace rule configuration, Prefix: "001(xxx)45(xx)", Replace: "9001\$145\$2". When you dial out "0012354599" on your phone, the IP phone will replace the number with "90012354599". "\$1" means 3 digits in the first parenthesis, that is, "235". "\$2" means 2 digits in the second parenthesis, that is, "99".

**Note** The IP phone supports a new dial plan mechanism - digit map. Digit maps are defined by a single string or a list of strings. If a number you dial matches any string of a digit map, the call is automatically placed.

Note that if digit map feature is enabled, the old dial plan rules (described in this chapter) will be ignored. For more information, contact your system administrator.

## Replace Rule

You can configure one or more replace rules (up to 100) to remove the specified string and replace it with another string. You can configure a pattern with wildcards (refer to the expression syntax in the table above), so that any string that matches the pattern will be replaced. This feature is convenient for you to dial out a long number. For example, a replace rule is configured as "Prefix: 1" and "Replace: 1234", when you try to dial out the number "1234", you just need to enter "1" on the phone and then tap **Send**.

### To add a replace rule via web user interface:

1. Click on **Settings->Dial Plan->Replace Rule**.

2. Enter the string (e.g., 1) in the **Prefix** field.
3. Enter the string (e.g., 1234) in the **Replace** field.
4. Enter the desired line ID in the **Account** field or leave it blank.

5. Click **Add** to add the replace rule.

When you enter the number "1" and then tap **Send**, the phone will dial out "1234" instead.

### Note

The valid values for the **Account** field can be one or more digits among 1-16. Every two digits must be separated by a comma. For example, when you enter the value "1, 2" in the **Account** field, this replace rule will apply to account1 and account2.

If you leave the **Account** field blank or enter 0, the replace rule will apply to all accounts.

### To edit a replace rule via web user interface:

1. Click on **Settings->Dial Plan->Replace Rule**.
2. Select the desired replace rule by checking the checkbox.
3. Edit the values in the **Prefix** and **Replace** fields.
4. Enter the desired line ID in the **Account** field or leave it blank.
5. Click **Edit** to accept the change.

### To delete one or more replace rules via web user interface:

1. Click on **Settings->Dial Plan->Replace Rule**.
2. Select one or more replace rules by checking the checkbox(es).
3. Click **Del** to delete the replace rule(s).

## Dial-now

You can configure one or more dial-now rules (up to 100) on your phone. When the dialed number matches the dial-now string, the number will be dialed out automatically. For example, a dial-now rule is configured as "2xx", any entered three-digit string beginning with 2 will then

be dialed out automatically on the phone.

**To add a dial-now rule via web user interface:**

1. Click on **Settings->Dial Plan->Dial-now**.
2. Enter the desired value (e.g., 2xx) in the **Rule** field.
3. Enter the desired line ID in the **Account** field or leave it blank.

For more information on the valid values for the **Account** field, refer to [Replace Rule](#) on page 172.

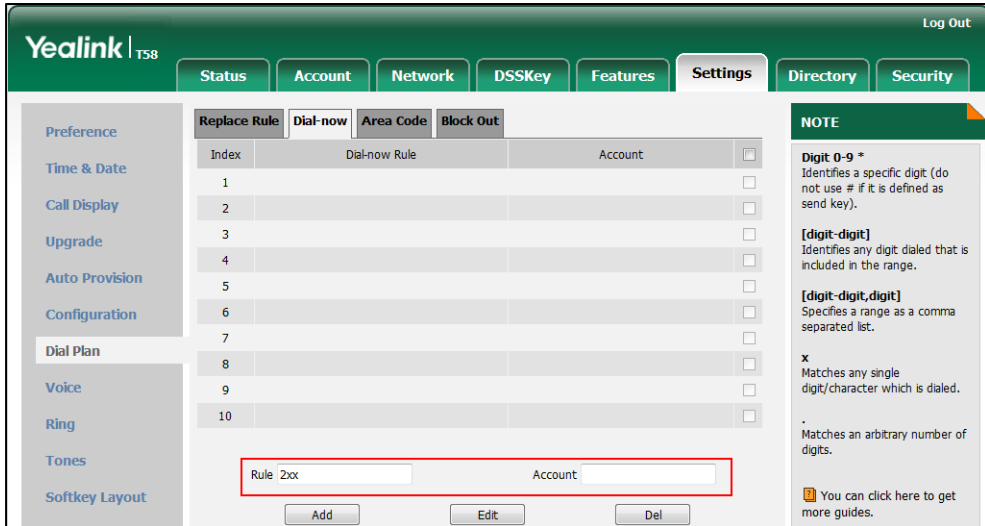

4. Click **Add** to add the dial-now rule.  
When you enter the number “234”, the phone will dial out “234” automatically without the pressing of any key.

**Note** You can also edit or delete the dial-now rule, refer to [Replace Rule](#) on page 172 for more information.

**Delay Time for Dial-Now Rule**

You can configure the delay time for dial-now rules. That is, you can configure your phone to automatically dial out the phone number which matches a dial-now rule, after the designated delay time.

**To configure the delay time for dial-now rule via web user interface:**

1. Click on **Features->General Information**.
2. Enter the time between 0 and 14 (seconds) in the **Time-Out for Dial-Now Rule** field.

The default value is "1".

Feature	Value	Help
Call Waiting	Enabled	?
Call Waiting On Code		?
Call Waiting Off Code		?
Auto Redial	Disabled	?
Auto Redial Interval (1~300s)	10	?
Auto Redial Times (1~300)	10	?
Key As Send	#	?
Reserve # in User Name	Enabled	?
Hotline Number		?
Hotline Delay(0~10s)	.4	?
Busy Tone Delay (Seconds)	0	?
Return Code When Refuse	486 (Busy Here)	?
Return Code When DND	480 (Temporarily Unava)	?
Call Completion	Disabled	?
Feature Key Synchronization	Disabled	?
<b>Time-Out for Dial-Now Rule</b>	<b>1</b>	?
RFC 2543 Hold	Disabled	?
Use Outbound Proxy In Dialog	Enabled	?
180 Ring Workaround	Enabled	?
Logon Wizard	Disabled	?

3. Click **Confirm** to accept the change.

**Note** Delay time for dial-now rule is configurable via web user interface only.

## Area Code

Area codes are also known as Numbering Plan Areas (NPAs). They usually indicate geographical areas in a country. This feature is necessary when dialing a phone number outside the code area. For example, an area code is configured as "Code: 0592, Min Length: 1, Max Length: 15". When you dial out the number "56789" (the length of the number is between 1 and 15), the phone will add the area code and dial out the number "059256789". You can only configure one area code rule on your phone.

### To configure the area code and lengths via web user interface:

1. Click on **Settings->Dial Plan->Area Code**.
2. Enter the desired values in the **Code**, **Min Length (1-15)** and **Max Length (1-15)** fields.
3. Enter the desired line ID in the **Account** field or leave it blank.

For more information on the valid values for the **Account** field, refer to [Replace Rule](#) on page 172.

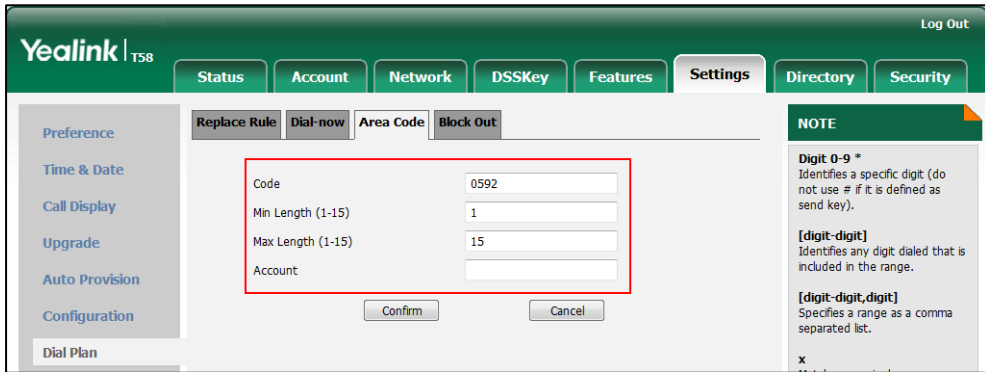

4. Click **Confirm** to accept the change.

**Note** The default value of minimum and maximum length is 1 and 15 respectively.

## Block Out

You can block some specific numbers (up to 10) from being dialed on your phone. When you dial a block out number on your phone, the dialing will fail and the touch screen will prompt "Forbidden Number".

### To add a block out number via web user interface:

1. Click on **Settings->Dial Plan->Block Out**.
2. Enter the desired value in the **BlockOut Number** field.
3. Enter the desired line ID in the **Account** field or leave it blank.

For more information on the valid values for the **Account** field, refer to [Replace Rule](#) on page 172.

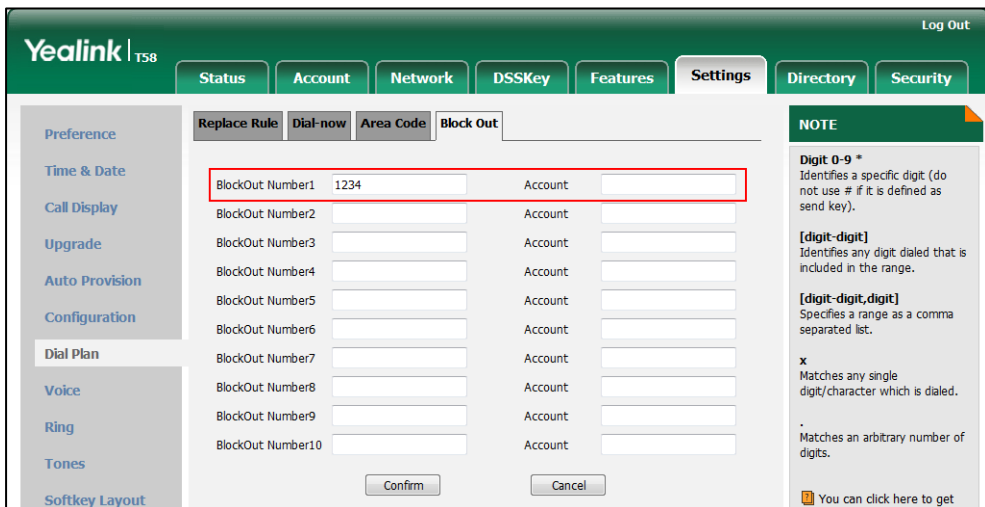

4. Click **Confirm** to add the block out number.



## Emergency Number

Public telephone networks in countries around the world have a single emergency telephone number (emergency services number), that allows a caller to contact local emergency services for assistance when necessary. The emergency telephone number may differ from country to country. It is typically a three-digit number so that it can be easily remembered and dialed quickly. Some countries have a different emergency number for each of the different emergency services.

You can specify the emergency telephone numbers on the IP phone for contacting the emergency services in an emergency situation. You can dial these numbers when the phone is locked. For more information on phone lock refer to [Phone Lock](#) on page 91.

### Note

Contact your local phone service provider for available emergency numbers in your area.

The IP phone also supports the emergency dialplan, which allows users to make emergency calls if the phone is locked or unregistered. For more information, contact your system administrator.

### To specify emergency numbers via web user interface:

1. Click on **Features->Phone Lock**.
2. Enter the emergency number in the **Emergency** field.

For multiple emergency numbers, enter a comma between every two numbers. The default emergency numbers are 112, 911 and 110.

The screenshot shows the Yealink T58 web user interface. The 'Features' tab is selected, and the 'Phone Lock' sub-tab is active. The 'Emergency' field is highlighted with a red box and contains the value '112,911,110'. Other fields include 'Phone Lock Enable' (Enabled), 'Phone Unlock PIN(0~15 Digit)' (\*\*\*\*\*), and 'Phone Lock Time Out(0~3600s)' (0). A 'NOTE' box on the right states: 'Phone Lock: The phone lock parameters for administrator. You can click here to get more guides.'

3. Click **Confirm** to accept the change.

### Note

Emergency number is configurable via web user interface only.

## Live Dialpad

You can enable live dialpad on the SIP-T58V/A smart media phone, which enables the IP phone to automatically dial out a phone number without the pressing of the send key. You can also configure a delay, where the phone will dial out the phone number automatically after the

designated period of time.

**To enable the live dialpad via web user interface:**

1. Click on **Settings->Preference**.
2. Select **Enabled** from the pull-down list of **Live Dialpad**.
3. Enter the desired delay time in the **Inter Digit Time(1~14s)** field.

The default delay time is 4.

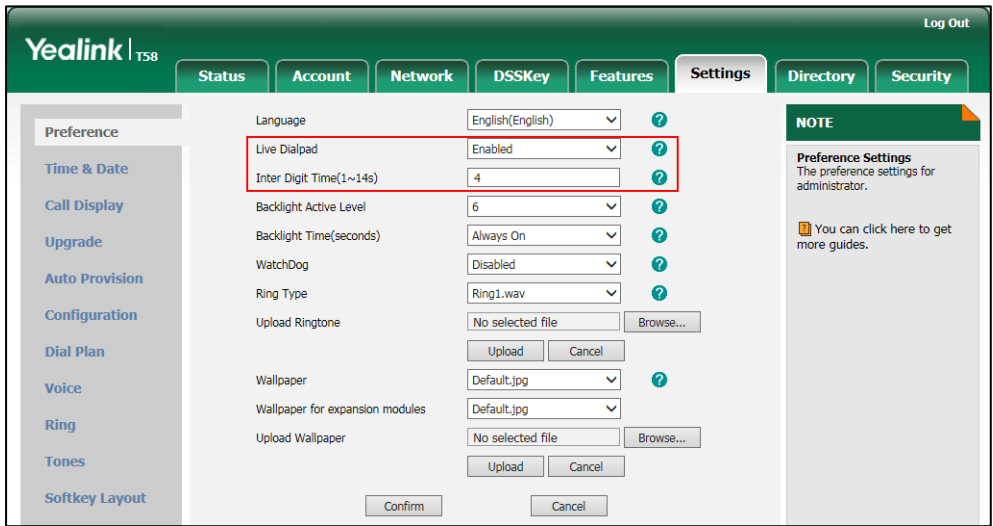

4. Click **Confirm** to accept the change.

**Note** Live dialpad is configurable via web user interface only.

## Hotline

You can dial a hotline number immediately upon lifting the handset, pressing the Speakerphone key or tapping the line key. You can also configure a delay, where the phone will dial out the hotline number automatically after a designated period of time.

**To configure the hotline number via phone user interface:**

1. Swipe down from the top of the screen or swipe left/right to go to the second idle screen.
2. Tap **Settings->Features->Hot Line**.
3. Enter the desired number in the **Number** field.
4. Enter the desired delay time in the **Hotline Delay** field.

The default value is "4".

The screenshot shows a mobile application interface for configuring a 'Hot Line'. The title bar at the top is teal and contains a back arrow on the left, the text 'Hot Line' in the center, and a checkmark on the right. Below the title bar is a list of features on the left side, each with an icon and a label: 'Auto Answer', 'DSS Keys', 'Key as Send', 'Hot Line' (which is highlighted with a grey background), 'Anonymous', 'Auto Redial', 'DND', and 'Intercom'. To the right of this list are two configuration fields: '1. Number:' with a text input field containing '1024', and '2. Hotline Delay:' with a text input field containing '4'. At the bottom of the screen, there is a black navigation bar with three white icons: a back arrow, a circle, and a square.

5. Tap ✓ to accept the change or ◀ to cancel.

Hotline is configurable via web user interface at the path **Features->General Information**.



## System Applications

---

The system applications are pre-installed on your phone and they cannot be uninstalled.

This chapter provides basic operating instructions for using the system applications. Topics include:

- [Managing Applications and Widgets](#)
- [Managing Running Applications](#)
- [APP Accounts](#)
- [FileManager](#)
- [Gallery](#)
- [Recorder](#)
- [Camera](#)
- [Email](#)
- [Browser](#)
- [Calendar](#)
- [Calculator](#)
- [Clock](#)

## Managing Applications and Widgets

### Adding a Widget to the Idle Screen

The SIP-T58V/A smart media phone provides widgets like analog clock, calendar, digital clock, email and photo gallery. You can conveniently add these widgets to the idle screen as preferred.

**To add a widget to idle screen:**

1. Long tap the empty spot on the idle screen.

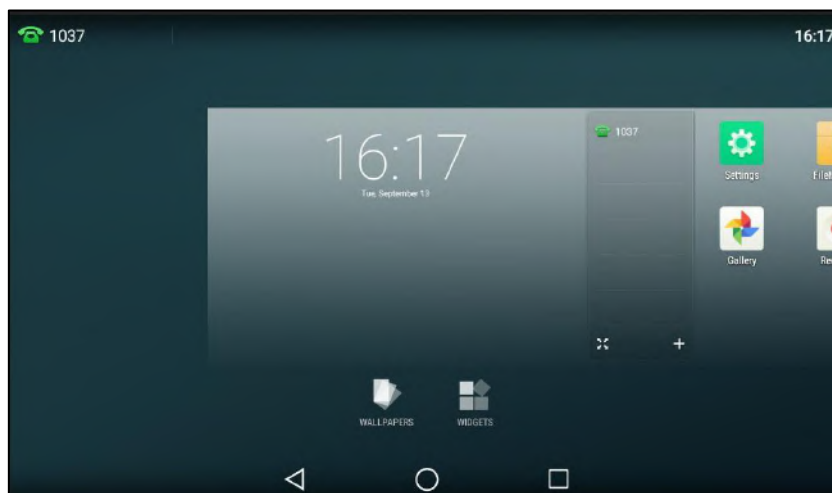

2. Tap **WIDGETS**.

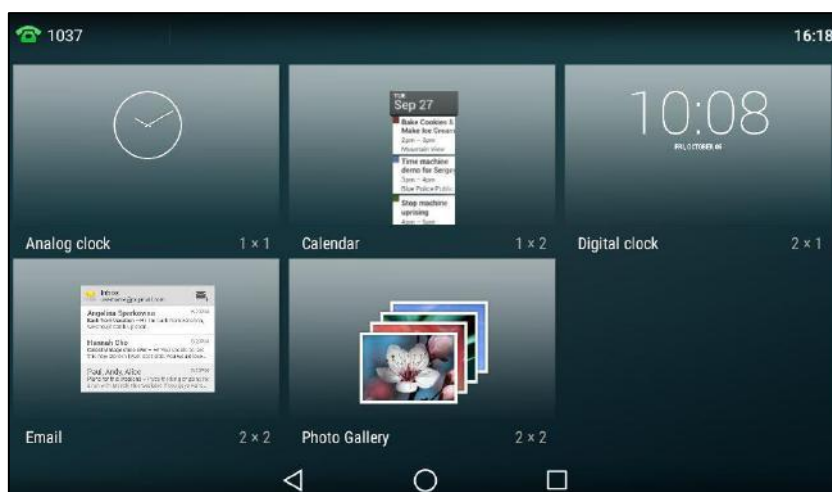

3. Drag the desired widget up/down/left/right to the destination spot on the idle screen.

If you want to add an email widget, and you have not registered an account on the **Email** or **Calendar** application, a wizard will be provided for you to set up the email account step by step. For more information, refer to [Adding APP Accounts](#) on page 188.

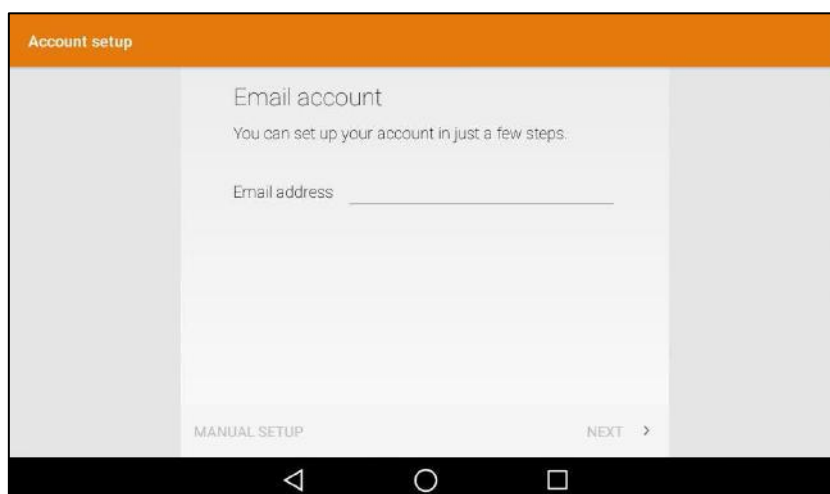

If you want to add a photo gallery widget, you will be required to choose the desired images to display.

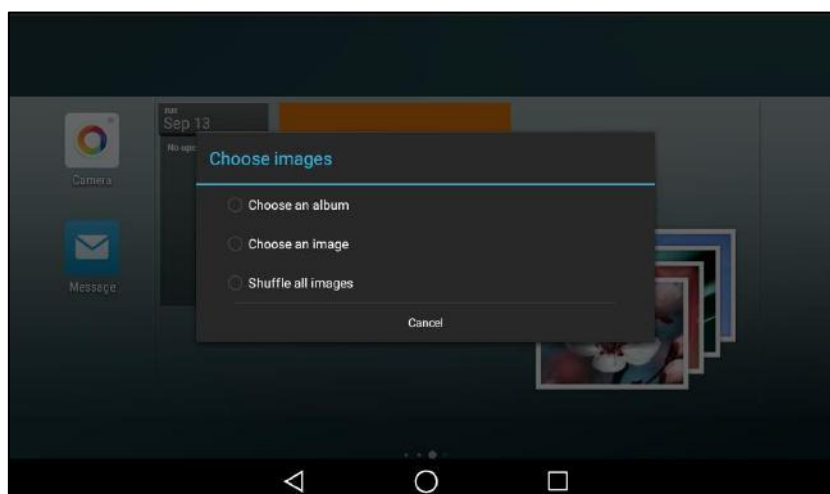

Before adding a widget to the idle screen, make sure the idle screen have enough space for the widget. Otherwise the widget cannot be added and the touch screen will prompt "No more room on this Home screen".

## Resizing a Widget

Certain widgets such as calendar, digital clock and email can be resized on the idle screen.

### To resize a widget:

1. Long tap the desired widget for about 2 seconds, and then lift your finger from the screen.

This will bring up the white frame as shown below:

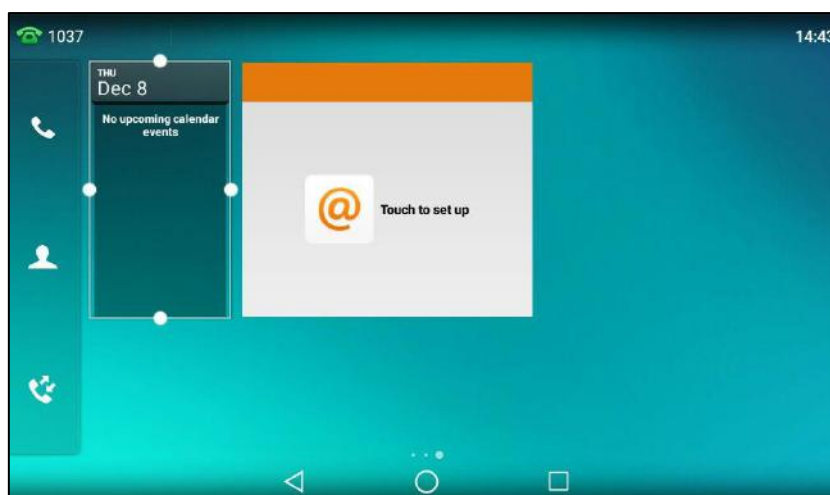

2. Drag the border of the frame to adjust the size.

## Moving an Application or Widget

You can move an application or widget to a different spot on the idle screen or to a different idle screen.

Before moving an application or widget, you should know the following:

- You can drag an application or widget to the rightmost of three idle screens to add an idle screen.
- If there is only one application or widget on the screen, you cannot drag the application or widget to the rightmost of three idle screens to add an idle screen.
- The idle screen (except the home screen) will be deleted automatically if there is no application or widget on the screen.

### To move an application or widget:

1. Long tap the desired item for about 2 seconds.



2. Drag the item up/down/left/right to the destination spot on the screen.

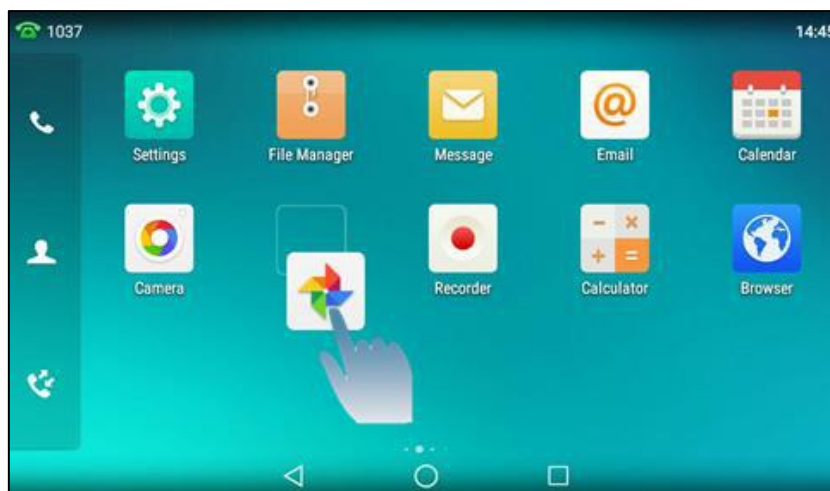

## Removing a Widget from the Idle Screen

Removing operation only removes the widget of the application on the screen. The application itself will not be uninstalled.

**To remove a widget from the idle screen:**

1. Long tap the desired item for about 2 seconds.  
The **Remove** field will appear on the top of the touch screen.

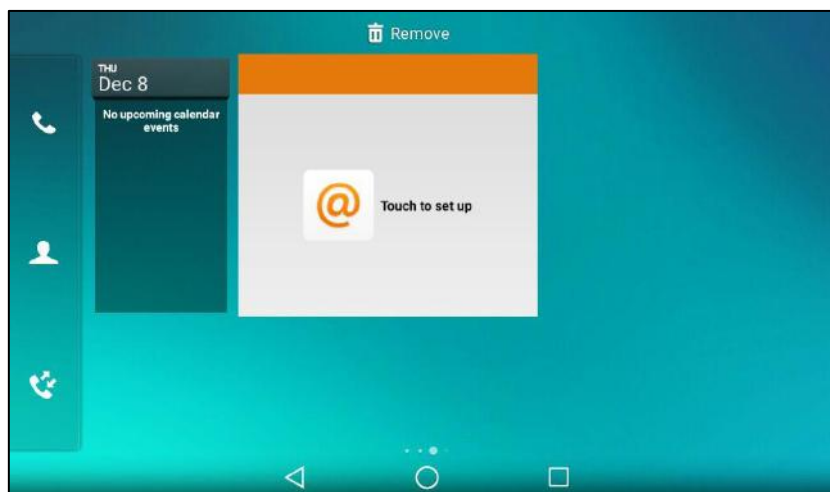

2. Drag the item to the **Remove** field to remove it.

## Creating a Folder

You can create a folder to organize your applications. For example, you can place the same kind of applications in a folder.

**To create a folder:**

1. Drag an application icon over another application icon.

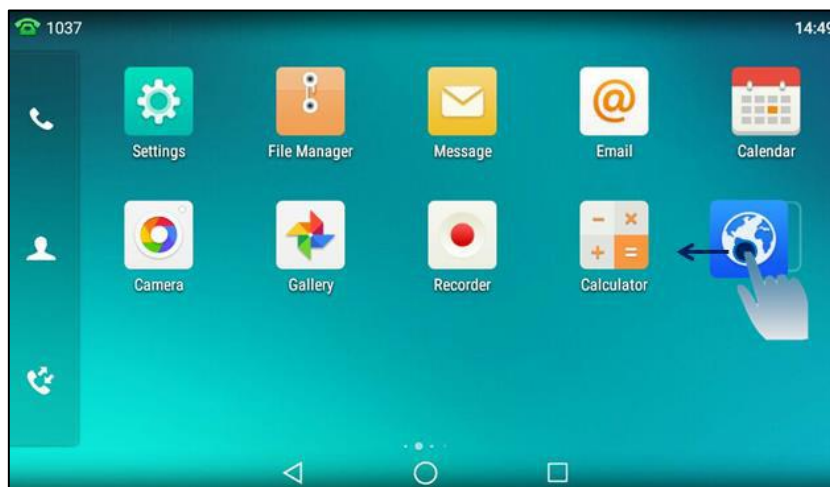

2. Lift your finger when a folder frame appears around the applications.

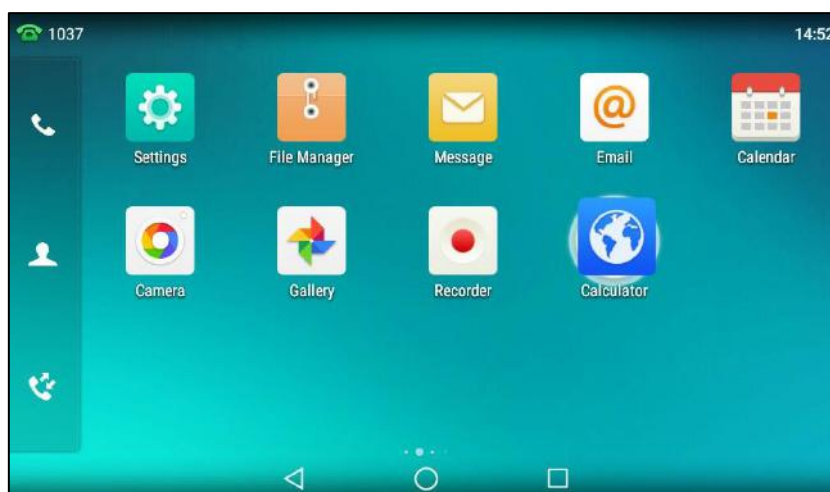

A new folder containing the selected applications is automatically created.

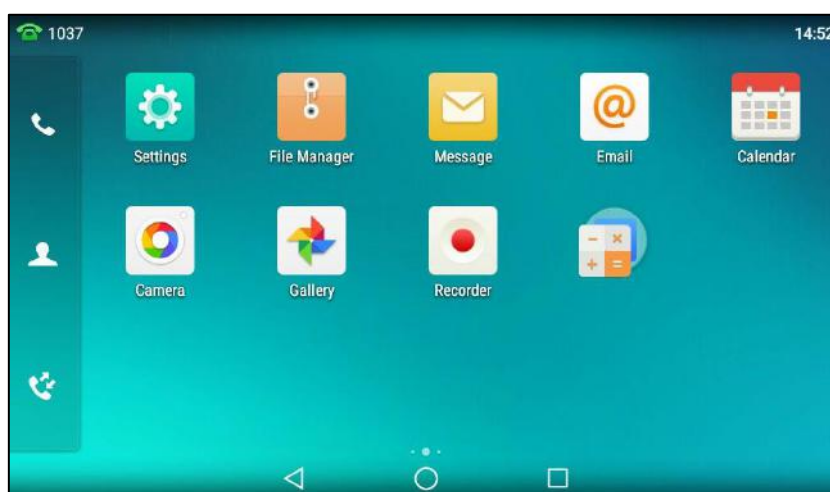

You can do the following:

- Drag another application icon to the folder to add more applications into the folder.
- Tap the folder and then drag an application icon in the folder to the destination spot on the idle screen to move the application from the folder to the idle screen.

The folder will be deleted automatically if there is only one application in the folder.

#### To rename a folder:

1. Tap the desired folder to expand the folder.

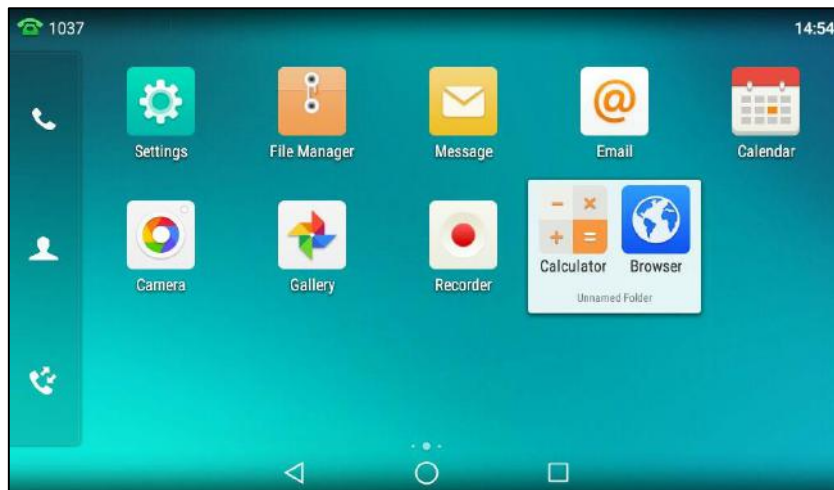

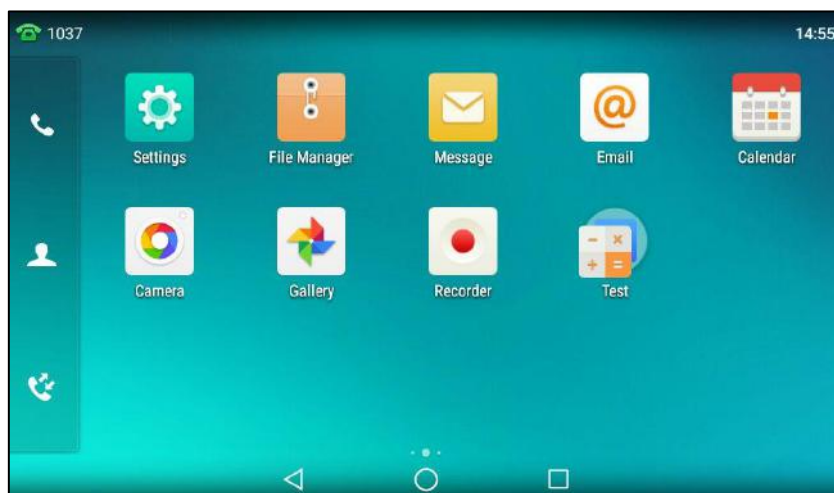

2. Tap the **Unnamed Folder** field.
3. Enter the desired folder name.
4. Tap **Done** on the onscreen keyboard.
5. Tap the blank area of the touch screen.

The folder name is renamed.



## Managing Running Applications

You can tap  to view and manage the list of recently used applications that are still running in the background. You can do the following:

- Swipe the desired application left or right to stop the running application.
- Tap  to stop all running applications.
- Tap the desired application to access the application.

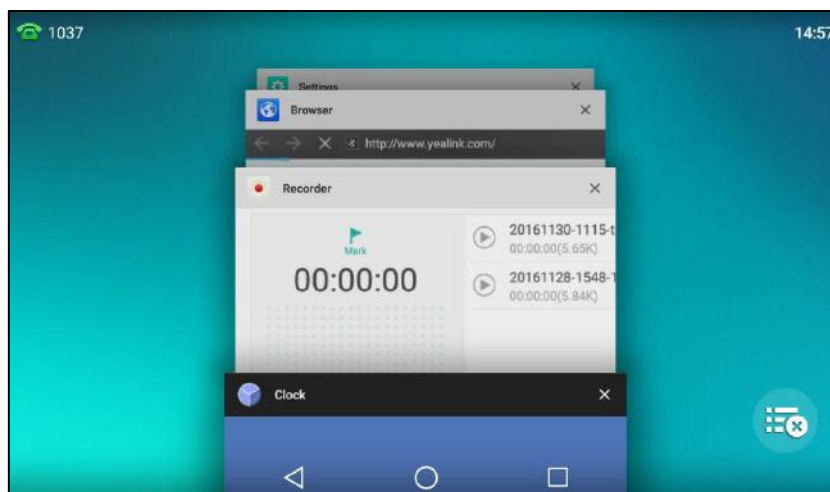

If there are no running applications, the touch screen will prompt "Your recent screens appear here".

## APP Accounts

**Email** and **Calendar** applications require a registered account. You can create accounts to have the best experience with your phone. You can also sync the account information or remove the account.

## Adding APP Accounts

**To add an app account via phone user interface:**

1. Swipe down from the top of the screen or swipe left/right to go to the second idle screen.

2. Tap **Settings**->**Basic**->**APP accounts**.

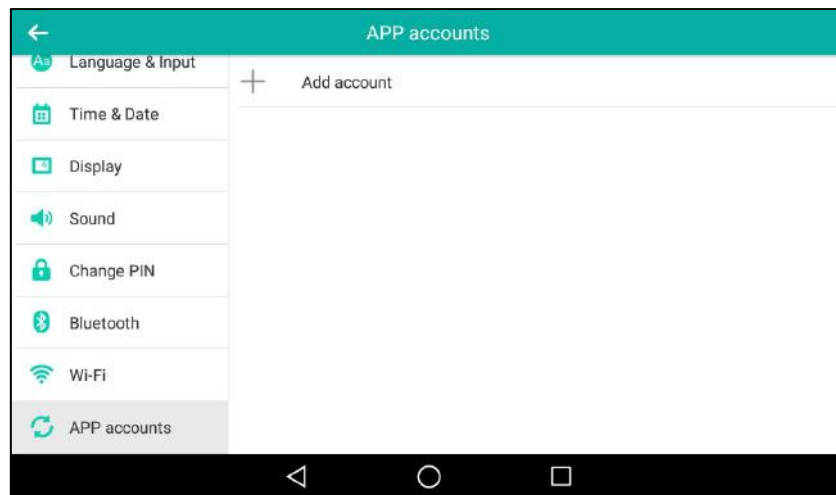

3. Tap **Add account**.

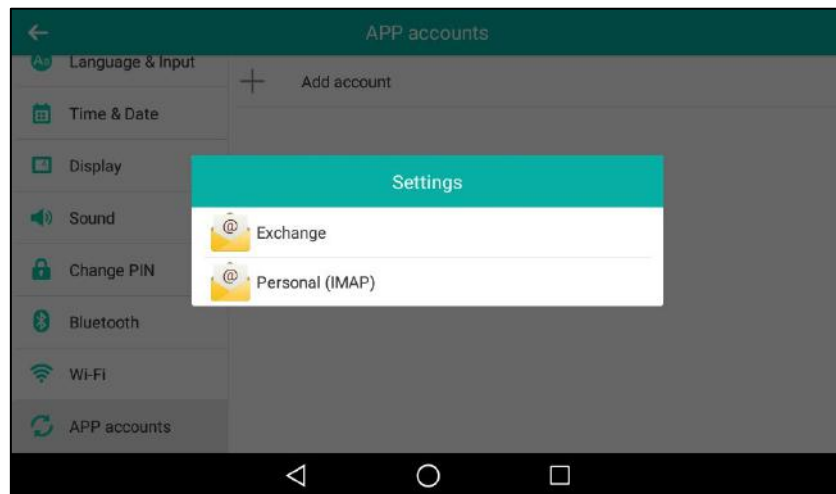

4. Tap a desired account type.
5. Enter the email address.
6. Tap **Next** or **Manual setup**.

7. Choose the email account type.

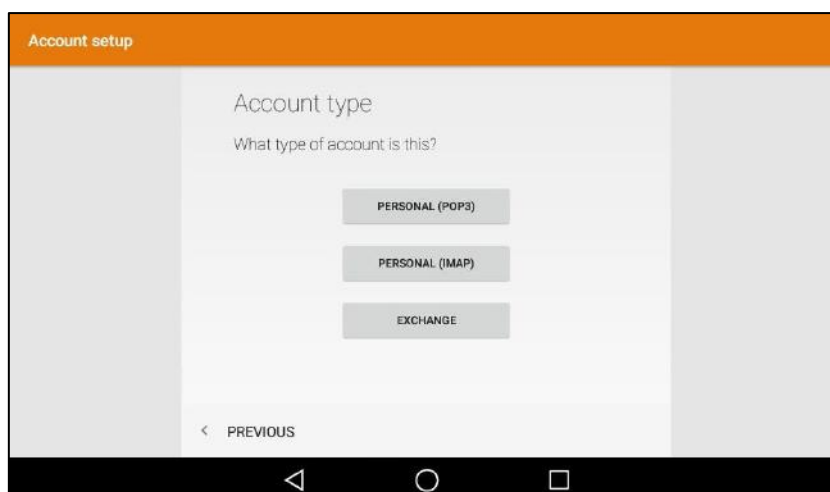

- **POP3:** When using POP3, all emails are stored locally instead of the server side. Please check with your network administrators for the correct email account settings for POP3.
- **IMAP:** When using IMAP, all emails are stored on the server side and users can see them from the IP phone or other mail clients as well. Please check with your network administrators for the correct email account settings for IMAP.
- **Exchange:** When using Exchange, all emails are stored in the central Exchange mail server and can be checked using capable mail client such as Microsoft Outlook. Please check with your network administrators for the correct email account settings for Exchange.

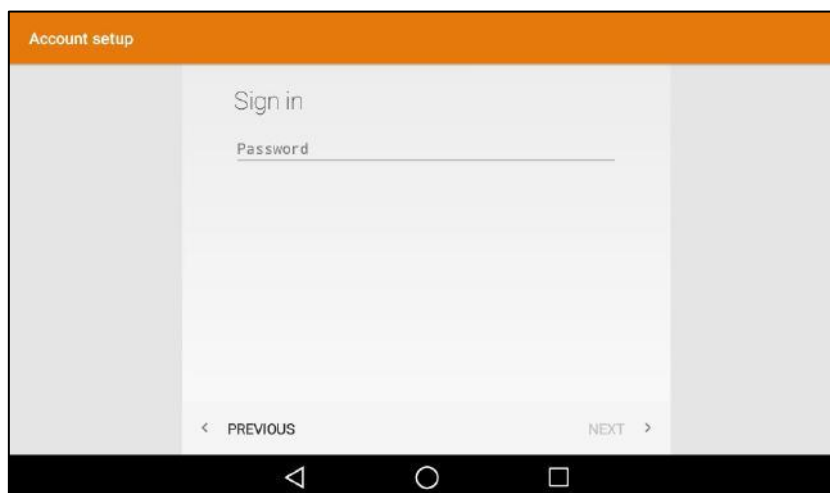

8. Enter the password and then tap **NEXT**.

- Configure the incoming server settings.

The screenshot shows the 'Incoming server settings' screen. The fields are filled with the following information:

USERNAME	ll506466499@sina.com
PASSWORD	.....
SERVER	pop.sina.com
SECURITY TYPE	STARTTLS
PORT	110
Delete email from server	When I delete from Inbox

Navigation buttons: < PREVIOUS, NEXT >

- Tap **Next**.

- Configure the outgoing server settings.

The screenshot shows the 'Outgoing server settings' screen. The fields are filled with the following information:

SMTP SERVER	smtp.sina.com
SECURITY TYPE	STARTTLS
PORT	587
Require sign in	<input checked="" type="checkbox"/>
USERNAME	ll506466499@sina.com
AUTHENTICATION	.....

Navigation buttons: < PREVIOUS, NEXT >

- Tap **Next**.

- Configure the account options.

The screenshot shows the 'Account options' screen. The settings are as follows:

Sync frequency	Every 15 minutes
Notify me when email arrives	<input checked="" type="checkbox"/>
Sync email from this account	<input checked="" type="checkbox"/>

Navigation buttons: < PREVIOUS, NEXT >

14. Tap **Next**.
15. Enter the string in the **Your name** field as the sender name.

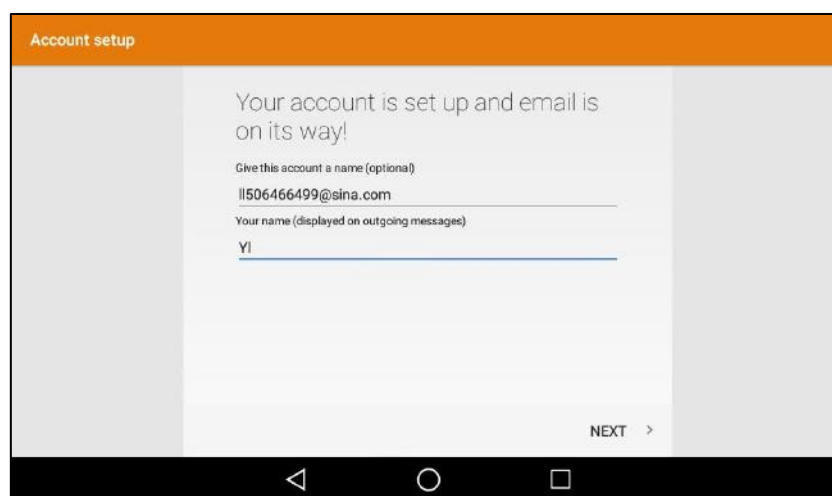

16. Tap **Next**.  
You are able to start using the email account now.

## Syncing APP Account Information

**To sync account information via phone user interface:**

1. Swipe down from the top of the screen or swipe left/right to go to the second idle screen.
2. Tap **Settings->Basic->APP accounts**.

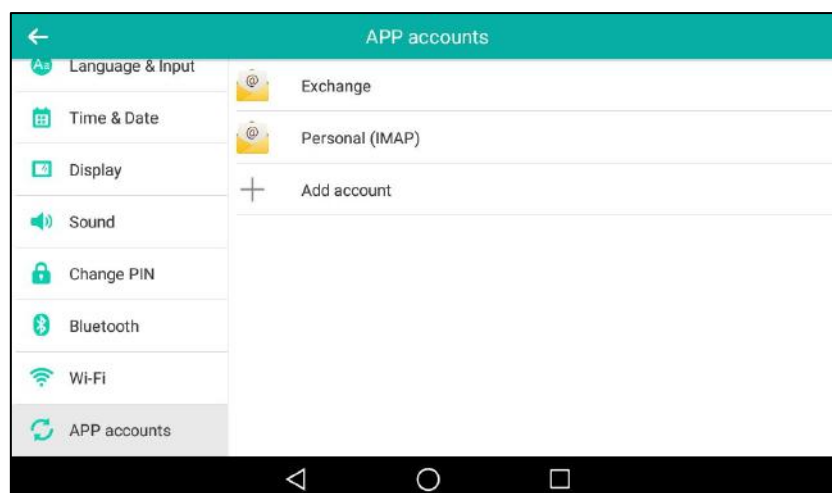



3. Tap the desired account type.

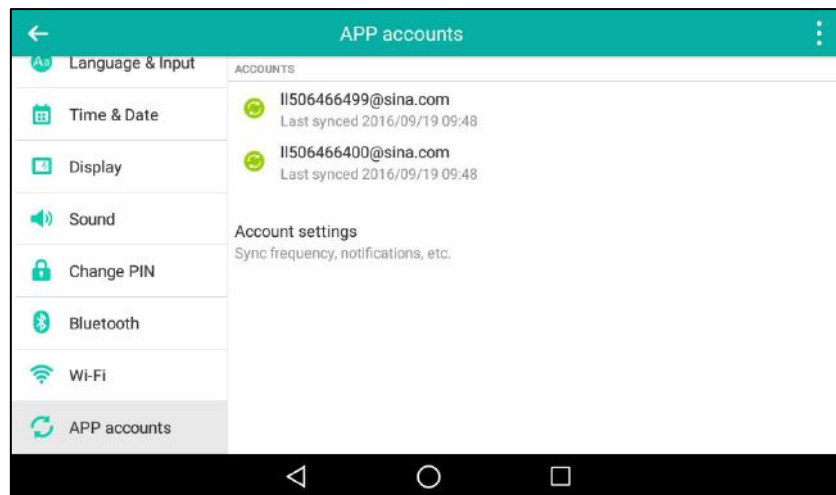

4. Do one of the following:

- Tap  and then tap **Sync now**.

In this example, it will sync both II506466499@sina.com and II506466400@sina.com information.

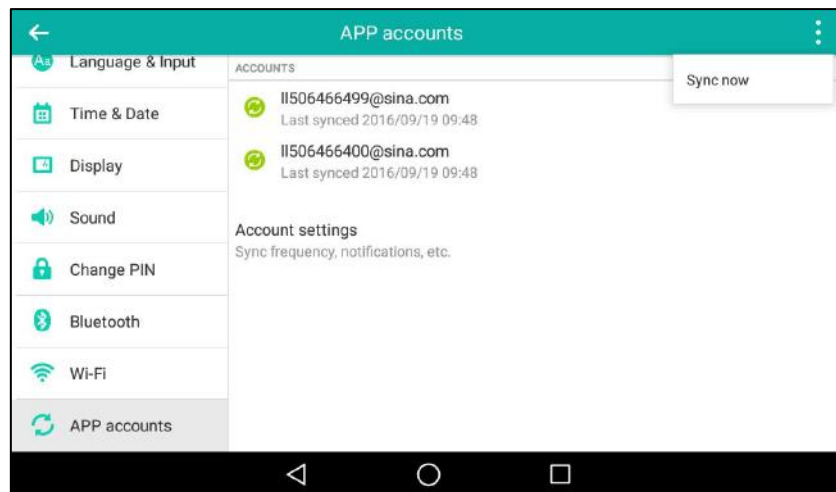

- Tap a desired account.
- Tap  and then tap **Sync now**.

In this example, it will only sync 1150466499@sina.com information.

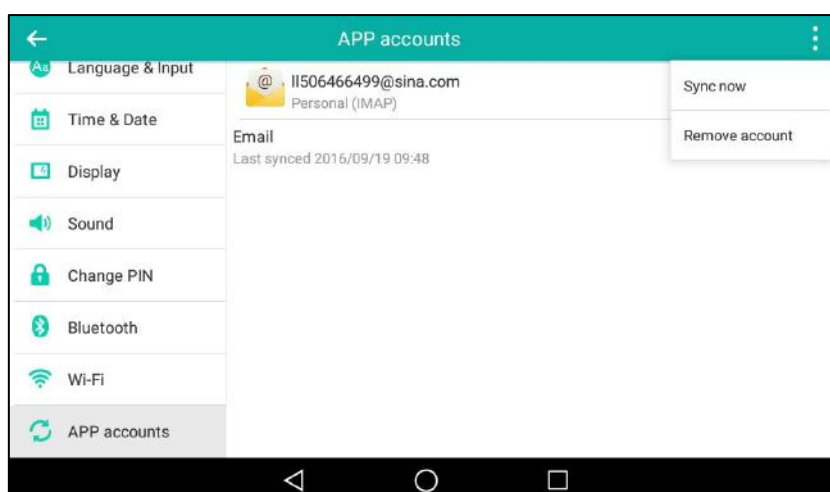

## Removing APP Accounts

**To remove an app account via phone user interface:**

1. Swipe down from the top of the screen or swipe left/right to go to the second idle screen.
2. Tap **Settings**->**Basic**->**APP accounts**.

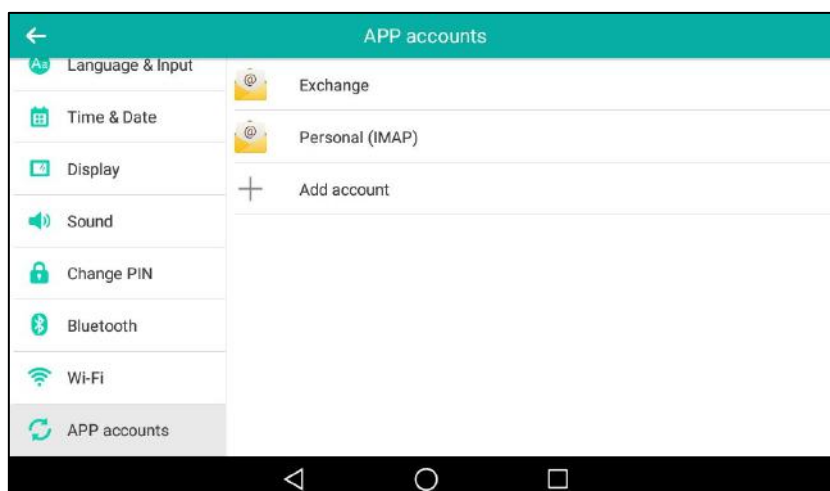

3. Tap a desired account type.

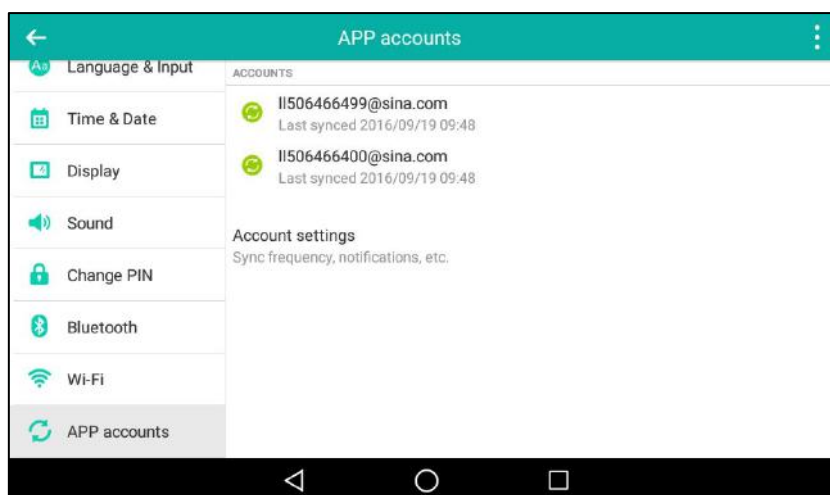

4. Tap a desired account.
5. Tap  and then tap **Remove account**.

The following prompt will appear on the touch screen of the phone:

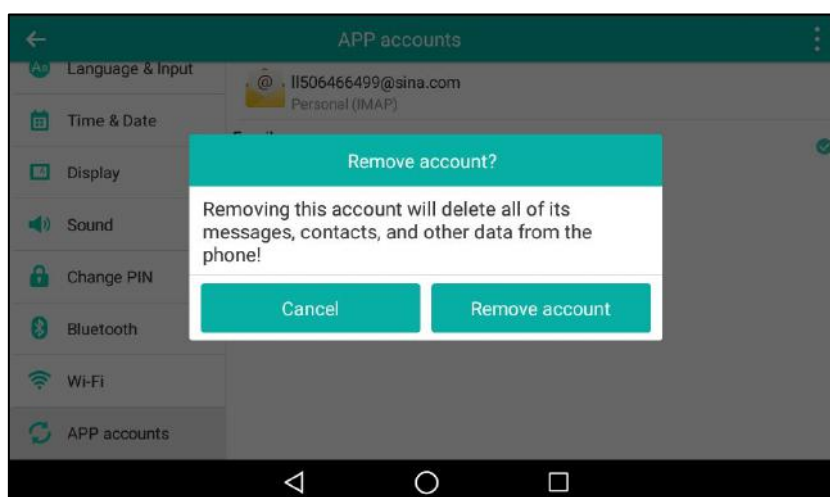

6. Tap **Remove account** to accept the change or **Cancel** to cancel.

## FileManager

**FileManager** is a tool that allows you to view, search, delete, copy or move photo/video/audio files. You can also share files via Bluetooth or email. It helps you to access and manage files in internal SD card as well as USB flash drive. For more information on how to connect the USB flash drive to your phone, refer to [Phone Installation](#) on page 31.

## Viewing Files

### To view pictures:

1. Swipe left or right to go to the second idle screen.
2. Tap  to launch **FileManager** application.
3. Tap **Photos** in the **Local Storage** field.

If a USB flash drive has been connected to your phone, you can tap **Photos** in the **USB Storage** field to view the pictures stored in USB flash drive.

Your pictures will display as a list.

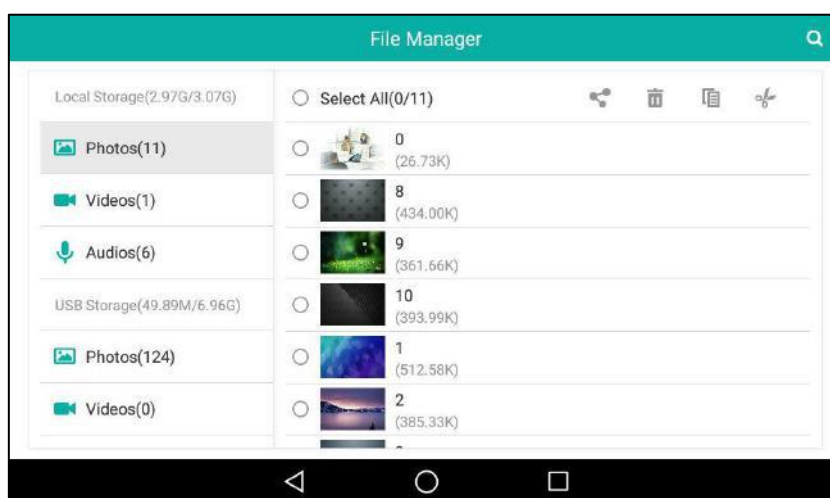

4. Tap the desired picture to view.  
The IP phone will automatically launch **Gallery** application to preview the picture.

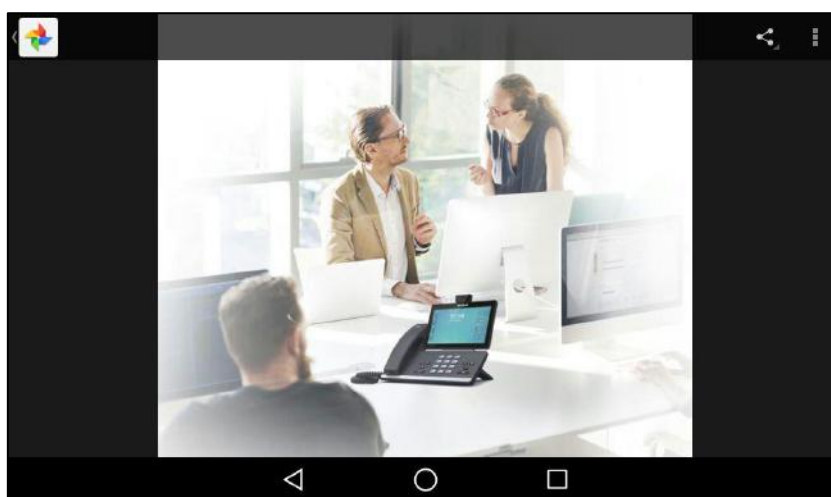

You can set the picture as wallpaper, print the picture and/or view detail information of the picture. For more information, refer to [Setting a Picture as Wallpaper](#) on page 213, [Printing Pictures](#) on page 215 and/or [Viewing Detail Information of the Pictures/Videos](#) on page 215.

**To view videos:**

1. Swipe left or right to go to the second idle screen.
2. Tap  to launch **FileManager** application.
3. Tap **Videos** in the **Local Storage** field.

If a USB flash drive has been connected to your phone, you can tap **Videos** in the **USB Storage** field to view the videos stored in USB flash drive.

Your videos will display as a list.

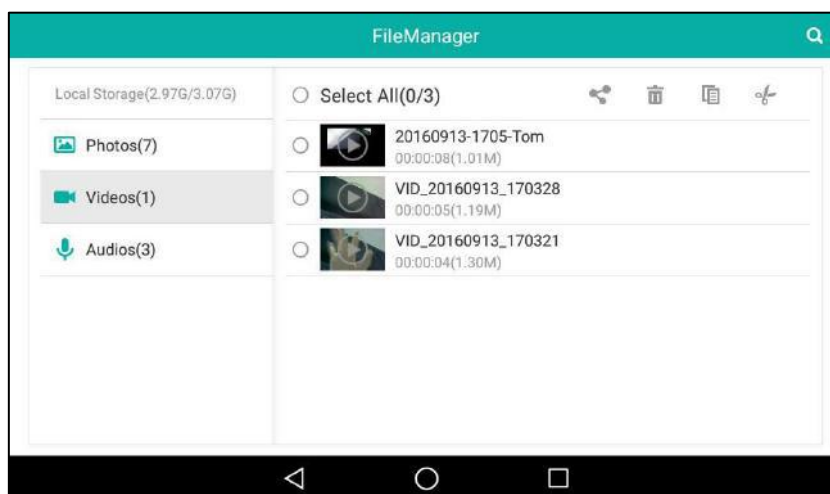



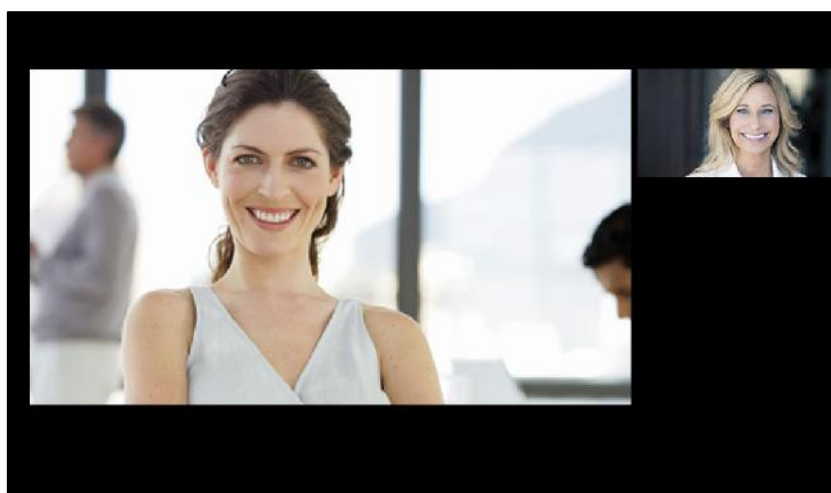

4. Tap the desired video to play.

The IP phone will automatically launch **Gallery** application to view the video.



During the playing, you can do the following:

- Tap the touch screen. Then  appears on the touch screen. Tap  to pause the playing. Then  appears on the touch screen. Tap  to continue the playing.
- Drag the slider to skip forward the playing or rewind the playing.

- Press  to adjust the media volume.

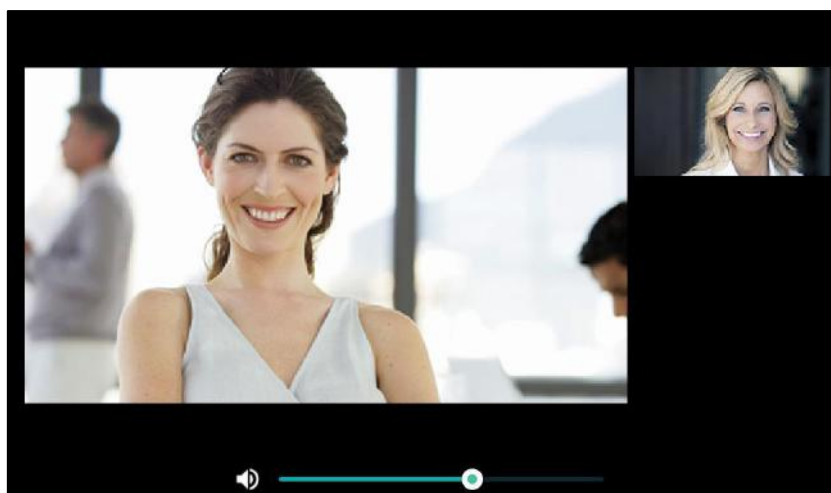

**Note**

The menu keys and Android keys will disappear within 5 seconds, you may tap the touch screen to show them again.

**To view audios:**

1. Swipe left or right to go to the second idle screen.
2. Tap  to launch **FileManager** application.
3. Tap **Audios** in the **Local Storage** field.

If a USB flash drive has been connected to your phone, you can tap **Audios** in the **USB Storage** field to view the audios stored in USB flash drive.

Your audios will display as a list.

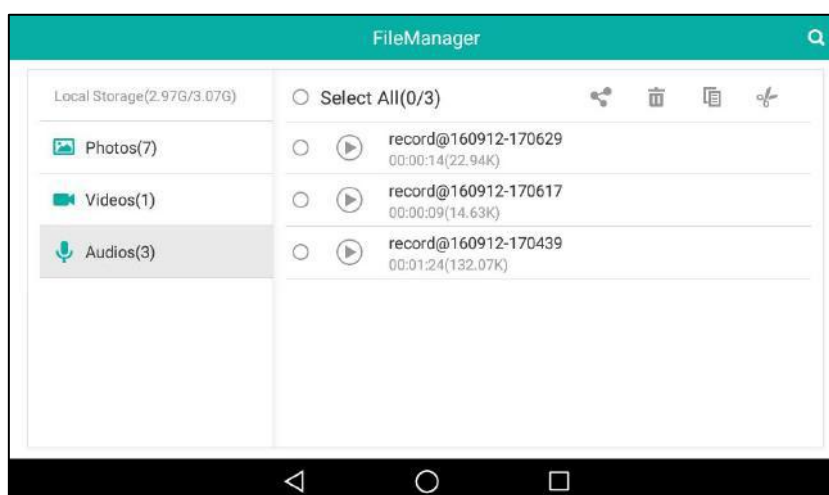

4. Tap the desired audio to play.

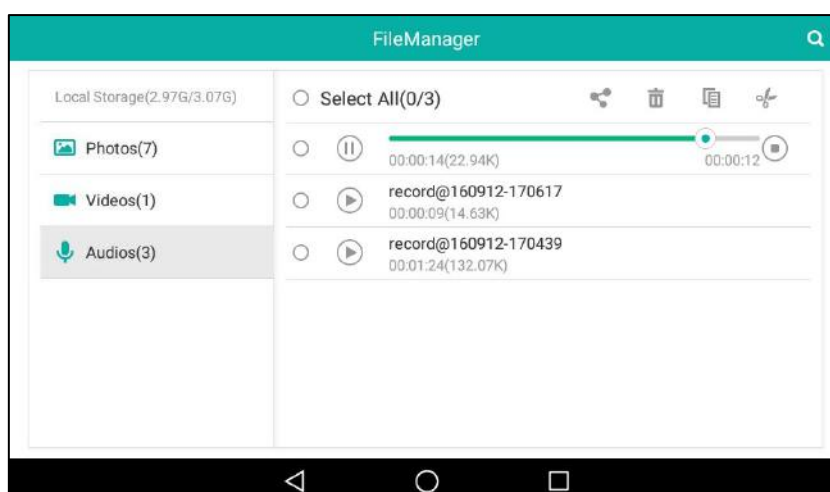

During the playing, you can do the following:

- Tap to pause the playing. Then appears on the touch screen. Tap to continue the playing.
- Drag the slider to skip forward the playing or rewind the playing.
- Press to adjust the volume of the speakerphone.
- Tap to stop the playing.

You can also swipe down from the top of the screen to enter the control center, and then tap **USB** to launch **FileManager** application to view the files if you have connected a USB flash drive to the phone.

## Searching Files

### To search files:

1. Swipe left or right to go to the second idle screen.
2. Tap to launch **FileManager** application.

3. Tap  on the top-right of the screen.

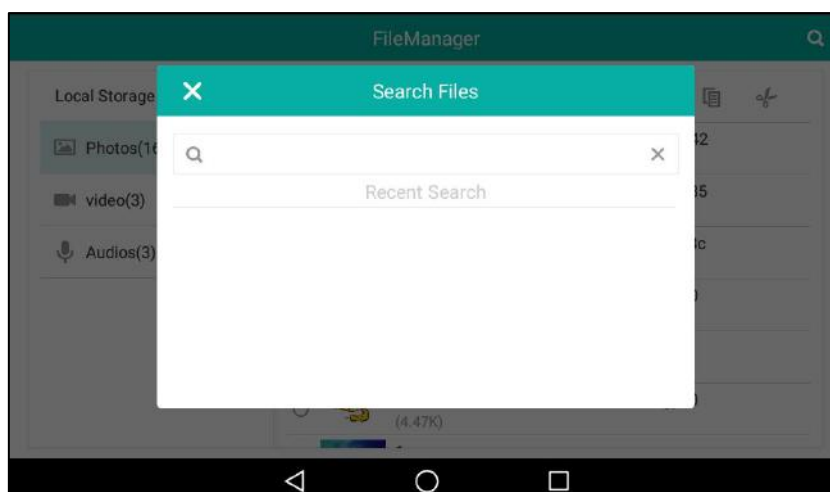

4. Enter one or more continuous characters of the file name.

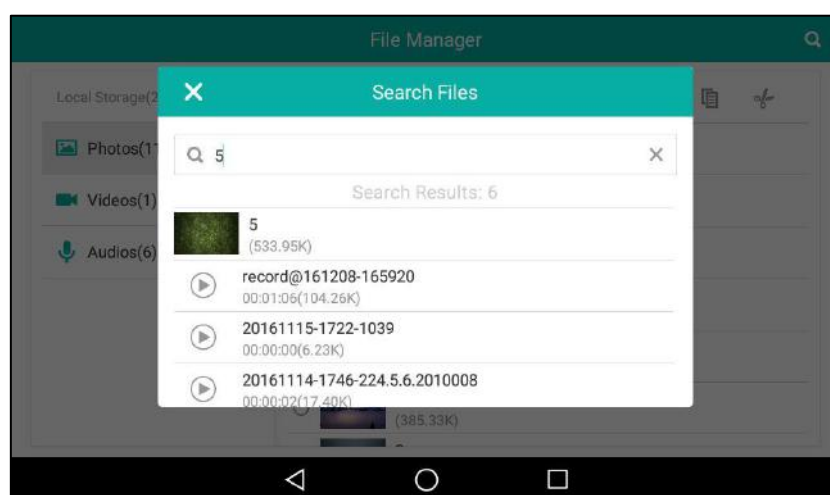

The file whose name matches the entered characters will appear on the touch screen. You can drag up and down to scroll through the searching results, and then tap the desired result to view the file.

## Copying Files

You can copy the files that stored in the USB flash drive to internal SD card, or copy the files that stored in internal SD card to the USB flash drive.

### To copy files:

1. Swipe left or right to go to the second idle screen.
2. Tap  to launch **FileManager** application.
3. Tap **Photos/Videos/Audios** in **Local Storage** field.



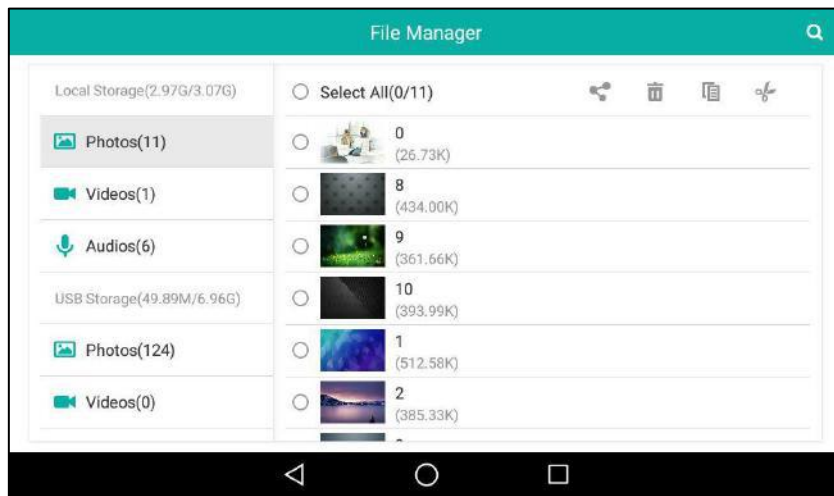

If a USB flash drive has been connected to your phone, you can tap **Photos/Videos/Audios** in the **USB Storage** field to view the files stored in USB flash drive. Your files will display as a list.

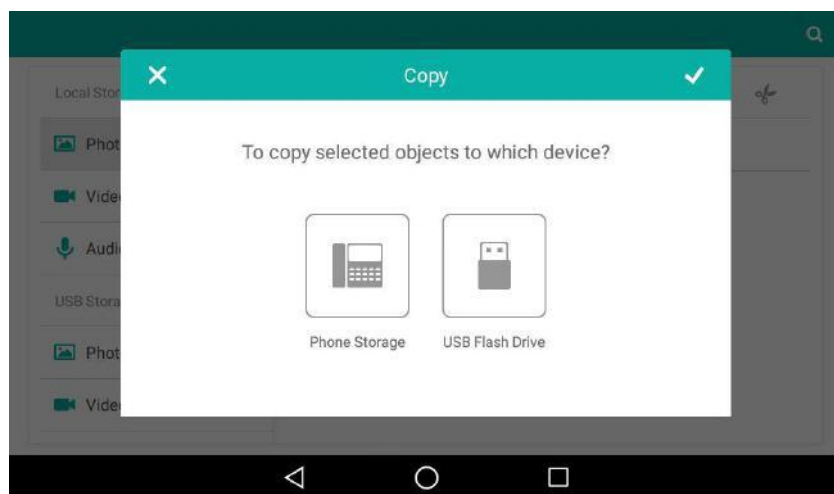

4. Drag up and down to scroll through the files if required.
5. Tap the checkbox(es) before the desired file(s).
6. Tap .

The following prompt will appear on the touch screen of the phone:



7. Tap the desired storage device to copy the file to.
8. Tap  to accept the change or  to cancel.

If the file has been copied successfully, the touch screen will prompt “Copy successfully”.

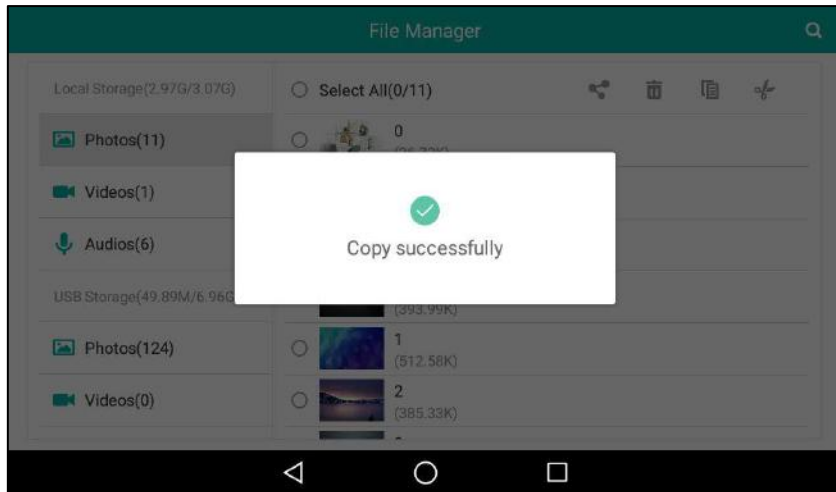

You can also tap the **Select All** checkbox to copy all files.

## Cutting Files (Moving Files)

The operating instructions on moving a file are similar to copying a file. The difference is that once the file is moved, the file will not be kept in the source storage device.

### To cut files:

1. Swipe left or right to go to the second idle screen.
2. Tap  to launch **FileManager** application.
3. Tap **Photos/Videos/Audios** in **Local Storage** field.

If a USB flash drive has been connected to your phone, you can tap **Photos/Videos/Audios** in the **USB Storage** field to view the files store in USB flash drive.

Your files will display as a list.

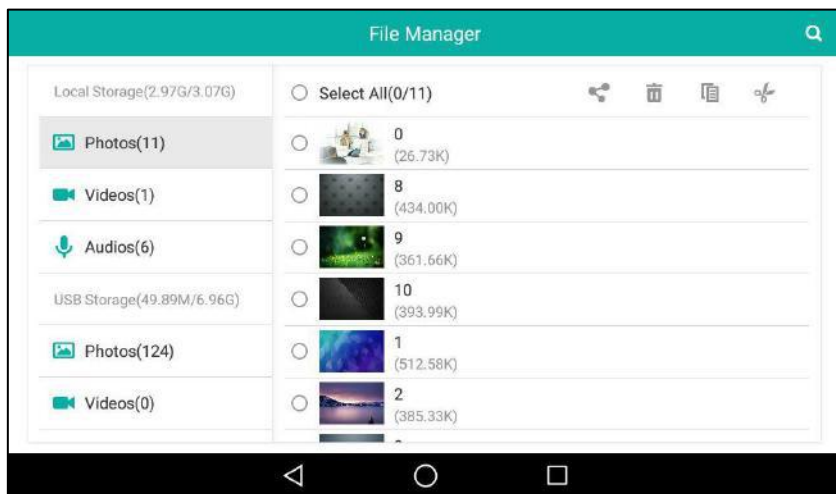



4. Drag up and down to scroll through the files if required.
5. Tap the checkbox(es) before the desired file(s).

6. Tap .

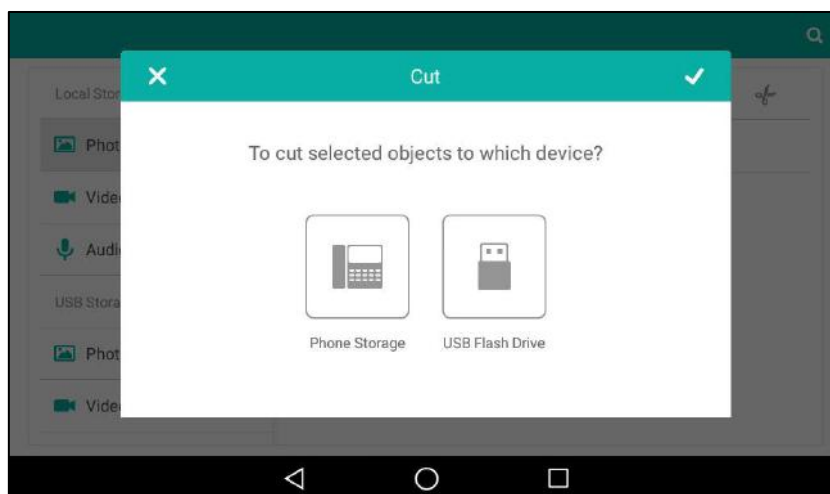
The following prompt will appear on the touch screen of the phone:



7. Tap the destination storage device.
8. Tap  to accept the change or  to cancel.

If the file is cut successfully, the touch screen will prompt "Cut successfully".

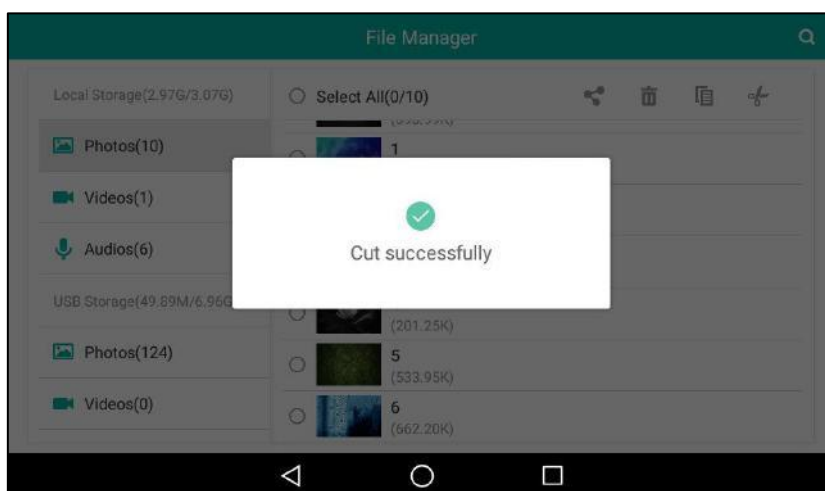

You can also tap the **Select All** checkbox to cut all files.

## Deleting Files

### To delete files:

1. Swipe left or right to go to the second idle screen.
2. Tap  to launch **FileManager** application.
3. Tap **Photos/Videos/Audios** in **Local Storage** field.

If a USB flash drive has been connected to your phone, you can tap

**Photos/Videos/Audios** in the **USB Storage** field to view the files store in USB flash drive.

Your files will display as a list.

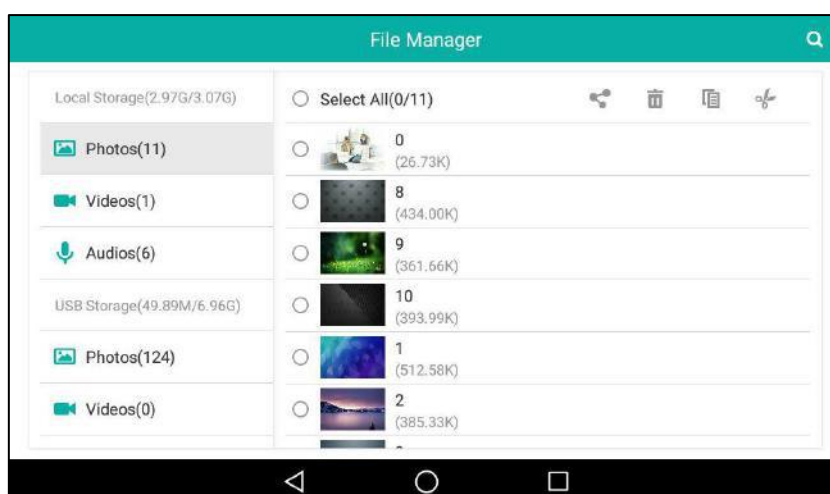

4. Drag up and down to scroll through the files if required.
5. Tap the checkbox(es) before the desired file(s).
6. Tap  .

The following prompt will appear on the touch screen of the phone:

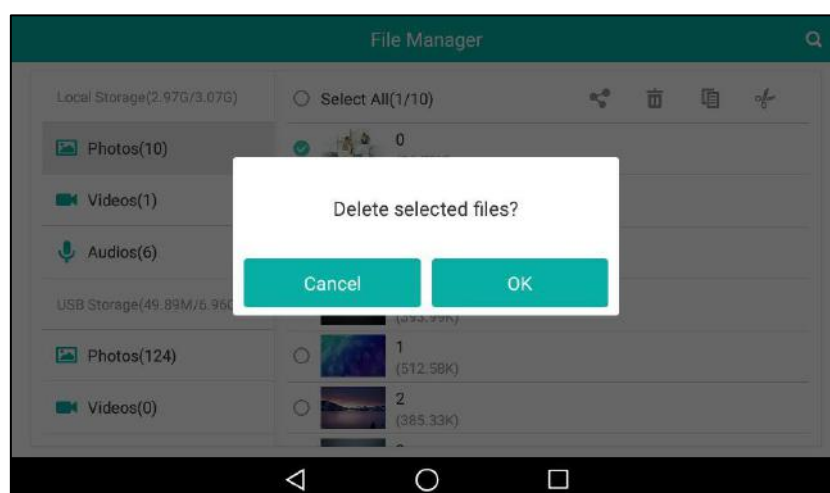

7. Tap **OK** to accept the change or **Cancel** to cancel.  
You can also tap the **Select All** checkbox to delete all files.

## Sharing Pictures/Videos/Audios

You can share pictures/videos/audios with other device via Bluetooth or email. Before sharing pictures/videos/audios via Bluetooth, make sure the Bluetooth device is discoverable.

The operating instructions on sharing pictures, video and audios are the same, the following take sharing pictures as example.

### To share picture(s) via Bluetooth:

1. Swipe left or right to go to the second idle screen.

2. Tap  to launch **FileManager** application.

3. Tap **Photos** in the **Local Storage** field.

If a USB flash drive has been connected to your phone, you can tap **Photos** in the **USB Storage** field to view the pictures stored in USB flash drive.

Your pictures will display as a list.

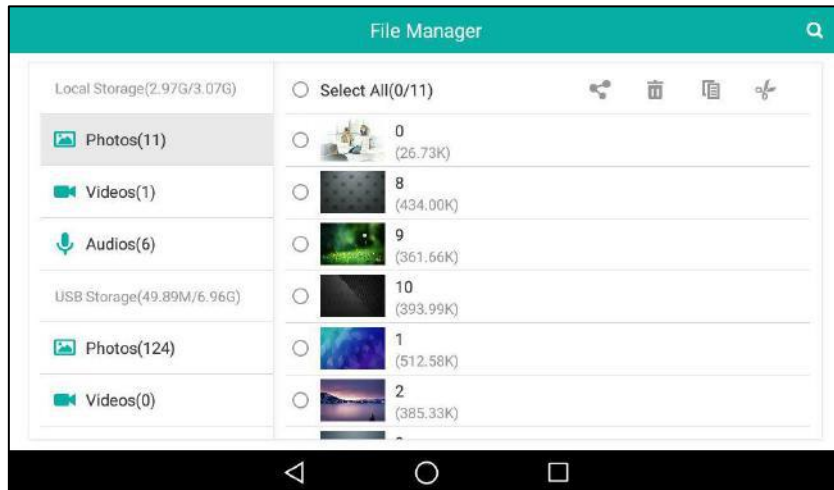

4. Drag up and down to scroll through the files if required.

5. Tap the checkbox(es) before the desired picture(s).

6. Tap  .

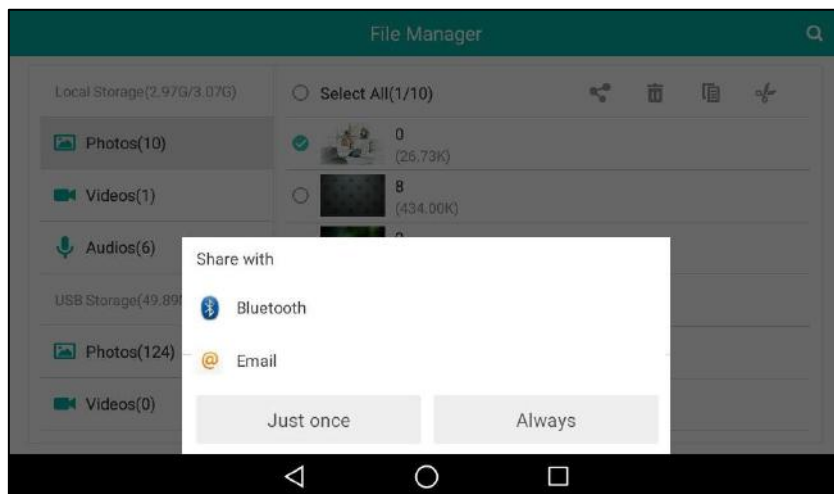

7. Tap **Bluetooth** and then tap **Always** or **Just once**.

The IP phone scans and displays the available Bluetooth device automatically.

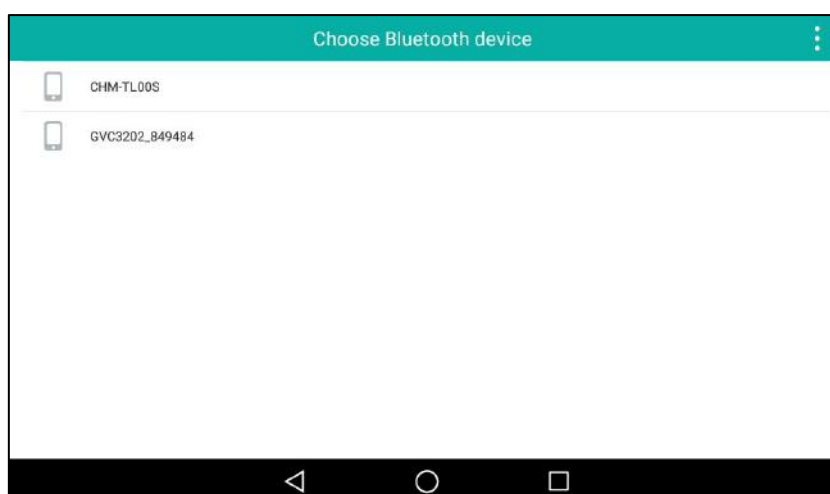

If there is no Bluetooth device found on the touch screen, tap  and then **Refresh** to search for the Bluetooth devices.

**Note** If the Bluetooth mode of the IP phone is deactivated, the touch screen will prompt "To use Bluetooth services, you must first turn on Bluetooth. Turn on Bluetooth now?". Tap **Turn on** to activate the Bluetooth mode.

8. Tap the desired Bluetooth device to share the pictures.

The touch screen will prompt "Sending n file to "XXX"" (n represents the number of pictures that is being send).

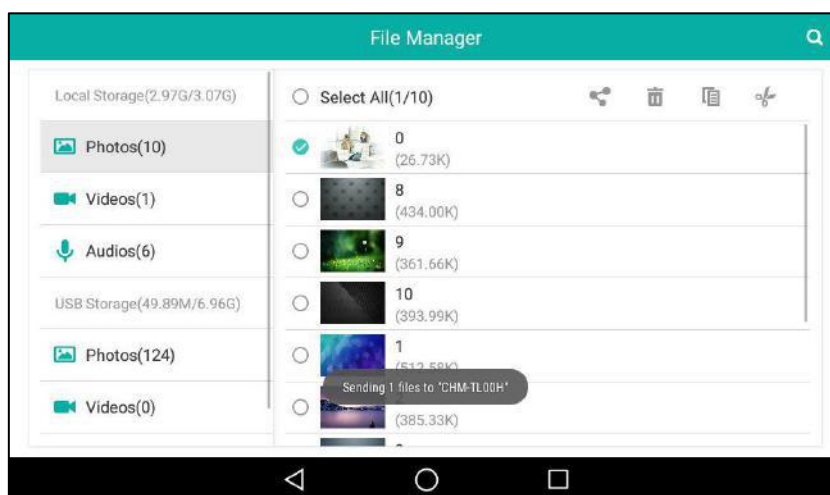

9. Accept the Bluetooth file transfer request on the Bluetooth device.

If the pictures are successfully transferred, the notification center will display a notification “Bluetooth share: Sent files n successful, n unsuccessful.” (n represents the number of files that are sent successfully or unsuccessfully).

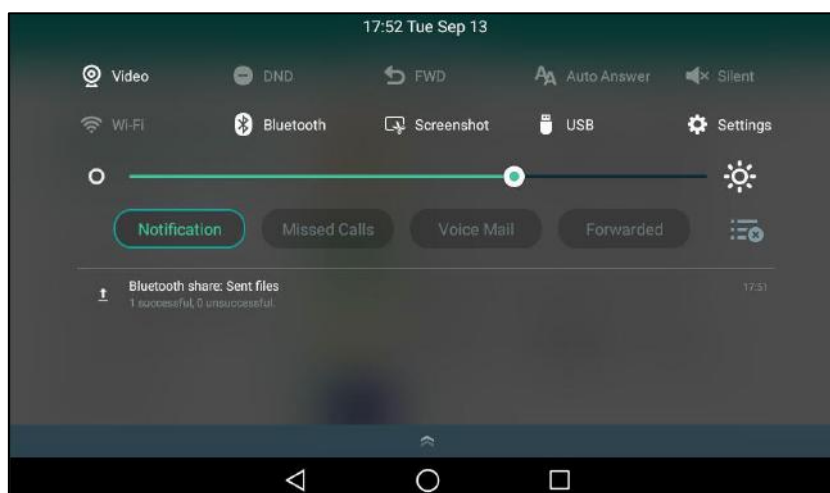

You can tap the notification to view the detail information about the shared pictures.

#### To share picture(s) via email:

1. Swipe left or right to go to the second idle screen.
2. Tap  to launch **Gallery** application.
3. Tap **Photos** in the **Local Storage** field.

If a USB flash drive has been connected to your phone, you can tap **Photos** in the **USB Storage** field to view the pictures stored in USB flash drive.

Your pictures will display as a list.

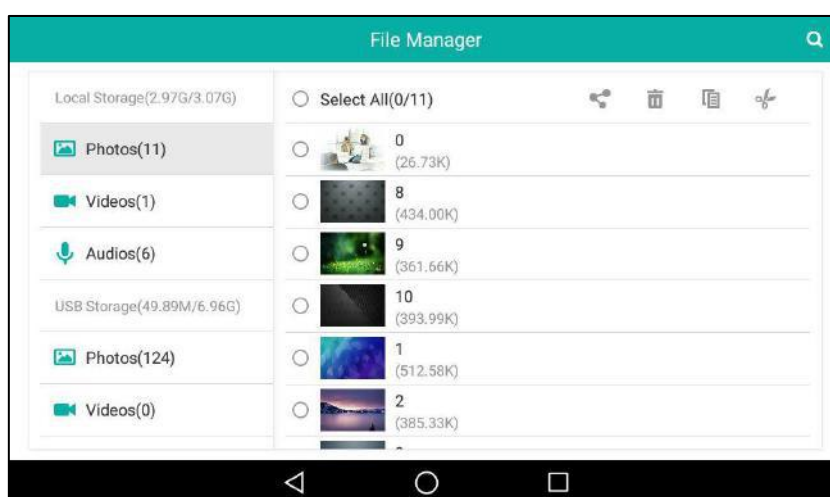

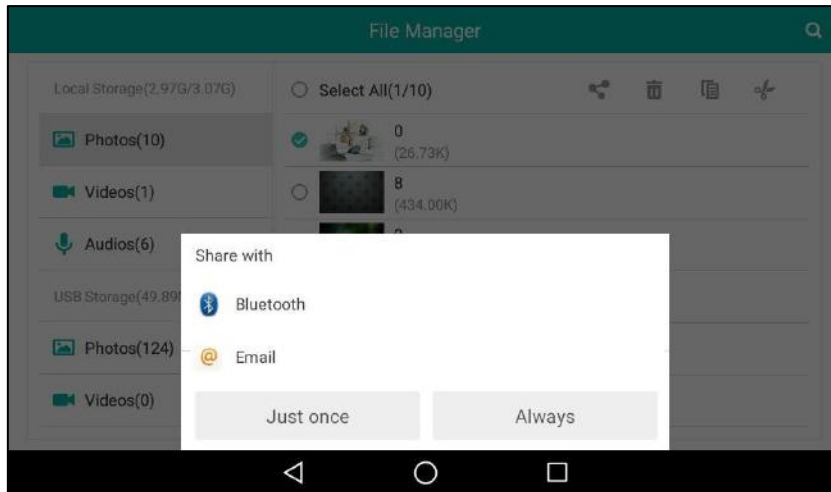

4. Drag up and down to scroll through the files if required.
5. Tap the checkbox(es) before the desired picture(s).

6. Tap  .

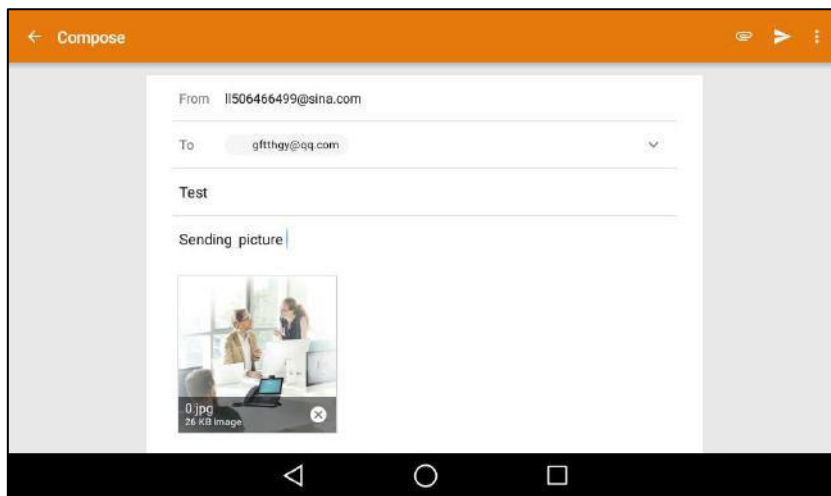

7. Tap **Email** and then tap **Always** or **Just once**.
8. (Optional.) Sign in an email account if required (refer to [Adding APP Accounts](#)).
9. Compose the Email.
10. Enter the email account you want to send the email to in the **To** field.
11. (Optional.) Enter the email subject in the **Subject** field.



12. Tap  to send the email.

The pictures are transferred as mail attachment. The attachment files size must be within 5MB. You can also share pictures with other devices via Bluetooth or email when previewing the pictures. And the operating instructions are the same with sharing pictures by **Gallery** application. For more information, refer to [Sharing Pictures/Videos](#) on page 219.

## Gallery

You can use **Gallery** application to view pictures/videos stored in internal SD card/USB flash drive or take pictures/videos. You can also perform basic editing tasks on pictures or set the desired picture as the wallpaper. The pictures/videos can be shared with friends via Bluetooth or



email.

## Viewing Pictures/Videos

### To view pictures/videos:

1. Swipe left or right to go to the second idle screen.
2. Tap  to launch **Gallery** application.

By default, the pictures/videos are displayed as thumbnails in an albums arrangement mode.

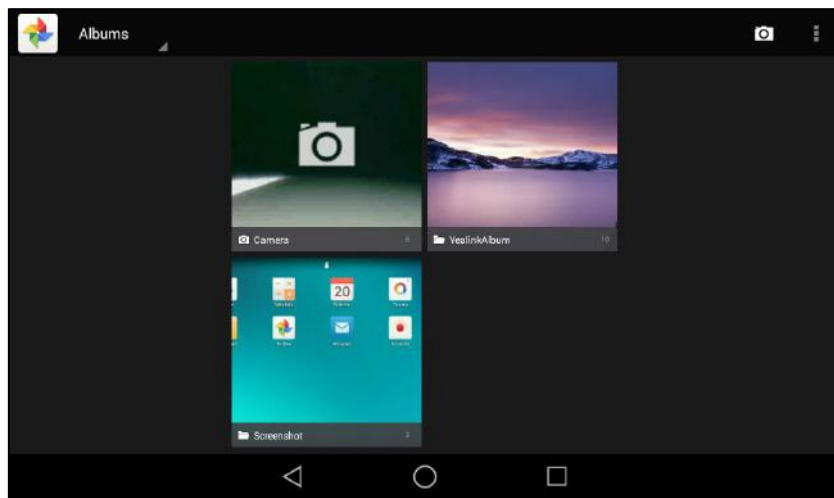

3. (Optional.) Tap **Albums**.

You can tap **Albums/Locations/Times/People/Tags** to view the pictures/videos in different arrangement modes.

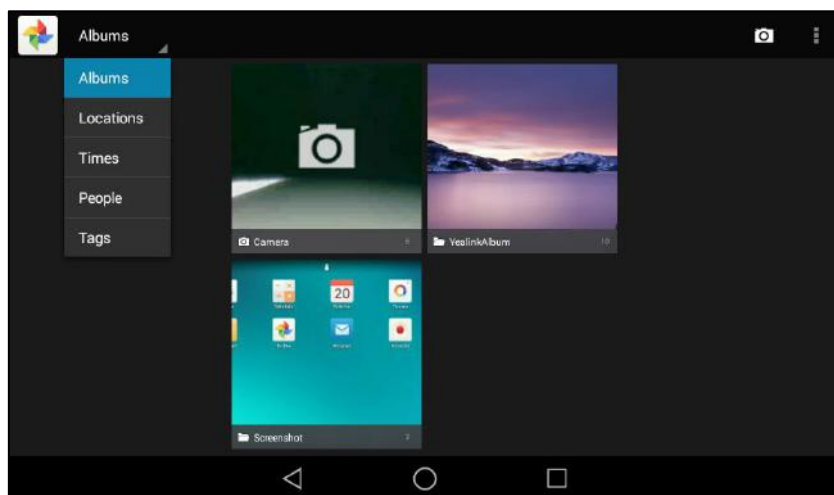

4. Swipe left/right to view all albums if required.



5. You can do the following:

- If you tap a picture album, you can do the following:

- Tap the album name on top-left of the touch screen.

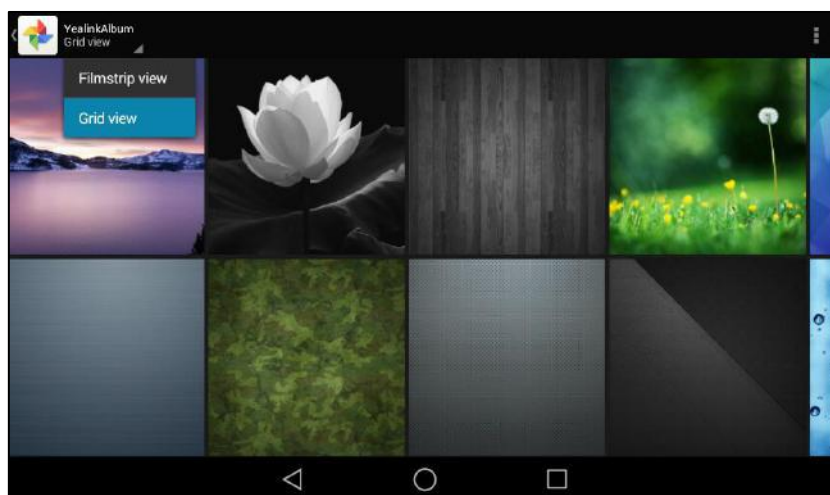
Tap **Filmstrip view** or **Grid view** to view the pictures in different modes.



- Tap  and then tap **Slideshow** to start a slide show of the pictures in the album.
- Tap  and then tap **Group by**.

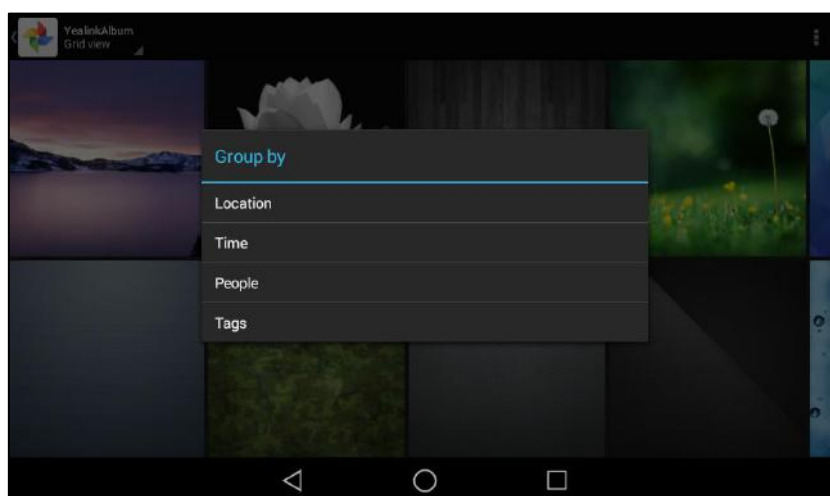

Tap a desired group type in the pop-up dialog box to view the pictures in different arrangement modes.

- Tap a desired picture to preview the picture.

- If you tap a video album, you can do the following:

- Tap the album name on top-left of the touch screen.

Tap **Filmstrip view** or **Grid view** to view the videos in different mode.

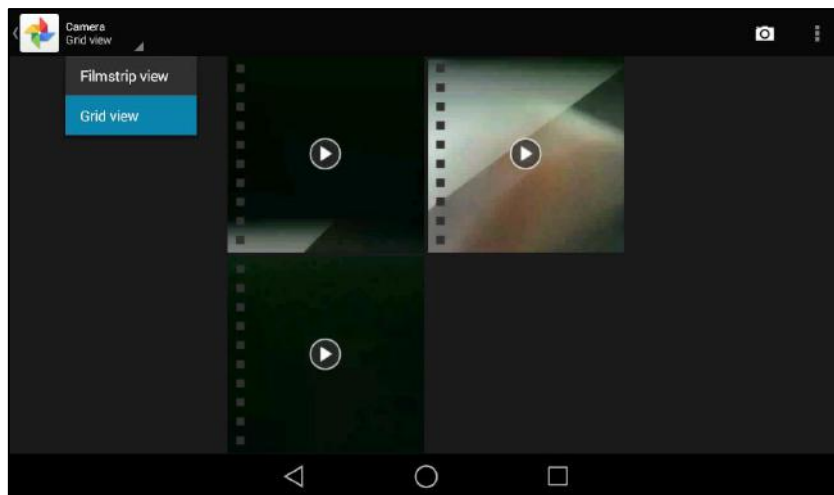

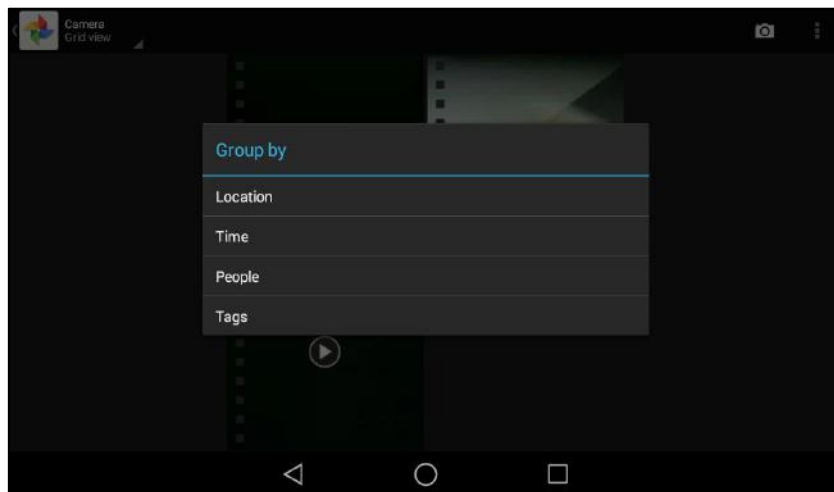

- Tap  and then tap **Group by**.



Tap a desired group type in the pop-up dialog box to view the videos in different arrangement modes.



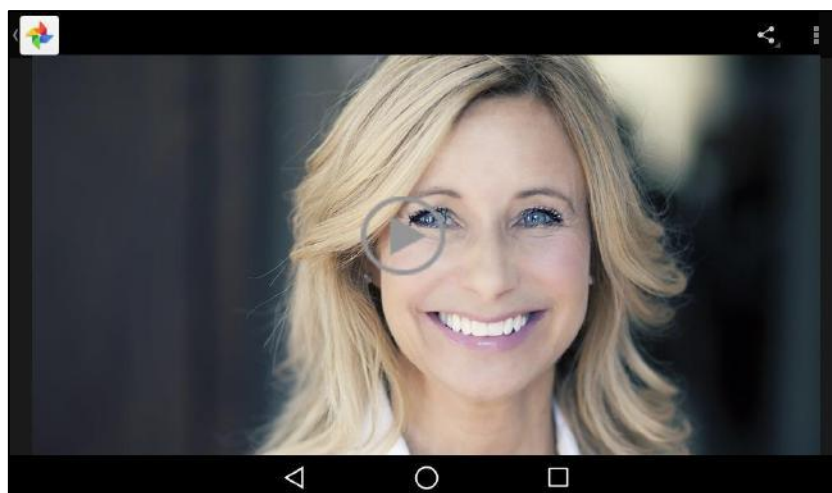

- Tap a desired video.

Videos show the icon  on the preview thumbnail. Tap  to play the video.



## Editing Pictures



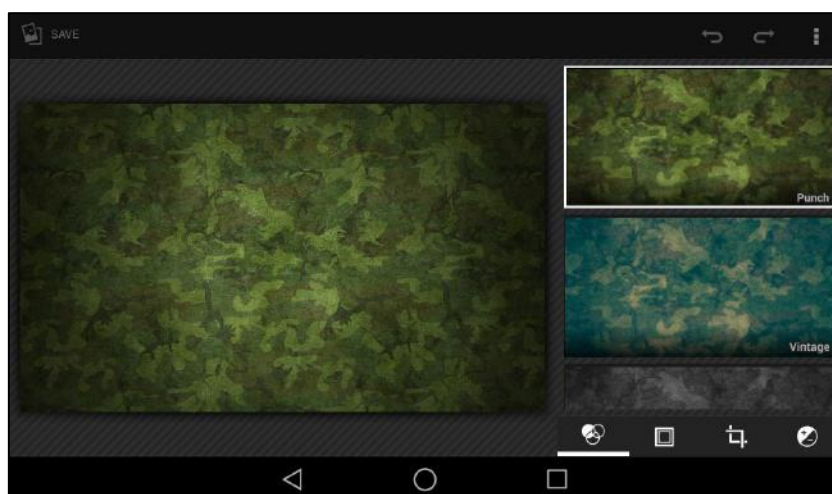

### To edit a picture:

1. Swipe left or right to go to the second idle screen.
2. Tap  to launch **Gallery** application.
3. Tap a desired picture album.
4. Tap the desired pictures.
5. You can do the following:
  - Tap  and then tap **Rotate left/Rotate right** to rotate the picture left/right.
  - Tap  and then tap **Crop** to resize the picture.
  - Tap  and then tap **Edit**.

The touch screen will display as below:



You can do the following:

- Tap  to add filters.
  - Tap  to add a picture frame.
  - Tap  .
    - Tap **Crop** to resize the picture.
    - Tap **Straighten** to straighten the picture.
    - Tap **Rotate** to rotate the picture clockwise.
    - Tap **Mirror** to flip the picture symmetrically.
    - Tap **Draw** to draw the picture.
  - Tap  to adjust the exposure, contrast, saturation, etc.
6. Tap **SAVE** to accept the change.

**Note**

The menu keys and Android keys will disappear within 5 seconds, you may tap the touch screen to show them again.

## Setting a Picture as Wallpaper

**To set a picture as wallpaper:**

1. Preview the picture (refer to [Viewing Pictures/Videos](#)).

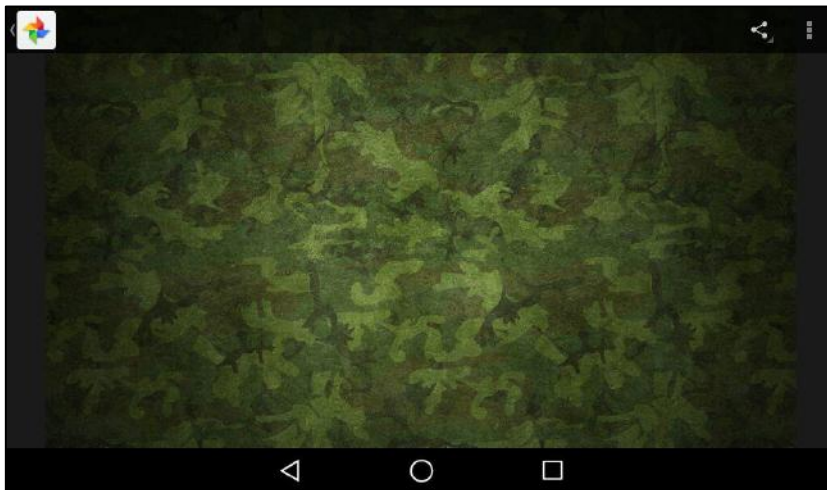

2. Tap .

The touch screen will display as below:

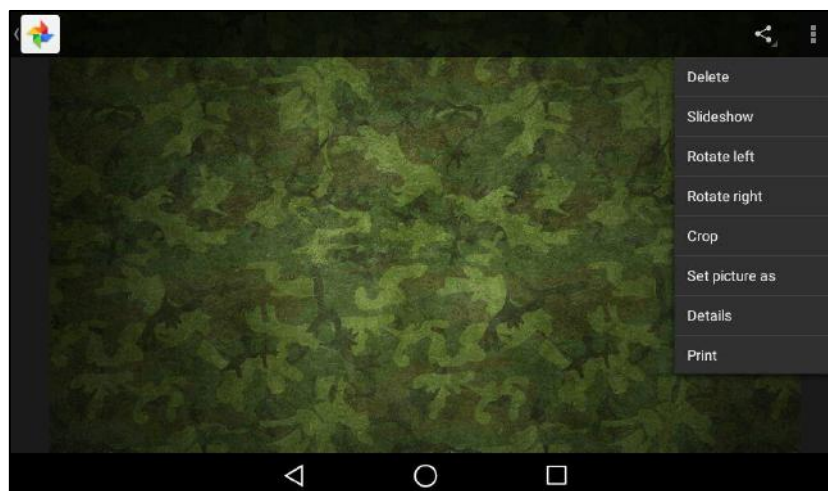

3. Tap **Set picture as**.

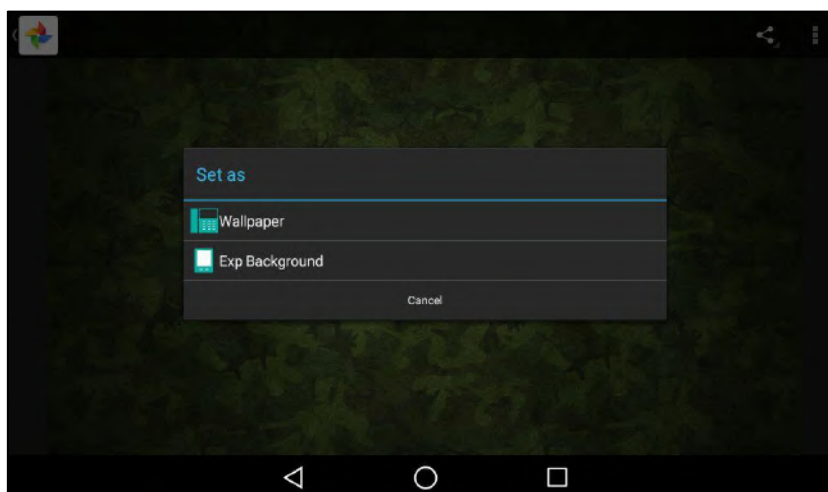

4. Do one of the following:
  - Tap **Wallpaper** and then tap **Set wallpaper** to set the picture as phone wallpaper.
  - Tap **Exp Background** and then tap **Set as exp background** to set the picture as EXP wallpaper.

**Note** The menu keys and Android keys will disappear within 5 seconds, you may tap the touch screen to show them again.

## Printing Pictures

### To print a picture:

1. Preview the picture (refer to [Viewing Pictures/Videos](#)).

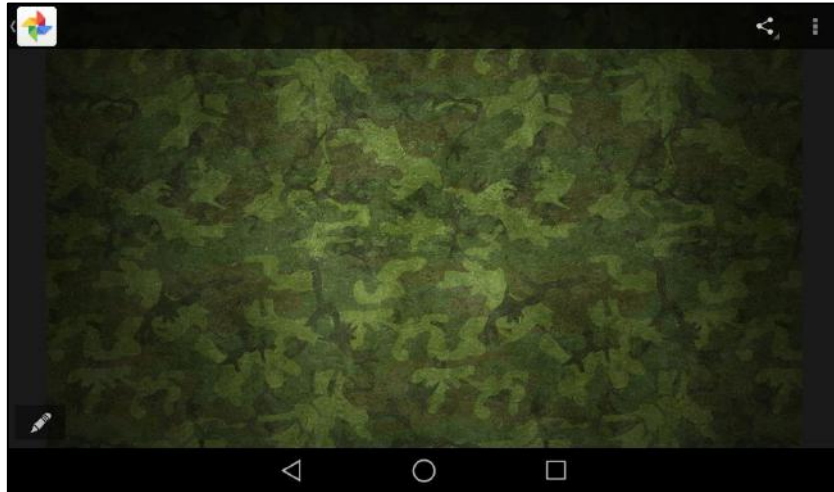

2. Tap .

The touch screen will display as below:

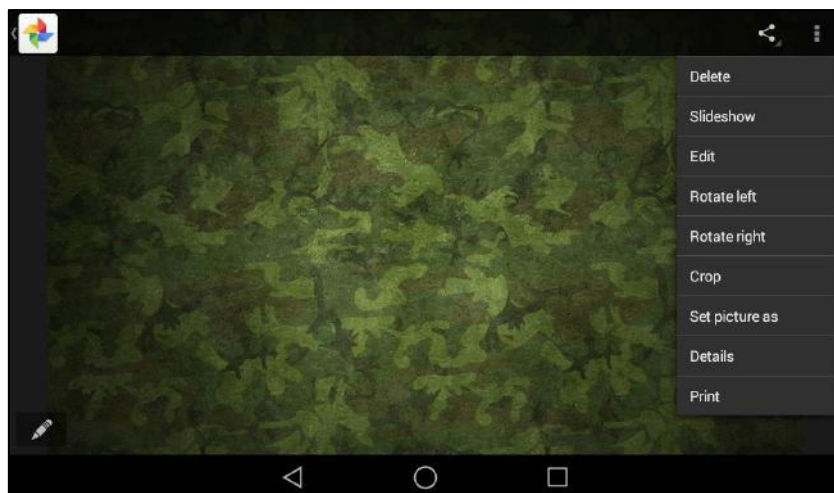

3. Tap **Print** to print the picture.

Before printing the picture, make sure your phone has connected to the network printer.  
For more information, refer to the documentation from the printer manufacturer.

## Viewing Detail Information of the Pictures/Videos

The operating instructions on viewing detail information of pictures and videos are the same, the following take viewing detail information of pictures as example.

**To view detail information of the picture:**

1. Preview the picture (refer to [Viewing Pictures/Videos](#)).

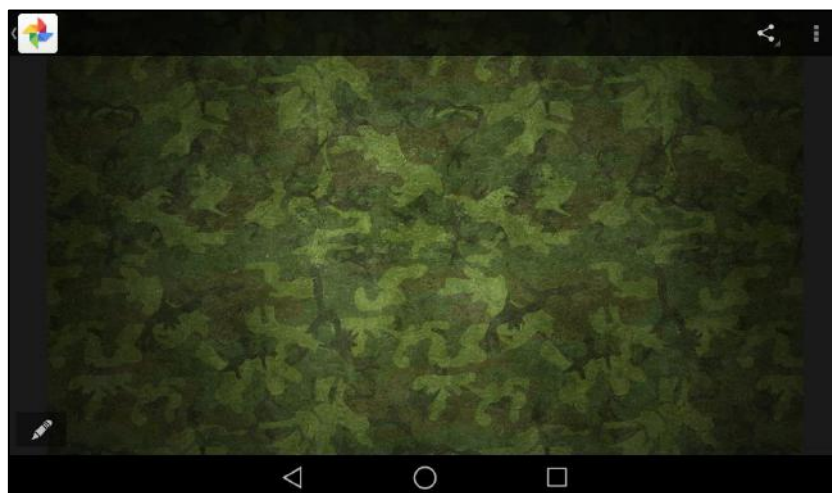

2. Tap .  
The touch screen will display as below:

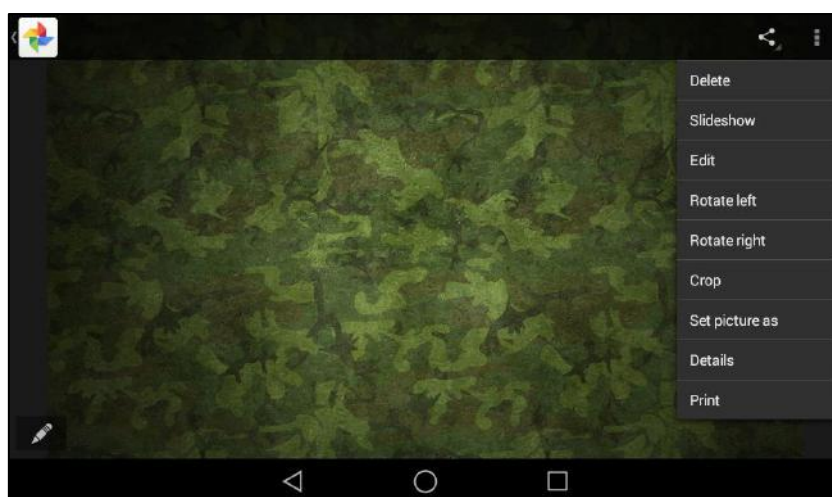

3. Tap **Details** to view the detail information of the picture.

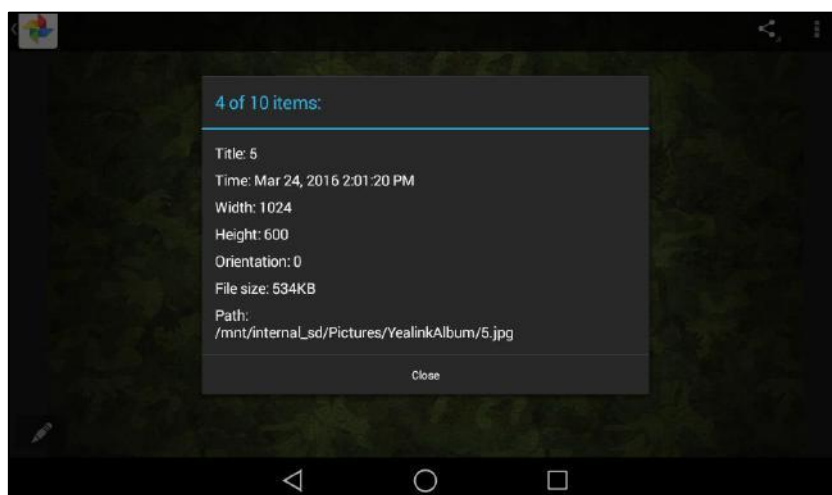





4. Tap **Close** to close the pop-up box.

## Deleting Pictures/Videos

The operating instructions on deleting pictures and videos are the same, the following take deleting pictures as example.

### To delete picture(s):

1. Swipe left or right to go to the second idle screen.
2. Tap  to launch **Gallery** application.
3. Tap a desired picture album.
4. Do one of the following:
  - Long tap one of the pictures.  
Tap on other pictures to select multiple pictures.
  - Tap  and then tap **Select item**.  
Tap the desired picture(s) to select multiple pictures.

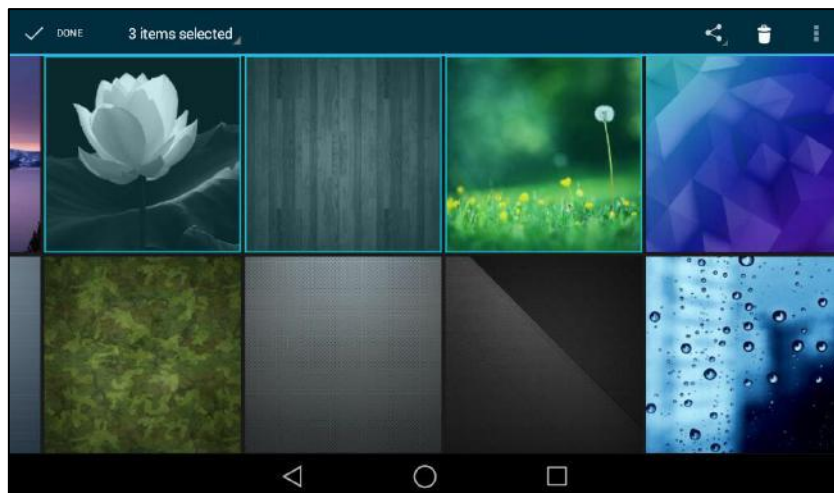

You can also tap **n items selected** (n represents the number of pictures you selected) and then tap **Select all** to select all pictures.

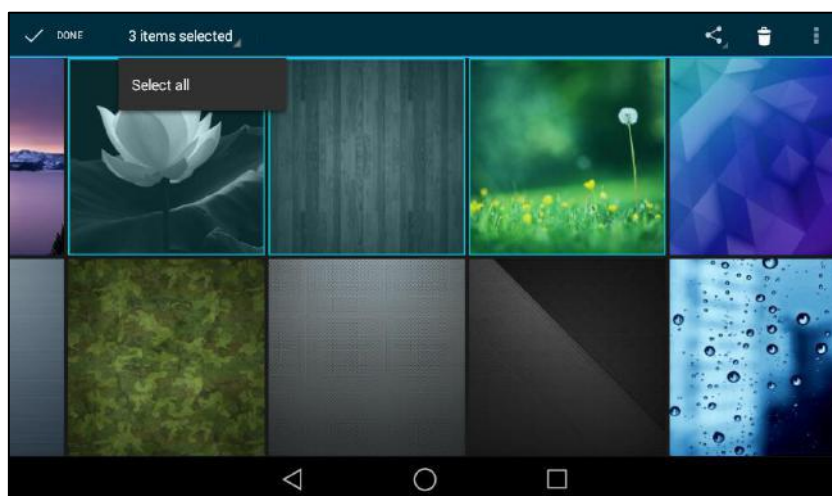

5. Tap  to delete the selected picture(s).  
The touch screen prompt "Delete selected item?".

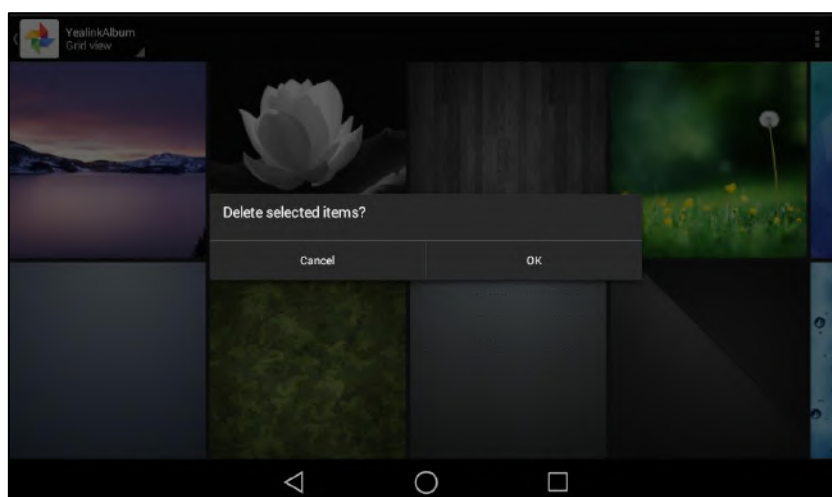



6. Tap **OK** to accept the change or **Cancel** to cancel.

## Taking a Picture/Video

Before taking a picture/video, you should connect the camera to the IP phone. For more information on how to connect the camera, refer to [Insert the camera](#) on page 32.

### To take a picture/video:

1. Swipe left or right to go to the second idle screen.
2. Tap  to launch **Gallery** application.

3. Tap  on the top-right of the touch screen.

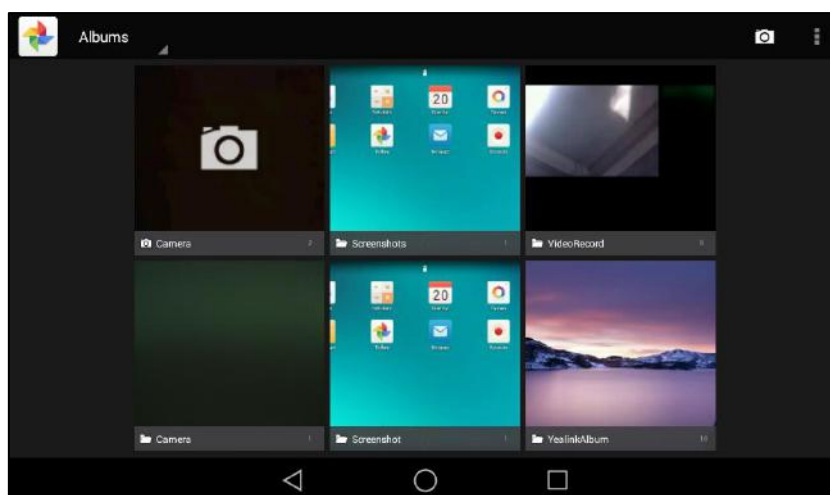

4. Take a picture or video (refer to [Taking Pictures](#) or [Recording Videos](#)).

## Sharing Pictures/Videos

You can share pictures/videos with other Bluetooth devices via Bluetooth or email. Before sharing pictures/videos via Bluetooth, make sure the Bluetooth device is discoverable.

The operating instructions on sharing pictures and sharing video are the same, the following take sharing pictures as example.

### To share picture(s) via Bluetooth:

1. Swipe left or right to go to the second idle screen.
2. Tap  to launch **Gallery** application.
3. Tap a desired picture album.
4. Do one of the following:
  - Long tap one of the pictures.  
Tap on other pictures to select multiple pictures.

- Tap  and then tap **Select item**.  
Tap the desired picture(s) to select multiple pictures.

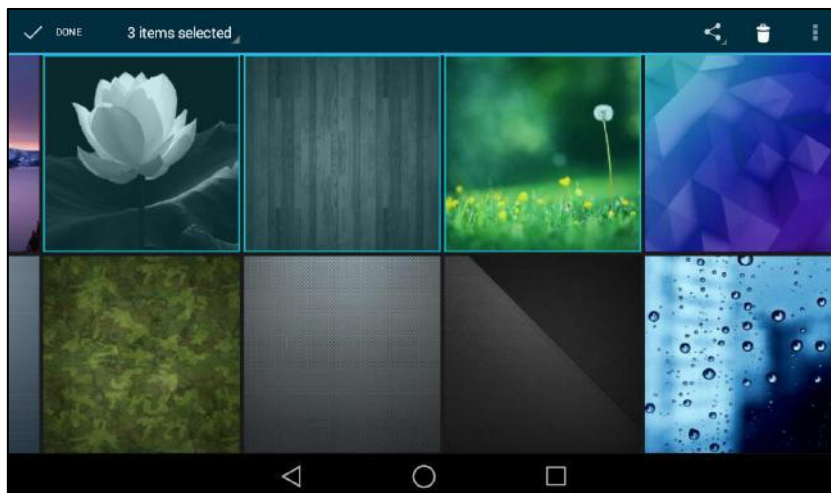

You can also tap **n items selected** (n represents the number of pictures you selected) and then tap **Select all** to select all pictures.

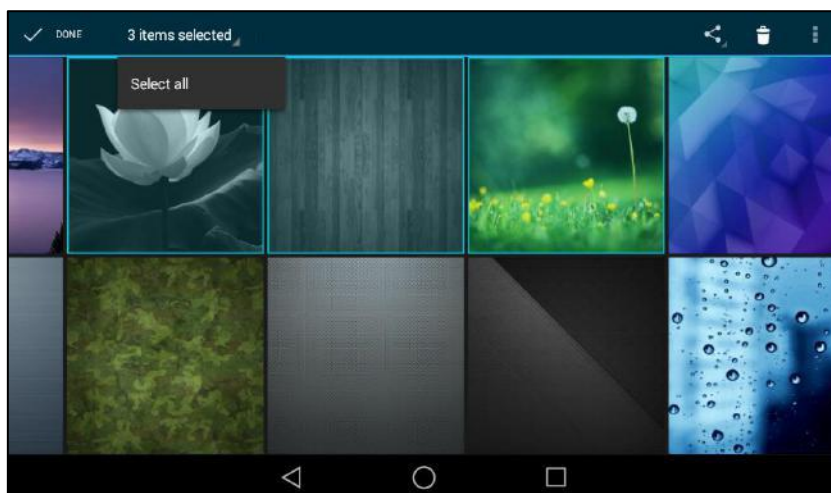

5. Tap  .

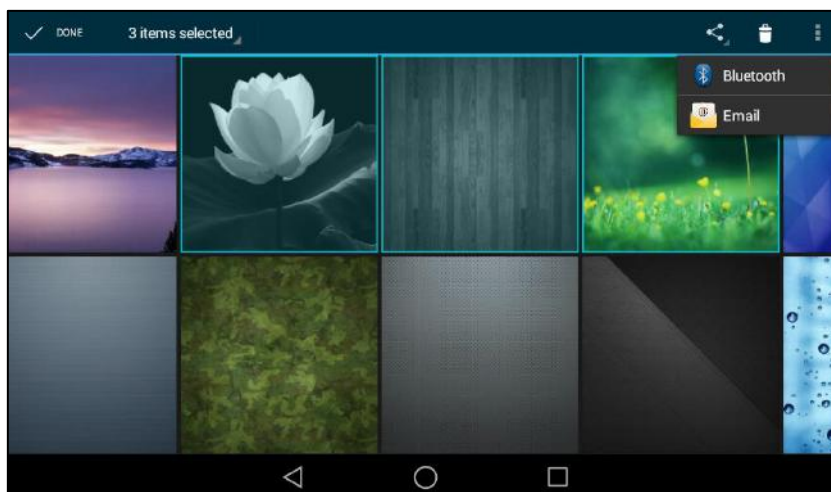

**6. Tap Bluetooth.**

The IP phone scans and displays the available Bluetooth device automatically.

If there is no Bluetooth device found on the touch screen, tap  and then **Refresh** to search for the Bluetooth devices.

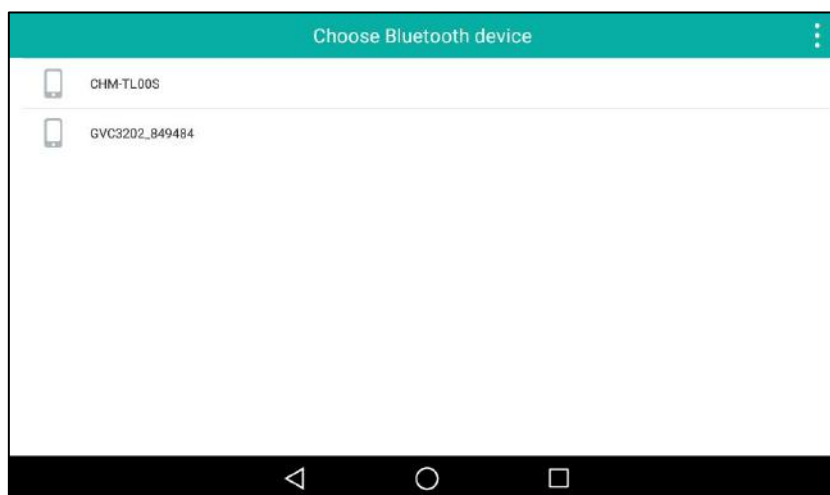
**Note**

If the Bluetooth mode of the IP phone is deactivated, the touch screen will prompt "To use Bluetooth services, you must first turn on Bluetooth. Turn on Bluetooth now?". Tap **Turn on** to activate the Bluetooth mode.

**7. Tap the desired Bluetooth device to share the pictures.**

The touch screen will prompt "Sending n file to "XXX"" (n represents the number of pictures that is being send).

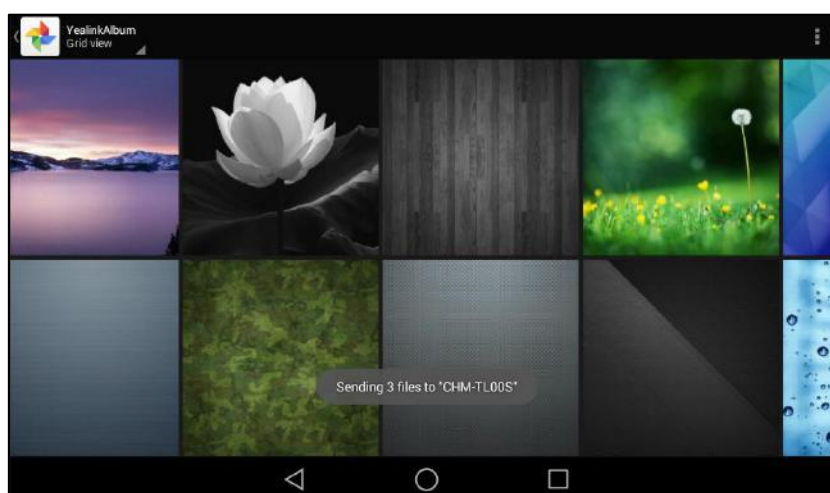

**8. Accept the Bluetooth file transfer request on the Bluetooth device.**

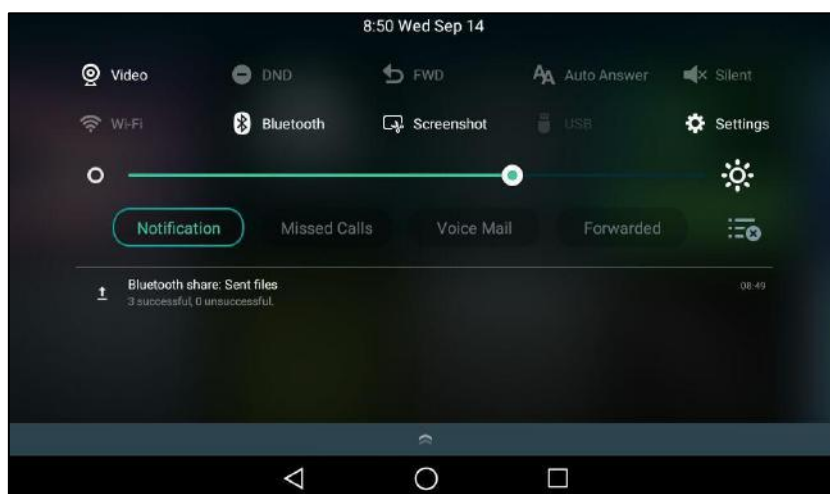
If the pictures are successfully transferred, the notification center will display a notification "Bluetooth share: Sent files n successful, n unsuccessful." (n represents the number of files that are sent successfully or unsuccessfully).



You can tap the notification to view the detail information about the shared pictures.

#### To share picture(s) via email:

1. Swipe left or right to go to the second idle screen.
2. Tap  to launch **Gallery** application.
3. Tap a desired picture album.
4. Do one of the following:
  - Long tap one of the pictures.  
Tap on other pictures to select multiple pictures.
  - Tap  and then tap **Select item**.  
Tap the desired picture(s) to select multiple pictures.

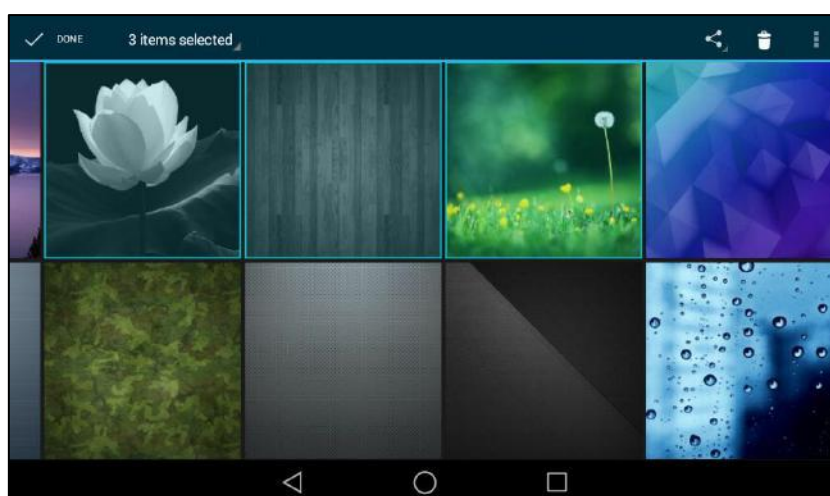

You can also tap **n items selected** and then tap **Select all** to select all pictures.

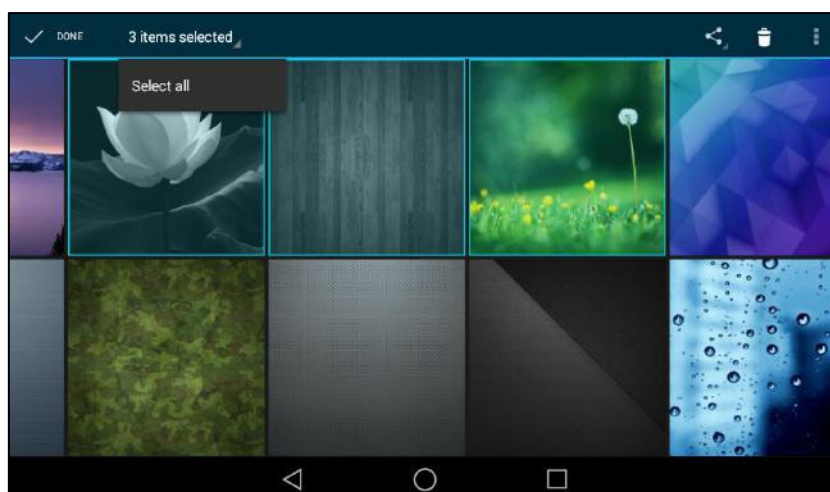

5. Tap .
6. Tap **Email**.
7. (Optional.) Sign in an email account if required (refer to [Signing In Email](#)).
8. Compose the Email.
9. Enter the email account you want to send the email to in the **To** field.
10. (Optional.) Enter the email subject in the **Subject** field.

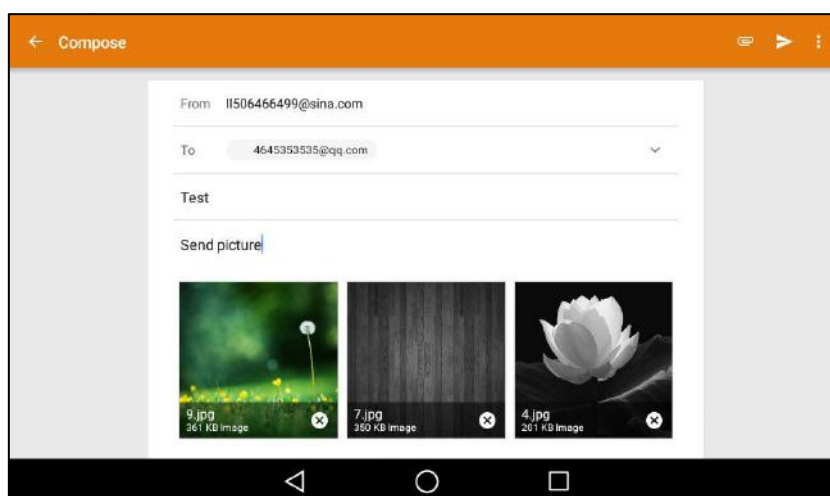

11. Tap **SEND** to send the email.  
The pictures are transferred as mail attachment. The attachment files size must be within 5MB.

## Recorder

You can use **Recorder** application to record audios and manage the recorded audios. During recording, you can mark specific moments so that you can quickly find and listen to them later. There is a time limit (12 hours) on the recorder. The recorded audios are saved with the name consisting of a prefix "record@" and date & time stamp, for example, record@20160303-092310

was created on March 3, 2016, at 09:23:10.

By default, the recorded audios are saved in the internal SD card. But if there is a USB flash drive connected to your phone, the recorded audios will be saved according to the priority: USB flash drive>internal SD card.



**Note** The recorded audios are saved in \*.amr format. You can play the recorded audios on either the phone itself or on a computer using an application capable of playing \*.amr files.

## Recording Audios

### To record an audio:

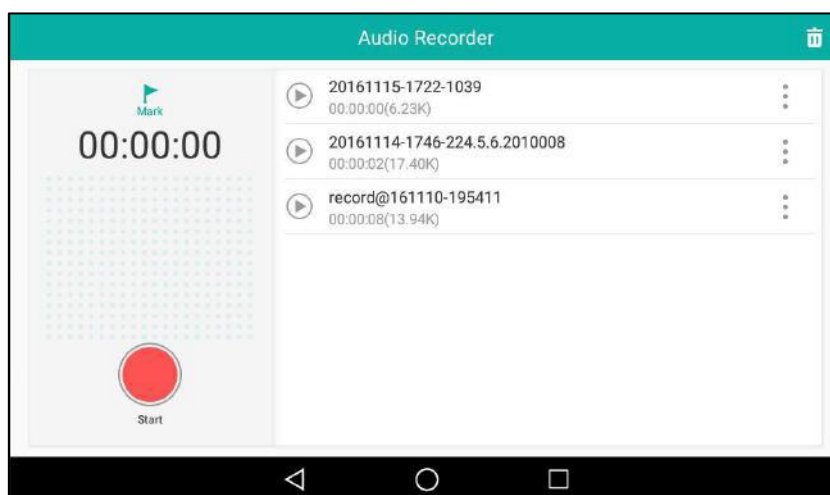
1. Swipe left or right to go to the second idle screen.
2. Tap  to launch **Recorder** application.



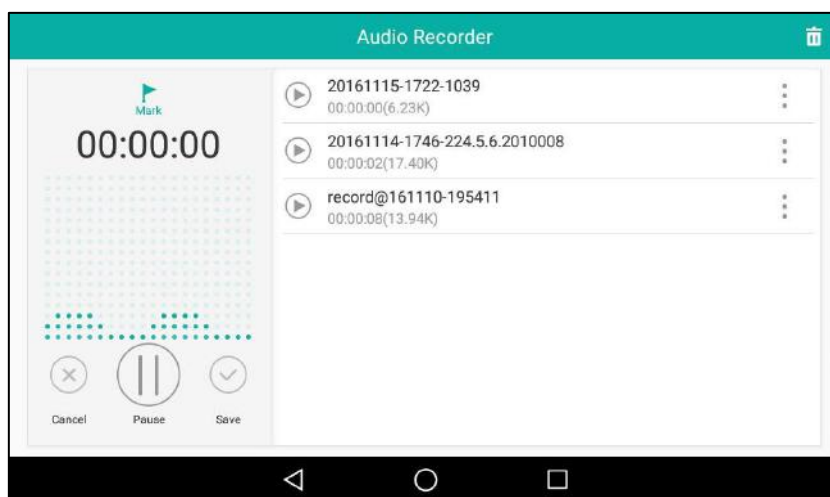

3. Tap  to start recording.
4. You can do one of the following:
  - Tap  to pause the recording, and then tap  to resume the recording.





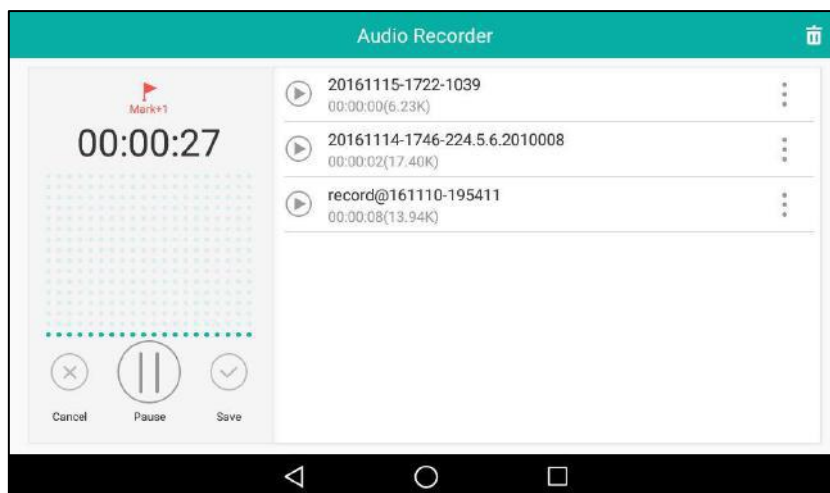

- Tap  to set a mark.



The icon changes to , the number will increase if you set more marks. And there is a red flag on this moment when playing the recorded audio.

5. Tap  to end the recording and save the recorded audio, or tap  to cancel the recording.

The recorded audio will be displayed on the right list automatically.

## Managing Recorded Audios

You can also use the **Recorder** application to play/delete/rename the recorded audios.

### To play the recorded audio:



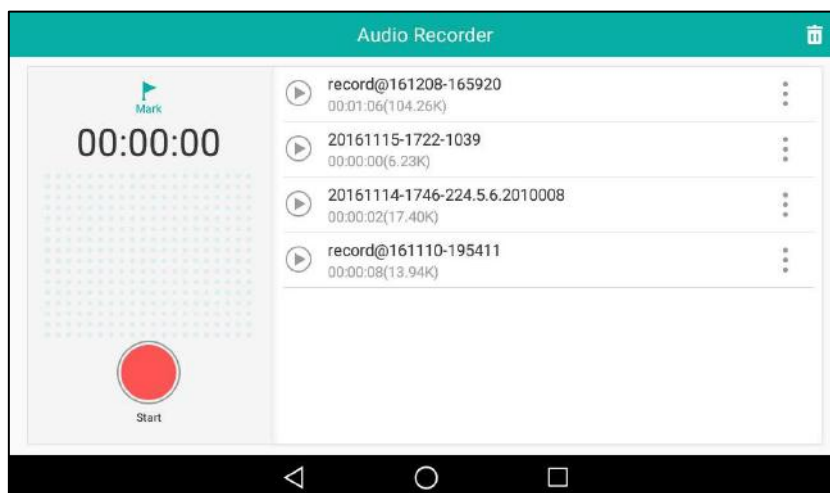

1. Swipe left or right to go to the second idle screen.
2. Tap  to launch **Recorder** application.

The recorded audios will display as a list.



3. Tap  before the desired recorded audio to play the recorded audio.

During the playing, you can do the following:

- Tap  to pause the playing.  
To continue the playing, tap .
- Drag the slider to skip forward the playing or rewind the playing.
- Drag the slider to the position with red flag to listen to the marked moments.
- Press  to adjust the volume of the speakerphone.
- Tap  to stop the playing.

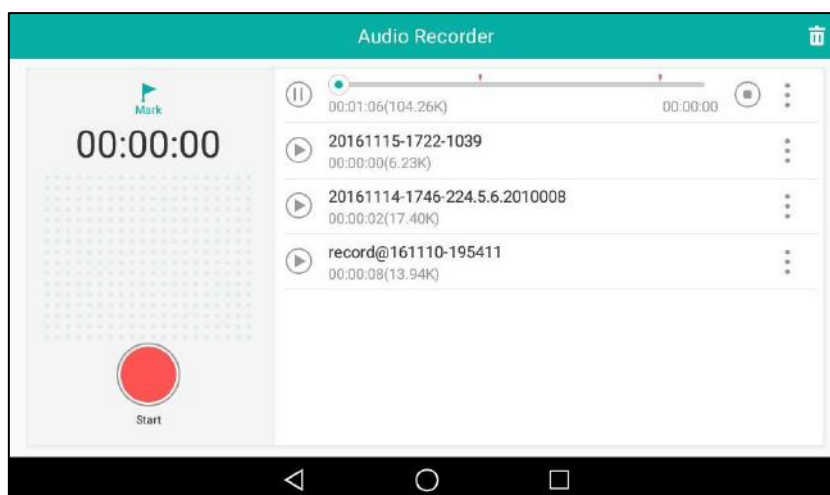

**To delete the recorded audio:**

1. Swipe left or right to go to the second idle screen.
2. Tap  to launch **Recorder** application.  
The recorded audios will display as a list.

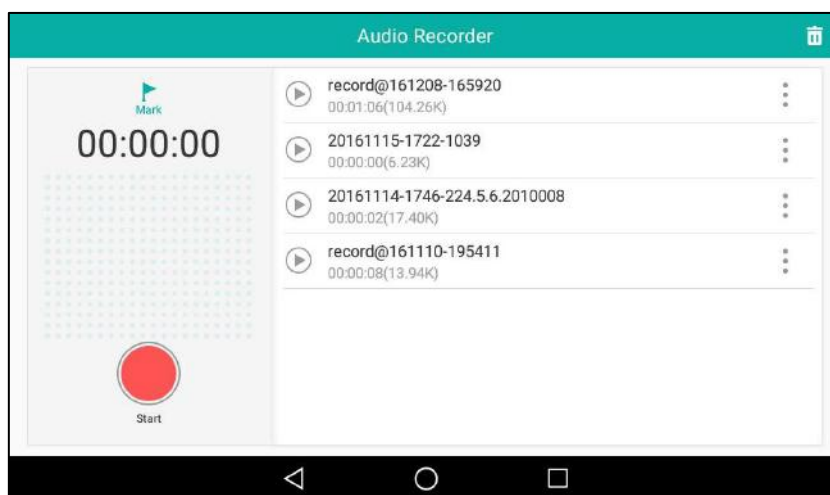

- Tap  after the desired recorded audio.

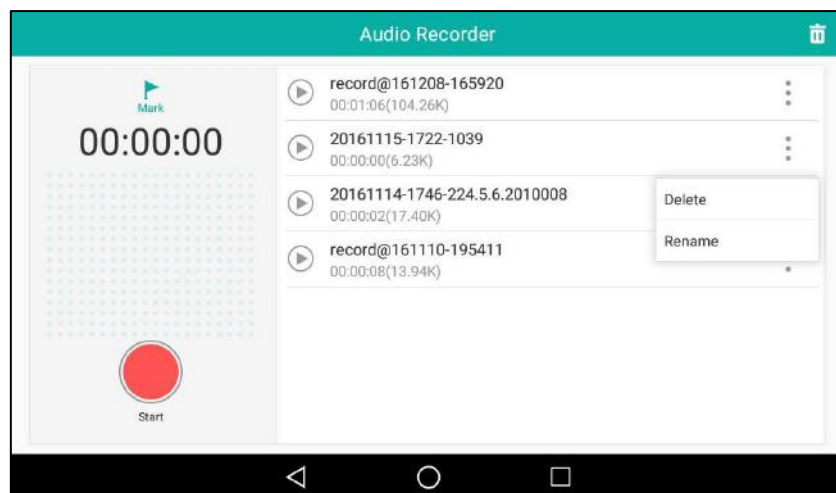

- Tap **Delete** to delete the recorded audio.  
The touch screen prompts "Are you sure to delete?".

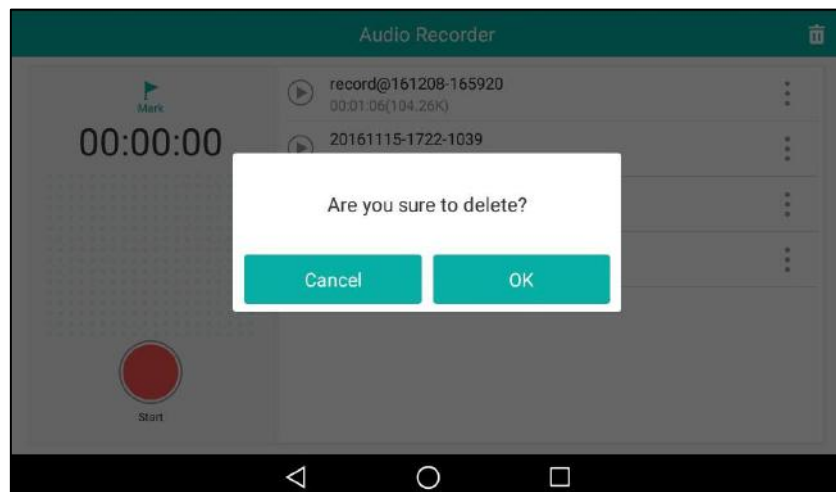



- Tap **OK** to accept the change or **Cancel** to cancel.  
If you want to delete all recorded audios, tap  on the top-right of the touch screen.

#### To rename a recorded audio:

- Swipe left or right to go to the second idle screen.
- Tap  to launch **Recorder** application.

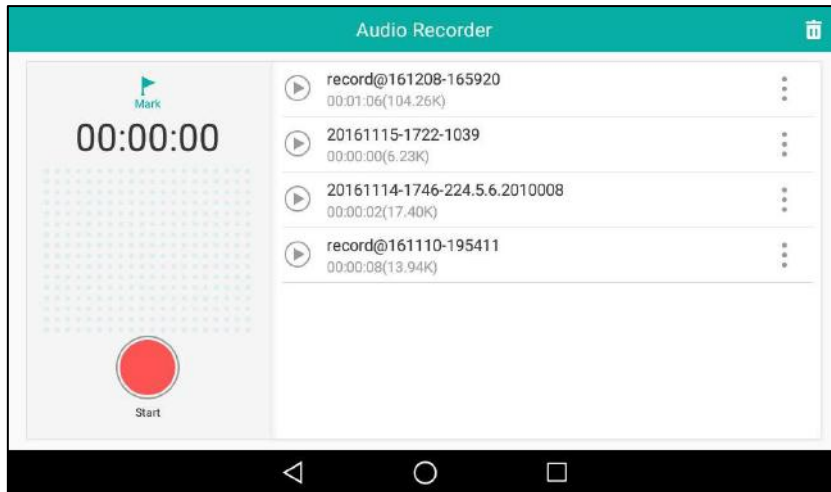
The recorded audios will display as a list.



3. Tap  after the desired recorded audios.
4. Tap **Rename**.

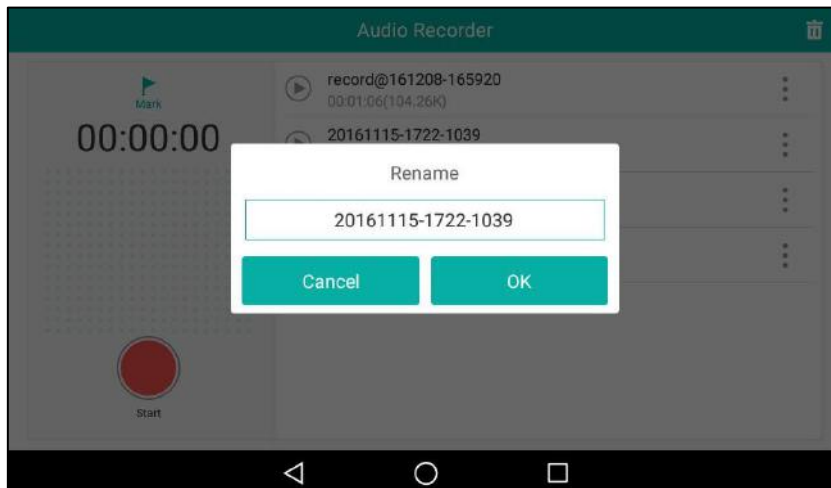

5. Enter the desired file name.
6. Tap **OK** to accept the change or **Cancel** to cancel.

## Camera

The IP phone supports taking pictures and recording videos via camera. For more information on how to connect the camera, refer to [Insert the camera](#) on page 32. The pictures/videos taken by camera are saved in the internal SD card. And the pictures are saved with the name consisting of a prefix "IMG" and date & time stamp, for example, IMG\_20160303-111413 was created on March 3, 2016, at 11:14:13. The videos are saved with the name consisting of a prefix "VID" and date & time stamp, for example, VID\_20160303-112328 was created on March 3, 2016, at 11:23:28.

### Note





The pictures/videos taken by camera are saved in \*.jpg/\*.mp4 format. You can view the pictures/videos on either the phone itself or on a computer using an application capable of viewing \*.jpg/\*.mp4 files.

## Taking Pictures

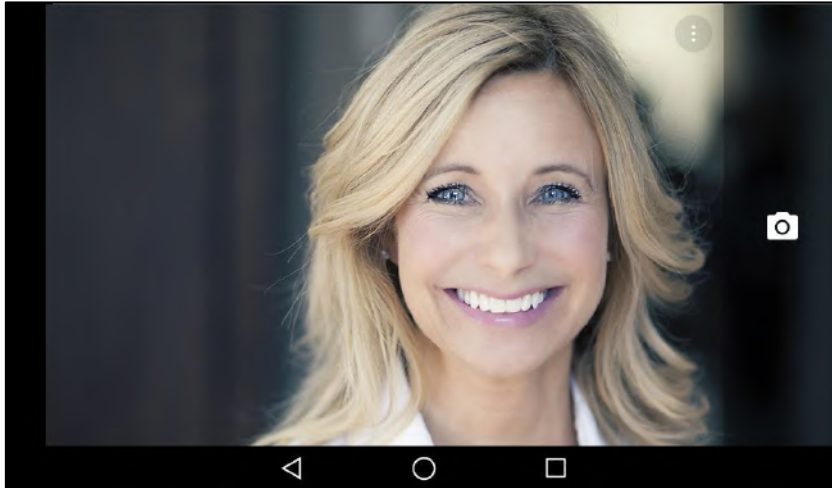
### To take a picture:

1. Swipe left or right to go to the second idle screen.
2. Tap  to launch **Camera** application.



3. (Optional.) Tap  and then do the following:
  - Tap  to turn on the camera grid.
  - Tap  to configure the camera timer.
4. Tap  to take a picture.

The IP phone will play a tone. You can swipe left to view all pictures taken by the camera.

## Recording Videos

### To record a video:



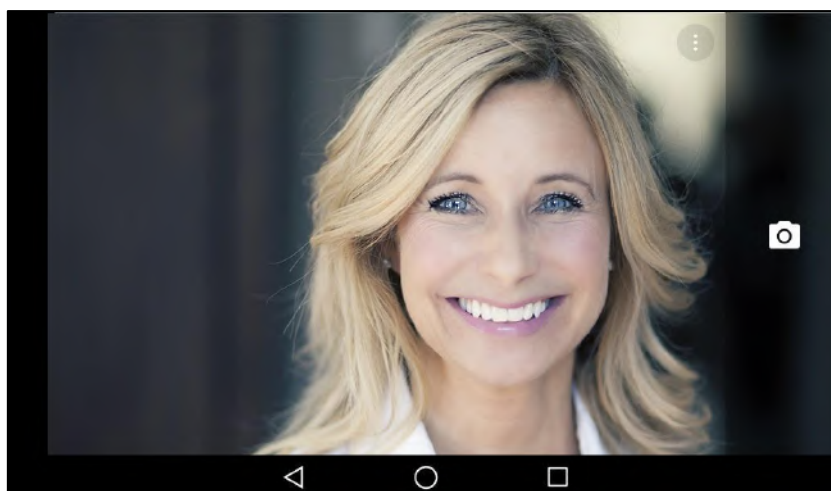

1. Swipe left or right to go to the second idle screen.

2. Tap  to launch **Camera** application.

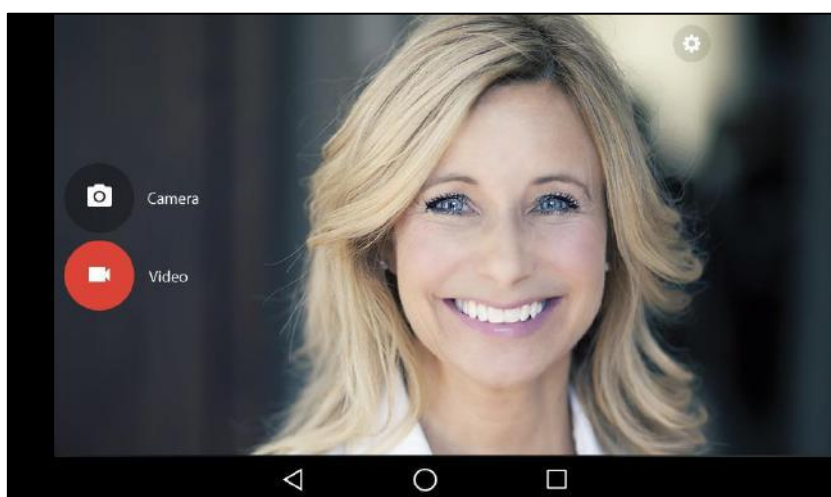

3. Swipe right and then tap **Video**.



4. (Optional.) Tap  and then tap  to turn on the camera grid.
5. Tap  to start recording.  
The IP phone will play a tone and recording time will appear on the left-top of the touch screen.
6. Tap  to stop recording.  
The IP phone will play a tone. You can swipe left to view all videos taken by the camera.

## Camera Settings

### To configure camera settings:

1. Swipe left or right to go to the second idle screen.

2. Tap  to launch **Camera** application.

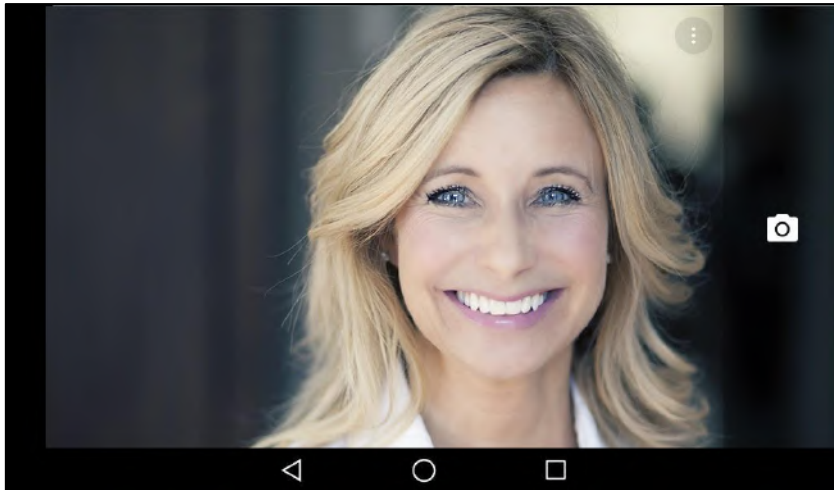

3. Swipe right.

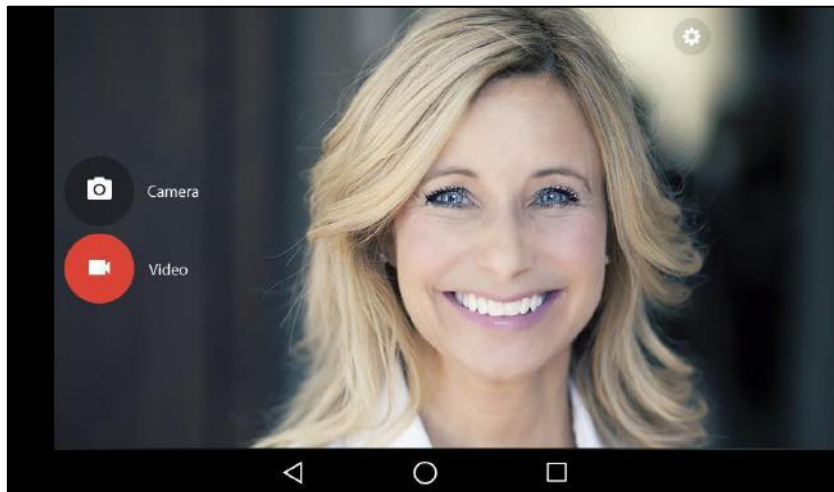

4. Tap .

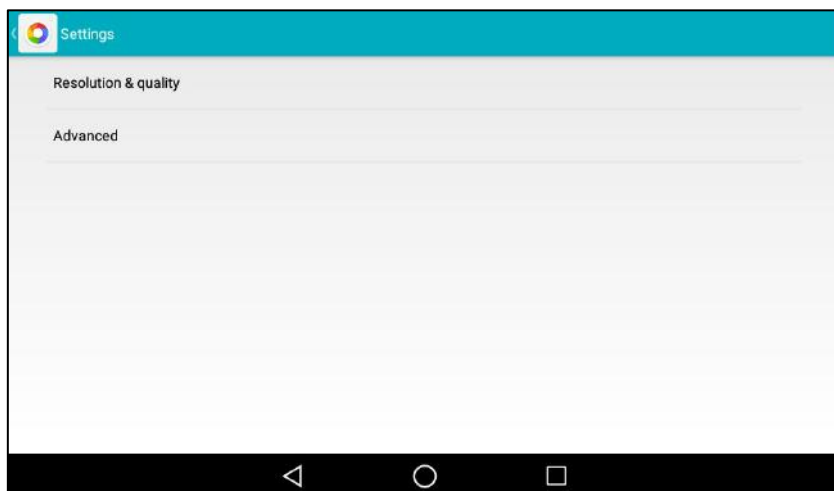

5. You can do the following:
  - Tap **Resolution & quality** to configure the resolution of the camera.
  - Tap **Advanced** and then tap **Manual exposure** to configure whether to use manual exposure.

## Email

You can use **Email** application to access personal or business email account, and send/receive emails. Before signing in email, you should configure the type of your email account.

### Signing In Email

When launching the **Email** application for the first time, a wizard will be provided for you to set up the email account step by step.

#### To sign in email:

1. Do one of the following:
  - Swipe left or right to go to the second idle screen.  
Tap  to launch **Email** application.
  - Swipe left or right to go to the third idle screen.  
Tap the email widget.

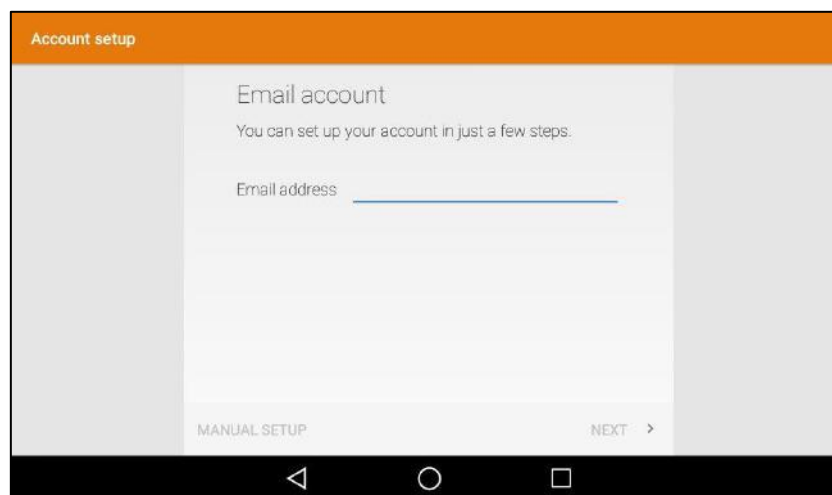

2. Sign in email, refer to [Adding APP Accounts](#).

## Sending Emails

#### To send an email:

1. Swipe left or right to go to the second idle screen.



2. Tap  to launch **Email** application.

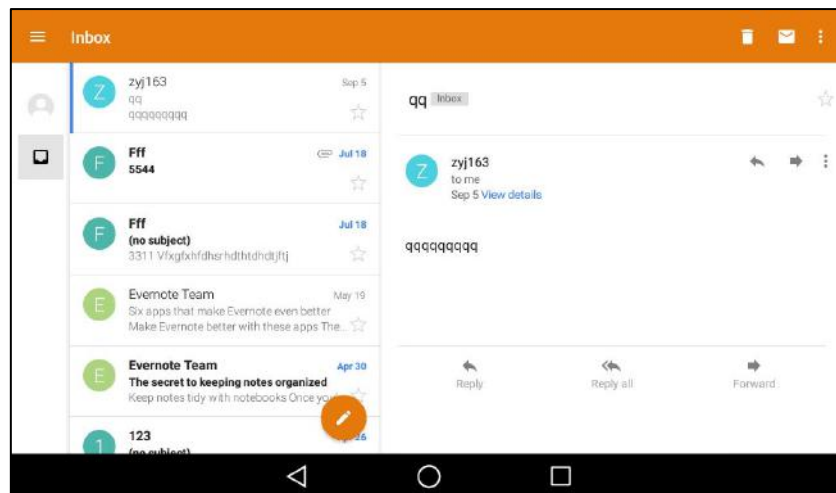

3. Tap .

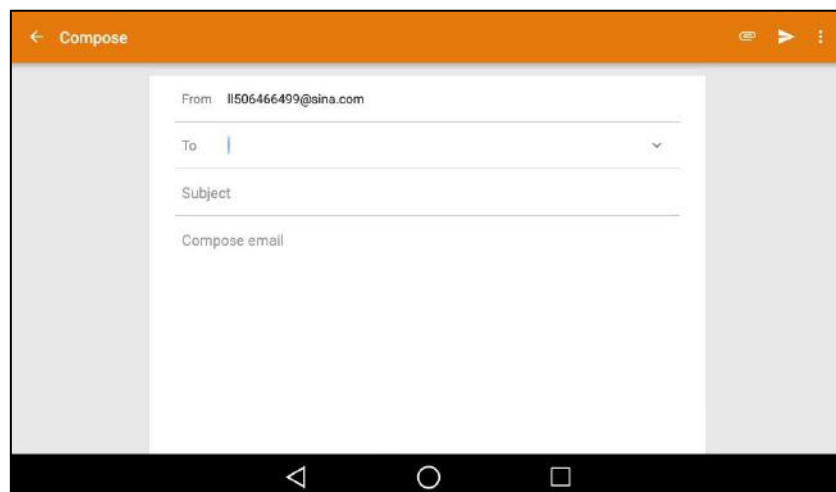

4. Compose the email.
5. Enter the email account you want to send the email to in the **To** field.
6. (Optional.) Enter the email subject in the **Subject** field.

- (Optional.) Tap  and then tap **Attach file** to add a file as mail attachment.  
The attachment file size must be within 5MB.

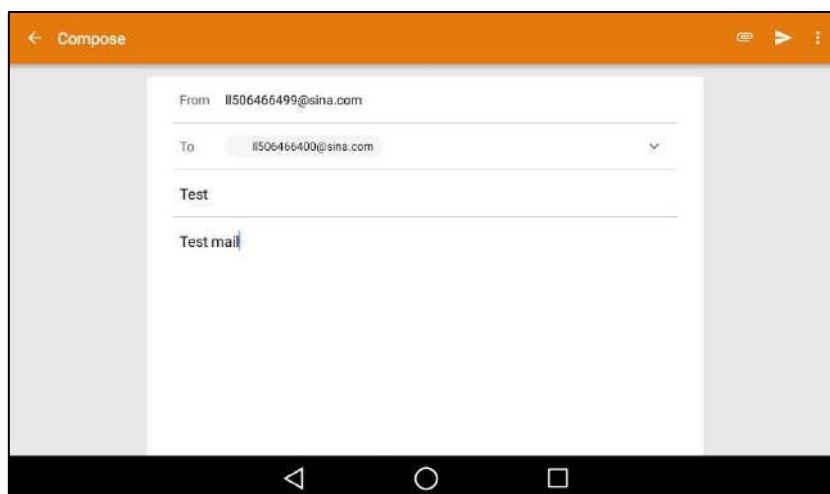



- Tap  to send the email.

## Reading Emails

If there is an incoming email, the IP phone will play a notification sound. And there is an incoming email notification on the notification center, you can tap the notification to read the email.

### To read an email:

- Swipe left or right to go to the second idle screen.
- Tap  to launch **Email** application.

If the email you want to read is not in the inbox, you can tap  on the top-left of the touch screen to select the folder that contains the email you want to read.

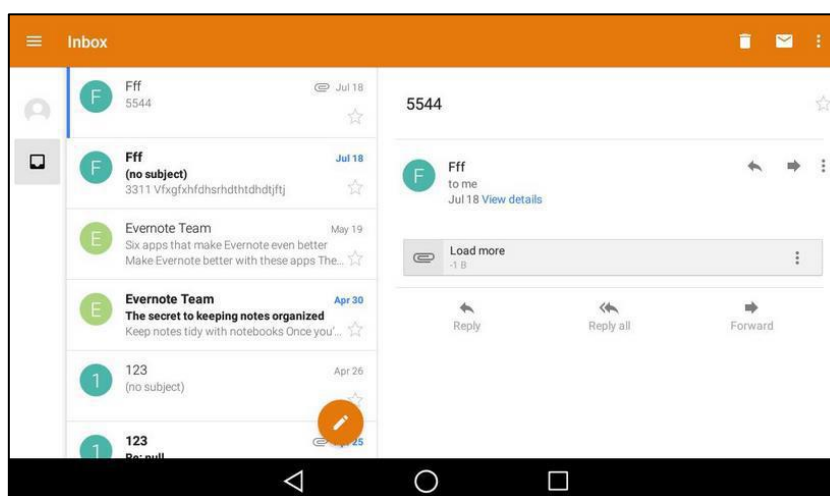

3. Tap the desired email to read.

## Deleting Emails

### To delete an email:

1. Swipe left or right to go to the second idle screen.
2. Tap  to launch **Email** application.

If the email you want to delete is not in the inbox, you can tap  on the top-left of the touch screen to select the folder that contains the email you want to delete.

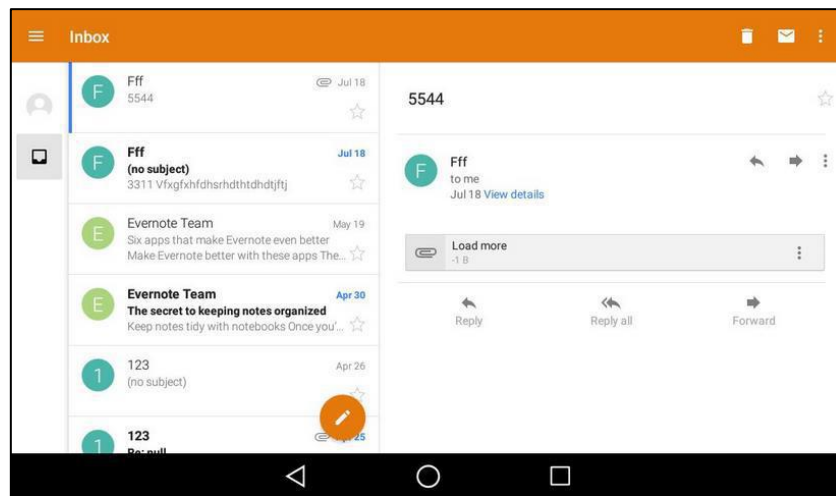

3. Long tap the desired email.

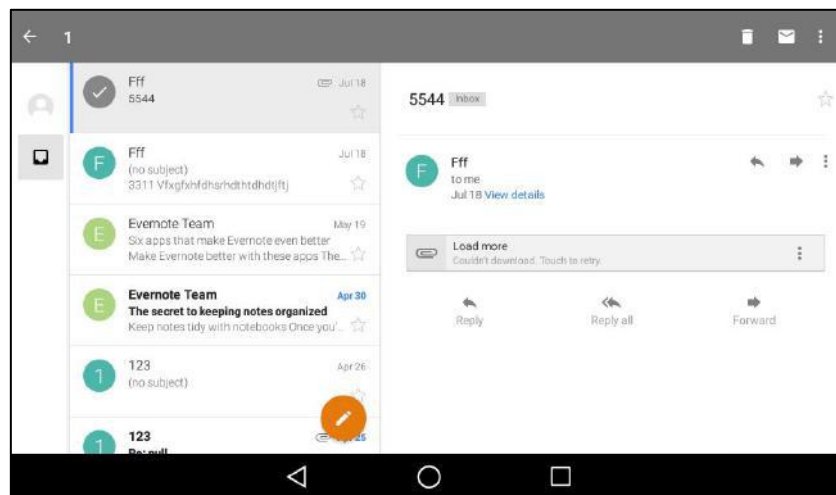

4. Tap  to delete the email.

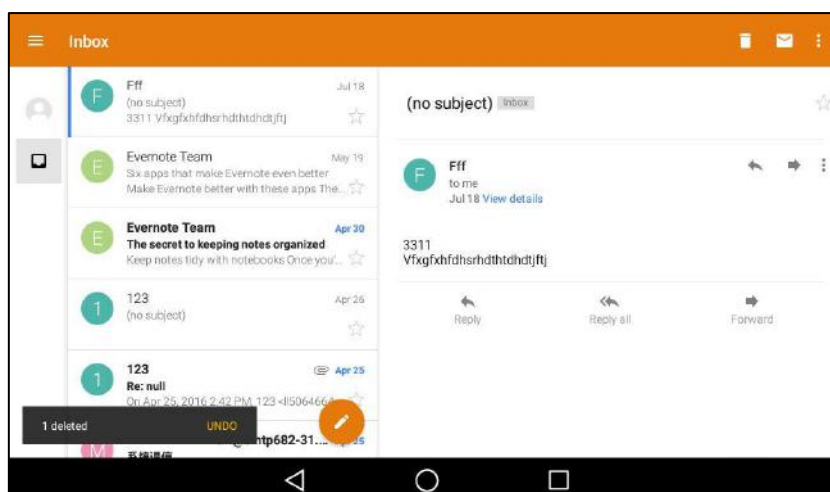

You can tap **UNDO** to cancel the deletion.





## Email Options

**To use the email options:**

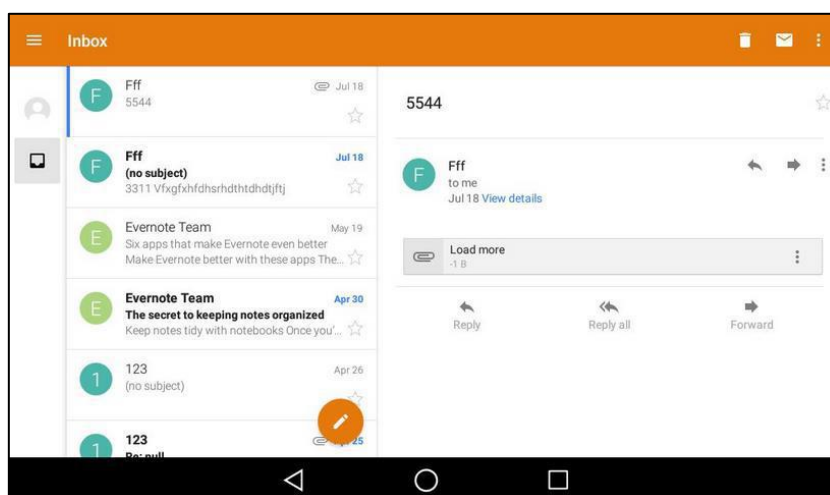
1. Swipe left or right to go to the second idle screen.
2. Tap  to launch **Email** application.

If the email you want to configure is not in the inbox, you can tap  on the top-left of the touch screen to select the folder that contains the email you want to configure.





3. You can do the following:
  - Tap  /  to mark the email as unread/read.
  - Tap  and then tap **Print** to print the email.
  - Long tap the desired email.
    - Tap  and then tap **Add star** to star the email.

## Multiple Email Accounts

You can add more than one email account on the IP phone.

### To add another email account on the IP phone:

1. Swipe left or right to go to the second idle screen.
2. Tap  to launch **Email** application.
3. Tap  on the top-left of the touch screen.

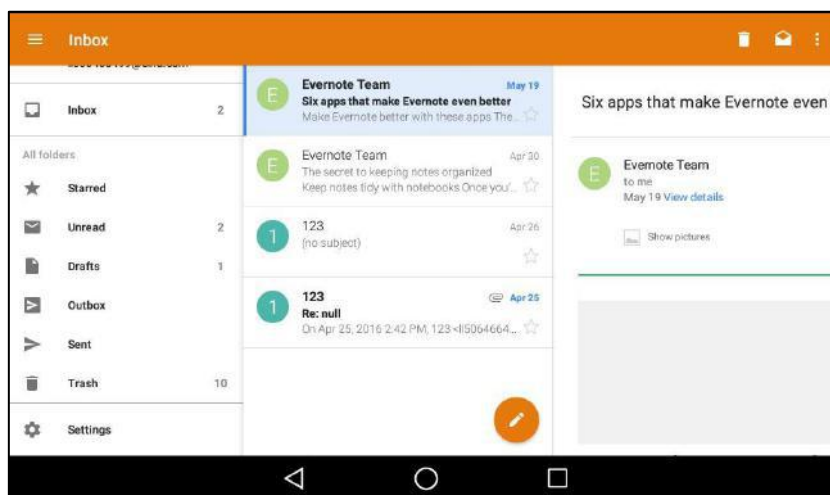

4. Tap **Settings->Add account**.

A new email account setup wizard will show up. For more information, refer to [Adding APP Accounts](#) on page 188.

Once another email account is successfully added, the touch screen will display as below:

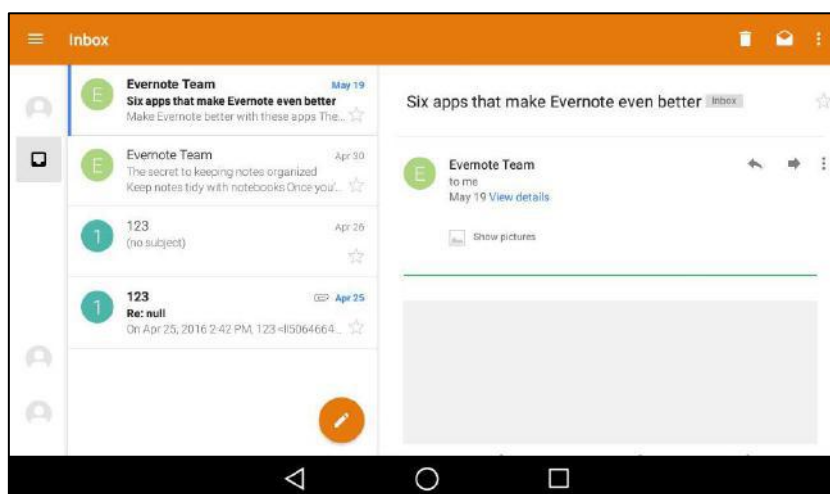

You can tap  on the bottom-left of the touch screen to switch between the email accounts.

## Email Widget

You should sign in the email if you have not registered an email account. For more information, refer to [Adding APP Accounts](#) on page 188.

After you sign in the email, you can choose the desired folder to display on the widget. If you add an email widget to display the unread emails, then you want the widget to display the incoming emails, you should add a new widget.

### To use the email widget:

1. Swipe left or right to go to the third idle screen.

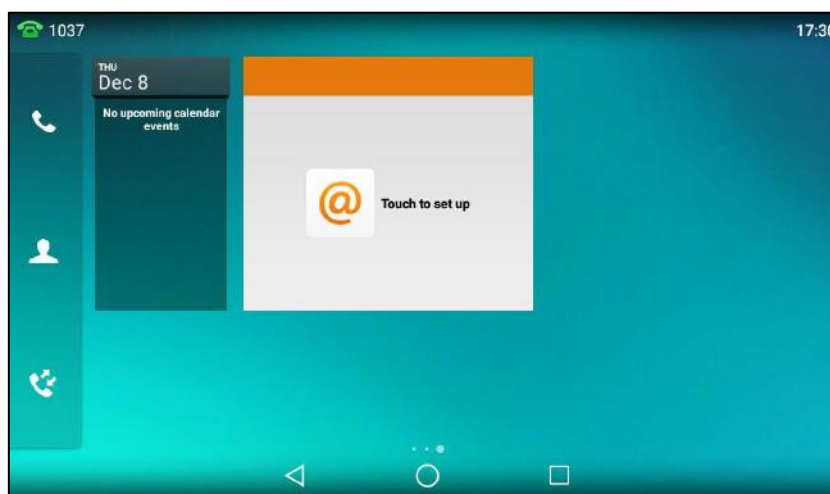

2. Tap the email widget.
3. Tap the desired account, if you have more than one email account.

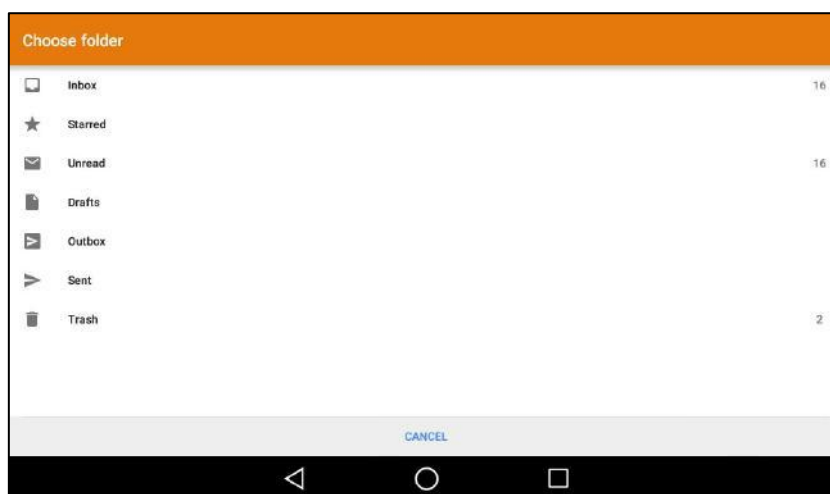

4. Tap the desired folder to display on the widget.  
If you select **Inbox**, the email widget will display as below:

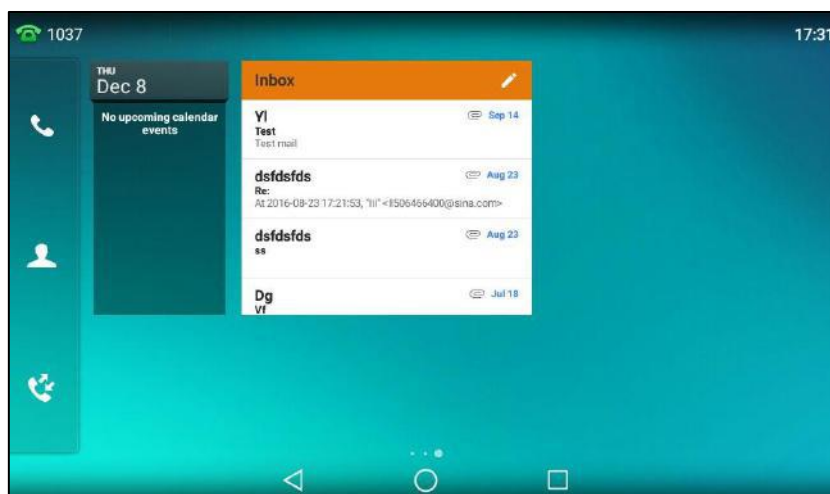

You can drag up and down to scroll through emails in inbox folder, and tap the desired email to view. You can also tap  on the top-right of the widget to compose and send an email.

## Sending Files via Email

The **Gallery** and **FileManager** applications support data transfer via Email. You can send pictures, audios or videos as mail attachments to other account. For more information, refer to [Sharing Pictures/Videos/Audios](#) on page 204 and [Sharing Pictures/Videos](#) on page 219.

## Browser

The **Browser** application could be used in a similar way as a PC-based web browser, i.e., browse web pages, bookmarks, set home pages, clear history and etc. The default home page is the Yealink website.

## Browsing a Web Page

**To browse a web page:**

1. Swipe left or right to go to the second idle screen.

2. Tap  to launch **Browser** application.

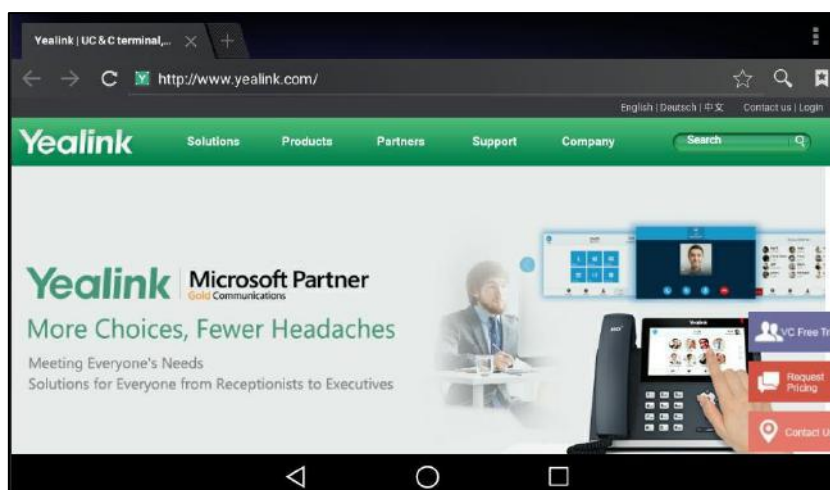

3. Enter a part of URL in the address input field of the browser.  
The phone will automatically retrieve and list similar websites.

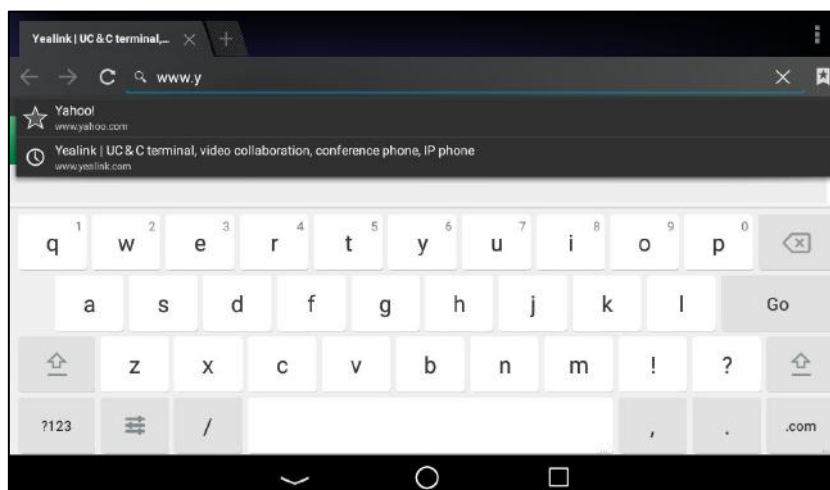

4. Tap the website you want to visit or enter the full URL then tap **Go** on the onscreen keyboard to browse the web page.
5. You can do the following:
  - Scroll up/down to view the web page.
  - Pinch open or pinch close the web page.

## Managing Bookmarks

You can bookmark the web pages that you frequently visit.



### To add a web page to the bookmarks list:

1. Swipe left or right to go to the second idle screen.
2. Tap  to launch **Browser** application.

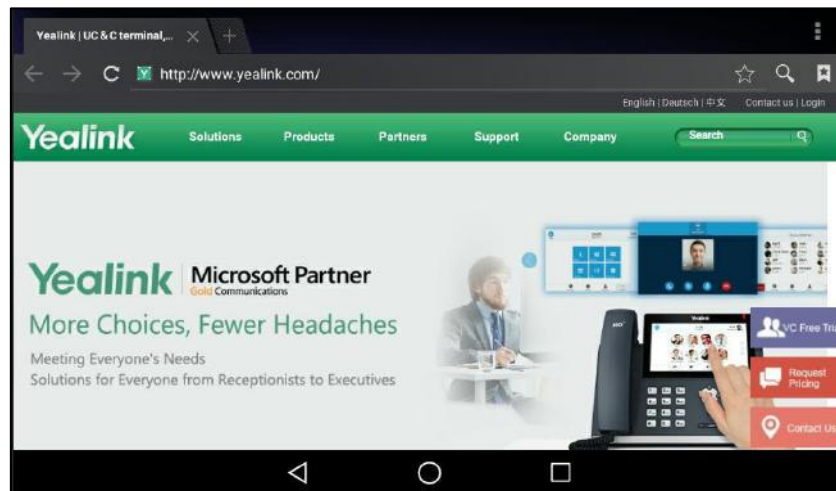

3. Open the web page you want to bookmark.
4. Tap .

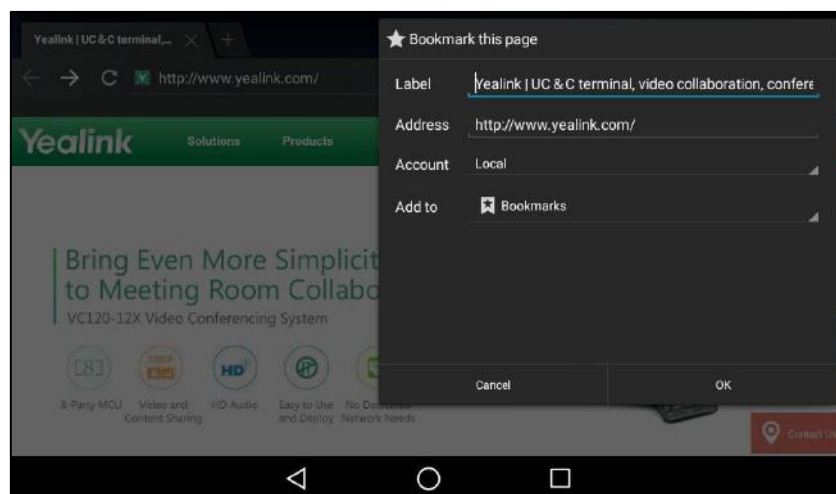

5. Edit the bookmark information in corresponding fields.
6. Tap **OK** to accept the change.

Then the web page is added to the **BOOKMARKS** list.

### To open a web page from the bookmarks list:

1. Swipe left or right to go to the second idle screen.

2. Tap  to launch **Browser** application.

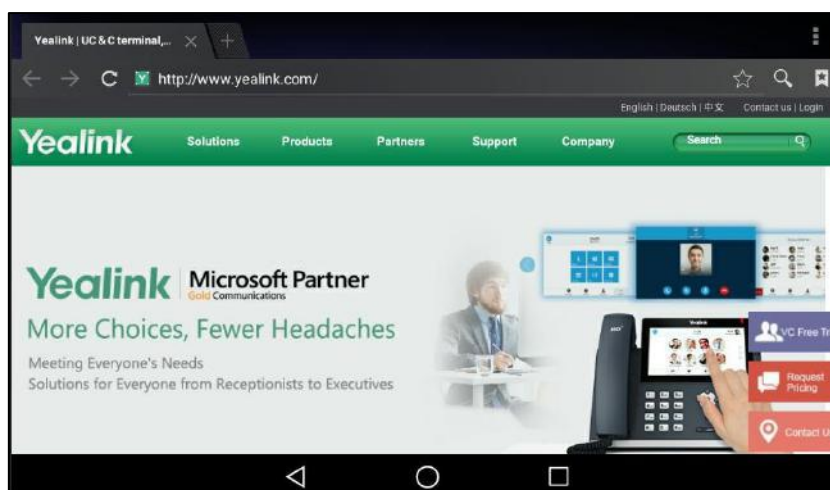

3. Tap  to access the **BOOKMARKS** list.  
There are some pre-configured bookmarks by default.

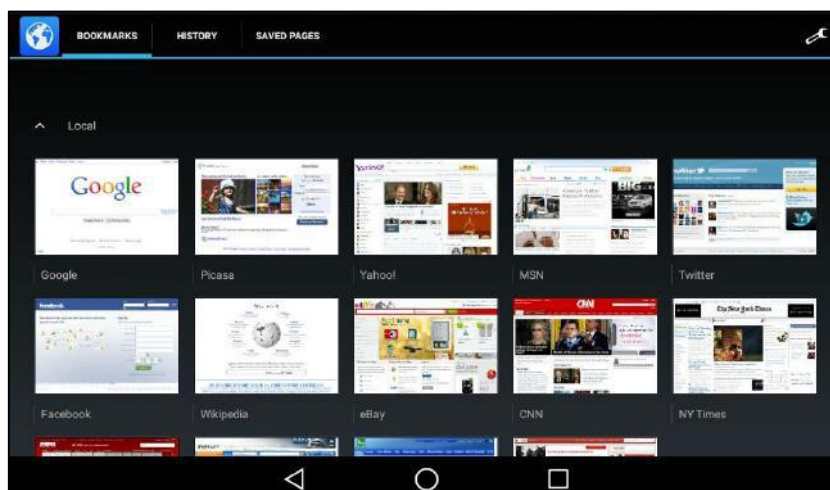



4. Tap the web page you want to visit.

**To edit a bookmark:**

1. Swipe left or right to go to the second idle screen.

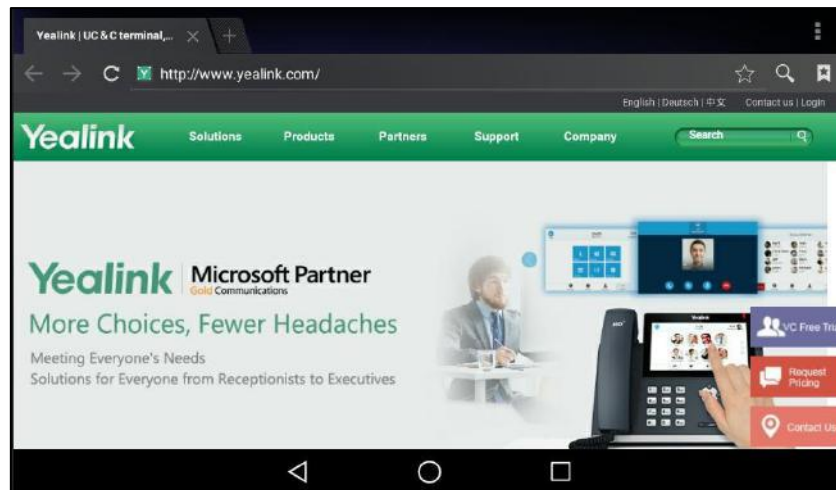
2. Tap  to launch **Browser** application.



3. Tap  to access the **BOOKMARKS** list.  
There are some pre-configured bookmarks by default.
4. Long tap the bookmark you want to edit.

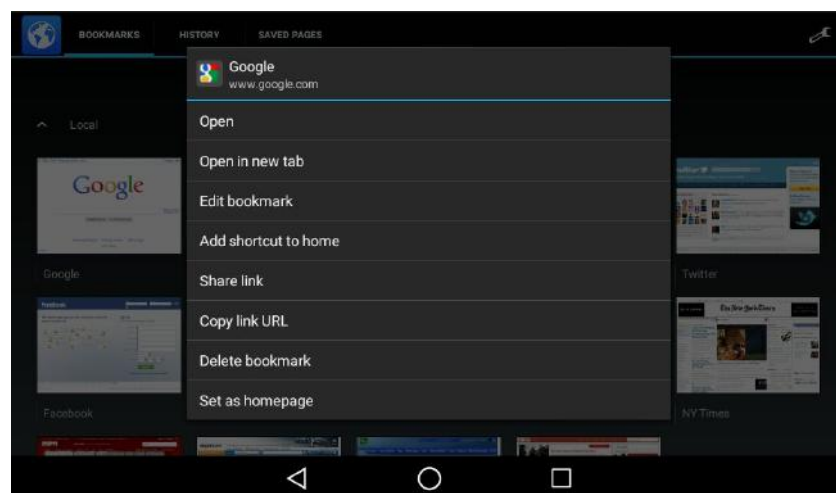

5. Tap **Edit bookmark** in the pop-up dialog box.

6. Edit the bookmark.

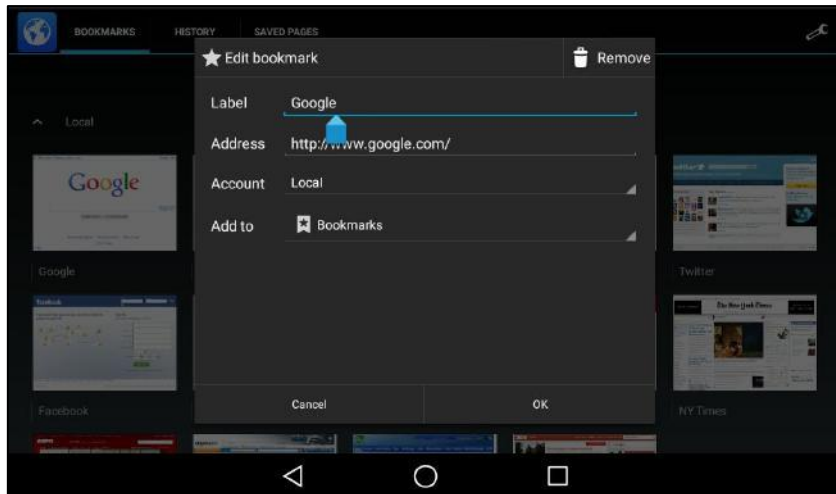

7. Tap **OK** to accept the change or **Cancel** to cancel.

**To delete a bookmark:**

1. Swipe left or right to go to the second idle screen.
2. Tap  to launch **Browser** application.

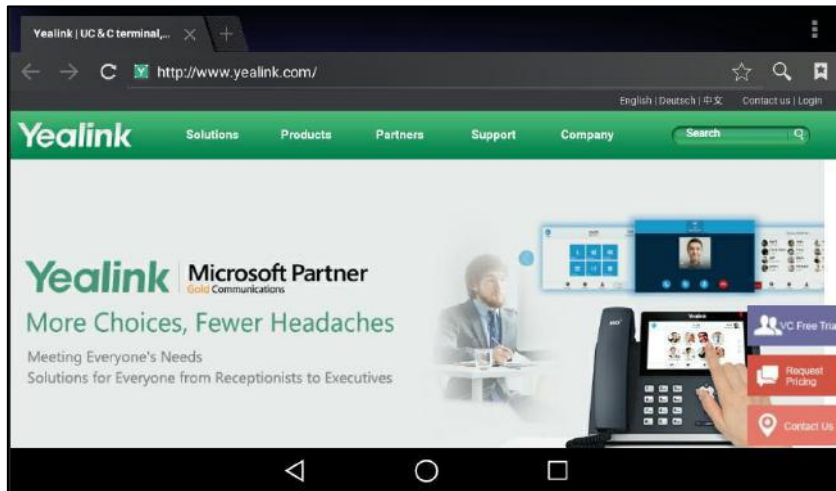

3. Tap  to access the **BOOKMARKS** list.  
There are some pre-configured bookmarks by default.
4. Long tap the bookmark you want to delete.
5. Tap **Delete bookmark** in the pop-up dialog box.
6. Tap **OK** to accept the change or **Cancel** to cancel.

## Setting a Home Page

You can set the web page you visit most frequently as the home page. Then, each time you open the browser, this web page is automatically opened.

**To set a home page:**

1. Swipe left or right to go to the second idle screen.
2. Tap  to launch **Browser** application.

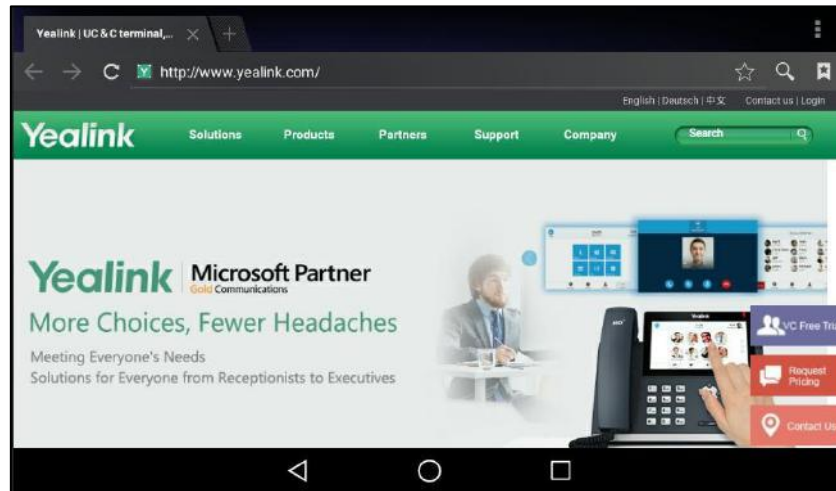

3. Tap .

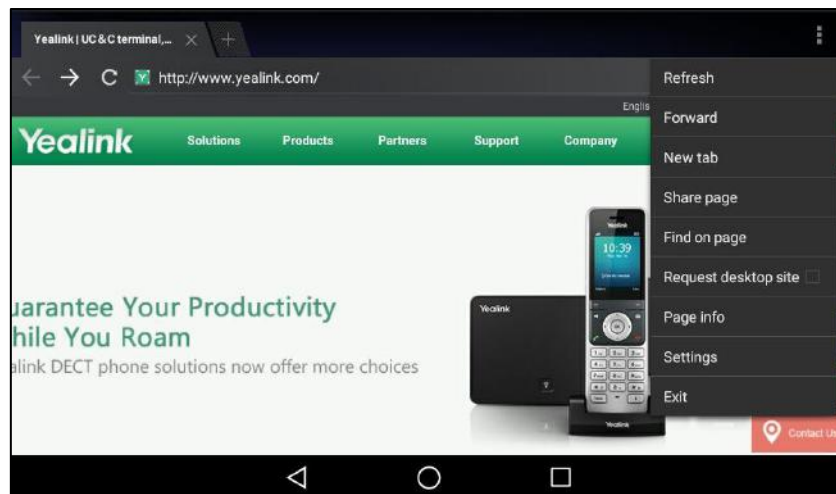

4. Tap **Settings->General->Set homepage**.

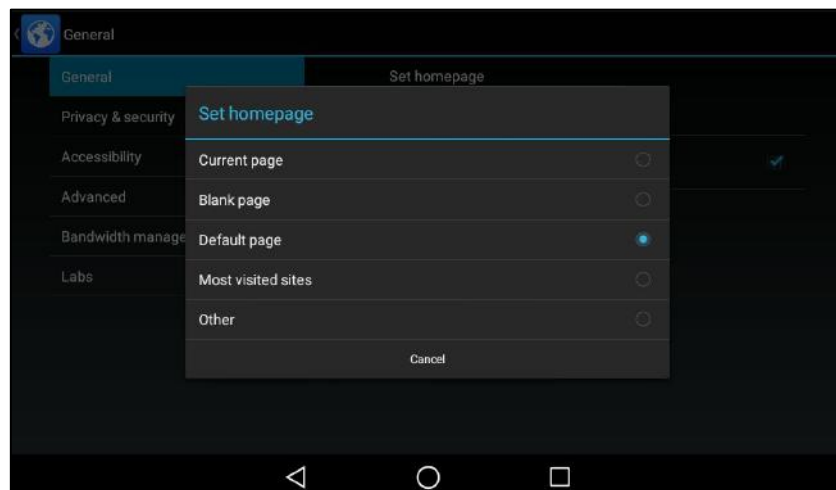

5. Tap the web page you want to set as the home page in the pop-up dialog box.  
You can also long tap a web page in **BOOKMARKS** list and then tap **Set as homepage**.

## Clearing the Navigation History

You can periodically clear your navigation history to protect your privacy and prevent information disclosure.

**To clear the navigation history:**

1. Swipe left or right to go to the second idle screen.
2. Tap  to launch **Browser** application.

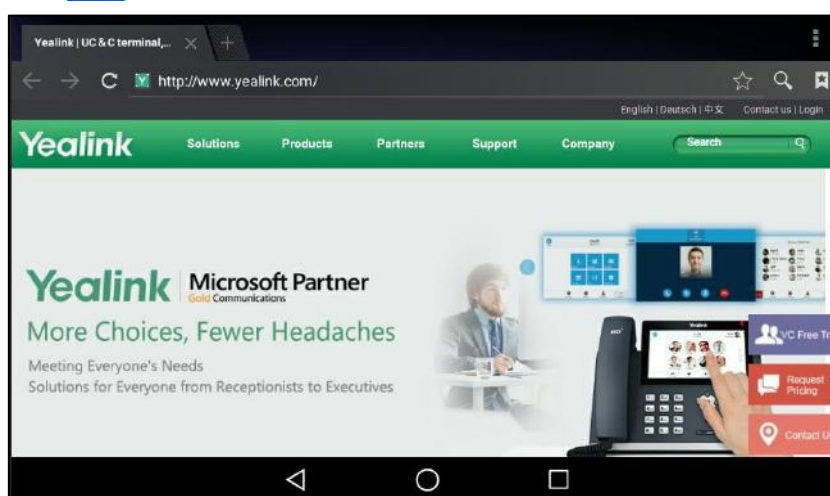

3. Tap .

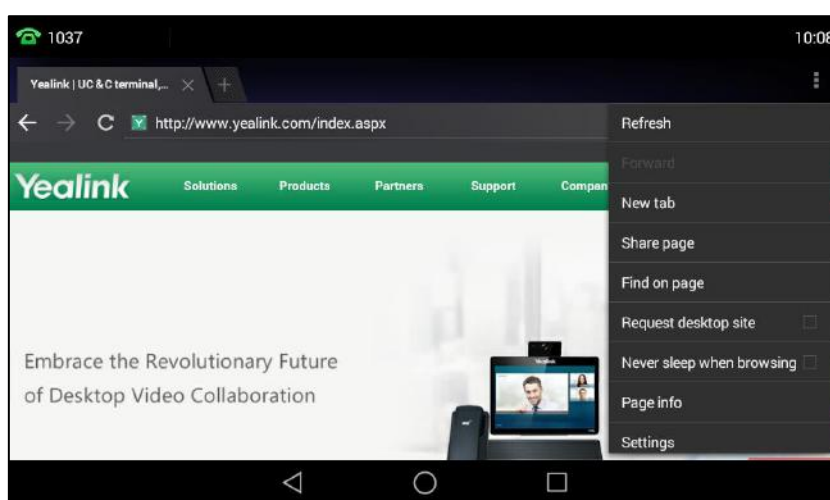

4. Tap **Settings->Privacy & security->Clear history**.

The touch screen prompt “Delete the browser navigation history?”.

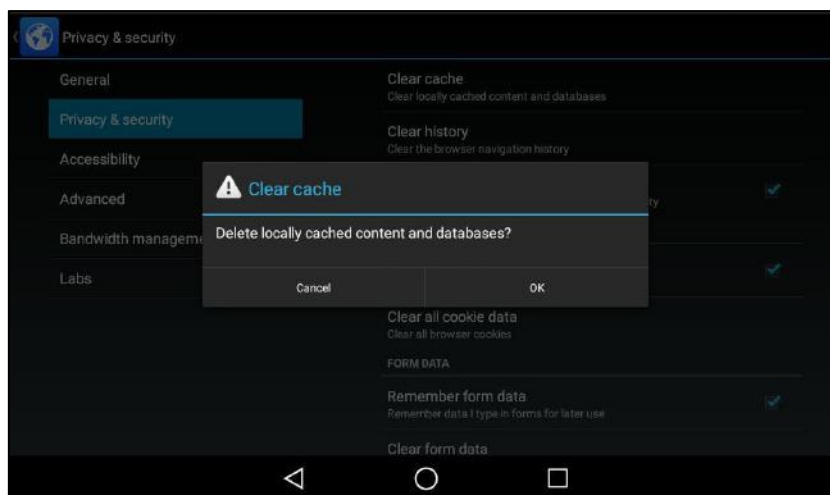



5. Tap **OK** to accept the change or **Cancel** to cancel.

## Modifying Browser Settings

**To modify browser settings:**

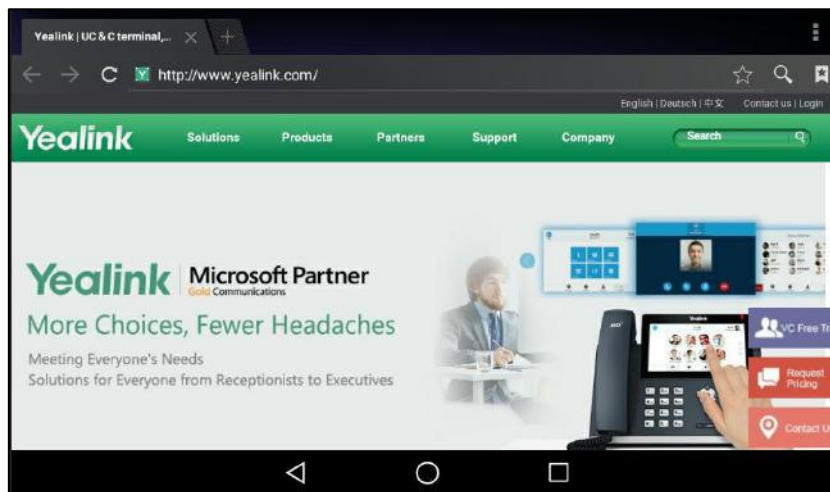
1. Swipe left or right to go to the second idle screen.
2. Tap  to launch **Browser** application.



3. Tap .
4. Tap **Settings**.
5. Customize the browser style you prefer.

## Calendar

You can use the **Calendar** application to synchronize events from email account as well as creating, modifying and viewing the events. The IP phone also provides notification for the

upcoming events from the Calendar.

## Signing In Calendar

Before creating an event, you should sign in an email account first. If you have registered an account on the **Email** application already, you can skip this operation.

**To sign in calendar:**

1. Swipe left or right to go to the second idle screen.
2. Tap  to launch **Calendar** application.

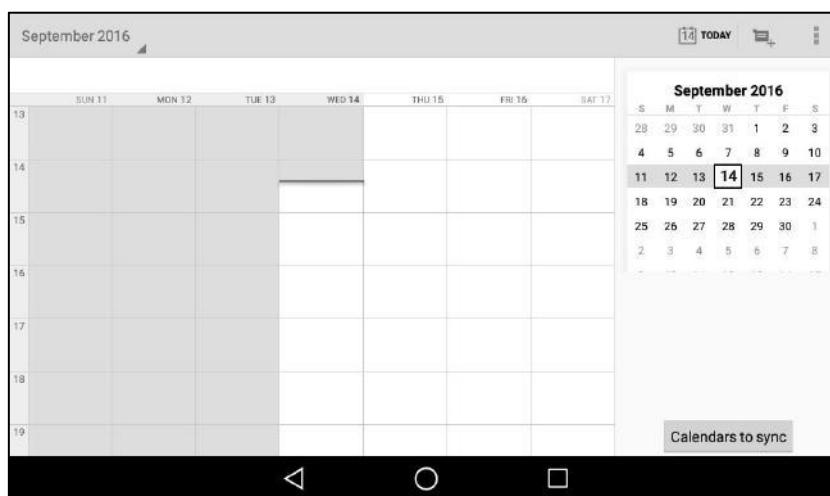

3. Tap .

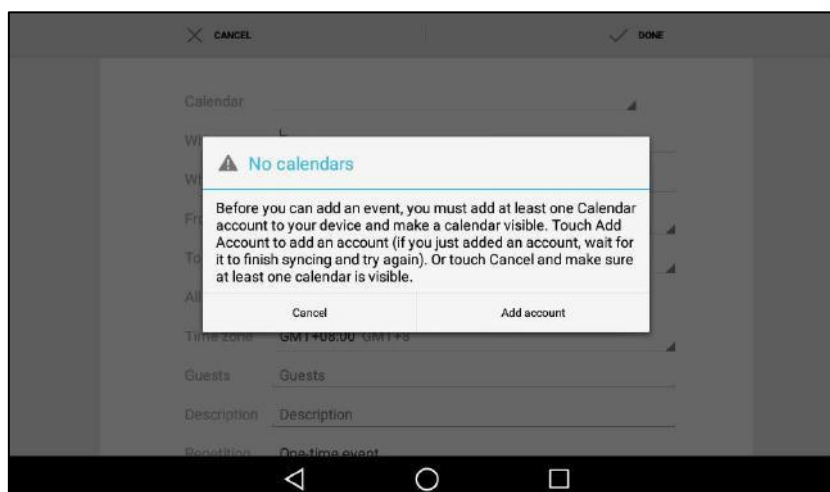

4. Tap **Add account**.
5. Sign in the Calendar, refer to [Adding APP Accounts](#).



## Creating an Event

**To create an event:**

1. Swipe left or right to go to the second idle screen.
2. Tap  to launch **Calendar** application.

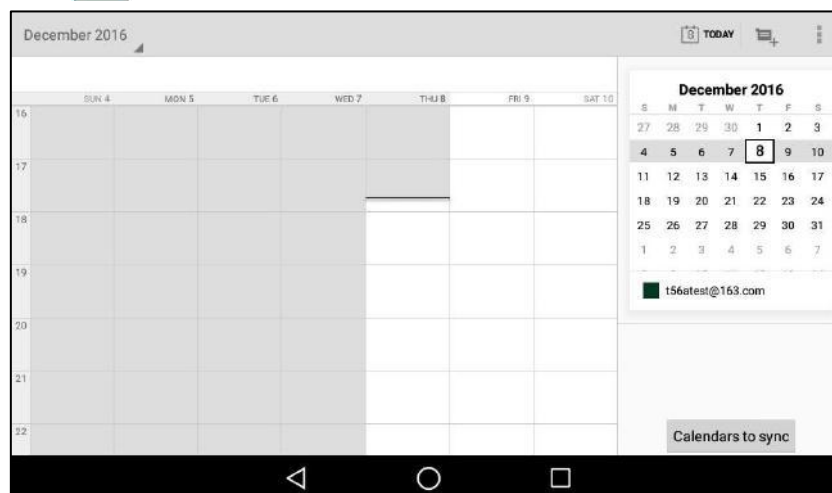

3. Tap a desired date.
4. Tap .

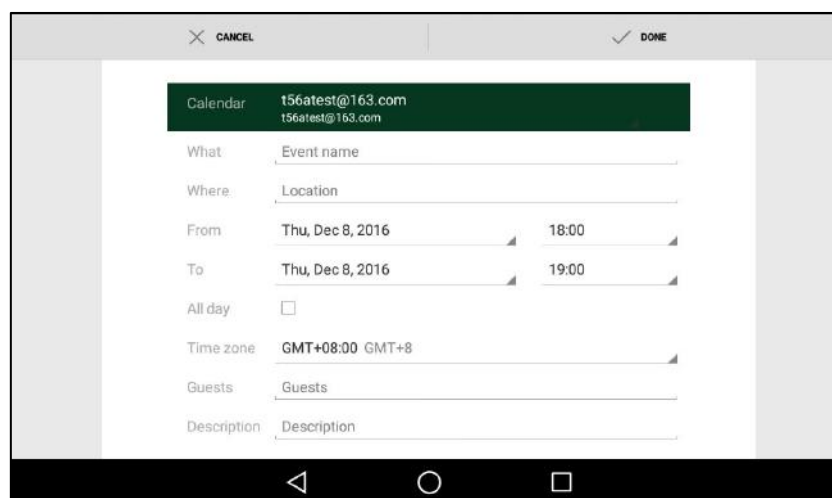

5. Edit the event.
6. Tap **DONE** to accept the change or **CANCEL** to cancel.

## Checking Events

On the calendar screen, you can check the information about an event you have added.

**To view calendar:**

1. Swipe left or right to go to the second idle screen.

2. Tap  to launch **Calendar** application.

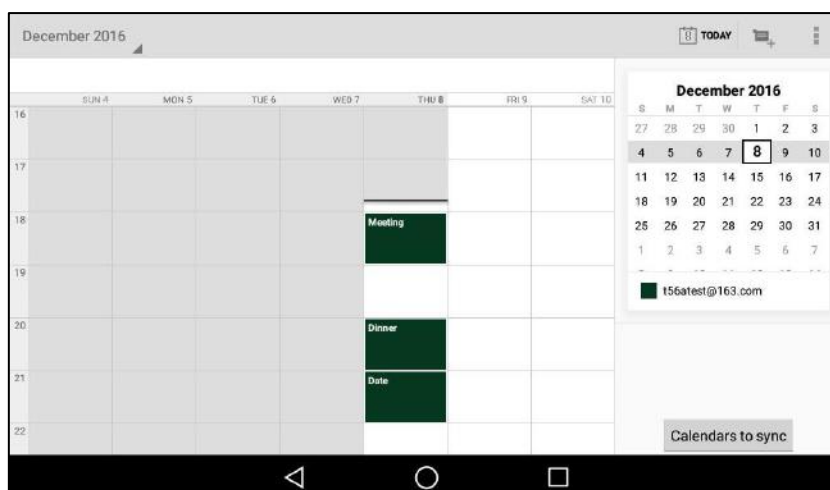

3. (Optional.) Tap **December 2016** on the top-left of the touch screen.

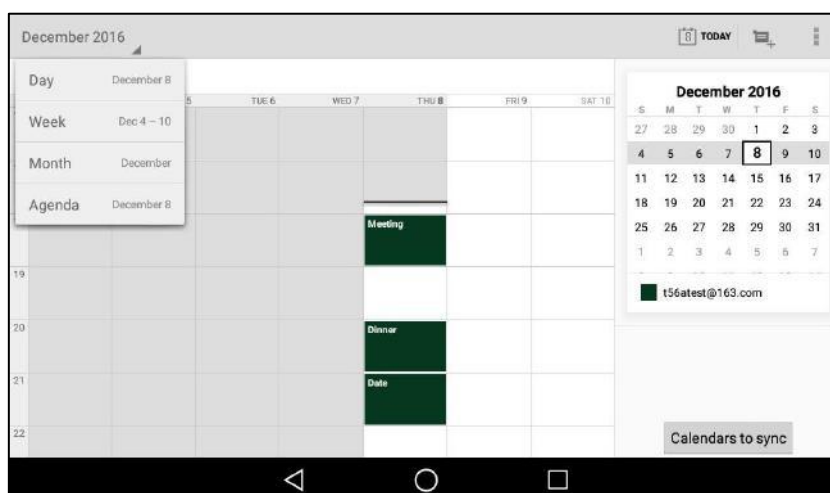

Tap **Day/Week/Month/Agenda** to select different time format to view the calendar.

In the agenda view, the events you have added are displayed as a list. You can tap **Touch to view events before XXX/Touch to view events after XXX** to view all events.

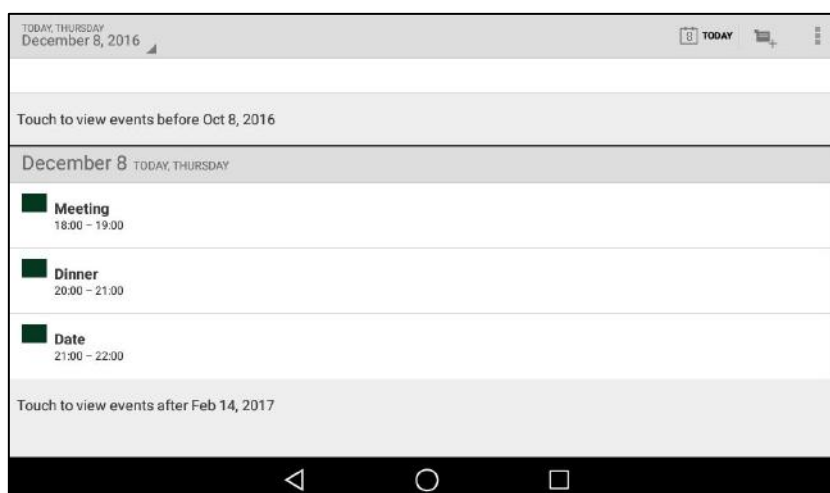

## Modifying the Calendar Settings

**To modify the calendar settings:**

1. Swipe left or right to go to the second idle screen.

2. Tap  to launch **Calendar** application.

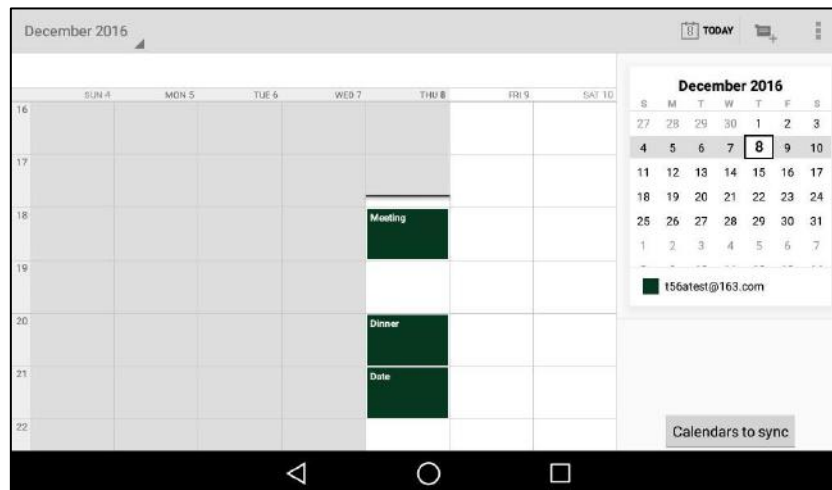

3. Tap .

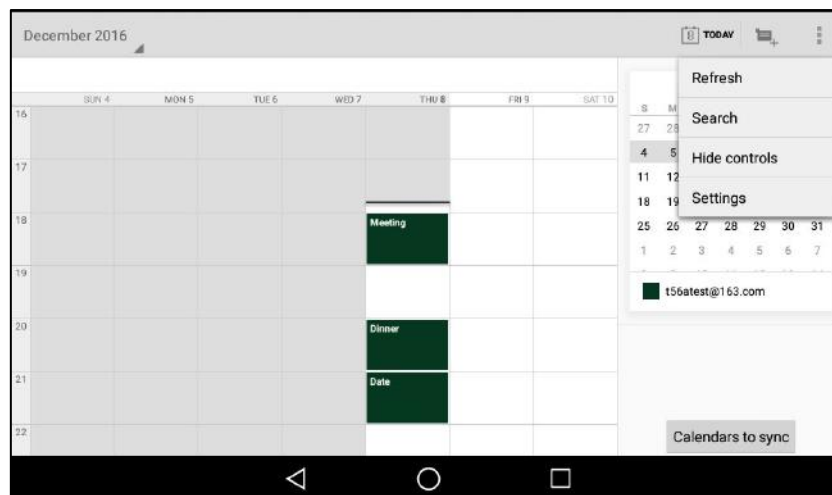

4. Tap **Settings**.
5. Customize the general settings and account settings.

## Calculator

You can use the **Calculator** application to perform simple or complex calculations.

**To access the calculator application:**

1. Swipe left or right to go to the second idle screen.

2. Tap  to launch **Calculator** application.

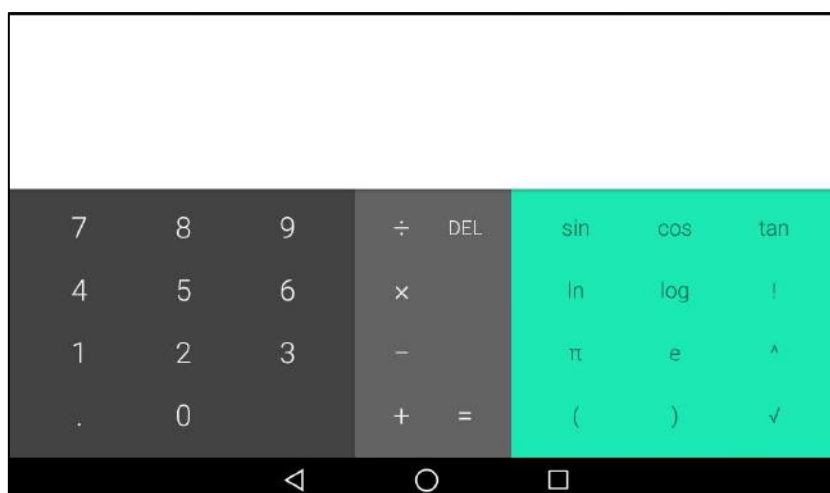

## Clock

You can use the **Clock** application to set an alarm, check the time of other cities in the world, calculate the lasting time of an event and set a timer.

## Alarm

**To set an alarm clock:**

1. Tap the digital clock widget on the home screen.

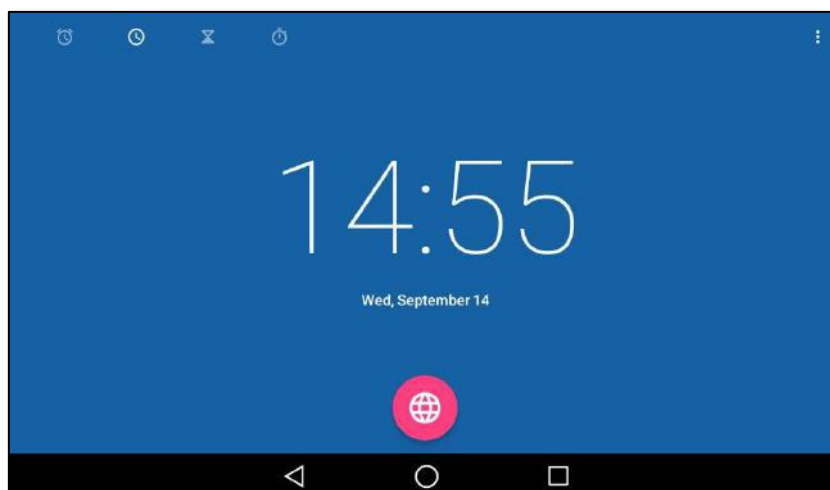

2. Tap  on the top-left of the touch screen.

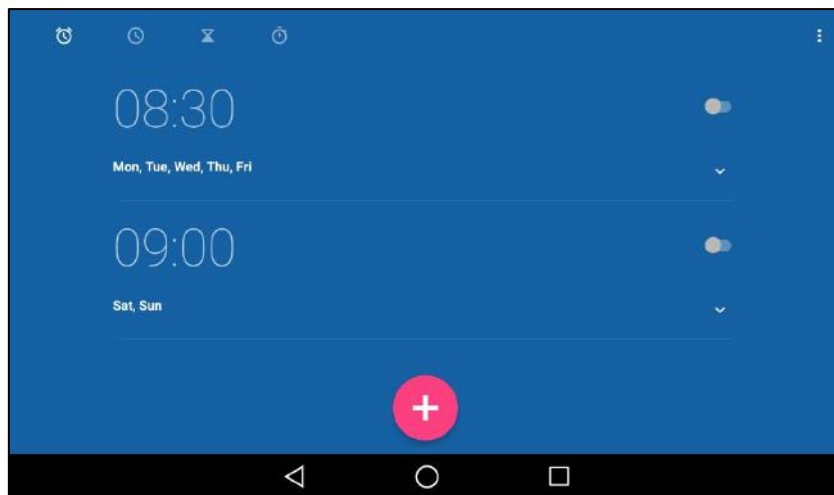

3. Tap  .

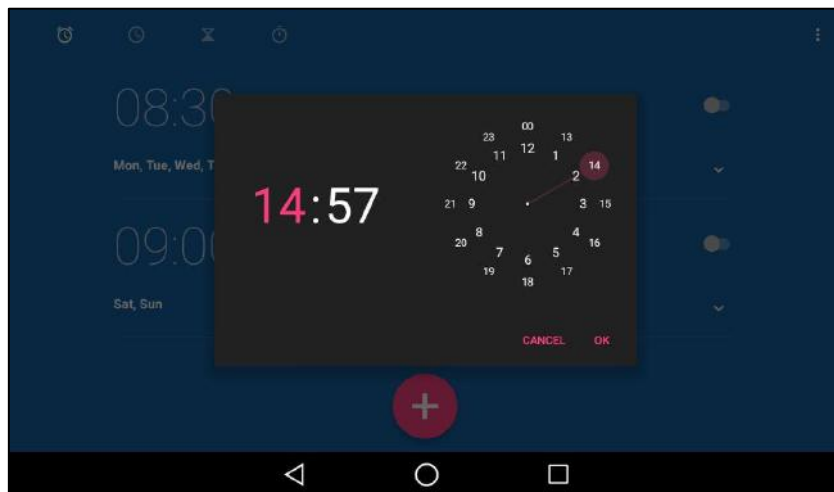

4. Tap the desired number to enter the alarm time.
5. Tap **OK**.  
The alarm clock you have set is displayed on the touch screen.

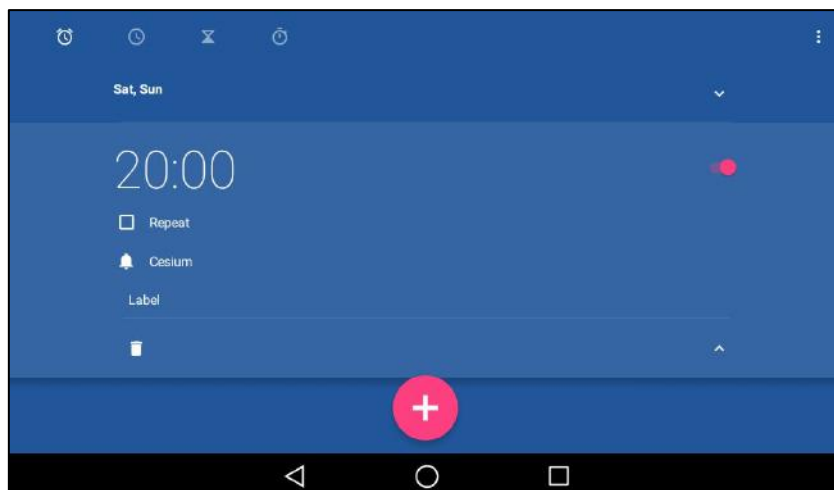

6. Tap the **Label** field and then enter a label for an alarm.
7. Tap the **REPEAT** radio box and then tap the repeat day of the alarm.
8. Tap  and then select a desired ringtone for alarm.

**Note** If you have set the time format as **12 Hour**, you need to select **AM** or **PM** when setting the alarm time. For more information on time format, refer to [Time & Date](#) on page 87.

**To edit an alarm clock:**

1. Tap the digital clock widget on the home screen.

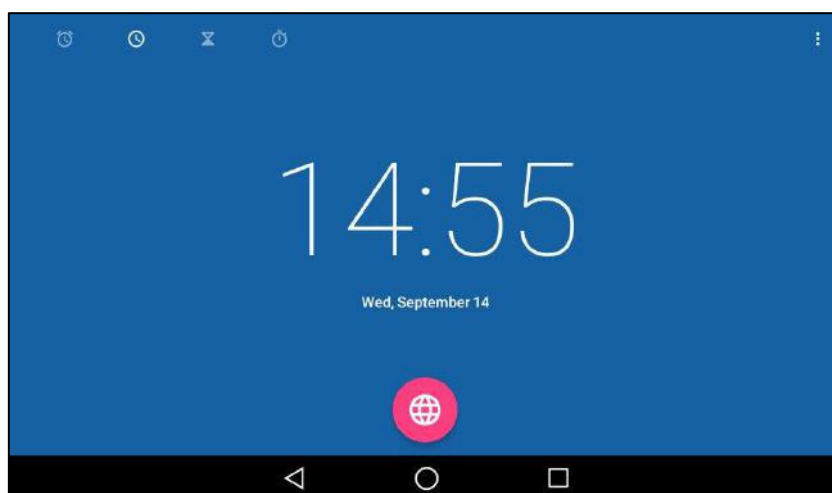

2. Tap  on the top-left of the touch screen.

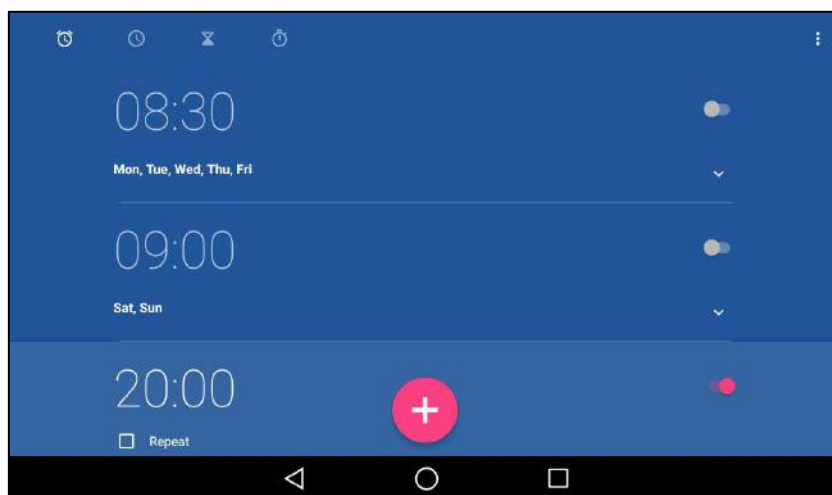

3. Drag up and down to scroll through alarms.
4. Select a desired alarm.
5. Tap the desired option to edit the alarm clock.

**To delete an alarm clock:**

1. Tap the digital clock widget on the home screen.

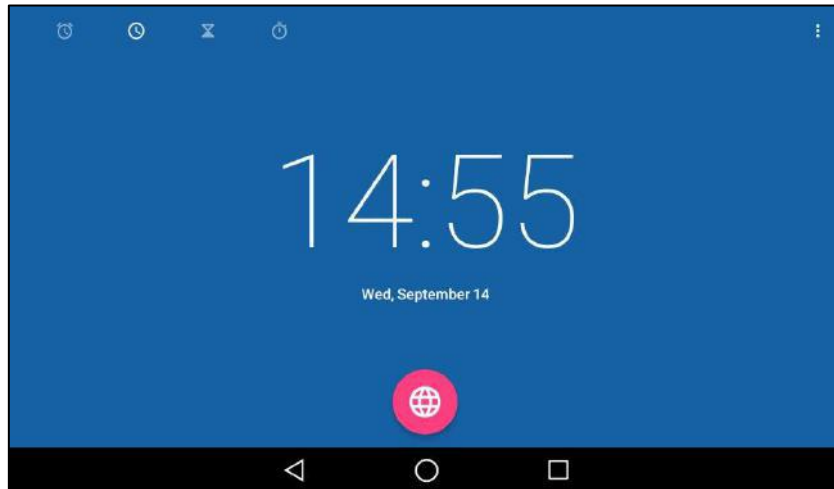

2. Tap  on the top-left of the touch screen.

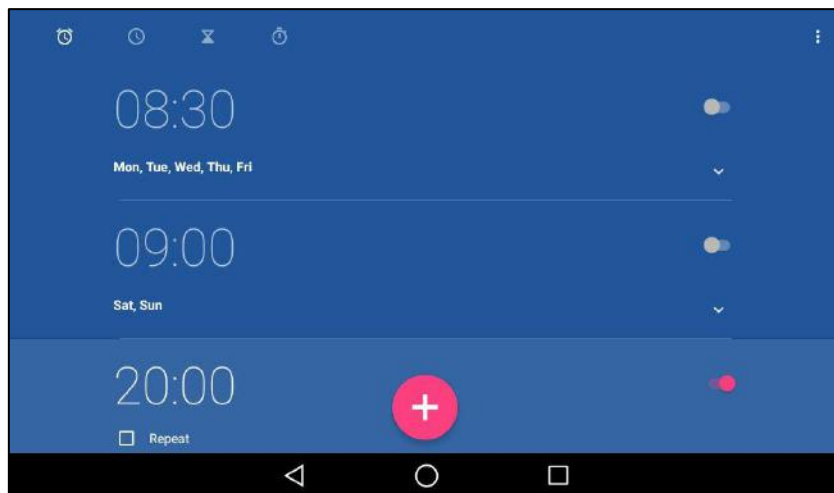





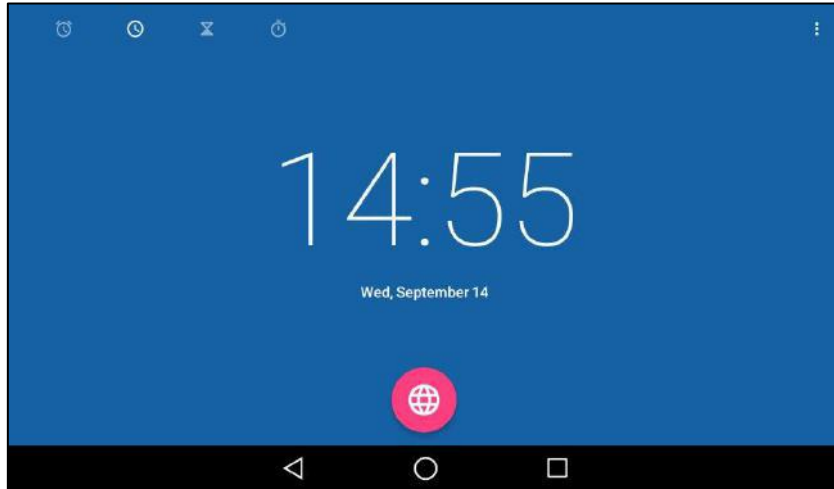

3. Select a desired alarm.
4. Tap  on the bottom-left of the alarm to delete the desired alarm.

You can tap **UNDO** to cancel the deletion.

**To configure the alarm sound parameters:**

1. Tap the digital clock widget on the home screen.



2. Tap  on the top-left of the touch screen.
3. Tap  and then tap **Settings**.
4. You can do the following:
  - Tap the **Silence after** field, and then tap the desired lasting time of the alarm bell in the pop-up dialog box. The alarm clock will automatically stop after this specified period of time.
  - Tap the **Snooze length** field, and then tap the desired snooze time after the alarm clock rings in the pop-up dialog box.
  - Tap the **Alarm volume** field, and then drag the slider to adjust the alarm volume.
  - Tap the **Volume buttons** field, and then configure the desired function for the Volume key when the alarm is ringing.
    - **Snooze:** Press  when the alarm is ringing, the alarm will stop and ring after a specified period of time.
    - **Dismiss:** Press  when the alarm is ringing, the alarm will stop.
    - **Do nothing:** Press  when the alarm is ringing, the alarm will still ring.

## Clock

**To add the clock of other cities in the world:**

1. Tap the digital clock widget on the home screen.



The touch screen displays the current date and time.

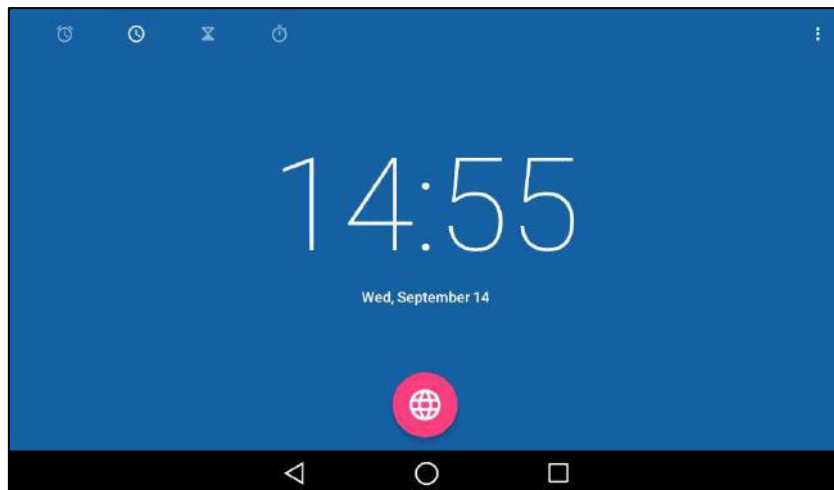

2. Tap  .

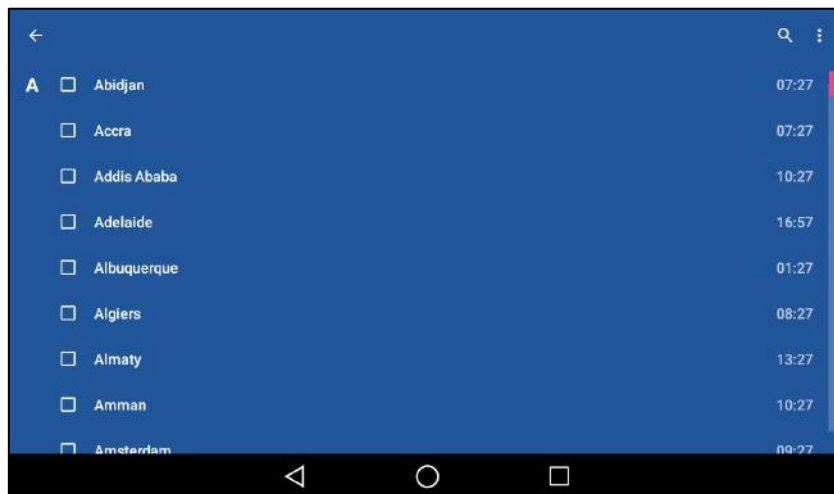

3. Drag up and down to scroll through the cities.
4. Tap the checkbox before the desired city.
5. Tap  to return to the clock screen.

The added clock of the desired city displays on the touch screen.

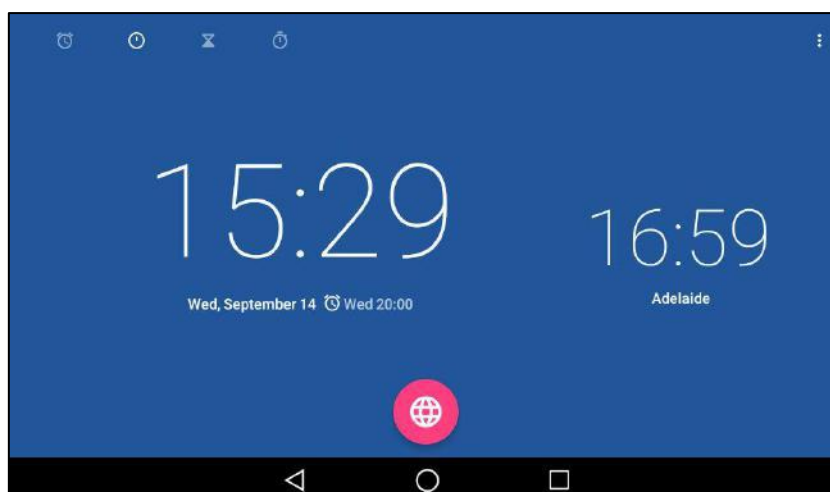

**To configure the clock display mode:**

1. Tap the digital clock widget on the home screen.

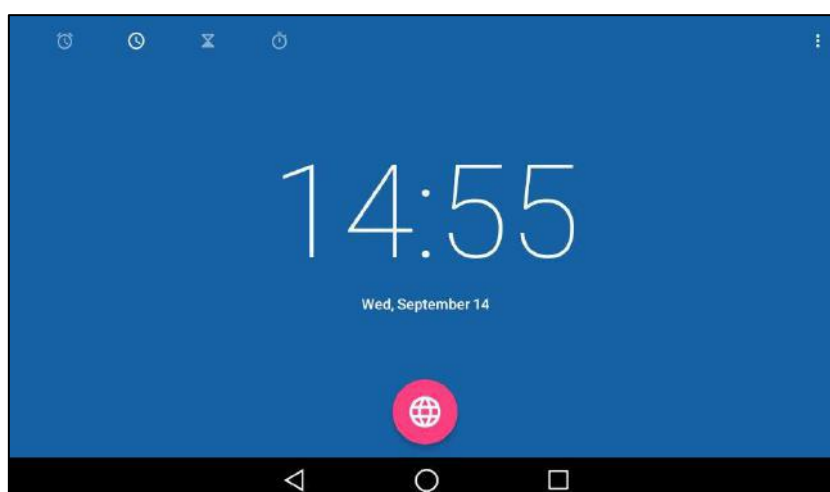

2. Tap  and then tap **Settings**.
3. You can do the following:
  - Tap the **Style** field.  
Tap **Analog** or **Digital** in the pop-up dialog box.
  - Mark the **Automatic home clock** radio box.
    - Tap the **Home time zone** field.  
Tap a desired time zone in the pop-up dialog box for the home clock.

## Timer

### To set a timer:

1. Tap the digital clock widget on the home screen.

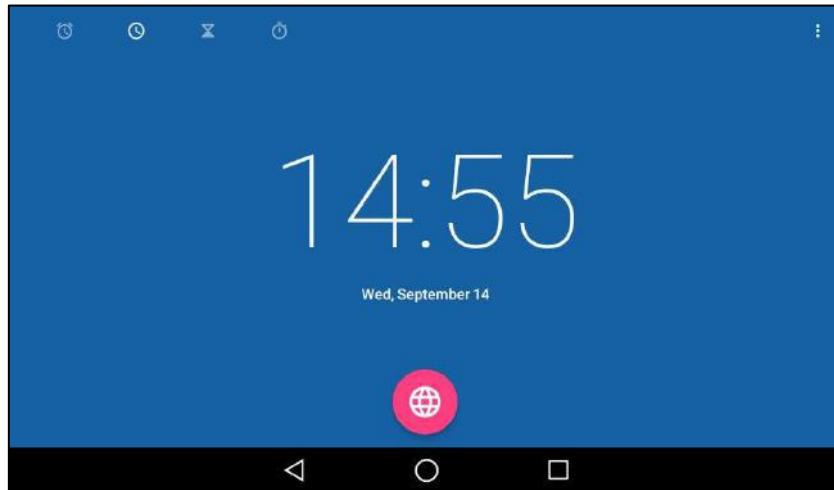

2. Tap .

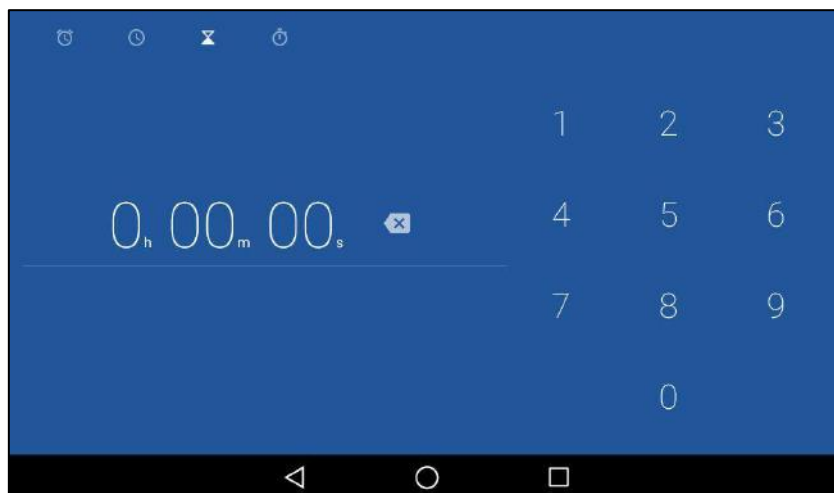



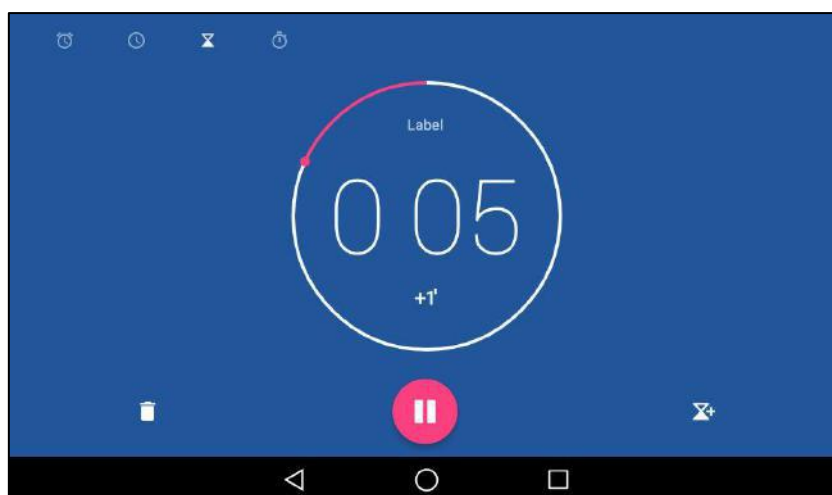

3. Enter the time by tapping the digits on the right of the screen.  
You can tap  to delete the entered numbers.

4. Tap  .



When the timer is running, you can do the following:

- Tap  to add an additional minute.
- Tap  to pause the timer, then you can do the following:
  - Tap  to resume the timer.
  - Tap  to restart the timer.
- Tap  to delete the current timer.

The timer beeps when the time is up. It keeps beeping until you tap to stop.

## Stopwatch

### To set a stopwatch:

1. Tap the digital clock widget on the home screen.

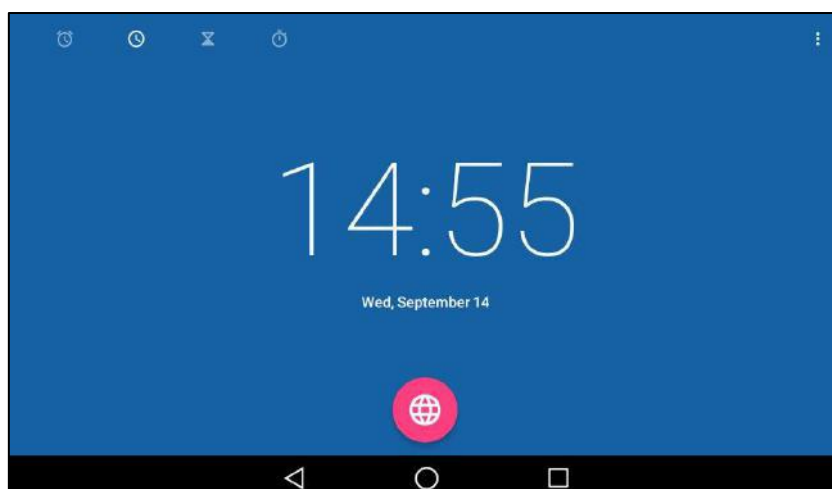



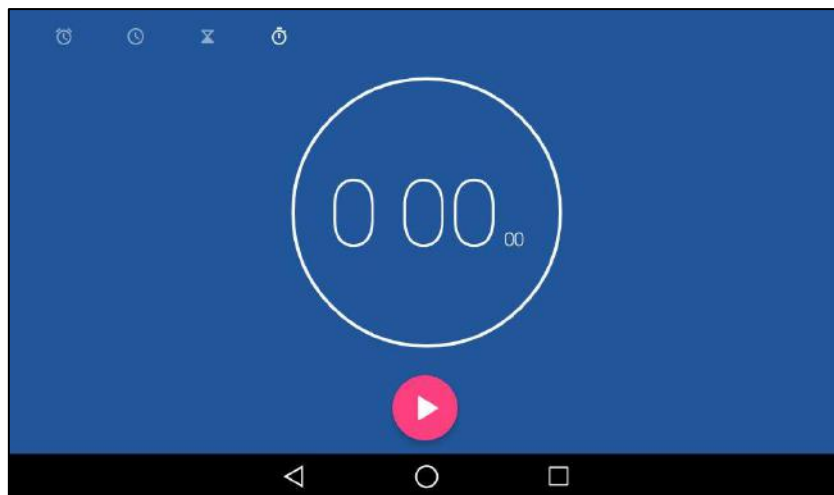

2. Tap .



3. Tap  to start the stopwatch.

4. You can do the following:

- Tap  to pause the stopwatch.
  - Tap  to reset the stopwatch.
  - Tap  and then tap **Bluetooth** or **Email** to share the record via Bluetooth or email. For more information, refer to [Sending Files via Bluetooth](#) on page 149 and [Sending Files via Email](#) on page 239.
- Tap  to add laps while the stopwatch is running.

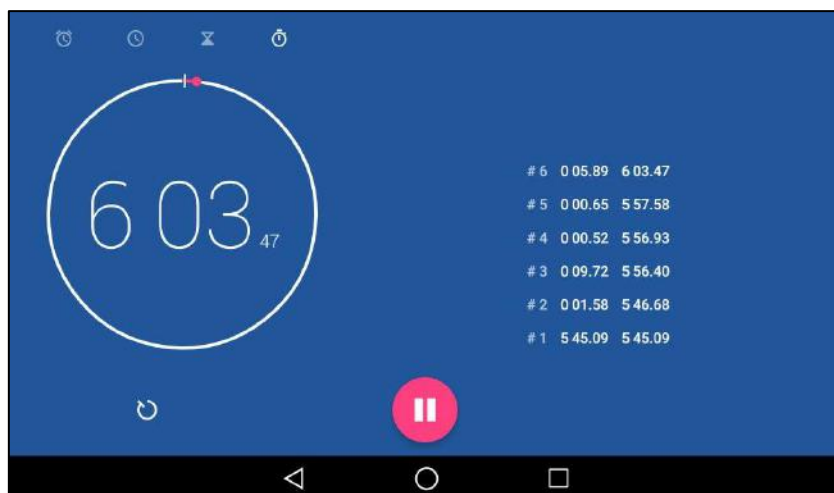



## Basic Phone Features

---

The SIP-T58V/A smart media phone is designed to be easily used like a regular phone on a public switched telephone network (PSTN). You can place calls, answer calls, transfer a call to someone else, or conduct a conference call.

This chapter provides basic operating instructions for the SIP-T58V/A smart media phone.

Topics include:

- [Placing Calls](#)
- [Answering Calls](#)
- [Audio-only/Video Selection](#)
- [Ending Calls](#)
- [Performing Operations during a Call](#)
- [Changing Video Call Settings](#)
- [Redialing Numbers](#)
- [Recent Call In Dialing](#)
- [Auto Answer](#)
- [Auto Redial](#)
- [Call Completion](#)
- [Recall](#)
- [Call Mute/Un-mute](#)
- [Call Hold/Resume](#)
- [Do Not Disturb \(DND\)](#)
- [Call Forward](#)
- [Call Transfer](#)
- [Call Waiting](#)
- [Conference](#)
- [Call Park/Retrieve](#)
- [Call Pickup](#)
- [Anonymous Call](#)
- [Anonymous Call Rejection](#)

## Placing Calls

You can place a call in one of three ways using your SIP-T58V/A smart media phone:

- Using the handset
- Using the speakerphone
- Using the headset

You can also dial the number first, and then choose the way you want to speak to the other party.

You can also dial an entry/contact from call history, local directory or remote phone book. For more information, refer to [Contact Management](#) on page 102 and [Call History Management](#) on page 126.

By default, you can set up a video call with the other party that is video-enabled. The IP phone can set up video calls with only two parties (even if more than two parties that set up a call with you can send video). If you do not connect the camera to the phone, the IP phone will not transmit the near-site video. For more information on how to connect the camera, refer to [Insert the camera](#) on page 32.

During a call, you can alternate between Speakerphone, Headset, and Handset modes by pressing the Speakerphone key, the HEADSET key, or by picking up the handset.

The call duration of the call and far-site's information (name or phone number) are visible on the touch screen. In the figure below, the video call to "Sandy" has lasted 3 seconds.



### Note

The phone will enter the video call full-screen within 5 seconds during a call, you may tap  or blank area of the touch screen to see the soft keys.



In the figure below, the audio-only call to “Jerry” (the phone number: 1039) has lasted 7 seconds.

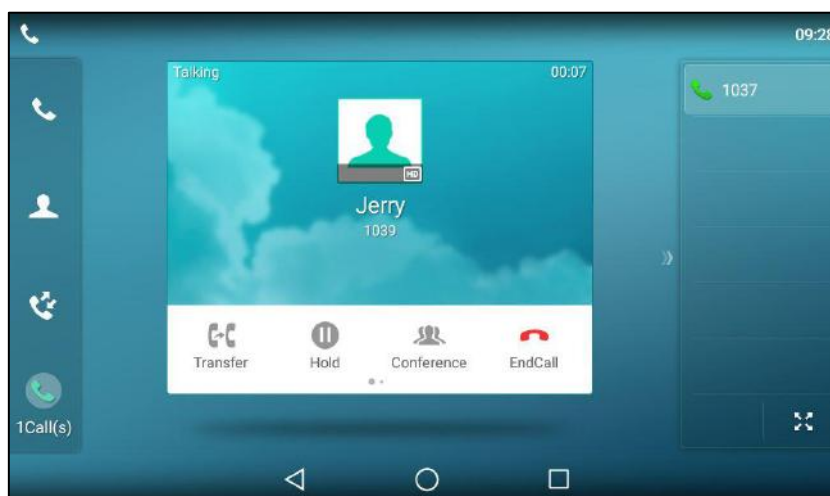

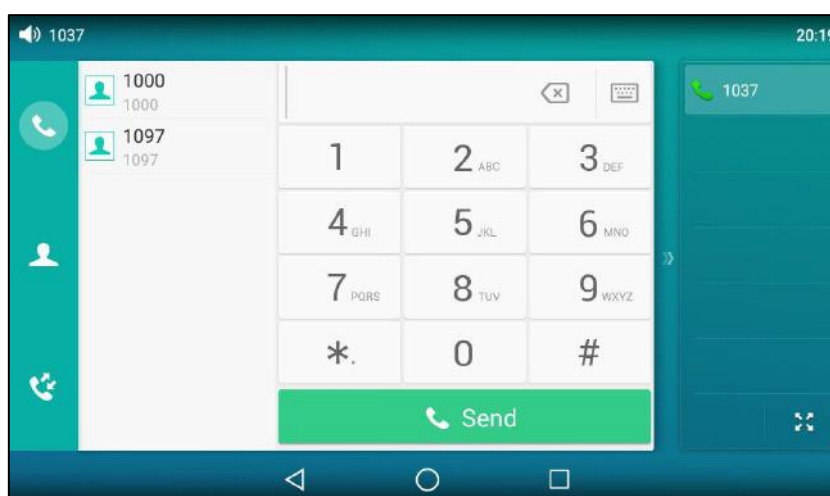

#### To place a call using the handset:

1. Pick up the handset.
2. Enter the desired number using the keypad or the dial pad on the touch screen.  
Tap  to see the onscreen keyboard, and then you can enter the number using the onscreen keyboard.



3. Press , or tap **Send**.

The # key is configured as a send key by default. You can also set the \* key as the send key, or set neither. For more information, refer to the [Key As Send](#) on page 90.

You can also tap  or  to search for an entry or contact after picking up the handset, and then tap the desired entry or contact to place a call.





#### Note

You can also dial using the SIP URI or IP address. To obtain the IP address of a phone, swipe down from the top of the screen or swipe left/right to go to the second idle screen and then tap **Settings**->**Status**. The maximum SIP URI or IPv4 address length is 32 characters. For example, SIP URI: 3606@sip.com, IP: 192.168.1.15.

Your phone may not support direct IP dialing. Contact your system administrator for more information.





**To place a call using the hands-free (speakerphone) mode:**

Do one of the following:

- With the handset on-hook, press  or tap the line key to obtain a dial tone.  
Enter the desired number using the keypad or the dial pad on the touch screen.  
Press  or tap **Send**.
- With the handset on-hook, enter the desired number using the keypad or the dial pad on the touch screen.  
Press ,  or tap **Send**.

**To place a call using the headset:**

Do one of the following:

- With the optional headset connected, press  to activate the headset mode.  
Tap the line key to obtain a dial tone.  
Enter the desired number using the keypad or the dial pad on the touch screen.  
Press  or tap **Send**.
- With the optional headset connected, press  to activate the headset mode.  
Enter the desired number using the keypad or the dial pad on the touch screen.  
Press  or tap **Send**.



**Note**

To permanently use the headset mode, refer to [Headset Prior](#) on page 134.

The SIP-T58V/A smart media phone can handle multiple calls at a time. However, only one active call (the call that has audio associated with it) can be in progress at any time. The SIP-T58V/A smart media phone can handle a maximum of 50 calls at one time.

**To place multiple calls:**

You can have more than one call on your SIP-T58V/A smart media phone. To place a new call during an active call, do one of the following:

- Tap the line key. The active call is placed on hold.  
Enter the desired number using the keypad or the dial pad on the touch screen.  
Press  or tap **Send**.
- Press  or tap the **Hold** soft key to place the original call on hold.  
Tap the **NewCall** soft key.  
Enter the desired number using the keypad or the dial pad on the touch screen.  
Press  or tap **Send**.

You can tap the desired call, and then tap the **Resume** soft key to retrieve it.

**Note**

If multiple accounts are registered on the phone, you can first tap the desired line key on the idle screen or tap the desired line from the status bar in dialing screen, and then you can use the selected account to place a call.

## Answering Calls

When you are not in another call, you can answer a call in one of three ways:

- Using the handset
- Using the speakerphone
- Using the headset

**Note**

You can reject incoming calls by tapping the **Reject** soft key to stop the phone from playing ring tone. You can also activate the Do Not Disturb mode to reject the incoming calls without ringing on your phone. For more information, refer to [Do Not Disturb \(DND\)](#) on page 287.

You can forward incoming calls to someone else by tapping the **FWD** soft key. For more information, refer to [Call Forward](#) on page 292.

## Answering When Not in Another Call

Call duration and destination will always appear on the touch screen for the active call.

### To answer a call using the handset:

1. Pick up the handset.

### To answer a call using the hands-free (speakerphone) mode:

Do one of the following:

- Press .
- With the handset on-hook and the headset mode deactivated, tap the **Answer** soft key.
- With the handset on-hook and the headset mode deactivated, tap the line key.

### To answer a call using the headset:

Do one of the following:

- Press .
- With the headset mode activated, tap the **Answer** soft key.
- With the headset mode activated, tap the line key.

## Answering When in Another Call

If you have an active call, and an incoming call arrives on the phone. The incoming call information is displayed on the touch screen.

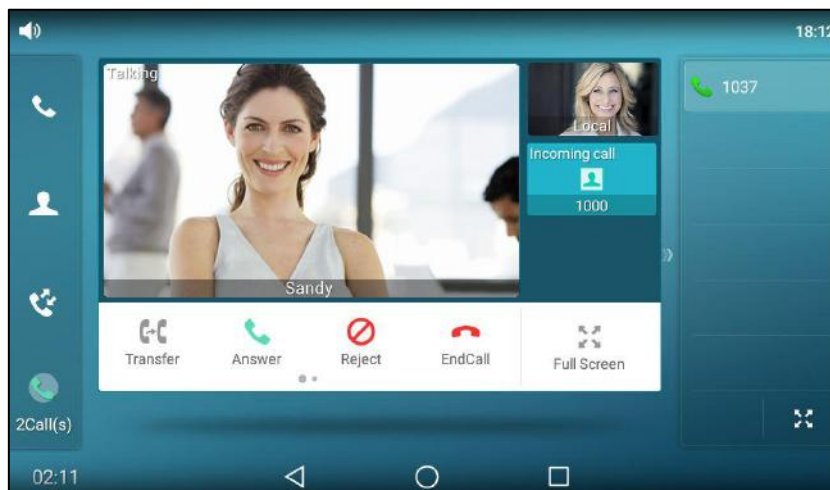

Do one of the following:

- Tap the **Answer** soft key.
- Tap the incoming call avatar.

Tap **Answer**.

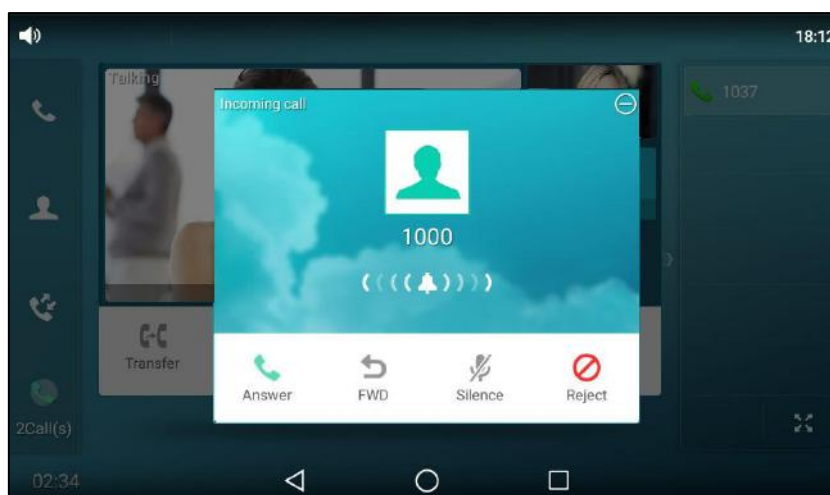

The incoming call is answered and the original call is placed on hold.

## Audio-only/Video Selection

You can choose to establish an audio-only call or video call while dialing or ringing. This feature should be pre-configured by your system administrator.

## Choosing to Place an Audio-only/Video Call

### To place an audio-only/video call:

1. Do one of following:
  - Enter the desired number using the keypad or the dial pad on the touch screen when the phone is idle.
  - Tap the line key when the phone is idle to enter the dialing screen.  
Enter the desired number using the keypad or the dial pad on the touch screen.

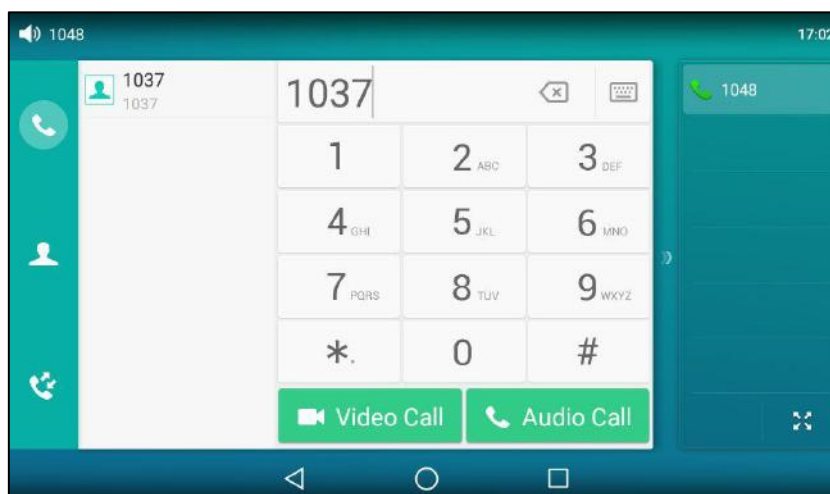

2. Tap **Video Call/Audio Call** to place a video call or audio-only call.

## Choosing to Answer the Video Call with Audio-only/Video

When an incoming video call arrives, you can choose to answer the call with audio-only/video.

### To answer the video call with audio-only/video:

When an incoming video call arrives, the touch screen will display as below:

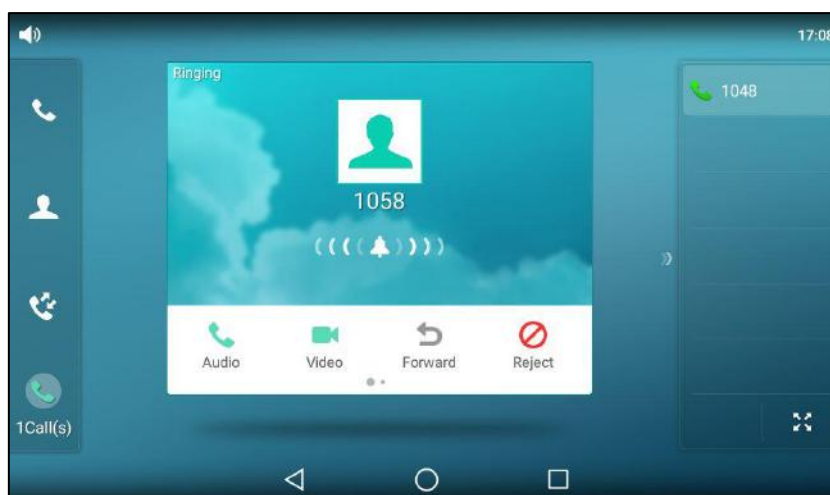

1. Tap the **Audio/Video** soft key to establish an audio-only call or video call.

## Ending Calls

### To end a call:

Do one of the following:

- If you are using the handset, tap the **EndCall** soft key or hang up the handset.
- If you are using the headset, tap the **EndCall** soft key.
- If you are using the speakerphone, press  or tap the **EndCall** soft key.

### Note

To end a call placed on hold, you can tap the **EndCall** soft key to end the call directly, or tap the **Resume** soft key to resume the call before ending it.

## Performing Operations during a Call

During the call, you may want to see if there is an event on schedule or check if there is a new email in the inbox and so on, you can exit the talking screen to access the corresponding application. And after the operation, you can return to the call conveniently.

The following operations are not allowed during the call:

- Record by **Recorder** application.
- Take pictures.
- Record videos.
- Playback audios/videos.
- Launch **Camera** application.

## Going to the Idle Screen during a Call

To go to the idle screen during a call:

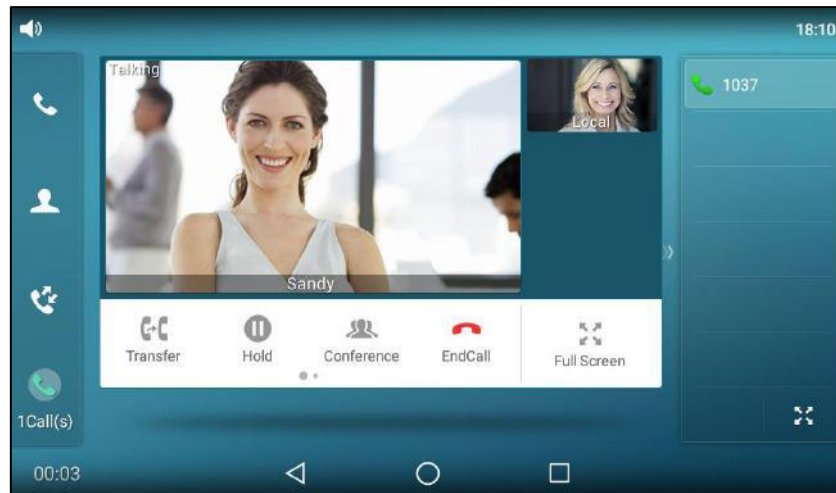

1. Tap , , or  to go to the idle screen.

When the phone exits the talking screen, the touch screen will display as below:



By default, a floating video window (far site) will display on the bottom-right of the touch screen. If you are in a conference video call, the floating video window will display all participants video image. If you hold the video call or you are in an audio-only call, the floating video window will not display. You can drag the floating video window to the desired location.

## Returning to the Talking Screen

To return to the talking screen:



- Tap  .
- Tap the floating video window.
- Tap **Back To Talking** on the top of the touch screen.

## Changing Video Call Settings

When you update video settings, you can change the way for the current video call to display on your IP phone.

You can update the following video settings on your phone:

- Stop Transmitting Video during a Call
- Change the Video Layout during Calls
- Preview the Near-Site Video

## Stopping Transmitting Video during a Call

You can unplug the camera or swipe down from the top of the screen in the video call screen and then tap **Video** to stop your phone from automatically transmitting your video during a video call. However, you cannot turn off far-site video.



If you stop transmitting video, the icon  will display on the near-site video, as shown below:



Your camera will not transmit video to your contact and the far site cannot see you.

Stopping transmitting video does not create an audio-only call. Even if you stop transmitting video, you can see the other party, and the call is still a video call. To place an audio-only call, contact your system administrator.

## Changing the Video Layout during Calls

During video calls, near-site and far-site video images are displayed on the touch screen. You can change the video layout.

The system supports three video layouts:

- One large, other small: One video image displays in a large size, the other video images along the right side of the screen displays in small sizes.
- Full screen: One video image displays in full size, the other video images are hidden.
- Same size: All video images display in the same size.

**To swap video during a video call via phone user interface:**

1. Tap the near-site (small window) video during a video call.



The near-site video will display in the center of the touch screen, and the far-site video will display on the top-right of the touch screen.

The following figure shows what the touch screen looks like after you tap the near-site video:



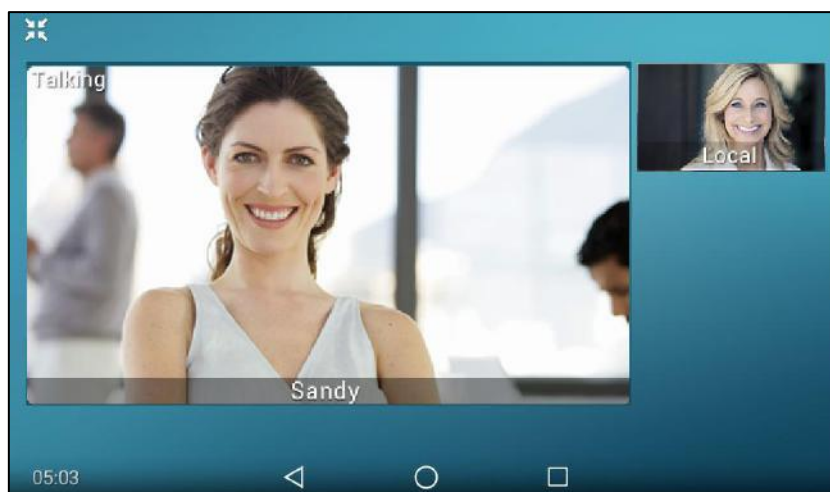

**To change the video layout to the same size mode during a video call via phone user interface:**

1. From the video call full-screen, pinch close the large window.

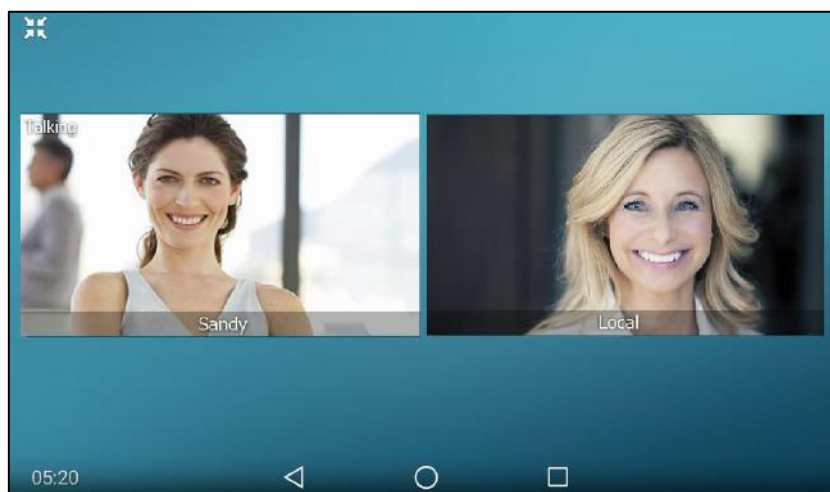

The following figure shows what the touch screen looks like in the same size mode:





You can tap /  or the blank area of the touch screen to go back to video call screen (refer to [Video Call Screen Display](#)) or tap the desired image to go back to “one big, other small” layout.

**To change the video layout to the full screen mode during a video call via phone user interface:**

1. From the video call full-screen, do one of the following:
  - Tap the large window.
  - Pinch open the large window.

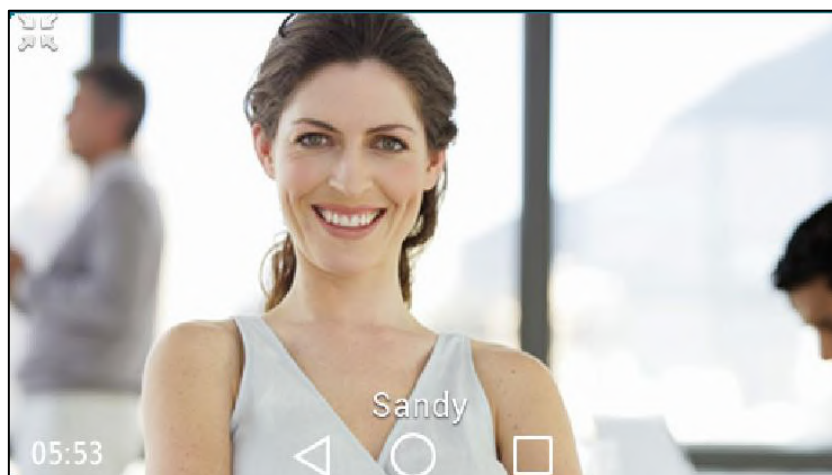
The small window is hidden, and the following figure shows what the touch screen looks like in full screen mode:





You can tap  or  to go back to video call screen (refer to [Video Call Screen Display](#)) or tap the video area to go back to "one big, other small" layout.

**To change the video layout during a video conference call via phone user interface:**

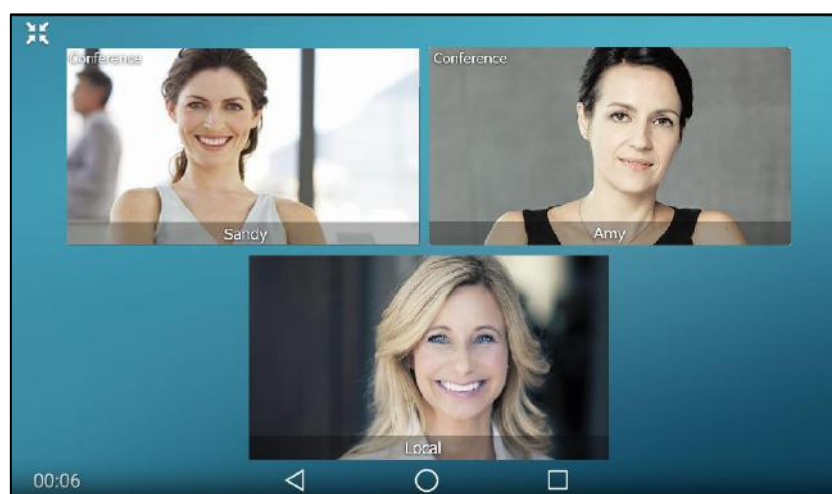
The default screen layout during a video conference call is the same size mode. The following figure shows what the touch screen looks like during a three-way video conference call:



You can tap /  or the blank area of the touch screen to go back to video call screen (refer to [Video Call Screen Display](#)) or tap one of the conference party to go back to the "one big, other small" layout.

The following figure shows what the touch screen looks like in the “one big, other small” layout during a three-way video conference call:

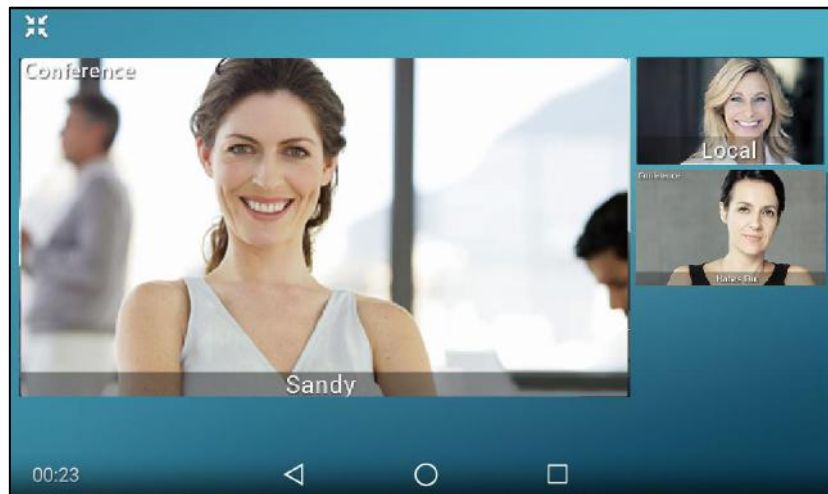

## Previewing the Near-Site Video

If you have connected the camera to the phone, you can preview the video of yourself that you display during video calls. For more information on how to connect the camera, refer to [Insert the camera](#) on page 32. During previewing, you can also configure camera settings. For more information, refer to [Camera Settings](#) on page 230.

**To preview the near-site video when the phone is idle, do one of the following:**

- Swipe down from the top of the screen to enter the control center and tap **Video**.
- Swipe left or right to go to the second idle screen and tap  to launch **Camera** application.

## Redialing Numbers

**To redial the last dialed number from your phone:**

1. Press  twice.  
A call to your last dialed number is attempted.

**To redial a previously dialed number from your phone:**

1. Press  when the phone is idle.
2. Tap the desired entry from the placed calls list.

## Recent Call In Dialing

To view the placed calls list when the phone is on the dialing interface, you should enable recent call in dialing in advance.

**To enable recent call in dialing via web user interface:**

1. Click on **Directory**->**Setting**.
2. Select **Enabled** from the pull-down list of **Recent Call In Dialing**.

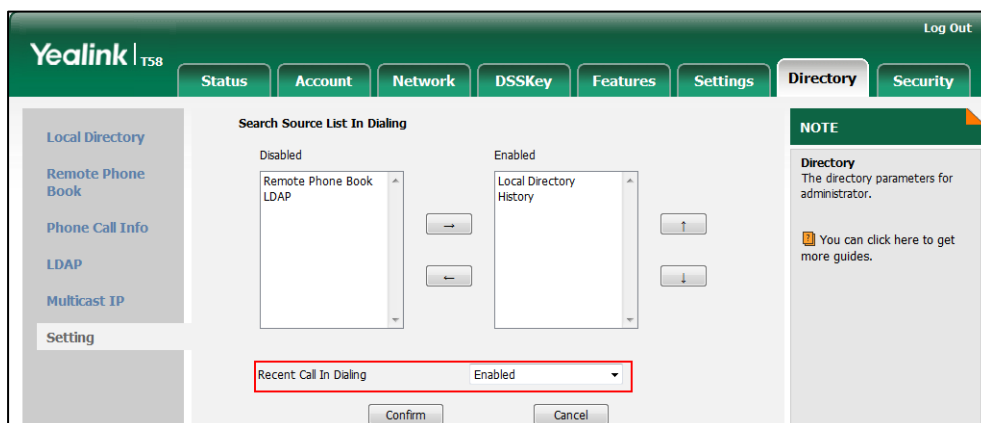

3. Click **Confirm** to accept the change.

**Note** Recent call in dialing is configurable via web user interface only.

**To view placed calls list when the phone is on the dialing interface:**

1. Pick up the handset, press the Speakerphone key or tap the line key.  
The touch screen displays the placed calls list.

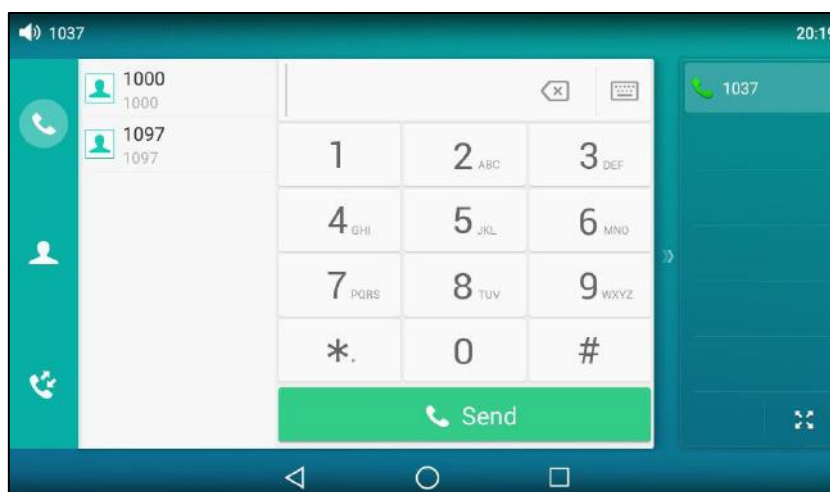

2. Drag up and down to scroll through placed calls.

You can also enter a few continuous characters of the contact name or continuous numbers of the contact number (office, mobile or other number) to search from placed calls list.

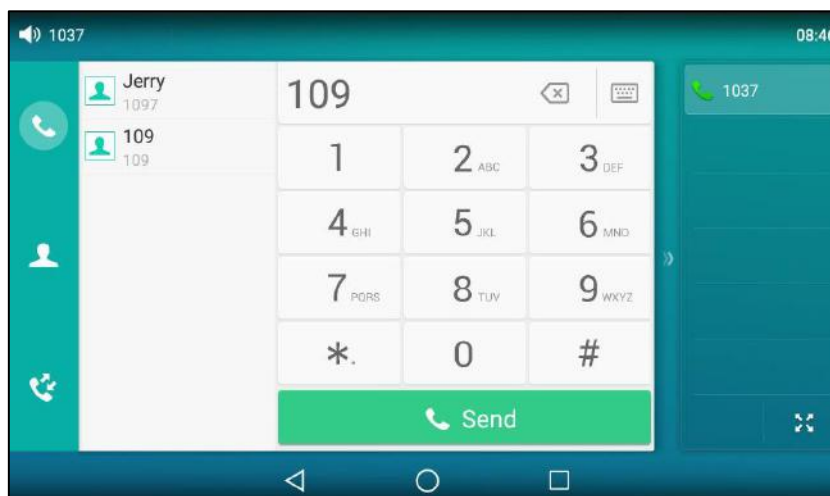

## Auto Answer

You can use auto answer to automatically answer an incoming call on a line. Auto answer is configurable on a per-line basis.

### To configure auto answer via phone user interface:

1. Swipe down from the top of the screen or swipe left/right to go to the second idle screen.
2. Tap **Settings->Features->Auto Answer**.
3. Tap the **On** radio box in the desired line.

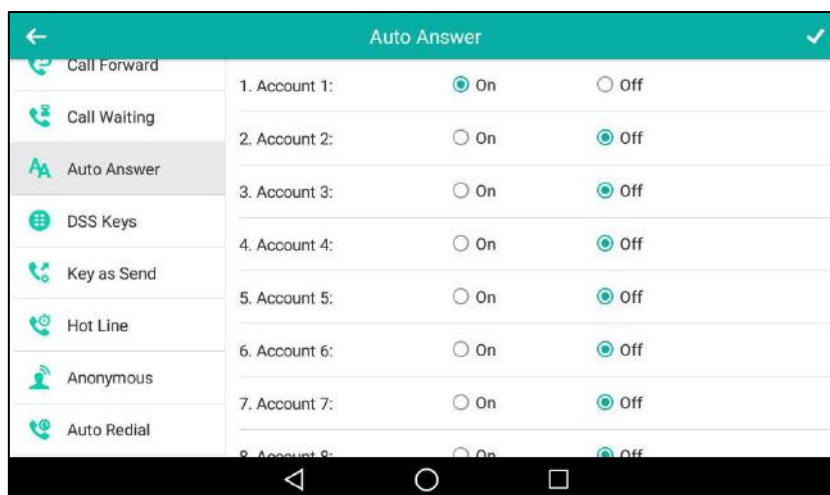

4. Tap  to accept the change or  to cancel.

The icon  will display on the status bar.



You can also swipe down from the top of the screen to enter the control center, tap **Auto Answer** to enter Auto Answer setting screen, and then enable auto answer feature for the desired line.

Auto answer is configurable via web user interface at the path **Account->Basic**.

**Note**

Auto answer is only applicable when there is no other call in progress on the phone.

## Auto Redial

You can enable auto redial to automatically redial a phone number when the called party is busy. You can also configure the number of auto redial attempts and the time to wait between redial attempts.



**To configure auto redial via phone user interface:**

1. Swipe down from the top of the screen or swipe left/right to go to the second idle screen.
2. Tap **Settings->Features->Auto Redial**.
3. Tap the **On** radio box in the **Auto Redial** field.
4. Enter the desired time (in seconds) in the **Redial Interval** field.  
The default value is "10".
5. Enter the desired number of redial attempts in the **Redial Times** field.

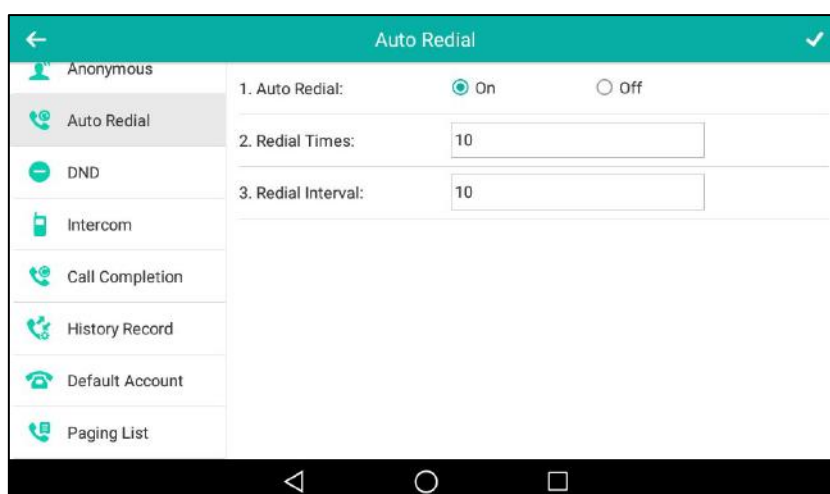

The default value is "10".



6. Tap  to accept the change or  to cancel.

Auto redial is configurable via web user interface at the path **Features->General Information**.

#### To use auto redial:

When the called party is busy, the touch screen prompts the following:

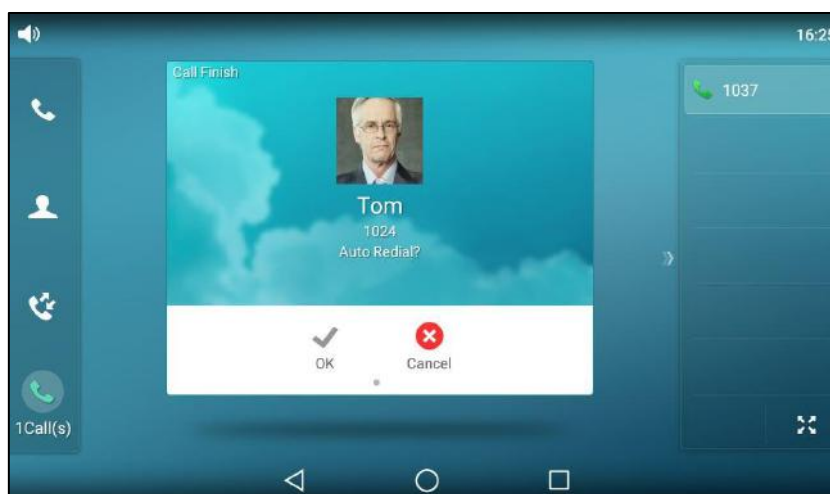

1. Tap **OK** to activate auto redial.

The touch screen prompts the following:

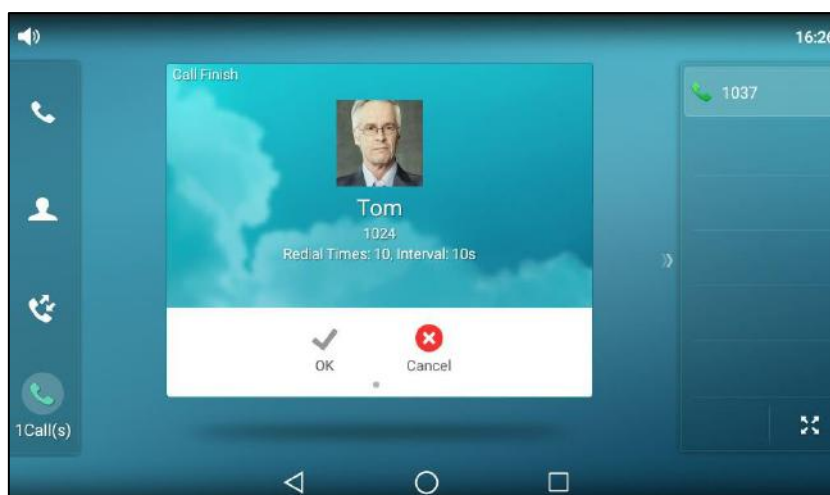

2. Wait for the designated period of time or tap **OK** to redial the phone number. The phone will retry as many times as configured until the called party is idle.



## Call Completion

You can use call completion to notify the caller who failed to reach a desired party when the party becomes available to receive a call.

**To enable call completion via phone user interface:**

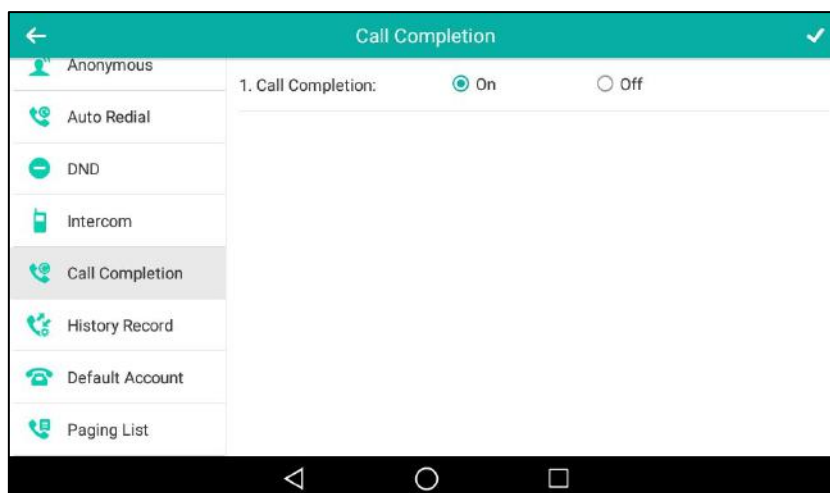
1. Swipe down from the top of the screen or swipe left/right to go to the second idle screen.
2. Tap **Settings->Features->Call Completion**.
3. Tap the **On** radio box in the **Call Completion** field.



4. Tap  to accept the change or  to cancel.

Call completion is configurable via web user interface at the path **Features->General Information**.

**To use call completion:**

When the called party is busy, the following prompt will appear on the touch screen of the phone:

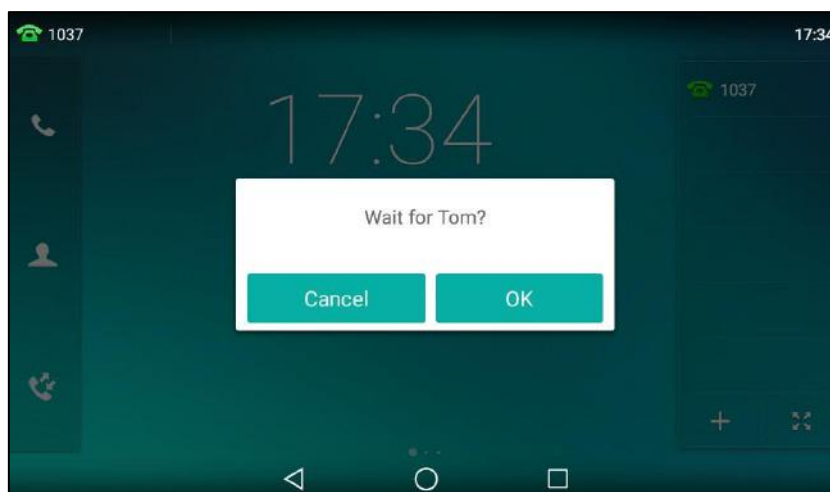

1. Tap **OK**, the phone will then return to the idle screen and call completion will be activated.

When the called party becomes idle, the touch screen prompts the following:

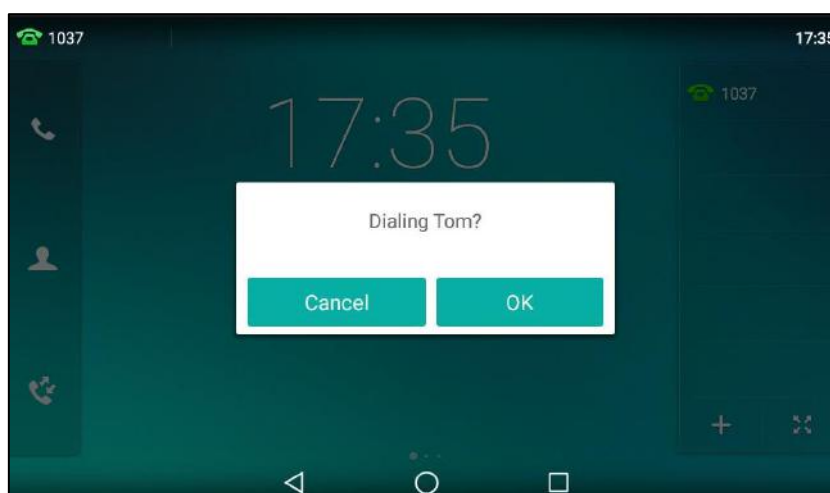

1. Tap **OK** to redial the number.

**Note**

Call completion is not available on all servers. For more information, contact your system administrator.

## Recall

You can tap a recall key to place a call back to the last incoming call.

**To configure a recall key via phone user interface:**

1. Swipe down from the top of the screen or swipe left/right to go to the second idle screen.

2. Tap **Settings->Features->DSS Keys**.
3. Tap the desired line key.
4. Tap the **Type** field.
5. Tap **Key Event** in the pop-up dialog box.
6. Tap the **Key Type** field.
7. Tap **ReCall** in the pop-up dialog box.
8. (Optional.) Enter the string that will appear on the touch screen in the **Label** field.

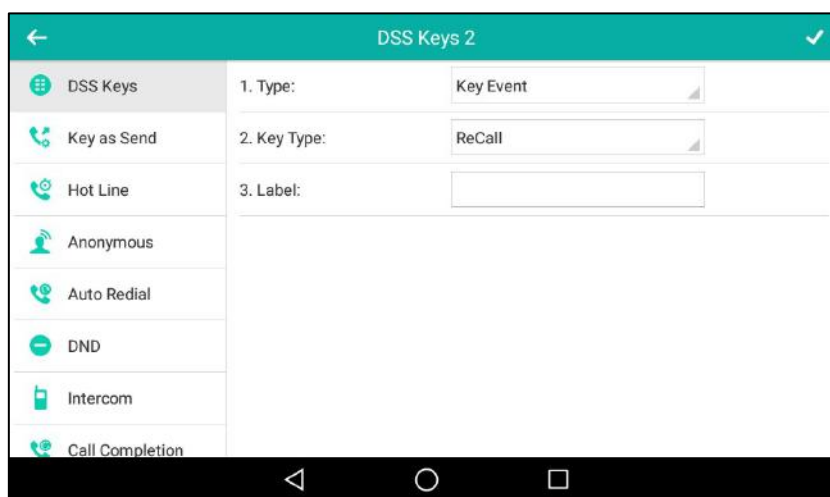

9. Tap ✓ to accept the change or ✗ to cancel.

You can also tap  on the idle screen to configure a recall key. For more information, refer to [DSS Keys](#) on page 151.

Recall key is configurable via web user interface at the path **DSSKey->Line key**.

## Call Mute/Un-mute

You can mute the microphone of the active audio device during an active call so that the other party cannot hear you. Call mute applies to all modes (Handset, Headset and Speakerphone).

## Keep Mute

Normally, the mute feature is deactivated when the active call ends. Keep mute feature enables you to make the mute state of your phone persist across calls. This feature should be pre-configured by your system administrator. When keep mute is enabled and you press the MUTE key, the phone stays in the mute state until you un-mute the microphone or until the phone restarts. It helps prevent the other party from hearing the noise coming from your room when auto answer is enabled on your phone. When you mute the phone in an idle state or any other states, the mute key LED illuminates solid red and the icon  appears on the status bar.



### To mute a call:

1. Press  during an active call.

The mute key LED illuminates solid red.

The following shows an audio-only call has been muted:



The following shows a video call has been muted:

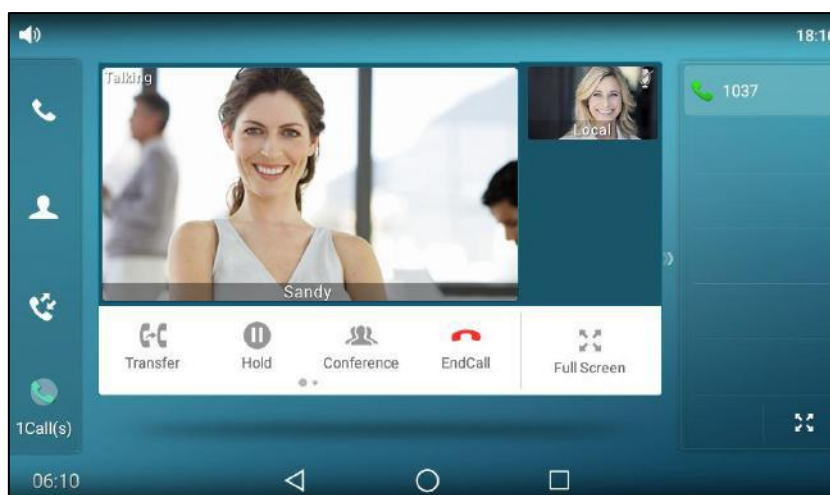

**To un-mute a call:**

1. Press  again to un-mute the call.  
The mute key LED goes out.

## Call Hold/Resume

You can place an active call on hold. Only one active call can be in progress on the phone at any time. Other calls can be made and received while placing the original call on hold. When you place a call on hold, your IP PBX may play music to the other party while waiting.

**To place a call on hold:**

1. Press  or tap the **Hold** soft key during a call.

The following shows an audio-only call has been held:

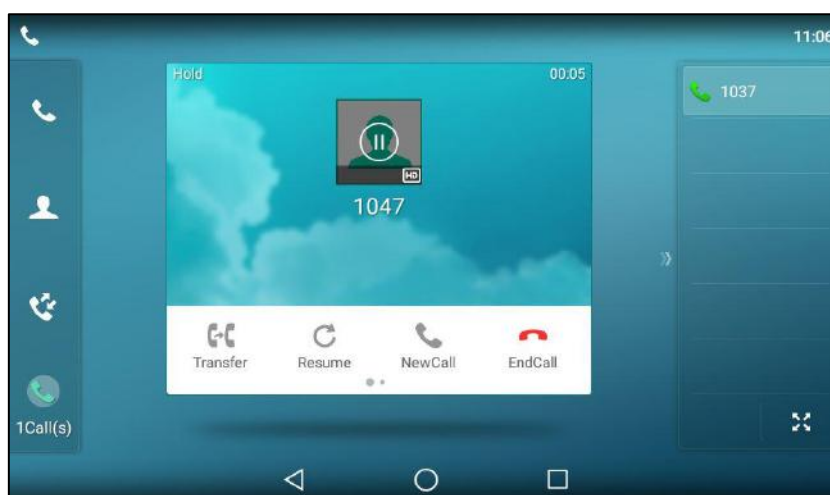

The following shows a video call has been held:

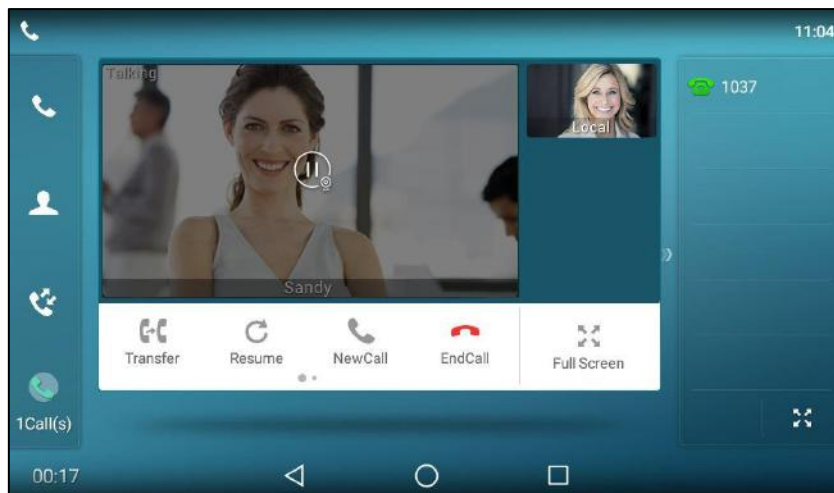

The phone will beep softly every 30 seconds to remind you that you still have a call on hold.

#### To resume a held call:

1. Press  or tap the **Resume** soft key.

#### Multiple Calls on Hold:

If multiple calls are placed on hold, do one of the following:

- Tap the desired call, and then tap the **Resume** soft key to retrieve it.
- Tap the desired call, and then tap the corresponding line key to retrieve it.

## Do Not Disturb (DND)

You can use DND to reject incoming calls automatically on the phone. The prompt message "**n New Missed Call(s)**" ("n" indicates the number of missed calls) will appear on the touch screen, and callers will receive a busy message. All calls you receive while DND is enabled are logged to your missed calls list.

#### Note

The prompt message will display only if Missed Call Log for the line is enabled. Missed call log is configurable via web user interface at the path **Account->Basic->Missed Call Log**.

Do not disturb is local to the phone, and may be overridden by the server settings. For more information, contact your system administrator.

You can enable/disable DND for the phone system, or you can customize DND for each or all accounts. Two DND modes:

- **Phone** (default): DND is effective for the phone system.
- **Custom**: DND can be configured for each or all accounts.

You can receive incoming calls from authorized numbers when DND is enabled.

**To configure the DND mode via web user interface:**

1. Click on **Features->Forward & DND**.
2. In the **DND** block, mark the desired radio box in the **Mode** field.

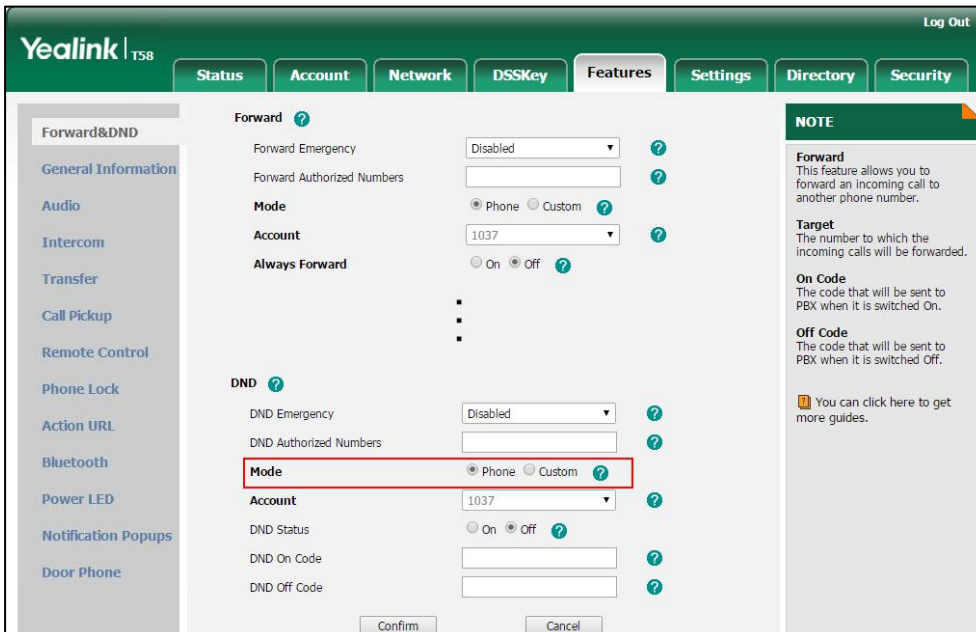

The screenshot shows the Yealink T58 web user interface. The 'Features' tab is selected, and the 'Forward & DND' section is active. The 'DND' configuration block is visible, with the 'Mode' field highlighted by a red box. The 'Mode' field has two radio buttons: 'Phone' (selected) and 'Custom'. Other fields include 'Forward Emergency' (Disabled), 'Forward Authorized Numbers', 'Account' (1037), 'Always Forward' (On), 'DND Emergency' (Disabled), 'DND Authorized Numbers', 'DND Status' (On), 'DND On Code', and 'DND Off Code'. A 'NOTE' panel on the right provides details about the Forward, Target, On Code, and Off Code features.

3. Click **Confirm** to accept the change.

**Note** DND mode is configurable via web user interface only.

**To enable DND in phone mode:**

1. Swipe down from the top of the screen to enter the control center and toggle **DND** on.  
The icon  on the status bar indicates that DND is enabled.



Incoming calls will be rejected automatically and "**n New Missed Call(s)**" ("n" indicates the number of missed calls. e.g., 1 New Missed Call(s)) will appear on the touch screen.

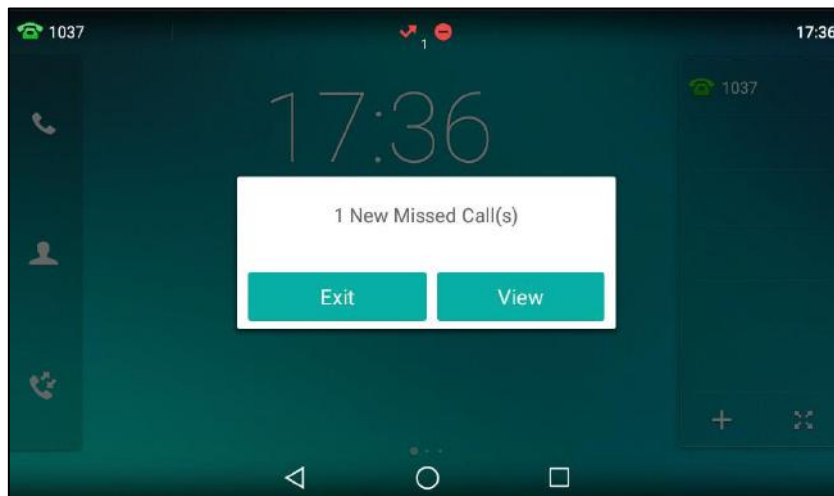

**Note**

When DND and busy forward are enabled in phone mode, all incoming calls will be forwarded to the configured destination number. For more information on busy forward, refer to [Call Forward](#) on page 292.

**To enable DND in custom mode for a specific account:**

1. Swipe down from the top of the screen to enter the control center and then tap **DND**.  
The touch screen displays a list of accounts registered on the phone.

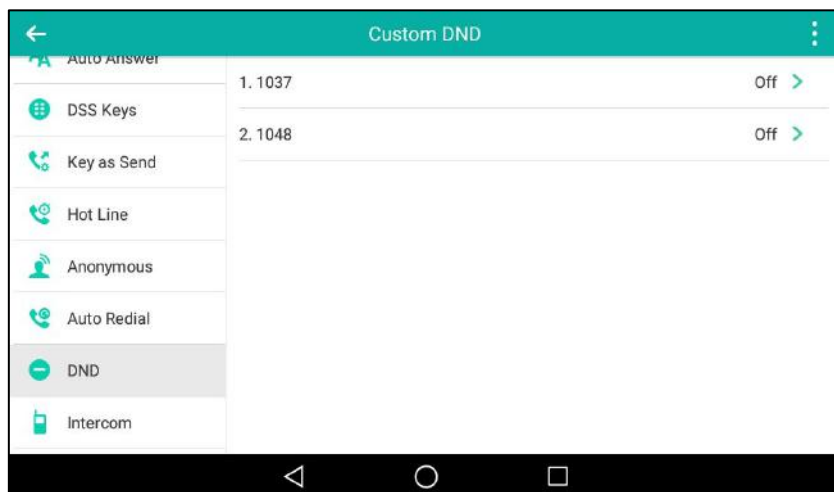



2. Tap the desired account.
3. Tap the **On** radio box in the **DND Status** field.

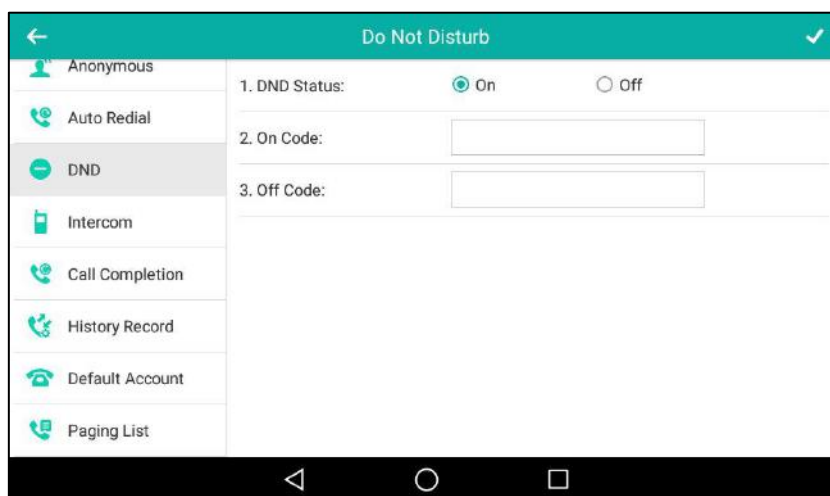

- (Optional.) Enter the DND on code or off code respectively in the **On Code** or **Off Code** field.





- Tap  to accept the change.

If you enable DND for the default account, the associated line icon will change to , and the icon  will appear on the status bar.



If you enable DND for the non-default account, only the associated line icon will change to , the icon  will not appear on the status bar.



If you enable DND for all accounts, all line icons will change to  and the icon  will appear on the status bar.



**Note**

When DND and busy forward are enabled for a specific account, incoming calls on the specific account will be forwarded to the configured destination number. For more information on busy forward, refer to [Call Forward](#) on page 292.

**To configure the DND authorized numbers via web user interface:**

1. Click on **Features->Forward & DND**.
2. Select **Enabled** from the pull-down list of **DND Emergency**.
3. Enter the numbers in the **DND Authorized Numbers** field.

For multiple numbers, enter a comma between every two numbers.

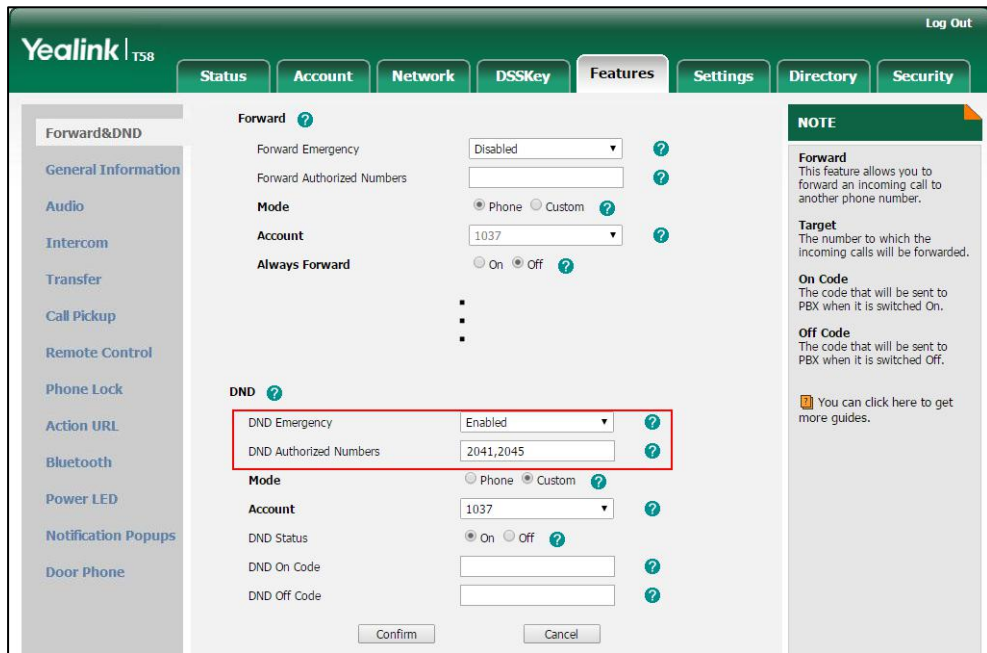

4. Click **Confirm** to accept the change.

When DND is enabled on the phone, the phone can still receive incoming calls from the numbers specified in the **DND Authorized Numbers** field.

**Note**

DND authorized number is configurable via web user interface only.  
 When the phone misses a call, a prompt window will pop up by default. If you want to disable the feature, contact your system administrator for more information.

**To disable DND in phone mode:**

1. Swipe down from the top of the screen to enter the control center and then tap **DND**.

**To disable DND in custom mode:**

1. Swipe down from the top of the screen to enter the control center and then tap **DND**.
2. Tap the desired account.
3. Tap the **Off** radio box of the **DND Status** field.
4. Tap  to accept the change.

## Call Forward

You can configure your phone to forward incoming calls to another party (static forwarding) or forward calls while your phone is ringing (dynamic forwarding).

You can forward an incoming call to an international telephone number. This feature is enabled by default. Incoming calls from some authorized numbers not to be forwarded when the call forward feature is enabled. The incoming call will not be logged in the Forwarded Calls list. This

feature is disabled by default.

### Note

Call forward is local to the phone, and may be overridden by the server settings. For more information, contact your system administrator.

If DND feature is enabled, the incoming calls will not be forwarded even if you configure no answer forward feature.

When the phone forwards a call, a prompt window will pop up by default. If you want to disable the feature, contact your system administrator for more information.

## Static Forwarding

Three types of static forwarding:

- **Always Forward:** Incoming calls are immediately forwarded.
- **Busy Forward:** Incoming calls are immediately forwarded if the phone is busy.
- **No Answer Forward:** Incoming calls are forwarded if not answered after a period of time.

You can enable/disable call forward for the phone system, or you can customize call forward for each or all accounts. Two call forward modes:

- **Phone (default):** Call forward is effective for the phone system.
- **Custom:** Call forward can be configured for each or all accounts.

**To configure the call forward mode via web user interface:**

1. Click on **Features->Forward & DND**.
2. In the **Forward** block, mark the desired radio box in the **Mode** field.

The screenshot shows the Yealink T58 web interface for configuring call forwarding. The 'Features' tab is active, and the 'Forward & DND' section is expanded. The 'Forward' block is visible, with the 'Mode' field highlighted by a red box. The 'Mode' field has two radio buttons: 'Phone' (selected) and 'Custom'. Below this, there are sections for 'Always Forward', 'Busy Forward', and 'No Answer Forward', each with 'On' and 'Off' radio buttons and a 'Target' input field. A 'NOTE' box on the right provides additional information about the Forward feature and codes.

3. Click **Confirm** to accept the change.

### Note

Call forward mode is configurable via web user interface only.

**To enable call forward in phone mode:**

1. Swipe down from the top of the screen or swipe left/right to go to the second idle screen.
2. Tap **Settings->Features->Call Forward**.
3. Tap the desired forwarding type.
4. Depending on your selection:
  - a) If you tap **Always Forward**:
    - 1) Tap the **On** radio box in the **Always Forward** field.
    - 2) Enter the destination number you want to forward all incoming calls to in the **Forward To** field.
    - 3) (Optional.) Enter the always forward on code or off code respectively in the **On Code** or **Off Code** field.

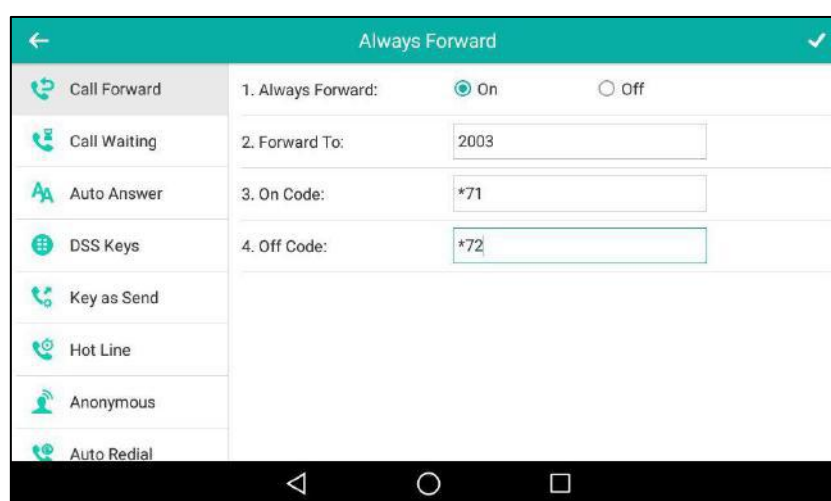

- b) If you tap **Busy Forward**:
  - 1) Tap the **On** radio box in the **Busy Forward** field.
  - 2) Enter the destination number you want to forward incoming calls to when the phone is busy in the **Forward To** field.

- 3) (Optional.) Enter the busy forward on code or off code respectively in the **On Code** or **Off Code** field.

Setting	Value
1. Busy Forward:	<input checked="" type="radio"/> On <input type="radio"/> Off
2. Forward To:	2003
3. On Code:	*73
4. Off Code:	*74

- c) If you tap **No Answer Forward**:

- 1) Tap the **On** radio box in the **No Answer Forward** field.
- 2) Enter the destination number you want to forward unanswered incoming calls to in the **Forward To** field.
- 3) Tap the **After Ring Time** field.
- 4) Tap the desired ring time to wait before forwarding from the pull-down list.  
The default ring time is 12 seconds.
- 5) (Optional.) Enter the no answer forward on code or off code respectively in the **On Code** or **Off Code** field.

Setting	Value
1. No Answer Forward:	<input checked="" type="radio"/> On <input type="radio"/> Off
2. Forward To:	2003
3. After Ring Time:	12s
4. On Code:	*75
5. Off Code:	*76

5. Tap to accept the change or to cancel.

The icon on the status bar indicates that the call forward is enabled.

You can also swipe down from the top of the screen to enter the control center, tap **Forward** to enter the desired Call Forward setting screen according to the current forward type. If you have not configured the call forward type, tapping **Forward** will turn to the Always Forward setting screen.

**To enable call forward in custom mode:**

1. Do one of the following:
  - Swipe down from the top of the screen or swipe left/right to go to the second idle screen.
  - Tap **Settings**->**Features**->**Call Forward**.
  - Press  when the phone is idle.
  - Swipe down from the top of the screen to enter the control center and then tap **Forward**.
2. Tap the desired account.

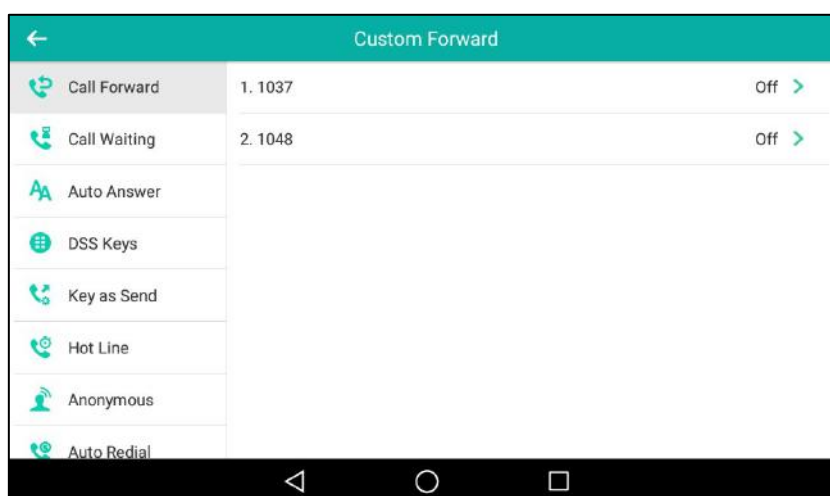

3. Tap the desired forwarding type.
4. Depending on your selection:
  - a) If you tap **Always Forward**:
    - 1) Tap the **On** radio box in the **Always Forward** field.
    - 2) Enter the destination number you want to forward all incoming calls to in the **Forward To** field.



- 3) (Optional.) Enter the always forward on code or off code respectively in the **On Code** or **Off Code** field.

The screenshot shows the 'Always Forward' settings screen. On the left is a list of call features: Call Forward, Call Waiting, Auto Answer, DSS Keys, Key as Send, Hot Line, Anonymous, and Auto Redial. The 'Call Forward' section is expanded to show four settings:
 

- 1. Always Forward:  On  Off
- 2. Forward To:
- 3. On Code:
- 4. Off Code:

You can also enable always forward for all accounts. Do the following:

- 1) Tap  and then tap **All Lines**.

This screenshot is similar to the previous one, but with a three-dot menu icon in the top right corner. A dropdown menu is open, showing two options: 'All Lines' (with a phone icon) and 'Save' (with a checkmark icon). The 'All Lines' option is currently selected.

The touch screen prompts "Copy to all lines?".

The screenshot shows the same 'Always Forward' settings screen, but a white dialog box is overlaid in the center. The dialog box contains the text 'Copy to all lines?' and two buttons: 'Cancel' and 'OK'.

- 2) Tap **OK** to accept the change or **Cancel** to cancel.
- b) If you select **Busy Forward**:**
- 1) Tap the **On** radio box in the **Busy Forward** field.
  - 2) Enter the destination number you want to forward incoming calls to when the phone is busy in the **Forward To** field.
  - 3) (Optional.) Enter the busy forward on code or off code respectively in the **On Code** or **Off Code** field.

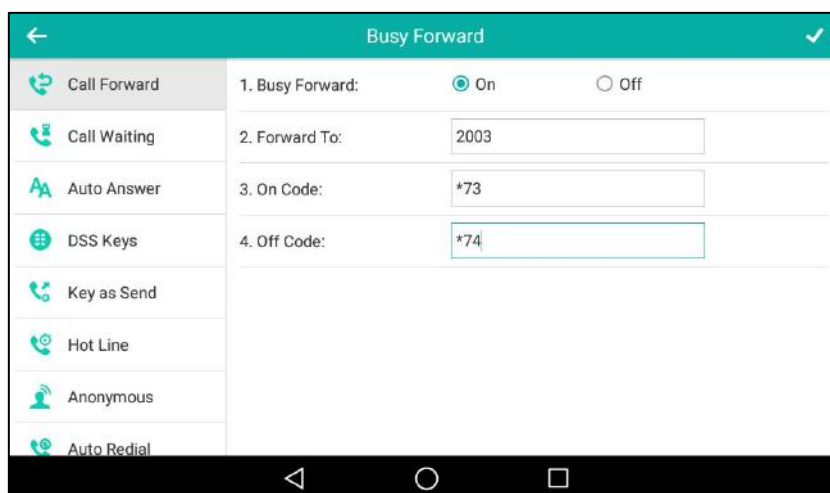

You can also enable busy forward for all accounts. Do the following:

- 1) Tap  and then tap **All Lines**.

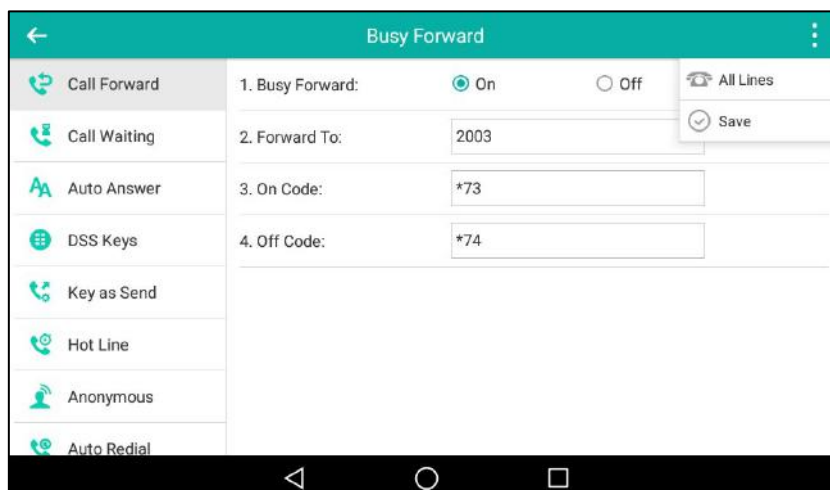

The touch screen prompts “Copy to all lines?”.

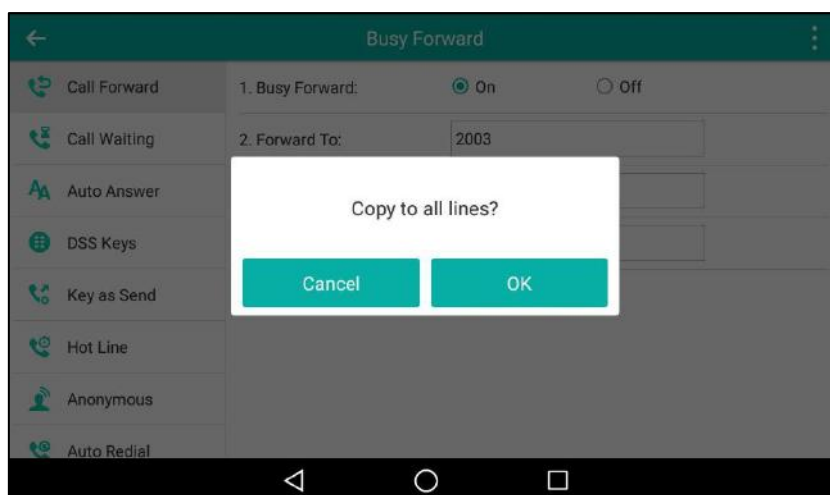

2) Tap **OK** to accept the change or **Cancel** to cancel.

c) If you select **No Answer Forward**:

- 1) Tap the **On** radio box in the **No Answer Forward** field.
- 2) Enter the destination number you want to forward unanswered incoming calls to in the **Forward To** field.
- 3) Tap the **After Ring Time** field.
- 4) Tap the desired ring time to wait before forwarding from the pull-down list.

The default ring time is 12 seconds.

- 5) (Optional.) Enter the no answer forward on code or off code respectively in the **On Code** or **Off Code** field.

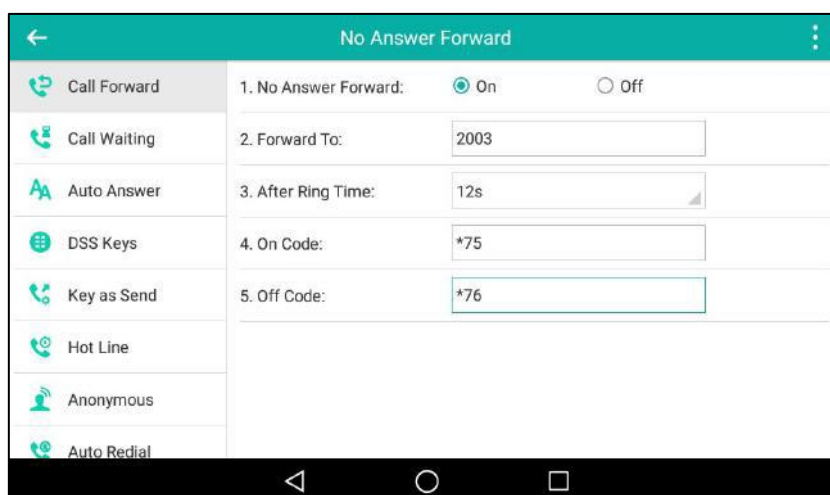



You can also enable no answer forward for all accounts. Do the following:

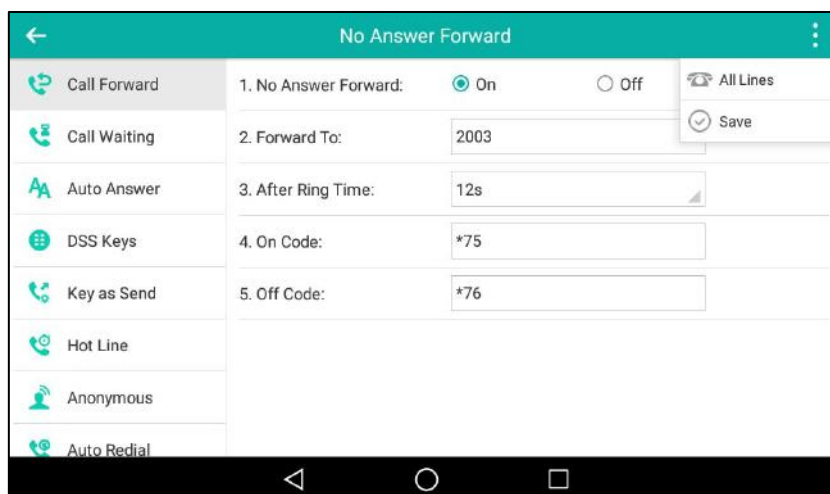

- 1) Tap  and then tap **All Lines**.

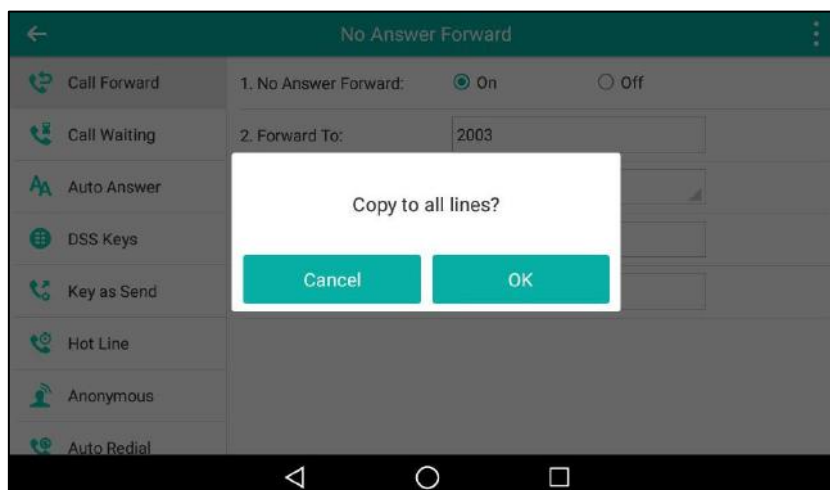



The touch screen prompts "Copy to all lines?".





- 2) Tap **OK** to accept the change or **Cancel** to cancel.
5. Tap  and then tap **Save** to accept the change.

If you enable call forward for the default account, the associated line icon will change to , and the icon  will appear on the status bar.



If you enable call forward for the non-default account, only the associated line icon will change to , the icon  will not appear on the status bar.



If you enable call forward for all accounts, all line icons will change to , and the icon  will appear on the status bar.



If the forward on code or off code is configured, the IP phone sends the corresponding code to the server when a certain action takes place. For example, if you set the Always Forward on code to be \*71 (may vary on different servers), and the target number to be 1234. When you enable Always Forward on the IP phone, the IP phone sends \*711234 to the server, and then the server will enable Always Forward feature on the server side, hence being able to get the right status of the extension.

Call forward is configurable via web user interface at the path **Features->Forward & DND**.

**Note**

You can also enter the SIP URI or IP address in the **Forward To** field. For more information on using the SIP URI or IP address, refer to [Placing Calls](#) on page 264.

Call forward is local to the phone, and may be overridden by the server settings. Call forward on code or off code may be different among servers. For more information, contact your system administrator.

**To configure the forward authorized numbers via web user interface:**

1. Click on **Features->Forward & DND**.
2. Select **Enabled** from the pull-down list of **Forward Emergency**.
3. Enter the numbers in the **Forward Authorized Numbers** field.  
For multiple numbers, enter a comma between every two numbers.

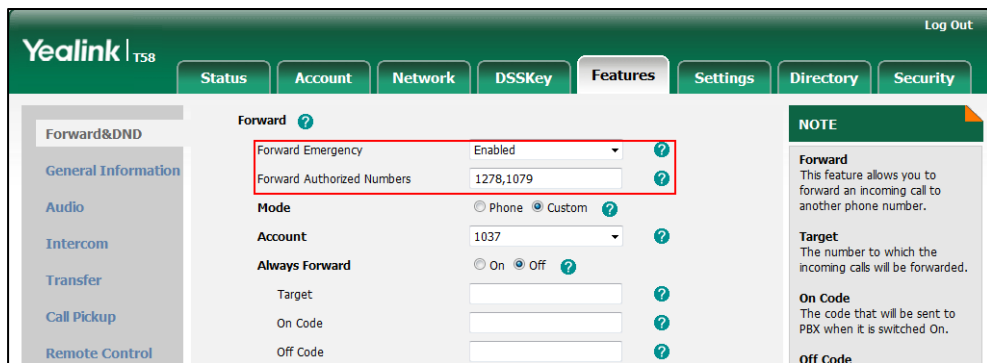

4. Click **Confirm** to accept the change.

When call forward is enabled on the phone, the phone cannot forward incoming calls from the numbers specified in the **Forward Authorized Numbers** field.

**Note**

Forward authorized number is configurable via web user interface only.

**To disable call forward in phone mode:**

Do one of the following:

- Swipe down from the top of the screen or swipe left/right to go to the second idle screen.  
Tap **Settings->Features->Call Forward**.  
Tap the desired forwarding type.

Tap the **Off** radio box.

Tap  to accept the change.

- Press  when the phone is idle.
- Swipe down from the top of the screen to enter the control center, and then tap **Forward**.

#### To disable call forward in custom mode for a specific account:

1. Do one of the following:
  - Swipe down from the top of the screen or swipe left/right to go to the second idle screen.
  - Tap **Settings->Features->Call Forward**.
  - Press  when the phone is idle.
  - Swipe down from the top of the screen to enter the control center and then tap **Forward**.

The touch screen displays a list of accounts registered on the phone.

2. Tap the desired account.
3. Tap the desired forwarding type.
4. Tap the **Off** radio box.
5. Tap  and then tap **Save** to accept the change.

## Dynamic Forwarding

#### To forward an incoming call to another party:

1. When the phone is ringing, tap the **FWD** soft key.
2. Enter the number you want to forward the incoming call to.

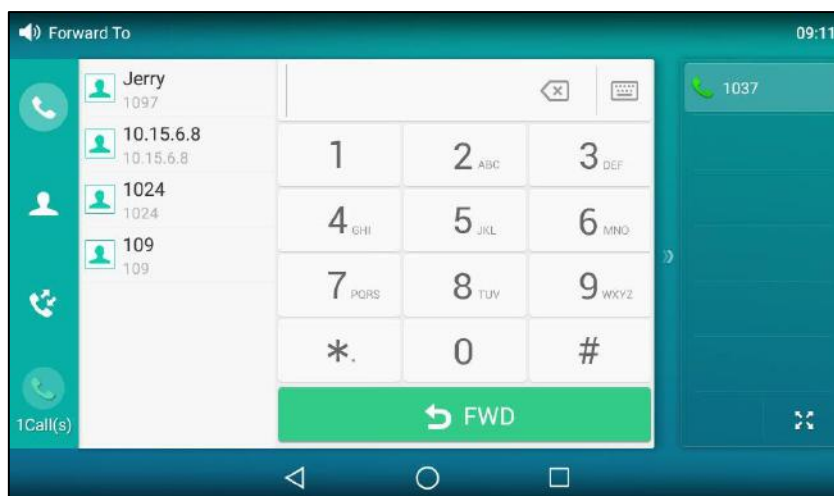

3. Press  or tap **FWD**.  
The touch screen prompts a call forward message.

## Call Transfer



You can transfer a call to another party in one of three ways:

- **Blind Transfer:** Transfer a call directly to another party without consulting.
- **Semi-Attended Transfer:** Transfer a call when the target phone is ringing.
- **Attended Transfer:** Transfer a call with prior consulting.

### Blind Transfer

Before performing a blind transfer (except you use dial number method), make sure that the transfer mode via Dsskey is configured as **Blind Transfer**. For more information on how to configure it, refer to [Configuring Transfer Mode via DssKey](#) on page 330.

#### To perform a blind transfer:

1. Press  or tap the **Transfer** soft key during a call.
2. Do one of the following:
  - Enter the number you want to transfer the call to.  
Press  to complete the transfer.
  - Enter the number you want to transfer the call to.  
Tap **Transfer**.

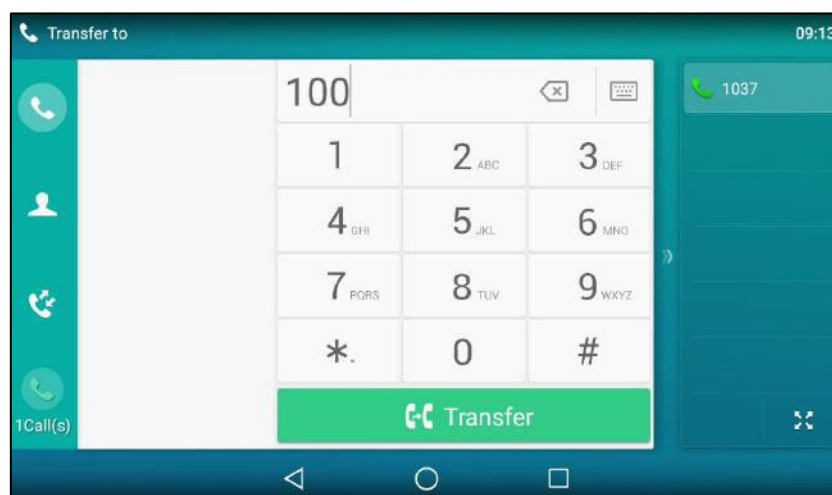



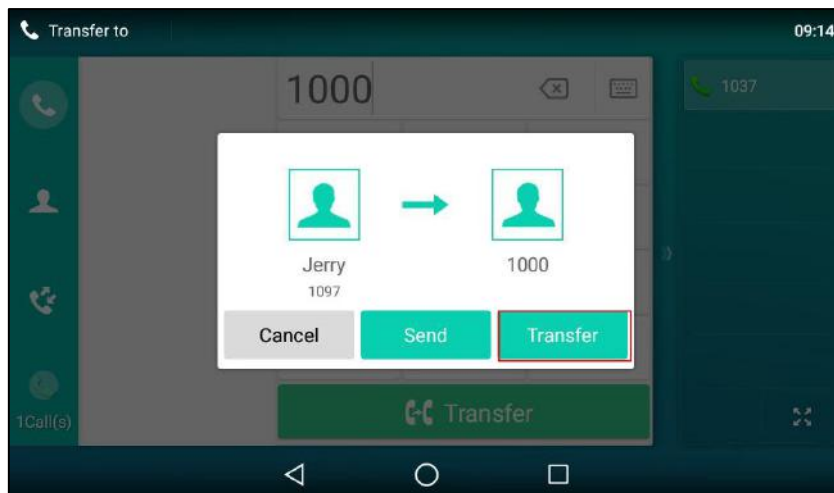

The phone will prompt a dialog box as the following picture shows:



Tap **Transfer** to complete the transfer. (The call will automatically dial out in about 5 seconds if you do not tap **Transfer**.)

- Tap , and then tap **Local Directory**. Search for the contact and tap the desired contact to complete the transfer.
- Tap , and then tap **Remote Phone Book**. Search for the contact and tap the desired contact to complete the transfer. (Remote phone book should be configured in advance, refer to [Remote Phone Book](#) on page 121 for more information.)
- Tap , and then tap the desired list. Tap the desired entry to complete the transfer. The call is then connected to the number to which you are transferring.

**To perform a blind transfer conveniently, do one of the following:**

- When there is an active call for the account selected from the **Account ID** field on the speed dial or BLF key. Drag the far-site window to that speed dial or BLF key.

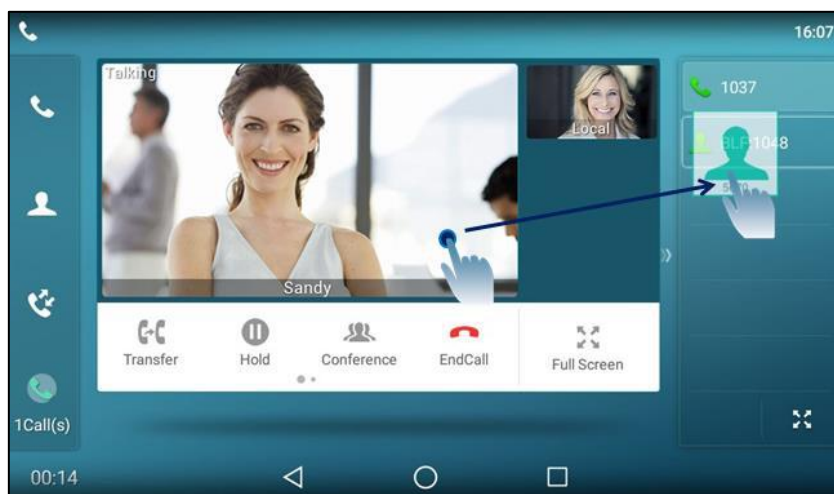

Then the call is connected to the number specified in the **Value** field of the speed dial or BLF key. For more information on how to configure a speed dial or BLF key, refer to [DSS Keys](#) on page 151.

- Make sure you have an active call and one or more calls on hold, drag one far-site window to another far-site window.

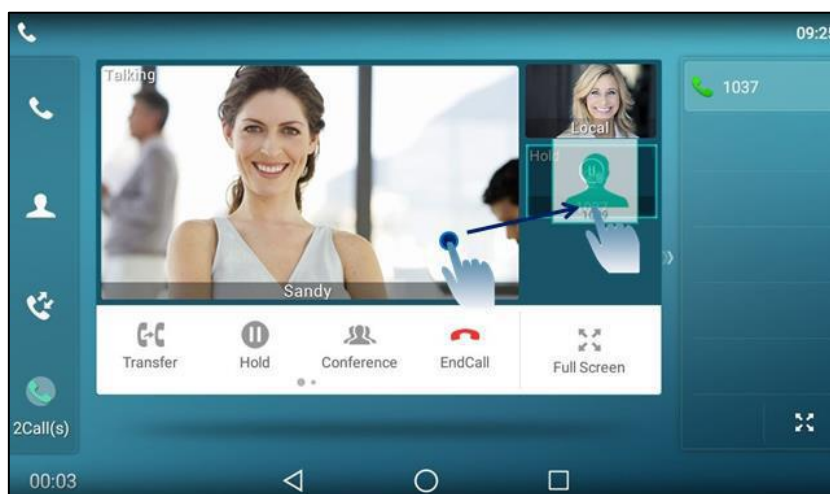

The touch screen prompts the following:

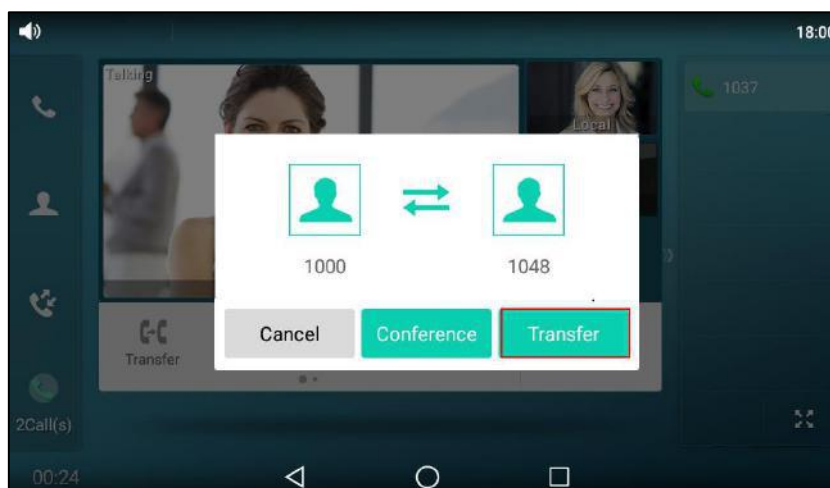



Tap **Transfer**.

Then the active call is connected to the number of the held party.

## Semi-Attended Transfer





Before performing a semi-attended transfer (except you use dial number method), make sure that the transfer mode via Dsskey is configured as **New Call** or **Attended Transfer**. For more information on how to configure it, refer to [Configuring Transfer Mode via DssKey](#) on page 330.

### To perform a semi-attended transfer:

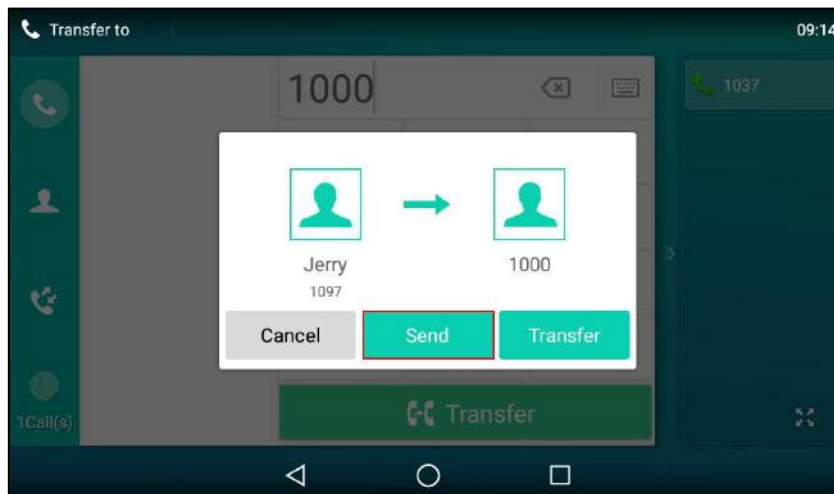
1. Press  or tap the **Transfer** soft key during a call.
2. Do one of the following:
  - Enter the number you want to transfer the call to.  
Press  to dial out.

- Enter the number you want to transfer the call to.  
Tap **Transfer**. The phone will prompt a dialog box. Tap **Send** to dial out. (The call will automatically dial out in about 5 seconds if you do not tap **Send**.)





- Tap , and then tap **Local Directory**. Search for the contact and tap the desired contact to dial out.
  - Tap , and then tap **Remote Phone Book**. Search for the contact and tap the desired contact to dial out. (Remote phone book should be configured in advance, refer to [Remote Phone Book](#) on page 121 for more information.)
  - Tap , and then tap the desired list. Tap the desired entry to dial out.
3. Press  or tap the **Transfer** soft key to complete the transfer when receiving ringback. If you are using a handset, the transfer can be completed by hanging up the handset.



## Attended Transfer

Before performing an attended transfer (except you use dial number method), make sure that the transfer mode via Dsskey is configured as **New Call** or **Attended Transfer**. For more information on how to configure it, refer to [Configuring Transfer Mode via DssKey](#) on page 330.

### To perform an attended transfer:

1. Press  or tap the **Transfer** soft key during a call.
2. Do one of the following:
  - Enter the number you want to transfer the call to.  
Press  to dial out.
  - Enter the number you want to transfer the call to.  
Tap **Transfer**. The phone will prompt a dialog box. Tap **Send** to dial out. (The call will automatically dial out in about 5 seconds if you do not tap **Send**.)
  - Tap , and then tap **Local Directory**. Search for the contact and tap the desired

contact to dial out.

- Tap , and then tap **Remote Phone Book**. Search for the contact and tap the desired contact to dial out. (Remote phone book should be configured in advance, refer to [Remote Phone Book](#) on page 121 for more information.)
  - Tap , and then tap the desired list. Tap the desired entry to dial out.
3. After the party answers the call, press  or tap **Transfer** soft key to complete the transfer.

If you are using a handset, the transfer can be completed by hanging up the handset.

## Call Waiting



You can enable or disable call waiting on the phone. If call waiting is enabled, you can receive another call when there is already an active call on the phone. Otherwise, another incoming call is automatically rejected by the phone with a busy message when there is an active call on the phone. You can also enable or disable the phone to play a warning tone when receiving another call.

### To configure call waiting via phone user interface:

1. Swipe down from the top of the screen or swipe left/right to go to the second idle screen.
2. Tap **Settings->Features->Call Waiting**.
3. Tap the **On** radio box in the **Call Waiting** field.
4. Tap the **On** radio box in the **Play Tone** field.
5. (Optional.) Enter the call waiting on code or off code respectively in the **On Code** or **Off Code** field.

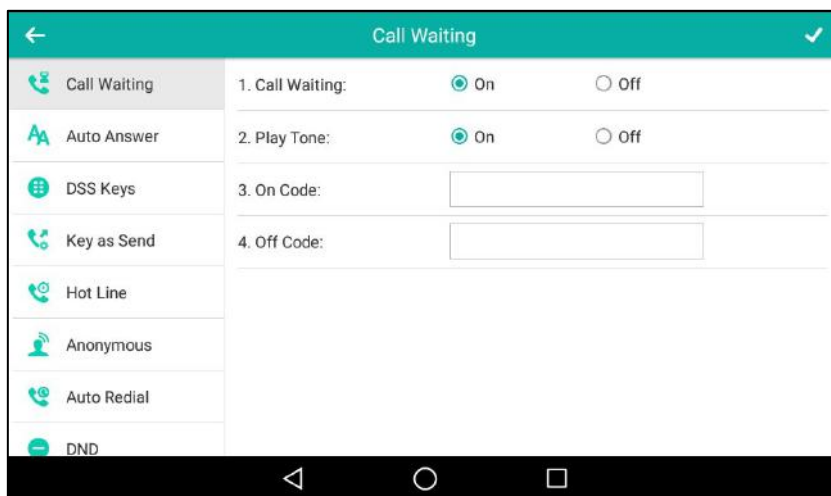
If on code or off code is configured, the IP phone will send the corresponding code to activate or deactivate call waiting on the server. They may vary on different servers.



6. Tap  to accept the change or  to cancel.

Call waiting is configurable via web user interface at the path **Features->General Information**.

## Conference

You can use the SIP-T58V/A smart media phone to create a conference using the phone's local conference and network conference. During a conference, you can manage each participant. You can mute, hold and remove individual participants in the video call screen. For more information on the video call screen, refer to [Video Call Screen Display](#) on page 47.

### Note

Network conference is not available on all servers. For more information, contact your system administrator.

## Local Conference

You can create up to three-way video conference call and five-way audio-only and video mixed conference. The audio-only and video mixed conference supports five parties participated (including yourself) at the same time including a maximum of three-way video calls.

The following figure shows what the touch screen looks like in a mixed conference call with three-way video calls and two-way audio-only calls:

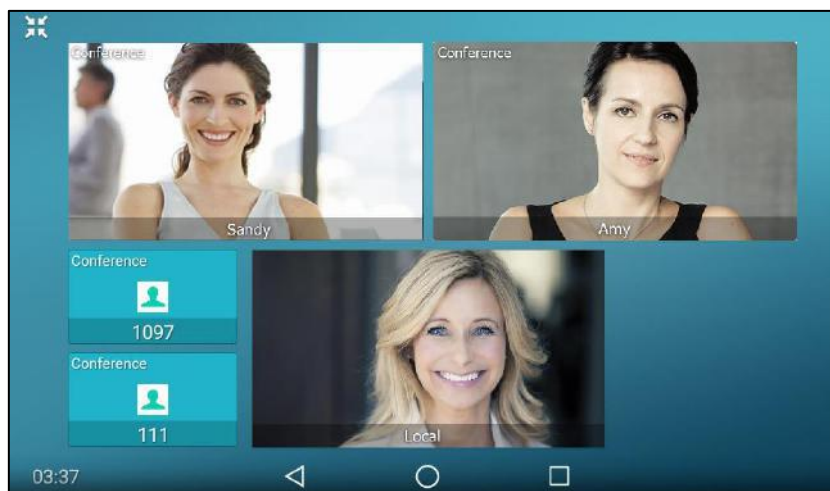

### To set up a local conference call:

1. Place a call to the first party.
2. When the first party answers the call, tap the **Conference** soft key to place a new call. The active call is placed on hold.
3. Enter the number of the second party, and then press  or tap **Conference**.

- When the second party answers the call, tap the **Conference** soft key on the second party call screen to join all parties in the conference.

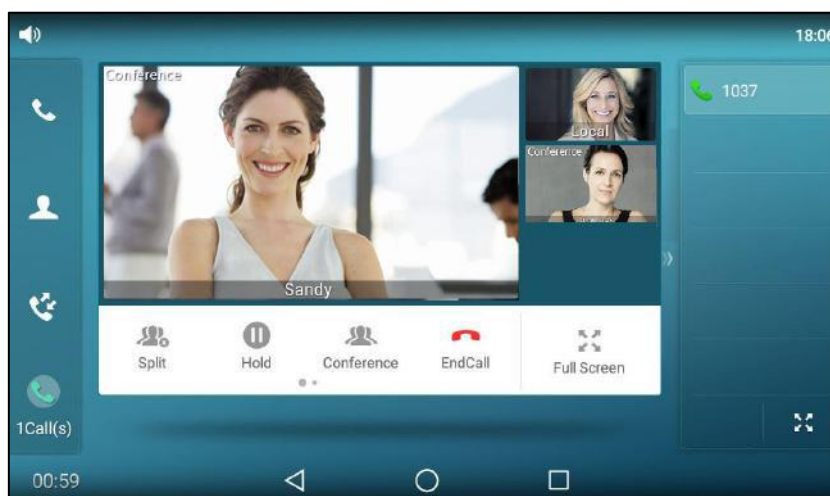

- Repeat steps 2 to 4 until you have added all intended parties.

**Note** The phone will enter the video call full-screen within 5 seconds during a call, you may tap  or blank area of the touch screen to see the soft keys.

**To join calls in a conference:**

- Make sure you have an active call and one or more calls are on hold (either on the same line key or a different line key).
- Do one of the following:
  - Drag one far-site window to another far-site window.

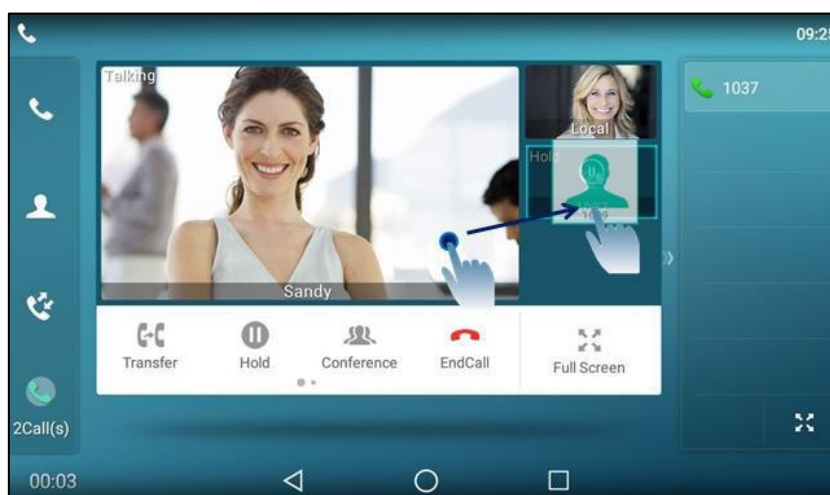

The touch screen prompts the following:

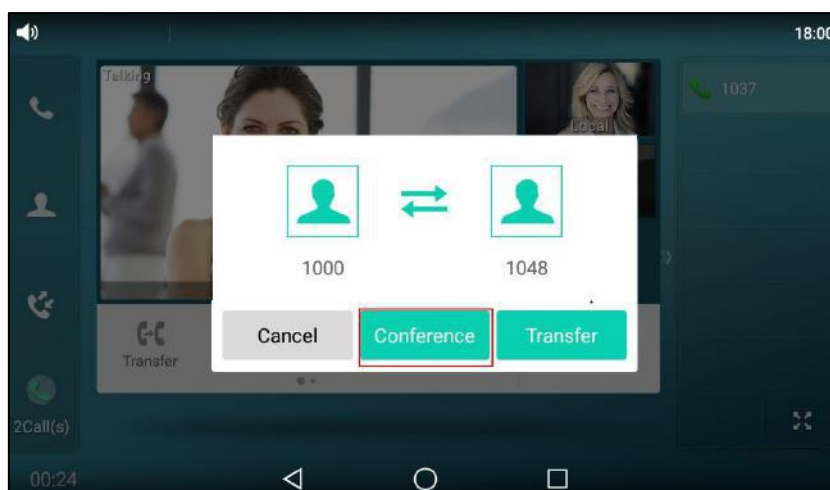

Tap **Conference**.

- Tap the desired call for conference and ensure that the call is active.  
Tap the **Conference** soft key.

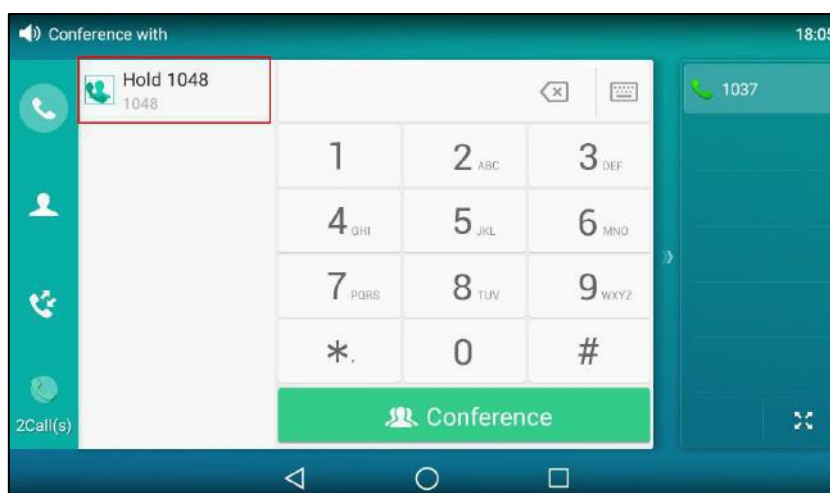

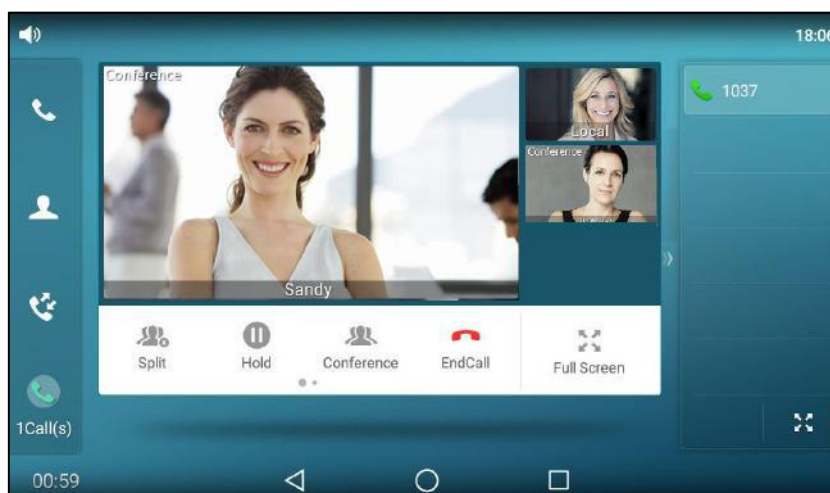

Tap the Hold call to join the calls in the conference.



- Repeat the step 2 to join more calls in the conference.

**During the conference call, you can do the following:**

- Press  or tap the **Hold** soft key to place the conference call on hold.
- Tap the **Conference** soft key to place a new call.
- Tap the **Split** soft key to split the conference call into individual calls on hold.
- Press  to mute the conference call, all other participants can hear each other, but they cannot hear you.
- Tap the **EndCall** soft key to drop the conference call.
- Long tap the desired party (if the far site only supports audio-only call, you can just tap it), the phone will prompt a dialog box as the following picture shows:

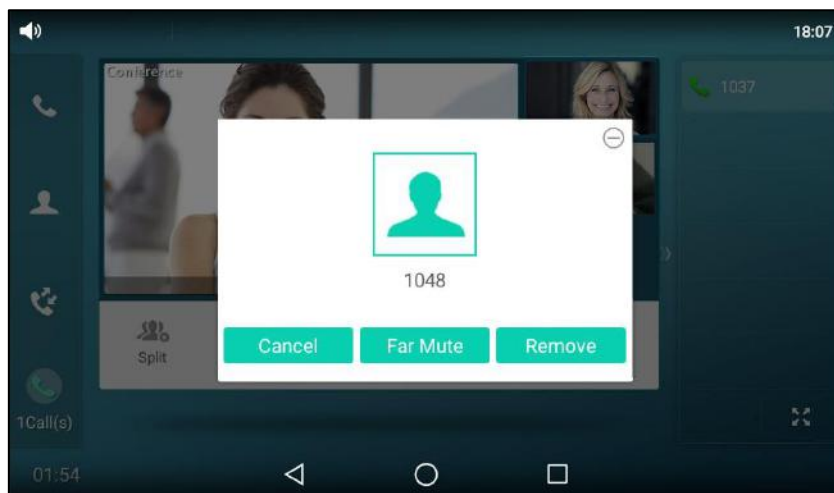

You can do the following:

- Tap **Far Mute** to mute the party. The muted party can hear everyone, but no one can hear the muted party.
- Tap **Remove** to remove the party.
- Tap **Cancel** or  to close the dialog box.

## Network Conference

You can use network conference feature on the SIP-T58V/A smart media phone to conduct an audio-only/video/audio-only and video mixed conference with multiple participants.

This feature allows you to perform the following:

- Join calls together in a conference call.
- Invite other party into an active conference call.



To use this feature, contact your system administrator for the network conference URI in advance.

**Note**

Network conference is not available on all servers. Contact your system administrator for more information.

**To configure network conference via web user interface:**

1. Click on **Account->Advanced**.
2. Select the desired account from the pull-down list of **Account**.
3. Select **Network Conference** from the pull-down list of **Conference Type**.
4. Enter the conference URI (e.g., conference@example.com) in the **Conference URI** field.

5. Click **Confirm** to accept the change.

**Note**

Network conference is configurable via web user interface only.

**To set up a network conference call:**

1. Place a call to the first party.
2. Tap the **Conference** soft key to place a new call.  
The active call is placed on hold.
3. Enter the number of the second party and press  or tap **Conference**.
4. When the second party answers the call, tap the **Conference** soft key to add the second party to the conference.
5. Tap the **Conference** soft key to place a new call.  
The conference call is placed on hold.

6. Enter the number of the new party and then press  or tap **Conference**.
7. When the new party answers the call, tap the **Conference** soft key to add the new party to the conference.
8. Repeat steps 5 to 7 until you have added all intended parties.

The procedures to set up a network conference call on specific servers may be different from introduced above. Contact your system administrator for more information.

## Call Park/Retrieve

You can use call park feature to place a call on hold, and then retrieve the call from another phone in the system (for example, a phone in another office or conference room). You can park an active call by tapping the **Park** soft key or call park key (if configured) on the phone. If the call is parked successfully, there is a voice prompt confirming that the call was parked. You can retrieve the parked call by tapping **Retrieve Park** or the retrieve park key (if configured). But if the parked call is not retrieved within a period of time defined by the system, the phone performing call park will receive the call back.

### Note

Call park is not available on all servers. Contact your system administrator for more information.

The IP phone supports call park feature under the following modes:

- **FAC mode:** park the call to the local extension or a desired extension through dialing the park code.
- **Transfer mode:** park the call to shared parking lot through performing a blind transfer to a call park number (call park code).

## FAC Mode

### To configure call park feature in FAC mode:

1. Click **Features->Pick up & Park**.
2. Select **FAC** from the **Call Park Mode** field.
3. Select **Enabled** from the **Call Park** field.  
If **Enabled** is selected, the **Park** soft key will display on the touch screen during a call, and the **Retrieve Park** will display on the dialing screen.
4. Enter the call park code in the **Call Park Code** field.  
It is configured for the **Park** soft key. This call park code will also apply to the call park key.
5. Enter the park retrieve code in the **Park Retrieve Code** field.

It is configured for **Retrieve Park**. This park retrieve code will also apply to the retrieve park key.

The screenshot shows the Yealink T58 web interface with the 'Features' tab selected. The 'Call Park' section is highlighted with a red box. The configuration is as follows:

Section	Parameter	Value
Call Pickup	Directed Call Pickup	Disabled
	Directed Call Pickup Code	
	Group Call Pickup	Disabled
	Group Call Pickup Code	
	Visual Alert for BLF Pickup	Disabled
	Audio Alert for BLF Pickup	Disabled
Call Park	Call Park Mode	FAC
	Call Park	Enabled
	Call Park Code	*68
	Park Retrieve Code	*88

Buttons: Confirm, Cancel

**NOTE**  
**Call Pickup**  
 The call pickup parameters for administrator.  
 You can click here to get more guides.

6. Click **Confirm**.

**Note** If the **Park** soft key or **Retrieve Park** doesn't appear on the touch screen, please select **Disabled** from the pull-down list of **Custom Softkey** via web user interface at path **Settings->Softkey Layout**.

#### To park a call in FAC mode:

1. Swipe the soft key area left and then tap the **Park** soft key during a call.

The phone will dial the configured call park code shown as below:

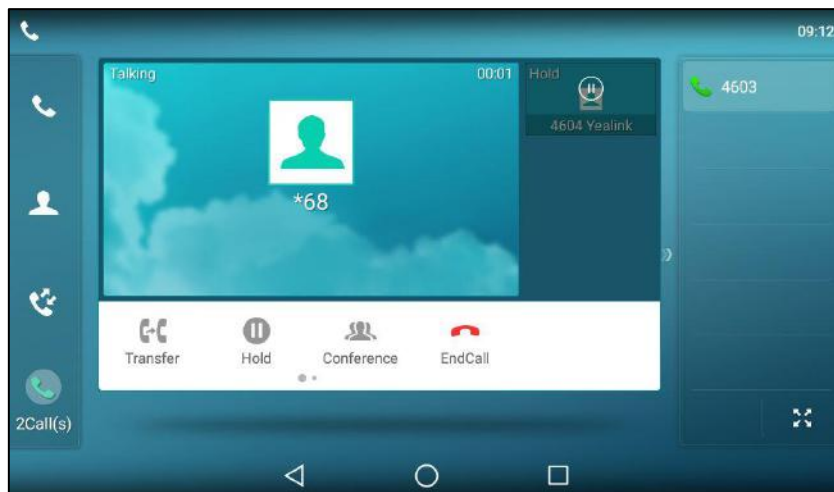

2. Do one of the following:
  - a) If you want to park the call against the local extension, press the # key.  
 If the call is parked successfully, you will hear a voice prompt confirming that the call is parked.

- b) If you want to park the call against desired extension.
  - 1) Enter the extension (for example, 4606) where you want to park the call.
  - 2) Press the # key.

If the call is parked successfully, you will hear a voice prompt confirming that the call is parked. The call is parked against the extension you entered.

From the Calls screen, you can also use a Call Park key (refer to [Call Park](#)) to park the call to desired destination directly.

**Note** You can also tap the desired BLF or BLF List key to park a call directly. For more information, refer to [Parking a Call/Retrieving a Parked Call to the Monitored User](#).

#### To retrieve a parked call in FAC mode:

1. Pick up the handset, press the Speakerphone key or tap the line key.

**Retrieve Park** appears on the touch screen.

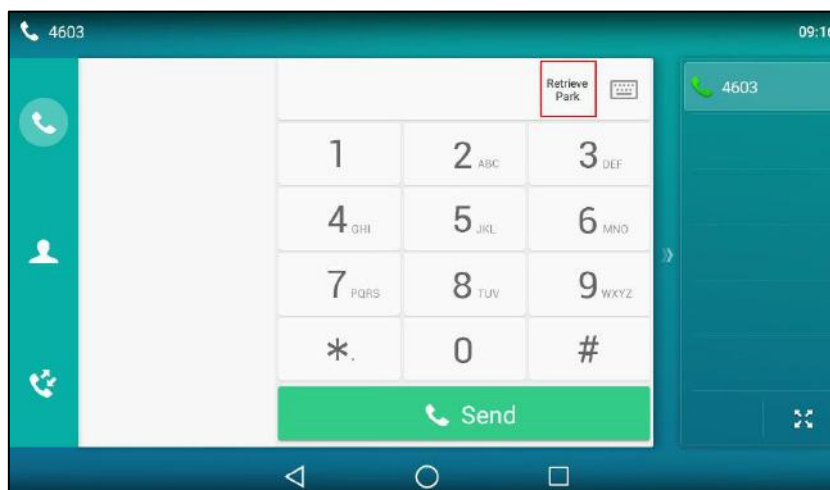

2. Tap **Retrieve Park**.

The phone will dial the configured park retrieve code and the Retrieve screen is shown as below:

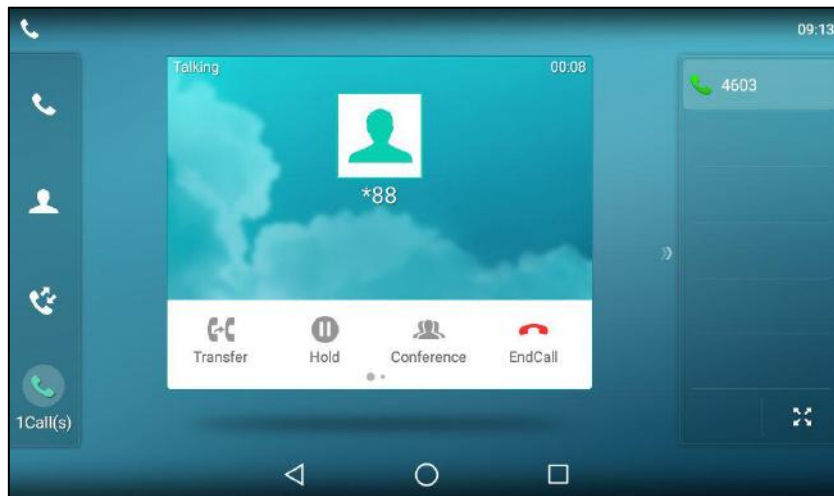

3. Follow the voice prompt, do one of the following:
  - Press the # key on the phone where the call is parked.
  - Enter the desired extension followed by # (for example, 4606#) on any phone.

From the Idle screen, you can also use a Park Retrieve key (refer to [Retrieve Park](#)) to retrieve the parked call from desired destination directly.

**Note** You can also tap the desired BLF or BLF List key to retrieve a parked call directly. For more information, refer to [Parking a Call/Retrieving a Parked Call to the Monitored User](#).

## Transfer Mode

### To configure call park feature in Transfer mode:

1. Click **Features**->**Pick up & Park**.
2. Select **Transfer** from the **Call Park Mode** field.
3. Select **Enabled** from the **Call Park** field.
 

If **Enabled** is selected, the **Park** soft key will display on the touch screen during a call, and **Retrieve Park** will display on the dialing screen.
4. Enter the call park code in the **Call Park Code** field.
 

It is configured for the **Park** soft key. This call park code will also apply to the call park key.
5. Enter the park retrieve code in the **Park Retrieve Code** field.

It is configured for **Retrieve Park**. This park retrieve code will also apply to the retrieve park key.

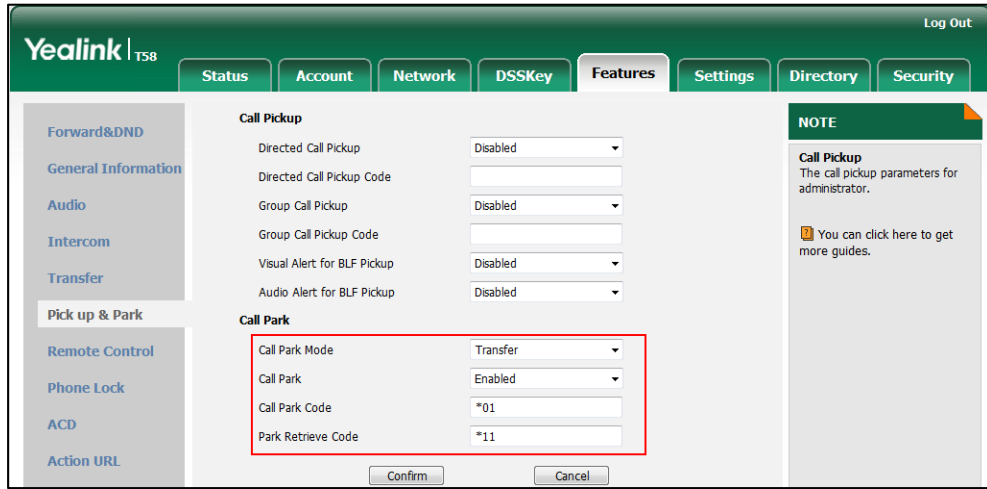

6. Click **Confirm**.

**Note** If the **Park** soft key or **Retrieve Park** doesn't appear on the LCD screen, please select **Disabled** from the pull-down list of **Custom Softkey** via web user interface at path **Settings->Softkey Layout**.

**To park a call in Transfer mode:**

1. Swipe the soft key area left and then tap the **Park** soft key during a call.  
The call will be directly transferred to the shared parking lot.

From the Calls screen, you can also use a Call Park key (refer to [Call Park](#)) to park the call to shared parking lot directly during a call.

**Note** For some servers, the system will return a specific retrieve park number (park retrieve code) from which the call can be retrieved after parking successfully.

**To retrieve a parked call in Transfer mode:**

1. Pick up the handset, press the Speakerphone key or tap the line key.
2. Tap **Retrieve Park**.  
The phone will retrieve the parked call from the shared parking lot.

From the Idle screen, you can also tap a Park Retrieve key (refer to [Retrieve Park](#)) to retrieve the parked call from shared parking lot directly when the phone is idle.

## Call Pickup

You can use call pickup to answer someone else's incoming call on your phone. The SIP-T58V/A smart media phone supports directed call pickup and group call pickup. Directed call pickup is used for picking up a call that is ringing at a target phone number. Group call pickup is used for picking up a call that is ringing at any phone number in a certain group. The pickup group should be predefined, contact your system administrator for more information.

You can pick up an incoming call by tapping **DPickup/GPickup** on the dialing screen. To use call pickup, you need to configure the call pickup code beforehand on a global or per-line basis via web user interface. The call pickup code configured on a per-line basis takes precedence over that configured on a global basis.

**Note** If there are many incoming calls at the same time, tapping **GPickup** on the phone will pick up the call that rings first.

## Directed Call Pickup

**To enable directed call pickup and configure the directed call pickup code on a global basis via web user interface:**

1. Click on **Features->Pick up & Park**.
2. Select **Enabled** from the pull-down list of **Directed Call Pickup**.
3. Enter the directed call pickup code in the **Directed Call Pickup Code** field.

The screenshot shows the Yealink T58 web user interface. The 'Features' tab is selected, and the 'Pick up & Park' sub-tab is active. The 'Call Pickup' configuration section is displayed, with the following settings:

Feature	Value
Directed Call Pickup	Enabled
Directed Call Pickup Code	*97
Group Call Pickup	Disabled
Group Call Pickup Code	
Visual Alert for BLF Pickup	Disabled
Audio Alert for BLF Pickup	Disabled
<b>Call Park</b>	
Call Park Mode	FAC
Call Park	Disabled
Call Park Code	
Park Retrieve Code	

At the bottom of the configuration area, there are 'Confirm' and 'Cancel' buttons. A 'NOTE' box on the right side of the page states: 'Call Pickup: The call pickup parameters for administrator. You can click here to get more guides.'

4. Click **Confirm** to accept the change.

**To configure the directed call pickup code on a per-line basis via web user interface:**

1. Click on **Account->Advanced**.
2. Select the desired account from the pull-down list of **Account**.

- Enter the directed call pickup code in the **Directed Call Pickup Code** field.

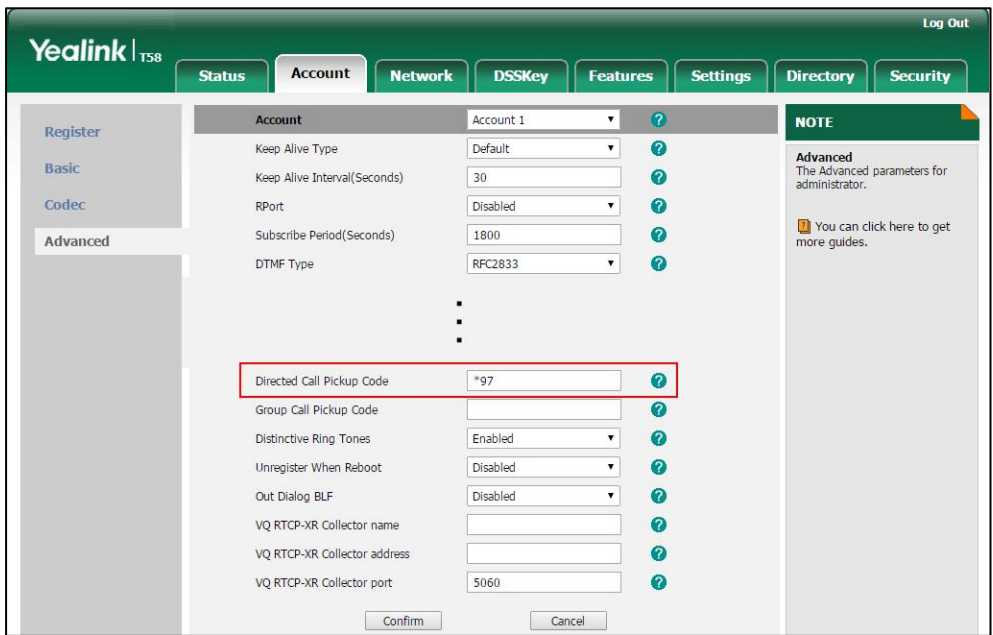

- Click **Confirm** to accept the change.

**To pick up a call directly:**

- Pick up the handset, press the Speakerphone key or tap the line key.  
**DPickup** appears on the touch screen.

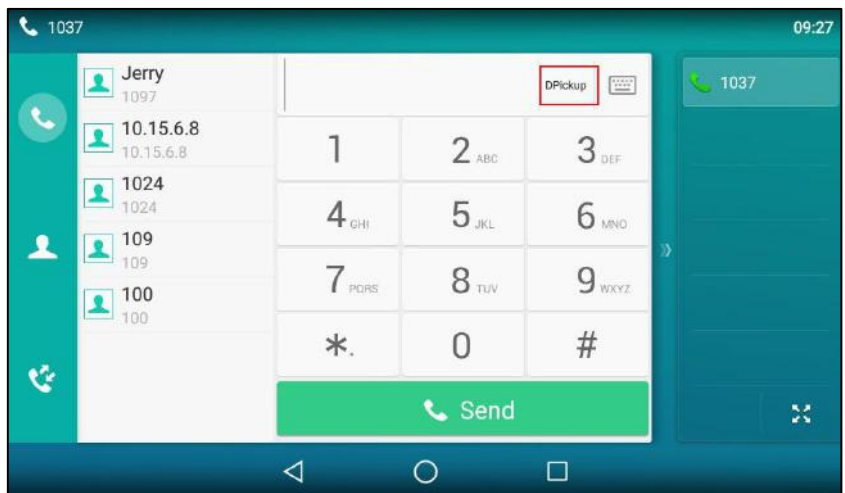

- Tap **DPickup** on your phone when the target phone receives an incoming call.
- Enter the phone number which is receiving an incoming call.
- Tap **DPickup** again.

The call is answered on your phone.

You can also configure a line key as a direct pickup key via phone user interface or web user interface. Once configured, you can pick up a call by tapping the direct pickup key directly. For more information, refer to [Line Keys](#) on page 151.



## Group Call Pickup

To enable group call pickup and configure the group call pickup code on a global basis via web user interface:

1. Click on **Features->Pick up & Park**.
2. Select **Enabled** from the pull-down list of **Group Call Pickup**.
3. Enter the group call pickup code in the **Group Call Pickup Code** field.

The screenshot shows the 'Features' configuration page for a Yealink T58 phone. The 'Call Pickup' section is active, with 'Group Call Pickup' set to 'Enabled' and 'Group Call Pickup Code' set to '\*98'. A red box highlights these two fields. Below this, the 'Call Park' section is visible with 'Call Park Mode' set to 'Transfer' and 'Call Park' set to 'Disabled'. The 'Confirm' and 'Cancel' buttons are at the bottom.

4. Click **Confirm** to accept the change.

To configure the group call pickup code on a per-line basis via web user interface:

1. Click on **Account->Advanced**.
2. Select the desired account from the pull-down list of **Account**.
3. Enter the group call pickup code in the **Group Call Pickup Code** field.

The screenshot shows the 'Account' configuration page for a Yealink T58 phone, specifically the 'Advanced' settings for 'Account 1'. The 'Group Call Pickup Code' field is highlighted with a red box and contains '\*98'. Other settings include 'Keep Alive Type' (Default), 'Keep Alive Interval' (30), 'RPort' (Disabled), 'Subscribe Period' (1800), and 'DTMF Type' (RFC2833). The 'Confirm' and 'Cancel' buttons are at the bottom.

4. Click **Confirm** to accept the change.

**To pick up a call in the group:**

1. Pick up the handset, press the Speakerphone key or tap the line key.  
**GPickup** appears on the touch screen.

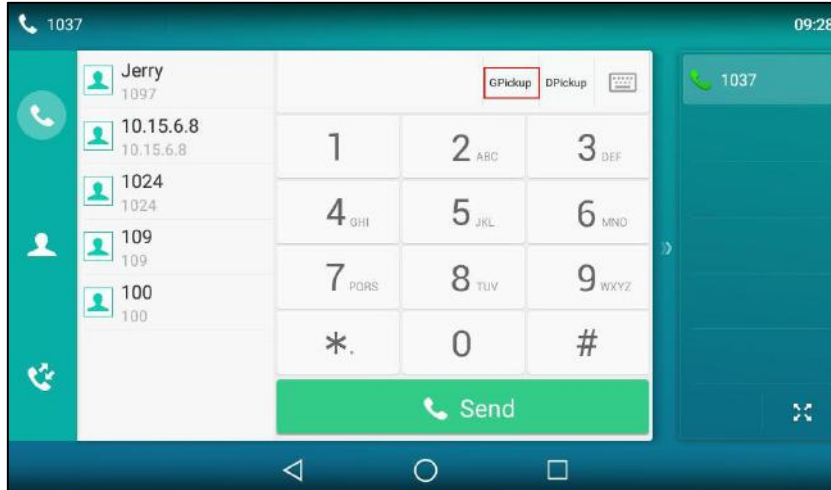

2. Tap **GPickup** on your phone when a phone in the group receives an incoming call.  
The call is answered on your phone.

You can also configure a line key as a group pickup key via phone user interface or web user interface. Once configured, you can pick up a call by tapping the group pickup key directly.

**Note** The directed call pickup code and group call pickup code are predefined on the system server. Contact your system administrator for more information.

## Anonymous Call

You can use anonymous call to block your identity and phone number from appearing to the called party when you call someone. For example, you want to call to consult some of the services, but don't want to be harassed. Anonymous call is configurable on a per-line basis. You can also configure the phone to send anonymous call on/off code to the server to activate/deactivate anonymous call on the server side.

**Note** Anonymous call is not available on all servers. Contact your system administrator for the anonymous call on code and off code.

**To configure anonymous call via phone user interface:**

1. Swipe down from the top of the screen or swipe left/right to go to the second idle screen.
2. Tap **Settings->Features->Anonymous**.
3. Tap the desired line.

4. Tap the **On** radio box in the **Local Anonymous** field.
5. (Optional.) Tap the **On Code** or **Off Code** radio box in the **Send Anony Code** field.
6. (Optional.) Enter the anonymous call on code and off code respectively in the **On Code** and **Off Code** field beneath the **Send Anony Code** field.

The phone will send the configured on code or off code depending on your selection when you enable or disable anonymous call feature on the phone.

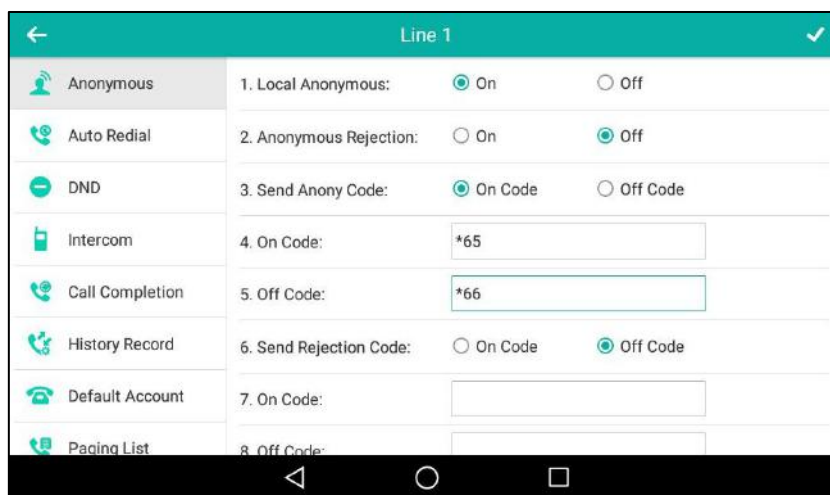

7. Tap to accept the change or to cancel.

Anonymous call is configurable via web user interface at the path **Account->Basic**.

#### To place an anonymous call:

1. Using the specific line on the phone to place a call to phone B.  
The touch screen of phone B prompts an incoming call from anonymous.

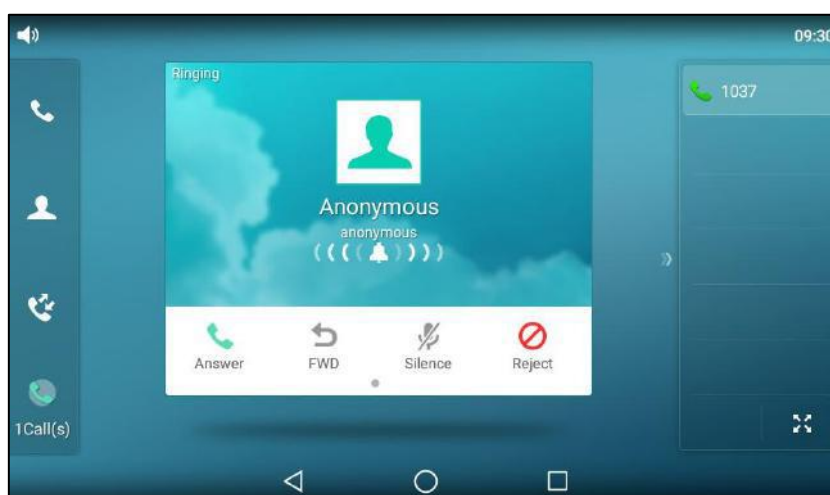

## Anonymous Call Rejection

You can use anonymous call rejection to reject incoming calls from anonymous callers. Anonymous call rejection automatically rejects incoming calls from callers who deliberately



block their identities and numbers from being displayed. Anonymous call rejection is configurable on a per-line basis. You can also configure the phone to send anonymous call rejection on/off code to the server to activate/deactivate anonymous call rejection on the server side.

**To configure anonymous call rejection via phone user interface:**

1. Swipe down from the top of the screen or swipe left/right to go to the second idle screen.
2. Tap **Settings->Features->Anonymous**.
3. Tap the desired line.
4. Tap the **On** radio box in the **Anonymous Rejection** field.
5. (Optional.) Tap the **On Code** or **Off Code** radio box in the **Send Rejection Code** field.
6. (Optional.) Enter the anonymous call rejection on code and off code respectively in the **On Code** and **Off Code** field beneath the **Send Rejection Code** field.

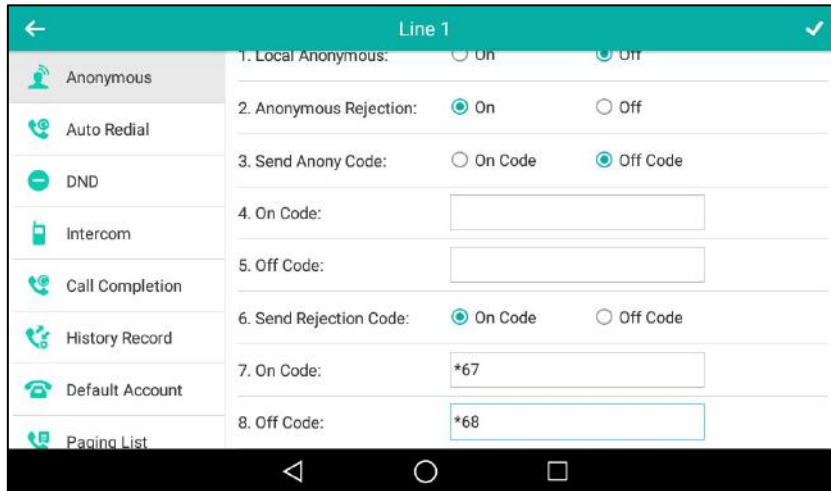
The phone will send the configured on code or off code depending on your selection when you enable or disable anonymous call rejection feature on the phone.



7. Tap  to accept the change or  to cancel.

Anonymous call rejection is configurable via web user interface at the path **Account->Basic**.

If phone B has anonymous call feature enabled and places a call to your phone, the call will be rejected, and the touch screen of the phone B will display the following:

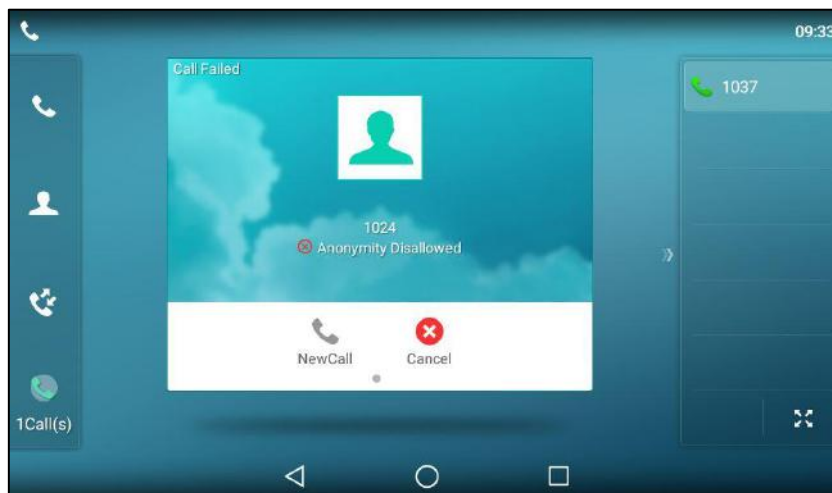



---

## Advanced Phone Features

---

This chapter provides operating instructions for the advanced features of the SIP-T58V/A smart media phone. Topics include:

- [Busy Lamp Field \(BLF\)](#)
- [BLF List](#)
- [Screenshot](#)
- [Call Recording](#)
- [Hot Desking](#)
- [Intercom](#)
- [Multicast Paging](#)
- [Music on Hold](#)
- [Automatic Call Distribution \(ACD\)](#)
- [Shared Call Appearance \(SCA\)](#)
- [Message](#)

If you require additional information or assistance with your new phone, contact your system administrator.

### Busy Lamp Field (BLF)

You can use BLF to monitor a specific line for status changes on the phone. For example, you can configure a BLF key on the phone to monitor the status of a friend's line (busy or idle). The BLF key icon illuminates solid red when the friend's line is in use. For more information, contact your system administrator.

### Configuring the BLF Feature on the Phone

You need to configure the IP phone to perform BLF monitoring. IP phones being monitored do not require any configuration.

#### Configuring a BLF Key

**To configure a BLF key via phone user interface:**

1. Swipe down from the top of the screen or swipe left/right to go to the second idle screen.
2. Tap **Settings->Features->DSS Keys**.
3. Tap the desired line key.

4. Tap the **Type** field.
5. Tap **BLF** in the pop-up dialog box.
6. Tap the **Account ID** field.
7. Tap the desired line in the pop-up dialog box.
8. (Optional.) Enter the string that will appear on the touch screen in the **Label** field.
9. Enter the phone number or extension you want to monitor in the **Value** field.
10. (Optional.) Enter the directed call pickup code in the **Extension** field.

If it is configured, when the monitored user receives an incoming call, the supervisor can tap the BLF key to pick up the call directly.

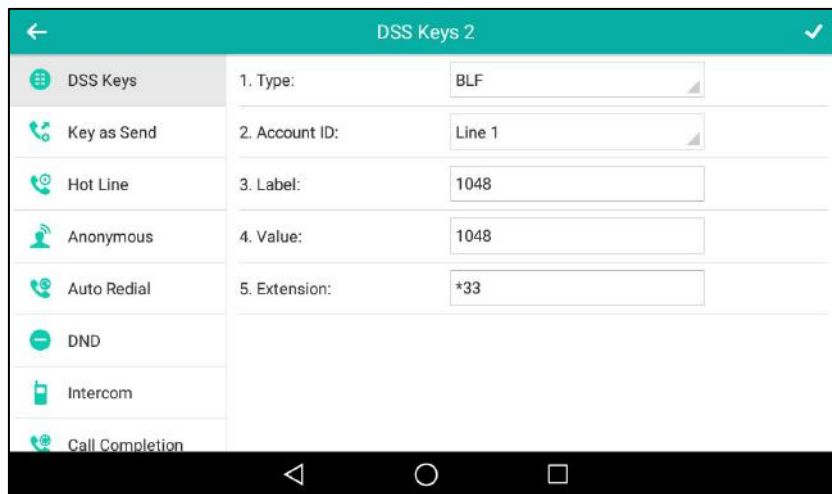

11. Tap ✓ to accept the change or ✗ to cancel.

BLF key is configurable via web user interface at the path **DSSKey->Line key**.

## Configuring Visual and Audio Alert for BLF pickup

You can enable audio alert feature for BLF pickup on the phone. This allows the monitoring phone to play a warning tone when the monitored line receives an incoming call. You can also enable visual alert feature for BLF pickup on the phone. This allows the touch screen of the monitoring phone to display the caller ID when the monitored line receives an incoming call.

**To enable visual and audio alert features via web user interface:**

1. Click on **Features->Pick up & Park**.
2. Select **Enabled** from the pull-down list of **Visual Alert for BLF Pickup**.



3. Select **Enabled** from the pull-down list of **Audio Alert for BLF Pickup**.

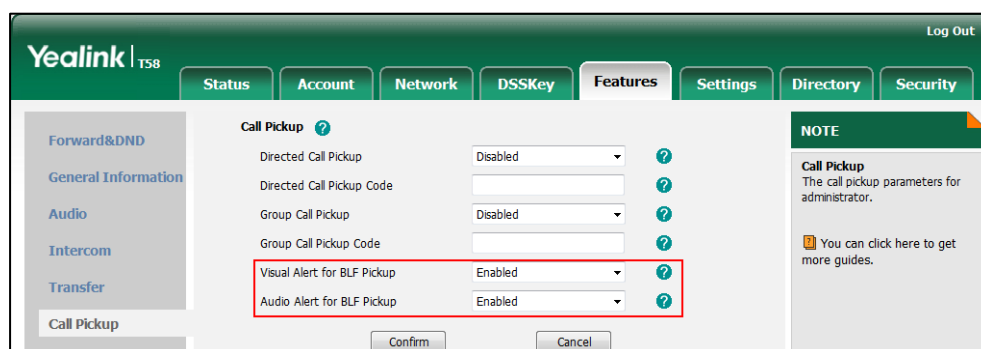

4. Click **Confirm** to accept the change.

#### Note

Visual and audio alert features are configurable via web user interface only.

When the monitored line receives an incoming call, the following occurs on your phone:

- The phone plays a warning tone (if enabled).
- The BLF key icon flashes red.
- The caller ID appears on the touch screen (if enabled).

In the following figure, the touch screen shows an incoming call from 1024 on the monitored line.

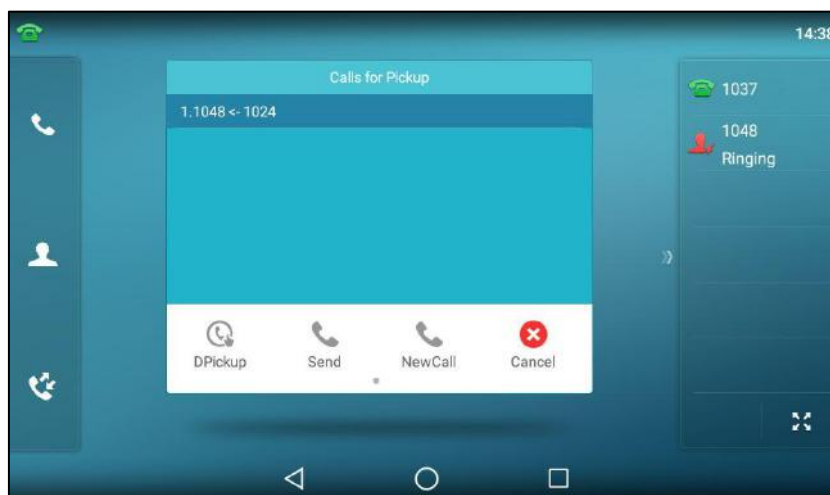

#### You can do the following actions:

- Tap the **DPickup** soft key to pick up the call.
- Tap the **Send** soft key to dial out the monitored phone number.
- Tap the **NewCall** soft key to place a new call.
- Tap the **Cancel** soft key to exit the screen.

## Configuring Transfer Mode via DssKey

When there is an active call on the IP phone, you can handle the active call differently depending on the configuration of the transfer mode via Dsskey with the BLF key.

### To configure the transfer mode via Dsskey via web user interface:

1. Click on **Features->Transfer**.
2. Select the desired transfer mode from the pull-down list of **Transfer Mode via Dsskey**.
  - If you select **Blind Transfer**, tap the BLF key to blind transfer the call to the monitored user.
  - If you select **Attended Transfer**, tap the BLF key to dial out the monitored phone number and then perform an attended or a semi-attended transfer.
  - If you select **New Call**, tap the BLF key to place a new call to the monitored user. The original call is placed on hold.

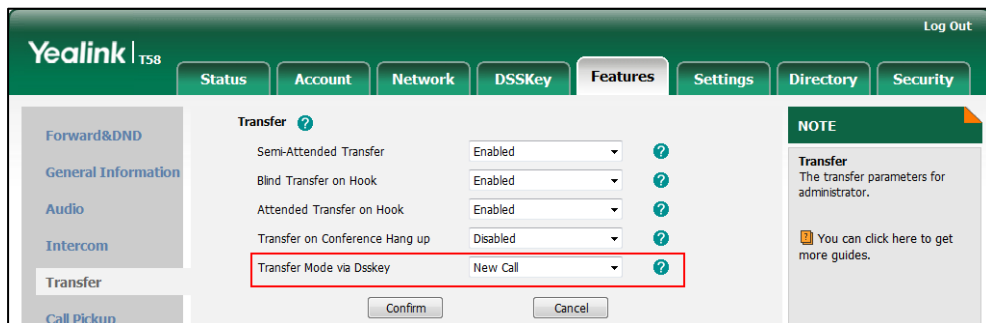

3. Click **Confirm** to accept the change.

**Note** Transfer Mode via DssKey is also applicable to BLF list feature.

## Configuring Directed Call Pickup Code

If you configure the directed call pickup code in advance, you can pick up the monitored user's incoming call by tapping the BLF key. You can configure the directed call pickup code when configuring a BLF key. For more information, refer to [Configuring a BLF Key](#) on page 327. You can also configure the directed call pickup code on a global or per-line basis via web user interface.

If you enable visual alert feature, you can also pick up the monitored user's incoming call by tapping the **DPickup** soft key. To use the **DPickup** soft key to pick up the call, the call pickup code can only be configured on a global or per-line basis via web user interface.

**Note** The pickup code is used in the following order of preference: Extension (DSSKey->Line Key)>Directed Call Pickup Code (Account->Advanced)>Directed Call Pickup Code (Features->Pick up & Park). If pickup code is not configured, tapping the BLF key/**DPickup** soft key will directly call the monitored user when he/she receives an incoming call.

To configure directed call pickup feature on a global basis via web user interface:

1. Click on **Features->Pick up & Park**.
2. Enter the desired pickup code in the **Directed Call Pickup Code** field.

The screenshot shows the 'Call Pickup' configuration page in the Yealink T58 web interface. The 'Features' tab is selected. The 'Directed Call Pickup' dropdown is set to 'Enabled'. The 'Directed Call Pickup Code' text input field is highlighted with a red box and contains the value '\*8'. Other fields include 'Group Call Pickup' (Disabled), 'Group Call Pickup Code' (empty), 'Visual Alert for BLF Pickup' (Enabled), and 'Audio Alert for BLF Pickup' (Enabled). There are 'Confirm' and 'Cancel' buttons at the bottom. A 'NOTE' box on the right states: 'Call Pickup: The call pickup parameters for administrator. You can click here to get more guides.'

3. Click **Confirm** to accept the change.

To configure the directed call pickup code on a per-line basis via web user interface:

1. Click on **Account->Advanced**.
2. Select the desired account from the pull-down list of **Account**.
3. Enter the desired pickup code in the **Directed Call Pickup Code** field.

The screenshot shows the 'Advanced' configuration page for 'Account 1' in the Yealink T58 web interface. The 'Account' dropdown is set to 'Account 1'. The 'Directed Call Pickup Code' text input field is highlighted with a red box and contains the value '\*8'. Other fields include 'Keep Alive Type' (Default), 'Keep Alive Interval(Seconds)' (30), 'RPort' (Disabled), 'Subscribe Period(Seconds)' (1800), 'DTMF Type' (RFC2833), 'Group Call Pickup Code' (empty), 'Distinctive Ring Tones' (Enabled), 'Unregister When Reboot' (Disabled), 'Out Dialog BLF' (Disabled), 'VQ RTPC-XR Collector name' (empty), 'VQ RTPC-XR Collector address' (empty), and 'VQ RTPC-XR Collector port' (5060). There are 'Confirm' and 'Cancel' buttons at the bottom. A 'NOTE' box on the right states: 'Advanced: The advanced parameters for administrator. You can click here to get more guides.'

4. Click **Confirm** to accept the change.

## Using BLF Feature on the Phone

You can use the BLF key in the following ways:

- Place a call to the monitored user.

- Transfer a call to the monitored user.
- Pick up an incoming call of the monitored user.

## Placing a Call to the Monitor User

You can tap a BLF key to dial out the monitored phone number when the monitored line is idle.

### To place a call to the monitored user when the IP phone is idle:

1. Tap the BLF key.  
The IP phone dials out the phone number of the monitored user.

## Transferring a Call to the Monitored User

When there is already an active call on the IP phone, you can transfer the active call to the monitored user by tapping the BLF key. The phone handles the active call differently depending on the configuration of the transfer mode via Dsskey with the BLF key (refer to [Configuring Transfer Mode via DssKey](#)). The transfer mode via Dsskey has the following modes:

- Blind Transfer
- Attended Transfer
- New Call

### To perform a blind transfer:

When the transfer mode via Dsskey is set to **Blind Transfer** and there is already an active call on the IP phone, you can do the following:

1. Tap the BLF key of the monitored user which you want to transfer this call to.  
Then the active call is connected to the number of the monitored user.

### To perform a semi-attended transfer:

When the transfer mode via Dsskey is set to **Attended Transfer** and there is already an active call on the IP phone, you can do the following:

1. Tap the BLF key of the monitored user which you want to transfer this call to. The phone will dial the number of the monitored user.
2. Tap the BLF key of the monitored user again or the **Transfer** soft key to complete the transfer when receiving ringback.

### To perform an attended transfer:

When the transfer mode via Dsskey is set to **Attended Transfer** and there is already an active call on the IP phone, you can do the following:

1. Tap the BLF key of the monitored user which you want to transfer this call to. The phone will dial the number of the monitored user.
2. Tap the BLF key of the monitored user again or the **Transfer** soft key to complete the transfer after the monitored user answers the call.

**To perform a new call:**

When the transfer mode via Dsskey is set to **New Call** and there is already an active call on the IP phone, you can do the following:

1. Tap the BLF key of the monitored user you want to call.

The phone will dial the number of the monitored user. The original call is placed on hold.

## Picking up an Incoming Call of the Monitored User

When the monitored user receives an incoming call, the BLF key icon of the monitored user will become  and flashing. You can use the BLF key to pick up an incoming call of the monitored user. If you enable visual alert feature on the phone, you can pick up the incoming call using the **DPickup** soft key. Before picking up an incoming call, ensure that the directed call pickup code has been configured in advance.

**To pick up an incoming call using the BLF key or the DPickup soft key:**

1. Tap the BLF key or the **DPickup** soft key.

The incoming call of the monitored user is answered on the IP phone.

**Note**

If the directed call pickup code is not configured, the phone will place a call to the monitored user instead of picking up an incoming call of the monitored user when you tap the BLF key or the **DPickup** soft key.

## Parking a Call/Retrieving a Parked Call to the Monitored User

You can use the BLF key to park a call or retrieve a parked call directly in FAC mode. Make sure that the call park feature is configured in advance (refer to [FAC Mode](#)).

**To park a call in FAC mode:**

1. During a call, tap the **Park** soft key.
2. Tap the desired BLF key to park the call to the monitored user.

**To retrieve a parked call in FAC mode:**

1. Tap **Retrieve Park** on the dialing screen.
2. Tap the desired BLF key to retrieve a call that is parked to the monitored user.

## BLF List

You can use the BLF List feature to monitor a list of users defined by your system administrator. For example, your system administrator enables BLF List, and creates a BLF List URI (e.g., BLFList@example.com) including a list of user1, user2 on the server. The BLF List keys on the IP phone can present the status of user1 and user2. The key icons illuminate flashing or solid depending on the status of those users. For more BLF List key icon, refer to [Line Key Icons](#) on page 17.

You can use the BLF List keys in the following ways:

- When the monitored user is idle, tap the BLF list key to dial out the phone number.
- When there is already an active call on the IP phone, you can transfer the active call to the monitored user by tapping the BLF List key. The phone handles the active call differently depending on the configuration of the transfer mode via Dsskey with the BLF list key. For more information on the transfer mode via Dsskey, refer to [Configuring Transfer Mode via DssKey](#) on page 330.
- When the monitored user receives an incoming call, tap the BLF list key to pick up the call directly. Before picking up an incoming call, ensure that the BLF List Pickup Code has been configured in advance. If the code is not configured, the phone will place a call to the monitored user instead of picking up the incoming call of the monitored user when you tap the BLF List key.
- When there is a conversation on the monitored user, tap the BLF list key to barge in and set up a conference call. Before barging in an active call, ensure that the BLF List Barge In Code has been configured in advance. If the code is not configured, the phone will place a call to the monitored user instead of barging in an active call of the monitored user when you tap the BLF List key.
- When a call is being parked against the monitored phone, tap the BLF List key to retrieve the parked call from the monitored user. Before retrieving the parked call, ensure that the BLF List Retrieve Call Parked Code has been configured in advance. If the code is not configured, the phone will place a call to the monitored user instead of retrieving the parked call when you tap the BLF List key.

**To configure BLF List settings via web user interface:**

1. Click on **Account->Advanced**.
2. Select the desired account from the pull-down list of **Account**.
3. Enter the BLF List URI in the **BLF List URI** field.
4. (Optional.) Enter the directed pickup code in the **BLF List Pickup Code** field.
5. (Optional.) Enter the barge-in code in the **BLF List Barge In Code** field.

6. (Optional.) Enter the call park retrieve code in the **BLF List Retrieve Call Parked Code** field.

The screenshot shows the Yealink T58 web interface with the 'Account' tab selected. The 'Account' configuration page is displayed for 'Account 1'. The following fields are visible:

Field	Value
Keep Alive Type	Default
Keep Alive Interval(Seconds)	30
RPort	Disabled
Subscribe Period(Seconds)	1800
DTMF Type	RFC2833
PTime(ms)	20
BLF List URI	4609@yealink.com
BLF List Pickup Code	*97
BLF List Barge In Code	*33
BLF List Retrieve Call Parked Code	*88
Shared Line	Disabled
VQ RTPC-XR Collector address	
VQ RTPC-XR Collector port	5060

The 'BLF List Retrieve Call Parked Code' field is highlighted with a red box. The interface also includes a 'NOTE' section on the right and 'Confirm' and 'Cancel' buttons at the bottom.

7. Click **Confirm** to accept the change.

#### Note

For more information on BLF List URI/BLF List Pickup Code/BLF List Barge In Code/BLF List Retrieve Call Parked Code, contact your system administrator.

According to the response message from the server, the IP phone will automatically configure the BLF List keys beginning from the first unused DSS key (The default order of BLF list keys assigned automatically is Line Key->Ext Key). Once any DSS key is seized, the IP phone will skip to configure the next DSS key.

You can receive a visual or/and an audio alert (if enabled) on your phone when the monitored user receives an incoming call. For more information, refer to [Configuring Visual and Audio Alert for BLF pickup](#) on page 328.

#### Note

The pickup code is used in the following order of preference: BLF List Pickup Code (Account->Advanced)>Directed Call Pickup Code (Account->Advanced)>Directed Call Pickup Code (Features->Pick up & Park). If all of them are not configured, tapping the BLF List key will directly call the monitored user when he/she receives an incoming call. For more information about pickup code, refer to [Call Pickup](#) on page 319.

## Screenshot

You can tap **Screenshot** on the control center or press  during the call to capture a screenshot. The screenshots are saved in the internal SD card with the name consisting of a prefix "Screenshot" and date & time stamp, for example, Screenshot\_2016-03-02-14-00-26 was

created on March 2, 2016, at 14:00:26. You can view the screenshots by **FileManager** or **Gallery** application. For more information, refer to [FileManager](#) on page 195 and [Gallery](#) on page 208.

**Note**

The screenshots are saved in \*.png format. You can view the screenshots on either the phone itself or on a computer using an application capable of viewing \*.png files.

**To capture a screenshot:**

1. Swipe down from the top of the screen to enter the control center.

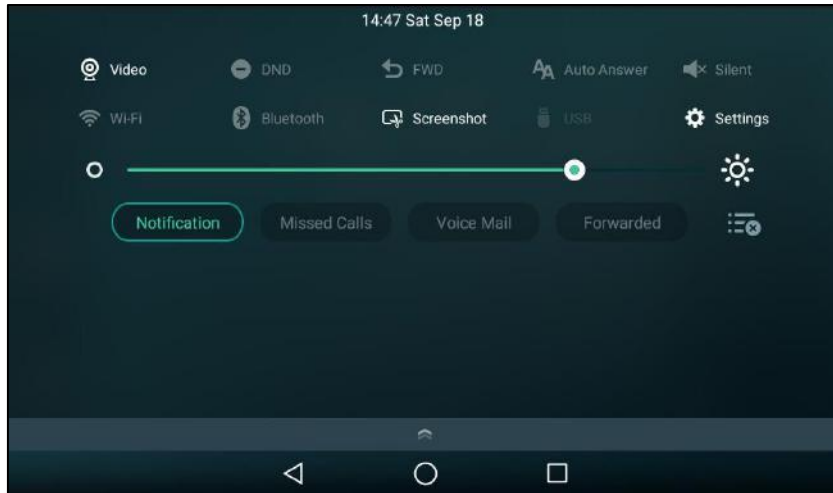

2. Tap **Screenshot**.

If the screenshot is successfully saved, the notification center will display a notification "Screenshot captured."

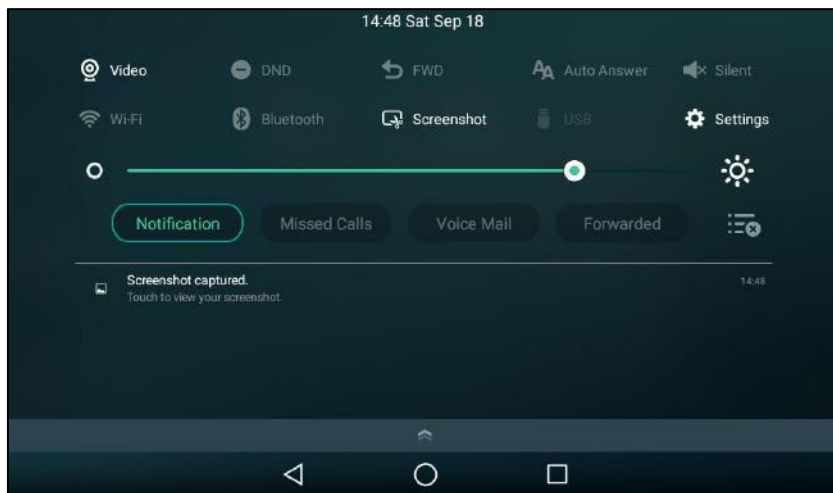

You can tap the notification to view the latest screenshot.

If there is no enough space in internal SD card, you cannot save the screenshot, and the notification center will display a notification "Couldn't capture screenshot."



## Call Recording

### Call and Conference Recording Using a Softkey

You can record active calls or conferences by tapping the **Record** soft key on your phone, and there is a time limit - 12 hours. You can set a mark while recording. This feature is useful during important meetings or discussions, allowing you to mark some pivotal point in the discussion that you'll need to reference later.

The recorded video calls are saved in \*.mkv format and include a date & time stamp and the other party's number/IP address/name (or the first person's number/IP address/name you called), for example, 20160302-1452-Tom was created on March 2, 2016, at 14:52 and you have a call with Tom. The recorded audio-only calls are saved in \*.aac format. You can view the recorded files by **FileManager** application.

By default, the recorded files are saved in the internal SD card. But if there is a USB flash drive connected to your phone, the recorded files will be saved in the storage device according to the priority: USB flash drive>internal SD card.

#### Note

If you use a record key to record a call, the recorded file will be stored in servers. For more information, refer to [Call Recording Using a Record Key](#) on page 340.

Before recording any call, especially those involving PSTN, it is necessary to know about the rules and restrictions of any governing call-recording in the place you are in. It is also very important to have the consent of the person you are calling before recording the conversation.

**The Record soft key controls the recording function, and is available (you need to swipe the soft key area left to see it):**

- When there are one or more calls connected to your phone
- During an active call
- When calls are muted
- During an attended transfer
- During a conference call

**The Record soft key is not available:**

- When there are no connected calls on your phone
- When you place a new call (to transfer or to conference)
- When the phone prompts you to answer an incoming call

**The recording is not be paused when the following occurs:**

- You place a call on hold.
- You mute a call.

- You set up a conference call
- You perform the semi-attended or attended transfer
- An incoming calls arrives on your phone

## Call Recording



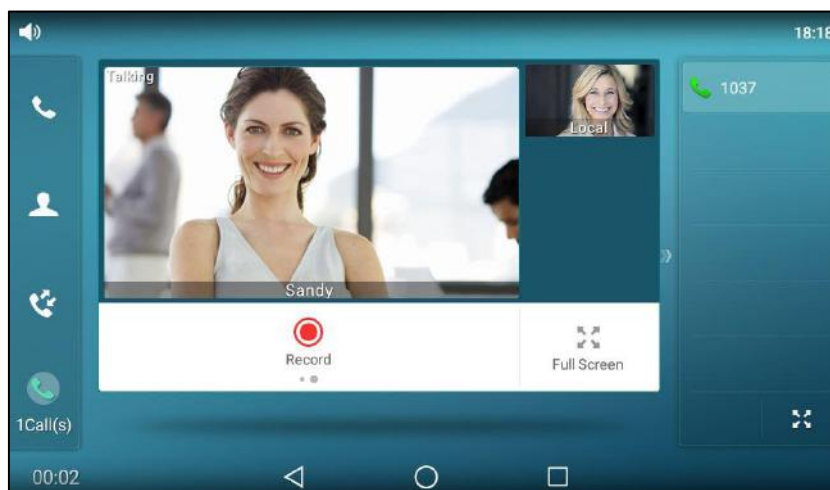

### To record a call via phone user interface:

1. Swipe the soft key area left and then tap the **Record** soft key during a call.

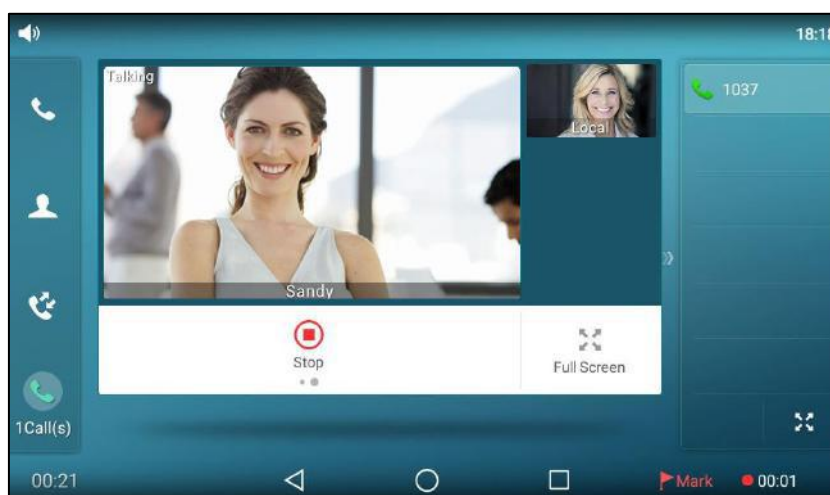

If the recording starts successfully, the recording icon  and recording duration will appear on the bottom-right of the touch screen.



2. (Optional.) Tap  on the bottom-right of the screen to set a mark. The icon changes to , the number will increase if you set more marks. And there is a red flag on this moment when playing the recorded file. If you tap the **Hold** soft key or press the  key while recording, only you are recorded. If you press  while recording, only the callee is recorded.

**Note** You can hold, transfer or set up a conference call while recording.

When you end a call while recording, the recording will be stopped and saved automatically.

**To stop recording while the phone records, do one of the following:**

- Swipe the soft key area left and then tap the **Stop** soft key during a call.

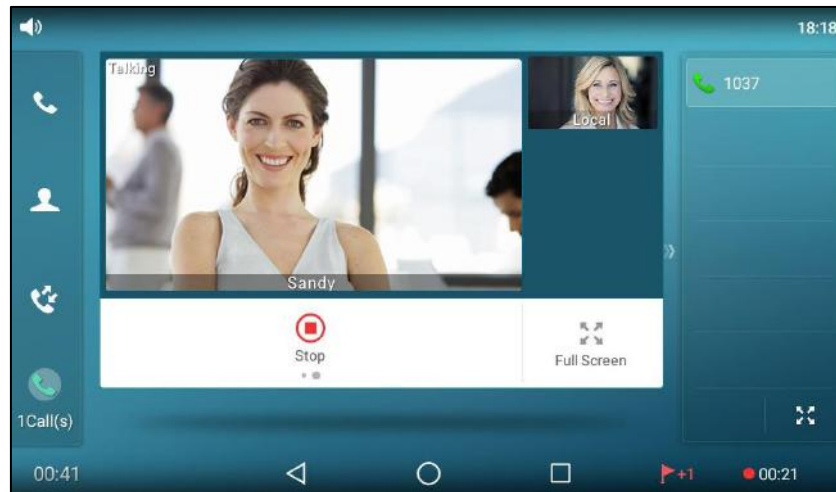

The status bar prompts "Call has been successfully recorded on device".

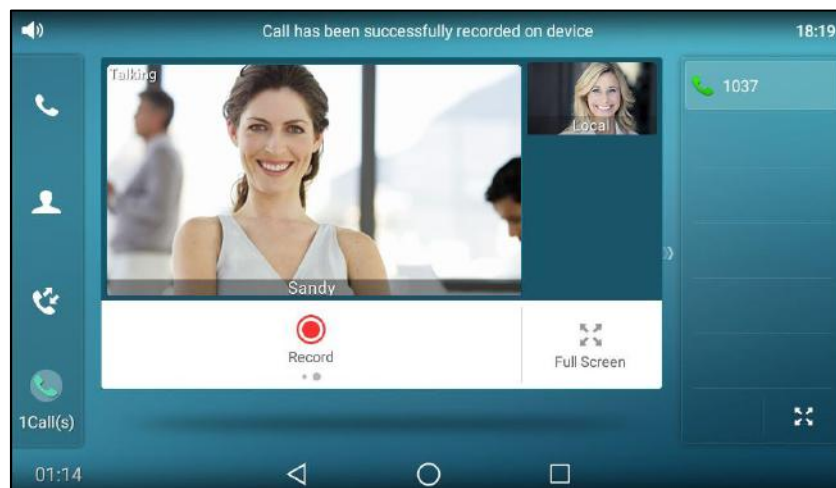

- When there is only a call on the phone, tap the **EndCall** soft key.



The status bar prompts “Call has been successfully recorded on device”, the recording icon and recording duration disappear, and the phone returns back to the idle screen.



The recording will be stored as a new file when the phone starts recording again.

## Conference Recording

You can record conference calls in the same way as other calls with the following exceptions:

- All conference participants are recorded while recording. If one of the participants taps the **Hold** soft key or presses the  key, only that participant is recorded. When a conference call is placed on hold, recording of the conference is paused. You can place or answer other calls, which will be recorded in the same file. When the conference call is resumed, recording of the conference resumes.
- All conference participants are recorded while recording. If one of the participants presses , only that participant is not recorded.

## Call Recording Using a Record Key

You can record calls by tapping a record key on the phone. The SIP-T58V/A smart media phone supports record and URL record.

Two ways of call recording:

- **Record:** The phone sends a SIP INFO message containing a specific header “Record: on/off” to trigger a recording.
- **URL Record:** The phone sends an HTTP URL request to trigger a recording. Contact your system administrator for the predefined URL.

### Note

If you record a call using a softkey, the recorded file will be stored in the internal SD card or USB flash drive. For more information, refer to [Call and Conference Recording Using a Softkey](#) on page 337.

Before recording any call, especially those involving PSTN, it is necessary to know about the rules and restrictions of any governing call-recording in the place you are in. It is also very important to have the consent of the person you are calling before recording the conversation.

Call recording is not available on all servers. Contact your system administrator for more information.

**To configure a record key via phone user interface:**

1. Swipe down from the top of the screen or swipe left/right to go to the second idle screen.
2. Tap **Settings->Features->DSS Keys**.
3. Tap the desired line key.
4. Tap the **Type** field.
5. Tap **Key Event** in the pop-up dialog box.
6. Tap the **Key Type** field.
7. Tap **Record** in the pop-up dialog box.
8. (Optional.) Enter the string that will appear on the touch screen in the **Label** field.

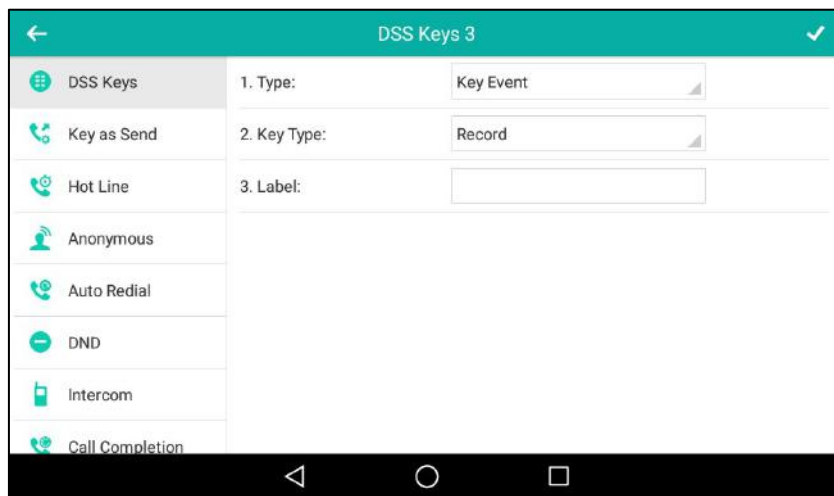

9. Tap ✓ to accept the change or ◀ to cancel.

**To configure a URL record key via phone user interface:**

1. Swipe down from the top of the screen or swipe left/right to go to the second idle screen.
2. Tap **Settings->Features->DSS Keys**.
3. Tap the desired line key.
4. Tap the **Type** field.
5. Tap **URL Record** in the pop-up dialog box.
6. (Optional.) Enter the string that will appear on the touch screen in the **Label** field.

7. Enter the URL (e.g., http://10.1.2.224/phonerecording.cgi) in the **URL Record** field.

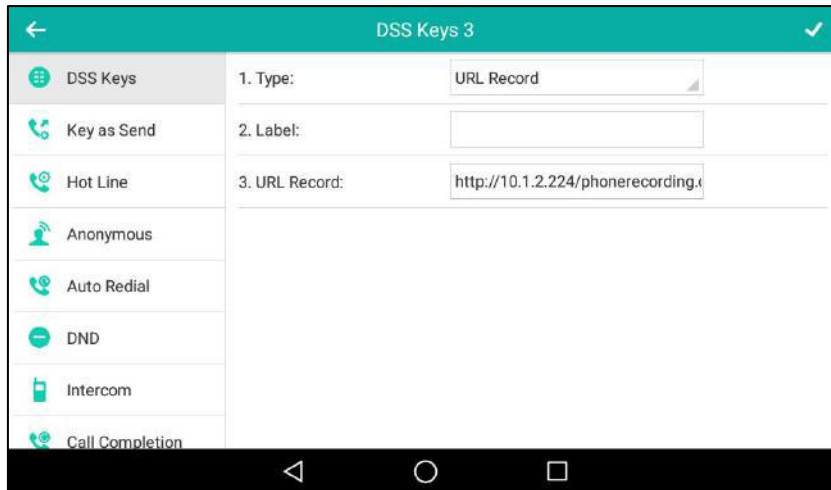

8. Tap to accept the change or to cancel.

Record and URL record keys are configurable via web user interface at the path **DSSKey->Line Key**.

**The Record and URL Record keys control the recording function, and are available:**

- During an active call
- When calls are on hold or muted
- During a conference call

**The Record and URL Record keys are not available when:**

- There are no connected calls on your phone
- You place a new call

**To record a call:**

1. Tap the Record key or URL Record key during a call.



If the recording starts successfully, the recording icon will appear at the bottom-right corner of the contact avatar and the icon indicator of the Record key or URL Record key will change to .

2. Tap the Record key or URL Record key again to stop recording.

The recording icon disappears from the bottom-right corner of the contact avatar and the icon indicator of the Record key or URL Record key changes to .

Recording status indications you need to know:

Circumstance	Icons on the touch screen
A recording is started	appears on the touch screen
A recording cannot be started	appears for 1 second

Circumstance	Icons on the touch screen
A recording cannot be stopped	 appears for 1 second, then goes back
The recording box is full	 appears for 1 second
The call cannot be recorded	 appears for 1 second

You can listen to the recordings stored on your server system. For example, you can dial an access code to listen to the recordings.

**Note**

The way in which you listen to the recordings may be different depending on the server. Contact your system administrator for more information.

## Hot Desking

Hot desking originates from the definition of being the temporary physical occupant of a work station or surface by a particular employee. A primary motivation for hot desking is cost reduction. This feature is regularly used in places where not all the employees are in the office at the same time, or not in the office for very long, which means that actual personal offices would be often vacant, consuming valuable space and resources.

You can use hot desking on the SIP-T58V/A smart media phone to log out of existing accounts and then log into a new account. As a result, many users can share the phone resource at different times. To use this feature, you need to configure a hot desking key in advance.

**Note**

Hot desking is not available on all servers. Contact your system administrator for more

### To configure a hot desking key via phone user interface:

1. Swipe down from the top of the screen or swipe left/right to go to the second idle screen.
2. Tap **Settings->Features->DSS Keys**.
3. Tap the desired line key.
4. Tap the **Type** field.
5. Tap **Key Event** in the pop-up dialog box.
6. Tap the **Key Type** field.
7. Tap **Hot Desking** in the pop-up dialog box.

8. (Optional.) Enter the string that will appear on the touch screen in the **Label** field.

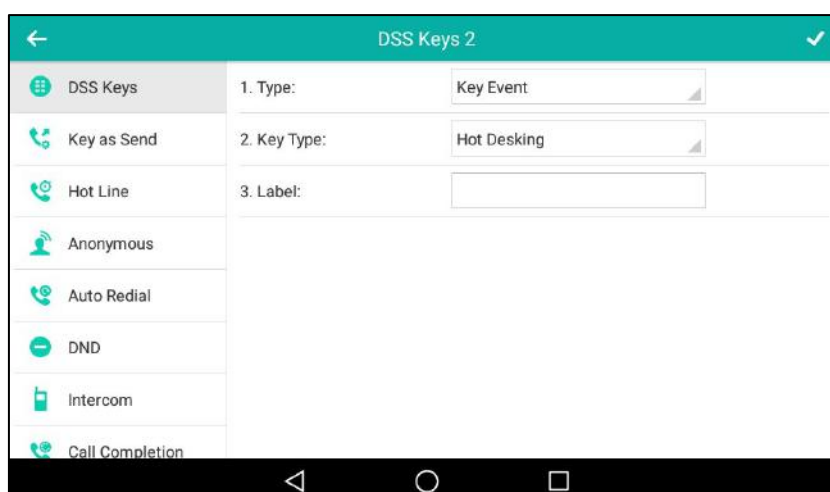

9. Tap ✓ to accept the change or ◀ to cancel.

Hot desking key is configurable via web user interface at the path **DSSKey->Line Key**.

**To use hot desking:**

1. Tap the hot desking key when the phone is idle.  
The touch screen prompts the following warning:

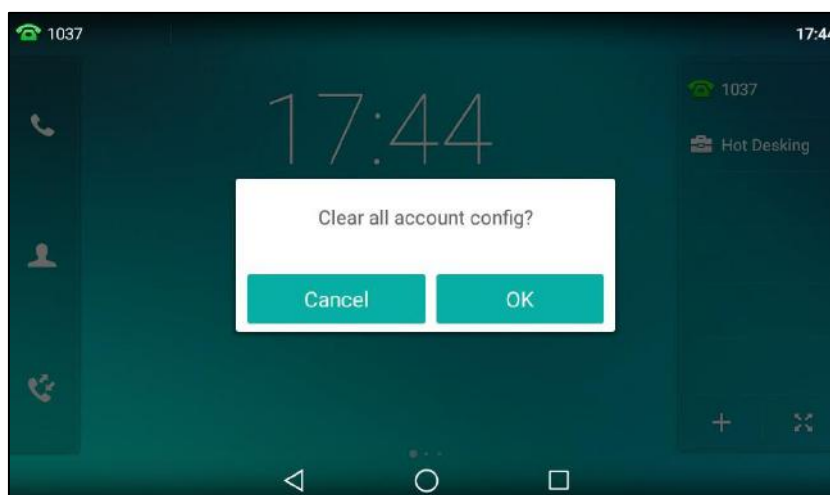

2. Tap **OK**.  
Registration configurations of all accounts on the phone will be cleared immediately.



The login wizard will be displayed as below:

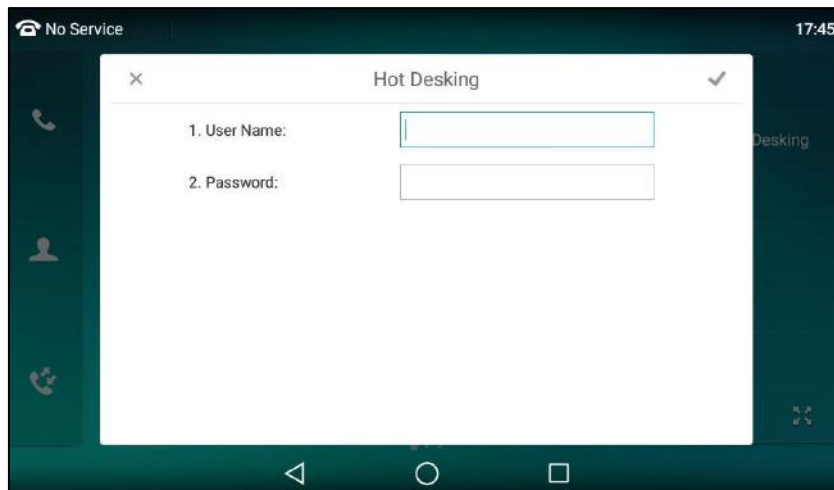

3. Enter the login information in each field.
4. Tap ✓ to accept the change or ◀ to cancel.

## Intercom

Intercom is a useful feature in an office environment to quickly connect with the operator or the secretary. You can tap the intercom key to automatically connect with a preconfigured target extension for outgoing intercom calls, and the target extension will automatically answer incoming intercom calls by default. You can also use intercom key to monitor the target extension for status changes on the phone.

**Note** Intercom is not available on all servers. Contact your system administrator for more information.

## Configuring the Intercom Feature on the Phone

### Configuring an Intercom Key

**To configure an intercom key via phone user interface:**

1. Swipe down from the top of the screen or swipe left/right to go to the second idle screen.
2. Tap **Settings**->**Features**->**DSS Keys**.
3. Tap the desired line key.
4. Tap the **Type** field.
5. Tap **Intercom** in the pop-up dialog box.
6. Tap the **Account ID** field.
7. Tap the desired line in the pop-up dialog box.
8. (Optional.) Enter the string that will appear on the touch screen in the **Label** field.
9. Enter the target extension number in the **Value** field.

- (Optional.) Enter the directed call pickup code in the **Extension** field.

If it is configured, when the target extension receives an incoming call, you can tap the intercom key to pick up the call directly. Contact your system administrator for more information.

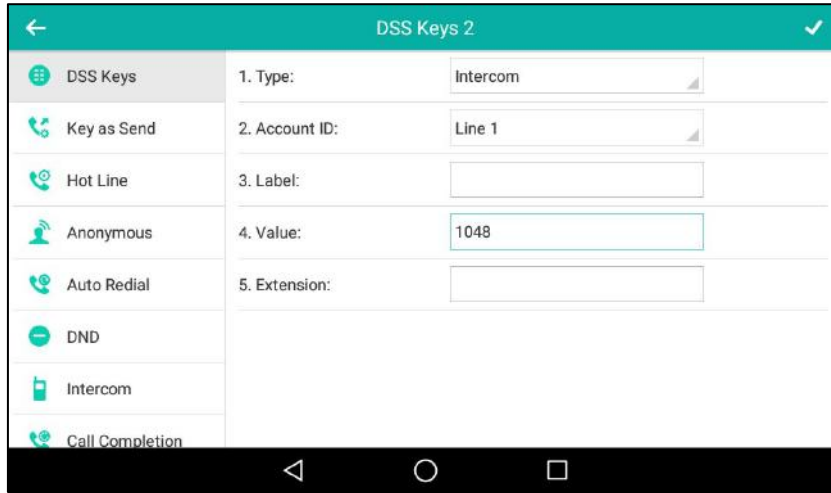

- Tap to accept the change or to cancel.

Intercom key is configurable via web user interface at the path **DSSKey->Line Key**.

## Incoming Intercom Calls

The SIP-T58V/A smart media phone supports automatically answering an incoming intercom call by default. The phone automatically plays a warning tone when it receives an incoming intercom call. In addition, you can enable the phone to mute the microphone when it automatically answers an incoming intercom call. You can also enable the phone to automatically answer an incoming intercom call while there is already an active call on the phone. The active call is then placed on hold.

Intercom features you need to know:

Intercom Feature	Description
Intercom Allow	Enable or disable the IP phone to automatically answer an incoming intercom call.
Intercom Mute	Enable or disable the IP phone's microphone for intercom calls.
Intercom Tone	Enable or disable the IP phone to play a warning tone when it receives an incoming intercom call.
Intercom Barge	Enable or disable the IP phone to automatically answer an incoming intercom call while there is already an active call on the phone.

### Intercom Allow

You can enable or disable the phone to automatically answer an incoming intercom call. If Intercom Allow is enabled, the phone will automatically answer an incoming intercom call. If

Accept Intercom is disabled, the phone will reject incoming intercom calls and send a busy message to the caller. Accept Intercom is enabled by default.

**Note**

Your administrator can set a period of delay time before the phone automatically answers intercom calls. Contact your system administrator for more information.

**Intercom Mute**

You can mute or un-mute the phone's microphone for intercom calls automatically. If Intercom Mute is enabled, the microphone will be muted for intercom calls. If Intercom Mute is disabled, the microphone will work for intercom calls. Intercom Mute is disabled by default.

**Intercom Tone**

You can enable or disable the phone to play a warning tone when receiving an intercom call. If Intercom Tone is enabled, the phone will play a warning tone before answering the intercom call. If Intercom Tone is disabled, the phone will automatically answer the intercom call without warning. Intercom Tone is enabled by default.

**Intercom Barge**

You can enable or disable the phone to automatically answer an incoming intercom call while there is already an active call on the phone. If Intercom Barge is enabled, the phone will automatically answer the intercom call and place the active call on hold. If Intercom Barge is disabled, the phone will handle an incoming intercom call like a waiting call. Intercom Barge is disabled by default.

**Note**

To enable the phone to receive a new incoming call when it has an active call, make sure that call waiting feature is enabled on the phone in advance. For more information, refer to [Call Waiting](#) on page 308.

**To configure intercom features via phone user interface:**

1. Swipe down from the top of the screen or swipe left/right to go to the second idle screen.
2. Tap **Settings->Features->Intercom**.

3. Make the desired changes.

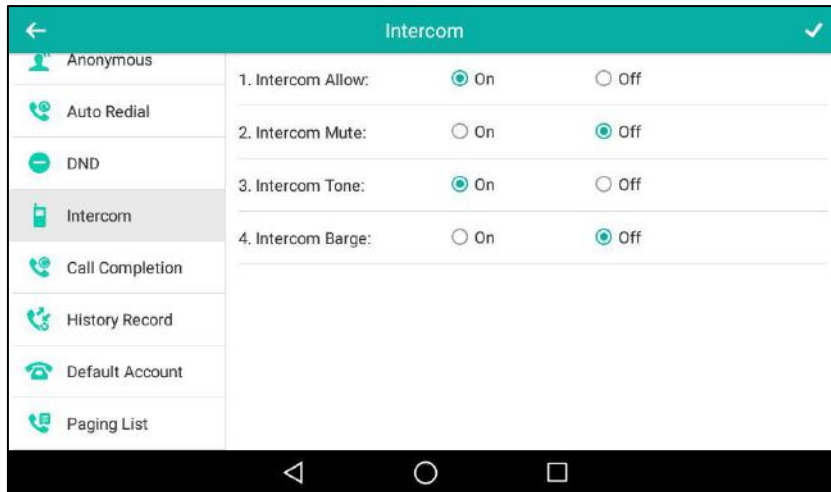

4. Tap ✓ to accept the change or ◀ to cancel.

These specific parameters are configurable via web user interface at the path **Features->Intercom**.

## Using Intercom Feature on the Phone

You can use the intercom key in the following ways:

- Place a call to the target extension.
- Pick up an incoming call of the target extension.

### Placing an Intercom Call to the Target Extension

**To place an intercom call when the target phone is idle:**

1. Tap the intercom key.

The target extension plays a warning tone and automatically answers the call in the hands-free (speakerphone) mode by default.

### Picking up an Incoming Call of the Target Extension

When the target extension receives an incoming call, the intercom key icon of the target extension will become  and solid. If you configure the directed call pickup code in advance, you can pick up the target extension's incoming call by tapping the intercom key. You can configure the directed call pickup code when configuring an intercom key. For more information, refer to [Configuring an Intercom Key](#) on page 345.

**To pick up an incoming call when the target phone is ringing:**

1. Tap the intercom key.

The incoming call of the target extension is answered on the IP phone.

**Note**

If the directed call pickup code is not configured, the phone will place a call to the target extension instead of picking up an incoming call of the target extension when you tap the intercom key.

## Multicast Paging

You can use multicast paging to quickly and easily broadcast time sensitive announcements out to people who are listening to a specific multicast group and a specific channel. You can configure a multicast paging key or a paging list key on the phone, which allows you to send a Real Time Transport Protocol (RTP) stream to the pre-configured multicast address(es) and channel(s) without involving SIP signaling. You can configure the phone to receive an RTP stream from pre-configured multicast listening address(es) and channel(s) without involving SIP signaling. You can specify up to 31 multicast listening addresses and channel(s) .

The following describes 31 paging channels:

- **0:** You can broadcast audio to channel 0. Note that the Yealink IP phones running old firmware version (old paging mechanism) can be regarded as listening to channel 0. It is the default channel.
- **1 to 25:** You can broadcast audio to a specific channel. We recommend that you specify these channels when broadcasting with Polycom IP phones which have 25 channels you can listening to.
- **26 to 30:** You can broadcast audio to a specific channel. We recommend that you specify these channels when broadcasting with Yealink IP phones running new firmware version (new paging mechanism).

The IP phones will automatically ignore all incoming multicast paging calls on the different channel.

## Sending RTP Stream

**To configure a multicast paging key via phone user interface:**

1. Swipe down from the top of the screen or swipe left/right to go to the second idle screen.
2. Tap **Settings->Features->DSS Keys**.
3. Tap the desired line key.
4. Tap the **Type** field.
5. Tap **Key Event** in the pop-up dialog box.
6. Tap the **Key Type** field.

7. Tap **Multicast Paging** in the pop-up dialog box.
8. (Optional.) Enter the string that will appear on the touch screen in the **Label** field.
9. Enter the multicast IP address and port number (e.g., 224.5.6.20:10008) in the **Value** field.  
The valid multicast IP addresses range from 224.0.0.0 to 239.255.255.255.
10. Enter the desired channel in the **Channel** field.  
The valid channel ranges from 0 to 30.

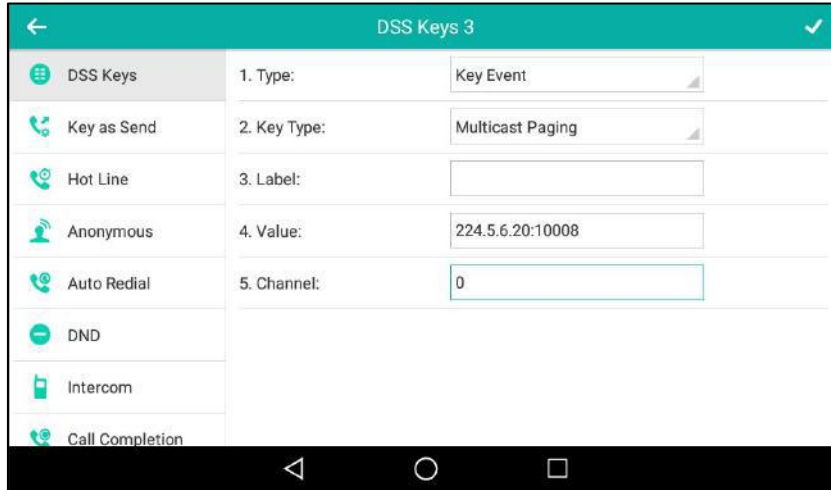

11. Tap ✓ to accept the change or ◀ to cancel.

Multicast paging key is configurable via web user interface at the path **DSSKey->Line Key**.

**To configure a paging list key via phone user interface:**

1. Swipe down from the top of the screen or swipe left/right to go to the second idle screen.
2. Tap **Settings->Features->DSS Keys**.
3. Tap the desired line key.
4. Tap the **Type** field.
5. Tap **Key Event** in the pop-up dialog box.
6. Tap the **Key Type** field.
7. Tap **Paging List** in the pop-up dialog box.

- (Optional.) Enter the string that will appear on the touch screen in the **Label** field.

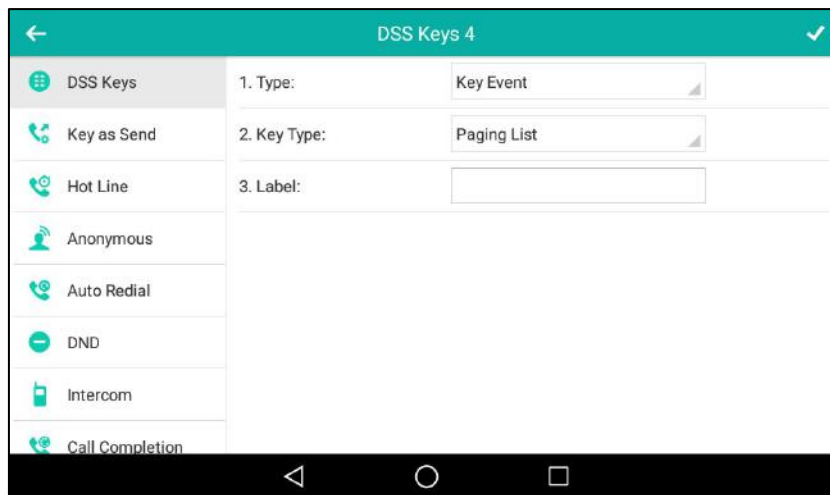

- Tap to accept the change or to cancel.

Paging list key is configurable via web user interface at the path **DSSKey->Line Key**.

#### To configure paging list via phone user interface:

- Tap the paging list key when the phone is idle.

If the paging list key is not configured, you can also swipe down from the top of the screen or swipe left/right to go to the second idle screen. Then tap **Settings->Features->Paging List** to configure the paging list.

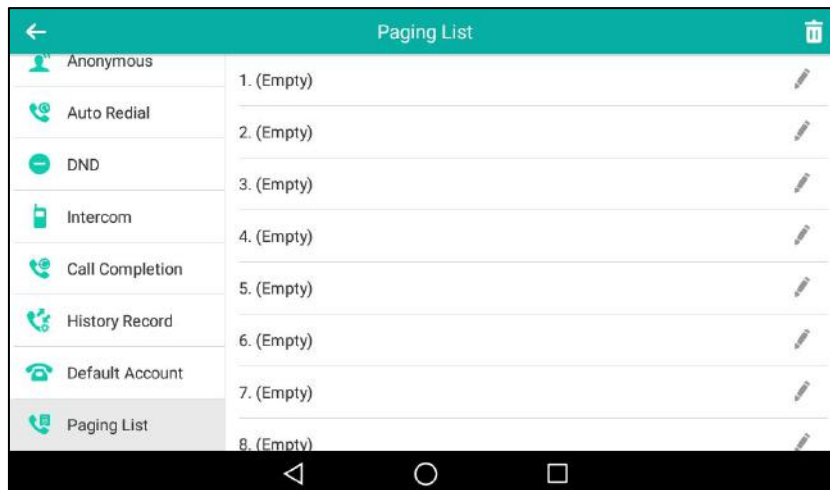

- Tap after the desired paging group.
- Enter the multicast IP address and port number (e.g., 224.5.6.20:10008) in the **Address** field.

The valid multicast IP addresses range from 224.0.0.0 to 239.255.255.255.

- Enter the paging group name in the **Label** field.
- Enter the desired channel in the **Channel** field.

The valid channel ranges from 0 to 30.

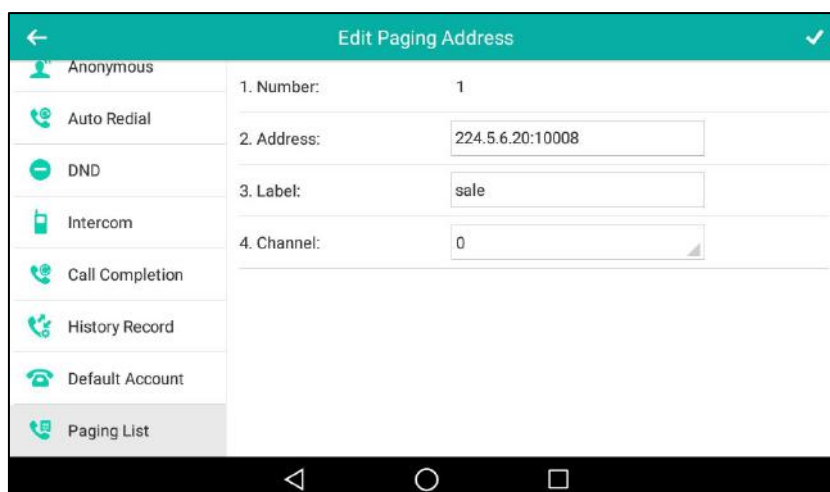

6. Tap ✓ to accept the change or ◀ to cancel.
7. Repeat steps 2 to 6, you can add more paging groups.

Paging list is configurable via web user interface at the path **Directory->Multicast IP**.

**To delete paging group via phone user interface:**

1. Tap the paging list key when the phone is idle.

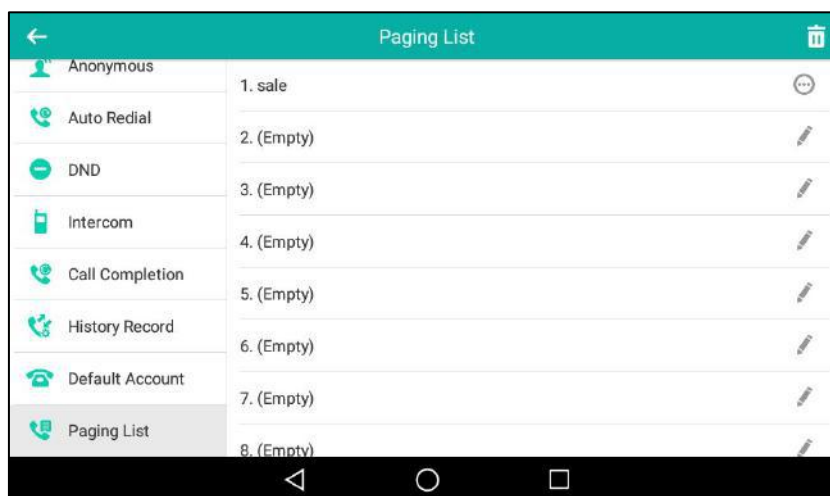



2. Tap  after the desired paging group.

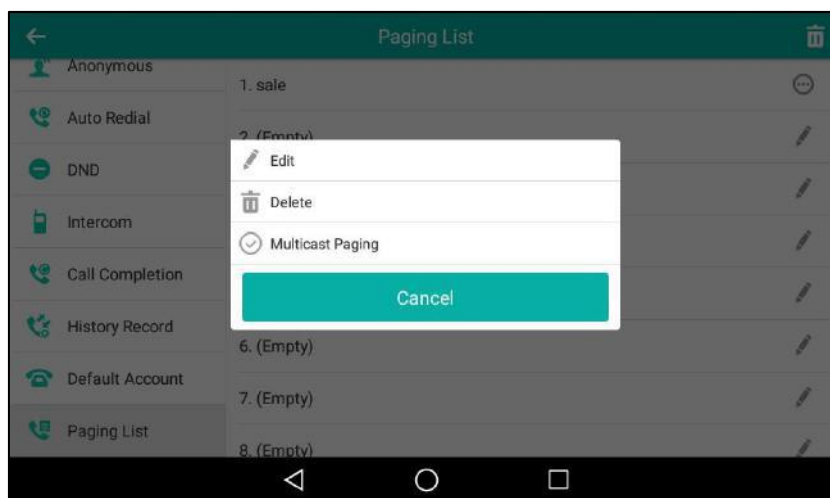

**Note** The icon  only appears after the configured paging group.

3. Tap **Delete**.

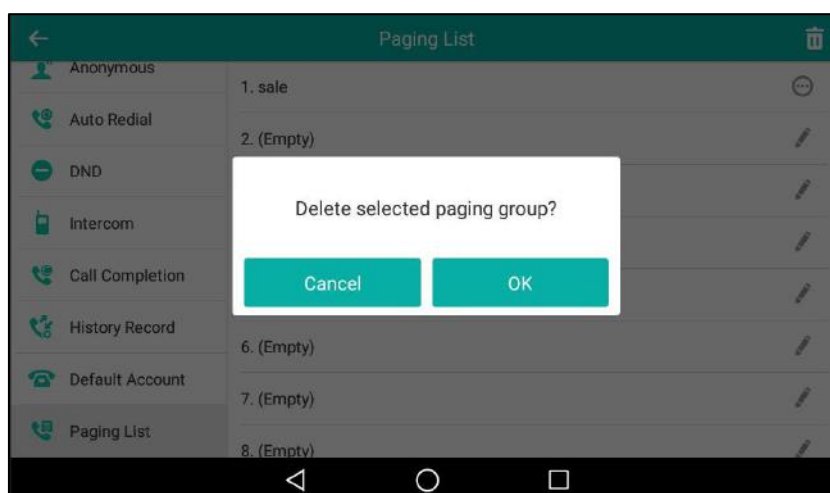

4. Tap **OK** to accept the change or **Cancel** to cancel.

If you want to delete all paging groups, you can tap  on the top-right of the touch screen.

You can also configure the phone to use a default codec for sending multicast RTP stream via web user interface.

**To configure a default codec for multicast paging via web user interface:**

1. Click on **Features->General Information**.
2. Select the desired codec from the pull-down list of **Multicast Codec**.

The default codec is G722.

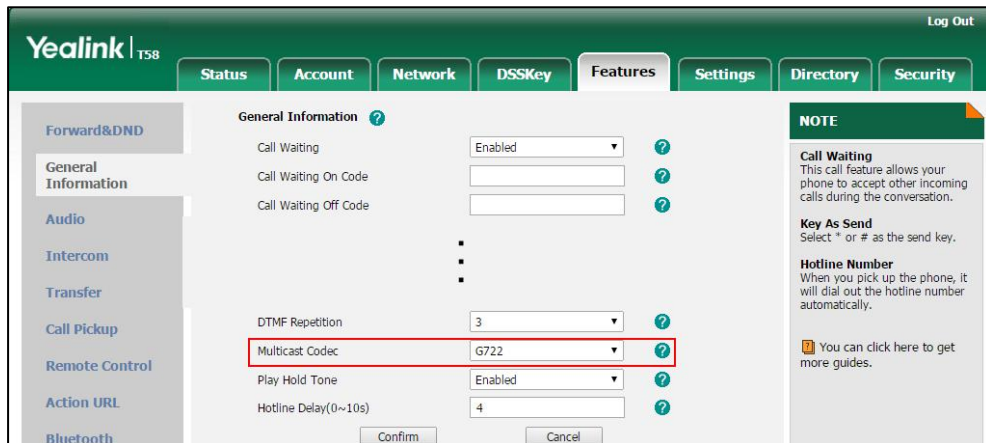

3. Click **Confirm** to accept the change.

**Note** If G722 codec is used for multicast paging, the touch screen will display the icon  to indicate that it is providing high definition voice.

Default codec for multicast paging is configurable via web user interface only.

## Receiving RTP Stream

You can configure the phone to receive a Real Time Transport Protocol (RTP) stream from the pre-configured multicast address(es) and channel(s) without involving SIP signaling. You can specify up to 31 multicast addresses and channel(s) that the phone listens to on the network.

**Note** RTP stream is listened in the hands-free (speakerphone) mode by default. If you want to listen the RTP stream using the engaged audio device (speakerphone, handset or headset), contact your system administrator for more information.

Fixed volume to play RTP stream for specified paging group is configurable by your system administrator.

How the phone handles incoming multicast paging calls depends on Paging Barge and Paging Priority Active parameters configured via web user interface.

### Paging Barge

Paging Barge feature defines the lowest priority of the multicast listening address from which the phone can receive an RTP stream when there is a voice call (a normal phone call rather than a multicast paging call) in progress. If it is disabled, all incoming multicast paging calls will be automatically ignored. If it is set to a specify priority value, the incoming multicast paging calls with higher or equal priority are automatically answered and the ones with lower priority are ignored. Valid values for Paging Barge:

- **1 to 31:** Define the lowest priority of the multicast listening address from which the phone

can receive an RTP stream, 1 with the highest priority, 31 with the lowest.

- **Disabled:** The voice call in progress will take precedence over all incoming paging calls.

### Paging Priority Active

Paging Priority Active feature decides how the phone handles incoming multicast paging calls when there is already a multicast paging call on the phone. If enabled, the phone will ignore incoming multicast paging calls with lower priorities, otherwise, the phone will answer incoming multicast paging calls automatically and place the previous multicast paging call on hold. If disabled, the phone will automatically ignore all incoming multicast paging calls.

### To configure multicast listening addresses via web user interface:

1. Click on **Directory**->**Multicast IP**.
2. Select the desired value from the pull-down list of **Paging Barge**.
3. Select the desired value from the pull-down list of **Paging Priority Active**.
4. Enter the multicast IP address(es) and port number (e.g., 224.5.6.20:10008) which the phone listens to for incoming RTP multicast in the **Listening Address** field.
5. (Optional.) Enter the label in the **Label** field.  
Label will appear on the touch screen when receiving the multicast RTP stream.
6. Select the desired channel to listen from the pull-down list of **Channel**.  
The default channel is 0.

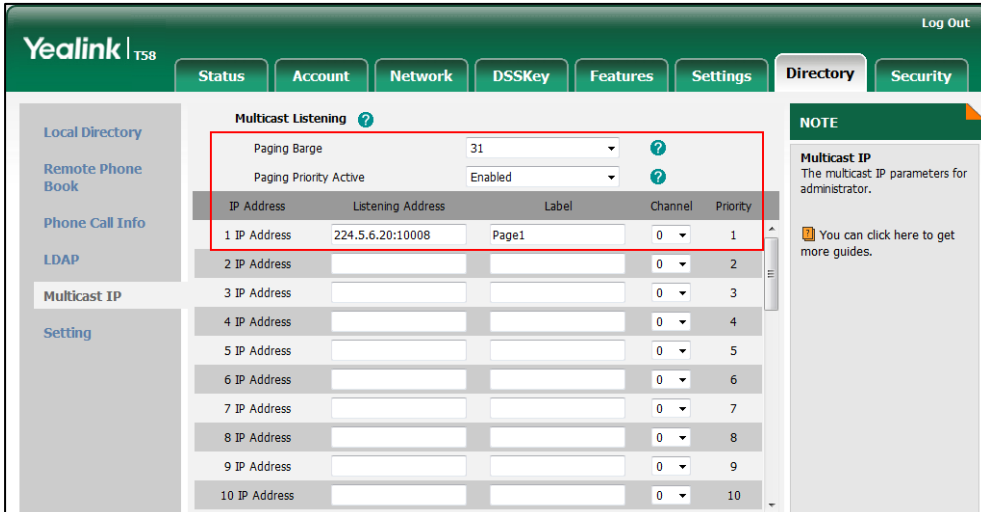

IP Address	Listening Address	Label	Channel	Priority
1 IP Address	224.5.6.20:10008	Page1	0	1
2 IP Address			0	2
3 IP Address			0	3
4 IP Address			0	4
5 IP Address			0	5
6 IP Address			0	6
7 IP Address			0	7
8 IP Address			0	8
9 IP Address			0	9
10 IP Address			0	10

7. Click **Confirm** to accept the change.

### Note

The priorities of listening addresses are predefined: 1 with the highest priority, 31 with the lowest. Multicast listening addresses are configurable via web user interface only.

## Using Multicast Paging

### To send RTP stream via a multicast paging key when the receiver's phone is idle:

1. Tap the multicast paging key when the phone is idle.  
The phone sends RTP to a preconfigured multicast address (IP: Port).  
Both the sender's and receiver's phones play a warning tone and the receiver automatically answers the multicast RTP session in the hands-free (speakerphone) mode.  
The multicast paging key icon will become  and solid.  
The following figure shows a multicast RTP session on the phone:

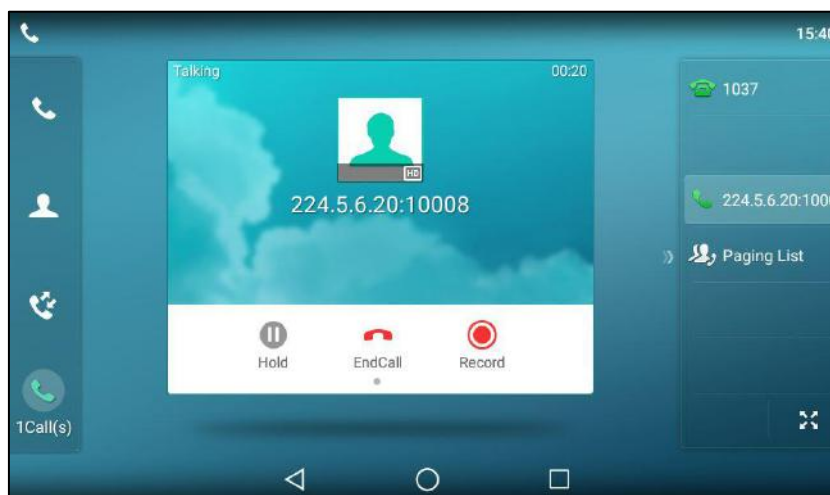

2. You can do the following:
  - Tap the **Hold** soft key to place the current multicast RTP session on hold.  
The sender's phone places the multicast RTP session on hold and receiver's phone releases the session.  
To resume the held multicast RTP session, tap the **Resume** soft key.  
The multicast RTP session is established again.
  - Tap the **EndCall** soft key to cancel the multicast RTP session.
  - Tap the **Record** soft key to record a call.  
To stop recording, tap the **Stop** soft key.

#### Note

Multicast RTP is one way only from the sender to the multicast address(es) (receiver). For outgoing RTP multicasts, all other existing calls on the phone will be placed on hold.

### To send RTP stream via a paging key list when the receiver's phone is idle:

1. Tap paging list key when the phone is idle.
2. Do one of the following to send RTP:
  - Tap the desired paging group.

- Tap  after the desired paging group, and then tap **Multicast Paging**.
3. You can do the following:
- Tap the **Hold** soft key to place the current multicast RTP session on hold.  
The sender's phone places the multicast RTP session on hold and receiver's phone releases the session.  
To resume the held multicast RTP session, tap the Resume soft key.  
The multicast RTP session is established again.
  - Tap the **EndCall** soft key to cancel the multicast RTP session.
  - Tap the **Record** soft key to record a call.  
To stop recording, tap the **Stop** soft key.

## Music on Hold

Music on hold (MoH) is the business practice of playing recorded music to fill the silence that would be heard by the party placed on hold. To use this feature, you should specify a SIP URI pointing to a Music on Hold Server account. When a call is placed on hold, the phone will send a SIP INVITE message to the Music on Hold Server account. The Music on Hold Server account automatically answers the SIP INVITE messages and immediately plays audio from some source located anywhere (LAN, Internet) to the held party. Contact your system administrator for the SIP URI.

### To configure music on hold server via web user interface:

1. Click on **Account->Advanced**.
2. Select the desired account from the pull-down list of **Account**.
3. Enter the SIP URI (e.g., sip:moh@sip.com) in the **Music Server URI** field.

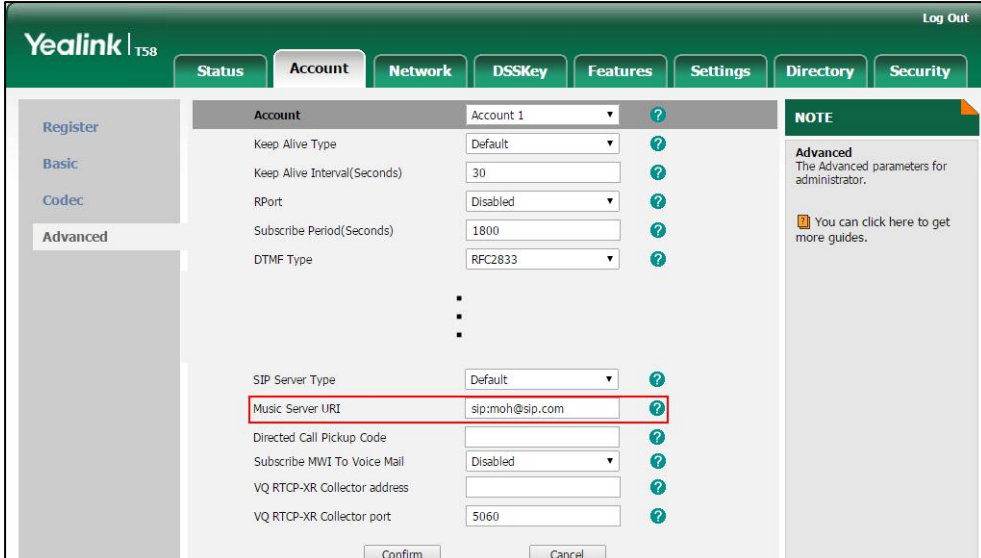

The screenshot shows the Yealink T58 web user interface. The top navigation bar includes 'Status', 'Account', 'Network', 'DSSKey', 'Features', 'Settings', 'Directory', and 'Security'. The 'Account' section is active, showing a list of accounts with 'Account 1' selected. The 'Advanced' configuration tab is selected, displaying various settings. The 'Music Server URI' field is highlighted with a red box and contains the value 'sip:moh@sip.com'. Other settings include 'Keep Alive Type' (Default), 'Keep Alive Interval(Seconds)' (30), 'RPort' (Disabled), 'Subscribe Period(Seconds)' (1800), 'DTMF Type' (RFC2833), 'SIP Server Type' (Default), 'Directed Call Pickup Code', 'Subscribe MWI To Voice Mail' (Disabled), 'VQ RTPC-XR Collector address', and 'VQ RTPC-XR Collector port' (5060). A 'NOTE' section on the right states: 'Advanced: The Advanced parameters for administrator. You can click here to get more guides.' The bottom of the page has 'Confirm' and 'Cancel' buttons.

4. Click **Confirm** to accept the change.

When you place a call on hold, music will be played to the held party.

**Note** For this feature to function, all involved parties cannot use encrypted RTP (SRTP).  
Music on hold server is configurable via web user interface only.

## Automatic Call Distribution (ACD)



ACD is often used in offices for customer service, such as call center. The ACD system handles large volumes of incoming calls from callers who have no need to talk to a specific person but who require assistance from any of multiple persons at the earliest opportunity. ACD on the SIP-T58V/A IP phone allows the ACD system to distribute large volumes of incoming calls to the registered ACD users. To use this feature, you should configure an ACD key in advance. For more information on ACD key LED indicators, refer to [Line Key Icons](#) on page 17.

**Note** ACD is not available by default. Check with your system administrator to find out if this feature is available on your phone.

### To configure an ACD key via phone user interface:

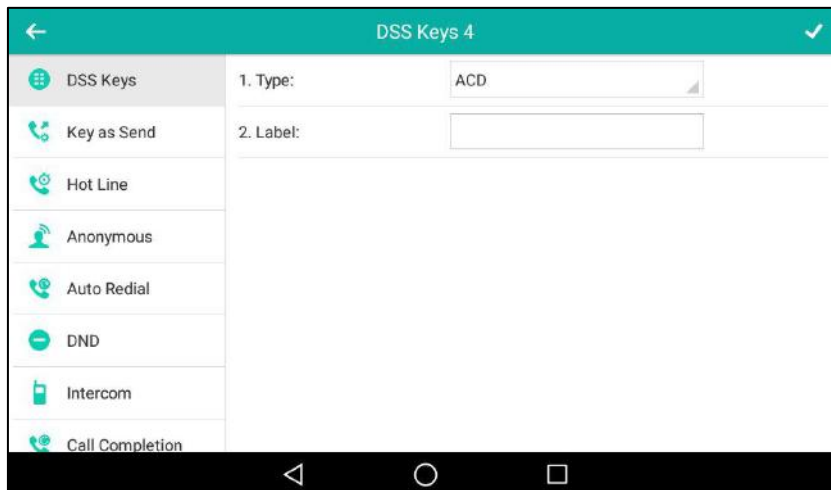
1. Swipe down from the top of the screen or swipe left/right to go to the second idle screen.
2. Tap **Settings->Features->DSS Keys**.
3. Tap the desired line key.
4. Tap the **Type** field.
5. Tap **ACD** in the pop-up dialog box.
6. (Optional.) Enter the string that will appear on the touch screen in the **Label** field.



7. Tap  to accept the change or  to cancel.

ACD key is configurable via web user interface at the path **DSSkey->Line Key**.

**To log into the ACD system:**

1. Tap the ACD key when the phone is idle.

The touch screen prompts you the following information:

**User ID:** the identity used to log into the queue.

**Password:** the password used to log into the queue.

2. Tap **Login** to log in.

**Note**

Contact your system administrator for the User ID and Password to access the ACD system.

After configuring an ACD key, you can tap the ACD key to log into the ACD system. After logging in, you are ready to receive calls from the ACD system. You can tap the ACD key to show your current ACD user status. You can tap **Available/Unavailable** to change your ACD user status. ACD user status synchronizes on both IP phone and ACD system.

When you set the ACD user status to be available, the ACD key icon indicator will become  and solid, and then the server begins distributing calls to your IP phone.

When you set the ACD user status to be unavailable, the ACD key icon indicator will become  and flashing, and then the server temporarily stops distributing calls to your IP phone. To log out of the ACD system, tap **Logout**.

**Note**

It is recommended that you configure only one ACD key per phone, since only one ACD key can be in use on your phone at any time.

## Shared Call Appearance (SCA)

You can use SCA feature to share an extension which can be registered on two or more IP phones at the same time. The shared line is indicated by a different line icon.

In the following figure, the first line is shared and the second line is private:



If two phones share a line, an incoming call to this extension will cause both phones to ring simultaneously. The incoming call can be answered on either phone but not both.

This feature is very useful in the boss and secretary scenario. For example, the secretary can share the boss's extension on her phone. When there is an incoming call to the extension of the boss, both the phones of the boss and the secretary will ring simultaneously. Either the boss or the secretary can answer the call. Calls on the shared line can be placed on hold, barged in or retrieved from another shared phone.



## Configuring SCA Feature on the IP Phone

You can configure a primary account on the IP phone and other alternate accounts on the other IP phones. In a SCA Hybrid Key System scenario, you can automatically assign multiple DSS keys with Line type for a registered shared line on the phone (If auto linekeys feature is enabled). For example, party A, party B share the account 4603, phone A registers the primary account 4603 and assigns line key 1 and line key 2 for the account 4603, phone B registers the alternate account 4603\_1 and assigns line key 1 and line key 2 for the account 4603\_1, phone C registers the account 4604.

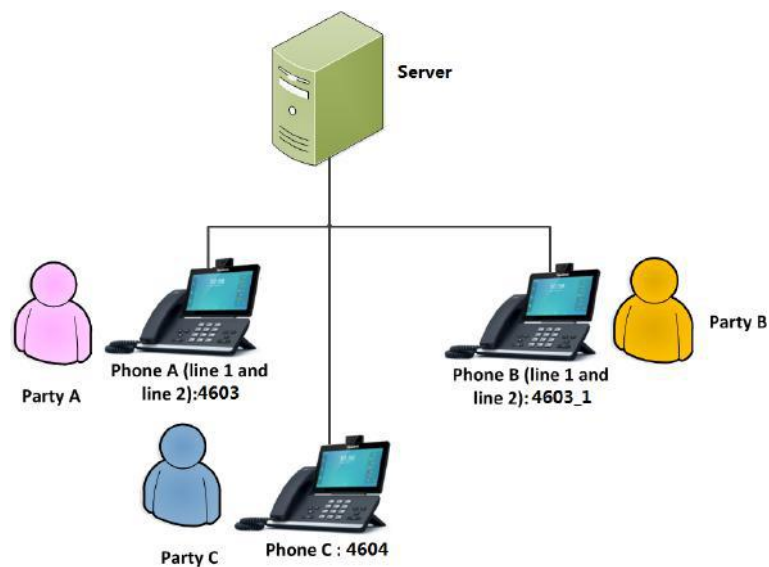

**To configure the auto linekeys feature via web user interface:**

1. Click on **Features-> General Information**.
2. Select **Enabled** from the pull-down list of **Auto LineKeys**.

If **Auto LineKeys** is enabled, you can automatically assign multiple DSS keys with Line type for a registered shared line on the phone.

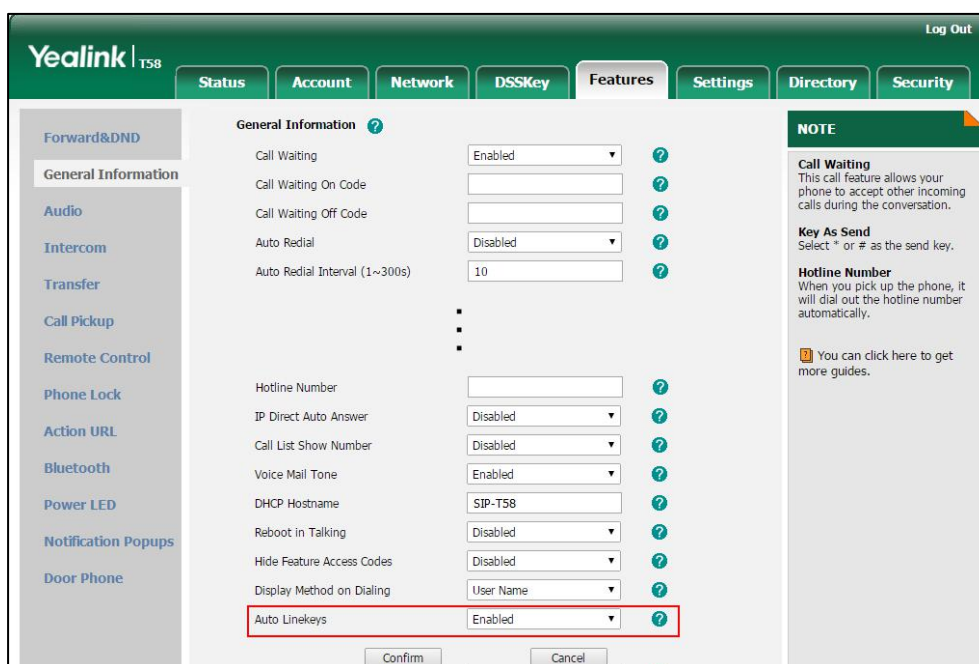

3. Click **Confirm** to accept the change.

To configure the shared line settings and the number of line key on phone A via web user interface:

1. Register the primary account 4603.

The screenshot shows the Yealink T58 web interface for configuring Account 1. The 'Account' tab is selected, and the 'Register' section is highlighted with a red box. The 'SIP Server 1' section is also highlighted with a red box. The 'Outbound Proxy Server' section is highlighted with a red box. The 'NOTE' section on the right provides additional information. The page includes a 'Log Out' link in the top right corner and 'Confirm' and 'Cancel' buttons at the bottom.

2. Click on **Advanced**, and then select **Share Call Appearance** from the pull-down list of **Shared Line**.
3. Enter the desired number in the **Number of line key** field.  
This field appears only if **Auto Linekeys** feature is enabled.

The default value is 1. In this example, the value is set to 2.

The screenshot shows the Yealink T58 web interface. The top navigation bar includes 'Status', 'Account', 'Network', 'DSSKey', 'Features', 'Settings', 'Directory', and 'Security'. The 'Account' tab is selected, and the 'Advanced' sub-tab is active. The main configuration area is titled 'Account' and shows 'Account 1' selected. A list of configuration parameters is displayed, including 'Keep Alive Type', 'Keep Alive Interval(Seconds)', 'RPort', 'Subscribe Period(Seconds)', 'DTMF Type', 'DTMF Info Type', 'DTMF Payload Type(96~127)', 'Retransmission', 'Shared Line', 'Call Pull Feature Access Code', 'Out Dialog BLF', 'VQ RTPC-XR Collector name', 'VQ RTPC-XR Collector address', 'VQ RTPC-XR Collector port', and 'Number of line key'. The 'Number of line key' field is highlighted with a red box and contains the value '2'. Other fields like 'Shared Line' and 'VQ RTPC-XR Collector port' are also highlighted with red boxes. A 'NOTE' section on the right states: 'Advanced The Advanced parameters for administrator. You can click here to get more guides.' At the bottom, there are 'Confirm' and 'Cancel' buttons.

4. Click **Confirm** to accept the change.

The phone A will automatically configure the line keys from the first unused DSS key, according to the configured number in the **Number of line key** field.

To configure the shared line settings and the number of line key on phone B via web user interface:

1. Register the alternate account 4603\_1.  
(Enter the primary account 4603 in the **Register Name** field.)

The screenshot shows the Yealink T58 web interface for configuring an account. The 'Account' tab is selected, and the 'Register' section is active. The 'Register Status' is 'Registered'. The 'Line Active' dropdown is set to 'Enabled'. The 'Label' field contains '4603\_1'. The 'Display Name' field contains '4603\_1'. The 'Register Name' field contains '4603'. The 'User Name' field contains '4603\_1'. The 'Password' field is masked with dots. The 'SIP Server 1' section is expanded, showing 'Server Host' as 'pbx.yealink.com' and 'Port' as '5060'. The 'SIP Server 2' section is collapsed. The 'Enable Outbound Proxy Server' dropdown is set to 'Enabled'. The 'Outbound Proxy Server 1' field contains '10.1.8.11' and 'Port' is '5060'. The 'Outbound Proxy Server 2' field is empty and 'Port' is '5060'. The 'Proxy Fallback Interval' is '3600'. The 'NAT' dropdown is set to 'Disabled'. A 'NOTE' section on the right provides information about 'Display Name', 'Register Name', 'User Name', and 'NAT Traversal'. A 'Confirm' button and a 'Cancel' button are at the bottom.

2. Click on **Advanced**, and then select **Share Call Appearance** from the pull-down list of **Shared Line**.
3. Enter the desired number in the **Number of line key** field.  
This field appears only if **Auto Linekeys** feature is enabled.

The default value is 1. In this example, the value is set to 2.

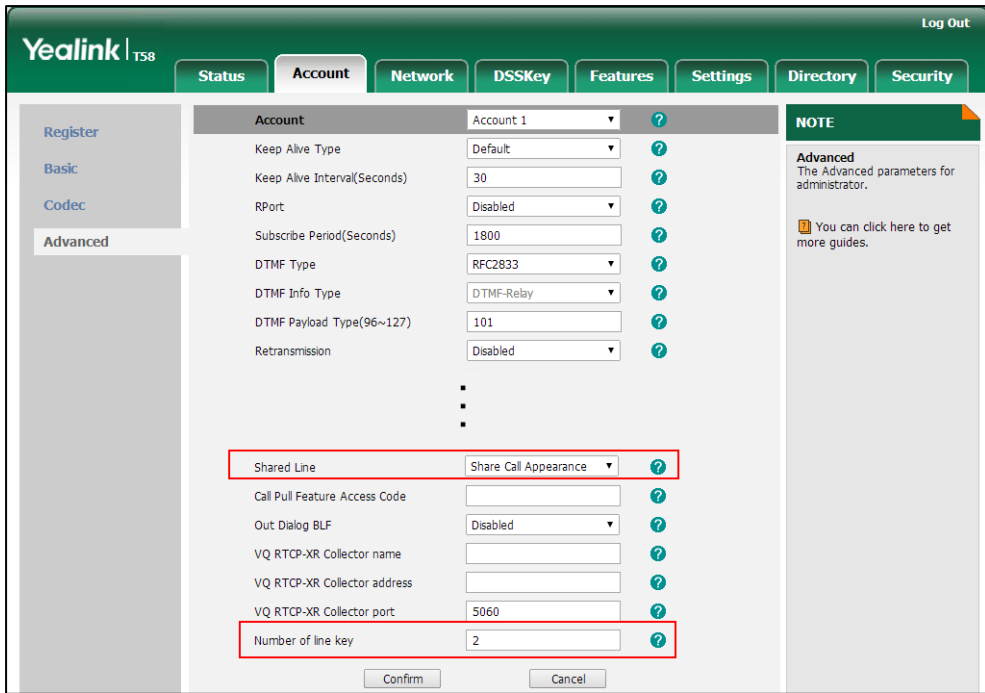

4. Click **Confirm** to accept the change.

The phone B will automatically configure the line keys from the first unused DSS key, according to the configured number in the **Number of line key** field.

### Configuring Private Hold Soft Key or Private Hold Key

Public hold allows any shared line to retrieve the held call. Private hold only allows the hold party to retrieve the held call. For example, you can retrieve the held call on either phone A or phone B when you place a call on public hold; you can retrieve the held call only on phone A when you place a call on private hold on phone A. By default, the private hold soft key isn't displayed on the touch screen. You need to configure either the private hold soft key or a private hold key before you place the call on private hold.

**To configure the private hold soft key via web user interface:**

1. Click on **Settings->Softkey Layout**.
2. Select **Enabled** from the pull-down list of **Custom Softkey**.
3. Select **On Talk** from the pull-down list of **Call States**.
4. Select **Private Hold** from the **Unselected Softkeys** column and then click  .

The **Private Hold** appears in the **Selected Softkeys** column.

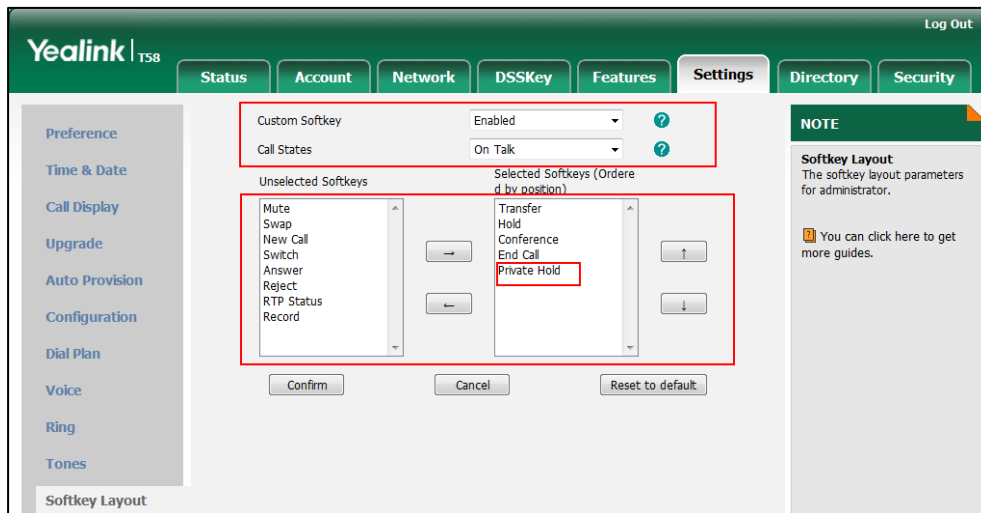



5. Click **Confirm** to accept the change.

**Note** Configuring the private hold soft key may affect the softkey layout in the Talking state. Contact your administrator for more information.

**To configure a private hold key via phone user interface:**

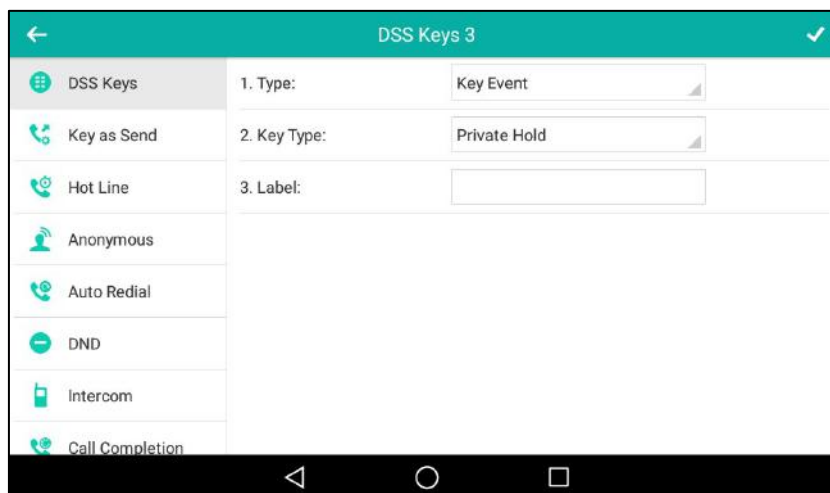
1. Swipe down from the top of the screen or swipe left/right to go to the second idle screen.
2. Tap **Settings->Features->DSS Keys**.
3. Tap the desired line key.
4. Tap the **Type** field.
5. Tap **Key Event** in the pop-up dialog box.
6. Tap the **Key Type** field.
7. Tap **Private Hold** in the pop-up dialog box.
8. (Optional.) Enter the string that will appear on the touch screen in the **Label** field.



9. Tap  to accept the change or  to cancel.

## Configuring Call Pull Feature

Call pull feature allows users to retrieve an existing call from another shared phone that is in active or public hold status.

**To configure the call pull feature access code via web user interface:**

1. Click on **Account->Advanced**.
2. Select the desired account from the pull-down list of **Account**.
3. Enter the call pull feature access code (e.g., \*11) in the **Call Pull Feature Access Code** field.

4. Click **Confirm** to accept the change.

The phone will dial out “\*11” automatically when you tap the **CallPull** soft key.

## Using SCA Feature on the IP Phone

This section provides you with detailed information on using the SIP-T58V/A smart media phone in a SCA Hybrid Key System scenario. In a SCA Hybrid Key System scenario, the status of the line key icon which associates with a shared line will change. For more information on line key icon, refer to [Icon Instructions](#) on page 16.

You can do the following using the IP phone in a SCA Hybrid Key System scenario:

- Place calls
- Answer calls
- Place a call on hold
- Retrieve a held call





- Barge in an active call
- Call Pull

## Placing Calls

You can have one call or multiple calls on the shared line.



### To place a call on the shared line:

Do one of following:

- Enter the desired number using the keypad or the dial pad on the touch screen when the phone is idle.  
Press , or tap **Send**.  
The phone will dial the entered number using the first line key.
- Tap the line key when the phone is idle to enter the dialing screen.  
Enter the desired number using the keypad or the dial pad on the touch screen and then press , or tap **Send**.  
The phone will dial the entered number using the selected line key.

### To place multiple calls on the shared line:

You can have more than one call on the shared line. To place a new call when there is an active call on the line key 1 of phone A, do one of the following on phone A:

- Press  or tap the **Hold** soft key. The original call is placed on hold.  
Tap the **NewCall** soft key to enter the dialing screen.  
Enter the desired number using the keypad or the dial pad on the touch screen.  
Press , or tap **Send**.  
Phone A will dial the entered number using the line key 2 automatically.
- Tap the line key. The original call is placed on hold.  
Enter the desired number using the keypad or the dial pad on the touch screen.  
Press , or tap **Send**.  
Phone A will dial the entered number using the selected line key.





## Answering Calls

You can have one call or multiple calls on the shared line. Incoming calls will be distributed evenly among the available line keys.

### To answer a call on the shared line:

When an incoming call arrives on the shared line, the phone A and phone B will ring simultaneously, and the icon indicators of the line key 1 on both phone A and phone B will become , and flashing. You can answer the incoming call on either phone A or phone B but not both.

Do one of the following on phone A or phone B:

- Tap the line key 1,  or tap the **Answer** soft key on phone A.  
The icon indicators of the line key 1 on phone A and phone B will become  and solid.
- Tap the line key 1,  or tap the **Answer** soft key on phone B.  
The icon indicators of the line key 1 on phone A and phone B will become  and solid.

**To answer multiple calls on the shared line:**

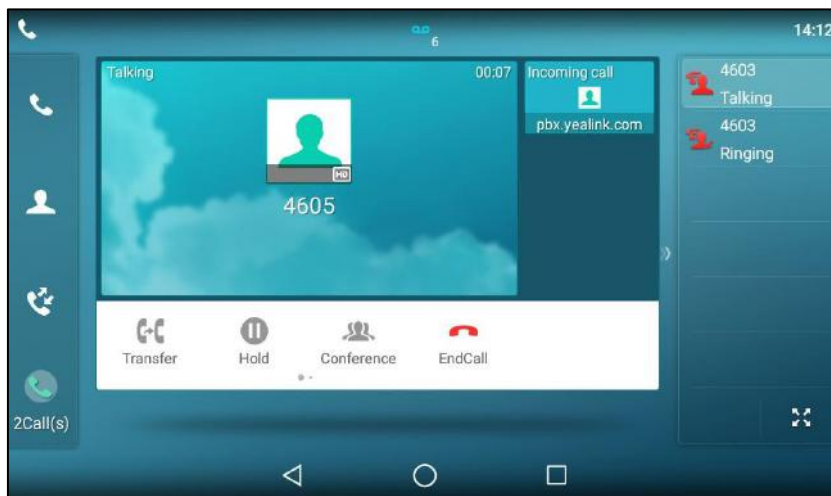

An incoming call arrives on the shared line when there is an active call on phone A's line key 1. The icon indicators of the line key 2 on both phone A and phone B will become  and flashing. You can answer the incoming call on either phone A or phone B. The touch screen of phone A displays the information of the incoming call (e.g., "Incoming call pbx.yealink.com").



**Note** Make sure call waiting feature is enabled on phone A. For more information, refer to [Call Waiting](#) on page 308.

Do one of the following on phone A:



- Tap the line key 2. Phone B stops ringing.
- Tap the **Answer** soft key. Phone B stops ringing.
- Tap the incoming call prompt box.  
Tap the **Answer** soft key. Phone B stops ringing.

The incoming call is answered and the original call is placed on hold. The icon indicators of the line key 1 on phone A and phone B will become  and solid indicating that there is the held call on the line key 1. The icon indicators of the line key 2 on phone A and phone B will become  and solid indicating that there is an active call on the line key 2.

You can also answer the call on phone B. Do one of the following on phone B:

- Tap the line key 2. Phone A stops ringing.

- Tap the **Answer** soft key. Phone A stops ringing.

The icon indicators of the line key 2 on phone A and phone B will become  and solid indicating that there is an active call on the line key 2. Meanwhile, the icon indicators of the line key 1 phone A and phone B will become  and solid indicating that there is the held call on the line key 1.

#### Note

If the number of incoming calls is greater than the configured line keys, the line keys will be used by sequence circulation.

## Placing a Call on Hold

### To place a call on public hold:

1. Press  or tap the **Hold** soft key on phone A when party A and party C are talking.





The icon indicators of line key 1 on phone A and phone B will become .

### To place a call on private hold:

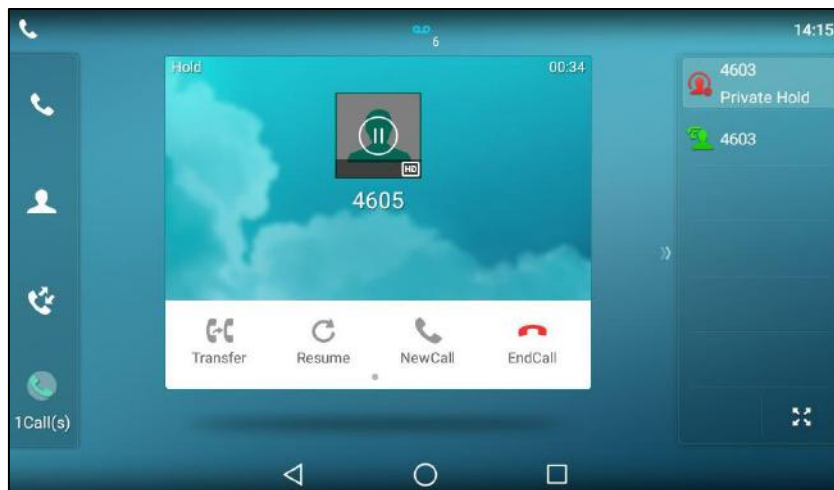
1. Press the **PriHold** soft key or private hold key on phone A when there is an active call on the shared line (You may need to swipe the soft key area left to see the **PriHold** soft key).



The icon indicators of line key 1 on phone A will become  when the shared line call is placed on private hold.



The icon indicators of line key 1 on phone B will become  when the shared line call is placed on private hold.

## Retrieving a Held Call

### To retrieve a call placed on public hold:

You can retrieve the public held call on either phone A or phone B.

#### To retrieve the call on phone A:

1. Tap , press  or tap the **Resume** soft key.  
The conversation between phone A and phone C is retrieved.

#### To retrieve the call on phone B:

Do one of the following:

- Tap .
- Long tap the desired line key. The **Cancel**, **CallPull**, **NewCall** and **Retrieve** soft keys appear on the touch screen.

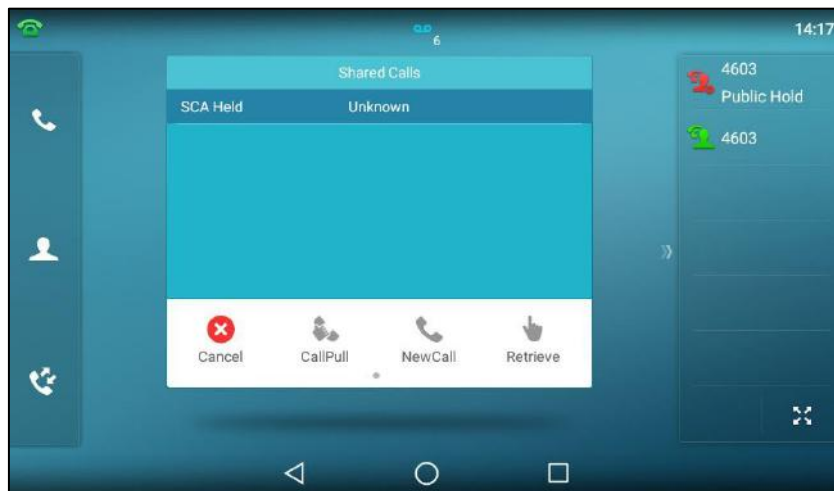



Tap the **Retrieve** soft key to retrieve the call.

The conversation is established between phone B and phone C, phone A disconnects the call. And the line key icon on phone A and phone B will become .

### To retrieve a call placed on private hold:

The private held call can be only retrieved by the hold party (party A).

Do the following:

1. Tap , press  or tap the **Resume** soft key on phone A.  
The conversation between phone A and phone C is retrieved.

## Barging In an Active Call



### To interrupt the active call on the shared line:

If phone A has only one active call, do the following:

1. Long tap the desired line key on phone B.

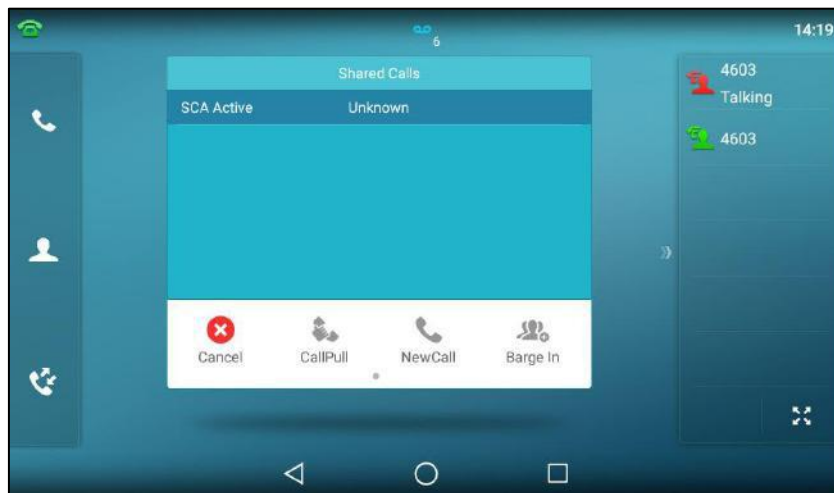
The **Cancel**, **CallPull**, **NewCall** and **Barge In** soft keys appear on the touch screen of phone B.



2. Tap the **Barge In** soft key to interrupt the active call of phone A.  
Party B will set up a conference call with the other parties in the active call.
3. Press , tap the **Hold** soft key or the **EndCall** soft key.
  - If any party in the conference call presses  or taps the **Hold** soft key, two-way voice can be heard between the remaining parties.
  - If party A or party B taps the **EndCall** soft key, the remaining parties are still connected. If the other party (not the shared line party) taps the **EndCall** soft key, the conference call is ended.

You can also tap the line key with the solid red icon indicator on phone B to set up a conference call with the other parties in the active call.

If phone A has more than one call, do the following:

1. Long tap the desired line key on phone B.

The list of calls appears on the touch screen of phone B.

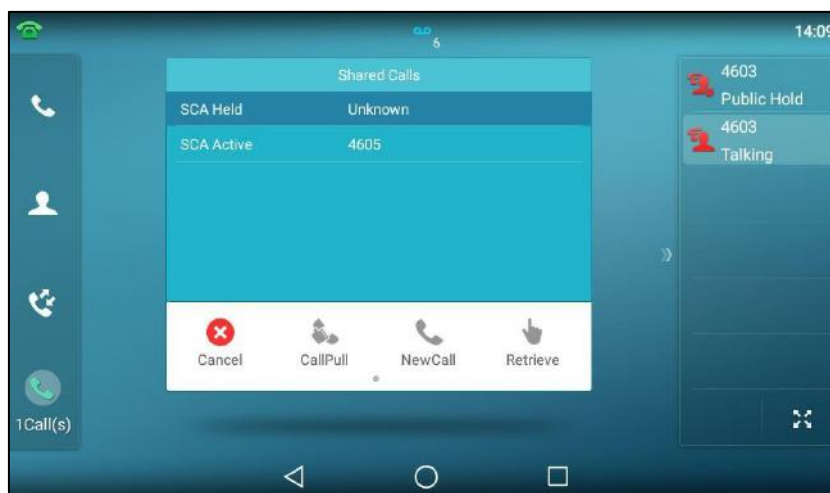

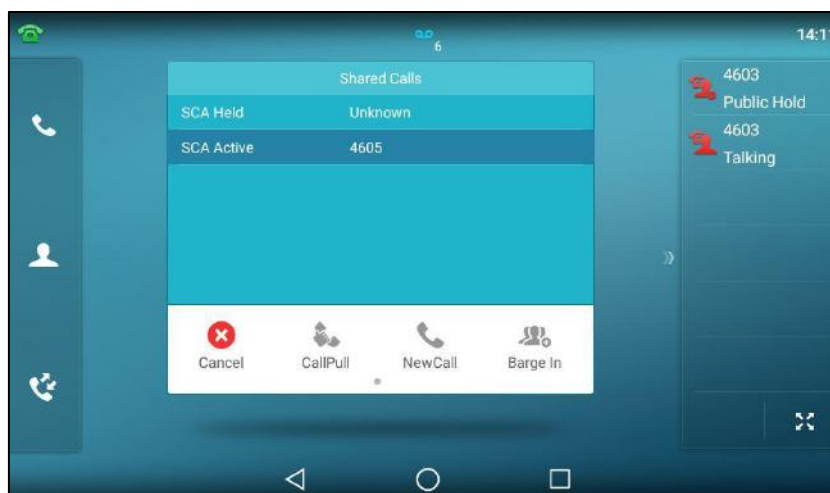

2. Tap the item to select the active call.

The **Cancel**, **CallPull**, **NewCall** and **Barge In** soft keys appear when the active call is highlighted.



3. Tap the **Barge In** soft key to interrupt the active call of phone A.

Party B may hear a warning tone and then set up a conference call with the other parties of the active call.

4. Press , tap the **Hold** soft key or the **EndCall** soft key.
  - If any party in the conference call presses , taps the **Hold** soft key, two-way voice can be heard between the remaining parties.
  - If party A or party B taps the **EndCall** soft key, the remaining parties are still connected. If the other party (not the shared line party) taps the **EndCall** soft key, the conference call is ended.

## Call Pull

Call pull feature allows users to retrieve an existing call from another shared phone that is in active or hold status. For example, when there is a call between phone A and phone C, you can use call pull feature on phone B to retrieve this call from phone A. Then the call is established between phone B and phone C.

### To retrieve a call from another shared phone:

If there is an active call between phone A and phone C, do the following:

1. Long tap the desired line key on phone B.

The **Cancel**, **CallPull**, **NewCall** and **Barge In** soft keys appear on the touch screen of phone B.

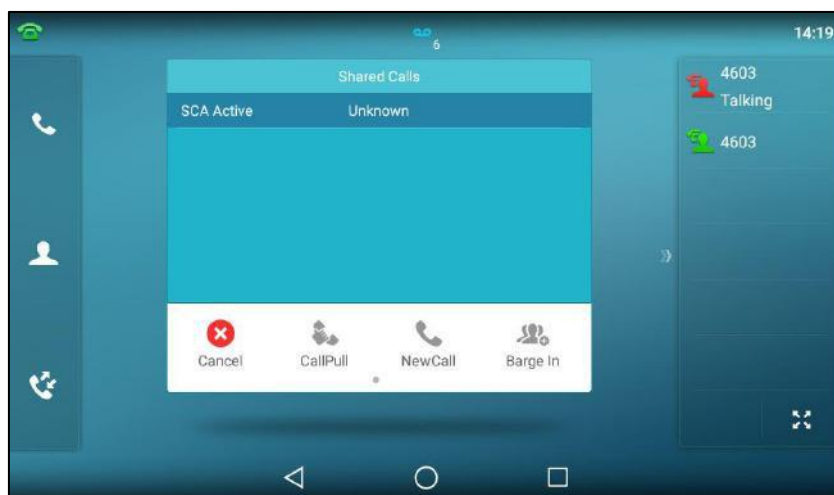

2. Tap the **CallPull** soft key.

The active call has been retrieved from the phone A successfully.

If there is a held call between phone A and phone C, do the following:

1. Long tap the desired line key on phone B.

The **Cancel**, **CallPull**, **NewCall** and **Retrieve** soft keys appear on the touch screen of phone B.

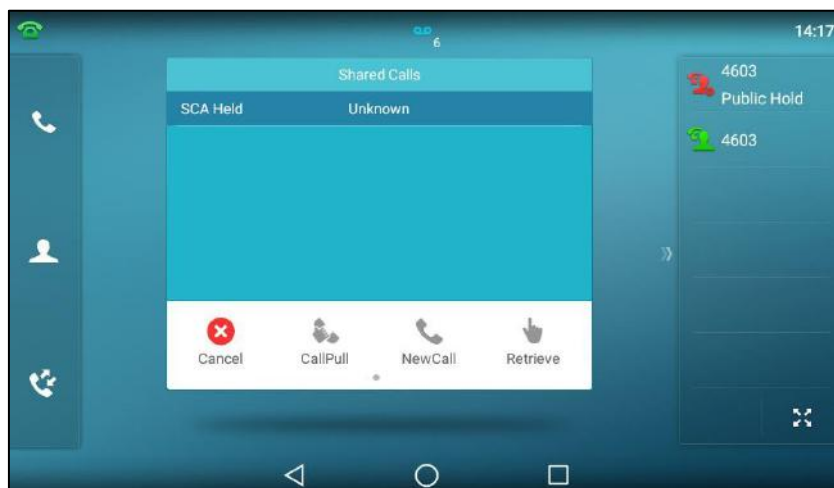

2. Tap the **CallPull** soft key.

The held call has been retrieved from the phone A successfully.

## Message

### Video/Voice Mail

You can leave video/voice mails for someone else using the SIP-T58V/A smart media phone. You can also access the video/voice mails that are stored in the voice mailbox. The usage of video mail is the same as that of voice mail, the following takes voice mail as an example.

**Note**

Video/voice mail is not available on all servers and differs from different servers. Contact your system administrator for more information.

When receiving a new voice mail, the phone will play a warning tone. The power indicator LED will slowly flash red, and the touch screen will prompt "n New Voice Mail(s)" ("n" indicates the number of unread voice mails, e.g., 176 New Voice Mail(s)) and display an icon .



If the voice mail pop-up message box disappears, it won't pop up again unless the user receives a new voice mail or the user re-registers the account that has unread voice mail(s).

**Note**

You can configure the phone not to display the pop-up prompt, contact your system administrator for more information.

The icon  on the status bar has a counter indicating the number of messages you haven't heard yet.



## Leaving Voice Mails

### To leave a voice mail:



You can leave a voice mail for someone else when he/she is busy or inconvenient to answer the call. Follow the voice prompt from the system server to leave a voice mail, and then hang up.

## Configuring the Voice Mail Access Codes

### To configure voice mail access codes via phone user interface:

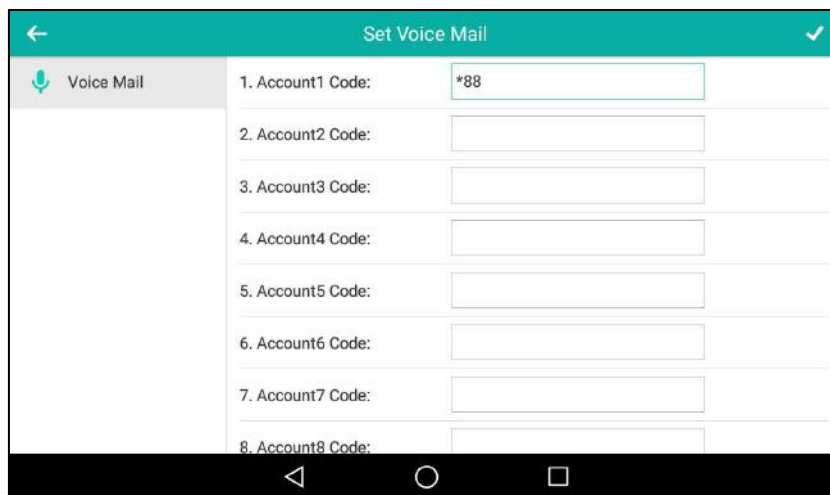
1. Swipe left or right to go to the second idle screen.
2. Tap  to launch **Message** application.
3. Tap **Set Voice Mail**.
4. Enter the voice mail access code (e.g., \*88) in the desired account field.



5. Tap  to accept the change or  to cancel.

### Note

Voice mail access codes must be predefined on the system server. Contact your system administrator for the more information.

## Listening to Voice Mails

### To listen to voice mails:

1. When the touch screen prompts that the phone receives a new voice mail, press  or tap **Connect** to dial out the voice mail access code.
2. Follow the voice prompt to listen to your voice mails.

### Note

Before listening to voice mails, ensure that the voice mail access code has been configured. For more information, refer to [Configuring the Voice Mail Access Codes](#) on page 377.

**To view the voice mail via phone user interface:**

1. Swipe left or right to go to the second idle screen.
2. Tap  to launch **Message** application.
3. Tap **View Voice Mail**.

The touch screen displays the amount of new and old voice mails.

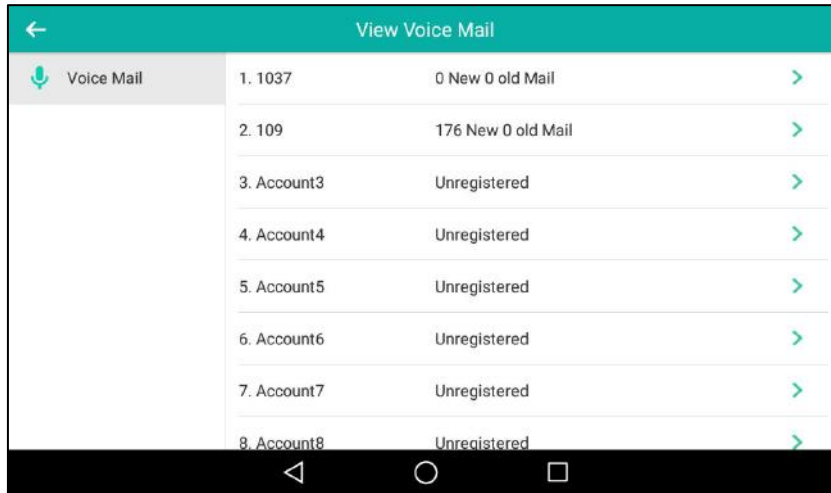

You can tap the account to listen to voice mails.

## Message Waiting Indicator (MWI)

The SIP-T58V/A smart media phone supports MWI when receiving a new voice mail. If someone leaves you a voice mail, you will receive a message waiting indicator. MWI will be indicated in three ways: a warning tone, an indicator message (including a voice mail icon) on the touch screen, and the power indicator LED slowly flashes red. This will be cleared when you retrieve all voice mails or delete them.

The MWI service is unsolicited for some servers, so the SIP-T58V/A smart media phone only handles the MWI messages sent from the server. But for other servers, the MWI service is solicited, so the SIP-T58V/A smart media phone must enable subscription for MWI.

**Note** MWI service is not available on all servers. Contact your system administrator for more information.

The MWI subscription parameters you need to know:

Options	Description
<b>Subscribe for MWI</b>	Enable or disable a subscription for MWI service.
<b>MWI Subscription Period</b>	Period of MWI subscription. The IP phone sends a refresh SUBSCRIBE request before initial subscription expires.
<b>Subscribe MWI To Voice</b>	Enable or disable a subscription to the voice mail number

Options	Description
<b>Mail</b>	for MWI service. To use this feature, you should also configure the voice mail number.

**Note**

The phone will send SUBSCRIBE messages for MWI service to the account or the voice number MWI service depending on the server. Contact your system administrator for more information.

**To configure subscribe for MWI via web user interface**

1. Click on **Account->Advanced**.
2. Select the desired account from the pull-down list of **Account**.
3. Select **Enabled** from the pull-down list of **Subscribe for MWI**.
4. Enter the period time in the **MWI Subscription Period(Seconds)** field.

The screenshot shows the Yealink T58 web interface. The 'Account' tab is active, and the 'Advanced' sub-tab is selected. The 'Account' dropdown is set to 'Account 2'. The 'Subscribe for MWI' dropdown is set to 'Enabled', and the 'MWI Subscription Period(Seconds)' text input field contains the value '3600'. A red rectangle highlights these two settings. On the right side, a 'NOTE' box states: 'Advanced The Advanced parameters for administrator. You can click here to get more guides.'

5. Click **Confirm** to accept the change.  
The IP phone will subscribe to the account number for MWI service by default.

**To enable subscribe MWI to voice mail via web user interface:**

1. Click on **Account->Advanced**.
2. Select the desired account from the pull-down list of **Account**.
3. Select **Enabled** from the pull-down list of **Subscribe for MWI**.
4. Select **Enabled** from the pull-down list of **Subscribe MWI To Voice Mail**.

- Enter the desired voice mail number in the **Voice Mail** field.

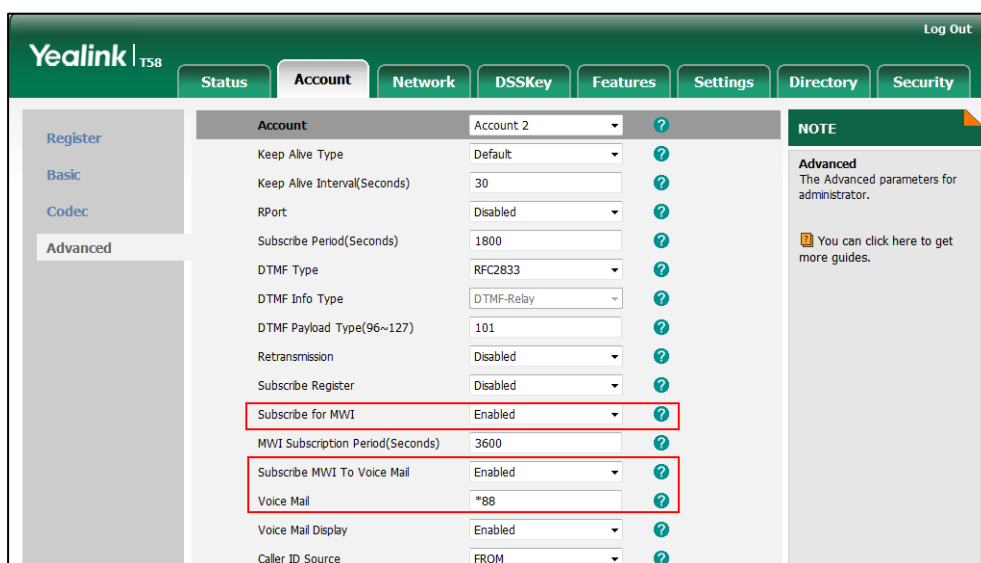

- Click **Confirm** to accept the change.

The IP phone will subscribe to the voice mail number for MWI service using Subscribe MWI To Voice Mail.

**Note**

MWI subscription is configurable via web user interface only.

## Appendix A - Time Zones

Time Zone	Time Zone Name
-11	Samoa
-10	United States-Hawaii-Aleutian, United States-Alaska-Aleutian
-9:30	French Polynesia
-9	United States-Alaska Time
-8	Canada(Vancouver,Whitehorse), Mexico(Tijuana,Mexicali), United States-Pacific Time
-7	Canada(Edmonton,Calgary), Mexico(Mazatlan,Chihuahua), United States-MST no DST, United States-Mountain Time
-6	Guatemala, El Salvador, Honduras, Nicaragua, Costa Rica, Belize, Canada-Manitoba(Winnipeg), Chile(Easter Islands), Mexico(Mexico City,Acapulco), United States-Central Time
-5	Peru, Bahamas(Nassau), Canada(Montreal,Ottawa,Quebec), Cuba(Havana), United States-Eastern Time,
-4:30	Venezuela(Caracas)
-4	Canada(Halifax,Saint John), Chile(Santiago), Paraguay(Asuncion), United Kingdom-Bermuda(Bermuda), United Kingdom(Falkland Islands), Trinidad&Tobago
-3:30	Canada-New Foundland(St.Johns)
-3	Argentina(Buenos Aires), Brazil(DST), Brazil(no DST), Denmark-Greenland(Nuuk)
-2:30	Newfoundland and Labrador
-2	Brazil(no DST)
-1	Portugal(Azores)
0	Denmark-Faroe Islands(Torshavn), GMT, Greenland, Ireland(Dublin), Morocco, Portugal(Lisboa,Porto,Funchal), Spain-Canary Islands(Las Palmas), United Kingdom(London)
+1	Albania(Tirane), Austria(Vienna), Belgium(Brussels), Caicos, Chad, Croatia(Zagreb), Czech Republic(Prague), Denmark(Kopenhagen), France(Paris), Germany(Berlin), Hungary(Budapest), Italy(Rome), Luxembourg(Luxembourg), Macedonia(Skopje), Namibia(Windhoek), Netherlands(Amsterdam), Spain(Madrid)
+2	Estonia(Tallinn), Finland(Helsinki), Gaza Strip(Gaza), Greece(Athens), Israel(Tel Aviv), Jordan(Amman), Latvia(Riga), Lebanon(Beirut), Moldova(Kishinev), Romania(Bucharest), Russia(Kaliningrad), Syria(Damascus), Turkey(Ankara), Ukraine(Kyiv, Odessa)
+3	East Africa Time, Iraq(Baghdad), Russia(Moscow)
+3:30	Iran(Teheran)
+4	Armenia(Yerevan), Azerbaijan(Baku), Georgia(Tbilisi), Kazakhstan(Aktau), Russia(Samara)
+4:30	Afghanistan(Kabul)
+5	Kazakhstan(Aqtobe), Kyrgyzstan(Bishkek), Pakistan(Islamabad), Russia(Chelyabinsk)
+5:30	India(Calcutta)
+5:45	Nepal(Katmandu)
+6	Kazakhstan(Astana, Almaty), Russia(Novosibirsk,Omsk)
+6:30	Myanmar(Naypyitaw)
+7	Russia(Krasnoyarsk), Thailand(Bangkok)
+8	Australia(Perth), China(Beijing), Russia(Irkutsk, Ulan-Ude), Singapore(Singapore)
+8:45	Eucla
+9	Japan(Tokyo), Korea(Seoul), Russia(Yakutsk,Chita)
+9:30	Australia(Adelaide), Australia(Darwin)
+10	Australia(Brisbane), Australia(Hobart),

<b>Time Zone</b>	<b>Time Zone Name</b>
	Australia(Sydney,Melbourne,Canberra), Russia(Vladivostok)
+10:30	Australia(Lord Howe Islands)
+11	New Caledonia(Noumea), Russia(Srednekolymsk Time)
+11:30	Norfolk Island
+12	New Zealand(Wellington,Auckland), Russia(Kamchatka Time)
+12:45	New Zealand(Chatham Islands)
+13	Tonga(Nukualofa)
+13:30	Chatham Islands
+14	Kiribati

# Index

## A

About This Guide [v](#)  
 Account Management [168](#)  
 Account Registration [168](#)  
 Activating/Deactivating the Bluetooth Mode [136](#)  
 Adding a Contact to the Blacklist [128](#)  
 Adding a Widget to the Idle Screen [181](#)  
 Adding Contacts [106](#)  
 Adding Groups [103](#)  
 Administrator Password [90](#)  
 Advanced Phone Features [327](#)  
 Alarm [252](#)  
 Anonymous Call [322](#)  
 Anonymous Call Rejection [323](#)  
 Answering Calls [267](#)  
 Answering When in Another Call [268](#)  
 Answering When Not in Another Call [267](#)  
 Area Code [175](#)  
 Appendix A - Time Zones [381](#)  
 APP Accounts [188](#)  
 Assigning Functionality to a Line Key [152](#)  
 Attended Transfer [307](#)  
 Audio Settings [94](#)  
 Audio-only/Video Call Selection [268](#)  
 Auto Answer [279](#)  
 Auto Redial [280](#)

## B

Backlight [82](#)  
 Barging In an Active Call [373](#)  
 Basic Network Settings [58](#)  
 Basic Phone Features [263](#)  
 Blacklist [120](#)  
 BLF List [333](#)  
 Blind Transfer [304](#)  
 Block Out [176](#)  
 Bluetooth-Enabled Mobile Phone [143](#)  
 Bluetooth Headset [136](#)  
 Browser [239](#)  
 Browsing a Web Page [239](#)  
 Busy Lamp Field (BLF) [327](#)

## C

Calculator [251](#)  
 Calendar [247](#)  
 Call and Conference Recording Using a Softkey [337](#)  
 Call Completion [282](#)  
 Call Forward [292](#)  
 Call Mute/Un-mute [284](#)  
 Call History Management [126](#)  
 Call Hold/Resume [286](#)  
 Call Park [314](#)

Call Pickup [314](#)  
 Call Recording [337](#)  
 Call Recording Using a Record Key [340](#)  
 Call Transfer [304](#)  
 Call Waiting [308](#)  
 Camera [228](#)  
 Camera Settings [230](#)  
 Changing Video Call Settings [272](#)  
 Changing the Video Layout during Calls [273](#)  
 Checking Events [249](#)  
 Clearing the Navigation History [246](#)  
 Clock [252](#)  
 Conference [309](#)  
 Configuration Screen Display [44](#)  
 Configuring an Access URL [121](#)  
 Configuring the BLF Feature on the Phone [327](#)  
 Configuring the Intercom Feature on the Phone [345](#)  
 Configuring SCA Feature on the IP Phone [361](#)  
 Connecting to the Wired Network [36](#)  
 Connecting to the Wireless Network [36](#)  
 Contact Management [102](#)  
 Control Center/Notification Center [41](#)  
 Copying Files [200](#)  
 Creating an Event [249](#)  
 Creating a Folder [185](#)  
 Customizing Your Phone [71](#)  
 Cutting Files (Moving Files) [202](#)

## D

Declaration of Conformity [ii](#)  
 Default Account [170](#)  
 Deleting a Line Key [155](#)  
 Deleting Contacts [111](#)  
 Deleting Emails [235](#)  
 Deleting Files [203](#)  
 Deleting Groups [105](#)  
 Deleting History Records [129](#)  
 Deleting Pictures/Videos [217](#)  
 Directed Call Pickup [319](#)  
 Disabling Wi-Fi Feature [68](#)  
 Dial-now [173](#)  
 Dial Plan [171](#)  
 Dialing Screen Display [45](#)  
 Disabling History Records [131](#)  
 Disconnecting the Bluetooth Device [140](#)  
 Disconnecting the Wireless Network Connection [67](#)  
 Do Not Disturb (DND) [287](#)  
 Documentations [27](#)  
 DSS Keys [151](#)  
 Dual Headset [135](#)  
 Dynamic Forwarding [303](#)

**E**

- Editing Contacts [110](#)
- Editing Device Information [140](#)
- Editing Groups [104](#)
- Editing Pictures [212](#)
- Email [232](#)
- Email Options [236](#)
- Email Widget [238](#)
- Emergency Number [177](#)
- Ending Calls [268](#)
- Entering Data and Editing Fields [50](#)
- Exchanging Places of Line Keys [153](#)

**F**

- Feature Status Icons [16](#)
- FileManager [195](#)

**G**

- Gallery [208](#)
- General Settings [71](#)
- Getting Started [29](#)
- Going to the Idle Screen during a Call [271](#)
- Group Call Pickup [321](#)

**H**

- Hardware Component Instructions [13](#)
- Headset Use [133](#)
- Headset Mode Activation/Deactivation [134](#)
- Headset Prior [134](#)
- Hotline [178](#)
- Hot Desking [343](#)

**I**

- Icon Instructions [16](#)
- Idle Screen [37](#)
- Importing/Exporting Contact lists [117](#)
- In This Guide [v](#)
- Incoming/Outgoing Call Lookup [122](#)
- Incoming Intercom Calls [346](#)
- Input Method [85](#)
- Intercom [345](#)

**K**

- Key as Send [90](#)
- Key Tone [99](#)

**L**

- Language [84](#)
- Leaving Voice Mails [377](#)
- LED Instructions [22](#)
- Line Key Icons [16](#)
- Line Key Features [158](#)
- Line Keys [151](#)
- Live Dialpad [177](#)
- Listening to Voice Mails [377](#)

- Local Conference [309](#)
- Local Directory [103](#)

**M**

- Making the Phone Discoverable [139](#)
- Managing Applications and Widgets [181](#)
- Managing Bookmarks [240](#)
- Managing Running Applications [188](#)
- Managing Recorded Audios [225](#)
- Manually Connect an Available Wireless Network [61](#)
- Message [376](#)
- Message Waiting Indicator (MWI) [378](#)
- Mobile Contacts [123](#)
- Modifying Browser Settings [247](#)
- Modifying the Calendar Settings [251](#)
- Moving an Application or Widget [184](#)
- Multicast Paging [349](#)
- Multiple Email Accounts [237](#)
- Multiple Line Keys per Account [171](#)
- Music on Hold [357](#)
- Mute a Call [284](#)

**N**

- Navigating Menus and Fields [41](#)
- Network Conference [312](#)
- Network Connection [36](#)
- Notification Sound [101](#)

**O**

- Other Icons [19](#)
- Outgoing Intercom Calls [345](#)
- Overview [13](#)
- Optional Accessories [31](#)

**P**

- Packaging Contents [29](#)
- Pairing and Connecting the Bluetooth Device [136](#)
- Performing Operations during a Call [270](#)
- Phone Initialization [36](#)
- Phone Installation [31](#)
- Phone Lock [91](#)
- Phone Status [55](#)
- Phone User Interface [23](#)
- Placing a Call from History Records [127](#)
- Placing Calls [264](#)
- Placing Calls to Contacts [115](#)
- Power Saving [79](#)
- Previewing the Near-Site Video [277](#)
- Programable Keys [165](#)
- Printing Pictures [215](#)

**R**

- Reading Emails [234](#)
- Recall [283](#)
- Recent Call In Dialing [277](#)



- Receiving Files via Bluetooth [149](#)
  - Receiving RTP Stream [354](#)
  - Recorder [223](#)
  - Recording Videos [229](#)
  - Recording Audios [224](#)
  - Redialing Numbers [277](#)
  - Registration [37](#)
  - Renaming the Paired Bluetooth Device [140](#)
  - Remote Phone Book [121](#)
  - Removing a Widget from the Idle Screen [185](#)
  - Replace Rule [172](#)
  - Resizing a Widget [183](#)
  - Returning to the Call Screen [272](#)
  - Ring Tones [97](#)
- S**
- Screen Saver [76](#)
  - Screenshot [335](#)
  - Search Source List in Dialing [131](#)
  - Semi-Attended Transfer [306](#)
  - Searching Files [199](#)
  - Searching for Contacts [116](#)
  - Sending Emails [232](#)
  - Sending Files via Bluetooth [149](#)
  - Sending Files via Email [239](#)
  - Sending Pictures [204](#)
  - Sending Pictures/Videos [219](#)
  - Sending RTP Stream [349](#)
  - Setting a Home Page [244](#)
  - Shared Call Appearance (SCA) [358](#)
  - Signing In Calendar [247](#)
  - Signing In Email [232](#)
  - Silent Mode [101](#)
  - Static Forwarding [293](#)
  - Stopping Transmitting Video during a Call [272](#)
  - Stopwatch [260](#)
  - System Applications [181](#)
  - System Customizations [133](#)
- T**
- Table of Contents [vii](#)
  - Taking Pictures [229](#)
  - Taking a Picture/Video [218](#)
  - The Home Screen [38](#)
  - The Second Idle Screen [39](#)
  - The Third Idle Screen [40](#)
  - Touch Sounds [100](#)
  - Time & Date [87](#)
  - Timer [259](#)
- U**
- Unpairing the Bluetooth Device [142](#)
  - Uploading Contact Photos [113](#)
  - Uploading the Custom Picture via Web User Interfaces [23](#)
  - Using BLF Feature on the Phone [331](#)
  - Using the Onscreen Keyboard [51](#)
  - Using the Phone Keypad and Onscreen Dial Pad [55](#)
  - Using the Touch Screen [37](#)
  - Using Intercom Feature on the Phone [348](#)
  - Using Multicast Paging [356](#)
  - Using SCA Feature on the IP Phone [368](#)
- V**
- Volume [94](#)
  - Viewing Detail Information of the Pictures/Videos [215](#)
  - Viewing Files [196](#)
  - Viewing History Records [126](#)
  - Viewing Pictures/Videos [209](#)
  - Viewing the Connected Wireless Network Information [67](#)
  - Video Call Screen Display [47](#)
  - Video Call Full-Screen Display (Both Far- and Near-Site Videos Exist) [49](#)
  - Video/Voice Mail [376](#)
- W**
- Warranty [ii](#)
  - Wallpaper [71](#)
  - Web User Interface [23](#)
  - Wi-Fi Protected Setup (WPS) [63](#)
  - Wireless Network Settings [60](#)