

iRobot[®]

Roomba[®]

Vacuum Cleaning Robot

Discovery/400 series Owner's Manual

www.irobot.com



Dear iRobot Roomba Owner,

Thank you for purchasing an iRobot Roomba vacuum cleaning robot. You've joined the millions of people who clean with robots - the smarter way to get it done.

Please take a few moments to read this manual and get acquainted with your Roomba, to get the best performance from your robot. If you have any questions, visit our website at www.irobot.com for more information.

Register your robot to instantly activate your warranty and enjoy these exclusive benefits:

- **Take advantage of iRobot's award-winning customer service**
Get support tailored to your specific robot, including answers to questions, maintenance tips, video demos, live chat and more.
- **Get product updates and other valuable information**
Be among the first to find out about new robots, exclusive discounts and special promotions.

When you register, you can also tell us about your experience with your Roomba; iRobot listens to our customers and makes enhancements to our robots based on your valued feedback. We'd love to hear from you!

Register your robot right now at www.irobot.com/register.

On behalf of the entire team, thank you for choosing iRobot; we appreciate your business, feedback and loyalty.

Here's to robots that make a difference!

Yours for less chores and more life,



Colin Angle
Chairman, CEO and Co-Founder
iRobot Corporation

P.S. Don't miss out on your exclusive benefits! Register your Roomba online right now at www.irobot.com/register.

Important Tips

For Best Performance

- Remove and clean Roomba's brushes after every use.
- Empty Roomba's bin and clean its filter after every use.
- Use a Virtual Wall® (optional accessory) to keep Roomba cleaning where you want it.
- Use your Roomba frequently.

Battery Life

To extend Roomba's battery life and keep Roomba cleaning at peak performance:

- Always keep Roomba plugged in when not in use.
- Recharge Roomba as soon as possible. Waiting several days to recharge Roomba can damage the battery.
- For storage off the charger, remove the battery from Roomba and store in a cool, dry place.
 - Blue or black batteries should be stored after Roomba has been used.
 - Yellow batteries should be stored after being fully charged.

 Roomba contains electronic parts. DO NOT submerge Roomba or spray it with water. Clean with a dry cloth only.

Table of Contents

iRobot Roomba Anatomy.....	5 - 10
Cleaning Pattern.....	11
Cleaning Modes.....	11
Cleaning System.....	12
Battery Storage and Charging	13 - 14
Virtual Wall (optional accessory for select models)...	15 - 16
Home Base (optional accessory for select models)	17
Remote Control (optional accessory for select models).....	18
Scheduler Remote Control (optional accessory for select models).....	19 - 23
Maintenance	24 - 25
Troubleshooting.....	26
Important Safety Instructions	27
iRobot Customer Care	28

iRobot Roomba Anatomy

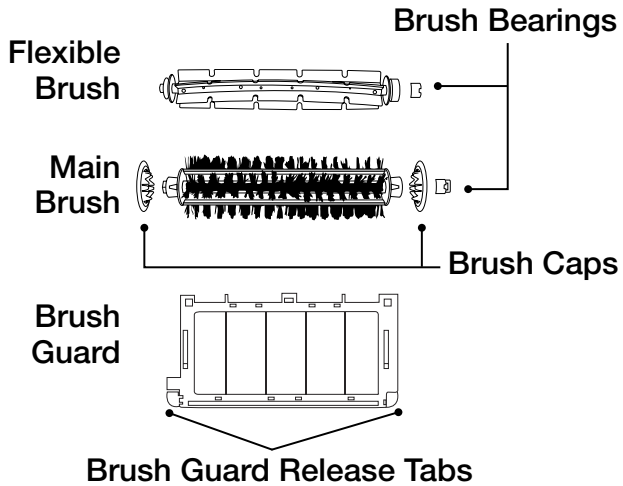
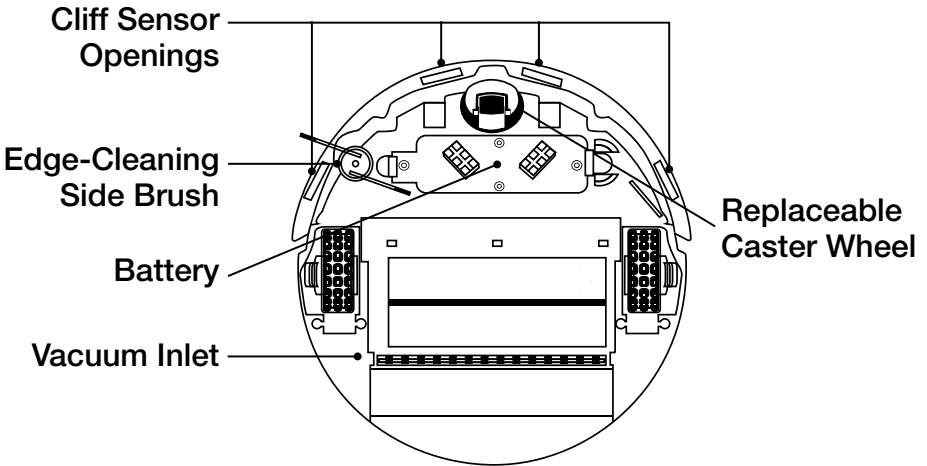

iRobot Roomba Anatomy

4000 Model Series

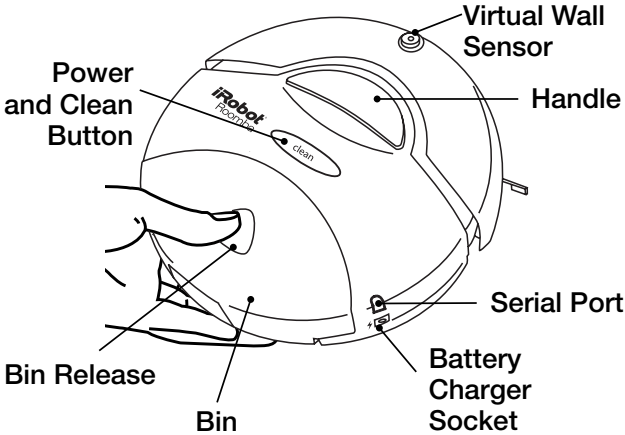

iRobot Roomba Anatomy

410 Model Series

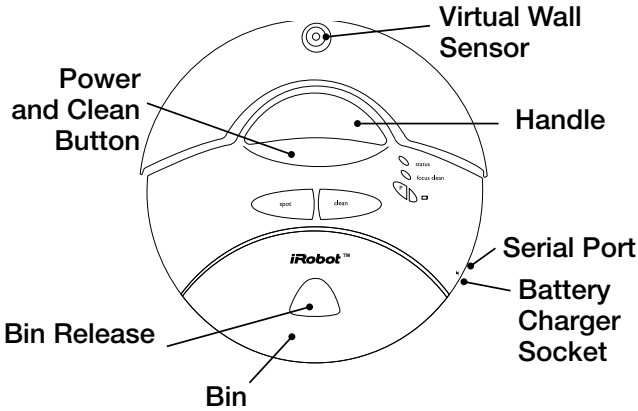

User Interface

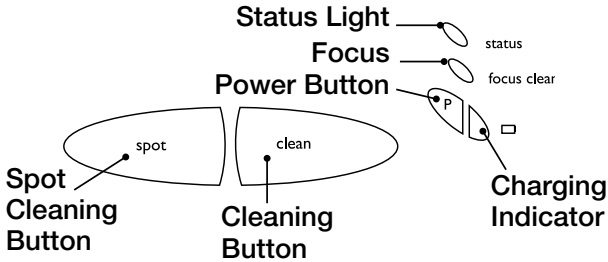

iRobot Roomba Anatomy

411-419 Model Series

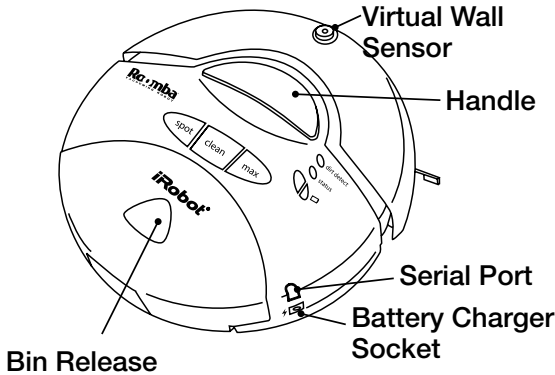

User Interface

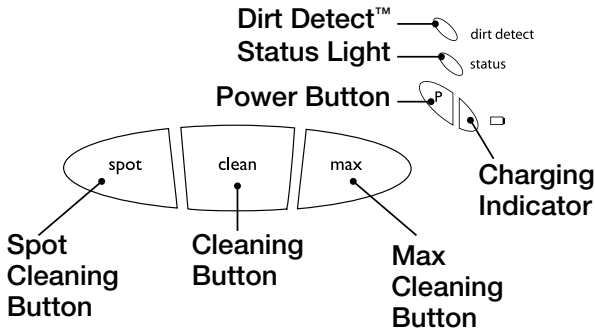

iRobot Roomba Anatomy

420- 434 Model Series

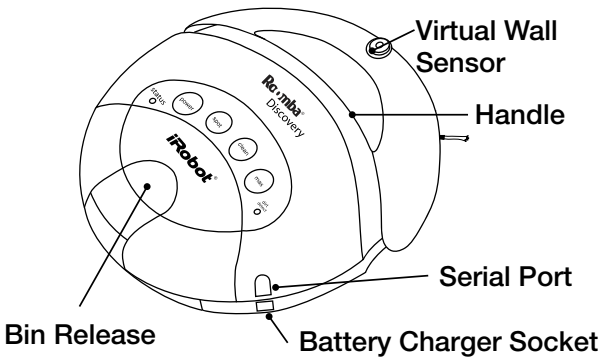

User Interface

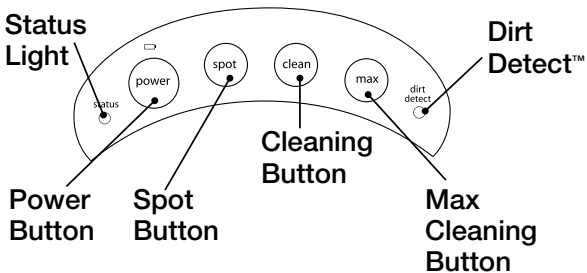

iRobot Roomba Anatomy

435- 440 Model Series

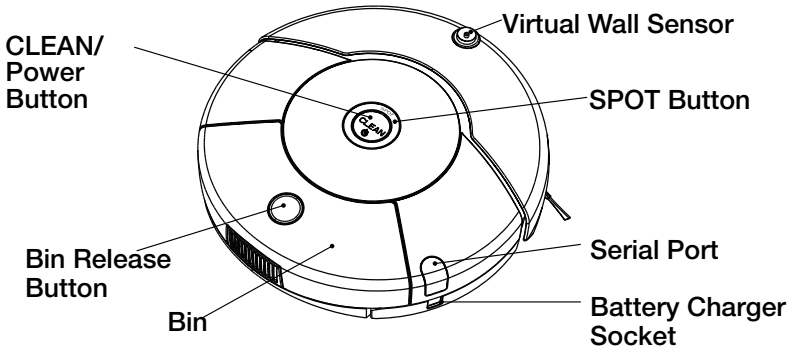

User Interface



Cleaning Pattern

Roomba is a robot that cleans floors differently than the way most people clean their floors. Roomba uses its robot intelligence to efficiently clean the whole floor, under and around furniture, and along walls.

Roomba calculates the optimal cleaning path as it cleans and determines when to use its various cleaning behaviors.

Spiraling: Roomba uses a spiral motion to clean a concentrated area.

Wall Following: Roomba uses this technique to clean the full perimeter of the room and navigate around furniture and obstacles.

Room Crossing: Roomba crisscrosses the room to ensure full cleaning coverage.

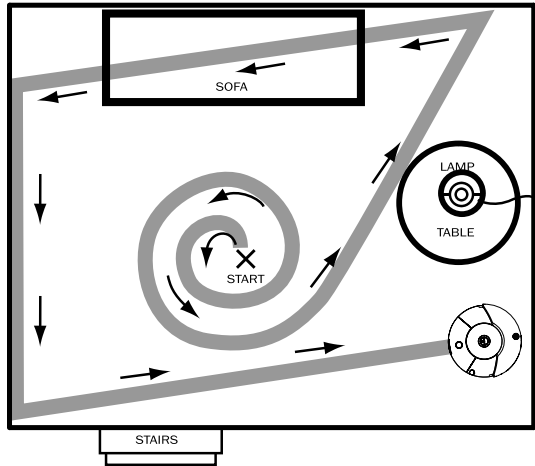

Cleaning Modes

Roomba will clean based on the cleaning mode you select. Roomba has two cleaning modes:

Clean Mode

Roomba automatically calculates the room size and adjusts its cleaning time appropriately.

Spot Mode

Roomba will spiral approximately three feet in diameter and then spiral back to where it started, intensely cleaning a localized area.

TIP: Roomba takes approximately 25 minutes to clean an average room and will pass over the same area of the floor multiple times to ensure total floor coverage.

TIP: For most efficient cleaning, clear your floor of clutter and use a Virtual Wall to confine Roomba to one room.

Cleaning System

Roomba features a patented three-stage cleaning system.

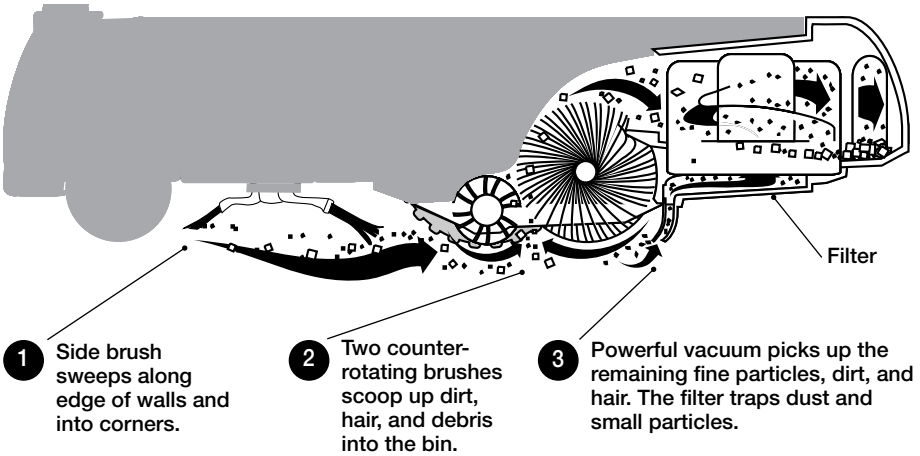

Floor Surfaces

Roomba works on wood, carpet, tile, vinyl, and linoleum, and adjusts automatically to different floor types.

Roomba automatically senses stairs and other cliffs. Roomba is not recommended for shag carpet or rugs with tassels.

Battery Storage and Charging

Roomba is powered by a rechargeable battery. Roomba's battery can last for hundreds of cleaning cycles if cared for properly.

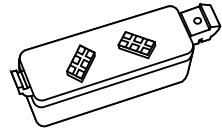

Battery Life

To extend the battery life, iRobot recommends always storing Roomba plugged in. For more details on how to maintain Roomba's battery life, visit www.irobot.com/support.

TIP: Recharge Roomba as soon as possible. Waiting several days to recharge Roomba can damage the battery.

TIP: For storage off the charger, remove the battery from Roomba and store in a cool, dry place.

Cleaning Time

You should fully charge Roomba's battery before each cleaning cycle. When fully charged, Roomba's battery will last for at least one full clean cycle.

16-Hour Refresh Charge

If Roomba has been left off the charger for an extended period, Roomba will initiate a special 16-hour charge cycle. This extensive charge refreshes Roomba's battery and extends the battery life. While charging, Roomba's "Clean" button will pulse quickly. Note: For best results, do not interrupt this Refresh Charge.

TIP: For best performance, charge Roomba's battery overnight before using Roomba for the first time.

Charging Roomba

Charge Roomba by plugging the charger directly into Roomba's battery charger socket.

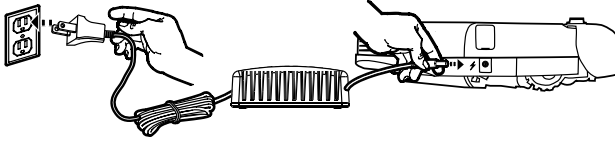

Or

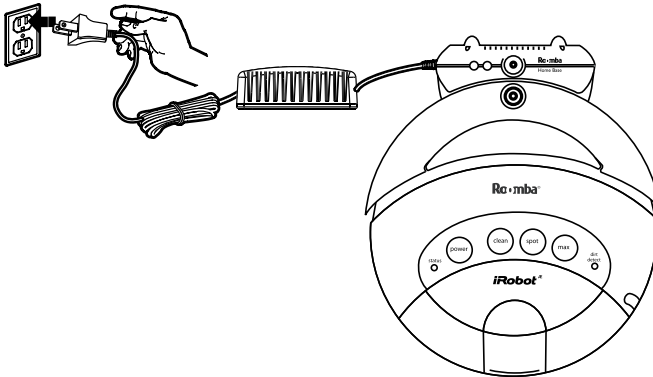

Charging Lights

Roomba uses the CLEAN button light to indicate that it is charging. Use the chart to determine that status of the battery.

CLEAN/Power Indicator Light	Battery Status
Solid red	Battery empty
Amber pulse	Charging
Solid green	Fully charged
Quick amber pulse	16-hour refresh charge

Virtual Wall®

(optional accessory for select models)

Virtual Walls create an invisible barrier that Roomba will not cross. This invisible barrier can be used to confine Roomba to a particular room or area, and prevent it from getting too close to electrical or computer cords, delicate objects on the floor, etc.

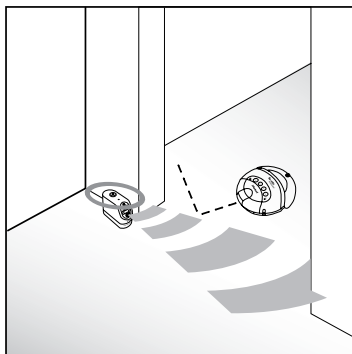

The Virtual Walls can be set to block an opening up to seven feet long. Note that the width of the Virtual Wall's beam also increases as its length increases, creating a cone-shaped area which Roomba cannot pass. The Virtual Wall also creates a halo of protection around itself, preventing Roomba from getting too close.

TIP: For best performance, place the Virtual Wall on the outside of the doorway you wish to block.

Slim Virtual Wall (models 400-420)

The Virtual Wall requires 2 "D" batteries and automatically shuts off after 135 minutes. If the power light blinks green, the batteries will soon need replacement. Use the slider bar to adjust the length of the barrier. A higher range will drain the battery faster.

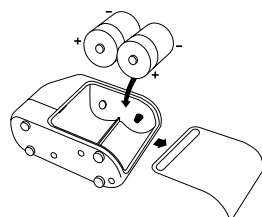
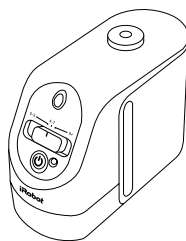

TIP: Point the iRobot logo towards the opening you would like to block.

TIP: Scheduling Virtual Walls (when programmed) will turn on a few minutes before Roomba.

Virtual Wall®

(continued)

Compact Manual Virtual Wall

(models 430 and up)

A Manual Virtual Wall must be turned on by hand at the beginning of the cleaning cycle to activate the barrier. A Manual Virtual Wall and its power light will shut off after 135 minutes. When battery levels are low, the Virtual Wall power light will blink slowly to indicate that it needs new batteries.



TIP: Point the arrows on top of the Virtual Wall towards the opening you would like to block.

Compact Auto Virtual Wall

(models 430 and up)

When an Auto Virtual Wall is set to “Auto” mode, the power light blinks repeatedly to indicate it is on. When battery levels are low, the Virtual Wall blinks repeatedly twice to indicate that it needs new batteries. To save battery power, switch the Auto Virtual Wall to “Off.” When in “Auto” mode, the batteries should last approximately six months.



TIP: Point the arrows on top of the Virtual Wall towards the opening you would like to block.

Compact Virtual Wall Battery Installation

To open the battery compartment, simply apply pressure on both iRobot logos located on either side of the Virtual Wall and pull the bottom out, separating the pieces.

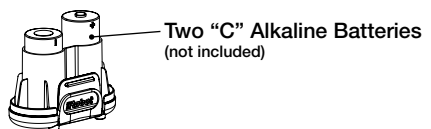
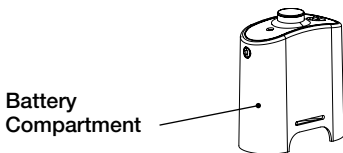

Home Base®

(select models)

Roomba returns to the Home Base at the end of a cleaning cycle or when its battery is running low. Roomba needs to find the infrared signal of the Home Base in order to return.

Always keep the Home Base plugged in. When Roomba is on the Home Base, the lights on the Home Base will be solid to indicate Roomba is connected to the Home Base.

Home Base Location

You should position the Home Base on a hard level surface and in an area where Roomba has a clear path to return to the dock at the end of a cleaning cycle. If Roomba is unable to dock on its first attempt, it will try again until it successfully docks.

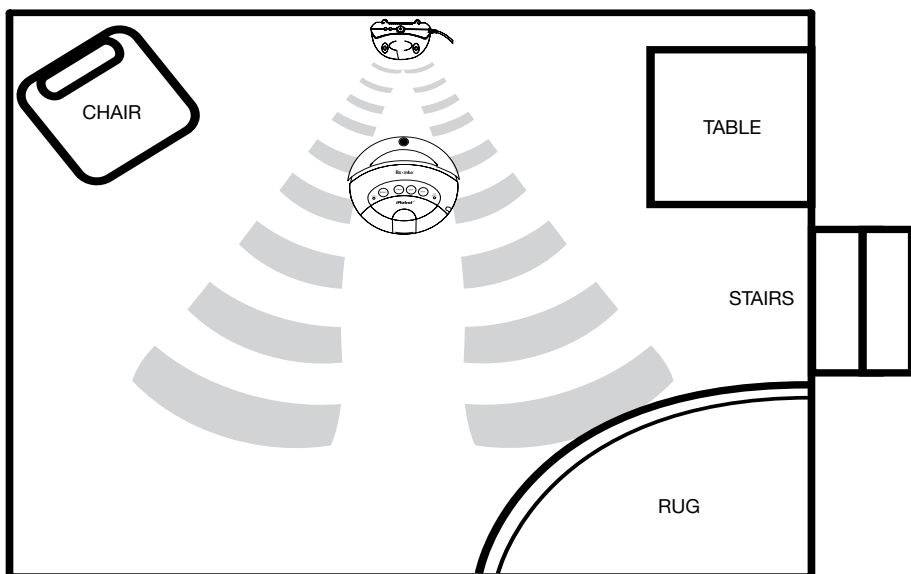

⚠ The Roomba Remote, Virtual Wall and Home Base operate using an invisible infrared beam. If they are all used in the same area, Roomba may see multiple infrared signals and will not operate. The Remote **WILL NOT** dock if you have a Virtual Wall near the Home Base. Fluorescent lights can also impact Virtual Wall and Home base performance.

Remote Control

(optional accessory for select models)

The Remote Control lets you conveniently control Roomba's functions. You can use it to turn Roomba on and off, and steer it around your room without bending down. It also gives you remote access to commands.

Original Remote Control

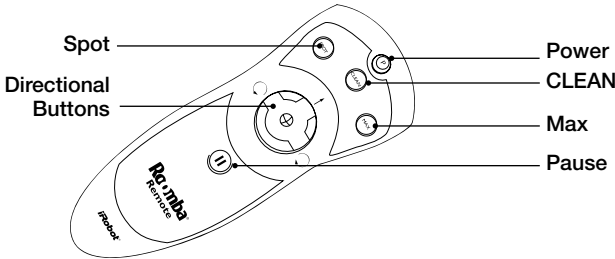

SPOT	Roomba focuses on intensely cleaning a local area.
CLEAN	Roomba calculates the room size and adjusts its cleaning time appropriately.
MAX	Roomba runs until battery is depleted.
PAUSE	Pause Roomba in the middle of a cleaning cycle. Press pause again to continue.

Remote Control

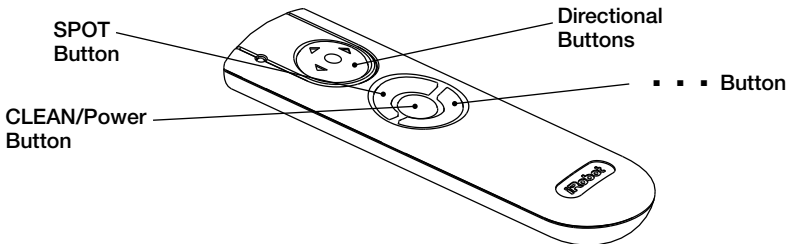

SPOT	Roomba focuses on intensely cleaning a local area.	
CLEAN	Roomba calculates the room size and adjusts its cleaning time appropriately.	
...	Models 435 - 499	Roomba enters Spot mode.

Scheduler Remote Control

(optional accessory for select models)

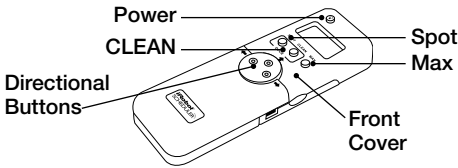

Scheduling
Virtual
Wall



The Scheduler Remote Control is included with the Roomba Scheduler. Other Roomba models are compatible with the iRobot Scheduler Remote Control Upgrade.

Use the Scheduler Remote Control to program your cleaning times. Then send your schedule to Roomba and the scheduling Virtual Walls. Install the batteries and set the time before using for the first time.

Setting the Time

- 1 Open the Scheduler Remote Control's front cover. The display will turn red and read "SET TIME."



- 2 Press New/Save and Delete simultaneously. The display will change to read "SUN 12:00."

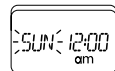

- 3 Press + to change the day.

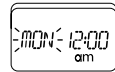

- 4 Press → to navigate to the hour on the display.

- 5 Press + to change the hour. To select AM or PM, simply scroll past 12:00.

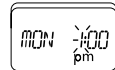

- 6 Press → to navigate to the minute on the display.

- 7 Press + to change the minute. Hold + to scroll quickly.

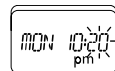

- 8 Press New/Save to save. After the time has been set, it will flash three times to indicate the time has been saved. Close the Scheduler Remote's cover to verify that the correct time has been set.



Setting Schedules

To schedule iRobot Roomba to clean:

- 1 Open the Scheduler Remote Control's front cover to enter Scheduler mode.

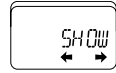

- 2 Press New/Save to begin setting a schedule.

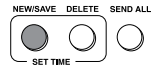

- 3 Press + to select the day of the week.



- 4 Press ➡ to navigate to the hour field.

- 5 Press + to schedule the hour. To select AM or PM, simply scroll past 12:00.



- 6 Press ➡ to navigate to the minute field.

- 7 Press + to schedule the minute.



- 8 Press ➡ to navigate to the Once/Weekly field.

- 9 Press + to choose Once or Weekly. Choose Weekly if you want Roomba to clean on the same day and time every week.



- 10 Press New/Save once to save the schedule. The LCD will flash three times to indicate that the schedule has been set.



⚠ Don't forget to send the schedule to both Roomba and the scheduling Virtual Walls.

Sending Schedules

After setting a cleaning time, you need to send the schedule to Roomba and the scheduling Virtual Walls.

To send a schedule to your Roomba:

1 Power on Roomba with the Power button.

2 Open the Scheduler Remote Control's front cover, point the remote at Roomba and press Send All. The display will flash to indicate the remote is sending the schedule. Roomba will play a song to indicate the schedule is received and the Status light will begin blinking.

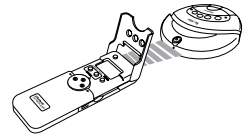

3 Make sure Roomba is on the Home Base or in the center of the area you want to clean. Roomba will clean at the time you have scheduled.

Roomba's Status light will blink amber to indicate that Roomba is scheduled to clean.

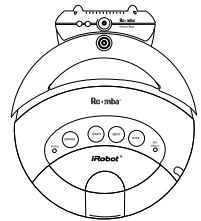

⚠ To accept a schedule, Roomba must either be at least 8 feet from the Home Base or charging on the Home Base and Roomba's power must be on. iRobot Scheduler, Virtual Walls and Home Base all operate using invisible infrared beams. If used in the same area, Roomba may see multiple infrared signals and not respond to commands. Make sure all Virtual Walls are turned off when using Scheduler.

Sending Schedules

To send a schedule to the scheduling Virtual Walls:

- 1 Press and hold the power button on each scheduling Virtual Wall until the Scheduled light turns on.

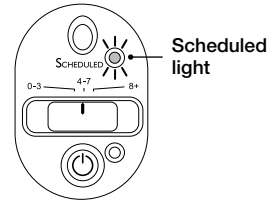

- 2 Point the Scheduler remote at each scheduling Virtual Wall and press Send All to send the schedule. The display will flash, indicating that the remote is sending the schedule to the Virtual Wall.

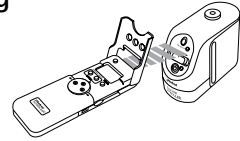

- 3 The Virtual Wall's Scheduled light will blink to confirm that it is scheduled to automatically turn on at the time you programmed.
-

TIP: You can clear the schedule from the scheduling Virtual Wall and Roomba by removing their batteries, or by deleting all cleaning times from the remote and re-sending the cleared schedule to the scheduling Virtual Walls.

Changing Schedules

- 1 Open the Scheduler Remote's cover. The display should read "SHOW ◀ ▶." If it reads "Set Time", see p. 15.

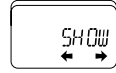

- 2 Scroll through the programmed schedules using ◀ or ▶ until you find the schedule you want to change.



- 3 Press New/Save when the remote displays the schedule you wish to change.

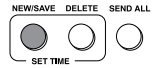

- 4 Scroll to the field you wish to change using the ◀ and ▶ buttons and use the + to change the time, day, or frequency.

- 5 Press New/Save to save the new time.



- 6 Send the updated schedule to Roomba and the scheduling Virtual Walls.

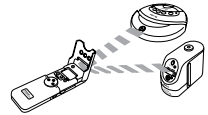

Deleting Schedules

- 1 Open the Scheduler Remote's cover. The display should read "SHOW ◀ ▶." If it reads "Set Time", see p. 15.

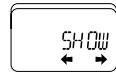

- 2 Scroll through the schedules using ◀ or ▶ until the schedule you wish to delete is displayed.

- 3 Press Delete to clear the schedule.



- 4 Send the deleted schedule to Roomba and the scheduling Virtual Walls. See pp. 17 – 18 for details.

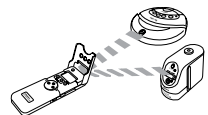

TIP: You can clear the schedule from the scheduling Virtual Walls and from Roomba by removing and replacing the batteries.

Maintenance

To keep Roomba running at peak performance, it is recommended that you perform the following maintenance regularly:

1 Remove and empty Roomba's bin

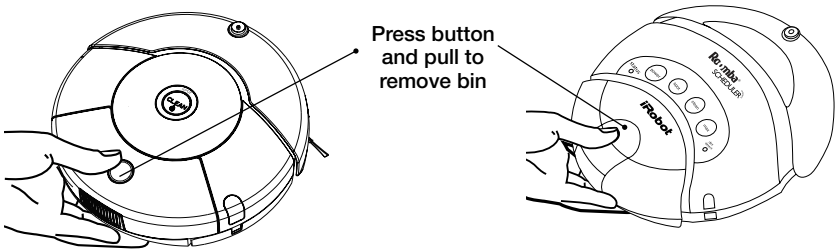

2 Clean Roomba's filter compartment

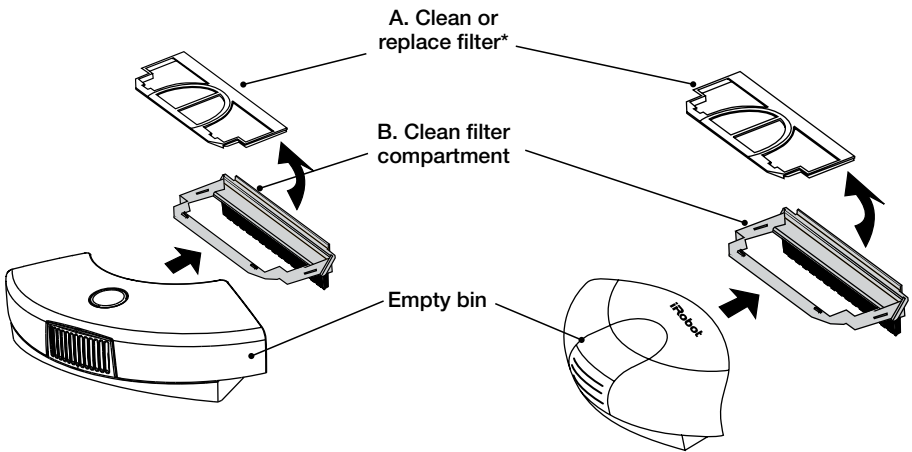

**Replace filter every 2 months*

TIP: Bin emptying and brush cleaning should be done after every cleaning cycle. Also be sure to regularly check the front caster wheel for hair build up.

TIP: If you notice Roomba picking up less debris from your floor, empty the bin and clean the brushes.

3 Clean Roomba's brushes

A. Remove brush guard by lifting both yellow tabs.

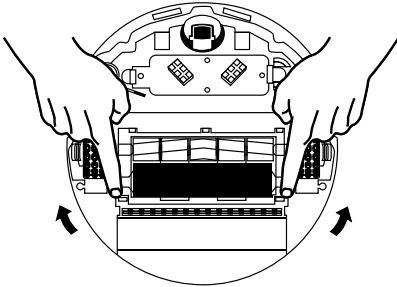

B. Remove and clean Roomba's brushes.

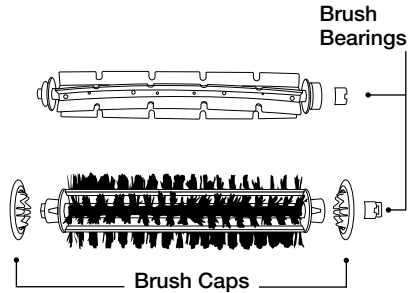

TIP: When replacing brush caps, make sure the alignment feature is properly rotated so it snaps into place.

C. Remove and clean hair and dirt from Roomba's yellow brush bearings.

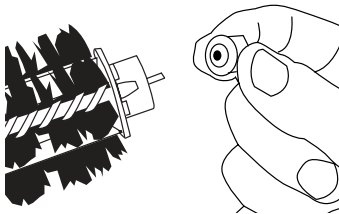

D. Remove and clean Roomba's brush caps.

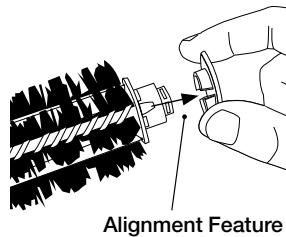

E. Use the included cleaning tool to easily remove hair from Roomba's brushes.

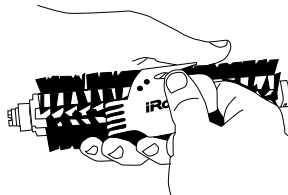

Visit www.irobot.com/support for information on keeping Roomba running at peak performance.

⚠ Excessive build up of hair in Roomba's brushes and bearings can permanently damage Roomba. Inspect brush bearings regularly.

⚠ Do not attempt to run Roomba without the bearings. If you misplace Roomba's brush bearings, contact iRobot Customer Care for replacement bearings.

Troubleshooting

Roomba will tell you when something is wrong with a two-tone “uh-oh” sound followed by beeping. Refer to the chart below to resolve Roomba’s problem. If the problem is not resolved, visit www.irobot.com/support.

Number of beeps after “uh-oh”	Likely cause	What to do
No beeps	A wheel is stuck or is not touching the ground	Pick up Roomba, place it down securely on the floor and touch the clean button to restart the cycle.
1	The main brushes cannot turn	Turn over Roomba and remove the brush guard by pushing the two yellow tabs. Remove the brushes, clear any obstructions, and replace them again.
2	The side brush cannot turn	Turn over Roomba. Look to see if something is wrapped around the side brush. Remove the side brush with a screw driver and check for string or hair that may be wrapped around it.
3	The vacuum cannot run	Remove and empty Roomba’s bin.
4	A wheel cannot run	Your Roomba may be stuck or something may be wrapped around a wheel. Look for something wrapped around the wheels. Push them in and out and make sure they turn easily.
5	The cliff sensors have failed or are blocked	Turn over Roomba and clear any debris that might be caught underneath the front bumper in the cliff sensors. You can also use compressed air to clean them out.
6	Wheel obstruction or robot attempting to drive over an obstacle	Turn over Roomba and remove any obstructions that prevent the wheels from seating all the way up into Roomba’s body. Also, remove any obstacles that Roomba could drive over.
9	Sensor error	Please contact iRobot Customer Support.
10	Roomba is stuck	Pick up Roomba and start it again somewhere else. Use a virtual wall or other barrier to keep Roomba away from the place it got stuck.

Miscellaneous Troubleshooting

Problem	Likely cause	What to do
Roomba’s CLEAN/ Power light will not illuminate	Battery not seated correctly	Remove Roomba’s battery by pushing the side clips and re-insert the battery making sure you hear an audible click.
Roomba is not picking up debris	Bin is full	Empty the bin and clean Roomba’s brushes.
Roomba does not charge	Charger is not plugged in	Ensure that the charger is correctly connected to the wall and to Roomba. Roomba’s charger will illuminate a solid green light when plugged into a power source.
Roomba backs up frequently and behaves erratically	Dirty cliff sensors	Use compressed air to clean out Roomba’s cliff sensors.

Important Safety Instructions

⚠ CAUTION: DO NOT EXPOSE THE ELECTRONICS OF ROOMBA, ITS BATTERY, OR THE CHARGER. THERE ARE NO USER-SERVICEABLE PARTS INSIDE. REFER SERVICING TO QUALIFIED SERVICE PERSONNEL. CHARGE USING STANDARD U.S. (120V AC) OUTLET ONLY.

Always exercise caution when operating your Roomba. To reduce the risk of injury or damage, keep these safety precautions in mind when setting up, using and maintaining Roomba:

GENERAL SAFETY INSTRUCTIONS

- Read all safety and operating instructions before operating Roomba.
- Retain the safety and operating instructions for future reference.
- Heed all warnings on Roomba, battery, charger and in owner's manual.
- Follow all operating and use instructions.
- Refer all non-routine servicing to iRobot.

ROOMBA USE RESTRICTIONS

- Roomba is for indoor use only.
- Roomba is not a toy. Do not sit or stand on this device. Small children and pets should be supervised when Roomba is cleaning.
- Clean with a dry cloth only. Do not pour or spray water onto Roomba.
- Do not use this device to pick up anything that is burning or smoking.
- Do not use this device to pick up spills of bleach, paint, or other chemicals, or anything wet.
- Before using this device, pick up objects like clothing, loose papers, pull cords for blinds or curtains, power cords, and any fragile objects. If the device passes over a power cord and drags it, there is a chance an object could tumble off a table or shelf.
- If the room to be cleaned contains a balcony, a physical barrier should be used to prevent access to the balcony and ensure safe operation.
- Always remove the battery before long-term storage or transportation.
- Roomba 400 Series is not recommended for shag, high pile carpet or tassels.
- This appliance is not intended for use by persons (including children) with reduced physical, sensory or mental capabilities, or lack of experience and knowledge, unless they have been given supervision or instruction concerning use of the appliance by a person responsible for their safety.
- Children should be supervised to ensure they do not play with the appliance.

ROOMBA BATTERY AND CHARGING

- Charge using a standard U.S. (120V AC) outlet only. Product may not be used with any type of power converter. Use of other power converters will immediately void the warranty.
- Use only the charger supplied by the manufacturer to charge this device.
- Do not use a charger with a damaged cord or plug.
- Charge indoors only.
- Roomba's power supply may be protected with a surge protector in the event of severe electrical storms.
- Never handle chargers with wet hands.
- Always disconnect Roomba from the charger before cleaning.

iRobot Customer Care

If you have questions or comments about Roomba, please contact iRobot before contacting a retailer.

Please visit our web site at www.irobot.com for support tips, frequently asked questions, or information about accessories and other iRobot products. We would like to hear from you.

Should you still need assistance:

- Visit the iRobot support web site at www.irobot.com/support
- Call our customer care representatives at **877.855.8593**

iRobot Customer Care Hours:

- Monday – Friday 9AM – 7PM Eastern Time
- Saturday 9AM – 6PM Eastern Time

iRobot Customer Care International

To contact an international partner near you for sales and technical support, visit www.irobot.com/international.

Get iRobot accessories at store.irobot.com

International customers visit www.irobot.com/international



© 2010 iRobot Corporation, 8 Crosby Drive, Bedford, MA 01730. All rights reserved.
iRobot, Roomba, Virtual Wall and Home Base are registered trademarks of iRobot Corporation. [00179.0210]

U.S. Pat. Nos. 6,594,844 | 6,690,134 | 6,809,490 | 6,883,201 | 6,956,348 | 7,155,308 | 7,173,391 |
7,196,487 | 7,288,912 | 7,332,890 | 7,388,343 | 7,389,156 | 7,429,843 | 7,430,455 | 7,441,298 | 7,448,113.
Additional Patents Pending.